

PUBLICATION NUMBER TH 6284
ISSUE: 4.10.91

1991 AND 1992

NANOSECOND UNIVERSAL COUNTERS

RACAL INSTRUMENTS LTD.

RACAL INSTRUMENTS LTD.

480 Bath Road, Slough, Berkshire SL1 6BE, England.
Telephone: (01628) 604455. Fax: (01628) 662017

RACAL INSTRUMENTS INC.

4 Goodyear Street, P.O. Box C-19541, Irvine, CA 92713, USA.
Telephone: (714) 859-8999. Fax: (714) 859 2505

RACAL SYSTEMS ELECTRONIQUE S.A.

18 Avenue Dutarte, 78150 Le Chesnay, France.
Telephone: (1) 39 55 88 88. Fax: (1) 39 55 67 35

RACAL SYSTEMS ELETTRONICA srl

Strada 2, Palazzo C4
20090 Milanofiori Assago Milan, Italy.
Telephone: (02) 5750. 1796 (aut.res.). Fax: (02) 5750.1828

RACAL ELECTRONIK SYSTEM GmbH

Frankenforster Strasse 21, 51427 Bergisch Gladbach 1, Germany.
Telephone: 02204 9222-0. Fax: 02204 21491

RACAL

PUBLICATION DATE: MARCH 1985

Copyright © 1985 by Racal-Dana Instruments Ltd. Printed in England. All rights reserved.
This book or parts thereof may not be reproduced in any form without written permission of the publishers.



CE CONFORMITY:

EC Directives 73/23/EEC, 89/336/EEC, 92/31/EEC and 93/68/EEC

Units that carry the CE mark are designed to conform to standards, IEC 348, EN 50081-1, EN 50082-1, when used in accordance with these instructions.

SAFETY

Always operate the product in accordance with the instructions in this manual.

EMC

To ensure that EMC integrity is retained always follow good EMC practice. In particular:

- (1) Use good quality coaxial connections for signal input and output leads
- (2) Use good quality screened data or control cables and connectors.
- (3) Ensure that cable screens are properly terminated within the connectors. Do not use cables if the terminations are loose or frayed.
- (4) Ensure that the screening is continuous through to the chassis of the equipment.
- (5) Ensure that any associated equipment is CE marked or is of good EMC design and performance.

(1990, 1991, 1991M, 1992, 1998, 1998M, 1999)

RACAL Instruments Ltd.

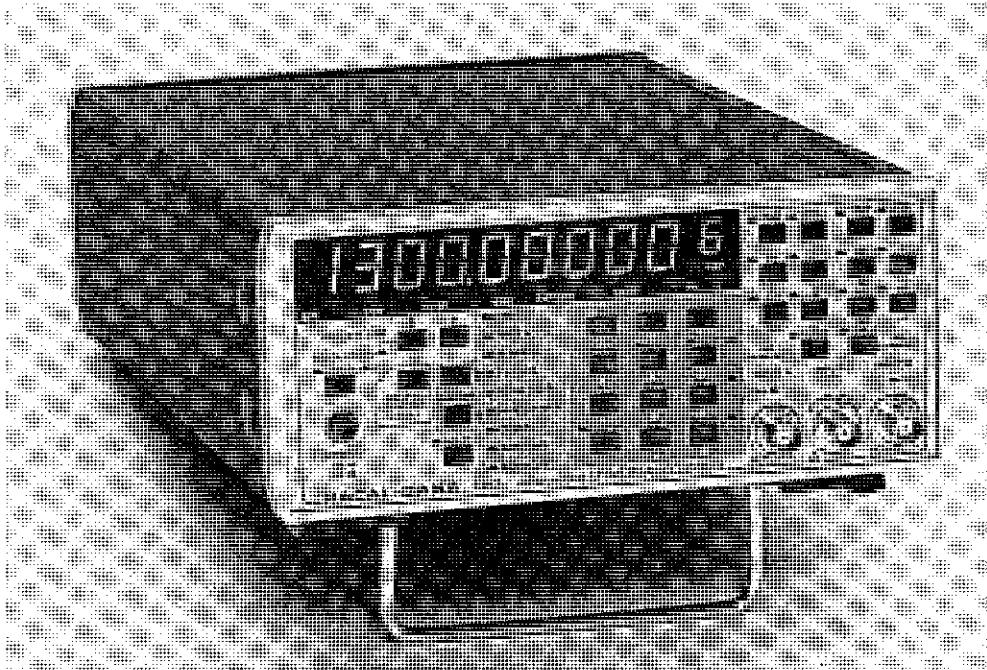

Universal Counter 1992

TABLE OF CONTENTS

Paragraph	Title	Page
SECTION 1	TECHNICAL SPECIFICATION	1-1
SECTION 2	GENERAL DESCRIPTION	2-1
1	Introduction	2-1
2	Measurement Functions	2-1
2	Frequency A Function	2-1
3	Frequency C Function	2-1
4	Period A Function	2-1
5	Time Interval Function	2-1
7	Total A Function	2-2
9	Phase A rel B Function	2-2
10	Ratio A/B Function	2-2
11	Ratio C/B Function	2-2
12	Check Function	2-2
13	Signal Input Channels	2-2
16	Low-Pass Filter	2-3
17	Math Function	2-3
18	Special Functions	2-4
19	Error Indication	2-4
20	External Arming	2-4
21	Display Format	2-4
22	Hold Feature	2-4
23	Resolution and Gate Time	2-5
24	External Frequency Standard Input	2-5
25	Standby Mode	2-5
26	Initialization	2-5
27	Options Available	2-6
27	Frequency Standards (04X Options)	2-6
28	Reference Frequency Multiplier (Option 10)	2-6
29	GPIB Interface (Option 55)	2-6
30	Battery Pack (Option 07)	2-6
34	Rack Mounting Kits	2-7
SECTION 3	PREPARATION FOR USE	3-1
1	Unpacking	3-1
3	Power Supply	3-1
3	AC Line Voltage Setting	3-1
5	Line Fuse	3-2
6	Power Cord	3-2
9	Functional Check	3-2
13	Frequency Standard	3-4
15	External Arming	3-4
16	Trigger Level Output	3-4
17	Preparation For Use With the GPIB	3-4
17	Introduction	3-4
18	Connection to the GPIB	3-4
19	Address Setting and Display	3-5

TABLE OF CONTENTS (Continued)

21	GPIB Check	3-7
24	Remote and Local Message Check	3-7
28	Local Lockout and Clear Lockout Check	3-8
31	Data Output Check	3-9
32	SRQ and Status Byte Check	3-9
34	Device Clear and Selected Device Clear Check	3-10
36	IFC Check	3-11
37	TALK ONLY Selector Check	3-11
38	Option Fitting Instructions	3-11
38	Single-Instrument Fixed Rack Mounting Kit 11-1648	3-11
40	Double-Instrument Fixed Rack Mounting Kit 11-1649	3-12
43	PCB-Mounted Frequency Standard 11-1713	3-13
46	Ovened Frequency Standards 11-1710 and 11-1711	3-14
49	Reference Frequency Multiplier Option 11-1645	3-15
51	GPIB Option 11-1626	3-15
53	Battery Pack Option 11-1625	3-16

SECTION 4

	OPERATING INSTRUCTIONS	4-1
1	Introduction	4-1
2	Description of Controls, Indicators and Connectors	4-1
2	Front Panel Items	4-1
3	Rear Panel Items	4-7
4	Frequency Measurement	4-10
5	Period Measurement	4-11
6	Time Interval Measurement	4-12
7	Totalize Measurement	4-13
7	Total A by B	4-13
8	Manual Totalize	4-15
9	Phase Measurement	4-16
10	Ratio Measurement	4-17
11	Trigger Level	4-18
11	Trigger Level Modes	4-18
12	Displaying and Setting the Manual Trigger Level	4-18
13	Displaying the Auto-Trigger Level	4-19
14	Single-Shot Auto-Trigger Level	4-20
16	Automatic Attenuation Setting	4-20
17	Display Resolution	4-21
22	Setting the Display Resolution	4-21
23	Resolution With External Stop Circuit Arming	4-21
24	Gate Time	4-22
26	Stop Circuit Arming Delay	4-23
26	Use of the Delay	4-23
28	Displaying the Delay	4-24
29	Changing the Delay	4-24
31	Enabling and Disabling the Delay	4-24
32	Special Functions	4-24
32	Special Function Numbering	4-24
33	Special Function Register	4-24
34	Setting the Special Function Register	4-26
37	Enabling and Disabling the Special Functions	4-26
38	Error Codes	4-27
39	Clearing the Error Codes	4-28

TABLE OF CONTENTS (Continued)

40	Math Function	4-28
43	Displaying the Math Constants	4-29
44	Changing the Constants	4-29
46	Enabling and Disabling the Math Function	4-29
47	External Arming	4-29
48	Using the Battery Pack Option	4-30
48	Power Supply Changeover	4-30
49	Battery-Low Indication	4-30
51	Operating Instructions	4-30
52	Operation From the Battery	4-30
54	Operation From an External DC Supply	4-31
55	Battery Charging	4-31
SECTION 5	OPERATION VIA THE GPIB	5-1
1	Introduction	5-1
2	GPIB Operating Modes	5-1
3	Talk Only Mode	5-1
8	Addressed Mode	5-2
9	Data Output Format	5-2
10	Deferred Commands and Immediate Commands	5-2
11	Service Request	5-4
13	Status Byte	5-4
14	Explanation of Response to Interface Messages	5-6
16	Address Messages	5-6
20	Local Lockout	5-6
22	Device Clear and Selected Device Clear	5-6
24	Serial Poll Enable and Serial Poll Disable	5-8
27	Group Execute Trigger	5-8
28	Go to Local	5-8
29	Untalk and Unlisten	5-8
30	Input Command Codes	5-8

LIST OF TABLES

Table	Title	Page
3.1	GPIB Connector Pin Assignment	3-5
3.2	Address Switch Settings	3-6
4.1	Resolution With External Arming	4-21
4.2	Resolution and Gate Time	4-22
4.3	Special Functions	4-25
4.4	Error Codes	4-27
4.5	Use of Math Function	4-28
5.1	Output Message Format	5-3
5.2	Function Letters	5-4
5.3	Status Byte Format	5-5
5.4	Response to Bus Messages	5-7
5.5	Permitted Terminators	5-9
5.6	Instrument Preset Code	5-9
5.7	Measurement Function Code	5-9
5.8	Input Control Codes	5-10
5.9	Measurement Control Codes	5-10
5.10	Store and Recall Codes	5-11
5.11	Numerical Input Format	5-12
5.12	Numerical Input Ranges	5-13
5.13	Gate Times	5-14
5.14	Special Function Codes	5-14
5.15	Service Request Codes	5-14
5.16	Alphabetic List of Command Codes	5-15

LIST OF ILLUSTRATIONS

Fig.	Title	Page
4.1	Use of Stop Circuit Delay	4-23
4.2	Special Function Register Display	4-26

SECTION 1

TECHNICAL SPECIFICATION

Technical Specification

Model 1991

Input Characteristics

Inputs A and B

Frequency Range	
Input A	DC to 160MHz DC coupled 10Hz to 160MHz AC coupled
Input B	DC to 100MHz DC coupled 10Hz to 100MHz AC coupled

Sensitivity

Sine Wave	25mVrms DC to 100MHz 50mVrms to 160MHz
Pulse	75mV p-p, 5nS min. width

Dynamic Range (× 1 attenuation)	75mV to 5V p-p to 50MHz 75mV to 2.5V p-p to 100MHz 150mV to 2.5V p-p to 160MHz
---	--

Signal Operating Range

× 1 attenuation	± 5.1V
× 10 attenuation	± 51V

Input Impedance (nominal)

(× 1 and × 10 atten.)	
Separate Mode	50ohms or 1 Megohm // ≤45pF
Common Mode	50ohms or 1 Megohm // ≤55pF

Maximum Input (without damage)

50 ohms	5V(DC + ACrms)
1 Megohm (× 1 attenuation)	260V(DC + ACrms), DC to 2kHz Decreasing to 5V rms, at 100kHz and above.
1 Megohm (× 10 attenuation)	260V(DC + ACrms), DC to 20kHz Decreasing to 50Vrms at 100kHz and above.

Coupling

AC or DC.

Low Pass Filter

50kHz nominal (Input A selectable).

Trigger Slope

+ve or -ve

Attenuator

×1 or ×10. In Auto Trigger mode, attenuator selected automatically if necessary.

Trigger Level Range

Manual	
× 1 attenuation	± 5.1V in 20mV steps.
× 10 attenuation	± 51V in 200mV steps.
Automatic	± 51V.

Trigger Level Accuracy

Manual and Automatic	
× 1 attenuation	± 30mV ± 1% of trigger level reading.
× 10 attenuation	± 300mV ± 1% of trigger level reading.

Auto Trigger

Frequency Range	DC and 50Hz to 100MHz (Typically 160MHz)
Min. Amplitude (AC) × 10 attenuator	Typically 150mV p-p* Automatically selected if input signal exceeds ±5.1V or 5.1V p-p*.

Trigger Level Outputs (Rear Panel)

Range	± 5.1V.
Accuracy (Relative to true trigger level)	
× 1 attenuation	± 1% V output ± 10mV
× 10 attenuation	± 1% V output ± 100mV
Impedance	10 kohm nominal.

External Arming

A comprehensive external arming capability to determine the START and/or STOP point of a measurement. Available on all measurement functions except phase.

Input Signal (via Rear Panel) TTL compatible (min. pulse width 200ns).

Slope +ve or -ve independently selectable on START or STOP arm.

Impedance 1 kohm nominal.

Measurement Modes

Frequency A

Range	DC to 160MHz.
Digits Displayed	3 to 9 digits plus overflow
LSD Displayed (Hz)	$F \times 10^{-D}$ (D = No. of digits, F = Freq. rounded up to next decade)*.
Resolution *(Hz)	± LSD† ± (Trig. Error* × Freq.) / Gate Time.
Accuracy *(Hz)	± Resolution ± (Timebase Error × Frequency)

Time Interval

Range	
Separate Mode	0 to 8×10^5 sec. Typically -2nS to +8 × 10 ⁵ Sec.
Common Mode	5nS to 8×10^5 Sec.
Input	
Common	Input A START and STOP
Separate	Input A START Input B STOP
Trigger Slopes	+ve or -ve Selectable START and STOP.
LSD Displayed	1nS min.
Resolution *(Sec)	± LSD ± 1nS ± Trig Error*
Accuracy *(Sec)	± Resolution ± (Timebase Error × TI). ± Trigger Level Timing Error* ± 2nS**

Time Delay

Available on Time Interval and Totalize.

Range	200 μS to 800 mS nominal.
Step Size	25 μS nominal.
Accuracy	± 0.1% Rdg. ± 50 μS

Period A

Range	6.25nS to 1.7×10^3 Sec
Digits Displayed	3 to 9 digits plus overflow.
LSD Displayed (Sec)	$P \times 10^{-D}$ (D = No. of digits, P = Period rounded up to next decade)*.
Resolution *(Sec)	$\pm \text{LSD}^\dagger \pm (\text{Trig. Error}^* \times \text{Period}) / \text{Gate Time}$.
Accuracy *(Sec)	$\pm \text{Resolution} \pm (\text{Timebase Error} \times \text{Period})$.

Ratio A/B

Specified for higher frequency applied to Input A.

Range	DC to 100MHz on both inputs.
LSD Displayed (for 6-9 digits selected)	$\left(\frac{10}{\text{Freq. B} \times \text{Gate Time}} \right)$, rounded to nearest decade*.
Resolution *	$\pm \text{LSD} \pm (\text{Trig. Error B}^* / \text{Gate Time}) \times \text{Ratio}$.
Accuracy*	$\pm \text{Resolution}$.

Totalize A by B

Accumulative or single totalize.

Input	Input A.
Range	$10^{12}-1$ (Max. 9 most significant digits displayed).
Maximum Rate	10^8 events/Sec.
Minimum Pulse Width	5nS min. at trigger points.
Accuracy	± 1 count.
Start/Stop	Electrical (Input B) or Manual.

Phase (A rel. to B)

Range	0.1° to 360° .
LSD Displayed	0.1° to 1MHz. 1.0° to 10MHz. 10° to 100MHz.
Resolution *(degrees)	$\pm \text{LSD} \pm (\text{TI Resolution/Period A}) \times 360^\circ$
Accuracy *(degrees)	$\pm \text{LSD} \pm (\text{TI Accuracy/Period A}) \times 360^\circ$

Amplitude Measurement

Peak*	
Frequency Range	50Hz to 20MHz.
Amplitude Range	160mV p-p to 51V p-p.
Resolution	
× 1 attenuation	20mV
× 10 attenuation	200mV
Accuracy	
× 1 attenuation	$\pm 50\text{mV} \pm 6\% \text{ V p-p}$. (Typically $\pm 40\text{mV} \pm 2\% \text{ V p-p}$.)
× 10 attenuation	$\pm 500\text{mV} \pm 10\% \text{ V p-p}$. (Typically $\pm 400\text{mV} \pm 3\% \text{ V p-p}$.)

DC (<15mV p-p AC)

Amplitude Range	$\pm 51\text{V}$.
Resolution	
× 1 attenuation	20mV
× 10 attenuation	200mV
Accuracy	
× 1 attenuation	$\pm 40\text{mV} \pm 1\% \text{ Rdg}$.
× 10 attenuation	$\pm 400\text{mV} \pm 1\% \text{ Rdg}$.

Math

Available on all measurements except Phase and Check.

Function	$(\text{Result} - X)/Z$.
Entry Range	$\pm 1 \times 10^{-10}$ to $\pm 1 \times 10^{10}$ to 9 significant figures.

General

Internal Timebase

Crystal Controlled	
Frequency	10MHz.
Aging	2×10^{-6} in the first year.
Temperature Stability	1×10^{-5} over the range 0 to $+50^\circ\text{C}$.
Adjustment	Via rear panel.

Frequency Standard Output

Frequency	10MHz.
Amplitude	$>600\text{mV p-p}$ into 50 ohms.
Impedance	250 ohms nominal.

External Standard Input

Frequency	10MHz (see also Option 10 for other frequencies).
Signal Amplitude (Sine Wave)	Min. 100mV rms Max. 10V rms
Impedance	1 kohm nominal at 1V p-p 500 ohms nominal at 10V p-p

Gate Time

(Frequency, Period and Ratio modes).	Automatically determined by resolution selected (Range 1 msec - 10sec)*.
Resolution Selected	Gate Time (seconds)
9 + overflow	10 . .
9	1
8	0.1
7	0.01
6,5,4,3	0.001

Single Cycle (Hold)

Enables a single measurement to be initiated and held.

Display

9-digit, high brightness, 14mm LED display in engineering format with exponent digit.

† 2LSD for 6-9 digits displayed.
* See Definitions.

Power Requirements	90-110
Voltage	103-127 193-237 212-265 VAC
Frequency Rating	45-450 Hz 35VA Max.
Operating Temperature Range	0° to + 50°C.
Storage Temperature Range	-40°C to +70°C
Safety	Designed to meet the requirements of IEC348 and follow the guidelines of UL1244.
Weight	Net 3.63kg (8lb.) excl. battery 6.8kg (15lb.) inc. battery Shipping 5.5kg (11lb.) excl. battery 8.75kg (19.3lb.) inc. battery
Shipping Dimensions	430 x 360 x 280mm (16.91 x 14.2 x 11.0 ins.)

Model 1992

Specification identical to that for Model 1991 with the addition of the following:-

Input Characteristics

Input C

Frequency Range	40MHz to 1.3GHz.
Sensitivity Sine Wave	<10mV rms, 40MHz to 1GHz <75mV rms to 1.3GHz.
Dynamic Range	10mV rms to 5V rms to 1GHz. 75mV rms to 5V rms to 1.3GHz.
Input Impedance	50 ohms nominal AC coupled.
VSWR	≤ 2:1 at 1GHz.
Maximum Input	7V rms (fuse protected). Fuse located in BNC connector.
Damage Level	25W.

Measurement Modes

Frequency C

Range	40MHz to 1.3GHz.
LSD	As for Frequency A*.
Resolution* and Accuracy*	As for Frequency A.

Ratio C/B

Specified for higher frequency applied to Input C.

Range	Input C 40MHz to 1.3GHz. Input B DC to 100MHz.
LSD Displayed (for 6-9 digits selected)	$\left(\frac{640}{\text{Freq. B} \times \text{Gate Time}} \right)$, rounded to nearest decade*.
Resolution* and Accuracy*	As for Ratio A/B.

Option 01 Rear Panel Inputs

A rear panel input, factory fitted option, is available for ATE applications. Inputs A and B are in parallel with those on the front panel while input C (Model 1992 only) is fitted in place of the front panel input.

Option 04T

Temperature Controlled Crystal Oscillator

Frequency	10MHz.
Aging Rate	3×10^{-7} /month. 1×10^{-6} in the first year.
Temperature Stability	1×10^{-6} over the range 0 to +40°C (operable to +50°C).
Adjustment	Via rear panel.

Option 04A

Ovened Oscillator

Frequency	10MHz
Aging Rate	3×10^{-9} /day averaged over 10 days after 3 months continuous operation.
Temperature Stability	$\pm 3 \times 10^{-9}$ /°C averaged over range 0° to +45°C (operable to +50°C).
Warm Up Adjustment	Typically $\pm 1 \times 10^{-7}$ within 6 minutes. Via rear panel.

Option 04B

High Stability Ovened Oscillator

Frequency	10MHz
Aging Rate	5×10^{-10} /day averaged over 10 days after 3 months continuous operation.
Temperature Stability	$\pm 6 \times 10^{-10}$ /°C averaged over range 0° to +45°C (operable to +50°C).
Warm Up Adjustment	$\pm 1 \times 10^{-7}$ within 20 minutes. Via rear panel.

Option 07

Rechargeable Battery Pack and External DC Operation.

Battery Type	Sealed lead-acid cells.
Battery Life	Typically 4 hours at +25°C (10 hrs on standby).
Battery Condition	Display indicates battery low.
External DC	11-16V via socket on rear panel (-ve ground, not isolated).

Option 10

Reference Frequency Multiplier

Input Frequency	1, 2, 5 or 10MHz ($\pm 1 \times 10^{-5}$).
Input Amplitude and Impedance	As for external standard input.

Option 55

GPIB Interface

Designed to comply with IEEE-STD-488 (1978) and to conform with the guidelines of IEEE-STD-728 (1982).

Control Capability

All functions and controls programmable except power on/off and standby charge.

Output

Engineering format (11 digits and exponent).

IEEE-STD-488 Subsets	SH1, AH1, T5, TE0, L4, LE0, SR1, RL1, PPO, DC1, DT1, CO, E2.
Handshake Time	250 μ S to 1mS/character dependent on message content.
Read Rate	Typically 20/sec dependent upon measurement function.

Definitions

LSD (Least Significant Digit).

In Frequency and Period modes display automatically upranges at 1.1 \times decade and downranges at 1.05 \times decade, except on Input C for input frequency > 1GHz.

Accuracy and Resolution Expressed as an RMS value.

Trigger Error RMS.

$$\text{Trigger Error (seconds)} = \sqrt{\frac{(e_{i1}^2 + e_{n1}^2)}{S1^2} + \frac{(e_{i2}^2 + e_{n2}^2)}{S2^2}}$$

where e_i = input amplifier RMS noise (typically 150 μ V RMS in 160MHz bandwidth).

e_n = input signal RMS noise in 160MHz bandwidth.

S = Slew rate at trigger point V/Sec.

Suffix 1 denotes START edge

Suffix 2 denotes STOP edge

In Frequency A, Period A, Frequency B and Period B modes triggering is always on positive going edge.

Trigger Level Timing Error

$$\text{Trigger Level Timing Error (Seconds)} = 0.035 \left(\frac{1}{S1} - \frac{1}{S2} \right)$$

$$\text{typically} = 0.018 \left(\frac{1}{S1} - \frac{1}{S2} \right)$$

S1 = Slew rate on START edge V/Sec.

S2 = Slew rate on STOP edge V/Sec.

Gate Time

The nominal gate time indicated is set by the resolution selected in Frequency Period Ratio and Check modes. It is the value which is used in the calculation of LSD and Resolution. The true gate time will be extended from this value by up to:

- One period of the input signal(s) on Frequency B, Period B and Ratio A/B.
- Two periods of the input signal on Frequency A and Period A.
- One period of input signal B on Ratio C/B.

Peak and Peak-to-Peak Amplitudes

Peak is defined as being the highest or lowest point at which the signal width is 5nS. Similarly, Peak-to-Peak is the difference between the highest and lowest points at which the signal width is 5nS.

Supplied Accessories

Power Cord
Spare Fuse
Operator's Manual
Spare 1.3GHz Fuse (Model 1992 only).

Ordering Information

1991	160MHz Universal Counter
1992	1300MHz Universal Counter

Options and Accessories

01*	Rear Panel Inputs	11-1709 (Model 1991)
01*	Rear Panel Inputs	11-1732 (Model 1992)
04T**	TCXO	11-1713
04A**	Oven Oscillator	11-1710
04B**	High Stability Oven Oscillator	11-1711
07†	Battery Pack	11-1625
10	Reference Frequency Multiplier	11-1645
55†	GPIB Interface	11-1626
60	Handles	11-1730
60A	Rack Mounting Kit (Fixed, Single)	11-1648
60B	Rack Mounting Kit (Fixed, Double)	11-1649
61	Carrying Case	15-0773
61M	Protectomuff Case	15-0736
65	Chassis Slides (incl. Rack Mounts)	11-1716
	Thru-line Connector	11-0167
	Telescopic Antenna	23-9020
	High Impedance Probe	23-9104
	1.3GHz Fuse (Pkt. 5)	11-1718

* Fitting Option 01 may affect certain specification parameters.

** Only one frequency standard may be fitted at any one time. The standard reference will be supplied unless option 04T, 04A or 04B is specified.

† The battery pack and GPIB options cannot both be fitted.

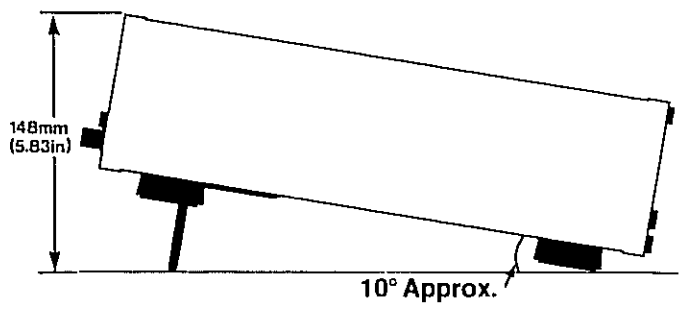
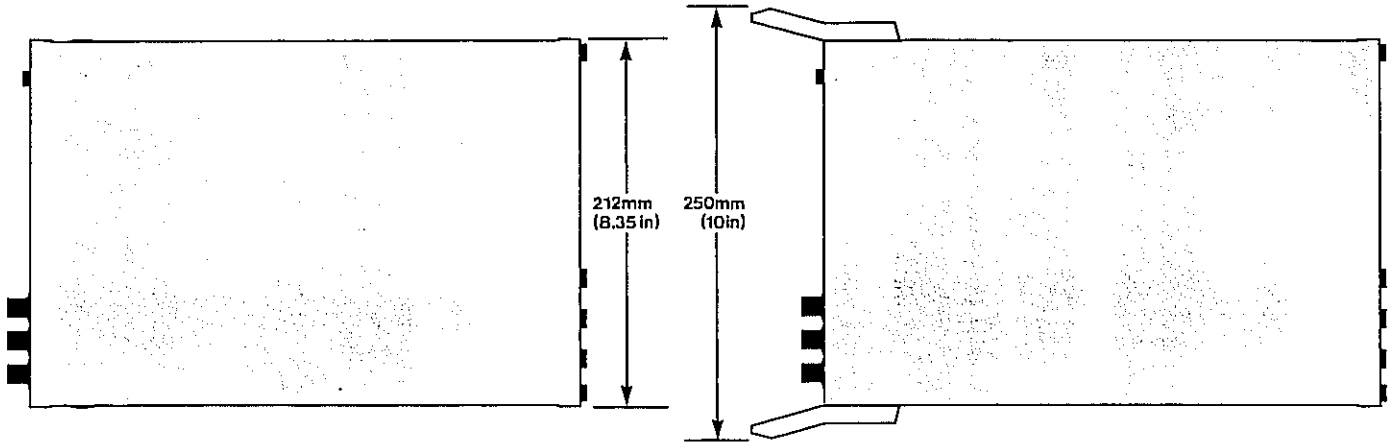
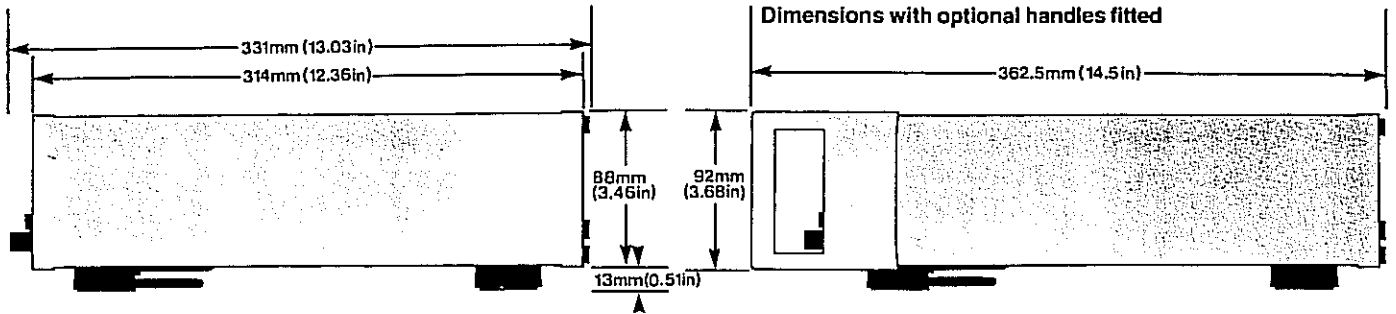

INTRODUCTION

- 1 The Racal-Dana universal counters, Models 1991 and 1992, are microprocessor controlled instruments offering high accuracy measurements with a comprehensive range of facilities. The Model 1992 is provided with an additional C channel which extends the frequency measuring range from 160 MHz to 1.3 GHz.

MEASUREMENT FUNCTIONS**Frequency A Function**

- 2 The Frequency A function is used to measure the frequency of the signal applied to the channel A input. A resolution of nine digits is available with a one-second gate time.

Frequency C Function

- 3 The Frequency C function is available on Model 1992 only. It is used to measure the frequency of the signal applied to the channel C input. A resolution of nine digits is available with a one-second gate time.

Period A Function

- 4 The Period A function is used to measure the period of the waveform applied to the A channel input. A number of periods, depending upon the resolution (and therefore the gate time) selected, are measured, and the average value is displayed.

Time Interval Function

- 5 The Time Interval function is used to make single-shot measurements of the time interval between:
 - (1) An event occurring at the channel A input and a later event at the channel B input (using separate input channels).
 - (2) Two events occurring at the channel A input (using a common input channel).
- 6 The arming of the stop circuit can be delayed for a time set by the operator. This prevents the measurement interval being stopped prematurely by spurious pulses, such as those caused by contact bounce.

Total A Function

- 7 The Total A function permits events occurring at the channel A input to be totalized. The counting interval can be controlled by:
- (1) Electrical start and stop signals applied to the channel B input (Total A by B).
 - (2) Successive operations of a front panel key (Manual Totalize).
- 8 Delayed arming of the stop circuit, to prevent spurious triggering, is available in the Total A by B mode. The Manual Totalize mode provides the facility for totalizing cumulatively over a number of periods.

Phase A rel B Function

- 9 The Phase A rel B function is used to measure the phase difference between the waveform applied to the A channel input and that applied to the channel B input. The phase difference is displayed in degrees, and indicates the phase lead at the channel A input.

Ratio A/B Function

- 10 The Ratio A/B function is used to measure the ratio of the frequency applied to the channel A input to that applied to the channel B input.

Ratio C/B Function

- 11 The Ratio C/B function is available on Model 1992 only. It is used to measure the ratio of the frequency applied to the channel C input to that applied to the channel B input.

CHECK FUNCTION

- 12 With the Check function selected a number of functional tests of the instrument's circuits can be made without the use of additional test equipment. Although these tests do not check the instrument's performance to its published specification, they can be used to verify that the equipment is operating correctly following receipt or transportation to a new location. A suitable functional check procedure is given in Section 3.

SIGNAL INPUT CHANNELS

- 13 Signal input channels A and B are fully independent, but provision is made for connection of the signal at the channel A input into both channels. When this is done, the channel B input socket is isolated from channel B.

14 Each channel is provided with independent controls to permit the selection of:

- (1) AC or DC input coupling.
- (2) 1 M Ω or 50 Ω input impedance.
- (3) X1 or X10 input attenuation.
- (4) Positive- or negative-slope trigger.
- (5) Manually-set or automatically-set input trigger level.

The manually-set trigger level is entered into an internal store.

The auto trigger level is derived by measuring the positive and negative peaks of the input signal. If the peak-to-peak value exceeds 5.1 V, or if either peak is outside the range ± 5.1 V, the X10 attenuator is switched in. The trigger level is then set to the arithmetic mean of the measured value.

When operating on auto trigger with the X10 attenuator in circuit, the attenuator will be switched out if the peak-to-peak value is less than 4.6 V and both peak values are within the range ± 4.6 V.

The trigger levels in use are available at pins mounted on the rear panel of the instrument. The voltage range is ± 5.1 V regardless of whether the attenuator is switched in or not, so the voltage should be multiplied by 10 when the attenuator is in circuit.

15 Signal input channel C is available on Model 1992 only. This input has a nominal input impedance of 50 Ω and is AC coupled. Protection against excessive signal levels is provided by a fuse in the input socket.

LOW-PASS FILTER

16 An internal low-pass filter can be introduced to reduce the bandwidth of channel A to 50 kHz (nominal).

MATH FUNCTION

17 When the math function is active, the displayed value is

$$\frac{\text{Measurement result} - X}{Z}$$

where X and Z are values entered into stores within the instrument by the operator. X is set to 0 and Z to 1 when the instrument is first switched on. By suitable choice of values for X and Z, ratio, offset (null) and percentage-difference displays can be obtained.

SPECIAL FUNCTIONS

- 18 A number of special functions are available to the operator. These provide test procedures and operating facilities additional to those available by operation of the front panel controls. Details are given in Section 4 of this manual.

ERROR INDICATION

- 19 Certain errors in the operation of the instrument will result in the generation of error codes, which will be displayed. Details are given in Section 4 of this manual.

EXTERNAL ARMING

- 20 External arming of the start and stop circuits for the measurement interval can be carried out by means of signals connected to a socket mounted on the rear panel. Any combination of internal and external arming can be selected by use of the appropriate special function.

DISPLAY FORMAT

- 21 The display uses an engineering format, with a nine digit mantissa and one exponent digit. Overflow of the most significant digits can be used to increase the display resolution.

HOLD FEATURE

- 22 The hold feature allows readings to be held indefinitely. A new measurement cycle is initiated using the RESET key.

RESOLUTION AND GATE TIME

- 23 In the Total A by B and Manual Totalize modes, the counting interval (gate time) is controlled by the time interval between the start and stop signals at the channel B input, or between successive operations of the HOLD key. In the Frequency A, Frequency C, Period A, Ratio A/B and Ratio C/B modes, the gate time is determined by the display resolution selected. In Phase mode, the gate time is fixed and the display resolution is determined by the input signal frequency. Details of the relationship between gate time and resolution for each measurement mode are given in Section 4 of this manual.

EXTERNAL FREQUENCY STANDARD INPUT

- 24 The instrument may be operated using an external frequency standard. The instrument will operate from the external standard, in preference to the internal standard, whenever the signal at the EXT STD INPUT socket is of sufficient amplitude. It will revert to operation from the internal standard automatically if the input from the external standard is removed.

STANDBY MODE

- 25 When the instrument is switched to standby, the internal frequency standard continues to operate but the measuring circuits are switched off. If the battery pack option is fitted and an external power supply is connected, the battery is charged at the full rate.

INITIALIZATION

- 26 When the instrument is first switched on, or when it is initialized via the GPIB, it is set to the following conditions:

Measurement Function	FREQ A
Display Resolution	8 digits
Channel A and B Inputs	Manual trigger AC coupling Negative-slope trigger 1 M Ω input impedance LF filter disabled Common input disabled
Delay	Disabled
Delay Store	200 μ s

Math Function	Disabled
X Store	0
Z Store	1
Hold	Disabled
Special Functions	Functions 10, 20, 30, 40, 50, 60, 70 enabled.

OPTIONS AVAILABLE

Frequency Standards (04X Options)

- 27 A wide range of internal frequency standard options is available. The technical specifications are given in Section 1 of this manual. The frequency standard can be changed, if required, by the customer: instructions are given in Section 3.

Reference Frequency Multiplier (Option 10)

- 28 The reference frequency multiplier is an internally-mounted, phase-locked multiplier, which permits the use of external frequency standard signals at 1 MHz, 2 MHz, 5 MHz or 10 MHz. The multiplier can be fitted by the customer: instructions are given in Section 3.

GPIB Interface (Option 55)

- 29 An internally mounted interface to the IEEE-488-GPIB is available. This permits remote control of all the instrument's functions except the power ON/OFF and standby switching. The interface can be fitted by the customer: instructions are given in Section 3. The GPIB interface cannot be fitted to an instrument already fitted with the battery pack option. An adapter, Racal-Dana part number 23-3254, to convert the connector to the IEC 625-1 standard is available as an accessory.

Battery Pack (Option 07)

- 30 Fitting the internal battery permits the instrument to be used in locations where no suitable AC supply is available. The option also allows operation from an external DC supply with the INT/EXT switch set to EXT position.
- 31 The battery is trickle-charged whenever the instrument is operated from an AC supply. Charging at the full rate is carried out when the instrument is switched to the standby mode and connected to an external AC or DC supply. A full charge requires approximately 14 hours.
- 32 The instrument will operate continuously for approximately 4 hours from a fully-charged battery. It will switch off automatically when the battery approaches the discharged condition. The STBY/CHRG indicator starts to flash approximately 15 minutes before this occurs. The battery life can be extended by use of the Battery-Save facility.

- 33 The battery pack can be fitted by the customer. Instructions are given in Section 3. The battery pack cannot be fitted to an instrument already fitted with the GPIB interface option.

Rack Mounting Kits

- 34 The following kits, permitting the instrument to be mounted in a standard 19-inch rack are available:

- (1) Single instrument, fixed-mount kit (Option 60A).
(Racal-Dana part number 11-1648).
The mounted instrument occupies half the rack width and is two rack units (3.5 inches) in height. The instrument is mounted offset in the rack and may be at either side.
- (2) Double instrument, fixed-mount kit (Option 60B).
(Racal-Dana part number 11-1649).
The panel of the mounting kit occupies the full rack width and is two rack units (3.5 inches) in height. Two instruments can be mounted side-by-side.

- 35 All the kits can be fitted by the customer. Instructions are given in Section 3.

UNPACKING

- 1 Unpack the instrument carefully to avoid unnecessary damage to the factory packaging.
- 2 If it becomes necessary to return the instrument to Racal-Dana Instruments for calibration or repair, the original packaging should be used. If this is not possible, a strong shipping container should be used. Ensure that sufficient internal packing is used to prevent movement of the instrument within the container during transit.

POWER SUPPLY

AC Line Voltage Setting

- 3 Before use, check that the AC voltage selector is set correctly for the local AC supply. The voltage range already set can be seen through a window in the selector board retaining clamp to the left of the AC power plug.
- 4 If it is necessary to change the setting, proceed as follows:
 - (1) Undo the selector board retaining clamp on the rear panel.
 - (2) Withdraw the board.
 - (3) Replace the board with the required voltage setting positioned so that it will show through the window in the retaining clamp.
 - (4) Replace the retaining clamp.

Line Fuse

- 5 Check that the rating of the line fuse is suitable for the AC voltage range in use. The fuse should be of the $\frac{1}{4}$ in x $1\frac{1}{4}$ in, glass cartridge, surge-resisting type. The required rating is:

90 V to 127 V: 500 mA (Racal-Dana part number 23-0052).
188 V to 265 V: 250 mA (Racal-Dana part number 23-0056).

Power Cord

- 6 The 1991 and 1992 are Safety Class 1 instruments, and are designed to meet international safety standards. A protective ground terminal, which forms part of the power-input connector on the rear panel, is provided. Each instrument is supplied with a 3-core power cord. Only the power cord supplied should be used to make electrical connection to the power-input connector.
- 7 AC power for the instrument must be taken from a power outlet incorporating a protective ground connector. When the green/yellow conductor of the power cord is joined to this connector, the exposed metalwork of the instrument is grounded. The continuity of the protective ground connection must not be broken by the use of 2-core extension cords or 3-prong to 2-prong adapters.
- 8 Connection of the power cord to the power outlet must be made in accordance with the standard color code.

	European	American
Line	Brown	Black
Neutral	Blue	White
Ground (Earth)	Green/Yellow	Green

FUNCTIONAL CHECK

- 9 The check given in paragraph 11 tests the operation of most of the instrument's circuits to establish whether the instrument is functioning correctly. The procedure should be followed when the instrument is first taken into use, and after transportation to a new location. It does not check that the instrument is operating to the published specification. Detailed specification tests are given in Section 7 of the maintenance manual.
- 10 A 50 Ω coaxial test lead, fitted with BNC connectors is required. This lead must be at least 60 cm, but not more than 1 m long.
- 11 (1) Connect the instrument to a suitable AC supply.
- (2) Switch the instrument on. Check that the instrument type-number appears in the display for approximately two seconds, followed by a number which indicates the software version and issue numbers.

- (3) Press the FUNCTION ↓ key until the CHECK indicator lights. Check that the display shows 10.000000 6 and that the GATE indicator is flashing.
- (4) Verify that the RESOLUTION indicator is lit. Press the RESOLUTION ↓ key five times, ensuring that the resolution of the display is decreased by one digit each time.
- (5) Press the RESOLUTION ↑ key to increase the resolution to nine digits.

12 If required, the following additional checks may also be performed, using the instrument's special functions.

- (1) Press

7 1 SHIFT STORE SF SHIFT SF .

Check that all LEDs, with the exception of TRIG A, TRIG B, GATE and STBY/CHRG flash on and off every two seconds. If the GPIB option is installed, the REM, ADDR and SRQ indicators should be lit.

- (2) Connect the 10 MHz STD OUTPUT socket on the rear panel to the front panel INPUT A connector, using the coaxial test lead.

- (3) Press

7 7 SHIFT STORE SF .

Verify that the display shows *0.***** 0 Hz where * indicates a blanked digit. The X10, 50Ω, DC, FILTER and COM A indicators for channel A should light in turn.

- (4) Disconnect the coaxial lead from the INPUT A connector. The display should show an error number after a few seconds.

- (5) Connect the coaxial lead to the INPUT B connector.

- (6) Press

7 8 SHIFT STORE SF .

Check that the display shows *0.***** 0 Hz. The X10, 50Ω and DC indicators for channel B should light in turn.

- (7) Disconnect the coaxial lead from the INPUT B connector and the 10 MHz STD OUT connector. The display should show Er 56.

- (8) Switch the instrument off.

FREQUENCY STANDARD

- 13 If it is intended to use an external frequency standard, the output of the frequency standard should be connected to the EXT STD INPUT connector on the rear panel of the instrument. The connection should be made using coaxial cable. Switch on the frequency standard and the instrument: check that the EXT STD indicator on the front panel of the instrument lights.
- 14 A 10 MHz signal, derived from the frequency standard in use, is available at the 10 MHz STD OUT connector on the rear panel of the instrument. If this signal is used, the connection should be made using coaxial cable.

EXTERNAL ARMING

- 15 If external arming is to be used, the arming signal should be connected to the EXT ARM INPUT connector on the rear panel.

TRIGGER LEVEL OUTPUT

- 16 The trigger levels in use on channels A and B are available via pins on the instrument rear panel. If required, connection to the pins should be made using a clip-on probe or small crocodile clip.

PREPARATION FOR USE WITH THE GPIB

Introduction

- 17 The instrument must be prepared for use in accordance with the instructions given in Paragraphs 3 to 8 before the instructions given in this section are implemented.

Connection to the GPIB

- 18 Connection to the GPIB is made via a standard IEEE-488 connector, mounted on the rear panel. The pin assignment is given in Table 3.1. An adapter, Racal-Dana part number 23-3254, to convert the connector to the IEC 625-1 standard is available as an optional accessory.

TABLE 3.1

GPIB Connector Pin Assignment

Pin	Signal Line	Pin	Signal Line
1	DIO 1	13	DIO 5
2	DIO 2	14	DIO 6
3	DIO 3	15	DIO 7
4	DIO 4	16	DIO 8
5	EOI	17	REN
6	DAV	18	Gnd (6)
7	NRFD	19	Gnd (7)
8	NDAC	20	Gnd (8)
9	IFC	21	Gnd (9)
10	SRQ	22	Gnd (10)
11	ATN	23	Gnd (11)
12	SHIELD	24	Gnd (5 and 17)

Address Setting and Display

- 19 The interface address is set using five switches, A1 to A5, which are mounted on the rear panel. The permitted address settings, in binary, decimal and ASCII character form, are given in Table 3.2. The GPIB address set can be displayed, in decimal form, by pressing

SHIFT **RECALL** **LOCAL** .

If the address is changed, this key sequence must be repeated to display the new address. The instrument is returned to the measurement mode by pressing

CONTINUE .

- 20 For addressed operation, the TALK ONLY switch must be in the logic '0' position (down). When this switch is in the logic '1' position, the interface is switched to the talk-only mode. The settings of switches A1 to A5 are then irrelevant.

TABLE 3.2

Address Switch Settings

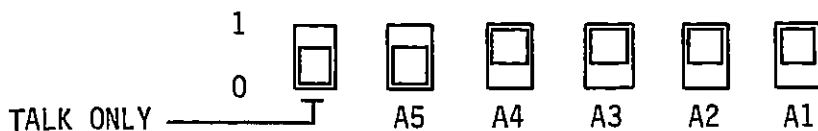

SWITCH SETTINGS					ADDRESS CODES		
					DECIMAL	ASCII LISTEN ADDRESS	ASCII TALK ADDRESS
A5	A4	A3	A2	A1			
0	0	0	0	0	0	SP	@
0	0	0	0	1	1	!	A
0	0	0	1	0	2	"	B
0	0	0	1	1	3	#	C
0	0	1	0	0	4	\$	D
0	0	1	0	1	5	%	E
0	0	1	1	0	6	&	F
0	0	1	1	1	7	'	G
0	1	0	0	0	8	(H
0	1	0	0	1	9)	I
0	1	0	1	0	10	*	J
0	1	0	1	1	11	+	K
0	1	1	0	0	12	,	L
0	1	1	0	1	13	-	M
0	1	1	1	0	14	.	N
0	1	1	1	1	15	/	O
1	0	0	0	0	16	0	P
1	0	0	0	1	17	1	Q
1	0	0	1	0	18	2	R
1	0	0	1	1	19	3	S
1	0	1	0	0	20	4	T
1	0	1	0	1	21	5	U
1	0	1	1	0	22	6	V
1	0	1	1	1	23	7	W
1	1	0	0	0	24	8	X
1	1	0	0	1	25	9	Y
1	1	0	1	0	26	:	Z
1	1	0	1	1	27	;	[
1	1	1	0	0	28	<	\
1	1	1	0	1	29	=]
1	1	1	1	0	30	>	^

GPIB CHECK

- 21 The procedure which follows checks the ability of the instrument to accept, process and send GPIB messages. The correct functioning of the instrument under local control should be verified before the procedure is attempted.
- 22 The recommended test equipment is the Hewlett-Packard HP-85 GPIB controller, with the I/O ROM in the drawer. It is assumed that the select code of the controller I/O port is 7, and that the address of the instrument is 15 (to change the address, see Paragraph 19). If any other controller or select code/address combination is used, the GPIB commands given in the following paragraphs will require modification. The controller should be connected to the GPIB interface of the instrument via a GPIB cable. No connection should be made to the channel A, B or C inputs.
- 23 Successful completion of the GPIB check proves that the instrument's GPIB interface is operating correctly. The procedure does not check that all the device-dependent commands can be executed. However, if the GPIB interface works correctly and the instrument operates correctly under local control, there is a high probability that it will respond to all device-dependent commands.

Remote and Local Message Check

- 24 Switch the instrument on. Check that the REM, ADDR and SRQ indicators flash on and off once. If the indicators do not flash, or if they flash continuously, there is a fault on the GPIB board.
- 25 Test as follows:

Action	HP-85 Code	Your Controller
Send the REN message true, together with the instrument's listen address	REMOTE 715	

Check that the REM indicator lights.

- 26 Test as follows:

Action	HP-85 Code	Your Controller
Send the device-dependent command CK	OUTPUT 715; "CK"	

Check that the ADDR indicator lights and that the Check mode is selected.

27 Test as follows:

Action	HP-85 Code	Your Controller
Send the instrument's listen address followed by the GTL message	LOCAL 715	

Check that the REM indicator is off. The ADDR indicator will also be off if the controller used sends the unlisten message (UNL) true automatically. This is the case when using the HP-85.

Local Lockout and Clear Lockout Check

28 Test as follows:

Action	HP-85 Code	Your Controller
Send the REN message true, together with the instrument's listen address	REMOTE 715	
Send the LLO message	LOCAL LOCKOUT 7	

Check that the REM indicator lights. Operate the LOCAL key on the front panel and verify that the REM indicator remains lit.

29 Test as follows:

Action	HP-85 Code	Your Controller
Send the REN message false	LOCAL 7	

Check that the REM indicator is off.

30 Test as follows:

Action	HP-85 Code	Your Controller
Send the REN message true, together with the instrument's listen address	REMOTE 715	

Check that the REM indicator lights. Press the LOCAL key and verify that the REM indicator turns off.

Data Output Check

31 Test as follows:

Action	HP-85 Code	Your Controller
Set the instrument to the check mode by sending the listen address, followed by the device-dependent command CK	OUTPUT 715; "CK"	
Prepare a store to receive a 21-byte data string	DIM Z\$ [21]	
Send the instrument's talk address. Store the 21-byte data string in the prepared store	ENTER 715; Z\$	
Display the contents of the store	DISP Z\$	

Check that the display reads CK+0010.0000000E+06 with the cursor moved to the next line, indicating that carriage return (CR) and line feed (LF) have been accepted.

SRQ and Status Byte Check

32 Test as follows:

Action	HP-85 Code	Your Controller
Send the REN message true	REMOTE 7	
Set the instrument to send the SRQ message when an error is detected, and force the generation of error code 05 by sending the device-dependent command XXX	OUTPUT 715;"IPXXX"	
Store the status of the GPIB interface of the controller, in binary form, as variable T	STATUS 7, 2; T	
Display the status of the SRQ line	DISP"SRQ=";BIT(T,5)	

Check that the HP-85 displays SRQ=1, the SRQ status bit is at logic '1' or the SRQ line is ≤ 0.8 V. Check that the SRQ indicator on the instrument is lit.

33 Test as follows:

Action	HP-85 Code	Your Controller
Conduct a serial poll and store the status byte as variable R	R = SPOLL (715)	
Display variable R	DISP "R="; R	

Check that the SRQ indicator is turned off when the serial poll is made. The value of R should be 101 (in binary form, R should be 0000000001100101). If using an HP-85 controller, check that the ADDR indicator is turned off.

Device Clear and Selected Device Clear Check

34 Test as follows:

Action	HP-85 Code	Your Controller
Set the instrument to the Total A by B mode by sending the listen address, followed by the device-dependent command TA	OUTPUT 715;"TA"	
Send the DCL message true	CLEAR 7	

Check that the function indicated on the instrument front panel changes to **FREQ A**.

35 Test as follows:

Action	HP-85 Code	Your Controller
Reset the instrument to the Total A by B mode by sending the listen address, followed by the device-dependent command TA	OUTPUT 715;"TA"	
Send the SDC message true	CLEAR 715	

Check that the function indicated on the instrument front panel changes to **FREQ A**.

IFC Check

36 Test as follows:

Action	HP-85 Code	Your Controller
Send the ATN message false Send the IFC message true	RESUME 7 ABORTIO 7	

Check that the ADDR indicator is turned off.

TALK ONLY Selector Test

- 37
- (1) Set the TALK ONLY switch in the instrument rear panel to '1'. Check that the REMOTE indicator is turned off and the ADDR indicator lights.
 - (2) Set the TALK ONLY switch to '0'. Check that the ADDR indicator turned is off.

OPTION FITTING INSTRUCTIONS

Single-Instrument Fixed Rack Mounting Kit 11-1648 (Option 60A)

38 The kit comprises:

Item	Qty	Racal-Dana Part Number
Short mounting bracket	1	16-0643
Long mounting bracket	1	16-0644
Screw, M4 x 16	4	24-7733
Crinkle washer M4	4	24-2802
Spacer, plain M4x5	4	24-4112
Screw, M6 x 16	4	24-7995
Cup washer, M6	4	24-2809
Caged nut, M6	4	24-2240

39 Assemble the kit to the instrument as follows:

- (1) Disconnect the AC power cord at the rear panel.
- (2) Remove the two screws which secure the bezel to the rear panel: remove the bezel.
- (3) Remove the bottom cover by sliding it towards the rear of the instrument.
- (4) Remove the instrument's feet from the bottom cover.
- (5) Replace the bottom cover. Replace and secure the bezel.

- (6) Remove the four blind grommets from the sides of the instrument. This will reveal two threaded holes in each side frame.
- (7) At one side of the instrument, secure a mounting bracket to the side frame, using two spacers, M4 screws and crinkle washers. Position the spacers between the mounting bracket and the side frame.
- (8) Repeat step (7) at the other side of the instrument.
- (9) Fit the cup washers to the M6 screws. Offer the instrument up to the rack in the required position, and secure the brackets to the rack using the M6 screws and nuts.

Double-Instrument Fixed Rack Mounting Kit 11-1649 (Option 60B)

40 The kit comprises:

Item	Qty	Racal-Dana Part Number
Short mounting bracket	2	16-0643
Screw, M4 x 16	4	24-7733
Crinkle washer, M4	4	24-2802
Spacer, plain, M4 x 5	4	24-4112
Spacer, female	2	14-1583
Spacer, male	2	14-1584
Mating plate	1	13-2000
Rivet, plastic	4	24-3211
Screw, M6 x 16	4	24-7995
Cup washer, M6	4	24-2809
Caged nut, M6	4	24-2240

41 Prepare both instruments as follows:

- (1) Disconnect the AC power cord at the rear panel.
- (2) Remove the two screws which secure the bezel to the rear panel: remove the bezel.
- (3) Remove the bottom cover by sliding it towards the rear of the instrument.
- (4) Remove the instrument's feet from the bottom cover.
- (5) Replace the bottom cover. Replace and secure the bezel.
- (6) Remove the four blind grommets from the sides of the instrument. This will reveal two threaded holes in each side frame.
- (7) Remove two buffers from the bezel at the side which is to be at the centre of the rack.

42 Assemble the kit to the instruments as follows:

- (1) At the sides which are to be at the centre of the rack, secure the female spacers to one instrument and the male spacers to the other. The spacers screw into the threaded holes in the side frames.
- (2) At the other side of each instrument, secure a mounting bracket to the side frame, using two plain spacers, M4 screws and crinkle washers. Position the spacers between the mounting bracket and the side frame.
- (3) Fit the male spacers on one instrument into the female spacers on the other.
- (4) Position the mating plate to bridge the gap between the bezels. Secure it by pushing the plastic rivets through the plate into the buffer holes.
- (5) Fit the cup washers to the M6 screws. Offer the two instruments up to the rack in the required position, and secure the brackets to the rack using the M6 screws and nuts.

PCB-Mounted Frequency Standard, 11-1713 (Option 04T)

43 The kit comprises:

Item	Qty	Racal-Dana Part Number
Plate assembly	1	11-1610
Oscillator PCB	1	19-1208
Crinkle washer M3	3	24-2801
Screw, M3 x 6	3	24-7721

Installation

- 44
- (1) Disconnect the AC power cord at the rear panel.
 - (2) Remove the two screws which secure the bezel to the rear panel: remove the bezel.
 - (3) Remove the top cover by sliding it towards the rear of the instrument.
 - (4) Remove the frequency standard already fitted. Instructions are given in Paragraph 45 or Paragraph 48, according to type.
 - (5) Secure the PCB to the plate assembly, using an M3 screw and washer from the kit. The screw should be passed through the mounting hole in the board and screwed into the threaded spacer of the plate assembly. The component side of the board should be towards the plate assembly.
 - (6) Connect the PCB to the motherboard at PL14, with the plate assembly towards the rear panel of the instrument.

42 Assemble the kit to the instruments as follows:

- (1) At the sides which are to be at the centre of the rack, secure the female spacers to one instrument and the male spacers to the other. The spacers screw into the threaded holes in the side frames.
- (2) At the other side of each instrument, secure a mounting bracket to the side frame, using two plain spacers, M4 screws and crinkle washers. Position the spacers between the mounting bracket and the side frame.
- (3) Fit the male spacers on one instrument into the female spacers on the other.
- (4) Position the mating plate to bridge the gap between the bezels. Secure it by pushing the plastic rivets through the plate into the buffer holes.
- (5) Fit the cup washers to the M6 screws. Offer the two instruments up to the rack in the required position, and secure the brackets to the rack using the M6 screws and nuts.

PCB-Mounted Frequency Standard, 11-1713 (Option 04T)

43 The kit comprises:

Item	Qty	Racal-Dana Part Number
Plate assembly	1	11-1610
Oscillator PCB	1	19-1208
Crinkle washer M3	3	24-2801
Screw, M3 x 6	3	24-7721

Installation

- 44
- (1) Disconnect the AC power cord at the rear panel.
 - (2) Remove the two screws which secure the bezel to the rear panel: remove the bezel.
 - (3) Remove the top cover by sliding it towards the rear of the instrument.
 - (4) Remove the frequency standard already fitted. Instructions are given in Paragraph 45 or Paragraph 48, according to type.
 - (5) Secure the PCB to the plate assembly, using an M3 screw and washer from the kit. The screw should be passed through the mounting hole in the board and screwed into the threaded spacer of the plate assembly. The component side of the board should be towards the plate assembly.
 - (6) Connect the PCB to the motherboard at PL14, with the plate assembly towards the rear panel of the instrument.

- (7) Secure the plate assembly to the rear panel, using two M3 screws and washers. The screws pass through the holes adjacent to the **FREQ STD ADJUST** aperture and screw into the plate assembly.
- (8) Replace the top cover. Replace and secure the bezel.

Removal

- 45 (1) Remove the two screws adjacent to the **FREQ STD ADJUST** aperture in the rear panel.
- (2) Pull the PCB and plate assembly upwards until the board is disconnected from the motherboard.

Opened Frequency Standards 11-1710 and 11-1711 (Options 04A and 04B)

- 46 The kit comprises:

Item	Qty	Racal-Dana Part Number
Oscillator assembly	1	9444 for 11-1710 9423 for 11-1711
Crinkle washer, M3	2	24-2801
Screw, M3 x 6	2	24-7721

Installation

- 47 (1) Disconnect the AC power cord at the rear panel.
- (2) Remove the two screws which secure the bezel to the rear panel: remove the bezel.
- (3) Remove the top cover by sliding it towards the rear of the instrument.
- (4) Remove the frequency standard already fitted. Instructions are given in Paragraph 45 or Paragraph 48, according to type.
- (5) Connect the flying lead on the oscillator assembly to SK14 on the motherboard.
- (6) Secure the oscillator assembly to the rear panel of the instrument, using the M3 screws and washers. The screws pass through the holes adjacent to the **FREQ STD ADJUST** aperture and screw into the oscillator assembly.
- (7) Replace the top cover. Replace and secure the bezel.

Removal

- 48 (1) Remove the two screws adjacent to the **FREQ STD ADJUST** aperture in the rear panel.
- (2) Lift the oscillator assembly out of the chassis and disconnect the flying lead from the motherboard at PL14.

Reference Frequency Multiplier Option 11-1645 (Option 10)

49 The kit comprises:

Item	Qty	Racal-Dana Part Number
Frequency multiplier	1	19-1164
Crinkle washer, M3	2	24-2801
Screw, M3 x 6	2	24-7721

- 50
- (1) Disconnect the AC power cord at the rear panel.
 - (2) Remove the two screws which secure the bezel to the rear panel: remove the bezel.
 - (3) Remove the top cover by sliding it towards the rear of the instrument.
 - (4) Remove the frequency standard if an ovened type is fitted.
 - (5) Remove the shorting link from between pins 8 and 9 on PL16.

NOTE: This link should be stored in a safe place. It must be replaced if Option 10 is removed from the instrument.
 - (6) Connect the frequency multiplier PCB to the motherboard at PL16 and PL17, with the threaded spacers towards the right-hand side frame.
 - (7) Secure the PCB to the side frame, using the M3 screws and washers.
 - (8) Replace and secure the frequency standard if it was removed in (5).
 - (9) Replace the top cover. Replace and secure the bezel.

GPIB Option 11-1626 (Option 55)

51 The kit comprises:

Item	Qty	Racal-Dana Part Number
GPIB board assembly	1	19-1146
Shakeproof washer, M3	2	24-2813
Screw, M3 x 6	2	24-7721

NOTE 1:

This option cannot be fitted to an instrument already fitted with the battery pack option.

NOTE 2:

The software version number (the first part of the decimalised number) on the GPIB ROM (IC10) must be the same as that for the main instrument ROM (IC22 on the motherboard).

- 52 (1) Disconnect the AC power cord at the rear panel.

- (2) Remove the two screws which secure the bezel to the rear panel: remove the bezel.
- (3) Remove the top cover by sliding it towards the rear of the instrument.
- (4) Remove the blanking plate from the rear panel by pushing out the plastic rivets from the inside of the instrument.
- (5) Hold the GPIB board, component side down, with the GPIB connector towards the rear panel. Connect the ribbon cable to the motherboard at SK4.
- (6) Tilt the board, and lower it into the instrument. Position it with the support brackets just below the top flanges of the side frames.
- (7) Slide the board towards the rear panel so that the support brackets enter the grooves immediately below the top flanges of the side frames.
- (8) Secure the bracket which carries the GPIB connector to the rear panel using the M3 screws and washers.

NOTE:

The screws and washers provide the ground connection between the GPIB connector and the instrument chassis. Tighten the screws firmly to ensure that a good connection is obtained.

- (9) Replace the top cover. Replace and secure the bezel.

Battery Pack Option 11-1625 (Option 07)

53 The kit comprises:

Item	Qty	Racal-Dana Part Number
PCB assembly	1	11-1722
Mounting bracket	1	11-1599
Battery pack	1	11-1723
Cover plate	1	13-2040
Crinkle washers, M3	2	24-2801
Screws, M3	2	24-7721
Crinkle washers, M4	6	24-2802
Plain washers, M4	2	24-2705
Screws, M4	6	24-7730
Spare fuse, 3AT	1	23-0069

NOTE:

This option cannot be fitted to an instrument already fitted with the GPIB interface option.

- 54 (1) Disconnect the AC power cord at the rear panel.

- (2) Remove the two screws which secure the bezel to the rear panel: remove the bezel.
- (3) Remove the top cover by sliding it towards the rear of the instrument.
- (4) Remove the blanking plate from the rear panel by pushing out the plastic rivets from the inside of the instrument.
- (5) If a PCB-mounted frequency standard is fitted, remove the two screws adjacent to the FREQ STD ADJUST aperture.
- (6) Remove the four screws which secure the rear panel to the side frames.
- (7) Ease the rear panel away from the instrument until it disconnects from the motherboard at PL19 and PL20.
- (8) Hold the PCB assembly with the switches towards the rear of the instrument and the PCB connector pointing downwards.
- (9) Lower the assembly into the chassis and connect the PCB to the motherboard at PL21, taking care that it mates correctly.
- (10) Replace and secure the rear panel.
- (11) If a PCB-mounted frequency standard is fitted, secure it to the rear panel with the screws removed in (5).
- (12) Position the cover plate over the switches protruding through the rear panel. Secure the cover plate and the rear panel to the PCB assembly, using the M3 screws and washers.
- (13) Secure the mounting bracket to the right-hand side frame, using two M4 screws and washers. The horizontal flange should be towards the top of the instrument.
- (14) Position the battery pack within the chassis, with the supporting lugs resting on the mounting bracket. Secure the battery pack to the left-hand side frame, using two M4 screws and washers.
- (15) Secure the supporting lugs to the mounting bracket, using M4 screws and washers.
- (16) Connect the flying lead on the battery pack to the connector on the PCB assembly.
- (17) Replace the top cover. Replace and secure the bezel.

INTRODUCTION

- The instrument should be prepared for use in accordance with the instructions given in Section 3. If the instrument is being used for the first time, or at a new location, pay particular attention to the setting of the AC voltage selector.

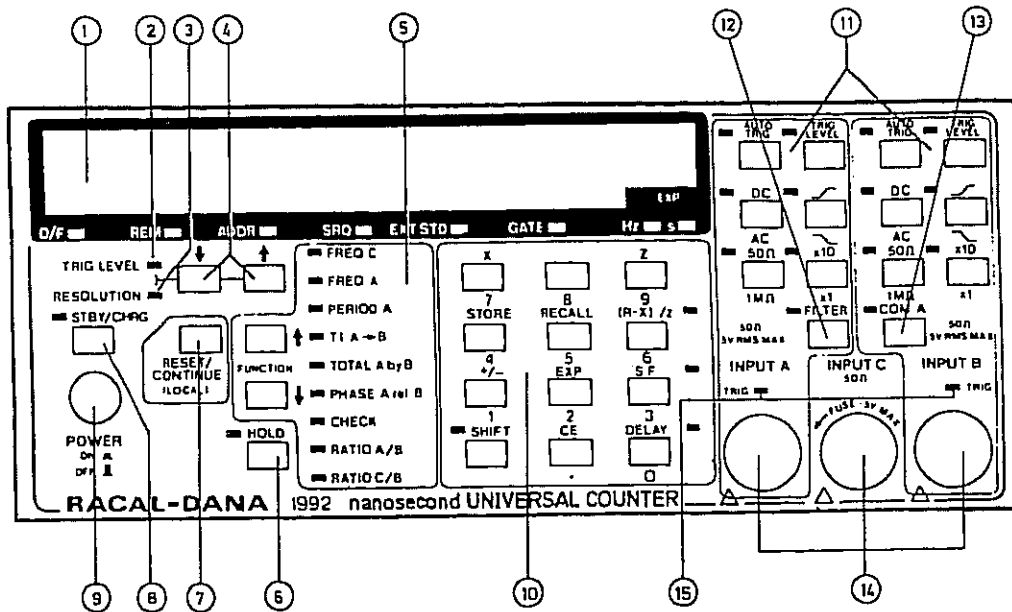

DESCRIPTION OF CONTROLS, INDICATORS AND CONNECTORS

Front Panel Items

2

Reference	Item	Description
①	Display	A 7-segment, LED, digital display, used to display: (1) The result of a measurement. (2) A number awaiting entry into an internal store. (3) A number recalled from an internal store. (4) Error indications.

Reference	Item	Description
	<p>O/F Indicator</p> <p>REM Indicator</p> <p>ADDR Indicator</p> <p>SRQ Indicator</p> <p>EXT STD Indicator</p> <p>GATE Indicator</p> <p>Display Units Indicators</p>	<p>The display format is in engineering format, with a 9-digit mantissa and a 1-digit exponent. The exponent is normally a multiple of three.</p> <p>The exponent digit is blanked, and should be assumed to be zero, for:</p> <p>(1) Display of phase mode measurement results.</p> <p>(2) Totalize measurement results having less than ten digits.</p> <p>(3) Numbers not involving an exponent which have been entered using the numeric keypad.</p> <p>Lights when the measurement result has overflowed the ninth digit of the display.</p> <p>Lights when the instrument is operating under remote control.</p> <p>Lights when the instrument is acting as a listener or as a talker.</p> <p>Lights when the instrument generates a service request.</p> <p>Lights when the instrument is operating from an external frequency standard.</p> <p>Lights while a measurement cycle is in progress.</p> <p>The Hz indicator lights for a frequency display. The s indicator lights for a time display. Neither indicator lights for a display of phase angle, ratio, total, trigger level or a number.</p>
②	TRIG LEVEL Control Indicator	Lights when a trigger level is being displayed. The displayed trigger level can be stepped up or down using the ↑ and ↓ keys, or can be changed using the numeric keyboard.

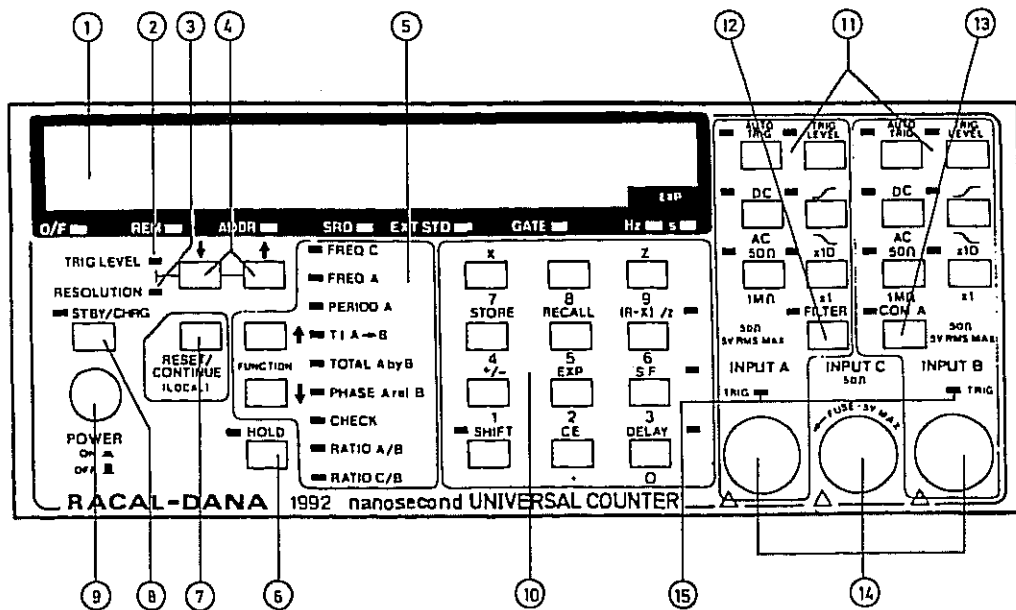

Reference	Item	Description
③	RESOLUTION Control Indicator	Lights to show that the resolution of the display, and, therefore, the measurement period (gate time) can be changed by means of the \uparrow or \downarrow control keys.
④	Step-Up \uparrow and Step-Down \downarrow Keys	Used to step the display resolution or the displayed value of trigger level up or down.
⑤	Function Selector	The functions can be selected in turn using the FUNCTION \uparrow and \downarrow keys. The function selection 'wraps round' at both ends.
⑥	HOLD Key	Successive operations put the instrument into and out of the Hold (single-shot measurement) mode. The indicator lights when the instrument is in the Hold mode. Readings are triggered using the RESET key. When the instrument is in the Manual Totalize mode (using special function 61) successive operations of the key start and stop the measurement cycle.

Reference	Item	Description
⑦	RESET/CONTINUE (LOCAL) Key	<p>This key has three functions.</p> <p>RESET Clears the display and triggers a new measurement cycle when the instrument is in the measurement mode.</p> <p>CONTINUE Returns the instrument to the measurement mode and triggers a measurement cycle, following the display of a number recalled from store. It can also be used to clear the OP Er indication.</p> <p>LOCAL Returns the instrument to local control from remote GPIB control provided local lockout is not set.</p>
⑧	STBY/CHRG Key	<p>Successive operations switch the instrument into and out of the standby state. The indicator lights when the instrument is in the standby state.</p> <p>If the battery pack option is installed the indicator flashes when the battery approaches the discharged state. The battery is charged at the full rate when the instrument is in standby and external power is applied.</p>
⑨	POWER Switch	Controls the AC or DC power to the instrument.
⑩	Numeric Keypad	Used to enter numbers into, and recall numbers from, the instrument's internal stores. Also used to enable and disable the math function, the special functions and the stop circuit arming delay (hold off).

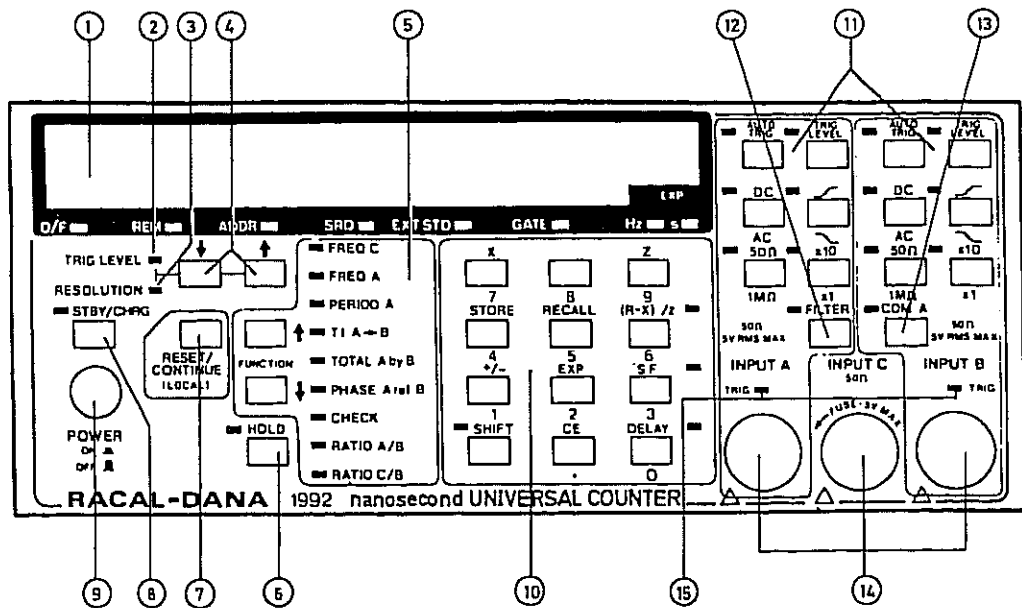

Reference	Item	Description
⑪	Measurement Channel Controls	The A and B channels have identical control keys.
	AUTO TRIG Key	Used to select auto-trigger level or manual trigger level. The indicator lights when auto-trigger level is selected.
	TRIG LEVEL Key	Successive operations display the trigger level in use and store the displayed trigger level. The indicator flashes when the trigger level is being displayed. (The trigger level control indicator ② will also light).
	AC/DC Key	Used to select AC or DC coupling of the input signal. The indicator lights when DC coupling is selected.
	Trigger Slope Key	Used to select the positive-going, \nearrow or negative-going, \searrow , edge of the input waveform for triggering. The indicator lights when the positive-going edge is selected.
	50 Ω /1 M Ω Key	Used to select 50 Ω or 1 M Ω input impedance. The indicator lights when 50 Ω is selected.

Reference	Item	Description
	X10/X1 Key	Used to select attenuation of the input signal. With X10 selected the input is attenuated by a factor of 10. The indicator lights when X10 is selected.
⑫	FILTER Key	Successive operations enable and disable the channel A input filter. The indicator lights when the filter is enabled.
⑬	COM A Key	<p>Used to connect the channel A input to channels A and B in parallel (common configuration). The indicator lights when the common configuration is selected. The channel A AUTO TRIG key controls both channels, the channel B AUTO TRIG key being rendered inoperative. The channel B AUTO TRIG indicator follows the state of the channel A indicator.</p> <p>Both channels adopt the same trigger level with auto-trigger level selected. Different trigger levels can be set in the two channels when manual trigger level is selected.</p> <p>The channel A 50 Ω/1 MΩ, X10/X1 and DC/AC keys control both channels. The channel B X10/X1 and DC/AC indicators follow the state of the channel A indicators. The channel B 50 Ω/1 MΩ indicator continues to show the impedance of the channel B input.</p>
⑭	Input Connectors	All inputs are BNC connectors.
⑮	TRIG Indicators	<p>Channels A and B are provided with trigger indicators.</p> <p>(1) Indicator permanently lit. Trigger level too low or signal input held in high state.</p> <p>(2) Indicator flashing. Channel being triggered.</p> <p>(3) Indicator permanently off. Trigger level too high or signal input held in low state.</p>

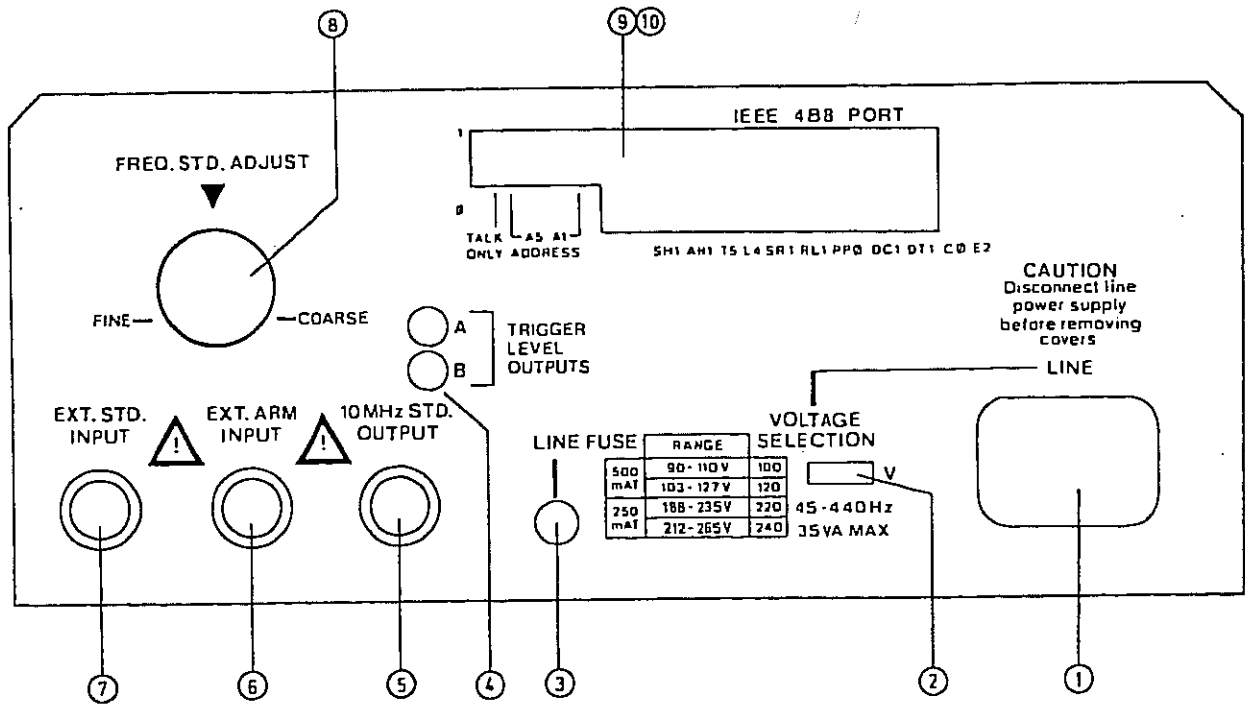

Rear Panel Items

3

Reference	Item	Description
①	AC Power Input Plug	A standard connector for the AC power supply. A RFI filter is incorporated.
②	Line Voltage Selector	Voltage selection is changed by repositioning a printed circuit board inside the instrument. The voltage selected can be seen through the window.
③	Line Fuse	A $\frac{1}{4}$ in x $1\frac{1}{4}$ in, anti-surge, glass cartridge fuse. The required fuse ratings for different line voltage ranges are shown on the panel and in Section 3 of this manual.
④	Trigger Level Output	The trigger levels in use on the channels A and B are available at two pins. The voltage range is ± 5.1 V, regardless of whether or not the X10 attenuator is selected.

Reference	Item	Description
⑤	10 MHz STD OUTPUT	A BNC connector, providing a 10MHz signal locked to the frequency standard in use.
⑥	EXT ARM INPUT	A BNC connector for accepting external arming signals.
⑦	EXT STD INPUT	A BNC connector for connecting an external frequency standard. The instrument will operate from the external frequency standard whenever a signal of suitable frequency and amplitude is applied. The frequency required is 10 MHz unless the reference frequency multiplier option is fitted. With this option, frequencies of 1 MHz, 2 MHz, 5 MHz and 10 MHz are acceptable.
⑧	FREQ. STD. ADJUST	This aperture provides access to allow adjustment of the internal frequency standard.
⑨	GPIB Option GPIB Address Switches GPIB Connector	Switches A1 to A5 define the listen and talk addresses for GPIB operation in the addressed mode. The talk-only switch must be in the '0' position. With the talk-only switch in the '1' position the instrument is set to the talk-only condition. The positions of switches A1 to A5 are then irrelevant. An IEEE-488-1978 standard connector used to connect the instrument to the GPIB. An adapter, Racal-Dana part number 23-3254, to convert the connector to the IEC 625-1 standard is available as an accessory.

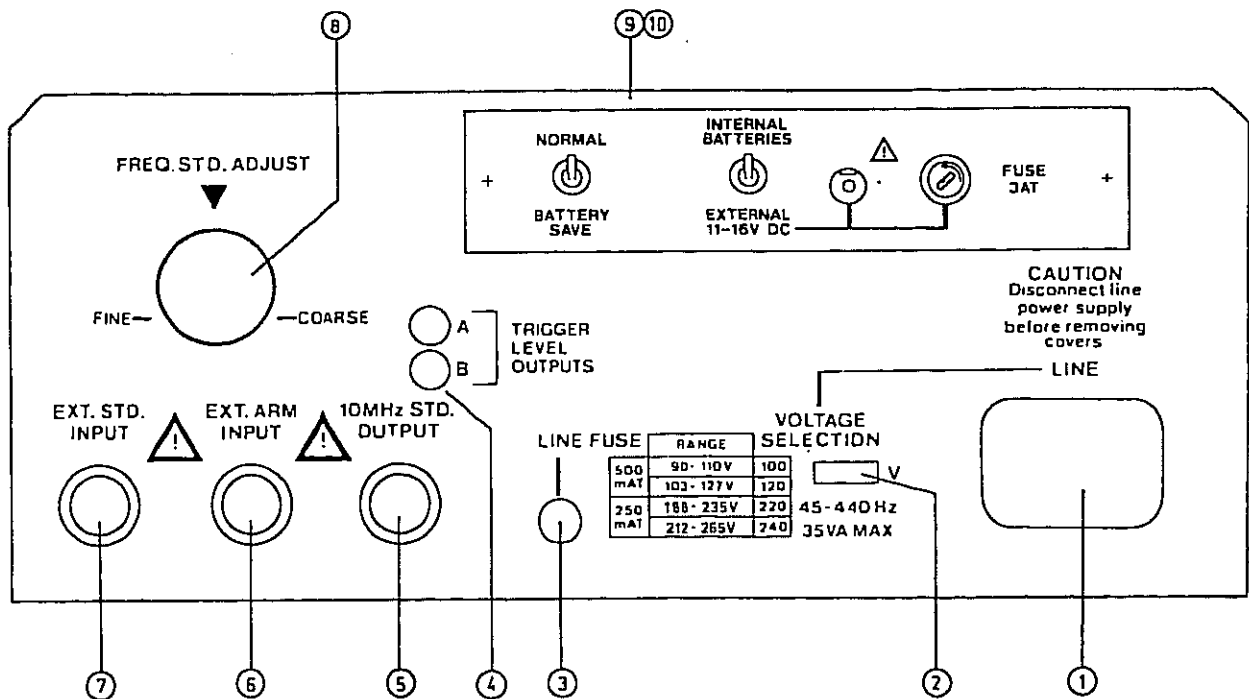

Reference	Item	Description
⑩	Battery-Pack Option DC Power Input Plug Battery NORMAL/SAVE Switch INTERNAL/EXTERNAL DC Supply Switch DC Supply Fuse	Permits the instrument power to be derived from an external DC supply. Used to select the Battery-Save facility. Used to select operation from the internal battery or an external DC supply A ¼ in x 1¼ in glass cartridge fuse of the anti-surge type. The required rating is 3 AT.

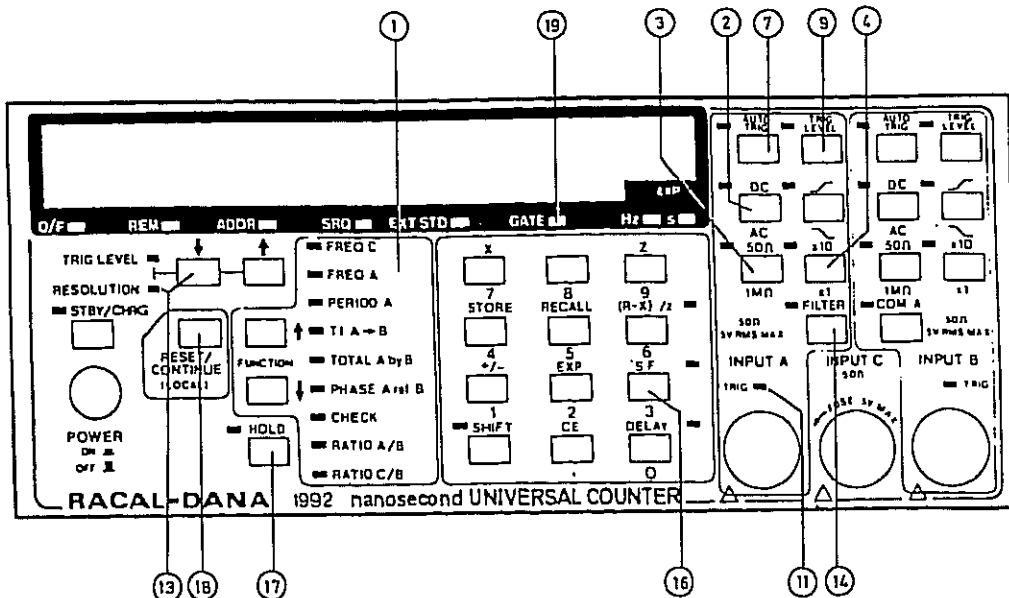

FREQUENCY MEASUREMENT

- 4 (1) Switch the power on.
 - (2) Select the FREQ A or FREQ C (Model 1992 only) measurement mode, using the function selector (1).
 - (3) If channel A is to be used, set the AC/DC coupling (2), input impedance (3), and attenuator (4) as required.
 - (4) Connect the signal to be measured to the channel A or C input.
- CAUTION: SIGNAL LEVEL**
ENSURE THAT THE INPUT SIGNAL DOES NOT EXCEED THE DAMAGE LEVELS SPECIFIED IN SECTION 1 OF THIS MANUAL.
- (5) If channel A is used, select auto-trigger (7), or set the manual trigger level to the required value (9). Check that the channel A TRIG indicator (11) flashes.
 - (6) Select the required display resolution (13).
 - (7) If a frequency below 50 kHz is to be measured in the presence of noise, enable the filter (14).
 - (8) If external arming is to be used, connect the arming signal and enter the required special function number. Enable the special functions (16).
 - (9) If operation in the hold mode is required, select HOLD (17) and press the RESET key (18).
 - (10) Check that the GATE indicator (19) flashes on during the measurement period.

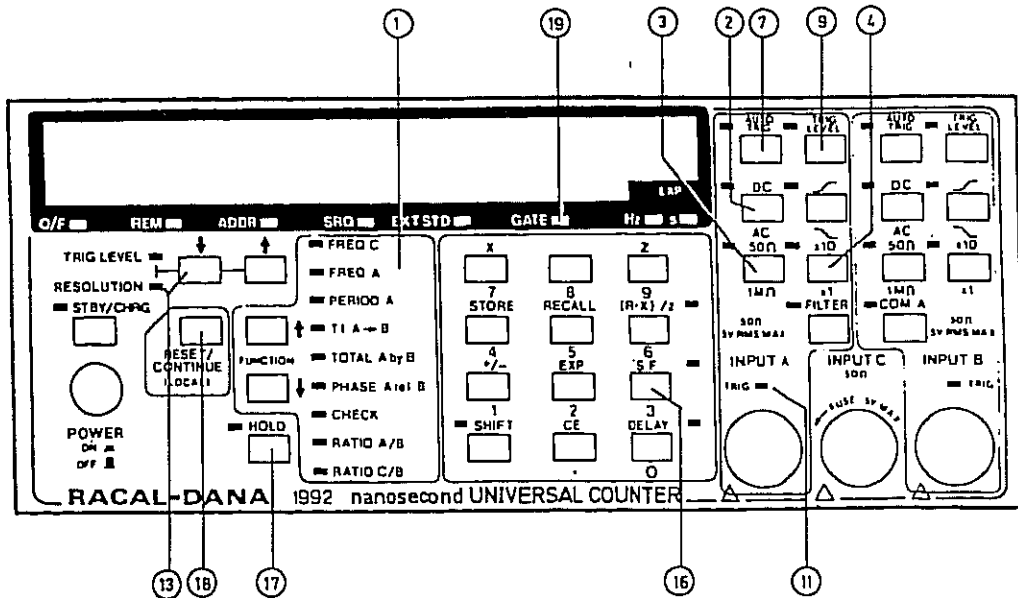

PERIOD MEASUREMENT

- 5 (1) Switch the power on.
- (2) Select the PERIOD A measurement mode, using the function selector ① .
- (3) Set the AC/DC coupling ② , input impedance ③ , and attenuator ④ for channel A, as required.
- (4) Connect the signal to be measured to the channel A input.

CAUTION: SIGNAL LEVEL

ENSURE THAT THE INPUT SIGNAL LEVEL DOES NOT EXCEED THE DAMAGE LEVELS SPECIFIED IN SECTION 1 OF THIS MANUAL.

- (5) Select auto-trigger ⑦ , or set the manual trigger level to the required value ⑨ . Check that the channel A TRIG indicator 11 flashes.
- (6) Select the required display resolution ⑬ .
- (7) If external arming is to be used, connect the arming signal and enter the required special function number. Enable the special functions ⑯ .
- (8) If hold mode operation is required, select HOLD ⑰ and press the RESET key ⑱ .
- (9) Check that the GATE indicator ⑲ flashes on during the measurement period.

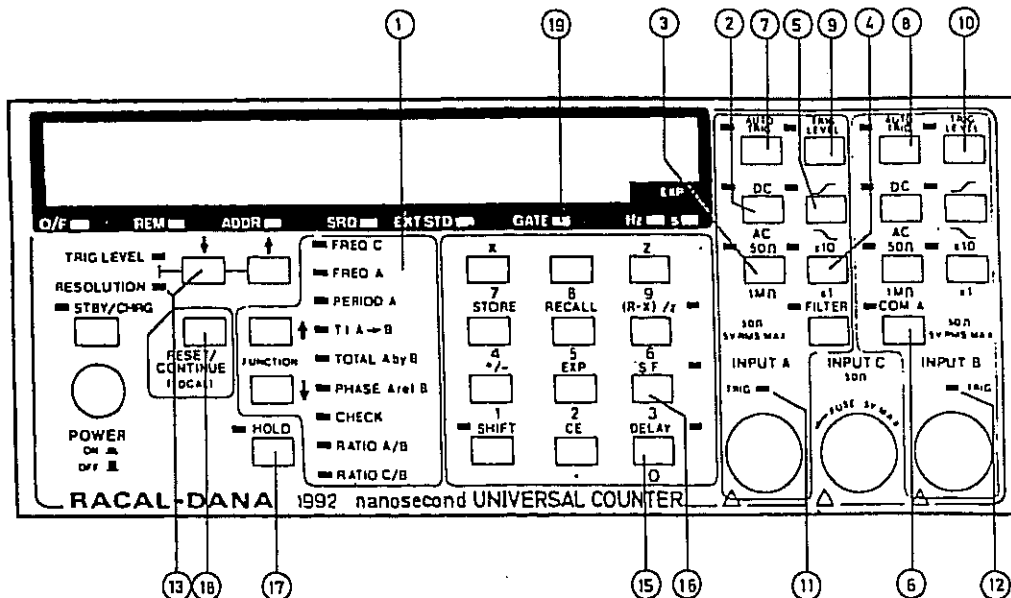

TIME INTERVAL MEASUREMENT

- 6
- (1) Switch the power on.
 - (2) Select the T.I. A → B measurement mode, using the function selector ①.
 - (3) Set the AC/DC coupling ②, input impedance ③, attenuator ④, and slope ⑤, as required. If the start and stop signals are from the same source, select COM A ⑥.
 - (4) Connect the start signal to the channel A input. If a separate stop-signal source is used, connect the stop signal to the channel B input and set the associated input controls.
- CAUTION: SIGNAL LEVEL**
ENSURE THAT THE INPUT SIGNALS DO NOT EXCEED THE DAMAGE LEVELS SPECIFIED IN SECTION 1 OF THIS MANUAL.
- (5) Select auto-trigger ⑦ ⑧, or set the manual trigger levels to the required values ⑨ ⑩. Check that the TRIG indicators ⑪ ⑫ flash.
 - (6) Select the required display resolution ⑬.
 - (7) If a delay to the stop circuit is required, enter the required delay in the delay store and enable the delay ⑮.
 - (8) If external arming is to be used, connect the arming signal and enter the required special function number. Enable the special functions ⑯.
 - (9) If hold mode operation is required, select HOLD ⑰ and press the RESET key ⑱.
 - (10) Check that the GATE indicator ⑲ flashes on during the measurement period.

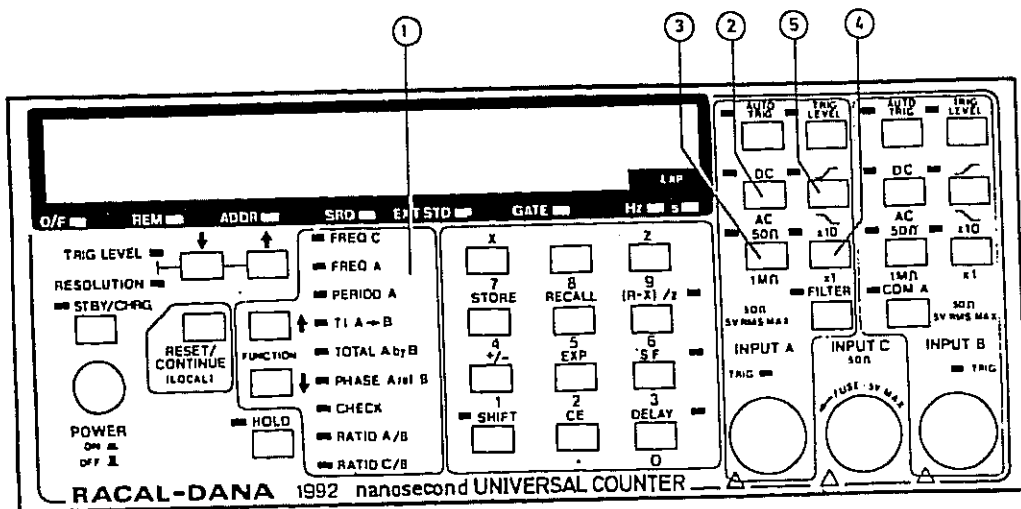

TOTALIZE MEASUREMENT

Total A by B

7

- (1) Switch the power on.
- (2) Select the TOTAL A by B measurement mode using the function selector ①.
- (3) Set the AC/DC coupling ②, input impedance ③, attenuator ④ and slope ⑤ as required for both channels.

NOTE:

The channel A slope switch selects the slope of the events which are counted. The measurement period starts on the slope of the B channel signal selected by the channel B slope switch, and stops on the opposite slope.

- (4) Connect the signal to be totalized to the channel A input and the control signal to the channel B input.

CAUTION: SIGNAL LEVELS

ENSURE THAT THE SIGNAL LEVELS DO NOT EXCEED THE DAMAGE LEVELS SPECIFIED IN SECTION 1 OF THIS MANUAL.

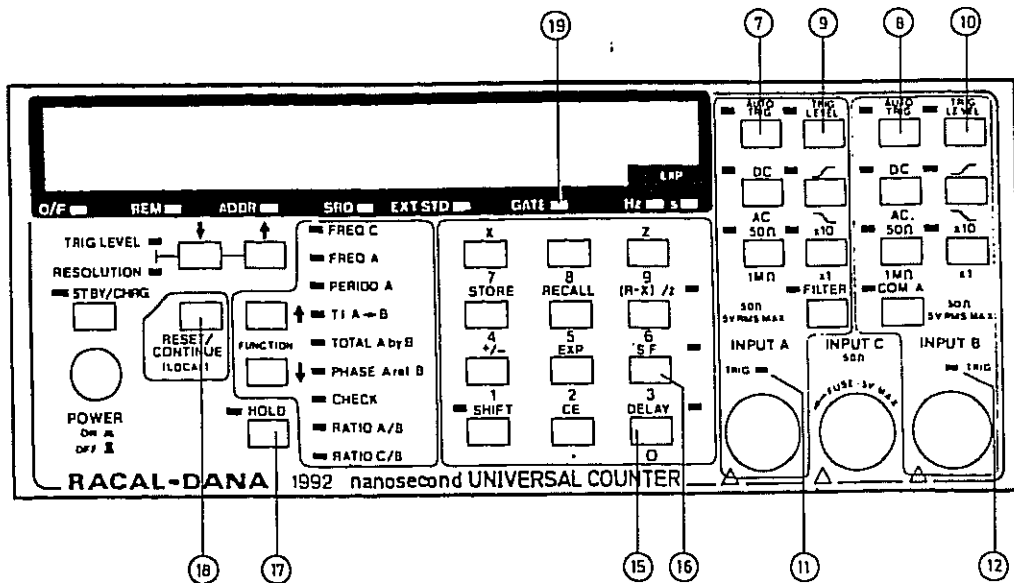

- (5) Select auto-trigger (7) (8), or set the manual trigger levels to the required values (9) (10). Check that the TRIG indicators (11) (12) flash.
- (6) If a delay to the stop circuit is to be used, enter the required delay into the delay store and enable the delay (15).
- (7) If external arming is to be used, connect the arming signal and enter the required special function number. Enable the special functions (16).
- (8) If hold mode operation is required, select HOLD (17) and RESET (18).
- (9) Trigger a measurement cycle. Check that the GATE indicator (19) flashes on during the measurement period.

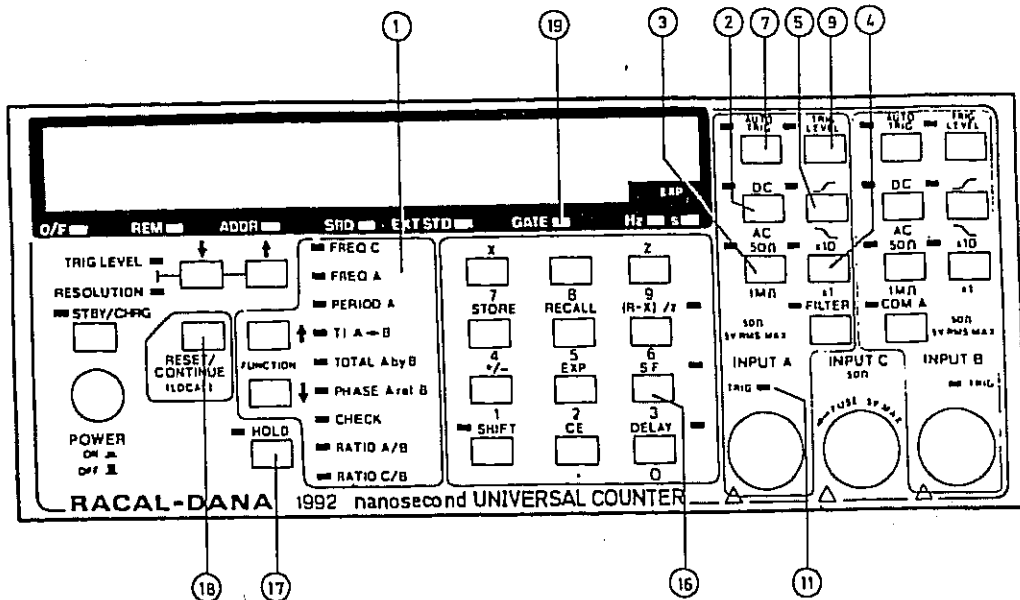

Manual Totalize

8

- (1) Switch the power on.
- (2) Select the TOTAL A by B measurement mode, using the function selector ①.
- (3) Set the AC/DC coupling ②, input impedance ③, attenuator ④ and slope ⑤ of channel A as required.
- (4) Enter 61 in the special function register and enable the special functions ⑬. The HOLD indicator ⑫ will light.
- (5) Connect the signal to be totalized to the channel A input.

CAUTION: SIGNAL LEVEL

ENSURE THAT THE INPUT SIGNAL DOES NOT EXCEED THE DAMAGE LEVELS SPECIFIED IN SECTION 1 OF THIS MANUAL.

- (6) Select auto-trigger ⑦, or set the manual trigger level to the required value ⑨. Check that the TRIG indicator ⑪ flashes.
- (7) Start and stop a measurement using the HOLD key ⑫. The HOLD indicator will be turned off and the GATE indicator ⑰ will light during the measurement period. The displayed result is cumulative over successive measurement cycles. If required, clear the display after a measurement cycle by pressing the RESET key ⑱.

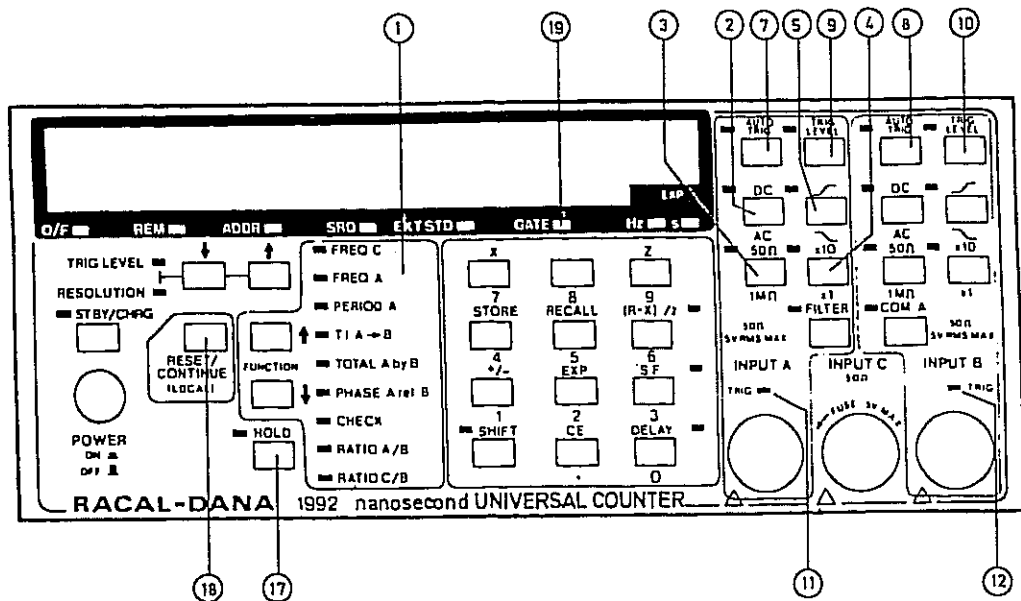

PHASE MEASUREMENT

- 9
- (1) Switch the power on.
 - (2) Select the PHASE A rel B measurement mode, using the function selector ① .
 - (3) Set the AC/DC coupling ② , input impedance ③ , attenuator ④ and slope ⑤ as required.
 - (4) Connect the signals to be compared to the channel A and B inputs (the larger and cleaner signal to channel A for maximum accuracy).

CAUTION SIGNAL LEVELS

ENSURE THAT THE INPUT SIGNALS DO NOT EXCEED THE DAMAGE LEVELS SPECIFIED IN SECTION 1 OF THIS MANUAL.

- (5) Select auto-trigger ⑦ ⑧ , or set the manual trigger levels to the required values ⑨ ⑩ . Check that the TRIG indicators ⑪ ⑫ flash.
- (6) If hold mode operation is required, select HOLD ⑰ and press the RESET key ⑱ .
- (7) Check that the GATE indicator ⑲ flashes on during the measurement cycle.

NOTE:

The phase measurement is always positive, and is the angle by which the signal applied to channel A leads that applied to channel B.

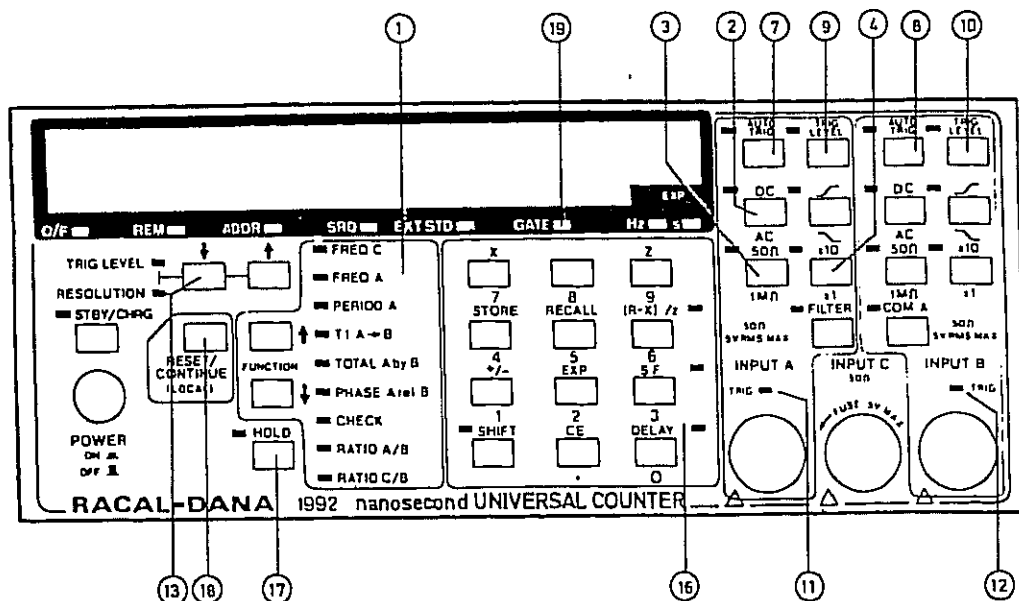

RATIO MEASUREMENT

- 10 (1) Switch the power on.
- (2) Select the RATIO A/B or RATIO C/B (1992 only) measurement mode, using the function selector ① .
- (3) Set the AC/DC coupling ② , input impedance ③ , and attenuator ④ as required.
- (4) Connect one of the signals to channel B and the other to channel A or C. The lower frequency signal should be connected to channel B.

CAUTION: SIGNAL LEVEL

ENSURE THAT THE INPUT SIGNALS DO NOT EXCEED THE DAMAGE LEVELS SPECIFIED IN SECTION 1 OF THIS MANUAL.

- (5) Select auto-trigger ⑦ ⑧, or set the manual trigger levels to the required values ⑨ ⑩. Check that the TRIG indicators ⑪ ⑫ flash.
- (6) Select the required display resolution ⑬ .
- (7) If external arming is to be used, connect the arming signal and enter the required special function number. Enable the special functions ⑯ .
- (8) If hold mode operation is required, select HOLD ⑰ and press the RESET key ⑱ .
- (9) Check that the GATE indicator ⑲ flashes on during the measurement period.

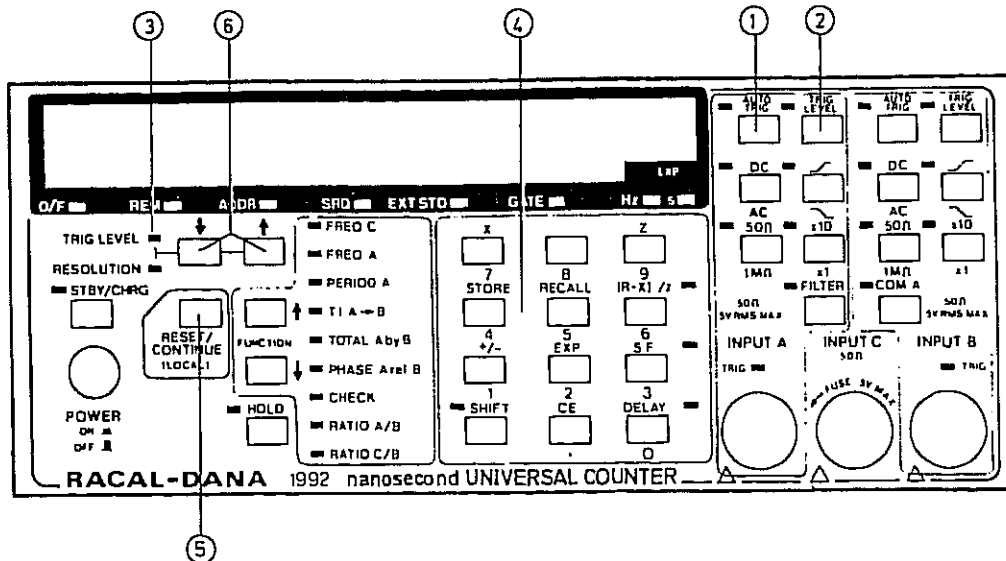

TRIGGER LEVEL

Trigger Level Modes

- 11 The trigger level may be set by the operator (manual trigger level) or determined automatically by the instrument (auto-trigger level). The auto-trigger level is the arithmetic mean of the positive and negative-peak values of the input signal. The two modes are enabled alternately by successive operations of the AUTO TRIG key ①. The indicator lights when the auto-trigger mode is selected.

Displaying and Setting the Manual Trigger Level

- 12 (1) Select the manual trigger mode using the AUTO TRIG key ①.
- (2) Display the trigger level by pressing the TRIG LEVEL key ②. The associated indicator will flash and the trigger level control indicator ③ will light.
- (3) To change the trigger level:
- (a) Enter the required value, using the numeric keypad ④.

NOTE:

Up to this point the instrument can be returned to the measurement mode with the trigger level unchanged by pressing the CONTINUE key ⑤,

or

- (b) Use the step up ↑ or step down ↓ control key ⑥.

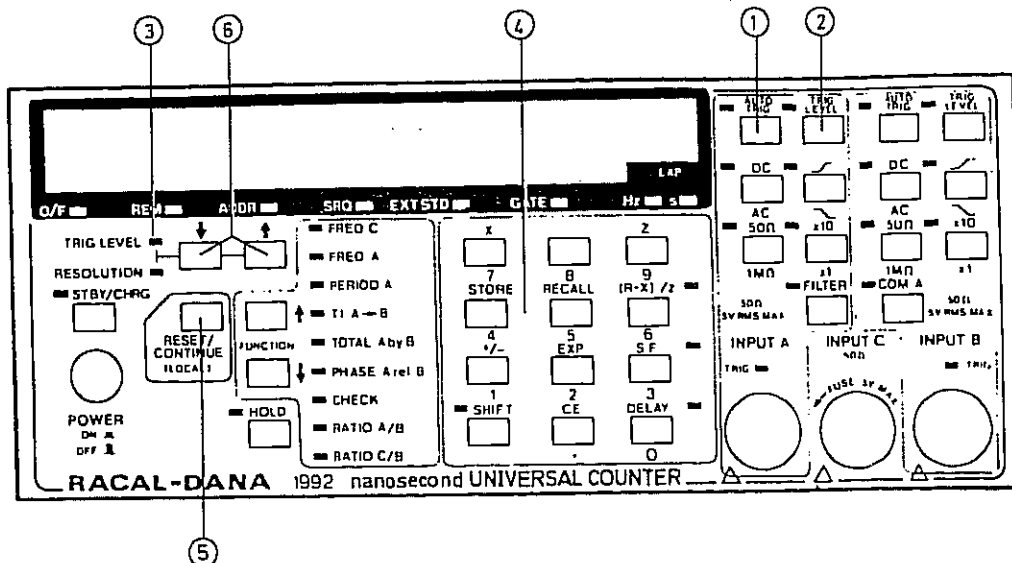

- (4) Return the instrument to the measurement mode by pressing the TRIG LEVEL key (2). The TRIG LEVEL indicator and the trigger level control indicator (3) will go out.

NOTE:

There is only one trigger level store for each channel. Use of the auto-trigger mode will result in the manual trigger level being overwritten.

Displaying the Auto-Trigger Level

- 13 (1) Select the auto-trigger mode, using the AUTO TRIG key (1).
- (2) Display the auto-trigger level by pressing the TRIG LEVEL key (2). The associated indicator will flash and the trigger level control indicator (3) will light.

NOTE:

Any attempt to make a numerical entry while the auto-trigger level is being displayed will cause the OP Er message to be displayed.

- (3) Return the instrument to the measurement mode by pressing the TRIG LEVEL key (2) or the CONTINUE key (5). The TRIG LEVEL indicator and the trigger level control indicator (3) will go out.

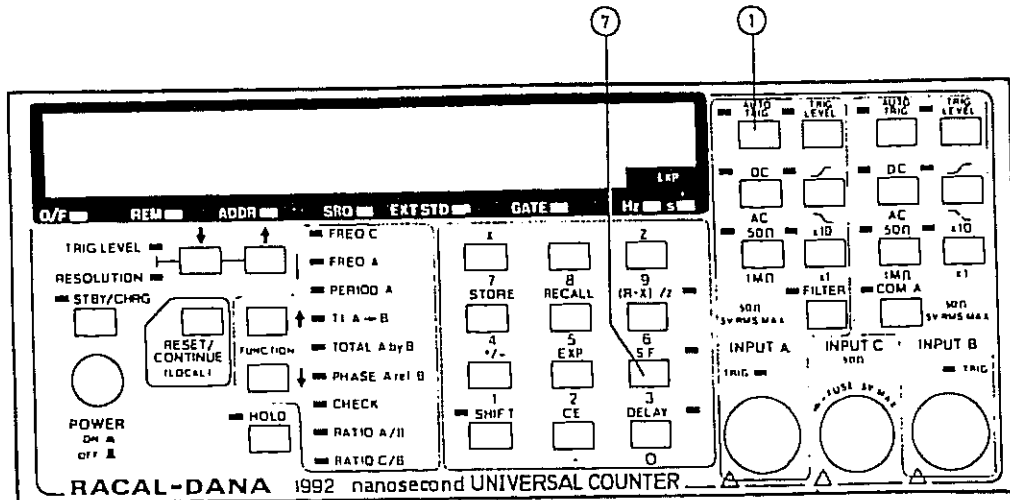

Single-Shot Auto-Trigger Level

14 The auto-trigger level is normally measured continuously, and varies if the peak levels of the signal change. A single-shot measurement of auto-trigger level can be made using special function 31. This value remains stored as a manual trigger level until:

- (1) Another single-shot measurement is made, or
- (2) A new manual trigger level is entered.

15 To make a single-shot measurement of auto-trigger level:

- (1) Enter 31 in the special function register ⑦ .
- (2) Enable the special functions ⑦ .
- (3) Select AUTO TRIG ① . The associated indicator lights while the level is calculated and stored, and is then turned off.

Further one-shot measurements are made by selecting AUTO TRIG with special function 31 active.

Automatic Attenuation Setting

16 When operating in the auto-trigger mode, automatic switching of the X10 attenuator occurs as follows:

- (1) The attenuator is switched in if the peak-to-peak value of the measured signal exceeds 5.1 V or if either peak is outside the range ± 5.1 V.
- (2) The attenuator is switched out if the peak-to-peak value of the measured signal is less than 4.6 V and both peaks are within the range ± 4.6 V.

DISPLAY RESOLUTION

- 17 For all measurement functions other than TOTAL A by B and PHASE A rel B, the resolution refers to the number of zeros displayed when no signal is applied at the input. The resolution can be set to display 3 to 10 digits. (For a resolution of 10, the most significant digit overflows the display). A 10% overrange of the display is permitted without a change of range. Because of this, an additional digit with a value of 1 may appear at the more significant end of the display when measurements are made.
- 18 With some measurement functions, the number of digits appearing may be less than the selected resolution to ensure they are rounded to meaningful values.
- 19 When ratio measurements are made, no more than eight digits are displayed, regardless of the resolution selected.
- 20 For the TOTAL A by B measurement function the display shows the true total of events counted from 1 to 999 999 999. For higher totals the exponent is used.
- 21 For the PHASE A rel B measurement, up to four digits may be displayed for frequencies up to 1 MHz and up to three digits for higher frequencies. Leading zeros are suppressed. For frequencies above 10 MHz the resolution of the display is 10^0 , and a place-holding zero is displayed as the least-significant digit.

Setting the Display Resolution

- 22 Whenever the resolution control indicator is lit, the resolution can be changed using the step-up \uparrow and step-down \downarrow keys. To step up from nine to ten digits, the step up key must be held for approximately two seconds.

Resolution With External Stop Circuit Arming

- 23 When external arming of the stop circuit is used, the minimum display resolution is governed by the arming period, as shown in Table 4.1.

TABLE 4.1

Resolution With External Arming

Arming Period	Minimum Resolution
Less than 100 μ s	4
100 μ s to 1 ms	5
1 ms to 10 ms	6
10 ms to 100 ms	7
100 ms to 1 s	8
1 s to 10 s	9

GATE TIME

- 24 For the frequency, period and ratio measurement functions, the gate time is related to the resolution selected, as shown in Table 4.2.

TABLE 4.2
Resolution and Gate Time

Resolution	Gate Time
.10 (9 digits + overflow)	10 s
9	1 s
8	100 ms (see NOTE 2)
7	10 ms
6	1 ms
5	1 ms
4	1 ms
3	1 ms

NOTE 1:

The gate times shown are nominal. Due to the use of the recipromatic counting technique the gate time may be extended by:

- (a) Up to one period of the input signal on FREQ B and RATIO A/B.
- (b) Up to two periods of the input signal on FREQ A and PERIOD A.
- (c) Up to 64 periods of the input signal on FREQ C and RATIO C/B.

NOTE 2:

A resolution of 8 is selected when the instrument is first switched on.

NOTE 3:

With resolutions of 3, 4 and 5 selected, measurements are averaged.

- 25 For the PHASE A rel B measurement function the gate time depends upon the signal frequency. The gate time is approximately 25 ms for frequencies above 200 Hz, but will be increased at lower frequencies.

STOP CIRCUIT DELAY (HOLD OFF)

Use of the Delay

- 26 The stop circuit can be delayed when the T.I. A \rightarrow B or the TOTAL A by B measurement function is selected. The required delay is entered into an internal store by the operator. The delay function can then be enabled and disabled as required. The delay is set to 204.8 μ s (minimum delay) when the instrument is first switched on.
- 27 The delay can be used to prevent the stop circuit being triggered prematurely by spurious signals, such as those resulting from contact bounce. The principle is shown in Fig 4.1.

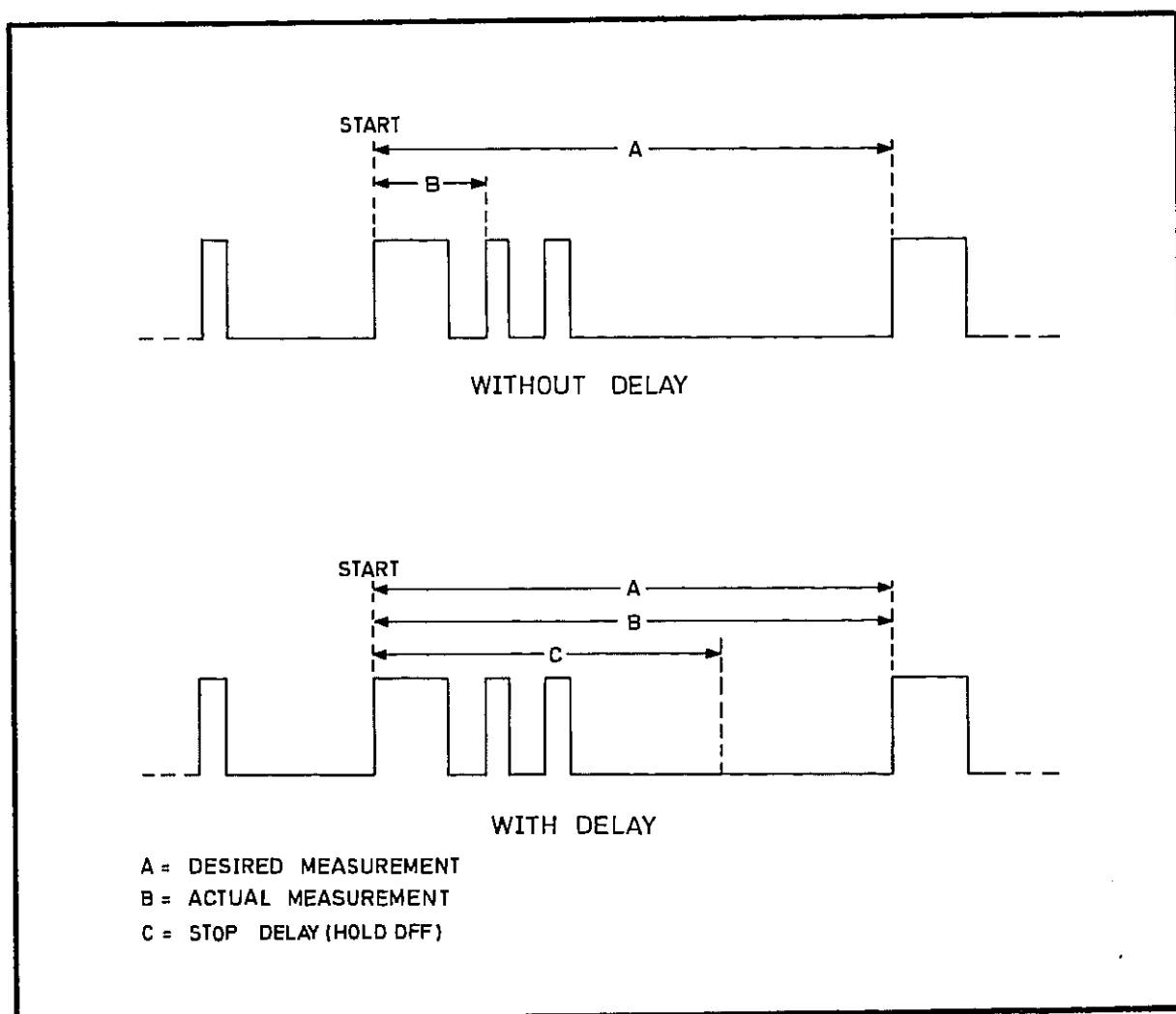

Fig 4.1 Use of Stop Circuit Delay

Displaying the Delay

- 28 The value of delay held in the store can be displayed by pressing

SHIFT **RECALL** **DELAY** .

Changing the Delay

- 29 A new value is entered into the delay store using the numeric keypad. Either direct decimal or exponential format may be used. For example, a delay of 305 μ s may be entered using

. **0** **0** **0** **3** **0** **5** **SHIFT** **STORE** **DELAY**

or **3** **0** **5** **SHIFT** **EXP** **6** **SHIFT** **+/-** **SHIFT** **STORE** **DELAY** .

The instrument returns to the measurement mode automatically once the new delay value is stored.

- 30 The value of delay entered is rounded to the nearest 25.6 μ s before it is stored. The permitted range of delay is from 204.8 μ s to 800 ms. Attempted entry of an out-of-range value will result in the display of OP Er (operator error). The number in the delay store is retained when the instrument is switched to standby.

Enabling and Disabling the Delay

- 31 The stop delay is enabled and disabled by means of the key sequence

SHIFT **DELAY** .

The DELAY indicator lights when the delay is enabled.

SPECIAL FUNCTIONS

Special Function Numbering

- 32 The special functions provided for use by the operator are listed in Table 4.3. Each special function is defined by a two-digit number.

Special Function Register

- 33 One special function from each decade is entered into a special function register. Only the second digit is stored: the decade is indicated by the position of the digit in the register. The default state is with 0 entered in each position. The contents of the register can be displayed by pressing

SHIFT **RECALL** **SF** .

A typical display is illustrated in Fig 4.2.

TABLE 4.3

Special Functions

Function Number	Function		
10	Arming	Start Internal	Stop Internal
11		External +ve	Internal
12		External -ve	Internal
13		Internal	External +ve
14		Internal	External -ve
15		External +ve	External +ve
16		External +ve	External -ve
17		External -ve	External +ve
18		External -ve	External -ve
20	Normal operation		
21	Channels A and B interchanged (see NOTE 1)		
30	Continuous measurement of auto-trigger level		
31	One-shot measurement of auto-trigger level		
40	Display time between measurement cycles	[150ms 0 1s 10s 300s]	-(see NOTE 2)
41			
42			
43			
44			
50	Value displayed by operation of TRIG LEVEL	[Trigger level Signal positive peak Signal negative peak]	
51			
52			
60	Measurement made with TOTAL A by B selected	[Normal TOTAL A by B Manual Totalize]	
61			
70	Function with CHECK selected	[10 MHz check LED check]	
71			
72-76	Reserved for diagnostic testing		
77	Channel A relay check		
78	Channel B relay check		

NOTE 1:

Special function 21 permits FREQ B, PERIOD B, T.I. B → A, TOTAL B by A and Phase B rel A. For these functions:

- (1) FREQ B is specified to 100 MHz only.
- (2) PERIOD B is specified down to 10 ns
- (3) TOTAL B by A operates for one complete cycle of the channel A signal. The stop circuit delay is available on channel A.

NOTE 2:

Special functions 40, 42, 43 and 44 are only available when in local control. Special function 41 is selected automatically when in remote control.

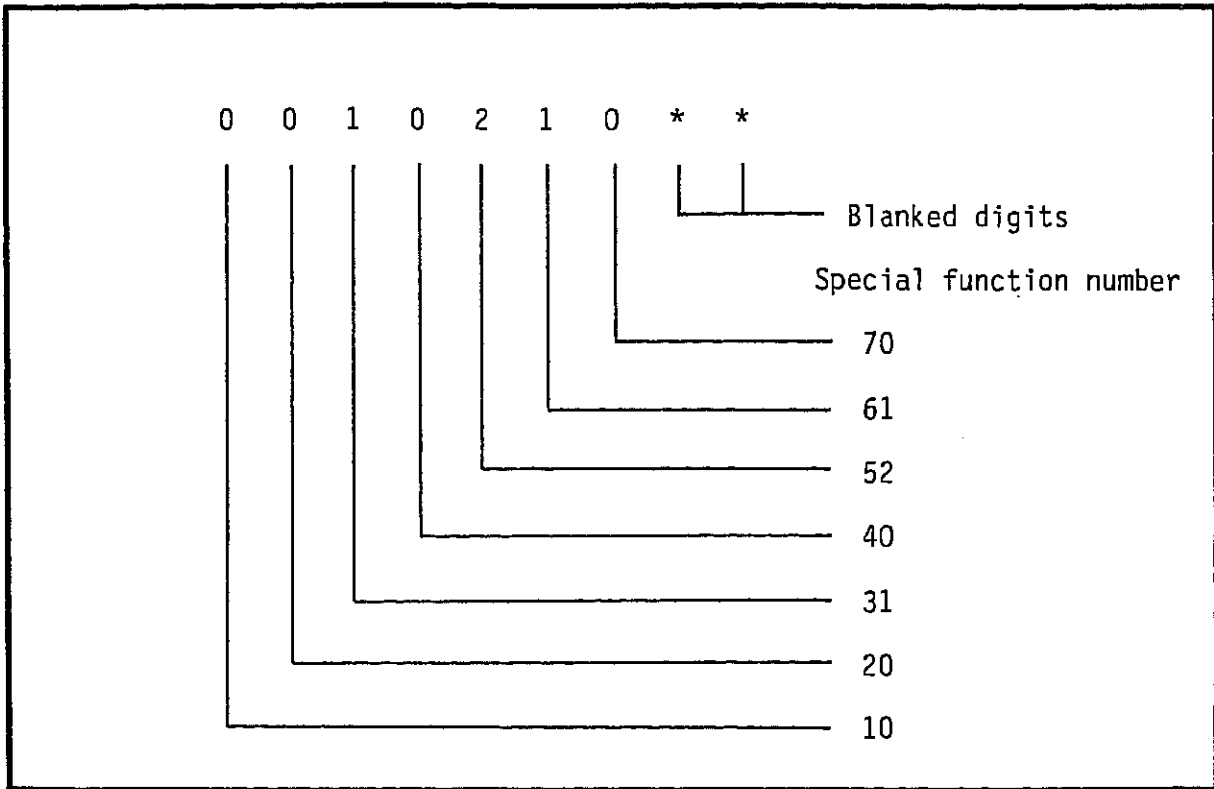

Fig 4.2 Special Function Register Display

Setting the Special Function Register

- 34 When a special function is to be used, its number must first be entered into the register. This is done by pressing

N
N
SHIFT
STORE
SF
.

where NN is the special function number to be entered. The digits enter the display as the keys are pressed. The instrument returns to the measurement mode automatically once the number is stored.

- 35 When a number is stored it overwrites the number stored in the same decade. To remove a number from the register, another number from the same decade must be stored.
- 36 The numbers stored in the register are retained while the instrument is switched to the standby mode.

Enabling and Disabling the Special Functions

- 37 The default state corresponds to the default state of the special function register, i.e., with special functions 10, 20, 30, 40, 50, 60 and 70 enabled. The group of special functions whose numbers are entered in the special function register are enabled and disabled by means of the key sequence

SHIFT
SF
.

The SF indicator lights when this group of special functions is enabled.

NOTE:

A special function entered in the register while the special functions are enabled will be enabled immediately.

ERROR CODES

38 The instrument is able to detect a number of error states, which are indicated on the display. The meanings of the error codes are shown in Table 4.4

TABLE 4.4
Error Codes

Display	Error
Er 01	Phase measurement attempted on signals of different frequencies.
Er 02	Measurement result too large for the display.
Er 03	Overflow of internal counters.
OP Er	Error in numerical entry.
Er 50	Incorrect result obtained when in check mode.
Er 51	<div style="display: flex; align-items: center; justify-content: center;"> <div style="border-left: 1px solid black; border-right: 1px solid black; padding: 0 10px;">Relay or amplifier failure</div> <div style="margin: 0 10px;">}</div> <div style="display: flex; flex-direction: column; align-items: center;"> <div style="margin-bottom: 10px;">Channel A</div> <div style="margin-bottom: 10px;">COM A</div> <div>Channel B</div> </div> <div style="margin-left: 10px;">{</div> <div style="display: flex; flex-direction: column; align-items: center;"> <div style="margin-bottom: 10px;">X10/X1</div> <div style="margin-bottom: 10px;">50 Ω/1 MΩ</div> <div style="margin-bottom: 10px;">DC/AC</div> <div>FILTER</div> <div style="margin-bottom: 10px;">X10/X1</div> <div style="margin-bottom: 10px;">50 Ω/1 MΩ</div> <div>DC/AC</div> </div> </div>
Er 52	
Er 53	
Er 54	
Er 55	
Er 56	
Er 57	
Er 58	
Er 60	Microprocessor paging fault
Er 61	Microprocessor RAM fault

NOTE:

Error codes Er 51 to Er 55 will only be generated with special function 77 active.

Error codes Er 56 to Er 58 will only be generated with special function 78 active.

Clearing the Error Codes

39 Error code Er 01 is cleared by:

- (1) Making a phase measurement on signals of equal frequency.
- (2) Selecting another measurement function.

Error codes Er 02 and Er 03 are cleared by:

- (1) Obtaining a measurement result that is within range.
- (2) Selecting another measurement function

OP Er is cleared by pressing **RESET**.

MATH FUNCTION

40 The math function may be used with all measurement functions except Phase A rel B and CHECK. Its use permits the measured value to be offset and/or scaled before being displayed.

41 When the maths function is active the display indicates
$$\frac{\text{Measurement result} - X}{Z}$$

where X and Z are values entered into stores within the instrument by the operator. When the instrument is first switched on, X is set to 0 and Z to 1.

NOTE:

It is possible to set the constant Z to zero. However, any attempt to use the math function with this value set will cause an error code to be generated.

42 Displays of ratio, offset (null) and percentage difference can be obtained by setting X and Z as shown in Table 4.5.

TABLE 4.5
Uses of Math Function

Function Displayed	X	Z
Ratio: Measurement/N	0	N
Offset: Measurement - N	N	1
Percentage difference: 100 (Measurement-N)/N	N	N/100

Displaying the Math Constants

43 The values held in the X and Z stores can be displayed by pressing

SHIFT **RECALL** **X** or
SHIFT **RECALL** **Z** .

Changing the Constants

44 New values are entered into the math-constant stores using the numeric keypad. Either direct decimal or exponential format may be used. For example, a value for X of 0.0231 may be entered using

. **0** **2** **3** **1** **SHIFT** **STORE** **X**
or **2** **3** **1** **SHIFT** **EXP** **4** **SHIFT** **+/-** **SHIFT** **STORE** **X** .

The instrument returns to the measurement mode automatically once the new value is stored.

45 The ranges of permissible values are:

(1) $1 \times 10^{-9} < Z < 1 \times 10^{10}$

(2) 0

(3) $-1 \times 10^{10} < Z < -1 \times 10^{-9}$

For negative numbers the ninth digit is available, but not displayed.

Enabling and Disabling the Math Function

46 The math function is enabled and disabled by means of the key sequence

SHIFT **(R-X)/Z** .

The (R-X)/Z indicator lights when the function is enabled.

EXTERNAL ARMING

47 This feature allows the start and/or stop point to be synchronized to a real time event or complex signal. Arming signal is connected to rear panel input and the relevant special function selected (Table 4.3). The measurement gate opening and closing are still determined by the input signal but can be conditioned (armed) by the external arming signal. Minimum start to stop external arming period is 50 μ s (80 μ s for RATIO A/B).

USING THE BATTERY PACK OPTION

Power Supply Changeover

- 48 When the battery pack option is installed, the instrument can be powered from the internal battery, an external DC supply of 11V to 16V, or an external AC supply. If the instrument is operating from either the DC supply or the battery, it will automatically change to operation from the AC supply when this is connected. The battery will not take over from either the AC or the DC supply if the supply fails. An external DC supply will not take over from the AC supply if the AC supply fails.

Battery-Low Indication

- 49 When the instrument is operating from the internal battery, or from an external DC supply, the STBY/CHRG indicator will start to flash as the supply voltage approaches the minimum permissible level. This occurs regardless of whether the instrument is in the standby mode or not. When operating from the battery, the instrument can be used in the measurement mode for approximately 15 minutes after the indicator commences flashing.
- 50 When the voltage of the battery or the external DC supply reaches the minimum permissible level, the instrument shuts down completely.

Operating Instructions

- 51 Instructions for preparing the instrument to make measurements are given in the following paragraphs. No other change in the operating procedure is required.

Operation From the Battery

- 52
- (1) Set the internal/external switch on the rear panel to INTERNAL BATTERIES.
 - (2) Set the BATTERY SAVE/NORMAL switch to NORMAL.
 - (3) Switch the instrument on.
 - (4) Check that the instrument goes through the normal switch-on sequence. If the STBY indicator is flashing, or if there is no display, charge the battery.
- 53 If the battery-save facility is to be used, set the BATTERY SAVE/NORMAL switch to BATTERY SAVE. The instrument will remain in the measurement mode for approximately one minute and will then switch to standby. It can be returned to the measurement mode for a further period of one minute by pressing the STBY/CHRG key.

Operation From an External DC Supply

- 54
- (1) Ensure that the instrument is switched off.
 - (2) Connect the DC supply to the DC power-input plug on the rear panel. The mating connector is a 2.1 mm coaxial socket.

CAUTION: SUPPLY POLARITY

THE POSITIVE SIDE OF THE SUPPLY MUST BE CONNECTED TO THE CENTER CONDUCTOR.

- (3) Set the internal/external switch on the rear panel to EXTERNAL 11-16V.
- (4) Switch the instrument on. Check that the instrument goes through the normal switch-on sequence.

Battery Charging

- 55
- The battery is trickle-charged whenever the instrument is operated from an AC supply and the internal/external switch is set to INTERNAL BATTERIES. To charge the battery at the full rate, connect the instrument to an external AC or DC supply and select the standby mode.

INTRODUCTION

- 1 The instrument must be prepared for use in accordance with the instructions given in Section 3. If the instrument is being used for the first time, or at a new location, pay particular attention to the setting of the AC line voltage selector.

GPIB OPERATING MODES

- 2 The instrument can be operated via the GPIB in either the addressed mode or the talk-only mode.

TALK-ONLY MODE

- 3 The talk-only mode may be used in systems which do not include a controller. Such a system permits remote reading of the instrument's measurement data, but the instrument is operated by means of the front-panel controls as described in Section 4.
- 4 The rate at which measurements are made is determined by the instrument. The output buffer is updated at the end of each measurement cycle, overwriting the previous measurement data if this has not been transferred to the listener.
- 5 The transfer of data from the instrument to the listener is triggered by the listener. The instrument's output buffer is cleared when the data transfer is complete. Problems arising from the differences between the measurement rate and data transfer trigger rate are resolved according to the following protocol:
 - (1) If data transfer is in progress at the end of a measurement cycle, the updating of the output buffer is delayed. The data transferred will relate to the previous measurement cycle.
 - (2) If the data transfer trigger occurs during a measurement cycle and the output buffer is empty, data transfer will be delayed until the buffer is updated. The data transferred will then relate to the latest measurement cycle.
 - (3) If a measurement cycle is completed before the results of the previous cycle have been transferred to the listener, the buffer will be updated. The data for the previous cycle will be overwritten and lost.

- 6 The rate at which measurements are made can be controlled in the following ways:
- (1) The gate time of the instrument (duration of the measurement cycle) can be controlled by choosing an appropriate display resolution.
 - (2) A time interval can be introduced between measurement cycles by using special functions 40 to 44.
 - (3) The instrument can be operated in the hold mode. Single measurement cycles can be triggered, when required, by means of the RESET key.
- 7 The format of the data output is described in Table 5.1.

ADDRESSED MODE

- 8 In addressed-mode operation, all the instrument's functions, except the power ON/OFF and standby switching, can be controlled by means of device-dependent commands, sent via the bus, when the instrument is addressed to listen. The measurements made, and data regarding the instrument's status, can be read via the bus when the instrument is addressed to talk. If the instrument is addressed to talk when the output buffer is empty, no data transfer can take place and bus activity will cease. Data transfer will commence when the output buffer is updated at the end of the next measurement cycle.

DATA OUTPUT FORMAT

- 9 The same output message format is used for the transmission of measured values and numbers recalled from the instrument's internal stores. The message consists of a string of 21 ASCII characters for each value transmitted. These are to be interpreted as shown in Table 5.1. The units should be assumed to be Hz, seconds, degrees or a ratio, depending upon the commands previously given to the instrument.

DEFERRED COMMANDS AND IMMEDIATE COMMANDS

- 10 Some commands (known as Deferred Commands) are accepted until a terminating character or message is received, see Table 5.5. The whole string will then be obeyed. Other commands (known as Immediate Commands) are obeyed as soon as they are received. These are indicated, in Table 5.16, by an asterisk.

Example: OUTPUT 716; FA ALI SRS5 S81 CR LF

Because SRS is an immediate command, Frequency A, A Channel 50 Ω and 5 digit Resolution will be set following receipt of SRS5.

TABLE 5.1

Output Message Format

Byte No	Interpretation	Permitted ASCII Characters
1	Function letter	} See Table 5.2
2	Function letter	
3	Sign of measurement	+ or -
4	Most significant digit	0 to 9
5	Digit	0 to 9 or .
6	Digit	0 to 9 or .
7	Digit	0 to 9 or .
8	Digit	0 to 9 or .
9	Digit	0 to 9 or .
10	Digit	0 to 9 or .
11	Digit	0 to 9 or .
12	Digit	0 to 9 or .
13	Digit	0 to 9 or .
14	Digit	0 to 9 or .
15	Least significant digit	0 to 9 or .
16	Exponent indicator	E
17	Sign of exponent	+ or -
18	More significant digit	0 to 9
19	Less significant digit	0 to 9
20	Carriage return	CR
21	Line Feed	LF

NOTE 1:

Bytes 4 to 15 will always include 11 digits and a decimal point. Zeros will be added, where necessary, in the more significant digit positions.

NOTE 2:

The exponent indicated by bytes 18 and 19 will always be a multiple of three.

TABLE 5.2

Function Letters

Function	Function Letters
Frequency A	FA
Frequency C	FC
Ratio A/B	RA
Ratio C/B	RC
Time interval	TI
Total A by B	TA
Phase	PH
Period A	PA
Check	CK
Recalled Data	Function Letters
Unit type	UT
Resolution	RS
Trigger level, A channel	LA
Trigger level, B channel	LB
Math constant X	MX
Math constant Z	MZ
Delay time	DT
Special function	SF
Master software issue number	MS
GPIB software issue number	GS

NOTE:

Spaces are substituted for the function letters when special function 81 is active.

SERVICE REQUEST

- 11 The instrument can be set, by means of device-dependent commands, to generate the service request message (SRQ) when:
- (1) A measurement cycle is completed
 - (2) A change of frequency standard occurs
 - (3) An error state is detected
 - (4) Any combination of (1), (2) and (3).
- 12 The generation of the SRQ may also be inhibited. The necessary commands are given in Table 5.14. Option (3) of Paragraph 10 is selected when the instrument is first switched on.

STATUS BYTE

- 13 The format of the status byte, generated in response to a serial poll, is given in Table 5.3.

TABLE 5.3

Status Byte Format

DIO Line	Function
1	LSB
2	Number of error detected (binary)
3	MSB (See NOTE 1)
4	'1' = frequency standard changed
5	'1' = reading ready (See NOTE 2)
6	'1' = error detected
7	'1' = service requested
8	'1' = gate open

NOTE 1:

The error code numbers which can occur are:

- 1 Phase measurement attempted on waveforms of differing frequency.
- 2 Result out of range of the display
- 3 Overflow of internal counters
- 4 Error in numerical entry
- 5 Syntax error in GPIB command

No measurement data string is available if error code 1, 2 or 3 is generated.

NOTE 2:

Regardless of the SRQ mode in use, the SRQ message that a reading is ready is not generated following a data-recall operation.

NOTE 3:

The errors are cleared as follows:

- Error 1: Correct the difference in input frequencies or change the measurement mode in use.
- Error 2: The error is cleared when an in-range measurement is completed.
- Error 3: The error is cleared when an in-range measurement is completed.
- Error 4: The error is cleared when a valid numerical entry is made.
- Error 5: The command string will be correctly executed up to the point at which the error occurs. The remainder of the string will be hand-shaken, but not executed. The error is cleared when the next valid command is received.

EXPLANATION OF RESPONSE TO INTERFACE MESSAGES

- 14 The instrument will respond to all valid device-dependent commands which are received after it has been addressed to listen. Device-dependent commands are recognized as such because they are transmitted with the attention (ATN) message false.
- 15 The instrument also responds to a number of multi-line interface messages. These are recognized because they are transmitted with the ATN message true. Refer to Table 5.4, which gives the instrument's response to different bus messages. The following paragraphs detail the instrument's response to these messages. Any multi-line message not specifically mentioned is hand-shaken, but is otherwise ignored.

Address Messages

- 16 The instrument responds to address messages defined by the setting of the address switches, A1 to A5, on the rear panel.
- 17 On receipt of its listen address, the instrument becomes a listener. If it has previously been addressed to talk it ceases to act as a talker. If in the local control state when the address is received, the instrument goes to the remote control state provided that the REN message is true.
- 18 On receipt of its talk address, the instrument becomes a talker. If it has previously been addressed to listen it ceases to act as a listener. If in the local control state when the address is received, it will remain under local control.
- 19 If the instrument has been addressed to talk, and then receives the talk address of another device, it ceases to act as a talker.

Local Lockout

- 20 The instrument will respond to the local lockout (LLO) message regardless of its addressed state. The return-to-local function of the LOCAL key on the front panel is disabled (the RESET/CONTINUE function remains enabled when in local control).
- 21 Local lockout is cleared by sending the remote enable (REN) message false. This returns all devices on the bus to the local control state.

Device Clear and Selected Device Clear

- 22 The instrument only responds to the device clear (DCL) message and the selected device clear (SDC) message when it is in the remote control state. It will only respond to the SDC message if it is a listener, but will respond to the DCL message regardless of its addressed state.
- 23 The instrument responds to either message by reverting to the functions and settings of the power-up state. No change is made to the condition of the GPIB interface.

TABLE 5.4

Response to Bus Messages

Message	Addressed State	Instrument Response
Address	Any	For listen address: Becomes a listener and goes to the remote control state. If previously addressed to talk, ceases to act as a talker. For talk address: Becomes a talker. If previously addressed to listen, ceases to be a listener. For talk address of another device: If previously addressed to talk, ceases to be a talker.
Local Lockout (LLO)	Any	LOCAL key disabled. (Cleared by sending the REN message false).
Device Clear (DCL)	Any, but must be in remote control.	Reverts to power-up state.
Selected Device Clear (SDC)	Listen and in remote control	
Serial Poll Enable (SPE)	Any	Enters the serial poll mode state (SPMS). If addressed to talk while in this state, sends the status byte.
Serial Poll Disable (SPD)	Any	Enters the serial poll idle state (SPIS). If addressed to talk while in this state, sends data in the output message format.
Group Execute Trigger (GET)	Listen, and no measurement cycle in progress	Takes a measurement.
Go to Local (GTL)	Listen	Reverts to local control.
Untalk Unlisten	Talk Listen	Ceases to be a talker. Ceases to be a listener. The ADDR indicator is turned off.

- 31 If more than one command is to be sent, no delimiters are required. If necessary, commas, spaces and semicolons may be included in command strings as an aid to clarity without affecting the operation of the instrument. Each command string must be followed by an end-of-string terminating group. The permitted terminating groups are shown in Table 5.5.

TABLE 5.5

Permitted Terminators

1	2	3	4	5	6
LF	LF EOI true	CR EOI true	CR LF	CR LF EOI true	Last Character EOI true

TABLE 5.6

Instrument Preset Code

Function	Code
Set instrument functions and settings to the power-up state	IP

TABLE 5.7

Measurement Function Codes

Function	Code
Frequency A	FA
Frequency C	FC
Period A	PA
Time interval	TI
Total A by B	TA
Phase of A relative to B	PH
Ratio A/B	RA
Ratio C/B	RC
Check	CK

NOTE:

The 1991 does not accept FC and RC as valid commands.

TABLE 5.8

Input Control Codes

Function	Code	
	A Channel	B Channel
AC coupling selected	AAC	BAC
DC coupling selected	ADC	BDC
1 M Ω input impedance selected	AHI	BHI
50 Ω input impedance selected	ALI	BLI
Positive slope trigger selected	APS	BPS
Negative slope trigger selected	ANS	BNS
X10 attenuator disabled	AAD	BAD
X10 attenuator enabled	AAE	BAE
Manual trigger level selected	AMN	BMN
Auto trigger level selected	AAU	BAU
A channel filtering enabled	AFE	
A channel filtering disabled	AFD	
A and B channels separate	BCS	
A and B channels common	BCC	

TABLE 5.9

Measurement Control Codes

Function	Code
Select continuous measurement mode	T0 (see NOTE 1)
Select one-shot measurement mode	T1 (see NOTE 2)
Take one measurement or start totalize measurement	T2 (see NOTE 3)
Stop totalize measurement	T3 (see NOTE 3)
Read present value without stopping totalize measurement	RF (see NOTE 4)
Delay disabled	DD
Delay enabled	DE
Reset (Stop measurement cycle and clear output buffer)	RE
Maths function disabled	MD
Maths function enabled	ME

NOTE 1:

When making continuous measurements the output buffer is updated at the end of each gate period. If the buffer is being read via the GPIB when the gate period ends, updating is delayed until reading is complete.

NOTE 2:

When one-shot measurements are being made, the output buffer is cleared each time command T2 is received. The measurement made must, therefore, be read before a further measurement cycle is triggered.

NOTE 3:

When making totalize measurements, commands T2 and T3 are used with TA and special function 61. In this mode the readings made in successive totalize periods are cumulative. The RE command is used to reset the count to zero when required.

NOTE 4:

The RF command (reading on the fly) must be sent each time a reading is required. The reading is obtained when the instrument is made a talker.

TABLE 5.10

Store and Recall Codes

Function	Code
Recall unit type	RUT
Store display resolution number	SRS
Recall display resolution number	RRS
Store A channel manual trigger level	SLA (see NOTE 1)
Recall A channel manual trigger level or peak level	RLA (see NOTES 1 and 2)
Store B channel manual trigger level	SLB (see NOTE 1)
Recall B channel manual trigger level or peak level	RLB (see NOTES 1 and 2)
Store maths constant X	SMX
Recall maths constant X	RMX
Store maths constant Z	SMZ
Recall maths constant Z	RMZ
Store arming delay value	SDT
Recall arming delay value	RDT
Recall special function register	RSF
Recall master software issue number	RMS
Recall GPIB software issue number	RGS

NOTE 1:

The manual trigger level is automatically scaled by a factor of 10 when the X10 attenuator is switched in or out of circuit. Ensure that the correct input attenuation is selected before storing or recalling the trigger level.

NOTE 2:

The levels recalled by commands RLA and RLB depend upon the enablement of special functions 50, 51 and 52.

NOTE 3:

Numbers to be stored should follow the store command. The format to be used for numerical entry is given in Table 5.11. The limiting values for numerical entries are given in Table 5.12.

NOTE 4:

The instrument returns to the measurement mode automatically at the completion of a store or recall operation.

NOTE 5:

No SRQ message is generated for recalled data.

TABLE 5.11

Numerical Input Format

Byte	Interpretation	Permitted ASCII Characters
1	Sign of mantissa	+ or -
2	Most significant digit	0 to 9 or .
3	Digit	0 to 9 or .
4	Digit	0 to 9 or .
5	Digit	0 to 9 or .
6	Digit	0 to 9 or .
7	Digit	0 to 9 or .
8	Digit	0 to 9 or .
9	Digit	0 to 9 or .
10	Digit	0 to 9 or .
11	Least significant digit	0 to 9 or .
12	Exponent indicator	E or e
13	Sign of exponent	Space, + or -
14	More significant digit	0 to 9
15	Less significant digit	0 to 9

NOTE 1:

Spaces, nulls or zeros occurring immediately before byte 1 will be ignored.

NOTE 2:

Byte 1 may be omitted. A positive mantissa will then be assumed.

NOTE 3:

Bytes 2 to 11 may contain up to nine digits and a decimal point. If more than nine digits are entered without a decimal point, excess digits will be truncated. The excess digits will, however, increase the power of ten stored.

If fewer than nine digits are required the unused bytes may be omitted.

NOTE 4:

Spaces or nulls entered between bytes 11 and 12 will be ignored.

NOTE 5:

The exponent group, bytes 12 to 15, may be omitted.

NOTE 6:

Byte 13 may be omitted or transmitted as a space. In either case a positive exponent will be assumed.

NOTE 7:

Byte 15 may be omitted for a single-digit exponent.

NOTE 8:

Units are assumed to be volts for trigger level and seconds for delay time.

TABLE 5.12

Numerical Input Ranges

Function	Command Code	Numerical Limits	
		Low	High
Resolution	SRS	3	10
Trigger Level (X1)	SLA, SLB	-5.1	+5.1
Trigger Level X10	SLA, SLB	-51	+51
Math constant	SMX, SMZ	$\geq 1 \times 10^{-9}$ $> -1 \times 10^{10}$	$< 1 \times 10^{10}$ $\leq -1 \times 10^{-9}$
Delay time	SDT	200×10^{-6}	0.8

NOTE 1:

Numbers entered will be rounded up before storage, as follows:

- (1) Trigger level (X1) to next multiple of 20 mV
- (2) Trigger level (X10) to next multiple of 200 mV
- (3) Delay time to next multiple of 25.6 μ s

NOTE 2:

Resolution entries will be rounded down to the next integer. The related gate times are shown in Table 5.13.

NOTE 3:

The math constant Z can be set to zero. However, any attempt to use the math function with this value set will cause an error code to be generated.

TABLE 5.13

Gate Times

Number of digits in Freq. Period and Check	Gate Time	Resolution number
10	10 s	10
9	1 s	9
8	100 ms	8
7	10 ms	7
6	1 ms	6
5	1 ms	5
4	1 ms	4
3	1 ms	3

TABLE 5.14

Special Function Codes

Function	Code
Special functions disabled	SFD
Special functions enabled	SFE
Enter special function nn in special function register	Snn

NOTE 1:

The list of special functions is given in Section 4 Table 4.3.

NOTE 2:

A special function entered in the register while the special functions are enabled will be enabled immediately.

TABLE 5.15

Service Request Codes

Function	Code
Inhibit generation of SRQ	Q0
SRQ generated when error is detected	Q1
SRQ generated for measurement ready	Q2
SRQ generated for measurement ready or error detected	Q3
SRQ generated for frequency standard changeover	Q4
SRQ generated for frequency standard changeover or error detected	Q5
SRQ generated for measurement ready or frequency standard changeover	Q6
SRQ generated for measurement ready, error detected or frequency standard changeover	Q7

NOTE:

SRQ is not generated by data recalled from store.

TABLE 5.16

Alphabetic List of Command Codes

Code		Code	
AAC	A channel, AC coupling	ME	Maths function enabled
AAD	A channel X10 attenuator disabled	PA	Period A
AAE	A channel X10 attenuator enabled	PH	Phase A relative to B
AAU	A channel autotrigger	Qn	SRQ mode
ADC	A channel, DC coupling	RA	Ratio A/B
AFD	A channel filtering disabled	RC	Ratio C/B (1992 only)
AFE	A channel filtering enabled	RDT	Recall delay time
AHI	A channel, 1 M Ω	RE	Reset measurement
ALI	A channel, 50 Ω	RF	Read total so far
AMN	A channel manual trigger	RGS	Recall GPIB software issue
ANS	A channel, -ve slope	RLA	Recall A channel trigger or peak level
APS	A channel, +ve slope	RLB	Recall B channel trigger or peak level
BAC	B channel, AC coupling	RMS	Recall master software issue number
BAD	B channel X10 attenuator disabled	RMX	Recall maths constant X
BAE	B channel X10 attenuator enabled	RMZ	Recall maths constant Z
BAU	B channel autotrigger	RRS	Recall resolution
BCC	A and B channels common	RSF	Recall special function
BCS	A and B channel separate	RUT	Recall unit type
BDC	B channel, DC coupling	Snn	Special function
BHI	B channel, 1 M Ω	SDT	Store delay time
BLI	B channel, 50 Ω	SFD	Special function disabled
BMN	B channel manual trigger	SFE	Special function enabled
BNS	B channel, -ve slope	SLA	Store A channel trigger level
BPS	B channel, +ve slope	SLB	Store B channel trigger level
CK	Check	SMX	Store maths constant X
DD	Delay disabled	SMZ	Store maths constant Z
DE	Delay enabled	SRS	Store resolution
FA	Frequency A	Tn	Measurement mode or Start/Stop reading
FC	Frequency C (1992 only)	TI	Time interval
* IP	Instrument preset	TA	Total A by B
MD	Maths function disabled		

NOTE:

n represents a single digit.

* Indicates an Immediate mode command (see page 5-2)