



User's Manual
SD375 Dynamic Analyzer II
Part Two
Legacy Manual

COGNITIVE VISION, INC.
7220 Trade Street, Suite 101
San Diego, CA 92121-2325 USA

analyzers@cognitivevision.com
www.cognitivevision.com

Tel: 1.858.578.3778 / Fax: 1.858.578.2778
In USA: 1.800.VIB.TEST (842.8378)

LEGACY MANUAL POLICY

Cognitive Vision Legacy manuals are those product manuals and documentation that accompanied earlier products and product lines which have since been discontinued (“Legacy Products”). Over the past thirty years, these include products that were sold by Spectral Dynamics, Scientific Atlanta and Smiths Industries.

Cognitive Vision, Inc. provides downloadable copies of these manuals strictly as a courtesy to its customers who continue to use Legacy Products. **IMPORTANT:** Please read the following Disclaimer carefully. Any use of this manual indicates your express agreement with this policy.

If you have any questions regarding this policy, or for additional information regarding the serviceability of any Legacy Product(s), please call our service department.

DISCLAIMER

IN DOWNLOADING THIS MANUAL, THE USER UNDERSTANDS AND EXPRESSLY AGREES THAT COGNITIVE VISION MAKES NO WARRANTIES WHATSOEVER, EITHER EXPRESS OR IMPLIED, INCLUDING ANY WARRANTY OF MERCHANTABILITY OR FITNESS FOR A PARTICULAR PURPOSE. IN USING THIS MANUAL, THE USER ACKNOWLEDGES THAT ALL PREVIOUS PRODUCT WARRANTIES ISSUED BY SPECTRAL DYNAMICS, SCIENTIFIC ATLANTA AND SMITHS INDUSTRIES FOR LEGACY PRODUCTS HAVE SINCE EXPIRED.

IN PROVIDING THIS MANUAL, COGNITIVE VISION ASSUMES NO LIABILITY OR RESPONSIBILITY WHATSOEVER TO THE USER OF THIS MANUAL, THE USER’S AGENTS AND/OR CUSTOMERS, OR ANY OTHER PARTY, FOR ANY CLAIMED INACCURACY IN THIS MANUAL, OR FOR DAMAGE CAUSED OR ALLEGED TO BE CAUSED DIRECTLY OR INDIRECTLY BY ANY USE OF THIS MANUAL, REGARDLESS OF WHETHER COGNITIVE VISION WAS INFORMED ABOUT THE POSSIBILITY OF SUCH DAMAGES, OR FOR ANY CLAIM MADE AGAINST THE USER’S ORIGINAL PRODUCT WARRANTY.

FURTHER, COGNITIVE VISION SHALL NOT BE RESPONSIBLE FOR ANY INTERRUPTION OF SERVICE, LOSS OF BUSINESS, ANTICIPATORY PROFITS, CONSEQUENTIAL DAMAGES, OR INDIRECT OR SPECIAL DAMAGES ARISING UNDER ANY CIRCUMSTANCES, OR FROM ANY CAUSE OF ACTION WHATSOEVER INCLUDING CONTRACT, WARRANTY, STRICT LIABILITY OR NEGLIGENCE.

NOTWITHSTANDING THE ABOVE, IN NO EVENT SHALL COGNITIVE VISION’S LIABILITY TO THE USER EXCEED AN AMOUNT EQUAL TO THE REPLACEMENT COST OF THIS MANUAL.

COGNITIVE VISION, INC.
7220 Trade Street, Suite 101
San Diego, CA 92121-2325 USA

analyzers@cognitivevision.com
www.cognitivevision.com

Telephone: 1.858.578.3778 / Fax: 1.858.578.2778
IN USA: 1.800.VIB.TEST (842.8378)

SECTION II

INSTALLATION

2.1 INTRODUCTION

This section contains instructions for performing an initial inspection of the Model SD375. General safety precautions are included after the initial inspection. Preparation for use and return shipment procedures including procedures for claiming warranty repairs and repacking for shipment are also described in this section.

2.2 INITIAL INSPECTION

Although the SD375 is thoroughly inspected mechanically and electrically before packing for shipment, it must be inspected upon receipt for damage in transit.

2.2.1 Unpacking

Use care in removing the instrument from its shipping container to prevent damage to the front- and rear-panel controls. Save the shipping container and all packing materials until the instrument has been thoroughly inspected for damage and checked for proper operation.

2.2.2 Equipment Furnished

Ensure that each item on the packing list is included with the shipment. Accessory kits may be shipped in separate containers.

2.2.3 Inspection for Physical Damage

Inspect all panels for dents, signs of chipped paint, or scratches. Check for broken or bent connectors, switches, and knobs. Photographs of damage may be helpful in substantiating subsequent claims.

2.2.4 Reshipment Procedure

If the Model SD375 is to be reshipped after receipt, use of the original shipping container and packing materials is recommended. If original packing materials are not available, the following materials should be used:

- a. A double wall carton with a test strength of 350 pounds and of sufficient size to accommodate the required packing.
- b. Heavy paper or sheets of cardboard to protect all surfaces.

- c. Nonabrasive material such as polyurethane or cushioned paper between projecting parts and wall of carton.
- d. At least 4 inches of shock-absorbent material such as extra firm polyurethane.

2.2.5 Returned Equipment with Warranty or Damage Claims

If the SD375 is found to be damaged in transit or does not operate as specified when received, notify the carrier and the nearest Scientific-Atlanta, Inc., Spectral Dynamics Division sales/service office or representative immediately. The local office will arrange for repair or replacement. Be sure to attach a card showing the owner's name, address, telephone number, and a description of the service required.

2.3 SAFETY PRECAUTIONS

The Model SD375 Dynamic Analyzer II presents no hazard to operating personnel if operated in accordance with the instructions contained in this manual.

2.3.1 Explosion Hazard

Do not operate the SD375 in any environment where flammable vapors may exist. Operation of any electrical instrument in such an environment constitutes a definite explosion hazard.

2.3.2 Shock Hazard

When connected to a three-contact power receptacle, the three-conductor ac power cable supplied with the SD375 grounds the panel and the chassis. This grounding protects the operator from possible injury. To preserve this protection when operating from a two-conductor outlet, use a three-conductor to two-conductor adapter and connect the adapter wire to ground at the power outlet before connecting the instrument. Covers and safety plates should be removed **ONLY** by **QUALIFIED** maintenance personnel. Dangerous voltages are present inside this instrument whenever the power cord is connected even when the power switch is off.

2.4 PREPARATION FOR USE

2.4.1 Power Requirements

The SD375 Dynamic Analyzer II is designed to operate on either 115 Vac or 230 Vac. Therefore, before applying power to the instrument, check the following:

- There are two transformer slide switches (labeled S1 and S2) located on the rear panel. Both switches must always be in the same position (either 115 or 230 as determined by the power available).
- The fuse in fuseholder F1 should be a 10 amp SLO-BLO for either 115 Vac or 230 Vac operation.
- There is a toggle switch located in the power supply for selecting low-line-voltage operation (Refer to Figure 2-1). For normal operation with both rear-panel slide switches in their proper positions, the toggle switch must be in the 120 volt position. For operation in areas where low line voltage is encountered (such as in Japan), the rear-panel slide switches must be in the 115 Vac position and the toggle switch must be in the 100/110 V position. If low line voltage is experienced in countries that normally employ 230 Vac line voltage, this toggle switch can be utilized in the 100/110 V position even if both rear-panel slide switches are in the 230 Vac position.

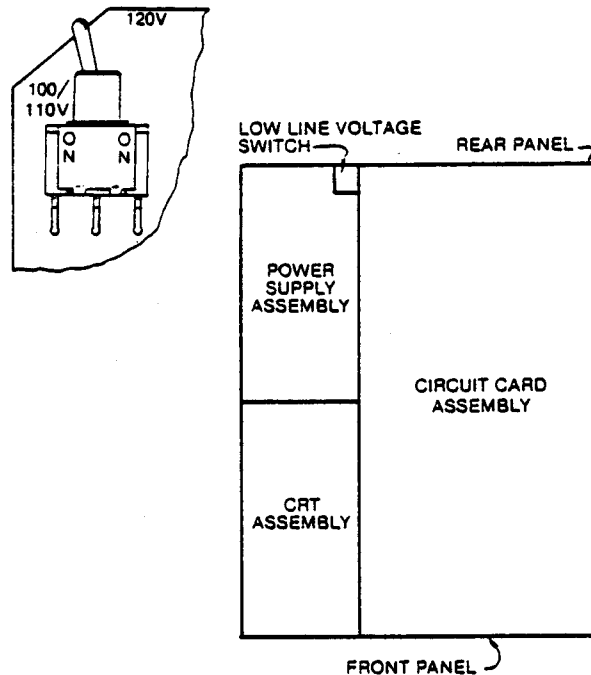

Figure 2-1. Low Line Voltage Toggle Switch, Location

WARNING

Removal of the top cover of the SD375 is required for access to the low line voltage switch. Prior to removing the cover, ensure that power to the instrument is turned off and that the power cord is unplugged. After the cover is removed, do not touch any components in the power supply assembly or the crt assembly other than the low line voltage toggle switch.

2.4.2 Mounting

The SD375 is shipped from the factory as a bench instrument with bail (tilt stand) and trim in place. Rack-mounting hardware is provided as part of the accessory kit and must be attached before mounting the instrument in a rack.

2.4.3 Cooling

The SD375 requires at least 1/2" open space above and 3 1/2" open space behind the instrument for proper cooling. Never place anything directly on top of the SD375 when the instrument is turned on.

SECTION III

OPERATION

3.1 INTRODUCTION

This section is for the operator of the SD375. Simple, but complete operating instructions are provided for both the experienced operator and the first-time user. Included is a description of all the front and rear-panel controls, indicators and connectors.

The first part of this section contains a front-panel outline and proper power-on procedures. This information is intended to introduce you to the instrument before proceeding to the detailed front-panel description. The detailed front-panel description, subsection 3.4, contains individual descriptions of each touch control, basic information as to what they do, and how to use them. The following is a guide to how this information is presented.

Subsection 3.4.1 describes the primary functions performed by the SD375 (SPECT, TF, POWER, TIME, STAT and OCTAVE). Included with this description is an example of each primary function menu item (there are 39 in all). Each sample display is accompanied by a simplified formula. A summary of the calculations performed by the SD375 and a table defining the functions and symbols precedes the menu examples. The calculations are provided to *acquaint* the user with what is actually happening to his data. Keep in mind that each display item formula is a calculation performed on *acquired* data and the selection will also influence *acquisition*.

Subsection 3.4.2 describes control of data acquisition. Frequency range selection, input level selection, transient analysis, weighting and averaging are covered in this subsection.

Subsection 3.4.3 describes control of the display. This includes X and Y axis scaling, Y axis gain, X axis expansion, phase offset, the source of the display, eg., RT (Real Time) - Input Memory, M1 - Averager Memory, M2 - Storage Memory, and how you want the display (single, dual, upper or lower, swap A and B).

Subsection 3.4.4 describes control of the numeric readouts. The X and Y axis *units* are determined by these controls along with cursor control and related cursor functions.

Subsection 3.4.5 describes plotter operation. These controls are used for both analog and digital plotters. Digital plotter operation requires the I/O option.

Subsection 3.4.6 describes the front-panel recall and storage feature.

Subsection 3.4.7 describes the display identification and text entry feature.

Subsection 3.4.8 describes the special features provided with your SD375. These are: the programs "master list", the internally generated test signal, the MARK feature, the system reset function and I/O execute.

3.2 AN INTRODUCTION TO THE FRONT PANEL

The SD375 is equipped with a touch control front panel. Other than the four small knobs just to the right of the display, the two INPUT BNC connectors and the PWR Pushbutton/Indicator, there are no lever switches, protruding pushbuttons or rotary switches on the front panel.

When a front-panel touch control is pressed, the instrument will respond with an audio feedback signal (a subtle “beep”) and if the touch control has an LED indicator in the upper left-hand corner, the LED will light confirming selection of the touch control you just pressed. Keep in mind that this is just an outline as some of the touch controls don’t have LED indicators, some of the touch controls are locked out during certain functions and may or may not respond with an audio feedback signal during these conditions and some of the LED indicators indicate a “toggle” condition. These variations will be covered in the detailed description of the front panel.

3.2.1 Front Panel Outline

Figure 3-1 shows the front panel separated into numbered groups. A brief outline of the numbered groups is also included. This outline is not intended to be a “button pushing” guide; rather it is provided to give the first-time user a general overview of the front panel of the instrument.

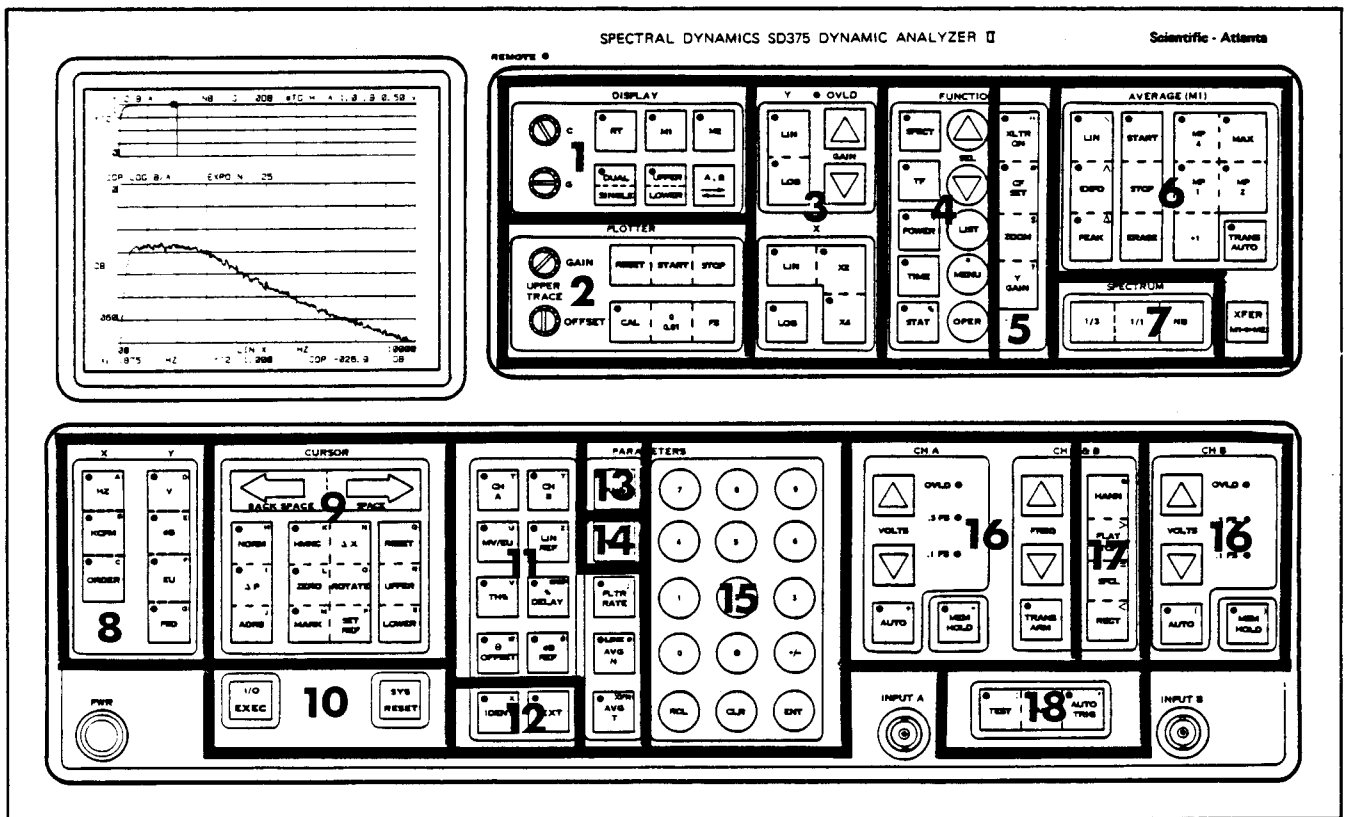
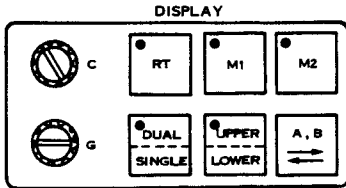

Figure 3-1. SD375 Front Panel Separated into Groups.

Group 1

DISPLAY controls. They determine:



- a. The source of the display
 1. RT (Real Time)
 2. M1 (Averager Memory)
 3. M2 (Storage Memory)
- b. The type of display
 1. Dual Trace
 2. Single Trace, i.e., Upper trace only (Single trace, CH A), Lower trace only (Single trace, CH B).

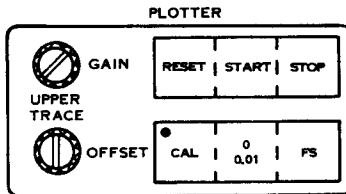

Group 2

Controls for operating an analog or digital plotter. Digital plotter operation requires the I/O (-3) Option.

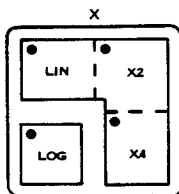
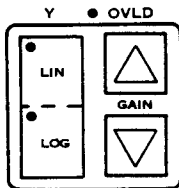

Group 3

Controls for display distribution. LIN or LOG on both the X and Y axis, GAIN (70 dB in 10 dB steps on the Y axis; 80 dB in 10 dB steps for gain displays such as transfer function and ratio), and expansion (X2 and X4) on the X axis.

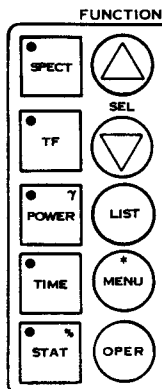

Group 4

The column of touch controls on the left side of this group controls the five primary functions performed by the SD375 (SPECT, TF, POWER, TIME and STAT). Each of these functions is accompanied by a menu that lists the available subfunctions associated with each primary function. The SEL UP/DOWN and MENU controls are for menu manipulation. The LIST control is used for the CURSOR group MARK listing and the SPECTRUM group OCTAVE listing.

Group 5

Controls for the TRANSLATOR (-1) Option.

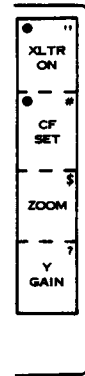

Group 6

Controls for the data averaging and memory storage process.

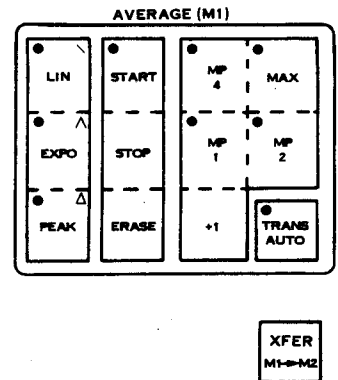

Group 7

Controls for enabling or disabling the OCTAVE (-2) Option.

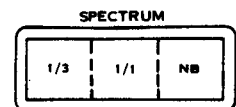

Group 8

Controls for determining the type of X and Y axis display units.

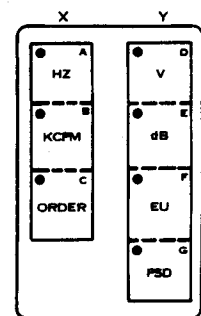

Group 9

Controls for positioning the cursor and performing a large amount of cursor related functions. The ZERO and ROTATE controls use the cursor to manipulate Time Domain data in the input memories.

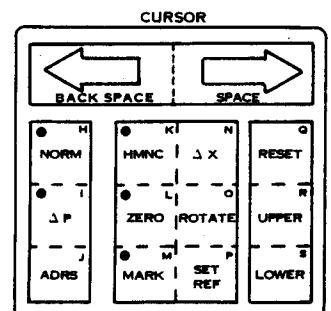



Group 10

I/O EXEC - See the I/O (-3) Option Manual. SYS RESET - Memory Flush.

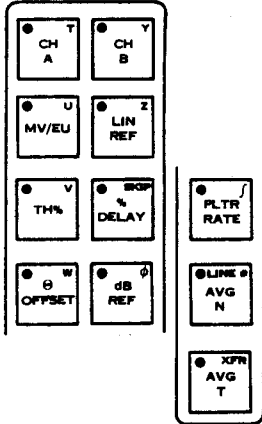

Group 11

Controls for entering and enabling important numerical values used in acquisition/analysis and display of signal data.

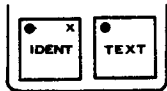

Group 12

Controls for customizing annotation on user's display and hard copy. IDENT is for assigning specific identification numbers to a particular display. TEXT is a special text entry feature for changing or adding annotation to any display or menu.



Group 13

This control is used for storing and recalling complete front-panel configurations.



Group 14

This control is used for accessing nine different programs available to the user.

Group 15

This group is referred to as the “keypad.” It’s used for assigning, entering and clearing values for group 11, entering numerical values and assigning line numbers for the text entry feature and for menu selection.

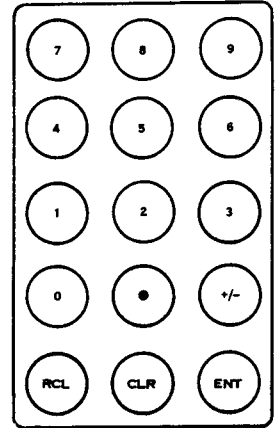

Group 16

Controls for selecting the input level for each channel and the frequency/analysis range for both channels.

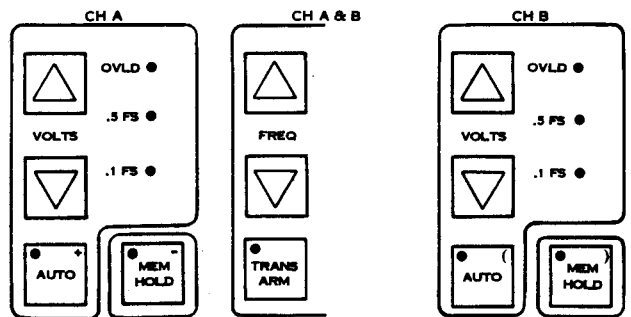

Group 17

Controls for selection of one of four FFT weighting functions.

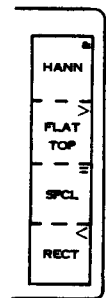

Group 18

Front-end group for selecting: coupling (ac or dc), internally generated test signal and the AUTO TRIG function associated with the transient capture function.

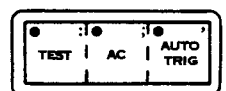

3.3 GETTING STARTED

This part of Section III tells you proper power-on procedures and what you are supposed to see once you've turned the instrument on.

3.3.1 Power-On Procedures

The first thing you want to do is to check the area of the rear panel where the power cord is to be connected and refer to Figure 3-2.

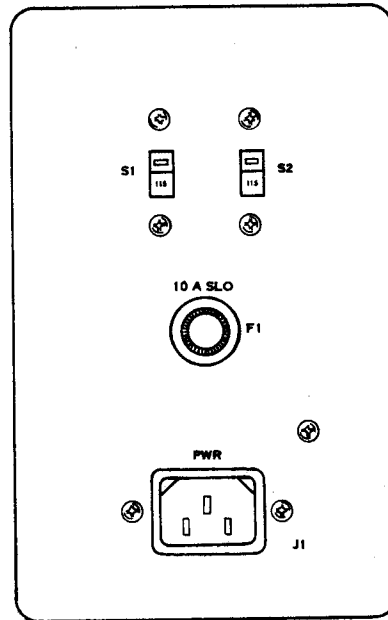

Figure 3-2. Rear-panel Power Group Showing the Location of the Transformer Slide Switches, Fuse Holder and Power Cord Connection.

Check the fuse holder and make sure the proper fuse is installed (you want to do this with the power cord *disconnected*). Check the transformer slide switches (the switches labeled S1 and S2) and make sure that the proper line voltage is selected. *Both* switches must be either in the 115 Vac or the 230 Vac position.

CAUTION

Before turning the SD375 on, make sure there is at least 1-3/4 inches of open space above the top cover and at least 4 inches of open space behind the rear-panel fans for proper cooling. *Never* place anything on top of the instrument.

Plug the female end of the power cord into J1. Don't plug the other end in just yet. Refer to Figure 3-3 and the front panel of the SD375 and make sure that the words NOT ON both appear on the front-panel PWR pushbutton/indicator. Plug the other end of the power cord into the power source. Press the PWR pushbutton/indicator until only the word ON can be read and the pushbutton lights.

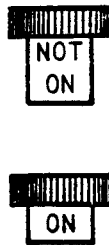
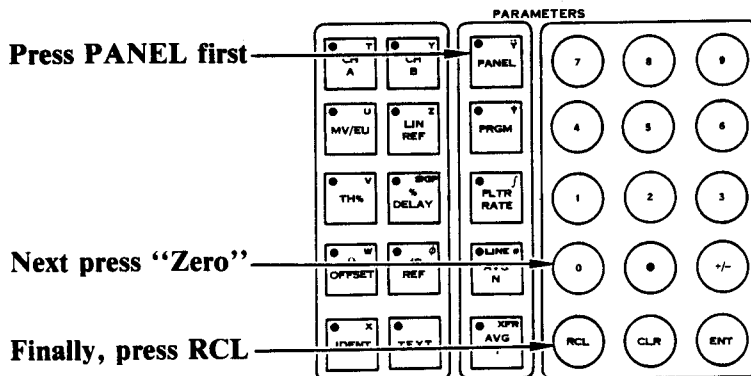

Figure 3-3. Front-panel PWR Pushbutton/Indicator Showing Both the On and Not On (Off) Positions.

At this point you're probably looking at the front panel of the SD375 and wondering what indications, if any, show that the instrument is operating properly. Since the SD375 has a touch control front panel, there is no preset group of mechanical switch positions already established prior to power-on. What happens is this. When power is first applied, the front-panel configuration will be the same configuration that existed just before the last power-down. There is, however, a front-panel default configuration that you can use as a reference or starting point. The configuration is called "Panel Zero Recall" and this is how you get it.



You have just performed a "Panel Zero Recall" (providing, of course, the instrument is turned on). The front-panel configuration and display will appear as shown in Figures 3-4 and 3-5.

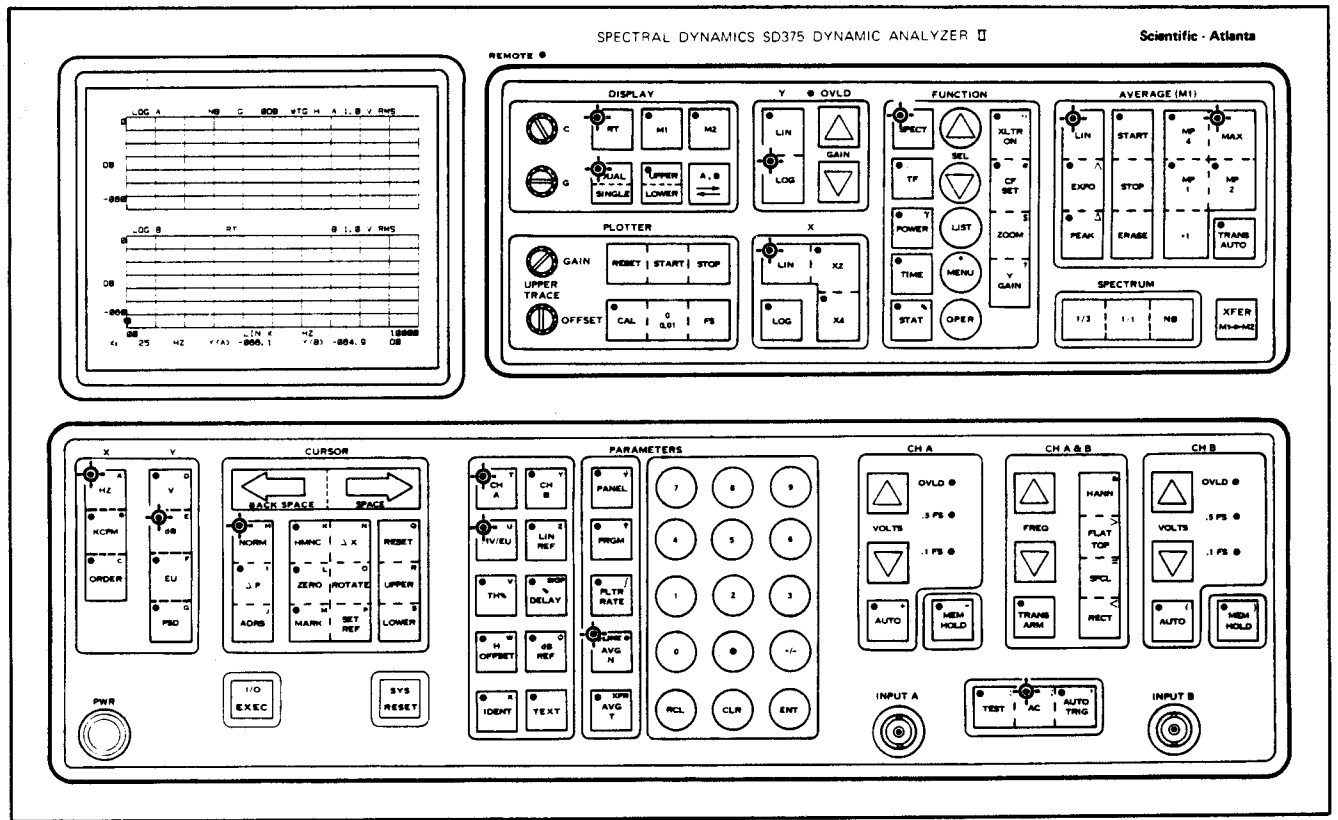

Figure 3-4. Touch Control LEDs With This Indication ϕ Should Be Lit After A "Panel Zero Recall."

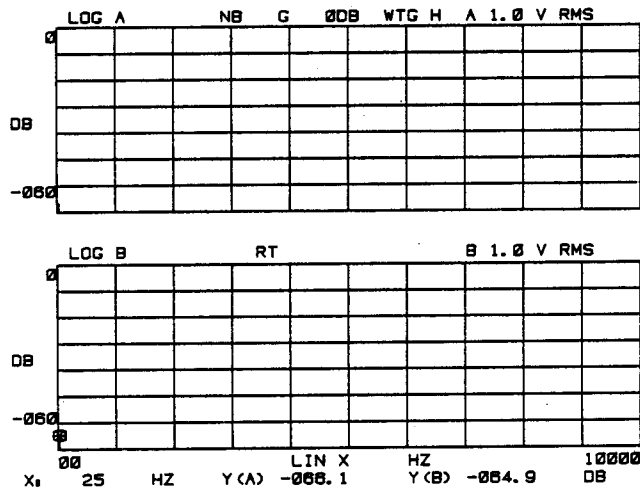

Figure 3-5. This Is What the Display Will Look Like (Without Input Data) After a "Panel Zero Recall."

If you've applied power to the instrument and everything seems to be operating properly, but you're not getting anything on the display, there's a good chance the contrast control has been turned all the way down. The contrast control (Figure 3-6) is located just to the right of the crt and is one of only four knobs on the front panel. The contrast control (the knob with the letter "C" just to its right) controls the intensity of the entire display. The grid control (again, Figure 3-6) is located just below the contrast control and controls the intensity of the grid only. If necessary, adjust these controls until the display intensity is to your satisfaction.

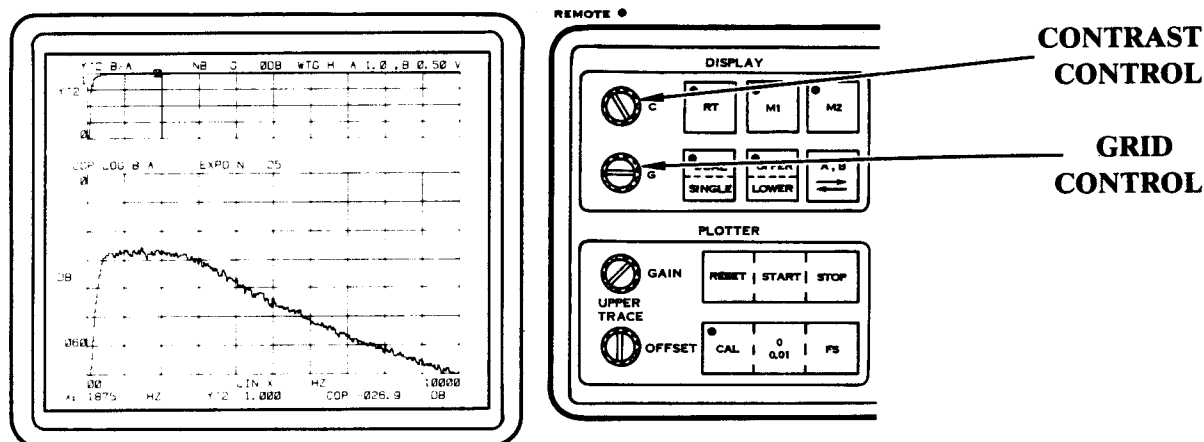

Figure 3-6. Contrast and Grid Controls.

3.4 DESCRIPTION OF THE FRONT PANEL TOUCH CONTROLS

The SD375 is a menu and display oriented instrument. Although most parameters can be selected directly from the front panel, the primary functions and various programs require access via the menu listings. In addition, all selected functions and display parameters such as type of display, frequency range, number of averages, input levels, sensitivities, etc. appear on the crt.

While operating the instrument, you will find that some controls are automatically locked out in certain modes of operation. This is to guard against erroneous or useless data. For example, when displaying an input time waveform, it is not possible to select a log amplitude display. Similarly, when averaging is in progress, such as spectrum or transfer function averaging, certain controls such as frequency range, input sensitivity and weighting are locked out and cannot be manipulated until the averaging process has been terminated and erased.

3.4.1 Primary Functions — The FUNCTION and SPECTRUM Group Touch Controls

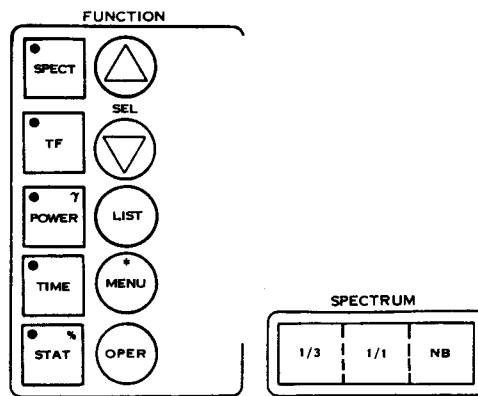

These are the controls for the five primary functions (six including the octave option) performed by the SD375. Each function (SPECT, TF, POWER, TIME, STAT, Octave; Octave refers to the 1/3 and 1/1 touch controls in the SPECTRUM group) has a corresponding menu. Each menu contains a list of operations directly related to each primary function. For example, if you press SPECT and then MENU, the SPECTRUM MENU will appear, as shown in Figure 3-7, on the display.

3.4.1.1 Using the Primary Function Menus

When a particular primary function touch control is pressed, a LED, located in the upper left-hand corner of the selected touch control will light. When you press MENU, the menu displayed will be the menu that corresponds to the primary function touch control that has its LED lit. For example, if you are displaying the SPECTRUM MENU, the LED on the SPECT touch control will be lit. The Octave touch controls do not have LED indicators. Therefore, if none of the primary function touch control LEDs are lit, (SPECT, TF, POWER, TIME, STAT) then the instrument is either turned off or it's in one of the Octave modes. To exit the Octave mode, press the SPECTRUM group NB touch control. The instrument will default to SPECT.

Refer to Figure 3-7 and note that there is an asterisk next to one of the menu items on each menu. The asterisk indicates which menu item is to be displayed when the OPER touch control is pressed. Pressing the OPER touch control is the way you exit the menu mode.

The SEL UP/DOWN touch controls are used to position the asterisk next to the desired menu selection. However, there are two alternate methods of menu selection you can use. The first method is to press the SEL UP/DOWN touch controls without displaying the menu. The display will change according to the corresponding item on the menu. For example: If selection 1 on the SPECTRUM MENU (SPECT A & B) is being displayed, pressing the SEL DOWN touch control once (without displaying the menu) will change the display to selection 2 (GAA & GBB). This is true for all the FUNCTION group menus shown in Figure 3-7. The other method can be convenient if, for instance, you are at SPECTRUM MENU selection 13 and you want to go back to selection 1. Instead of pressing the SEL UP touch control twelve times, you can go to the numbered "keypad" in the PARAMETERS group, press 1 and then press ENT. The asterisk will go directly to selection 1. This method of selection can be used only when displaying a menu.



THE SEL UP/DOWN TOUCH CONTROLS MOVE THE ASTERISK ON THE MENU UP OR DOWN

PRESS MENU TO DISPLAY THE MENU AND TO MAKE YOUR SELECTION

PRESS OPER TO DISPLAY YOUR SELECTION

OR

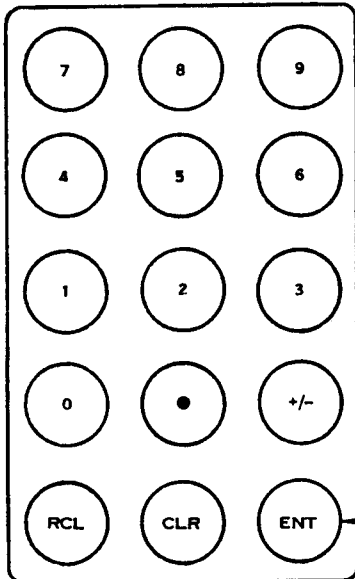

PRESS THE NUMBER OF THE MENU SELECTION ON THE "KEYPAD"

PRESS ENT, THEN PRESS OPER TO DISPLAY YOUR SELECTION

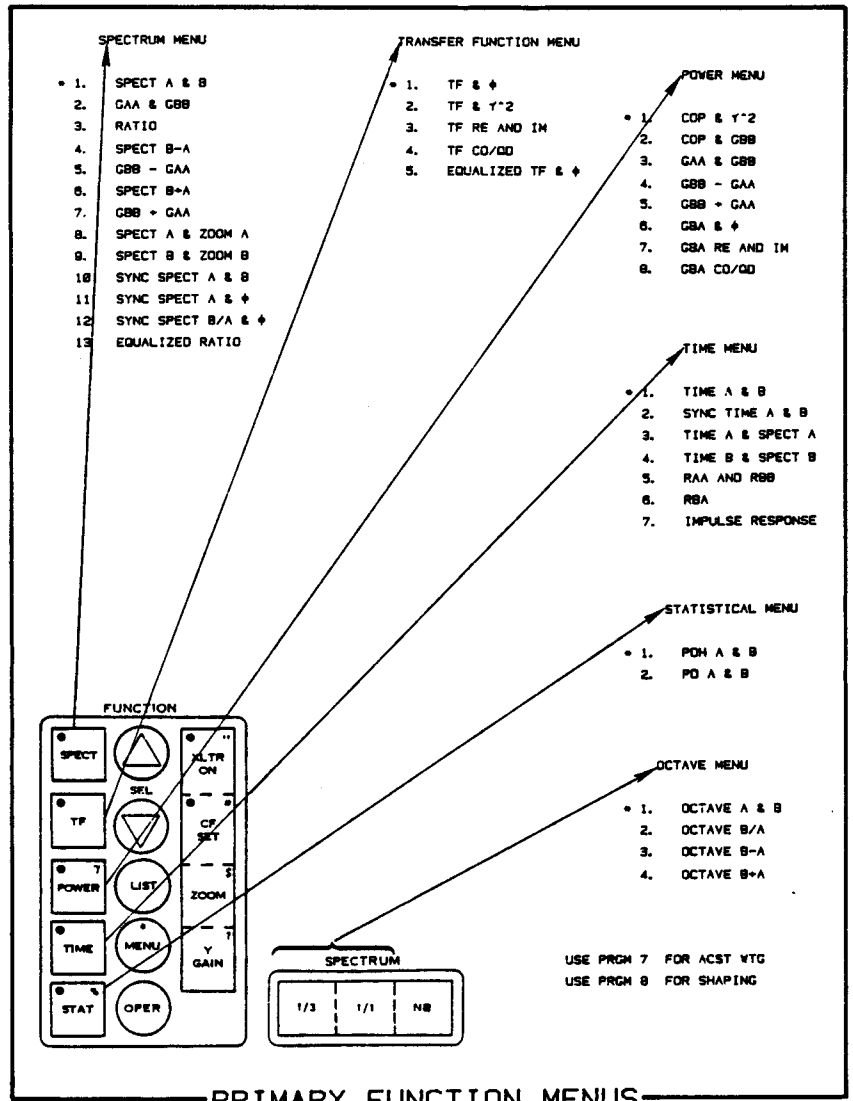

Figure 3-7. Using the Primary Function Menus.

3.4.1.2 A Description of the Primary Function Menus

In order to give you a comprehensive description of the primary functions and each primary function menu item, the formula for the calculations performed by each function and each menu item is included with the description. While it's not required to have a complete knowledge of the mathematics performed by the SD375, the formula provided with the description can be used for comparison purposes to give you an idea as to what each menu item means in relation to the basic operation performed by each primary function.

Figure 3-8 is quite extensive as it contains an example of each item from each menu. The sample displays shown in Figure 3-8 are typical for each menu selection, but not the only way to display each selection. There are three types of display grids that you will encounter on the SD375 display: single, dual and scroll-dual. While the outside dimensions of these three types of grids will remain constant, grid scaling, the number of grid lines, etc., will change according to the type of X and Y axis units selected (HZ, KCPM, ORDERS, V, dB, EU, PSD) and the display scaling selected (LIN X or LIN Y, LOG X or LOG Y). A single trace display of either the upper or lower trace of a dual display can also be selected. Single trace display examples of either the upper or lower trace of each dual display are also shown in Figure 3-8. Note that, regardless of the type of dual display selected (dual or scroll-dual), the single trace display of either the upper or lower trace will always have the same outside dimensions. An example of this is SPECTRUM MENU selection 12 shown in Figure 3-8. While the dual trace is the scroll-dual type, displaying the upper trace only provides outside grid dimensions that are the same as *all* the single trace displays.

3.4.1.3 Calculations

The SD375 deals with frequency domain information via an FFT on time domain samples taken. You need to know *what* quantities are actually dealt with by the SD375.

The pure fourier transform for a sample would be:

$$\mathcal{F}[a(t)] = A(j\omega)$$

$$\mathcal{F}[b(t)] = B(j\omega)$$

A(j ω) and B(j ω) are complex numbers that could be expressed in real and imaginary parts so that for any particular "cell" (which corresponds to the ω or radian frequency value: the value of ω being $2\pi f$),

$$A(j\omega) = a + jb$$

$$B(j\omega) = c + jd$$

A *complete* display of a spectrum would require a 3-dimensional display with a real axis (a or b), an imaginary axis (c or d) and an ω or frequency axis. Normal spectrum display, however, displays the $|A|$ or $|B|$ (magnitude) where:

$$|A| = \sqrt{a^2 + b^2} \quad \text{hence} \quad |A|^2 = a^2 + b^2$$

$$|B| = \sqrt{c^2 + d^2} \quad |B|^2 = c^2 + d^2$$

The SD375, internally, handles the data in mag^2 . These are the “power” data, and are the quantities:

$$\overline{G_{AA}} = \overline{a^2 + b^2}$$

$$\overline{G_{BB}} = \overline{c^2 + d^2}$$

The phase relationship *between* A and B is an important consideration, and must be preserved. Hence, the SD375 also works with a quantity called “cross spectrum.” The value of cross spectrum can be seen by attempting the complex number calculation of transfer function.

$$H(j\omega) = \frac{B(j\omega)}{A(j\omega)} = \frac{c + jd}{a + jb}$$

By resolving the imaginary component out of the denominator (the imaginary component is the symbol “j”, the $\sqrt{-1}$ complex number operator that allows the inclusion of the phase relationship in the transform) of the transfer function calculation using the complex conjugate of the denominator:

$$\frac{c + jd}{a + jb} = \frac{c + jd}{a + jb} \times \frac{a - jb}{a - jb} = \frac{(ac + bd) + j(ad - bc)}{a^2 + b^2}$$

We find that the denominator is obviously G_{AA} . The numerator is the *cross spectrum*, or G_{BA} . The SD375 stores $\overline{G_{BA}}$ in rectangular coordinates (real and imaginary) where:

$$\overline{ac + bd} = \overline{G_{BA \text{ REAL}}} = (\overline{CO})$$

$$j(\overline{ad - bc}) = \overline{G_{BA \text{ IMAG}}} = (\overline{QUAD})$$

When you display transfer function and phase, you are displaying the *magnitude* of the transfer function with the phase in the upper-scroll display. The following formulae show how this is achieved:

$$TF = \frac{\overline{G}_{BA}}{\overline{G}_{AA}} = \frac{\overline{G}_{BA \text{ REAL}} + j \overline{G}_{BA \text{ IMAG}}}{\overline{G}_{AA}}$$

hence phase

$$\phi = \tan^{-1} \left(\frac{\overline{G}_{BA \text{ IMAG}}}{\overline{G}_{BA \text{ REAL}}} \right)$$

and

$$|TF| = \sqrt{\left(\frac{\overline{G}_{BA \text{ REAL}}}{\overline{G}_{AA}} \right)^2 + \left(\frac{\overline{G}_{BA \text{ IMAG}}}{\overline{G}_{AA}} \right)^2}$$

One important factor must be noted in these formulae. When dealing with transfer function, power or correlation, the SD375 is always displaying the *average* memory data. The average quantity is denoted by: \overline{G}_{AA} , \overline{G}_{BB} , $\overline{G}_{BA \text{ REAL}}$, $\overline{G}_{BA \text{ IMAG}}$. Each quantity is averaged separately, then the functions to be displayed are calculated from these averaged quantities.

The Phenomenon of "Coherence" (γ^2)

Suppose we were measuring a band-pass filter whose transfer function was:

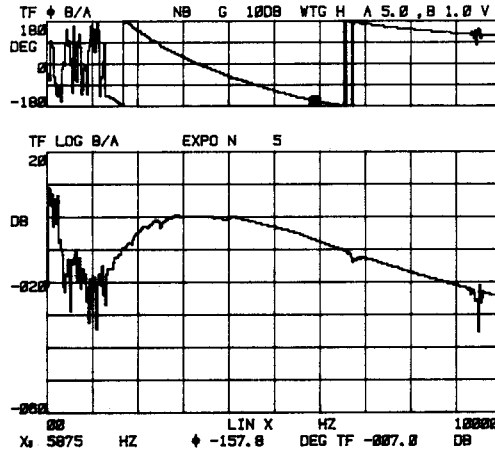

Example of Band Pass Filter Transfer Function

Any number of A-B frequency domain "pictures" represent data that could result in that TF. For example, the following spectra result in such a TF.

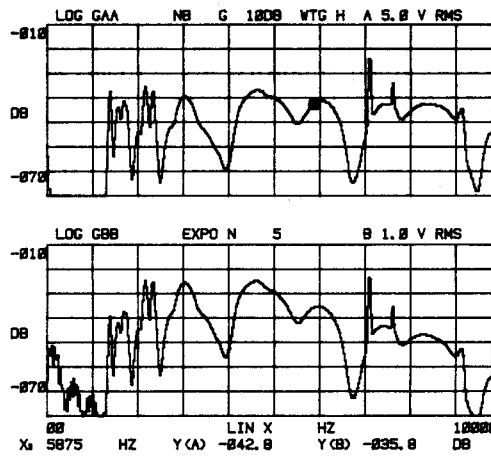

Examples of Frequency Domain Pictures

All that is required is that $|G_{BA}|/G_{AA}$ have that form.

However, if we were to input to our specimen a *single* frequency, we would get the TF as shown in the following sketch.

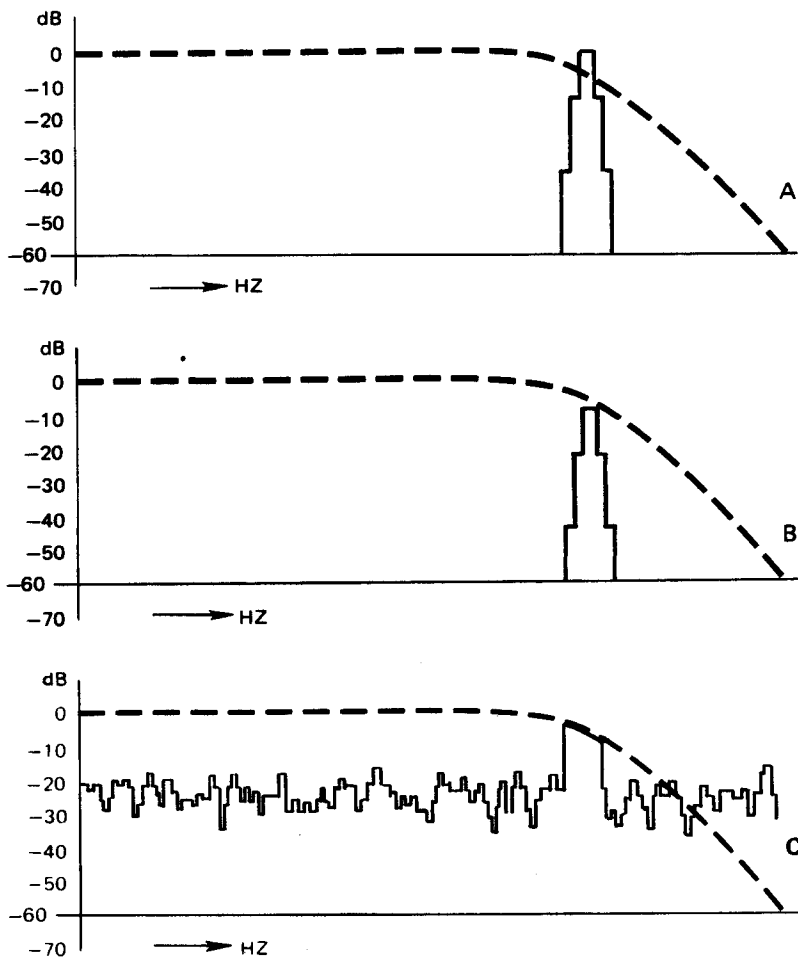

Example of Single Frequency TF

The reason the TF curve takes this form is that the “data” in all the frequencies other than the excitation frequency is the (more than 70 dB down) “noise base” of the SD375. In other words, the only signal present at those frequencies is totally random very low level environmental noise.

Effectively, the TF measured at those frequencies is “noise base” divided by “noise base”. If we displayed the *phase* relationship, as well, we would observe a noisy phase relationship at those frequencies. That occurs because there is no consistent phase relationship to measure.

The -20 dB TF measured at these frequencies is, in fact, not a valid measurement. If we input random noise of some energy to A, the output B will also be random noise. But the *relationship* between A and B will be consistent, if the specimen has a consistent transfer function. The “noisy” phase and invalid gain shows up when there is *no* consistent relationship *between* A and B. Coherence is a measurement of this.

The quantity G_{BA} is averaged separately from G_{AA} and G_{BB} . G_{AA} and G_{BB} are the mag^2 of A and B spectra. G_{BA} is a *signed* quantity. A series of random, unrelated values averaged as mag^2 will result in a much larger quantity than a series of random values averaged as signed quantities. This will happen because the random phase relationship will produce both positive and negative values which will

cancel each other out. If the relationship is “totally” random, the result will be very close to zero, when compared to the values averaged as mag². If a consistent relationship does exist, the phase will be consistent, yielding no “positive on this pass, negative on the next” to cancel.

Hence, if we render G_{BA} to a form compatible with G_{AA} and G_{BB} , the ratio between the two should be a value from 0 to 1 indicating the validity, or “coherence” of the values averaged.

NOTE

There is *always* a relationship between A and B. Coherence tells you whether or not that relationship is a characteristic of the specimen or the random universe we live in.

We calculate coherence via:

$$\gamma^2 = \frac{|\overline{G_{BA}}|^2}{\overline{G_{AA}} \overline{G_{BB}}}$$

since (ignoring the average characteristics)

$$G_{BA} = |B| |A|_{\text{REAL}} + |B| |A|_{\text{IMAG}}$$

and

$$G_{AA} = |A|^2; G_{BB} = |B|^2$$

then

$$\frac{|\overline{G_{BA}}|^2}{\overline{G_{AA}} \cdot \overline{G_{BB}}} = \frac{(|B| |A|)^2}{|A|^2 |B|^2} = 1$$

excepting, of course, where the A-B relationship is random, in which case G_{BA}^2 will approach 0 in relationship to $G_{AA} \cdot G_{BB}$. Thus we achieve our measurement of “coherence”.

Coherence is shown in the upper display. The Y axis scaling, you’ll notice, is from 0 to 1.

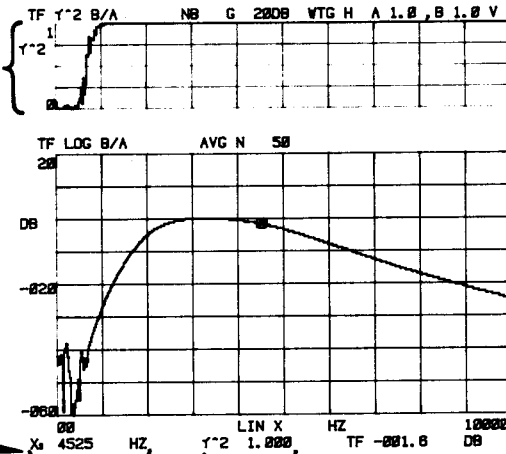

Coherence at 4525 Hz is 1.000

Example of Coherence (γ^2)

Table 3-1. Definitions of Functions and Symbols

All formulae will be expressed in terms of G_{AA} , G_{BB} , T_A , T_B , CO , $QUAD$ and their averages.

- G_{AA} - Mag² or Power Spectrum, Channel A
- G_{BB} - Mag² or Power Spectrum, Channel B
- $\sqrt{G_{AA}}$ - Spectrum, Channel A
- $\sqrt{G_{BB}}$ - Spectrum, Channel B
- T_A - Time Domain Data, Channel A
- T_B - Time Domain Data, Channel B
- $\overline{G_{BA}}$ - Cross Spectrum
- \overline{CO} - G_{BA} REAL
- \overline{QUAD} - G_{BA} IMAG
- ϕ - Phase angle of FFT
- $\mathcal{F}^{-1} []$ - Inverse FFT
- γ^2 - Coherence
- (M1) - Contents of Memory 1 (Averager Memory)
- (M2) - Contents of Memory 2 (Storage Memory)
- (SYNC) - FFT of Time Averaged Data
- (ZOOM) - Translated data (the "-1" Option)

Any quantities with an "overbar" are averaged quantities. For example, $\overline{G_{AA}}$ = Average of G_{AA} , $\overline{G_{BA}}$ = Average of G_{BA} = $\overline{CO} + j\overline{QUAD}$ (CO and QUAD are averaged separately), $\overline{T_A}$ = Averaged Time Domain data Channel A, etc.

Keep in mind that the formulae shown with the examples in Figure 3-8 are simplified representations of the complex calculations performed by the SD375. For example, SPECTRUM MENU selection 6, SPECT B + A is not straight-forward addition. What actually takes place is a calculation in the form of $\sqrt{A^2 + B^2}$, e.g., $3 + 4 = 5$ or more precisely $\sqrt{3^2 + 4^2} = \sqrt{9 + 16} = \sqrt{25} = 5$.

SPECTRUM MENU

1. SPECT A & B (RMS magnitude of CH A & CH B spectrum)

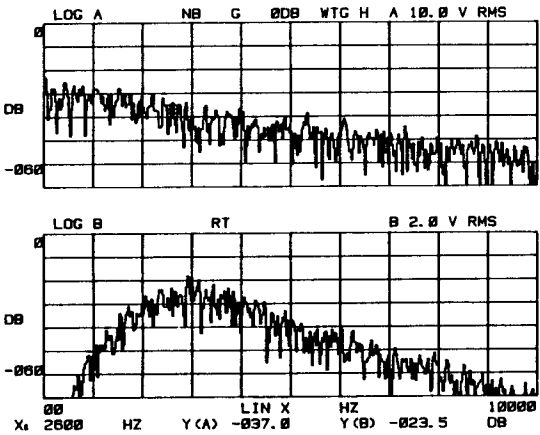

DUAL TRACE
FORMULA

UPPER	LOWER
\sqrt{GAA}	\sqrt{GBB}

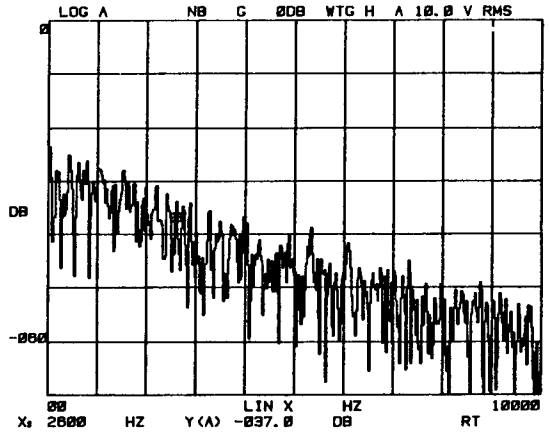

SINGLE TRACE CH A
DATA TYPE

UPPER	LOWER
SPECT	SPECT

2. GAA & GBB (Power spectrum (A² & B²) of CH A & CH B)

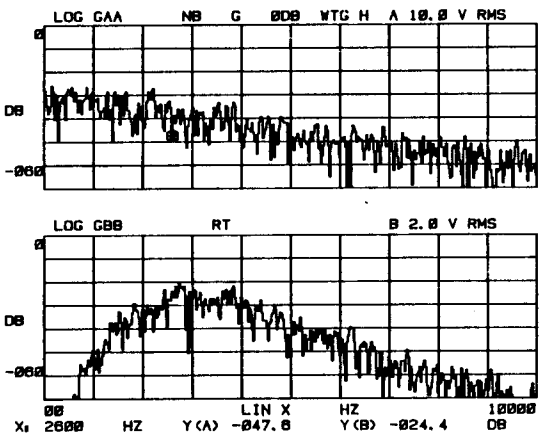

DUAL TRACE
FORMULA

UPPER	LOWER
GAA	GBB

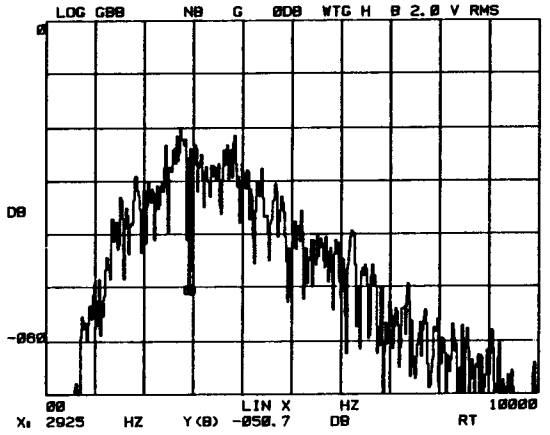

SINGLE TRACE CH B
DATA TYPE

UPPER	LOWER
POWER	POWER

Figure 3-8. Sample Displays of Each of the Primary Function Menu Items

SPECTRUM MENU (CONTINUED)

3. RATIO

(Transmissibility display of B/A or A/B)

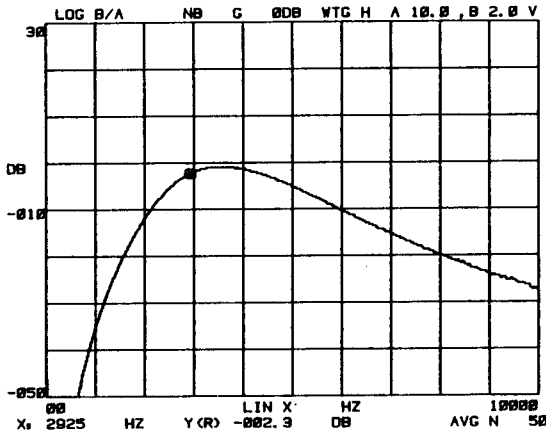

SINGLE TRACE ONLY

FORMULA DATA TYPE

$$\frac{\sqrt{GBB}}{\sqrt{GAA}}$$

GAIN

4. SPECT B-A

(RMS spectrum difference, i.e. $\sqrt{B^2 - A^2}$)

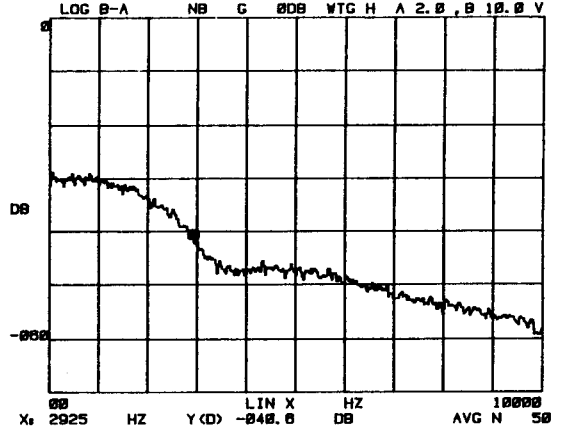

SINGLE TRACE ONLY

FORMULA DATA TYPE

$$\sqrt{GBB-GAA}$$

SPECT

5. GBB - GAA

(Power spectrum difference, i.e., $B^2 - A^2$)

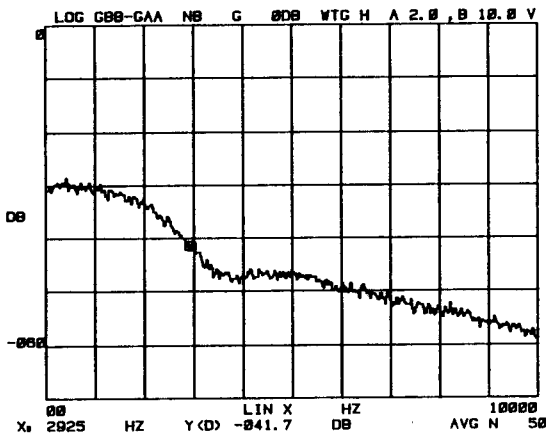

SINGLE TRACE ONLY

FORMULA DATA TYPE

GBB-GAA

POWER

6. SPECT B+A

(RMS spectrum sum, i.e. $\sqrt{B^2 + A^2}$)

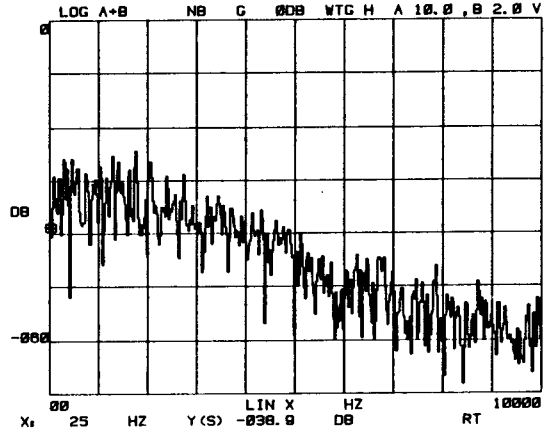

SINGLE TRACE ONLY

FORMULA DATA TYPE

$$\sqrt{GBB+GAA}$$

SPECT

Figure 3-8. Sample Displays of Each of the Primary Function Menu Items (Continued)

SPECTRUM MENU (CONTINUED)

7. GBB + GAA (Power spectrum sum, i.e., B² + A²)

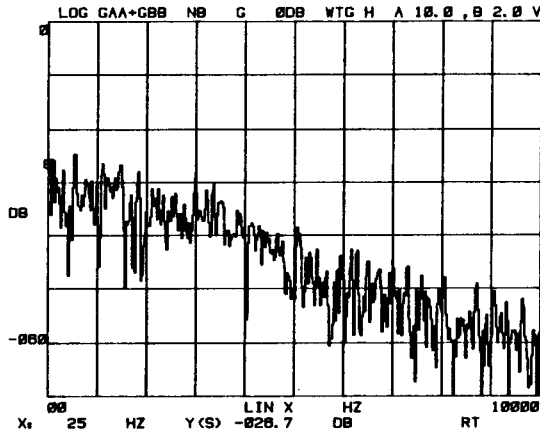

SINGLE TRACE ONLY

FORMULA	DATA TYPE
GBB+GAA	POWER

8. SPECT A & ZOOM A (Simultaneous baseband & zoom spectrum of CH A)

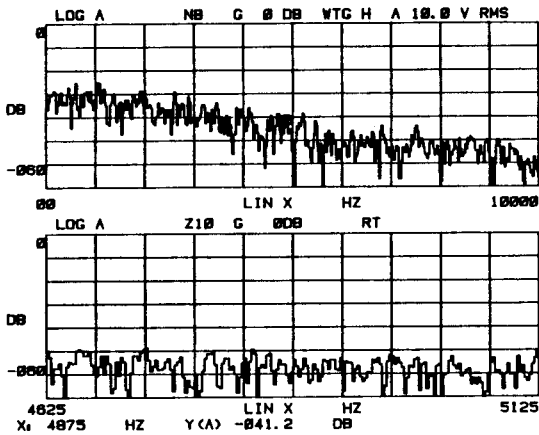

DUAL TRACE
FORMULA

UPPER	LOWER
\sqrt{GAA}	\sqrt{GAA} (ZOOM)

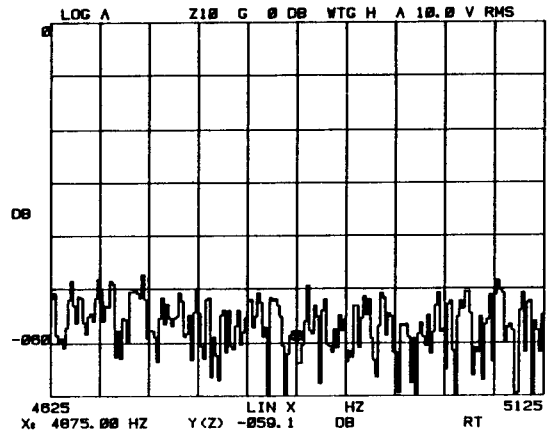

SINGLE TRACE LOWER (ZOOM)
DATA TYPE

UPPER	LOWER
SPECT	SPECT

Figure 3-8. Sample Displays of Each of the Primary Function Menu Items (Continued)

SPECTRUM MENU (CONTINUED)

9. SPECT B & ZOOM B (Simultaneous baseband & zoom spectrum of CH B)

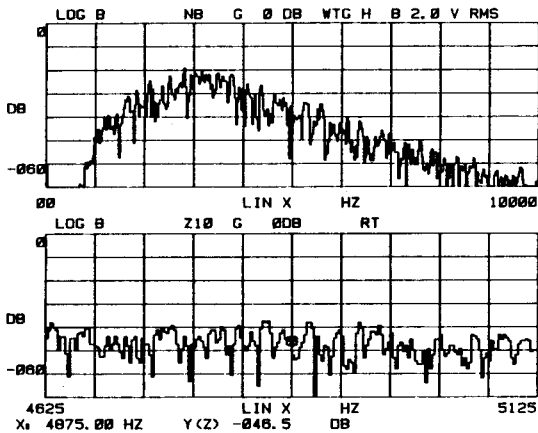

DUAL TRACE
FORMULA

UPPER	LOWER
$\sqrt{G_{BB}}$	$\sqrt{G_{BB}} \text{ (ZOOM)}$

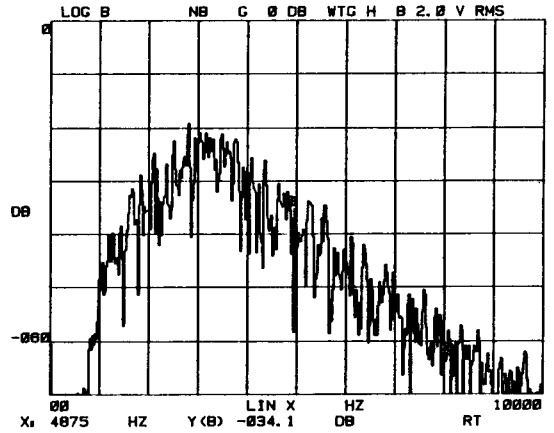

SINGLE TRACE UPPER
DATA TYPE

UPPER	LOWER
SPECT	SPECT

10 SYNC SPECT A & B (Synchronous spectrum of CH A & CH B referenced to external trigger)

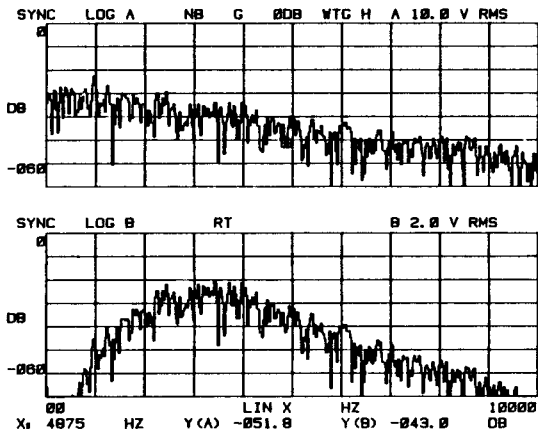

DUAL TRACE
FORMULA

UPPER	LOWER
$\sqrt{G_{AA}} \text{ (SYNC)}$	$\sqrt{G_{BB}} \text{ (SYNC)}$

NOTE

G_{XX} (Sync) is an FFT of Time_X , e.g., frequency picture of time averaged signal data.

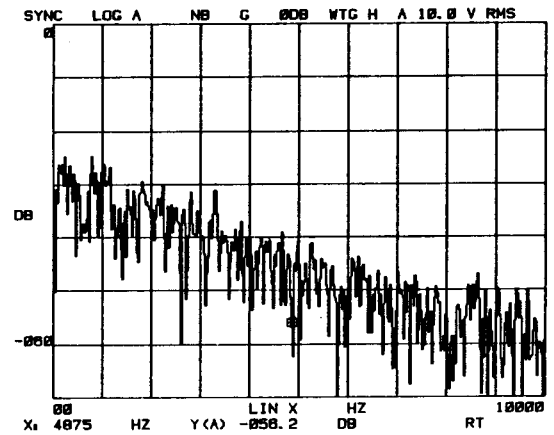

SINGLE TRACE CH A
DATA TYPE

UPPER	LOWER
SPECT	SPECT

Figure 3-8. Sample Displays of Each of the Primary Function Menu Items (Continued)

SPECTRUM MENU (CONTINUED)

11 SYNC SPECT A & ϕ (Spectrum A & phase)

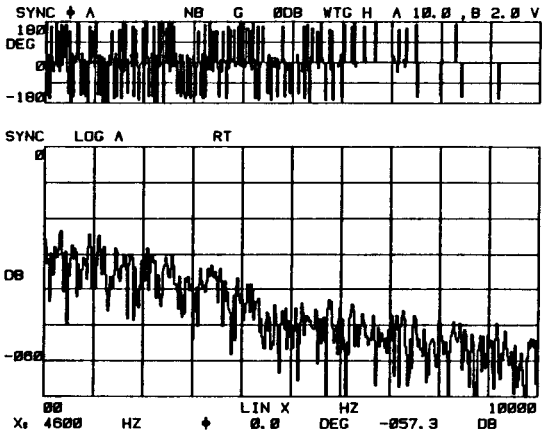

SCROLL-DUAL
FORMULA

UPPER	LOWER
$\phi_{REF} - \phi_A$	$\sqrt{GAA} (\text{SYNC})$

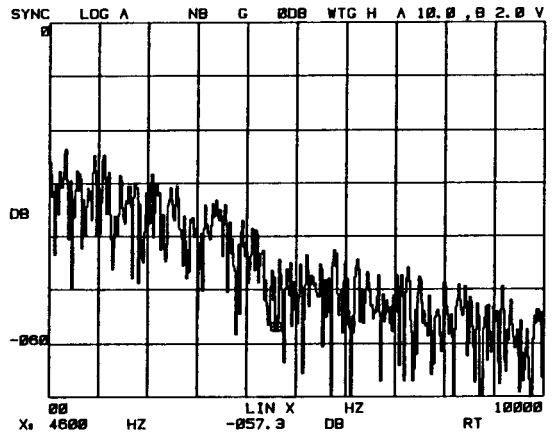

SCROLL-DUAL LOWER TRACE
DATA TYPE

UPPER	LOWER
DEGREES	SPECT

12 SYNC SPECT B/A & ϕ (Synchronous spectrum ratio & phase — "SYNC TF")

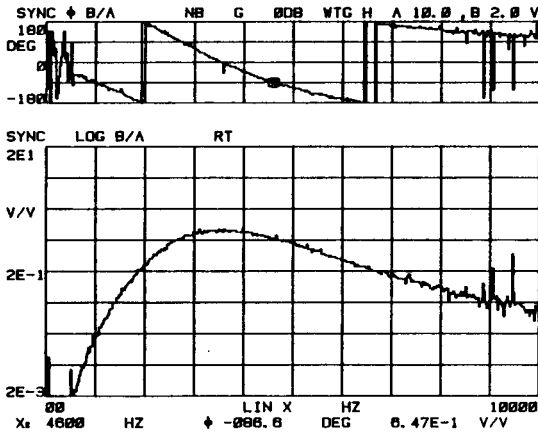

SCROLL-DUAL
FORMULA

UPPER	LOWER
$\phi_B - \phi_A$	$\frac{\sqrt{GBB} (\text{SYNC})}{\sqrt{GAA} (\text{SYNC})}$

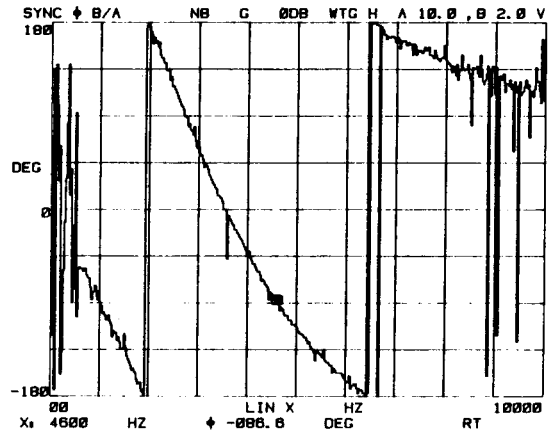

SCROLL-DUAL UPPER TRACE
DATA TYPE

UPPER	LOWER
DEGREES	SPECT

Figure 3-8. Sample Displays of Each of the Primary Function Menu Items (Continued)

SPECTRUM MENU (CONTINUED)

13

EQUALIZED RATIO (Compensating a ratio with a reference ratio, i.e., M1/M2)

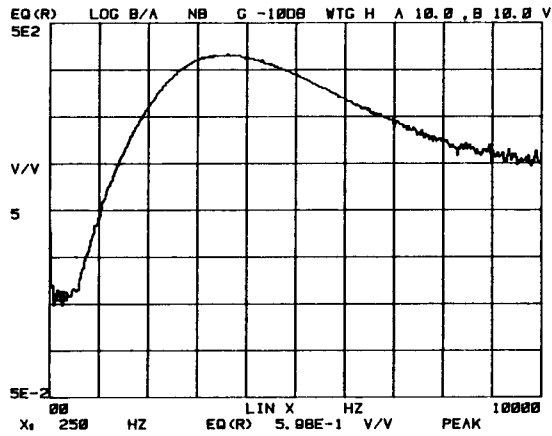

SINGLE TRACE ONLY

FORMULA

DATA TYPE

$$\frac{\sqrt{G_{BB}}(M2) / \sqrt{G_{AA}}(M2)}{\sqrt{G_{BB}}(M1) / \sqrt{G_{AA}}(M1)}$$

GAIN

Figure 3-8. Sample Displays of Each of the Primary Function Menu Items (Continued)

TRANSFER FUNCTION MENU

1. TF & ϕ (Transfer function gain of B/A & phase)

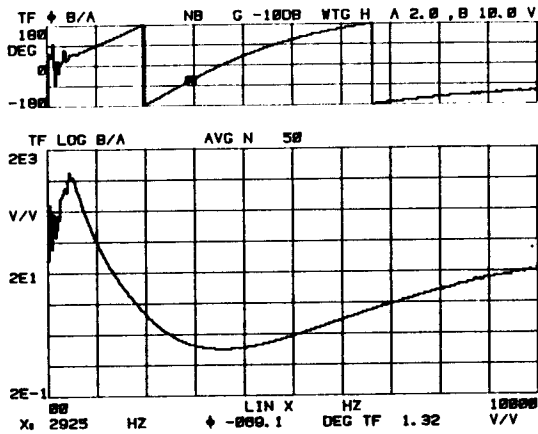

SCROLL-DUAL
FORMULA

$$\text{TAN}^{-1} \left(\frac{\text{UPPER QUAD}}{\text{CO}} \right) \quad \frac{\text{LOWER} \sqrt{\text{CO}^2 + \text{QUAD}^2}}{\text{GAA}}$$

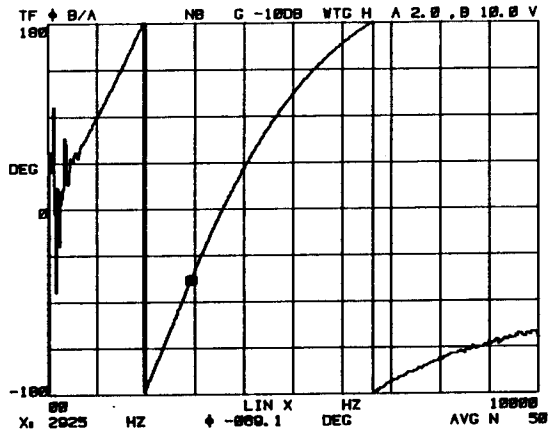

SCROLL-DUAL UPPER TRACE
DATA TYPE

UPPER DEGREES LOWER GAIN

2. TF & γ^2 (Transfer function gain of B/A & coherence)

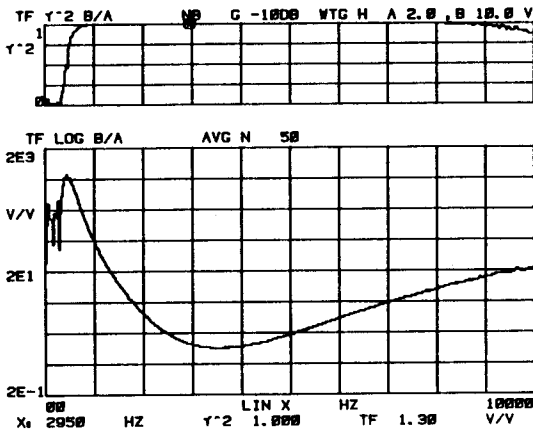

SCROLL-DUAL
FORMULA

$$\frac{\text{UPPER} \sqrt{\text{CO}^2 + \text{QUAD}^2}}{\text{GAA} \times \text{GBB}} \quad \frac{\text{LOWER} \sqrt{\text{CO}^2 + \text{QUAD}^2}}{\text{GAA}}$$

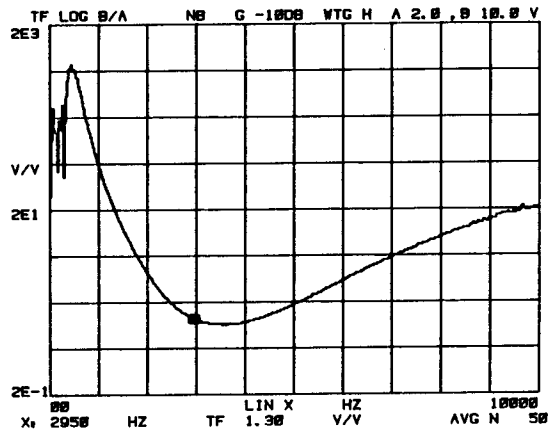

SCROLL-DUAL LOWER TRACE
DATA TYPE

UPPER UNITY LOWER GAIN

Figure 3-8. Sample Displays of Each of the Primary Function Menu Items (Continued)

TRANSFER FUNCTION MENU (CONTINUED)

3. TF RE AND IM (Transfer function real & imaginary)

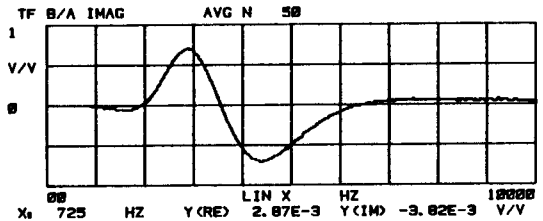
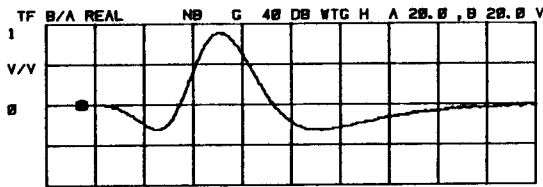

DUAL TRACE
FORMULA

UPPER

$\frac{CO}{GAA}$

LOWER

$\frac{QUAD}{GAA}$

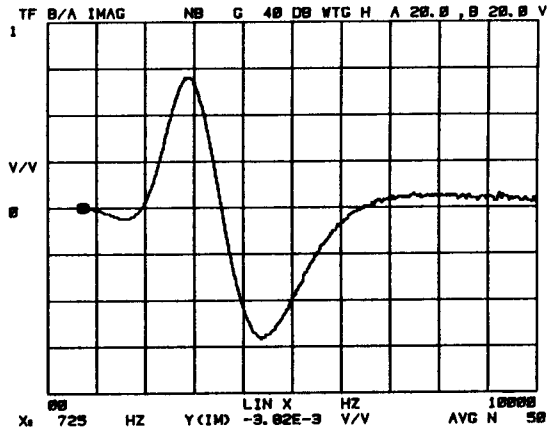

SINGLE TRACE LOWER
DATA TYPE

UPPER

GAIN

LOWER

GAIN

4. TF CO/QD (Nyquist display of TF real vs. imaginary)

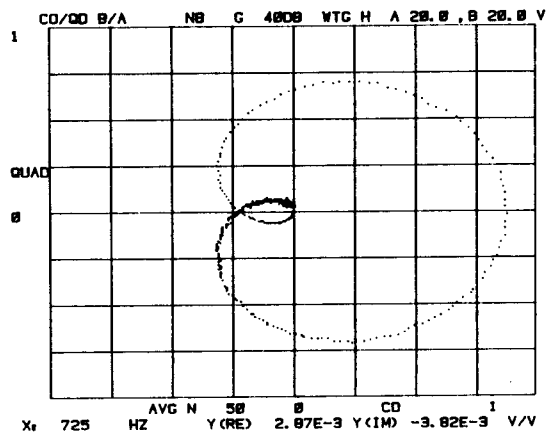

SINGLE TRACE ONLY

FORMULA

X AXIS

$\frac{CO}{GAA}$

Y AXIS

$\frac{QUAD}{GAA}$

DATA TYPE

GAIN

Figure 3-8. Sample Displays of Each of the Primary Function Menu Items (Continued)

TRANSFER FUNCTION MENU (CONTINUED)

5. EQUALIZED TF & ϕ

(Compensating a TF & phase measurement with reference TF & phase data, i.e., M1/M2)

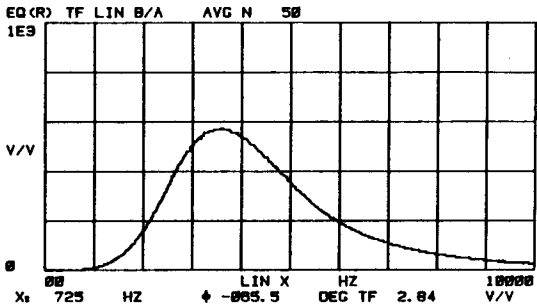
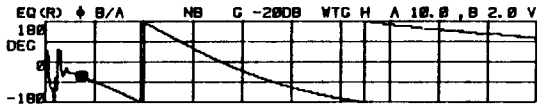

SCROLL-DUAL

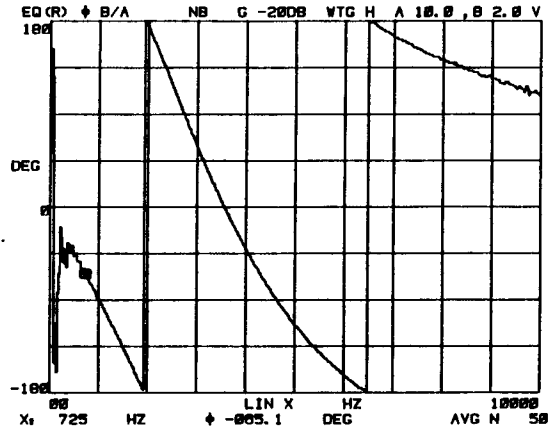

SCROLL-DUAL UPPER TRACE

FORMULA

$$\text{UPPER} \\ \text{TAN}^{-1} \left(\frac{\text{QUAD}_2}{\text{CO}_2} \right) - \text{TAN}^{-1} \left(\frac{\text{QUAD}_1}{\text{CO}_1} \right)$$

$$\text{LOWER} \\ \frac{\sqrt{\text{CO}_2^2 + \text{QUAD}_2^2 / \text{GAA}_2}}{\sqrt{\text{CO}_1^2 + \text{QUAD}_1^2 / \text{GAA}_1}}$$

DATA TYPE

UPPER	LOWER
DEGREES	GAIN

Figure 3-8. Sample Displays of Each of the Primary Function Menu Items (Continued)

POWER MENU

1. COP & γ^2 (Coherent Output Power & coherence)

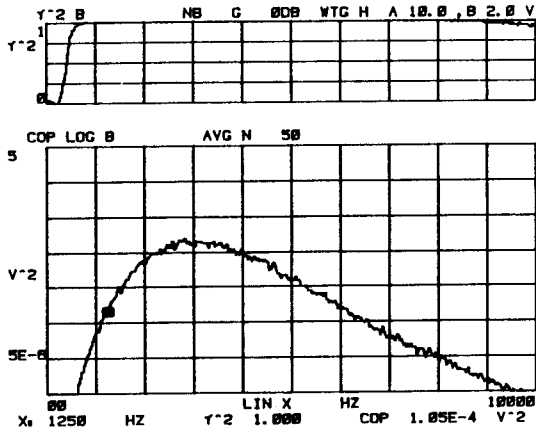

SCROLL-DUAL
FORMULA

UPPER	LOWER
$\frac{CO^2 + QUAD^2}{GAA \times GBB}$	$\frac{CO^2 + QUAD^2}{GAA}$

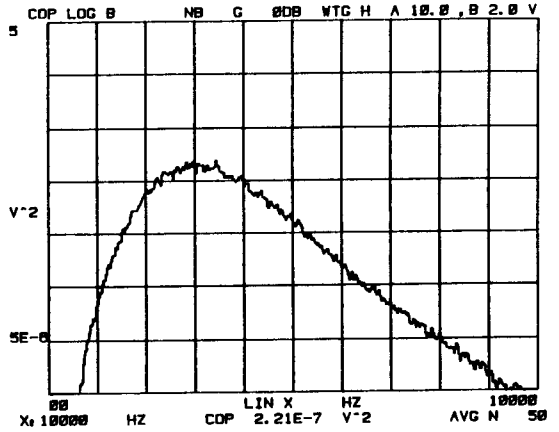

SCROLL-DUAL LOWER TRACE
DATA TYPE

UPPER	LOWER
UNITY	POWER

2. COP & GBB (Coherent Output Power & Total Power)

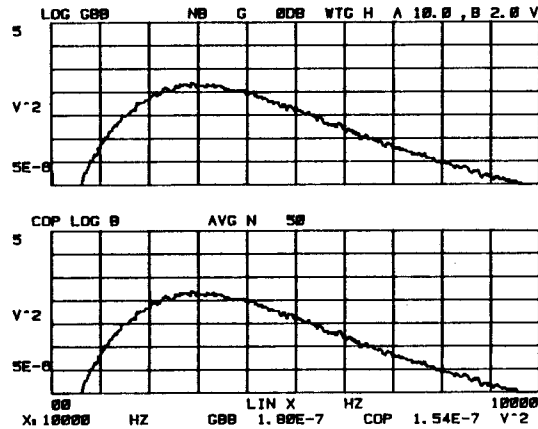

DUAL TRACE
FORMULA

UPPER	LOWER
GBB	$\frac{CO^2 + QUAD^2}{GAA}$

NOTE

COP = G_{BB} (output power) times γ^2 (coherence), e.g., that part of output power actually generated by input power.

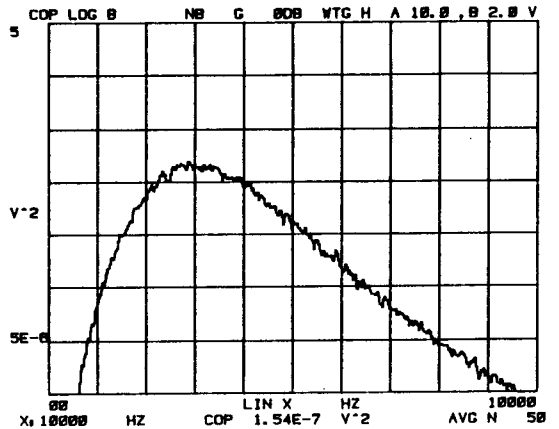

SINGLE TRACE LOWER
DATA TYPE

UPPER	LOWER
POWER	POWER

Figure 3-8. Sample Displays of Each of the Primary Function Menu Items (Continued)

POWER MENU (CONTINUED)

3. GAA & GBB (Averaged Power Spectrum (A² & B²) of CH A & CH B)

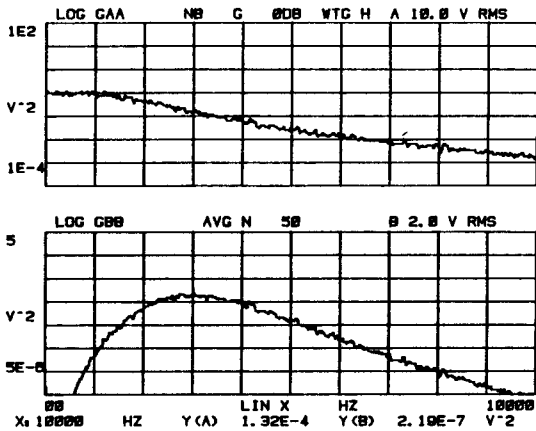

DUAL TRACE

FORMULA

UPPER LOWER
 GAA GBB

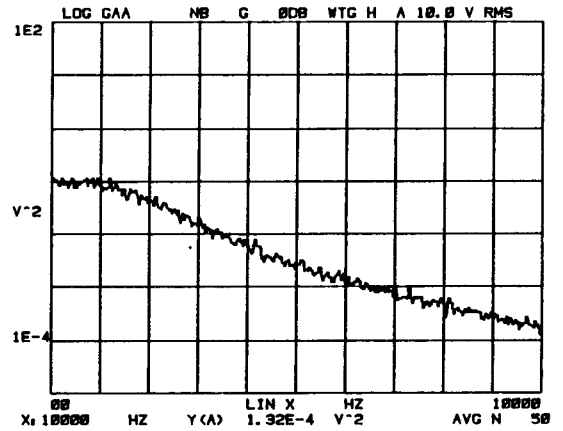

SINGLE TRACE CH A

DATA TYPE

UPPER LOWER
 POWER POWER

4. GBB - GAA (Averaged Power Spectrum difference, i.e., B² - A²)

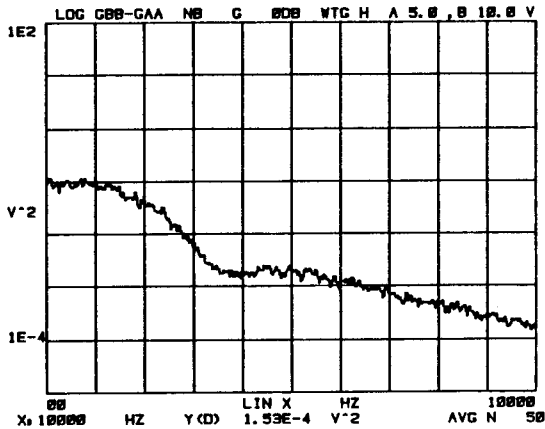

SINGLE TRACE ONLY

FORMULA DATA TYPE

GBB - GAA POWER

5. GBB + GAA (Averaged Power Spectrum sum, i.e., B² + A²)

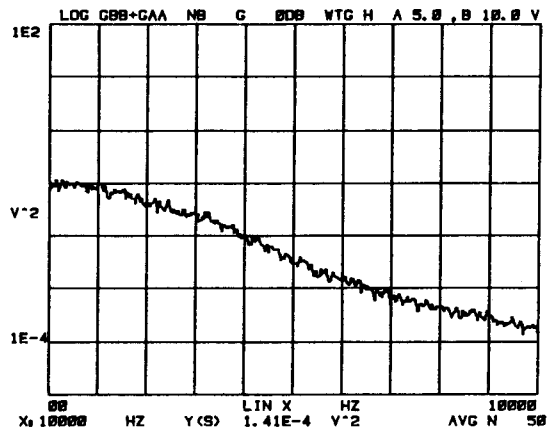

SINGLE TRACE ONLY

FORMULA DATA TYPE

GBB + GAA POWER

Figure 3-8. Sample Displays of Each of the Primary Function Menu Items (Continued)

POWER MENU (CONTINUED)

6. GBA & ϕ (Cross Spectrum & phase)

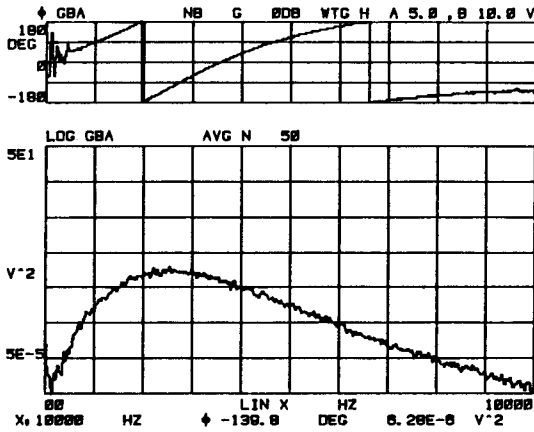

SCROLL-DUAL

FORMULA

$$\text{TAN}^{-1} \left(\frac{\text{UPPER}}{\text{CO}} \right) \quad \sqrt{\text{CO}^2 + \text{QUAD}^2}$$

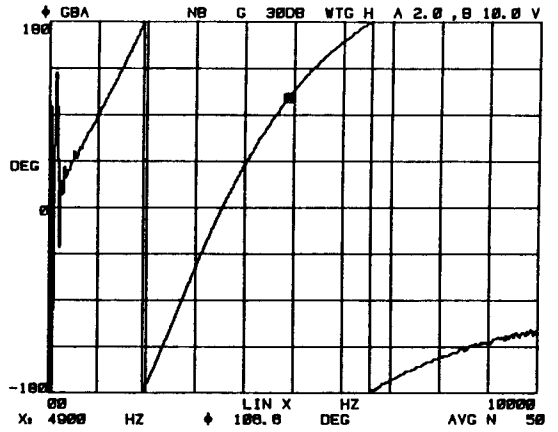

SCROLL-DUAL UPPER TRACE

DATA TYPE

UPPER LOWER
DEGREES POWER

7. GBA RE AND IM (Cross Spectrum real & imaginary)

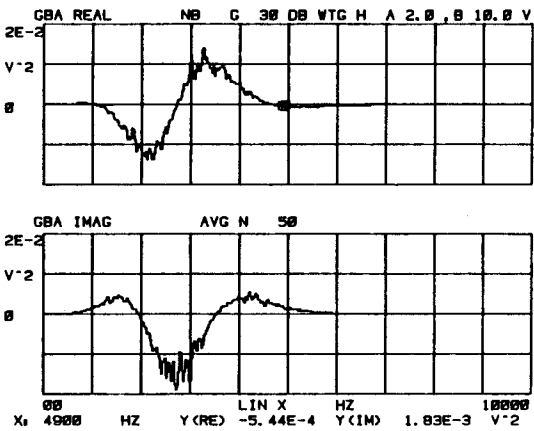

DUAL TRACE

FORMULA

UPPER LOWER
CO QUAD

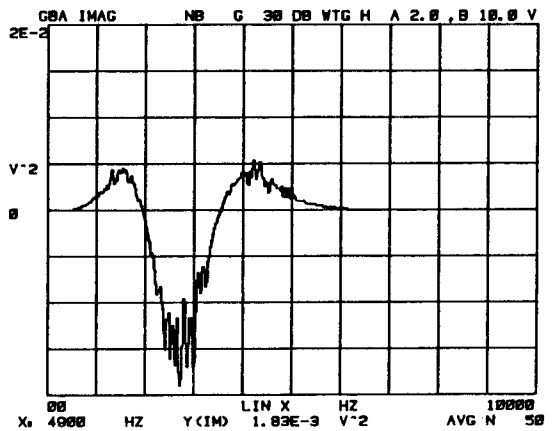

SINGLE TRACE LOWER

DATA TYPE

UPPER LOWER
POWER POWER

Figure 3-8. Sample Displays of Each of the Primary Function Menu Items (Continued)

POWER MENU (CONTINUED)

8. GBA CO/QD (Cross Spectrum real vs. imaginary)

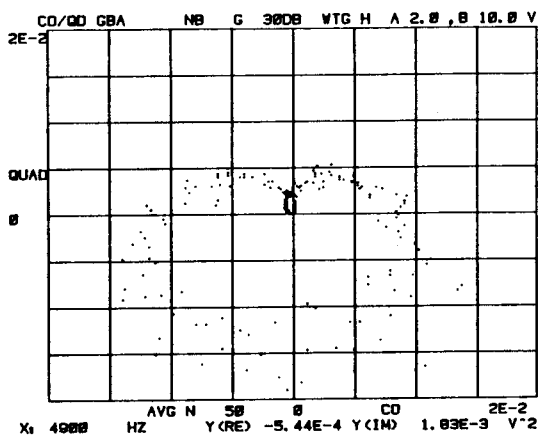

SINGLE TRACE ONLY

FORMULA		DATA TYPE
X AXIS	Y AXIS	POWER
CO	QUAD	

Figure 3-8. Sample Displays of Each of the Primary Function Menu Items (Continued)

TIME MENU

1. TIME A & B (Filtered digitized time waveform of CH A & CH B)

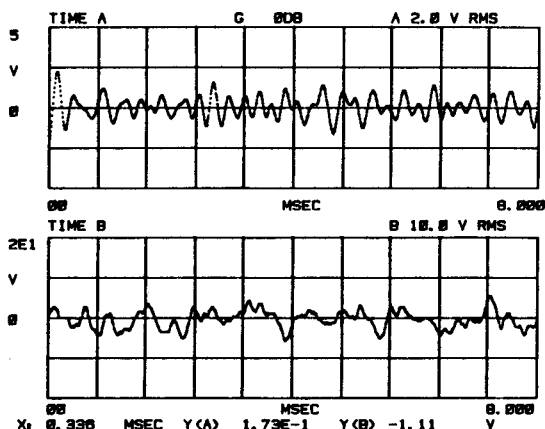

DUAL TRACE
FORMULA

UPPER	LOWER
TA	TB

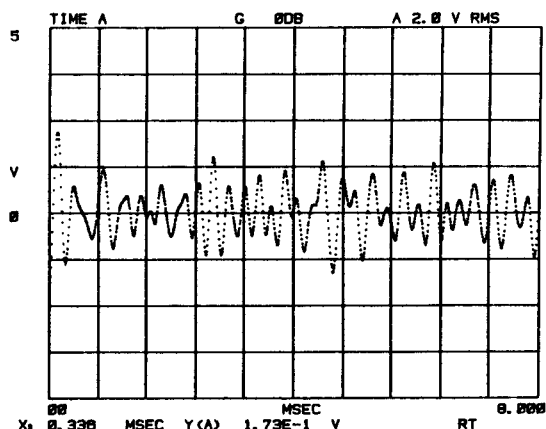

SINGLE TRACE CH A
DATA TYPE

UPPER	LOWER
TIME	TIME

2. SYNC TIME A & B (Synchronous time waveform of CH A & CH B referenced to external trigger)

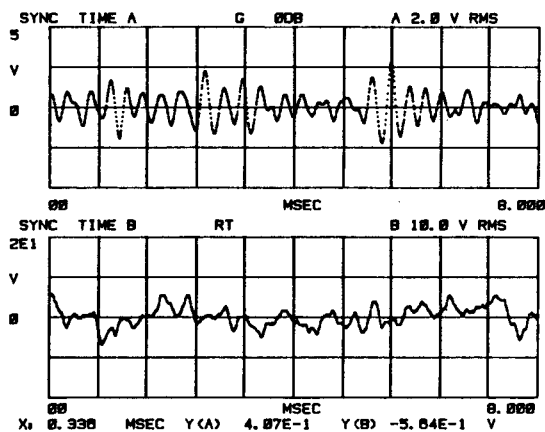

DUAL TRACE
FORMULA

UPPER	LOWER
TA	TB

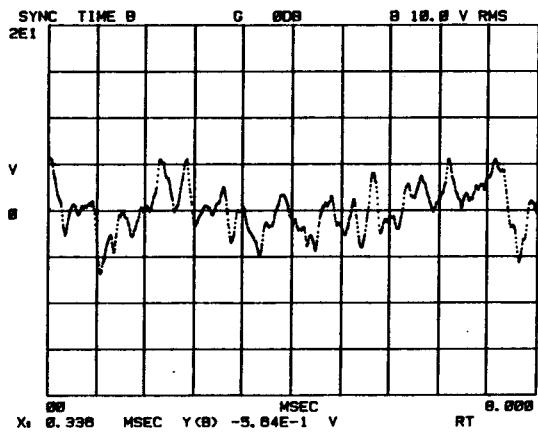

SINGLE TRACE CH B
DATA TYPE

UPPER	LOWER
TIME	TIME

Figure 3-8. Sample Displays of Each of the Primary Function Menu Items (Continued)

TIME MENU (CONTINUED)

3. TIME A & SPECT A (Simultaneous time waveform and spectrum of CH A)

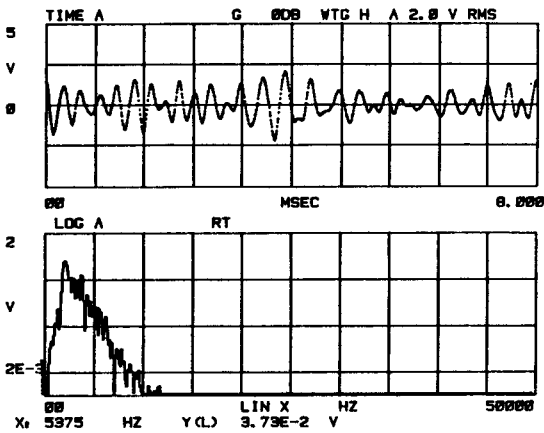

DUAL TRACE
FORMULA

UPPER LOWER
TA \sqrt{GAA}

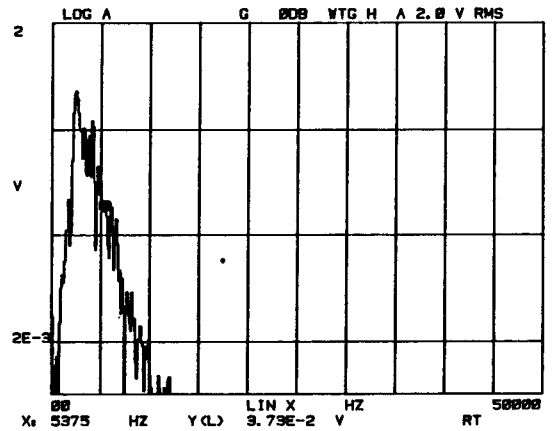

SINGLE TRACE LOWER
DATA TYPE

UPPER LOWER
TIME SPECT

4. TIME B & SPECT B (Simultaneous time waveform and spectrum of CH B)

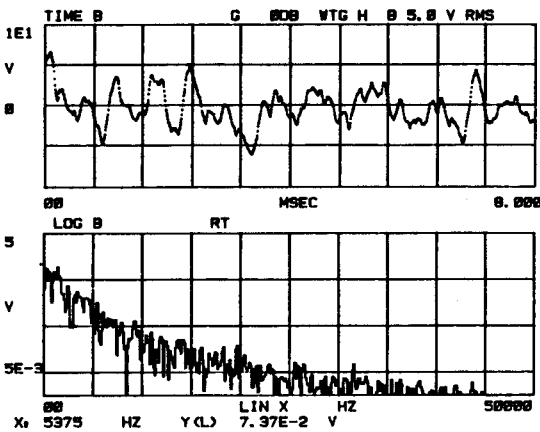

DUAL TRACE
FORMULA

UPPER LOWER
TB \sqrt{GBB}

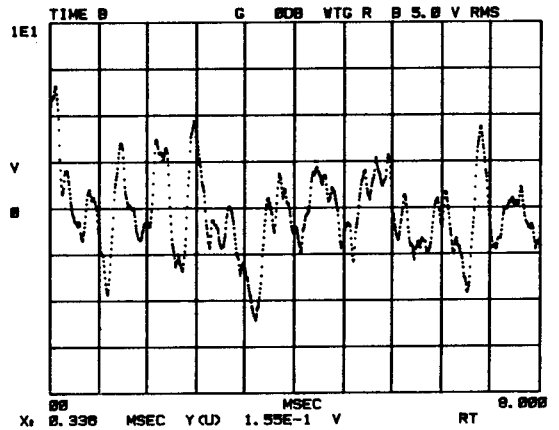

SINGLE TRACE UPPER
DATA TYPE

UPPER LOWER
TIME SPECT

Figure 3-8. Sample Displays of Each of the Primary Function Menu Items (Continued)

TIME MENU (CONTINUED)

5. RAA AND RBB (Normalized Auto Correlation of CH A & CH B)

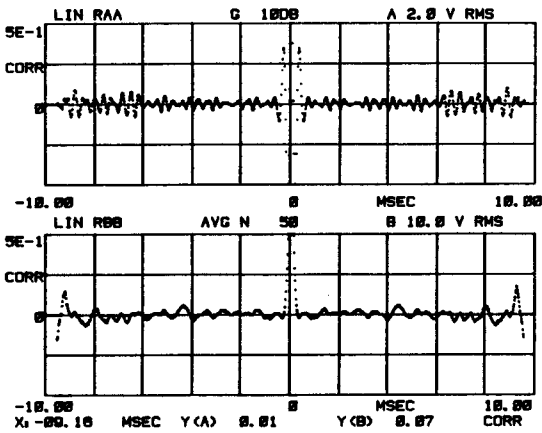

DUAL TRACE
FORMULA

UPPER	LOWER
$\mathcal{F}^{-1}[GAA]$	$\mathcal{F}^{-1}[GBB]$

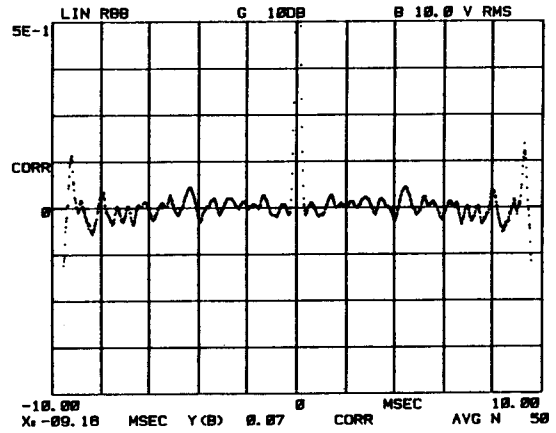

SINGLE TRACE CH B
DATA TYPE

UPPER	LOWER
TIME	TIME

6. RBA (Normalized Cross Correlation)

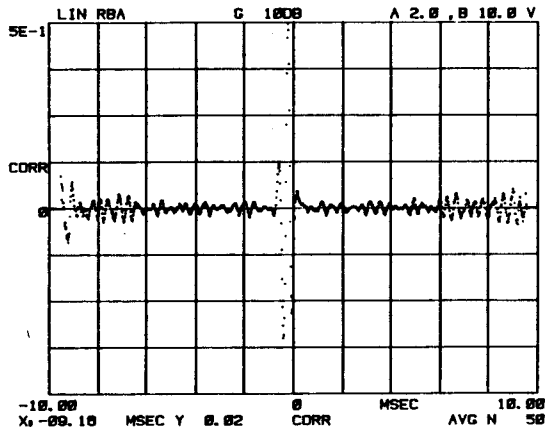

SINGLE TRACE ONLY

FORMULA	DATA TYPE
$\mathcal{F}^{-1}[GBA]$	TIME

7. IMPULSE RESPONSE (Inverse Fourier transform of transfer function)

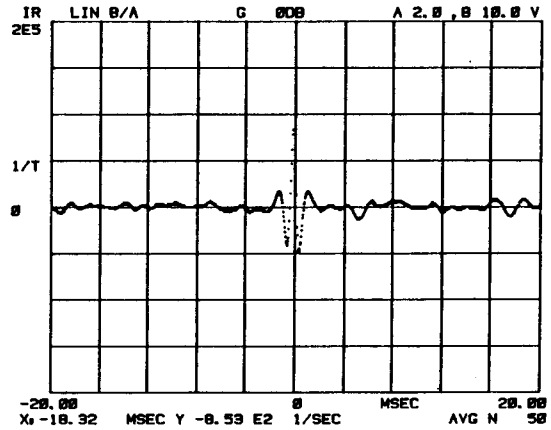

SINGLE TRACE ONLY

FORMULA	DATA TYPE
$\mathcal{F}^{-1}\left[\frac{GBA}{GAA}\right]$	TIME

Figure 3-8. Sample Displays of Each of the Primary Function Menu Items (Continued)

STATISTICAL MENU

1. PDH A & B (Probability Density Histogram of CH A & CH B)

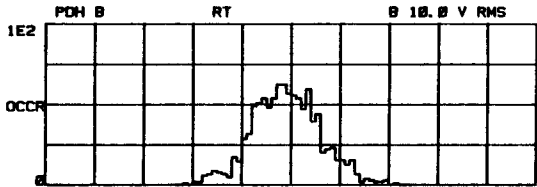
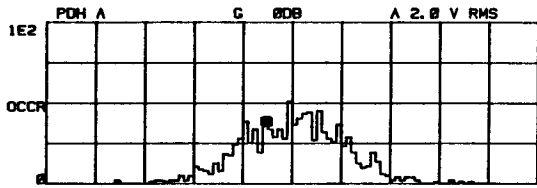

DUAL TRACE
FORMULA

UPPER

LOWER

OCCUR WITHIN
A VOLTAGE WINDOW

OCCUR WITHIN
A VOLTAGE WINDOW

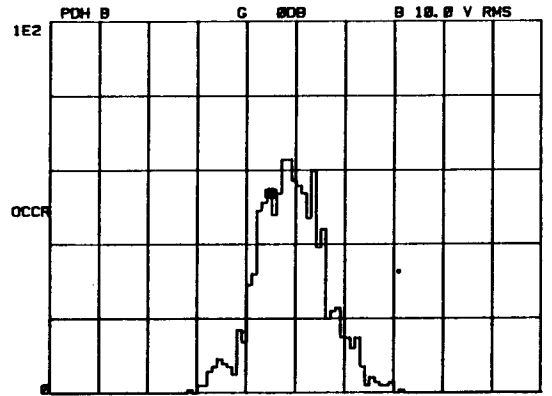

SINGLE TRACE CH B

DATA TYPE

UPPER
COUNT

LOWER
COUNT

2. PD A & B (Probability Distribution (cumulative) of CH A & CH B)

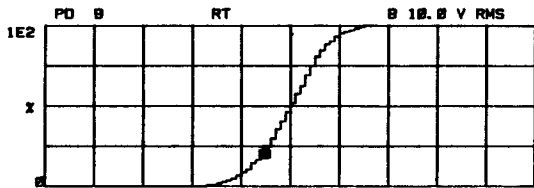
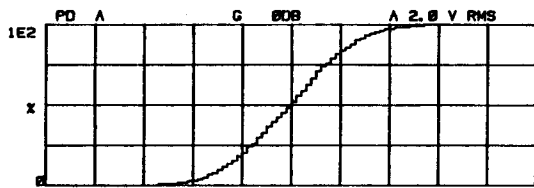

DUAL TRACE
FORMULA

UPPER

LOWER

% TOTAL OCCUR % TOTAL OCCUR

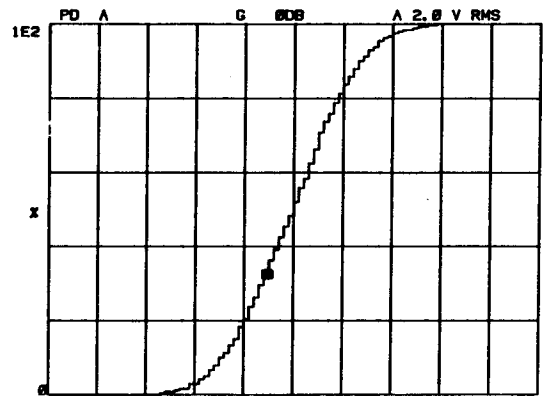

SINGLE TRACE CH A
DATA TYPE

UPPER
COUNT

LOWER
COUNT

Figure 3-8. Sample Displays of Each of the Primary Function Menu Items (Continued)

OCTAVE MENU

1. OCTAVE A & B

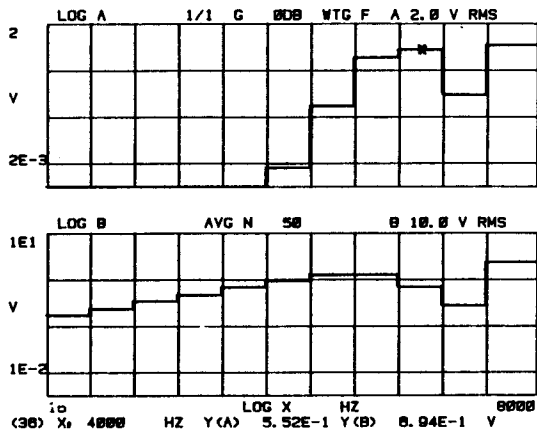

DUAL TRACE
(1/1 OCTAVE)

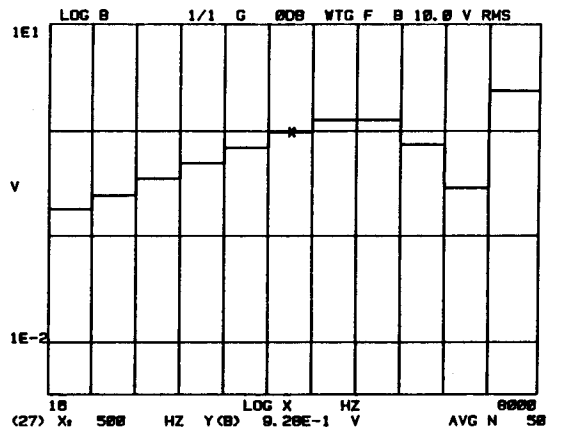

SINGLE TRACE CH B
(1/1 OCTAVE)

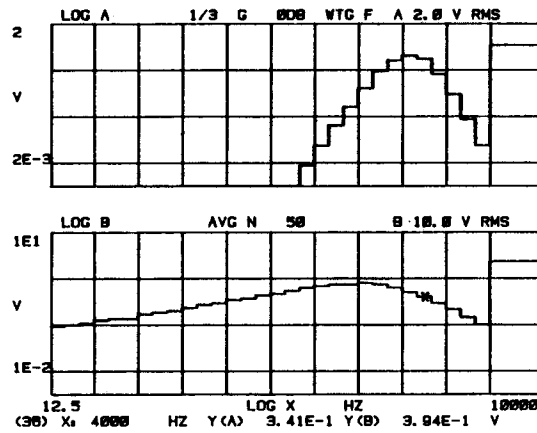

DUAL TRACE
(1/3 OCTAVE)

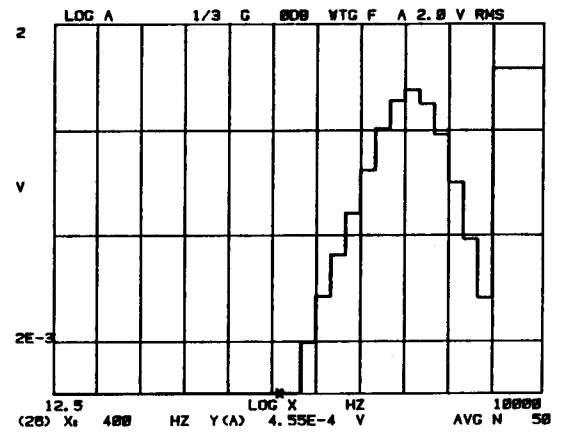

SINGLE TRACE CH A
(1/3 OCTAVE)

Figure 3-8. Sample Displays of Each of the Primary Function Menu Items (Continued)

OCTAVE MENU (CONTINUED)

2. OCTAVE B/A

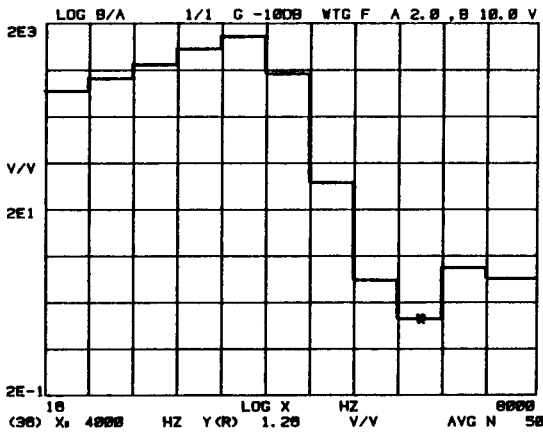

SINGLE TRACE ONLY
(1/1 OCTAVE)

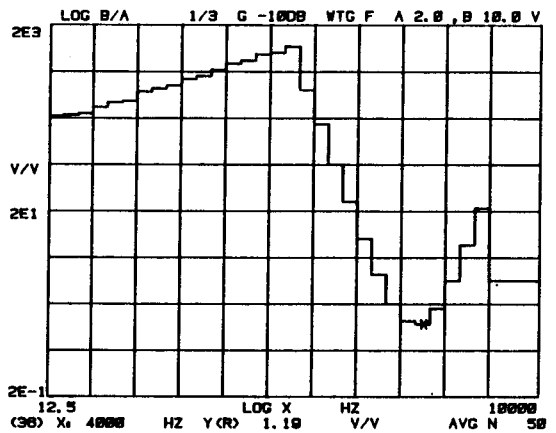

SINGLE TRACE ONLY
(1/3 OCTAVE)

3. OCTAVE B-A

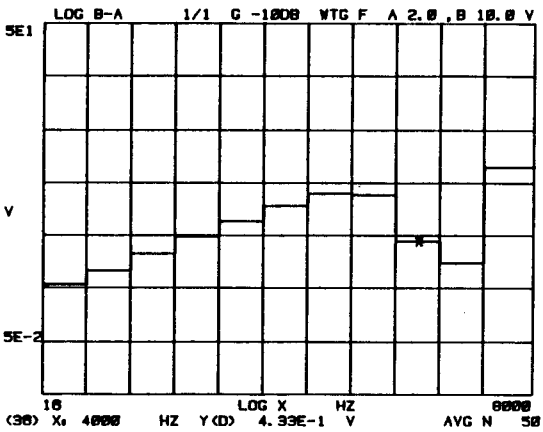

SINGLE TRACE ONLY
(1/1 OCTAVE)

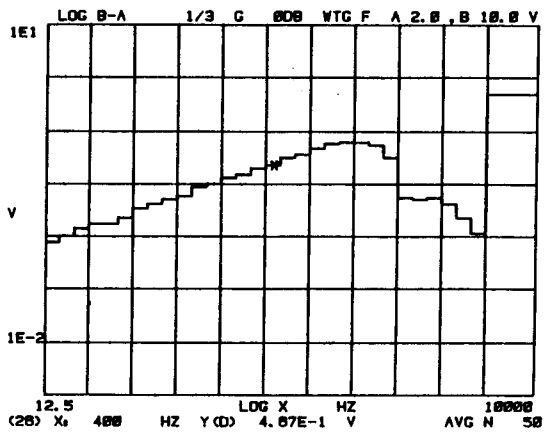

SINGLE TRACE ONLY
(1/3 OCTAVE)

Figure 3-8. Sample Displays of Each of the Primary Function Menu Items (Continued)

OCTAVE MENU (CONTINUED)

4. OCTAVE B+A

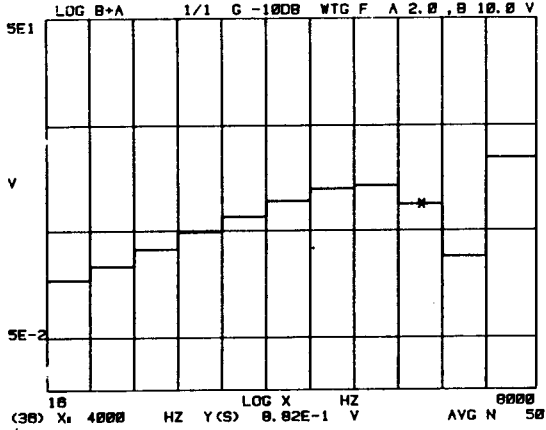

SINGLE TRACE ONLY
(1/1 OCTAVE)

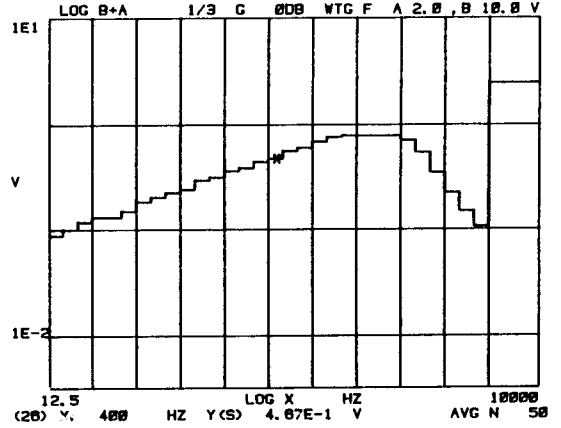

SINGLE TRACE ONLY
(1/3 OCTAVE)

Figure 3-8. Sample Displays of Each of the Primary Function Menu Items (Continued)