

GTE Sprint Communications
Central Region
Transmission Systems Operations

Model 4661 Baseband Noise Transmitter

IMPORTANT NOTICE

**New Manual Information and/or
Documentation is provided in
the back cover envelope**



When ordering parts from Scientific-Atlanta, Inc., be sure to include the equipment model number, equipment serial number, and a description of the part.

MODEL NO. _____

SERIAL NO. _____

MODEL 4661
BASEBAND NOISE TRANSMITTER

*In all correspondence concerning this publication, refer to **35G018D***

Fourth Edition
August, 1983

Copyright© 1982
Scientific-Atlanta, Inc.
All Rights Reserved

163285

WARRANTY

Each standard catalog product manufactured by Scientific-Atlanta, Inc., is warranted to meet all published specifications and to be free from defects in material and workmanship. The company's liability under this warranty is limited to servicing or adjusting equipment and/or replacement of defective parts of any equipment returned to the factory, freight paid by buyer, within a period of one year from date of shipment from the factory, unless a shorter period is specified. Equipment showing damage by misuse, or abnormal conditions of operation, shall be excluded from this warranty. Scientific-Atlanta, Inc., shall in no event be responsible for incidental or consequential damages, including without limitation personal injury or property damage.

Tubes used in Scientific-Atlanta, Inc., equipment carry standard tube manufacturers' warranties which may be fulfilled directly from the tube manufacturer or its distributor. Microwave tubes failing within the stated warranty period should be handled directly with Scientific-Atlanta, Inc., in accordance with instructions packed with the equipment or tube. Cable and other items manufactured by others and not made an integral part of equipment of Scientific-Atlanta's manufacture shall carry the original manufacturer's warranty.

Products manufactured by Scientific-Atlanta, Inc., to customers' specifications are warranted to be free of defects in material and workmanship and shall conform to all specifications made a part of the contract or purchase order. Inspection and acceptance shall be conclusive as to fulfilling this warranty, except as to latent defects providing, however, that all claims made or to be made for any reason must be made in writing within one year of shipment from Scientific-Atlanta's plant. Scientific-Atlanta, Inc., responsibility under this warranty shall be limited to repair or replacement of defective work or parts returned to Scientific-Atlanta, Inc., with transportation charges to Scientific-Atlanta, Inc., plant and return paid by buyer. Scientific-Atlanta, Inc., may at its option elect to correct any warranty defects by sending its supervisory or technical representative at Scientific-Atlanta, Inc., expense to customer's plant or location within the continental United States to make on-site corrections. Scientific-Atlanta, Inc., shall in no event be responsible for incidental or consequential damages, including without limitation personal injury or property damage. **SINCE SCIENTIFIC-ATLANTA, INC., HAS NO CONTROL OVER CONDITIONS OF USE, NO WARRANTY IS MADE OR IMPLIED AS TO SUITABILITY FOR CUSTOMER'S INTENDED USE, BEYOND SUCH PERFORMANCE SPECIFICATIONS AS ARE MADE A PART OF THE PURCHASE ORDER. THERE ARE NO WARRANTIES, EXPRESS OR IMPLIED, EXCEPT AS STATED HEREIN.** This limitation on warranties shall not be modified by verbal representations.

Equipment shipped F.O.B. Scientific-Atlanta, Inc., plant shall become the property of buyer upon delivery to and receipt from carrier. Damage in shipment should be handled by the buyer directly with the carrier by immediately requesting carrier's inspection upon evidence of damage in shipment. **DO NOT RETURN ANY SCIENTIFIC-ATLANTA PRODUCT TO THE FACTORY UNTIL SHIPPING INSTRUCTIONS ARE RECEIVED.**

SCIENTIFIC-ATLANTA, INC.

TABLE OF CONTENTS

<u>Paragraph</u>		<u>Page</u>
CHAPTER 1 GENERAL INFORMATION		
1.1	General	1-1
1.2	Purpose of Equipment	1-1
1.3	General Description	1-2
1.4	Technical Characteristics	1-10
CHAPTER 2 INSTALLATION		
2.1	General	2-1
2.2	Unpacking and Inspection	2-1
2.3	Installation	2-2
CHAPTER 3 OPERATION		
3.1	Operation	3-1
3.2	Operating Precautions	3-1
3.3	Operation	3-3
3.4	Computation of Noise Power Level	3-5
3.5	Test Procedure for NPR	3-7

TABLE OF CONTENTS - continued

<u>Paragraph</u>		<u>Page</u>
CHAPTER 4		
THEORY OF OPERATION		
4.1	General	4-1
4.2	Theory of Operation	4-1
CHAPTER 5		
MAINTENANCE		
5.1	General	5-1
5.2	Troubleshooting	5-1
5.3	Test Specifications	5-2
5.4	Module Replacement	5-9
CHAPTER 6		
PARTS LISTS		
6.1	General	6-1
6.2	Explanation of Column Headings	6-1
6.3	Ordering Parts	6-2
6.4	Parts Substitution	6-2
CHAPTER 7		
DIAGRAMS		
7.1	Index	7-1

LIST OF ILLUSTRATIONS

<u>Figure</u>	<u>Title</u>	<u>Page</u>
1-1	Model 4661 Baseband Noise Transmitter	1-3
1-2	Model 4661 Baseband Noise Transmitter, Block Diagram	1-5
1-3	Noise Load Spectrum	1-6
3-1	Testing NPR, Block Diagram Analysis	3-8

LIST OF TABLES

<u>TABLE</u>	<u>TITLE</u>	<u>PAGE</u>
1-1	CCIR Recommended Frequencies for FDM Relay Systems	1-8
1-2	Model 4661 Baseband Noise Transmitter, Nomenclature Characteristics	1-9
1-3	Model 4661 Baseband Noise Transmitter Technical Characteristics	1-11
1-4	Baseband Noise Transmitter Bandstop Filter Characteristics	1-12
3-1	Model 4661 Baseband Noise Transmitter, Controls and Indicators	3-1
3-2	Appropriate Filter Selection	3-4
3-3	CCIR Recommended Noise Loading Levels	3-6
4-1	Switch/Module Relationship	4-3
5-1	Suggested Test Equipment (Equivalent test equipment may be used)	5-3
5-2	Frequencies of High/Low Pass Filters for Channel Loading	5-7
5-3	Bandstop Filter Specifications	5-8
5-4	Model 4661 Baseband Noise Transmitter Module Replacement Adjustments	5-10

CHAPTER 1

GENERAL INFORMATION

1.1 GENERAL

1.1.1 This manual contains information necessary for the proper installation, operation, maintenance and adjustments for the Scientific-Atlanta Model 4661 Baseband Noise Transmitter. A replacement parts list, component location illustrations and schematic diagrams are also included. When changes are made to any of the above, the changes will be identified and described in a notice following the title page.

1.2 PURPOSE OF EQUIPMENT

1.2.1 The Model 4661 Baseband Noise Transmitter is designed to generate a noise spectrum having the specific characteristics required for testing microwave relay systems. The output signal can be used in both noise load testing and/or baseband response testing and the signal output power can be controlled from 0 to -49.9 dBm in 0.1 dB steps.

1.2.2 Noise loading is a technique that is used to simulate the multichannel baseband signal of a Frequency Division Multiplex (FDM) microwave relay system for the measurement of system performance. The baseband input of an FDM system consists of many signals occupying discrete frequency slots. Due to the random nature of switching, usage, and irregularities of voice signals, these signals (when combined to form the composite baseband signal) have statistical properties very similar to those of broad-band noise. Therefore, for system tests, the baseband message traffic can be replaced by a baseband spectrum of white noise. The advantage of using broad-band noise for

the test signal is that it allows the measurement of system performance that is similar to that obtained under actual loading conditions but is more consistent and accurately repeatable.

1.2.3 The performance of an FDM message transmission system is measured by the noise power ratio (NPR) or signal-to-noise ratio (SNR). NPR is the ratio expressed in decibels of (a) the power in a voice channel (or small bandwidth) when the system is driven by a uniform noise spectrum to (b) the power in that channel with the noise drive blocked from that channel. SNR is the ratio commonly expressed in decibels of the standard test tone level to the noise in that channel when the system is fully noise loaded except for that channel. NPR and SNR are directly related since the system is noise loaded in the same manner for both tests. The noise generated within the FDM transmission system can be caused by intermodulation, echo distortion, local oscillator or carrier noise, and thermal noise. The composite signal is measured when the system is noise loaded, and is usually referred to as intermodulation plus thermal noise. If the noise drive is removed, the resulting noise is considered to be thermal noise.

1.2.4 The Model 4661 Baseband Noise Transmitter output signal can be used as the broad-band noise source to permit NPR and SNR testing. The output signal is very stable because it is conditioned by an Automatic Level Control (ALC) circuit which maintains a constant output level referenced to 0 dBm.

1.3 GENERAL DESCRIPTION

1.3.1 A Model 4661 Baseband Noise Transmitter is an independent unit measuring 4.4 inches high by 18.6 inches wide and 18.8 inches deep. The mainframe operates from 115/230 volt, $\pm 10\%$, 50/60 Hz ac source and weighs approximately 25 pounds (11.5 kg's). Figure 1-1 is a photograph of a typical Model 4661 Baseband Noise Transmitter.

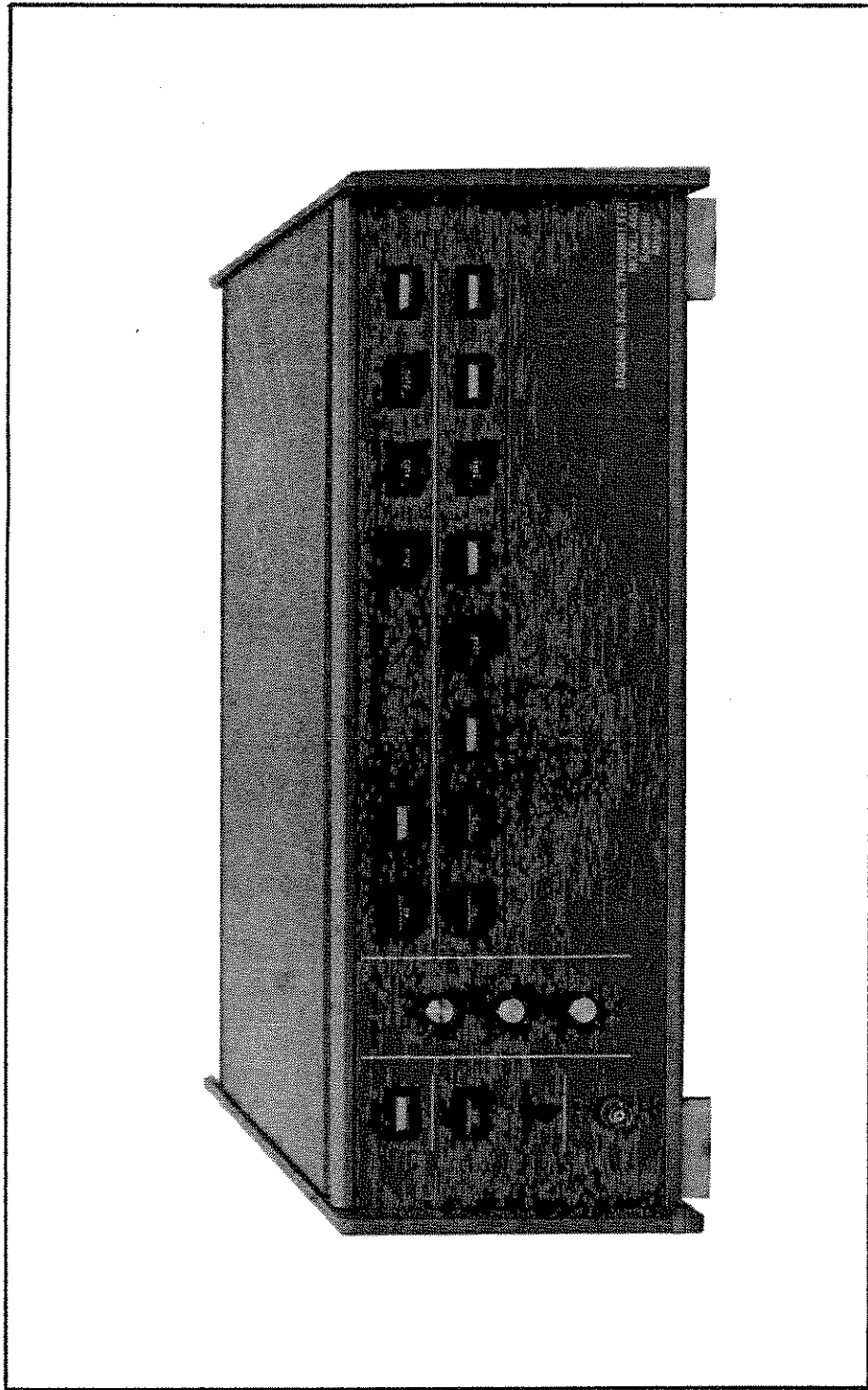

Figure 1-1. Model 4661 Baseband Noise Transmitter

1.3.2 The Model 4661 Baseband Noise Transmitter can contain an assortment of high pass filters, low pass filters and band stop or notch filters. The filter selection is a customer option. Filter replacement has been made as easy as possible and can be performed in a field environment using only a Phillips-head screwdriver. Even the signal output connector, which is normally BNC coax, can be replaced with optional connectors compatible with either large or small WECO type, or large or small Siemens type connectors. This flexibility eliminates any need for special cables while providing interface capability with widest range of common equipment.

1.3.3 The Model 4661 Baseband Noise Transmitter provides a band limited noise drive signal for NPR and SNR tests. The signal is passed through band-stop or notch filters to block the input noise at selected frequency bands. A Model 4661 Baseband Noise Transmitter contains a resistive white-noise source which excites band limiting and band-stop filters. A maximum of two high-pass, four low-pass, and eight band limiting filters can be installed in a Model 4661 Baseband Noise Transmitter. Filters are available for testing radios with 12 to 2700 channel capacity. A simplified block diagram of the Model 4661 Baseband Noise Transmitter is shown in Figure 1-2.

1.3.4 The output signal power can be adjusted in 0.1 dB steps from 0 dBm to -49.9 dBm. The output power is regulated by an automatic level control (ALC) to maintain the power constant as the band stop filters are switched in and out, and maintain power calibration for different channel loadings or noise bandwidths.

1.3.5 The noise power spectrum for a Model 4661 Baseband Noise Transmitter is illustrated in Figure 1-3. The power spectrum shown in Figure 1-3A is with the bandwidth determined by the high-pass and low-pass filters installed in a typical

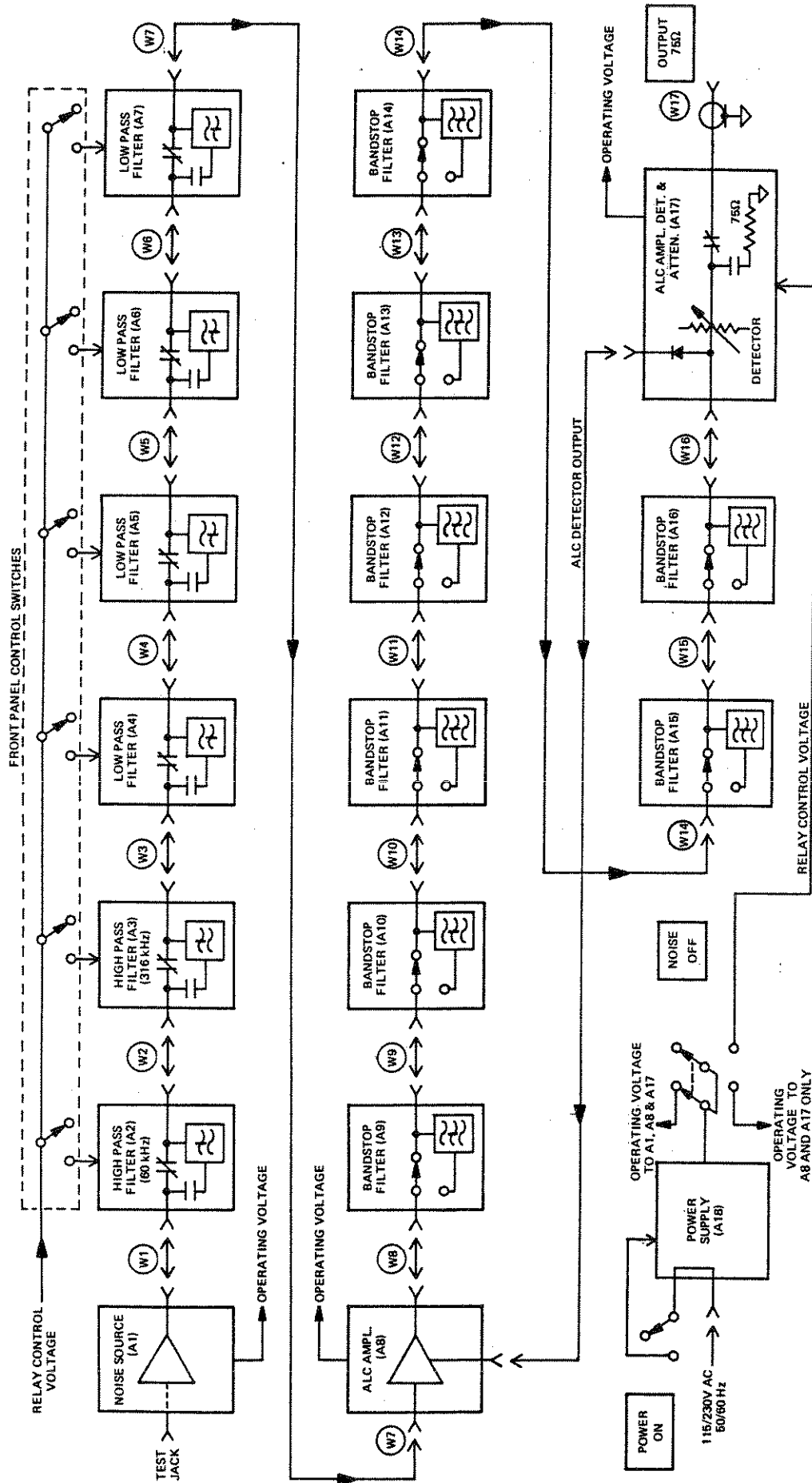
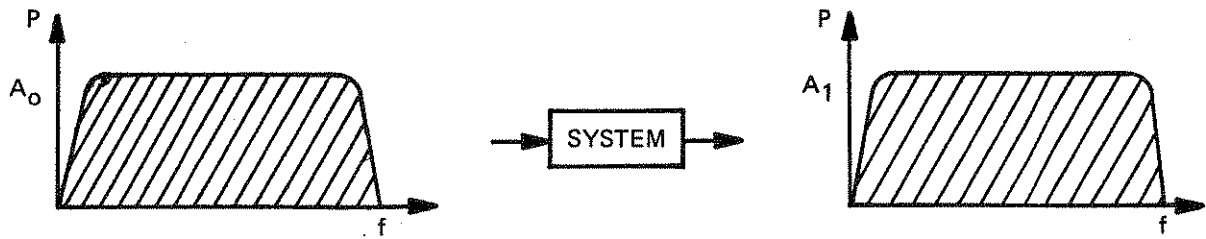
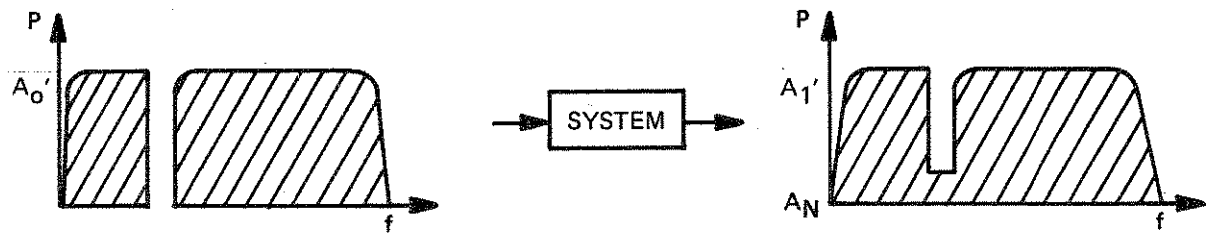

Figure 1-2. Model 4661 Baseband Noise Transmitter, Block Diagram



3A – Reference Power Measurement



3B – Total Noise Measurement

$$NPR = A_1 - A_N$$

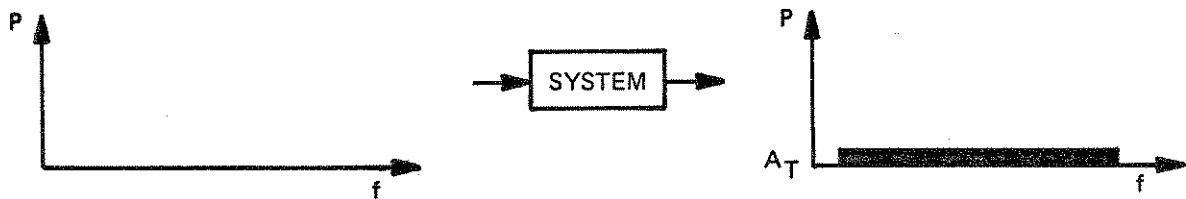

3C – Thermal Noise Measurement

$$N_{INTERMODE} = A_N - A_T$$

Figure 1-3. Noise Load Spectrum

Model 4661 Baseband Noise Transmitter. The drive level to the system is adjusted and a reference reading A_1 is taken at the output of the system under test. In Figure 1-3B, the power spectrum is shown with a band-stop filter switched in. Since the total drive power is maintained constant by the ALC Amplifier, the spectral density A_0^1 will be somewhat higher than A_0 (shown in Figure 1-3A). The power output (in a single channel) from the system under test is measured again and is shown as A_N in Figure 1-3B. A measurement of ANPR (expressed in decibels) for that frequency or slot is given by $A_1 - A_N$.

1.3.6 If the noise source is switched OFF, the resulting noise is the thermal noise of the system under test. This is illustrated in Figure 1-3C. The intermodulation noise is $A_N - A_T$.

1.3.7 The NPR of a system is a function of baseband frequency. Normally, the system is tested at a low frequency, a high frequency, and one or more intermediate frequencies. Table 1-1 contains a listing of CCIR recommended frequencies for band-limiting and band-stop filters for FDM relay systems.

Table 1-1
 CCIR Recommended Frequencies for FDM Relay Systems

System Capacity Channels	Cut-Off Frequencies of Band Limiting Filters		Frequencies of Available Measuring Channels (kHz)								
	High Pass Filters	Low Pass Filters	70	270							
60	60	300	70	270							
120	60	552	70	270	534						
300	60	1296	70	270	534	1248					
600	60	2600	70	270	534	1248	2438				
960	60	4100	70	270	534	1248	2438	3886			
900	316	4100			534	1248	2438	3886			
1260	60	5600	70	270	534	1248	2438	3886	5340		
1200	316	5600			534	1248	2438	3886	5340		
1800	316	8160			534	1248	2438	3886	5340	7600	
2700	316	12360			534	1248	2438	3886	5340	7600	11700

1.3.8 The model number nomenclature for a Model 4661 Baseband Noise Transmitter is given in Table 1-2. The mainframe for which this manual is applicable is the Model 4661. High-pass filters carry the identification of Model 4661 with a frequency designator. Likewise, separate model numbers are provided to the low-pass and band-stop filters. These filter frequencies correspond to the CCIR recommendation as listed in Table 1-2.

Table 1-2
Model 4661 Baseband Noise Transmitter,
Nomenclature Structure

Model 4661 Baseband Noise Transmitter			
Model 4661		Mainframe	
High Pass Filters		Band Stop Filters	
4661-12	12 kHz	4661-16	16 kHz
4661-60	60 kHz	4661-56	56 kHz
4661-316	316 kHz	4661-70	70 kHz
		4661-98	98 kHz
		4661-140	140 kHz
		4661-185	185 kHz
		4661-240	240 kHz
		4661-270	270 kHz
		4661-394	394 kHz
		4661-534	534 kHz
		4661-770	770 kHz
		4661-1002	1002 kHz
		4661-1248	1248 kHz
		4661-1730	1730 kHz
		4661-1960	1960 kHz
		4661-2438	2438 kHz
		4661-3150	3150 kHz
		4661-3886 LC	3886 kHz
		4661-3886 XTAL	3886 kHz
		4661-5340 LC	5340 kHz
		4661-5340 XTAL	5340 kHz
		4661-6900 LC	6900 kHz
		4661-7600 LC	7600 kHz
		4661-7600 XTAL	7600 kHz
		4661-9624 XTAL	9624 kHz
		4661-10840 LC	10840 kHz
		4661-10912 XTAL	10912 kHz
		4661-11700 XTAL	11700 kHz
Low Pass Filters			
4661-108	108 kHz		
4661-156	156 kHz		
4661-204	204 kHz		
4661-252	252 kHz		
4661-300	300 kHz		
4661-408	408 kHz		
4661-552	552 kHz		
4661-804	804 kHz		
4661-1052	1052 kHz		
4661-1296	1296 kHz		
4661-1796	1796 kHz		
4661-2045	2045 kHz		
4661-2600	2600 kHz		
4661-3284	3284 kHz		
4661-4100	4100 kHz		
4661-5600	5600 kHz		
4661-7284	7284 kHz		
4661-8160	8160 kHz		
4661-10164	10164 kHz		
4661-11404	11404 kHz		
4661-12360	12360 kHz		

Table 1-2
Model 4661 Baseband Noise Transmitter,
Nomenclature Structure - continued

Accessories (Optional Output Connector/Hardware)	
S-A 86035	Bulkhead BNC
S-A 86036	Bulkhead to WECO 558A
S-A 86037	Bulkhead to WECO 470C
S-A 86038	Bulkhead to small Siemens
S-A 86039	Bulkhead to large Siemens
S-A 86040	Bulkhead Connector Locknut
S-A 86041	Bulkhead Connector Hookwrench
Model 4662-1	Soft cover carrying case for the Model 4661 Baseband Noise Transmitter
Model 4662-2	Hard cover shipping case for the Model 4661 Baseband Noise Transmitter

1.4 TECHNICAL CHARACTERISTICS

1.4.1 Technical characteristics and specifications for the Model 4661 Baseband Noise Transmitter are provided in Table 1-3, Technical Specifications. Characteristics of the available filters are listed in Table 1-4.

Table 1-3
Model 4661 Baseband Noise Transmitter
Technical Characteristics

Feature	Characteristics
Channel Loadings	12 to 2700
Output Level	Set in 10, 1, and 0.1 dB steps 0 dBm to -49.9 dBm
Frequency Response Flatness	± 0.15 dB between outer measuring channels
Output Power Accuracy	At 0 dBm ± 0.25 dB
Attenuation Accuracy	± 0.1 dB for each 10 dB or 1 dB step; and ± 0.025 dB for each .1 dB step
White Noise Peak Value	>12 dB nominal peak-to-RMS ratio
Output Impedance	75 ohm, unbalanced
Output Connector	Universal bulkhead connector with following options: BNC Small (470C) and Large (558A) WECO, Small (1.5/5.6) and Large (2.5/6) Siemens
Temperature Operating Range	0°C to 40°C
Power Requirements	110/220V ac, 50/60 Hz
Dimensions	6.15" x 18.57" x 18.825" 15.65 cm x 47.16cm x 47.81 cm
Weight	35 lbs (15.9 kg)
Return Loss	>26 dB
Band Stop Filters	Per CCIR 399-2 (See Table 1-4)
Band Limiting Filters	Per CCIR 399-2 (See Table 1-1)

Table 1-4
Baseband Noise Transmitter Bandstop
Filter Characteristics

Centre Frequency f_c (kHz)	Bandwidth (kHz) in relation to f_c over which the discrimination should be at least:			Bandwidth (kHz) in relation to f_c outside of which the discrimination should not exceed:	
	70 dB	55 dB	30 dB	3 dB	0.5 dB
70	±1.5	±2.2	±3.5	±12	±18
270	±1.5	±2.3	±2.9	±8	±24
534	±1.5	±3.5	±7.0	±15	±48
1248	±1.5	±4.0	±11.0	±35	±110
2438	±1.5	±4.5	±19.0	±60	±220
3886	±1.5	±15.0 ±1.8	±30.0 ±3.5	±110 ±12	±350 ±100
5340	±1.5	±2.2	±4.0	±14	±140
7600	±1.5	±2.4	±4.6	±16	±200
11700	±1.5	±3.0	±7.0	±20	±300

CHAPTER 2 INSTALLATION

2.1 GENERAL

2.1.1 This chapter contains information necessary for the installation of the Model 4661 Baseband Noise Transmitter and prepare it for initial operation. Operating instructions are provided in CHAPTER 3 - OPERATION.

2.2 UNPACKING AND INSPECTION

2.2.1 Carefully unpack the shipping cartons observing all instructions that may be printed on the carton. Separate the packing material from the main units and any packages of loose items (i.e., hardware, cables, connectors, etc.). Temporarily set the shipping cartons and packing material aside in a safe place and inspect the units and associated items, if any, for shipping damage. If damage is evident, contact both the carrier and the nearest Scientific-Atlanta sales representative immediately. Save the packing materials and shipping papers for inspection by the carrier's representative. Do not return a unit to Scientific-Atlanta without receiving specific return shipment instructions.

2.2.2 Save the shipping cartons and packing material until satisfactory operation of the Model 4661 Baseband Noise Transmitter is determined. The shipping cartons and packing material may then be used for storage or protection during further transport of the equipment if necessary.

2.3 INSTALLATION

2.3.1 Test Bench Arrangement: The Model 4661 Baseband Noise Transmitter is shipped assembled and ready to operate. If it is to be operated at a test bench, prepare an area which is convenient and where cable length can be as short as possible.

2.3.2 Filter Installation: Filters for the Model 4661 Baseband Noise Transmitter may be separately purchased and installed to the mainframe in the field. Extra coaxial cable will be supplied with each additional ordered filter. The only tool required is a Phillips-head screwdriver.

2.3.3 To change or add a high, low, or band-stop filter, first switch the ac power OFF and remove the ac power cord from the rear panel connector. Remove the top and bottom covers after removing two rear panel securing screws per cover. Filters mounted near the rear panel are high- and low-pass units. Filters mounted behind the front panel are band-stop units. All modules are identified on the top with an adhesive decal.

2.3.4 The mainframe is silk screened with the various module locations and identified by "A-" numbers and filter type. The module (or modules) to be changed (or added) should first be located on the mainframe. Remove two recessed flat head screws from the bottom at the respective location. These screws are the only securing hardware for the module to the mainframe.

2.3.5 Disconnect the cable connections as necessary. Remove the disconnected module. The new module is to be replaced in this location. Secure in place using the two flat head screws removed in 2.3.4, and reconnect the coaxial cables. If the module replacement is a high- or low-pass filter of a different frequency, the front panel push-button should be replaced.

NOTE

Damage to the push-button switch may result if the switch is locked "in" (energized position) while being removed. If the indicating pushbutton is removed more than a few times, the lock mechanism may become fatigued. When this occurs, a new switch should be ordered or the old one cemented. If cement is used, the push-button is no longer removeable except by complete destruction which then necessitates a new switch.

2.3.6 Band-stop filters (immediately behind the front panel) are replaced in a similar manner. Two recessed flat head screws secure the module to the mainframe. Remove the two screws and disconnect the appropriate cable connections. Removing an active band-stop module may be easier if the pushbutton switch is locked "in" (energized position) to afford extra clearance to pass the printed circuit board (A19) behind the front panel.

2.3.7 A quick check to verify that the installation of filters have been performed correctly is as follows:

1. Recheck that all module coax connectors are properly and securely seated.
2. Connect the ac power cord to the rear panel connector.
3. Apply ac power by operating the front panel POWER switch. The signal path through the Model 4661 Baseband Transmitter is sequential starting from module A1 through module A16. Connect some indicating test equipment to the OUTPUT connector to be sure the signal achieves this sequential flow.

0 1 2 3 4 5 6 7 8 9

CHAPTER 3 OPERATION

3.1 GENERAL

3.1.1 This chapter contains information for operating the Model 4661 Baseband Noise Transmitter. Front panel controls, indicators and connectors are described in tabular form under Table 3-1.

3.2 OPERATING PRECAUTIONS

3.2.1 The Model 4661 Baseband Noise Transmitter is designed to be both reliable and transportable from location to location. Always be sure that the fuse rating is compatible with the ac supply source in addition to choosing an operating location where excessive cable length can be avoided and still have easy access to necessary interface connections.

3.2.2 Remember that the Model 4661 Baseband Noise Transmitter can be operated from either 115 or 230 volts ac.

Table 3-1
Model 4661 Baseband Noise Transmitter,
Controls and Indicators

Control/Indicator	Function
POWER-ON Switch	Controls the application of ac power. This switch is self-indicating with an orange background when energized.
NOISE-OFF Switch	In the energized position (OFF), the power supply is disconnected from the Noise Source Module (A1) and the OUTPUT-75 Ω connector (J1) is terminated with 75 ohms.

Table 3-1
Model 4661 Baseband Noise Transmitter,
Controls and Indicators - continued

Control/Indicator	Function
UNCALIBRATED Indicator	This indicator is illuminated when the internal Automatic Level Control (ALC) circuit detects the output signal is out of tolerance. When not illuminated, the output signal level is calibrated to 0 dBm with respect to the POWER LEVEL-dBm switches.
OUTPUT-75 Ω Jack	A convenient termination for the signal generated by the Model 4661 Baseband Noise Transmitter. It is also a universal bulkhead connector in two halves which permit convenient adaption to BNC, WECO, or Seimens connectors using the proper optional half. (See Chapter 6-Parts List.)
POWER LEVEL-dBm 10 position tenth 10 position unit 5 position decade	These switches, when operated together, adjust the noise power output from 0 dBm to -49.9 dBm. When all switches are set to the 0 position, the noise power output signal level will equal 0 dBm.
HIGH PASS FILTER Two switch positions	When energized (orange background), a high pass filter with a cutoff frequency as labeled on the switch is electronically inserted into the signal path and limits the noise bandwidth.
LOW PASS FILTER Four switch positions	When energized (orange background), a low pass filter with a cutoff frequency as labeled on the switch is electronically inserted into the signal path and limits the noise bandwidth.
BANDSTOP FILTER-kHz Eight switch positions	When energized (orange background), a band stop filter with a center frequency as labeled on the switch is connected into the signal path.

3.3 OPERATION

3.3.1 Before applying ac power, verify that cable connections to peripheral equipment has been properly made and securely seated. If suitable radio performance test equipment is available, (i.e., a Model 4671 IF/Baseband Analyzer and Model 4673 X-Y Recorder, or the equivalents) prepare to run a back-to-back test to verify the initial operating status of the test equipment involved. This simple procedure can provide operator assurance that the final test results will be valid.

3.3.2 OPERATING INSTRUCTIONS FOR MODEL 4661 BASEBAND NOISE TRANSMITTER

1. Depress POWER switch.
2. Select one HIGH PASS and one LOW PASS from the Table 3-2 for the appropriate channel loading.
3. For Noise Power Ratio (NPR) tests, select the appropriate band stop filters from Table 3-2.
4. For Baseband Response tests, remove all band stop filters.
5. For Thermal and Tone Search tests, depress the NOISE-OFF switch. (Observe that UNCALIBRATED indicator is now illuminated.)
6. Set the precision attenuators for the required output level. (Output power level is a direct reading from the POWER LEVEL-dBm switches.)
7. When the signal output level can not be maintained to the proper level selected, the UNCALIBRATED indicator will illuminate.

Table 3-2
Appropriate Filter Selection

System Capacity Channels	Limits of the Band Occupied by Telephone Channels, kHz	Effective Cut-Off Frequencies of Band-limiting Filters, kHz		Frequencies of Available Measuring Channels kHz	
		High-pass	Low-pass		
60	60-300	60±1	300±2	70	270
120	60-552	60±1	552±4	70	270 534
300	60-1296 64-1296	60±1	1296±8	70	270 534 1248
600	60-2540 64-2660	60±1	2600±20	70	270 534 1248 2438
960	60-4028 64-4024	60±1	4100±30	70	270 534 1248 2438 3886
900	316-4188	316±5	4100±30	534	1248 2438 3886
1260	60-5636 60-5564	60±1	5600±50	70	270 534 1248 2438 3886 5340
1200	316-5564	316±5	5600±50	534	1248 2438 3886 5340
1800	312-8120 312-8204 316-8204	316±5	8160±75	534	1248 2438 3886 5340 7600
2700	312-12336 316-12388 312-12388	316±5	12360±100	534	1248 2438 3886 5340 11700

3.4 COMPUTATION OF NOISE POWER LEVEL

3.4.1 The NPR or noise loading test makes use of gaussian noise to simulate the actual baseband traffic being carried by the radio. The power level of the noise signal should be the same as that of the baseband multiplex signal when the radio is heavily loaded. Since the actual traffic activity and level varies, the noise power normally applied to the system is set by standards generated by the Bell System and CCIR Recommendations. The noise power is a function of the number of channels and is given by the following formulas:

A. For 240 or more channels, CCIR recommends

$$P_{AV} = -15 + 10 \log_{10} N \text{ dBm0}$$

where N is the number of channels and P_{AV} is the average noise power.

B. For 240 or more channels, the Bell System formula is

$$P_{AV} = -16 + 10 \log_{10} N \text{ dBm0}$$

C. For less than 240 channels, CCIR recommends

$$P_{AV} = -1 + 4 \log_{10} N \text{ dBm0}$$

3.4.2 The CCIR recommended system loading level is summarized in Table 3-3. Table 3-3 also gives the total noise power measured at a point of zero relative transmission level (dBm0), the standard relative transmission level (dBr) at the interconnect point, and the total noise power applied (dBm) at the interconnect.

Table 3-3
CCIR Recommended Noise Loading Levels

No. of Channels	System Loading Level dBm0	CCIR Test Tone Level Per Channel dBm	Total Power Drive Level dBm
60	6.1	-36	-29.9
120	7.3	-36	-28.7
300	9.8	-36	-26.2
600	12.8	-36 -33	-23.2 -20.2
960	14.8	-36 -33	-21.2 -18.2
900	14.8	-33	-18.2
1260	16.0	-33	-17
1200	15.9	-33	-17.1
1500	16.8	-33	-16.2
1800	17.5	-33	-15.5
2100	18.2	-33	-14.8
2700	19.3	-33	-13.8

3.4.3 For example, presume that the Model 4661 Baseband Noise Transmitter is used to test a 600 channel radio with a relative transmission level of -33 dBm at the interconnect point. In this application, the Model 4661 Baseband Noise Transmitter would have the following band limiting filters selected:

Model 4661-60 60 kHz High Pass Filter
Model 4661-2600 2600 kHz Low Pass Filter

3.4.4 Band stop filters may be selected from the following:

Model 4661-70 70 kHz Band Stop Filter
Model 4661-270 270 kHz Band Stop Filter
Model 4661-534 534 kHz Band Stop Filter
Model 4661-1248 1248 kHz Band Stop Filter
Model 4661-2438 2438 kHz Band Stop Filter

Usually low, mid, and high range band stop filters are selected. An appropriate choice for this example would be 70 kHz, 534 kHz, and 2438 kHz filters.

3.4.5 The total noise for 600 channels is (from Table 3-4) -20.2 dBm. The total power would be set to -20 dBm by setting the POWER LEVEL-dBm switches on the Model 4661 Baseband Noise Transmitter to 20.2 dB. The Model 4661 Baseband Noise Transmitter is then connected to the baseband input of the radio.

3.5 TEST PROCEDURE FOR NPR

3.5.1 Typical block diagrams illustrating the Noise Loading test set-up are shown in Figure 3-1. Select the high- and low-pass filters from Table 3-2 for the appropriate channel loading. Set the POWER LEVEL-dBm attenuator switches for the correct drive level from Table 3-3. Tune the selective level meter, noise receiver, or the Scientific-Atlanta Model 4671 IF/Baseband Analyzer (operating in the MANUAL MODE) to the band stop filter frequency. Measure the noise in dB with the band stop filter out. Switch the band stop filter into the signal path and measure the noise in the notched frequency slot. The difference between the two measurements (with the band stop filter in, and out) is the NPR reading (in dB) of the system.

3.5.2 The contributions of thermal noise can be measured by depressing the NOISE-OFF switch and measuring only the system noise.

3.5.3 These procedures (in paragraphs 3.5.1 and 3.5.2) must be repeated for measuring all channels of interest. If the Scientific-Atlanta Model 4671 IF/Baseband Analyzer is used as the receiver, both the NPR and the thermal test can be performed in two minutes. This is accomplished by operating the Model 4671

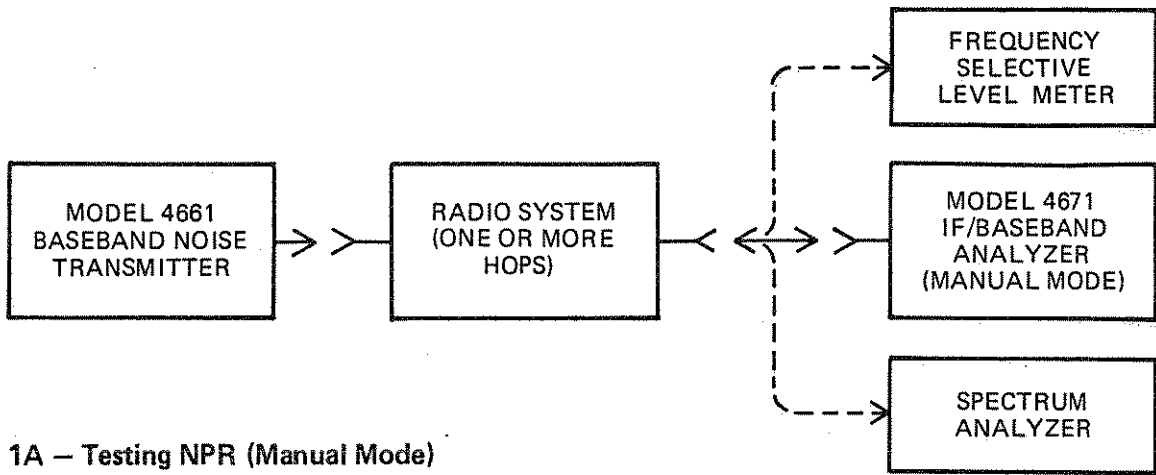

1A - Testing NPR (Manual Mode)

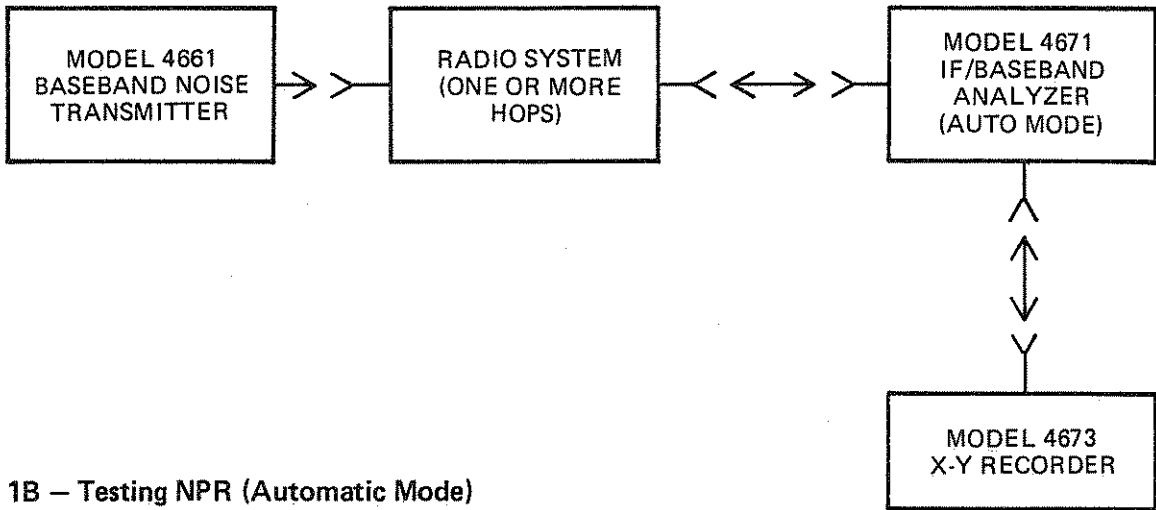

1B - Testing NPR (Automatic Mode)

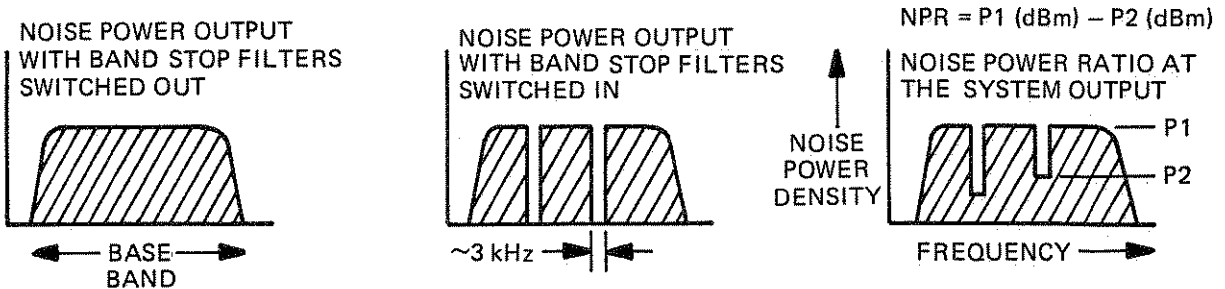

1C - Noise Loading Test, Idealized Representations

Figure 3-1. Testing NPR, Block Diagram Analysis

IF/Baseband Analyzer in the AUTO MODE and is a swept test for NPR. Using this arrangement, all slot frequencies are in the noise signal path for the NPR test, and then the test is repeated for thermal noise with the Model 4661 Baseband Noise Transmitter conditioned by depressing the NOISE-OFF pushbutton. Note: Do not adjust any control or pushbutton after establishing the NPR test results. Thermal noise testing requires the identical test set-up used for NPR testing to obtain valid data. The test results can be plotted using the Scientific-Atlanta Model 4673 X-Y Recorder to provide a permanent record. If both test results are plotted on the same sheet of graph paper, the test results will also provide valuable information by relating the amount of intermodulation noise to the amount of thermal noise.



CHAPTER 4 THEORY OF OPERATION

4.1 GENERAL

4.1.1 The Model 4661 Baseband Noise Transmitter uses very little active circuitry. Only the Noise Source module (A1), the Automatic Level Control module (A8), and the Automatic Level Control Detector module (A17) use transistor amplifiers. The remaining modules of high, low, and bandstop filters are all passive circuits.

4.2 THEORY OF OPERATION

4.2.1 All circuits used in the Model 4661 Baseband Noise Transmitter are separated by functions and each function is contained in a separate module that attach to the Mainframe chassis. Every Model 4661 Baseband Noise Transmitter must be provided with a Noise Source module (A1), an Automatic Level Control (ALC) module (A8), an Attenuator and ALC Detector module (A17), and a Power Supply module (A18). The remaining module positions are filled with optional filter modules which have been ordered separately. The Model 4661 Baseband Noise Transmitter Mainframe provides a maximum mounting capacity for two high-pass filters, four low-pass filters and eight bandstop filters. A typical Mainframe can be provided with the maximum compliment or any portion thereof, as desired.

4.2.2 Front panel pushbutton switches are etched with numbers corresponding to the filter frequency which they control. Each pushbutton switch, when depressed, will lock in the "in" position and indicate, with an orange background, the energized module frequency. Depressing the pushbutton again releases the

switch and deenergizes the module to a "through connection" condition. Using the pushbuttons to select both a high-pass filter and a low-pass filter will limit the bandwidth of the broadband white noise signal from the Noise Source module (A1) to the OUTPUT -75 Ω front panel connector. The noise bandwidth signal will have an output power of 0 dBm which is maintained by the ALC Amplifier module (A8) circuit and the ALC Detector module (A17) circuit.

4.2.3 Filter Operation. If two high pass filters are selected, the higher cutoff frequency high-pass filter will attenuate part of the passband of the lower cutoff frequency high-pass filter. In normal operation, it is advisable to select one high-pass filter only. The low-pass filter selection is governed by a priority system made possible by the Filter Select printed circuit board (A20). This allows switch position A20A3 to have first priority and the priority levels continue in order through switch position A20A6. Normally, switch position A20A3 will correspond to the lowest frequency cutoff and sequence through the switch positions to the highest frequency low-pass filter in an ascending order of priority. A table is provided on the Model 4661 Baseband Noise Transmitter rear panel which designates selected high and low-pass filters to simulate correct channel loading. Note that each filter circuit uses special factory selected components and requires a special tuning procedure. The filters are NOT a field repairable item.

4.2.4 Front Panel Switches. The front panel high-pass and low-pass filter select switches correspond to particular module locations in the mainframe. Switching a selected filter into the signal path is accomplished by energizing relays in the appropriate module. The relay is energized through contacts on the front panel switch. Correlation between a front panel filter select switch and a filter module location is shown in Table 4-1.

Table 4-1
Switch/Module Relationship

Select Switch	Operated Module	Suggested Filter Function
A20S1	A2	High-Pass
A20S2	A3	High-Pass
A20S3	A4	Low-Pass
A20S4	A5	Low-Pass
A20S5	A6	Low-Pass
A20S6	A7	Low-Pass

4.2.5 Bandstop filters (module location A9 through A16) are manually switched and their relative position and order does not matter. It is suggested that the bandstop filters be installed in a descending order of frequency from position A9 through A16.

4.2.6 Depressing the front panel NOISE OFF switch (A20S2) to the locking "in" position will cause relay A17K1 in the Attenuator module (A17) to deenergize. The relay contacts are arranged so the deenergized condition terminates the output signal into a 75-ohm impedance and removes the operating voltage from the Noise Source module (A1).

4.2.7 The front panel UNCALIBRATED indicator (CR1) will be illuminated when the output signal being applied to the Attenuator circuit in the ALC Detector module (A17) can not be maintained at 0 dBm.

4.2.8 High-Pass Filters. The high-pass filters are seventh-order Chebyshev designs. These filters are designed for 26 dB passband return loss, although coil losses and component value tolerances reduce this value to 20 to 23 dB. The minimum stop band attenuation is approximately 40 dB.

4.2.9 Low-Pass Filters. The low-pass filters are seventh-order Cauer-Chebyshev design. The bandwidth of a filter is adjusted to make the noise bandwidth equal to the nominal specified bandwidth. The 3 dB bandwidth for most of the low-pass filters is higher than the specified cut-off frequency. The design value for pass-band return loss is 26 dB for most of the filters, but the actual minimum return loss varies from 20 to 23 dB because of coil losses and component tolerances. The low-pass filters have built in attenuation to compensate for the higher noise power in the wider bandwidths.

4.2.10 Bandstop Filters. The design of the bandstop filters vary. In general, they are transformations from fifth-order Chebyshev low-pass filters with pass band ripple of 0.044 dB.

4.2.11 Power Supply (A18). The Power Supply (A18) consists of a dual primary transformer, a bridge rectifier, and a three-terminal regulator. The rectifier and regulator are mounted on an individual printed circuit board with associated components. Nominal output voltage from the power supply is -24 volts dc. The three-terminal regulator is an integrated circuit with built-in thermal protection and fold-back shortcircuit protection. The power supply operates through fuse protection from either 115 or 230 volts ac, $\pm 10\%$, at 47 to 63 Hz.

4.2.12 Noise Source (A2A1). The noise originates primarily as thermal noise from resistors at the input of a high-gain amplifier, although some transistor noise is also present. The noise is amplified by three transistor stages, each with feedback to provide gain stability. The first stage is made up of transistors A1, A2, and associated components. The second stage contains transistors Q3, Q4, and Q5, and the third stage contains Q6, Q7, and Q8.

4.2.13 The input to transistor Q1 is terminated by resistors R1, R3, and R4. It is the thermal noise from these resistors that is the main source of noise. The first amplifier stage is a non-inverting feedback pair with gain determined primarily by the feedback network consisting of resistors R7, R8, and R9. Capacitor C2 provides for a 2 dB peaking adjustment at approximately 24 MHz.

4.2.14 The second and third stages are similar. For the second stage, feedback is from the output of transistor Q4, through the emitter follower Q5 to the base of Q4. The gain is determined primarily by the feedback network consisting of resistors R21, R22, and R23. The output of the third stage is applied through resistor R36 to the output connector J2. The output impedance is 75 ohms.

4.2.15 Automatic Level Control (ALC) Amplifier (A8),
General Description. The noise power output signal to be applied to the precision Attenuator (A17) is held constant by the Automatic Level Control circuit. The noise signal through the band limiting filters is applied to the amplifier input where it passes through a broadband varactor diode attenuator. The noise signal is amplified through three separate stages, each stage compensated with a feedback loop and applied to the module output connector (J2). The amplified output signal is then either (1) applied through selected bandstop filters, or (2) bypass the bandstop filters to become input signal to the Automatic Level Control Detector circuit (A17).

4.2.16 The input noise signal which has been routed through selected bandstop filters has lost a small amount of noise power through filter attenuation. The function of the ALC Detector circuit (A17) is to compensate for this loss by increasing the gain of the ALC Amplifier (A8).

4.2.17 ALC Amplifier (A8) Detailed Circuit Description
(See Figure 7-9). The input to J1 is amplified by emitter follower Q1 and applied to the varactor attenuator consisting of CR2 and CR3. The attenuation of this network is varied by changing the reverse bias on CR2 and CR3. The control voltage appears at the junction of R5 and CR1.

4.2.18 The output of the varactor attenuator is applied to the FET input of a transistor feedback pair consisting of Q2 and Q3. Gain is determined primarily by the feedback network consisting of resistors R10, R11, and R13. The signal is further amplified by transistors Q4, Q5, and Q6. For this stage, feedback is determined by resistors R19, R20, and R21. The output impedance of the emitter follower Q6 is quite low. The output of this stage is further amplified by transistors Q7, Q8, and Q9. This stage requires the feedback network of resistors R27, R28, and R29. The output impedance of the emitter follower circuit using transistor Q9 is low, but using resistor R30 makes the output impedance of the ALC Amplifier circuit to be 75 ohms.

4.2.19 Attenuator and ALC Detector (A17) Detailed Circuit Description (See Figure 7-9). The noise signal output from the ALC Amplifier (A8) circuit is applied to input connector J1. This noise signal is sampled by transistor Q1 and applied to a temperature regulated matched detector consisting of U1. This circuit arrangement provides excellent power stability and requires very little warm-up time. The signal is rectified by U1 and provides a differential output which is amplified by the circuit using U2-B. Resistor R90 supplies an offset current and sets the output power level. The output of U2-B controls the ALC Amplifier (A8) gain by adjusting the varactor attenuator bias. The output of U2-B is also applied to a circuit which senses if the control voltage is too high or too low for proper operation of the ALC Amplifier (A8). Either out-of-limit condition

CHAPTER 5 MAINTENANCE

5.1 GENERAL

5.1.1 Due to the reliability and nature of the equipment, frequency periodic maintenance and alignment of the Scientific-Atlanta Model 4661 Baseband Noise Transmitter is not necessary or recommended. It is recommended, however, that it be inspected and calibrated by Scientific-Atlanta personnel or representatives on a yearly basis. This action will insure that the instruments will meet all published specifications and provide the user with trouble free, accurate performance. The nearest Scientific-Atlanta Representative or the nearest Regional Service Center can arrange for such factory calibration. Regional Service Centers are listed on the last page of this chapter.

5.2 TROUBLESHOOTING

5.2.1 The intent of this section is to enable the technician to repair instruments out of warranty by locating and identifying defective modules or printed circuit boards. Once the defective module or printed circuit board has been isolated, either a pre-tested replacement unit may be obtained from Scientific-Atlanta or further troubleshooting may be performed within the module. It is suggested that prior to troubleshooting within a module or printed circuit board that the technician review thoroughly the applicable section in the Theory of Operation, Chapter 4, and the appropriate schematic.

NOTE

MOST OF THE CIRCUITS IN THIS UNIT ARE FACTORY ALIGNED AND SEALED AND NO ATTEMPT SHOULD BE MADE TO REPAIR OR ALIGN IN THE FIELD. THESE CIRCUITS ARE LISTED AS FOLLOWS:

4661 Baseband Noise Transmitter

(1) 4661-12	(18) 4661-4100	(35) 4661-770
(2) 4661-60	(19) 4661-5600	(36) 4661-1002
(3) 4661-316	(20) 4661-7284	(37) 4661-1248
(4) 4661-108	(21) 4661-8160	(38) 4661-1730
(5) 4661-156	(22) 4661-10164	(39) 4661-1960
(6) 4661-204	(23) 4661-11404	(40) 4661-2438
(7) 4661-252	(24) 4661-12360	(41) 4661-3150
(8) 4661-300	(25) 4661-16	(42) 4661-3886 LC
(9) 4661-408	(26) 4661-56	(43) 4661-3886 XTAL
(10) 4661-552	(27) 4661-70	(44) 4661-5340 LC
(11) 4661-804	(28) 4661-98	(45) 4661-5340 XTAL
(12) 4661-1052	(29) 4661-140	(46) 4661-6900 LC
(13) 4661-1296	(30) 4661-185	(47) 4661-7600 LC
(14) 4661-1796	(31) 4661-240	(48) 4661-7600 XTAL
(15) 4661-2045	(32) 4661-270	(49) 4661-9624 XTAL
(16) 4661-2600	(33) 4661-394	(50) 4661-10840 LC
(17) 4661-3284	(34) 4661-534	(51) 4661-10912 XTAL
		(52) 4661-11700 XTAL

5.3 TEST SPECIFICATIONS

5.3.1 Once the main malfunctioning area has been identified, the individual modules and printed circuit boards may be tested to verify performance by using the following test specifications. Also included is a listing of suggested test equipment.

5.3.2 Suggested Test Equipment. Table 5-1 lists the suggested test equipment necessary to perform the Maintenance Tests in this chapter on the Model 4661 Baseband Noise Transmitter. Equivalent test equipment may be substituted.

Table 5-1
Suggested Test Equipment
 (Equivalent test equipment may be used)

- A. Power Supply, HP 6205B
- B. Power supply, HP 6284A
- C. Oscilloscope, Tektronix 475
- D. Signal Generator, Wanded & Goltermann AT-610
- E. DVM, HP 3465A
- F. Selective Level Meter, Wandel & Goltermann AT-611

NOTES:

- (1) The reference letters (A through F) will be used in the following paragraphs to refer to specific pieces of test equipment.
- (2) Power supplies should have a common return between voltage potentials and the equipment under test chassis. The following paragraphs refer to this common connection as "ground".

5.3.3 Attenuator and ACL Detector Module

A. Attenuator:

Test equipment required: D and F

1. Connect the 75 Ω output from the signal generator to J1 on the attenuator module. Connect the 75 Ω input of the selective level meter to J2 on the attenuator module. Set the attenuator to 0 dB.
2. Inject a 0 dBm, 1 MHz CW signal into the attenuator. Note reading on the selective level meter.
3. Decrease the attenuator in 1 dB steps until 49 dB is reached. The maximum error for each 1 dB step should be ± 0.1 dB. The maximum error for up to ten 1 dB steps should be ± 0.3 dB.

B. Detector

Requirement: C1 -24(± 0.5)V dc
 J1 1 MHz tone

Test equipment required: D and E

1. This is an open loop test.
2. Apply a 1 MHz tone at 0 dBm to input J1. Voltage reading at C2 should be -20.0(± 0.5)V dc.
3. Change the input signal level to -10 dBm and the voltage at C2 should ramp up to -14.7(± 0.5)V dc.
4. If there is a malfunction in the indicating circuit, consisting of Q2 and Q3, improper readings can be acquired in this test. Most malfunctions occur in the indicating circuit and are clued by the above voltages being out of bounds. (-14.7 to -20)
5. The UNCALIBRATED light should be illuminated during this test.
6. Remove signal input at J1. When the NOISE-OFF switch is energized, the output connector at the front panel should read 75 ohms.

5.3.4 ALC Amplifier (A8)

Test equipment required: B, D, and F

1. Apply -24(± 0.5)V dc to feedthrough capacitor C1.
2. Apply -14.0 volts to C2.
3. Apply a 1 MHz tone at -40 dBm to J1. Output should read -9(± 2) dBm.
4. Record the actual reading.
5. Change the voltage at C2 for -19 volts.
6. Measure reading.
7. Solve the following equation to see if this amplifier has the minimum dynamic range.

Using absolute values,

(Reading at step 4 - Reading at step 6) ≥ 18

8. Vary the frequency from 50 kHz to 11.5 MHz. The output of the ALC should not vary more than ± 0.3 dB.

5.3.5 Noise Source Module (A1)

Test equipment required: B and F

1. Apply $-24(\pm 1)V$ dc to feedthrough capacitor C1.
2. Connect the 75Ω input of the selective level meter to J1. Set the measurement bandwidth to 1.74 kHz. Set the frequency to 1 MHz.
3. Note the reading at 1 MHz. It should be typically between -50 and -46 dBm. Scan the selective level meter from 50 kHz to 11.5 MHz. The output of the noise source should not vary more than ± 0.5 dB from the 1 MHz value.

NOTE:

- (1) Since the output of the NOISE SOURCE Module (A1) is white noise, the meter on the selective level meter will be jumpy.
- (2) Most failures of the NOISE SOURCE Module (A1) are characterized by catastrophic failure, that is, no output or an output which rolls off sharply.

5.3.6 Filters

Test equipment required: D and F

All of the filters contain only passive components with the exception of the relays for switching the filters out of the circuit.

CAUTION

ONCE A DEFECTIVE FILTER IS LOCATED,
NO ATTEMPT SHOULD BE MADE TO RE-
ALIGN THE FILTER IN THE FIELD.

Connect the 75 Ω output of the signal generator to J1 on the filter and connect the 75 Ω input of the selective level meter to J2 on the filter.

1. The frequencies of the high and low-pass filters for the corresponding channel loading are shown in Table 5-2.
2. The tolerance of the nominal effective cut off frequencies are shown. The nominal cut off frequency is defined as that of a hypothetical filter having ideal square cut off characteristics and transmitting the same power as the real filter.
3. The attenuation of the high-pass filters should be a minimum of 25 dB at a frequency 20% below the nominal cut off.
4. The attenuation of the low-pass filters should be a minimum of 25 dB at 20% above the nominal cut off.
5. Within the band occupied by the outer measuring channels, a pair of high and low-pass filters should be flat to within 0.2 dB as per CCIR 399-1 3.2.
6. The band stop filters should meet the specifications as listed in Table 5-3 as per CCIR 399-2, Table III.

Table 5-2.
Frequencies of High/Low Pass Filters
for Channel Loading

System Capacity Channels	Limits of the Band Occupied by Telephone Channels, kHz	Effective Cut-Off Frequencies of Band-limiting Filters, kHz		Frequencies of Available Measuring Channels kHz								
		High-pass	Low-pass	70	270	534	1248	2438	3886	5340		
60	60-300	60±1	300±2	70	270							
120	60-552	60±1	552±4	70	270	534						
300	60-1300 64-1296	60±1	1296±8	70	270	534	1248					
960	60-4028 64-4024	60±1	4100±30	70	270	534	1248	2438	3886			
900	316-4188	316±5	4100±30			534	1248	2438	3886			
1260	60-5636 60-5564	60±1	5600±50	70	270	534	1248	2438	3886	5340		
1200	316-5564	316±5	5600±50			534	1248	2438	3886	5340		
1800	312-8120 312-8204 316-8204	316±5	8160±75			534	1248	2438	3886	5340		
2700	312-12336 316-12388 312-12388	316±5	12360±100			534	1248	2438	3886	5340		
						7600						
						7600						

Table 5-3.
Bandstop Filter Specifications

Centre Frequency f_c (kHz)	Bandwidth (kHz) in Relation to f_c Over Which the Discrimination Should be at Least				Bandwidth (kHz), in Relation to f_c Outside of Which the Discrimination Should Not Exceed		
	70 dB	55 dB	30 dB	3 dB	0.5 dB		
70	± 1.5	± 2.2	± 3.5	± 12	± 18		
270	± 1.5	± 2.3	± 2.9	± 8	± 24		
534	± 1.5	± 3.5	± 7.0	± 15	± 48		
1248	± 1.5	± 4.0	± 11.0	± 35	± 110		
2438	± 1.5	± 4.5	± 19.0	± 60	± 220		
3886	± 1.5	± 15.0	± 30.0	± 110	± 350		
5340	± 1.5	± 1.8	± 3.5	± 12	± 100		
7600	± 1.5	± 2.2	± 4.0	± 14	± 140		
11700	± 1.5	± 2.4	± 4.6	± 16	± 200		
	± 1.5	± 3.0	± 7.0	± 20	± 300		

5.3.7 Power Supply

Test equipment required: E

The power supply is tested in the unit by merely measuring the output voltage at the feedthrough capacitor C1 while under load. Output should measure $-24(\pm 1)V$ dc. Ripple voltage should be less than 10mV under load.

5.4 **MODULE REPLACEMENT**

5.4.1 Once the defective module has been isolated, a pretested replacement unit can be easily installed with only a few required adjustments. Table 5-4 outlines the necessary adjustments for each module.

Table 5-4
Model 4661 Baseband Noise
Transmitter Module Replacement Adjustments

Module Name	Adjust	For	Adjustment Conditions
Attenuator ALC and Detector Assembly (A17)	R90	0 dBm output power	<ol style="list-style-type: none"> 1. Connect a power meter such as W&G Model EPM-1 to 75 ohm output. 2. Set front panel attenuator to 0 dB.
Noise Source Assembly (A1)	A1C2 (TILT)	Flat Back-to-back baseband test	<ol style="list-style-type: none"> 1. Perform back-to-back baseband response. 2. Adjust A1C2 to affect the tilt of the response.
All Filters	No adjustments -----		
ALC Amplifier (A8)	C12 (TILT)	0 dBm output power	<ol style="list-style-type: none"> 1. Perform back-to-back baseband response. 2. Adjust A8C12 to affect the tilt of the response.
Power Supply (A18)	No adjustments -----		

DOMESTIC REGIONAL SERVICE CENTERS

Northeastern Regional Office
149 Middlesex Turnpike
Burlington, Massachusetts 01803
Tel: 617-272-1256

Midwest Regional Office
Fidelity Bldg., Suite 306
11550 N. Meridian
Carmel, Indiana 46032
Tel: 317-846-7142

Washington D.C. Regional Office
Washington Business Park
5100-J Philadelphia Way
Tanham, Maryland 20706
Tel: 301-577-4830

Southwestern Regional Office
1237 Executive Drive, East
Richardson, Texas 75081
Tel: 214-238-1116

Mid Atlantic Regional Office
2100 Route 208
Fair Lawn, New Jersey 07410
Tel: 201-791-8777

So. California Regional Office
P.O. Box 2668
10039 Pioneer Boulevard
Santa Fe Springs, California 90670
Tel: 213-949-9411

Southeastern Regional Office
4025 Pleasantdale Road
Atlanta, Georgia 30340
Tel: 404-449-2021

No. California Regional Office
3375 Scott Boulevard, Suite 304
Santa Clara, California 95051
Tel: 408-496-1040

Florida Regional Office
P.O. Box 2143
841 West Emmett St.
Kissimmee, Florida 32741
Tel: 305-846-0055

INTERNATIONAL SERVICE CENTERS**CANADA**

Scientific-Atlanta, Ltd.
1640 Bonhill Road
Unit 6
Mississauga, Ontario L5T1C8
Tel: 416-677-6555
Telex: 06983600

GERMANY

Scientific-Atlanta GmbH
Albert Schweitzerstrasse 66/3
D8000 Munich 83, Germany
Tel: 49.8967.1044
Telex: 5212264

ENGLAND

Scientific-Atlanta, Ltd.
Horton Manor
Stanwell Road, Horton
Slough SL3 9PA, England
Tel: 44.2812-3211
Telex: 849406

ITALY

Scientific-Atlanta, S.p.A.
Via Benedetto Croce 19
00142 Rome, Italy
Tel: 39.06.5420244
Telex: 721441

FRANCE

Scientific-Atlanta S.A.
4 Avenue Gabriel Peri
78360 Montesson
France
Tel: 33.1.9769191
Telex: #46385

CHAPTER 6 PARTS LISTS

6.1 GENERAL

6.1.1 The parts lists for a standard Model 4661 Baseband Noise Transmitter are included in this chapter. Special modifications, if any, are described at the front of this manual.

6.2 EXPLANATION OF COLUMN HEADINGS

6.2.1 REF. DESIG. This identifies the assigned reference designation applicable to a system or equipment sub-unit having a separate prefix and arrangement of individual components.

6.2.2 COMP. DESIG. This identifies the components of the sub-unit in alpha-numerical order.

6.2.3 SCIENTIFIC-ATLANTA (S-A) PART NO. A five or six digit number assigned by the manufacturer to the specific part for identification and correct replacement ordering information.

6.2.4 DESCRIPTION. A brief electrical and/or mechanical description of the component. Abbreviations used in this column are explained at the end of the chapter.

6.2.5 FSCM. The proper Federal Supply Code for manufacturers are entered in this column. The code numbers are from the Federal Supply Code for Manufacturers Cataloging Handbooks H4-1 (Name to Code) and H4-2 (Code to Name) in effect as of the publication date of this manual. Alphabetical codes have been arbitrarily assigned to suppliers not assigned in the H4 handbooks and these identifying codes are cross-referenced (code to name) at the end of this section.

6.2.6 MGR. PART NO. The number assigned to a part by an outside supplying manufacturer is listed in this column.

6.3 ORDERING PARTS

6.3.1 When ordering parts from Scientific-Atlanta, always include the Scientific-Atlanta part number, the part description, the unit name, the unit serial number, the subassembly name, the part manufacturer (FSCM) and the manufacturer's part number.

6.4 PARTS SUBSTITUTION

6.4.1 Common components may differ from those identified in the parts list. This difference is due to the substitution of a more current part during assembly. When this occurs, the replacement may be either a part identical to the type removed or a part meeting the description given in the parts list.

PARTS LIST INDEX

	<u>Page</u>
Model 4661 Baseband Noise Transmitter	6-5
A01 Noise Source Assembly	6-6
A08 ALC Amplifier Assembly	6-8
A17 ALC Detector/Attenuator Assembly	6-10
A18 Power Supply Assembly	6-13
A19 Rear Panel Interface PCB Assembly	6-14
A20 Filter Select PCB Assembly	6-15
A21 Equalizer Assembly	6-16
Blank Spacer (Filter) Assembly	6-17
12 kHz High Pass Filter Assembly	6-18
60 kHz High Pass Filter Assembly	6-19
316 kHz High Pass Filter Assembly	6-20
108 kHz Low Pass Filter Assembly	6-21
156 kHz Low Pass Filter Assembly	6-22
204 kHz Low Pass Filter Assembly	6-23
252 kHz Low Pass Filter Assembly	6-24
300 kHz Low Pass Filter Assembly	6-25
408 kHz Low Pass Filter Assembly	6-26
552 kHz Low Pass Filter Assembly	6-27
804 kHz Low Pass Filter Assembly	6-28
1052 kHz Low Pass Filter Assembly	6-29
1296 kHz Low Pass Filter Assembly	6-30
1796 kHz Low Pass Filter Assembly	6-31
2045 kHz Low Pass Filter Assembly	6-32
2600 kHz Low Pass Filter Assembly	6-33
3284 kHz Low Pass Filter Assembly	6-34
4100 kHz Low Pass Filter Assembly	6-35
5600 kHz Low Pass Filter Assembly	6-36
7284 kHz Low Pass Filter Assembly	6-37
8160 kHz Low Pass Filter Assembly	6-39
10164 kHz Low Pass Filter Assembly	6-40
11404 kHz Low Pass Filter Assembly	6-41
12360 kHz Low Pass Filter Assembly	6-42
16 kHz Notch Filter Assembly	6-43
56 kHz Notch Filter Assembly	6-44
70 kHz Notch Filter Assembly	6-45
98 kHz Notch Filter Assembly	6-46
140 kHz Notch Filter Assembly	6-47
185 kHz Notch Filter Assembly	6-48
240 kHz Notch Filter Assembly	6-49
270 kHz Notch Filter Assembly	6-50
394 kHz Notch Filter Assembly	6-51
534 kHz Notch Filter Assembly	6-52
770 kHz Notch Filter Assembly	6-53
1002 kHz Notch Filter Assembly	6-54
1248 kHz Notch Filter Assembly	6-55
1730 kHz Notch Filter Assembly	6-56

PARTS LISTS INDEX - CONTINUED

	<u>Page</u>
1960 kHz Notch Filter Assembly	6-57
2438 kHz Notch Filter Assembly	6-58
3150 kHz Notch Filter Assembly	6-59
3886 kHz Notch Filter Assembly	6-60
5340 kHz Notch Filter Assembly	6-61
6900 kHz Notch Filter Assembly	6-62
7600 kHz Notch Filter Assembly	6-63
10840 kHz Notch Filter Assembly	6-64
Crystal Controlled Notch Filter Assemblies	6-65

MODEL 4661 BASEBAND NOISE TRANSMITTER - 155938

COMP DESIG	S-A PART NO	-----DESCRIPTION-----	FSCM	-----MFR PART NO-----
A01	156375	NOISE SOURCE ASSY- MODEL 4661		
A02	78700	FACTORY SELECTED VALUE		
A03	78700	FACTORY SELECTED VALUE		
A04	78700	FACTORY SELECTED VALUE		
A05	78700	FACTORY SELECTED VALUE		
A06	78700	FACTORY SELECTED VALUE		
A07	78700	FACTORY SELECTED VALUE		
A08	156376	ALC AMPLIFIER ASSEMBLY		
A09	78700	FACTORY SELECTED VALUE		
A10	78700	FACTORY SELECTED VALUE		
A11	78700	FACTORY SELECTED VALUE		
A12	78700	FACTORY SELECTED VALUE		
A13	78700	FACTORY SELECTED VALUE		
A14	78700	FACTORY SELECTED VALUE		
A15	78700	FACTORY SELECTED VALUE		
A16	78700	FACTORY SELECTED VALUE		
A17	156394	ALC DETECTOR AND 0-49.9DB ATTENUATOR		
A18	156393	POWER SUPPLY ASSEMBLY		
A19	156328	PWB ASSY- REAR PANEL INTERFACE		
① A20	156325	PWB ASSY- FILTER SELECT		
A20	304949	PWB ASSY- FILTER SELECT		
A21	158652	PWB ASSY- EQUALIZER, MODEL 4661		
J01	78700	FACTORY SELECTED VALUE		
J02	86035	CONN COAX VERSACON 9 ADAPTER TO BNC		S-226
J03	86036	CONN COAX VERSACON 9 ADAPTER TO WE 558A		S-228
J04	86037	CONN COAX VERSACON 9 ADAPTER TO WE 470C		S-336
J05	86038	CONN COAX VERSACON 9 ADAPTER TO 1.6/5.6		S-224
J06	86039	CONN COAX VERSACON 9 ADAPTER TO 2.5/6		S-225
J07	86040	CONN COAX VERSACON 9 LOCKNUT FOR BULKHD		
P01	85041	CONN COAX CONHX SNAP-ON BHD MALE .15 CBL	98291	51-127-0000
P02	85041	CONN COAX CONHX SNAP-ON BHD MALE .15 CBL	98291	51-127-0000
S01	158690	SWITCH- OPDT, PUSH-PUSH, SILVER CONTACTS		
S01	158690	SWITCH- OPDT, PUSH-PUSH, SILVER CONTACTS		
W01	158691	CABLE		
W01	156471	CABLE- STANDARD, 3 1/2INS LONG, 4661		
W02	156471	CABLE- STANDARD, 3 1/2INS LONG, 4661		
W03	156471	CABLE- STANDARD, 3 1/2INS LONG, 4661		
W04	156471	CABLE- STANDARD, 3 1/2INS LONG, 4661		
W05	156471	CABLE- STANDARD, 3 1/2INS LONG, 4661		
W06	156471	CABLE- STANDARD, 3 1/2INS LONG, 4661		
W07	156471	CABLE- STANDARD, 3 1/2INS LONG, 4661		
W08	156471	CABLE- STANDARD, 3 1/2INS LONG, 4661		
W09	156471	CABLE- STANDARD, 3 1/2INS LONG, 4661		
W10	156471	CABLE- STANDARD, 3 1/2INS LONG, 4661		
W11	156471	CABLE- STANDARD, 3 1/2INS LONG, 4661		
W12	156471	CABLE- STANDARD, 3 1/2INS LONG, 4661		
W13	156471	CABLE- STANDARD, 3 1/2INS LONG, 4661		
W14	156471	CABLE- STANDARD, 3 1/2INS LONG, 4661		
W15	156471	CABLE- STANDARD, 3 1/2INS LONG, 4661		
W16	156470	CABLE- A16 TO A17		
W17	156134	CABLE RF		
W18	158696	CABLE-INTERFACE		
① W19	158697	CABLE- CONTROL, FRONT PANEL		
W19	304950	CABLE- CONTROL, FRONT PANEL		
W20	158686	CABLE- A6 TO A8		
W21	158587	CABLE- A5 TO A8		
W22	158688	CABLE- A4 TO A8		
W23	85129	CORD SET 3-WIRE #18 125V 7 1/2-FT W/FEM	70903	17250-YELLOW

① APPLIES TO SERIAL NUMBERS 364 AND BELOW (APPROXIMATELY).

MODEL 4661 NOISE SOURCE ASSEMBLY MODULE - 156375

REF DESIG PREFIX: MODEL 4661-A01

REF DESIG	PART NO.	DESCRIPTION	FSCM CODE	VENDOR PART NUMBER
A 001		PWB ASSY- NOISE SOURCE, MODEL 4661		
C 001	0077863	CAPACITR .001 MF 500V FDTHRU THD GMV	33095	54-804-002-102P
J 001	0085152	CONN COAX SMB MALE TO SLDR CUP 75 OHM	98291	51-143-0000
J 002	0085152	CONN COAX SMB MALE TO SLDR CUP 75 OHM	98291	51-143-0000
W 001	0158695	CABLE- CONTROL		

MODEL 4661-A01 PWB ASSEMBLY - 155897 (A01A1)

C 001	0080139	CAPACITR .1 MF 50V CER MONO -20%+80%	72982	8131-050-651-104Z
C 002	0079171	CAPACITR 9-35 PF MIN CER DISC PC MT	72982	538-011 D 9-35
C 003	0081101	CAPACITR 1 MF 50V CER MONO 20%	72982	8131-050-651-105M
C 004	0081101	CAPACITR 1 MF 50V CER MONO 20%	72982	8131-050-651-105M
C 005	0080139	CAPACITR .1 MF 50V CER MONO -20%+80%	72982	8131-050-651-104Z
C 006	0076718	CAPACITR 30 MF 50V WET SLUG TANT POL 20%	37942	MTP-306M-050P1B
C 007		NOT ASSIGNED		
C 008	0081101	CAPACITR 1 MF 50V CER MONO 20%	72982	8131-050-651-105M
C 009	0076718	CAPACITR 30 MF 50V WET SLUG TANT POL 20%	37942	MTP-306M-050P1B
C 010	0081101	CAPACITR 1 MF 50V CER MONO 20%	72982	8131-050-651-105M
C 011	0080139	CAPACITR .1 MF 50V CER MONO -20%+80%	72982	8131-050-651-104Z
C 012	0081995	CAPACITR .001 MF 100V CER MONO X7R 10%	72982	8121-100-X7R-102K
C 013	0081101	CAPACITR 1 MF 50V CER MONO 20%	72982	8131-050-651-105M
C 014		NOT ASSIGNED		
C 015	0081098	CAPACITR .47 MF 50V CER MONO 20%	72982	8131-050-651-474M
C 016	0076718	CAPACITR 30 MF 50V WET SLUG TANT POL 20%	37942	MTP-306M-050P1B
C 017		NOT ASSIGNED		
C 018	0070490	CAPACITR 30 PF 500V SILVER MICA 5%	14655	CD15ED300J03
C 019	0081101	CAPACITR 1 MF 50V CER MONO 20%	72982	8131-050-651-105M
C 020	0081971	CAPACITR 2.2 PF 100V CER DISC COJ +- .25P	72982	835-024-COJ0-229C
C 021		NOT ASSIGNED		
C 022	0081101	CAPACITR 1 MF 50V CER MONO 20%	72982	8131-050-651-105M
C 023	0081101	CAPACITR 1 MF 50V CER MONO 20%	72982	8131-050-651-105M
C 024	0081101	CAPACITR 1 MF 50V CER MONO 20%	72982	8131-050-651-105M
C 025	0076718	CAPACITR 30 MF 50V WET SLUG TANT POL 20%	37942	MTP-306M-050P1B
E 001	0081718	CORE BEAD FERRITE 7D .138X.037X.150L GRN	78488	57-1413
E 003	0081718	CORE BEAD FERRITE 7D .138X.037X.150L GRN	78488	57-1413
E 004	0081718	CORE BEAD FERRITE 7D .138X.037X.150L GRN	78488	57-1413
E 005	0081718	CORE BEAD FERRITE 7D .138X.037X.150L GRN	78488	57-1413
L 001	0070736	INDUCTOR 33 UH SURMIN UNSHLD MOLDED 10%	76493	9310-52
Q 001	0078215	TRANSSTR 2N5089 NPN SIL	04713	2N5089
Q 001	0077147	TRANSSTR 2N3947 NPN SIL	04713	2N3947
Q 002	0086341	TRANSSTR A5T4260 PNP SIL HI FREQ		A5T4260
Q 002	0255279	TRANSSTR A8T4260 PNP SIL		A8T4260
Q 002	0170339	TRANSSTR 2N4260 PNP SIL		2N4260
Q 003	0077147	TRANSSTR 2N3947 NPN SIL	04713	2N3947
Q 004	0035669	TRANSSTR 2N5179 SIL NPN	04713	2N5179
Q 005	0077147	TRANSSTR 2N3947 NPN SIL	04713	2N3947
Q 006	0077147	TRANSSTR 2N3947 NPN SIL	04713	2N3947
Q 007	0035669	TRANSSTR 2N5179 SIL NPN	04713	2N5179
Q 008	0077147	TRANSSTR 2N3947 NPN SIL	04713	2N3947

- ① APPLIES TO SERIAL NO. *257 AND BELOW
 ② APPLIES TO SERIAL NO. *258 THROUGH 276
 ③ APPLIES TO SERIAL NO. *277 AND ABOVE
 ④ APPLIES TO SERIAL NO. *314 AND BELOW
 ⑤ APPLIES TO SERIAL NO. *315 AND ABOVE

*SERIAL NO.'S ARE APPROXIMATE

MODEL 4661-A01 PWB ASSEMBLY - 155897 (A01A1)

REF DESIG	PART NO.	DESCRIPTION	FSCM CODE	VENDOR PART NUMBER
R 001	0079713	RESISTOR 2.00K OHM RN55C 1% MTL FLM		RN55C2001F
R 002	0083089	RESISTOR 75.0 OHM RN55C 1% MTL FLM		RN55C75R0F
R 003	0081406	RESISTOR 19.6K OHM RN55C 1% MTL FLM		RN55C1962F
R 004	0081406	RESISTOR 19.6K OHM RN55C 1% MTL FLM		RN55C1962F
R 005	0078766	RESISTOR 1.62K OHM RN55C 1% MTL FLM		RN55C1621F
R 006	0071862	RESISTOR 47 OHM 1/4W 10% COMP	01121	RCR07G470KS
R 007	0079984	RESISTOR 4.02K OHM RN55C 1% MTL FLM		RN55C4021F
R 008	0079318	RESISTOR 121 OHM RN55C 1% MTL FLM		RN55C1210F
R 009	0079725	RESISTOR 3.16K OHM RN55C 1% MTL FLM		RN55C3161F
R 010	0071951	RESISTOR 1.0K OHM 1/4W 10% COMP	01121	RCR07G102KS
R 011	0080380	RESISTOR 2.74K OHM RN55C 1% MTL FLM		RN55C2741F
R 012	0076723	RESISTOR 39 OHM 1/4W 10% COMP	01121	RCR07G390KS
R 013	0072039	RESISTOR 15K OHM 1/4W 10% COMP	01121	RCR07G153KS
R 014		NOT ASSIGNED		
R 015	0072026	RESISTOR 10K OHM 1/4W 10% COMP	01121	RCR07G103KS
R 016	0083087	RESISTOR 61.9 OHM RN55C 1% MTL FLM		RN55C61R9F
R 017	0083081	RESISTOR 15.4 OHM RN55C 1% MTL FLM		RN55C15R4F
R 018	0083087	RESISTOR 61.9 OHM RN55C 1% MTL FLM		RN55C61R9F
R 019	0071951	RESISTOR 1.0K OHM 1/4W 10% COMP	01121	RCR07G102KS
R 020	0071973	RESISTOR 1.8K OHM 1/4W 10% COMP	01121	RCR07G182KS
R 021	0079713	RESISTOR 2.00K OHM RN55C 1% MTL FLM		RN55C2001F
R 022	0071989	RESISTOR 3.3K OHM 1/4W 10% COMP	01121	RCR07G332KS
R 023	0079318	RESISTOR 121 OHM RN55C 1% MTL FLM		RN55C1210F
R 024	0071989	RESISTOR 3.3K OHM 1/4W 10% COMP	01121	RCR07G332KS
R 025	0084489	POT 100 OHM 1/2W CER .30 DIA VERT ADJ 4T	80294	3339P-1-101
R 026	0071887	RESISTOR 100 OHM 1/4W 10% COMP	01121	RCR07G101KS
R 027	0072039	RESISTOR 15K OHM 1/4W 10% COMP	01121	RCR07G153KS
R 028	0072026	RESISTOR 10K OHM 1/4W 10% COMP	01121	RCR07G103KS
R 029	0076723	RESISTOR 39 OHM 1/4W 10% COMP	01121	RCR07G390KS
R 030	0071951	RESISTOR 1.0K OHM 1/4W 10% COMP	01121	RCR07G102KS
R 031	0071973	RESISTOR 1.8K OHM 1/4W 10% COMP	01121	RCR07G182KS
R 032	0079713	RESISTOR 2.00K OHM RN55C 1% MTL FLM		RN55C2001F
R 033	0071989	RESISTOR 3.3K OHM 1/4W 10% COMP	01121	RCR07G332KS
R 034	0083858	RESISTOR 133 OHM RN55C 1% MTL FLM		RN55C1330F
R 035	0071951	RESISTOR 1.0K OHM 1/4W 10% COMP	01121	RCR07G102KS
R 036	0083089	RESISTOR 75.0 OHM RN55C 1% MTL FLM		RN55C75R0F
R 037	0083087	RESISTOR 61.9 OHM RN55C 1% MTL FLM		RN55C61R9F
R 038	0083087	RESISTOR 61.9 OHM RN55C 1% MTL FLM		RN55C61R9F
R 039	0083081	RESISTOR 15.4 OHM RN55C 1% MTL FLM		RN55C15R4F
R 040	0071966	RESISTOR 1.5K OHM 1/4W 10% COMP	01121	RCR07G152KS

MODEL 4661 ALC AMPLIFIER ASSEMBLY MODULE - 156376

REF DESIG PREFIX: MODEL 4661-A08

REF DESIG	PART NO.	DESCRIPTION	FSCM CODE	VENDOR PART NUMBER
A 001		PWB ASSY- ALC AMPLIFIER		
C 001	0077863	CAPACITR .001 MF 500V FDTHRU THD GMV	33095	54-804-002-102P
C 002	0077863	CAPACITR .001 MF 500V FDTHRU THD GMV	33095	54-804-002-102P
J 001	0085152	CONN COAX SMB MALE TO SLDR CUP 75 OHM	98291	51-143-0000
J 002	0085152	CONN COAX SMB MALE TO SLDR CUP 75 OHM	98291	51-143-0000
W 001	0158694	CABLE- CONTROL, ALC		

MODEL 4661-A08 PWB ASSEMBLY - 156374 (A08A1)

C 001	0080139	CAPACITR .1 MF 50V CER MONO -20%+80%	72982	8131-050-651-104Z
C 002	0079001	CAPACITR 25 MF 50V	80183	500D256G050CC7
C 003	0079001	CAPACITR 25 MF 50V	80183	500D256G050CC7
C 004	0080139	CAPACITR .1 MF 50V CER MONO -20%+80%	72982	8131-050-651-104Z
C 005	0080139	CAPACITR .1 MF 50V CER MONO -20%+80%	72982	8131-050-651-104Z
C 006	0081098	CAPACITR .47 MF 50V CER MONO 20%	72982	8131-050-651-474M
C 007	0081101	CAPACITR 1 MF 50V CER MONO 20%	72982	8131-050-651-105M
C 008		NOT ASSIGNED		
C 009	0080139	CAPACITR .1 MF 50V CER MONO -20%+80%	72982	8131-050-651-104Z
C 010	0080139	CAPACITR .1 MF 50V CER MONO -20%+80%	72982	8131-050-651-104Z
C 011	0080139	CAPACITR .1 MF 50V CER MONO -20%+80%	72982	8131-050-651-104Z
C 012	0079097	CAPACITR 3-15 PF MIN CER DISC PC MT	72982	538-011 D 3-15
C 013	0081101	CAPACITR 1 MF 50V CER MONO 20%	72982	8131-050-651-105M
C 014	0081101	CAPACITR 1 MF 50V CER MONO 20%	72982	8131-050-651-105M
C 015	0081101	CAPACITR 1 MF 50V CER MONO 20%	72982	8131-050-651-105M
C 016	0079001	CAPACITR 25 MF 50V	80183	500D256G050CC7
C 017	0081101	CAPACITR 1 MF 50V CER MONO 20%	72982	8131-050-651-105M
C 018	0082007	CAPACITR 4.3 PF 100V CER DISC COH +- .25P	72982	835-024-COHO-439C
C 019	0078700	FACTORY SELECTED VALUE		
C 020	0078700	FACTORY SELECTED VALUE		
CR001	0074186	DIODE 1N935A TC REF 9.0V .01% .5W	04713	1N935A
CR002	0081807	DIODE MV1401 VARACTOR SIL WIRE LEADS	04713	MV1401
CR003	0081807	DIODE MV1401 VARACTOR SIL WIRE LEADS	04713	MV1401
E 005	0081718	CORE BEAD FERRITE 7D .138X,037X,150L GRN	78488	57-1413
L 001	0078716	INDUCTOR 100 UH SUBMIN UNSHLD 10%	91637	IR-2
L 002	0078716	INDUCTOR 100 UH SUBMIN UNSHLD 10%	91637	IR-2
L 003	0070736	INDUCTOR 33 UH SUBMIN UNSHLD MOLDED 10%	76493	9310-52
L 005	0078716	INDUCTOR 100 UH SUBMIN UNSHLD 10%	91637	IR-2
Q 001	0035669	TRANSSTR 2N5179 SIL NPN	04713	2N5179
Q 002	0076960	TRANSSTR 2N4221 FET N-CHNL JUNC	04713	2N4221
Q 003	0086341	TRANSSTR A5T4260 PNP SIL HI FREQ		A5T4260
Q 003	0170339	TRANSSTR 2N4260 PNP SIL		2N4260
Q 003	0255279	TRANSSTR A8T4260 PNP SIL		A8T4260
Q 004	0035669	TRANSSTR 2N5179 SIL NPN	04713	2N5179
Q 005	0035669	TRANSSTR 2N5179 SIL NPN	04713	2N5179
Q 006	0077147	TRANSSTR 2N3947 NPN SIL	04713	2N3947
Q 007	0035669	TRANSSTR 2N5179 SIL NPN	04713	2N5179
Q 008	0035669	TRANSSTR 2N5179 SIL NPN	04713	2N5179
Q 009	0079329	TRANSSTR 2N5109 NPN SIL	79089	2N5109

- ① APPLIES TO SERIAL NO. *257 AND BELOW
 ② APPLIES TO SERIAL NO. *258 THROUGH 276
 ③ APPLIES TO SERIAL NO. *277 AND ABOVE

*SERIAL NO.'S ARE APPROXIMATE

MODEL 4661-A08 PWB ASSEMBLY - 156374 (A08A1)

REF DESIG	PART NO.	DESCRIPTION	FSCM CODE	VENDOR PART NUMBER
R 001	0083089	RESISTOR 75.0 OHM RN55C 1% MTL FLM		RN55C75R0F
R 002	0072077	RESISTOR 47K OHM 1/4W 10% COMP	01121	RCR07G473KS
R 003	0072077	RESISTOR 47K OHM 1/4W 10% COMP	01121	RCR07G473KS
R 004	0071989	RESISTOR 3.3K OHM 1/4W 10% COMP	01121	RCR07G332KS
R 005	0072026	RESISTOR 10K OHM 1/4W 10% COMP	01121	RCR07G103KS
R 006	0071989	RESISTOR 3.3K OHM 1/4W 10% COMP	01121	RCR07G332KS
R 007	0078963	RESISTOR 1.00 MEG RN60C 1% MTL FLM		RN60C1004F
R 008	0078963	RESISTOR 1.00 MEG RN60C 1% MTL FLM		RN60C1004F
R 009	0071938	RESISTOR 680 OHM 1/4W 10% COMP	01121	RCR07G681KS
R 010	0072034	RESISTOR 12K OHM 1/4W 10% COMP	01121	RCR07G123KS
④ R 011	0081733	RESISTOR 750 OHM 1/4W 5% COMP	01121	RCR07G751JS
R 011	0074703	RESISTOR 1.2K OHM 1/4W 5% COMP	01121	RCR07G122JS
R 012	0076275	RESISTOR 22 OHM 1/4W 10% COMP	01121	RCR07G220KS
R 013	0071977	RESISTOR 2.2K OHM 1/4W 10% COMP	01121	RCR07G222KS
R 014	0071989	RESISTOR 3.3K OHM 1/4W 10% COMP	01121	RCR07G332KS
R 015	0072068	RESISTOR 39K OHM 1/4W 10% COMP	01121	RCR07G393KS
R 016	0072064	RESISTOR 33K OHM 1/4W 10% COMP	01121	RCR07G333KS
R 017	0071951	RESISTOR 1.0K OHM 1/4W 10% COMP	01121	RCR07G102KS
R 018	0071960	RESISTOR 1.2K OHM 1/4W 10% COMP	01121	RCR07G122KS
R 019	0078248	RESISTOR 1.00K OHM RN60C 1% MTL FLM		RN60C1001F
R 020	0082101	RESISTOR 1.47K OHM RN60C 1% MTL FLM		RN60C1471F
R 021	0078461	RESISTOR 100 OHM RN60C 1% MTL FLM		RN60C1000F
R 022	0071954	RESISTOR 1.0K OHM 1/2W 10% COMP	01121	RCR20G102KS
R 023	0074723	RESISTOR 5.6K OHM 1/4W 5% COMP	01121	RCR07G562JS
R 024	0075651	RESISTOR 2.0K OHM 1/4W 5% COMP	01121	RCR07G202JS
R 025	0074696	RESISTOR 470 OHM 1/4W 5% COMP	01121	RCR07G471JS
R 026	0071973	RESISTOR 1.8K OHM 1/4W 10% COMP	01121	RCR07G182KS
R 027	0082096	RESISTOR 825 OHM RN60C 1% MTL FLM		RN60C8250F
R 028	0078248	RESISTOR 1.00K OHM RN60C 1% MTL FLM		RN60C1001F
R 029	0078867	RESISTOR 221 OHM RN60D 1% MTL FLM		RN60D2210F
R 030	0083089	RESISTOR 75.0 OHM RN55C 1% MTL FLM		RN55C75R0F
P 031	0075630	RESISTOR 330 OHM 1W 10% COMP	01121	RCR32G331KS
R 032	0078461	RESISTOR 100 OHM RN60C 1% MTL FLM		RN60C1000F

④ APPLIES TO SERIAL NUMBERS 336 AND BELOW (APPROXIMATELY).

MODEL 4661 ALC DETECTOR/0 - 49.9 DB ATTENUATOR MODULE - 156394

REF DESIG PREFIX: MODEL 4661-A17

REF DESIG	PART NO.	DESCRIPTION	FSCM CODE	VENDOR PART NUMBER
A 001		PWB ASSY- ALC DET. AND 0-49.9DB ATTEN		
C 001	0077863	CAPACITR .001 MF 500V F0THRU THD GMV	33095	54-804-002-102P
C 002	0077863	CAPACITR .001 MF 500V F0THRU THD GMV	33095	54-804-002-102P
C 003	0077863	CAPACITR .001 MF 500V F0THRU THD GMV	33095	54-804-002-102P
C 004	0077863	CAPACITR .001 MF 500V F0THRU THD GMV	33095	54-804-002-102P
J 001	0085152	CONN COAX SMB MALE TO SLDR CUP 75 OHM	98291	51-143-0000
J 002	0085152	CONN COAX SMB MALE TO SLDR CUP 75 OHM	98291	51-143-0000
③ W 001	0255858	CABLE ASSY, ALC POWER		

MODEL 4661-A17 PWB ASSEMBLY - 151415 (A17A1)

C 001	0070544	CAPACITR .001 MF 1KV CER DISC Z5F 10%	71590	DD102
C 002	0080139	CAPACITR .1 MF 50V CER MONO -20%+80%	72982	8131-050-651-104Z
C 003	0079001	CAPACITR 25 MF 50V	80183	500D256G050CC7
C 004	0075417	CAPACITR .01 MF 150V CER DISC Z5V-40+60%	71590	DDM-103
C 005	0080139	CAPACITR .1 MF 50V CER MONO -20%+80%	72982	8131-050-651-104Z
C 007	0080139	CAPACITR .1 MF 50V CER MONO -20%+80%	72982	8131-050-651-104Z
C 008	0080139	CAPACITR .1 MF 50V CER MONO -20%+80%	72982	8131-050-651-104Z
C 009	0081101	CAPACITR 1 MF 50V CER MONO 20%	72982	8131-050-651-105M
C 010	0081101	CAPACITR 1 MF 50V CER MONO 20%	72982	8131-050-651-105M
C 011	0081098	CAPACITR .47 MF 50V CER MONO 20%	72982	8131-050-651-474M
C 012	0080139	CAPACITR .1 MF 50V CER MONO -20%+80%	72982	8131-050-651-104Z
① CR001	0071142	DIODE 1N4154 SIL 25V 150MA	80368	1N4154
CR002	0071142	DIODE 1N4154 SIL 25V 150MA	80368	1N4154
CR003	0071142	DIODE 1N4154 SIL 25V 150MA	80368	1N4154
② CR004	0077488	DIODE 1N4737A SI ZEN 7.5V 5% 1W	04713	1N4737A
CR004	0171571	DIODE 1M75ZS1 SI ZEN 7.5V 1% 1W		1M18ZS1
CR005	0083986	DIODE 1N4746A SI ZEN 18V 5% 1W	04713	1N4746A
① CR005	0171570	DIODE 1M18ZS1 SI ZEN 18V 1% 1W		1M18ZS1
② K 001	0083153	RELAY 26.5VDC DPDT PC MT	98927	50GBDN-1-A-700
L 001	0079926	INDUCTOR 10 UH SUBMIN UNSHLD 10%	91637	IR-2
L 002	0081718	COPE BEAD FERRITE 7D .138X.037X.150L GRN	78488	57-1413
L 003	0081718	CORE BEAD FERRITE 7D .138X.037X.150L GRN	78488	57-1413
Q 001	0035669	TRANSSTR 2N5179 SIL NPN	04713	2N5179
Q 002	0077148	TRANSSTR 2N3251 PNP SIL	04713	2N3251
Q 003	0077147	TRANSSTR 2N3947 NPN SIL	04713	2N3947
R 001	0079729	RESISTOR 13.0K OHM RM55C 1% MTL FLM		RN55C1302F
R 002	0079655	RESISTOR 1 OHM 1/RW 1% DEP CAR	91637	DC-1/8
R 003	0074655	RESISTOR 6.2 OHM 1/4W 5% COMP	01121	RCR07G6R2JS
R 004	0079729	RESISTOR 13.0K OHM RM55C 1% MTL FLM		RN55C1302F
R 005	0079717	RESISTOR 6.49K OHM RM55C 1% MTL FLM		RN55C6491F
R 006	0086335	RESISTOR 1.8 OHM 1/2W 5% COMP		RC20G1R8J
R 007	0079717	RESISTOR 6.49K OHM RM55C 1% MTL FLM		RN55C6491F
R 008	0081773	RESISTOR 4.32K OHM RN60D 1% MTL FLM		RN60D4321F
R 009	0075542	RESISTOR 2.7 OHM 1/2W 5% COMP	01121	RCR20G2R7JS
R 010	0081773	RESISTOR 4.32K OHM RN60D 1% MTL FLM		RN60D4321F
P 011	0079725	RESISTOR 3.16K OHM RM55C 1% MTL FLM		RN55C3161F
R 012	0076284	RESISTOR 3.3 OHM 1/4W 10% COMP	01121	RCR07G3R3KS
R 013	0079725	RESISTOR 3.16K OHM RM55C 1% MTL FLM		RN55C3161F
R 014	0083901	RESISTOR 2.61K OHM RM55C 1% MTL FLM		RN55C2611F
R 015	0082304	RESISTOR 4.3 OHM 1/4W 5% COMP	01121	RCR07G4R3JS

① APPLIES TO SERIAL NO. *308 AND BELOW

② APPLIES TO SERIAL NO. *309 AND ABOVE

*SERIAL NO.'S ARE APPROXIMATE

③ APPLIES TO SERIAL NUMBERS 336 AND BELOW (APPROXIMATELY).

MODEL 4661-A17 PWB ASSEMBLY - 151415 (A17A1)

REF DESIG	PART NO.	DESCRIPTION	FSCM CODE	VENDOR PART NUMBER
R 016	0083901	RESISTOR 2.61K OHM RN55C 1% MTL FLM		RN55C2611F
R 017	0083898	RESISTOR 2.15K OHM RN55C 1% MTL FLM		RN55C2151F
R 018	0082679	RESISTOR 5.1 OHM 1/4W 5% COMP	01121	RCR07G5P1JS
R 019	0083898	RESISTOR 2.15K OHM RN55C 1% MTL FLM		RN55C2151F
R 020	0083895	RESISTOR 1.87K OHM RN55C 1% MTL FLM		RN55C1871F
R 021	0074655	RESISTOR 6.2 OHM 1/4W 5% COMP	01121	RCR07G6R2JS
R 022	0083895	RESISTOR 1.87K OHM RN55C 1% MTL FLM		RN55C1871F
P 023	0078927	RESISTOR 1.65K OHM RN55C 1% MTL FLM		RN55C1651F
R 024	0082444	RESISTOR 6.8 OHM 1/4W 5% COMP	01121	RCR07G6R8JS
R 025	0078927	RESISTOR 1.65K OHM RN55C 1% MTL FLM		RN55C1651F
R 026	0083890	RESISTOR 1.47K OHM RN55C 1% MTL FLM		RN55C1471F
P 027	0076867	RESISTOR 7.5 OHM 1/4W 5% COMP	01121	RCR07G7R5JS
R 028	0083890	RESISTOR 1.47K OHM RN55C 1% MTL FLM		RN55C1471F
R 029	0083859	RESISTOR 147 OHM RN55C 1% MTL FLM		RN55C1470F
R 030	0084987	RESISTOR 107 OHM RN55C .5% MTL FLM		RN55C1070D
R 031	0079724	RESISTOR 8.06K OHM RN55C 1% MTL FLM		RN55C8061F
R 032	0083859	RESISTOR 147 OHM RN55C 1% MTL FLM		RN55C1470F
R 033	0079724	RESISTOR 8.06K OHM RN55C 1% MTL FLM		RN55C8061F
P 034	0075687	RESISTOR 47K OHM 1/4W 5% COMP	01121	RCR07G473JS
R 035	0084988	RESISTOR 374 OHM RN55C .25% MTL FLM		RN55C3740C
P 036	0084986	RESISTOR 90.9 OHM RN55C .25% MTL FLM		RN55C90R9C
R 037	0084986	RESISTOR 90.9 OHM RN55C .25% MTL FLM		RN55C90R9C
R 038	0083859	RESISTOR 147 OHM RN55C 1% MTL FLM		RN55C1470F
P 039	0084987	RESISTOR 107 OHM RN55C .5% MTL FLM		RN55C1070D
R 040	0079724	RESISTOR 8.06K OHM RN55C 1% MTL FLM		RN55C8061F
P 041	0079724	RESISTOR 8.06K OHM RN55C 1% MTL FLM		RN55C8061F
R 042	0083859	RESISTOR 147 OHM RN55C 1% MTL FLM		RN55C1470F
P 043	0075687	RESISTOR 47K OHM 1/4W 5% COMP	01121	RCR07G473JS
R 044	0084988	RESISTOR 374 OHM RN55C .25% MTL FLM		RN55C3740C
R 045	0084986	RESISTOR 90.9 OHM RN55C .25% MTL FLM		RN55C90R9C
R 046	0084986	RESISTOR 90.9 OHM RN55C .25% MTL FLM		RN55C90R9C
R 047	0083099	RESISTOR 1.30K OHM RN55C 1% MTL FLM		RN55C1301F
R 048	0083082	RESISTOR 17.4 OHM RN55C 1% MTL FLM		RN55C17R4F
R 049	0083082	RESISTOR 17.4 OHM RN55C 1% MTL FLM		RN55C17R4F
P 050	0083099	RESISTOR 1.30K OHM RN55C 1% MTL FLM		RN55C1301F
R 051	0083098	RESISTOR 649 OHM RN55C 1% MTL FLM		RN55C6490F
R 052	0083082	RESISTOR 17.4 OHM RN55C 1% MTL FLM		RN55C17R4F
R 053	0083098	RESISTOR 649 OHM RN55C 1% MTL FLM		RN55C6490F
P 054	0078914	RESISTOR 442 OHM RN55C 1% MTL FLM		RN55C4420F
P 055	0083083	RESISTOR 26.7 OHM RN55C 1% MTL FLM		RN55C26R7F
P 056	0078914	RESISTOR 442 OHM RN55C 1% MTL FLM		RN55C4420F
R 057	0083097	RESISTOR 332 OHM RN55C 1% MTL FLM		RN55C3320F
R 058	0083084	RESISTOR 35.7 OHM RN55C 1% MTL FLM		RN55C35R7F
R 059	0083097	RESISTOR 332 OHM RN55C 1% MTL FLM		RN55C3320F
R 060	0083096	RESISTOR 267 OHM RN55C 1% MTL FLM		RN55C2670F
R 061	0083085	RESISTOR 45.3 OHM RN55C 1% MTL FLM		RN55C45R3F
R 062	0083096	RESISTOR 267 OHM RN55C 1% MTL FLM		RN55C2670F
R 063	0083095	RESISTOR 226 OHM RN55C 1% MTL FLM		RN55C2260F
R 064	0083086	RESISTOR 56.2 OHM RN55C 1% MTL FLM		RN55C56R2F
R 065	0083095	RESISTOR 226 OHM RN55C 1% MTL FLM		RN55C2260F
P 066	0078912	RESISTOR 196 OHM RN55C 1% MTL FLM		RN55C1960F
R 067	0083088	RESISTOR 66.5 OHM RN55C 1% MTL FLM		RN55C66R5F
R 068	0078912	RESISTOR 196 OHM RN55C 1% MTL FLM		RN55C1960F
R 069	0085059	RESISTOR 174 OHM RN55C .5% MTL FLM		RN55C1740D
R 070	0083142	RESISTOR 78.7 OHM RN55C 1% MTL FLM		RN55C78R7F
P 071	0085059	RESISTOR 174 OHM RN55C .5% MTL FLM		RN55C1740D
P 072	0085058	RESISTOR 158 OHM RN55C .5% MTL FLM		RN55C1580D
R 073	0083143	RESISTOR 93.1 OHM RN55C 1% MTL FLM		RN55C93R1F
R 074	0085058	RESISTOR 158 OHM RN55C .5% MTL FLM		RN55C1580D
P 075	0079895	RESISTOR 75.0 OHM RN60C 1% MTL FLM		RN60C75R0F
R 076	0072113	RESISTOR 100K OHM 1/4W 10% COMP	01121	RCR07G104KS
R 077	0071989	RESISTOR 3.3K OHM 1/4W 10% COMP	01121	RCR07G332KS
R 078	0071989	RESISTOR 3.3K OHM 1/4W 10% COMP	01121	RCR07G332KS
R 079	0079132	RESISTOR 200K OHM RN55C 1% MTL FLM		RN55C2003F
R 080	0082178	RESISTOR 499K OHM RN60C 1% MTL FLM		RN60C4993F

MODEL 4661-A17 PWB ASSEMBLY - 151415 (A17A1)

REF DESIG	PART NO.	DESCRIPTION	FSCM CODE	VENDOR PART NUMBER
R 081	00R2178	RESISTOR 499K OHM RN60C 1% MTL FLM		RN60C4993F
R 082	0078577	RESISTOR 20.0K OHM RN60C 1% MTL FLM		RN60C2002F
P 083	0078577	RESISTOR 20.0K OHM RN60C 1% MTL FLM		RN60C2002F
R 084	0071989	RESISTOR 3.3K OHM 1/4W 10% COMP	01121	RCR07G332KS
R 085	0071977	RESISTOR 2.2K OHM 1/4W 10% COMP	01121	RCR07G222KS
R 086	0072026	RESISTOR 10K OHM 1/4W 10% COMP	01121	RCR07G103KS
R 087	0080997	RESISTOR 2.00K OHM RN60C 1% MTL FLM		RN60C2001F
R 088	0082166	RESISTOR 249K OHM RN60C 1% MTL FLM		RN60C2493F
P 089	0071907	RESISTOR 220 OHM 1/4W 10% COMP	01121	RCR07G221KS
R 090	0077598	POT 10K OHM 3/4W CER RECT 3/4W LONG 15T	73138	3009P-1-103
R 091	0079712	RESISTOR 36.5K OHM RN55C 1% MTL FLM		RN55C3652F
R 092	0071951	RESISTOR 1.0K OHM 1/4W 10% COMP	01121	RCR07G102KS
R 093	0072011	RESISTOR 5.6K OHM 1/4W 10% COMP	01121	RCR07G562KS
R 094	0072065	RESISTOR 33K OHM 1/2W 10% COMP	01121	RCR20G333KS
R 095	0072026	RESISTOR 10K OHM 1/4W 10% COMP	01121	RCR07G103KS
R 096	0072026	RESISTOR 10K OHM 1/4W 10% COMP	01121	RCR07G103KS
R 097	0072026	RESISTOR 10K OHM 1/4W 10% COMP	01121	RCR07G103KS
R 098	0071960	RESISTOR 1.2K OHM 1/4W 10% COMP	01121	RCR07G122KS
S 001	0148740	SWITCH, 5-POSITION, 4-POLE, 4-SECTIONS		
S 002	0148741	SWITCH, 10-POSITION, 2-POLE, 2-SECTIONS		
S 003	0148741	SWITCH, 10-POSITION, 2-POLE, 2-SECTIONS		
U 001	0078219	IC TRANSSTR ARRAY 2-NPN TEMP COMPENSATED	13715	726 HC
U 002	0081840	IC OP AMP 8L-DIP 70C COMP DUAL 741C	79089	LM1458N

MODEL 4661 POWER SUPPLY ASSEMBLY MODULE - 156393

REF DESIG PREFIX: MODEL 4661-A18

REF DESIG	PART NO.	DESCRIPTION	FSCM CODE	VENDOR PART NUMBER
A 001		PWB ASSY- POWER SUPPLY, -24 VOLTS		
C 001	0077863	CAPACITR ,001 MF 500V FDTHRU THD GMV	33095	54-804-002-102P
U 001	0083155	IC VLTG RGLTR NEG 24V 0.5A TYP T0220	04713	MC7924CT
① W 001	0158494	CABLE-POWER SUPPLY-PRODUCTION REFERENCE		
W 002	0162933	CABLE ASSY- POWER SWITCH		
W 002	0304947	CABLE- ASSY- POWER SWITCH		
W 003	0158695	CABLE- CONTROL		

MODEL 4661-A18 PWB ASSEMBLY - 156322 (A18A1)

C 001	0075221	CAPACITR 1100 MF 50V	80183	39D118G050HP4
C 002	0075221	CAPACITR 1100 MF 50V	80183	39D118G050HP4
CRO01	0080764	RECTIFIER ASSY 200V 2A	83003	VS-247
R 001	0071813	RESISTOR ,50 OHM 3W WW 5%	24681	VAL3
T 001	0084768	XFMR 2SFC 12V 1A EA 2PRT 115 50/500HZ	08779	DPC24-1000

① APPLIES TO SERIAL NUMBERS 364 AND BELOW (APPROXIMATELY).

MODEL 4661 REAR PANEL INTERFACE PWB ASSEMBLY - 156328

REF DESIG PREFIX: MODEL 4661-A19

REF DESIG	PART NO.	DESCRIPTION	FSCM CODE	VENDOR PART NUMBER
J 001	0085125	CONN HEADER DBL ROW STRAIGHT 4-PIN PC	00779	87227-2
J 002	0085125	CONN HEADER DBL ROW STRAIGHT 4-PIN PC	00779	87227-2
J 003	0085125	CONN HEADER DBL ROW STRAIGHT 4-PIN PC	00779	87227-2
J 004	0085125	CONN HEADER DBL ROW STRAIGHT 4-PIN PC	00779	87227-2
J 005	0085125	CONN HEADER DBL ROW STRAIGHT 4-PIN PC	00779	87227-2
J 006	0085125	CONN HEADER DBL ROW STRAIGHT 4-PIN PC	00779	87227-2
J 007	0085125	CONN HEADER DBL ROW STRAIGHT 4-PIN PC	00779	87227-2
J 008	0085125	CONN HEADER DBL ROW STRAIGHT 4-PIN PC	00779	87227-2
J 009	0085125	CONN HEADER DBL ROW STRAIGHT 4-PIN PC	00779	87227-2
J 010	0085126	CONN HEADER DBL ROW STRAIGHT 10-PIN PC	00779	87227-5

4661

MODEL 4661 FILTER SELECT PWB ASSEMBLY - 304949

REF DESIG PREFIX: MODEL 4661-A20

REF DESIG	PART NO.	DESCRIPTION	FSCM CODE	VENDOR PART NUMBER
J 001	0084585	CONN HEADER DBL ROW RT ANGLE 10-PIN PC	00779	87230-5
J 002	0084585	CONN HEADER DBL ROW RT ANGLE 10-PIN PC	00779	87230-5
S 001	0304042	SWITCH,FILTER SELECT 4661 BB NOISE XMTR		
S 002	0304042	SWITCH,FILTER SELECT 4661 BB NOISE XMTR		
S 003	0304042	SWITCH,FILTER SELECT 4661 BB NOISE XMTR		
S 004	0304042	SWITCH,FILTER SELECT 4661 BB NOISE XMTR		
S 005	0304042	SWITCH,FILTER SELECT 4661 BB NOISE XMTR		
S 006	0304042	SWITCH,FILTER SELECT 4661 BB NOISE XMTR		

MODEL 4661 EQUALIZER PWB ASSEMBLY - 158652

REF DESIG PREFIX: MODEL 4661-A21

REF DESIG	PART NO.	DESCRIPTION	FSCM CODE	VENDOR PART NUMBER
C 001	0081609	CAPACITR .012 MF 100V POLYSTYRENE 5%	24152	13RB123J
C 002	0081609	CAPACITR .012 MF 100V POLYSTYRENE 5%	24152	13RB123J
J 001	0084940	CONN COAX SMB MALE PC MT 75 OHM	98291	51-151-0000
J 002	0084940	CONN COAX SMB MALE PC MT 75 OHM	98291	51-151-0000
L 001	0158648	COIL ASSEMBLY		
R 001	0079895	RESISTOR 75.0 OHM RN60C 1% MTL FLM		RN60C75R0F
R 002	0079895	RESISTOR 75.0 OHM RN60C 1% MTL FLM		RN60C75R0F
R 003	0082099	RESISTOR 1.27K OHM RN60C 1% MTL FLM		RN60C1271F
R 004	0082304	RESISTOR 4.3 OHM 1/4W 5% COMP	01121	PCR07G4R3JS

155938 FILTER ASSEMBLY, BLANK SPACER

COMP DESIG	S-A PART NO	-----DESCRIPTION-----	FSCM	-----MFR PART NO-----
A01	156477	FILTER ASSY- SPACER, BANDSTOP		
S01	158690	SWITCH- DPDT, PUSH-PUSH, SILVER CONTACTS		
W01	158691	CABLE		

12 kHz HIGH PASS FILTER ASSEMBLY - 217526

REF DESIG PREFIX: MODEL 4661-12

REF DESIG	PART NO.	DESCRIPTION	FSCM CODE	VENDOR PART NUMBER
	0220453	INDICATOR- PUSH-BUTTON, STAMPED 12		
A 001	0217375	PWB ASSY- FILTER, HIGH PASS, MDL 4661-12		
C 001	0077863	CAPACITR .001 MF 500V FDTHRU THD GMV	33095	54-804-002-102P
J 001	0085152	CONN COAX SMB MALE TO SLDR CUP 75 OHM	98291	51-143-0000
J 002	0085152	CONN COAX SMB MALE TO SLDR CUP 75 OHM	98291	51-143-0000
W 001	0158695	CABLE- CONTROL		

MODEL 4661-12 PWB ASSEMBLY - 217375 (A001)

C 001	0083711	CAPACITR .22 MF 50V POLYSTYRENE 2%	37942	ST12B224G
C 002	0083709	CAPACITR .033 MF 50V POLYSTYRENE 2%	37942	ST12B333G
C 003	0079750	CAPACITR 1 MF 100V POLYCARR 5%	24152	22NB106J
C 004	0073507	CAPACITR .15 MF 100V POLYESTER 10%	14655	WMF1P15
C 005	0073507	CAPACITR .15 MF 100V POLYESTER 10%	14655	WMF1P15
C 006	0080986	CAPACITR .047 MF 200V POLYCARR 5%	24152	22WC473J
C 007	0079754	CAPACITR .0815 MF 100V POLYSTYRENE 5%	24152	13RB8152J
C 008	0079754	CAPACITR .0815 MF 100V POLYSTYRENE 5%	24152	13RB8152J
C 009	0079749	CAPACITR .5 MF 100V POLYCARR 5%	24152	22NB505J
C 010	0083711	CAPACITR .22 MF 50V POLYSTYRENE 2%	37942	ST12B224G
C 011	0083708	CAPACITR .027 MF 50V POLYSTYRENE 2%	37942	ST12B273G
CR001	0071122	DIODE 1N914 SIL 75V 75MA	80368	1N914
K 001	0083153	RELAY 26.5VDC DPDT PC MT	98927	50GBDN-1-A-700
K 002	0083153	RELAY 26.5VDC DPDT PC MT	98927	50GBDN-1-A-700
L 001	0220421	COIL ASSEMBLY		
L 002	0220422	COIL ASSEMBLY		
L 003	0220423	COIL ASSEMBLY		
L 004	0079170	INDUCTOR .05 UH SUBMIN UNSHLD MOLDED 10%	91637	IR-2

60 kHz HIGH PASS FILTER ASSEMBLY - 156377

REF DESIG PREFIX: MODEL 4661-60

REF DESIG	PART NO.	DESCRIPTION	FSCM CODE	VENDOR PART NUMBER
	0158660	INDICATOR- PUSH-BUTTON, STAMPED 60		
A 001	0156344	PWB ASSY- FILTER, HIGH PASS, MDL 4661-60		
C 001	0077863	CAPACITR .001 MF 500V FDTHRU THD GMV	33095	54-804-002-102P
J 001	0085152	CONN COAX SMB MALE TO SLDR CUP 75 OHM	98291	51-143-0000
J 002	0085152	CONN COAX SMB MALE TO SLDR CUP 75 OHM	98291	51-143-0000
W 001	0158695	CABLE- CONTROL		

MODEL 4661-60 PWB ASSEMBLY - 156344 (A001)

C 001	0080986	CAPACITR .047 MF 200V POLYCARB 5%	24152	22WC473J
C 002	0084855	CAPACITR .15 MF 50V POLYSTYRENE 2%	37942	ST12B154G
C 003	0083708	CAPACITR .027 MF 50V POLYSTYRENE 2%	37942	ST12B273G
C 004	0083174	CAPACITR .015 MF 50V POLYSTYRENE 2%	37942	ST12B153G
C 005	0083708	CAPACITR .027 MF 50V POLYSTYRENE 2%	37942	ST12B273G
C 006	0083708	CAPACITR .027 MF 50V POLYSTYRENE 2%	37942	ST12B273G
C 007	0084854	CAPACITR .091 MF 50V POLYSTYRENE 2%	37942	ST12B913G
C 008	0081581	CAPACITR .01 MF 100V POLYSTYRENE 5%	24152	13RB103J
C 009	0083174	CAPACITR .015 MF 50V POLYSTYRENE 2%	37942	ST12B153G
C 010	0081581	CAPACITR .01 MF 100V POLYSTYRENE 5%	24152	13RB103J
CR001	0071122	DIODE 1N914 SIL 75V 75MA	80368	1N914
K 001	0083153	RELAY 26.5VDC DPDT PC MT	98927	50GBDN-1-A-700
K 002	0083153	RELAY 26.5VDC DPDT PC MT	98927	50GBDN-1-A-700
L 001	0156429	COIL ASSEMBLY		
L 002	0156430	COIL ASSEMBLY		
L 003	0156430	COIL ASSEMBLY		
L 004	0079170	INDUCTOR .05 UH SUBMIN UNSHLD MOLDED 10%	91637	IR-2

316 kHz HIGH PASS FILTER ASSEMBLY - 156378

REF DESIG PREFIX: MODEL 4661-316

REF DESIG	PART NO.	DESCRIPTION	FSCM CODE	VENDOR PART NUMBER
	0158662	INDICATOR- PUSH-BUTTON, STAMPED 316		
A 001	0156335	PWB ASSY-FILTER, HIGH PASS, MDL 4661-316		
C 001	0077863	CAPACITR .001 MF 500V FDTHRU THD GMV	33095	54-804-002-102P
J 001	0085152	CONN COAX SMB MALE TO SLDR CUP 75 OHM	98291	51-143-0000
J 002	0085152	CONN COAX SMB MALE TO SLDR CUP 75 OHM	98291	51-143-0000
W 001	0158695	CABLE- CONTROL		

MODEL 4661-316 PWB ASSEMBLY - 156355 (A001)

C 001	0083172	CAPACITR .0082 MF 50V POLYSTYRENE 5%	37942	ST128822J
C 002	0083169	CAPACITR .005 MF 50V POLYSTYRENE 5%	37942	ST128502J
C 003	0083175	CAPACITR .039 MF 50V POLYSTYRENE 2%	37942	ST128393G
C 004	0083170	CAPACITR .0056 MF 50V POLYSTYRENE 5%	37942	ST128562J
C 005	0083171	CAPACITR .0075 MF 50V POLYSTYRENE 5%	37942	ST128752J
C 006	0083174	CAPACITR .015 MF 50V POLYSTYRENE 2%	37942	ST128153G
C 007	0083173	CAPACITR .01 MF 50V POLYSTYRENE 5%	37942	ST128103J
CR001	0071122	DIODE 1N914 SIL 75V 75MA	80368	1N914
K 001	0083153	RELAY 26.5VDC DPDT PC MT	98927	50GBDN-1-A-700
K 002	0083153	RELAY 26.5VDC DPDT PC MT	98927	50GBDN-1-A-700
L 001	0133069	COIL ASSY		
L 002	0133070	COIL ASSY		
L 003	0133070	COIL ASSY		
L 004	0079170	INDUCTOR .05 UH SUBMIN UNSHLD MOLDED 10%	91637	IR-2

108 kHz LOW PASS FILTER ASSEMBLY - 220446

REF DESIG PREFIX: MODEL 4661-108

REF DESIG	PART NO.	DESCRIPTION	FSCM CODE	VENDOR PART NUMBER
	0220454	INDICATOR- PUSH-BUTTON, STAMPED 108		
A 001	0217638	PWB ASSY- FILTER, LOW PASS, MDL 4661-108		
C 001	0077863	CAPACITR .001 MF 500V F0THRU THD GMV	33095	54-804-002-102P
J 001	0085152	CONN COAX SMB MALE TO SLD R CUP 75 OHM	98291	51-143-0000
J 002	0085152	CONN COAX SMB MALE TO SLD R CUP 75 OHM	98291	51-143-0000
W 001	0158695	CABLE- CONTROL		

MODEL 4661-108 PWB ASSEMBLY - 217638 (A001)

C 001	0084438	CAPACITR .013 MF 100V SILVER MICA 5%	53021	D301E133J03
C 002	0084562	CAPACITR .0033 MF 500V SILVER MICA 5%	14655	CD19FD332J03
C 003	0084441	CAPACITR .022 MF 100V SILVER MICA 1%	53021	D301E223F03
C 004	0084438	CAPACITR .013 MF 100V SILVER MICA 5%	53021	D301E133J03
C 005	0073893	CAPACITR .02 MF 300V SILVER MICA 5%	14655	CD30FD203J03
C 006	0086048	CAPACITR .012 MF 100V SILVER MICA 1%		D301E123F03
C 007	0077015	CAPACITR .0068 MF 500V SILVER MICA 5%	14655	CD30FD682J03
C 008	0083114	CAPACITR 750 PF 100V SILVER MICA 2%	53021	D151F751G03
C 009	0078805	CAPACITR 180 PF 500V SILVER MICA 1%	53021	D155C181F03
C 010	0081117	CAPACITR .0023 MF 100V SILVER MICA 5%	53021	D191C232J03
C 011	0086258	CAPACITR .0047 MF 100V SILVER MICA 1%		D191F472F03
C 012	0084972	CAPACITR .0013 MF 500V SILVER MICA 1%	53021	D195E132F03
C 013	0080767	CAPACITR .002 MF 500V SILVER MICA 1%	53021	D195C202F03
C 014	0078815	CAPACITR 300 PF 500V SILVER MICA 1%	53021	D155C301F03
C 015	0081101	CAPACITR 1 MF 50V CER MONO 20%	72982	8131-050-651-105M
C 016	0081101	CAPACITR 1 MF 50V CER MONO 20%	72982	8131-050-651-105M
C 017	0081101	CAPACITR 1 MF 50V CER MONO 20%	72982	8131-050-651-105M
C 018	0035654	CAPACITR 10 MF 25V SOLID TANT POL 10%	05397	T362B106K025AS
C 019	0081101	CAPACITR 1 MF 50V CER MONO 20%	72982	8131-050-651-105M
C 020	0082974	CAPACITR .01 MF 500V SILVER MICA 1%	53021	D305F103F03
C 021		NOT ASSIGNED		
CR001	0071122	DIODE 1N914 SIL 75V 75MA	80368	1N914
K 001	0083153	RELAY 26.5VDC DPDT PC MT	98927	50GBDN-1-A-700
K 002	0083153	RELAY 26.5VDC DPDT PC MT	98927	50GBDN-1-A-700
L 001	0220441	COIL ASSEMBLY		
L 002	0220442	COIL ASSEMBLY		
L 003	0220443	COIL ASSEMBLY		
L 004	0220444	COIL ASSEMBLY		
L 005	0079170	INDUCTOR .05 UH SUBMIN UNSHLD MOLDED 10%	91637	IR-2
P 001	0082455	JUMPER MALE INSULATED .20 SPACING	71279	461-2871-01-00-10
Q 001	0077147	TRANSSTR 2N3947 NPN SIL	04713	2N3947
Q 002	0077147	TRANSSTR 2N3947 NPN SIL	04713	2N3947
Q 003	0077147	TRANSSTR 2N3947 NPN SIL	04713	2N3947
R 001	0083275	RESISTOR 76.8 OHM RN60C 1% MTL FLM		RN60C76R8F
R 002	0083849	RESISTOR 49.9 OHM RN55C 1% MTL FLM		RN55C49R9F
R 003	0072039	RESISTOR 15K OHM 1/4W 10% COMP	01121	RCR07G153KS
R 004	0072026	RESISTOR 10K OHM 1/4W 10% COMP	01121	RCR07G103KS
R 005	0071951	RESISTOR 1.0K OHM 1/4W 10% COMP	01121	RCR07G102KS
R 006	0071973	RESISTOR 1.8K OHM 1/4W 10% COMP	01121	RCR07G182KS
R 007	0072064	RESISTOR 33K OHM 1/4W 10% COMP	01121	RCR07G333KS
R 008	0079321	RESISTOR 383 OHM RN55C 1% MTL FLM		RN55C3830F
R 009	0079713	RESISTOR 2.00K OHM RN55C 1% MTL FLM		RN55C2001F
R 010	0071951	RESISTOR 1.0K OHM 1/4W 10% COMP	01121	RCR07G102KS
R 011	0083089	RESISTOR 75.0 OHM RN55C 1% MTL FLM		RN55C75R0F
R 012	0076723	RESISTOR 39 OHM 1/4W 10% COMP	01121	RCR07G390KS

156 kHz LOW PASS FILTER ASSY - 252494

REF DESIG PREFIX: MODEL 4661-156

REF DESIG	PART NO.	DESCRIPTION	FSCM CODE	VENDOR PART NUMBER
A001	0252663 252489	INDICATOR-PUSH-BUTTON STAMPED 156 PWB ASSY-FILTER LOW PASS MDL 4661-156		
C001	0077863	CAPACITR .001 MF 500V FDTHRU THD GMV	33095	54-804-002-102P
J001	0085152	CONN COAX SMB MALE TO SLDR CUP 75 OHM	98291	51-143-0000
J002	0085152	CONN COAX SMB MALE TO SLDR CUP 75 OHM	98291	51-143-0000
W001	0158695	CABLE-CONTROL		

MODEL 4661-156 PWB ASSY - 252489 (A001)

AT001	0035870	ATTNUATR 0 DB FIXED T-PAD TO-5 CASE		KM11
C 001	0082974	CAPACITR .01 MF 500V SILVER MICA 1%	53021	D305F103F03
C 002	0080767	CAPACITR .002 MF 500V SILVER MICA 1%	53021	D195C202F03
C 003	0082972	CAPACITR .0082 MF 500V SILVER MICA 1%	53021	D305F822F03
C 004	0086048	CAPACITR .012 MF 100V SILVER MICA 1%		D301E123F03
C 005	0086048	CAPACITR .012 MF 100V SILVER MICA 1%		D301E123F03
C 006	0082972	CAPACITR .0082 MF 500V SILVER MICA 1%	53021	D305F822F03
C 007	0078829	CAPACITR .002595 MF 500V SILVER MICA 1%	53021	D195CXXXF03 2595 PF
① C 008	0078600	NOT ASSIGNED		
C 009	0076486	CAPACITR 560 PF 500V SILVER MICA 5%	14655	CD19FD561J03
C 009	0070532	CAPACITR 300 PF 500V SILVER MICA 5%	14655	CD15FD301J03
C 010	0082972	CAPACITR .0082 MF 500V SILVER MICA 1%	53021	D305F822F03
① C 011	0078600	NOT ASSIGNED		
C 011	0082970	CAPACITR .0024 MF 500V SILVER MICA 1%	53021	D205F242F03
C 012	0081525	CAPACITR .003 MF 500V SILVER MICA 5%	53021	CM06FD302J03
① C 013	0070542	CAPACITR 680 PF 500V SILVER MICA 5%	14655	CD19FD681J03
C 013	0084975	CAPACITR .0036 MF 500V SILVER MICA 1%	53021	D195F362F03
C 014	0081117	CAPACITR .0023 MF 100V SILVER MICA 5%	53021	D191C232J03
CR001	0071122	DIODE 1N914 SIL 75V 75MA	80368	1N914
K 001	0083153	RELAY 26,5VDC DPDT PC MT	98927	50G8DN-1-A-700
K 002	0083153	RELAY 26,5VDC DPDT PC MT	98927	50G8DN-1-A-700
L 001	0252483	COIL ASSY		
L 002	0252482	COIL ASSY		
L 003	0252482	COIL ASSY		
L 004	0079170	INDUCTOR .05 UH SUBMIN UNSHLD MOLDED 10%	91637	IR-2

① APPLIES TO SERIAL NUMBER 333 AND BELOW (APPROXIMATELY).

204 KHz LOW PASS FILTER ASSEMBLY - 217513

REF DESIG PREFIX: MODEL 4661-204

REF DESIG	PART NO.	DESCRIPTION	FSCM CODE	VENDOR PART NUMBER
	0220455	INDICATOR- PUSH-BUTTON, STAMPED 204		
A 001	0217511	PWB ASSY-FILTER, LOW PASS, MDL 4661-204		
C 001	0077863	CAPACITR .001 MF 500V FDTHRU THD GMV	33095	54-804-002-102P
J 001	0085152	CONN COAX SMB MALE TO SLDR CUP 75 OHM	98291	51-143-0000
J 002	0085152	CONN COAX SMB MALE TO SLDR CUP 75 OHM	98291	51-143-0000
W 001	0158695	CABLE- CONTROL		

MODEL 4661-204 PWB ASSEMBLY - 217511 (A001)

AT001	0035870	ATTNUATR 0 DB FIXED T-PAD TO-5 CASE		KM11
C 001	0082969	CAPACITR .001 MF 500V SILVER MICA 1%	53021	D195F102F03
C 002	0084974	CAPACITR .0018 MF 500V SILVER MICA 1%	53021	D195E182F03
C 003	0082974	CAPACITR .01 MF 500V SILVER MICA 1%	53021	D305F103F03
C 004	0080769	CAPACITR .0091 MF 100V SILVER MICA 1%	53021	D201C912F03
C 005	0082974	CAPACITR .01 MF 500V SILVER MICA 1%	53021	D305F103F03
C 006	0086049	CAPACITR .0075 MF 100V SILVER MICA 1%		D191F752F03
C 007	0084975	CAPACITR .0036 MF 500V SILVER MICA 1%	53021	D195E362F03
C 008		NOT ASSIGNED		
C 009	0077901	CAPACITR .0015 MF 500V SILVER MICA 5%	14655	CD19FD152J03
C 010	0084976	CAPACITR .0062 MF 300V SILVER MICA 1%	53021	D193F622F03
C 011		NOT ASSIGNED		
C 012	0084561	CAPACITR .0027 MF 500V SILVER MICA 5%	14655	CD19FD272J03
C 013	0078815	CAPACITR 300 PF 500V SILVER MICA 1%	53021	D155C301F03
C 014	0084972	CAPACITR .0013 MF 500V SILVER MICA 1%	53021	D195E132F03
C 015		NOT ASSIGNED		
C 016	0078803	CAPACITR 150 PF 500V SILVER MICA 1%	53021	D155C151F03
C 017		NOT ASSIGNED		
C 018		NOT ASSIGNED		
CR001	0071122	DIODE 1N914 SIL 75V 75MA	80368	1N914
K 001	0083153	RELAY 26.5VDC DPDT PC MT	98927	50GBDN-1-A-700
K 002	0083153	RELAY 26.5VDC DPDT PC MT	98927	50GBDN-1-A-700
L 001	0220424	COIL ASSEMBLY		
L 002	0220425	COIL ASSEMBLY		
L 003	0220425	COIL ASSEMBLY		
L 004		NOT ASSIGNED		
L 005	0220426	COIL ASSEMBLY		
L 006	0079170	INDUCTOR .05 UH SUBMIN UNSHLD MOLDED 10%	91637	IR-2
P 001	0082455	JUMPER MALE INSULATED .20 SPACING	71279	461-2871-01-00-10
R 001	0071832	RESISTOR 5.77 OHM 1/4W 1% DEP CAR	91637	DC-1/4
R 002	0071832	RESISTOR 5.77 OHM 1/4W 1% DEP CAR	91637	DC-1/4
R 003		NOT ASSIGNED		
R 004	0079895	RESISTOR 75.0 OHM RN60C 1% MTL FLM		RN60C75R0F
R 005	0079895	RESISTOR 75.0 OHM RN60C 1% MTL FLM		RN60C75R0F
R 006	0082106	RESISTOR 2.15K OHM RN60C 1% MTL FLM		RN60C2151F
R 007		NOT ASSIGNED		
R 008		NOT ASSIGNED		

252 kHz LOW PASS FILTER ASSEMBLY - 220374

REF DESIG PREFIX: MODEL 4661-252

REF DESIG	PART NO.	DESCRIPTION	FSCM CODE	VENDOR PART NUMBER
	0220456	INDICATOR- PUSH-BUTTON, STAMPED 252		
A 001	0220370	PWB ASSY- FILTER, LOW PASS, MDL 4661-252		
C 001	0077863	CAPACITR .001 MF 500V F0THRU THD GMV	33095	54-804-002-102P
J 001	0085152	CONN COAX SMB MALE TO SLD R CUP 75 OHM	98291	51-143-0000
J 002	0085152	CONN COAX SMB MALE TO SLD R CUP 75 OHM	98291	51-143-0000
W 001	0158695	CABLE- CONTROL		

MODEL 4661-252 PWB ASSEMBLY - 220370 (A001)

AT001	0035870	ATTENUATR 0 DB FIXED T-PAD TO-5 CASE		KM11
C 001	0070559	CAPACITR .0051 MF 300V SILVER MICA 1%	14655	CD19FD512F03
C 002	0084972	CAPACITR .0013 MF 500V SILVER MICA 1%	53021	D195E132F03
C 003	0082974	CAPACITR .01 MF 500V SILVER MICA 1%	53021	D305F103F03
C 004	0077015	CAPACITR .0068 MF 500V SILVER MICA 5%	14655	CD30FD682J03
C 005	0080769	CAPACITR .0091 MF 100V SILVER MICA 1%	53021	D201C912F03
C 006	0070559	CAPACITR .0051 MF 300V SILVER MICA 1%	14655	CD19FD512F03
C 007	0080767	CAPACITR .002 MF 500V SILVER MICA 1%	53021	D195C202F03
C 008	0083114	CAPACITR 750 PF 100V SILVER MICA 2%	53021	D151F751G03
C 009	0078809	CAPACITR 230 PF 500V SILVER MICA 1%	53021	D155C231F03
C 010	0080144	CAPACITR 430 PF 500V SILVER MICA 1%	53021	D155C431F03
C 011	0084549	CAPACITR 820 PF 500V SILVER MICA 2%	14655	CD19FD821G03
C 012		NOT ASSIGNED		
C 013	0082969	CAPACITR .001 MF 500V SILVER MICA 1%	53021	D195F102F03
C 014	0082969	CAPACITR .001 MF 500V SILVER MICA 1%	53021	D195F102F03
CR001	0071122	DIODE 1N914 SIL 75V 75MA	80368	1N914
K 001	0083153	RELAY 26.5VDC DPDT PC MT	98927	50GBDN-1-A-700
K 002	0083153	RELAY 26.5VDC DPDT PC MT	98927	50GBDN-1-A-700
L 001	0220427	COIL ASSEMBLY		
L 002	0220428	COIL ASSEMBLY		
L 003	0220428	COIL ASSEMBLY		
L 004	0079170	INDUCTOR .05 UH SUBMIN UNSHLD MOLDED 10%	91637	IR-2

300 KHz LOW PASS FILTER ASSEMBLY - 156379

REF DESIG PREFIX: MODEL 4661-300

REF DESIG	PART NO.	DESCRIPTION	FSCM CODE	VENDOR PART NUMBER
	0158661	INDICATOR- PUSH-BUTTON, STAMPED 300		
A 001	0156371	PWB ASSY- FILTER, LOW PASS, MDL 4661-300		
C 001	0077863	CAPACITR .001 MF 500V FDTHRU THD GMV	33095	54-804-002-102P
J 001	0085152	CONN COAX SMB MALE TO SLDR CUP 75 OHM	98291	51-143-0000
J 002	0085152	CONN COAX SMB MALE TO SLDR CUP 75 OHM	98291	51-143-0000
W 001	0158695	CABLE- CONTROL		

MODEL 4661-300 PWB ASSEMBLY - 156371 (A001)

REF DESIG	PART NO.	DESCRIPTION	FSCM CODE	VENDOR PART NUMBER
AT001	0035870	ATTENUATR 0 DB FIXED T-PAD TO-5 CASE		KM11
C 001	0076171	CAPACITR .0047 MF 500V SILVER MICA 5%	14655	CM06F472J03
C 002	0082969	CAPACITR .001 MF 500V SILVER MICA 1%	53021	D195F102F03
C 003	0082972	CAPACITR .0082 MF 500V SILVER MICA 1%	53021	D305F822F03
C 004	0084976	CAPACITR .0062 MF 300V SILVER MICA 1%	53021	D193F622F03
C 005	0086049	CAPACITR .0075 MF 100V SILVER MICA 1%		D191F752F03
C 006	0070559	CAPACITR .0051 MF 300V SILVER MICA 1%	14655	CD19FD512F03
C 007	0082970	CAPACITR .0024 MF 500V SILVER MICA 1%	53021	D205F242F03
C 008	0078810	CAPACITR 240 PF 500V SILVER MICA 1%	53021	D155C241F03
C 009	0078811	CAPACITR 250 PF 500V SILVER MICA 1%	53021	D155C251F03
C 010	0076486	CAPACITR 560 PF 500V SILVER MICA 5%	14655	CD19FD561J03
C 011	0078806	CAPACITR 200 PF 500V SILVER MICA 1%	53021	D155C201F03
C 012	0078805	CAPACITR 180 PF 500V SILVER MICA 1%	53021	D155C181F03
C 013	0073491	CAPACITR 12 PF 500V SILVER MICA 5%	14655	CD15CD120J03
C 014	0078803	CAPACITR 150 PF 500V SILVER MICA 1%	53021	D155C151F03
CR001	0071122	DIODE 1N914 SIL 75V 75MA	80368	1N914
K 001	0083153	RELAY 26.5VDC DPDT PC MT	98927	50GBDN-1-A-700
X 002	0083153	RELAY 26.5VDC DPDT PC MT	98927	50GBDN-1-A-700
L 001	0144815	COIL ASSY		
L 002	0144816	COIL ASSY		
L 003	0144816	COIL ASSY		
L 004	0079170	INDUCTOR .05 OH SUBMIN UNSHLD MOLDED 10%	91637	IR-2

408 kHz LOW PASS FILTER ASSY - 252495

REF DESIG PREFIX: MODEL 4661-408

REF DESIG	PART NO.	DESCRIPTION	FSCM CODE	VENDOR PART NUMBER
	0252664	INDICATOR-PUSH-BUTTON STAMPED 408		
A001	0252490	PWB ASSY-FILTER LOW PASS MDL 4661-408		
C 001	0077863	CAPACITR ,001 MF 500V FDIHTRU THD GMV	33095	54-804-002-102P
J 001	0085152	CONN COAX SMB MALE TO SLDR CUP 75 OHM	98291	51-143-0000
J 002	0085152	CONN COAX SMB MALE TO SLDR CUP 75 OHM	98291	51-143-0000
W 001	0158695	CABLE- CONTROL		

MODEL 4661-408 PWB ASSY - 252490 (A001)

AT001	0035878	ATTNUATR 9 DB FIXED T-PAD TO-5 CASE		KM3
C 001	0084975	CAPACITR ,0036 MF 500V SILVER MICA 1%	53021	D195E362F03
C 002	0082969	CAPACITR ,001 MF 500V SILVER MICA 1%	53021	D195F102F03
C 003	0084976	CAPACITR ,0062 MF 300V SILVER MICA 1%	53021	D193F622F03
C 004	0086258	CAPACITR ,0047 MF 100V SILVER MICA 1%		D191F472F03
C 005	0084975	CAPACITR ,0036 MF 500V SILVER MICA 1%	53021	D195E362F03
C 006	0084975	CAPACITR ,0036 MF 500V SILVER MICA 1%	53021	D195E362F03
C 007	0084974	CAPACITR ,0018 MF 500V SILVER MICA 1%	53021	D195E182F03
C 008	0084441	CAPACITR ,022 MF 100V SILVER MICA 1%	53021	D301E223F03
C 009	0084549	CAPACITR 820 PF 500V SILVER MICA 2%	14655	CD19FD821G03
C 010	0078600	NOT ASSIGNED		
C 011	0078600	NOT ASSIGNED		
C 012	0078810	CAPACITR 240 PF 500V SILVER MICA 1%	53021	D1S5C241F03
C 013	0078600	NOT ASSIGNED		
C 014	0080767	CAPACITR ,002 MF 500V SILVER MICA 1%	53021	D195C202F03
C 015	0081827	CAPACITR 160 PF 100V SILVER MICA 2%	53021	D1S1C161G03
C 016	0078600	NOT ASSIGNED		
C 017	0077015	CAPACITR ,0068 MF 500V SILVER MICA 5%	14655	CD30FD682J03
C 018	0078600	NOT ASSIGNED		
CR001	0071122	DIODE 1N914 SIL 75V 75MA	80368	1N914
K 001	0083153	RELAY 26,5VDC DPDT PC MT	98927	50GBDN-1-A-700
K 002	0083153	RELAY 26,5VDC DPDT PC MT	98927	50GBDN-1-A-700
L 001	0252474	COIL ASSY		
L 002	0252473	COIL ASSY		
L 003	0252473	COIL ASSY		
L 004	0252481	COIL ASSY		
L 005	0252477	COIL ASSY		
L 006	0079170	INDUCTOR ,05 UH SUBMIN UNSHLD MOLDED 10%	91637	IR-2
P 001	0082455	JUMPER MALE INSULATED ,20 SPACING	71279	461-2871-01-00-10
R 001	0082038	RESISTOR 10,5 OHM RN60D 1% MTL FLM		RN60D10R5F
R 002	0082038	RESISTOR 10,5 OHM RN60D 1% MTL FLM		RN60D10R5F
R 003	0082038	RESISTOR 10,5 OHM RN60D 1% MTL FLM		RN60D10R5F
R 004	0079895	RESISTOR 75,0 OHM RN60C 1% MTL FLM		RN60C75R0F
R 005	0079895	RESISTOR 75,0 OHM RN60C 1% MTL FLM		RN60C75R0F
R 006	0078893	RESISTOR 1,54K OHM RN60C 1% MTL FLM		RN60C1541F
R 007	0078600	NOT ASSIGNED		

552 kHz LOW PASS FILTER ASSEMBLY - 156380

REF DESIG PREFIX: MODEL 4661-552

REF DESIG	PART NO.	DESCRIPTION	FSCM CODE	VENDOR PART NUMBER
	0158663	INDICATOR- PUSH-BUTTON, STAMPED 552		
A 001	0156341	PWB ASSY-FILTER,LOW PASS, MDL 4661-552		
C 001	0077863	CAPACITR .001 MF 500V FDTHRU THD GMV	33095	54-804-002-102P
J 001	0085152	CONN COAX SMB MALE TO SLDR CUP 75 OHM	98291	51-143-0000
J 002	0085152	CONN COAX SMB MALE TO SLDR CUP 75 OHM	98291	51-143-0000
W 001	0158695	CABLE- CONTROL		

MODEL 4661-552 PWB ASSEMBLY - 156341 (A001)

AT001	0035876	ATTNUATR 3 DB FIXED T-PAD TO-5 CASE		KMS
C 001	0080767	CAPACITR .002 MF 500V SILVER MICA 1%	53021	D195C202F03
C 002	0077958	CAPACITR 680 PF 100V SILVER MICA 2%	14655	CD7FA681G03
C 003	0076171	CAPACITR .0047 MF 500V SILVER MICA 5%	14655	CM06F472J03
C 004	0081525	CAPACITR .003 MF 500V SILVER MICA 5%	53021	CM06FD302J03
C 005	0075197	CAPACITR .0039 MF 500V SILVER MICA 5%	14655	CD19FD392J03
C 006	0082970	CAPACITR .0024 MF 500V SILVER MICA 1%	53021	D205F242F03
C 007	0082969	CAPACITR .001 MF 500V SILVER MICA 1%	53021	D195F102F03
C 008	0073893	CAPACITR .02 MF 300V SILVER MICA 5%	14655	CD30FD203J03
C 009	0078974	CAPACITR 620 PF 500V SILVER MICA 5%	14655	CD19FD621J03
C 010	0077958	CAPACITR 680 PF 100V SILVER MICA 2%	14655	CD7FA681G03
C 011		NOT ASSIGNED		
C 012	0070509	CAPACITR 68 PF 500V SILVER MICA 5%	14655	CD15ED680J03
C 013	0078819	CAPACITR 470 PF 500V SILVER MICA 1%	53021	D155C471F03
C 014	0078813	CAPACITR 270 PF 500V SILVER MICA 1%	53021	D155C271F03
C 015	0078817	CAPACITR 360 PF 500V SILVER MICA 1%	53021	D155C361F03
C 016	0078818	CAPACITR 390 PF 500V SILVER MICA 1%	53021	D155C391F03
C 017	0084972	CAPACITR .0013 MF 500V SILVER MICA 1%	53021	D195E132F03
C 018		NOT ASSIGNED		
CR001	0071122	DIODE 1N914 SIL 75V 75MA	80368	1N914
K 001	0083153	RELAY 26.5VDC DPDT PC MT	98927	50GBDN-1-A-700
K 002	0083153	RELAY 26.5VDC DPDT PC MT	98927	50GBDN-1-A-700
L 001	0146208	COIL ASSY		
L 002	0146209	COIL ASSY		
L 003	0146210	COIL ASSY		
L 004	0156428	COIL ASSEMBLY		
L 005	0156424	COIL ASSEMBLY		
L 006	0079170	INDUCTOR .05 UH SURMIN UNSHLD MOLDED 10%	91637	IR-2
P 001	0082455	JUMPER MALE INSULATED .20 SPACING	71279	461-2871-01-00-10
R 001	0082038	RESISTOR 10.5 OHM RN60D 1% MTL FLM		RN60D10R5F
R 002	0082038	RESISTOR 10.5 OHM RN60D 1% MTL FLM		RN60D10R5F
R 003	0082038	RESISTOR 10.5 OHM RN60D 1% MTL FLM		RN60D10R5F
R 004	0079895	RESISTOR 75.0 OHM RN60C 1% MTL FLM		RN60C75R0F
R 005	0079895	RESISTOR 75.0 OHM RN60C 1% MTL FLM		RN60C75R0F
R 006	0078901	RESISTOR 3.16K OHM RN60C 1% MTL FLM		RN60C3161F
R 007	0078901	RESISTOR 3.16K OHM RN60C 1% MTL FLM		RN60C3161F
R 008		NOT ASSIGNED		

804 kHz LOW PASS FILTER ASSY - 252496

REF DESIG PREFIX: MODEL 4661-804

REF DESIG	PART NO.	DESCRIPTION	FSCM CODE	VENDOR PART NUMBER
	0252665	INDICATOR-PUSH-BUTTON STAMPED 804		
A001	0252491	PWB ASSY-FILTER LOW PASS MDL 4661-804		
C 001	0077863	CAPACITR ,001 MF 500V FDTHRU THD GMV	33095	54-804-002-102P
J 001	0085152	CONN COAX SMB MALE TO SLDR CUP 75 OHM	98291	51-143-0000
J 002	0085152	CONN COAX SMB MALE TO SLDR CUP 75 OHM	98291	51-143-0000
W 001	0158695	CABLE- CONTROL		

MODEL 4661-804 PWB ASSY - 252491 (A001)

C 001	0084974	CAPACITR ,0018 MF 500V SILVER MICA 1%	53021	D195E182F03
C 002	0082401	CAPACITR 400 PF 500V SILVER MICA 1%	53021	D155C401F03
C 003	0084975	CAPACITR ,0036 MF 500V SILVER MICA 1%	53021	D195E362F03
C 004	0084974	CAPACITR ,0018 MF 500V SILVER MICA 1%	53021	D195E182F03
C 005	0084973	CAPACITR ,0016 MF 500V SILVER MICA 1%	53021	D195E162F03
C 006	0084974	CAPACITR ,0018 MF 500V SILVER MICA 1%	53021	D195E182F03
C 007	0082969	CAPACITR ,001 MF 500V SILVER MICA 1%	53021	D195F102F03
C 008	0086048	CAPACITR ,012 MF 100V SILVER MICA 1%		D301E123F03
C 009	0085135	CAPACITR 592 PF 300V SILVER MICA 1%	53021	D153CXXXF03 592 PF
C 010	0082401	CAPACITR 400 PF 500V SILVER MICA 1%	53021	D155C401F03
C 011	0078600	NOT ASSIGNED		
C 012	0070519	CAPACITR 120 PF 500V SILVER MICA 5%	14655	CD15FD121J03
C 013	0082969	CAPACITR ,001 MF 500V SILVER MICA 1%	53021	D195F102F03
C 014	0084973	CAPACITR ,0016 MF 500V SILVER MICA 1%	53021	D195E162F03
C 015	0082401	CAPACITR 400 PF 500V SILVER MICA 1%	53021	D155C401F03
C 016	0078600	NOT ASSIGNED		
C 017	0078600	NOT ASSIGNED		
C 018	0078600	NOT ASSIGNED		
CR001	0071122	DIODE 1N914 SIL 75V 75MA	80368	1N914
K 001	0083153	RELAY 26,5VDC DPDT PC MT	98927	50GBDN-1-A-700
K 002	0083153	RELAY 26,5VDC DPDT PC MT	98927	50GBDN-1-A-700
L 001	0146209	A COIL ASSY		
L 002	0144817	A COIL ASSY		
L 003	0144817	A COIL ASSY		
L 004	0133075	A COIL ASSY		
L 005	0252480	COIL ASSY		
L 006	0079170	INDUCTOR ,05 UH SUBMIN UNSHLD MOLDED 10%	91637	IR-2
P 001	0082455	JUMPER MALE INSULATED ,20 SPACING	71279	461-2871-01-00-10
R 001	0082038	RESISTOR 10,5 OHM RN60D 1% MTL FLM		RN60D10R5F
R 002	0082038	RESISTOR 10,5 OHM RN60D 1% MTL FLM		RN60D10R5F
R 003	0082038	RESISTOR 10,5 OHM RN60D 1% MTL FLM		RN60D10R5F
R 004	0079895	RESISTOR 75,0 OHM RN60C 1% MTL FLM		RN60C75R0F
R 005	0079895	RESISTOR 75,0 OHM RN60C 1% MTL FLM		RN60C75R0F
R 006	0078893	RESISTOR 1,54K OHM RN60C 1% MTL FLM		RN60C1541F
R 007	0078600	NOT ASSIGNED		

1052 kHz LOW PASS FILTER ASSY - 252497

REF DESIG PREFIX: MODEL 4661-1052

REF DESIG	PART NO.	DESCRIPTION	FSCM CODE	VENDOR PART NUMBER
	0252666	INDICATOR-PUSH-BUTTON STAMPED 1052		
A001	0252492	PWB ASSY-FILTER LOW PASS MDL 4661-1052		
C 001	0077863	CAPACITR ,001 MF 500V FDTHRU THD GMV	33095	54-804-002-102P
J 001	0085152	CONN COAX SMB MALE TO SLDR CUP 75 OHM	98291	51-143-0000
J 002	0085152	CONN COAX SMB MALE TO SLDR CUP 75 OHM	98291	51-143-0000
W 001	0158695	CABLE- CONTROL		

MODEL 4661-1052 PWB ASSY - 252492 (A001)

C 001	0083153	RELAY 26,5VDC DPDT PC MT	98927	50GPDN-1-A-700
C 001	0084972	CAPACITR ,0013 MF 500V SILVER MICA 1%	53021	D195E132F03
C 002	0085136	CAPACITR 650 PF 300V SILVER MICA 1%	53021	D153C651F03
C 003	0082970	CAPACITR ,0024 MF 500V SILVER MICA 1%	53021	D205F242F03
C 004	0084974	CAPACITR ,0018 MF 500V SILVER MICA 1%	53021	D195E182F03
C 005	0080767	CAPACITR ,002 MF 500V SILVER MICA 1%	53021	D195C202F03
C 006	0084972	CAPACITR ,0013 MF 500V SILVER MICA 1%	53021	D195E132F03
C 007	0083114	CAPACITR 750 PF 100V SILVER MICA 2%	53021	D151F751G03
C 008	0086048	CAPACITR ,012 MF 100V SILVER MICA 1%		D301E123F03
C 009	0083113	CAPACITR 375 PF 100V SILVER MICA 2%	53021	D151FXXXG03 375 PF
C 010	0081826	CAPACITR 110 PF 100V SILVER MICA 2%	53021	D151C111G03
C 011	0078600	NOT ASSIGNED		
C 012	0081827	CAPACITR 160 PF 100V SILVER MICA 2%	53021	D151C161G03
C 013	0070519	CAPACITR 120 PF 500V SILVER MICA 5%	14655	CD15FD121J03
C 014	0080143	CAPACITR 256 PF 500V SILVER MICA 1%	53021	D105CXXXF03 256 PF
C 015	0078807	CAPACITR 210 PF 500V SILVER MICA 1%	53021	D155C211F03
C 016	0078600	NOT ASSIGNED		
C 017	0078600	NOT ASSIGNED		
C 018	0078600	NOT ASSIGNED		
CR001	0071122	DIODE 1N914 SIL 75V 75MA	80368	1N914
K 002	0083153	RELAY 26,5VDC DPDT PC MT	98927	50GPDN-1-A-700
L 001	0252472	COIL ASSY		
L 002	0252475	COIL ASSY		
L 003	0252475	COIL ASSY		
L 004	0148692	COIL ASSY		
L 005	0252479	COIL ASSY		
L 006	0079170	INDUCTOR ,05 UH SUBMIN UNSHLD MOLDED 10%	91637	IR-2
P 001	0082455	JUMPER MALE INSULATED ,20 SPACING	71279	461-2871-01-00-10
R 001	0082038	RESISTOR 10,5 OHM RN60D 1% MTL FLM		RN60D10R5F
R 002	0082038	RESISTOR 10,5 OHM RN60D 1% MTL FLM		RN60D10R5F
R 003	0082038	RESISTOR 10,5 OHM RN60D 1% MTL FLM		RN60D10R5F
R 004	0079895	RESISTOR 75,0 OHM RN60C 1% MTL FLM		RN60C75R0F
R 005	0079895	RESISTOR 75,0 OHM RN60C 1% MTL FLM		RN60C75R0F
R 006	0078893	RESISTOR 1,54K OHM RN60C 1% MTL FLM		RN60C1541F
R 007	0078600	NOT ASSIGNED		

1296 kHz LOW PASS FILTER ASSEMBLY - 156381

REF DESIG PREFIX: MODEL 4661-1296

REF DESIG	PART NO.	DESCRIPTION	FSCM CODE	VENDOR PART NUMBER
	0158664	A INDICATOR- PUSH-BUTTON, STAMPED 1296		
A 001	0156346	A PWB ASSY-FILTER,LOW PASS,MDL 4661-1296		
C 001	0077863	CAPACITR .001 MF 500V FDTHRU THD GMV	33095	54-804-002-102P
J 001	0085152	CONN COAX SMB MALE TO SLD R CUP 75 OHM	98291	51-143-0000
J 002	0085152	CONN COAX SMB MALE TO SLD R CUP 75 OHM	98291	51-143-0000
W 001	0158695	CABLE- CONTROL		

MODEL 4661-1296 PWB ASSEMBLY - 156346 (A001)

AT001	0035877	ATTNUATR 6 DB FIXED T-PAD TO-5 CASE		KM4
C 001	0082969	CAPACITR .001 MF 500V SILVER MICA 1%	53021	D195F102F03
C 002	0078814	CAPACITR 280 PF 500V SILVER MICA 1%	53021	D155C281F03
C 003	0080767	CAPACITR .002 MF 500V SILVER MICA 1%	53021	D195C202F03
C 004	0082969	CAPACITR .001 MF 500V SILVER MICA 1%	53021	D195F102F03
C 005	0077901	CAPACITR .0015 MF 500V SILVER MICA 5%	14655	CD19FD152J03
C 006	0082969	CAPACITR .001 MF 500V SILVER MICA 1%	53021	D195F102F03
C 007	0076486	CAPACITR 560 PF 500V SILVER MICA 5%	14655	CD19FD561J03
C 008	0082972	CAPACITR .0082 MF 500V SILVER MICA 1%	53021	D305F822F03
C 009	0078815	CAPACITR 300 PF 500V SILVER MICA 1%	53021	D155C301F03
C 010	0078803	CAPACITR 150 PF 500V SILVER MICA 1%	53021	D155C151F03
C 011	0073491	CAPACITR 12 PF 500V SILVER MICA 5%	14655	CD15CD120J03
C 012	0082400	CAPACITR 82 PF 500V SILVER MICA 1%	53021	D155C820F03
C 013	0076486	CAPACITR 560 PF 500V SILVER MICA 5%	14655	CD19FD561J03
C 014	0078816	CAPACITR 330 PF 500V SILVER MICA 1%	53021	D155C331F03
C 015	0078809	CAPACITR 230 PF 500V SILVER MICA 1%	53021	D155C231F03
C 016	0082398	CAPACITR 43 PF 500V SILVER MICA 1%	53021	D155C430F03
C 017	0080145	CAPACITR 450 PF 500V SILVER MICA 1%	53021	D155C451F03
C 018		NOT ASSIGNED		
CR001	0071122	DIODE 1N914 SIL 75V 75MA	80368	1N914
K 001	0083153	RELAY 26.5VDC DPDT PC MT	98927	50GBDN-1-A-700
K 002	0083153	RELAY 26.5VDC DPDT PC MT	98927	50GBDN-1-A-700
L 001	0144817	COIL ASSY		
L 002	0144818	COIL ASSY		
L 003	0144818	COIL ASSY		
L 004	0156427	COIL ASSEMBLY		
L 005	0156426	COIL ASSEMBLY		
L 006	0079170	INDUCTOR .05 UH SUBMIN UNSHLD MOLDED 10%	91637	IR-2
P 001	0082455	JUMPER MALE INSULATED .20 SPACING	71279	461-2871-01-00-10
R 001	0082038	RESISTOR 10.5 OHM RN60D 1% MTL FLM		RN60D10R5F
R 002	0082038	RESISTOR 10.5 OHM RN60D 1% MTL FLM		RN60D10P5F
R 003	0082038	RESISTOR 10.5 OHM RN60D 1% MTL FLM		RN60D10R5F
R 004	0079895	RESISTOR 75.0 OHM RN60C 1% MTL FLM		RN60C75R0F
R 005	0079895	RESISTOR 75.0 OHM RN60C 1% MTL FLM		RN60C75R0F
R 006	0078901	RESISTOR 3.16K OHM RN60C 1% MTL FLM		RN60C3161F
R 007	0078901	RESISTOR 3.16K OHM RN60C 1% MTL FLM		RN60C3161F
R 008		NOT ASSIGNED		

1796 kHz LOW PASS FILTER ASSEMBLY - 217518

REF DESIG PREFIX: MODEL 4661-1796

REF DESIG	PART NO.	DESCRIPTION	FSCM CODE	VENDOR PART NUMBER
	0220542	INDICATOR- PUSH-BUTTON, STAMPED 1796		
A 001	0217516	PWB ASSY- FILTER, LOW PASS,MDL 4661-1796		
C 001	0077863	CAPACITR .001 MF 500V FDTHRU THD GMV	33095	54-804-002-102P
J 001	0085152	CONN COAX SMB MALE TO SLDR CUP 75 OHM	98291	51-143-0000
J 002	0085152	CONN COAX SMB MALE TO SLDR CUP 75 OHM	98291	51-143-0000
W 001	0158695	CABLE- CONTROL		

MODEL 4661-1796 PWB ASSEMBLY - 217516 (A001)

REF DESIG	PART NO.	DESCRIPTION	FSCM CODE	VENDOR PART NUMBER
AT001	0035876	ATTNUATR 3 DB FIXED T-PAD TO-5 CASE		KM5
C 001	0084549	CAPACITR 820 PF 500V SILVER MICA 2%	14655	CD19FD821G03
C 002	0078806	CAPACITR 200 PF 500V SILVER MICA 1%	53021	D155C201F03
C 003	0082969	CAPACITR .001 MF 500V SILVER MICA 1%	53021	D195F102F03
C 004	0082969	CAPACITR .001 MF 500V SILVER MICA 1%	53021	D195F102F03
C 005	0082969	CAPACITR .001 MF 500V SILVER MICA 1%	53021	D195F102F03
C 006	0084549	CAPACITR 820 PF 500V SILVER MICA 2%	14655	CD19FD821G03
C 007	0082401	CAPACITR 400 PF 500V SILVER MICA 1%	53021	D155C401F03
C 008	0080769	CAPACITR .0091 MF 100V SILVER MICA 1%	53021	D201C912F03
C 009	0077153	CAPACITR 130 PF 500V SILVER MICA 5%	14655	CD15FD131J03
C 010		NOT ASSIGNED		
C 011		NOT ASSIGNED		
C 012	0080145	CAPACITR 450 PF 500V SILVER MICA 1%	53021	D155C451F03
C 013	0082398	CAPACITR 43 PF 500V SILVER MICA 1%	53021	D155C430F03
C 014	0078813	CAPACITR 270 PF 500V SILVER MICA 1%	53021	D155C271F03
C 015	0080142	CAPACITR 20 PF 500V SILVER MICA 5%	14655	CD15ED200J03
C 016	0080142	CAPACITR 20 PF 500V SILVER MICA 5%	14655	CD15ED200J03
C 017	0079974	CAPACITR 620 PF 500V SILVER MICA 5%	14655	CD19FD621J03
C 018		NOT ASSIGNED		
CR001	0071122	DIODE 1N914 SIL 75V 75MA	80368	1N914
K 001	0083153	RELAY 26.5VDC DPDT PC MT	98927	50GBDN-1-A-700
K 002	0083153	RELAY 26.5VDC DPDT PC MT	98927	50GBDN-1-A-700
L 001	0220548	COIL ASSY		
L 002	0220549	COIL ASSY		
L 003	0220549	COIL ASSY		
L 004	0082624	INDUCTOR 14.5T #22 START MP2 10-32X3/8 J	02113	BY DESCRIPTION
L 005	0220550	COIL ASSY		
L 006	0079170	INDUCTOR .05 OH SUBMIN UNSHLD MOLDED 10%	91637	IR-2
P 001	0082455	JUMPER MALE INSULATED .20 SPACING	71279	461-2871-01-00-10
R 001	0082038	RESISTOR 10.5 OHM RN60D 1% MTL FLM		RN60D10R5F
R 002	0082038	RESISTOR 10.5 OHM RN60D 1% MTL FLM		RN60D10R5F
R 003	0082038	RESISTOR 10.5 OHM RN60D 1% MTL FLM		RN60D10R5F
R 004	0079895	RESISTOR 75.0 OHM RN60C 1% MTL FLM		RN60C75R0F
R 005	0079895	RESISTOR 75.0 OHM RN60C 1% MTL FLM		RN60C75R0F
R 006	0078901	RESISTOR 3.16K OHM RN60C 1% MTL FLM		RN60C3161F
R 007	0078901	RESISTOR 3.16K OHM RN60C 1% MTL FLM		RN60C3161F
R 008		NOT ASSIGNED		

2045 kHz LOW PASS FILTER ASSEMBLY - 221211

REF DESIG PREFIX: MODEL 4661-2045

REF DESIG	PART NO.	DESCRIPTION	FSCM CODE	VENDOR PART NUMBER
	0221218	INDICATOR PUSH-BUTTON STAMPED 2045		
A 001	0221212	PWB ASSY LOW-PASS FILTER, MDL 4661-2045		
C 001	0077863	CAPACITR .001 MF 500V FDTHRU THD GMV	33095	54-804-002-102P
J 001	0085152	CONN COAX SMB MALE TO SLDR CUP 75 OHM	98291	51-143-0000
J 002	0085152	CONN COAX SMB MALE TO SLDR CUP 75 OHM	98291	51-143-0000
W 001	0158695	CABLE- CONTROL		

MODEL 4661-2045 PWB ASSEMBLY - 221212 (A001)

REF DESIG	PART NO.	DESCRIPTION	FSCM CODE	VENDOR PART NUMBER
AT001	0035876	ATTNUATR 3 DB FIXED T-PAD TO-5 CASE		KMS
C 001	0070534	CAPACITR 330 PF 500V SILVER MICA 5%	14655	CD15FD331J03
C 002	0073495	CAPACITR 39 PF 500V SILVER MICA 5%	14655	CD15E0390J03
C 003	0082969	CAPACITR .001 MF 500V SILVER MICA 1%	53021	D195F102F03
C 004	0073492	CAPACITR 15 PF 500V SILVER MICA 5%	00656	CD15CD150J03
C 005	0082969	CAPACITR .001 MF 500V SILVER MICA 1%	53021	D195F102F03
C 006	0076170	CAPACITR 510 PF 500V SILVER MICA 5%	14655	CD19FD511J03
C 007	0078805	CAPACITR 180 PF 500V SILVER MICA 1%	53021	D155C181F03
C 008	0080769	CAPACITR .0091 MF 100V SILVER MICA 1%	53021	D201C912F03
C 009	0070517	CAPACITR 100 PF 500V SILVER MICA 5%	14655	CD15FD101J03
C 010	0070532	CAPACITR 300 PF 500V SILVER MICA 5%	14655	CD15FD301J03
C 011	0070517	CAPACITR 100 PF 500V SILVER MICA 5%	14655	CD15FD101J03
C 012	0070531	CAPACITR 270 PF 500V SILVER MICA 5%	14655	CD15FD271J03
C 013	0083114	CAPACITR 750 PF 100V SILVER MICA 2%	53021	D151F751G03
C 014	0070519	CAPACITR 120 PF 500V SILVER MICA 5%	14655	CD15FD121J03
C 015	0073492	CAPACITR 15 PF 500V SILVER MICA 5%	00656	CD15CD150J03
C 016	0085137	CAPACITR 188 PF 500V SILVER MICA 1%	53021	D185CX188F03
C 017	0070529	CAPACITR 220 PF 500V SILVER MICA 5%	14655	CD15FD221J03
C 018		NOT ASSIGNED		
CR001	0071122	DIODE 1N914 SIL 75V 75MA	80368	1N914
K 001	0083153	RELAY 26.5VDC DPDT PC MT	98927	50GBDN-1-A-700
K 002	0083153	RELAY 26.5VDC DPDT PC MT	98927	50GBDN-1-A-700
L 001	0220548	COIL ASSY		
L 002	0220549	COIL ASSY		
L 003	0220549	COIL ASSY		
L 004	0082624	INDUCTOR 14.5T #22 START MP2 10-32X3/8 J	02113	BY DESCRIPTION
L 005	0220550	COIL ASSY		
L 006	0079170	INDUCTOR .05 UH SUBMIN UNSHLD MOLDED 10%	91637	IR-2
P 001	0082455	JUMPER MALE INSULATED .20 SPACING	71279	461-2871-01-00-10
R 001	0082038	RESISTOR 10.5 OHM RN60D 1% MTL FLM		RN60D10R5F
R 002	0082038	RESISTOR 10.5 OHM RN60D 1% MTL FLM		RN60D10R5F
R 003	0082038	RESISTOR 10.5 OHM RN60D 1% MTL FLM		RN60D10R5F
R 004	0079895	RESISTOR 75.0 OHM RN60C 1% MTL FLM		RN60C75R0F
R 005	0079895	RESISTOR 75.0 OHM RN60C 1% MTL FLM		RN60C75R0F
R 006	0078901	RESISTOR 3.16K OHM RN60C 1% MTL FLM		RN60C3161F
R 007	0078901	RESISTOR 3.16K OHM RN60C 1% MTL FLM		RN60C3161F
R 008		NOT ASSIGNED		

2600 kHz LOW PASS FILTER ASSEMBLY - 156382

REF DESIG PREFIX: MODEL 4661-2600

REF DESIG	PART NO.	DESCRIPTION	FSCM CODE	VENDOR PART NUMBER
	0158665	INDICATOR- PUSH-BUTTON, STAMPED 2600		
A 001	0156348	PWB ASSY-FILTER,LOW PASS, MDL 4661-2600		
C 001	0077863	CAPACITR .001 MF 500V FDTHRU THD GMV	33095	54-804-002-102P
J 001	0085152	CONN COAX SMR MALE TO SLDR CUP 75 OHM	98291	51-143-0000
J 002	0085152	CONN COAX SMR MALE TO SLDR CUP 75 OHM	98291	51-143-0000
W 001	0158695	CABLE- CONTROL		

MODEL 4661-2600 PWB ASSEMBLY - 156348 (A001)

AT001	0035878	ATTNUATR 9 DB FIXED T-PAD TO-5 CASE		KM3
C 001	0076486	CAPACITR 560 PF 500V SILVER MICA 5%	14655	CD19FD561J03
C 002	0080923	CAPACITR 130 PF 500V SILVER MICA 1%	53021	D155C131F03
C 003	0082969	CAPACITR .001 MF 500V SILVER MICA 1%	53021	D195F102F03
C 004	0078974	CAPACITR 620 PF 500V SILVER MICA 5%	14655	CD19FD621J03
C 005	0073498	CAPACITR 820 PF 500V SILVER MICA 5%	14655	CD19FD821J03
C 006	0076486	CAPACITR 560 PF 500V SILVER MICA 5%	14655	CD19FD561J03
C 007	0078813	CAPACITR 270 PF 500V SILVER MICA 1%	53021	D155C271F03
C 008	0082974	CAPACITR .01 MF 500V SILVER MICA 1%	53021	D305F103F03
C 009	0081821	CAPACITR 33 PF 100V SILVER MICA 2%	53021	D151C330G03
C 010		NOT ASSIGNED		
C 011	0070470	CAPACITR 10 PF 500V SILVER MICA 5%	14655	CD15CD100J03
C 012		NOT ASSIGNED		
C 013	0077963	CAPACITR 100 PF 300V SILVER MICA 2%	14655	CD6FC101G03
C 014	0077659	CAPACITR 62 PF 500V SILVER MICA 5%	14655	CD6ED620J03
C 015	0080142	CAPACITR 20 PF 500V SILVER MICA 5%	14655	CD15ED200J03
C 016	0080142	CAPACITR 20 PF 500V SILVER MICA 5%	14655	CD15ED200J03
C 017	0083114	CAPACITR 750 PF 100V SILVER MICA 2%	53021	D151F751G03
C 018	0080142	CAPACITR 20 PF 500V SILVER MICA 5%	14655	CD15ED200J03
CR001	0071122	DIODE 1N914 SIL 75V 75MA	80368	1N914
K 001	0083153	RELAY 26,5VDC DPDT PC MT	98927	50GBDN-1-A-700
K 002	0083153	RELAY 26,5VDC DPDT PC MT	98927	50GBDN-1-A-700
L 001	0142847	COIL ASSEMBLY		
L 002	0142848	COIL ASSEMBLY		
L 003	0142848	COIL ASSEMBLY		
L 004	0035983	INDUCTOR .216 UH 25MHZ J-CORE 5,5T ORNGE	02113	PER CONT. DWG.
L 005	0156425	COIL ASSEMBLY		
L 006	0079170	INDUCTOR .05 UH SUBMIN UNSHLD MOLDED 10%	91637	IR-2
P 001	0082455	JUMPER MALE INSULATED .20 SPACING	71279	461-2871-01-00-10
R 001	0071832	RESISTOR 5.77 OHM 1/4W 1% DEP CAR	91637	DC-1/4
R 002	0071832	RESISTOR 5.77 OHM 1/4W 1% DEP CAR	91637	DC-1/4
R 003		NOT ASSIGNED		
R 004	0079895	RESISTOR 75.0 OHM RN60C 1% MTL FLM		RN60C75R0F
R 005	0079895	RESISTOR 75.0 OHM RN60C 1% MTL FLM		RN60C75R0F
R 006	0082106	RESISTOR 2.15K OHM RN60C 1% MTL FLM		RN60C2151F
R 007		NOT ASSIGNED		
R 008		NOT ASSIGNED		

3284 kHz LOW PASS FILTER ASSY - 252498

REF DESIG PREFIX: MODEL 4661-3284

REF DESIG	PART NO.	DESCRIPTION	FSCM CODE	VENDOR PART NUMBER
	0252667	INDICATOR-PUSH-BUTTON STAMPED 3284		
A001	0252493	PWB ASSY-FILTER LOW PASS MDL 4661-3284		
C 001	0077863	CAPACITR .001 MF 500V FDTHRU THD GMV	33095	54-804-002-102P
J 001	0085152	CONN COAX SMB MALE TO SLDR CUP 75 OHM	98291	51-143-0000
J 002	0085152	CONN COAX SMB MALE TO SLDR CUP 75 OHM	98291	51-143-0000
W 001	0158695	CABLE- CONTROL		

MODEL 4661-3284 PWB ASSY - 252493 (A001)

C 001	0078819	CAPACITR 470 PF 500V SILVER MICA 1%	53021	D155C471F03
C 002	0081827	CAPACITR 160 PF 100V SILVER MICA 2%	53021	D151C161G03
C 003	0084549	CAPACITR 820 PF 500V SILVER MICA 2%	14655	CD19FD821G03
C 004	0078819	CAPACITR 470 PF 500V SILVER MICA 1%	53021	D155C471F03
C 005	0063114	CAPACITR 750 PF 100V SILVER MICA 2%	53021	D151F751G03
C 006	0083114	CAPACITR 750 PF 100V SILVER MICA 2%	53021	D151F751G03
C 007	0078811	CAPACITR 250 PF 500V SILVER MICA 1%	53021	D155C251F03
C 008	0084976	CAPACITR .0062 MF 300V SILVER MICA 1%	53021	D193F622F03
C 009	0080142	CAPACITR 20 PF 500V SILVER MICA 5%	14655	CD15ED200J03
C 010	0078600	NOT ASSIGNED		
C 011	0078600	NOT ASSIGNED		
C 012	0078600	NOT ASSIGNED		
C 013	0078803	CAPACITR 150 PF 500V SILVER MICA 1%	53021	D155C151F03
C 014	0078600	NOT ASSIGNED		
C 015	0078600	NOT ASSIGNED		
C 016	0078600	NOT ASSIGNED		
C 017	0084974	CAPACITR .0018 MF 500V SILVER MICA 1%	53021	D195E182F03
C 018	0078600	NOT ASSIGNED		
CR001	0071122	DIODE 1N914 SIL 75V 75MA	80368	1N914
K 001	0083153	RELAY 26.5VDC DPDT PC MT	98927	50GBDN-1-A-700
K 002	0083153	RELAY 26.5VDC DPDT PC MT	98927	50GBDN-1-A-700
L 001	0252476	COIL ASSY		
L 002	0252471	COIL ASSY		
L 003	0252471	COIL ASSY		
L 004	0082357	INDUCTOR 4.5T #22 START MP5 10-32X3/8 J	02113	PER DWG 82357
L 005	0252478	COIL ASSY		
L 006	0079170	INDUCTOR .05 UH SUBMIN UNSHLD MOLDED 10%	91637	IR-2
P 001	0082455	JUMPER MALE INSULATED .20 SPACING	71279	461-2871-01-00-10
R 001	0074657	RESISTOR 8.65 OHM 1/4W 1% DEP CAR	91637	DC-1/4
R 002	0074657	RESISTOR 8.65 OHM 1/4W 1% DEP CAR	91637	DC-1/4
R 003	0078600	NOT ASSIGNED		
R 004	0079895	RESISTOR 75.0 OHM RN60C 1% MTL FLM		RN60C75R0F
R 005	0079895	RESISTOR 75.0 OHM RN60C 1% MTL FLM		RN60C75R0F
R 006	0082106	RESISTOR 2.15K OHM RN60C 1% MTL FLM		RN60C2151F
R 007	0078600	NOT ASSIGNED		

4100 kHz LOW PASS FILTER ASSEMBLY - 156383

REF DESIG PREFIX: MODEL 4661-4100

REF DESIG	PART NO.	DESCRIPTION	FSCM CODE	VENDOR PART NUMBER
	0158666	INDICATOR- PUSH-BUTTON, STAMPED 4100		
A 001	0156338	PWB ASSY-FILTER, LOW PASS, MDL 4661-4100		
C 001	0077863	CAPACITR .001 MF 500V EDTHRU THD GMV	33095	54-804-002-102P
J 001	0085152	CONN COAX SMB MALE TO SLD R CUP 75 OHM	98291	51-143-0000
J 002	0085152	CONN COAX SMB MALE TO SLD R CUP 75 OHM	98291	51-143-0000
W 001	0158695	CABLE- CONTROL		

MODEL 4661-4100 PWB ASSEMBLY - 156338 (A001)

AT001	0035878	ATTNUATR 9 DB FIXED T-PAD TO-5 CASE		KM3
C 001	0078817	CAPACITR 360 PF 500V SILVER MICA 1%	53021	D155C361F03
C 002	0070509	CAPACITR 68 PF 500V SILVER MICA 5%	14655	CD15ED680J03
C 003	0076170	CAPACITR 510 PF 500V SILVER MICA 5%	14655	CD19FD511J03
C 004	0078819	CAPACITR 470 PF 500V SILVER MICA 1%	53021	D155C471F03
C 005	0076486	CAPACITR 560 PF 500V SILVER MICA 5%	14655	CD19FD561J03
C 006	0078816	CAPACITR 330 PF 500V SILVER MICA 1%	53021	D155C331F03
C 007	0078805	CAPACITR 180 PF 500V SILVER MICA 1%	53021	D155C181F03
C 008	0070559	CAPACITR .0051 MF 300V SILVER MICA 1%	14655	CD19FD512F03
C 009	0070496	CAPACITR 43 PF 500V SILVER MICA 5%	14655	CD15ED430J03
C 010		NOT ASSIGNED		
C 011	0078326	CAPACITR 24 PF 500V SILVER MICA 5%	14655	CD6ED240J03
C 012	0080923	CAPACITR 130 PF 500V SILVER MICA 1%	53021	D155C131F03
C 013		NOT ASSIGNED		
C 014		NOT ASSIGNED		
C 015	0080142	CAPACITR 20 PF 500V SILVER MICA 5%	14655	CD15ED200J03
C 016	0073490	CAPACITR 5 PF 500V SILVER MICA +/- .5PF	14655	CD15CD050D03
C 017	0082402	CAPACITR 680 PF 500V SILVER MICA 1%	53021	D155C681F03
C 018		NOT ASSIGNED		
CR001	0071122	DIODE 1N914 SIL 75V 75MA	80368	1N914
K 001	0083153	RELAY 26.5VDC DPDT PC MT	98927	50GBDN-1-A-700
K 002	0083153	RELAY 26.5VDC DPDT PC MT	98927	50GBDN-1-A-700
L 001	0142845	COIL ASSEMBLY		
L 002	0142846	COIL ASSEMBLY		
L 003	0142846	COIL ASSEMBLY		
L 004	0082357	INDUCTOR 4.5T #22 START MP4 10-32X3/8 J	02113	BY DESCRIPTION
L 005	0156423	COIL ASSEMBLY		
L 006	0079170	INDUCTOR .05 UH SUBMIN UNSHLD MOLDED 10%	91637	IR-2
P 001	0082455	JUMPER MALE INSULATED .20 SPACING	71279	461-2871-01-00-10
R 001	0074657	RESISTOR 8.65 OHM 1/4W 1% DEP CAR	91637	DC=1/4
R 002	0074657	RESISTOR 8.65 OHM 1/4W 1% DEP CAR	91637	DC=1/4
R 003	0074657	RESISTOR 8.65 OHM 1/4W 1% DEP CAR	91637	DC=1/4
R 004	0079895	RESISTOR 75.0 OHM RN60C 1% MTL FLX		RN60C75R0F
R 005	0079895	RESISTOR 75.0 OHM RN60C 1% MTL FLX		RN60C75R0F
R 006	0082106	RESISTOR 2.15K OHM RN60C 1% MTL FLX		RN60C2151F
R 007		NOT ASSIGNED		
R 008		NOT ASSIGNED		

5600 kHz LOW PASS FILTER ASSEMBLY - 156384

REF DESIG PREFIX: MODEL 4661-5600

REF DESIG	PART NO.	DESCRIPTION	FSCM CODE	VENDOR PART NUMBER
	0158667	INDICATOR- PUSH-BUTTON, STAMPED 5600		
A 001	0156350	PWR ASSY-FILTER, LOW PASS, MDL 4661-5600		
C 001	0077863	CAPACITR .001 MF 500V FDTHRU THD GMV	33095	54-804-002-102P
J 001	0085152	CONN COAX SMB MALE TO SLDR CUP 75 OHM	98291	51-143-0000
J 002	0085152	CONN COAX SMB MALE TO SLDR CUP 75 OHM	98291	51-143-0000
W 001	0158695	CABLE- CONTPOL		

MODEL 4661-5600 PWB ASSEMBLY - 156350 (A001)

AT001	0035878	ATTNUATR 9 DB FIXED T-PAD TO-5 CASE		KM3
C 001	0078815	CAPACITR 300 PF 500V SILVER MICA 1%	53021	D155C301F03
C 002	0081832	CAPACITR 65 PF 500V SILVER MICA 2%	53021	D155C650G03
C 003	0078819	CAPACITR 470 PF 500V SILVER MICA 1%	53021	D155C471F03
C 004	0081828	CAPACITR 330 PF 100V SILVER MICA 2%	53021	D151C331G03
C 005	0080144	CAPACITR 430 PF 500V SILVER MICA 1%	53021	D155C431F03
C 006	0078810	CAPACITR 240 PF 500V SILVER MICA 1%	53021	D155C241F03
C 007	0078805	CAPACITR 180 PF 500V SILVER MICA 1%	53021	D155C181F03
C 008	0084973	CAPACITR .0016 MF 500V SILVER MICA 1%	53021	D195E162F03
C 009	0084388	CAPACITR 91 PF 500V SILVER MICA 1%	14655	CD15FD910F03
C 010	0081829	CAPACITR 15 PF 500V SILVER MICA +/- .5 PF	53021	D155C150D03
C 011		NOT ASSIGNED		
C 012	0070490	CAPACITR 30 PF 500V SILVER MICA 5%	14655	CD15ED300J03
C 013		NOT ASSIGNED		
C 014	0070470	CAPACITR 10 PF 500V SILVER MICA 5%	14655	CD15CD100J03
C 015		NOT ASSIGNED		
C 016	0073491	CAPACITR 12 PF 500V SILVER MICA 5%	14655	CD15CD120J03
C 017		NOT ASSIGNED		
C 018		NOT ASSIGNED		
CR001	0071122	DIODE 1N914 SIL 75V 75mA	80368	1N914
K 001	0083153	RELAY 26.5VDC DPDT PC MT	98927	50GBDN-1-A-700
K 002	0083153	RELAY 26.5VDC DPDT PC MT	98927	50GBDN-1-A-700
L 001	0133075	COIL ASSY		
L 002	0133076	COIL ASSY		
L 003	0133076	COIL ASSY		
L 004	0082360	INDUCTOR 9.5T #22 START MP2 10-32X3/8 J	02113	BY DESCRIPTION
L 005	0156422	COIL ASSEMBLY		
L 006	0079170	INDUCTOR .05 UH SUBMIN UNSHLD MOLDED 10%	91637	IR-2
P 001	0082455	JUMPER MALE INSULATED .20 SPACING	71279	461-2871-01-00-10
R 001	0082043	RESISTOR 13.3 OHM RN60D 1% MTL FLM		RN60D13R3F
R 002	0082043	RESISTOR 13.3 OHM RN60D 1% MTL FLM		RN60D13R3F
R 003	0082043	RESISTOR 13.3 OHM RN60D 1% MTL FLM		RN60D13R3F
R 004	0079895	RESISTOR 75.0 OHM RN60C 1% MTL FLM		RN60C75R0F
R 005	0079895	RESISTOR 75.0 OHM RN60C 1% MTL FLM		RN60C75R0F
R 006	0082099	RESISTOR 1.27K OHM RN60C 1% MTL FLM		RN60C1271F
R 007		NOT ASSIGNED		
R 008		NOT ASSIGNED		

4661

7284 kHz LOW PASS FILTER ASSEMBLY - 163091

REF DESIG PREFIX: MODEL 4661-7284

REF DESIG	PART NO.	DESCRIPTION	FSCM CODE	VENDOR PART NUMBER
	0163029	INDICATOR- PUSH-BUTTON, STAMPED 7284		
A 001	0163090	PWB ASSY-FILTER, LO PASS, MDL 4661-7284		
C 001	0077863	CAPACITR .001 MF 500V FDTHRU THD GMV	33095	54-804-002-102P
J 001	0085152	CONN COAX SMB MALE TO SLDL CUP 75 OHM	98291	51-143-0000
J 002	0085152	CONN COAX SMB MALE TO SLDL CUP 75 OHM	98291	51-143-0000
W 001	0158695	CABLE- CONTROL		

MODEL 4661-7284 PWB ASSEMBLY - 163090(A001) - ①

REF DESIG	PART NO.	DESCRIPTION	FSCM CODE	VENDOR PART NUMBWR
AT001	0035878	ATTNUATR 9 DB FIXED T-PAD TD-5 CASE		KM3
C 001	0078806	CAPACITR 200 PF 500V SILVER MICA 1%	53021	D155C201F03
C 002	0070498	CAPACITR 47 PF 500V SILVER MICA 5%	14655	CD15ED470J03
C 003	0078817	CAPACITR 360 PF 500V SILVER MICA 1%	53021	D155C361F03
C 004	0080923	CAPACITR 130 PF 500V SILVER MICA 1%	53021	D155C131F03
C 005	0078815	CAPACITR 300 PF 500V SILVER MICA 1%	53021	D155C301F03
C 006	0078805	CAPACITR 180 PF 500V SILVER MICA 1%	53021	D155C181F03
C 007	0077963	CAPACITR 100 PF 300V SILVER MICA 2%	14655	CD6FC101G03
C 011	0080923	CAPACITR 130 PF 500V SILVER MICA 1%	53021	D155C131F03
C 012	0081829	CAPACITR 15 PF 500V SILVER MICA +- .5 PF	53021	D155C150D03
C 013	0070470	CAPACITR 10 PF 500V SILVER MICA 5%	14655	CD15CD100J03
CR001	0071122	DIODE 1N914 SIL 75V 75MA	80368	1N914
K 001	0083153	RELAY 26.5VDC DPDT PC MT	98927	50GBDN-1-A-700
K 002	0083153	RELAY 26.5VDC DPDT PC MT	98927	50GBDN-1-A-700
L 001	0142843	COIL ASSEMBLY		
L 002	0142844	COIL ASSEMBLY		
L 003	0142844	COIL ASSEMBLY		
L 004	0079170	INDUCTOR .05 UH SUBMIN UNSHLD MOLDED 10%	91637	IR-2

MODEL 4661-7284 PWB ASSEMBLY - 163090(A001)

AT001	0035878	ATTNUATR 9 DB FIXED T-PAD TD-5 CASE		KM3
C 001	0078806	CAPACITR 200 PF 500V SILVER MICA 1%	53021	D155C201F03
C 002	0070498	CAPACITR 47 PF 500V SILVER MICA 5%	14655	CD15ED470J03
C 003	0078817	CAPACITR 360 PF 500V SILVER MICA 1%	53021	D155C361F03
C 004	0080923	CAPACITR 130 PF 500V SILVER MICA 1%	53021	D155C131F03
C 005	0078815	CAPACITR 300 PF 500V SILVER MICA 1%	53021	D155C301F03
C 006	0078805	CAPACITR 180 PF 500V SILVER MICA 1%	53021	D155C181F03
C 007	0077963	CAPACITR 100 PF 300V SILVER MICA 2%	14655	CD6FC101G03
C 008	0084561	CAPACITR .0027 MF 500V SILVER MICA 5%	14655	CD19FD272J03
C 009	0070490	CAPACITR 30 PF 500V SILVER MICA 5%	14655	CD15ED300J03
C 013	0080923	CAPACITR 130 PF 500V SILVER MICA 1%	53021	D155C131F03
C 014	0081829	CAPACITR 15 PF 500V SILVER MICA +- .5 PF	53021	D155C150D03
C 015	0070470	CAPACITR 10 PF 500V SILVER MICA 5%	14655	CD15CD100J03
CR001	0071122	DIODE 1N914 SIL 75V 75MA	80368	1N914
K 001	0083153	RELAY 26.5VDC DPDT PC MT	98927	50GBDN-1-A-700
K 002	0083153	RELAY 26.5VDC DPDT PC MT	98927	50GBDN-1-A-700
L 001	0142843	A COIL ASSEMBLY		
L 002	0142844	A COIL ASSEMBLY		
L 003	0142844	A COIL ASSEMBLY		
L 004	0082357	INDUCTOR 4.5T #22 START MP5 10-32X3/8 J	02113	PER DWG 82357
L 005	0156421	COIL ASSEMBLY		
L 006	0079170	INDUCTOR .05 UH SUBMIN UNSHLD MOLDED 10%	91637	IR-2
P 001	0082455	JUMPER MALE INSULATED .20 SPACING	71279	461-2871-01-00-10
P 001	0079852	RESISTOR 10.0 OHM RN60D 1% MTL FLM		RN60D10R0F
P 002	0078852	RESISTOR 10.0 OHM RN60D 1% MTL FLM		RN60D10R0F
P 003	0078852	RESISTOR 10.0 OHM RN60D 1% MTL FLM		RN60D10R0F
P 004	0079895	RESISTOR 75.0 OHM RN60C 1% MTL FLM		RN60C75R0F
P 005	0079995	RESISTOR 75.0 OHM RN60C 1% MTL FLM		RN60C75R0F
P 006	0078901	RESISTOR 3.16K OHM RN60C 1% MTL FLM		RN60C3161F
P 007	0078901	RESISTOR 3.16K OHM RN60C 1% MTL FLM		RN60C3161F

① APPLIES TO SERIAL NUMBERS 373 AND BELOW (APPROXIMATELY).

8160 kHz LOW PASS FILTER ASSEMBLY - 156385

REF DESIG PREFIX: MODEL 4661-8160

REF DESIG	PART NO.	DESCRIPTION	FSCM CODE	VENDOR PART NUMBER
	0158668	INDICATOR- PUSH-BUTTON, STAMPED 8160		
A 001	0156352	PWB ASSY-FILTER, LOW PASS,MDL 4661-8160		
C 001	0077863	CAPACITR .001 MF 500V F0THRU THD GMV	33095	54-804-002-102P
J 001	0085152	CONN COAX SMB MALE TO SLDR CUP 75 OHM	98291	51-143-0000
J 002	0085152	CONN COAX SMB MALE TO SLDR CUP 75 OHM	98291	51-143-0000
W 001	0158695	CABLE- CONTROL		

MODEL 4661-8160 PWB ASSEMBLY - 156352 (A001)

AT001	0035878	ATTNUATR 9 DB FIXED T-PAO TO-5 CASE		KM3
C 001	0078805	CAPACITR 180 PF 500V SILVER MICA 1%	53021	D155C181F03
C 002	0073495	CAPACITR 39 PF 500V SILVER MICA 5%	14655	CD15ED390J03
C 003	0078815	CAPACITR 300 PF 500V SILVER MICA 1%	53021	D155C301F03
C 004	0078808	CAPACITR 220 PF 500V SILVER MICA 1%	53021	D155C221F03
C 005	0078813	CAPACITR 270 PF 500V SILVER MICA 1%	53021	D155C271F03
C 006	0078805	CAPACITR 180 PF 500V SILVER MICA 1%	53021	D155C181F03
C 007	0082399	CAPACITR 75 PF 500V SILVER MICA 1%	53021	D155C750F03
C 008	0082970	CAPACITR .0024 MF 500V SILVER MICA 1%	53021	D205F242F03
C 009	0070487	CAPACITR 27 PF 500V SILVER MICA 5%	14655	CD15ED270J03
C 010		NOT ASSIGNED		
C 011	0070470	CAPACITR 10 PF 500V SILVER MICA 5%	14655	CD15CD100J03
C 012	0070487	CAPACITR 27 PF 500V SILVER MICA 5%	14655	CD15ED270J03
C 013	0073492	CAPACITR 15 PF 500V SILVER MICA 5%	00656	CD15CD150J03
C 014	0073492	CAPACITR 15 PF 500V SILVER MICA 5%	00656	CD15CD150J03
C 016	0073491	CAPACITR 12 PF 500V SILVER MICA 5%	14655	CD15CD120J03
C 017		NOT ASSIGNED		
C 018		NOT ASSIGNED		
CR001	0071122	DIODE 1N914 SIL 75V 75MA	80368	1N914
K 001	0083153	RELAY 26.5VDC DPDT PC MT	98927	50GBDN-1-A-700
K 002	0083153	RELAY 26.5VDC DPDT PC MT	98927	50GBDN-1-A-700
L 001	0148692	COIL ASSY		
L 002	0148693	COIL ASSY		
L 003	0148693	COIL ASSY		
L 004	0082357	INDUCTOR 4.5T #22 START MP4 10-32X3/8 J	02113	RY DESCRIPTION
L 005	0156421	COIL ASSEMBLY		
L 006	0079170	INDUCTOR .05 UH SUBMIN UNSHLD MOLDED 10%	91637	IR-2
P 001	0082455	JUMPER MALE INSULATED .20 SPACING	71279	461-2871-01-00-10
R 001	0078852	RESISTOR 10.0 OHM RN60D 1% MTL FLM		RN60D10R0F
R 002	0078852	RESISTOR 10.0 OHM RN60D 1% MTL FLM		RN60D10R0F
R 003	0078852	RESISTOR 10.0 OHM RN60D 1% MTL FLM		RN60D10R0F
R 004	0079895	RESISTOR 75.0 OHM RN60C 1% MTL FLM		RN60C75R0F
R 005	0079895	RESISTOR 75.0 OHM RN60C 1% MTL FLM		RN60C75R0F
R 006	0078901	RESISTOR 3.16K OHM RN60C 1% MTL FLM		RN60C3161F
R 007	0078901	RESISTOR 3.16K OHM RN60C 1% MTL FLM		RN60C3161F
R 008		NOT ASSIGNED		

10164 KHz LOW PASS FILTER ASSEMBLY - 217523

REF DESIG PREFIX: MODEL 4661-10164

REF DESIG	PART NO.	DESCRIPTION	FSCM CODE	VENDOR PART NUMBER
	0220543	INDICATOR- PUSH-BUTTON, STAMPED 10164		
A 001	0217521	PWB ASSY-FILTER, LOW PASS,MDL 4661-10164		
C 001	0077863	CAPACITR .001 MF 500V FDTHRU THD GMV	33095	54-804-002-102P
J 001	0085152	CONN COAX SMB MALE TO SLDR CUP 75 OHM	98291	51-143-0000
J 002	0085152	CONN COAX SMB MALE TO SLDR CUP 75 OHM	98291	51-143-0000
W 001	0158695	CABLE- CONTROL		

MODEL 4661-10164 PWB ASSEMBLY - 217521 (A001)

AT001	0035878	ATTNUATR 9 DB FIXED T-PAD TO-5 CASE		KM3
C 001	0080923	CAPACITR 130 PF 500V SILVER MICA 1%	53021	D155C131F03
C 002	0073495	CAPACITR 39 PF 500V SILVER MICA 5%	14655	CD15ED390J03
C 003	0078808	CAPACITR 220 PF 500V SILVER MICA 1%	53021	D155C221F03
C 004	0085137	CAPACITR 188 PF 500V SILVER MICA 1%	53021	D155CXXXF03 188 PF
C 005	0078809	CAPACITR 230 PF 500V SILVER MICA 1%	53021	D155C231F03
C 006	0080923	CAPACITR 130 PF 500V SILVER MICA 1%	53021	D155C131F03
C 007	0070509	CAPACITR 6R PF 500V SILVER MICA 5%	14655	CD15ED680J03
C 008	0084973	CAPACITR .0016 MF 500V SILVER MICA 1%	53021	D195E162F03
C 009	0073493	CAPACITR 18 PF 500V SILVER MICA 5%	14655	CD15CD180J03
C 010	0081829	CAPACITR 15 PF 500V SILVER MICA +/- .5 PF	53021	D155C150D03
C 011		NOT ASSIGNED		
C 012	0082398	CAPACITR 43 PF 500V SILVER MICA 1%	53021	D155C430F03
C 013		NOT ASSIGNED		
C 014		NOT ASSIGNED		
C 015	0084970	CAPACITR 27 PF 500V SILVER MICA 2%	53021	D155E270G03
C 016	0078600	NOT ASSIGNED		
C 017	0078803	CAPACITR 150 PF 500V SILVER MICA 1%	53021	D155C151F03
C 018		NOT ASSIGNED		
CR001	0071122	DIODE 1N914 SIL 75V 75MA	80368	1N914
K 001	0083153	RELAY 26.5VDC DPDT PC MT	98927	50GRDN-1-A-700
K 002	0083153	RELAY 26.5VDC DPDT PC MT	98927	50GRDN-1-A-700
L 001	0220551	COIL ASSY		
L 002	0220552	COIL ASSY		
L 003	0220552	COIL ASSY		
L 004	0035981	INDUCTOR .085 UH 50MHZ J-CORE 2.5T BRN	02113	PER CONT, DWG.
L 005	0220553	COIL ASSY		
L 006	0079170	INDUCTOR .05 UH SUBMIN UNSHLD MOLDED 10%	91637	IR-2
P 001	0082455	JUMPER MALE INSULATED .20 SPACING	71279	461-2871-01-00-10
R 001	0082038	RESISTOR 10.5 OHM RN60D 1% MTL FLM		RN60D10R5F
R 002	0082038	RESISTOR 10.5 OHM RN60D 1% MTL FLM		RN60D10R5F
R 003	0082038	RESISTOR 10.5 OHM RN60D 1% MTL FLM		RN60D10R5F
R 004	0079895	RESISTOR 75.0 OHM RN60C 1% MTL FLM		RN60C75R0F
R 005	0079895	RESISTOR 75.0 OHM RN60C 1% MTL FLM		RN60C75R0F
R 006	0078901	RESISTOR 3.16K OHM RN60C 1% MTL FLM		RN60C3161F
R 007	0078901	RESISTOR 3.16K OHM RN60C 1% MTL FLM		RN60C3161F
R 008		NOT ASSIGNED		

11404 kHz LOW PASS FILTER ASSEMBLY - 221383

REF DESIG PREFIX: MODEL 4661-11404

REF DESIG	PART NO.	DESCRIPTION	FSCM CODE	VENDOR PART NUMBER
	0222222	INDICATOR PUSH-BUTTON STAMPED 11404		
A 001	0221385	PWB ASSY, LP FILTER MDL 4661-11404		
C 001	0077863	CAPACITR .001 MF 500V FDTHRU THD GMV	33095	54-804-002-102P
J 001	0085152	CONN COAX SMB MALE TO SLDR CUP 75 OHM	98291	51-143-0000
J 002	0085152	CONN COAX SMB MALE TO SLDR CUP 75 OHM	98291	51-143-0000
W 001	0158695	CABLE- CONTROL		

MODEL 4661-11404 PWB ASSEMBLY - 221385 (A001)

AT001	0035879	ATTENUATR 12 DB FIXED T-PAD TO-5 CASE		KM2
C 001	0077153	CAPACITR 130 PF 500V SILVER MICA 5%	14655	CD15FD131J03
C 002	0070492	CAPACITR 33 PF 500V SILVER MICA 5%	14655	CD15ED330J03
C 003		NOT ASSIGNED		
C 004	0080922	CAPACITR 120 PF 500V SILVER MICA 1%	53021	D155C121F03
C 005	0078407	CAPACITR 210 PF 500V SILVER MICA 1%	53021	D155C211F03
C 006	0081743	CAPACITR 75 PF 500V SILVER MICA 5%	14655	CD15ED750J03
C 007	0070509	CAPACITR 68 PF 500V SILVER MICA 5%	14655	CD15ED680J03
C 008	0078817	CAPACITR 360 PF 500V SILVER MICA 1%	53021	D155C361F03
C 009	0070487	CAPACITR 27 PF 500V SILVER MICA 5%	14655	CD15ED270J03
C 010		NOT ASSIGNED		
C 011		NOT ASSIGNED		
① C 012	0078809	CAPACITR 230 PF 500V SILVER MICA 1%	53021	D155C231F03
C 013	0070492	CAPACITR 33 PF 500V SILVER MICA 5%	14655	CD15ED330J03
C 014		NOT ASSIGNED		
C 015	0080142	CAPACITR 20 PF 500V SILVER MICA 5%	14655	CD15ED200J03
C 016	0070498	CAPACITR 47 PF 500V SILVER MICA 5%	14655	CD15ED470J03
② C 017	0085137	CAPACITR 188 PF 500V SILVER MICA 1%	53021	D155CXXXF03 188 PF
CR001	0071122	DIODE 1N914 SIL 75V 75MA	80368	1N914
K 001	0083153	RELAY 26.5VDC DPDT PC MT	98927	50GBDN-1-A-700
K 002	0083153	RELAY 26.5VDC DPDT PC MT	98927	50GBDN-1-A-700
L 001	0221386	COIL ASSY		
L 002	0221387	COIL ASSY		
L 003	0221387	COIL ASSY		
L 004	0082359	INDUCTOR 7.5T #22 START MP4 10-32X3/8 J	02113	BY DESCRIPTION
L 005	0221389	COIL ASSY		
L 006	0079170	INDUCTOR .05 UH SUBMIN UNSHLD MOLDED 10%	91637	IR-2
P 001	0082455	JUMPER MALE INSULATED .20 SPACING	71279	461-2871-01-00-10
R 001	0078854	RESISTOR 53.6 OHM RN60C 1% MTL FLM		RN60C53R6F
R 002	0078852	RESISTOR 10.0 OHM RN60D 1% MTL FLM		RN60D10R0F
R 003	0078852	RESISTOR 10.0 OHM RN60D 1% MTL FLM		RN60D10R0F
R 004	0079895	RESISTOR 75.0 OHM RN60C 1% MTL FLM		RN60C75R0F
R 005	0079895	RESISTOR 75.0 OHM RN60C 1% MTL FLM		RN60C75R0F
R 006	0079727	RESISTOR 2.55K OHM RN55C 1% MTL FLM		RN55C2551F
R 007	0079727	RESISTOR 2.55K OHM RN55C 1% MTL FLM		RN55C2551F
R 008	0079727	RESISTOR 2.55K OHM RN55C 1% MTL FLM		RN55C2551F

① C 013 IS NOT ASSIGNED ON SERIAL NUMBERS 338 AND BELOW (APPROXIMATELY).

② APPLIES TO SERIAL NUMBERS 338 AND BELOW (APPROXIMATELY).

12360 KHz LOW PASS FILTER ASSEMBLY - 156386

REF DESIG PREFIX: MODEL 4661-12360

REF DESIG	PART NO.	DESCRIPTION	FSCM CODE	VENDOR PART NUMBER
	0158669	INDICATOR- PUSH-BUTTON, STAMPED 12360		
A 001	0156354	PWB ASSY-FILTER,LOW PASS,MDL 4661-12360		
C 001	0077863	CAPACITR .001 MF 500V FDTHRU THD GMV	33095	54-804-002-102P
J 001	0085152	CONN COAX SMB MALE TO SLDR CHP 75 OHM	98291	51-143-0000
J 002	0085152	CONN COAX SMB MALE TO SLDR CHP 75 OHM	98291	51-143-0000
W 001	0158695	CABLE- CONTROL		

MODEL 4661-12360 PWB ASSEMBLY - 156354 (A001)

AT001	0035879	ATTNUATR 12 DB FIXED T-PAD TQ-5 CASE		KM2
C 001	0080922	CAPACITR 120 PF 500V SILVER MICA 1%	53021	D155C121F03
C 002	0082397	CAPACITR 30 PF 500V SILVER MICA 1%	53021	D155C300F03
C 003	0078806	CAPACITR 200 PF 500V SILVER MICA 1%	53021	D155C201F03
C 004	0078803	CAPACITR 150 PF 500V SILVER MICA 1%	53021	D155C151F03
C 005	0085137	CAPACITR 188 PF 500V SILVER MICA 1%	53021	D155CXXXF03 188 PF
C 006	0084971	CAPACITR 62 PF 500V SILVER MICA 1%	53021	D155E620F03
C 007	0084971	CAPACITR 62 PF 500V SILVER MICA 1%	53021	D155E620F03
C 008	0084973	CAPACITR .0016 MF 500V SILVER MICA 1%	53021	D195E162F03
C 009	0073493	CAPACITR 18 PF 500V SILVER MICA 5%	14655	CD15CD180J03
C 010		NOT ASSIGNED		
C 011		NOT ASSIGNED		
C 012	0073491	CAPACITR 12 PF 500V SILVER MICA 5%	14655	CD15CD120J03
C 013	0073490	CAPACITR 5 PF 500V SILVER MICA +/- .5PF	14655	CD15CD050D03
C 014		NOT ASSIGNED		
C 015	0084971	CAPACITR 62 PF 500V SILVER MICA 1%	53021	D155E620F03
C 016	0078600	NOT ASSIGNED		
C 017	0081825	CAPACITR 87 PF 100V SILVER MICA 2%	53021	D151C870G03
C 018		NOT ASSIGNED		
CR001	0071122	DIODE 1N914 SIL 75V 75MA	80368	1N914
K 001	0083153	RELAY 26.5VDC DPDT PC MT	98927	50GRDN-1-A-700
K 002	0083153	RELAY 26.5VDC DPDT PC MT	98927	50GRDN-1-A-700
L 001	0156411	COIL ASSEMBLY		
L 002	0156413	COIL ASSEMBLY		
L 003	0156413	COIL ASSEMBLY		
L 004	0035981	INDUCTOR .085 UH 50MHZ J-CORE 2.5T BRN	02113	PER CONT. DWG.
L 005	0156455	COIL ASSEMBLY		
L 006	0079170	INDUCTOR .05 UH SUBMIN UNSHLD MOLDED 10%	91637	IR-2
P 001	0082455	JUMPER MALE INSULATED .20 SPACING	71279	461-2871-01-00-10
R 001	0082038	RESISTOR 10.5 OHM RN60D 1% MTL FLM		RN60D10R5F
R 002	0082038	RESISTOR 10.5 OHM RN60D 1% MTL FLM		RN60D10R5F
R 003	0082038	RESISTOR 10.5 OHM RN60D 1% MTL FLM		RN60D10R5F
R 004	0079895	RESISTOR 75.0 OHM RN60C 1% MTL FLM		RN60C75R0F
R 005	0079895	RESISTOR 75.0 OHM RN60C 1% MTL FLM		RN60C75R0F
R 006	0078901	RESISTOR 3.16K OHM RN60C 1% MTL FLM		RN60C3161F
R 007	0078901	RESISTOR 3.16K OHM RN60C 1% MTL FLM		RN60C3161F
R 008		NOT ASSIGNED		

4661

16 kHz NOTCH FILTER ASSEMBLY - 220448

REF DESIG PREFIX: MODEL 4661-16

REF DESIG	PART NO.	DESCRIPTION	FSCM CODE	VENDOR PART NUMBER
	0220449	INDICATOR- PUSH-BUTTON, STAMPED 16		
A 001	0217378	PWB ASSY- FILTER, NOTCH, MDL 4661-16		
J 002	0085152	CONN COAX SMB MALE TO SLDR CUP 75 OHM	98291	51-143-0000
W 001	0156457	CABLE		

MODEL 4661-16 PWB ASSEMBLY - 217378 (A001)

C 001	0079754	CAPACITR .0815 MF 100V POLYSTYRENE 5%	24152	13RB8152J
C 002	0081026	CAPACITR .18 MF 50V POLYCARB 5%	01378	160-0688
C 003	0084853	CAPACITR .068 MF 50V POLYSTYRENE 2%	37942	ST12B683G
C 004	0073507	CAPACITR .15 MF 100V POLYESTER 10%	14655	WMF1P15
C 005	0083173	CAPACITR .01 MF 50V POLYSTYRENE 5%	37942	ST12R103J
C 006	0083171	CAPACITR .0075 MF 50V POLYSTYRENE 5%	37942	ST12B752J
C 007	0076941	CAPACITR .01 MF 100V MET POLYCARB 5%	99515	H2E1-103D
C 008	0084853	CAPACITR .068 MF 50V POLYSTYRENE 2%	37942	ST12B683G
C 009	0083710	CAPACITR .05 MF 50V POLYSTYRENE 2%	37942	ST12B503G
J 001	0084940	CONN COAX SMB MALE PC MT 75 OHM	98291	51-151-0000
L 001	0220429	COIL ASSEMBLY		
L 002	0220430	COIL ASSEMBLY		
L 003	0220431	COIL ASSEMBLY		
L 004	0220430	COIL ASSEMBLY		
L 005	0220429	COIL ASSEMBLY		
L 006	0079170	INDUCTOR .05 UH SUBMIN UNSHLD MOLDED 10%	91637	IR-2
L 007	0079166	INDUCTOR .15 UH SUBMIN UNSHLD 10%	91637	IR-2
S 001	0156467	SWITCH- DPDT, MOMENTARY, PC MOUNT		
S 002	0156466	SWITCH- DPDT, PSH-PSH, MOMEN, PC MOUNT		

56 kHz NOTCH FILTER ASSY - 252651

REF DESIG PREFIX: MODEL 4661-56

REF DESIG	PART NO.	DESCRIPTION	FSCM CODE	VENDOR PART NUMBER
F01	0252657	INDICATOR-PUSH-BUTTON STAMPED 56		
A001	0252645	PWB ASSY FILTER, NOTCH B MDL 4661-56		
J 2	0085152	CONN COAX SMB MALE TO SLDR CUP 75 OHM	98291	51-143-0000
W 1	0156457	CABLE		

MODEL 4661-56 PWB ASSY - 252645 (A001)

C 1	0070559	CAPACITR ,0051 MF 300V SILVER MICA 1%	14655	CD19FD512F03
C 2	0082974	CAPACITR .01 MF 500V SILVER MICA 1%	53021	D305F103F03
C 3	0082974	CAPACITR .01 MF 500V SILVER MICA 1%	53021	D305F103F03
C 4	0082974	CAPACITR .01 MF 500V SILVER MICA 1%	53021	D305F103F03
C 5	0070559	CAPACITR ,0051 MF 300V SILVER MICA 1%	14655	CD19FD512F03
C 6	0082969	CAPACITR .001 MF 500V SILVER MICA 1%	53021	D195F102F03
C 7	0084972	CAPACITR .0013 MF 500V SILVER MICA 1%	53021	D195E132F03
C 8	0082970	CAPACITR .0024 MF 500V SILVER MICA 1%	53021	D205F242F03
C 9	0080144	CAPACITR 430 PF 500V SILVER MICA 1%	53021	D155C431F03
C 10	0084549	CAPACITR 820 PF 500V SILVER MICA 2%	14655	CD19FD821G03
J 1	0084940	CONN COAX SMB MALE PC MT 75 OHM	98291	51-151-0000
L 1	0252626	COIL ASSY		
L 2	0252632	COIL ASSY		
L 3	0252627	COIL ASSY		
L 4	0252632	COIL ASSY		
L 5	0252626	COIL ASSY		
L 6	0079170	INDUCTOR .05 UH SUBMIN UNSHLD MOLDED 10%	91637	IR-2
L 7	0079166	INDUCTOR .15 UH SUBMIN UNSHLD 10%	91637	IR-2
S 1	0156467	A SWITCH- DPDT, MOMENTARY, PC MOUNT		
S 2	0156466	SWITCH- DPDT, PSH-PSH, MOMEN, PC MOUNT		

70 kHz NOTCH FILTER ASSEMBLY - 156387

REF DESIG PREFIX: MODEL 4661-70

REF DESIG	PART NO.	DESCRIPTION	FSCM CODE	VENDOR PART NUMBER
	0158673	INDICATOR- PUSH-BUTTON, STAMPED 70		
A 001	0156357	PWB ASSY- FILTER, NOTCH, MDL 4661-70		
J 002	0085152	CONN COAX SMB MALE TO SDR CUP 75 OHM	98291	51-143-0000
W 001	0156457	CABLE		

MODEL 4661-70 PWB ASSEMBLY - 156357 (A001)

C 001	0083171	CAPACITR .0075 MF 50V POLYSTYRENE 5%	37942	ST12B752J
C 002	0079754	CAPACITR .0815 MF 100V POLYSTYRENE 5%	24152	13R88152J
C 003	0083174	CAPACITR .015 MF 50V POLYSTYRENE 2%	37942	ST12B153G
C 004	0079754	CAPACITR .0815 MF 100V POLYSTYRENE 5%	24152	13R88152J
C 005	0083171	CAPACITR .0075 MF 50V POLYSTYRENE 5%	37942	ST12B752J
C 006	0084636	CAPACITR .00051 MF 50V POLYSTYRENE 5%	37942	ST12B511J
C 007		NOT ASSIGNED		
C 008		NOT ASSIGNED		
C 009		NOT ASSIGNED		
C 010	0084636	CAPACITR .00051 MF 50V POLYSTYRENE 5%	37942	ST12B511J
J 001	0084940	CONN COAX SMB MALE PC MT 75 OHM	98291	51-151-0000
L 001	0144807	COIL ASSY		
L 002	0144806	COIL ASSY		
L 003	0144808	COIL ASSY		
L 004	0144806	COIL ASSY		
L 005	0144807	COIL ASSY		
L 006	0079170	INDUCTOR .05 UH SUBMIN UNSHLD MOLDED 10%	91637	IR-2
L 007	0079166	INDUCTOR .15 UH SUBMIN UNSHLD 10%	91637	IR-2
S 001	0156467	SWITCH- DPDT, MOMENTARY, PC MOUNT		
S 002	0156466	SWITCH- DPDT, PSH-PSH, MOMEN, PC MOUNT		

98 kHz NOTCH FILTER ASSEMBLY - 220373

REF DESIG PREFIX: MODEL 4661-98

REF DESIG	PART NO.	DESCRIPTION	FSCM CODE	VENDOR PART NUMBER
	0220450	INDICATOR- PUSH-BUTTON, STAMPED 98		
A 001	0220368	PWB ASSY- FILTER, NOTCH, MDL 4661-98		
J 002	0085152	CONN COAX SMB MALE TO SLDR CUP 75 OHM	98291	51-143-0000
W 001	0156457	CABLE		

MODEL 4661-98 PWB ASSEMBLY - 220368 (A001)

C 001	0075197	CAPACITR .0039 MF 500V SILVER MICA 5%	14655	CD19FD392J03
C 002	0079754	CAPACITR .0815 MF 100V POLYSTYRENE 5%	24152	13RB8152J
C 003	0086049	CAPACITR .0075 MF 100V SILVER MICA 1%		D191F752F03
C 004	0079754	CAPACITR .0815 MF 100V POLYSTYRENE 5%	24152	13RB8152J
C 005	0075197	CAPACITR .0039 MF 500V SILVER MICA 5%	14655	CD19FD392J03
C 006	0078806	CAPACITR 200 PF 500V SILVER MICA 1%	53021	D155C201F03
C 007		NOT ASSIGNED		
C 008		NOT ASSIGNED		
C 010	0078806	CAPACITR 200 PF 500V SILVER MICA 1%	53021	D155C201F03
J 001	0084940	CONN COAX SMB MALE PC MT 75 OHM	98291	51-151-0000
L 001	0220432	COIL ASSEMBLY		
L 002	0220433	COIL ASSEMBLY		
L 003	0220434	COIL ASSEMBLY		
L 004	0220433	COIL ASSEMBLY		
L 005	0220432	COIL ASSEMBLY		
L 006	0079170	INDUCTOR .05 UH SUBMIN UNSHLD MOLDED 10%	91637	IR-2
L 007	0079166	INDUCTOR .15 UH SUBMIN UNSHLD 10%	91637	IR-2
S 001	0156467	SWITCH- DPDT, MOMENTARY, PC MOUNT		
S 002	0156466	SWITCH- DPDT, PSH-PSH, MOMEN, PC MOUNT		

140 kHz NOTCH FILTER ASSY - 252652

REF DESIG PREFIX: MODEL 4661-140

REF DESIG	PART NO.	DESCRIPTION	FSCM CODE	VENDOR PART NUMBER
	0252658	INDICATOR-PUSH-BUTTON STAMPED 140		
A001	0252646	PWB ASSY-FILTER, NOTCH B MDL 4661-140		
J 1	0085152	CONN COAX SMB MALE TO SLDR CUP 75 OHM	98291	51-143-0000
W 1	0156457	CABLE		

MODEL 4661-140 PWB ASSY - 252646 (A001)

C 1	0080146	CAPACITR 675 PF 500V SILVER MICA 1%	53021	D155CXXXF03 675 PF
C 2	0082974	CAPACITR .01 MF 500V SILVER MICA 1%	53021	D305F103F03
C 3	0084973	CAPACITR .0016 MF 500V SILVER MICA 1%	53021	D195E162F03
C 4	0082974	CAPACITR .01 MF 500V SILVER MICA 1%	53021	D305F103F03
C 5	0080146	CAPACITR 675 PF 500V SILVER MICA 1%	53021	D155CXXXF03 675 PF
C 6	0078805	CAPACITR 180 PF 500V SILVER MICA 1%	53021	D155C181F03
C 7	0078600	NOT ASSIGNED		
C 8	0070522	CAPACITR 150 PF 500V SILVER MICA 5%	14655	CD15FD151J03
C 9	0078600	NOT ASSIGNED		
C 10	0078806	CAPACITR 200 PF 500V SILVER MICA 1%	53021	D155C201F03
J 1	0084940	CONN COAX SMB MALE PC MT 75 OHM	98291	51-151-0000
L 1	0252628	COIL ASSY		
L 2	0252633	COIL ASSY		
L 3	0252629	COIL ASSY		
L 4	0252633	COIL ASSY		
L 5	0252628	COIL ASSY		
L 6	0079170	INDUCTOR .05 UH SUBMIN UNSHLD MOLDED 10%	91637	IR-2
L 7	0079166	INDUCTOR .15 UH SUBMIN UNSHLD 10%	91637	IR-2
S 1	0156467	A SWITCH- DPDT, MOMENTARY, PC MOUNT		
S 2	0156466	SWITCH- DPDT, PSH-PSH, MOMEN, PC MOUNT		

185 kHz NOTCH FILTER ASSEMBLY - 217531

REF DESIG PREFIX: MODEL 4661-185

REF DESIG	PART NO.	DESCRIPTION	FSCM CODE	VENDOR PART NUMBER
	0220451	INDICATOR- PUSH-BUTTON, STAMPED 185		
A 001	0217529	PWB ASSY- FILTER, NOTCH, MODEL 4661-185		
J 002	0085152	CONN COAX SMB MALE TO SLD R CUP 75 OHM	98291	51-143-0000
W 001	0156457	CABLE		

MODEL 4661-185 PWB ASSEMBLY - 217529 (A001)

C 001	0082402	CAPACITR 680 PF 500V SILVER MICA 1%	53021	D155C681F03
C 002	0086049	CAPACITR .0075 MF 100V SILVER MICA 1%		D191F752F03
C 003	0084972	CAPACITR .0013 MF 500V SILVER MICA 1%	53021	D195E132F03
C 004	0086049	CAPACITR .0075 MF 100V SILVER MICA 1%		D191F752F03
C 005	0082402	CAPACITR 680 PF 500V SILVER MICA 1%	53021	D155C681F03
C 006		NOT ASSIGNED		
C 007	0070542	CAPACITR 680 PF 500V SILVER MICA 5%	14655	CD19FD681J03
C 008		NOT ASSIGNED		
C 009	0070542	CAPACITR 680 PF 500V SILVER MICA 5%	14655	CD19FD681J03
C 010		NOT ASSIGNED		
J 001	0084940	CONN COAX SMB MALE PC MT 75 OHM	98291	51-151-0000
L 001	0220435	COIL ASSEMBLY		
L 002	0220436	COIL ASSEMBLY		
L 003	0220437	COIL ASSEMBLY		
L 004	0220436	COIL ASSEMBLY		
L 005	0220435	COIL ASSEMBLY		
L 006	0079170	INDUCTOR .05 UH SUBMIN UNSHLD MOLDED 10%	91637	IR-2
L 007	0079166	INDUCTOR .15 UH SUBMIN UNSHLD 10%	91637	IR-2
S 001	0156467	SWITCH- DPDT, MOMENTARY, PC MOUNT		
S 002	0156466	SWITCH- DPDT, PSH-PSH, MOMEN, PC MOUNT		

4661

240 kHz NOTCH FILTER ASSEMBLY - 220375

REF DESIG PREFIX: MODEL 4661-240

REF DESIG	PART NO.	DESCRIPTION	FSCM CODE	VENDOR PART NUMBER
	0220452	INDICATOR- PUSH-BUTTON, STAMPED 240		
A 001	0220372	PWB ASSY- FILTER, NOTCH, MDL 4661-240		
J 002	0085152	CONN COAX SMB MALE TO SLDR CUP 75 OHM	98291	51-143-0000
W 001	0156457	CABLE		

MODEL 4661-240 PWB ASSEMBLY - 220372 (A001)

C 001	0078819	CAPACITR 470 PF 500V SILVER MICA 1%	53021	D155C471F03
C 002	0070559	CAPACITR .0051 MF 300V SILVER MICA 1%	14655	CD19FD512F03
C 003	0082969	CAPACITR .001 MF 500V SILVER MICA 1%	53021	D195F102F03
C 004	0070559	CAPACITR .0051 MF 300V SILVER MICA 1%	14655	CD19FD512F03
C 005	0078819	CAPACITR 470 PF 500V SILVER MICA 1%	53021	D155C471F03
C 006	0073496	CAPACITR 56 PF 500V SILVER MICA 5%	14655	CD15ED560J03
C 007	0077667	CAPACITR 620 PF 100V SILVER MICA 5%	14655	CD7FA621J03
C 008		NOT ASSIGNED		
C 009	0077667	CAPACITR 620 PF 100V SILVER MICA 5%	14655	C07FA621J03
C 010	0073496	CAPACITR 56 PF 500V SILVER MICA 5%	14655	CD15ED560J03
J 001	0084940	CONN COAX SMB MALE PC MT 75 OHM	98291	51-151-0000
L 001	0220438	COIL ASSEMBLY		
L 002	0220439	COIL ASSEMBLY		
L 003	0220440	COIL ASSEMBLY		
L 004	0220439	COIL ASSEMBLY		
L 005	0220438	COIL ASSEMBLY		
L 006	0079170	INDUCTOR .05 UH SUBMIN UNSHLD MOLDED 10%	91637	IR-2
L 007	0079166	INDUCTOR .15 UH SUBMIN UNSHLD 10%	91637	IR-2
S 001	0156467	SWITCH- DPDT, MOMENTARY, PC MOUNT		
S 002	0156466	SWITCH- DPDT, PSH-PSH, MOMEN, PC MOUNT		

270 kHz NOTCH FILTER ASSEMBLY - 156388

REF DESIG PREFIX: MODEL 4661-270

REF DESIG	PART NO.	DESCRIPTION	FSCM CODE	VENDOR PART NUMBER
	0158674	A INDICATOR- PUSH-BUTTON, STAMPED 270		
A 001	0156360	A PWB ASSY- FILTER, NOTCH, MDL 4661-270		
J 002	0085152	CONN COAX SMB MALE TO SLDR CUP 75 OHM	98291	51-143-0000
W 001	0156457	CABLE		

MODEL 4661-270 PWB ASSEMBLY - 156360 (A001)

C 001	0078819	CAPACITR 470 PF 500V SILVER MICA 1%	53021	D155C471F03
C 002	0070559	CAPACITR .0051 MF 300V SILVER MICA 1%	14655	CD19FD512F03
C 003	0076486	CAPACITR 560 PF 500V SILVER MICA 5%	14655	CD19FD561J03
C 004	0070559	CAPACITR .0051 MF 300V SILVER MICA 1%	14655	CD19FD512F03
C 005	0078819	CAPACITR 470 PF 500V SILVER MICA 1%	53021	D155C471F03
C 006		NOT ASSIGNED		
C 007		NOT ASSIGNED		
C 008	0078816	CAPACITR 330 PF 500V SILVER MICA 1%	53021	D155C331F03
C 009		NOT ASSIGNED		
C 010		NOT ASSIGNED		
J 001	0084940	CONN COAX SMB MALE PC MT 75 OHM	98291	51-151-0000
L 001	0144810	COIL ASSY		
L 002	0156420	COIL ASSY		
L 003	0144811	COIL ASSY		
L 004	0156420	COIL ASSY		
L 005	0144810	COIL ASSY		
L 006	0079170	INDUCTOR .05 UH SUBMIN UNSHLD MOLDED 10%	91637	IR-2
L 007	0079166	INDUCTOR .15 UH SUBMIN UNSHLD 10%	91637	IR-2
S 001	0156467	SWITCH- DPDT, MOMENTARY, PC MOUNT		
S 002	0156466	SWITCH- DPDT, PSH-PSH, MOMEN, PC MOUNT		

394 kHz NOTCH FILTER ASSY - 252653

REF DESIG PREFIX: MODEL 4661-394

REF DESIG	PART NO.	DESCRIPTION	FSCM CODE	VENDOR PART NUMBER
	0252659	INDICATOR-PUSH-BUTTON STAMPED 394		
A001	0252647	PWB ASSY-FILTER, NOTCH B MDL 4661-394		
J 1	0085152	CONN COAX SMB MALE TO SLD R CUP 75 OHM	98291	51-143-0000
W 1	0156457	CABLE		

MODEL 4661-394 PWB ASSY - 252647 (A001)

C 1	0085137	CAPACITR 188 PF 500V SILVER MICA 1%	53021	D155CXXXF03 188 PF
C 2	0082970	CAPACITR .0024 MF 500V SILVER MICA 1%	53021	D205F242F03
C 3	0078819	CAPACITR 390 PF 500V SILVER MICA 1%	53021	D155C391F03
C 4	0084972	CAPACITR .0013 MF 500V SILVER MICA 1%	53021	D195E132F03
C 5	0085137	CAPACITR 188 PF 500V SILVER MICA 1%	53021	D155CXXXF03 188 PF
C 6	0078600	NOT ASSIGNED		
C 7	0078819	CAPACITR 470 PF 500V SILVER MICA 1%	53021	D155C471F03
C 8	0078600	NOT ASSIGNED		
C 9	0084972	CAPACITR .0013 MF 500V SILVER MICA 1%	53021	D195E132F03
C 10	0078600	NOT ASSIGNED		
J 1	0084940	CONN COAX SMB MALE PC MT 75 OHM	98291	51-151-0000
L 1	0252634	COIL ASSY		
L 2	0156420	A COIL ASSY		
L 3	0252625	COIL ASSY		
L 4	0156420	A COIL ASSY		
L 5	0252634	COIL ASSY		
L 6	0079170	INDUCTOR .05 UH SUBMIN UNSHLD MOLDED 10%	91637	IR-2
L 7	0079166	INDUCTOR .15 UH SUBMIN UNSHLD 10%	91637	IR-2
S 1	0156467	A SWITCH- DPDT, MOMENTARY, PC MOUNT		
S 2	0156466	SWITCH- DPDT, PSH-PSH, MOMEN, PC MOUNT		

534 kHz NOTCH FILTER ASSEMBLY - 156389

REF DESIG PREFIX: MODEL 4661-534

REF DESIG	PART NO.	DESCRIPTION	FSCM CODE	VENDOR PART NUMBER
	0158675	INDICATOR- PUSH-BUTTON, STAMPED 534		
A 001	0156362	PWB ASSY- FILTER, NOTCH, MDL 4661-534		
J 002	0085152	CONN COAX SMB MALE TO SLDR CUP 75 OHM	98291	51-143-0000
W 001	0156457	CABLE		

MODEL 4661-534 PWB ASSEMBLY - 156362 (A001)

C 001	0078803	CAPACITR 150 PF 500V SILVER MICA 1%	53021	D155C151F03
C 002	0084549	CAPACITR 820 PF 500V SILVER MICA 2%	14655	CD19FD821G03
C 003	0078816	CAPACITR 330 PF 500V SILVER MICA 1%	53021	D155C331F03
C 004	0084549	CAPACITR 820 PF 500V SILVER MICA 2%	14655	CD19FD821G03
C 005	0078803	CAPACITR 150 PF 500V SILVER MICA 1%	53021	D155C151F03
C 006	0084970	CAPACITR 27 PF 500V SILVER MICA 2%	53021	D155E270G03
C 007	0082400	CAPACITR 82 PF 500V SILVER MICA 1%	53021	D155C820F03
C 008	0073491	CAPACITR 12 PF 500V SILVER MICA 5%	14655	CD15CD120J03
C 009	0082400	CAPACITR 82 PF 500V SILVER MICA 1%	53021	D155C820F03
C 010	0084970	CAPACITR 27 PF 500V SILVER MICA 2%	53021	D155E270G03
J 001	0084940	CONN COAX SMB MALE PC MT 75 OHM	98291	51-151-0000
L 001	0156417	COIL ASSY		
L 002	0156419	COIL ASSY		
L 003	0156418	COIL ASSY		
L 004	0156419	COIL ASSY		
L 005	0156417	COIL ASSY		
L 006	0079170	INDUCTOR .05 UH SURMIN UNSHLD MOLDED 10%	91637	IR-2
L 007	0079166	INDUCTOR .15 UH SURMIN UNSHLD 10%	91637	IR-2
S 001	0156467	SWITCH- DPDT, MOMENTARY, PC MOUNT		
S 002	0156466	SWITCH- DPDT, PSH-PSH, MOMEN, PC MOUNT		

770 KHZ NOTCH FILTER ASSY - 252654

REF DESIG PREFIX: MODEL 4661-770

REF DESIG	PART NO.	DESCRIPTION	FSCM CODE	VENDOR PART NUMBER
	0252660	INDICATOR-PUSH-BUTTON STAMPED 770		
A001	0252648	PWB ASSY-FILTER, NOTCH B MDL 4661-770		
J 1	0085152	CONN COAX SMB MALE TO SLDR CUP 75 OHM	98291	51-143-0000
W 1	0156457	CABLE		

MODEL 4661-770 PWB ASSY - 252648 (A001)

C 1	0081834	CAPACITR 77 PF 500V SILVER MICA 2%	53021	D155C770G03
C 2	0080767	CAPACITR ,002 MF 500V SILVER MICA 1%	53021	D195C202F03
C 3	0081827	CAPACITR 160 PF 100V SILVER MICA 2%	53021	D151C161G03
C 4	0080767	CAPACITR ,002 MF 500V SILVER MICA 1%	53021	D195C202F03
C 5	0081834	CAPACITR 77 PF 500V SILVER MICA 2%	53021	D155C770G03
C 6	0078600	NOT ASSIGNED		
C 7	0078600	NOT ASSIGNED		
C 8	0078600	NOT ASSIGNED		
C 9	0078600	NOT ASSIGNED		
C 10	0078600	NOT ASSIGNED		
J 1	0084940	CONN COAX SMB MALE PC MT 75 OHM	98291	51-151-0000
L 1	0252623	COIL ASSY		
L 2	0252636	COIL ASSY		
L 3	0252624	COIL ASSY		
L 4	0252636	COIL ASSY		
L 5	0252623	COIL ASSY		
L 6	0079170	INDUCTOR ,05 UH SUBMIN UNSHLD MOLDED 10%	91637	IR-2
L 7	0079166	INDUCTOR ,15 UH SUBMIN UNSHLD 10%	91637	IR-2
S 1	0156467	A SWITCH- DPDT, MOMENTARY, PC MOUNT		
S 2	0156466	SWITCH- DPDT, PSH-PSH, MOMEN, PC MOUNT		

1002 kHz NOTCH FILTER ASSY - 252655

REF DESIG PREFIX: MODEL 4661-770

REF DESIG	PART NO.	DESCRIPTION	FSCM CODE	VENDOR PART NUMBER
	0252661	INDICATOR-PUSH-BUTTON STAMPED 1002		
A001	0252649	PWB ASSY-FILTER, NOTCH B MDL 4661-1002		
J 1	0085152	CONN COAX SMB MALE TO SLDR CUP 75 OHM	98291	51-143-0000
W 1	0156457	CABLE		

MODEL 4661-1002 PWB ASSY - 252649 (A001)

C 1	0081831	CAPACITR 38 PF 500V SILVER MICA 2%	53021	D155C380G03
C 2	0080145	CAPACITR 450 PF 500V SILVER MICA 1%	53021	D155C451F03
C 3	0084971	CAPACITR 62 PF 500V SILVER MICA 1%	53021	D155E620F03
C 4	0080145	CAPACITR 450 PF 500V SILVER MICA 1%	53021	D155C451F03
C 5	0081831	CAPACITR 38 PF 500V SILVER MICA 2%	53021	D155C380G03
C 6	0082397	CAPACITR 30 PF 500V SILVER MICA 1%	53021	D155C300F03
C 7	0078806	CAPACITR 200 PF 500V SILVER MICA 1%	53021	D155C201F03
C 8	0082400	CAPACITR 82 PF 500V SILVER MICA 1%	53021	D155C820F03
C 9	0078806	CAPACITR 200 PF 500V SILVER MICA 1%	53021	D155C201F03
C 10	0082400	CAPACITR 82 PF 500V SILVER MICA 1%	53021	D155C820F03
J 1	0084940	CONN COAX SMB MALE PC MT 75 OHM	98291	51-151-0000
L 1	0252621	COIL ASSY		
L 2	0252637	COIL ASSY		
L 3	0252622	COIL ASSY		
L 4	0252637	COIL ASSY		
L 5	0252621	COIL ASSY		
L 6	0079170	INDUCTOR .05 UH SUBMIN UNSHLD MOLDED 10%	91637	IR-2
L 7	0079166	INDUCTOR .15 UH SUBMIN UNSHLD 10%	91637	IR-2
S 1	0156467	A SWITCH- DPDT, MOMENTARY, PC MOUNT		
S 2	0156466	SWITCH- DPDT, PSH=PSH, MOMEN, PC MOUNT		

1248 kHz NOTCH FILTER ASSEMBLY - 156390

REF DESIG PREFIX: MODEL 4661-1248

REF DESIG	PART NO.	DESCRIPTION	FSCM CODE	VENDOR PART NUMBER
	0158676	INDICATOR- PUSH-BUTTON, STAMPED 1248		
A 001	0156364	PWB ASSY- FILTER, NOTCH, MDL 4661-1248		
J 002	0085152	CONN COAX SMB MALE TO SLDR CUP 75 OHM	98291	51-143-0000
W 001	0156457	CABLE		

MODEL 4661-1248 PWB ASSEMBLY - 156364 (A001)

C 001	0077965	CAPACITR 51 PF 500V SILVER MICA 2%	14655	CD6ED510G03
C 002	0078818	CAPACITR 390 PF 500V SILVER MICA 1%	53021	D155C391F03
C 003	0081835	CAPACITR 106 PF 500V SILVER MICA 2%	53021	D155CXXXG03 106 PF
C 004	0078818	CAPACITR 390 PF 500V SILVER MICA 1%	53021	D155C391F03
C 005	0077965	CAPACITR 51 PF 500V SILVER MICA 2%	14655	CD6ED510G03
C 007	0078806	CAPACITR 200 PF 500V SILVER MICA 1%	53021	D155C201F03
C 008		NOT ASSIGNED		
C 009	0078806	CAPACITR 200 PF 500V SILVER MICA 1%	53021	D155C201F03
J 001	0084940	CONN COAX SMB MALE PC MT 75 OHM	98291	51-151-0000
L 001	0156412	COIL ASSY		
L 002	0156415	COIL ASSY		
L 003	0138177	COIL ASSEMBLY		
L 004	0156415	COIL ASSY		
L 005	0156412	COIL ASSY		
L 006	0079170	INDUCTOR .05 UH SUBMIN UNSHLD MOLDED 10%	91637	IR-2
L 007	0079166	INDUCTOR .15 UH SUBMIN UNSHLD 10%	91637	IR-2
S 001	0156467	SWITCH- DPDT, MOMENTARY, PC MOUNT		
S 002	0156466	SWITCH- DPDT, PSH-PSH, MOMEN, PC MOUNT		

1730 kHz NOTCH FILTER ASSEMBLY - 217536

REF DESIG PREFIX: MODEL 4661-1730

REF DESIG	PART NO.	DESCRIPTION	FSCM CODE	VENDOR PART NUMBER
	0220541	INDICATOR- PUSH-BUTTON, STAMPED 1730		
A 001	0217534	PWB ASSY- FILTER, NOTCH, MDL 4661-1730		
J 002	0085152	CONN COAX SMR MALE TO SLDR CUP 75 OHM	98291	51-143-0000
W 001	0156457	CABLE		

MODEL 4661-1730 PWB ASSEMBLY - 217534 (A001)

C 001	0073495	CAPACITR 39 PF 500V SILVER MICA 5%	14655	CD15ED390J03
C 002	0078818	CAPACITR 390 PF 500V SILVER MICA 1%	53021	D155C391F03
C 003	0082399	CAPACITR 75 PF 500V SILVER MICA 1%	53021	D155C750F03
C 004	0078818	CAPACITR 390 PF 500V SILVER MICA 1%	53021	D155C391F03
C 005	0073495	CAPACITR 39 PF 500V SILVER MICA 5%	14655	CD15ED390J03
C 006		NOT ASSIGNED		
C 007	0081821	CAPACITR 33 PF 100V SILVER MICA 2%	53021	D151C330G03
C 008		NOT ASSIGNED		
C 009	0081821	CAPACITR 33 PF 100V SILVER MICA 2%	53021	D151C330G03
C 010		NOT ASSIGNED		
J 001	0084940	CONN COAX SMR MALE PC MT 75 OHM	98291	51-151-0000
L 001	0220545	COIL ASSY		
L 002	0220546	COIL ASSY		
L 003	0220547	COIL ASSY		
L 004	0220546	COIL ASSY		
L 005	0220545	COIL ASSY		
L 006	0079170	INDUCTOR .05 UH SUBMIN UNSHLD MOLDED 10%	91637	IR-2
L 007	0079166	INDUCTOR .15 UH SUBMIN UNSHLD 10%	91637	IR-2
S 001	0156467	SWITCH- DPDT, MOMENTARY, PC MOUNT		
S 002	0156466	SWITCH- DPDT, PSH-PSH, MOMEN, PC MOUNT		

1960 KHZ NOTCH FILTER ASSEMBLY - 221208

REF DESIG PREFIX: MODEL 4661-1960

REF DESIG	PART NO.	DESCRIPTION	FSCM CODE	VENDOR PART NUMBER
	0221207	INDICATOR, STAMPED 1960		
A 001	0221209	PWB ASSY-FILTER, NOTCH 1960 KHZ		
J 002	0085152	CONN COAX SMB MALE TO SLDR CUP 75 OHM	98291	51-143-0000
W 001	0156457	CABLE		

MODEL 4661-1960 PWB ASSEMBLY - 221209 (A001)

C 001	0070487	CAPACITR 27 PF 500V SILVER MICA 5%	14655	CD15ED270J03
C 002	0070522	CAPACITR 150 PF 500V SILVER MICA 5%	14655	CD15FD151J03
C 003	0073496	CAPACITR 56 PF 500V SILVER MICA 5%	14655	CD15ED560J03
C 004	0070522	CAPACITR 150 PF 500V SILVER MICA 5%	14655	CD15FD151J03
C 005	0070487	CAPACITR 27 PF 500V SILVER MICA 5%	14655	CD15ED270J03
C 006		NOT ASSIGNED		
C 007	0077664	CAPACITR 160 PF 500V SILVER MICA 5%	53021	D105C161J03
C 008		NOT ASSIGNED		
C 009	0077664	CAPACITR 160 PF 500V SILVER MICA 5%	53021	D105C161J03
C 010		NOT ASSIGNED		
L 001	0220545	COIL ASSY		
L 002	0220546	COIL ASSY		
L 003	0220547	COIL ASSY		
L 004	0220546	COIL ASSY		
L 005	0220545	COIL ASSY		
L 006	0079170	INDUCTOR .05 UH SUBMIN UNSHLD MOLDED 10%	91637	IR-2
L 007	0079166	INDUCTOR .15 UH SUBMIN UNSHLD 10%	91637	IR-2
S 001	0156467	SWITCH- DPDT, MOMENTARY, PC MOUNT		
S 002	0156466	SWITCH- DPDT, PSH-PSH, MOMEN, PC MOUNT		

2438 KHz NOTCH FILTER ASSEMBLY - 156391

REF DESIG PREFIX: MODEL 4661-2438

REF DESIG	PART NO.	DESCRIPTION	FSCM CODE	VENDOR PART NUMBER
	0158677	INDICATOR- PUSH-BUTTON, STAMPED 2438		
A 001	0156366	PWB ASSY- FILTER, NOTCH, MDL 4661-2438		
J 002	0085152	CONN COAX SMB MALE TO SLDR CUP 75 OHM	98291	51-143-0000
W 001	0156457	CABLE		

MODEL 4661-2438 PWB ASSEMBLY - 156366 (A001)

C 001	0080142	CAPACITR 20 PF 500V SILVER MICA 5%	14655	CD15ED200J03
C 002	0078815	CAPACITR 300 PF 500V SILVER MICA 1%	53021	D155C301F03
C 003	0084970	CAPACITR 27 PF 500V SILVER MICA 2%	53021	D155E270G03
C 004	0078815	CAPACITR 300 PF 500V SILVER MICA 1%	53021	D155C301F03
C 005	0080142	CAPACITR 20 PF 500V SILVER MICA 5%	14655	CD15ED200J03
C 006		NOT ASSIGNED		
C 007	0070470	CAPACITR 10 PF 500V SILVER MICA 5%	14655	CD15CD100J03
C 008	0073493	CAPACITR 18 PF 500V SILVER MICA 5%	14655	CD15CD180J03
C 009	0070470	CAPACITR 10 PF 500V SILVER MICA 5%	14655	CD15CD100J03
C 010		NOT ASSIGNED		
J 001	0084940	CONN COAX SMB MALE PC MT 75 OHM	98291	51-151-0000
L 001	0138177	COIL ASSEMBLY		
L 002	0156414	COIL ASSY		
L 003	0138178	COIL ASSEMBLY		
L 004	0156414	COIL ASSY		
L 005	0138177	COIL ASSEMBLY		
L 006	0079170	INDUCTOR .05 UH SUBMIN UNSHLD MOLDED 10%	91637	IR-2
L 007	0079166	INDUCTOR .15 UH SUBMIN UNSHLD 10%	91637	IR-2
S 001	0156467	SWITCH- DPDT, MOMENTARY, PC MOUNT		
S 002	0156466	SWITCH- DPDT, PSH-PSH, MOMEN, PC MOUNT		

3150 kHz NOTCH FILTER ASSY - 252656

REF DESIG PREFIX: MODEL 4661-3150

REF DESIG	PART NO.	DESCRIPTION	FSCM CODE	VENDOR PART NUMBER
	0252662	INDICATOR-PUSH-BUTTON STAMPED 3150		
A001	0252650	PWB ASSY-FILTER, NOTCH B MDL 4661-3150		
J 1	0085152	CONN COAX SMB MALE TO SLDR CUP 75 OHM	98291	51-143-0000
W 1	0156457	CABLE		

MODEL 4661-3150 PWB ASSY - 252650 (A001)

C 1	0081820	CAPACITR 11 PF 100V SILVER MICA 5%	53021	D151C110J03
C 2	0078812	CAPACITR 260 PF 500V SILVER MICA 1%	53021	D155C261F03
C 3	0081830	CAPACITR 35 PF 500V SILVER MICA 2%	53021	D155C350G03
C 4	0078812	CAPACITR 260 PF 500V SILVER MICA 1%	53021	D155C261F03
C 5	0081820	CAPACITR 11 PF 100V SILVER MICA 5%	53021	D151C110J03
C 6	0070470	CAPACITR 10 PF 500V SILVER MICA 5%	14655	CD15CD100J03
C 7	0084971	CAPACITR 62 PF 500V SILVER MICA 1%	53021	D155E620F03
C 8	0078600	NOT ASSIGNED		
C 9	0078600	NOT ASSIGNED		
C 10	0070470	CAPACITR 10 PF 500V SILVER MICA 5%	14655	CD15CD100J03
J 1	0084940	CONN COAX SMB MALE PC MT 75 OHM	98291	51-151-0000
L 1	0252630	COIL ASSY		
L 2	0252638	COIL ASSY		
L 3	0252631	COIL ASSY		
L 4	0252638	COIL ASSY		
L 5	0252630	COIL ASSY		
L 6	0079170	INDUCTOR .05 UH SUBMIN UNSHLD MOLDED 10%	91637	IR-2
L 7	0079166	INDUCTOR .15 UH SUBMIN UNSHLD 10%	91637	IR-2
S 1	0156467	SWITCH- DPDT, MOMENTARY, PC MOUNT		
S 2	0156466	SWITCH- DPDT, PSH-PSH, MOMEN, PC MOUNT		

3886 kHz NOTCH FILTER ASSEMBLY - 156392

REF DESIG PREFIX: MODEL 4661-3886

REF DESIG	PART NO.	DESCRIPTION	FSCM CODE	VENDOR PART NUMBER
	0158678	INDICATOR- PUSH-BUTTON, STAMPED 3886		
A 001	0156368	PWB ASSY- FILTER, NOTCH, MDL 4661-3886		
J 002	0085152	CONN COAX SMB MALE TO SLDR CUP 75 OHM	98291	51-143-0000
W 001	0156457	CABLE		

MODEL 4661-3886 PWB ASSEMBLY - 156368 (A001)

C 001	0070470	CAPACITR 10 PF 500V SILVER MICA 5%	14655	CD15CD100J03
C 002	0078807	CAPACITR 210 PF 500V SILVER MICA 1%	53021	D155C211F03
C 003	0073495	CAPACITR 39 PF 500V SILVER MICA 5%	14655	CD15ED390J03
C 004	0078807	CAPACITR 210 PF 500V SILVER MICA 1%	53021	D155C211F03
C 005	0070470	CAPACITR 10 PF 500V SILVER MICA 5%	14655	CD15CD100J03
C 006	0079799	CAPACITR 7 PF 500V SILVER MICA 10%	84171	CD15CD070K03
C 007		NOT ASSIGNED		
C 008		NOT ASSIGNED		
C 009		NOT ASSIGNED		
C 010	0079799	CAPACITR 7 PF 500V SILVER MICA 10%	84171	CD15CD070K03
J 001	0084940	CONN COAX SMB MALE PC MT 75 OHM	98291	51-151-0000
L 001	0156409	COIL ASSY		
L 002	0156416	COIL ASSY		
L 003	0156410	COIL ASSY		
L 004	0156416	COIL ASSY		
L 005	0156409	COIL ASSY		
L 006	0079170	INDUCTOR .05 UH SUBMIN UNSHLD MOLDED 10%	91637	IR-2
L 007	0079166	INDUCTOR .15 UH SUBMIN UNSHLD 10%	91637	IR-2
S 001	0156467	SWITCH- DPDT, MOMENTARY, PC MOUNT		
S 002	0156466	SWITCH- DPDT, PSH-PSH, MOMEN, PC MOUNT		

5340 kHz NOTCH FILTER ASSEMBLY - 163076

REF DESIG PREFIX: MODEL 4661-5340LC

REF DESIG	PART NO.	DESCRIPTION	FSCM CODE	VENDOR PART NUMBER
	0158679	INDICATOR- PUSH-BUTTON, STAMPED 5340		
A 001	0163075	PWB ASSY- FILTER, NOTCH, MDL 4661-5340LC		
J 002	0085152	CONN COAX SMB MALE TO SLDR CUP 75 OHM	98291	51-143-0000
W 001	0156457	CABLE		

MODEL 4661-5340LC PWB ASSEMBLY - 163075 (A001)

C 001	0079143	CAPACITR 2-8 PF MIN CER DISC PC MT	72982	538-011 A 2-8
C 002	0078811	CAPACITR 250 PF 500V SILVER MICA 1%	53021	D155C251F03
C 003	0079097	CAPACITR 3-15 PF MIN CER DISC PC MT	72982	538-011 D 3-15
C 004	0078811	CAPACITR 250 PF 500V SILVER MICA 1%	53021	D155C251F03
C 005	0079143	CAPACITR 2-8 PF MIN CER DISC PC MT	72982	538-011 A 2-8
C 006	0082011	CAPACITR 6.2 PF 100V CER DISC COH +/- .25P	72982	835-024-COHO-629C
C 008	0081934	CAPACITR 18 PF 100V CER DISC COG 5%	72982	835-COGO-180J
C 010	0082011	CAPACITR 6.2 PF 100V CER DISC COH +/- .25P	72982	835-024-COHO-629C
J 001	0084940	CONN COAX SMB MALE PC MT 75 OHM	98291	51-151-0000
L 001	0138169	COIL ASSY		
L 002	0138162	COIL ASSY		
L 003	0138170	COIL ASSY		
L 004	0138162	COIL ASSY		
L 005	0138169	COIL ASSY		
L 006	0079166	INDUCTOR .15 UH SUBMIN UNSHLD 10%	91637	IR-2
L 007	0079170	INDUCTOR .05 UH SUBMIN UNSHLD MOLDED 10%	91637	IR-2
S 001	0156467	SWITCH- DPDT, MOMENTARY, PC MOUNT		
S 002	0156466	SWITCH- DPDT, PSH-PSH, MOMEN, PC MOUNT		

6900 kHz NOTCH FILTER ASSEMBLY - 163081

REF DESIG PREFIX: MODEL 4661-6900LC

REF DESIG	PART NO.	DESCRIPTION	FSCM CODE	VENDOR PART NUMBER
	0163030	INDICATOR- PUSH-BUTTON, STAMPED 6900		
A 001	0163080	A PWB ASSY- FILTER, NOTCH, MDL 4661-6900LC		
J 002	0085152	CONN COAX SMB MALE TO SLDR CUP 75 OHM	98291	51-143-0000
W 001	0156457	CABLE		

MODEL 4661-6900LC PWB ASSEMBLY - 163080 (A001)

C 001	0079143	CAPACITR 2-8 PF MIN CER DISC PC MT	72982	538-011 A 2-8
C 002	0078806	CAPACITR 200 PF 500V SILVER MICA 1%	53021	D155C201F03
C 003	0079097	CAPACITR 3-15 PF MIN CER DISC PC MT	72982	538-011 D 3-15
C 004	0078806	CAPACITR 200 PF 500V SILVER MICA 1%	53021	D155C201F03
C 005	0079143	CAPACITR 2-8 PF MIN CER DISC PC MT	72982	538-011 A 2-8
C 006	0082011	CAPACITR 6.2 PF 100V CER DISC COH +/- .25P	72982	835-024-COHO-629C
C 008	0081932	CAPACITR 16 PF 500V CER DISC COG 5%	72982	831-COHO-160J
C 010	0082011	CAPACITR 6.2 PF 100V CER DISC COH +/- .25P	72982	835-024-COHO-629C
J 001	0084940	CONN COAX SMB MALE PC MT 75 OHM	98291	51-151-0000
L 001	0138171	COIL ASSY		
L 002	0138163	COIL ASSY		
L 003	0138172	COIL ASSY		
L 004	0138163	COIL ASSY		
L 005	0138171	COIL ASSY		
L 006	0079166	INDUCTOR .15 UH SUBMIN UNSHLD 10%	91637	IR-2
L 007	0079170	INDUCTOR .05 UH SUBMIN UNSHLD MOLDED 10%	91637	IR-2
S 001	0156467	SWITCH- DPDT, MOMENTARY, PC MOUNT		
S 002	0156466	SWITCH- DPDT, PSH-PSH, MOMEN, PC MOUNT		

7600 kHz NOTCH FILTER ASSEMBLY - 163086

REF DESIG PREFIX: MODEL 4661-7600LC

REF DESIG	PART NO.	DESCRIPTION	FSCM CODE	VENDOR PART NUMBER
	0158680	INDICATOR- PUSH-BUTTON, STAMPED 7600		
A 001	0163085	PWB ASSY- FILTER, NOTCH, MDL 4661-7600LC		
J 002	0085152	CONN COAX SMB MALE TO SLDR CUP 75 OHM	98291	51-143-0000
W 001	0156457	CABLE		

MODEL 4661-7600LC PWB ASSEMBLY - 163085 (A001)

C 001	0079143	CAPACITR 2-8 PF MIN CER DISC PC MT	72982	538-011 A 2-8
C 002	0070522	CAPACITR 150 PF 500V SILVER MICA 5%	14655	CD15FD151J03
C 003	0079097	CAPACITR 3-15 PF MIN CER DISC PC MT	72982	538-011 D 3-15
C 004	0070522	CAPACITR 150 PF 500V SILVER MICA 5%	14655	CD15FD151J03
C 005	0079143	CAPACITR 2-8 PF MIN CER DISC PC MT	72982	538-011 A 2-8
C 006	0082014	CAPACITR 8.2 PF 100V CER DISC COH +/- .25P	72982	835-024-COHO-829C
C 008	0081936	CAPACITR 20 PF 100V CER DISC COG 5%	72982	835-COG0-200J
C 010	0082014	CAPACITR 8.2 PF 100V CER DISC COH +/- .25P	72982	835-024-COHO-829C
J 001	0084940	CONN COAX SMB MALE PC MT 75 OHM	98291	51-151-0000
L 001	0138167	COIL ASSY		
L 002	0138163	COIL ASSY		
L 003	0138168	COIL ASSY		
L 004	0138163	COIL ASSY		
L 005	0138167	COIL ASSY		
L 006	0079166	INDUCTOR .15 UH SUBMIN UNSHLD 10%	91637	IR-2
L 007	0079170	INDUCTOR .05 UH SURMIN UNSHLD MOLDED 10%	91637	IR-2
S 001	0156467	SWITCH- DPDT, MOMENTARY, PC MOUNT		
S 002	0156466	SWITCH- DPDT, PSH-PSH, MOMEN, PC MOUNT		

10840 kHz NOTCH FILTER ASSEMBLY - 221374

REF DESIG PREFIX: MODEL 4661-10840

REF DESIG	PART NO.	DESCRIPTION	FSCM CODE	VENDOR PART NUMBER
	0221375	PUSHBUTTON STAMPED 10840		
A 001	0221376	PWB ASSY=FILTER,NOTCH, MDL 4661-10840		
J 002	0085152	CONN COAX SMB MALE TO SLDR CUP 75 OHM	98291	51-143-0000
W 001	0156457	CABLE		

MODEL 4661-10840 PWB ASSEMBLY - 221376 (A001)

C 001	0079143	CAPACITR 2-8 PF MIN CER DISC PC MT	72982	538-011 A 2-8
C 002	0078803	CAPACITR 150 PF 500V SILVER MICA 1%	53021	D155C151F03
C 003	0079172	CAPACITR 5.5-18 PF MIN CER DISC PC MT	72982	538-011 A 5.5-18
C 004	0078803	CAPACITR 150 PF 500V SILVER MICA 1%	53021	D155C151F03
C 005	0079143	CAPACITR 2-8 PF MIN CER DISC PC MT	72982	538-011 A 2-8
C 006	0077955	CAPACITR 3 PF 500V SILVER MICA +-1PF	14655	CD6CD030C03
C 007	0070490	CAPACITR 30 PF 500V SILVER MICA 5%	14655	CD15ED300J03
C 008	0073491	CAPACITR 12 PF 500V SILVER MICA 5%	14655	CD15CD120J03
C 009	0070490	CAPACITR 30 PF 500V SILVER MICA 5%	14655	CD15ED300J03
C 010	0077955	CAPACITR 3 PF 500V SILVER MICA +-1PF	14655	CD6CD030C03
J 001	0084940	CONN COAX SMB MALE PC MT 75 OHM	98291	51-151-0000
L 001	0221370	COIL ASSY		
L 002	0221372	COIL ASSY		
L 003	0221371	COIL ASSY		
L 004	0221372	COIL ASSY		
L 005	0221370	COIL ASSY		
L 006	0079166	INDUCTOR .15 UH SUBMIN UNSHLD 10%	91637	IR-2
L 007	0079170	INDUCTOR .05 UH SUBMIN UNSHLD MOLDED 10%	91637	IR-2
S 001	0156467	SWITCH- DPDT, MOMENTARY, PC MOUNT		
S 002	0156466	SWITCH- DPDT, PSH-PSH, MOMEN, PC MOUNT		

CRYSTAL CONTROLLED FILTERS

COMP DESIG	S-A PART NO	-----DESCRIPTION-----	FSCM	-----MFR PART NO-----
	158644	FILTER ASSY- NOTCH, 3886KHZ, CRYSTAL		
	158645	FILTER ASSY- NOTCH, 5340KHZ, CRYSTAL		
	158646	FILTER ASSY- NOTCH, 7600KHZ, CRYSTAL		
	158647	FILTER ASSY- NOTCH, 11700KHZ, CRYSTAL		

FSCM-MANUFACTURER CROSS REFERENCE

FSCM	MANUFACTURER
09656	AEROVOX CORPORATION, NEW BRADFORD, MASS.
00779	AMP, INC, HARRISBURG, PA.
01121	ALLEN-BRADLEY CO., MILWAUKEE, WISC.
01295	TEXAS INSTRUMENTS, INC., DALLAS, TEXAS
02113	COILCRAFT, CARY, ILL.
04713	MOTOROLA SEMICONDUCTOR PDTS., PHOENIX, ARIZ.
13715	FAIRCHILD SEMICONDUCTOR CORP., SAN RAFAEL, CALIF.
14655	CORNELL-DUBILIER ELEC. CORP., S. PLAINFIELD, N.J.
24152	SEI MFG. CO., NORTHRIDGE, CALIF.
33095	SPECTRUM CONTROL, INC., FAIRVIEW, PA.
37942	MALLORY P R & CO., INC., INDIANAPOLIS, IND.
53021	SANGAMO ELECTRIC CO., SPRINGFIELD, ILL.
70903	BELDEN MANUFACTURING CO., CHICAGO, ILL.
71279	CAMBRIDGE THERMIONIC CORP., CAMBRIDGE, MASS.
71590	CENTRALAB, MILWAUKEE, WISC.
72982	ERIE RESISTOR CORP., ERIE, PA.
73138	BECKMAN INSTRUMENT, FULLERTON, CALIF.
73445	AMPEREX ELECTRONIC CORP., HICKSVILLE, N.Y.
76493	MILLER, J W CO., LOS ANGELES, CALIF.
78488	STACKPOLE CARBON CO-MAGNET DIV., ST. MARYS, PA.
79089	RADIO CORP. OF AMERICA, HARRISON, N.J.
80183	SPARAGUE PDTS. CO., N. ADAMS, MASS.
80294	BOURNS LABORATORIES, INC., RIVERSIDE, CALIF.
80368	SYLVANIA ELECTRIC PDTS, INC., NEW YORK, N.Y.
91637	DALE PRODUCTS, INC., COLUMBUS, NEB.
98291	SEAELECTRO CORP., MAMARONECK, N.Y.
98927	ELECTRONICS SPECIALTY CO-PORTLAND ELECTRONICS DIV., PORTLAND, OR

CHAPTER 7 DIAGRAMS

7.1 GENERAL

7.1.1 The diagrams contained in this chapter are provided for both detailed troubleshooting if a malfunction should occur and as a training aid for maintenance personnel who will be responsible for the care and operation of the Model 4661 Baseband Noise Transmitter.

7.2 ARRANGEMENT OF DIAGRAMS

7.2.1 The diagrams are arranged using the alpha-numeric designations assigned to the sub-assemblies of the Model 4661 Baseband Noise Transmitter.

7.3 INDEX OF DIAGRAMS

7.3.1 The schematic and assembly diagrams contained in this chapter are arranged as follows:

LIST OF ILLUSTRATIONS
MODEL 4661 BASEBAND NOISE TRANSMITTER

<u>Figure</u>	<u>Title</u>	<u>Page</u>
7-1	Model 4661 Baseband Noise Transmitter, Component Location	7-13
7-2	Model 4661 Baseband Noise Transmitter, Wiring Diagram	7-14
7-3	Model 4661 Baseband Noise Transmitter, Schematic	7-15
7-4	Noise Source Assembly (A1), Component Location	7-16
7-5	Noise Source Assembly (A1), Schematic	7-17
7-6	ALC Amplifier Assembly (A8), Component Location	7-18
7-7	ALC Amplifier Assembly (A8), Schematic	7-19
7-8	ALC Detector/0 to 49.9 dB Attenuator Assembly (A17), Component Location	7-20
7-9	ALC Detector/0 to 49.9 dB Attenuator Assembly (A17), Schematic	7-21
7-10	Power Supply Assembly (A18), Component Location	7-22
7-11	Power Supply Assembly (A18), Schematic	7-23
7-12	Rear Panel Interface Printed Circuit Board (A19), Component Location	7-24
7-13	Filter Select Printed Circuit Board (A20), Component Location	7-25

LIST OF ILLUSTRATIONS - CONTINUED

<u>Figure</u>	<u>Title</u>	<u>Page</u>
7-14	Equalizer Printed Circuit Board (A21), Component Location	7-26
7-15	Equalizer Printed Circuit Board (A21), Schematic	7-27
7-16	Bandstop Spacer Assembly	7-28
7-17	Bandstop Spacer Assembly Printed Circuit Board	7-29
7-18	12 kHz High Pass Filter Assembly, Component Location	7-30
7-19	12 kHz High Pass Filter Assembly, Schematic	7-31
7-20	60 kHz High Pass Filter Assembly, Component Location	7-32
7-21	60 kHz High Pass Filter Assembly, Schematic	7-33
7-22	316 kHz High Pass Filter Assembly, Component Location	7-34
7-23	316 kHz High Pass Filter Assembly, Schematic	7-35
7-24	108 kHz Low Pass Filter Assembly, Component Location	7-36
7-25	108 kHz Low Pass Filter Assembly, Schematic	7-37

LIST OF ILLUSTRATIONS - CONTINUED

<u>Figure</u>	<u>Title</u>	<u>Page</u>
7-26	156 kHz Low Pass Filter Assembly, Component Location	7-38
7-27	156 kHz Low Pass Filter Assembly, Schematic	7-39
7-28	204 kHz Low Pass Filter Assembly, Component Location	7-40
7-29	204 kHz Low Pass Filter Assembly, Schematic	7-41
7-30	252 kHz Low Pass Filter Assembly, Component Location	7-42
7-31	252 kHz Low Pass Filter Assembly, Schematic	7-43
7-32	300 kHz Low Pass Filter Assembly, Component Location	7-44
7-33	300 kHz Low Pass Filter Assembly, Schematic	7-45
7-34	408 kHz Low Pass Filter Assembly, Component Location	7-46
7-35	408 kHz Low Pass Filter Assembly, Schematic	7-47
7-36	552 kHz Low Pass Filter Assembly, Component Location	7-48
7-37	552 kHz Low Pass Filter Assembly, Schematic	7-49

LIST OF ILLUSTRATIONS - CONTINUED

<u>Figure</u>	<u>Title</u>	<u>Page</u>
7-38	804 kHz Low Pass Filter Assembly, Component Location	7-50
7-39	804 kHz Low Pass Filter Assembly, Schematic	7-51
7-40	1052 kHz Low Pass Filter Assembly, Component Location	7-52
7-41	1052 kHz Low Pass Filter Assembly, Schematic	7-53
7-42	1296 kHz Low Pass Filter Assembly, Component Location	7-54
7-43	1296 kHz Low Pass Filter Assembly, Schematic	7-55
7-44	1796 kHz Low Pass Filter Assembly, Component Location	7-56
7-45	1796 kHz Low Pass Filter Assembly, Schematic	7-57
7-46	2045 kHz Low Pass Filter Assembly, Component Location	7-58
7-47	2045 kHz Low Pass Filter Assembly, Schematic	7-59
7-48	2600 kHz Low Pass Filter Assembly, Component Location	7-60
7-49	2600 kHz Low Pass Filter Assembly, Schematic	7-61

LIST OF ILLUSTRATIONS - CONTINUED

<u>Figure</u>	<u>Title</u>	<u>Page</u>
7-50	3284 kHz Low Pass Filter Assembly, Component Location	7-62
7-51	3284 kHz Low Pass Filter Assembly, Schematic	7-63
7-52	4100 kHz Low Pass Filter Assembly, Component Location	7-64
7-53	4100 kHz Low Pass Filter Assembly, Schematic	7-65
7-54	5600 kHz Low Pass Filter Assembly, Component Location	7-66
7-55	5600 kHz Low Pass Filter Assembly, Schematic	7-67
7-56	7284 kHz Low Pass Filter Assembly, Component Location	7-68
7-57, 7-57a	7284 kHz Low Pass Filter Assembly, Schematic	7-69, 7-69a
7-58	8160 kHz Low Pass Filter Assembly, Component Location	7-70
7-59	8160 kHz Low Pass Filter Assembly, Schematic	7-71
7-60	10164 kHz Low Pass Filter Assembly, Component Location	7-72
7-61	10164 kHz Low Pass Filter Assembly, Schematic	7-73

LIST OF ILLUSTRATIONS - CONTINUED

<u>Figure</u>	<u>Title</u>	<u>Page</u>
7-62	11404 kHz Low Pass Filter Assembly, Component Location	7-74
7-63	11404 kHz Low Pass Filter Assembly, Schematic	7-75
7-64	12360 kHz Low Pass Filter Assembly, Component Location	7-76
7-65	12360 kHz Low Pass Filter Assembly, Schematic	7-77
7-66	16 kHz Notch Filter Assembly, Component Location	7-78
7-67	16 kHz Notch Filter Assembly, Schematic	7-79
7-68	56 kHz Notch Filter Assembly, Component Location	7-80
7-69	56 kHz Notch Filter Assembly, Schematic	7-81
7-70	70 kHz Notch Filter Assembly, Component Location	7-82
7-71	70 kHz Notch Filter Assembly, Schematic	7-83
7-72	98 kHz Notch Filter Assembly, Component Location	7-84
7-73	98 kHz Notch Filter Assembly, Schematic	7-85

LIST OF ILLUSTRATIONS - CONTINUED

<u>Figure</u>	<u>Title</u>	<u>Page</u>
7-74	140 kHz Notch Filter Assembly, Component Location	7-86
7-75	140 kHz Notch Filter Assembly, Schematic	7-87
7-76	185 kHz Notch Filter Assembly, Component Location	7-88
7-77	185 kHz Notch Filter Assembly, Schematic	7-89
7-78	240 kHz Notch Filter Assembly, Component Location	7-90
7-79	240 kHz Notch Filter Assembly, Schematic	7-91
7-80	270 kHz Notch Filter Assembly, Component Location	7-92
7-81	270 kHz Notch Filter Assembly, Schematic	7-93
7-82	394 kHz Notch Filter Assembly, Component Location	7-94
7-83	394 kHz Notch Filter Assembly, Schematic	7-95
7-84	534 kHz Notch Filter Assembly, Component Location	7-96
7-85	534 kHz Notch Filter Assembly, Schematic	7-97

LIST OF ILLUSTRATIONS - CONTINUED

<u>Figure</u>	<u>Title</u>	<u>Page</u>
7-86	770 kHz Notch Filter Assembly, Component Location	7-98
7-87	770 kHz Notch Filter Assembly, Schematic	7-99
7-88	1002 kHz Notch Filter Assembly, Component Location	7-100
7-89	1002 kHz Notch Filter Assembly, Schematic	7-101
7-90	1248 kHz Notch Filter Assembly, Component Location	7-102
7-91	1248 kHz Notch Filter Assembly, Schematic	7-103
7-92	1730 kHz Notch Filter Assembly, Component Location	7-104
7-93	1730 kHz Notch Filter Assembly, Schematic	7-105
7-94	1960 kHz Notch Filter Assembly, Component Location	7-106
7-95	1960 kHz Notch Filter Assembly, Schematic	7-107
7-96	2438 kHz Notch Filter Assembly, Component Assembly	7-108
7-97	2438 kHz Notch Filter Assembly, Schematic	7-109

LIST OF ILLUSTRATIONS - CONTINUED

<u>Figure</u>	<u>Title</u>	<u>Page</u>
7-98	3150 kHz Notch Filter Assembly, Component Location	7-110
7-99	3150 kHz Notch Filter Assembly, Schematic	7-111
7-100	3886 kHz Notch Filter Assembly, Component Location	7-112
7-101	3886 kHz Notch Filter Assembly, Schematic	7-113
7-102	5340 kHz Notch Filter Assembly, Component Location	7-114
7-103	5340 kHz Notch Filter Assembly, Schematic	7-115
7-104	6900 kHz Notch Filter Assembly, Component Location	7-116
7-105	6900 kHz Notch Filter Assembly, Schematic	7-117
7-106	7600 kHz Notch Filter Assembly, Component Location	7-118
7-107	7600 kHz Notch Filter Assembly, Schematic	7-119

LIST OF ILLUSTRATIONS - CONTINUED

<u>Figure</u>	<u>Title</u>	<u>Page</u>
7-108	10840 kHz Notch Filter Assembly, Component Location	7-120
7-109	10840 kHz Notch Filter Assembly, Schematic	7-121

1
2
3
4
5
6
7
8
9
10
11
12
13
14
15
16
17
18
19
20
21
22
23
24
25
26
27
28
29
30
31
32
33
34
35
36
37
38
39
40
41
42
43
44
45
46
47
48
49
50
51
52
53
54
55
56
57
58
59
60
61
62
63
64
65
66
67
68
69
70
71
72
73
74
75
76
77
78
79
80
81
82
83
84
85
86
87
88
89
90
91
92
93
94
95
96
97
98
99
100