

# Model SR630

## 16 Channel Thermocouple Reader



1290-D Reamwood Avenue  
Sunnyvale, CA 94089 U.S.A.  
Phone: (408) 744-9040 • Fax: (408) 744-9049  
Email: [info@thinkSRS.com](mailto:info@thinkSRS.com) • [www.thinkSRS.com](http://www.thinkSRS.com)

Copyright © 1992, 1994, 1995, 1997  
Stanford Research Systems, Inc.  
All Rights Reserved  
Revision 1.3 (09/2001)



Specifications	4
Preparations for Use	5
Symbols	6
Quick Start Instructions	7
Instrument Overview	8
Front Panel Description	9
Rear Panel Description	11
Operation	12
Connecting Thermocouples	12
Setting Instrument Parameters (GPIB Address, RS232 Baud Rate, Time and Date, Printer Mode, and Scan Dwell Time/Logging Mode)	12
Setting Channel Parameters (Measurement Units, Scan Enable, TC Type, Nominal Temperature, Temperature Deviation, Chart Span Alarm Enable, Alarm Relay, and Temperature Limits)	13
Troubleshooting and error messages	15
Computer Interfaces	16
Command List	17
Programming Examples	22
Thermocouple Reference Data	26
Characteristics of Thermocouple Types	27
Calibration	29
Voltmeter Input Offsets	30
Voltmeter Gain Factors	30
Zone Block Temperature Offsets	30
Channel Temperature Offsets	31
Analog Output Gain Factors	31
Circuit Description	33
Microprocessor System	33
Display Drivers	33
Analog Outputs and Block Temperature	34
Time and Date	35
Relay Multiplexers	35
Input Amplifiers and ADC	35
Power Supplies	36
Computer Interfaces	36
Front Panel Display	37
Component Parts List	38
Circuit Schematic Diagrams	51

# Specifications

## Voltmeter Specifications

Channels	16
Input Type	Independent, floating, and differential.
Input Resistance	10 MOhms between + & -, >1 GOhm to ground.
Input Capacitance	.001 uF
Input Bias Current	<100 pA
Input Protection	250 Vrms
Full Scale Display	$\pm 9.999$ , $\pm 99.99$ , $\pm 999.9$ mVdc $\pm 9.999$ , $\pm 99.99$ Vdc
Range Select	Automatic
Resolution	$\pm 1$ of least significant displayed digit.
Offset	$\pm 2$ of least significant displayed digit.
Gain Accuracy	0.05%
Conversion Rate	10 Hz for 50 Hz line, 12 Hz for 60 Hz line.
Line Rejection	>100:1

## Thermocouple Specifications

(Input Specifications are same as the Voltmeter Specifications)

Channels	16
Thermocouple Types	B, E, J, K, R, S, T
Display Units	Degrees C, F and K
Display Resolution	0.1 Degree C
Temperature Displays	Actual, Nominal, or Offset
Open Check Current	250 uA
Accuracy	0.5 Deg C for J, K, E, and T 1.0 Deg C for R, S, and B

(Errors are for the SR630 only. Standard errors for thermocouple wire are 2 to 5 times the error due to the SR630. See section on thermocouple reference data for additional information.)

## Scanning and Data Logging Functions

Dwell Time	10 to 9999 seconds between successive scans.
Alarm	Temperature or voltage limit for each channel.
Alarm Relay	Rated for up to 1 amp and 100V DC/AC, 30W/60VA maximum (resistive load).
Scan Enable	Channel may be scanned or skipped.
Proportional Outputs	For Channels 1, 2, 3 and 4, $\pm 10$ V.
Printer Output	Voltages, Temperatures, Time and Date as a list or in a graphical format.
Data Memory	Last 2048 measurements in battery backed-up memory.

## General

Store and Recall	Nine locations for instrument set-up.
Interfaces	RS232, GPIB, and Centronics Printer (Standard) All instrument functions controllable via RS232 or GPIB.
Power	100/120/220/240 Vac, 50/60 Hz.
Rack Mount	Optional
Dimensions	8.5" x 3.5" x 13" ( W x H x D )
Weight	9 lb.

(All specifications apply for 18° C to 28° C operation.)

**\*\*\*\*\*CAUTION\*\*\*\*\***

This instrument may be damaged if operated with the LINE VOLTAGE SELECTOR card set for the wrong ac line voltage or if the wrong fuse is installed.

### Line Voltage

The SR630 can operate from a 100 V, 120 V, 220 V or 240 V ac power source having a line frequency of 50 or 60 Hz. Before connecting the power cord to a power source, verify that the LINE VOLTAGE SELECTOR card, located in the rear-panel fuse holder of the unit, is set so that the correct ac input voltage value is visible.

Conversion from one ac input voltage to another requires a change in the fuse holder's LINE VOLTAGE SELECTOR card position and a new fuse. Disconnect the power cord, slide the fuse holder cover to the left and rotate the fuse-pull lever to remove the fuse. Remove the small printed circuit board. Select the operating voltage by orienting the printed circuit board. Press the circuit board firmly into its slot, so the desired voltage is visible. Rotate the fuse-pull lever back into its normal position and insert the correct fuse into the fuse holder.

### Line Fuse

Verify that the correct line fuse is installed before connecting the line cord to the unit. For 100 V and 120 V, use a 1/2 Amp fuse and for 220 V and 240 V, use a 1/4 Amp fuse.

### Line Cord

The SR630 has a detachable, three-wire power cord with a three-contact plug for connection to both the power source and protective ground. The protective ground connects to the accessible metal parts of the instrument to ground. To prevent

electrical shock, always use a power source outlet that has a properly grounded protective-ground contact.

### Power-Up

All instrument settings are stored in nonvolatile memory (RAM backed-up) and are retained when the power is turned off. They are not affected by the removal of the line cord. If the power-on self test passes, the unit will return to the settings in effect when the power was last turned off. If an error is detected, or if the backup battery is exhausted, default settings will be used.

### Use in Biomedical Applications

Under certain conditions, the SR630 may prove to be unsafe for applications involving human subjects. Incorrect grounding, component failure, and excessive common-mode input voltages are examples of conditions in which the instrument may expose the subject to large input currents. Therefore, Stanford Research Systems does not recommend the SR630 for such applications.

### Furnished Accessories

- Power cord
- Operating manual

### Environmental Conditions









#### OPERATING

Temperature: +10° C to +40° C  
(Specifications apply over +18° C to +28° C)  
Relative Humidity: < 90% Non-condensing

#### NON-OPERATING

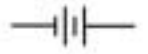
Temperature: -25° C to +65° C  
Humidity: < 95% Non-condensing

## Symbols you may find on SRS products.

Symbol	Description
	Alternating current
	Caution - risk of electric shock
	Frame or chassis terminal
	Caution - refer to accompanying documents
	Earth (ground) terminal
	Battery
	Fuse
	On (supply)
	Off (supply)

1. Remove the rear cover thermal shield and attach a K-type (Chromel-Alumel) thermocouple to channel #1's input on the rear panel. (One such thermocouple has been provided with the unit.) The red lead should be connected to the negative (-) input and the yellow lead to the positive (+) input. (These are US color codes.) Replace the thermal shield.
2. Verify that the power entry module on the rear panel is set for the voltage in your area. Using a three wire power cord, connect the unit to line power.
3. Press the POWER button to turn the unit 'ON'. Use the CHANNEL SELECT keys to select channel #1. Use the PARAMETER SELECT keys to select 'UNITS' from the parameter list. Select centigrade scale by pressing the number '7' on the PARAMETER ENTRY key pad. Then select 'TC TYPE' from the parameter list, and set the thermocouple type to K by pressing the number '3'.
4. The temperature, in degrees centigrade, should be displayed in the MEASUREMENT window. Warming the thermocouple with your fingers should cause the temperature to rise: if the reported temperature goes down, then the thermocouple was probably attached with the wrong polarity. (Remember, the red lead is negative for the US, positive for European standards.) Type K thermocouples have a standard limit of error of  $\pm 2.2$  °C. Type K thermocouples supplied by SRS have special limits of error of  $\pm 1.1$  °C.



Figure 1. SR630 Thermocouple Reader

## Instrument Overview

The Model SR630 is a 16 Channel "computing" microvoltmeter. The unit can digitize 16 rear panel differential inputs with a resolution of 15 bits plus sign. Gains and offsets are controlled to microvolt levels. The dual slope integrating converter is synchronized to the line frequency for high noise immunity. The unit completes 10/12 conversions per second when used on a 50/60 Hz line.

The unit determines the temperature of a thermocouple junction by measuring the voltage and computing the temperature from the known characteristics of B, E, J, K, R, S or T type thermocouples. Additional junctions are formed where the thermocouples connect to the back panel of the instrument, but the SR630 compensates for these by measuring the temperature of the connector block and subtracting the expected voltages (which depend on the thermocouple type and connector block temperature) before computing the thermocouple temperature.

Four analog outputs on the rear panel of the instrument may be used to drive strip chart recorders or to adjust proportional temperature

controllers. Small offset voltages at the outputs may be nulled from the front panel or via the computer interfaces.

The SR630 has GPIB (IEEE-488), RS232 and printer interfaces. The GPIB and RS232 may be used to control all functions and to read data from the instrument. The printer port may be used to log data from the 16 channels in either a numerical or graphic format.

An alarm may be set to signal when the measured temperature goes above  $T_{max}$  or below  $T_{min}$  or if the thermocouple becomes an open circuit. A rear panel BNC provides a switch closure during an alarm condition or when the unit is turned off.

A battery-backed-up real-time clock maintains the time and date when the unit is off. An alarm may be set to signal when the measured temperature goes above  $T_{max}$  or below  $T_{min}$  or if the thermocouple becomes an open circuit. A rear panel BNC provides a switch closure when there is an alarm condition, or when the unit is turned "OFF".



## Displays

The front panel has three display windows. Generally, the left display indicates the selected channel, the middle display an instrument or channel parameter value (e.g. GPIB address or temperature alarm limits), and the right display the measured value (in the appropriate units).

## Channel Select and Scanning Mode

The CHANNEL up/down buttons select one of sixteen rear panel inputs. Pressing the up and down buttons simultaneously causes the instrument to begin scanning selected channels (A channel is selected by setting its SCAN ENABLE parameter to "yes"). In scan mode, the SCANNING LED will be lit and selected channels will be read as rapidly as possible, beginning with the lowest channel number. If a printer is hooked up, scan data will be printed (in either List or Graph mode) at the end of the run. The DWELL TIME (10 to 9999 seconds) sets the time between the start of subsequent scans.

The rear panel analog outputs will be updated only when the corresponding channel is scanned or displayed manually. Printer activity stops when scanning is stopped.

## Parameter Select

PARAMETERS are selected for display and modification using the parameter up/down keys. These parameters are listed in Table 1. The first six are "instrument parameters" which may be modified regardless of the selected channel; the rest are channel specific.

## Store and Recall

Store (STO) and Recall (RCL) keys are used to save and retrieve parameter settings for all channels (not just a selected channel). There are nine storage locations (1-9) and ten possible recall locations(0-9). To store/recall location 7 press STO/RCL 7 EXC. Recalling location 0 will set the instrument to its default state.

	Name	Description
Instrument:	GPIB ADD	GPIB interface address, 1-31
	RS232 BAUD	RS232 baud rate, 150, 300, ... 9600 baud
	DATE	Month.Day.Year (US Format) Ex: 12/31/1999
	TIME	Hours.Minutes Seconds(24 Hour Format) Ex: 23:59:00
	PRINTER	Off, List, grph ( Off, list or graphics )
	DWELL	Time between start of scans, and buffer mode (stop/roll)
Each Channel:	UNITS	Select Degrees K, C, F, mVdc, or Vdc
	SCAN ENABLE	Select Yes or No for inclusion in scan list
	TC TYPE	Thermocouple type B, E, J, K, R, S, or T
	Tnom	Nominal temperature for this channel and chart center
	$\Delta T = T - T_{nom}$	Measured deviation from nominal temperature
	CHART SPAN	Range of values for strip charts and analog outputs
	ALARM ENABLE	Enable alarm if temperature exceeds limits
	Tmax	Upper limit before alarm
Tmin	Lower limit before alarm	

Table 1. List of instrument and Channel Parameters

Channel: Display channel 1, not scanning.

Parameter: Display GPIB address. Set parameters as follows:

GPIB ADD	Not affected
RS232 BAUD	Not affected
DATE	Not affected
TIME	Not affected
PRINTER	Off
DWELL	10 s
UNITS	Deg C
SCAN ENABLE	Yes
TC TYPE	K
T NOM	0
CHART SPAN	1000
ALARM ENABLE	Yes for 1 to 4
Tmax	1000
Tmin	0

**Table 2. Instrument Default State (after RCL 0)**

### Parameter Entry

Parameters may be entered using the 15-button keypad. If the instrument is in the GPIB REMOTE mode, press the execute (EXC) key first to return to LOCAL operation. Numeric parameters (e.g. GPIB address or nominal temperatures ) may be entered directly, while non-numeric ones (e.g. printer mode and display units) are selected by pressing the key directly below the desired legend.

The PARAMETER display indicates non-numeric data as follows:

PRINTER	oFF	LISt	grPh	
UNITS	AbS	CEnt	FrEn	dC
SCAN EN	yES	no		

The entered parameter becomes valid when the EXC key is pressed or when a parameter up/down

key is pressed. The backspace key (BKSP) may be used to delete a key press or to return to the previous value if all of the new key presses are deleted.

If the UNITS for a channel are changed, then Tnom, CHART SPAN, Tmax and Tmin will be calculated to replace the existing values. This allows the user to change units without affecting the operation of the alarms or analog outputs. The relative temperature display will be in the new units.

The TEMP key provides a convenient way to enter the present temperature for Tnom.

The MEASUREMENT Display will be formatted for -999.9 to 9999. degrees or ±9.999 mV, ±99.99 mV, ±999.9 mV, ±9.999 V, or ±99.99 V. Minus signs are displayed but plus signs are omitted on all displays. Selected units for each channel are indicated on the units indicators just to the right of the display.

### Status Indicators

Status indicators are located above the power switch. These LEDs indicate the various conditions detailed in Table 3.

REMOTE	GPIB Remote state. (Press EXC to go to LOCAL.)
GPIB	Turns on for any GPIB activity, and stays on until end-of-record.
RS232	Turns on for any RS232 activity, and stays on until end-of-record.
PRINTER	Turns on when data sent to printer.
ERROR	Red LED for command, parameter or printer errors.

**Table 3. Status Indicators**



Figure 2. SR630 Rear Panel

The rear panel of the instrument is shown in Figure 2. The thermal shield has been removed by unscrewing the thumbscrews on either end of the shield. The printer port, GPIB (IEEE-488 compatible) and RS232 interfaces are located along the top. All control functions and parameter settings may be set via the GPIB or RS232 interfaces.

The RS232 port is type DCE and may be attached directly to PCs by using a standard (i.e. not "null-modem") serial cable. The RS232 baud rate may be set from the front panel to any standard speed from 150 to 9600 baud.

A Centronics compatible printer may be attached (for data logging) by using a standard "PC" parallel cable. The printer interface supports two print modes: LIST mode which lists the time, date and temperatures (or voltages) for all channels selected to be scanned, and a graphics mode, which prints a strip chart recording of the selected channels, with a new line printed every Dwell Time. A line of text which details all instrument settings is printed whenever a print mode is selected.

Four rear panel analog outputs provide dc outputs in the range of  $\pm 10.0$  Vdc. These outputs may be set to track the difference between the nominal and measured temperatures (or voltages) of the corresponding channel (1 through 4) for proportional temperature control or analog strip chart recording. The analog voltage at these rear panel outputs is given by:

$$V_{out} = 20 * ( T - T_{nom} ) / \text{Chart Span}$$

If the output voltage is used to control a heater to maintain an object above ambient temperature, the user should enter a negative chart span so that the output voltage will decrease (reducing heater power) as the measured temperature increases.

If desired, the analog outputs may also be configured (via remote programming) as simple voltage sources in the range  $\pm 10$ V.

The 16 differential inputs to the SR630 are also located on the rear panel. Each input floats with respect to chassis ground and has a 10 M $\Omega$  resistance between the + and - terminals.

## Connecting Thermocouples

Thermocouples may be connected to the instrument by removing the thermal shield on the rear panel. This shield is important for accurate temperature measurements and should be replaced after the thermocouples are attached. Type B, E, J, K, R, S or T thermocouples may be used. The thermocouple type must be specified for each channel, either by front panel entry, or via one of the computer interfaces.

## Setting Instrument Parameters

Six parameters affect the entire instrument while eight are channel-dependent. Instrument parameters are GPIB address, RS232 baud rate, printer mode, dwell time, logging mode, time and date. Channel parameters are units (volts or temperature), scan enable, thermocouple type, nominal temperature (or voltage), chart span, alarm enable and alarm limits (max,min).

Parameters are selected with the PARAMETER SELECT up/down keys. Once selected, the current parameter value will be displayed.

Some parameters, such as UNITS, become effective as soon as the key is pressed. Others, like GPIB address or time and date become effective only after the EXC key is pressed, or when another parameter is selected. This allows editing of entered values from the front panel before they take effect. The BKSP (backspace) key may be used to delete entered values. Backspacing through all the entered values for a new parameter will cause the previous value of that parameter to appear. The LED indicator for a parameter will blink when a new value is entered until that value takes effect.

All parameters may be set or read via the front panel or computer interfaces. All parameters, except for GPIB address, RS232 baud rate, time and date, may be stored and recalled. Nine settings (1-9) may be stored at any one time. RCL 0 will restore default settings.

## GPIB Address

The GPIB address may be changed by entering a number from 0 to 31. The default GPIB address for the SR630 is 19. The new GPIB address will take effect when the EXC key is pressed, or when a PARAMETER SELECT up/down key is pressed.

## RS232 Baud Rate

The RS232 baud rate, for serial communications between the SR630 and a computer, may be set by selecting the "RS232 BAUD" parameter. The current RS232 baud rate will be displayed in the PARAMETER window. A new value of 150, 300, 600, 1200, 2400, 4800, or 9600 baud may be entered. The new RS232 baud rate will take effect when the EXC key is pressed, or when either PARAMETER SELECT key is pressed.

## Date

The date may be displayed or modified by selecting DATE(m,d,y) parameter. Dates are entered and displayed in US format, with 0's. So, to set the date to September 1, 1995 enter 09011995. The new date will take effect when the EXC key is pressed, or when either PARAMETER SELECT key is pressed.

## Time

The SR630 clock may be displayed or modified by selecting the TIME(hr,min,sec) parameter. Times are entered and displayed in a 24 hour format, with 0's. E.g. To set the time to 30 seconds after 5:00 pm enter 170030. The new time will take effect when the EXC key is pressed, or when either PARAMETER SELECT key is pressed.

## Printer Mode

There are three printer modes: off, list, and graphical. A printer may be used to log data of the scanned channels. The list mode prints the time, date, and value of all scanned channels whenever a scan is completed. The graphic mode produces a strip chart record on the printed output. The range of values printed in the graphics mode is set by the CHART SPAN parameter. To view or set the printer mode select PRINTER and use the PRT MODE key (the decimal point key) to toggle between print modes. The new print mode will take

effect when the EXC key is pressed, or when a PARAMETER SELECT up/down key is pressed.

## Scan Dwell Time and Data Logging

The SR630 can scan any of 16 channels, storing up to 2048 measurements with time and date stamps, with or without printing. The time between the beginning of scans, in seconds, may be viewed or modified by selecting the DWELL parameter. The dwell time may be set from 10 to 9999 seconds. The new dwell time will take effect when the EXC key is pressed, or when a PARAMETER SELECT up/down key is pressed. (See Scan Enable in channel parameter description.)

When a scan is started, data will be stored in non-volatile memory with time and date stamps. This data buffer is large enough to hold 2048 measurements. When the buffer is full, the logger will either stop or begin to overwrite (roll-over) the oldest data, depending on the mode setting. The logging mode will appear in the MEASUREMENT window as either StoP or rOLL when the DWELL parameter is selected. The YES/NO key (the minus sign on the PARAMETER ENTRY key pad) may then be used to change the logging status. This change takes effect immediately. Note: Beginning a scan from the front panel will automatically start storage of data from the first memory location in the data buffer (cf. remote programming).

## Setting Channel Parameters

Eight parameters may be set for each of the 16 channels. Parameter settings for each channel are independent of the settings for all the other channels. For example, UNITS, nominal temperature, and alarm limits may be set to different values for each channel. The setting of the channel parameters is detailed below. To set these parameters for any particular channel, first select the channel (1 to 16) by using the CHANNEL SELECT up/down keys. Then select the channel parameter of interest with the PARAMETER SELECT up/down keys. The PARAMETER ENTRY keypad may be used to modify the displayed parameter.

## Measurement Units

Display units for a measurement may be set when UNITS is selected in the parameter list. Degrees Kelvin (absolute), centigrade, Fahrenheit, volts or

millivolts may be selected by pressing the corresponding key along the top row of keys in the PARAMETER ENTRY section. Selected units become effective immediately. Units are indicated by an indicator to the right of the MEASUREMENT window, and are abbreviated in the PARAMETER window.

## Scan Enable

A channel will be read during scanning if the SCAN ENABLE parameter is set to "YES". To read or modify the scan enable status, select SCAN ENABLE from the list of channel parameters. The YES/NO key (the minus sign on the PARAMETER ENTRY keypad) may be used to change the scan enable status. Scan enable status takes effect immediately.

## TC Type

The SR630 supports 7 different thermocouple types. For details and characteristics of these thermocouples, see the "Thermocouple Reference Data" section. To display or modify the thermocouple type for a selected channel, select TC TYPE from the list of parameters. The TC TYPE is displayed in the PARAMETER window as a single digit number, 0 to 6 : B=0, E=1, J=2, K=3, R=4, S=5, T=6 (as indicated on the parameter-entry keypad). For example, pressing "3" when the TC TYPE parameter is lit will cause the thermocouple type to change immediately to K. This parameter has no effect when voltages are displayed.

**Special Note:** The CHART SPAN, Tnom,  $\Delta T$ , Tmax and Tmin parameters may be used to specify either temperatures (the usual case) or voltages. In this way, the SR630 may be used to display, list, graph, and alarm either temperature or voltage conditions. Values must be entered in the same units which have been set for the channel: a temperature should be entered if UNITS has been set to degrees K, C or F, and a voltage should be entered if UNITS has been set to volts or millivolts.

## Nominal Temperature or Voltage

A nominal temperature (voltage) may be displayed and set for each channel by selecting the Tnom parameter. The nominal value is subtracted from

the present measurement when  $\Delta T = T - T_{nom}$  is the selected parameter. The nominal value also sets

### Temperature or Voltage Deviation

Select  $\Delta T = T - T_{nom}$  to display the deviation of the present reading from the nominal temperature (or voltage). The deviation from nominal is displayed in the units set for the channel. No data may be entered when  $\Delta T = T - T_{nom}$  is displayed.

### Chart Span

The CHART SPAN parameter sets the full-scale temperature (or voltage) for the rear-panel analog outputs and graphics mode printer output. To display or modify the span, select CHART SPAN with the PARAMETER SELECT up/down keys. For example, if the span is set to 25 degrees, then the analog output will be at full scale (+10 Vdc ) when the temperature for that channel is 25 degrees greater than nominal, and minus full scale (-10 Vdc ) when the temperature is 25 degrees below nominal. CHART SPAN may be set to a negative value, in which case the analog output decreases as the temperature increases. This feature may be used for controlling heaters in a closed-loop system. In such a control system, the gain of the feedback is increased when the chart span is decreased.

### Alarm Enable

The alarm feature may be enabled on a channel-by-channel basis. To examine or modify the alarm enable status for the currently selected channel, use the PARAMETER SELECT up/down keys to select the ENABLE (ALARM) parameter. The YES/NO key ( the minus sign on the keypad ) may be used to modify the current alarm enable status. If the measured temperature ( or voltage ) exceeds the set limits ( Tmax and Tmin ), and the alarm enable status bit is set, then the audio alarm will sound. The out-of-limit channel number is displayed on the front panel, and a rear panel BNC provides a switch closure (e.g. to turn on an alarm LED or light).

### Alarm Relay

The relay switch is a Hasco HS212 in a SPST layout, rated for up to 1A and 100V AC or DC, 30W/60VA maximum into a resistive load. Operate

the center value for the analog strip chart outputs and for graphical printer outputs.

and release times are approximately 3 mS and 2 mS respectively.

### Temperature (Voltage) Limits

Both the upper and lower temperature (or voltage) limits for the alarm function may be set for each channel. To display or set the upper temperature (or voltage) limit, use the PARAMETER SELECT up/down keys to light the Tmax indicator. The temperature (or voltage) limit may be entered using the numeric PARAMETER ENTRY keypad. The value must be entered in the units set for the channel. Tmin may be entered in the same way.

If the UNITS parameter is changed between degrees K, C or F, the alarm limits will also be converted, so that the alarms will not be affected by this change. However, different alarm limits are saved for voltages, so selecting volts or millivolts for the channel will affect alarm limits.

Note: The alarm will not activate if the specified channel is never measured (i.e. not selected or not enabled for scanning) even if the ALARM ENABLE parameter is set to "YES."

### Multiplexer Mode

The SR630 may be used as a 15 Channel differential analog signal multiplexer. This allows one of 15 analog signals selected by the SR630 to be passed to other instruments.

In this mode of operation, the relay for channel 16 will always be enabled. The selected channel may be read by the SR630 and is available to other instruments on the terminals which are normally used as an input to channel 16. To enter the multiplex mode, press the Bksp and "-" buttons on the front panel simultaneously.

This mode of operation may also be activated via the GPIB or RS232 interfaces by using the MPXM 1 command. The mode is disabled with the MPXM 0 command, or whenever the unit is turned off. Note: the relays will stay in their activated positions on power-down and remain so until reset upon power-up.

Once the multiplex mode is selected, a channel may be selected from either the front panel or by the computer.



## Unit does not turn "ON":

- 1) Power cord and line voltage?
- 2) Fuse blown?
- 3) Power entry module set for local voltage?

## Does not read voltages correctly

- 1) Wrong channel selected?
- 2) Rear panel connections shorted or loose?
- 3) UNITS set incorrectly?
- 4) Defective internal relay? (try another channel)
- 5) Voltage greater than  $\pm 100$  V?
- 6) Time, Date or Dwell displayed?
- 7) ac voltage present?

## Does not read temperatures correctly

..in addition to voltage problems above,...

- 1) Wrong thermocouple type specified?
- 2) Thermocouple + and - swapped? (Red="-")
- 3) Defective thermocouple?
- 4) Thermal shield not in place?
- 5) Outside temperature range for couple type?

## Alarms not working

- 1) Alarm limits in correct units?
- 2) Tmax set lower than Tmin?
- 3) Channel not scanned?
- 4) Alarm Enable turned "OFF"?

## Printing problems

- 1) Printer error ?
- 2) Out of paper?
- 3) Printer off-line?
- 4) Not scanning?
- 5) Wrong print mode?

## Logging problems

- 1) Wrong mode selected (Roll vs. Stop)?
- 2) Not placed in scan mode?
- 3) Lost record by re-entering scan mode?
- 4) Scan enabled for channels of interest?

## Miscellaneous problems

Key pad does not work -- GPIB Lockout? (press EXC to go to LOCAL)

Does not scan -- Scan Enable off on all channels?

Does not retain settings when turned off or loses time and date settings -- replace lithium battery inside unit on main PCB.

Instrument is "hung"-- RAM may be corrupted, try a cold boot by holding down the BKSP (backspace) key while turning the unit "ON". This will reset the instrument to its default state (including GPIB address and RS232 baud rate); factory calibration values are recalled from ROM, and the time and date will need to be reset.

### Error List

- Error 0: Attempt to read empty log
- Error 1: Memory checksum error
- Error 2: No channels selected in scan mode
- Error 3: Recalled set-up corrupted
- Error 4: Problem reading logged data
- Error 5: Printer time-out error
- Error 6: Command syntax error
- Error 7: Range error
- Error 8: Communications buffer overflow

## Remote Programming

The SR630 Thermocouple Reader may be programmed remotely through either GPIB (IEEE-488) or RS-232 interfaces. Any computer supporting these interfaces may be used to control and read data from the SR630 .

The SR630 supports both the IEEE-488.1 (1978) interface standard and the required common commands of the IEEE-488.2 (1987) Standard. To communicate with the SR630 over the GPIB interface, the proper device address must be set. This may be done from the front panel by using the PARAMETER SELECT up and down arrow keys to select GPIB ADD from the parameter list. Use the numeric keypad to enter a number between 1 and 31.

RS232 commands are identical to those used with GPIB. The baud rate for RS-232 communications may be set from 150 to 9600 baud by using the PARAMETER SELECT up and down arrow keys to select RS232 BAUD from the parameter list. Use the numeric keypad to enter a baud rate (150,300, 600,.. 9600).

## Command Syntax

Communications with the SR630 use ASCII characters. Commands may be in either UPPER or lower case and may contain any number of embedded space characters.

A command to the SR630 consists of a four character command mnemonic, arguments if necessary, and a command terminator. The terminator is a linefeed <lf> or EOI for GPIB, a <cr> or <lf> for RS232. No command processing occurs until a command terminator is received. Command mnemonics beginning with an asterisk are IEEE-488.2 (1987) defined common commands. Commands may require one or more parameters, with multiple parameters separated by commas.

Multiple commands may be sent on one command line by separating them by semicolons ";". Sending multiple commands in one line ensures that they will be executed simultaneously and allows synchronization to be achieved using the synchronization commands.

There is no need to wait between commands. The SR630 has a 256 character input buffer and processes commands in the order received. If the buffer fills up, the SR630 will hold off handshaking on the GPIB. Similarly, the instrument has a 256 character output buffer to store output until the host computer is ready to receive it. If the output buffer is filled, it is cleared and an error reported.

The present value of a particular parameter may be determined by querying the SR630 for its value. A query is formed by appending a question mark "?" to the command mnemonic and omitting the desired parameter from the command. If multiple queries are sent on one command line (separated by semicolons, of course), answers will be returned in a single response line with the individual responses separated by semicolons. All GPIB responses are terminated with a linefeed and an EOI; all RS232 responses are terminated with a carriage return and a linefeed (<cr><lf>).

## Examples:

UNIT 12, CENT	Set units for channel 12 to centigrade.
TTYP 12, K	Specify K-type thermocouple for channel 12 .
MEAS? 12	Measure temperature of channel 12.

## Detailed Command List

The four letter mnemonic in each command sequence specifies the command. The rest of the sequence consists of parameters. Multiple parameters are separated by commas. Commands that may be queried have a question mark in parentheses (?) after the mnemonic. (The parentheses are not actually sent as part of the command string.) Commands that may ONLY be queried have a ? after the mnemonic. Commands that MAY NOT be queried have no question mark.

## General (channel independent) commands

### **GPIB(?) n**

The GPIB command sets or reads the GPIB address. If remote commands are being sent over GPIB, changing the address will stop communications.

### **BAUD(?) n**

The BAUD command sets or reads the RS232 baud rate. Choices are 150, 300, 600, 1200, 2400, 4800 and 9600. Sending this command is recommended at the start of a program as this will initialize the SR630's RS232 port. However, changing the baud rate while talking over RS232 will stop communications (cf. GPIB).

### **TIME(?) n,n,n**

The TIME command sets or reads the time on the SR630. Command transmission order is Hr, Min, Sec. Queries will return the time in the same format separated by commas. Note: the SR630's clock runs on 24hr time ( e.g. 5:00 PM = 17:00).

### **DATE(?) n,n,n**

The DATE command sets or reads the date. Proper format for transmission is Month, Day, Year. Queries will return the date in the same format separated by commas.

### **PRTM(?) mnem**

The PRTM command sets the printer mode. The user can choose between GRPH and LIST modes, or the printer may be turned OFF.

### **DWEL(?) n**

The DWEL command sets the time between the start of successive scans. The time n is specified in seconds and is in the range 10 to 9999.

## Channel-dependent commands

### **UNIT(?) ch,mnem**

The UNIT command selects the units of channel ch. Possible arguments are ABS (Kelvin), CENT, FHRN, mDC (mV) or DC. Queries will return the currently assigned mnemonic.

### **SCNE(?) ch,mnem**

The SCNE commands enables or disables the scan option on channel ch. Possible arguments are YES or NO, and queries will return the same format.

### **TTYP(?) ch,mnem**

The TTYP command selects the thermocouple type for channel ch. Possible arguments are B,E,J,K,R,S and T. Queries will return the currently-assigned letter type. Note: although the SR630 displays thermocouple type numerically on the front panel, numeric arguments are not allowed for this command.

### **TNOM(?) ch,n**

The TNOM command sets the nominal temperature value for channel ch to n. The range of possible values is :

For temperature: -270 to +3300  
For voltage: -99.999 to 99.999

### **TDLT? ch**

The TDLT command returns the value of delta T for channel ch, defined as T measured - T nominal.

### **SPAN(?) ch,x**

The SPAN command sets or reads the allowable span for channel ch (to set printer graph ranges or for the rear panel strip chart outputs).

# Command List

## **ALRM(?) ch,mnem**

The ALRM command enables (YES) or disables (NO) the alarm function for channel ch.

## **TMIN(?) ch,x**

The TMIN command sets the alarm lower voltage or temperature limit of channel ch to x. The range for x is the same as for the command TNOM.

## **TMAX(?) ch,x**

The TMAX command sets the alarm upper voltage or temperature limit of channel ch to x. The range for x is the same as for TMIN and TNOM.

## **VMOD(?) ch,i**

The VMOD command allows the user to set the rear panel analog output ch to either (i=0) track the corresponding channel or (i=1) act as a programmable voltage source. The allowable range for ch is 1-4.

## **VOUT(?) ch,x**

The VOUT command sets the output voltage of analog output ch (1-4) when set for programmable output. The voltage can be in the range -9.999 to 9.999.

## **Calibration Commands**

### **\*CAL? n**

The \*CAL command allows the user to calibrate either the offset or gain bytes. Options for n are:

- 0 autocal all offset bytes
- 1-8 calibrate individual offset byte n.
- 9-16 calibrate individual gain byte n.

Offset calibration is performed using channel 16 as the reference (ch 16 must be shorted) while gain calibration requires a reference on channel 15

equal to the full-scale voltage of the range to be calibrated.

The \*CAL? command will return one of the following values:

- 0 Calibration successful.
- byte n Out of range result when attempting to calibrate byte n.
- 200 Cal mode error (e.g. user was in relay multiplex mode when trying to calibrate).

### **CALB(?) n**

The CALB command allows the user to read or write cal byte n. For a full listing of the cal bytes and their descriptions, see the chapter on Calibration.

## **Data Logging Commands**

### **SCAN(?) i**

The SCAN command enables (i=1) or disables (i=0) the scanning and logging mode. Note: Unlike starting a scan via the front panel, the SCAN 1 command does not reset the buffer counter (NPTS) each time, so successive scans may be run without losing old data. Data may be cleared with the BCLR command.

### **DATM(?) i**

The DATM command selects the logging data mode of the 630. Options for i are:

- 0 ASCII mode.
- 2 Brief ASCII Mode (see RLOG below).

### **BUFM(?) i**

The BUFM command determines whether the 630 will stop logging data (i=0) or begin overwriting the oldest data (i=1) when the buffer is full. If the buffer mode is changed after taking data, a BCLR is highly recommended to prevent possible overwrite problems.

## BCLR

The BCLR command clears the data buffer and stops logging measurements.

## NPTS?

The NPTS? query returns the number of measurements stored in the logging buffer. The maximum number of readings stored is 2048.

## RLOG i,j

Read j measurements in the logging buffer, beginning with item i. The maximum value of i is 2047, maximum for j is 2048-i or NPTS. ASCII data has the format: Chan#, Units (0=ABS, 1=CENT, 2=FHRN, 3 = mDC, 4=DC), measured value, Month, Day, Year, Hr, Min, Sec <lf>. Brief ASCII omits time and date values.

RLOG queries sent as part of a multiple-command line will not be returned with ';' delimiters but will be separated by a <lf>.

Note: Although multiple measurements may be returned using RLOG, reading only a single measurement at a time is recommended (i.e. RLOG x,1) for maximum program control. This also minimizes possible synchronization problems.

## Measurement Commands

### MEAS? ch

The MEAS? query returns the value measured by channel ch in the selected units. Note: mDC returns values in milliVolts while DC returns values in Volts. (See UNIT and CHAN commands.)

### CHAN(?) ch

The CHAN command switches the 630 to read from channel ch. The query version (CHAN?) returns the current channel number.

## \*WAI

The \*WAI (wait) command holds off further command execution until all commands currently in progress are completed. This command ensures that a particular operation is finished before continuing.

## GPIB Common Commands

### \*IDN?

The IDN? common query returns the SR630's device identification string. The string format is:

```
StanfordResearchSystems,SR630,xxxx,yyyy
```

where xxxx is the serial number and yyyy is the firmware version number.

### \*STO i

The \*STO command stores the current parameter settings for all 16 channels in memory. The argument i can be in the range 1-9.

### \*RCL i

The \*RCL command recalls parameter setting i from memory. The argument can be from 1-9 or 0 to recall default settings.

### \*CLS

The \*CLS command clears all status registers.

### \*ESE(?) i

The \*ESE command sets the standard status byte enable register to the value i.

### \*ESR? i

The \*ESR? command reads the value of the the standard event status byte. If the parameter i is present, the value of bit i is returned. Reading this register will clear it while reading bit i will only clear bit i.

# Command List

## \*PSC? i

The \*PSC common command sets the value of the power-on status clear bit. If i=1, the power-on status clear bit is set and all status and enable registers are cleared on power-up. If j=0, the bit is cleared and all the status and enable registers will retain their values on power-down. This allows the unit to send a service request on power-up.

## \*RST

The \*RST command returns the SR630 to the default configuration. This command is equivalent to doing a RCL 0 from the front panel.

## \*SRE(?)

The \*SRE common command sets the serial poll enable register to the value i.

## \*STB? i

The \*STB? common query reads the value of the serial poll byte. If the argument i is present, the value of bit i is returned. Reading this register has no effect on its value as it is a summary of the other status registers.

## Status Byte Definitions

### Serial Poll Status Byte:

bit	name	usage
0	OVRG	Overrange error. Query overrange status register to determine channel(s).
1	RLOG error	No data in RLOG buffer when queried.
2	RLOG timeout	The SR630 timed-out while waiting to send back RLOG data. Timeout length is 65.5 seconds.
3	OPEN	Open circuit error. Query OPEN status register to determine channel(s).

4	MAV	The GPIB output queue is non-empty.
5	ESB	An unmasked bit in the standard status byte has been set.
6	RQS/MSS	SRQ (service request) bit.
7	ALRM	An Alarm condition has been met. Query ALMS register to determine which channel(s).

The ESB bit is set whenever any unmasked bit (i.e. one with the corresponding bit in the byte enable register set) in the standard event register is set. This bit will not be cleared until the condition which set the bit is cleared. A service request will be generated whenever an unmasked bit in the serial poll register is set. Note that service requests are only produced when the bit is first set and thus any condition will only produce one service request. Accordingly, if a service request is desired every time an event occurs, the status bit must be cleared between events.

### Standard Event Status Byte:

bit	name	usage
0	OPC	Not used by the SR630.
1	unused	
2	Query Error	Set on output queue overflow
3	Device error	RCL command failed or RAM corrupted on power-up (reset to defaults).
4	Execution Err	Set by an out-of-range parameter or non-completion of some command due to an error condition (e.g. overload).
5	Command Err	Set by a command syntax error or an unrecognized command.
6	URQ	Not used by the SR630.
7	PON	Set by power on.

This status byte is defined by IEEE-488.2 (1987) and is used primarily to report errors in commands received over communications interfaces. The bits

in this register stay set once set and are cleared by reading them or by executing the \*CLS command.

## Miscellaneous Commands

### OPEN? {i}

The OPEN? query reads the open channel status register (16 bits). A bit value of 1 signifies an open channel. Each channel may be queried individually by specifying the proper bit (bits 0-15 for channels 1-16 respectively), or if no argument is used, the status of all channels will be returned as a 16 bit integer. Note: this command only works when units of temperature are selected.

### OVRG? {i}

The OVRG query reads the channel overrange status register. A bit value of 1 indicates that a channel has exceeded its range limit (e.g. input voltage >1.00V while on the mV scale). The register contains 16 bits which may be queried individually or collectively as per the OPEN? query.

### ALMS? {i}

The ALMS query reads the alarm status register. When an alarm condition is met, the bit for the specified channel is set to 1. The 16 bits in this register may be queried with or without an argument as per the OVRG? and OPEN? queries.

**Note:** For each of the three preceding commands, querying a register will clear it while querying a specific bit will clear only that bit.

### MPXM i

The MPXM command is used to set (i=1) or reset (i=0) the "multiplex mode". In this mode of operation, the relay for channel 16 is always enabled, allowing the SR630 to serve as a 1:15 differential analog multiplexer so that any one of the signals on channels 1 to 15 may be passed to other instruments via the terminals for channel 16. This command will be ignored if the unit is in calibration mode or scanning mode.

## Program Examples

This program is a simple example of interfacing the SR630 Thermocouple monitor to a PC via the RS232. A standard serial cable is connected between the COM1 port of the PC and the RS232 port of the SR630. The program was written in GW BASIC.

```
10 ' Example program to read measurements from the SR630
20 ' This program uses IBM Basic and communicates via the COM1
30 ' RS232 port
40 '
50 ' Set up COM1 for 9600 baud, no parity, 8 data bits, 2 stop bits
60 ' ignore dsr, and cd
70 OPEN "COM1:9600, n, 8, 2, ds, cd" as #1
80 PRINT #1, " " 'Clear COM1
90 '
100 ' Now set up sr630: reset and choose units for ch1 and ch16
110 PRINT #1, "*RST; UNIT1,ABS; UNIT16, FHRN"
120 '
130 PRINT "Channel 1 (K)           Channel 16 (F)"
140 PRINT #1, "MEAS?1"          ' Measure channel 1
150 INPUT #1, VAL1              ' Get reading from sr630
160 PRINT #1, "MEAS?16"        ' Now do the same for ch 16
170 INPUT #1, VAL2
180 PRINT VAL1, VAL2
190 GOTO 140                    ' Loop forever
```



This program, written in Microsoft C, illustrates use of the SR630 Thermocouple Reader with the GPIB interface bus. The program also uses the data logging buffer of the SR630. (Note: use of the data logging buffer is optional. In most interface applications, the computer will select the channel and read the data without the use of scans and data buffers.)

```
/* This program will scan three channels (1-3) then print out the first */
/* twenty-one points of logger data (received in Ascii form)          */

/* This program is written in Microsoft C version 5.1. The header file */
/* for the GPIB interface is supplied by ms-c488.h and is supplied by CEC */

/* To compile this program, use the command: CL/AL/c prog.c.          */
/* Then link the resulting object file with GPIB.obj (supplied by CEC) */

#include <ms-c488.h>
#include <stdio.h>
#include <stdlib.h>
#include <string.h>
#include <time.h>

#define sr630 19 /* GPIB address for thermocouple */

/* function prototypes */
void InitGpib(void);
void TxGpib(int,char*);
void GetGpib(int);

/* global variables */
char recv[40];
int status,length;
void main(void)
{
    int i,chan,units;
    double value;
    char string[20];
    time_t a,b;

    InitGpib();
    TxGpib(sr630,"*rst;unit1,abs;unit2,cent;unit3,fhrn"); /* reset sr630
                                                            ch 1 units: Kelvin
                                                            ch2: Centigrade
                                                            ch 3: Fahrenheit */
```

## Program Examples

```
TxGpib(sr630,"bclr;dwel10;datm2");          /* clear buffer
                                           10 second dwell time,
                                           brief ascii logging */

for (i=4;i<17;i++) /* disable scans for all other channels */
{
    sprintf(string,"scne%d,NO",i);
    TxGpib(sr630,string);
}

TxGpib(sr630,"scan1"); /* enter scan mode*/

/* scan for 75 seconds */
time(&a);
do time(&b);
while(difftime(b,a) <75.);

TxGpib(sr630,"scan0"); /* turn off scan */

printf("Channel 1 (K)   Channel 2 (C)   Channel 3 (F)\n");
for (i=0;i<21;i++)          /* now read measurements from buffer */
{
    /* and print out in columns */
    sprintf(string,"rlog%d,1",i); /* want the ith reading */
    TxGpib(sr630,string);
    GetGpib(sr630);
    sscanf(recv,"%d,%d,%lf",&chan,&units,&value);
    printf("  %6.3lf      ",value);
    if(i%3 ==2) printf("\n");
}
}
/* ***** */
void InitGpib (void)          /* initialize the CEC GPIB card as controller */
{
    int my_address, system_controller,seg;

    /* Find the CEC card address */
    for (seg=0x4000;seg<0xF000;seg+=0x400)
    {
        if ((peek(seg,50) == 'C') &&
            (peek(seg,51) == 'E') &&
            (peek(seg,52) == 'C'))
            break;
    }
}
```

```

if (pc488_seg(seg))
{
    printf("No Gpib Card found.\n");
    exit(0);
}
my_address = 21;
system_controller = 0;
initialize (&system_controller, &my_address);
transmit (&status, "IFC UNT UNL REN DCL ");
}
/* ***** */
void TxGpib (int address,char *command) /* transmit command to address */
{
    char t_string[100];
    int result;

    result = sprintf (t_string,"UNT UNL MTA LISTEN %d DATA '%s' 10",
        address,command);
    transmit (&status, t_string);
}
/* ***** */
void GetGpib (int address) /* get an answer from device at address */
{
    char r_string[40], temp[80];

    sprintf (r_string, "UNT UNL MLA TALK %d", address);
    transmit (&status, r_string);

    strcpy (temp, " ");
    receive (&status, &length, temp);
    if (status==8)
    {
        printf("Timeout error.\n");
        exit(0);
    }
    strcpy (recv, temp);
}
/* ***** */

```

## Thermocouple Reference Data

It was observed a long time ago ( Seebeck, 1822 ) that a voltage exists across the junction of dissimilar metals. Figure 3 shows a thermocouple junction formed by joining two metallic alloys, A and B. The voltage across the thermocouple junction depends on the type of metals used and the temperature of the junction. The mechanism responsible for this voltage is quite complicated, but certain characteristics associated with this phenomenon make the junction useful for measuring temperature.

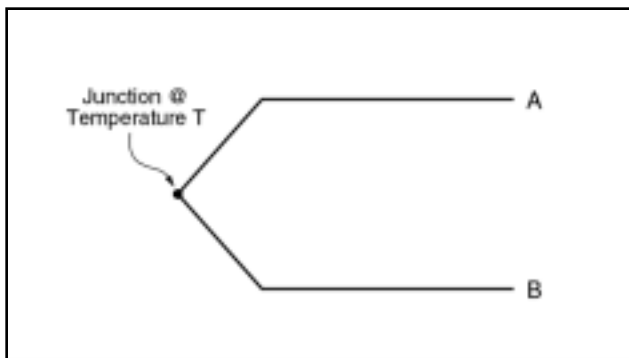

**Figure 3. A Thermocouple Junction of Alloys A and B.**

The most important characteristic is that the voltage generated is approximately linear with temperature. The change in junction voltage as a function of junction temperature is given by :

$$\text{eq 1.} \quad \Delta V = a \times \Delta T$$

where 'a' is the Seebeck coefficient. The magnitude of this coefficient depends on the types of metals used to form the junction: typical values range from 0 to 100  $\mu\text{V}/\text{C}$ . Unfortunately, the magnitude of the coefficient depends on temperature. It is generally smaller at low temperatures, and may change by more than a factor of two over the useful operating range of a thermocouple. Despite this non-linearity, the induced voltage is (usually) a monotonically increasing function of temperature, and the voltages generated by certain pairs of dissimilar metals have been accurately tabulated. These

tabulated values are referenced to the voltage seen across a junction at 0 °C.

A problem arises when one tries to measure the voltage across the dissimilar metal junction: two additional thermocouple junctions are formed where the wires are attached to the voltmeter. Figure 4 illustrates this problem. If the wires leads which connect to the voltmeter are made of alloy "C", then thermal emf's exist at the A-C and B-C junctions. There are two approaches to solving this problem: use a reference junction at a known temperature or make corrections for the thermocouples formed by the connection to the voltmeter.

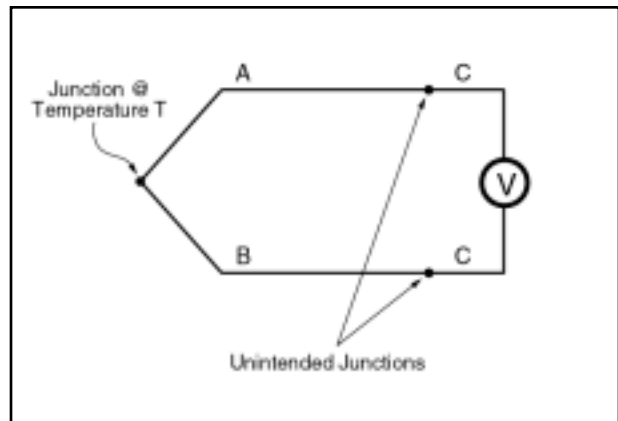

**Figure 4. Measuring Thermocouple Voltage Creates Two Additional Junctions.**

Figure 5 shows the use of a "reference" or "compensating" junction. With this arrangement, there are still two additional thermocouple junctions formed where the compensated thermocouple is connected to the voltmeter. However, the junctions are identical (they are both junctions between alloys A and C). If the junctions are at the same temperature then the voltage across each junction will be equal and opposite, and so will not affect the meter reading. Typically, the reference junction is held at 0 C (by an ice bath, for example) so that the voltmeter readings may be used to determine the temperature.

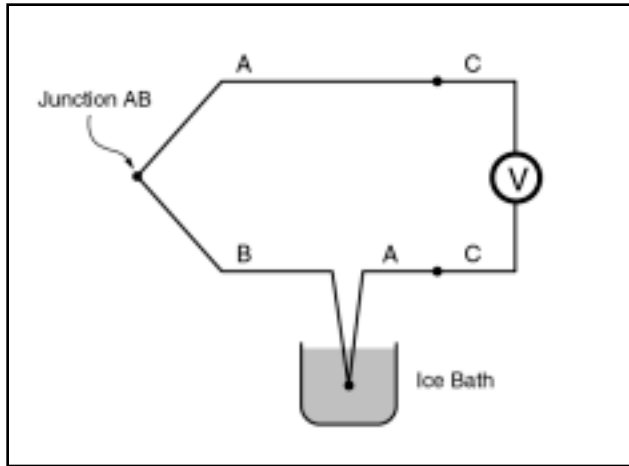

**Figure 5. Using a Reference Junction to Compensate Thermocouple (Not required for the SR630)**

The second approach to the problem depends on the fact that the voltage across the junction A-C plus the voltage across the junction C-B (Fig. 4) is the same as would be seen across a junction of A-B. The presence of an intermediate metal (C) has no effect, as long as all the junctions are at the same temperature. This allows us to correct for the voltage seen by the voltmeter in Figure 4 by measuring the temperature at the A-C and B-C junctions and subtracting the voltage which we would expect for an A-B junction at the measured temperature. In the SR630 the temperature of the A-C and C-B junctions are measured with a low cost, high resolution semiconductor detector, and the "expected voltage" is the tabulated voltage for the A-B thermocouple at the measured temperature of the A-C and C-B junctions.

The advantage of the second method (which is used in the SR630) is that any thermocouple type may be used without having to change compensation junctions or maintain ice baths.

### Characteristics of Thermocouple Types

Any two dissimilar metals may be used to make a thermocouple. Of the infinite number of thermocouple combinations which can be made, the world has settled on seven types which exhibit a range of desirable features. These thermocouple types are known by a single letter designation: J, K, T, E, R, S or B. While the composition of these thermocouples are international standards, the color codes of the wires are not. For example, in the US, the negative lead is always red, while the rest of the world uses red to designate the positive lead. Often, standard thermocouple types are referred to by their trade names. For example, K type is sometimes called Chromel-Alumel which are the trade names of the Ni-Cr and Ni-Al wire alloys.

Important criteria for a good thermocouple include a large, stable Seebeck coefficient, wide temperature range and good corrosion resistance. Generally, each wire of the thermocouple is an alloy. Variations in alloy composition and the condition of the junction between the wires are sources of error in temperature measurements. The standard error of thermocouple wire varies from  $\pm 0.8\text{C}$  to  $\pm 4.4\text{C}$  depending on the type of thermocouple used.

Type	B	E	J	K	R	S	T
Positive Material	Pt/Rh(30%)	Ni/Cr	Fe	Ni/Cr	Pt/Rh(13%)	Pt/Rh(10%)	Cu
Negative Material	Pt/Rh(6%)	Cu/Ni	Cu/Ni	Ni/Al	Pt	Pt	Cu/Ni
Positive Color(USA)	Grey	Purple	White	Yellow	Black	Black	Blue
Negative Color(USA)	Red	Red	Red	Red	Red	Red	Red
Lowest Temperature	50C	-200C	0C	-200C	0C	0C	-200C
Highest Temperature	1700C	900C	750C	1250C	1450C	1450C	350C
Minimum Std Error	$\pm 4.4\text{C}$	$\pm 1.7\text{C}$	$\pm 2.2\text{C}$	$\pm 2.2\text{C}$	$\pm 1.4\text{C}$	$\pm 1.4\text{C}$	$\pm 0.8\text{C}$

Table 4. Thermocouple Reference Data

## Thermocouple Reference Data

---

Voltage vs. Temperature measurements have been tabulated by NIST for each of the seven standard thermocouple types. These tables are stored in the read-only memory of the SR630 Thermocouple Reader. The instrument's microprocessor interpolates between the table entries in order to achieve 0.1 C resolution when converting a voltage measurement to a temperature.

The K type thermocouple is recommended for most general purpose applications: it offers a wide temperature range, low standard error, and has good corrosion resistance. The K type thermocouples provided by SRS have a standard error of  $\pm 1.1\text{C}$ , half the error designated for this type.

## Overview

There are two areas of concern in the calibration of the SR630: its performance as a microvoltmeter, and its performance as a thermocouple reader. To achieve a high degree of accuracy as a microvoltmeter we need offset and gain calibrations. For high accuracy as a thermocouple reader we need to accurately determine the "reference junction" temperature.

The hardware has been designed to minimize the sources of error. Inputs are treated in a fully differential manner, the input amplifiers are chopper stabilized, and the reference junction "zone box" is well-isolated and thermally massive. Additionally, a small semiconductor sensor is implanted in the "box" to accurately measure the reference junction temperature. Small remaining errors are canceled by firmware using final test calibration values.

The factory calibration values are burned in EPROM; these values are moved to battery backed-up RAM when the unit is turned "ON" for the first time, or if the BKSP key is held down during power-up.

Calibration values may be changed from the front panel if the calibration jumper (on the main PCB inside the unit) is in the "enable" position. To access calibration values, press the TEMP and BKSP keys simultaneously. If the message "no cAL JPr" appears, then the calibration jumper is in the "disable" position.

The unit should be on for at least 1/2 hour prior to calibration. Typically, input offset voltages on the order of 10  $\mu$ V will appear in the first few minutes of operation.

Calibration constants may be changed directly, or, in the case of offsets and gains, modified by firmware calibration routines. These routines are also accessed by pressing the TEMP and BKSP keys together.

## Locations of Calibration Constants

- 1 Voltage offset for 30 mV range
- 2 Voltage offset for 100 mV range
- 3 Voltage offset for 300 mV range
- 4 Voltage offset for 1V range
- 5 Voltage offset for 3V range
- 6 Voltage offset for 10 V range
- 7 Voltage offset for 30 V range
- 8 Voltage offset for 100V range
  
- 9 Gain constant for 30 mV range
- 10 Gain constant for 100 mV range
- 11 Gain constant for 300 mV range
- 12 Gain constant for 1V range
- 13 Gain constant for 3V range
- 14 Gain constant for 10V range
- 15 Gain constant for 30V range
- 16 Gain constant for 100V range
  
- 17 Temperature offset of connector block
  
- 18 Channel 1 temperature offset
- 19 Channel 2 temperature offset
- 20 Channel 3 temperature offset
- 21 Channel 4 temperature offset
- 22 Channel 5 temperature offset
- 23 Channel 6 temperature offset
- 24 Channel 7 temperature offset
- 25 Channel 8 temperature offset
- 26 Channel 9 temperature offset
- 27 Channel 10 temperature offset
- 28 Channel 11 temperature offset
- 29 Channel 12 temperature offset
- 30 Channel 13 temperature offset
- 31 Channel 14 temperature offset
- 32 Channel 15 temperature offset
- 33 Channel 16 temperature offset
  
- 34 #1 output voltage offset
- 35 #2 output voltage offset
- 36 #3 output voltage offset
- 37 #4 output voltage offset

## Input Offset Calibration Values

A firmware calibration routine is used to null the input offset voltage for each of the 8 voltage ranges. These offsets are expressed in ADC bits, with a range of -128 to +127. (expected offsets are about 10-20 bits.) The offset calibration constant represents the number which is to be subtracted from the ADC value such that 0.00 is reported for the voltage of a shorted input. (Increasing these calibration constants will decrease the reported voltage.)

A short circuit should be placed on channel 16's input. After the unit has warmed-up for at least 1/2 hour, press both the TEMP and BKSP keys simultaneously to access the offset calibration routine.

With the display showing "cL oFFS All", press the EXC key to start the offset calibration routine. The numbers 1 to 8 should appear on the right-most display as the offset value is determined for each gain range. Offsets are nulled to within 1 LSB of the displayed voltage by this routine, i.e., to within 1  $\mu$ V of zero on the 30 mV scale. The offset for a single gain range may be calibrated also by selecting the range (1-8) with the channel select keys and pressing EXE.

## Gain Factors

There are gain errors associated with the input attenuator, the amplifier, and the ADC. The gain errors are independent of the selected channel because the multiplexer relays' resistances are very much less than the 10 MOhm input impedance.

To correct for these gain errors, known voltages will be applied to channel 15, and read by the ADC. A calibration constant will be determined for each of the eight gain ranges which will be used to correct subsequent measurements.

After the unit has warmed-up for at least 1/2 hour, press both the TEMP and BKSP keys simultaneously to access the gain calibration routine. The display will show "cL oFFS ALL". Press the PARAMETER SELECT  $\Delta$  (up-arrow) to change the display to read "cL gAin 0.03".

Now apply  $30.000 \pm 0.005$  mV to channel 15 and press the EXC key to calibrate the 30 mV voltage scale.

Press the CHANNEL SELECT  $\Delta$  (up-arrow) key to change the display to "cL gAin 0.1". Apply  $100.00 \pm 0.01$  mV to the channel 15 input and press the EXC key to calibrate the 100 mV scale.

Repeat for the remaining ranges by pressing the CHANNEL SELECT  $\Delta$  key, applying the full-scale voltage indicated in the MEASUREMENT display, and pressing the EXC button.

Range	Applied Voltage
0.03	$30.000 \pm 0.003$ mV
0.10	$100.00 \pm 0.01$ mV
0.30	$300.00 \pm 0.03$ mV
1.00	$1.000 \pm 0.0001$ V
3.00	$3.000 \pm 0.0003$ V
10.0	$10.00 \pm 0.001$ V
30.0	$30.00 \pm 0.003$ V
100.	$0 \pm 0.01$ V

## Temperature Calibrations

To obtain the temperature from a voltage measurement, we need to measure the temperature of the "reference junction". This is the thermocouple junction formed where the thermocouple wires connect to the rear panel terminal strip.

There is a semiconductor temperature sensor located in the center of the metal block behind the terminal strip. Unfortunately the sensor, which provides a voltage of 10 mV per degree F, has an error of about  $\pm 1$   $^{\circ}$  F, and so must be calibrated. Calibration constant #17 is used to correct for the sensor's error.

Knowing the correct temperature of the reference junction allows the microprocessor to subtract the emf generated by this junction from the measured voltage in order to determine the emf of the thermocouple junction of interest.





To calibrate the semiconductor sensor, attach a K-type thermocouple to channel 8, and install the thermal shield in such a way as to press the thermocouple leads against the thermal block on the rear panel of the instrument. Attach the other end of this thermocouple to an thermometer with a  $\pm 0.1^\circ\text{C}$  error. Use the SR630 to read the temperature on channel 8. ( Be certain to configure channel 8 to display in units of  $^\circ\text{C}$ , and specify TC TYPE = 3.) Subtract the reading on the SR630 from the temperature indicated on the reference thermometer, and multiply by ten. The result should be added to calibration constant #17, the block temperature offset.

For example, if the reference thermometer reads  $25.4^\circ\text{C}$ , and the SR630 indicates  $25.0^\circ\text{C}$ , then  $10*(25.4-25.0)=4$  should be added to calibration constant #17.

To adjust calibration constant #17, press the TEMP and BKSP keys simultaneously, so that the display shows "cL oFFS ALL". Then press the PARAMETER SELECT  $\Delta$  (up-arrow) key twice to display the first calibration constant. (See list in preceding section.) Then press the CHANNEL SELECT  $\Delta$  (up-arrow) key 16 times to display calibration constant #17. Add the result of the calibration calculation to the present value (which is displayed in the MEASUREMENT window. Type the sum using the numeric keypad, and press the EXC key to enter the result.

After adjusting the block temperature calibration constant, the SR630 should read the same temperature as the reference thermometer. Note that the standard limits of error for the thermocouple wire used in the calibration do not affect the accuracy of the calibration.

### Channel Temperature Offsets

Each channel has a calibration byte which simply offsets the computed temperature, and these are stored as calibration constants #18 through #33. This allows the user to precisely calibrate the instrument for each channel in order to remove any remaining inaccuracies, such as the thermocouple wire standard error. All of these temperature offsets have a nominal value of zero.

These offsets have a range of  $\pm 127$ , allowing temperature offsets of  $\pm 12.7^\circ\text{C}$ . Increasing these calibration constants will increase the reported temperature. To adjust calibration constant #18, press the TEMP and BKSP keys simultaneously, so that the display shows "cL oFFS ALL". Then press the PARAMETER SELECT  $\Delta$  (up-arrow) key twice to display the first calibration constant. (See list in preceding section.) Then press the CHANNEL SELECT  $\Delta$  (up-arrow) key 17 times to display calibration constant #18. Type the desired temperature offset for channel #1 (in tenths of  $^\circ\text{C}$ ) using the numeric keypad, and press the EXC key to enter the result.

To access the next calibration value, press the CHANNEL SELECT  $\Delta$  (up-arrow) once, and enter the desired temperature offset for the next channel, per the table at the beginning of this section.

### Analog Output Voltage Offsets

There are four calibration constants (#34-37) which are used to correct offset errors on the rear panel analog outputs. To calibrate these offsets we will set the rear panel outputs to zero, measure the actual output voltage, compute the correction to the calibration constant by dividing the actual offset by  $0.005\text{ V}$ , and subtracting this correction to the present calibration constant.

To set the rear panel outputs to zero, configure channels 1 through 4 for UNITS = mV, and CHART SPAN = 100. Place a short on channels 1 through 4. Use the CHANNEL SELECT keys to select channel 1. Measure and record the output voltage on the rear panel BNC #1. Repeat for channels 2, 3 and 4 by first selecting the channel, then measuring the corresponding output.

Compute the required correction to each output's offset calibration constant by dividing the observed offset by  $0.005$ . ( The offset may be corrected in  $5\text{ mV}$  increments. ) These corrections will be subtracted from the corresponding calibration constant per the table in the preceding section.

For example, if the voltage at the #1 BNC output is found to be 0.028 V, then calibration constant #34 will be decreased by  $0.028/0.005$  which rounds to 6.

To adjust calibration constant #34, press the TEMP and BKSP keys simultaneously, so that the display shows "cL oFFS ALL". Then press the PARAMETER SELECT  $\Delta$  (up-arrow) key twice to display the first calibration constant. (See list in preceding section.) Then press the CHANNEL SELECT  $\Delta$  (up-arrow) key to select calibration constant #34.. Subtract the computed correction to the existing calibration constant and key in the new value using the numeric keypad, and press the EXC key to enter the result.

Repeat for calibration constants #35, 36 and 37.

All circuitry for the SR630 are located on three printed circuit boards. The front panel PCB contains the LED lamps, seven segment displays and the keypad matrix. The rear panel PCB contains the GPIB, RS232 and printer interfaces. The main PCB, which runs the length of the instrument, contains all the other analog and digital circuitry. The rear portion of the main PCB is thermally isolated from the rest of the unit to reduce thermal gradients which can reduce the accuracy of temperature measurements.

The front panel PCB and the interface PCB attach to the main PCB via 40 pin ribbon cables. The terminal strip for the 16 differential input channels is mounted directly to the main PCB. A metal block is placed directly behind the terminal strip ( in thermal contact with the terminal strip ) to reduce temperature fluctuations. The temperature of the metal block is measured with a semiconductor sensor in order to compensate for the thermal emf's created at the terminal strip connections.

### **Main PCB**

#### **Microprocessor System. (TC1C, Sheet 1 of 6).**

The CPU is a CMOS Z80B, running at 4.9152 MHz. This clock frequency is convenient for generating baud rate, ADC and real-time interrupt clocks.

The CPU may be interrupted ( non-maskable ) by the RTI ( real time interrupt ). During this interrupt the next row of LEDs is refreshed, the next row of keyboard lines is read and the ADC's busy bit is read (data will also be read if the ADC BUSY just went low). Various other tasks, such as updating the TIME and DATE as well as changing to the next channel if scanning, will also be handled during the RTI.

The CPU may also be interrupted by either the UARTs RXRDY (receiver data ready bit) or the GPIB interrupt. These interrupts are "wire-or'ed" to the maskable interrupt input, -INT. The CPU determines the interrupting source by interrogating the status registers in the UART and GPIB controllers.

A 32Kx8 EPROM, mapped to the bottom of the 64K memory space, is used to store program memory and factory calibration constants. A battery backed-up 32Kx8 CMOS RAM, mapped to the upper 32K, stores program data, instrument settings, and current calibration values. The CPU verifies the integrity of the RAM contents on reset: if the RAM is corrupted, then it will be initialized to default settings and factory calibration values. This initialization will also be done if the BKSP key is held down when the unit is turned "ON".

The active calibration bytes, which are stored in the RAM, may be altered by the user via a special front panel operation mode. This mode will only be available if the CAL Enable/Disable jumper is in the Enable position. The function of the calibration bytes is detailed in the calibration section of this manual.

An 8253 Counter/Timer is used to generate clocks for real-time interrupts, baud rates, and analog-to-digital conversion. The real time interrupt rate is 12 times the line frequency ( either 600 Hz or 720 Hz.) The baud rate clock may be set from 16 x 150 Hz to 16 x 9600 Hz. The ADC, which requires 5120 clocks to complete a conversion, is clocked at either 51.200 kHz (for 50 Hz line frequency) or 61.44 kHz (for 60 Hz lines) in order to provide a high degree of noise immunity at the line frequency and its harmonics.

A 74HC154 1:16 decoder generates port strobes during I/O requests. The drivers for the LED displays will be disabled if the CPU should cease operation.

#### **Display Drivers (TC2C, Sheet 2 of 6)**

The front panel LED displays are time multiplexed into six slots. To refresh the display, all the STROBE lines are de-asserted (by writing 1's to the strobe latch), the segment data for the next pair of displays is written to the EVEN and ODD latches (a segment is turned "ON" by writing a zero to the corresponding latch bit), LED indicators in the next row are turned "ON" (by writing a zero to the corresponding LAMP bit), and by asserting the next column strobe (by writing a zero to the selected STROBE bit).

Address	Name	Description
00H	-CS_TIMER	Chip select for 8253 Counter/Timer.
08H	-LED_STB	LED, Key scan and alarm strobes.
10H	-LED_EVEN	Segment data for even display digits.
18H	-LED_ODD	Segment data for odd display digits.
20H	-LED_LAMP	Lamp data for individual indicators.
28H	-KEY_RD	Keyboard and ADC clock and data inputs.
30H	-DAC_MPX	DAC refresh MPX and DAC LSBs & RTC .
38H	-DAC_STB	Eight MSBs to DAC refresh circuit.
40H	-CS_TEMP	Temperature comparator and RTC inputs.
48H	-CS_RLY_CTL	Input relay control (& RTC MPX control).
50H	-CS_BITS_IN	Overload, CAL enable & interface bits.
58H	-CS_BITS_OUT	Amp gain, ADC RD, RTC and printer ctl.
60H	-CS_GPIB	GPIB controller chip select.
68H	-CS_UART	UART controller chip select.
70H	-CS_PRINTER	Eight bit latch for printer data.
78H	RLY_SHIFT	Shift strobe for 16 channel relay multiplexer.

**Table 10. I/O Port Addresses and Functions**

The display refresh is part of the real-time interrupt routine. Keyboard data and ADC BUSY bits are read via the KEY\_RD input port just prior to changing the display STROBES. The line frequency is also determined (during program initialization) by measuring the duration of the LINE period at this input port.

If the ADC BUSY bit is low, but was high at the start of the previous real-time interrupt, then it is time to read the ADC data. The ADC data is read by a tight, uninterrupted routine which synchronizes itself to the ADC\_CLK.

An audio transducer for key-clicks and alarms may also be enabled via the STROBE latch. Setting the MSB of the strobe latch low for a few periods of the RTI will generate a keyclick sound; holding this bit low will generate a 600 Hz tone for alarms. If the CPU stops refreshing the STROBE latch contents, the output enable on all the LED segment, lamp, and strobe latches will be disabled, turning off all the LEDs and the audio transducer.

**Analog Outputs and Reference Junction Temperature (TC3C, Sheet 3 of 6)**

There are four S/H channels which are refreshed by a 12 bit DAC to provide the rear panel analog outputs. The eight bit DAC\_MPX latch controls the channel to be refreshed and holds the 4 LSBs to be loaded into the DAC when the -DAC\_STB is asserted.

The four S/H's have gain of x4 buffers to drive the rear panel analog outputs. These outputs have a  $\pm 10.0$  Vdc range, a sub-ohm output impedance, and are stable driving cables and capacitive loads.

The 12 bit DAC is also used to digitize the block temperature sensor. The comparator bit for each temperature transducer is inspected just prior to refreshing the next channel. If the comparator bit read with the -CS\_TEMP strobe is high, the 12 bit value for the corresponding channel is decremented: if the comparator bit is low, the 12 bit value will be incremented. This will cause the DAC output to track the voltage of interest with a resolution of 0.36 mV, yielding a temperature resolution of 0.02 °C.

### Time and Date

The time and date are maintained by a battery backed-up clock and oscillator. To write and address data to the IC, the quad analog switch 74HC4066 is enabled by setting RTC\_MPX high, which connects the four LSB DAC bits to the IC. The 74HC4066 is disabled when reading from the part.

### Relay Multiplexers (TC4C, Sheet 4 of 6)

There are 16 differential inputs which are multiplexed to a single input amplifier. Each input is treated in a fully-differential manner: trace paths, junctions, relays, and components for the + and - are all identical.

Relay multiplexers and a floating ADC section are required to meet the +/-200 V common mode range specification. The floating analog ground for the ADC section is referenced to the negative input of the selected channel.

### Latching Relays

Latching, DPDT relays with bifurcated contacts are used in the input multiplexer. Because these relays are switched with a low duty cycle pulse they will not warm-up, and the double-throw action allows termination of the input into a constant 10 M $\Omega$  impedance.

The latching relays have two coils: applying power to the RESET coil will de-select the input, and power applied to the SET coil will select the input. All relays are reset individually as a part of the power-on sequence. The attenuator relay will be automatically reset by the power up/down RESET signal. This protects the input amplifier from SCR latch-up when the power is first applied.

The pulse which SETs or RESETs a relay is about 20 ms long. A particular coil is turned "ON" by writing a "1" to the corresponding position in the 32 bit shift register. The shift register is RESET (by setting bit0 of U400 low) after 20 mS. Break-before-make is used to avoid momentarily shorting two inputs together.

Data is shifted from the MSB of the DATA BUS into the 32 bit shift register. There is a one-bit queue which isolates the noisy data bus from the analog section (U107B), hence 33 clocks of the chip select RLY\_SHIFT are needed to fill the 32-bit shift register.

The input resistance of each channel is 10 M $\Omega$ : each channel terminates into its own 10 M $\Omega$  resistor when not selected, and the 1/100 input attenuator provides a 10 M $\Omega$  resistance when the channel is selected.

Q2 of the RLY\_CTL latch controls the input attenuator. On power-on reset, the attenuator divides the input signal by 100 and provides the attenuated signal via 100 k $\Omega$  source resistance to the input amplifier. Setting Q2 high provides an unattenuated signal via 10 K $\Omega$  resistors to the input amplifier.

Q1 of the RLY\_CTL latch controls a reed relay which is used to test for "open" thermocouples. A thermocouple is considered "open" if its resistance exceeds 1 k $\Omega$ . To check this, Q1 is set high to close the relay, connecting a 2.50 Vdc source via a 10 k $\Omega$  resistor to the output. If more than a 250 mVdc change is seen at the input, then the "Open" message will be displayed. This test will be performed only when the UNITS selected for the channel is Degrees K, C or F.

### Input Amplifiers and ADC (TC5C, Sheet 5 of 6)

Both the (+) and (-) inputs have identical input amplifiers. The source resistance, amplifier type, gain control multiplexer and passive components are matched to cancel offset errors due to thermal emf's, bias currents, etc.

These amplifiers are chopper stabilized, giving an input offset voltage of less than 5  $\mu$ V, and an input offset voltage of about 0.05  $\mu$ V/deg-C. A voltage clamp circuit prevents the input signal from exceeding the power supply voltages for the (+) input amplifier. This clamp circuit is not required for the (-) input, as the power supply's ground is referenced to the (-) input.

A dual channel 1:4 analog multiplexer sets the gain for both amplifiers. Logic inputs to this multiplexer are opto-isolated from chassis ground. Amplifier gain is selected by the GAIN\_SEL\_A and B control lines which determine the amount of feedback returned to the inverting input.

The protection network clamps the inverting input to  $\pm 4$  Vdc. The TND907 diodes (essentially 1N4148s in a chip package) in series with the Zener diodes isolate the inverting input from the low impedance ( and high capacitance ) of the Zeners. The Zeners are biased on to reduce capacitive effects. The back-to-back diodes between the inverting and non-inverting inputs of the amplifier turn on if the input exceeds  $\pm 4.7$  V. Input current is limited by a 10 k $\Omega$  (1W) resistor. These diodes do not leak, as the voltage across them in normal operation is the input offset voltage (less than 5  $\mu$ V).

A dual slope, integrating Analog to Digital Converter is used to digitize a signal to 15 bits plus sign. The ADC converter looks differentially between the amplified (+) and (-) inputs. The converter continually cycles through the various phases of A/D conversion: autozero, integrate, de-integrate, and reset.

The ADC requires 4 x 1280 clock cycles to complete a full cycle. The clock frequency is set by the CPU so that the integrate phase is exactly one cycle of the line frequency (either 50 or 60Hz ). By doing this, any line frequency noise will average to zero during the integrate phase, greatly reducing the ADC susceptibility to line frequency noise ( and its harmonics ).

The result of the A/D conversion is available for about 20 ms after the falling edge of the ADC\_BUSY bit. This bit is polled by the CPU during the RTI: when it is seen to go low the CPU will read data and status bits from the ADC by reading the bits into the 74HC165 shift register. These bits are then clocked to the CPU via the opto-isolator with the same clock that is used by the ADC.

### Overload And Underload Detection

Four comparators look at the amplified input signal to maintain the optimum gain setting for the input amplifier.

If the OVERLOAD bit is set, the gain is reduced and the result of the next ADC read is ignored (even if the ADC result does not indicate an overflow.)

If the UNDERLOAD bit is set, the gain is increased. The next ADC result corresponds to the input before the gain was increased, and this result may be used.

### Power Supplies (TC6C, Sheet 6 of 6)

The unit uses full-wave bridge rectifiers and linear regulators to produce +5,  $\pm 15$  (chassis ground referenced) and  $\pm 5$  (floating) supplies. Floating supplies are referenced to the (-) input of the selected input channel.

A power entry module fuses, filters, and configures the primary taps of the power transformer for 100/120/220 or 240 Vac (50/60Hz) operation. The line frequency is filtered and discriminated to the logic signal "LINE", which is measured by the CPU on initialization to determine the appropriate ADC clock frequency.

A reset circuit generates a RESET on power-up or power-down. This RESET also inhibits writes to RAM until after the power supplies have settled.

### Computer Interfaces (TC7B, Sheet 1 of 1)

A 40 pin connector connects the computer/printer interface PCB to the main PCB. The interface PCB has GPIB, RS232 and printer interface components. The pinout of the connector is such that no damage will be done if the connector is plugged in backwards.

Either the GPIB controller or RS232 UART may interrupt the processor to request service. The printer status must be polled by the CPU.

Bits 1 and 3 on the printer connector are protected against accidental connection to an RS232 device.

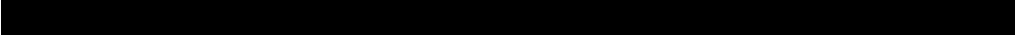



The RS232 port is configured as a DCE (data communications equipment) and is programmed for 8 data bits, 2 stop bits, and no parity. The default baud rate is 9600 bits per second, but may be set from 150 to 9600 baud. The RS232 port may be connected directly to a PC's COM port using a standard serial cable.

### **Front Panel Display (TC0B, Sheet 1 of 1)**

The front panel PCB is a time-multiplexed 11 digit, 26 lamp, 21 key user interface. The program's RTI changes display data 600 times a second; with 6 column strobos this means the entire display is refreshed every 10 ms.

A column of lamps, keys, or a pair of digits is accessed by pulling one strobe line (STB0-5) high. Selected LEDs are turned on by setting the corresponding bits (LAMP0-3) low or by pulling down the appropriate segment bit in the digit display. A key press will cause one of the input lines (KEY0-3) to go high. Any key seen in the same state for several RTI's will be considered valid.

# Components Part List

## Main Board Parts List

<u>REF</u>	<u>SRS part#</u>	<u>VALUE</u>	<u>DESCRIPTION</u>
BT100	6-00001-612	BR-2/3A 2PIN PC	Battery
C 100	5-00002-501	100P	Capacitor, Ceramic Disc, 50V, 10%, SL
C 101	5-00027-503	.01U	Capacitor, Ceramic Disc, 50V, 20%, Z5U
C 102	5-00002-501	100P	Capacitor, Ceramic Disc, 50V, 10%, SL
C 104	5-00225-548	.1U AXIAL	Capacitor, Ceramic, 50V,+80/-20% Z5U AX
C 300	5-00225-548	.1U AXIAL	Capacitor, Ceramic, 50V,+80/-20% Z5U AX
C 301	5-00002-501	100P	Capacitor, Ceramic Disc, 50V, 10%, SL
C 302	5-00002-501	100P	Capacitor, Ceramic Disc, 50V, 10%, SL
C 303	5-00002-501	100P	Capacitor, Ceramic Disc, 50V, 10%, SL
C 304	5-00002-501	100P	Capacitor, Ceramic Disc, 50V, 10%, SL
C 305	5-00225-548	.1U AXIAL	Capacitor, Ceramic, 50V,+80/-20% Z5U AX
C 306	5-00225-548	.1U AXIAL	Capacitor, Ceramic, 50V,+80/-20% Z5U AX
C 307	5-00225-548	.1U AXIAL	Capacitor, Ceramic, 50V,+80/-20% Z5U AX
C 308	5-00225-548	.1U AXIAL	Capacitor, Ceramic, 50V,+80/-20% Z5U AX
C 309	5-00225-548	.1U AXIAL	Capacitor, Ceramic, 50V,+80/-20% Z5U AX
C 310	5-00006-501	15P	Capacitor, Ceramic Disc, 50V, 10%, SL
C 311	5-00008-501	22P	Capacitor, Ceramic Disc, 50V, 10%, SL
C 312	5-00225-548	.1U AXIAL	Capacitor, Ceramic, 50V,+80/-20% Z5U AX
C 400	5-00247-533	.001U	Capacitor, Metallized Polyester
C 500	5-00061-513	.001U	Capacitor, Mylar/Poly, 50V, 5%, Rad
C 501	5-00061-513	.001U	Capacitor, Mylar/Poly, 50V, 5%, Rad
C 502	5-00056-512	.1U	Cap, Stacked Metal Film 50V 5% -40/+85c
C 503	5-00056-512	.1U	Cap, Stacked Metal Film 50V 5% -40/+85c
C 504	5-00056-512	.1U	Cap, Stacked Metal Film 50V 5% -40/+85c
C 505	5-00056-512	.1U	Cap, Stacked Metal Film 50V 5% -40/+85c
C 506	5-00056-512	.1U	Cap, Stacked Metal Film 50V 5% -40/+85c
C 507	5-00183-535	.1U - 2%	Capacitor, Polypropylene
C 508	5-00248-535	.47U	Capacitor, Polypropylene
C 509	5-00248-535	.47U	Capacitor, Polypropylene
C 510	5-00225-548	.1U AXIAL	Capacitor, Ceramic, 50V,+80/-20% Z5U AX
C 600	5-00030-520	2200U	Capacitor, Electrolytic, 16V, 20%, Rad
C 601	5-00030-520	2200U	Capacitor, Electrolytic, 16V, 20%, Rad
C 602	5-00192-542	22U MIN	Cap, Mini Electrolytic, 50V, 20% Radial
C 603	5-00192-542	22U MIN	Cap, Mini Electrolytic, 50V, 20% Radial
C 604	5-00100-517	2.2U	Capacitor, Tantalum, 35V, 20%, Rad
C 605	5-00100-517	2.2U	Capacitor, Tantalum, 35V, 20%, Rad
C 606	5-00100-517	2.2U	Capacitor, Tantalum, 35V, 20%, Rad
C 607	5-00192-542	22U MIN	Cap, Mini Electrolytic, 50V, 20% Radial
C 608	5-00201-526	2200U	Capacitor, Electrolytic, 35V, 20%, Rad
C 609	5-00201-526	2200U	Capacitor, Electrolytic, 35V, 20%, Rad
C 610	5-00027-503	.01U	Capacitor, Ceramic Disc, 50V, 20%, Z5U
C 611	5-00192-542	22U MIN	Cap, Mini Electrolytic, 50V, 20% Radial

<u>REF</u>	<u>SRS part#</u>	<u>VALUE</u>	<u>DESCRIPTION</u>
C 612	5-00100-517	2.2U	Capacitor, Tantalum, 35V, 20%, Rad
C 613	5-00100-517	2.2U	Capacitor, Tantalum, 35V, 20%, Rad
C 614	5-00192-542	22U MIN	Cap, Mini Electrolytic, 50V, 20% Radial
C 615	5-00196-520	6800U	Capacitor, Electrolytic, 16V, 20%, Rad
C 616	5-00040-509	1.0U	Capacitor, Electrolytic, 50V, 20%, Rad
C 617	5-00192-542	22U MIN	Cap, Mini Electrolytic, 50V, 20% Radial
C 618	5-00225-548	.1U AXIAL	Capacitor, Ceramic, 50V,+80/-20% Z5U AX
C 619	5-00225-548	.1U AXIAL	Capacitor, Ceramic, 50V,+80/-20% Z5U AX
C 620	5-00225-548	.1U AXIAL	Capacitor, Ceramic, 50V,+80/-20% Z5U AX
C 621	5-00225-548	.1U AXIAL	Capacitor, Ceramic, 50V,+80/-20% Z5U AX
C 622	5-00225-548	.1U AXIAL	Capacitor, Ceramic, 50V,+80/-20% Z5U AX
C 623	5-00225-548	.1U AXIAL	Capacitor, Ceramic, 50V,+80/-20% Z5U AX
C 624	5-00225-548	.1U AXIAL	Capacitor, Ceramic, 50V,+80/-20% Z5U AX
C 625	5-00225-548	.1U AXIAL	Capacitor, Ceramic, 50V,+80/-20% Z5U AX
C 626	5-00225-548	.1U AXIAL	Capacitor, Ceramic, 50V,+80/-20% Z5U AX
C 627	5-00225-548	.1U AXIAL	Capacitor, Ceramic, 50V,+80/-20% Z5U AX
C 628	5-00225-548	.1U AXIAL	Capacitor, Ceramic, 50V,+80/-20% Z5U AX
C 629	5-00225-548	.1U AXIAL	Capacitor, Ceramic, 50V,+80/-20% Z5U AX
C 630	5-00225-548	.1U AXIAL	Capacitor, Ceramic, 50V,+80/-20% Z5U AX
C 631	5-00225-548	.1U AXIAL	Capacitor, Ceramic, 50V,+80/-20% Z5U AX
C 632	5-00225-548	.1U AXIAL	Capacitor, Ceramic, 50V,+80/-20% Z5U AX
C 633	5-00225-548	.1U AXIAL	Capacitor, Ceramic, 50V,+80/-20% Z5U AX
C 634	5-00225-548	.1U AXIAL	Capacitor, Ceramic, 50V,+80/-20% Z5U AX
C 635	5-00225-548	.1U AXIAL	Capacitor, Ceramic, 50V,+80/-20% Z5U AX
C 636	5-00225-548	.1U AXIAL	Capacitor, Ceramic, 50V,+80/-20% Z5U AX
C 637	5-00225-548	.1U AXIAL	Capacitor, Ceramic, 50V,+80/-20% Z5U AX
C 638	5-00225-548	.1U AXIAL	Capacitor, Ceramic, 50V,+80/-20% Z5U AX
C 639	5-00225-548	.1U AXIAL	Capacitor, Ceramic, 50V,+80/-20% Z5U AX
C 640	5-00225-548	.1U AXIAL	Capacitor, Ceramic, 50V,+80/-20% Z5U AX
C 641	5-00225-548	.1U AXIAL	Capacitor, Ceramic, 50V,+80/-20% Z5U AX
C 642	5-00225-548	.1U AXIAL	Capacitor, Ceramic, 50V,+80/-20% Z5U AX
C 643	5-00225-548	.1U AXIAL	Capacitor, Ceramic, 50V,+80/-20% Z5U AX
C 644	5-00225-548	.1U AXIAL	Capacitor, Ceramic, 50V,+80/-20% Z5U AX
C 645	5-00219-529	.01U	Cap, Monolythic Ceramic, 50V, 20%, Z5U
C 646	5-00219-529	.01U	Cap, Monolythic Ceramic, 50V, 20%, Z5U
C 647	5-00219-529	.01U	Cap, Monolythic Ceramic, 50V, 20%, Z5U
C 648	5-00219-529	.01U	Cap, Monolythic Ceramic, 50V, 20%, Z5U
C 649	5-00219-529	.01U	Cap, Monolythic Ceramic, 50V, 20%, Z5U
C 650	5-00219-529	.01U	Cap, Monolythic Ceramic, 50V, 20%, Z5U
C 651	5-00219-529	.01U	Cap, Monolythic Ceramic, 50V, 20%, Z5U
C 652	5-00219-529	.01U	Cap, Monolythic Ceramic, 50V, 20%, Z5U
C 653	5-00219-529	.01U	Cap, Monolythic Ceramic, 50V, 20%, Z5U
C 654	5-00219-529	.01U	Cap, Monolythic Ceramic, 50V, 20%, Z5U
C 655	5-00219-529	.01U	Cap, Monolythic Ceramic, 50V, 20%, Z5U
C 656	5-00219-529	.01U	Cap, Monolythic Ceramic, 50V, 20%, Z5U

## Components Part List

<b>REF</b>	<b>SRS part#</b>	<b>VALUE</b>	<b>DESCRIPTION</b>
C 657	5-00219-529	.01U	Cap, Monolythic Ceramic, 50V, 20%, Z5U
C 658	5-00219-529	.01U	Cap, Monolythic Ceramic, 50V, 20%, Z5U
C 659	5-00219-529	.01U	Cap, Monolythic Ceramic, 50V, 20%, Z5U
C 660	5-00219-529	.01U	Cap, Monolythic Ceramic, 50V, 20%, Z5U
C 661	5-00219-529	.01U	Cap, Monolythic Ceramic, 50V, 20%, Z5U
C 662	5-00219-529	.01U	Cap, Monolythic Ceramic, 50V, 20%, Z5U
C 663	5-00219-529	.01U	Cap, Monolythic Ceramic, 50V, 20%, Z5U
C 664	5-00219-529	.01U	Cap, Monolythic Ceramic, 50V, 20%, Z5U
C 665	5-00219-529	.01U	Cap, Monolythic Ceramic, 50V, 20%, Z5U
C 666	5-00219-529	.01U	Cap, Monolythic Ceramic, 50V, 20%, Z5U
C 667	5-00219-529	.01U	Cap, Monolythic Ceramic, 50V, 20%, Z5U
C 668	5-00219-529	.01U	Cap, Monolythic Ceramic, 50V, 20%, Z5U
C 669	5-00219-529	.01U	Cap, Monolythic Ceramic, 50V, 20%, Z5U
C 670	5-00219-529	.01U	Cap, Monolythic Ceramic, 50V, 20%, Z5U
C 671	5-00219-529	.01U	Cap, Monolythic Ceramic, 50V, 20%, Z5U
C 672	5-00219-529	.01U	Cap, Monolythic Ceramic, 50V, 20%, Z5U
C 673	5-00219-529	.01U	Cap, Monolythic Ceramic, 50V, 20%, Z5U
C 674	5-00219-529	.01U	Cap, Monolythic Ceramic, 50V, 20%, Z5U
C 675	5-00219-529	.01U	Cap, Monolythic Ceramic, 50V, 20%, Z5U
C 676	5-00219-529	.01U	Cap, Monolythic Ceramic, 50V, 20%, Z5U
C 677	5-00225-548	.1U AXIAL	Capacitor, Ceramic, 50V,+80/-20% Z5U AX
C 678	5-00219-529	.01U	Cap, Monolythic Ceramic, 50V, 20%, Z5U
C 679	5-00225-548	.1U AXIAL	Capacitor, Ceramic, 50V,+80/-20% Z5U AX
C 700	5-00225-548	.1U AXIAL	Capacitor, Ceramic, 50V,+80/-20% Z5U AX
C 701	5-00225-548	.1U AXIAL	Capacitor, Ceramic, 50V,+80/-20% Z5U AX
C 702	5-00225-548	.1U AXIAL	Capacitor, Ceramic, 50V,+80/-20% Z5U AX
C 703	5-00225-548	.1U AXIAL	Capacitor, Ceramic, 50V,+80/-20% Z5U AX
C 704	5-00225-548	.1U AXIAL	Capacitor, Ceramic, 50V,+80/-20% Z5U AX
C 705	5-00225-548	.1U AXIAL	Capacitor, Ceramic, 50V,+80/-20% Z5U AX
C 706	5-00022-501	.001U	Capacitor, Ceramic Disc, 50V, 10%, SL
C 707	5-00100-517	2.2U	Capacitor, Tantalum, 35V, 20%, Rad
C 708	5-00012-501	330P	Capacitor, Ceramic Disc, 50V, 10%, SL
C 709	5-00012-501	330P	Capacitor, Ceramic Disc, 50V, 10%, SL
C 710	5-00100-517	2.2U	Capacitor, Tantalum, 35V, 20%, Rad
C 711	5-00012-501	330P	Capacitor, Ceramic Disc, 50V, 10%, SL
C 712	5-00012-501	330P	Capacitor, Ceramic Disc, 50V, 10%, SL
C 713	5-00012-501	330P	Capacitor, Ceramic Disc, 50V, 10%, SL
C 714	5-00012-501	330P	Capacitor, Ceramic Disc, 50V, 10%, SL
D 1	3-00012-306	GREEN	LED, Rectangular
D 2	3-00012-306	GREEN	LED, Rectangular
D 3	3-00012-306	GREEN	LED, Rectangular
D 4	3-00012-306	GREEN	LED, Rectangular
D 5	3-00012-306	GREEN	LED, Rectangular
D 6	3-00012-306	GREEN	LED, Rectangular
D 7	3-00012-306	GREEN	LED, Rectangular

<b>REF</b>	<b>SRS part#</b>	<b>VALUE</b>	<b>DESCRIPTION</b>
D 8	3-00012-306	GREEN	LED, Rectangular
D 9	3-00012-306	GREEN	LED, Rectangular
D 10	3-00012-306	GREEN	LED, Rectangular
D 11	3-00012-306	GREEN	LED, Rectangular
D 12	3-00012-306	GREEN	LED, Rectangular
D 13	3-00012-306	GREEN	LED, Rectangular
D 14	3-00012-306	GREEN	LED, Rectangular
D 15	3-00012-306	GREEN	LED, Rectangular
D 16	3-00012-306	GREEN	LED, Rectangular
D 17	3-00012-306	GREEN	LED, Rectangular
D 18	3-00012-306	GREEN	LED, Rectangular
D 19	3-00012-306	GREEN	LED, Rectangular
D 21	3-00012-306	GREEN	LED, Rectangular
D 22	3-00012-306	GREEN	LED, Rectangular
D 23	3-00012-306	GREEN	LED, Rectangular
D 24	3-00012-306	GREEN	LED, Rectangular
D 26	3-00013-306	RED	LED, Rectangular
D 27	3-00012-306	GREEN	LED, Rectangular
D 28	3-00012-306	GREEN	LED, Rectangular
D 31	3-00004-301	1N4148	Diode
D 32	3-00004-301	1N4148	Diode
D 33	3-00004-301	1N4148	Diode
D 34	3-00004-301	1N4148	Diode
D 35	3-00004-301	1N4148	Diode
D 36	3-00004-301	1N4148	Diode
D 100	3-00203-301	1N5711	Diode
D 101	3-00004-301	1N4148	Diode
D 102	3-00004-301	1N4148	Diode
D 103	3-00004-301	1N4148	Diode
D 300	3-00368-301	1N753A	Diode
D 301	3-00368-301	1N753A	Diode
D 500	3-00470-301	1N5221B	Diode
D 501	3-00470-301	1N5221B	Diode
D 600	3-00062-340	KBP201G/BR-81D	Integrated Circuit (Thru-hole Pkg)
D 601	3-00062-340	KBP201G/BR-81D	Integrated Circuit (Thru-hole Pkg)
D 603	3-00062-340	KBP201G/BR-81D	Integrated Circuit (Thru-hole Pkg)
D 604	3-00004-301	1N4148	Diode
D 700	3-00198-301	1N5231B	Diode
D 701	3-00198-301	1N5231B	Diode
J 1	1-00038-130	40 PIN DIL	Connector, Male
J 100	1-00038-130	40 PIN DIL	Connector, Male
J 200	1-00038-130	40 PIN DIL	Connector, Male
J 300	1-00003-120	BNC	Connector, BNC
J 301	1-00003-120	BNC	Connector, BNC
J 302	1-00003-120	BNC	Connector, BNC

## Components Part List

<b>REF</b>	<b>SRS part#</b>	<b>VALUE</b>	<b>DESCRIPTION</b>
J 303	1-00003-120	BNC	Connector, BNC
J 700	1-00238-161	GPIB SHIELDED	Connector, IEEE488, Reverse, R/A, Female
J 701	1-00016-160	RS232 25 PIN D	Connector, D-Sub, Right Angle PC, Female
J 702	1-00016-160	RS232 25 PIN D	Connector, D-Sub, Right Angle PC, Female
JP100	1-00045-130	3 PIN STRAIGHT	Connector, Male
JP700	1-00038-130	40 PIN DIL	Connector, Male
PC1	7-00371-701	SR630 MAIN	Printed Circuit Board
PC2	7-00370-701	SR630 FP	Printed Circuit Board
PC3	7-00372-701	SR630 OPTION	Printed Circuit Board
Q 101	3-00021-325	2N3904	Transistor, TO-92 Package
Q 102	3-00021-325	2N3904	Transistor, TO-92 Package
Q 200	3-00022-325	2N3906	Transistor, TO-92 Package
Q 201	3-00022-325	2N3906	Transistor, TO-92 Package
Q 202	3-00022-325	2N3906	Transistor, TO-92 Package
Q 203	3-00022-325	2N3906	Transistor, TO-92 Package
Q 204	3-00022-325	2N3906	Transistor, TO-92 Package
Q 205	3-00022-325	2N3906	Transistor, TO-92 Package
Q 206	3-00022-325	2N3906	Transistor, TO-92 Package
Q 501	3-00022-325	2N3906	Transistor, TO-92 Package
Q 600	3-00026-325	2N5210	Transistor, TO-92 Package
Q 604	3-00026-325	2N5210	Transistor, TO-92 Package
R 100	4-00048-401	2.2K	Resistor, Carbon Film, 1/4W, 5%
R 101	4-00034-401	10K	Resistor, Carbon Film, 1/4W, 5%
R 102	4-00027-401	1.5K	Resistor, Carbon Film, 1/4W, 5%
R 103	4-00022-401	1.0M	Resistor, Carbon Film, 1/4W, 5%
R 104	4-00034-401	10K	Resistor, Carbon Film, 1/4W, 5%
R 105	4-00034-401	10K	Resistor, Carbon Film, 1/4W, 5%
R 106	4-00034-401	10K	Resistor, Carbon Film, 1/4W, 5%
R 108	4-00034-401	10K	Resistor, Carbon Film, 1/4W, 5%
R 109	4-00027-401	1.5K	Resistor, Carbon Film, 1/4W, 5%
R 110	4-00032-401	100K	Resistor, Carbon Film, 1/4W, 5%
R 111	4-00057-401	220	Resistor, Carbon Film, 1/4W, 5%
R 200	4-00048-401	2.2K	Resistor, Carbon Film, 1/4W, 5%
R 201	4-00081-401	470	Resistor, Carbon Film, 1/4W, 5%
R 202	4-00081-401	470	Resistor, Carbon Film, 1/4W, 5%
R 203	4-00081-401	470	Resistor, Carbon Film, 1/4W, 5%
R 204	4-00081-401	470	Resistor, Carbon Film, 1/4W, 5%
R 205	4-00081-401	470	Resistor, Carbon Film, 1/4W, 5%
R 206	4-00081-401	470	Resistor, Carbon Film, 1/4W, 5%
R 207	4-00081-401	470	Resistor, Carbon Film, 1/4W, 5%
R 208	4-00081-401	470	Resistor, Carbon Film, 1/4W, 5%
R 209	4-00081-401	470	Resistor, Carbon Film, 1/4W, 5%
R 210	4-00081-401	470	Resistor, Carbon Film, 1/4W, 5%
R 211	4-00081-401	470	Resistor, Carbon Film, 1/4W, 5%
R 212	4-00081-401	470	Resistor, Carbon Film, 1/4W, 5%

<u>REF</u>	<u>SRS part#</u>	<u>VALUE</u>	<u>DESCRIPTION</u>
R 213	4-00081-401	470	Resistor, Carbon Film, 1/4W, 5%
R 214	4-00081-401	470	Resistor, Carbon Film, 1/4W, 5%
R 215	4-00081-401	470	Resistor, Carbon Film, 1/4W, 5%
R 216	4-00081-401	470	Resistor, Carbon Film, 1/4W, 5%
R 217	4-00056-401	22	Resistor, Carbon Film, 1/4W, 5%
R 218	4-00056-401	22	Resistor, Carbon Film, 1/4W, 5%
R 219	4-00056-401	22	Resistor, Carbon Film, 1/4W, 5%
R 220	4-00056-401	22	Resistor, Carbon Film, 1/4W, 5%
R 221	4-00056-401	22	Resistor, Carbon Film, 1/4W, 5%
R 222	4-00081-401	470	Resistor, Carbon Film, 1/4W, 5%
R 223	4-00081-401	470	Resistor, Carbon Film, 1/4W, 5%
R 224	4-00081-401	470	Resistor, Carbon Film, 1/4W, 5%
R 225	4-00081-401	470	Resistor, Carbon Film, 1/4W, 5%
R 226	4-00081-401	470	Resistor, Carbon Film, 1/4W, 5%
R 227	4-00081-401	470	Resistor, Carbon Film, 1/4W, 5%
R 228	4-00034-401	10K	Resistor, Carbon Film, 1/4W, 5%
R 229	4-00048-401	2.2K	Resistor, Carbon Film, 1/4W, 5%
R 230	4-00048-401	2.2K	Resistor, Carbon Film, 1/4W, 5%
R 231	4-00048-401	2.2K	Resistor, Carbon Film, 1/4W, 5%
R 232	4-00031-401	100	Resistor, Carbon Film, 1/4W, 5%
R 300	4-00218-408	10.00K	Resistor, Metal Film, 1/8W, 0.1%, 25ppm
R 301	4-00048-401	2.2K	Resistor, Carbon Film, 1/4W, 5%
R 302	4-00048-401	2.2K	Resistor, Carbon Film, 1/4W, 5%
R 303	4-00138-407	10.0K	Resistor, Metal Film, 1/8W, 1%, 50PPM
R 304	4-00138-407	10.0K	Resistor, Metal Film, 1/8W, 1%, 50PPM
R 305	4-00138-407	10.0K	Resistor, Metal Film, 1/8W, 1%, 50PPM
R 306	4-00138-407	10.0K	Resistor, Metal Film, 1/8W, 1%, 50PPM
R 307	4-00057-401	220	Resistor, Carbon Film, 1/4W, 5%
R 308	4-00057-401	220	Resistor, Carbon Film, 1/4W, 5%
R 309	4-00057-401	220	Resistor, Carbon Film, 1/4W, 5%
R 310	4-00057-401	220	Resistor, Carbon Film, 1/4W, 5%
R 311	4-00386-407	30.9K	Resistor, Metal Film, 1/8W, 1%, 50PPM
R 312	4-00386-407	30.9K	Resistor, Metal Film, 1/8W, 1%, 50PPM
R 313	4-00386-407	30.9K	Resistor, Metal Film, 1/8W, 1%, 50PPM
R 314	4-00386-407	30.9K	Resistor, Metal Film, 1/8W, 1%, 50PPM
R 315	4-00048-401	2.2K	Resistor, Carbon Film, 1/4W, 5%
R 316	4-00048-401	2.2K	Resistor, Carbon Film, 1/4W, 5%
R 317	4-00048-401	2.2K	Resistor, Carbon Film, 1/4W, 5%
R 318	4-00048-401	2.2K	Resistor, Carbon Film, 1/4W, 5%
R 319	4-00034-401	10K	Resistor, Carbon Film, 1/4W, 5%
R 320	4-00034-401	10K	Resistor, Carbon Film, 1/4W, 5%
R 321	4-00034-401	10K	Resistor, Carbon Film, 1/4W, 5%
R 322	4-00034-401	10K	Resistor, Carbon Film, 1/4W, 5%
R 323	4-00218-408	10.00K	Resistor, Metal Film, 1/8W, 0.1%, 25ppm
R 324	4-00130-407	1.00K	Resistor, Metal Film, 1/8W, 1%, 50PPM

## Components Part List

<u>REF</u>	<u>SRS part#</u>	<u>VALUE</u>	<u>DESCRIPTION</u>
R 325	4-00716-407	1.40K	Resistor, Metal Film, 1/8W, 1%, 50PPM
R 326	4-00716-407	1.40K	Resistor, Metal Film, 1/8W, 1%, 50PPM
R 327	4-00034-401	10K	Resistor, Carbon Film, 1/4W, 5%
R 401	4-01610-407	9.90M	Resistor, Metal Film, 1/8W, 1%, 50PPM
R 402	4-00684-408	100.0K	Resistor, Metal Film, 1/8W, 0.1%, 25ppm
R 403	4-00451-448	10.0K	Resistor, Metal Film, 1W, 1%,
R 404	4-00451-448	10.0K	Resistor, Metal Film, 1W, 1%,
R 405	4-00684-408	100.0K	Resistor, Metal Film, 1/8W, 0.1%, 25ppm
R 406	4-00218-408	10.00K	Resistor, Metal Film, 1/8W, 0.1%, 25ppm
R 407	4-00035-401	10M	Resistor, Carbon Film, 1/4W, 5%
R 408	4-00035-401	10M	Resistor, Carbon Film, 1/4W, 5%
R 409	4-00035-401	10M	Resistor, Carbon Film, 1/4W, 5%
R 410	4-00035-401	10M	Resistor, Carbon Film, 1/4W, 5%
R 411	4-00035-401	10M	Resistor, Carbon Film, 1/4W, 5%
R 412	4-00035-401	10M	Resistor, Carbon Film, 1/4W, 5%
R 413	4-00035-401	10M	Resistor, Carbon Film, 1/4W, 5%
R 414	4-00035-401	10M	Resistor, Carbon Film, 1/4W, 5%
R 415	4-00035-401	10M	Resistor, Carbon Film, 1/4W, 5%
R 416	4-00035-401	10M	Resistor, Carbon Film, 1/4W, 5%
R 417	4-00035-401	10M	Resistor, Carbon Film, 1/4W, 5%
R 418	4-00035-401	10M	Resistor, Carbon Film, 1/4W, 5%
R 419	4-00035-401	10M	Resistor, Carbon Film, 1/4W, 5%
R 420	4-00035-401	10M	Resistor, Carbon Film, 1/4W, 5%
R 421	4-00035-401	10M	Resistor, Carbon Film, 1/4W, 5%
R 422	4-00035-401	10M	Resistor, Carbon Film, 1/4W, 5%
R 423	4-00031-401	100	Resistor, Carbon Film, 1/4W, 5%
R 500	4-00076-401	390	Resistor, Carbon Film, 1/4W, 5%
R 501	4-00031-401	100	Resistor, Carbon Film, 1/4W, 5%
R 502	4-00031-401	100	Resistor, Carbon Film, 1/4W, 5%
R 503	4-00081-401	470	Resistor, Carbon Film, 1/4W, 5%
R 504	4-00076-401	390	Resistor, Carbon Film, 1/4W, 5%
R 505	4-00081-401	470	Resistor, Carbon Film, 1/4W, 5%
R 506	4-00076-401	390	Resistor, Carbon Film, 1/4W, 5%
R 507	4-00081-401	470	Resistor, Carbon Film, 1/4W, 5%
R 509	4-00021-401	1.0K	Resistor, Carbon Film, 1/4W, 5%
R 510	4-00081-401	470	Resistor, Carbon Film, 1/4W, 5%
R 511	4-00076-401	390	Resistor, Carbon Film, 1/4W, 5%
R 512	4-00081-401	470	Resistor, Carbon Film, 1/4W, 5%
R 513	4-00081-401	470	Resistor, Carbon Film, 1/4W, 5%
R 514	4-00081-401	470	Resistor, Carbon Film, 1/4W, 5%
R 515	4-00081-401	470	Resistor, Carbon Film, 1/4W, 5%
R 516	4-00048-401	2.2K	Resistor, Carbon Film, 1/4W, 5%
R 517	4-00021-401	1.0K	Resistor, Carbon Film, 1/4W, 5%
R 518	4-00155-407	150K	Resistor, Metal Film, 1/8W, 1%, 50PPM
R 519	4-00685-408	100	Resistor, Metal Film, 1/8W, 0.1%, 25ppm



<u>REF</u>	<u>SRS part#</u>	<u>VALUE</u>	<u>DESCRIPTION</u>
R 520	4-00145-407	110	Resistor, Metal Film, 1/8W, 1%, 50PPM
R 521	4-00686-408	6.190K	Resistor, Metal Film, 1/8W, 0.1%, 25ppm
R 522	4-00687-408	3.320K	Resistor, Metal Film, 1/8W, 0.1%, 25ppm
R 523	4-00217-408	1.000K	Resistor, Metal Film, 1/8W, 0.1%, 25ppm
R 524	4-00688-408	1.470K	Resistor, Metal Film, 1/8W, 0.1%, 25ppm
R 525	4-00689-408	2.150K	Resistor, Metal Film, 1/8W, 0.1%, 25ppm
R 526	4-00689-408	2.150K	Resistor, Metal Film, 1/8W, 0.1%, 25ppm
R 527	4-00689-408	2.150K	Resistor, Metal Film, 1/8W, 0.1%, 25ppm
R 528	4-00689-408	2.150K	Resistor, Metal Film, 1/8W, 0.1%, 25ppm
R 529	4-00688-408	1.470K	Resistor, Metal Film, 1/8W, 0.1%, 25ppm
R 530	4-00688-408	1.470K	Resistor, Metal Film, 1/8W, 0.1%, 25ppm
R 531	4-00689-408	2.150K	Resistor, Metal Film, 1/8W, 0.1%, 25ppm
R 532	4-00689-408	2.150K	Resistor, Metal Film, 1/8W, 0.1%, 25ppm
R 533	4-00689-408	2.150K	Resistor, Metal Film, 1/8W, 0.1%, 25ppm
R 534	4-00689-408	2.150K	Resistor, Metal Film, 1/8W, 0.1%, 25ppm
R 535	4-00688-408	1.470K	Resistor, Metal Film, 1/8W, 0.1%, 25ppm
R 536	4-00688-408	1.470K	Resistor, Metal Film, 1/8W, 0.1%, 25ppm
R 537	4-00688-408	1.470K	Resistor, Metal Film, 1/8W, 0.1%, 25ppm
R 538	4-00217-408	1.000K	Resistor, Metal Film, 1/8W, 0.1%, 25ppm
R 539	4-00048-401	2.2K	Resistor, Carbon Film, 1/4W, 5%
R 540	4-00193-407	499	Resistor, Metal Film, 1/8W, 1%, 50PPM
R 541	4-00193-407	499	Resistor, Metal Film, 1/8W, 1%, 50PPM
R 542	4-00135-407	1.50K	Resistor, Metal Film, 1/8W, 1%, 50PPM
R 543	4-00176-407	3.01K	Resistor, Metal Film, 1/8W, 1%, 50PPM
R 544	4-00176-407	3.01K	Resistor, Metal Film, 1/8W, 1%, 50PPM
R 545	4-00135-407	1.50K	Resistor, Metal Film, 1/8W, 1%, 50PPM
R 546	4-00130-407	1.00K	Resistor, Metal Film, 1/8W, 1%, 50PPM
R 547	4-00130-407	1.00K	Resistor, Metal Film, 1/8W, 1%, 50PPM
R 548	4-00131-407	1.00M	Resistor, Metal Film, 1/8W, 1%, 50PPM
R 549	4-00131-407	1.00M	Resistor, Metal Film, 1/8W, 1%, 50PPM
R 601	4-00032-401	100K	Resistor, Carbon Film, 1/4W, 5%
R 604	4-00034-401	10K	Resistor, Carbon Film, 1/4W, 5%
R 605	4-00032-401	100K	Resistor, Carbon Film, 1/4W, 5%
R 606	4-00034-401	10K	Resistor, Carbon Film, 1/4W, 5%
R 607	4-00032-401	100K	Resistor, Carbon Film, 1/4W, 5%
R 608	4-00021-401	1.0K	Resistor, Carbon Film, 1/4W, 5%
R 700	4-00021-401	1.0K	Resistor, Carbon Film, 1/4W, 5%
R 701	4-00021-401	1.0K	Resistor, Carbon Film, 1/4W, 5%
R 702	4-00021-401	1.0K	Resistor, Carbon Film, 1/4W, 5%
R 703	4-00021-401	1.0K	Resistor, Carbon Film, 1/4W, 5%
R 704	4-00021-401	1.0K	Resistor, Carbon Film, 1/4W, 5%
SO101	1-00026-150	28 PIN 600 MIL	Socket, THRU-HOLE
SO504	1-00028-150	8 PIN 300 MIL	Socket, THRU-HOLE
SP200	6-00096-600	MINI	Misc. Components
SW600	2-00023-218	DPDT	Switch, Panel Mount, Power, Rocker

## Components Part List

T 1	6-00093-610	SR630	Transformer
<u>REF</u>	<u>SRS part#</u>	<u>VALUE</u>	<u>DESCRIPTION</u>
U 1	3-00288-340	HDSP-H101	Integrated Circuit (Thru-hole Pkg)
U 2	3-00288-340	HDSP-H101	Integrated Circuit (Thru-hole Pkg)
U 3	3-00288-340	HDSP-H101	Integrated Circuit (Thru-hole Pkg)
U 4	3-00288-340	HDSP-H101	Integrated Circuit (Thru-hole Pkg)
U 5	3-00288-340	HDSP-H101	Integrated Circuit (Thru-hole Pkg)
U 6	3-00288-340	HDSP-H101	Integrated Circuit (Thru-hole Pkg)
U 7	3-00288-340	HDSP-H101	Integrated Circuit (Thru-hole Pkg)
U 8	3-00288-340	HDSP-H101	Integrated Circuit (Thru-hole Pkg)
U 9	3-00288-340	HDSP-H101	Integrated Circuit (Thru-hole Pkg)
U 10	3-00288-340	HDSP-H101	Integrated Circuit (Thru-hole Pkg)
U 11	3-00288-340	HDSP-H101	Integrated Circuit (Thru-hole Pkg)
U 100	3-00298-340	Z80H	Integrated Circuit (Thru-hole Pkg)
U 102	3-00299-341	32KX8-70L	STATIC RAM, I.C.
U 103	3-00491-340	UPD71054C	Integrated Circuit (Thru-hole Pkg)
U 104	3-00158-340	74HC154N	Integrated Circuit (Thru-hole Pkg)
U 105	3-00411-340	74HC273	Integrated Circuit (Thru-hole Pkg)
U 106	3-00044-340	74HC244	Integrated Circuit (Thru-hole Pkg)
U 107	3-00049-340	74HC74	Integrated Circuit (Thru-hole Pkg)
U 108	3-00155-340	74HC04	Integrated Circuit (Thru-hole Pkg)
U 109	3-00045-340	74HC32	Integrated Circuit (Thru-hole Pkg)
U 110	3-00155-340	74HC04	Integrated Circuit (Thru-hole Pkg)
U 111	3-00039-340	74HC14	Integrated Circuit (Thru-hole Pkg)
U 112	3-00196-335	HS-212S-5	Relay
U 200	3-00046-340	74HC374	Integrated Circuit (Thru-hole Pkg)
U 201	3-00046-340	74HC374	Integrated Circuit (Thru-hole Pkg)
U 202	3-00046-340	74HC374	Integrated Circuit (Thru-hole Pkg)
U 203	3-00046-340	74HC374	Integrated Circuit (Thru-hole Pkg)
U 205	3-00044-340	74HC244	Integrated Circuit (Thru-hole Pkg)
U 206	3-00049-340	74HC74	Integrated Circuit (Thru-hole Pkg)
U 300	3-00412-340	AD1403	Integrated Circuit (Thru-hole Pkg)
U 301	3-00105-340	LM741	Integrated Circuit (Thru-hole Pkg)
U 302	3-00411-340	74HC273	Integrated Circuit (Thru-hole Pkg)
U 303	3-00185-340	LM2901	Integrated Circuit (Thru-hole Pkg)
U 305	3-00413-340	LM34DZ	Integrated Circuit (Thru-hole Pkg)
U 307	3-00414-340	74HC4066	Integrated Circuit (Thru-hole Pkg)
U 308	3-00415-340	AD7845	Integrated Circuit (Thru-hole Pkg)
U 309	3-00270-340	74HC4051	Integrated Circuit (Thru-hole Pkg)
U 310	3-00044-340	74HC244	Integrated Circuit (Thru-hole Pkg)
U 311	3-00416-340	TC8250AP	Integrated Circuit (Thru-hole Pkg)
U 312	3-00087-340	LF347	Integrated Circuit (Thru-hole Pkg)
U 400	3-00411-340	74HC273	Integrated Circuit (Thru-hole Pkg)
U 401	3-00308-335	DS2E-ML2-DC5V	Relay
U 402	3-00308-335	DS2E-ML2-DC5V	Relay
U 403	3-00308-335	DS2E-ML2-DC5V	Relay

<u>REF</u>	<u>SRS part#</u>	<u>VALUE</u>	<u>DESCRIPTION</u>
U 404	3-00308-335	DS2E-ML2-DC5V	Relay
U 405	3-00308-335	DS2E-ML2-DC5V	Relay
U 406	3-00308-335	DS2E-ML2-DC5V	Relay
U 407	3-00308-335	DS2E-ML2-DC5V	Relay
U 408	3-00308-335	DS2E-ML2-DC5V	Relay
U 409	3-00308-335	DS2E-ML2-DC5V	Relay
U 410	3-00308-335	DS2E-ML2-DC5V	Relay
U 411	3-00308-335	DS2E-ML2-DC5V	Relay
U 412	3-00308-335	DS2E-ML2-DC5V	Relay
U 413	3-00308-335	DS2E-ML2-DC5V	Relay
U 414	3-00308-335	DS2E-ML2-DC5V	Relay
U 415	3-00308-335	DS2E-ML2-DC5V	Relay
U 416	3-00308-335	DS2E-ML2-DC5V	Relay
U 417	3-00308-335	DS2E-ML2-DC5V	Relay
U 418	3-00126-335	51A05	Relay
U 419	3-00195-340	CA3082	Integrated Circuit (Thru-hole Pkg)
U 420	3-00303-340	74HC164	Integrated Circuit (Thru-hole Pkg)
U 421	3-00195-340	CA3082	Integrated Circuit (Thru-hole Pkg)
U 422	3-00303-340	74HC164	Integrated Circuit (Thru-hole Pkg)
U 423	3-00303-340	74HC164	Integrated Circuit (Thru-hole Pkg)
U 424	3-00195-340	CA3082	Integrated Circuit (Thru-hole Pkg)
U 425	3-00303-340	74HC164	Integrated Circuit (Thru-hole Pkg)
U 426	3-00195-340	CA3082	Integrated Circuit (Thru-hole Pkg)
U 427	3-00195-340	CA3082	Integrated Circuit (Thru-hole Pkg)
U 503A	3-00004-301	1N4148	Diode
U 503B	3-00004-301	1N4148	Diode
U 503C	3-00004-301	1N4148	Diode
U 503D	3-00004-301	1N4148	Diode
U 503E	3-00004-301	1N4148	Diode
U 503F	3-00004-301	1N4148	Diode
U 503G	3-00004-301	1N4148	Diode
U 503H	3-00004-301	1N4148	Diode
U 504	3-00419-340	LTC1051	Integrated Circuit (Thru-hole Pkg)
U 506	3-00420-340	TSC850	Integrated Circuit (Thru-hole Pkg)
U 507	3-00417-340	74HC165	Integrated Circuit (Thru-hole Pkg)
U 509	3-00412-340	AD1403	Integrated Circuit (Thru-hole Pkg)
U 510	3-00402-340	74HC4052	Integrated Circuit (Thru-hole Pkg)
U 511	3-00185-340	LM2901	Integrated Circuit (Thru-hole Pkg)
U 512	3-00250-340	PS2401A-2	Integrated Circuit (Thru-hole Pkg)
U 513	3-00250-340	PS2401A-2	Integrated Circuit (Thru-hole Pkg)
U 514	3-00446-340	6N137	Integrated Circuit (Thru-hole Pkg)
U 515	3-00446-340	6N137	Integrated Circuit (Thru-hole Pkg)
U 516	3-00446-340	6N137	Integrated Circuit (Thru-hole Pkg)
U 517	3-00446-340	6N137	Integrated Circuit (Thru-hole Pkg)
U 600	3-00112-329	7805	Voltage Reg., TO-220 (TAB) Package

## Components Part List

<u>REF</u>	<u>SRS part#</u>	<u>VALUE</u>	<u>DESCRIPTION</u>
U 601	3-00119-329	7905	Voltage Reg., TO-220 (TAB) Package
U 602	3-00114-329	7815	Voltage Reg., TO-220 (TAB) Package
U 603	3-00120-329	7915	Voltage Reg., TO-220 (TAB) Package
U 605	3-00112-329	7805	Voltage Reg., TO-220 (TAB) Package
U 700	3-00645-340	NAT9914BPD	Integrated Circuit (Thru-hole Pkg)
U 701	3-00078-340	DS75160A	Integrated Circuit (Thru-hole Pkg)
U 702	3-00079-340	DS75161A	Integrated Circuit (Thru-hole Pkg)
U 703	3-00300-340	74LS374	Integrated Circuit (Thru-hole Pkg)
U 704	3-00263-340	DS75451N	Integrated Circuit (Thru-hole Pkg)
U 705	3-00110-340	MC1489	Integrated Circuit (Thru-hole Pkg)
U 706	3-00493-340	UPD71051C	Integrated Circuit (Thru-hole Pkg)
U 707	3-00109-340	MC1488	Integrated Circuit (Thru-hole Pkg)
X 100	6-00095-620	4.9152 MHZ	Crystal
X 300	6-00015-620	32.768 KHZ	Crystal
Z 0	0-00014-002	6J4	Power_Entry Hardware
Z 0	0-00043-011	4-40 KEP	Nut, Kep
Z 0	0-00050-011	8-32 KEP	Nut, Kep
Z 0	0-00079-031	4-40X3/16 M/F	Standoff
Z 0	0-00081-032	320882	Termination
Z 0	0-00089-033	4"	Tie
Z 0	0-00096-041	#4 SPLIT	Washer, Split
Z 0	0-00126-053	3-1/2" #24	Wire #24 UL1007 Strip 1/4x1/4 Tin
Z 0	0-00128-053	4" #24	Wire #24 UL1007 Strip 1/4x1/4 Tin
Z 0	0-00129-053	5" #24	Wire #24 UL1007 Strip 1/4x1/4 Tin
Z 0	0-00187-021	4-40X1/4PP	Screw, Panhead Phillips
Z 0	0-00208-020	4-40X3/8PF	Screw, Flathead Phillips
Z 0	0-00231-043	#4 SHOULDER	Washer, nylon
Z 0	0-00233-000	HANDLE1	Hardware, Misc.
Z 0	0-00237-016	F1404	Power Button
Z 0	0-00238-026	6-32X1/4PF	Screw, Black, All Types
Z 0	0-00243-003	TO-220	Insulators
Z 0	0-00259-021	4-40X1/2"PP	Screw, Panhead Phillips
Z 0	0-00284-025	10-32X1/2	Screw, Allen Head
Z 0	0-00286-053	6" #24 GRN	Wire #24 UL1007 Strip 1/4x1/4 Tin
Z 0	0-00299-000	1/8" ADHES TAPE	Hardware, Misc.
Z 0	0-00408-000	1/4" ADHES TAPE	Hardware, Misc.
Z 0	0-00410-032	BLOCK	Termination
Z 0	0-00411-000	1/4" ADHES	Hardware, Misc.
Z 0	0-00412-060	CAPTIVE PANEL	Screw, Misc
Z 0	0-00500-000	554808-1	Hardware, Misc.
Z 0	0-00523-048	5-5/8" #18	Wire, #18 UL1015 Strip 3/8 x 3/8 No Tin
Z 0	0-00893-026	8-32X3/8PF	Screw, Black, All Types
Z 0	1-00052-171	40 COND	Cable Assembly, Ribbon
Z 0	1-00073-120	INSL	Connector, BNC
Z 0	1-00087-131	2 PIN JUMPER	Connector, Female

<u>REF</u>	<u>SRS part#</u>	<u>VALUE</u>	<u>DESCRIPTION</u>
Z 0	1-00133-171	40 COND	Cable Assembly, Ribbon
Z 0	1-00172-170	9535	Cable Assembly, Multiconductor
Z 0	4-00541-435	130V/1200A	Varistor, Zinc Oxide Nonlinear Resistor
Z 0	5-00262-548	.01U AXIAL	Capacitor, Ceramic, 50V,+80/-20% Z5U AX
Z 0	6-00003-611	.5A 3AG	Fuse
Z 0	7-00194-715	PS300-38	Bracket
Z 0	7-00257-720	SR560-20	Fabricated Part
Z 0	7-00258-720	SR560-26	Fabricated Part
Z 0	7-00384-709	SR630-1	Lexan Overlay
Z 0	7-00386-720	SR630-9	Fabricated Part
Z 0	7-00387-721	SR630-10	Machined Part
Z 0	7-00388-720	SR630-11/-12	Fabricated Part
Z 0	7-00389-720	SR630-13/-14	Fabricated Part
Z 0	7-00397-740	SR630	Keypad, Conductive Rubber
Z 0	7-00680-720	PS300-52	Fabricated Part
Z 0	9-00267-917	GENERIC	Product Labels
Z 0	9-00552-924	COPPERFOIL;1"	Tape, All types

### Miscellaneous Parts List

<u>REF</u>	<u>SRS part#</u>	<u>VALUE</u>	<u>DESCRIPTION</u>
U 101	3-00229-342	27256-200	EPROM/PROM, I.C.
Z 0	0-00150-026	4-40X1/4PF	Screw, Black, All Types
Z 0	0-00179-000	RIGHT FOOT	Hardware, Misc.
Z 0	0-00180-000	LEFT FOOT	Hardware, Misc.
Z 0	0-00185-021	6-32X3/8PP	Screw, Panhead Phillips
Z 0	0-00204-000	REAR FOOT	Hardware, Misc.
Z 0	0-00248-026	10-32X3/8TRUSSP	Screw, Black, All Types
Z 0	0-00326-026	8-32X1/4PP	Screw, Black, All Types
Z 0	7-00122-720	DG535-36	Fabricated Part
Z 0	7-00217-735	PS300-40	Injection Molded Plastic
Z 0	7-00259-720	SR560-28	Fabricated Part
Z 0	7-00260-720	SR560-27	Fabricated Part

