

---

**Tektronix**<sup>®</sup>  
COMMITTED TO EXCELLENCE

# Instructions

067-1133-00  
110-S Power Supply  
Test Fixture

---

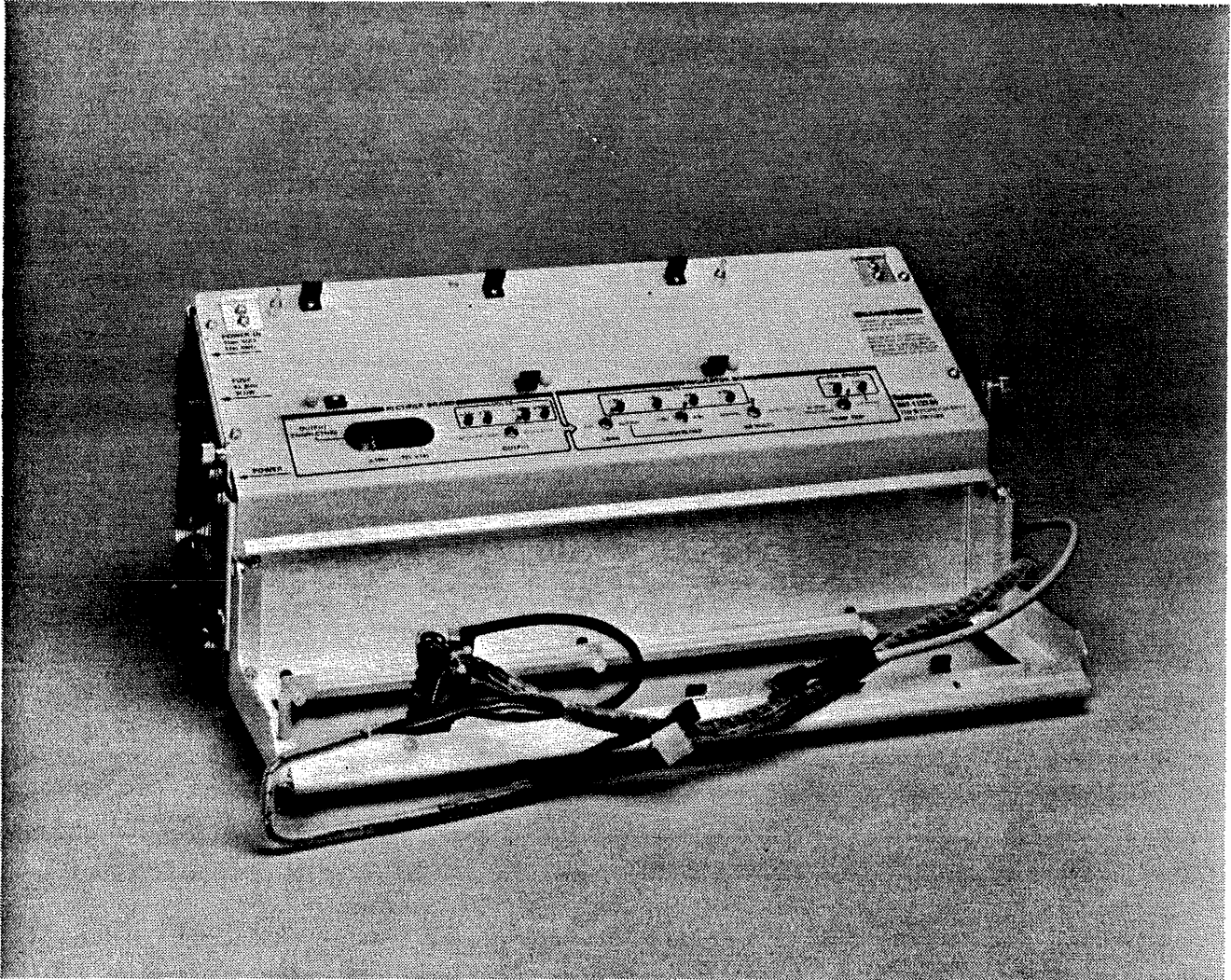

**Copyright © 1984 Tektronix, Inc. All rights reserved.  
Contents of this publication may not be reproduced in  
any form without the written permission of Tektronix,  
Inc.**

**Products of Tektronix, Inc. and its subsidiaries are covered by U.S. and foreign patents and/or pending patents.**

**TEKTRONIX, TEK, SCOPE-MOBILE, and  are registered trademarks of Tektronix, Inc. TELEQUIPMENT is a registered trademark of Tektronix U.K. Limited.**

**Printed in U.S.A. Specification and price change privileges are reserved.**

**TABLE OF CONTENTS**

**SAFETY SUMMARY** ..... ii

**INTRODUCTION** ..... 1

    Scope ..... 1

    Product Description ..... 1

    Controls and Indicators ..... 1

        Controls ..... 1

        Indicators ..... 2

**SPECIFICATIONS/CHECKS** ..... 3

    Electrical Specification ..... 3

    Mechanical Specification ..... 4

    Functional Checks ..... 5

        Test Equipment Required ..... 5

        Procedure..... 5

**REPLACEABLE ELECTRICAL PARTS** ..... 11

**REPLACEABLE MECHANICAL PARTS** ..... 17

**CIRCUIT DIAGRAM**

**CHANGE INFORMATION**

## SAFETY SUMMARY

### *Note*

*The general safety information in this part of the summary is for both operating and servicing personnel. Specific warnings and cautions will be found throughout the manual where they apply, but may not appear in the summary.*

### **Terms In This Manual**

CAUTION statements identify conditions or practices that could result in damage to the equipment or other property.

WARNING statements identify conditions that could result in personal injury or loss of life.

### **Terms As Marked On Equipment**

CAUTION indicates a personal injury hazard not immediately accessible as one reads the markings, or a hazard to property including the equipment itself.

DANGER indicates a personal injury hazard not immediately accessible as one reads the markings.

### **Do Not Service Alone**

Do not perform internal service or adjustment of this product unless another person capable of rendering first aid and resuscitation is present.

### **Use Care When Servicing With Power On**

Dangerous voltages exist at several points in this product. To avoid personal injury, do not touch exposed connections and components while power is on.

Disconnect power before removing protective panels, soldering, or replacing components.

### **Power Source**

This product is intended to operate from a power source that will not apply more than 132 volts rms between the supply conductors or between either supply conductor and ground. A protective ground connection by way of the grounding conductor in the power cord is essential for safe operation.

### **Grounding the Product**

This product is grounded through the grounding conductor of the power cord. To avoid electrical shock, plug the power cord into a properly wired receptacle before connecting to the product. A protective ground connection by way of the grounding conductor in the power cord is essential for safe operation.

### **Danger Arising From Loss of Ground**

Upon loss of the protective-ground connection, all accessible conductive parts can render an electrical shock.

### **Use the Proper Fuse**

To avoid fire hazard, use only the fuse of correct type, voltage rating, and current rating as specified in the parts list for your product.

Refer fuse replacement to qualified service personnel.



## INTRODUCTION

### SCOPE

The 067-1133-00 Instruction Sheet documents only the description of the 110-S Power Supply Test Fixture and its operation.

#### *NOTE*

*Operating instructions for testing and troubleshooting the 110-S Power Supply Module (A10) using this test unit is not covered in this instruction sheet. Refer to the Component Level Troubleshooting section in the 110-S Service Manual for detail operating instructions information.*

### PRODUCT DESCRIPTION

The 067-1133-00 (110-S Power Supply Test Fixture) is a functional checking and troubleshooting fixture for the 110-S Synchronizer power supply module A10, while the module is removed from the host 110-S. This unit provides the minimum-resistance loads necessary for the unregulated supplies on the 110-S Rectifier board (A10A1) and the regulated supplies on the 110-S Regulator board (A10A2). The unit also checks the 110-S power supply module's protective circuitry for overvoltage, overcurrent, and high temperature conditions.

### CONTROLS AND INDICATORS

#### Controls

**POWER** - Main power switch for Power Supply Test Fixture.

**OUTPUT** - Two-position switch.

**RECTIFIER LOAD** - Connects the output of the unregulated supplies (+150 V) and the regulated supplies (-12 V and +14 V) from the Rectifier board (A10A1) to load resistors within the Test Fixture.

**REGULATOR** - Connects the output of the supplies from the Rectifier board to the input of the Regulator board (A10A2).

**LOAD** - Two-position switch.

**MIN** - Places a minimum load on the regulated supplies ( $\pm 5$  V and  $\pm 15$  V) from the Regulator board.

**NORMAL** - Places a normal load on the regulated supplies, approximately the same load as experienced in the 110-S Synchronizer.

**OVERLOAD** - A three-position switch that is used in conjunction with the LOAD switch in the NORMAL position.

**Center Position** - No overload condition is applied to either supply.

**-5 V** - Applies a static overload condition on the -5 volt supply. Used to check the -5 V overcurrent protection circuitry.

**+5 V** - Applies a static overload condition on the +5 volt supply. Used to check the +5 V overcurrent protection circuitry.

**$\pm 5$  VOLTS** - Two-position switch used to test the undervoltage and overvoltage circuitry for the  $\pm 5$  volt supplies. The LOAD switch should be in the MIN position for this test.

**NORMAL** - The +5 voltage sense line, that is monitored by the switching regulator circuitry on the Regulator board, is connected directly to the +5 V supply.

**LIMITS TEST** - Forces the voltage of the  $\pm 5$  V supplies below their undervoltage condition and then gradually increases the voltage of the supplies to an overvoltage condition.

**TEMP TEST** - Three-position switch used to test the Fan and Shutdown circuitry on the Regulator board with overtemperature conditions.

**Center Position** - Represents a normal operating temperature condition for the  $\pm 15$  V supplies heatsink during the test.

**OVERTEMP** - Represents an overtemperature condition (greater than  $75^{\circ}$  C and less than  $85^{\circ}$  C). Should cause the fan circuitry on the Regulator board under test to supply maximum fan voltage (29 V) and light the Overtemp indicator on the front edge of the Regulator board.

**HI-TEMP SHUTDOWN** - Represents a temperature condition of greater than  $85^{\circ}$  C. Should cause the power supply module to shut down the regulated supplies ( $\pm 15$  V and  $\pm 5$  V) and light the Overtemp indicator on the front edge of the Regulator board.

## Indicators

**VOLTS** - Eight LEDs (light-emitting diodes) to indicate the presence of the unregulated and regulated supplies.

**FAN SPEED** - Two LEDs to indicate what the fan speed would be if connected in the 110-S instrument. The appropriate LED lights to indicate the present condition (Normal or Fast).



## SPECIFICATIONS/CHECKS

## ELECTRICAL SPECIFICATION

Characteristic	Performance Requirement	Supplemental Information (Nominal Values)
<b>Rectifier Load</b>		
$\pm 150$ V	500 ohms $\pm 10\%$	115 W at 90 VAC 190 W at 115 VAC 240 W at 130 VAC
+14 V	100 ohms $\pm 10\%$	150 mA (Includes 10 mA for LED)
-12 V	470 ohms $\pm 10\%$	36 mA (Includes 10 mA for LED)
<b>Regulator Load</b>		
+5 V Normal Min	21 A $\pm 10\%$ 1 ohm $\pm 10\%$	5 A
-5 V Normal Min	13 A $\pm 10\%$ 1 ohm $\pm 10\%$	5 A
+15 V Normal Min	17.5 ohms $\pm 10\%$ 70.0 ohms $\pm 10\%$	867 mA (Includes 224 mA 10 mA for LED)
-15 V Normal Min	17.5 ohms $\pm 10\%$ 70.0 ohms $\pm 10\%$	867 mA (Includes 224 mA 10 mA for LED)
+5 V Overload	Greater than 31 A.	LOAD switch in normal.
-5 V Overload	Greater than 20 A.	LOAD switch in normal.
$\pm 5$ Volts (Limits Test)	Pin 7 of U612 scans from greater than 11 volts to less than 1.5 volts in 30 to 45 seconds nominally.	Minimum scan of the +5 V supplies from a low of 4.1 volts to a high of 5.8 volts.  ( $\pm 5$ V overvoltage protection disabled)

**ELECTRICAL SPECIFICATION (Cont.)**

Characteristic	Performance Requirement	Supplemental Information (Nominal Values)
<b>Temperature Test</b>		
Overtemp	7.0 V $\pm$ 0.25 V	
Shutdown	+8 V $\pm$ 0.25 V	

**MECHANICAL SPECIFICATION**

Characteristic	Supplemental Information
Height	9.15 inches (232.4 mm)
Width	21.7 inches (551.2 mm)
Depth	7.0 inches (177.8 mm)
Weight	11 pounds (5.0 kg)

## FUNCTIONAL CHECKS

### Test Equipment Required

#### 1. Digital Multimeter

DC voltmeter: range, 0 to 15 volts; accuracy,  $\pm 0.1\%$ .

Ohmmeter: range, 1 to 500 ohms; accuracy,  $\pm 1\%$ .

A TEKTRONIX DM 502A Digital Multimeter installed in a TEKTRONIX TM 500-Series Power Module is recommended.

#### 2. DC Power Supply

Voltage outputs:  $\pm 5$  volts at 0.1 A  
 $\pm 15$  volts at 0.5 A

A TEKTRONIX PS 503A Power Supply installed in a TEKTRONIX TM 500-Series Power Module is recommended.

#### 3. Resistor

Value: 100 ohms,  $\frac{1}{2}$  watt

### Procedure

#### NOTE

*The following checks do not require a 110-S Power Supply Module A10 to be installed on the 067-1133-00 test fixture. Also the test fixture does not require an ac power source during the checks.*

#### 1. Check $\pm 150$ V Rectifier Load

- a. Connect an ohmmeter across pins 1 and 2 of J844, which is located through the opening in the front panel of the 067-1133-00.
- b. Set the OUTPUT switch in the RECTIFIER LOAD position.

- c. CHECK - for a resistance of 250 ohms  $\pm 10\%$ .
- d. Disconnect the ohmmeter lead that is connected to pin 2 and reconnect it to pin 3 of J844.
- e. CHECK - for a resistance of 250 ohms  $\pm 10\%$ .

**2. Check +14 V Rectifier Load**

- a. Connect an ohmmeter across pins 2 and 3 of J842, which is located through the opening in the front panel of the 067-1133-00.
- b. Set the OUTPUT switch in the RECTIFIER LOAD position.
- c. CHECK - for a resistance of 100 ohms  $\pm 10\%$ .

**3. Check -12 V Rectifier Load**

- a. Connect an ohmmeter across pins 3 and 4 of J842.
- b. Set the OUTPUT switch in the RECTIFIER LOAD position.
- c. CHECK - for a resistance of 470 ohms  $\pm 10\%$ .

**4. Check Rectifier Board Voltage Indicators**

- a. Set the OUTPUT switch in the REGULATOR position.
- b. Connect the ground reference of an external dc power supply to pin 1 of J844.
- c. Connect +15 volts from the external power supply to pin 2 of J844.
- d. CHECK - that the +150 V LED (light-emitting diode) is dimly lit.
- e. Move the +15 volt supply to pin 2 of J842.
- f. CHECK - that the +14 V LED is lit.
- g. Remove the +15 volt source.
- h. Connect -15 volts from the external power supply to pin 3 of J844.
- i. CHECK - that the -150 V LED is dimly lit.
- j. Move the -15 volt source to pin 4 of J842.
- k. CHECK - that the -12 V LED is lit.
- l. Remove the -15 volt power supply.

**5. Check Regulator Board Minimum Loads**

- a. Set the LOAD switch in the MIN position.
- b. Connect an ohmmeter across pin 2 of J226 and pin 4 of J426, on the PS Plug Adapter board at the end of the cable from the 067-1133-00.
- c. CHECK - the +5 volt minimum load for 1 ohm  $\pm 10\%$ .
- d. Reconnect the ohmmeter across pin 3 of J226 and pin 4 of J426.
- e. CHECK - the -5 volt minimum load for 1 ohm  $\pm 10\%$ .
- f. Reconnect the ohmmeter across pins 5 and 6 of J326.
- g. CHECK - the  $\pm 15$  volt minimum load for 140 ohms  $\pm 10\%$ .

**6. Check the  $\pm 15$  V Normal Load**

- a. Set the LOAD switch to the NORMAL position.
- b. Connect an ohmmeter across pin 5 of J326 and 4 of J426.
- c. CHECK - for a resistance of 17.5 ohms  $\pm 10\%$ .
- d. Move the ohmmeter lead from pin 5 of J326 to pin 6 of J326.
- e. CHECK - for a resistance of 17.5 ohms  $\pm 10\%$ .

**7. Check  $\pm 5$  V Resistive Loads in NORMAL and OVERLOAD Conditions**

- a. Disconnect P226, P326, and P426 from the PS Plug Adapter board.
- b. Connect an ohmmeter across pin 1 of P326 and pin 2 of P426.
- c. CHECK - for a resistance of 1 ohm  $\pm 10\%$ .
- d. Reconnect the ohmmeter across pin 1 of P226 and pin 2 of P326.
- e. CHECK - for a resistance of 2 ohms  $\pm 10\%$ .
- f. Reconnect the ohmmeter across pin 1 of P226 and pin 1 of P326.
- g. CHECK - for a resistance of 2 ohms  $\pm 10\%$ .
- h. Reconnect the ohmmeter across pin 3 of P326 and pin 3 of P426.
- i. CHECK - for a resistance of 1 ohms  $\pm 10\%$ .

**8. Check +5 V Active Components for NORMAL and OVERLOAD Conditions**

- a. Set the LOAD switch to the MIN position.
- b. With P226, P326, and P426 disconnected from PS Plug Adapter board, connect ground of an external dc power supply to pin 1 of J844.
- c. Connect an external +5 volt source to one end of a 100-ohm, ½ watt resistor.
- d. Connect a voltmeter between ground and the end of the 100 ohm resistor that is opposite the +5 volt supply; this end of the resistor will be referred to as side B for the remaining portion of this step.
- e. Connect side B of the 100-ohm resistor to pin 2 of P426.
- f. CHECK - the voltmeter for +5 volt reading; set the LOAD switch to the NORMAL position and check for less than +0.7 volts.
- g. Connect side B of the 100-ohm resistor to pin 1 of P226 and set the LOAD switch to the MIN position.
- h. CHECK - the voltmeter for +5 volt reading; set the LOAD switch to the NORMAL position and check for less than +0.7 volts.
- i. Set the LOAD switch to MIN.
- j. CHECK - the voltmeter for less than +0.7 volts as the OVERLOAD switch is pressed to the +5 V side.

**9. Check -5 V Active Components for NORMAL and OVERLOAD Condition**

- a. Set the LOAD switch to the MIN position.
- b. With P226, P326, and P426 disconnected from the PS Plug Adapter board and the ground of an external dc power supply connected to pin 1 of J844, connect an external -5 volt supply to one end of a 100-ohm, ½ watt resistor.
- c. Connect a voltmeter between ground and the end of the 100-ohm resistor that is opposite the -5 V supply; this end of the resistor will be referred to as side B in the remaining portion of this step.
- d. Connect side B of the 100-ohm resistor to pin 3 of P326.
- e. CHECK - the voltmeter for -5 volt reading.
- f. Set the LOAD switch to NORMAL.

- g. CHECK - the voltmeter for less than -0.7 volts.
- h. Set the LOAD switch to MIN.
- i. CHECK - the voltmeter for less than -0.7 volts as the OVERLOAD switch is pressed to the -5 V side.

#### 10. Check Regulator Board Voltage Indicator

- a. With P226, P326, and P426 plugs disconnected and the ground of the external supply connected to pin 1 of J844, connect external supplies as listed below:
  - +5 volts to pin 1 of P426.
  - 5 volts to pin 3 of P326
  - +15 volts to pin 6 of P326
  - 15 volts to pin 5 of P326
- b. CHECK - that the appropriate LEDs (+5V, -5V, +15V, and -15V) lights as the external supplies are connected to the pins indicated above.
- c. Remove the external supplies.

#### 11. Check FAN SPEED Recognition

- a. With the ground reference from the external power supply connected to pin 1 of J844, connect an external +15 volt supply to pin 6 of P226 on the PS Plug Adapter board.
- b. Connect an external 0 to -15 variable volt supply to pin 5 of P226.
- c. Connect a voltmeter between pin 5 of P226 and the ground reference of the external supply.
- d. CHECK - that only the NORMAL LED is lit as the variable supply is varied from 0 to about -6 volts. The LED should gradually dim as the supply is varied.
- e. CHECK - that both the NORMAL LED and the FAST LED are out as the variable supply is varied between -8 and -10 volts.
- f. CHECK - that the FAST LED starts to turn on as the variable supply increases to approximately -12 volts.
- g. Disconnect the external supplies.

**12. Check TEMP TEST Selection**

- a. Connect the ground reference of an external supply to pin 1 of J844 the front panel of the 067-1133-00 Test Fixture.
- b. Connect the +15 volt supply to pin 2 of J842 on the front panel of the 067-1133-00 Test Fixture.
- c. Connect a voltmeter between the P289 (the 9-3 wire at the end of the cable with the PS Plug Adapter board) and ground.
- d. CHECK - for a stable +8.62 volts  $\pm 2\%$  when the TEMP TEST switch is pressed to the HI-TEMP SHUTDOWN position and held for a short time.
- e. CHECK - for a stable +7.54 volts  $\pm 2\%$  when the TEMP TEST switch is pressed to the OVERTEMP position and held for a short time.
- f. Disconnect the external power supply and the voltmeter.

**13. Check  $\pm 5$  VOLTS Limit Test**

- a. With the ground reference of an external power supply connected to pin 1 of J844, connect an external +15 volts to pin 2 of J842 and the -15 volts to pin 4 of J842.
- b. Connect one end of a 100-ohm,  $\frac{1}{2}$  watt resistor to pin 1 of P426 and the other end to pin 5 of P426.
- c. Connect an external +5 volt supply to pin 1 of P426.
- d. Connect an voltmeter between pin 5 of P426 and ground.
- e. Leave the  $\pm 5$  VOLTS switch in the NORMAL position for at least ten seconds.
- f. Switch the  $\pm 5$  VOLTS switch to the LIMITS TEST position.
- g. CHECK - that the voltage at pin 5 of P426 jumps to approximately 5.35 volts when the switch is thrown and gradually decreases to less than 4.85 volts in 40 to 55 seconds before it stabilizes.
- h. Disconnect the external supplies and reconnect plugs P226, P326, and P426 to J226, J326, and J426, respectively on Power Supply Adaptive board.

This completes the functional test on the 067-1133-00 110-S Power Supply Test Fixture.



# REPLACEABLE ELECTRICAL PARTS

## PARTS ORDERING INFORMATION

Replacement parts are available from or through your local Tektronix, Inc. Field Office or representative.

Changes to Tektronix instruments are sometimes made to accommodate improved components as they become available, and to give you the benefit of the latest circuit improvements developed in our engineering department. It is therefore important, when ordering parts, to include the following information in your order: Part number, instrument type or number, serial number, and modification number if applicable.

If a part you have ordered has been replaced with a new or improved part, your local Tektronix, Inc. Field Office or representative will contact you concerning any change in part number.

Change information, if any, is located at the rear of this manual.

### LIST OF ASSEMBLIES

A list of assemblies can be found at the beginning of the Electrical Parts List. The assemblies are listed in numerical order. When the complete component number of a part is known, this list will identify the assembly in which the part is located.

### CROSS INDEX-MFR. CODE NUMBER TO MANUFACTURER

The Mfr. Code Number to Manufacturer index for the Electrical Parts List is located immediately after this page. The Cross Index provides codes, names and addresses of manufacturers of components listed in the Electrical Parts List.

### ABBREVIATIONS

Abbreviations conform to American National Standard Y1.1.

### COMPONENT NUMBER (column one of the Electrical Parts List)

A numbering method has been used to identify assemblies, subassemblies and parts. Examples of this numbering method and typical expansions are illustrated by the following:

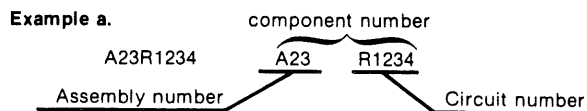

**Read: Resistor 1234 of Assembly 23**

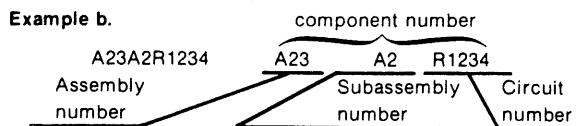

**Read: Resistor 1234 of Subassembly 2 of Assembly 23**

Only the circuit number will appear on the diagrams and circuit board illustrations. Each diagram and circuit board illustration is clearly marked with the assembly number. Assembly numbers are also marked on the mechanical exploded views located in the Mechanical Parts List. The component number is obtained by adding the assembly number prefix to the circuit number.

The Electrical Parts List is divided and arranged by assemblies in numerical sequence (e.g., assembly A1 with its subassemblies and parts, precedes assembly A2 with its subassemblies and parts).

Chassis-mounted parts have no assembly number prefix and are located at the end of the Electrical Parts List.

### TEKTRONIX PART NO. (column two of the Electrical Parts List)

Indicates part number to be used when ordering replacement part from Tektronix.

### SERIAL/MODEL NO. (columns three and four of the Electrical Parts List)

Column three (3) indicates the serial number at which the part was first used. Column four (4) indicates the serial number at which the part was removed. No serial number entered indicates part is good for all serial numbers.

### NAME & DESCRIPTION (column five of the Electrical Parts List)

In the Parts List, an Item Name is separated from the description by a colon (:). Because of space limitations, an Item Name may sometimes appear as incomplete. For further Item Name identification, the U.S. Federal Cataloging Handbook H6-1 can be utilized where possible.

### MFR. CODE (column six of the Electrical Parts List)

Indicates the code number of the actual manufacturer of the part. (Code to name and address cross reference can be found immediately after this page.)

### MFR. PART NUMBER (column seven of the Electrical Parts List)

Indicates actual manufacturers part number.

Replaceable Electrical Parts—067-1133-00

CROSS INDEX—MFR. CODE NUMBER TO MANUFACTURER

Mfr. Code	Manufacturer	Address	City, State, Zip
01121	ALLEN-BRADLEY COMPANY	1201 2ND STREET SOUTH	MILWAUKEE, WI 53204
01295	TEXAS INSTRUMENTS, INC. SEMICONDUCTOR GROUP	P.O. BOX 5012	DALLAS, TX 75222
04713	MOTOROLA, INC., SEMICONDUCTOR PROD. DIV.	5005 E MCDOWELL RD, PO BOX 20923	PHOENIX, AZ 85036
06383	PANDUIT CORPORATION	17301 RIDGELAND	TINLEY PARK, IL 60477
09353	C AND K COMPONENTS, INC.	103 MORSE STREET	WATERTOWN, MA 02172
15238	ITT SEMICONDUCTORS, A DIVISION OF INTER NATIONAL TELEPHONE AND TELEGRAPH CORP.	P.O. BOX 168, 500 BROADWAY	LAWRENCE, MA 01841
22526	BERG ELECTRONICS, INC.	YOUK EXPRESSWAY	NEW CUMBERLAND, PA 17070
27014	NATIONAL SEMICONDUCTOR CORP.	2900 SEMICONDUCTOR DR.	SANTA CLARA, CA 95051
27193	CUTLER-HAMMER, INC. SPECIALTY PRODUCTS DIVISION	4201 N. 27TH ST.	MILWAUKEE, WI 53216
27264	MOLEX, INC.	2222 WELLINGTON COURT	LISLE, IL 60532
55680	NICHICON/AMERICA/CORP.	6435 N PROESEL AVENUE	CHICAGO, IL 60645
56289	SPRAGUE ELECTRIC CO.	87 MARSHALL ST.	NORTH ADAMS, MA 01247
58361	GENERAL INSTRUMENT CORP. OPTO ELECTRONICS DIV.	3400 HILLVIEW AVE	PALO ALTO, CA 94304
63743	WARD LEONARD ELECTRIC CO., INC.	31 SOUTH ST.	MOUNT VERNON, NY 10550
80009	TEKTRONIX, INC.	P O BOX 500	BEAVERTON, OR 97077
82389	SWITCHCRAFT, INC.	5555 N. ELSTON AVE.	CHICAGO, IL 60630
82877	ROTRON, INC.	7-9 HASBROUCK LANE	WOODSTOCK, NY 12498
91637	DALE ELECTRONICS, INC.	P. O. BOX 609	COLUMBUS, NE 68601
95146	ALCO ELECTRONICS PRODUCTS, INC.	P. O. BOX 1348	LAWRENCE, MA 01842
T0946	SAN-O INDUSTRIAL CORP.	170 WILBUR PL	BAHEMIA, LONG ISLAND, NY 1171

Component No.	Tektronix Part No.	Serial/Model No. Eff Dscnt	Name & Description	Mfr Code	Mfr Part Number
A1	670-8416-00		CKT BOARD ASSY:PWR SPLY TESTER	80009	670-8416-00
A2	670-8494-00		CKT BOARD ASSY:PWR SPLY PLUG ADPT	80009	670-8494-00
A1	670-8416-00		CKT BOARD ASSY:PWR SPLY TESTER	80009	670-8416-00
A1C512	290-0830-00		CAP.,FXD,ELCTLT:10 UF,5%,20V	56289	150D106X5020B2
A1C709	290-0845-00		CAP.,FXD,ELCTLT:330UF,10+50%,25 WVDC	55680	ULB1E331TEAANA
A1CR631	152-0040-00		SEMICONV DEVICE:SILICON,600V,1A	15238	LG109
A1CR713	152-0141-02		SEMICONV DEVICE:SILICON,30V,150MA	01295	1N4152R
A1CR731	152-0040-00		SEMICONV DEVICE:SILICON,600V,1A	15238	LG109
A1CR738	152-0040-00		SEMICONV DEVICE:SILICON,600V,1A	15238	LG109
A1CR838	152-0040-00		SEMICONV DEVICE:SILICON,600V,1A	15238	LG109
A1J208	131-0589-00		TERMINAL,PIN:0.46 L X 0.025 SQ	22526	48283-029
A1J212	131-2250-00		CONN,RCPT,ELEC:CKT BD,5 MALE	27264	09-61-1053
A1J223	131-0589-00		TERMINAL,PIN:0.46 L X 0.025 SQ	22526	48283-029
A1J225	131-2676-00		CONN,RCPT,ELEC:CKT BD,1 X 3,0.1 SPACING	22526	65780-003
A1J228	131-2250-00		CONN,RCPT,ELEC:CKT BD,5 MALE	27264	09-61-1053
A1J236	131-3007-00		CONN,RCPT,ELEC:CKT BD,1 X 5,0.156	27264	09-88-1051
A1J239	131-3007-00		CONN,RCPT,ELEC:CKT BD,1 X 5,0.156	27264	09-88-1051
A1J735	131-3006-00		CONN,RCPT,ELEC:CKT BD,1 X 4,0.1	27264	22-29-2041
A1J842	131-3006-00		CONN,RCPT,ELEC:CKT BD,1 X 4,0.1	27264	22-29-2041
A1J844	131-3007-00		CONN,RCPT,ELEC:CKT BD,1 X 5,0.156	27264	09-88-1051
A1R239	308-0426-00		RES.,FXD,WW:470 OHM,5%,3W	91637	CW2B-470R0J
A1R307	308-0568-00		RES.,FXD,WW:35 OHM,5%,5W	91637	CW5-35R00J
A1R325	308-0078-00		RES.,FXD,WW:70 OHM,5%,5W	63743	7686
A1R332	308-0078-00		RES.,FXD,WW:70 OHM,5%,5W	63743	7686
A1R407	308-0079-00		RES.,FXD,WW:117 OHM,5%,5W	91637	CW5-11R0J
A1R425	308-0078-00		RES.,FXD,WW:70 OHM,5%,5W	63743	7686
A1R432	308-0078-00		RES.,FXD,WW:70 OHM,5%,5W	63743	7686
A1R439	308-0110-00		RES.,FXD,WW:100 OHM,5%,8W	56289	283EX100R0JQ24
A1R512	315-0224-00		RES.,FXD,CMPSN:220K OHM,5%,0.25W	01121	CB2245
A1R525	308-0078-00		RES.,FXD,WW:70 OHM,5%,5W	63743	7686
A1R532	308-0078-00		RES.,FXD,WW:70 OHM,5%,5W	63743	7686
A1R537	303-0623-00		RES.,FXD,CMPSN:62K OHM,5%,1W	01121	GB6235
A1R539	308-0108-00		RES.,FXD,WW:15K OHM,5%,5W	91637	CW5-15001J
A1R541	303-0623-00		RES.,FXD,CMPSN:62K OHM,5%,1W	01121	GB6235
A1R607	308-0079-00		RES.,FXD,WW:117 OHM,5%,5W	91637	CW5-11R0J
A1R612	315-0224-00		RES.,FXD,CMPSN:220K OHM,5%,0.25W	01121	CB2245
A1R622	315-0132-00		RES.,FXD,CMPSN:1.3K OHM,5%,0.25W	01121	CB1325
A1R623	315-0331-00		RES.,FXD,CMPSN:330 OHM,5%,0.25W	01121	CB3315
A1R625	308-0078-00		RES.,FXD,WW:70 OHM,5%,5W	63743	7686
A1R632	308-0078-00		RES.,FXD,WW:70 OHM,5%,5W	63743	7686
A1R639	308-0108-00		RES.,FXD,WW:15K OHM,5%,5W	91637	CW5-15001J
A1R703	315-0161-00		RES.,FXD,CMPSN:160 OHM,5%,0.25W	01121	CB1615
A1R705	321-0171-00		RES.,FXD,FILM:590 OHM,1%,0.125W	91637	MFF1816G590R0F
A1R706	321-0097-00		RES.,FXD,FILM:100 OHM,1%,0.125W	91637	MFF1816G100R0F
A1R712	321-0510-00		RES.,FXD,FILM:2M OHM,1%,0.125W	91637	HFF188G20003F
A1R713	321-0220-00		RES.,FXD,FILM:1.91K OHM,1%,0.125W	91637	MFF1816G19100F
A1R722	315-0331-00		RES.,FXD,CMPSN:330 OHM,5%,0.25W	01121	CB3315
A1R725	315-0132-00		RES.,FXD,CMPSN:1.3K OHM,5%,0.25W	01121	CB1325
A1R739	301-0102-00		RES.,FXD,CMPSN:1K OHM,5%,0.50W	01121	EB1025
A1R806	321-0178-00		RES.,FXD,FILM:698 OHM,1%,0.125W	91637	MFF1816G698R0F
A1R839	301-0122-00		RES.,FXD,CMPSN:1.2K OHM,5%,0.5W	01121	EB1225
A1U612	156-0853-00		MICROCIRCUIT,LI:OPERATIONAL AMPLIFIER,DUAL	27014	LM358N
A1VR512	152-0168-00		SEMICONV DEVICE:ZENER,0.4W,12V,5%	04713	SZG35009K4

Replaceable Electrical Parts—067-1133-00

Component No.	Tektronix Part No.	Serial/Model No. Eff Dscont	Name & Description	Mfr Code	Mfr Part Number
A2	670-8494-00		CKT BOARD ASSY:PWR SPLY PLUG ADPT	80009	670-8494-00
A2J226	131-2576-00		TERM SET,PIN: 6 CONTACT,MALE		
A2J326	131-2576-00		TERM SET,PIN: 6 CONTACT,MALE		
A2J426	131-2250-00		CONN.RCPT,ELEC:CKT BD,5 MALE	27264	09-61-1053
A2P109	131-2863-00		CONN.,RCPT,ELEC:FEMALE,3 X 16,0.1	06383	100-348-452
CHASSIS PARTS					
B92	119-0026-00		FAN,AXIAL:1.500 X 4.750 INCH,WHISPER	82877	WR2A1
DS702	150-1014-00		LAMP,LED:RED,50MA	58361	Q6444/MV5054-1
DS704	150-1014-00		LAMP,LED:RED,50MA	58361	Q6444/MV5054-1
DS713	150-1014-00		LAMP,LED:RED,50MA	58361	Q6444/MV5054-1
DS716	150-1014-00		LAMP,LED:RED,50MA	58361	Q6444/MV5054-1
DS720	150-1014-00		LAMP,LED:RED,50MA	58361	Q6444/MV5054-1
DS724	150-1014-00		LAMP,LED:RED,50MA	58361	Q6444/MV5054-1
DS730	150-1014-00		LAMP,LED:RED,50MA	58361	Q6444/MV5054-1
DS732	150-1014-00		LAMP,LED:RED,50MA	58361	Q6444/MV5054-1
DS734	150-1014-00		LAMP,LED:RED,50MA	58361	Q6444/MV5054-1
DS736	150-1014-00		LAMP,LED:RED,50MA	58361	Q6444/MV5054-1
F96	159-0211-00		FUSE CARTRIDGE:3AG,5 AMP,250V,SLOW BLOW	T0946	NSDLO5A
J98	131-1084-00		CONNECTOR,RCPT,;3 BLADE,6A,250V	82389	EAC-302
Q904	151-0616-00		TRANSISTOR:SILICON,PNP	04713	SJE377
Q913	151-0616-00		TRANSISTOR:SILICON,PNP	04713	SJE377
Q922	151-0616-00		TRANSISTOR:SILICON,PNP	04713	SJE377
Q930	151-0477-00		TRANSISTOR:SILICON,NPN	04713	SJE374
Q940	151-0477-00		TRANSISTOR:SILICON,NPN	04713	SJE374
R11	308-0097-00		RES.,FXD,WW:	63743	55S1R00J
R12	308-0097-00		RES.,FXD,WW:	63743	55S1R00J
R13	308-0097-00		RES.,FXD,WW:	63743	55S1R00J
R21	308-0097-00		RES.,FXD,WW:	63743	55S1R00J
R22	308-0098-00		RES.,FXD,WW:	63743	7694
R23	308-0097-00		RES.,FXD,WW:	63743	55S1R00J
R31	308-0098-00		RES.,FXD,WW:	63743	7694
R32	308-0097-00		RES.,FXD,WW:	63743	55S1R00J
R33	308-0097-00		RES.,FXD,WW:	63743	55S1R00J
R41	308-0097-00		RES.,FXD,WW:	63743	55S1R00J
R42	308-0097-00		RES.,FXD,WW:	63743	55S1R00J
R43	308-0098-00		RES.,FXD,WW:	63743	7694
R51	308-0097-00		RES.,FXD,WW:	63743	55S1R00J
R52	308-0098-00		RES.,FXD,WW:	63743	7694
R53	308-0097-00		RES.,FXD,WW:	63743	55S1R00J
R61	308-0098-00		RES.,FXD,WW:	63743	7694
R62	308-0097-00		RES.,FXD,WW:	63743	55S1R00J
R63	308-0097-00		RES.,FXD,WW:	63743	55S1R00J
S804	260-1485-00		SWITCH,TOGGLE:SPDT,5A,115VAC,CENTER OFF	09353	5930-00-368-1403
S812	260-1335-00		SWITCH,TOGGLE:SPDT,0.4A,20VDC	09353	7101 SHCB8E
S818	260-1485-00		SWITCH,TOGGLE:SPDT,5A,115VAC,CENTER OFF	09353	5930-00-368-1403
S825	260-1840-00		SWITCH,TOGGLE:4PDT,3A,250V	95146	MTA406N/UL
S833	260-1840-00		SWITCH,TOGGLE:4PDT,3A,250V	95146	MTA406N/UL
S94	260-1060-01		SWITCH,TOGGLE:DPST,15A,125VAC	27193	8906K-2507

# REPLACEABLE MECHANICAL PARTS

## PARTS ORDERING INFORMATION

Replacement parts are available from or through your local Tektronix, Inc. Field Office or representative.

Changes to Tektronix instruments are sometimes made to accommodate improved components as they become available, and to give you the benefit of the latest circuit improvements developed in our engineering department. It is therefore important, when ordering parts, to include the following information in your order: Part number, instrument type or number, serial number, and modification number if applicable.

If a part you have ordered has been replaced with a new or improved part, your local Tektronix, Inc. Field Office or representative will contact you concerning any change in part number.

Change information, if any, is located at the rear of this manual.

## ITEM NAME

In the Parts List, an Item Name is separated from the description by a colon (:). Because of space limitations, an Item Name may sometimes appear as incomplete. For further Item Name identification, the U.S. Federal Cataloging Handbook H6-1 can be utilized where possible.

## FIGURE AND INDEX NUMBERS

Items in this section are referenced by figure and index numbers to the illustrations.

## INDENTATION SYSTEM

This mechanical parts list is indented to indicate item relationships. Following is an example of the indentation system used in the description column.

```

1 2 3 4 5
Name & Description
Assembly and/or Component
Attaching parts for Assembly and/or Component
-----
Detail Part of Assembly and/or Component
Attaching parts for Detail Part
-----
Parts of Detail Part
Attaching parts for Parts of Detail Part
-----

```

Attaching Parts always appear in the same indentation as the item it mounts, while the detail parts are indented to the right. Indented items are part of, and included with, the next higher indentation. The separation symbol --- \* --- indicates the end of attaching parts.

**Attaching parts must be purchased separately, unless otherwise specified.**

## ABBREVIATIONS

INCH	ELCTRN	ELECTRON	IN	INCH	SE	SINGLE END
# NUMBER SIZE	ELEC	ELECTRICAL	INCAND	INCANDESCENT	SECT	SECTION
ACTR ACTUATOR	ELECTLT	ELECTROLYTIC	INSUL	INSULATOR	SEMICON	SEMICONDUCTOR
ADPTR ADAPTER	ELEM	ELEMENT	INTL	INTERNAL	SHLD	SHIELD
ALIGN ALIGNMENT	EPL	ELECTRICAL PARTS LIST	LPHLDR	LAMPHOLDER	SHLDR	SHOULDERED
AL ALUMINUM	EQPT	EQUIPMENT	MACH	MACHINE	SKT	SOCKET
ASSEM ASSEMBLED	EXT	EXTERNAL	MECH	MECHANICAL	SL	SLIDE
ASSY ASSEMBLY	FIL	FILLISTER HEAD	MTG	MOUNTING	SLFLKG	SELF-LOCKING
ATTEN ATTENUATOR	FLEX	FLEXIBLE	NIP	NIPPLE	SLVG	SLEEVEING
AWG AMERICAN WIRE GAGE	FLH	FLAT HEAD	NON WIRE	NOT WIRE WOUND	SPR	SPRING
BD BOARD	FLTR	FILTER	OBD	ORDER BY DESCRIPTION	SQ	SQUARE
BRKT BRACKET	FR	FRAME or FRONT	OD	OUTSIDE DIAMETER	SST	STAINLESS STEEL
BRS BRASS	FSTNR	FASTENER	OVH	OVAL HEAD	STL	STEEL
BRZ BRONZE	FT	FOOT	PH BRZ	PHOSPHOR BRONZE	SW	SWITCH
BSHG BUSHING	FXD	FIXED	PL	PLAIN or PLATE	T	TUBE
CAB CABINET	GSKT	GASKET	PLSTC	PLASTIC	TERM	TERMINAL
CAP CAPACITOR	HDL	HANDLE	PN	PART NUMBER	THD	THREAD
CER CERAMIC	HEX	HEXAGON	PNH	PAN HEAD	THK	THICK
CHAS CHASSIS	HEX HD	HEXAGONAL HEAD	PWR	POWER	TNSN	TENSION
CKT CIRCUIT	HEX SOC	HEXAGONAL SOCKET	RCPT	RECEPTACLE	TPG	TAPPING
COMP COMPOSITION	HLCPS	HELICAL COMPRESSION	RES	RESISTOR	TRH	TRUSS HEAD
CONN CONNECTOR	HLEXT	HELICAL EXTENSION	RGD	RIGID	V	VOLTAGE
COV COVER	HV	HIGH VOLTAGE	RLF	RELIEF	VAR	VARIABLE
CPLG COUPLING	IC	INTEGRATED CIRCUIT	RTNR	RETAINER	W/	WITH
CRT CATHODE RAY TUBE	ID	INSIDE DIAMETER	SCH	SOCKET HEAD	WSHR	WASHER
DEG DEGREE	IDENT	IDENTIFICATION	SCOPE	OSCILLOSCOPE	XFMR	TRANSFORMER
DWR DRAWER	IMPLR	IMPELLER	SCR	SCREW	XSTR	TRANSISTOR

Replaceable Mechanical Parts—067-1133-00

CROSS INDEX—MFR. CODE NUMBER TO MANUFACTURER

Mfr. Code	Manufacturer	Address	City, State, Zip
000GY	DEK INC.	3480 SWENSEN AVE.	ST. CHARLES, IL 60174
02768	ILLINOIS TOOL WORKS, INC., FASTEX DIV.	195 ALGONQUIN ROAD	DES PLAINES, IL 60016
06383	PANDUIT CORPORATION	17301 RIDGELAND	TINLEY PARK, IL 60477
09922	BURNDY CORPORATION	RICHARDS AVENUE	NORWALK, CT 06852
24931	SPECIALITY CONNECTOR CO., INC.	2620 ENDRESS PLACE	GREENWOOD, IN 46142
34785	DEK INC.	1555 HAWTHORNE LN.	W CHICAGO, IL 60185
59730	THOMAS AND BETTS COMPANY	36 BUTLER ST.	ELIZABETH, NJ 07207
73743	FISCHER SPECIAL MFG. CO.	446 MORGAN ST.	CINCINNATI, OH 45206
77250	PHEOLL MANUFACTURING CO., DIVISION OF ALLIED PRODUCTS CORP.	5700 W. ROOSEVELT RD.	CHICAGO, IL 60650
78189	ILLINOIS TOOL WORKS, INC. SHAKEPROOF DIVISION	ST. CHARLES ROAD	ELGIN, IL 60120
79807	WROUGHT WASHER MFG. CO.	2100 S. O BAY ST.	MILWAUKEE, WI 53207
80009	TEKTRONIX, INC.	P O BOX 500	BEAVERTON, OR 97077
81041	HOWARD INDUSTRIES, DIVISION OF MSL INDUSTRIES, INC.	P O BOX 287	MILFORD, IL 60953
83385	CENTRAL SCREW CO.	2530 CRESCENT DR.	BROADVIEW, IL 60153
83907	ACCURATE RUBBER PRODUCTS CO.	123 N. RACINE	CHICAGO, IL 60607
86928	SEASTROM MFG. COMPANY, INC.	701 SONORA AVENUE	GLENDAL, CA 91201
S3629	PANEL COMPONENTS CORP.	2015 SECOND ST.	BERKELEY, CA 94170
T1372	ELECTRI-CORD MFG CO INC	312 E. MAIN ST.	WESTFIELD, PA 16950

Replaceable Mechanical Parts—067-1133-00

Fig. & Index No.	Tektronix Part No.	Serial/Model No.		Qty	1 2 3 4 5					Name & Description	Mfr Code	Mfr Part Number
		Eff	Dscont									
1-1	351-0113-00			2						GUIDE,CKT CARD:MOLDED ACETAL 6.75 INCH LO	80009	351-0113-00
-2	343-0853-00			4						CLAMP,LOOP:0.5 DIA,NYLON	000GY	021-0500
-3	385-0100-00			3						SPACER,POST:0.5 L W/6-32 THD THRU,NYLON ***** (ATTACHING PARTS) *****	80009	385-0100-00
-4	211-0578-00			3						SCREW,MACHINE:6-32 X 0.438 1NCH,PNH STL ***** (END ATTACHING PARTS) *****	83385	ORD BY DESCR
-5	385-0016-00			2						SPACER,POST:1.0 L W/6-32 THD THRU,NYLON ***** (ATTACHING PARTS) *****	80009	385-0016-00
-6	211-0578-00			2						SCREW,MACHINE:6-32 X 0.438 1NCH,PNH STL ***** (END ATTACHING PARTS) *****	83385	ORD BY DESCR
-7	134-0025-00			4						BUTTON,PLUG:	02768	1207120241000101
-8	348-0048-00			8						FOOT,CAMERA:BLACK VINYL,W/6-32 STUD ***** (ATTACHING PARTS) *****	80009	348-0048-00
-9	210-0457-00			8						NUT,PL,ASSEM WA:6-32 X 0.312,STL CD PL ***** (END ATTACHING PARTS) *****	83385	ORD BY DESCR
-10	342-0700-00			3						INSULATOR,PLATE: ***** (ATTACHING PARTS) *****		
-11	211-0007-00			3						SCREW,MACHINE:4-40 X 0.188,PNH STL,CD PL ***** (END ATTACHING PARTS) *****	83385	ORD BY DESCR
-12	344-0373-00			3						CLIP,CKT BOARD: ***** (ATTACHING PARTS) *****		
-13	211-0658-00			3						SCR,ASSEM WSHR:6-32 X 0.312 L,PNH,STL	78189	ORD BY DESCR
-14	210-0457-00			3						NUT,PL,ASSEM WA:6-32 X 0.312,STL CD PL ***** (END ATTACHING PARTS) *****	83385	ORD BY DESCR
-15	441-1578-00			1						CHASSIS,REMOTE:		
-16	333-3129-00			1						PANEL,FRONT: ***** (ATTACHING PARTS) *****		
-17	211-0658-00			8						SCR,ASSEM WSHR:6-32 X 0.312 L,PNH,STL	78189	ORD BY DESCR
-18	211-0559-00			8						SCREW,MACHINE:6-32 X 0.375*100 DEG,FLH ST ***** (END ATTACHING PARTS) *****	83385	ORD BY DESCR
-19	344-0131-00			6						CLIP,SPG TENS:CIRCUIT BOARD MOUNTING ***** (ATTACHING PARTS) *****	80009	344-0131-00
-20	211-0244-00			6						SCR,ASSEM WSHR:4-40 X 0.312 INCH,PNH STL	78189	ORD BY DESCR
-21	210-0586-00			6						NUT,PL,ASSEM WA:4-40 X 0.25,STL,CD PL ***** (END ATTACHING PARTS) *****	78189	211-041800-00
-22	----			3						TRANSISTOR:(SEE Q904,Q913,Q922 REPL) ***** (ATTACHING PARTS) *****		
-23	211-0244-00			3						SCR,ASSEM WSHR:4-40 X 0.312 INCH,PNH STL ***** (END ATTACHING PARTS) *****	78189	ORD BY DESCR
-24	214-1621-00			2						PIN,GUIDE:0.74 INCH LONG	80009	214-1621-00
-25	210-0055-00			2						WASHER,LOCK:SPLIT,0.145 ID X 0.253 OD,S	83385	ORD BY DESCR
-26	129-0595-00			3						SPACER,POST:0.38 L,4-40 THRU THD,NYLON ***** (ATTACHING PARTS) *****	80009	129-0595-00
-27	211-0244-00			3						SCR,ASSEM WSHR:4-40 X 0.312 INCH,PNH STL ***** (END ATTACHING PARTS) *****	78189	ORD BY DESCR
-28	343-1175-00			2						RETAINER,CHAS: ***** (ATTACHING PARTS) *****		
-29	211-0658-00			4						SCR,ASSEM WSHR:6-32 X 0.312 L,PNH,STL ***** (END ATTACHING PARTS) *****	78189	ORD BY DESCR
-30	----			2						TRANSISTOR:(SEE Q930,Q940 REPL) ***** (ATTACHING PARTS) *****		
-31	211-0244-00			2						SCR,ASSEM WSHR:4-40 X 0.312 INCH,PNH STL ***** (END ATTACHING PARTS) *****	78189	ORD BY DESCR
-32	214-2991-00			5						HEAT SINK,XSTR:T-220,ALUMINUM ***** (ATTACHING PARTS) *****	80009	214-2991-00
-33	211-0244-00			5						SCR,ASSEM WSHR:4-40 X 0.312 INCH,PNH STL ***** (END ATTACHING PARTS) *****	78189	ORD BY DESCR
-34	----			2						SWITCH,TOGGLE:(SEE S825,S833 REPL) ***** (ATTACHING PARTS) *****		
-35	210-0562-00			2						NUT,PLAIN,HEX:0.25-40 X 0.312 INCH,BBS	73743	2X20224-402
-36	210-0940-00			2						WASHER,FLAT:0.25 ID X 0.375 INCH OD,STL ***** (END ATTACHING PARTS) *****	79807	ORD BY DESCR

Replaceable Mechanical Parts—067-1133-00

Fig. & Index No.	Tektronix Part No.	Serial/Model No. Eff	Dscont	Qty	1	2	3	4	5	Name & Description	Mfr Code	Mfr Part Number
1-37	-----			1						SWITCH,TOGGLE:(SEE S812 REPL) *****ATTACHING PARTS*****		
-38	210-0562-00			1						NUT,PLAIN,HEX.:0.25-40 X 0.312 INCH,BBS	73743	2X20224-402
-39	210-0940-00			1						WASHER,FLAT:0.25 ID X 0.375 INCH OD,STL *****END ATTACHING PARTS*****	79807	ORD BY DESCR
-40	-----			2						SWITCH,TOGGLE:(SEE S804,S818 REPL) *****ATTACHING PARTS*****		
-41	210-0562-00			1						NUT,PLAIN,HEX.:0.25-40 X 0.312 INCH,BBS	73743	2X20224-402
-42	210-0940-00			1						WASHER,FLAT:0.25 ID X 0.375 INCH OD,STL *****END ATTACHING PARTS*****	79807	ORD BY DESCR
-43	-----			1						CKT BOARD ASSY:POWER SUPPLY (SEE A1 REPL) *****ATTACHING PARTS*****		
-44	211-0244-00			5						SCR,ASSEM WSHR:4-40 X 0.312 INCH,PNH STL *****END ATTACHING PARTS*****	78189	ORD BY DESCR
-45	-----			-						CKT BOARD ASSY INCLUDES:		
-46	-----			2						.CONN,RCPT,ELEC:(SEE A1J735,A1J842 REPL)		
-47	-----			3						.CONN,RCPT,ELEC:(SEE A1J236,A1J239 .A1J844 REPL)		
-48	136-0727-00			1						.TERM SET,PIN:(SEE A1J225 REPL)	09922	DILB8P-108
-49	-----			2						.CONN,RCPT,ELEC:(SEE A1J212,A1J228 REPL)		
-50	-----			8						.TERM SET,PIN:(SEE A1J208 A1J223 REPL)		
-51	-----			3						CONN,RCPT,ELEC:(SEE A1J98 REPL) *****ATTACHING PARTS*****		
-52	211-0538-00			2						SCREW,MACHINE:6-32 X 0.312"100 DEG,FLH ST *****END ATTACHING PARTS*****	83385	ORD BY DESCR
-53	210-0204-00			1						TERMINAL,LUG:0.146 INCH DIA DE,45 DEG BE *****ATTACHING PARTS*****	78189	2157-06-01-2520N
-54	210-0408-00			1						NUT,PLAIN,HEX.:6-32 X 0.312 INCH,BRS *****END ATTACHING PARTS*****	73743	3040-402
-55	200-2264-00			1						CAP.,FUSEHOLDER:3AG FUSES	S3629	FEK 031 1666
-56	204-0833-00			1						BODY,FUSEHOLDER:3AG & 5 X 20MM FUSES	S3629	031.1653(MDLFEU)
-57	210-1039-00			1						WASHER,LOCK:INT,0.521 ID X 0.625 INCH O	24931	ORD BY DESCR
-58	200-0237-04			1						COVER,FUSE HLDR:PLASTIC,SAFETY CONTROLLED	80009	200-0237-04
-59	200-2222-00			1						GUARD,FAN: *****ATTACHING PARTS*****	81041	6-182-033
-60	211-0648-00			4						SCR ASSEM WSHR:6-32 X 0.625 INCH,PNH,STL	80009	211-0648-00
-61	210-0457-00			3						NUT,PL,ASSEM WA:6-32 X 0.312,STL CD PL *****END ATTACHING PARTS*****	83385	ORD BY DESCR
-62	105-0948-00			1						LATCH,PWR SPLY:LEFT *****ATTACHING PARTS*****	80009	105-0948-00
-63	212-0507-00			1						SCREW,MACHINE:10-32 X 0.375 INCH,PNH STL	83385	ORD BY DESCR
-64	210-1266-00			1						WASHER,FLAT:0.193 ID X 0.475 OD X 0.007 *****END ATTACHING PARTS*****	86928	5702-79-75
-65	-----			1						SWITCH,TOGGLE:(SEE S94 REPL) *****ATTACHING PARTS*****		
-66	210-0473-00			1						NUT,PLAIN,DODEC:0.469-32 X 0.638 INCH,BRS	80009	210-0473-00
-67	386-2977-00			1						PLATE,SWITCH:ON/OFF		
-68	210-0021-00			1						WASHER,LOCK:INTL,0.476 ID X 0.60"OD ST	78189	1222-01-00-0541C
-69	210-0414-00			1						NUT,PLAIN,HEX.:0.468-32 X 0.562 INCH,BRS *****END ATTACHING PARTS*****	73743	3167-402
-70	343-0549-00			4						STRAP,TIEDOWN:0.091 W X 3.62 INCH LONG	06383	PLT1M
-71	-----			1						FAN:(SEE B92 REPL)		
-72	-----			18						RES,FXD,WW:SEE R11,R12,R13,R21,R22,R23, R31,R32,R33,R41,R43,R42,R43,R51,R52,R53 R61,R62,R63 REPL *****ATTACHING PARTS*****		
-73	212-0095-00			12						SCREW,MACHINE:8-32 X 3.750 PNH	77250	ORD BY DESCR
-74	210-0008-00			12						WASHER,LOCK:INTL,0.02 THK	78189	1208-00-00-0541C
-75	166-0037-00			36						SPACER,SLEEVE:0.180ID X 0.25OD X 0.56" LG	80009	166-0037-00
-76	210-0458-00			12						NUT,PL,ASSEM WA:8-32 X 0.344 INCH,STL *****END ATTACHING PARTS*****	83385	ORD BY DESCR



Replaceable Mechanical Parts—067-1133-00

Fig. & Index No.	Tektronix Part No.	Serial/Model No.		Qty	1 2 3 4 5					Name & Description	Mfr Code	Mfr Part Number
		Eff	Dscont									
1-77	348-0048-00			8						FOOT,CAMERA:BLACK VINYL,W/6-32 STUD *****ATTACHING PARTS*****	80009	348-0048-00
-78	210-0457-00			8						NUT,PL,ASSEM WA:6-32 X 0.312,STL CD PL *****END ATTACHING PARTS*****	83385	ORD BY DESCR
-79	343-0835-00			1						CLAMP,LOOP:0.375 ID,NYLON W/ADH BACK	34785	021-0375
-80	343-0853-00			4						CLAMP,LOOP:0.5 DIA,NYLON	000GY	021-0500
-81	105-0949-00			1						LATCH,PWR SPLY:RIGHT *****ATTACHING PARTS*****	80009	105-0949-00
-82	212-0507-00			1						SCREW,MACHINE:10-32 X 0.375 INCH,PNH STL	83385	ORD BY DESCR
-83	210-1266-00			1						WASHER,FLAT:0.193ID X 0.075 THK,STL *****END ATTACHING PARTS*****	86928	5702-79-75C
-84	348-0051-00			1						GROMMET,RUBBER:BLACK,ROUND,0.75 ID	83907	1107
-85	441-1577-00			1						CHASSIS,MAIN:TEST FIXTURE		
-86	-----			1						CKT BOARD ASSY:PLUG ADPT(SEE A2 REPL)		
-87	-----			1						.CONN,RCPT,ELEC:(SEE A2P109 REPL)		
-88	-----			2						.TERM SET,PIN:(SEE A2J226,A2J326 REPL)		
-89	-----			1						.CONN,RCPT,ELEC:(SEE A2J426 REPL)		
-90	348-0171-00			1						.GROMMET,PLASTIC:U-SHAPED	80009	348-0171-00
-91	348-0070-01			1						.PAD,CUSHIONING:2.03 X 0.69 X 0.18 SI RBR	80009	348-0070-01
-92	346-0133-00			1						.STRAP,TIE DOWN:0.091 W X 14.0 L,PLASTIC	59730	TY-234M
-93	179-2942-00			1						WIRING HARNESS:POWER TESTER CABLE	80009	179-2942-00
-94	198-5429-00			1						.WIRE SET,ELEC:	80009	198-5429-00
										STANDARD ACCESSORIES		
-95	161-0066-00			1						CABLE ASSY,PWR,;3,18 AWG,115V,98.0 L	T1372	ORD BY DESCR
	070-5176-00			1						SHEET,TECHNICAL:INSTR	80009	070-5176-00



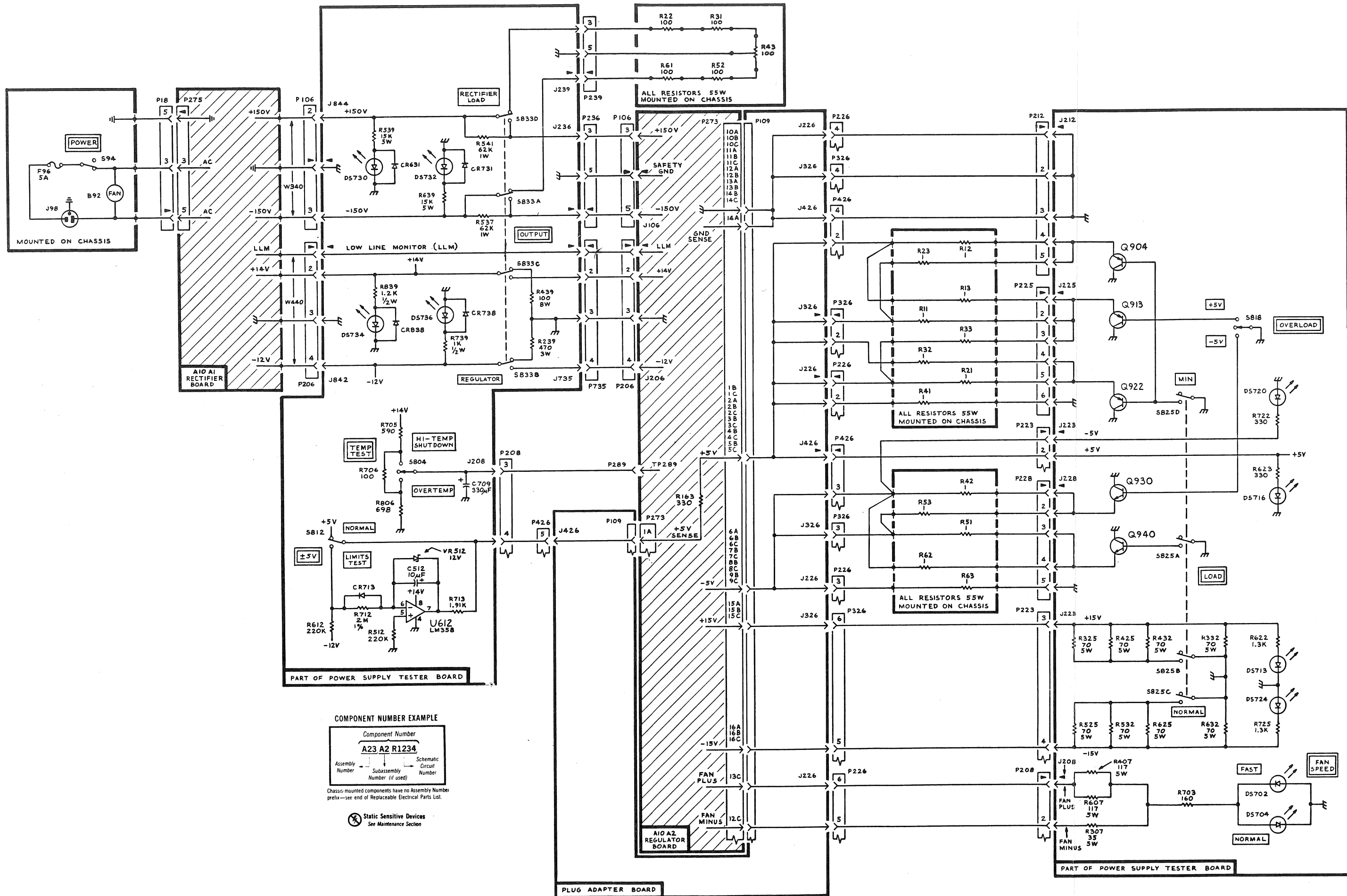

**COMPONENT NUMBER EXAMPLE**

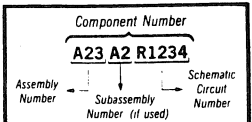

Chassis-mounted components have no Assembly Number prefix—see end of Replaceable Electrical Parts List.

⊗ Static Sensitive Devices  
See Maintenance Section

FIG. 1 EXPLODED

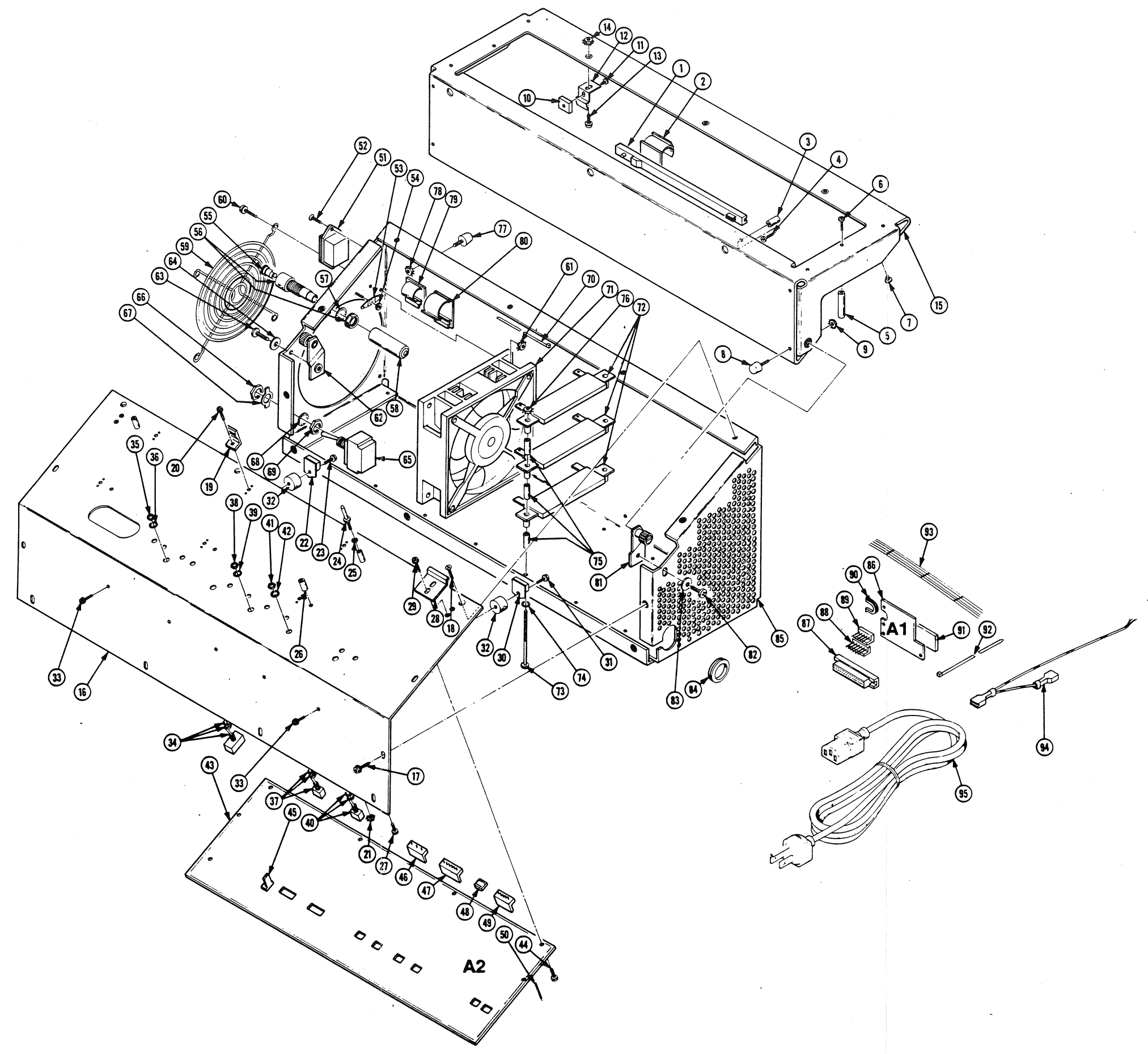

## MANUAL CHANGE INFORMATION

At Tektronix, we continually strive to keep up with latest electronic developments by adding circuit and component improvements to our instruments as soon as they are developed and tested.

Sometimes, due to printing and shipping requirements, we can't get these changes immediately into printed manuals. Hence, your manual may contain new change information on following pages.

A single change may affect several sections. Since the change information sheets are carried in the manual until all changes are permanently entered, some duplication may occur. If no such change pages appear following this page, your manual is correct as printed.

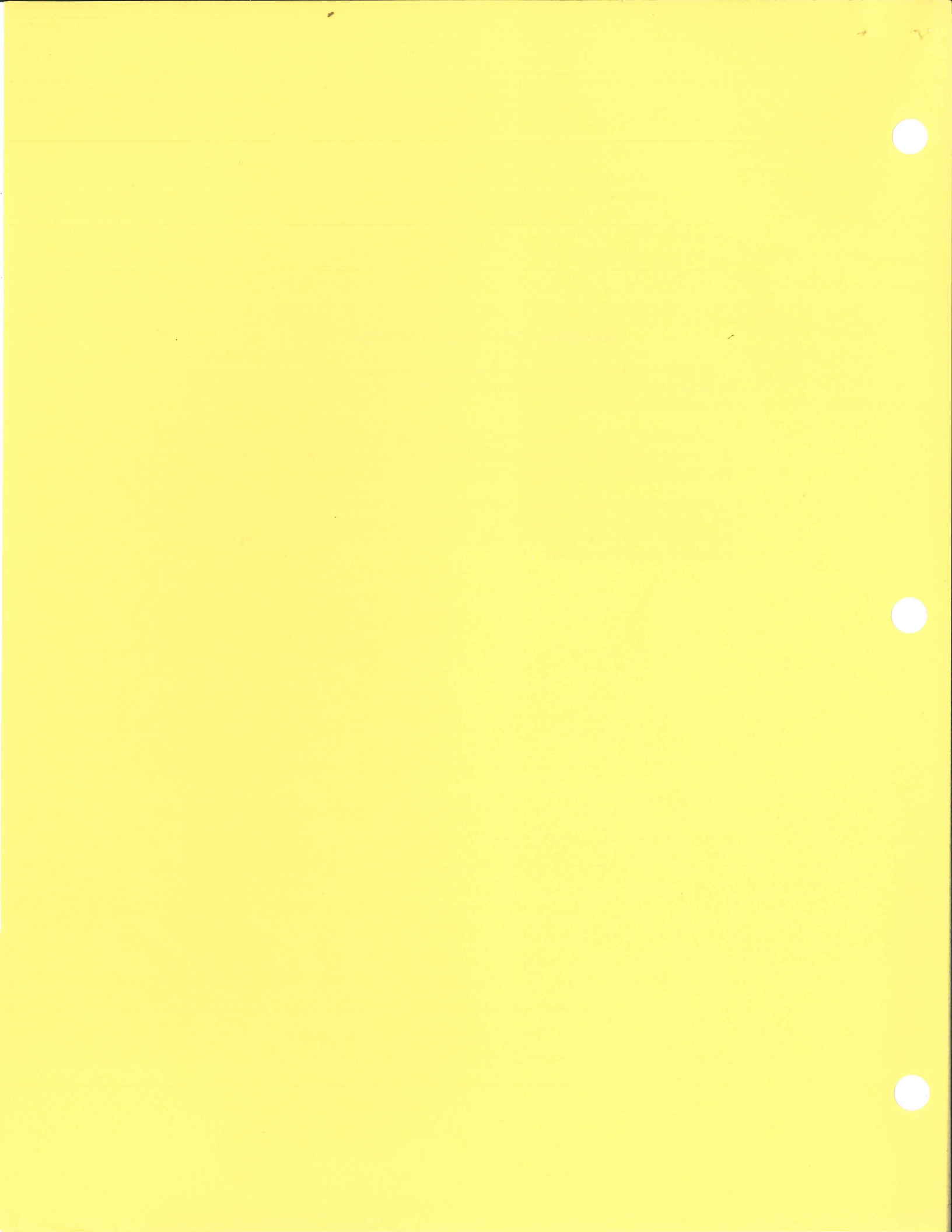

Date: 6/29/89

Change Reference: M69710

Product: All TV Products

Manual Part No: All TV Products

**DESCRIPTION**

**ELECTRICAL PARTS LIST CHANGES - RESISTORS**

For improved internal inventory control, Tektronix Television Division is eliminating almost all usage of a particular class of resistor. In all cases, the replacement resistor is the same value with a higher wattage rating, better tolerance, or better thermal characteristics. The following list shows the new part number for each of the replaced resistors. Make sure to use the new part numbers when ordering replacement resistors.

<u>Old Part No.</u>	<u>New Part No.</u>	<u>Old Part No.</u>	<u>New Part No.</u>	<u>Old Part No.</u>	<u>New Part No.</u>
321-0001-00	322-3001-00	321-0156-00	322-3156-00	321-0215-00	322-3215-00
321-0030-00	322-3030-00	321-0158-00	322-3158-00	321-0216-00	322-3216-00
321-0034-00	322-3034-00	321-0160-00	322-3160-00	321-0217-00	322-3217-00
321-0039-00	322-3039-00	321-0161-00	322-3161-00	321-0218-00	322-3218-00
321-0044-00	322-3044-00	321-0162-00	322-3162-00	321-0219-00	322-3219-00
321-0047-00	322-3047-00	321-0163-00	322-3163-00	321-0220-00	322-3220-00
321-0050-00	322-3050-00	321-0164-00	322-3164-00	321-0221-00	322-3221-00
321-0051-00	322-3051-00	321-0165-00	322-3165-00	321-0222-00	322-3222-00
321-0056-00	322-3056-00	321-0166-00	322-3166-00	321-0222-07	322-3222-07
321-0058-00	322-3058-00	321-0169-00	322-3169-00	321-0223-00	322-3223-00
321-0065-00	322-3065-00	321-0170-00	322-3170-00	321-0225-00	322-3225-00
321-0073-00	322-3073-00	321-0171-00	322-3171-00	321-0226-00	322-3226-00
321-0085-00	322-3085-00	321-0172-00	322-3172-00	321-0227-00	322-3227-00
321-0085-01	321-0085-07	321-0173-00	322-3173-00	321-0228-00	322-3228-00
321-0085-03	321-0085-07	321-0173-01	322-0173-07	321-0230-00	322-3230-00
321-0086-00	322-3086-00	321-0175-00	322-3175-00	321-0231-00	322-3231-00
321-0089-00	322-3089-00	321-0176-00	322-3176-00	321-0232-00	322-3232-00
321-0092-00	322-3092-00	321-0177-00	322-3177-00	321-0233-00	322-3233-00
321-0093-00	322-3093-00	321-0177-02	322-3177-02	321-0234-00	322-3234-00
321-0097-00	322-3097-00	321-0178-00	322-3178-00	321-0235-00	322-3235-00
321-0098-00	322-3098-00	321-0179-00	322-3179-00	321-0236-00	322-3236-00
321-0101-00	322-3101-00	321-0181-00	322-3181-00	321-0237-00	322-3237-00
321-0105-00	322-3105-00	321-0182-00	322-3182-00	321-0238-00	322-3238-00
321-0106-00	322-3106-00	321-0183-00	322-3183-00	321-0239-00	322-3239-00
321-0108-00	322-3108-00	321-0184-00	322-3184-00	321-0239-03	321-0239-07
321-0109-00	322-3109-00	321-0185-00	322-3185-00	321-0241-00	322-3241-00
321-0110-00	322-3110-00	321-0188-00	322-3188-00	321-0242-00	322-3242-00
321-0114-00	322-3114-00	321-0189-00	322-3189-00	321-0243-00	322-3243-00
321-0114-03	321-0114-07	321-0191-00	322-3191-00	321-0244-00	322-3244-00
321-0117-00	322-3117-00	321-0192-00	322-3192-00	321-0246-00	322-3246-00
321-0119-00	322-3119-00	321-0193-00	322-3193-00	321-0248-00	322-3248-00
321-0121-00	322-3121-00	321-0193-07	322-3193-07	321-0250-00	322-3250-00
321-0123-00	322-3123-00	321-0194-00	322-3194-00	321-0251-00	322-3251-00
321-0126-00	322-3126-00	321-0195-00	322-3195-00	321-0252-00	322-3252-00
321-0128-00	322-3128-00	321-0196-00	322-3196-00	321-0254-00	322-3254-00
321-0130-00	322-3130-00	321-0197-00	322-3197-00	321-0255-00	322-3255-00
321-0132-00	322-3132-00	321-0198-00	322-3198-00	321-0256-00	322-3256-00
321-0133-00	322-3133-00	321-0199-00	322-3199-00	321-0256-07	322-3501-07
321-0134-00	322-3134-00	321-0199-03	321-0199-06	321-0258-00	322-3258-00
321-0135-00	322-3135-00	321-0200-00	322-3200-00	321-0259-00	322-3259-00
321-0138-00	322-3138-00	321-0201-00	322-3201-00	321-0260-00	322-3260-00
321-0139-00	322-3139-00	321-0202-00	322-3202-00	321-0261-00	322-3261-00
321-0141-00	322-3141-00	321-0203-00	322-3203-00	321-0262-00	322-3262-00
321-0143-00	322-3143-00	321-0204-00	322-3204-00	321-0264-00	322-3264-00
321-0143-03	321-0143-07	321-0205-00	322-3205-00	321-0265-00	322-3265-00
321-0145-00	322-3145-00	321-0206-00	322-3206-00	321-0266-00	322-3266-00
321-0146-00	322-3146-00	321-0207-00	322-3207-00	321-0267-00	322-3267-00
321-0147-00	322-3147-00	321-0208-00	322-3208-00	321-0268-00	322-3268-00
321-0150-00	322-3150-00	321-0210-00	322-3210-00	321-0269-00	322-3269-00
321-0151-00	322-3151-00	321-0211-00	322-3211-00	321-0271-00	322-3271-00
321-0152-00	322-3152-00	321-0213-00	322-3213-00	321-0273-00	322-3273-00
321-0154-00	322-3154-00	321-0214-00	322-3214-00	321-0275-00	322-3275-00

Date: 6/29/89

Group Code 24

Change Reference: M69710Product: All TV ProductsManual Part No: All TV Products

<u>Old Part No.</u>	<u>New Part No.</u>	<u>Old Part No.</u>	<u>New Part No.</u>	<u>Old Part No.</u>	<u>New Part No.</u>
321-0276-00	322-3276-00	321-0329-02	321-0329-03	321-0410-00	322-3410-00
321-0277-00	322-3277-00	321-0330-00	322-3330-00	321-0411-00	322-3411-00
321-0279-00	322-3279-00	321-0331-00	322-3331-00	321-0412-00	322-3412-00
321-0280-00	322-3280-00	321-0333-00	322-3333-00	321-0414-00	322-3414-00
321-0281-00	322-3281-00	321-0334-00	322-3334-00	321-0414-07	322-3504-07
321-0282-00	322-3282-00	321-0335-00	322-3335-00	321-0418-00	322-3418-00
321-0284-00	322-3284-00	321-0336-00	322-3336-00	321-0421-00	322-3421-00
321-0285-00	322-3285-00	321-0338-00	322-3338-00	321-0426-00	322-3426-00
321-0286-00	322-3286-00	321-0339-00	322-3339-00	321-0431-00	322-3431-00
321-0286-07	322-3502-07	321-0342-00	322-3342-00	321-0437-00	322-3437-00
321-0287-00	322-3287-00	321-0344-00	322-3344-00	321-0439-00	322-3439-00
321-0289-00	322-3289-00	321-0346-00	322-3346-00	321-0442-00	322-3442-00
321-0289-07	322-3289-07	321-0350-00	322-3350-00	321-0443-00	322-3443-00
321-0292-00	322-3292-00	321-0352-00	322-3352-00	321-0444-00	322-3444-00
321-0293-00	322-3293-00	321-0354-00	322-3354-00	321-0450-00	322-3450-00
321-0294-00	322-3294-00	321-0356-00	322-3356-00	321-0457-00	322-3457-00
321-0295-00	322-3295-00	321-0357-00	322-3357-00	321-0469-00	322-3469-00
321-0296-00	322-3296-00	321-0360-00	322-3360-00	321-0481-00	322-3481-00
321-0297-00	322-3297-00	321-0363-00	322-3363-00	321-0603-00	322-3603-07
321-0299-00	322-3299-00	321-0364-00	322-3364-00	321-0612-00	322-3487-00
321-0301-00	322-3301-00	321-0367-00	322-3367-00	321-0612-03	321-0612-07
321-0302-00	322-3302-00	321-0369-00	322-3369-00	321-0666-00	321-0666-07
321-0304-00	322-3304-00	321-0371-00	322-3371-00	321-0674-00	321-0674-04
321-0305-00	322-3305-00	321-0373-00	322-3373-00	321-0677-00	321-0677-07
321-0306-00	322-3306-00	321-0374-00	322-3374-00	321-0793-03	321-0793-07
321-0308-00	322-3308-00	321-0377-00	322-3377-00	321-0816-03	321-0816-07
321-0310-00	322-3310-00	321-0378-00	322-3378-00	321-0928-03	321-0928-07
321-0311-00	322-3311-00	321-0381-00	322-3381-00	321-0932-03	321-0929-07
321-0314-00	322-3314-00	321-0383-00	322-3383-00	321-0962-03	321-0962-07
321-0315-00	322-3315-00	321-0385-00	322-3385-00	321-1283-03	321-1283-07
321-0318-00	322-3318-00	321-0385-07	322-3506-07	321-1289-03	321-1289-07
321-0318-03	321-0318-07	321-0389-00	322-3389-00	321-1296-03	321-1296-07
321-0322-00	322-3322-00	321-0392-00	322-3392-00	321-1614-07	322-3507-07
321-0324-00	322-3324-00	321-0393-00	322-3393-00	321-1683-07	322-3508-07
321-0325-00	322-3325-00	321-0394-00	322-3394-00	321-1684-07	322-3509-07
321-0326-00	322-3326-00	321-0396-00	322-3396-00	321-1702-03	321-1705-04
321-0327-00	322-3327-00	321-0402-00	322-3402-00	321-1727-07	322-3498-07
321-0328-00	322-3328-00	321-0404-00	322-3404-00	321-1728-07	322-3512-07
321-0329-00	322-3329-00	321-0405-00	322-3405-00		