User Reference

Part No. 070-7419-01
Product Group 47

THE
11402A
& 11403

DIGITIZING
OSCILLOSCOPES

for CHANGE INFORMATION
this manual.

Tektronix®

Instrument Serial Numbers

Each instrument manufactured by Tektronix has a serial number on a panel insert or tag, or stamped on the chassis. The first letter in the serial number designates the country of manufacture. The last five digits of the serial number are assigned sequentially and are unique to each instrument. Those manufactured in the United States have six unique digits. The country of manufacture is identified as follows:

B010000	Tektronix, Inc., Beaverton, Oregon, USA
G100000	Tektronix Guernsey, Ltd., Channel Islands
E200000	Tektronix United Kingdom, Ltd., London
J300000	Sony/Tektronix, Japan
H700000	Tektronix Holland, NV, Heerenveen, The Netherlands

Instruments manufactured for Tektronix by external vendors outside the United States are assigned a two digit alpha code to identify the country of manufacture (e.g., JP for Japan, HK for Hong Kong, etc.).

Tektronix, Inc., P.O. Box 500, Beaverton, OR 97077

Copyright © Tektronix, Inc., 1989. All rights reserved. Tektronix products are covered by U.S. and foreign patents, issued and pending. The following are registered trademarks:
TEKTRONIX, TEKPROBE, TEK, SCOPEMOBILE and



Centronics® is a registered trademark of Data Computer Corporation.

Epson® is a registered trademark of Epson America, Inc.

HP LaserJet is a product of the Hewlett-Packard Company.

HP ThinkJet is a product of the Hewlett-Packard Company.

IBM® is a registered trademark of International Business Machines Corporation.

Proprinter® is a registered trademark of International Business Machines Corporation.

t This Manual

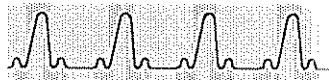

This is the front panel reference manual for the 11402A and 11403 Digitizing Oscilloscopes. If you are a new user, first read the *11402A and 11403 Tutorial* to become familiar with the oscilloscope. Use this User Reference to answer specific questions about operation of the oscilloscope.

The first section, *At a Glance*, presents quick get-acquainted information and a map of the various menus. Each menu is accompanied by pointers into the detailed second section, *In Detail*.

**ated
uals**

Other manuals that complete the documentation set for the 11402A and 11403 Digitizing Oscilloscopes:

- The *11402A and 11403 Tutorial* (Tektronix part number 070-7418-01) gives step-by-step instructions that demonstrate basic operation of the oscilloscope.
- The *11402A and 11403 QuickStart Package* (U.S.A. Tektronix part number 020-1767-01, Europe 020-1768-01) is a complete learning laboratory, including a signal generating board and a workbook. A videotape for the QuickStart Package is included with your oscilloscope. These show you how to use the power of the 11402A or 11403 Oscilloscope to get the types of measurements you need. The QuickStart Package is available at no charge, but you need to mail in the postage-paid card included with the oscilloscope.
- The *11402A and 11403 Programmer Reference* (Tektronix part number 070-7420-01) describes using a computer to control the oscilloscope through GPIB or RS-232-C interfaces.
- The *11201A/11402A/11403 Command Reference* (Tektronix part number 070-7421-01) describes the commands used to program the oscilloscope.
- The *11201A/11402A/11403 Quick Reference* (Tektronix part number 070-7734-01) provides an index of operations, and the front-panel steps to invoke each operation.
- The *11402A and 11403 Service Reference* (Tektronix part number 070-7422-01) provides information to repair and replace components of the oscilloscope.



At a Glance 1

- Front Panel and Plug-in Units 2-3
- Rear Panel 4-5
- Display and Touch Panel 6-7
- Icons 8-9
- Knobs, Knob Menu, and Keypad Menu 10-11
- Major Menu Buttons 12-13
- Waveform Major Menu 14-15
- Trigger Major Menu 16-17
- Measure Major Menu 18-19
- Store/Recall Major Menu 20-21
- Utility1 Major Menu 22-23
- Utility2 Major Menu 24-25

In Detail 27

- Acquisition 29
- Audio Feedback 37
- Autoset 39
- Averaging and Enveloping 43
- Color Display (11403) 47
- Cursors 51
- Diagnostics 57
- Enhanced Accuracy 63
- GPIB Parameters 65
- Graticules 69
- Hardcopy 73
- Horizontal Controls 83
- Initialization 89
- Instrument Identification 91
- Labeling 93
- Measurements 97
- Monochrome Display (11402A) 115
- Plug-in Units 117
- Point Accumulate Mode 125
- Power-On 127
- Probes and Cables 131
- Record Length 139
- RS-232-C Parameters 143
- Stored Settings 147



Stored Waveforms	153
Time and Date	159
Triggering	161
Vectored Waveforms	167
Vertical Controls	171
Waveform Definition and Management	175
Windows	187
XY Waveforms	191
Appendix A: Accessories	195
Appendix B: Specifications	199
Appendix C: Safety	209
Appendix D: Algorithms	213
Appendix E: Hardcopy Defaults	235
Appendix F: Messages	237
Glossary	239
Index	249



This section presents general operating instructions and a road map of the menu system. All menus are shown in this section. Once you find a menu of interest, you will be directed to a page in the In Detail section that discusses that menu's features.

You may want to consult the *11402A and 11403 Tutorial* for a complete introduction to the oscilloscope.

Front Panel and Plug-in Units	2-3
Rear Panel	4-5
Display and Touch Panel	6-7
Icons	8-9
Knobs, Knob Menu, and Keypad Menu	10-11
Major Menu Buttons	12-13
Waveform Major Menu	14-15
Trigger Major Menu	16-17
Measure Major Menu	18-19
Store/Recall Major Menu	20-21
Utility1 Major Menu	22-23
Utility2 Major Menu	24-25



The display shows the waveforms and the menus, which you touch to activate. See page 6.

The major menu buttons let you select the major menu that will appear at the bottom of the display. See page 12.

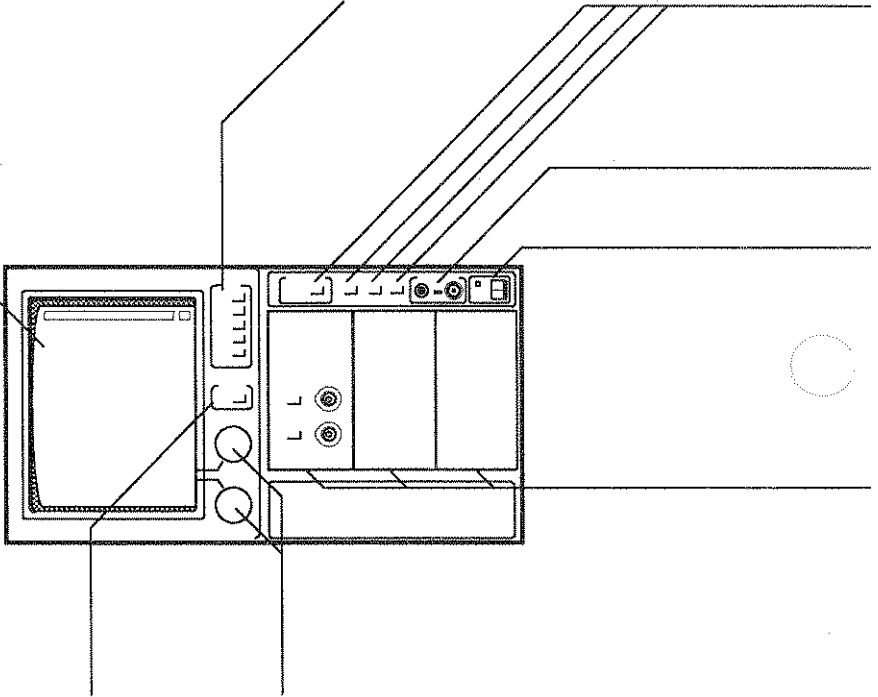

Touch Panel On/Off lets you turn off the touch panel so that you can use the physical buttons to activate the display without inadvertently making menu selections.

The two knobs control many functions of the oscilloscope. You set the knobs to control specific functions when you make menu selections or touch icons. The knobs are described on page 10.

Front Panel and Plug-in Units

The **DIGITIZER** button stops and starts waveform acquisition—see page 32. The **AUTOSET** button quickly sets the oscilloscope parameters for a waveform display—see page 39. The **HARDCOPY** button prints a copy of the display—see page 73. The **ENHANCED ACCURACY** button calibrates the system for greatest accuracy—see page 63.

The **CALIBRATOR** output provides a known signal for calibrating probes and input cables. See page 135 .

Use the **ON/STANDBY** switch as the power switch once the oscilloscope is installed. See page 127.

You install plug-in units or blank covers in the plug-in compartments. See page 117.



Power line controls include the **LINE VOLTAGE SELECTOR SWITCH**, the fuse, the power connector, and the **PRINCIPAL POWER SWITCH**. See page 127.

The **RS-232-C** connector allows a remote computer to control the oscilloscope through a serial interface. See page 143.

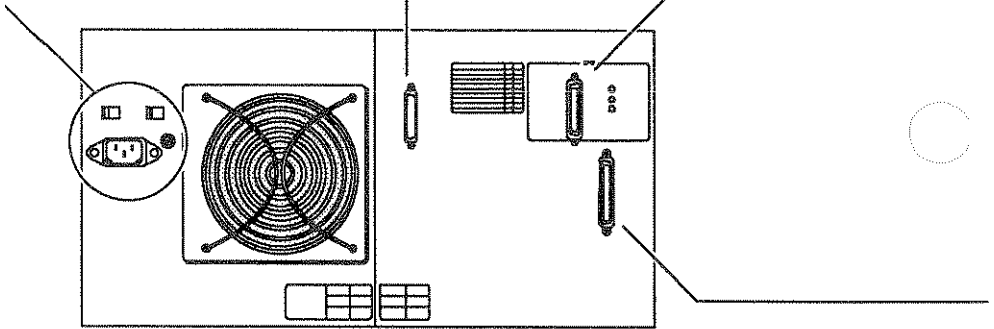

Rear Panel

The **GPIB** connector allows a remote computer to control the oscilloscope through an IEEE Standard 488 parallel interface. Three lights show the status of the parallel bus. See page 65.

The **PRINTER** connector lets you attach an Epson FX-80 or compatible printer using a Centronics interface. See page 73.



reform (highlighted) and unselected
 is labels and readouts apply to the selected
 aveforms can be selected by touching
 age 181.

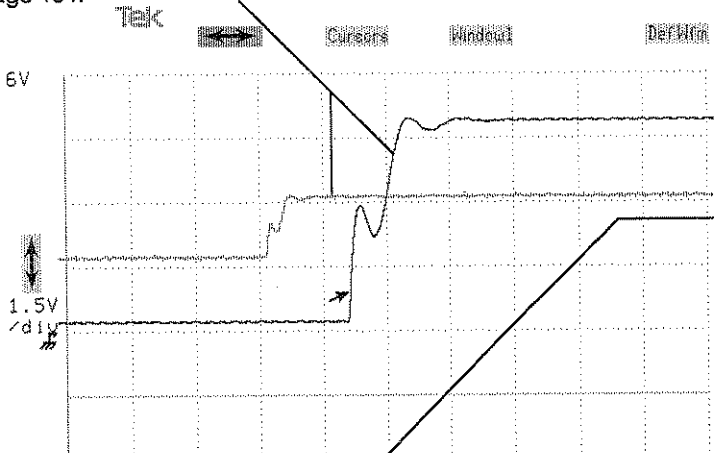

RS232C Parameters					
Baud Rate	Echo	Stop Bits			
9600Bd	On	2			
Parity	Flagging	Delay			
None	Soft	0			
EOL String	Verbose	Debug			
CR/LF	On	Off			
SP18	RS232C	Hardcopy	562ns		
TalkListen	9600Bd	Bitmap	Main Size	100ns/div	
1		Screen	Main Pos	-450ns	
Extended Diagnostic	Self Test		Page to Utility Menu	Remove Wfm 3 Avg(L2) Main	Pan/Zoom off



Display and Touch Panel

The display shows the output of the oscilloscope, such as waveforms and measurement information. The display is combined with the touch panel to provide a menu system. Touch the selectors that are displayed in the various menus to execute those items. Each menu selector has a shaded top portion that names the selector, and a lower portion that shows the current status of the parameter that the selector controls.

RS232C Parameters		
aud rate 00Bd	Echo On	Stop Bits 2
parity none	Flagging Soft	Delay 0
String /LF	Verbose On	Debug Off

A pop-up menu lets you set specific parameters. This is the **RS232C** pop-up menu, which is accessed by touching the **RS232C** selector in the Utility2 major menu.

GPIB	RS232C	Hardcopy	
TalkListen 1	9600Bd	Bitmap ... Screen	
Extended Diagnostic	Self Test		Page to Utility1 Menu

Several different major menus are available. You display and use the major menus by pressing the major menu buttons. This is the Utility2 major menu. Touch the **RS232C** selector to display the **RS232C** pop-up menu. See page 12 for a description of the major menus.

ain Size 00ns/div	
ain Pos -450ns	
move m 3 (L2)	Pan/ Zoom off
ain	

The Knob menu always shows the parameters the knobs are currently assigned to control (top two selectors). You can also use the Knob menu to remove waveforms from the display. You can touch the knob labels to see the Keypad pop-up menu, which lets you enter a numeric value for any knob-controlled parameter. See page 10.

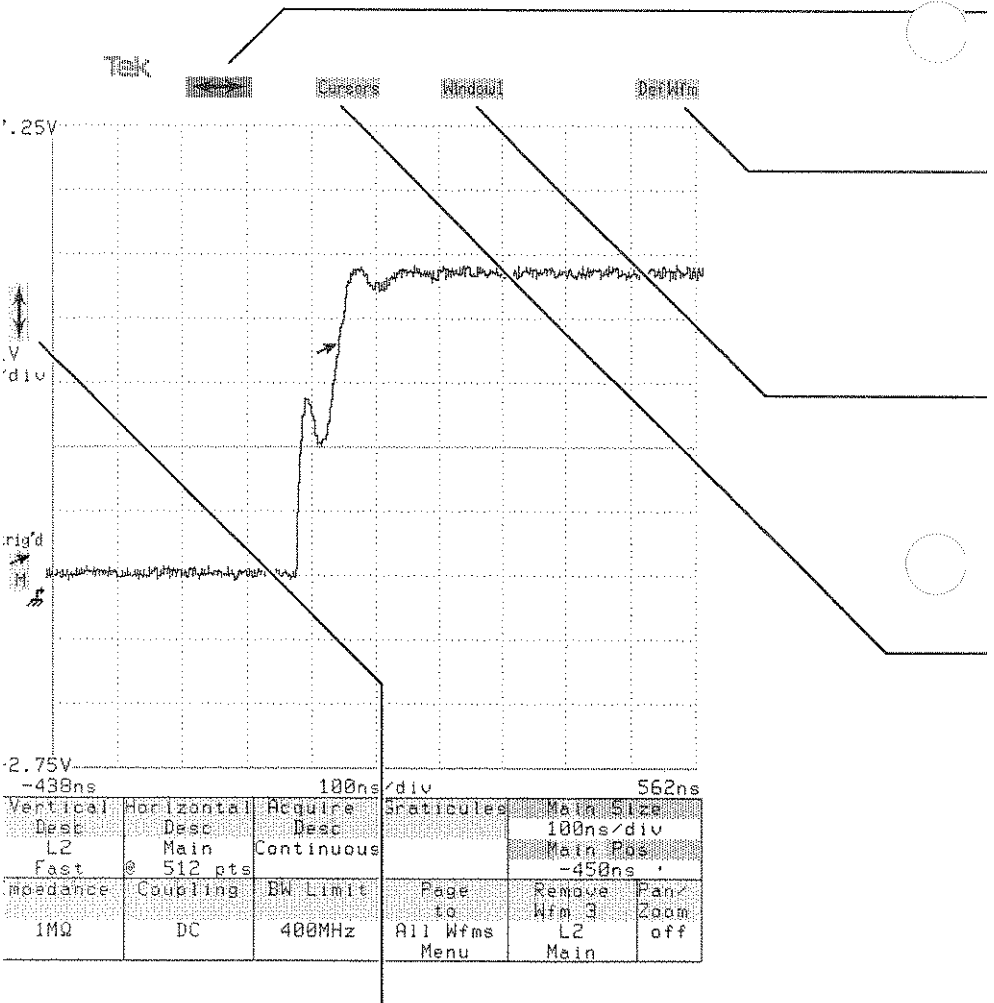

Touch the trigger icon to assign the knobs to adjust trigger level. If the oscilloscope is not triggered, 'No Trigger' appears above the word 'Trigger'. See page 161.

Touch the vertical icon to assign the knobs to adjust the waveform vertical size and position. See page 171.

Icons

Touch the horizontal icon to assign the knobs to adjust the waveform horizontal size and position. See page 83.

DefWfm

Touch the define waveform icon to display a pop-up menu that lets you define a new waveform to be displayed. See page 175.

Window1

Touch the window icon to create a new waveform that represents an enlarged portion of another waveform. See page 187.

Cursors

Touch the cursors icon to display bar or dot cursors to measure waveform values. See page 51.

Icons always appear on the screen. You can select them at any time, regardless of the major menu that is displayed.



labels always show the parameters (the parameters knobs will control). When an icon or otherwise knob assignments, the labels are highlighted. The left side of each knob label shows the current value of the parameter. When you turn a knob, you see the current value change and you will see the change play and on any displayed waveforms that show the parameter.

Touch either knob label to display the Keypad menu for that parameter.

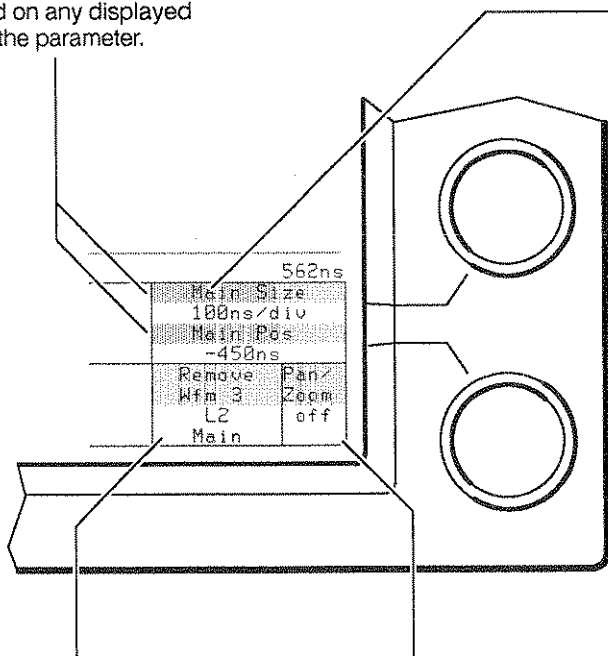

The **Remove** selector lets you remove a waveform from the display. To remove a waveform, touch (highlight) the waveform icon you want removed. Then touch the **Remove** selector. A pop-up menu appears to verify the removal. See page 175.

The **Pan/Zoom** selector lets you expand any part of a waveform using horizontal magnification. See page 83. When the knobs are assigned to vertical size and offset, this selector may change to provide more vertical control. See page 172.

Knobs, Knob Menu, and Keypad Menu

If you touch the wrong knob label by accident, the top two selectors let you choose the other knob parameter for Keypad menu manipulation.

Numeric Entry		% Knob Res		
Vert Size: L2		Vert Offset: L2		
Numeric Entry		Knob Res		
7	8	9	p	Coarse
4	5	6	n	Medium
1	2	3	μ	Fine
0	.	CHS	m	Set to Min
Back		Enter	Set to Max	
Space			100	
		Vert Size: L2	1V/div	
		Vert Offset: L2	2.25V	
Remove	Chan			
Wfm 3	Sel			
L2	L2			
Main				

The **Coarse**, **Medium**, and **Fine** selectors affect the knob resolution. When set to coarse, each knob click represents a greater change than when set to medium or fine.

The **Set to Min** and **Set to Max** selectors let you quickly set a parameter to either extreme of its range of adjustment.

to the
nu to
eric
ur
instead of
knob to
meter.
per
if you
the
d end
y
e Enter
IS
e sign of
r; Back
you
rs. The p
ino), μ
f m (milli)
: you
number.



MENUS

- FORM
- GENER
- SURE
- WIRE/ALL
- UTILITY

Ident	Words	Probes	Color
Initialize	Time S	Label	Page
	Date		Utility2
	14:29:34		Menu
	25-JAN-92		

1=458.0ns	Cursor
2= 572.0ns	Type
t= 1.622µs	Paired
Att= 979.5kHz	Date
	Page
	to
	Previous
	Menu

GPIB	RS232C	Hardcopy	
TalkListen	950086	Bitmap	
Extended	Self	Screen	
Diagnostic	Test		Page
			to
			Utility1
			Menu

major menu controls the h are markers that you our waveform to make ts. Use the **Cursors** icon to cursors major menu.

The Utility1 and Utility2 major menus control general oscilloscope parameters including display colors, GPIB and RS-232-C settings, and the internal clock. See pages 22 and 24.

Major Menu Buttons

Vertical Desc: L2	Horizontal Desc: Main	Require Desc: Continuous	Upper Criticula
Fast Impedance: 1M Ω	Coupling: DC	BR Limit: 400MHz	Page to: All Wfms Menu

The Waveform major menu controls waveform definition, acquisition, and the plug-in units. See page 14.

Peak: 1V	Rise: 18ns	Window 1: 1V	Page to: Waveform Menu
----------	------------	--------------	------------------------

An alternate form of the Waveform major menu, the All Wfms Status menu, can be displayed using the **Page to** selector in the Waveform major menu. Press the Waveform major menu button to alternate between this menu and the Waveform major menu. See page 14.

Trigger Select: Main	Source Desc: L2	Level: 3.85V	Time Holdoff: 700ns
Mode: Auto	Coupling: DC	Slope: +	Window Holdoff: none

The Trigger major menu controls triggering. See page 16.

Peak-Peak: 5.449V	Rise: 105.2ns	Measurements
		Statistics Comp & Def: continuous

The Measure major menu controls the automatic measurement system. See page 18.

1: Clear Waveform	Delete Waveform
1: Sequence Settings Off	Delete Settings

The Store/Recall major menu controls storage and recall of waveform data and oscilloscope settings. See page 20.



Waveform Description			
R	7	8	9
	4	5	6
	1	2	3
	0	EX	
Acq	Diff	Env	
Intg	Insp	Ln	
Signal	Smooth	Sort	
Back		Space	Cancel

This pop-up menu lets you specify the waveform description of the selected waveform. See page 175.



Vertical Desc	Horizontal Desc	Acquire Desc	Particle Desc
11	Main	Continuous	
Impedance	Coupling	BW Limit	Page to All Wfms Menu
1MΩ	DC	40MHz	

The **Page to** selector displays the alternate All Wfms Status major menu. This displays the status of all waveforms on the display. See page 182.



Channel Impedance	
50Ω	
1MΩ	

This menu lets you set the plug-in amplifier input page 119.

Channel Coupling	
Channel Select	DC
DC	
LC	
DC	

This pop-up menu lets you set the coupling of plug-in amplifier input channels. See page 120.



Waveform Major Menu

Horizontal	Description
Acquiring Timebase: Main	
Main Sample Interval:	199ns/point
Window Sample Interval:	20ns/point
Main Window:	Main Window
Record Length:	1024 points
Record Length:	1024 points
YF Display Mode	
Normal	Point
	Accumulate
XY Display Mode: X=Displayed Waveform	
Wfm 1:	Wfm 2
L1	L1
Main	Window 1
XY Display Mode: X=Stored Waveform	
ST01	

t accumulate
e controls.
page 125.

Record length controls.
See page 139.

XY waveform controls.
See page 191.

Acquire	Description
Average #	Stop Acquisition On
Off	Complete
Set AvgN	Average Complete
32	Soft Trig & Env
Envelope #	Envelope Complete
Off	
Set EnvN	Envelope Complete
32	
Run Acquisition	
Cont	1024

Averaging and
enveloping,
see page 43.

Acquisition
control,
see page 33.

Graticules
Reduce to Single Graticule
Create Second Graticule
Move Waveform to Other Graticule

Graticule controls.
See page 69.

Select	Bandwidth Limit
	20MHz
	100MHz
	400MHz

menu lets you set the
limits of plug-in
out channels.
22.



Select the trigger source using this pop-up menu. See page 162.

Main Trigger Source Description			
L1	C	R	LINE
L2			
Enter Desc Back Space Cancel			

At the Main or Low Trigger this selector. See page 162.

Trigger Select: Main	Source Desc: L1	Level: 2.325V	Trig Holdoff: 490ns
Mode: Auto	Coupling: DC	Slope: +	Window Holdoff: None HO: none Trig: Main

Trigger Mode
Auto Level
Auto
Normal

Main Trigger Coupling	
AC	DC
AC Low	DC High
AC High	DC Noise
AC Noise	DC Noise

Select the coupling for the trigger signal using this pop-up menu. See page 163.

Trigger Major Menu

Touch these selectors to assign the knobs to control the trigger level and holdoff. See page 164.

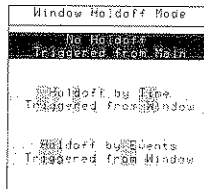

Use this pop-up menu to set the Window trigger holdoff mode. See page 164.

Touch this selector to change the trigger slope. See page 164.



Peak-Peak	
Left	Right
Limit	Limit
0%	100%
-21.2800us	81.1900us
Time Mode	
relative	

Touch a measurement readout to display a pop-up menu that lets you control the way the measurement is taken. See page 108.

Rise	Peak-Peak		Measurement
145.7 ns	5.459 V		Statistics Comp & Def continuous

These six selectors are reserved for readouts of the measurements that you select. This sample menu shows that two measurements are selected. See page 97.



These pop-up menus let you store and recall displayed waveforms. See page 153.

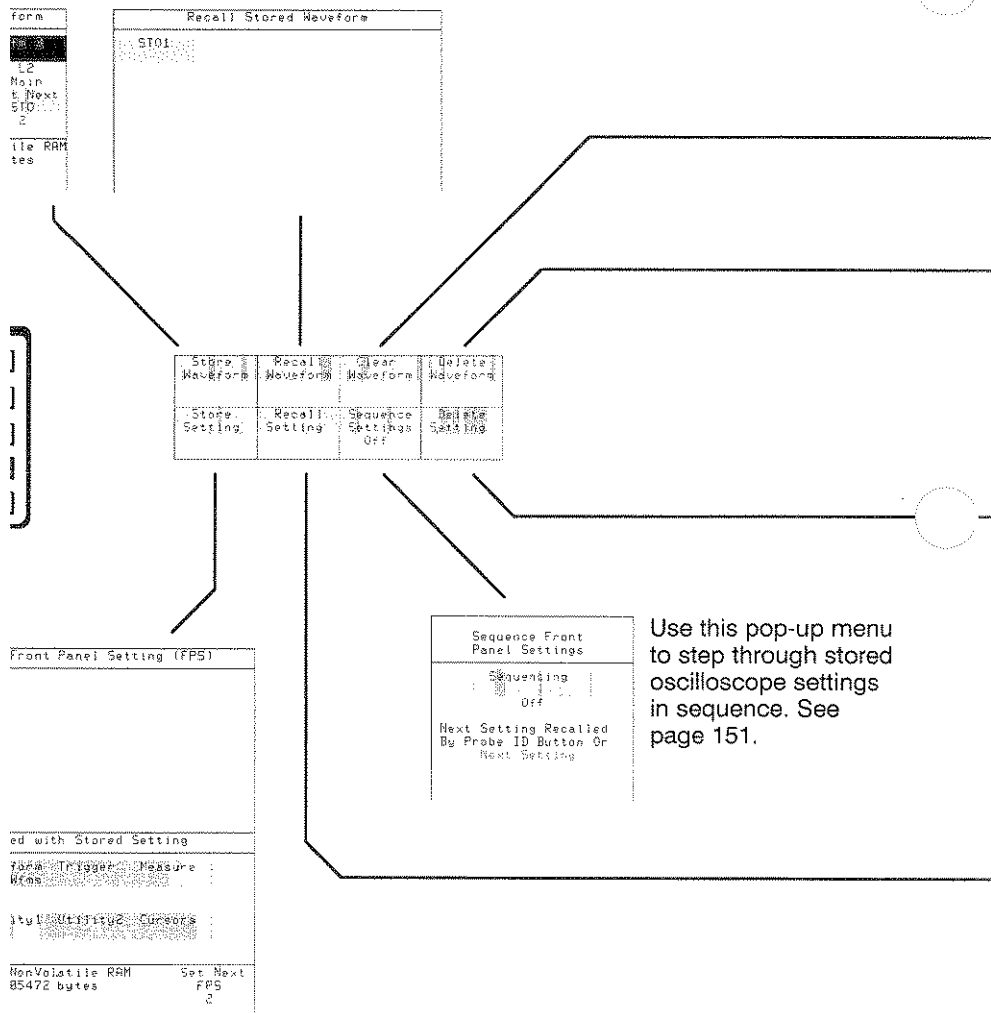

These pop-up menus let you store and recall displayed waveforms. See page 147.

Store/Recall Major Menu



Clear displayed waveforms using this pop-up menu. See page 34.

Delete displayed or stored waveforms using this pop-up menu. See page 153.

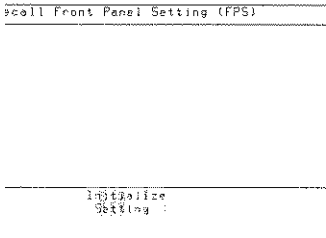
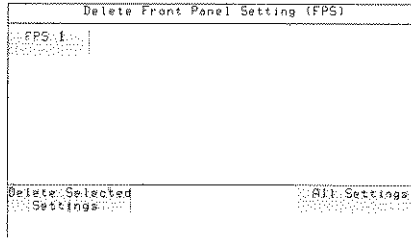
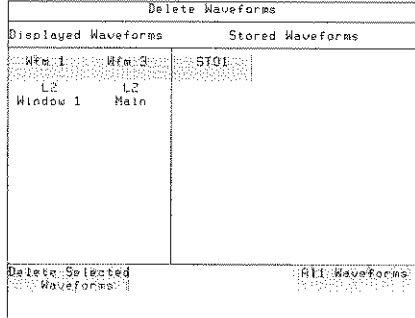

These pop-up menus let you recall or delete settings. See page 147.



Menu shows
firmware version
and installed options.

Identification	
Firmware	ID#
F6.1	
F6.2	
F6.3	
F2.4	D0306

Options	
Not Installed	Not Installed

Probes

Probe ID Function

Calibrate, Deskew, and Compensate Probes

To Cal, Deskew, and Compensate:

Connect probe or input to the calibrator;

Then select channel from this menu.

Use this pop-up menu to calibrate probes and to set the function of the probe ID button. See page 131.

Ident	Model	Probe	Color
Initialize	Time & Date	Label	Page
	9:48:46		Utility2
	27-JAN-89		Menu

Use the **Page** to selector or the **UTILITY** button to display the Utility2 major menu. See page 24.

Selector to initialize scope to a known age 89.

Time and Date	
Time:	10:28:39
Date:	27-JAN-89
Ontime:	108.5hrs
Powerups:	124 times
Time	Date
Hours	Month
10	JAN
Minutes	Day
23	27
Seconds	Year
39	89

Use this menu to set the oscilloscope clock. See page 159.

Utility1 Major Menu

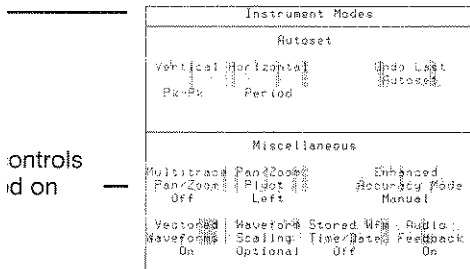

Controls
found on

Autoset controls are described on page 39.

Touch this selector to set the Enhanced Accuracy mode. See page 63.

Control waveform scaling with this selector. See page 167.

Touch this selector to turn the audible beep on or off. See page 37.

Control waveform scaling with this selector. See page 184.

Touch this selector to turn on or off display of time and date with stored waveforms. See page 155.

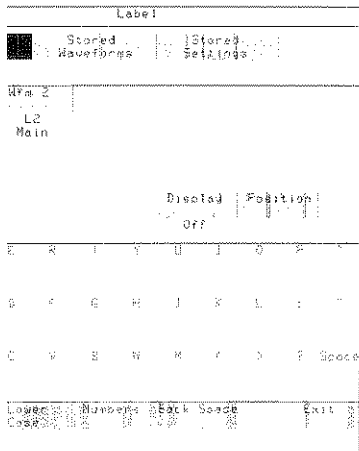

Use this pop-up menu to label a waveform or setting. See page 93.

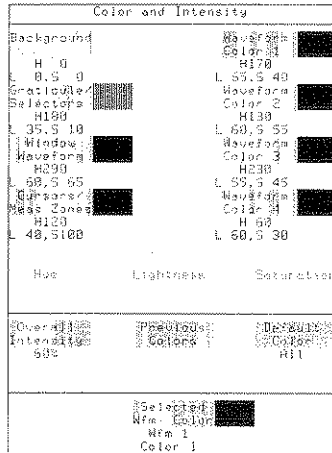

Use this pop-up menu to adjust the display colors or gray shades and overall display intensity. See pages 47 (11403) and 115 (11402A).



Use this pop-up menu to set GPIB parameters. See page 65.

GPIB Parameters	
C & F	V81.1
Mode	
TalkListen	
Address	
Terminator	E01
Debug	Off

Use this pop-up menu to set RS-232-C parameters. See page 143.

RS232C Parameters		
Baud Rate	9600Bd	Stop Bits
Parity	None	Flow Control
Handshake	None	Delay
CR-LF	On	Debug

GPIB	RS232C	Hardware	Page to Utility Menu
TalkListen	9600Bd	Bitmap Screen	
Extended Diagnostic	Self Test		

Use the **Page to** selector or the **UTILITY** button to display the Utility1 major menu. See page 22.

Use the **Self Test** and **Extended Diagnostic** selectors to operate the diagnostic system and verify that the oscilloscope is operating properly. See page 57.

Utility2 Major Menu

Hardcopy Parameters			
Printer		Color Map	
9 Pin	24 Pin	Background	Waveform Color 1
Tek 4692	Tek 4696	Spotcolor Selectors	Waveform Color 2
Bitmap Dump	Bit InkJet	Window	Waveform Color 3
HPGL		Cursors / Mass Zones	Waveform Color 4
Screen Format Screen	Direction Horizontal	Data Format	Default Color Map BinHex
Output Port		Hardcopy Abort	

Hardcopy controls are described on page 73.





This section provides detailed information about operation of the 11402A and 11403 Oscilloscopes. Refer to this section to answer specific questions about operation of the oscilloscope.

Acquisition	29
Audio Feedback	37
Autoset	39
Averaging and Enveloping	43
Color Display (11403)	47
Cursors	51
Diagnostics	57
Enhanced Accuracy	63
GPIB Parameters	65
Graticules	69
Hardcopy	73
Horizontal Controls	83
Initialization	89
Instrument Identification	91
Labeling	93
Measurements	97
Monochrome Display (11402A)	115
Plug-in Units	117
Point Accumulate Mode	125
Power-On	127
Probes and Cables	131
Record Length	139
RS-232-C Parameters	143
Stored Settings	147
Stored Waveforms	153
Time and Date	159
Triggering	161
Vectored Waveforms	167
Vertical Controls	171
Waveform Definition and Management	175
Windows	187
XY Waveforms	191



Position

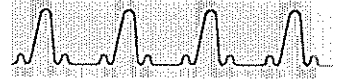

Acquisition is the process of collecting points of data from a signal and assembling them into a waveform record that is shown on the display. Once you create a waveform, the oscilloscope continues to acquire the signal and update the waveform record, and you see a live waveform on the display.

How are triggered

The oscilloscope collects samples from repetitions of a signal and determines the position of each sampled point with respect to the trigger event on that repetition. Samples may be taken both before and after the trigger event. This process continues until enough sampled points have been collected to assemble a complete waveform record.

Sampling in Real Time Mode

When the oscilloscope can acquire a complete waveform record based on a single trigger event, sampling occurs in *real time mode*. Non-repetitive events can be captured in real time mode.

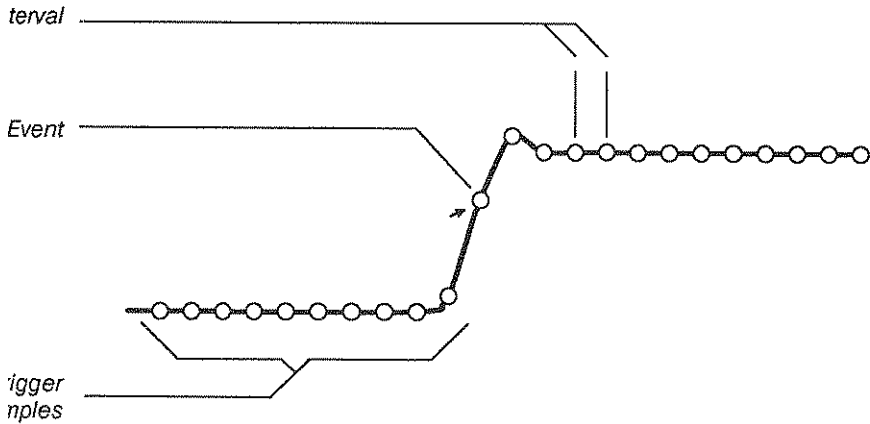

Real Time Acquisition of a Waveform



Real time sampling can occur only when the time between samples is at least as great as the time required to take a sample, and is guaranteed only when the setting is for a single channel with no windows and a sample interval greater than 50 ns. Any other settings may cause the oscilloscope to switch to equivalent time sampling.

Sampling in Equivalent Time Mode

etitive
an be
on the
e is in
it time
mode.

Samples from multiple repetitions of a signal can be assembled into a single waveform record. This is called *equivalent time sampling*. The oscilloscope does not necessarily acquire the samples in sequential order, but determines the position of each sample in the final waveform record based on the time between the sample and its trigger event.

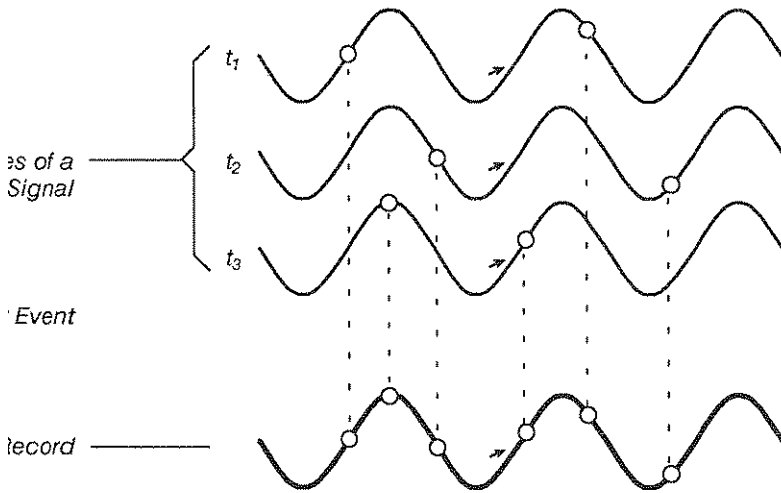

Equivalent Time Acquisition of a Waveform

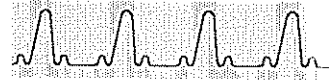

Sample Interval

The sample interval is the time difference between successive points on the waveform record. This is different from the *sample rate*, which is the actual time that it takes to sample and digitize the successive points in the waveform record.

To compute the sample interval, divide the time period that the waveform record displays by the number of points in the waveform record. For example, if you display a waveform at 20 ns per division, a little more than 200 ns of time is displayed. (There are a few points outside the 10-division graticule on either side.) If the waveform has 2048 points, the sample interval is 204.8 ns divided by 2048, or 100 ps.

You can set the number of points in a waveform record, called the *record length*, to be 512, 1024, 2048, 4096, 5120, 8192, or 10240 points. Setting the record length is described in more detail on page 139.

All waveforms on the Main time base have the same record length and horizontal size. Similarly, all waveforms on Window time bases share the same record length and horizontal size. This means that the oscilloscope uses one sample interval for main waveforms and a different sample interval for window waveforms. You can see what the current sample intervals are by looking at the top of the **Horizontal Desc** pop-up menu in the Waveform major menu.

These waveforms will all have the same sample interval for the main time base and the same sample interval for the window time bases.



illing ition

You can freeze the waveforms on the display at any time by pressing the **DIGITIZER** button. This button is found above the plug-in compartment, near the column of major menu buttons. This technique lets you stop live waveforms to examine them more closely.

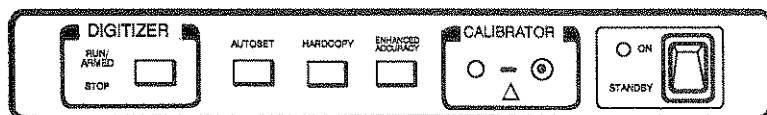

Next to the **DIGITIZER** button are **RUN/ARMED** and **STOP** lights. One or the other of these lights is always on, telling you whether acquisition is occurring.



The **Acquire Desc** pop-up menu in the Waveform major menu also controls acquisition. Use the selectors in the **Stop Acquisition On** section of the pop-up menu to specify that acquisition stop on various conditions.

Select **% Fill Complete** to have acquisition stop when the percentage of a complete record specified by the % Fill parameter has been reached for each waveform record. Select **% Set** to set the % Fill parameter using the knobs or knob keypad menu.

How to
acquire
menu
aging
, see
g and
g on
page 43.

Acquire Description						
			Stop Acquisition On			
Average N:	% Fill	Set %				
Off	Complete	99%				
Set AvgN:	Average					
32	Complete					
		Both				
Envelope M:	Envelope	Avg & Enu				
Off	Complete					
Set EnuN:	Single					
32	Trigger					
			Run Acquisition			
			Continuous			
Vertical Desc	Horizontal Desc	Acquire Desc	Graticules	Main Size		
L2	Main	Continuous		10µs/div		
Fast	@ 1024 pts			Main Pgs		
				-21.2µs		
Impedance	Coupling	BW Limit	Page to Menu	Remove Wfm 2	Pan/Zoom	
1MΩ	DC	400MHz	All Wfms	L2	off	
				Main		

The Acquire Desc Pop-Up Menu



Select **Single Trigger** to stop acquisition when a single Main trigger is detected and the time base duration has expired. In Real Time sampling mode, you can use single trigger to acquire a single triggered sweep of a non-repetitive signal.

If you use the averaging or enveloping features, you can select **Average Complete**, **Envelope Complete**, or **Both Avg & Env** to specify that acquisition stop after enough records have been acquired to provide a complete average and/or envelope.

When you wish to resume normal, continuous acquisition, touch the **Continuous** selector under the heading **Run Acquisition**.

aring orms

A waveform may be displayed but not acquiring new waveform data. This will happen when a waveform becomes untriggered in Normal trigger mode, or if you use the **DIGITIZER** button to stop acquisition.

When the waveform is displayed but is not acquiring data, the waveform record from the last acquisition remains on the display. This is why waveforms appear frozen on the display when you stop acquisition.

You can clear waveform data from the display using the **Clear Waveform** pop-up menu in the Store/Recall major menu. This pop-up menu is illustrated on the next page. To clear a waveform, touch the selector in the pop-up menu that represents the waveform you want to clear. Waveforms are identified both by waveform number and by waveform expression and time base.

The **Clear All** selector lets you clear all continuously acquired waveforms at once.

You cannot clear a waveform that displays only stored waveform data. For example, if you have a waveform that is defined to be **STO1 + STO2**, that waveform will not be listed in the **Clear Waveform** pop-up menu.

If you clear waveforms that are being acquired (live waveforms on the display), they will blink momentarily and then continue to be displayed as new waveform records are acquired.



Clear Waveform	
Wfm 1	Wfm 2
L1-L2	L2
Main	Main
Wfm 3	Wfm 4
L1	L2
Main	Main
Wfm 5	Wfm 6
L1+L2	Avg(L1)
Main	Main
Wfm 7	Wfm 8
Intg(L1)	L1
Main	Main
Clear All	

Store Waveform	Recall Waveform	Clear Waveform	Delete Waveform	Main Size 10 μ s/div	Main Pos -21.2 μ s
Store Setting	Recall Setting	Sequence Settings Off	Delete Setting	Remove Wfm 8 L1 Main	Pan/Zoom off

The Clear Waveform Pop-Up Menu



Feedback



When you select a function on the touch screen, you will hear a beep that means your selection has been noted and is being acted on. The beep can be turned on or off.

To turn the audio feedback on or off, use the **Modes** pop-up menu from the Utility1 major menu. Touch the **Audio Feedback** selector in this pop-up menu to turn the beep off or on.

audio
back
ector

Instrument Modes					
Autoset					
Vertical	Horizontal	Undo Last Autoset			
Pk-Pk	Period				
Miscellaneous					
Multitrace	Pan/Zoom	Enhanced			
Pan/Zoom	Pivot	Accuracy Mode			
Off	Left	Manual			
Vectored	Waveform	Stored Wf	Audio		
Waveforms	Scaling	Time/Date	Feedback		
On	Optional	Off	On		
Ident	Modes	Probes	Color	Main Size	
				10 μ s/div	
				Main Pos	
				-21.2 μ s	
Initialize	Time & Date	Label	Page to	Remove	Pan/Zoom
	10:49:03		Utility2	Wfm 8	L1
	12-JAN-89		Menu	Main	off

The Modes Pop-Up Menu

k



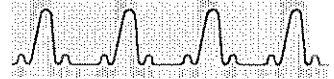

Adjusting an oscilloscope to display a stable waveform of usable size and amplitude can be a time-consuming process. The AutoSet feature can quickly give you a stable, meaningful waveform display.

AUTOSET
button

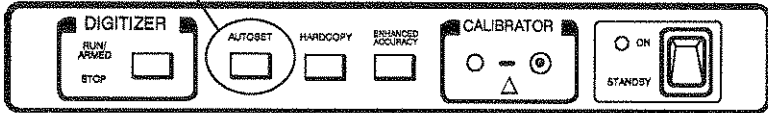

channels
just be
ed for
work
perly.

When you press the **AUTOSET** button, you tell the oscilloscope to examine the selected waveform and adjust the following for optimal display:

- **Vertical** gain and offset; for calculated waveforms, vertical size and position
- **Main** and **Window** horizontal size and position
- **Trigger** level and, if necessary, trigger source

If you press the **AUTOSET** button when no waveforms are defined, the oscilloscope will search the input channels for a signal and display the first signal found. During the search, the plug-in amplifiers will be set to their most sensitive gain settings and to 0 V offset; they will not be restored to their previous settings. Plug-in amplifier coupling is not changed, so a signal at an input channel that has coupling turned off will not be detected.



g an
oset

If you don't like the results of an Autoset, you can restore the status of the oscilloscope by touching the **Undo Last Autoset** selector in the **Modes** pop-up menu of the Utility1 major menu.

Instrument Modes					
Autoset					
Vertical	Horizontal	Undo Last Autoset			
Pk-Pk	Period				
Miscellaneous					
Multitrace	Pan/Zoom	Enhanced			
Pan/Zoom	Pivot	Accuracy Mode			
Off	Left	Manual			
Vectorized	Waveform	Stored Wfm	Audio		
Waveforms	Scaling	Time/Date	Feedback		
On	Optional	Off	On		
Ident	Modes	Probes	Color	Main Size	
				10 μ s/div	
				Main Pos	
				-21.2 μ s	
Initialize	Time & Date	Label	Page to	Remove Wfm	Pan/Zoom
	10:49:03		Utility2	L1	off
	12-JAN-89		Menu	Main	

The Modes Pop-Up Menu

oset
ions

The **Modes** pop-up menu lets you set several Autoset parameters so that you can tailor the Autoset operation to your needs. In addition to the **Undo Last Autoset** selector, the **Autoset** section of this pop-up menu has two selectors that let you specify independently the vertical and horizontal Autoset characteristics of the oscilloscope.

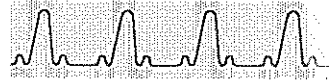

Vertical Autoset Options

The **Vertical** selector cycles among four values: Peak-to-Peak, TTL, ECL, and Off.

Peak-to-Peak mode sets the vertical gain and offset so that the waveform will be four to nine divisions high and centered vertically on the graticule. Trigger level will also be set. The trigger source will be set to match the waveform source if the time base becomes untriggered.

TTL and ECL modes set the vertical gain and offset and trigger level to values appropriate to the TTL and ECL logic families. Both set plug-in amplifier and trigger coupling to DC and set Main trigger mode to Auto and Window trigger mode to Normal.

Vertical Autoset may also be turned Off. If you turn Vertical Autoset off, Horizontal Autoset will not work properly unless the signal is triggered.

Horizontal Autoset Options

The **Horizontal** selector cycles among four values: Period, Pulse, Edge, and Off. With any of the first three selected, Autoset will adjust the Main size and position. Main holdoff will be set to its minimum value of 490 ns if it is greater than 1 ms when Autoset is invoked. The trigger source will be set to match the signal source if the waveform becomes untriggered.

Period mode adjusts the Main size and position so that at least three cycles of a repetitive signal appear on the graticule. Based on the trigger slope, either a rising edge or a falling edge is placed two divisions from the left of the graticule. The Window horizontal size is set to 1/10 of the main size, with Window1 and Window2 positions set to two and five divisions from the left of the Main graticule. Window holdoff will be set to its minimum if the delay between the Main and Window triggers is more than five times the Main size.

Pulse mode sets the Main size so that approximately one pulse is displayed across six horizontal divisions of the screen. The trigger slope determines whether a rising or falling edge is placed two divisions from the left edge of the graticule.



Edge mode sets the Main size to display the edge of a pulse across the entire graticule and sets Main position so that the edge is centered horizontally on the graticule. The trigger slope determines whether a rising or falling edge is displayed.

Horizontal Autoset may be turned off without affecting Vertical Autoset.

ases

Autoset treats certain classes of waveforms differently. If you invoke Autoset with a stored waveform selected, the result will be a vertical scaling of the waveform (unless Vertical Autoset is turned off). If an active Horizontal Autoset mode is selected, Autoset will set the horizontal magnification (Zoom) to 1. Invoking Autoset on a high precision waveform will cause Pan/Zoom to be turned off.

precisions are
Wave-
ing on
184.

When the selected waveform is a multi-channel waveform, Vertical Autoset will be applied only to each channel but Horizontal Autoset will be applied only to the first channel in the waveform description. The amplifier gains of the input channels will be matched only if the waveform is defined as a “fast,” as opposed to “high precision,” waveform.

When Autoset is performed on an XY waveform, the two components of the waveform are autoset individually. If one of the components of the XY waveform is a multi-channel “fast” waveform, both components will be treated as multi-channel waveforms and the amplifier gains for the channels involved will therefore be matched. Horizontal Autoset is executed only on the horizontal component of the XY waveform.

If the selected waveform is on a Window time base, invoking Autoset will cause the Main waveform to be autoset if the Main time base is not triggered. If the Main time base is triggered, Autoset will simply adjust the size and position of the window. If Vertical Autoset is in TTL or ECL mode, the vertical size and position of the window will also be set.

Filtering and Enveloping



The averaging and enveloping functions allow you to examine and manage noisy signals.

- Averaging reduces the apparent noise of a displayed waveform and provides a cleaner display. The oscilloscope presents a waveform that is an average of several accumulated waveform records. Each sample in a record is numerically averaged with the same sample in all the other records. The resulting waveform is displayed.
- Enveloping shows the cumulative effect of noise over a period of time. It is similar to averaging in that several waveform records are accumulated and a combined result is displayed. An enveloped waveform shows the maximum excursions of the individual waveform records. This often results in a “thicker” waveform that shows the limits of variation of the signal.

Averaging and Enveloping

There are two ways to establish an averaged or enveloped waveform.

1. If you are establishing a new waveform you can use the **AVG()** or **ENV()** waveform functions as you define your waveform. These can be selected from the **DefWfm** menu. For more information on this method, see *Waveform Definition and Management* on page 175.
2. The easiest method is to establish the waveform without averaging or enveloping. Then, after you have the waveform adjusted, you can invoke either averaging or enveloping.

The following procedure describes averaging and enveloping using the second method described above.

- Step 1: Create the waveform you want using any method.
- Step 2: If the waveform isn't selected, touch the waveform to select it.

To ensure fine adjustment, see *Positioning* on page 175.



- Step 3: To average the waveform, press the **WAVEFORM** button, touch the **Acquire Desc** selector in the major menu, and then touch the **Average N** selector in the pop-up menu.
- Step 4: To envelope the waveform, press the **WAVEFORM** button, touch the **Acquire Desc** selector in the major menu, and then touch the **Envelope N** selector in the pop-up menu.

Acquire Description					
		Stop Acquisition On			
Average N	% Fill	Set %			
On	Complete	99%			
Set AvgN	Average				
32	Complete				
		Both Avg & Env			
Envelope N	Envelope				
Off	Complete				
Set EnvN	Single				
32	Trigger				
		Run Acquisition			
		Continuous			
Vertical Desc	Horizontal Desc	Acquire Desc	Graticules	Main Size	
Avg(L1)	Main	Avg# >32		10µs/div	
Fast	@ 1024 pts			Main Pos	
				-21.2µs	
Impedance	Coupling	BW Limit	Page to All Wfms Menu	Remove Wfm 1 Aug(L1) Main	Pan/Zoom off
1MΩ	DC	400MHz			

The Acquire Desc Pop-Up Menu

The **Vertical Desc** selector status will show that the average or envelope function is part of the waveform expression.

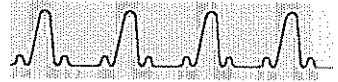

ting
g or
ing

When you want to return to normal waveform display, touch the **Average N** or **Envelope N** selector in the **Acquire Desc** pop-up menu.

unt

Several complete waveform records are combined to form an averaged or enveloped waveform. You can set the number of records that the oscilloscope accumulates and combines.

Use the **Set Avg N** and **Set Env N** selectors in the **Acquire Desc** pop-up menu to assign the knobs to set the number of records. The top knob sets the number of records to accumulate for an average, and the bottom knob does the same for enveloping.

Each knob click changes the current value by a multiple of two in the coarse setting. You can use the numeric keypad to enter specific values or to change the knob resolution.

ting
tion

You can have the oscilloscope stop acquiring waveform data when a complete average or envelope is accumulated. When the oscilloscope stops acquiring data the waveform will appear to be frozen. The selectors in the **Stop Acquisition On** section of the **Acquire Desc** pop-up menu let you specify **Single Trigger**, **Average Complete**, **Envelope Complete**, or **Both Avg & Env**. When you want to resume normal continuous acquisition, touch the **Continuous** selector.

s of
and
ing

Averaging improves the accuracy of some measurements because it reduces the effects of random noise. However, some measurements can be affected adversely by averaging or enveloping. For example, if the signal has horizontal jitter, a rise time measurement taken from the averaged waveform will be slower than the actual rise time. Be cautious when taking measurements of averaged or enveloped waveforms.



Display (11403)



Specific colors are assigned to the items on the display. The background, graticule and selectors, and cursors and measurement annotations are displayed in distinct colors for easy identification. In addition, there are up to four colors for waveforms and an additional color for window waveforms.

The four waveform colors are assigned automatically to waveforms as the waveforms are defined. When a window waveform is defined, it is displayed in the window waveform color. When you select a waveform, its color brightens.

tion You can modify the display colors to suit your preferences using the **Color** pop-up menu in the Utility1 major menu, shown on the next page. You can change the colors displayed and the overall intensity of the display. You can also reassign the color of the selected waveform to any of the four waveform colors.

The upper section of the **Color** pop-up menu has a selector for each display color. Next to each selector is a box the color of that display entity, and beneath the selector is a readout of the hue, lightness, and saturation values of that color.

- **Hue** is the characteristic associated with a color name, such as red. It is expressed in degrees on a range of 0° to 360°.
- **Lightness** is the intensity of the color, or the amount of light it transmits. Lightness is expressed from 0% (black) to 100% (white).
- **Saturation** is the vividness of the color, or the extent that it differs from gray. Saturation is expressed from 0% (maximum white content) to 100% (fully saturated).

To change the color of a display entity, select the entity in the **Color** pop-up menu. The knobs are automatically assigned to control **Lightness** and **Saturation**; select **Hue** if you want to adjust the hue of the color. Adjust the color using the control knobs.



Color and Intensity

Background	Waveform	
H 0	Color 1	
L 0,S 0	H170	
Graticule	L 65,S 40	
Selectors	Waveform	
H100	Color 2	
L 35,S 10	H130	
Window	L 60,S 55	
Waveform	Waveform	
H290	Color 3	
L 60,S 65	H230	
Cursors	L 55,S 45	
Meas Zones	Waveform	
H120	Color 4	
L 40,S100	H 60	
	L 60,S 30	

Hue Lightness Saturation

Overall Intensity	Previous Colors	Default Color
60%		H11

Selected Wfm Color

Wfm 1
Color 1

Ident	Modes	Probes	Color	Main Size	Pan/Zoom
				10ms/div	
				Main Pos	
				-21.2ms	
Initialize	Time & Date	Label	Page to Utility2 Menu	Remove Wfm 1 L1 Main	off
	17:53:37 11-FEB-89				

The Color Pop-Up Menu



ring lors

Two selectors in the **Color** pop-up menu let you restore colors to their default settings or to the colors previously defined.

- **Previous Colors** restores all eight display entities to the colors they had when you displayed the **Color** pop-up menu.
- **Default Color** sets the selected display entity to the factory default color.

When no display entities are selected, the **All** label is displayed below the **Default Color** selector, and touching **Default Color** will set all eight display entities to the factory default colors.

ning orm lors

Although the four waveform colors are assigned to waveforms in order as they are created, you can change a waveform's color assignment using the **Selected Wfm Color** selector at the bottom of the **Color** pop-up menu.

The status area below the **Selected Wfm Color** shows the waveform number of the selected waveform and the number of the color assigned to that waveform, for example **Wfm 1 Color 1**. The box next to the selector displays the color of the waveform.

Touch the **Selected Waveform Color** selector to change the color assignment of the selected waveform. As you touch the **Selected Waveform Color** selector, it cycles through the four waveform colors available. If the selected waveform is a window waveform, only one color, the **Window Waveform** color, is available.

the play sity

You can adjust the overall intensity, or brightness, of the display. Touch the **Overall Intensity** selector in the **Color** pop-up menu to assign the knobs to control the intensity of the display. Overall intensity can be from 0% to 100%.

11403)





Cursors provide a way to measure the difference between two waveform locations that you specify. Cursors are markers that you position using the knobs. Once the cursors are positioned, readouts in the Cursors major menu show the absolute locations of the two cursors and the difference (Δ) between them.

- **Vertical cursors** are a pair of vertical bars. The positions of the cursors and the horizontal distance between them are shown in horizontal axis units.
- **Horizontal cursors** are a pair of horizontal bars. The positions of the cursors and the vertical distance between them are shown in vertical axis units.
- **Paired Dot cursors** are a pair of small, diamond-shaped dots resting on the waveform. As you move a dot cursor using the knob, it follows the waveform to the left or right. The cursor readout shows both the vertical and horizontal positions, in the respective axis units.
- **Split Dot cursors** appear similar to paired dots, except the dots may be on different waveforms. The readout indicates both the vertical and horizontal measurements, in the respective axis units.

ng the
asure-
o take
nts in-
using
sors.

You can use cursors to take several measurements. However, the automated measurement system is easier, faster, and more accurate. You can take many common measurements using the Measure major menu. See Measurements on page 97 for more information.



Cursor Position

wave-
plays
ng on
rsors.

Before you use cursors, display the waveform(s) you want to measure. The waveform should be selected (highlighted). For split-dots cursors, either waveform may be selected.

To invoke the Cursor major menu, touch the **Cursors** icon, located above the graticule with the selected waveform. This icon operates like one of the menu buttons at the right of the screen; it has its own major menu. When the Cursor menu is displayed, none of the lights of the major menu buttons are lighted.

When you touch the **Cursors** icon, the oscilloscope displays the cursors and their readouts. Whenever you touch the **Cursors** icon, the knobs are assigned to adjust cursor positions.

Icon
like a
button.

The **Cursor Type** selector displays a pop-up menu that allows you to select the cursors appropriate to your application. The data readouts associated with the displayed cursors appear in the left half of the major menu area. Select **Page to Previous Menu**, immediately below the **Cursor Type** selector, to exit the Cursors menu and return to the last major menu displayed.

Cursor Type			
Vertical Bars		Horizontal Bars	
Paired Dots		Split Dots	
Split Crsr 2 to Wfm			
Wfm 1		Wfm 2	
L1 Main		L2 Main	
v1= 4.820V	t1= 14.00 μ s	Cursor Type	Cursor 1
v2= 100.0mV	t2= 67.30 μ s	Paired Dots	14.00 μ s
Δ v= -4.720V	Δ t= 53.30 μ s	Page to Previous Menu	Cursor 2
	1/ Δ t= 18.76kHz	Remove L2 Main	67.30 μ s

The Cursors Major Menu and Cursor Type Pop-Up Menu

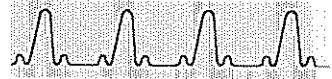

Selecting Cursor Types

At the top of the **Cursor Type** pop-up menu, you can select from four cursor types. If you select **Vertical Bars**, **Horizontal Bars**, or **Paired Dots**, the oscilloscope removes the pop-up menu and shows the selected cursors. The knobs control the cursor positions.

If you select **Split Dots**, the pop-up menu stays on the display and the lower half of the pop-up menu becomes active. The lower menu shows a selector for each displayed waveform (for example **Wfm 1**, **Wfm 2**). The selector for the displayed waveform is highlighted.

At this point, both split-dots cursors are assigned to the selected (highlighted) waveform. To assign the second (right-most) cursor to a different waveform, touch the selector for that waveform. This action removes the pop-up menu and moves the second cursor to the selected waveform.

Additional Cursor Facts

- Cursors appear on the selected waveform. If another waveform is selected the cursors move to it.
- Split Dot cursors cannot be used on XY waveforms. Other cursor types operate normally on XY waveforms.
- The horizontal cursor readout includes the inverse of the delta ($1/\Delta t$), which can be used to show frequency. The cursor readout also shows the absolute values of the cursor locations and the distance between them.
- A dot cursor is displayed as a vertical bar if it is placed on a waveform where waveform data cannot be displayed. For example, if your waveform is not triggered and therefore is not showing on the display, placing dot cursors on it will show vertical bars. This is because without waveform data, there is no known vertical position for the dot.



Cursor Examples

Measuring Waveform Amplitude

The following procedure shows how to use cursors to measure waveform amplitude.

- Step 1: Acquire and display a waveform you want to measure. Make sure all of the waveform is within the graticule area, but make the waveform as tall as possible.
- Step 2: Select the waveform you want to measure.
- Step 3: Touch **Cursors**, **Cursor Type** and **Horizontal Bars**.
- Step 4: Use the knobs to move the cursor positions to the top and bottom of the waveform. Use the **Cursor 1** or **Cursor 2** selectors in the Knob menu to increase the resolution of the knobs. This lets you position the cursors more precisely. The Δv readout at the display bottom indicates the waveform amplitude.

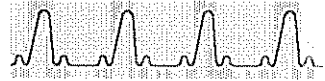

Measuring Time Between Points On Different Waveforms

The following procedure shows how to use cursors to measure time between points on different waveforms.

- Step 1: Create a display of the two waveforms you want to measure. Make sure that the point you want to measure on each waveform is visible on the display. For the most accurate results, use the shortest time per division that shows the points to be measured.
- Step 2: Leave either of these waveforms as the selected waveform, and note the number of the other waveform.
- Step 3: Touch **Cursors**, **Cursor Type** and **Split Dots**.
- Step 4: Touch the waveform selector of the other waveform that you want to place a cursor on. If you've forgotten its number, the waveform description appears in each selector.
- Step 5: The cursors are now placed, one on each waveform. Use the knobs to move the cursors to the two locations between which you want to measure time difference. Then read the time difference (Δt) at the bottom of the display.



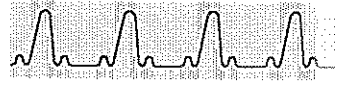

The oscilloscope features a diagnostic system that performs comprehensive tests. This assures you that the oscilloscope is operating correctly. A set of tests is performed automatically whenever the oscilloscope is powered on. You can execute additional diagnostic tests at any time.

There are three categories of tests:

- **Power-on Diagnostics** are extremely basic functional tests. These ensure that the various microprocessors are running and communicating with each other. The power-on diagnostics take about 5 seconds to execute and are run only at power-on.
- **Self-test Diagnostics** are a subset of the extended diagnostics and are executed as a group at power-on. You can also execute this group at any time. This group of tests takes about 15 seconds to execute.
- **Extended Diagnostics** are a complete set of tests which you can execute either individually or as a group at any time. A separate menu system controls the extended diagnostics. Any time the self-test diagnostics encounter a failure, the extended diagnostics menu remains on the screen to notify you of the failure.

The extended diagnostics menu is primarily intended as an aid for those servicing the oscilloscope. This manual introduces the menu but does not discuss the extended diagnostics completely. For complete information, see the *11402A and 11403 Service Reference*.



Power-on Diagnostics

Power-on diagnostics execute whenever you turn the power on. The power-on diagnostics test the most fundamental operations of the microprocessors and the communication paths between microprocessors.



While it takes about 5 seconds to execute, during this time the front panel lights will blink and the display will show the following message. (If the display is not yet warmed up, you may not be able to see the message.)

Power-on diagnostics take about 5 seconds to execute. During this time the front panel lights will blink and the display will show the following message. (If the display is not yet warmed up, you may not be able to see the message.)

Diagnostics in Progress

Comm Test in Progress

You will also hear “clicking” as the plug-in amplifiers perform their power-on diagnostics.

If the power-on diagnostics are completed successfully, the self-test diagnostics are executed immediately and you will see the message **Self Test in Progress** on the display.



If the power-on diagnostics fail, one or both of the following indications will notify you.

- The oscilloscope freezes and a message appears on the display. For example:

Dsy Kernel Failure RAM Data Bit

-
- The oscilloscope freezes, with some of the front panel lights turned on, and emits two high-low beeps.





-test stics

The self-test diagnostics execute automatically after the power-on diagnostics are completed successfully.

The self-test diagnostics can also be initiated by touching the **Self Test** selector and selecting **Self Test** in the **Self Test** verification pop-up menu in the Utility2 major menu.

The self-test diagnostics take 15 seconds to execute. During this time you will see the message **Self Test in Progress** on the display. You will also see the front panel lights blink on and off, and you will see several test patterns on the display.

If the self-test diagnostics are completed successfully, the oscilloscope will return to the state it was in before the self-test diagnostics ran. In the case where the self-test diagnostics were executed after power-on, the oscilloscope will return to the state it was in when last powered off.

If the self-test diagnostics fail, the extended diagnostic menu is displayed and the failure is noted on the display. You can exit the extended diagnostic system and try to use the oscilloscope, but until the failure is repaired you should not rely on any measurements taken. Call your service person to repair the cause of any failures.

ided stics

You can enter the extended diagnostic system through the Utility2 major menu by touching the **Extended Diagnostic** selector and selecting **Extended Diagnostic** in the **Extended Diagnostic** verification pop-up menu. When self-test diagnostics fail, the extended diagnostic system is entered automatically.

The extended diagnostic system is an independent subsystem of the oscilloscope. While in this system, the front panel buttons will not operate and the Extended Diagnostics menu covers the entire display.

To leave the extended diagnostic system and return to normal oscilloscope operation, touch the **(E) Exit** selector twice. The oscilloscope will return to the state it was in before the extended diagnostics were entered. In the case where extended diagnostics were entered after power-on, the oscilloscope will return to the state it was in when last powered off.



The top portion of the Extended Diagnostics menu shows three columns with the status of the diagnostic tests.

<u>SUBSYSTEM</u>	<u>INDEX</u>	<u>FAULTS</u>
a) Executive	****	
b) Display	****	
c) Digitizer	****	
d) Left	****	
e) Center	****	
f) Right	****	

If the extended diagnostic system has been entered because of a test failure, the asterisks in the **INDEX** column will be replaced with a failure index. The three columns of this display have the following meanings:

- **SUBSYSTEM** lists the names of the subsystem tests.
- **INDEX** shows the test status for each subsystem. Four asterisks (****) indicate the subsystem tests have yet to be executed. Four dashes (----) indicate the test requires some setup. If a blank appears in this column, the test requires interaction. The word **pass** indicates all tests in this subsystem have executed successfully. If **????** appears in this column, the tests of that particular subsystem are not appropriate for the oscilloscope as it is configured. Any other number or letter sequence indicates a diagnostic failure.
- **FAULTS** shows the number of tests in the subsystem that fail.

scope
ss the
nostic
ely on
ments
ll your
on for
repair.

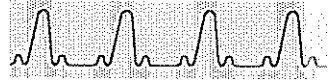

Running all of the extended diagnostic tests takes about 45 seconds. You may execute all the tests from the Extended Diagnostics menu by touching the **(x) All** selector to set the all parameter **On**, and then touching the **(r) Run** selector.

While the diagnostic tests are running, the **(r) Run** selector becomes a **(q) Quit** selector. You can touch this selector to stop execution of diagnostic tests.

When the extended diagnostic tests are complete, the **(r) Run** selector is displayed again, and the test status appears in the **INDEX** and **FAULT** columns.

When you are done with the extended diagnostic tests, touch the **(E) Exit** selector twice to exit the extended diagnostic system.



Enhanced Accuracy

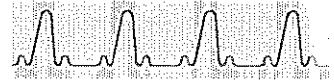

enced
r after
minute
period.

Enhanced Accuracy is an automatic self-calibration that achieves the highest accuracy level (better than 1% vertical accuracy) for the oscilloscope. Enhanced Accuracy calibrates the system from the channel inputs of the plug-in units through the digitizer.

To compensate for differences in propagation delay and achieve best system accuracy, probes and cables should also be calibrated. See Probe Calibration on page 135.

Changes of internal oscilloscope temperature greater than $\pm 5^{\circ}\text{C}$ or configuration changes such as installing new plug-in units or probes will require Enhanced Accuracy calibration. If you choose not to run Enhanced Accuracy calibrations, the oscilloscope will return to normal accuracy, which is typically 3% vertical accuracy or better.

When Enhanced Accuracy is in effect, the Enhanced Accuracy symbol () appears to the left of the graticule. This symbol also appears when the selected waveform is a stored waveform that was acquired with the system in the Enhanced Accuracy state.

ning
iced
racy

Enhanced accuracy calibration can be initiated either manually or automatically. To manually run Enhanced Accuracy calibration, press the **ENHANCED ACCURACY** button twice during normal operation. The second push confirms that you wish to start calibration. A message on the display will prompt you to run Enhanced Accuracy whenever the system reverts to normal accuracy.

The
ICED
RACY
button

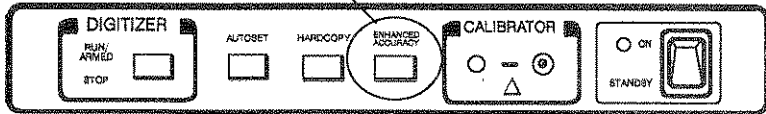



in the
while
accuracy
is in
gress.

In automatic Enhanced Accuracy mode, a message on the display tells you that Enhanced Accuracy calibration is needed and is starting.

Enhanced Accuracy calibration takes several minutes to execute. You should not turn off the oscilloscope or change any settings until the calibration is complete.

**g the
need
Mode**

To set the Enhanced Accuracy mode to **Manual** or **Automatic**, touch the **Enhanced Accuracy Mode** selector in the **Modes** pop-up menu in the Utility1 major menu. For front-panel operation, you may want to leave Enhanced Accuracy mode set to **Manual** so the automatic calibration won't interrupt your work unexpectedly. For operation by remote computer, you may want to use **Auto-**matic mode to maintain enhanced accuracy at all times.

**anced
Mode
selector**

Instrument Modes					
Autoset					
Vertical	Horizontal	Undo Last			
Pk-Pk	Period	Autoset			
Miscellaneous					
Multitrace	Pan/Zoom	Enhanced			
Pan/Zoom	Pivot	Accuracy Mode			
Off	Left	Manual			
Vectorized	Waveform	Stored Wf	Audio		
Waveforms	Scaling	Time/Date	Feedback		
On	Optional	Off	On		
Ident	Modes	Probes	Color	Main Size	
				10 μ s/div	
				Main Pos	
				-21.2 μ s	
Initialize	Time & Date	Label	Page to	Remove Wfm	Pan/Zoom
	10:49:03		Utility2	L1	off
	12-JAN-89		Menu	Main	

The Modes Pop-Up Menu

Parameters

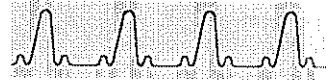

The oscilloscope can be controlled by a remote computer through one of two interfaces. These interfaces are industry standards IEEE STD 488 and RS-232-C. IEEE STD 488 is also known as the General Purpose Interface Bus or GPIB.

This manual does not discuss the details of connecting a remote computer to the oscilloscope or the syntax and capabilities of remote commands. That information is found in the *11402A and 11403 Programmer Reference* and the *11201A/11402A/11403 Command Reference*.

GPIB Location

The cable from your GPIB controller (computer) is connected to the **IEEE STD 488 PORT** connector on the oscilloscope rear panel. Three red lights show the status of specific GPIB signal lines:

- **SRQ** (Service Request) is lighted whenever any device on the bus activates the Service Request line. This indicates to the controller that some device has requested service. You cannot tell which device on the bus has asserted SRQ.
- **NRFD** (Not Ready For Data) is lighted whenever any listener device on the bus is not yet ready for the next data byte. You cannot tell which device on the bus is not ready.
- **NDAC** (Not Data Accepted) is lighted whenever a data byte is on the bus but has not yet been captured by all listener devices.

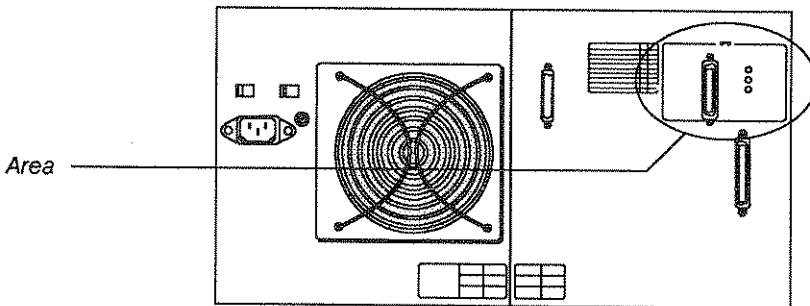

GPIB Rear Panel Connector and Lights



GPIB Parameters

Communication between the devices on a GPIB can occur only if all bus devices are configured in a compatible manner. For example, each device on the bus must have a unique identifying address.

Use the **GPIB** pop-up menu in the Utility2 major menu to set these GPIB parameters before you attempt to communicate with other devices on the bus.

GPIB Parameters					
C & F V81.1					
Mode					
TalkListen					
Address					
1					
Terminator					
EOI					
Debug					
Off					
GPIB	R5232C	Hardcopy		Main Size	
TalkListen	9600Bd	Bitmap		10 μ s/div	
1		Screen		Main Pos	
Extended	Self		Page	Remove	Pan/
Diagnostic	Test		to	Key 2	Zoom
			Utility1	L2	off
			Menu	Main	

The GPIB Pop-Up Menu

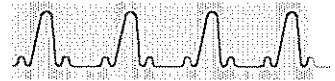

s are
when
e the
scope.

The **Mode** selector on the **GPIB** pop-up menu lets you set the mode to **TalkListen**, **Talk Only**, or **Off Bus**. **Off bus** effectively disconnects the oscilloscope from the bus. The oscilloscope must be in talk/listen mode to communicate with the GPIB controller. **Talk Only** may be used to generate display hardcopies on a GPIB printer or plotter.

Touching the **Address** selector assigns the knobs to control the GPIB address of the oscilloscope. The GPIB address can be from 0 to 30. No other device on the bus can use the number that you assign to the oscilloscope.

The **Terminator** selector lets you choose between **EOI** and **EOI/LF** message terminators. With either message terminator, the oscilloscope will assert **EOI** (the GPIB End Or Identify) at the end of each output message, and will recognize **EOI** as a message terminator. With the **Terminator** selector set to **EOI/LF**, the oscilloscope will also recognize a Line Feed (**LF**) character as an input message terminator, and will end each output message with a Carriage Return followed by a simultaneous Line Feed and asserted **EOI**. Set the **Terminator** selector to **EOI** to have the oscilloscope recognize only **EOI** as an input message terminator.

The **Debug** selector lets you turn the debugging feature **On** or **Off**. When you turn **Debug On**, the oscilloscope displays each command from the GPIB controller as it is executed. The messages appear at the top of the display. **Debug Off** is the normal mode of operation. Set **Debug On** if you need to watch the result of each oscilloscope command of a controlling program running in the GPIB controller. When debug mode is on it slows the GPIB interface throughput significantly.



ules

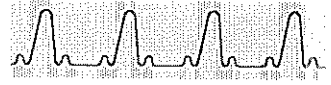

The grid on the display where waveforms appear is called a graticule. The graticule axis labels show you the horizontal and vertical scale factors of the selected waveform, usually expressed in time per division and voltage per division.

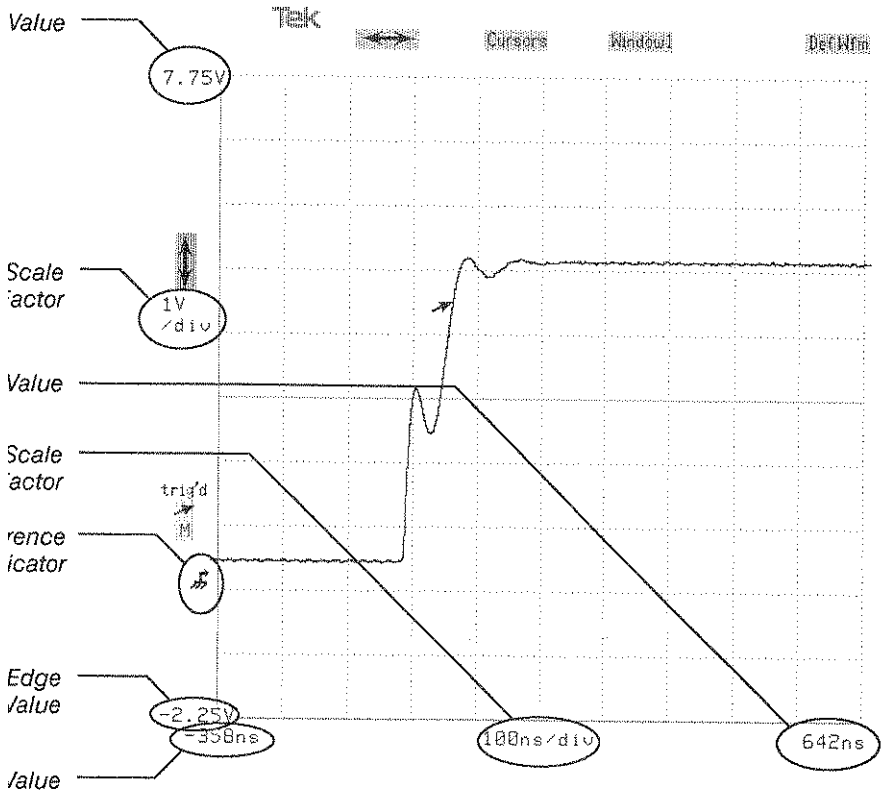

Graticule with Waveform

If a graticule shows two or more waveforms, one is the selected waveform and is highlighted. The axis labels are displayed in the color of the selected waveform. The other waveforms may not share the same axis labels.



ation
olors
s, see
splay
ge 47
Dis-
A) on
TAG.

You can display two different graticules, each half the height of a single-graticule display. In this case, the graticule with the selected waveform has the vertical (\updownarrow) and horizontal (\leftrightarrow) icons.

As with a single-graticule display, the menu selectors affect the selected waveform.

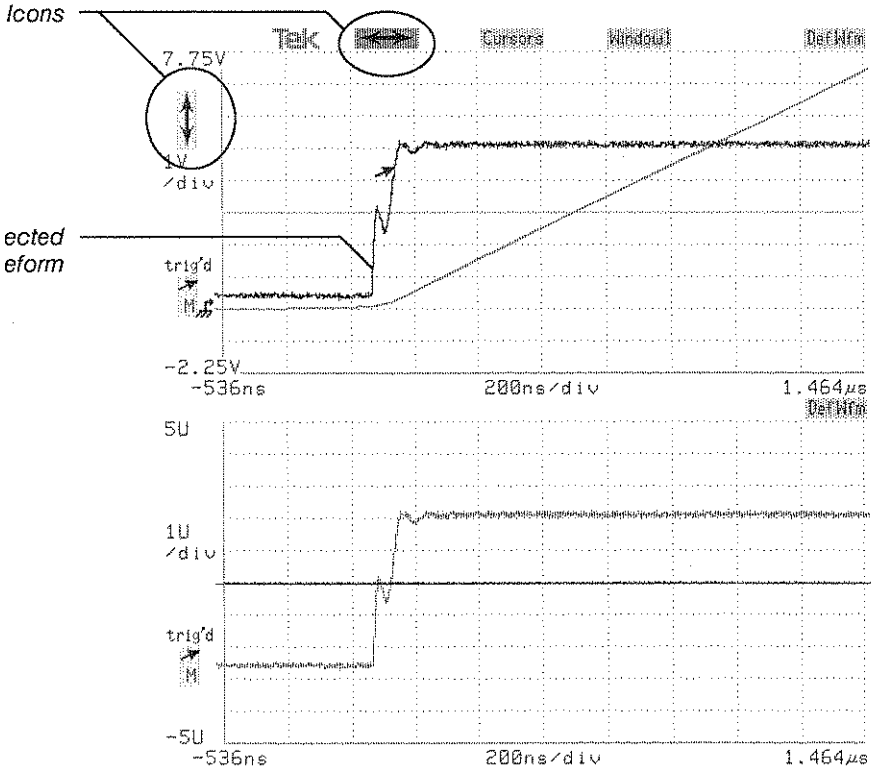

Dual Graticules with Multiple Waveforms

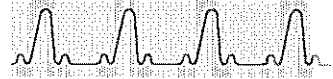

Graticules					
Reduce to Single Graticule					
Create Second Graticule					
Move Waveform to Other Graticule					
Vertical Desc L2 Fast	Horizontal Desc Main @ 1024 pts	Acquire Desc Continuous	Graticules	Vert. Size: L2 1V/div	Vert. Offset: L2 0V
Impedance 1MΩ	Coupling DC	BW Limit 400MHz	Page to All Wfms Menu	Remove Wfm 2 L2 Main	Chan Sel L2

The Graticules Pop-Up Menu

You can make any waveform the selected waveform by touching it. If you select the wrong one because the waveforms are close together, touch again until the desired waveform is selected. Other methods of selecting waveforms are discussed in Waveform Definition and Management on page 175.

You can control the number of graticules and the placement of waveforms on the graticules using the **Graticules** pop-up menu in the Waveform major menu. When dual graticules are displayed, the **Graticules** selector is renamed **Upper Graticule** or **Lower Graticule**, depending on which graticule has the icons and the selected waveform.



ging and rms

When only one graticule is displayed, you can create a dual-graticule display using the **Graticules** pop-up menu from the **Waveform** major menu. Touch the **Create Second Graticule** selector in this pop-up menu. The selected waveform and all waveforms from **Window** time bases will be placed on the lower graticule. The upper graticule will show all other waveforms.

When two graticules are displayed, you can move the selected waveform from one graticule to the other. Touch the **Move Waveform to Other Graticule** selector to move the waveform. After the waveform is moved, it remains the selected waveform. The horizontal icon (↔) and vertical icon (↕) move to the new graticule.

When two graticules are displayed, you can combine the waveforms from both graticules into a single-graticule display. Touch the **Reduce to Single Graticule** selector to combine the waveforms onto one large graticule. The waveform that was selected before the operation remains the selected waveform on the new single graticule.

If you remove all the waveforms from the lower graticule of a dual-graticule display, the display automatically reverts to a single graticule.

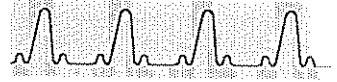

A variety of printers and plotters are supported for producing a paper copy of the display. This section will cover how to configure your system for most printers. Also, refer to your printer manual for the proper printer settings.

the nter

Connect the printer to the oscilloscope. Depending on the printer, you will want to use the **PRINTER** connector, the **GPIB** connector, or the **RS-232-C** connector.

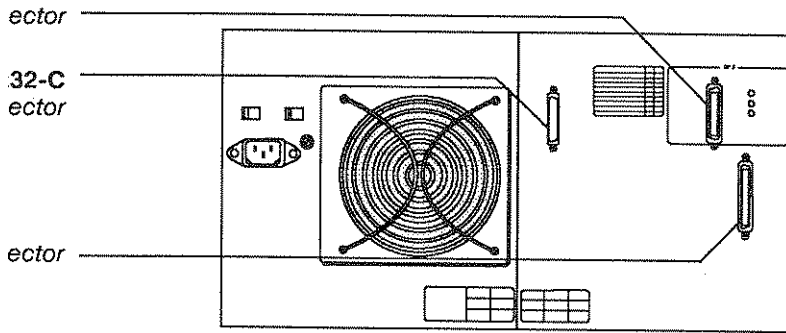

Rear Panel Connectors

- **PRINTER** is the appropriate connector for Centronics-compatible printers. This is the standard interface for the oscilloscope and no special configuration of the oscilloscope is required.
- **GPIB** is the General Purpose Interface Bus parallel interface connector. Use a standard cable fifteen meters or less in length. If you are not using a controller to initiate the hardcopy, set the GPIB Mode parameter of the oscilloscope to Talk Only and set the printer to Listen Only or Listen Always mode (address 31). Setting GPIB parameters is explained on page 66.



- **RS-232-C** is a serial interface connector. Use a standard, straight-wired cable with male connectors on both ends. Hard flagging is used, so all lines must be connected. Do not use a null modem cable. (The DB-25 to Centronics cable provided with many personal computers *cannot* be used to connect a printer to the oscilloscope, although it appears to match the RS-232-C connector.) The oscilloscope acts as a DCE device. Connecting the oscilloscope to a computer also requires a straight-wired cable, but soft flagging may be used.

The RS-232-C parameters baud rate, parity, and number of stop bits of the oscilloscope should be set to match the printer or computer. When you connect a printer to the RS-232-C connector, you may also need to set the RS-232-C flagging to **Hard**. Setting RS-232-C parameters is explained on page 143.



copy
ions

Set the printing properties of the oscilloscope using the **Hardcopy** pop-up menu in the Utility2 major menu. This menu includes selectors for seven types of printers and for specific options available with some printers.

Hardcopy Parameters			
Printer		Color Map	
B Pin	24 Pin	Background	Waveform Color 1
Tek 4692	Tek 4696	Graticule/	Waveform Selectors Color 2
Bitmap Dump	Alt InkJet	Window	Waveform Color 3
HPGL		Cursors/	Waveform Meas Zones Color 4
Screen Format	Direction	Data Format	Default Color Map
Screen	Horizontal	BinHex	Compacted
Output Port	Hardcopy Abort		
R5232C			

GAIB	R5232C	Hardcopy		Main Size	10ms/div
TalkListen	9600Bd	Bitmap		Main Pos	-21.2ms
1		Screen		Remove	Panel
Extended	Self		Page	Rfm 2	Zoom
Diagnostic	Test		to	L2	off
			Utility1	Main	
			Menu		

The Hardcopy Pop-Up Menu (11403)



n and
ciated
re not
ializa-
actory
ittings
ear in
dix E.

Printer Selections

The selectors in the Printer section of the **Hardcopy** pop-up menu determine the printing configuration of the oscilloscope. The settings of the other hardcopy parameters will vary according to the printer that is selected. When you change one of these parameters, you are setting its default value for the selected printer type. These settings are not changed when you initialize the oscilloscope.

- **8 Pin** supports several 8-pin dot-matrix printers, including the Tektronix 4644, Epson FX80 and Epson EX800. The IBM Proprinter and Epson RX80 may also be used, but only the **HiRes** screen format provides useful output. All the supported printers typically use the **PRINTER** connector.

Set the configuration switches on your printer as recommended in its manual except set No Auto Line Feed, No Perf Skip, and Inbuf On.

- **24 Pin** supports the Extended Epson command set for 24-pin dot-matrix printers, including the Epson LQ500, Epson LQ1000, Nec P6, and Nec P7. These printers typically use the **PRINTER** connector.

Set the configuration switches on your printer as recommended in its manual except set No Auto Line Feed, No Auto-Carriage Return, No Perf Skip, and Inbuf On.

- **Tek 4692** supports the Tektronix 4692 color graphics copier. The Tek 4693D may also be used when set to 4692 emulation, Full Color, Maximized by Interpolation, and Portrait Mode. These printers typically use the **PRINTER** connector.
- **Tek 4696** supports the Tektronix 4696 and 4695 color inkjet plotters. These printers typically use the **PRINTER** connector.



Screen Format

The **Screen Format** selector provides several qualities of hardcopy output. Different format selections are available for different printer types.

- **HiRes** produces an enhanced contrast display on printers with limited gray-scale capability. Selected items, including windows, are highlighted for easy identification. For plotters, **HiRes** produces a hardcopy of the entire screen in which every waveform record point is plotted.
- **Draft** produces hardcopies faster than **HiRes** mode but sacrifices some gray-scale capability. For plotters, **Draft** reproduces the screen without the major menu area, and plots only the minimum and maximum points of each waveform record at each horizontal screen location.
- **Reduced** produces low-resolution hardcopies a quarter of the size of **Draft** hardcopies. Advantages are quicker printing and use of less memory.
- **Screen** produces an exact color replica of the screen without reformatting to enhance features. Available for color printers and plotters only. For plotters, **Screen** prints the entire screen, but plots only the minimum and maximum points of each waveform record at each horizontal screen location.
- **Dithered** reduces saturation and increases contrast by dithering icons and selector backgrounds. May be used with Tek 4696, Tek 4692, and **Bitmap Dump**.

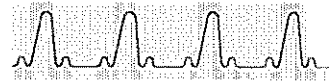

Direction

The **Direction** selector controls whether information is sent to a printer as horizontal rows or as vertical columns. For most printers, this has the effect of rotating the image by 90°. Some printers will produce an image more quickly in one direction than in the other. When **Direction** is set to **Horizontal**, screen information is sent to the printer by horizontal rows starting at the top left corner of the display. When it is set to **Vertical**, the information is sent by vertical columns starting at the bottom left corner of the display.

Data Format

When **Bitmap Dump** is selected, the screen data is transferred as an ASCII title block followed by a pixel data block. The format of the pixel data is determined by the **Data Format** setting. Touch this selector to cycle through the four available formats.

- **Binary** mode bytes of pixel data are sent as a stream of binary values without delimiters.
- **Binary Compacted** mode pixel data are compressed before being sent. See the discussion of compression, below.
- **BinHex** mode converts every four bits into a hexadecimal character. Each line is terminated by a new-line character.
- **BinHex Compacted** mode pixel data are compressed and then converted into BinHex characters.

Title Block — consists of three character strings terminated by new line characters. The first line contains the firmware version numbers, time and date, and the oscilloscope ID number. The second and third lines give the number of pixels per display line and the number of display lines, respectively. In **Binary** mode, the title block is terminated by a NULL character.



Pixel Data Compression—significantly reduces the size of the pixel data block. Without compression, each data byte contains a single three-bit pixel. With compression, two pixels are stored in the six low-order bits of the data byte, and the two high-order bits are a repetition encoding with the following meaning:

Repetition Encodings

Bit 7	Bit 6	Meaning
0	1	Pattern repeats once
1	0	Pattern repeats twice
1	1	Pattern repeats three times
0	0	Following byte(s) contain repetition count

If the second byte of the pixel block has a value in the range 4–255, it is the pattern repetition count. If the value is 1–3 decimal, it is the high order bits of a 10-bit repetition count, and the third byte of the pixel block contains the eight lower-order bits.

Output Port

The **Output Port** selector allows you to choose **GPiB**, **RS232C**, or **Centronics** (the **PRINTER** connector). The selection must match the rear panel connection.

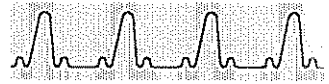

ing a
copy

Once you have installed a printer and configured the oscilloscope properly, you can make a hardcopy of the screen by pressing the **HARDCOPY** button on the front panel.

The
COPY
Button



Any displayed messages are removed before the hardcopy process begins. When you press the **HARDCOPY** button, the display freezes for a short time. The shades of intensity on the display may be altered. The printer starts printing immediately.

The length of time that the display is frozen depends on the hardcopy mode, complexity of the display, and memory available for hardcopies. During this pause the oscilloscope formats and buffers the print commands.

After the pause, the oscilloscope returns to normal operation and continues to print the hardcopy. When the display becomes active again, you may operate the oscilloscope without affecting the hardcopy being printed.

off the
or per-
cs un-
opy is
plete.

When the hardcopy is printed, a message is displayed. The hardcopy is not complete until this message appears. You should not turn off the oscilloscope, perform self-test diagnostics, or use the Extended Diagnostics menu until the hardcopy is complete. Any of these actions will terminate the hardcopy.

ng A
py In
ress

You can terminate a hardcopy by selecting **Hardcopy Abort**, in the **Hardcopy** pop-up menu. A message will appear stating that the hardcopy has been cancelled.

You can also terminate the hardcopy while the screen is still frozen by pressing the **HARDCOPY** button a second time.



Horizontal Controls



The horizontal controls let you set the horizontal size and placement of your waveforms. Touch the horizontal icon (↔) to access these controls.

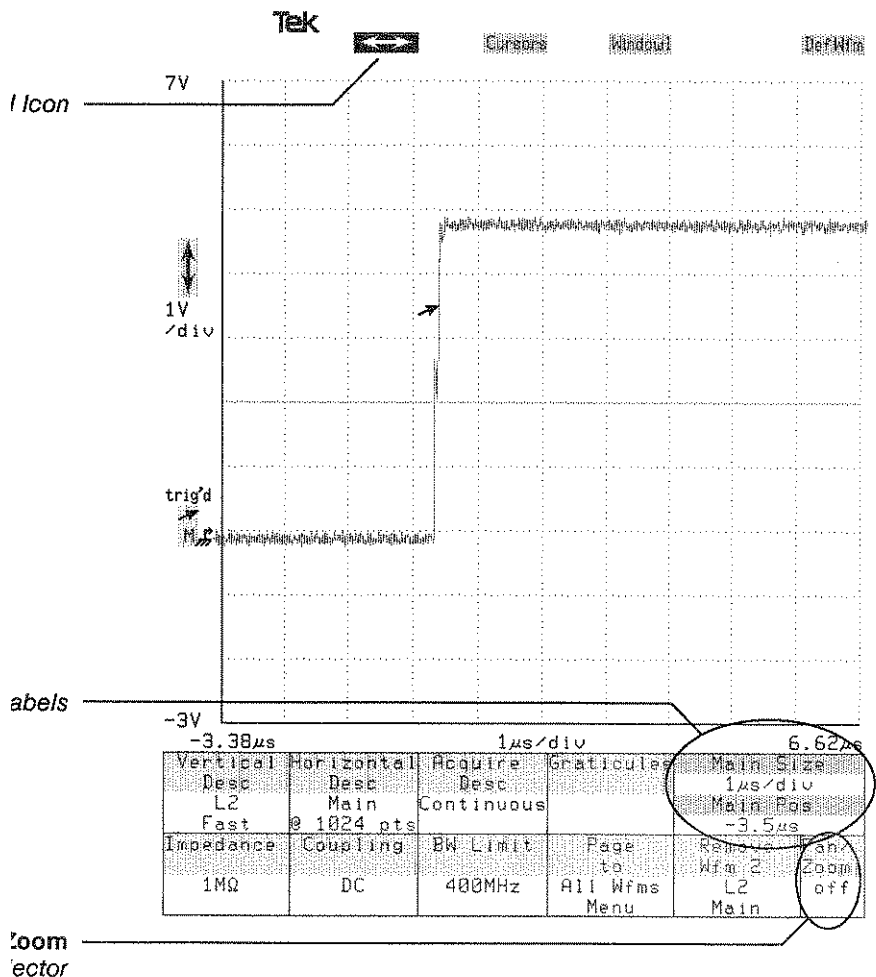

Horizontal Controls



ting Size ition

You can change the horizontal magnification, or *size*, of a waveform. You can also move the waveform left or right to see different portions of the waveform. This is called adjusting the horizontal *position*. To do either of these, touch the horizontal icon (↔). This assigns the knobs to adjust the horizontal size (top knob) and position (bottom knob) of the selected waveform.

label
a Key-
menu.
at hor-
e and
ically,
: them
mini-
It also
: knob
lution.

To change the size or position of a waveform, touch the desired waveform to select it. Then you can use the knobs to adjust horizontal size and position.

The axis label for the left edge of the graticule is slightly different from the horizontal position of a waveform. This is because waveforms extend slightly beyond the edges of the graticule. The illustration on the previous page shows the main position (in the knob label) is $-3.5 \mu\text{s}$, and the left edge of the graticule is $-3.38 \mu\text{s}$.

Interactions With Other Waveforms

The knob labels tell you whether the selected waveform is from the Main time base or a Window time base.

All waveforms from the Main time base share the same size and position. If you change the size or position of one main waveform, you will change the size or position of all of main waveforms.

All waveforms from Window time bases have the same horizontal size. If you change the horizontal size of one window waveform, you will change the horizontal size of all window waveforms. Each window waveform can have a unique horizontal position.



Zoom

Pan/Zoom allows you to magnify any portion of the selected waveform to examine it more closely. You can magnify (Zoom) the selected waveform to the point where each digitized sample appears on the display, and you can move the magnified waveform left and right (Pan) to examine any part of the waveform.

as not
e way
ta are
d and
it only
ay the
ta are
layed.

The maximum magnification is determined by the waveform record length, which is described on page 139. You can magnify a waveform until one point is shown for each horizontal division on the graticule. There are 10 horizontal divisions, so you can magnify a 512-point waveform up to 51 times. The greater the record length of a waveform, the greater the maximum available magnification will be.

Whenever the horizontal icon (\leftrightarrow) is highlighted, the lower right corner of the display shows the **Pan/Zoom** selector. Normally, Pan/Zoom is off, and the knobs are assigned to horizontal size and position. When you touch the **Pan/Zoom** selector to set it to on, the knobs are assigned to **Horz Mag** (Zoom) and **Horz Pos Gr** (Pan). The waveform on the next page is the same waveform shown on page 83, but magnified 10 times horizontally.

You use the top knob, **Horz Mag**, to specify how much magnification you want on the selected waveform. You use the bottom knob, **Horz Pos Gr**, to position onto the display the segment of the waveform that you want to view. The knob label status area shows how many waveform data points are not shown because they are off the left end of the screen. When you set **Horz Pos Gr** to zero, you display the left-most portion of the waveform.

You can use horizontal magnification to see the exact data points of a waveform record. Turn off waveform vectoring and set the magnification so that no more than 512 record points are shown on the graticule. Waveform vectoring is discussed in *Vectored Waveforms* on page 167.

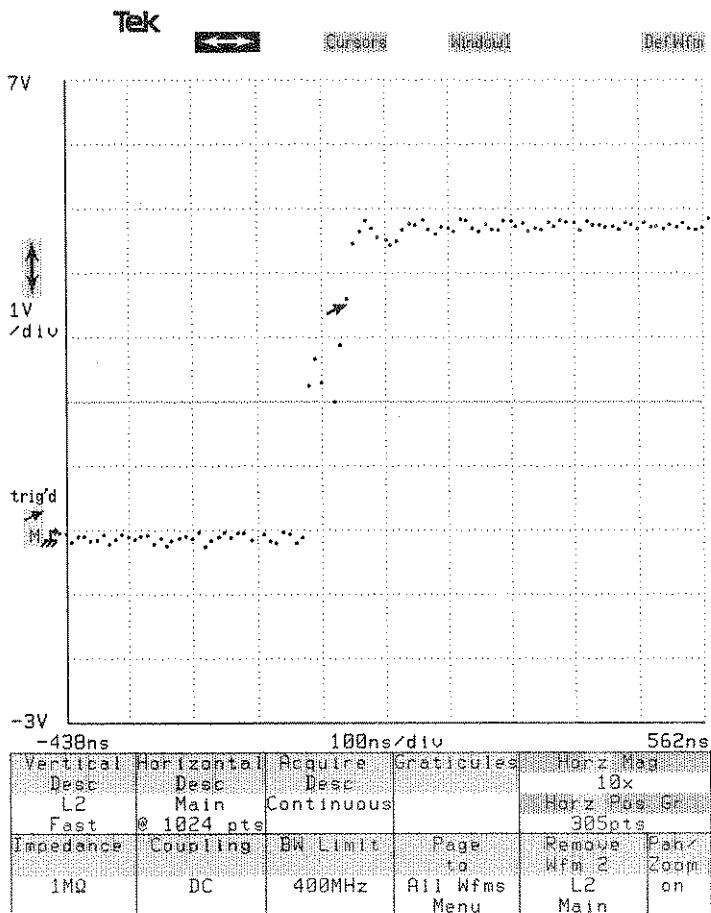

Horizontal Magnification with Pan/Zoom



Pan/Zoom Pivot

When you change the horizontal magnification with Pan/Zoom, the displayed waveform is expanded or contracted around a reference point, which remains fixed on the graticule. By entering the **Modes** pop-up menu of the Utility1 major menu and touching the **Pan/Zoom Pivot** selector, you can define this reference point to be the **Left**, **Center**, or **Right** of the graticule. Changing the pivot point will not affect the horizontal magnification or position of waveforms already on the display.

Instrument Modes					
Autoset					
Vertical	Horizontal	Undo Last Autoset			
Pk-Pk	Period				
Miscellaneous					
Multitrace	Pan/Zoom	Enhanced			
Pan/Zoom	Pivot	Accuracy Mode			
Off	Left	Manual			
Vectored	Waveform	Stored Wfm	Audio		
Waveforms	Scaling	Time/Date	Feedback		
On	Optional	Off	On		
Ident	Modes	Probes	Color	Main Size	
				10us/div	
				Main Pos	
				-21.2us	
Initialize	Time & Date	Label	Page to	Remove Wfm B	Pan/Zoom
	18:49:03		Utility2	L1	off
	12-JAN-89		Menu	Main	

The Modes Pop-Up Menu



Multitrace Pan/Zoom

Pan/Zoom can be used to position and magnify multiple waveforms. Select **Multitrace Pan/Zoom**, in the **Modes** pop-up menu of the Utility1 major menu. When you set Pan/Zoom to **on**, you will simultaneously set the horizontal magnification and position of all waveforms that are on the same graticule and have the same record length as the selected waveform.

Turning off multitrace Pan/Zoom does not change the horizontal magnification and position of displayed waveforms.

ization



Whenever you begin a new task, you should initialize the oscilloscope so that all settings are at “factory default.” That way you do not get unexpected results from settings that remain from the last use of the oscilloscope.

To initialize the system settings to default, touch the **Initialize** selector in the Utility1 major menu.

Initialize
selector

Ident	Modes	Probes	Color
Initialize	Time 2	Label	Page
	Date		to
	11:23:22		Utility2
	22-JAN-99		Menu

The Utility1 Major Menu

An alternate method to initialize the oscilloscope is to use the **Recall Setting** pop-up menu from the Store/Recall major menu. Touch the **Initialize Setting** selector in this pop-up menu to initialize the settings.

The following settings are *not* affected when you initialize:

- Stored settings and stored waveforms
- Hardcopy printer default settings
- Audio Feedback, Display Intensity, Enhanced Accuracy mode, Time/Date, and display color settings
- The following GPIB parameters: Address, Debug, Mode, and Terminator
- The following RS-232-C parameters: Baud Rate, Debug, Echo, Verbose, Stop Bits, Parity, Flagging, Delay, and EOL String



and sing atile RAM

You can erase all information stored in nonvolatile RAM (all stored settings and all stored waveforms) by holding down the **WAVEFORM** and **TRIGGER** major menu buttons when you turn on the oscilloscope. Release the buttons when the lights next to the major menu buttons stop flickering. When the power-on sequence is complete, the message "TekSecure nonvolatile RAM erased – instrument ID and enhanced accuracy constants retained" will appear on the display.

The following information is *not* lost when nonvolatile RAM is erased:

- Serial number of the oscilloscope
- Accumulated time the oscilloscope has been on
- Number of times the oscilloscope has been turned on
- Time and Date

Instrument Identification

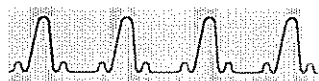

You can determine the configuration of your system by looking at the **Ident** pop-up menu in the Utility1 major menu.

Instrument Identification					
Instr	Section	FW Vers	ID#		
11403	Executive	F6.1			
11403	Digitizer	F6.0			
11403	Display	F6.3			
11A32	Left	F2.4	D0306		
N/7K	Center				
N/7K	Right				
Options					
2D - 768K NVRAM		Not Installed			
4D - DMA		Not Installed			
Ident	Modes	Probes	Color	Main Size	
				50ms/div	
				Main Pos	
				-6ms	
Initialize	Time & Date	Label	Page to	Remove	
	15:49:47		Utility2	Waveform	
	23-JAN-89		Menu		

The Ident Pop-Up Menu (11403)

The upper section of the **Ident** pop-up menu lists the internal processors of the oscilloscope and the contents of its plug-in compartments. It also displays the version number of the firm-ware (programming) and the serial number for each component. The notation "N/7K" means that the plug-in compartment is empty or contains a 7000-Series plug-in unit.

The lower section of the **Ident** pop-up menu shows whether options 2D (additional nonvolatile RAM) and 4D (Direct Memory Access, which increases GPIB transfer speed) are installed.



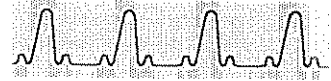

You can label active waveforms, stored waveforms, and stored settings for easier identification.

A label is a string of up to ten letters, numbers, or spaces that appears in the selector for a waveform or a stored setting. Labels for active waveforms may also be displayed on the screen with the waveform.

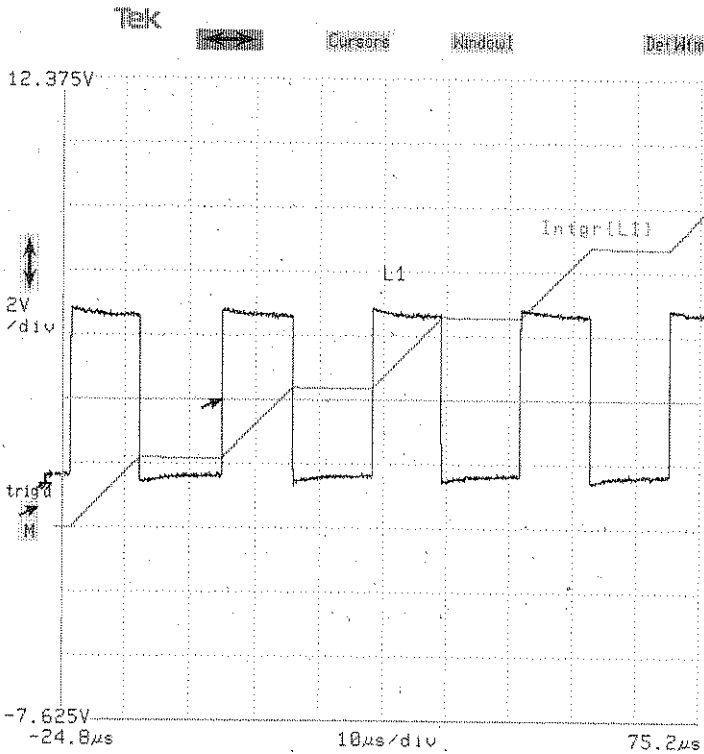

Labels Displayed with Active Waveforms



Labels

You can create and edit labels by using the **Label** pop-up menu, which appears on the next page. Select **Label** in the Utility1 major menu to display this pop-up. The uppermost section of this menu contains selectors for **Displayed Waveforms**, **Stored Waveforms**, and **Stored Settings**. Beneath these selectors, the selectors for individual active waveforms, stored waveforms, or stored settings appear. If there are more stored waveforms or stored settings than can be displayed at once, use the **Page↑** and **Page↓** selectors to scroll through the menu.

To create or change a label, select the item you want to label from the **Label** pop-up menu. For example, select **Stored Waveforms**, then select the stored waveform you want to label. You can then type the label by touching the character selectors in the lower half of the menu. The selectors beneath the characters allow you to choose **Upper Case** letters, **Lower Case** letters, or **Numbers**, which include some punctuation and symbols. You can mix uppercase letters, lowercase letters, and numbers within a label. As you type, the label appears in the selector, just below the waveform or setting number.

Use the **Back Space** selector to correct errors as you type a label. Use the **Exit** selector to leave the pop-up menu. When you leave the pop-up menu, new labels are entered automatically. If you want to enter a label without leaving the **Label** menu, touch the selector for the labeled item in the menu. Once a label is entered, it appears in every selector for the labeled item.

Use the same label for two or more items of the same type.

You cannot use the same label for two items of the same type. If you attempt to enter a duplicate label, the error message "Duplicate label - label not changed" will appear on the display and the previous label will be restored.

When you store a labeled waveform, or create an active waveform that displays a stored waveform, the label will be copied to the new waveform unless this would duplicate a label on another waveform in the same class.

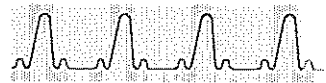

Label					
Displayed Waveforms		Stored Waveforms		Stored Settings	
Wfm 1		Wfm 2			
L1		L2			
Main		Main			
				Display Position	
				Off	
Q	W	E	R	T	Y
U	I	O	P	>	
A	S	D	F	G	H
J	K	L	:	"	
Z	X	C	V	B	N
M	<	>	?	Space	
Upper Case	Lower Case	Numbers	Back Space	Exit	
Ident	Modes	Probes	Color	Main Size	
				10 μ s/div	
				Main Pos	
				-21.2 μ s	
Initialize	Time & Date	Label	Page to Utility2 Menu	Remove Wfm 2 L2 Main	Pan/Zoom off
	12:17:58 13-FEB-89				

The Label Pop-Up Menu

Changing the waveform description of an active waveform will not change the label of the waveform, except when the new waveform description consists of a single stored waveform. The label of the stored waveform would then replace the active waveform's label.



ying with orms

Labels of displayed waveforms may be displayed on the screen with the waveforms. When **Displayed Waveforms** is selected, **Display** and **Position** selectors appear beneath the waveform selectors in the **Label** pop-up menu. Turning on **Display** will cause the labels to appear with the waveforms. Labels will appear in the selectors for all waveforms whether **Display** is turned on or off.

Labels that are displayed on the screen move with the waveforms. You can position each label relative to its waveform. Select **Position** to assign the knobs to set the vertical (top knob) and horizontal (bottom knob) position of the label. The label position is relative to a specific point on the waveform. By changing the horizontal position of the label, you are changing the point the label will follow. By changing the vertical label position, you can specify the vertical offset of the label from the point. If the waveform record point is out of the range of the graticule, the label will remain at the top or bottom of the graticule.

Measurements



Measurements are numeric readouts of properties of a waveform. Measurements are updated continuously so that as the signal changes the numeric readouts also change. You can select up to six measurements at a time. The measurement readouts for the selected waveform appear in the Measure major menu. The measurements are listed in the following table.

Measurements

Selector	Measures
Max	Maximum amplitude, the most positive peak voltage.
Min	Minimum amplitude, the most negative peak voltage.
Mid	Middle amplitude, halfway between maximum amplitude and minimum amplitude.
Mean	Arithmetic mean voltage.
RMS	True Root Mean Square voltage.
Peak-Peak	The voltage difference between maximum amplitude and minimum amplitude.
Gain	The ratio of the peak-to-peak amplitude of the reference waveform to the peak-to-peak amplitude of the selected waveform. For example, the gain of a waveform compared to itself is 1 (no units).
Over Shoot	The difference between the maximum amplitude and the topline value, expressed as a percentage of the difference between the topline and baseline values.
Under Shoot	The difference between the baseline value and the minimum amplitude, expressed as a percentage of the difference between the topline and baseline values.
Area+	The area under the curve of a waveform.
Area-	The difference between the area under the curve above a reference level and the area under the curve below that reference level.
Energy	The energy represented under the curve of a waveform. This integral of the squared voltages can be divided by the resistance of the circuit to yield power measurements.

Amplitude

Energy



Measurements (Cont.)

Selector	Measures
Rise	The transition time of a rising pulse edge.
Fall	The transition time of a falling pulse edge.
Period	The time taken for one complete signal cycle.
Frequency	The reciprocal of the period.
Width	The time the signal takes to go from one voltage level crossing to the next crossing of opposite slope.
Cross	The time from the trigger point to a specified level crossing.
Delay	The time between the first and last mesial crossings of a waveform within the measurement zone.
PropDelay	The time from the first mesial crossing of the selected waveform to the first mesial crossing of the delayed waveform within the measurement zone.
Skew	The time from the first mesial crossing of the reference waveform to the first mesial crossing of the selected waveform within their respective measurement zones.
Duty Cycle	The percentage of a period that a waveform spends above the mesial.
Phase	The phase angle from the reference waveform to the selected waveform.
Main→Win Trig Time	The time from the Main trigger point to the Window trigger point. This measurement allows much greater precision than other timing measurements, and is discussed in more detail later in this section.

Timing
Measurements

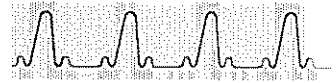

ip a
i for
ants

Measurements are taken from waveform record points. The waveform must be adjusted so that all areas that are needed to take the measurements are visible on the display. No part of the waveform should extend above or below the graticule display area. If a measurement requires a full cycle, as in frequency or period measurements, adjust the horizontal size to show at least two complete cycles of the signal. If a measurement requires a rising or falling edge, as in rise or cross measurements, adjust the horizontal size and position to show the complete rising or falling edge. Having an improperly adjusted waveform may result in an error measurement readout.

meter
ed on
e 33.

For best accuracy, the %Fill parameter should be set to 100. Otherwise the waveform record may include null points, which will affect the accuracy of the measurements.

ing
ants

Press the **MEASURE** button to display the Measure major menu. Initially, this menu is mostly blank. The six empty selectors are reserved as places where measurement readouts will appear when you select your measurements.

			Measure- ments
			Statistics Comp & Def

The Measure Major Menu

Touch the **Measurements** selector to display a pop-up menu with all the measurement selectors available. Touch the individual measurement selectors to take measurements of your waveform. As you select each measurement, the result of the measurement is immediately displayed in one of the selector areas of the Measure major menu.



The **Measurements** pop-up menu is shown below with two measurements, Frequency and RMS, selected. The numeric readouts for these two measurements appear in the major menu area.

Select
ments
here

op-up
u here

ew the
s here

Measurements					
Amplitude		Timing		Area/Energy	
Max	Mean	Rise	Fall	Area +	
Mid	RMS	Freq-	Period	Area -	
Min	Over Shoot	Delay	Prop- Delay	Energy	
Peak- Peak	Under Shoot	Cross	Width		
Gain		Duty Cycle	Phase		
		Skew	Main+Win Trig. Time		
Exit Menu			Clear All		
Frequency	RMS		Measure-	Main Size	
32.49 kHz	3.331 V		ments	10 μ s/div	
				Main Pos	
				-21.2 μ s	
			Statistics	Remove	Pan/
			Comp & Def	Wfm 1	Zoom
				L1	off
				Main	

Measurements Pop-Up Menu with Frequency and RMS Selected

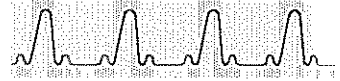

When the measurements you want are selected, you can remove the pop-up menu by touching either the **Exit Menu** selector in the pop-up menu or the **Measurements** selector in the major menu area. This lets you see the waveform as the measurements are taken.

The Main→Window Trigger Time Measurement

Unlike the other timing measurements, which are taken from digitized waveform samples, the Main→Window Trigger Time measurement is taken directly from the signals passing through the trigger circuits. You can use this feature to obtain very precise time interval measurements, similar to the “Time A→B mode” on a counter/timer.

To use the Main→Window Trigger Time measurement, select **Main→Win Trig Time** in the **Measurements** pop-up menu. Since you can set the trigger source, slope, level, and holdoff separately for the Main and Window time bases, you can define the Main and Window trigger events so that the time between them represents the time between edges on two different waveforms or on the same waveform, and you can be very specific about the events that define the beginning and end of the time interval.

First, define a separate trigger for the Window time base: touch the **Trigger Select** selector in the **Trigger** major menu until **Window** is selected, then select **Holdoff by Time: Triggered from Window** or **Holdoff by Events: Triggered from Window** in the **Window Holdoff Md** pop-up menu. Window triggering is described fully in the **Window Triggering** section on page 164. Use the **Source Desc** pop-up menu to define the trigger signal for the selected trigger (the one listed in the **Trigger Select** selector).

Selectors for trigger **Level**, **Holdoff**, and **Slope** for both the Main and Window triggers appear in the **Main→Win Trig Time** pop-up menu, which appears on the next page. Touch the **Main→Win Trig Time** selector to view this pop-up menu. The horizontal lines that appear on the display show the trigger levels. The vertical bars show the location of the trigger events in time and the trigger indicators (↗) show the location of the trigger events on the trigger signals.

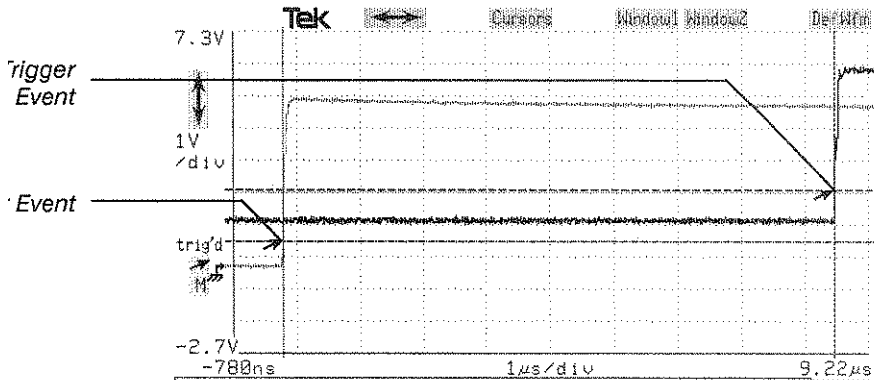

Trig Time			
Main Trigger	Window Trigger	Statistics	
Level	Level	Avg 10	Avg 100
800mV	1.1V		
Time Holdoff	Events Holdoff	Avg 1000	Avg Off
490ns	1		
Slope	Slope	Main+Win Trig Time	
+	+	max: 0.000000s	
Source Desc	Source Desc	min: 8.6702750μs	
L1	R3	stdv: 492.33830ps	
Main+Win Trig Time		Measurements	Trig Level: W
8.6707970			1.1V
μs			Event Holdoff: W
		Statistics	1
		Comp & Def continuous	Remove Wfm 1
			L1
			Main Trig

The Main→Win Trig Time Pop-Up Menu

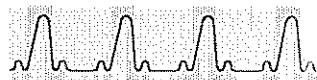

accuracy
based on
the cali-
brated
value 135.

When the oscilloscope is in the Enhanced Accuracy state and the probes have been calibrated and deskewed, the accuracy of the **Main→Win Trig Time** measurement is $\pm(250 \text{ ps} + 0.002\%$ of the measurement interval) and the precision is 10 ps with 100 averages.

Deleting Measurements

To delete a measurement, touch the **Measurements** selector in the Measure major menu. In the pop-up menu, touch the selectors for the measurements you want to remove. As you touch the measurement selectors, they will turn off highlighting and the measurement readouts will be removed from the major menu area. **Clear All** deletes all measurements. When you are finished removing measurements, touch the **Exit Menu** selector to remove the pop-up menu.



Statistics

The oscilloscope can collect mean, standard deviation, maximum, and minimum values for all active measurements. To control these statistical functions, select **Statistics Comp & Def** in the Measure major menu. The **Statistics Comp & Def** pop-up menu is displayed with **Statistics Options** selected.

Statistical Functions				
Statistics Options	Statistics on	Reset	Statistics 100	
Compare Options	Frequency		RMS	
Default Parameters	max: 32.62kHz	min: 32.35kHz	max: 3.341V	min: 3.308V
Exit	stdv: 48.59Hz		stdv: 5.939mV	
X Frequency 32.49 kHz	X RMS 3.322 V		Measurements	Statistics N 100
				Statistics N 100
		Statistics Comp & Def	Remove Wfm 1	
		sample # 2100	L1	Main

Statistical Functions in the Statistics Comp & Def Pop-Up Menu

Whenever the **Statistics Comp & Def** pop-up menu is displayed, selecting **Statistics Options** will display the statistical functions page of the pop-up menu.

Touch the **Statistics** selector to turn statistical computation on or off. When statistics are on, the mean values of the measurements appear in the measurement selectors in the major menu. The symbol \bar{x} , for mean, precedes the name of each measurement. The standard deviation, maximum, and minimum values of each measurement appear in the lower portion of the **Statistics Comp & Def** pop-up menu.

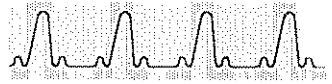

When statistics are on, the number of samples that have been used to determine the statistical values appears in the **Statistics Comp & Def** selector in the major menu. You can set the number of samples to be used for statistics by selecting **Statistics N** in the statistical functions page of the **Statistics Comp & Def** pop-up menu and then setting the value by using the control knobs.

To restart statistics, select **Reset** in the statistical functions page of the **Statistics Comp & Def** pop-up menu. Statistics will also be reset whenever the value of **Statistics N** is changed, when measurement parameters are changed, and when measurements are turned on or off.

If the oscilloscope encounters an error or an otherwise qualified measurement while computing statistics, the qualified sample will be discarded and a question mark (?) will precede the displayed statistics.

Main→Window Trigger Time Statistics

Statistics for the **Main→Win Trig Time** measurement do not appear in the **Statistics Comp & Def** pop-up menu. Instead, the **Main→Win Trig Time** statistics are controlled from the **Main→Win Trig Time** pop-up menu. To view statistics for this measurement, select **Main→Win Trig Time** in the measurement readout area and select **Avg 10**, **Avg 100**, or **Avg 1000** in the **Statistics** section of the pop-up menu to set the number of samples to take to determine the statistical values.

The mean **Main→Win Trig Time** value appears in the status area of the **Main→Win Trig Time** selector, and the maximum, minimum, and standard deviation values appear in the **Statistics** section of the **Main→Win Trig Time** pop-up menu. Select **Avg Off** to terminate statistics for this measurement. Always select **Avg Off** for a **Main→Window Trigger time** measurement in single trigger mode.



aring ments nces

You can establish reference values for your measurements and have the oscilloscope display the measurement readouts as the amount of variance from the reference value. For example, if you want to see how much a waveform varies from 0.5 V rms, you establish a reference value of 0.5 V rms. Then you turn on compare mode and the oscilloscope displays the difference between the reference value of 0.5 V rms and the rms value of the waveform being measured.

You can also save the current measurement readouts as the reference values for those measurements. If you then turn on the compare feature, you can observe how much the signal deviates from those references as you tune the circuit under test.

When the compare mode is on and measurement readouts show difference values, the measurement readouts show a delta (Δ) in the selector label to remind you that difference values are being displayed. For example, the **RMS** measurement readout in the major menu area becomes the Δ **RMS** readout when compare mode is turned on.

The compare feature affects all measurements on all waveforms. When you turn on compare mode, all measurement readouts show Δ comparison values, even if you select a different waveform.

Compare mode is turned on or off using the compare options page of the **Statistics Comp & Def** pop-up menu. Select **Compare Options** in the **Statistics Comp & Def** menu to display this page.

You set the reference values to the current measurement values by touching the **Save Current Meas Values as References** selector. When you touch this selector, all the reference values for measurements established on the selected waveform are copied from the current measurement readouts.



Compare and Reference Values				
Statistics Options	Compare off	Save Current Meas Values as References		
Compare Options	Adjust References			
Default Parameters	Frequency Ref 0Hz	RMS Ref 0V		
	Exit			
Frequency 32.49 kHz	RMS 3.322 V		Measurements	Main Size 10µs/div Main Pos -21.2µs
			Statistics Comp & Def continuous	Remove Wfm 1 L1 Main Pan/Zoom off

Compare Options in the Statistics Comp & Def Pop-Up Menu

When compare mode is off, you can use the knobs to set the reference values. A selector appears in the **Adjust References** section of the **Statistics Comp & Def** pop-up menu for each measurement currently established on the selected waveform. Each of these has the word **Ref** after the measurement name, for example, the **RMS Ref** selector. Touch the reference selector for the measurement reference you want to adjust, and both knobs are set to adjust that reference value. To set the numeric reference value, turn either knob or touch either knob label to display the keypad pop-up menu.



ing ment eters

Once you have established a measurement on a waveform, you can find out more information about the measurement and you can control the way the oscilloscope takes the measurement by changing the measurement parameters.

Touch the measurement readout selector in the major menu area to see the additional information. This displays a pop-up menu for the individual measurement. It also displays *annotation lines* that overlay the selected waveform displayed on the graticule. These lines show the value of the *measurement parameters* that pertain to that particular measurement.

In addition to the annotation lines, the portion of the waveform the oscilloscope uses to determine the measurement value is highlighted.

The illustration on the next page shows a typical pop-up menu for an individual measurement, along with the annotation lines and the highlighted portion of the waveform.

Many of the selectors in the measurement pop-up menu set the knobs to adjust the measurement parameters. As you turn the knob, the annotation lines move to reflect the new value of the measurement parameter. In the Frequency pop-up menu, the **Left Limit**, **Right Limit**, **Mesial**, and **S/N Ratio** selectors set the knobs to control those measurement parameters.

ve the
n lines
press-
SURE
button.

When you remove the measurement pop-up menu by touching its selector in the major menu area, the annotation lines remain on the display. The knob settings also remain, so you can set the knobs in the pop-up menu, remove the pop-up menu from the display, and adjust the measurement parameter with the annotation lines on the waveform. Your view of the waveform is not impeded by the measurement pop-up menu.

In the illustration on the next page, the Left Limit measurement parameter is set to 36%. The left limit vertical line is positioned 36% of the way across the graticule, and the oscilloscope measures the frequency from the first complete cycle to the right of the left limit. The highlighted portion of the waveform shows the area being measured.

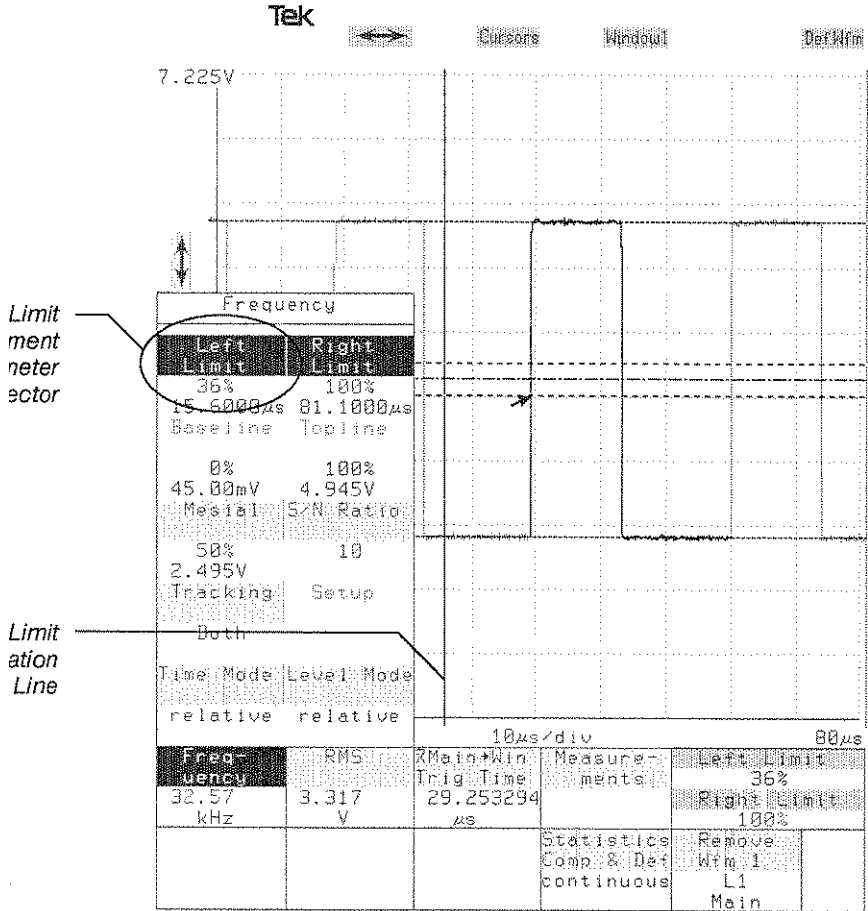
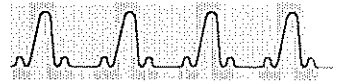

A Typical Individual Measurement Pop-Up Menu



The following table shows the measurement parameters. No pop-up menu for an individual measurement uses all these parameters; only the ones that apply to that particular measurement are shown in the pop-up menu.

Changing a measurement parameter in one measurement changes it in all measurements of the selected waveform that use that parameter, but does not change the parameter for other waveforms.

Measurement Parameters

Name	Definition
Baseline	The baseline value is the 0% level on which proximal, mesial, and distal levels are based. When tracking mode is set to Both or Baseline , the oscilloscope repeatedly determines the baseline and you cannot adjust it. When tracking mode is set to Topline or Off , you can set baseline, or you can have the oscilloscope set it once by touching the Setup selector in an individual measurement pop-up menu.
Data Interval	Determines whether the measurement will be taken from one cycle of the waveform or the entire measurement zone.
Distal	The distal (most distant from the origin) voltage level. Rise and fall times are measured between the proximal and distal voltage levels, which are typically 10% and 90% of the baseline to topline voltages.
Left Limit	The beginning of the waveform measurement zone.
Level Mode	Determines how the proximal, distal, mesial, and reference levels are set. In <i>absolute</i> level mode, you set these parameters as absolute values. In <i>relative</i> level mode, you set them in terms of percentages of the baseline to topline distance. In <i>top delta</i> and <i>base delta</i> modes, you set the parameters as offsets to be added to the topline and baseline, respectively.
Mesial	The middle voltage level.

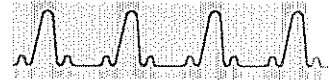

Measurement Parameters (Cont.)

Name	Definition
Proximal	The proximal (closest to origin) voltage level. Rise and fall times are measured between the proximal and distal voltage levels, which are typically 10% and 90% of the baseline to topline voltages.
Reference Level	The transition-crossing voltage level.
Right Limit	The end of the waveform measurement zone.
S/N Ratio	The amplitude of a noise rejection band centered on the mesial level. Transitions through the mesial level are qualified by S/N ratio by the requirement that the signal enter the noise rejection band and leave the noise rejection band at the opposite limit with the same slope and with no intermediate values outside the noise rejection band. S/N ratio may be set to any value from 1 to 99. The reciprocal of the number is the fraction of the peak-to-peak signal value that the noise rejection band extends above and below the mesial line. For a 1 V peak-to-peak signal, S/N ratio of 20 creates a noise rejection band 0.05 V above and 0.05 V below the mesial level.
Reference Waveform	The waveform to which the selected waveform is compared for the Gain, Phase, and Skew measurements. There is one reference waveform for all waveforms; it does not change when you select a different waveform.
Delayed Waveform	The waveform compared to the selected waveform for the PropDelay measurement. The delayed waveform is set separately for each waveform.
Slope	The direction the waveform must pass through a reference level.



Measurement Parameters (Cont.)

Name	Definition
Time Mode	Determines whether the left limit and right limit are set as absolute values or as percentages of the record length. In <i>absolute</i> time mode, these boundaries are set to absolute values. In <i>relative</i> mode, the boundaries are set as percentages of the record length, and the corresponding absolute values of the limits are displayed along with the percentages in the individual measurement pop-up menu.
Topline	The 100% level on which proximal, mesial, and distal levels are based. When tracking is set to Both or Topline , the oscilloscope repeatedly determines the topline for itself and you cannot adjust it. When tracking is set to Baseline or Off , you can set the topline or you can have the oscilloscope set it once by touching the Setup selector.
Tracking	Determines how the topline and baseline are set. When tracking is set to Both , the topline and baseline are repeatedly determined by the oscilloscope. When tracking is set to Topline , the oscilloscope determines the topline value and you can set the baseline. Similarly, setting tracking to Baseline causes the oscilloscope to set the baseline but allows you to set the topline. When tracking is Off , you set both topline and baseline.

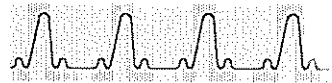

ing ault ters

Whenever you define a new waveform, the measurement parameters for that waveform are set to their initial values by copying them from a set of default parameters. The oscilloscope has one set of default parameters. You can set the default parameters to the values you want. This does not change the measurement parameters of any existing waveforms, but it will determine the initial value of the measurement parameters for all new waveforms that you define.

You might want to change the default parameters if you are about to create a number of waveforms and take measurements from them, and know that they will all need the same measurement parameters. Setting the default parameters before creating the waveforms is quicker than changing the measurement parameters of each waveform individually.

To change the default parameters, select **Default Parameters** in the **Statistics Comp & Def** pop-up menu. The Default Parameters page of the menu will be displayed, showing a selector for each measurement parameter. This pop-up menu appears on the next page.

Touch the selector that names the default you want to set. **Time Mode**, **Level Mode**, **Tracking**, **Slope**, and **Data Interval** cycle through the appropriate values. The other selectors set the knobs to adjust the measurement parameters. To reset the defaults to the values they have when the oscilloscope is initialized, select **Initialize Defaults**.

When you have set the defaults the way you want them, you can change all the measurement parameters of the selected waveform to the default settings by touching the **Copy Defaults to Sel Wfm** selector.



Default Parameters				
Statistics Options	Initialize Defaults		Copy Defaults to Sel Wfm	
Compare Options	LeftLimit	Time Mode	RightLimit	
Default Parameters	0	relative	100	
Exit	Tracking	Level Mode	Slope	
	Both	relative	+	
	Proximal	Distal	Reference Level	
	10%	90%	0V	
	Mesial	S/N Ratio	Data Interval	
	50%	10	one period	
	Topline	Baseline		
	0V		0V	
Frequency	RMS		Measurements	Left Limit
32.46 kHz	3.329 V			36%
				Right Limit
			Statistics Comp & Def continuous	100%
				Remove Wfm 1
				L1
				Main

Default Parameters in the Statistics Comp & Def Pop-Up Menu

ochrome Display (2A)

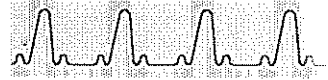

Specific contrasts (gray shades or brightnesses) are assigned to the items on the display. The background, graticule, waveforms, selectors, cursors, and measurement annotations are displayed in different contrasts for easy identification.

ting asts

You can modify the display contrasts to suit your preferences using the **Intensity** pop-up menu in the Utility1 major menu, shown on the next page.

The upper section of the **Intensity** pop-up menu has a selector for each display entity. Next to each selector is a box the contrast of that display entity. Each selector readout shows the contrast, from 0% to 100%.

To change the contrast of a display parameter, select the parameter in the **Intensity** pop-up menu. The knobs then adjust that contrast.

ring asts

Two selectors in the **Intensity** pop-up menu let you restore contrasts to their default settings or to the contrasts previously defined.

- **Previous Contrasts** restores all eight display entities to the contrasts they had when you displayed the **Intensity** pop-up menu.
- **Default Contrast** sets the selected display entity to the factory default contrast.

When no display entities are selected, the **All** label is displayed below the **Default Contrast** selector, and touching **Default Contrast** will set all eight display entities to the factory default contrasts.

g the play sity

You can adjust the overall intensity, or brightness, of the display. Touch the **Overall Intensity** selector in the **Intensity** pop-up menu to assign the knobs to control the intensity of the display. Overall intensity can be from 0% to 100%.



Intensity and Contrast		
Background		Text/Lines 45%
0%		
Selectors		Graticule 30%
24%		
Highlight Selectors		Unselected Waveform 26%
40%		
Cursors/ Meas. Zones		Selected Waveform 46%
74%		
Overall Intensity	Previous Contrasts	Default Contrast
60%		All

Ident	Modes	Probes	Intensity	Intensity
				60%
				Intensity 60%
Initialize	Time & Date 7:25:43 2-NOV-03	Label	Page to Utility2 Menu	Remove Waveform

The Intensity Pop-Up Menu

in Units

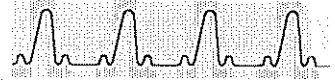

The oscilloscope has compartments for three plug-in units. Several types of plug-in units are available. This section includes general information about plug-in units. For information about a specific plug-in unit, refer to the manual for that unit.

and ing a Unit

Before installing a plug-in unit, set the oscilloscope **ON/STANDBY** switch to **STANDBY**. Align the grooves in the top and bottom of the unit with the guides at the top and bottom of the plug-in compartment. Push the plug-in unit until its front panel is flush with the front panel of the oscilloscope.

TION
or re-
unit
ver is
ON/
ch to
first.

To remove the plug-in unit, set the **ON/STANDBY** switch to **STANDBY**, then pull the release latch to disengage the unit and pull the plug-in unit straight out of the compartment.

ooove

Light

utton

ector

.atch

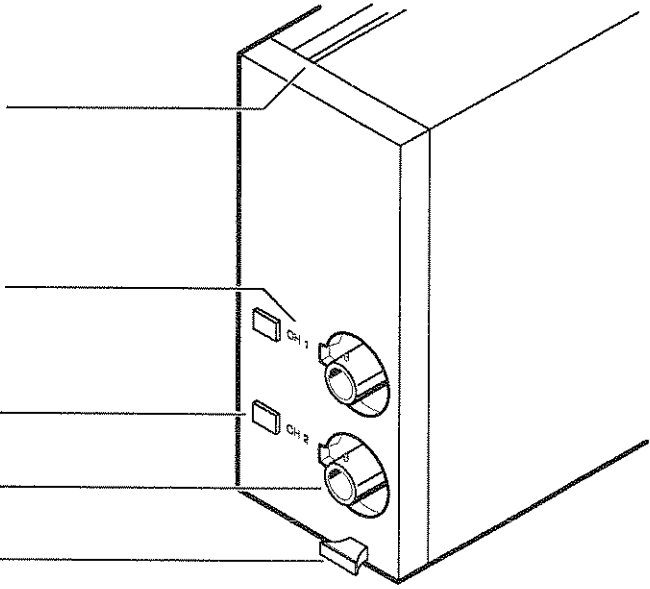

A Plug-in Amplifier



Plug-in settings are initialized when you install a new type of plug-in unit in the compartment. If you replace one plug-in unit with another of the same type, the existing settings are retained.

n/Off

A plug-in unit has a signal connector and an associated button and indicator light for each input channel. Buttons are labeled **CH#**, where # is the channel number. Pressing the button turns display of the input channel on or off. The green light next to the button will light whenever that channel is displayed.

Display of an input channel may also be turned on or off from the oscilloscope. For example, the display of an input channel of a plug-in amplifier is turned on when you define a waveform expression that includes that channel, and is turned off when all waveforms displaying the channel are removed from the display.

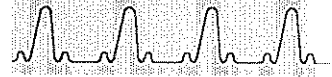

Input
ters

The operation of a plug-in unit is controlled by the oscilloscope. You set the input parameters of each input channel from the oscilloscope front panel or remote interface.

Channel Impedance

You can set the channel impedance by using the **Impedance** pop-up menu in the Waveform major menu. Select the channel you wish to set from the left side of the menu, then select the impedance from the right side of the menu. The available impedance values are determined by the type of plug-in amplifier installed.

When you use a probe, be sure to set the input impedance of the plug-in amplifier to match that of the probe.

Channel Impedance					
Channel Select					
L1				50Ω	
1MΩ					
L2				1MΩ	
1MΩ					
Vertical Desc L1 Fast	Horizontal Desc Main @ 1024 pts	Acquire Desc Continuous	Graticules	Main Size 10μs/div	Main Pos -26μs
Impedance	Coupling	BW Limit	Page to Menu	Remove Wfm 2 L1 Main	Pan/Zoom off
1MΩ	DC	400MHz			

The Impedance Pop-Up Menu



Channel Coupling

Use the **Coupling** pop-up menu in the Waveform major menu to set the coupling of input channels. Select the channel from the left side of the menu, then select coupling from the choices on the right side of the menu. The coupling options are different for single-ended and differential plug-in units. For a single-ended channel, three coupling options are available.

AC coupling blocks the DC component of the signal and allows only the AC component of the signal to be displayed. **DC** coupling passes the whole signal to be displayed on the screen. **Off** disconnects the selected channel and presents an infinite impedance at the input.

Channel Coupling					
Channel Select			+	-	
L1			AC		
DC					
L2			DC		
DC					
			Off		
Vertical Desc	Horizontal Desc	Acquire Desc	Graticules	Main Size	
L1	Main	Continuous		10µs/div	
Fast	@ 1024 pts			Main Pos	
Impedance	Coupling	BW Limit	Page to All Wfms Menu	Remove Wfm 2 L1 Main	Pan/Zoom off
1MΩ	DC	400MHz			

The Coupling Pop-Up Menu with a Single-Ended Channel Selected



If you select a channel of a differential plug-in unit, impedance may be selected for the “+” channel and the “-” channel, and an additional impedance option is available. **VC**, or voltage comparator, coupling generates a DC offset voltage, which you can set using the control knobs, at the specified channel for comparison to the input signal at the other differential channel. The signal connector will be disabled for the **VC** coupled channel.

Channel Coupling					
Channel Select					
L1		RI		+	-
DC		+:DC		Off	Off
		-:VC			
L2				AC	AC
DC				DC	DC
				VC	VC
Vertical Desc	Horizontal Desc	Acquire Desc	Graticules	Main Size	
L1	Main	Continuous		10 μ s/div	
Fast	@ 1024 pts			Main Pos	
Impedance	Coupling	BW Limit	Page to Menu	Remove Wfm 1	Pan/Zoom off
1M Ω	DC	400MHz		L1	
				Main	

The Coupling Pop-Up Menu with a Differential Channel Selected



Channel Bandwidth Limit

You can set the bandwidth limit of an input channel to reduce the amplitude of unwanted noise or interference at frequencies above the frequency of interest. Select the input channel from the left side of the **BW Limit** pop-up menu in the Waveform major menu, then select the bandwidth from the right side of the pop-up menu. The bandwidth limits available depend on the type of plug-in amplifier you are using.

Channel Bandwidth Limit					
Channel Select					
L1		400MHz		20MHz	
L2		400MHz		100MHz	
				400MHz	
Vertical Desc	Horizontal Desc	Acquire Desc	Graticules	Main Size	
L1	Main	Continuous		10 μ s/div	
Fast	@ 1024 pts			Main Pos	
Impedance	Coupling	BW Limit	Page to Menu	Remove Wfm 2	Pan/Zoom
1M Ω	DC	400MHz	All Wfms Menu	L1	off
				Main	

The BW Limit Pop-Up Menu



Offset Sensitivity

The vertical offset and sensitivity of a plug-in amplifier are controlled by the vertical settings of the oscilloscope. See Vertical Controls on page 171 for information on setting vertical size (sensitivity) and position (offset).

Circuit Loading

For several plug-in amplifiers, the input impedance for DC coupling is $50\ \Omega$. This low impedance requires some caution.

When input coupling is set to $50\ \Omega$, a $50\ \Omega$ termination resistance is connected directly from the input connector to ground. Take care that the circuit connected to the input will not be damaged by the $50\ \Omega$ load.

CAUTION

When switching with a voltage less than 25 V.

Switching coupling to DC when more than 25 V is present at the input will exceed the peak input voltage specification for some plug-in amplifiers, and thus may damage the input relay. A damaged relay could cause an error in calibration. Refer to the specifications for your plug-in amplifier. Take care not to invoke DC coupling unintentionally by recalling a stored setting that specifies DC coupling.

Some plug-in amplifiers will automatically disconnect the $50\ \Omega$ termination and display a message on the oscilloscope when the input voltage substantially exceeds 5 V rms. Refer to the manual for your plug-in amplifier.



ving

Overdriving occurs whenever a plug-in amplifier is driven out of its linear range. For many of the plug-in amplifiers, this linear range is ± 15 divisions. The amplifier will eventually reach an equilibrium value. The *overdrive recovery* of a plug-in amplifier is the time it takes the amplifier to settle to within a stated fraction of the equilibrium value after an input step. Overdriving can be used as a tool for certain measurements with plug-in amplifiers that have fast overdrive recovery.

For example, suppose a signal changes from $+1.7\text{ V}$ to $+0.8\text{ V}$ in 1 ns . You could use the overdrive recovery of a plug-in amplifier to determine if the signal stabilized immediately at $+0.8\text{ V}$ or if it had some small aberration after the transition. By setting the amplifier offset (vertical offset) to $+0.8\text{ V}$ and the sensitivity (vertical size) to 1 mV/division , aberrations of just 0.1% of the original transition will be 2.5 divisions in amplitude.

Refer to the specifications for your plug-in amplifier to determine whether its overdrive recovery is fast enough for your application.

Accumulate Mode

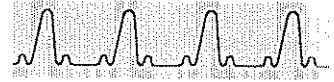

You can display a waveform in a mode that shows a history of the waveform. In point accumulate mode, individual samples that compose each waveform record are added to the display as individual dots and remain on the display indefinitely while new samples are taken and displayed.

accumulate
mode. It
is used with
single or re-
trigger points.
The waveform
can be
accumulate
mode.

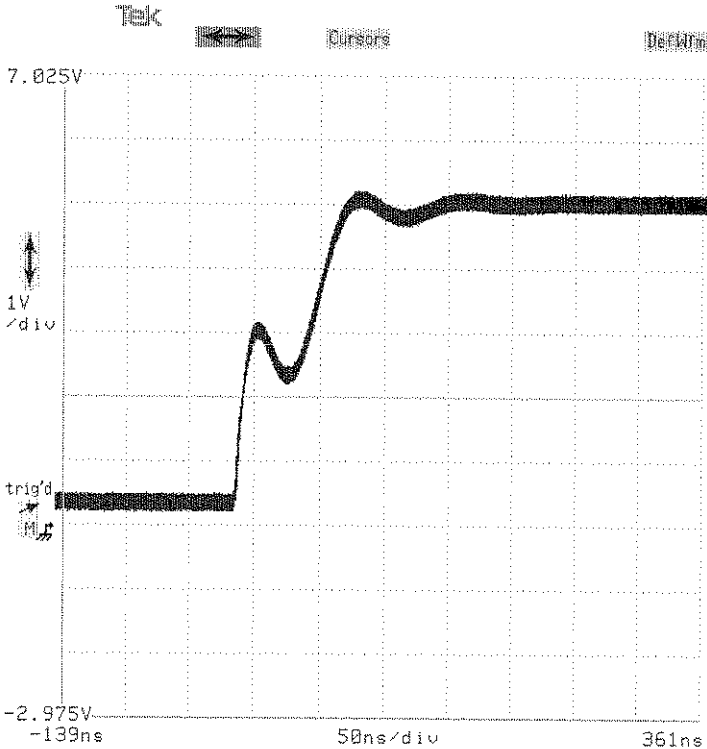

A Point Accumulate Waveform

A point accumulate mode waveform appears different from an enveloped waveform because you see the individual waveform record samples. For a complete discussion of enveloped waveforms, see Averaging and Enveloping on page 43.



Use the **Horizontal Desc** pop-up menu in the Waveform major menu to turn Point Accumulate mode on or off. Select **Point Accumulate** to turn on Point Accumulate mode and select **Normal** to turn it off.

Point Accumulate

Horizontal Description					
Acquiring Timebase: Main					
Main Sample Interval: 50ns/point					
Window Sample Interval: 50ns/point					
Main Record Length		Window Record Length			
1024 points		1024 points			
YT Display Mode					
Normal		Point Accumulate			
XY Display Mode: X=Displayed Waveform					
Wfm 1					
L1					
Main					
XY Display Mode: X=Stored Waveform					
Vertical Desc	Horizontal Desc	Acquire Desc	Graticules	Main Record Len	
L1 Fast	Main @ 1024 pts	Continuous		1024	
Impedance	Coupling	BW Limit	Page to Menu	Remove Wfm 1	
1MΩ	DC	400MHz	All Wfms	L1 Main	

The Horizontal Desc Pop-Up Menu

r-On



tion Before you first power on the oscilloscope, you should be certain that it is correctly installed. The installation sequence involves the following controls, connectors and switches on the rear panel:

- **POWER Connector**
- **FUSE**
- **LINE VOLTAGE SELECTOR switch**
- **PRINCIPAL POWER SWITCH**

Area

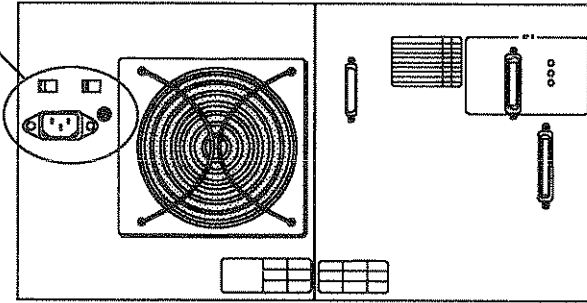

Power Connector, Fuse, and Switches

In addition, you will need to know the location of the **ON/STANDBY** switch on the front panel.

The
IDBY
witch

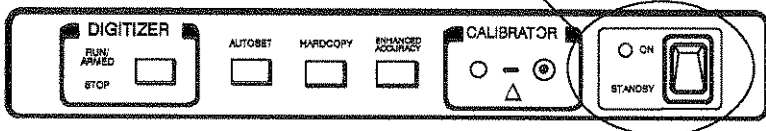



The following steps describe the installation procedure.

- Step 1: Set the **PRINCIPAL POWER SWITCH** to **OFF**.
- Step 2: Set the front panel **ON/STANDBY** switch to **STANDBY**.
- Step 3: Set the **LINE VOLTAGE SELECTOR** to the proper range for your power system.
- Step 4: Check the **FUSE** to be sure it is of the proper type and rating, as printed on the rear panel.
- Step 5: Install one or more plug-in amplifiers in the front panel compartments.

CAUTION
Do not
touch the
power
on.

To install a plug-in amplifier, align the grooves in the top and bottom of the amplifier with the guides at the top and bottom of the plug-in compartment. Push the plug-in amplifier until its front panel is flush with the front panel of the oscilloscope. Plug-in units are described on page 117.

- Step 6: Connect the power cord from the **POWER** connector to your power system.
- Step 7: Set the **PRINCIPAL POWER SWITCH** to **ON**.

The **PRINCIPAL POWER SWITCH** controls all AC power to the oscilloscope. The **ON/STANDBY** switch controls power to most of the oscilloscope's circuits, but continues to supply power to certain circuits even when set to **STANDBY**.

- Step 8: To operate the oscilloscope, set the front panel **ON/STANDBY** switch to **ON**.

Once the oscilloscope is installed, use the **ON/STANDBY** switch as the power switch.

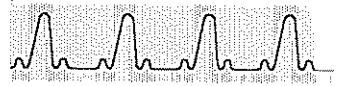
**-On
nce**

Each time you power on the oscilloscope, it performs a sequence of internal checks and then restores the settings that were established when it was last powered off. The sequence is:

crip-
nos-
e 57.

1. The power-on diagnostics are performed and take about 5 seconds to execute. If these diagnostics fail, the oscilloscope will freeze and you will not be able to operate it.
2. The self-test diagnostics are performed and take about 15 seconds to execute. If these diagnostics fail, the extended diagnostic system is entered and the Extended Diagnostics menu is displayed.
3. The system restores all the settings and waveforms that it can. If the configuration of plug-in units has not changed since the last power-down, the oscilloscope will completely restore to the state it was in when powered down.

**-Up
iod**

It takes about 20 minutes for the oscilloscope to warm up after power-on. Enhanced Accuracy is available after the oscilloscope warms up and achieves thermal stability. Enhanced Accuracy is described on page 63.



Probes and Cables

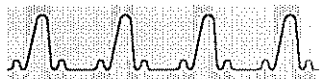

You can connect a signal source to the oscilloscope with a probe or with a coaxial cable with a BNC connector. Connect a cable by pushing the BNC connector onto the input channel connector and turn the connector to secure it. Use an attenuator with the cable when the signal voltage may exceed the capabilities of your input channel. In general, it is best to use the shortest cable possible to avoid signal distortion.

use a
mped-
input
match
nce of
ected
to it.

For many applications a probe is preferable to a cable connection. Common probe features include small, easily portable signal connectors and attenuation. Special-purpose probes are available for some applications, such as differential probes used for comparison of two signals.

This section concerns properties and functions common to most probes used with the 11000 Series. Refer to the documentation for the probe you are using for specific information.



19 a obe

The Tektronix catalog lists probes that are recommended for use with 11000-series oscilloscopes. These probes have a special connector and are connected both to the input channel and to a TekProbe interface that provides communication between the probe and the input channel. The active probes draw their power from the input channel connector.

To install a probe, place the probe connector over the input channel connector. The probe connector must be oriented so that the tab points to the lower left. The prongs around the outer rim of the probe connector will be flush with the input channel connector. Twist the circular plastic casing clockwise to secure the connection.

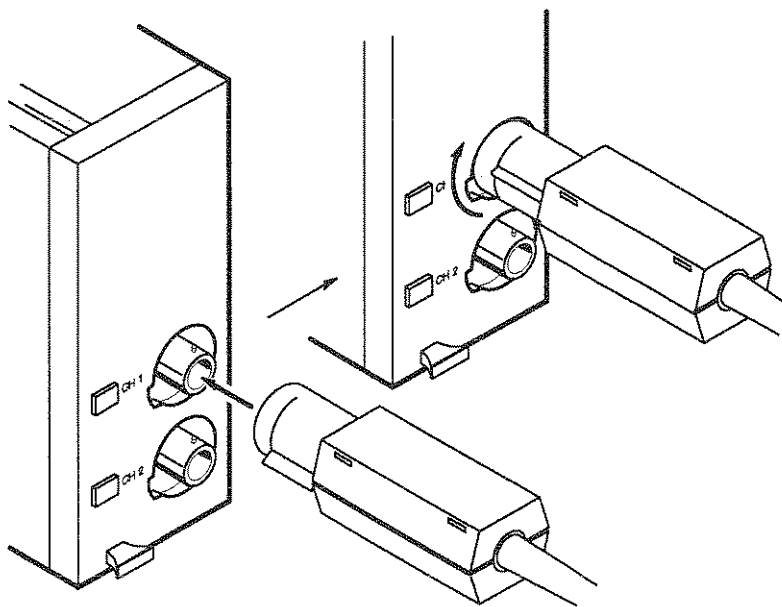

Connecting a Probe to the Input Channel

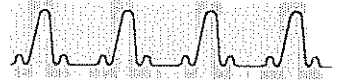

e ID ions

TekProbe intelligent probes can communicate with the oscilloscope through the input channel connection. Each probe is equipped with a **Probe ID** button which, when pressed, initiates some action by the oscilloscope.

You can use the **Probe ID** button on a probe to signal the oscilloscope to perform one of three functions. Three selectors in the **Probes** pop-up menu of the **Utility1** major menu determine what action is initiated when a **Probe ID** button is pressed.

- **Waveform Select/New Wfm** sets the **Probe ID** button to select a waveform displaying the channel or, if no such waveform exists, to create a new waveform displaying only that channel.
- **Wfm Select/New Wfm & Autoset** sets the **Probe ID** button to select a waveform displaying the channel or to define a new waveform displaying the channel and invoke Autoset on the new waveform.
- **Sequence Settings** sets the **Probe ID** button to select the next setting in the sequence when sequencing of stored settings is enabled. See *Sequencing Through Stored Settings*, on page 151, for an explanation of sequencing.



Probes

Probe ID Function

Option Select	Wfm Select/New	Sequence
New Wfm	Wfm & AutoSet	Settings

Calibrate, Deskew, and Compensate Probes

L1	C	R
----	---	---

L2	<p>To Cal, Deskew, and Compensate:</p> <p>Connect probe or input to the calibrator;</p> <p>Then select channel from this menu.</p>
----	--

Ident	Modes	Probes	Color	Lightness	Saturation
				0%	0%
Initialize	Time & Date	Label	Page to Utility2 Menu	Remove Wfm 1	L2 Main
	13:01:13 24-JAN-09				

The Probes Pop-Up Menu

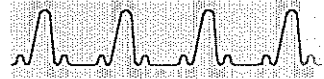

Probe Calibration

The calibrator provides a known and accurate square wave signal for use as a reference for voltage calibration, frequency compensation, and time deskewing of probes. The calibrator connector is next to the **ON/STANDBY** switch.

Calibrator Connector

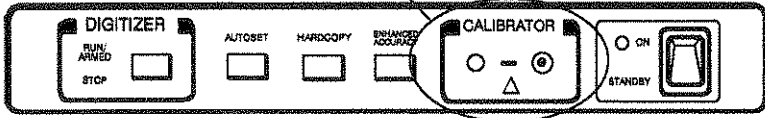

You initiate probe calibration using the **Probes** pop-up menu. The calibrator produces its signal only during probe calibration. You cannot display the calibrator signal at other times.

The following procedure may be used to calibrate, deskew, and compensate probes when you are using a standard single-ended plug-in amplifier:

- Step 1: Connect the probe or other input lead to the **CALIBRATOR** signal and ground connections.
- Step 2: Select the channel of the probe or input lead from the **Probes** pop-up menu. The channel will be vertically calibrated and then deskewed against the calibrator signal. When this process is complete, a message will appear prompting you to compensate the probe, and the Probe Compensation menu, shown on the next page, will replace the **Probes** pop-up menu.



Probe Compensation					
Select			Exit		
Next Chan			Comp		
Ident	Modes	Probes	Color	Main Size	
				10 μ s/div	
				Main Pos	
				-21.2 μ s	
Initialize	Time & Date	Label	Page to	Remove Wfm 1	Pan: Zoom
	12:19:59 13-FEB-89		Utility2 Menu	L1 Main	off

The Probe Compensation Menu

- Step 3: Adjust the compensation control on the probe so that the top of the square wave is flat.
- Step 4: If you wish to calibrate another channel, touch the **Select Next Chan** selector to return to the **Probes** pop-up menu. Otherwise, select **Exit Comp** to finish compensation.

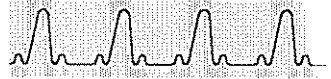

obes
aren-
unit
of the
type.

A different procedure is recommended to calibrate, deskew, and compensate probes when you are using a differential amplifier or differential comparator plug-in unit. This procedure will improve common mode rejection when you are using probes designed for use with a differential plug-in unit.

- Step 1: Connect one probe to the - input of the differential amplifier or comparator. There must be no probe connected to the + input.
- Step 2: Calibrate, deskew, and compensate the probe as described above, but do not exit the Probe Compensation menu.
- Step 3: Connect the other probe to the + input of the differential plug-in unit. Connect the probe to the **CALIBRATOR** signal and ground connections. Do not disconnect the other probe from the **CALIBRATOR**. The waveform on the screen will become a straight line which may have a small spike where the step was displayed. The segments of the waveform before and after this point may be vertically displaced from each other.
- Step 4: Compensate the probe by eliminating the spike in the displayed waveform. If the probes have a DC attenuation adjustment, you should use it to eliminate any vertical displacement of the two waveform segments.
- Step 5: Select **Exit Comp** in the Probe Compensation menu, and disconnect the probes from the **CALIBRATOR**.



rd Length

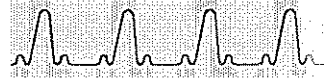

The number of samples that form a waveform is called the record length. You can select record lengths of 512, 1024, 2048, 4096, 5120, 8192, and 10240 points (samples).

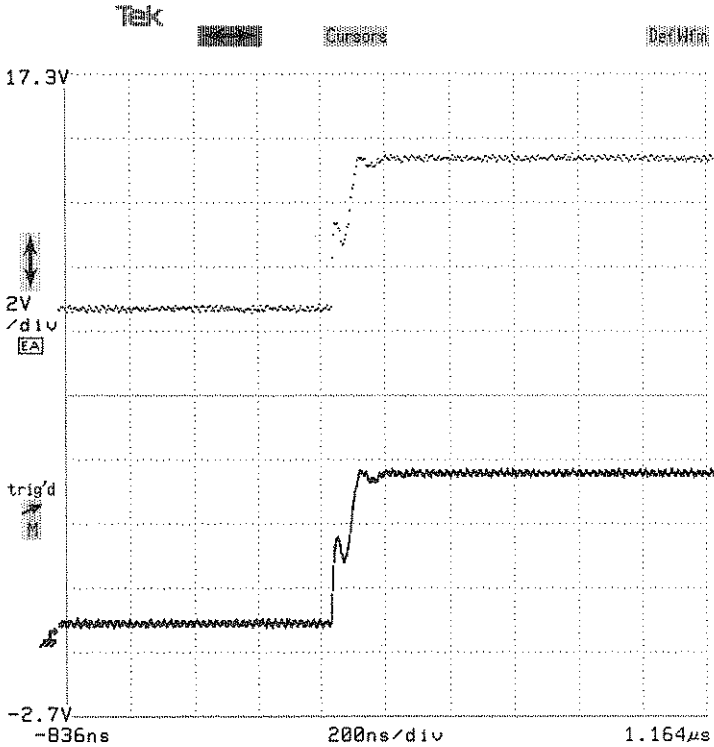

Waveforms with Record Lengths of 512 (top) and 5120 (bottom)



All waveforms on the Main time base have the same record length. Window waveforms similarly share identical record length. To set the record length, select **Main Record Length** or **Window Record Length** in the **Horizontal Desc** pop-up menu in the Waveform major menu. This menu is shown on the next page. The knobs will be assigned to control the Main and Window record lengths.

The sample intervals for the current settings are shown in the **Horizontal Desc** pop-up menu above the **Main Record Length** and **Window Record Length** selectors.

Point accumulate mode can only be used with waveforms having record lengths of 512, 1024, or 2048 points.

The 4096-point record length has the same sample interval (the time between successive waveform samples) as 5120-point records. Similarly, the 8192-point record length has the same sample interval as the 10240-point record length. The 4096-point and 8192-point waveforms do not cover the entire horizontal length of the graticule. Fourier transformations can only be performed on record lengths that are a power of two. The 4096-point and 8192-point record lengths are provided as a convenience, and the visual truncation is a natural result.



Record Length

Horizontal Description					
Acquiring Timebase: Main					
Main Sample Interval: 50ns/point					
Window Sample Interval: 50ns/point					
Main		Window			
Record Length		Record Length			
1024 points		1024 points			
YT Display Mode					
Normal		Point Accumulate			
XY Display Mode: X=Displayed Waveform					
Wfm 1					
L1					
Main					
XY Display Mode: X=Stored Waveform					
Vertical Desc	Horizontal Desc	Acquire Desc	Graticules	Main Record Len	Win Record Len
L1	Main	Continuous		1024	1024
Fast	@ 1024 pts				
Impedance	Coupling	BA Limit	Page to Menu	Remove Wfm 1	
1MΩ	DC	400MHz	All Wfms	L1	Main

The Horizontal Desc Pop-Up Menu



32-C Parameters



The oscilloscope can be controlled by a remote computer through one of two interfaces. These interfaces are industry standards IEEE STD 488 and RS-232-C.

This manual does not discuss the details of connecting a remote computer to the oscilloscope or the syntax and capabilities of remote commands. That information is found in the *11402A and 11403 Programmer Reference* and the *11201A/11402A/11403 Command Reference*.

32-C ction

Connect the cable from your computer to the **RS-232-C** connector on the oscilloscope rear panel. The oscilloscope is configured as data communications equipment (DCE), and the computer must be configured as data terminal equipment (DTE).

32-C
nector

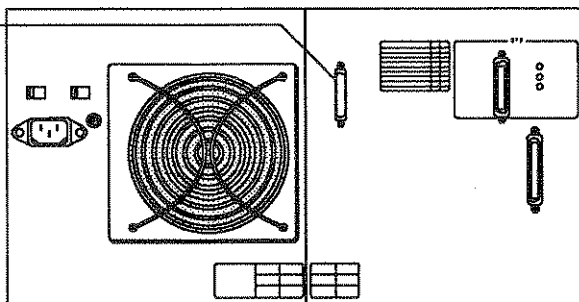

Location of the RS-232-C Connector on the Rear Panel

Setting 32-C eters

Communication between the oscilloscope and the attached computer can occur only if the two are configured in a compatible manner.

Use the **RS232C** pop-up menu in the Utility2 major menu to set the RS-232-C parameters directly, before you attempt to communicate with the attached computer. The following list describes each selector on the RS-232-C pop-up menu:



RS232C Parameters					
Baud Rate	Echo	Stop Bits			
9600Bd	On	2			
Parity	Flagging	Delay			
None	Soft	0			
EOL String	Verbose	Debug			
CR/LF	On	Off			
GPIO	RS232C	Hardcopy		Main Size	
Talk/Listen	9600Bd	Bitmap		5us/div	
1		Screen		Main Pos	
Extended Diagnostic	Self Test		Page to Utility1 Menu	Remove Wfm 1 L1 Main	Panel Zoom off

The RS232C Pop-Up Menu

32-C
 a not
 you
 e the
 ope.

- **Baud Rate** assigns the knobs to adjust baud rate and delay. You can set the baud rate to 110, 150, 300, 600, 1200, 2400, 2400, 4800, 9600, or 19200. You should set the baud rate to match the computer you are using.
- **Echo** lets you set Echo to **On** or **Off**. If you observe two identical characters transmitted when you expect only one, Echo is On when it shouldn't be. If you see no character transmitted when one was expected, Echo might be set to Off inappropriately.
- **Stop Bits** lets you select among 1, 1.5, or 2 stop bits. Touch the selector repeatedly until the appropriate number is shown in the selector. You should set the number of stop bits to match the computer you are using.

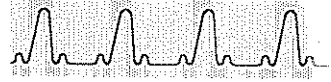

- **Parity** lets you select among **Even** parity, **Odd** parity, or **None**. Touch the selector repeatedly until the appropriate setting is displayed in the selector. Parity is an error detection scheme. You should set parity to match that of the computer you are using.
- **Flagging** lets you select among **Hard** flagging, **Soft** flagging, or **None**. Touch the selector repeatedly until the appropriate setting is displayed in the selector. Flagging is used by the oscilloscope or the computer to signal that its input buffer is full and that the other device should stop transmitting until further notice. You should set the type of flagging to match the computer you are using.
- **Delay** assigns the knobs to set the baud rate and delay. Delay is the minimum time that the oscilloscope will wait before responding to a command sent from the computer. The delay setting can be 0 to 60 seconds.
- **EOL String** lets you select the end-of-line query terminator to one of the following: **LF** (Line Feed), **CR** (Carriage Return), **CR/LF**, or **LF/CR**. Touch the selector repeatedly until the appropriate setting is displayed in the selector.
- **Verbose** lets you set Verbose **On** or **Off**. When Verbose is **On**, the oscilloscope posts to the computer a message stating the success or failure of each command sent to the oscilloscope. When Verbose is **Off**, the computer can specifically query the oscilloscope about the success or failure of each command.
- **Debug** lets you set Debug **On** or **Off**. When Debug is **On**, the oscilloscope displays each command from the computer as it is executed. The messages appear at the top of the display. Debug **Off** is the normal mode of operation. Set Debug **On** if you need to watch the result of each oscilloscope command of a program that is running in the computer. When Debug mode is on it slows performance significantly.

ameters



d Settings



When you initialize the oscilloscope, you recall a stored setting that was established at the factory. You can save your own settings for quick recall.

If you establish a test setup, you might want to store the setting and go to another task. After the settings have been changed because of the intervening work, you could recall the test setting that you saved.

You can also use sequencing to recall saved settings in a specific order. This is useful if your work requires several oscilloscope setups for standardized tests.

Stored settings are saved when you power off the oscilloscope. They will be available when you power on.

The following controls are not saved with stored settings and are not changed when settings are recalled:

- Stored waveforms
- GPIB and RS-232-C parameters
- Sequence settings mode



ings

Use the **Store Setting** pop-up menu in the Store/Recall major menu to store a setting. After you set the oscilloscope, touch the **Store Setting** selector to display the pop-up menu.

Store Present Front Panel Setting (FPS)					
FPS 1		FPS 2			
Test1					
Menu Displayed with Stored Setting					
Waveform		Waveform		Trigger	Measure
Single Wfm		All Wfms			
Store/Recall		Utility1	Utility2	Cursors	
Store Next FPS		Free NonVolatile RAM 100032 bytes		Set Next FPS 5	
Store Waveform	Recall Waveform	Clear Waveform	Delete Waveform	Set Next FPS 5	
				Set Next FPS 5	
Store Setting	Recall Setting	Sequence Settings Recall FPS 1	Delete Setting	Remove Wfm 1 L1 Main	

The Store Setting Pop-Up Menu

You can choose the major menu that will display when the stored setting is recalled. Touch the selector for the desired major menu in the section of the pop-up menu titled **Menu Displayed with Stored Setting**. Each major menu is listed as an option.

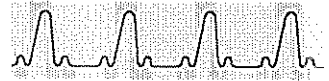

stored
label-
page 93.

After you choose the major menu you want recalled with the stored setting, touch **Store Next FPS** to store the setting. The FPS (Front Panel Setting) number that will be assigned to the setting appears under the label **Set Next FPS**. If you want to specify a number other than the default, you can assign the knobs to set the number by touching **Set Next FPS**. You can choose any number from 1 to 9999. If you choose a number that is already in use, the word "Exists!" appears under the **Store Next FPS** label. If you store the setting under that number the previously stored setting will be deleted.

You can also replace an existing stored setting with the current setting by touching one of the selectors in the top half of the **Store Setting** pop-up menu.

lings
ings

You can recall a stored setting using the **Recall Setting** pop-up menu in the Store/Recall major menu. Touch the **FPS n** selector, where n is the number of the setting you want to recall.

Recall Front Panel Setting (FPS)					
FPS 1					
Initialize Setting					
Store Waveform	Recall Waveform	Clear Waveform	Delete Waveform	Main Size 10µs/div	Main Pos -21.2µs
Store Setting	Recall Setting	Sequence Settings Off	Delete Setting	Remove Wfm 2 L2 Main	Pan/Zoom off

The Recall Setting Pop-Up Menu



The **Recall Setting** pop-up menu also provides a way to initialize the oscilloscope. Touch the **Initialize Setting** selector to reset the oscilloscope in the same way as when you touch the **Initialize** selector in the Utility1 major menu. Initialization is described completely on page 89.

ored tings

Use the **Delete Setting** pop-up menu in the Store/Recall major menu to delete a stored setting. Select the setting or settings to delete by touching the selectors in the top part of the pop-up menu. If more than fifteen settings are stored, **Page↑** and **Page↓** selectors will enable you to scroll through the menu. As you touch these selectors, they highlight to show that they will be deleted when you touch the **Delete Selected Settings** selector. Touch a highlighted selector a second time to remove it from the list of settings to be deleted. The **All Settings** selector is a quick way to select all the stored settings.

Delete Front Panel Setting (FPS)					
FPS 1					
Delete Selected Settings				All Settings	
Store Waveform	Recall Waveform	Clear Waveform	Delete Waveform	Main Size 10 μ s/div	Main Pos -21.2 μ s
Store Setting	Recall Setting	Sequence Settings Off	Delete Setting	Remove Wfm 2 L2 Main	Par/ Zoom off

The Delete Setting Pop-Up Menu

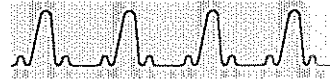

cing
ored
ings

If you have several settings saved, you can cycle through the settings in order. This is useful if you have a series of test setups that you want to use repeatedly.

The sequencing order of stored settings is the same as the order in which they appear in the **Store Setting** pop-up menu. That is, settings will be executed in numerical order.

You can determine the sequencing order of stored settings by choosing the numbers for those settings.

The **Sequence Settings** pop-up menu in the Store/Recall major menu allows you to turn **Sequencing** on or off. The field beneath the **Sequence Settings** label shows the setting that will be recalled next.

Sequence Front Panel Settings

Sequencing
Off

Next Setting Recalled
By Probe ID Button Or
Next Setting

Store Waveform	Recall Waveform	Clear Waveform	Delete Waveform	Main Size 10µs/div	Main Pos -21.2µs
Store Setting	Recall Setting	Sequence Settings Off	Delete Setting	Remove Win 2 L2 Main	Pan/Zoom on

The Sequence Settings Pop-up Menu

When sequencing is on, you can recall the next setting by touching the **Next Setting** selector in the **Sequence Settings** pop-up menu or by pressing a probe ID button.



Stored Waveforms



A stored waveform is a record of an acquired waveform. You can think of it as a “snapshot” of a waveform.

Once you have stored a waveform, you can use it as an element of waveform expressions in other waveforms. For example, you could define a waveform to be L1-STO3. This waveform acquires data from plug-in channel L1 and subtracts from each sample the data recorded in stored waveform number 3.

oring
orms

When you store a waveform, you take a copy of the waveform record of the selected waveform. Use the selectors in the **Store Waveform** pop-up menu of the Store/Recall major menu to store waveforms.

Store Waveform				
Wfm 1	Wfm 2			
L2	L1			
Main	Main			
Store All	Set Next			
	STO			
	3			
Free NonVolatile RAM 110000 bytes				
Store Waveform	Recall Waveform	Clear Waveform	Delete Waveform	Set Next STO 3
				Set Next STO 3
Store Setting	Recall Setting	Sequence Settings Off	Delete Setting	Remove Wfm 2 L1 Main

The Store Waveform Pop-Up Menu



Use the following steps to store a waveform:

- Step 1: Create a stable waveform on the display.
- Step 2: Press the **Store/Recall** major menu button, and touch the **Store Waveform** selector.
- Step 3: The waveform will be stored under the number shown in the **Set Next STO** selector. If you want to change this number, touch the selector and use the knobs to change the number. You cannot store a waveform in a location where another waveform is stored.
- Step 4: Touch the selector that represents the waveform you want to store. All displayed waveforms are listed.

stored
s. See
ing on
ge 93.

You can also use the **Store All** selector to store all the displayed waveforms as separate stored waveforms. In this case, the **Set Next STO** number is the first storage number that will be used.

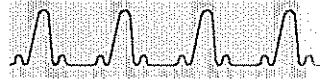

**Time
with
ored
orms**

You can display the time and date that a waveform was stored by selecting **Stored Wfm Time/Date**, in the **Modes** pop-up menu of the Utility1 major menu. The time and date for each stored waveform appears in the waveform selectors. Time and date can be displayed with stored waveforms regardless of whether **Stored Wfm Time/Date** was on when the waveforms were stored.

**Wfm
/Date
ector**

Instrument Modes					
Autoset					
Vertical	Horizontal	Undo Last Autoset			
Pk-Pk	Period				
Miscellaneous					
Multitrace	Pan/Zoom	Enhanced Accuracy Mode			
Pan/Zoom	Pivot	Manual			
Off	Left				
Vectored Waveforms	Waveform Scaling	Stored Wfm Time/Date	Audio Feedback		
On	Optional	Off	On		
Ident	Modes	Presets	Color	Main Size	
				10µs/div	
				Main Pos	
				-21.2µs	
Initialize	Time & Date	Label	Page to Utility2 Menu	Remove Wfm 8 L1 Main	Pan/Zoom off
	10:49:03 12-JAN-89				

The Modes Pop-Up Menu



Using Stored Waveforms

Once a waveform is stored, you can use it in a waveform expression. To create a waveform that displays a stored waveform, touch the **DefWfm** icon, then in the pop-up menu touch the **Stored Waveforms** selector, the selector for the stored waveform you want to display, and the **Enter Desc** selector.

The **Recall Waveform** pop-up menu provides a simpler way to do the same thing. Press the **Store/Recall** major menu button and touch the **Recall Waveform** selector to display the pop-up menu. In the pop-up menu, touch the selector for the stored waveform you want to display.

Recall Stored Waveform					
ST01	ST02	ST03			
Store Waveform	Recall Waveform	Clear Waveform	Delete Waveform	Set Next STO 3	
				Set Next STO 3	
Store Setting	Recall Setting	Sequence Settings Off	Delete Setting	Remove Wfm 1 L1 Main	

The Recall Waveform Pop-Up Menu

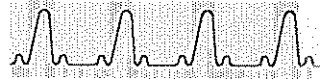
**ored
orms**

You can delete stored waveforms by using the **Delete Waveform** pop-up menu in the Store/Recall major menu. This pop-up menu is also used to delete displayed waveforms.

In the **Delete Waveform** pop-up menu, touch the selectors for the displayed and stored waveforms you want to delete. The waveforms are not deleted until you touch the **Delete Selected Waveforms** selector. You may select several waveforms to be deleted before touching the **Delete Selected Waveforms** selector. As you select waveforms to delete, their selectors highlight to tell you they will be deleted. If you touch a waveform selector by accident, touch it again to remove the highlighting. If you want to delete all the displayed and stored waveforms, touch the **All Waveforms** selector, then touch the **Delete Selected Waveforms** selector.

You cannot delete a stored waveform if it is being used as part of a displayed waveform. In the illustration on the next page, stored waveform 2 is used in the waveform definition of displayed waveform 2. The selector for stored waveform 2 cannot be selected.



Delete Waveforms					
Displayed Waveforms			Stored Waveforms		
Wfm 1	Wfm 2	ST01	ST02	ST035	
L1 Main	ST02				
Delete Selected Waveforms				All Waveforms	
Store Waveform	Recall Waveform	Clear Waveform	Delete Waveform	Hold Mag 1x	Horz Pos Scr
Store Setting	Recall Setting	Sequence Settings Off	Delete Setting	Remove Wfm 2 ST02	Par/Zoom on

The Delete Waveform Pop-Up Menu

and Date



The oscilloscope has an internal clock that keeps track of the time and date. You can set the clock using the **Time & Date** pop-up menu in the Utility1 major menu.

This menu also shows you how many times the oscilloscope has been powered on, and how many hours it has been on.

Time and Date	
Time: 14:50:35	
Date: 24-JAN-89	
Ontime: 85.0hrs	
Powerups: 98 times	
Time	Date
Hours	Month
14	JAN
Minutes	Day
50	24
Seconds	Year
35	89

Ident	Modes	Probes	Color	Main Size	Pan/Zoom
				10 μ s/div	
				Main Pos	
				-21.2 μ s	
Initialize	Time & Date	Label	Page to	Remove Wfm 1	Zoom
	14:50:35 24-JAN-89		Utility2 Menu	L1 Main	off

The Time & Date Pop-Up Menu

When you touch the **Year**, **Month**, **Day**, **Hour**, **Minute**, or **Second** selector, one of the knobs is assigned to set that clock parameter.



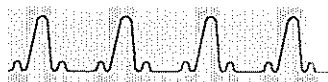

A trigger is an electrical event on which acquisition is based. The trigger event occurs when the trigger *source*, the signal being monitored by the trigger circuits, passes through a specified voltage *level* in the specified direction (the trigger *slope*). This event becomes a reference point when waveform samples are combined into a waveform record. In the absence of a trigger event, the oscilloscope cannot assemble a waveform record and the signal becomes *untriggered*.

The trigger status is shown to the left of the graticule. If the selected waveform is triggered, the status appears as **trig'd**. Otherwise, **!not trig'd** appears. Depending on the trigger *mode*, acquisition may stop when the signal becomes untriggered, leaving the last triggered waveform record frozen on the display. When acquisition continues in the absence of an adequate trigger, acquired samples will be displayed but will not be positioned properly, producing an unstable waveform display.

You can set the trigger signal source to be an input channel, a combination of input channels, or the AC line.

You can also set the trigger *coupling* to selectively pass part or all of the trigger signal to the trigger circuits.

To improve trigger stability, you can adjust the trigger *holdoff*, the period after a trigger event during which triggers are ignored.

Window waveforms are acquired on a separate time base which may be triggered either from the Main trigger or a from a distinct Window trigger. The trigger icon to the left of each graticule shows which trigger applies to the selected waveform on that graticule. The Main trigger icon appears as an arrow over the letter M (\overrightarrow{M}), the Window trigger as an arrow over the letter W (\overrightarrow{W}).

You can assign the knobs to set the trigger level and time holdoff of the selected waveform by touching the trigger icon (\overrightarrow{M} or \overrightarrow{W}). Use the selectors in the Trigger major menu to access all other trigger controls.

more
wave-
forms
see 187.

icon
design
at the
and
doff.



Trigger Selection

Trigger Select selects the Main or Window trigger. Selections you make from the Trigger major menu affect the selected trigger. You can also select the trigger by touching the trigger icon (\overline{M} or \overline{W}).

Source

The **Source Desc** selector displays a pop-up menu that allows you to define the trigger source. You can choose any input channel, combine center and left channels by adding and subtracting them, or select the AC line as the trigger source. Use **Backspace** to correct errors as you type in an expression. Press **Enter Desc** to enter the description and remove the pop-up.

may not be displayed as a Window trigger.

Main Trigger Source Description				
L1	C	R	LINE	
L2				
Enter Desc Back Space Cancel				
Trigger Select	Source Desc	Level	Time Holdoff	Trig Level: M
Main	L1	2.35V	490ns	2.35V
Mode	Coupling	Slope	Window Holdoff Mod	Remove Main Trig
Auto	DC	+	H0: none Trig: Main	L1 Main

The Trigger Major Menu and Source Desc Pop-Up Menu



ling The **Coupling** selector displays a pop-up menu that allows you to specify one of several trigger coupling options.

AC coupling blocks the DC component of the trigger signal. **DC** triggers acquisition when the DC level of the trigger signal reaches the specified trigger level.

AC Low Freq Reject rejects the DC component of the trigger signal and attenuates signals at frequencies below 40 kHz. **AC High Freq Reject** rejects the DC component of the trigger signal and attenuates high-frequency signals above 40 kHz. Select **DC High Freq Reject** to retain the DC component of the trigger signal and attenuate signals above 40 kHz.

AC Noise Reject rejects the DC component of the trigger signal and requires a greater peak-to-peak amplitude to produce a trigger event. Signals below 40 kHz are attenuated. **DC Noise Reject** also requires a greater peak-to-peak signal to produce a trigger event.

Main Trigger Coupling					
AC		DC			
AC Low Freq Reject					
AC High Freq Reject		DC High Freq Reject			
AC Noise Reject		DC Noise Reject			
Trigger Select	Source Desc	Level	Time Holdoff	Trig Level: M	
Main	L1	2.35V	490ns	2.35V	Time Holdoff: M
				490ns	
Mode	Coupling	Slope	Window Holdoff: Md	Remoue Wfm 1	Main Trig
Auto	DC	+	HO: none	L1	
			Trig: Main	Main	

The Coupling Pop-Up Menu



Slope

The **Slope** selector selects between + (a rising slope trigger event) and - (a falling slope trigger event).

Level and Holdoff

The **Level** selector assigns the knobs to set the trigger level (and trigger holdoff). Touching this selector is the same as touching the trigger icon to the left of the graticule.

The **Time Holdoff** selector assigns the knobs to set the trigger holdoff (and trigger level). This is the same as touching the trigger icon. If you have a window time base defined with trigger holdoff by events, this selector will appear as **Events Holdoff** when the window trigger is selected.

The Main time base holdoff can be set to any value from 490 ns to 10 seconds. The range of the Window time base holdoff by time is from 20 ns to the end of the Main record duration. Window time base holdoff by events may be from one to one billion events.

When one of the waveforms on the display matches the trigger signal, the trigger indicator (↗) appears on the waveform to show the trigger level.

Window Trigger

You specify a separate trigger for the Window time base by choosing Window holdoff by time or events. The Window trigger will occur on the Window trigger signal only after a specified amount of time or number of events have elapsed since the Main trigger event. You can specify trigger holdoff on the Main time base by time only.

The **Window Holdoff Md** selector displays a pop-up menu which allows you to select **No Holdoff: Triggered from Main**, to have the window run on the Main time base, **Holdoff by Time: Triggered from Window** to select a Window time base with a trigger time holdoff, or **Holdoff by Events: Triggered from Window** to select a Window time base with trigger holdoff by events.

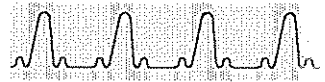

Window Holdoff Mode					
No Holdoff Triggered from Main					
Holdoff by Time Triggered from Window					
Holdoff by Events Triggered from Window					
Trigger Select	Source Desc	Level	Time Holdoff	Trig Level: M	
Main	L1	2.35V	490ns	2.35V	
Mode	Coupling	Slope	Window Holdoff Md	Remove Wfm 1	Main Trig
Auto	DC	+	H0: none Trig: Main	L1 Main	

The Window Holdoff Md Pop-Up Menu

You can specify different trigger sources for the Window trigger and the Main trigger, but you cannot use different trigger sources from the same plug-in. For example, if the Main trigger source is channel L1, you can define the Window trigger source to be L1, or even L1 + C1, but not L1 + L2. If you want to change the source description for both the Main and the Window trigger to L1 + L2, you must first eliminate the separate Window trigger (by setting **Window Holdoff Md** to No Holdoff) so that the trigger sources will not conflict.

A status indicator appears in the lower right corner of the knob menu when the Trigger major menu is displayed. This indicator shows the status of the selected waveform (not the selected trigger) and tells you which trigger applies to that waveform.



Mode

The **Mode** selector displays a pop-up menu which allows you to select **Auto Level**, **Auto**, or **Normal**.

In **Auto Level** mode, the oscilloscope automatically sets the trigger level on a triggering signal. You can change the level within 20% to 80% of the peak-to-peak signal. In the absence of an adequate trigger signal, the oscilloscope will acquire and display waveform samples without reference to a trigger event.

Auto mode is available for the Main trigger only. This mode provides triggered signal acquisition when the trigger level is correctly set and an adequate trigger signal is present. When the trigger signal is inadequate or the level is inappropriate, acquired samples are displayed without reference to a trigger event.

mode
signals
rates
30 Hz.

Normal mode is similar to **Auto** mode, except that acquisition stops when the trigger signal is inadequate or the level setting is inappropriate. When acquisition is stopped, the previously acquired waveform record remains frozen on the display. This mode should be used to acquire signals with repetition rates below 30 Hz.

Trigger Mode					
Auto Level					
Auto					
Normal					
Trigger Select	Source Desc	Level	Time Holdoff	Trig Level: M	
Main	L1	2.35V	490ns	2.35V	
				Time Holdoff: M	
				490ns	
Mode	Coupling	Slope	Window Holdoff Md	Remove Wfm: L1	Main Trig
Auto	DC	+	HO: none Trig: Main	Main	

The Mode Pop-Up Menu

ored Waveforms



Vectored waveforms is a display mode that enhances the appearance of displayed waveforms by eliminating any gaps or discontinuities.

The waveform display area is 512 pixels (dots) wide. When a waveform with a record length of 512 samples is displayed, each sample has its own unique horizontal position on the display. When waveforms with record lengths longer than 512 samples are displayed, two or more samples must share the same horizontal location. For a waveform of 5120 samples, each horizontal place shows the results of ten samples.

When more than one sample share the same horizontal location, the resulting display is always a series of vertical lines, called columns, that extend from the top sample to the bottom sample.

The oscilloscope normally extends the columns to touch adjacent columns, so that no gaps are shown in the waveform. You can turn this waveform vectoring off so that no intermediate data is assumed for display purposes.

Waveform vectoring makes the biggest difference in the appearance of a waveform with 512 samples. As the record length of a waveform increases, the visual enhancement of waveform vectoring becomes less evident.

When you display a 512-sample waveform with waveform vectoring turned off, the individual samples of the waveform appear as dots.

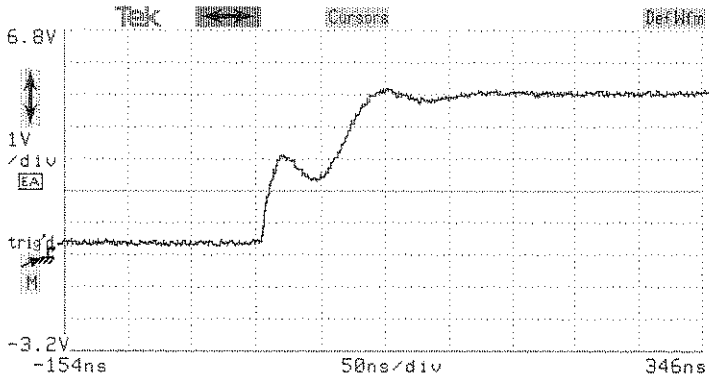
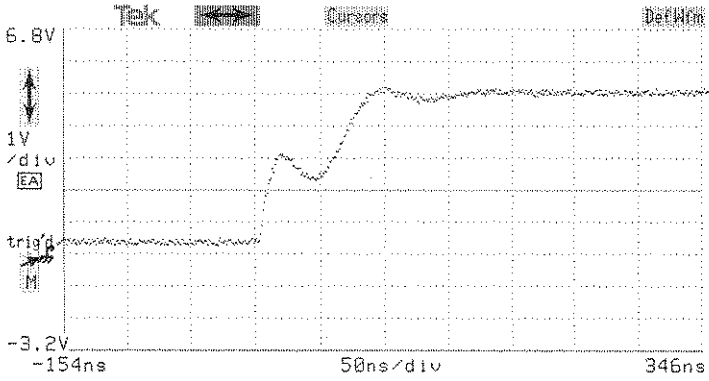

*Identical 512-Point Waveforms without Waveform Vectoring (top)
and with Waveform Vectoring (bottom)*



You turn waveform vectoring on or off using the **Modes** pop-up menu in the Utility1 major menu. Touch the **Vectored Waveforms** selector to set it to **Off** or **On**.

Vectored
Waveforms
Selector

Instrument Modes					
Autoset					
Vertical	Horizontal	Undo Last		Autoset	
Pk-Pk	Period				
Miscellaneous					
Multitrace	Pan/Zoom	Enhanced			
Pan/Zoom	Pivot	Accuracy Mode			
Off	Left	Manual			
Vectored Waveforms	Waveform Scaling	Stored Wfm	Time/Date	Audio Feedback	
On	Optional	Off	Off	On	
Ident	Modes	Probes	Color	Main Size	
				10µs/div	
				Main Pos	
				-21.2µs	
Initialize	Time & Date	Label	Page to	Remove Wfm B	Pan/ Zoom
	10:49:03		Utility2	L1	off
	12-JAN-89		Menu	Main	

The Modes Pop-Up Menu



Vertical Controls

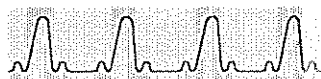

The vertical controls let you set the vertical size and placement of your waveforms. Touch the vertical icon (↕) to access these controls.

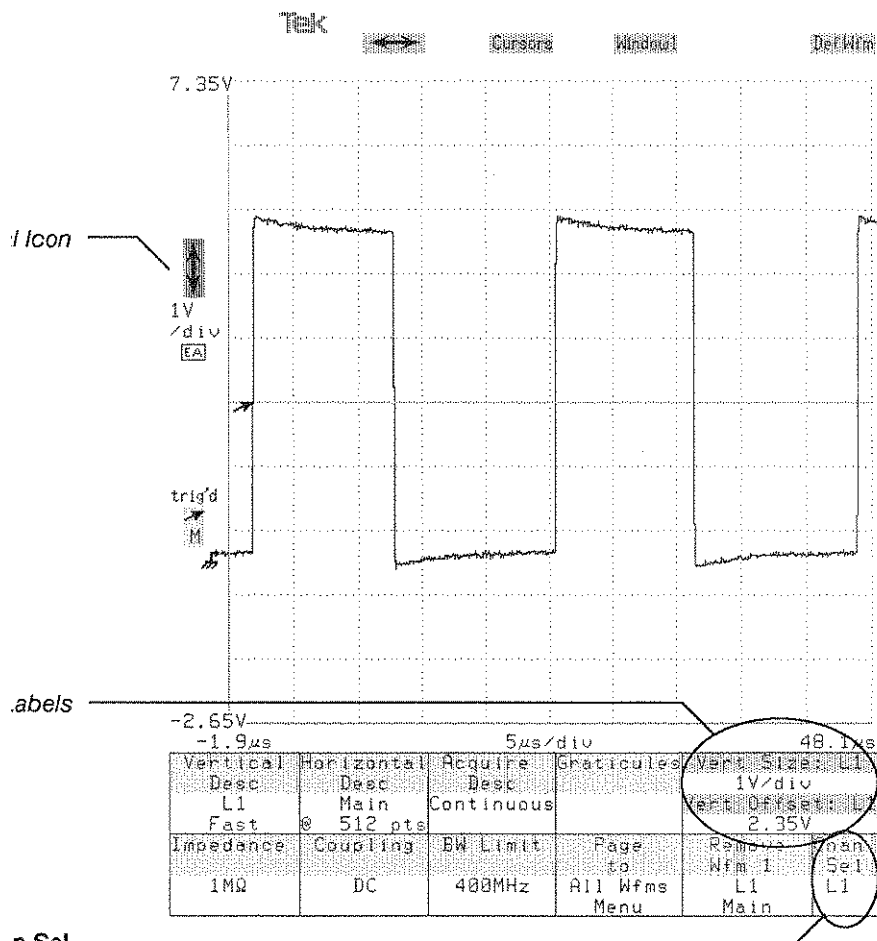

Vertical Controls

Vertical Controls



tical ffset

label
key-
menu.
it ver-
offset
or set
am or
bits. It
et the
ution.

You can change the vertical magnification, or *size*, of a waveform. You can also move the waveform up or down on the display. This is called adjusting the vertical *offset*. To do either, touch the vertical (\updownarrow) icon; this assigns the knobs to adjust the vertical size (top knob) and offset (bottom knob) of a channel of the selected waveform.

If you want to change the size or offset of a different waveform, touch the desired waveform to select it. Then use the knobs to adjust vertical size and offset.

Adjusting Channels and Adjusting Waveforms

When you adjust the vertical size or offset of a waveform, you are adjusting the sensitivity or DC offset of one of the channels that is in the waveform expression. If the waveform you are adjusting has the waveform expression $L1 + L2$, you can adjust the vertical size of only one channel at a time. This has the following side effects:

- Changing the channel size or offset for this waveform changes the channel size or offset for all the other waveforms that display that channel.
- If the waveform you are adjusting has more than one channel in its waveform expression, changing the vertical size of one channel does not change the size of the other channels. If the vertical scale factors of all the channels in a waveform do not match, the vertical size of the waveform is undefined.

For example, in the case of the waveform $L1 + L2$, if $L1$ has a vertical size of 50 mV/div and $L2$ has a vertical size of 100 mV/div, the waveform will have undefined vertical units.

You can select the channel you want to adjust. Whenever the vertical icon (\updownarrow) is highlighted, the lower right corner of the display shows the **Chan Sel** selector. This selector always shows the channel the knobs are set to adjust. You can touch this selector until it shows the channel you want to adjust, then use the knobs to adjust the channel.



Adjusting High Precision Waveforms

High precision waveforms use floating-point arithmetic in their calculation. When the selected waveform is a high precision waveform, you will see **High Prec** in the bottom line of the **Vertical Desc** selector in the **Waveform** major menu.

You can adjust the vertical size and position of high precision waveforms without adjusting a channel.

When you adjust the vertical controls of a high precision waveform, the **Chan Sel** selector at the lower right of the display can be used to specify the individual channel to adjust, and to specify the **Calcd Tra**, or calculated (high precision) waveform. When you specify that you want to adjust the calculated waveform, the knobs adjust the size and position of the waveform without changing the vertical size and position of other waveforms displaying that channel.

Trace Separation

When you adjust the vertical size and offset of a waveform on a Window time base, the **Chan Sel** selector at the lower right of the display can be used to specify the individual channel to adjust, and to specify **Trace Sep Md**, or trace separation mode. This vertical offset control lets you move a window waveform up or down to visually separate it from other window waveforms or from the Main time base waveform.

eform
ie 184
ion of
cision
orms.



Form Definition and gement



Waveforms are the visible representation on the display of the electrical signal, or combination of signals, that the oscilloscope samples and digitizes. You can define and display up to eight waveforms simultaneously.

You define a new waveform on the Main time base by entering a *waveform expression*. A waveform expression is a description of the signal sources and mathematical computation that determines the waveform display. An example of a simple waveform expression is **L1**, which specifies that a waveform should show the signal source of channel 1 in the left plug-in amplifier, with no mathematical computation. The waveform defined by this waveform expression displays the signal that the oscilloscope samples and digitizes from the specified input channel.

An example of a more complex waveform expression is **Log(L1 + L2)**, which specifies that the signals from channels 1 and 2 of the left plug-in amplifier are to be algebraically added, and the base 10 log of the sum is to be shown as the final waveform.



New orms

You can define a new waveform by pressing the appropriate input channel button on an input channel or by using the **DefWfm** icon to enter a waveform expression.

Defining Waveforms Using the Channel Button

e new
a win-
using
1 and
icons,
cribed
) 187.

When you want to define a waveform that represents a single input channel, you can press the **CH n** button, where n is the channel number for that channel. There are two limitations to this method of defining a waveform:

- The channel must not be part of any other waveform being displayed. If the green channel light is on, pressing the **CH n** button removes all waveforms that include that channel as part of their waveform definition.
- The waveform expression will consist only of this channel. You cannot use this method to enter complex waveform expressions.

Defining Waveforms Using the DefWfm Icon

You enter waveform expressions using the **DefWfm** icon. A **DefWfm** icon appears above the top right corner of the graticule or graticules on the display. Touch the **DefWfm** icon above the graticule on which you want to define a new waveform. When you touch the icon, a blank **DefWfm** pop-up menu is displayed. This pop-up menu covers the entire display, as shown on the next page.

Use the selectors of the **DefWfm** pop-up menu to “type” your waveform expression. As you type, the waveform expression you are building appears at the top of the pop-up menu. The **Back Space** selector lets you correct errors as you type. When your waveform expression is complete, touch the **Enter Desc** selector to remove the pop-up menu and create the new waveform.

For example, to enter the expression **Log(L1 + L2)**, touch the following selectors in sequence: **Log**(, **L1**, **+**, **L2**, **)**, **Enter Desc**.

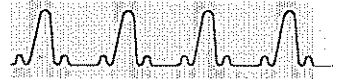

Vertical Description

Waveform being entered

Factors

keypad

Waveform Functions

Stored Waveforms

Waveforms or forms

Factors

Vertical Description						
Log(L1+						
L1	C	R		7	8	9 +
L2				4	5	6 -
				1	2	3 *
				0	-	EEX /
	Abst	Avg()	Diff()	Env()		
Waveform Functions	Exp()	Intgt	Intp()	Ln()		
Stored Waveforms	Log()	Signum()	Smooth()	Sqrt()		
Enter Desc	()	Back Space	Cancel		
Vertical Desc	Horizontal Desc	Acquire Desc	Graticules	Vert Size:	L1	
L1	Main	Continuous		1V/div	L1	
Fast	@ 512 pts			Vert Offset:	L1	
Impedance	Coupling	BW Limit	Page to	Remove	Chan	
1MΩ	DC	400MHz	All Wfms Menu	Wfm 1 L1 Main	Sel L1	

The DefWfm Pop-Up Menu



The selectors presented in the **DefWfm** pop-up menu are grouped into the following categories:

- **Channel Selectors** let you specify an input channel. Channel numbers of installed plug-in units only are displayed.
- **Numeric Keypad** lets you enter a numeric value, or one of the four arithmetic operators +, -, *, and /, as part of your waveform expression.
- **Waveform Functions** let you specify functions, which are listed on the next page. This area of the menu is shared with the stored waveforms selectors described below. If the **Waveform Functions** selector is highlighted, the waveform function selectors are shown. Touch the **Waveform Functions** selector to highlight it if the stored waveforms list is shown.
- **Stored Waveforms** list all the waveforms that have been stored. For a discussion of stored waveforms, see page 153. This area of the menu is shared with the waveform functions selectors described above. If the **Stored Waveforms** selector is highlighted, the stored waveform selectors are shown. Touch the **Stored Waveforms** selector to highlight it if the waveform functions list is shown.

include
waveform
functions and
operators in
waveform
expression.

You can combine Waveform Functions and Stored Waveforms in the same waveform expression by using the **Waveform Functions** and **Stored Waveforms** selectors. The expression **L1-(2*Smooth(STO1,5))** is entered as **L1, -, (, 2, *, Smooth(, Stored Waveforms, STO1, , , 5,) ,) , Enter Desc.**

in func-
tion open-
ings. You
closing
ings to en-
function
ments.

- **Syntax Selectors** let you specify the order of mathematical operations. Each opening parenthesis must be matched with a closing parenthesis. Use the comma (,) selector to separate arguments to functions, like **Smooth(**, that require more than one argument. Use **Back Space** to correct errors as you enter the waveform expression. Always finish your waveform expression by touching the **Enter Desc** selector.

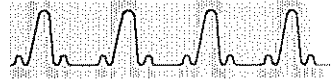

Using Waveform Functions in Waveform Expressions

Waveform functions operate on arguments which are usually channels or waveform expressions. The function is applied to each individual sample of the waveform. The waveform that is displayed results from the function's being applied to each sample.

Waveform Functions NIL

Function	Effect on Arguments
Abs(...)	The absolute value of the argument waveform.
Avg(...)	The average of several waveform record acquisitions of the argument. The number of records acquired is controlled by the knobs after touching the Avg N selector in the Acquire Desc pop-up menu.
Diff(...)	The differential of the argument.
Env(...)	The limit of excursion of several waveform record acquisitions of the argument. The number of records acquired is controlled by the knobs after touching the Env N selector in the Acquire Desc pop-up menu.
Exp(...)	The natural antilog of the argument.
Intg(...)	The integral of the argument.
Intp(...)	Replaces null points within a stored waveform with vertical values equal to the average of the next valid values on each side of the null point.
Ln(...)	The natural logarithm of the argument.
Log(...)	The base 10 logarithm of the argument.

enve-
plied
hat is
d and
ayed.
je 43.

forms
ed on
153.



Waveform Functions NIL

Function	Effect on Arguments
Signum(...)	The sign of the argument. Returns 1 if an argument is greater than zero and -1 if it is less than zero.
Sqrt(...)	The square root of the argument.
Smooth(...)	A moving average of a stored waveform. This function has two arguments, separated by a comma (.). The first is a stored waveform to be smoothed; the second is the number of samples in the moving average. If the second argument is 9, then 4 samples before each point and 4 samples after each point are averaged with the point value. If the second argument is an even number, one is subtracted from it to make it odd.

**form
bers**

When you define a new waveform, it is assigned a waveform number. Waveform numbers range from 1 through 8. New waveforms are assigned the lowest available number. Once a number is assigned to a waveform, the number does not change.



ating
forms

When you define a new waveform, it is the selected waveform and is highlighted.

When multiple waveforms are displayed, there is one selected waveform. The selectors, knobs, and buttons operate on the selected waveform. The graticule axis labels show the vertical and horizontal size and position of the selected waveform. Selectors that show waveform status, such as the **Vertical Desc** and **Horizontal Desc** selectors in the Waveform major menu, show the status of the selected waveform. When you use the horizontal (\leftrightarrow) and vertical (\updownarrow) icons to assign the knobs to adjust horizontal or vertical size and position, the adjustments affect the selected waveform.

When you have more than one waveform on the display, you can select and highlight any waveform. You can select a waveform by touching it on the display or by using the All Wfms Status major menu.

Selecting Waveforms by Touch

The fastest way to select a waveform is to touch it on the display. When you touch the graticule area of the display, a box is displayed that shows the boundaries of your touch. If a single waveform passes through the boxed area when you remove your finger, that waveform will become the selected waveform. The touch box disappears when you remove your finger and select a waveform.

You can drag your finger across the display to change the position of the box before you remove your finger to select the waveform.

If several waveforms pass through the area indicated by the touch box, one becomes the selected waveform when you remove your finger. Touching the same area repeatedly will select different waveforms. You can select waveforms by touching the same spot on the display repeatedly until the waveform you want is selected.



Selecting Waveforms Using the All Wfms Status Menu

You can see the status of all displayed waveforms at once using the All Wfms Status menu. You are shown the waveform number, the first part of the waveform expression, the time base, and the vertical and horizontal size per division.

To view this information, touch the **Page to** selector on the Waveform major menu. The entire Waveform major menu is replaced by the All Wfms Status major menu. The light beside the **WAVEFORM** button remains lighted.

This menu shows one selector for each displayed waveform. You can select any waveform by touching its selector. The selector for the selected waveform is always highlighted. The **Page to** selector restores the regular Waveform major menu.

1: L1 Main 1V 5 μ s	2: L2 Main 1V 5 μ s		
			Page to Waveform Menu

The All Wfms Status Menu

Changing Waveforms

You can change the waveform expression of the selected waveform. When you touch the **Vertical Desc** selector in the Waveform major menu, the **Vertical Desc** pop-up menu is displayed.

This menu is identical to the pop-up menu that is displayed when you touch the **DefWfm** icon. When you display the **Vertical Desc** pop-up menu, the waveform expression of the selected waveform appears at the top of the pop-up menu. You can use the **Back Space** selector to alter the waveform, or you can extend the waveform expression. When you touch the **Enter Desc** selector, the new waveform expression is applied to the selected waveform.

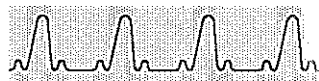

oving
orms

You can remove waveforms from the display in two different ways: using the **Remove Wfm** selector in the knob menu or using the **CH#** button beside the channel input connector.

Removing Waveforms Using the Remove Wfm Selector

The **Remove Wfm** selector in the knob menu always shows the number, the waveform expression, and the time base of the selected waveform. The knob menu is displayed at all times, so the **Remove Wfm** selector is available regardless of the major menu displayed.

When you touch the **Remove Wfm** selector, a small pop-up menu asks you to verify that you want to remove the waveform. This prevents you from removing a waveform accidentally.

Main Size	
5 μ s/div	
Main Pos	
-2.5 μ s	
Remove	Par/ Zoom
Wfm 2	off
L2	
Main	

The Remove Wfm Selector in the Knob Menu

Removing Waveforms Using the Channel Button

You can use the **CH#** button beside the input connector to remove all waveforms that display that channel as part of the waveform expression.

When an input channel is incorporated as part of the selected waveform, the green channel light beside the input connector turns on. If you press the channel button when the light is on, *all* waveforms displaying that channel are removed.



orm aling

When you define a new waveform, it is defined either as a fast waveform or a high precision waveform. Fast waveforms are computed with integer arithmetic and operate significantly faster than high precision waveforms. High precision waveforms use floating-point arithmetic to provide highest precision and accuracy.

Normally, the waveform is defined to be fast unless some part of the waveform expression forces high precision. Floating-point functions such as **Diff()** and **Log()** will force the waveform to be defined as high precision.

You can force waveforms to be defined as high precision waveforms by using the **Modes** pop-up menu in the Utility1 major menu. In this pop-up menu, the **Waveform Scaling** selector can be set to **Optional** or **Forced**. When **Waveform Scaling** is set to optional, new waveforms are defined as fast waveforms if they can be implemented as fast waveforms. When **Waveform Scaling** is set to forced, all new waveforms are defined as high precision waveforms.

Once a waveform is defined, its waveform scaling cannot be changed. The setting of the **Waveform Scaling** selector affects only the definition of new waveforms.

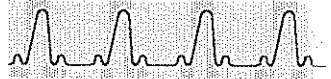

Scaling
lector

Instrument Modes					
Autoset					
Vertical	Horizontal	Undo Last Autoset			
Pk-Pk	Period				
Miscellaneous					
Multitrace	Pan/Zoom	Enhanced			
Pan/Zoom	Pivot	Accuracy Mode			
Off	Left	Manual			
Vectorized	Waveform	Stored Wfm	Audio		
Waveforms	Scaling	Time/Date	Feedback		
On	Optional	Off	On		
Ident	Modes	Probes	Color	Main Size	
				10 μ s/div	
				Main Pos	
				-21.2 μ s	
Initialize	Time & Date	Label	Page to	Remove Wfm	Pan/Zoom
	10:49:03		Utility2	8	off
	12-JAN-89		Menu	L1	
				Main	

The Modes Pop-Up Menu



DWS



A window waveform is a waveform that represents a horizontally magnified portion of another waveform. A window waveform is acquired separately from the main waveform that it magnifies.

Creating a Window

You create a window by touching the **Window1** icon above the graticule. When you touch the **Window1** icon, the oscilloscope creates a second graticule to show the window waveform. If a second graticule already exists, the window waveform will be displayed on the lower graticule.

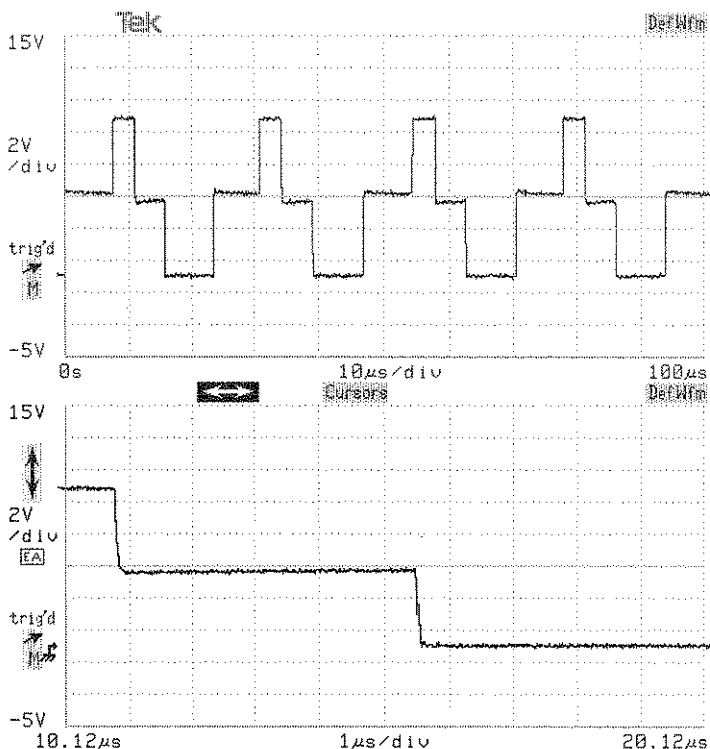
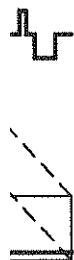

A Window Waveform Display



When you create a window waveform, it becomes the selected waveform. The oscilloscope shows this waveform in the selected window waveform color and highlights the windowed portion of the main waveform in this color.

Time and Trigger

The window waveform has the same waveform expression as the main waveform. The difference between the two is the time base that each uses; the main waveform uses the Main time base, while the window waveform uses a Window time base. The **Horizontal Desc** selector in the Waveform major menu always shows the time base of the selected waveform.

For more information on triggering, see page 161.

The Window time base can be triggered from the Main trigger or by a separate Window trigger. To define a window trigger, set **Trigger Select** in the Trigger major menu to **Window** and set **Window Holdoff Md** to either **Holdoff by Time: Triggered from Window** or **Holdoff by Events: Triggered from Window**. You can then set the Window trigger source, level, and holdoff just as you set the Main trigger. If you define a Window trigger, the Window trigger icon () will appear to the left of the graticule when a window waveform is selected and a second trigger arrow may appear on the main waveform.

For more information on record length, see page 139.

You can set the record length for window waveforms by touching the **Window Record Length** selector in the **Horizontal Desc** pop-up menu. The knobs will be assigned to adjust **Main Record Length** and **Window Record Length**.

The window waveform is independent of the main waveform. Once a window waveform is established, you can remove the main waveform or move the window waveform from graticule to graticule.

Creating a Second Window

You can create two window waveforms from each main waveform. After you create one window waveform, the **Window2** icon becomes available when the main waveform is selected. Touching this icon creates a second window waveform. Once a window waveform is created, touching the **Window1** or **Window2** icon simply selects that waveform. You cannot create a window waveform of a window waveform.

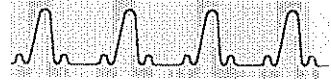

Windowing Size and Position

You can change the size and position of a window waveform just as you do with any main waveform. Touch the horizontal icon (\leftrightarrow) to assign the knobs to horizontal size and position. Complete information about horizontal size and position is on page 83.

Waveform same as if you zoom horizontally, you zoom horizontally.

All main waveforms share the same time base, so all have the same horizontal size and position. Each window waveform has its own time base, so each can have a different horizontal position. However, all window time bases have the same horizontal size. When you touch the horizontal icon (\leftrightarrow), the knobs are assigned to **Window Size** and **Window1 Position** or **Window2 Position**. The window size must be no greater than the main horizontal size.

As you change the horizontal size or position of a window waveform, the highlighted portion of the main waveform changes size and position. This allows you to always see the portion of the main waveform that the window waveform magnifies.

Trace Separation

When you touch the vertical icon (\updownarrow), the **Chan Sel** selector will indicate **Trc Sep Md**, or trace separation mode. In trace separation mode, the knobs are labeled **Trace Sep** and move the selected waveform up or down without moving other waveforms that show the same channels as the selected waveform. The offset of the plug-in channel is not changed. This lets you visually separate the selected window waveform from other window or main waveforms that may overlap it.

When you have used trace separation mode to move a window waveform, the graticule labels and ground reference indicator always apply to the selected window waveform.

You can use the **Chan Sel** selector to select a channel, and then adjust the vertical size or offset just as you would with any main waveform. Touch the **Chan Sel** selector until it indicates the channel you want. Complete information about vertical size and offset is on page 171.



waveforms



Most waveforms show a signal voltage (the vertical axis) as it varies over time (the horizontal axis). You can display a waveform that compares the amplitudes of two waveforms, independent of time. Such an XY waveform shows the signal voltage of one waveform on one axis against the signal voltage of the other waveform on the other axis.

It takes
a pair of XY
waveforms.

Two actively
wave-
formed XY
waveforms may
be displayed at
one time.

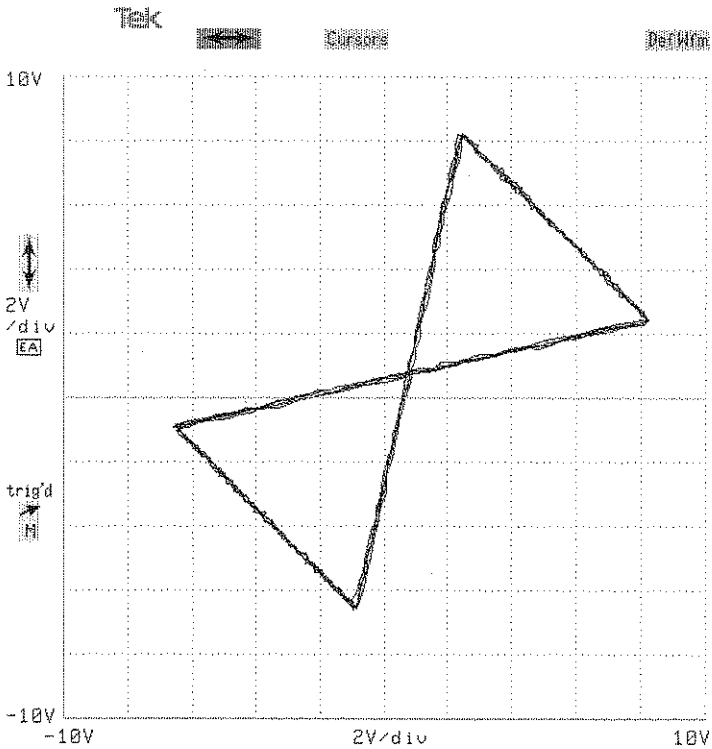

An XY Waveform

Two high-precision
waveforms are
displayed on
screen 184.

You can create an XY waveform to compare the amplitudes of two high-precision waveforms, or of two fast waveforms, but cannot combine a fast waveform with a high-precision waveform.



n XY
form

You initiate and control an XY waveform using the **Horizontal Desc** pop-up menu in the Waveform major menu. Two sections of the menu are titled **XY Display Mode**, one for displayed waveforms and one for stored waveforms.

Horizontal Description					
Acquiring Timebase: Main					
Main Sample Interval: 50ns/point					
Window Sample Interval: 50ns/point					
Main Record Length		Window Record Length			
1024 points		1024 points			
YT Display Mode					
Normal		Point Accumulate			
XY Display Mode: X=Displayed Waveform					
Wfm 1					
L1					
Main					
XY Display Mode: X=Stored Waveform					
Vertical Desc	Horizontal Desc	Acquire Desc	Graticules	Main Record Len	
L1	Main	Continuous		1024	
Fast	@ 1024 pts			Window Record Len	
				1024	
Impedance	Coupling	BW Limit	Page to	Remove Wfm 1	
1MΩ	DC	400MHz	All Wfms Menu	L1	
				Main	

reformation

The Horizontal Desc Pop-Up Menu

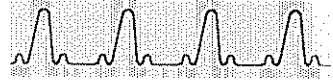

The sequence to follow when creating an XY waveform is:

- Step 1: Define a waveform that shows the information you want on the X axis (the horizontal axis). This waveform may be a displayed waveform or a stored waveform.
- Step 2: Define and display a waveform with the information you want on the Y axis (the vertical axis).
- Step 3: Touch or otherwise select the waveform that displays the Y-axis information.
- Step 4: Press the **WAVEFORM** major menu button, and touch the **Horizontal Desc** selector to display the pop-up menu.
- Step 5: Touch the selector in the **Horizontal Desc** pop-up menu that represents the waveform showing the X-axis information. If the X-axis waveform is a displayed waveform, it will appear in the section titled **XY Display Mode: X=Acquired Waveform**. If the X-axis waveform is a stored waveform, it will appear in the section titled **XY Display Mode: X=Stored Waveform**.

When you touch the X-axis waveform selector in the **Horizontal Desc** pop-up menu, the selected waveform is immediately converted into an XY waveform on the display. The waveform description of the X-axis waveform appears in the **Horizontal Desc** selector, and the waveform description of the Y-axis waveform appears in the **Vertical Desc** selector.

If the waveform defining the X-axis information is a displayed waveform, this process will leave two waveforms on the display: the XY waveform and the X-axis information waveform. Once the XY waveform is established, you can remove the waveform displaying the X-axis information.



To restore an XY waveform to normal Yt (voltage versus time) mode, select the XY waveform and touch the **Normal YT** selector in the **Horizontal Desc** pop-up menu.



Size ition

You can adjust the vertical and horizontal size and position of an XY waveform.

Touch the vertical icon (\updownarrow) to adjust the vertical size and position of the XY waveform. The knobs will be assigned to adjust **Vert Size** and **Vert Offset** of a channel that is displayed as part of the vertical axis description of the XY waveform. If the vertical axis description includes more than one channel, you can select and adjust the channels separately by touching the **Chan Sel** selector. The selected channel appears in the **Chan Sel** selector and in the knob labels.

Touch the horizontal icon (\leftrightarrow) to assign the knobs to adjust the horizontal size and position of the XY waveform. Since voltage information is displayed along the horizontal axis, horizontal position is controlled by adjusting the vertical size and offset of the channel(s) of the X-axis waveform. The knob labels will display **Horz Pos XY** and **Horz Size XY**, and the channel controlled by the knobs will appear in the **Chan Sel** selector. If more than one channel is displayed along the X axis, use the **Chan Sel** selector to select each displayed channel.



When you adjust the horizontal or vertical size and position of an XY waveform that displays stored waveform information, the **Chan Sel** selector displays **Calcd Tra**, and adjusting the size and position scales the waveform.



Index A: Accessories



Standard Accessories

The 11402A and 11403 Oscilloscope packages include the following standard accessories:

- The *11402A and 11403 Tutorial* (Tektronix part number 070-7418-01) gives step-by-step instructions that demonstrate basic operation of the oscilloscope.
- The *11402A and 11403 QuickStart Package* (U.S.A. Tektronix part number 020-1767-01, Europe 020-1768-01) is a complete learning laboratory, including a signal generating board and a workbook. A videotape for the QuickStart Package is included with your oscilloscope. These show you how to use the power of the 11402A or 11403 Oscilloscope to get the types of measurements you need. The QuickStart Package is available at no charge, but you need to mail in the postage-paid card included with the oscilloscope.
- The *11402A and 11403 Programmer Reference* (Tektronix part number 070-7420-01) describes using a computer to control the oscilloscope through GPIB or RS-232-C interfaces.
- The *11201A/11402A/11403 Command Reference* (Tektronix part number 070-7421-01) describes the commands used to program the oscilloscope.
- The *11201A/11402A/11403 Quick Reference* (Tektronix part number 070-7734-01) provides an index of operations, and the front-panel steps to invoke each operation.
- The *11402A and 11403 Service Reference* (Tektronix part number 070-7422-01) provides information to repair and replace components of the oscilloscope.
- Power Cord (North American 120 V), Tektronix part number 161-0066-00.

place-
er to a
oducts
ontact
ktronix
itative.



Optional Accessories

The following optional accessories have been selected from our catalog specifically for the 11402A and 11403 Oscilloscopes. For detailed information and prices, see a Tektronix products catalog or contact your local Tektronix field representative.

- Option 1R, Rack Mount—converts the 11402A or 11403 Oscilloscope for rack mounting.
- Option 2D, Memory Expansion—adds 768 kBytes of non-volatile memory to expand the waveform and settings memory.
- Option 1C, Loop-through BNC Connectors—adds eight BNC connectors to the front and rear panels of the oscilloscope so that signals may be routed from the front panel to the rear panel (or rear to front).
- Option 4D, DMA Controller—adds a DMA controller to the main processor system. GPIB data transfer is increased to 100 kBytes/second and the speed of other internal operations is increased.
- Two-meter GPIB cable, Tektronix part number 012-0991-00.
- Ten-foot RS-232-C cable, Tektronix part number 012-0911-00.
- Ten-foot Centronics-compatible printer cable, Tektronix part number 012-0555-00.
- Tektronix Lab Cart, Model K217.
- Tektronix 4696 Color Printer.
- Tektronix 4693D Color Printer.
- Tektronix HC100 Color Plotter.

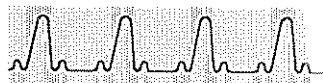

Power Cords

The following power cords are available for the 11402A and 11403 Oscilloscopes.

- Option A1 Universal European 220 V/6 A, 50 Hz, Tektronix part number 161-0066-09.
- Option A2 United Kingdom 240 V/6 A, 50 Hz, Tektronix part number 161-0066-10.
- Option A3 Australian 240 V/6 A, 50 Hz, Tektronix part number 161-0066-11.
- Option A4 North American 250 V/10 A, 60 Hz, Tektronix part number 161-0066-12.
- Option A5 Switzerland 240 V/6A, 50 Hz, Tektronix part number 161-0154-00.



C

C

C

Index B: Specifications



The electrical characteristics apply to the following conditions:

- The oscilloscope has had a 20-minute warm-up period.
- The oscilloscope is operating in an environment that meets the limits described in Environmental Specifications in this section.

Vertical System Specifications

Characteristic	Specifications
Input sources	3 plug-in amplifiers, up to 12 channels
Bandwidth	Dependent on plug-in amplifier
Rise time	Dependent on plug-in amplifier
Vertical resolution	10 bits. Signal averaging of N acquisitions increases bit resolution by $\log_2(N)$ up to a limit of 14 bits
Input sensitivity	Dependent on plug-in amplifier
Vertical acquisition resolution	
Single graticule	100 points/div
Dual graticule	100 points/div
Vertical display resolution	
Single graticule	50 pixels/div
Dual graticule	25 pixels/div



Time Base Specifications

Characteristic	Specification
Internal reference clock	Crystal-controlled reference oscillator.
Time interval accuracy with acquired waveforms	0.002% \pm 100 ps
Sample rate	
Single channel	Any single channel from the Left, Center, or Right plug-in compartment may be acquired at up to 20 Msample/s
Two channel	Any combination of two channels from different plug-in compartments may be acquired at up to 5 Msample/s
Three channel	Any combination of three channels from different plug-in compartments may be acquired at up to 2.5 Msample/s
Record Length	User selectable, 512, 1024, 2048, 4096, 5120, 8192, or 10240 points
Sweep rate resolution	1-2-5 steps from 0.5 ns to 100 s
Record duration	5.11 ns to 1023 s

*Input and Output Specifications*

Characteristic	Specification
Touch panel	Infrared beam touchable array, 22 rows of 11 columns
Knobs	2 general-purpose knobs, set by user to desired function
Calibrator	Active only during Probe Calibration
Output Voltage	Suitable for calibration DC gain of 10X probes at ≤ 5 V/div at the probe tip



Trigger Specifications

Characteristic	Specification
Trigger source	Two independent trigger circuits (Main and Window) can derive triggers from the Left, Center, and Right plug-in compartments. Main time base may also be triggered from the AC line.
Trigger mode	
Auto	Free runs after 60 ms timeout with no trigger detected (Main trigger only)
Auto Level	Automatically establishes a level for the trigger source; seeks new level after 60 ms timeout. Main free runs in absence of signal
Normal	Triggering occurs only after valid triggering event
Trigger level	Can be set independently for Main and Window trigger circuits.
Trigger level resolution	0.1% of full scale
Minimum holdoff	
Main	500 ns or less
Window	20 ns or less
Maximum holdoff	
Main	10 s
Window	1024 s



Trigger Specifications (Cont.)

Characteristic	Specification
Main Trigger sensitivity DC Coupled	0.5 divisions from DC to 50 MHz; 1.5 divisions from 50 MHz to 1 GHz with minimum holdoff
DC Noise-Reject Coupled	1.2 divisions from DC to 50 MHz; 3 divisions from 50 MHz to 1 GHz with minimum holdoff
DC High-Freq. Reject Coupled	0.65 divisions from DC to 30 kHz
AC coupled	0.5 divisions from 60 Hz to 50 MHz; 1.5 divisions from 50 MHz to 1 GHz with minimum holdoff. Attenuates signals below 60 Hz
AC Noise-Reject Coupled	1.2 divisions from 60 Hz to 50 MHz; 3 divisions from 50 MHz to 1 GHz with minimum holdoff
AC High-Freq. Reject Coupled	0.65 divisions from 60 Hz to 30 kHz
AC Low-Freq. Reject Coupled	0.65 divisions from 80 kHz to 50 MHz; 1.5 divisions from 50 MHz to 1 GHz with minimum holdoff.



Trigger Specifications (Cont.)

Characteristic	Specification
Window Trigger sensitivity DC Coupled	0.5 divisions from DC to 50 MHz; 1.5 divisions from 50 MHz to 500 MHz with minimum holdoff
DC Noise-Reject Coupled	1.2 divisions from DC to 50 MHz; 3 divisions from 50 MHz to 500 MHz with minimum holdoff
DC High-Freq. Reject Coupled	0.65 divisions from DC to 30 kHz
AC coupled	0.5 divisions from 60 Hz to 50 MHz; 1.5 divisions from 50 MHz to 500 MHz with minimum holdoff. Attenuates signals below 60 Hz
AC Noise-Reject Coupled	1.2 divisions from 60 Hz to 50 MHz; 3 divisions from 50 MHz to 500 MHz with minimum holdoff
AC High-Freq. Reject Coupled	0.65 divisions from 60 Hz to 30 kHz
AC Low-Freq. Reject Coupled	0.65 divisions from 80 kHz to 50 MHz; 1.5 divisions from 50 MHz to 500 MHz with minimum holdoff.

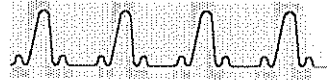

Display Specifications

Characteristic	Specification
CRT	
11403	8 1/2 inch diagonal, color, magnetic deflection. Vertical raster orientation. Nominal screen size 6.087 inches vertical by 4.496 inches horizontal
11402A	9 inch diagonal, monochrome, magnetic deflection. Vertical raster orientation. Nominal screen size 6.16 inches vertical by 4.80 inches horizontal
Character display	44 lines of 55 characters
Character height	Minimum 0.10 in (upper case)

AC Line Power Specifications

Characteristic	Specification
Voltage Ranges	90 to 132 V rms or 180 to 250 V rms Selected by rear panel Line Voltage Selector. Voltage ranges apply for waveform distortion, which reduces peak line voltage 5% or less
Frequency	48 Hz to 440 Hz
Power consumption	320 W maximum
Maximum Line Current	4.6 A rms at 50 Hz, 90 V line, with 5% clipping.
Fuse Rating	6 A, 250 V, normal blow



Environmental Specifications

Characteristic	Specification
Temperature	Meets MIL-T-28800C, Type III, Class 5, tested per paragraphs 4.5.5.1.3 and 4.5.5.1.4
Operating	0°C to 50°C
Non-operating	-40°C to +75°C (Possible loss of nonvolatile memory and clock information below -40°C)
Humidity	Exceeds MIL-T-28800C, Type III, Class 5, tested per paragraph 4.5.5.1.2.2 Up to 95% relative humidity, at up to 50°C
Altitude	Meets MIL-T-28800C, Type III, Class 5
Operating	Up to 4.5km (15,000 ft)
Non-operating	Up to 15km (50,000 ft)
Vibration	Operating, plug-in units not installed: meets MIL-T-28800C, Section 4.5.5.3.1, Type III, Class 5
Shock	Non-operating, plug-in units not installed: meets MIL-T-28800C, Section 4.5.5.4.1, Type III, Class 5, Equipment not operating
Bench handling	Operating: meets MIL-T-28800C, Type III, Section 4.5.5.4.3, Class 5



Environmental Specifications (Cont.)

Characteristic	Specification
Packaged product vibration and bounce	Packaged product, plug-in units not installed: meets ASTM D995-75, Method A, Para 5 (NSTA Proj. 1A-B-1)
Drop of packaged product	Packaged product, plug-in units not installed: meets ASTM D775-61, Method 1, Para 5 (NSTA Proj. 1A-B-2)
Electrostatic immunity	No disruption or degradation of performance from electrostatic discharge common in the office/laboratory environment
Electromagnetic compatibility	Plug-in units or blank panels must be installed in all plug-in compartments



Index C:

y

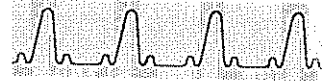

The following safety information applies to all operators and service personnel.

Terms in Manuals

CAUTION statements identify conditions or practices that could result in damage to the equipment or other property.

WARNING statements identify conditions or practices that could result in personal injury or loss of life.

Terms on Equipment

CAUTION indicates a personal injury hazard not immediately accessible as one reads the marking, or a hazard to property including the equipment itself.

DANGER indicates a personal injury hazard immediately accessible as one reads the marking.

Symbols in Manuals



Static Sensitive Devices

Symbols on Equipment



DANGER
High Voltage



*Protective
ground (earth)
terminal*



ATTENTION
*Refer to
manual*



Power Source

This product is intended to operate from a power source that will not apply more than 250 V rms between the supply conductors or between either supply conductor and ground.

Grounding the Oscilloscope

The oscilloscope is grounded through the power cord. To avoid electric shock, plug the power cord into a properly wired receptacle where earth ground has been verified by a qualified service person. Do this before making connections to the input or output terminals of the oscilloscope.

Without the protective ground, all parts of the oscilloscope are shock hazards. This includes knobs and controls that may appear to be insulators.

Use the Proper Fuse

Using an improper fuse can create a fire hazard. Always use fuses that exactly meet the specifications in the parts list. Match fuse type, voltage rating, and current rating.

Do Not Remove Covers or Panels

To avoid personal injury, do not operate this oscilloscope without the panels or covers.

Do Not Operate in Explosive Atmospheres

The oscilloscope provides no explosion protection from static discharges or arcing components. Do not operate the oscilloscope in an atmosphere of explosive gases.

Electrostatic Discharge

Never apply a voltage to a plug-in that is outside the range printed on the plug-in front panel. Operate the oscilloscope only in a static-controlled environment.

CAUTION
Do not operate the oscilloscope without the covers or panels. The covers or panels may be hot from the heat of the oscilloscope.

CAUTION
Do not apply a voltage to a plug-in that is outside the range printed on the plug-in front panel. Operating the oscilloscope in a static-controlled environment is also a hazard.

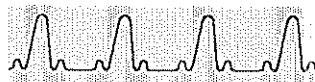
**ig for
ment**

If you ship the oscilloscope, pack it in the original shipping carton and packing material. If the original packing material is unavailable, package the oscilloscope as follows:

- Step 1: Obtain a corrugated cardboard shipping carton with inside dimensions at least 15 cm (6 in) taller, wider, and deeper than the oscilloscope. The shipping carton must be constructed of cardboard with 375 pound test strength.
- Step 2: If you are shipping the oscilloscope to a Tektronix field office for repair, attach a tag to the oscilloscope showing the oscilloscope owner and address, the name of the person to contact about the oscilloscope, the oscilloscope type, and the serial number.
- Step 3: Wrap the oscilloscope with polyethylene sheeting or equivalent material to protect the finish.
- Step 4: Cushion the oscilloscope on all sides by tightly packing dunnage or urethane foam between the carton and the oscilloscope, allowing 7.5 cm (3 in) on each side.
- Step 5: Seal the carton with shipping tape or an industrial stapler.



Index D: ithms

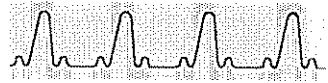

Digitized waveforms are a sequence of samples stored as 16-bit signed integers. The samples are numbered from 0 through the waveform record length less one; a 512-point waveform record numbers samples from 0 through 511.

Three sample values represent invalid data points:

- The value $-32,768$ (hexidecimal 8000) represents *null*, an unacquired data point. A waveform that is defined but has never been acquired contains null values. Clearing a waveform fills it with null values.
- The value $-32,767$ (hexidecimal 8001) represents a data value below the dynamic range of the digitizer. This is called *underrange*. Underrange values do not appear on a displayed waveform.
- The value $+32,767$ (hexidecimal 7FFF) represents a data value above the dynamic range of the digitizer. This is called *overrange*. Overage values do not appear on a displayed waveform.

When a waveform function encounters one of these three data values, it passes the invalid data value as its output. When a measurement encounters one of these three data values, the measurement is qualified by \leq , \geq , or is noted as an error. There are exceptions to these rules, which are noted in the following algorithm descriptions. All waveform functions assume that the waveform record contains data other than these three values, unless specifically noted.



form tions

Absolute Value

$$Abs(n) = W(n)$$

for $W(n) \geq 0$

$$Abs(n) = -W(n)$$

for $W(n) < 0$

where:

n = index into the record of data points

$W(n)$ = input sampled data point

Average

$$Avg_p(n) = W(n)$$

for $p = 1$

$$Avg_p(n) = Avg_{p-1}(n) + \frac{W(n) - Avg_{p-1}(n)}{2^{INT(\log_2(p/\log_e 2))}}$$

for $1 < p < P$

$$Avg_p(n) = Avg_{p-1}(n) + \frac{W(n) - Avg_{p-1}(n)}{P}$$

for $p \geq P$

where:

n = index into record of data points

$W(n)$ = input sampled data point

p = record number

P = total number of records specified for average

INT = integer part of

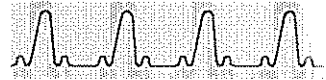

Differentiate

$$Diff(n) = [W(1) - W(0)]/T$$

for $n = 0$

$$Diff(n) = [W(n + 1) - W(n - 1)]/(2T)$$

for $1 \leq n \leq (R - 1)$

$$Diff(R - 1) = [W(R - 1) - W(R - 2)]/T$$

for $n = R - 1$

where:

n = index into the record of data points

$W(n)$ = input sampled data point

T = time interval between successive samples

R = record length

Envelope

$$Env_p(n) = W(n)$$

for $p = 1$

$$Env_p(n) = \text{Minimum of } [Env_{p-1}(n), W(n), W(n + 1)]$$

for $p > 1$ and n even(2, 4, 6, ..., $R - 1$)

$$Env_p(n) = \text{Maximum of } [Env_{p-1}(n), W(n - 1), W(n)]$$

for $p > 1$ and n odd(1, 3, 5, ..., $R - 2$)

where:

n = index into record of data points

$W(n)$ = input sampled data point

p = record number

R = record length

P , the total number of records specified for enveloping, is used only to determine completion for conditional acquisition when acquisition is stopped on envelope complete.



Exponential

$$Exp(n) = e^{W(n)}$$

where:

n = index into record of data points

$W(n)$ = input sampled data point

This function is implemented by the 80287 math coprocessor and supporting routines.

Integrate

$$Intg(n) = 0$$

for $n = 0$

$$Intg(n) = \left[1/2 W(0) + \sum_{m=1}^{n-1} W(m) + 1/2 W(n) \right] \times T$$

for $1 \leq n \leq R$

where:

n = index into record of data points

$W(n)$ = input sampled data point

T = time interval between successive samples

R = record length in points



Interpolate

$$Intp(n) = W(l) + \left[\frac{W(r) - W(l)}{r - l} \right] \times (n - l)$$

for all n ; $l \geq 0$ and $r \leq R - 1$

$$Intp(n) = W(r)$$

for all n ; $l < 0$ and $r \leq R - 1$

$$Intp(n) = W(l)$$

for all n ; $l \geq 0$ and $r > R - 1$

$$Intp(n) = W(n)$$

otherwise

where

n = index into record of data points

$W(n)$ = input sampled data point

R = record length in points

l = index of the acquired data point preceding the unacquired data

r = index of the acquired data point following the unacquired data

Logarithm

$$Log(n) = \log_{10} W(n)$$

where:

n = index into record of data points

$W(n)$ = input sampled data point

This function is implemented by the 80287 math coprocessor and supporting routines.



Natural Logarithm

$$\text{Ln}(n) = \log_e W(n)$$

where:

n = index into record of data points

$W(n)$ = input sampled data point

This function is implemented by the 80287 math coprocessor and supporting routines.

Signum

$$\text{Signum}(n) = 1$$

for $W(n) > 0$

$$\text{Signum}(n) = 0$$

for $W(n) = 0$

$$\text{Signum}(n) = -1$$

for $W(n) < 0$

where:

n = index into record of data points

$W(n)$ = input sampled data point



Smooth

$$\text{Smooth}(n) = (1/s) \left[\sum_{m=0}^{n+h} W(m) + (h-n) \times W(0) \right]$$

for $n < h$

$$\text{Smooth}(n) = (1/s) \left[\sum_{m=n-h}^{n+h} W(m) \right]$$

for $h \leq n \leq R-1-h$

$$\text{Smooth}(n) = (1/s) \left[\sum_{m=n-h}^{R-1} W(m) + (R-1-n) \times W(R-1) \right]$$

for $n > R-1-h$

where:

n = index into record of data points

$W(n)$ = waveform record point with index n

s = smoothing interval in samples; the second argument

h = half interval: $(s-1)/2$ rounded up

R = record length in points

The smoothed waveform is derived by computing the average value of the corresponding point of the original waveform and some number of points of the original waveform on either side of the corresponding point. The number of points on either side is derived from the smoothing interval, the second argument of the Smooth function. The Smooth function can be performed on stored waveforms only.

Near the ends of the waveform, nonexistent points beyond the ends of the waveform are required for averaging. The nonexistent points are assumed to be the value of the corresponding end points. This method of extending the waveform is arbitrary, so the results within a smoothing interval of the ends of the waveform must be interpreted accordingly.



Square Root

$$\text{Sqrt}(n) = W(n)^{1/2}$$

where:

n = index into record of data points

$W(n)$ = input sampled data point

This function is implemented by the 80287 math coprocessor and supporting routines.

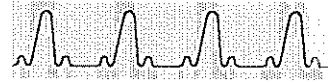

ients

Measurements are taken using the measurement parameters. You can directly set many the measurement parameters, or you can specify that some are to be determined automatically by the oscilloscope. It is common to have the oscilloscope dynamically measure topline and baseline.

You specify automatic topline and baseline positioning by turning tracking to Both in the individual measurement pop-up menus. The mesial level, once the topline and baseline values have been determined, is calculated:

$$mesial = [(m\%/100) \times (topline - baseline)] + baseline$$

where $m\%$ is the percentage of topline to baseline height to use for mesial level. Proximal and distal levels are calculated similarly from percentage levels. These percentage levels are set using the knobs.

When you use tracking, the topline and baseline are determined from a histogram of the waveform, as follows:

1. Create a histogram of the waveform data points. For each possible vertical value, count the number of data points having that value.
2. The largest value that has a non-zero point count is the maximum value.
3. The smallest value that has a non-zero point count is the minimum value.
4. Determine the median value, halfway between the maximum and minimum values.
5. Examine the point counts between the median value and the maximum value, to find the largest point count. If this point count is greater than the *Floor* value (defined below), the value associated with the point count is the topline. If the largest point count is not greater than *Floor*, then the maximum value is used as the topline.



6. Examine the point counts between the median value and the minimum value to find the largest point count. If this point count is greater than the *Floor* value (defined below), the value associated with the point count is the baseline. If the largest point count is not greater than *Floor*, then the minimum value is used as the baseline.

The *Floor* value is calculated as the maximum of two values, *AVE* and *Correction*, to insure that the topline or baseline calculated is appropriate for the waveform measurement zone.

$$AVE = \frac{2}{n} \sum_{j=1}^n count_j$$

where:

$count_j$ = the j th non-zero point count in the waveform histogram

n = the number of non-zero point counts in the waveform histogram

$$Correction = 8 + MULT \frac{n}{512}$$

where:

n = the number of points in the measurement zone

MULT is determined by signal amplitude:

MULT = 1 for signal amplitude > 7.5 divisions

MULT = 2,

5.0 divisions < signal amplitude < 7.5 divisions

MULT = 3,

2.5 divisions < signal amplitude < 5.0 divisions

MULT = 4,

signal amplitude < 2.5 divisions.

**Area+**

$$Area+ = \sum_{j=m}^{n-1} \frac{Abs[W(j+1)-R] + ABS[w(j)-R]}{2} \times T$$

where:

- m = index of left-most measurement zone sample
- n = index of right-most measurement zone sample
- $W(j)$ = input sampled data point
- R = reference level measurement parameter
- T = time interval between successive samples
- Abs = the absolute value function

Area-

$$Area- = \sum_{j=m}^{n-1} \frac{[W(j+1) - R] + [w(j) - R]}{2} \times T$$

where:

- m = index of left-most measurement zone sample
- n = index of right-most measurement zone sample
- $W(j)$ = input sampled data point
- R = reference level measurement parameter
- T = time interval between successive samples

Cross

The cross measurement finds the left-most crossing of the reference level of the proper slope that is within the measurement zone. The horizontal position of the crossing point is displayed.

Linear interpolation between vertical points and between time intervals is necessary to determine the crossing time when the reference level value does not correspond to acquired data.



Delay

1. On the selected waveform, search the measurement zone for the left-most mesial crossing. The horizontal position is $Cross_1$.
2. On the same waveform, search the measurement zone for the right-most mesial crossing. The horizontal position is $Cross_2$.
3. Calculate the delay:

$$Delay = Cross_2 - Cross_1$$

Linear interpolation between vertical points and between time intervals is necessary to determine the crossing time when the mesial value does not correspond to acquired data.

Duty Cycle

1. Calculate the *Period* of the selected waveform (perform a period measurement).
2. Calculate the pulse width of the selected waveform (perform a width measurement). This value is *Width* .
3. If the positive portion of the part of the waveform measured for the *Period* measurement lies between the first two mesial crossings in the measurement zone, then:

$$DutyCycle = \frac{100 \times Width}{Period}$$

If the positive portion of the part of the waveform measured for the *Period* measurement lies between the second and third mesial crossings in the measurement zone, then:

$$DutyCycle = 100 - \frac{100 \times Width}{Period}$$



Energy

$$Energy = \sum_{j=m}^{n-1} \frac{W(j+1)^2 + w(j)^2}{2} \times T$$

where:

- m = index of left-most measurement zone sample
- n = index of right-most measurement zone sample
- $W(j)$ = input sampled data point
- T = time interval between successive samples

Fall

1. Find the first point in the measurement zone that is greater than the distal value, searching from left to right.
2. From this point, find the first distal crossing and note the time, t_d .
3. From the distal crossing, examine points to the right, looking for the proximal crossing t_p . Update t_d if subsequent distal crossings are found.
4. Calculate the fall time:

$$Fall = t_p - t_d$$

Linear interpolation between vertical points and between time intervals is necessary to determine the crossing times, when the proximal and distal values do not correspond to acquired data.



Frequency

1. Search the measurement zone for the left-most mesial crossing of positive slope. Continue the search to the right to find the first upper signal/noise ratio level crossing to the right of the first mesial crossing. The horizontal coordinate of this crossing is $Cross_p$.
2. Search the measurement zone for the left-most mesial crossing of negative slope. Continue the search to the right to find the first lower signal/noise ratio level crossing to the right of the second mesial crossing. The horizontal coordinate of this crossing is $Cross_n$.
3. If $Cross_p < Cross_n$, set $Cross_1 = Cross_p$, $Cross_2 = Cross_n$, and $Slope = positive$.
If $Cross_p > Cross_n$, set $Cross_1 = Cross_n$, $Cross_2 = Cross_p$, and $Slope = negative$.
4. If $Slope = positive$, search for the third left-most mesial crossing, and continue the search to find the next upper signal/noise ratio level crossing to the right. If $Slope = negative$, use the next lower signal/noise ratio level crossing to the right. The horizontal coordinate of this crossing is $Cross_3$.
5. Calculate the frequency:

$$Frequency = \frac{1}{Cross_3 - Cross_1}$$

Linear interpolation between vertical points and between time intervals is necessary to determine the crossing time, when the mesial value does not correspond to acquired data.



Gain

1. Calculate the peak-to-peak value of the reference waveform. (Perform a Peak-Peak measurement). This value is $PeakPeak_{ref}$.
2. Calculate the peak-to-peak value of the selected waveform. (Perform a Peak-Peak measurement). This value is $PeakPeak_{sel}$.
3. Calculate the gain:

$$Gain = PeakPeak_{sel} / PeakPeak_{ref}$$

Main→Window Trigger Time

The Main→Window trigger time measurement is performed in the digitizer. The value reported is the time from the trigger event for the Main time base to the trigger event for the Window time base.

Max

The maximum digitized or calculated data point in the measurement zone of the waveform record. An overrange value in the waveform record will qualify the measurement readout with "≥". If the waveform is null, the measurement value will show "error".

Mean

$$Mean = \sum_{j=m}^{n-1} \frac{W(j+1) + W(j)}{[2(n-m)]}$$

where:

- m = index of left-most measurement zone sample
- n = index of right-most measurement zone sample
- $W(j)$ = sampled data point

The summation extends over the interval of time corresponding to one period when Data Interval is set to one period, or the entire measurement zone when Data Interval is set to the entire zone.



Mid

$$Mid = \frac{Max + Min}{2}$$

An overrange value in the waveform record will qualify the measurement with “≥”, and an underrange value in the waveform record will qualify the measurement with “≤”. If the waveform record has both underrange and overrange values, the measurement readout will be “0.0000 ?V”. If the waveform is null, the measurement value will show “error”.

Min

The minimum digitized or calculated data point in the measurement zone of the waveform record. An underrange value in the waveform record will qualify the measurement readout with “≤”. If the waveform is null, the measurement value will show “error”.

Overshoot

$$OverShoot = 100 \frac{Max - topline}{topline - baseline}$$

If the values of *topline* and *baseline* are equal, the measurement value will show “error”.

Peak-Peak

$$PeakPeak = Max - Min$$

An overrange value in the waveform record will qualify the measurement with “≥”, and an underrange value in the waveform record will qualify the measurement with “≤”. If the waveform record has both underrange and overrange values, the measurement readout will also be qualified with “≥”. If the waveform is null, the measurement value will show “error”.

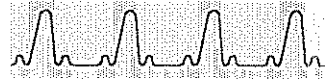

Period

1. Search the measurement zone for the left-most mesial crossing of positive slope. Continue the search to the right to find the first upper signal/noise ratio level crossing to the right of the first mesial crossing. The horizontal coordinate of this crossing is $Cross_p$.
2. Search the measurement zone for the left-most mesial crossing of negative slope. Continue the search to the right to find the first lower signal/noise ratio level crossing to the right of the second mesial crossing. The horizontal coordinate of this crossing is $Cross_n$.
3. If $Cross_p < Cross_n$, set $Cross_1 = Cross_p$, $Cross_2 = Cross_n$, and $Slope = \text{positive}$. If $Cross_p > Cross_n$, set $Cross_1 = Cross_n$, $Cross_2 = Cross_p$, and $Slope = \text{negative}$.
4. If $Slope = \text{positive}$, search for the third left-most mesial crossing, and continue the search to find the next upper signal/noise ratio level crossing to the right. If $Slope = \text{negative}$, use the next lower signal/noise ratio level crossing to the right. The horizontal coordinate of this crossing is $Cross_3$.
5. Calculate the period:

$$Period = Cross_3 - Cross_1$$

Linear interpolation between vertical points and between time intervals is necessary to determine the crossing time when the mesial value does not correspond to acquired data.



Phase

1. Calculate the period value of the reference waveform. (Perform a Period measurement). This value is *Period* .
2. Calculate the delay from the reference waveform to the selected waveform. (Perform a Skew measurement). This value is *Skew* .
3. Calculate the phase shift:

$$Phase = \frac{Skew}{360 \times Period} \text{ mod } 360$$

If the measurement of either *Period* or *Skew* results in an error, the *Phase* measurement will show "error".

Prop Delay

1. On the selected waveform, search the measurement zone for the left-most mesial crossing of the specified slope. The horizontal position is *Cross_{sel}* .
2. On the delayed waveform, search the measurement zone for the left-most mesial crossing of the specified slope. The horizontal position is *Cross_{dy}* .
3. Calculate the delay:

$$PropDelay = Cross_{dy} - Cross_{sel}$$

Linear interpolation between vertical points and between time intervals is necessary to determine the crossing time when the mesial value does not correspond to acquired data.

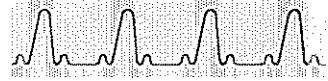

Rise

1. Find the first point in the measurement zone that is less than the proximal value, searching from left to right.
2. From this point, find the first proximal crossing and note the time, t_p .
3. From the proximal crossing, examine points to the right, looking for the distal crossing t_d . Update t_p if subsequent proximal crossings are found.
4. Calculate the rise time:

$$\text{Rise} = t_d - t_p$$

Linear interpolation between vertical points and between time intervals is necessary to determine the crossing times when the proximal and distal values do not correspond to acquired data.

RMS

$$\text{RMS} = \sum_{j=m}^{n-1} \frac{[W(j+1)^2 + W(j)^2]^{1/2}}{2(n-m)}$$

where:

- m = index of left-most measurement zone sample
- n = index of right-most measurement zone sample
- $W(j)$ = sampled data point

The summation extends over the interval of time corresponding to one period when Data Interval is set to one period, or the entire measurement zone when Data Interval is set to the entire zone.



Skew

1. On the reference waveform, search the measurement zone for the left-most mesial crossing. The horizontal position is $Cross_{ref}$.
2. On the selected waveform, search the measurement zone for the left-most mesial crossing. The horizontal position is $Cross_{sel}$.
3. Calculate the skew:

$$Skew = Cross_{sel} - Cross_{ref}$$

Linear interpolation between vertical points and between time intervals is necessary to determine the crossing time when the mesial value does not correspond to acquired data.

Under Shoot

$$UnderShoot = 100 \frac{baseline - Min}{topline - baseline}$$

If the values of *topline* and *baseline* are equal, the measurement value will show "error".

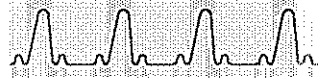

Width

1. Search the measurement zone for the leftmost mesial crossing of positive slope. Continue the search to the right to find the first upper signal/noise ratio level crossing to the right of the first mesial crossing. The horizontal coordinate of this crossing is $Cross_p$.
2. Search the measurement zone for the leftmost mesial crossing of negative slope. Continue the search to the right to find the first lower signal/noise ratio level crossing to the right of the second mesial crossing. The horizontal coordinate of this crossing is $Cross_n$.
3. If $Cross_p < Cross_n$, set $Cross_1 = Cross_p$, $Cross_2 = Cross_n$, and $Slope = positive$. If $Cross_p > Cross_n$, set $Cross_1 = Cross_n$, $Cross_2 = Cross_p$, and $Slope = negative$.
4. Calculate the width:

$$Width = Cross_2 - Cross_1$$

Linear interpolation between vertical points and between time intervals is necessary to determine the crossing time when the mesial value does not correspond to acquired data.



C

C

C

ndix E:

copy Defaults



The following table summarizes the factory default settings associated with each printer selection in the **Hardcopy** pop-up menu. These settings are not affected by initialization.

Hardcopy Defaults

Printer	Screen Format	Direction	Data Format	Output Port
8 pin	HiRes	N/A	N/A	Centronics
24 pin	HiRes	N/A	N/A	Centronics
Tek 4692	Screen	Vertical	N/A	Centronics
Tek 4696	Dithered	Vertical	N/A	Centronics
Bitmap Dump	Screen	Vertical	BinHex Compacted	Centronics
Alt Inkjet	Draft	Horizontal	N/A	Centronics
HPGL	HiRes	N/A	N/A	Centronics

The default settings for the color map associated with a color printer setting may be recovered by selecting **Default Color Map**.

ultra



C

C

C

Index F: Messages



The oscilloscope displays a message at the top of the display whenever one of the following events occurs:

- Errors indicate that the oscilloscope cannot perform a requested operation.
- Warnings are displayed when the oscilloscope performs the requested operation, but warns you that the results may be corrupted or meaningless.
- Ready Messages indicate that the oscilloscope is waiting for your response to complete the task.
- Operation Complete Messages indicate that an operation is complete.

When a message appears on the display, you can remove it by performing any operation: touching the graticule area, making a menu selection, or pressing a button.

When a hardcopy is made, any message on the display is removed immediately before making the copy.

Selected Message Actions

The meaning of most messages is self-evident. This section lists some of the messages that might be unclear, and gives more information about the cause of the message.

Autoset – not functional with this waveform type.

The selected waveform is a window waveform that has no parent waveform on the Main time base and the Main time base is not triggered.

Autoset – trigger search failed.

Horizontal Autoset failed because the oscilloscope was not triggered and Vertical Autoset was turned off.



That XY waveform has incompatible components.

You cannot create an XY waveform that compares a Fast waveform (a waveform acquired using integer arithmetic) to a High Precision waveform.

Front panel locked out.

A command from a computer on a remote interface (GPIB or RS-232-C) has disabled the touch panel. The oscilloscope will ignore front panel selections until the remote computer restores touch panel operation.

Hardcopy absent or off-line.

The **PRINTER** (Centronics) output port is selected, and there is no printer connected to the **PRINTER** port or the printer is offline. Be sure you have selected the appropriate output port from the **Hardcopy** pop-up menu, and check the printer.



Acquisition

The process of sampling the signals coming through the input channels and accumulating the samples into waveforms.

Active Graticule

In a dual-graticule display, the graticule that shows the selected waveform.

Annotation Lines

Lines that appear on a waveform to show the measurement parameters.

Autoset

A means of letting the oscilloscope set itself to provide a stable and meaningful display of a given waveform.

Averaging

Displaying a waveform that is the combined result of several acquisitions, thereby reducing apparent noise.

Axis Label

There are three notations on each axis. The first and last notation on each axis show the numeric value of the graticule edge (*not* the edge of the displayed points, which are slightly outside the graticule). The center notation is the scale factor expressed in units per division.

Bandwidth

The frequency range within which an instrument's performance with regard to a particular characteristic falls within specified limits. For oscilloscopes and amplifiers, bandwidth is usually given as an upper limit (the lower limit is DC).

Bitmap Dump

A hardcopy mode in which an image of the display is sent, usually to a computer, as a series of binary or binhex data.

**Calibration**

Fine-tuning of the system for vertical and horizontal (time base) accuracy. The oscilloscope, plug-in units, and probes or cables must be calibrated together as a system for best accuracy.

Channel

The input connector on a plug-in unit, to which you attach a probe or cable connected to the signal source. Also, the smallest component of a waveform expression.

Channel Number

The number assigned to a specific signal input connector.

Compensation

For probes, the adjustment of controlling elements that compensate for undesirable characteristics.

Complex Waveform

A waveform with a waveform description beyond a single channel specification. Any waveform using a numeric value, a function, a reference to a stored waveform, or an arithmetic operator is a complex waveform. However, using the average function does not make a waveform complex.

Control Knob

see Knob.

Coupling

The association of two or more systems or circuits for the transfer of power or information from one to the other.

Cursor

Any of four styles of paired markers that you position with the knobs. The oscilloscope displays the positions of the cursors and the distance between them in axis units.



Default Measurement Parameter

A value from the default set of measurement parameters. You can change the default values. Whenever a waveform is created, the measurement parameters are copied from the default set.

Delayed Sweep

See Window.

Display

The face of the screen on which waveforms, menus, icons, and messages appear. The display also includes the touch panel for user input and selection.

Distal

The most distant point from a reference point. As used in the 11403 Oscilloscope, the ending measurement point for timing measurements.

Dithered

A hardcopy mode in which black-and-white patterns are used to produce varying shades of gray corresponding to the different display colors.

Dragging

The act of changing your touch panel selection by moving your finger without removing it from the screen. The selection that is activated is the last one that you were touching before removing your finger from the display.

Dual Graticule

A display with two graticules. Each one is half the height of the single graticule.

Enhanced Accuracy

An automatic self-calibration of the oscilloscope and any installed plug-in units as a system. Probes or cables must also be calibrated as part of the system for best accuracy.

**Entry Line**

A text line that shows your input as you enter selections in a pop-up menu.

Enveloping

Displaying a waveform that shows the extremes of variation of the input signal(s) over several acquisitions.

Equivalent Time

An acquisition mode in which waveform data from several triggered sweeps of the time base are combined into a single waveform record.

Free-running

A condition in which the waveform is displayed without a trigger.

GPIB (General Purpose Interface Bus)

An interface (IEEE standard 488) that can be used for remote computer control of, and data capture from, the oscilloscope.

Graticule

The grid where waveforms are displayed.

Hardcopy

A paper print of the display.

Holdoff

The interval between acquisitions during which the time base and trigger circuit are inhibited.

Horizontal Size

See Main Size.

Icon

A marker near the edge of the graticule that performs a specific function when touched.

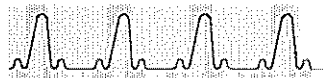
**Initialization**

Setting the oscilloscope to a completely known, default condition.

Interpolation

A function used to derive values for points between known sampled values.

Keypad Menu

A pop-up menu that controls knob resolution and lets you enter specific numeric values for any control to which a knob is assigned.

Knob

One of the two large rotary controls to the right of the oscilloscope screen.

Knob Assignment

The value that a knob will adjust at a given time.

Knob Menu

The on-screen menu that always displays the current knob assignment. The knob menu also lets you display the Keypad menu.

Knob Resolution

The amount of change caused by each click of a knob.

Main Size

The span of time displayed within each horizontal graticule division on the Main time base.

Main Time Base

The time base on which waveforms other than window waveforms are acquired.

Major Menu

A menu that is displayed across the bottom of the screen. One of the major menus is always displayed.



Major Menu Button

A labeled button to the right of the display that determines which major menu is displayed.

Measurement

An automated numeric readout that the oscilloscope provides and updates directly from the displayed waveform in real time.

Measurement Parameter

One of several controls, including reference values and limits, that determine how measurements are taken. You can change these parameters to control the automated measurements.

Measurement Statistics

The accumulation of a history of individual measurement readouts, showing the maximum, minimum, mean, and standard deviation values of a selected number of measurement samples.

Measurement Tracking

The process of automatically adjusting the measurement parameters to reflect changes in the waveform.

Mesial

The middle point of a range of points. As used in the 11403 Oscilloscope, the middle measurement point between proximal and distal points for timing measurements, and the intermediate height between baseline and topline for amplitude measurements.

Nonvolatile RAM (NVRAM)

Internal oscilloscope memory that is not lost when the oscilloscope is turned off.

Outline Box

A visual feedback mechanism of the touch panel. Your potential selection is always indicated by a box while your finger is touching the screen.

**Pixel**

A visible point on the display. The display is 551 pixels wide and 704 pixels high. Each pixel may be set to any of the display colors.

Point Accumulate Mode

A mode of operation where the oscilloscope displays newly acquired waveform data points while keeping the previously acquired data points on the screen.

Pop-up Menu

A temporary menu that provides an interactive dialog for a specific function. A sub-menu of a major menu.

Principal Power Switch

The master power switch located on the rear panel of the oscilloscope.

Proximal

The point closest to a reference point. As used in the 11403 Oscilloscope, the beginning measurement point for timing measurements.

Queuing (Spooling)

The temporary storage of data in preparation for output to an external device, for example a printer or computer.

Real Time

An acquisition mode in which all the samples for a waveform record are taken from a single triggered sweep of the time base.

Record Length

The number of samples (data points) that make up a waveform record.

RS-232-C

An interface that can be used for remote computer control of, and data capture from, the oscilloscope.

**Sample Interval**

The time interval between successive samples in a waveform record.

Sampling Rate

The speed with which the oscilloscope acquires samples, expressed in samples per second.

Selected Waveform

The waveform that is acted on by the knobs and menu selectors, and to which measurement readouts apply.

Selector

An area of a menu that performs some action when you touch it.

Setting

The state of the front panel and system at a given time.

Single Trigger

An acquisition mode in which acquisition is stopped after a single trigger is detected and the time base duration has expired.

Single Sweep

See Single Trigger.

Single Shot

See Single Trigger.

Spooling

See Queuing

Standby

A condition in which input power is disconnected from all but a few of the oscilloscope's circuits. Standby is generally used when the oscilloscope is not in use.

**Stored Waveform**

A collection of sampled points that constitute a single waveform record that is saved in memory.

Time Base

The time-dependent specifications that control the acquisition of a waveform. The time base determines when and for how long to acquire and digitize signal data points.

Time/Division

See Main Size.

Trace

See Waveform.

Tracking

The process of automatically adjusting the measurement parameters or window position to reflect changes in the waveform.

Trigger

An electrical event that is used as a horizontal reference for acquired waveform samples.

Uptime

The cumulative number of hours the oscilloscope has been powered on.

Vertical Description

see Waveform Description.

Vertical Size

The number of vertical axis units displayed within a vertical division of the graticule. Usually the vertical units are volts and the vertical size corresponds to plug-in amplifier sensitivity.

Volts/Division

See Vertical Size.

**Waveform**

The visible representation of an input signal or combination of signals.

Waveform Description

The definition of what the waveform displays. It can include one or more channels combined arithmetically and modified by functions.

Waveform Number

A number assigned by the oscilloscope to identify a waveform. Displayed waveforms are numbered 1 through 8. A new waveform is always given the lowest available number.

Waveform Record

The data points that make up a waveform on the display or in memory.

Window

A waveform that represents a horizontally expanded portion of another waveform. Windows are acquired on a separate time base from the waveforms they magnify.

XY Waveform

A graphical comparison of two waveforms. Both horizontal and vertical position of the data points in an XY waveform reflect signal data.

Yt Waveform

A waveform where the vertical position of the waveform data points reflects signal data and the horizontal position of the waveform data points reflects time.



A

Accuracy, Enhanced, 63–64

Acquire Desc pop-up menu, 33–34, 43–45

Acquisition, 29–35

conditional, 33–34

equivalent time, 30

real time, 29–30

stopping and starting, 32

Algorithms

measurement, 213, 221–233

waveform function, 213–220

All Wfms Status menu, 182

Amplifiers. *See Plug-in units*

Audio feedback, 37

Autoset, 39–42

Horizontal, 41–42

Pan/Zoom, 42

search, 39

stored waveforms, 42

Vertical, 41

window, 42

XY waveforms, 42

AUTOSET button, 39

Averaging, 34, 43–45

Axis labels, 69

B

Bandwidth, plug-in channels, 122

Baseline, 221–222

Beep. *See Audio feedback*

Buttons, 2

AUTOSET, 39

DIGITIZER, 32

ENHANCED ACCURACY, 63



HARDCOPY, 81
MEASURE, 12–13
STORE/RECALL, 12–13
TRIGGER, 12–13
UTILITY, 12
WAVEFORM, 12–13

BW Limit pop-up menu, 122

C

Calibration, probes, 135–137

Calibrator, 135–137

Calipers. *See* *Cursors*

Chan Sel selector, 172

Channel button, 118

Clear Waveform pop-up menu, 34–35

Clearing waveforms, 34–35

Clock. *See* *Time and date*

Color, 47–49

 windows, 188

Color pop-up menu, 47–49

Connectors, 2, – 5

GPIB, 65, 73

POWER, 127

PRINTER, 73

RS-232-C, 73–74, 143

Contrast, 115–116

Coupling, plug-in channels, 120–121

Coupling (trigger) pop-up menu, 163

Coupling (vertical) pop-up menu, 120–121

Cursor Type pop-up menu, 51–53

Cursors, 51–55

Cursors icon, 52

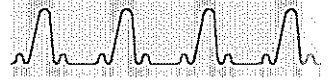

D

- DefWfm** icon, 176–179
- DefWfm** pop-up menu, 176–179
- Delay Time. *See Window size and position*
- Delayed Sweep. *See Windows*
- Delayed Time/Div. *See Window time base*
- Delete Setting** pop-up menu, 150
- Delete Waveform** pop-up menu, 157–158
- Diagnostics, 57–61
 - extended, 57, 59–61
 - power-on, 57–58
 - self-test, 57, 59
- Digitizer, 29
- DIGITIZER** button, 32
- Display, 2, 6–7
- Display intensity, 49, 115–116
- Displaying Labels, 96

E

- Enhanced Accuracy, 63–64
- ENHANCED ACCURACY** button, 63
- Enveloping, 34, 43–45
- Equivalent time sampling, 30
- Erasing nonvolatile RAM, 90
- Error messages, 237–238

F

- Fast. *See Waveform scaling*
- Fine Position. *See Knob menu*
- Fuse, 4–5, 127, 205



G

GPIB, 65–67

GPIB connector, 65, 73

GPIB pop-up menu, 66–67

Graticules, 69–72

Graticules pop-up menu, 71–72

H

Hardcopy, 73–81

 Defaults, 235

HARDCOPY button, 81

Hardcopy pop-up menu, 75–81, 235

High precision. *See* *Waveform scaling*

Horizontal

 controls, 83–88

 ↔ icon, 189

 Pan/Zoom, 85–86

 size and position, 30–31, 83–86, 189

Horizontal Desc pop-up menu, 126, 140–141, 192–194

↔ Horizontal icon, 83–84

I

Icons, 8–9

Cursors, 52

DefWfm, 176–179

 ↔ horizontal, 83–84, 189

 ↖ Main Trigger, 161

 ↑ vertical, 171–173, 189

 ↖ Window Trigger, 161, 188

Window1, 187–188

Window2, 188

Ident pop-up menu, 91



Impedance, 119

Impedance pop-up menu, 119

Initialization, 89–90

erasing nonvolatile RAM, 90

Input Parameters pop-up menu, 119

Installing plug-in units, 117–118

Instrument identification, 91

Intensity, display, 49, 115–116

Intensity pop-up menu, 115–116

K

Keypad pop-up menu, 10–11

Knob menu, 10–11

Knobs, 2, 10–11

L

Label pop-up menu, 94–95

Labels, 93–96

displayed on graticule, 96

positioning, 96

LINE VOLTAGE SELECTOR switch, 127

Lower Graticule pop-up menu, 71–72

M

Main position. *See Horizontal size and position*

Main size. *See Horizontal size and position*

Measurements, 97–114

algorithms, 213, 221–233

Area+, 97, 223

Area-, 97, 223

comparing to references, 106–107

Cross, 98, 223



- default parameters, 113–114
 - defining, 99–101
 - Delay, 98, 224
 - Duty Cycle, 98, 224
 - Energy, 97, 225
 - factors affecting accuracy, 45
 - Fall, 98, 225
 - Frequency, 98, 226
 - Gain, 97, 227
 - individual measurement pop-up menus, 108–109
 - Main–Win Trig Time, 98, 101–103, 227
 - Max, 97, 227
 - Mean, 97, 227
 - Mid, 97, 228
 - Min, 97, 228
 - Over Shoot, 97, 228
 - parameters, 108–111
 - Peak–Peak, 97, 228
 - Period, 98, 229
 - Phase, 98, 230
 - PropDelay, 98, 230
 - Rise, 98, 231
 - RMS, 97, 231
 - Skew, 98, 232
 - trigger, 101–103
 - Under Shoot, 97, 232
 - Width, 98, 233–234
- Measurements** pop-up menu, 99–103
- Menus, 12–25
- Messages, 237–238
- Modes** pop-up menu, 37, 40, 64, 87–88, 155, 169, 184–185
- Multitrace Pan/Zoom, 88

N

- Nonvolatile RAM, erasing, 90



O

- Offset, vertical, 123
- ON/STANDBY** switch, 127
- Overall intensity, 49, 115–116

P

- Packaging, 211
- Pan/Zoom, 85–88
 - multitrace, 87–88
 - pivot, 87
- Plug-in units, 117–124
 - bandwidth, 122
 - channel button, 118
 - compartments, 2
 - coupling, 120–121
 - DC circuit loading, 123
 - impedance, 119
 - installation, 117–118
 - overdriving, 124
 - removal, 117
- Point accumulate mode, 125–126
- Polarity, vertical. *See Waveforms, defining*
- Pop-up menus, 6–7
 - Acquire Desc**, 33–34, 43–45
 - BW Limit**, 122
 - Clear Waveform**, 34–35
 - Color**, 47–49
 - Coupling** (trigger), 163
 - Coupling** (vertical), 120–121
 - Cursor Type**, 51–53
 - DefWfm**, 176–179
 - Delete Setting**, 150
 - Delete Waveform**, 157–158
 - GPIB**, 66–67
 - Graticules**, 71–72



Hardcopy, 75–81, 235
Horizontal Desc, 126, 140–141, 192–194
Ident, 91
Impedance, 119
individual measurement, 108–109
Input Parameters, 119
Intensity, 115–116
Keypad, 10–11
Label, 94–95
Lower Graticule, 71–72
Measurements, 99–101, 103
Mode, 166
Mode (trigger), 166
Modes, 37, 40, 64, 87–88, 155, 169, 184–185
Probe Compensation, 135–137
Probes, 133–137
Recall Setting, 149–150
Recall Waveform, 156
RS232C, 143–145
Sequence Settings, 151
Source Desc (trigger), 162
Statistics Comp & Def, 104–107, 113–114
Store Setting, 148–149
Store Waveform, 153–154
Time & Date, 159
Upper Graticule, 71–72
Vertical Desc, 182
Window Holdoff Md, 165
POWER connector, 127
Power-on, 127–129
PRINCIPAL POWER SWITCH, 127
PRINTER connector, 73
Printing. *See Hardcopy*
Probe Calibration, 135–137
Probe Compensation pop-up menu, 135–137
Probe ID button, 133–134



- Probes, 131–137
 - Connection, 132
 - installation, 132
- Probes** pop-up menu, 133–137

R

- Real Time sampling, 29–30
- Recall Setting** pop-up menu, 149–150
- Recall Waveform** pop-up menu, 156
- Record length, 139–141
 - windows, 188
- Removing plug-in units, 117
- RS-232-C connector, 73–74, 143
- RS-232-C parameters, 143–145
- RS232C** pop-up menu, 143–145

S

- Safety, 209–211
- Sample interval, 140
- Scaling, waveform, 184–185
- Sensitivity, vertical, 123
- Sequence Settings, 147
- Sequence Settings** pop-up menu, 151
- Settings
 - default, 89
 - initialize, 89
 - sequencing, 151
 - stored, 147–151
- Shipping, 211
- Single Shot. *See Acquisition, single trigger*
- Single Sweep. *See Acquisition, single trigger*
- Smooth function, 179–180



- Source Desc** (trigger) pop-up menu, 162
- Specifications, 199–206
- Statistics, 104–105
- Statistics Comp & Def** pop-up menu, 104–107, 113–114
- Status indicators, trigger, 165
- Store Setting** pop-up menu, 148–149
- Store Waveform** pop-up menu, 153–154
- Stored settings, 147–151
 - sequencing, 151
- Stored waveforms, 153–158
 - Time and Date, 155
- Sweep. *See Waveforms*
- Sweep Mag. *See Pan/Zoom*
- Switches, 2, 4–5
 - LINE VOLTAGE SELECTOR**, 127
 - ON/STANDBY**, 127
 - PRINCIPAL POWER SWITCH**, 127

T

- Time & Date** pop-up menu, 159
- Time and Date, stored waveforms, 155
- Time and date, 159
- Time bases, 84
- Time/Division. *See Horizontal size and position*
- Topline, 221–222
- Touch panel, 6–7
- Trace. *See Waveform*
- Trace Separation, 189
- Trigger Holdoff, range, 164
- Trigger icons, 161



- Triggering, 161–166
 - Auto Level Mode, 166
 - Auto Mode, 166
 - Coupling, 161, 163
 - events holdoff, 164
 - holdoff, 161, 164–165
 - ↔ indicator, 164
 - Level, 164
 - mode, 166
 - Normal Mode, 166
 - source, 161
 - source description, 164
 - status, 165
 - time holdoff, 164
 - windows, 161, 164, 188

U

- Upper Graticule** pop-up menu, 71–72

V

- Vectored waveforms, 167–169
- Vertical
 - accuracy. *See Enhanced Accuracy*
 - ➔ icon, 171–173, 189
 - polarity. *See Waveforms, defining*
 - position, 171–173
 - size and offset, 171–173, 189
- Vertical Desc** pop-up menu, 182
- Vertical offset, 123
- Vertical sensitivity, 123
- Volts/Division. *See Vertical size and offset*



W

- Waveforms, 175–185
 - clearing, 34–35
 - defining, 175–179
 - functions, 43
 - modifying, 182
 - removing, 183
 - scaling, 184–185
 - selecting, 70–71, 181–182
 - stored, 153–158
 - trace separation, 173
 - vectoring, 167–169
 - waveform expressions, 175–179
 - waveform function algorithms, 213–220
 - waveform numbers, 180
 - XY, 191–194
- Window Holdoff Md** pop-up menu, 165
- Window trigger icon, 188
- Window1** icon, 187–188
- Window2** icon, 188
- Windows, 187–189
 - color, 188
 - holdoff, 164
 - record length, 188
 - time base, 188
 - triggering, 164, 188

X

- XY waveforms, 191–194