

222 HANDHELD DIGITAL STORAGE OSCILLOSCOPE

222

HANDHELD DIGITAL STORAGE OSCILLOSCOPE

OPERATORS

*Please Check for
CHANGE INFORMATION
at the Rear of This Manual*

Copyright © 1988 Tektronix, Inc. All rights reserved. Contents of this publication may not be reproduced in any form without the written permission of Tektronix, Inc.

Products of Tektronix, Inc. and its subsidiaries are covered by U.S. and foreign patents and/or pending patents.

TEKTRONIX, TEK, and  are registered trademarks of Tektronix, Inc.

Printed in U.S.A. Specification and price change privileges are reserved.

Certificate of the Manufacturer/Importer

We hereby certify that the 222 DIGITAL STORAGE
OSCILLOSCOPE AND ALL INSTALLED OPTIONS
complies with the RF Interference Suppression requirements of
Amtsbl.-Vfg 1046/1984.

The German Postal Service was notified that the equipment is being marketed.

The German Postal Service has the right to re-test the series and to verify that it complies.

TEKTRONIX

Bescheinigung des Herstellers/Importeurs

Hiermit wird bescheinigt, daß der/die/das 222 DIGITAL STORAGE
OSCILLOSCOPE AND ALL INSTALLED OPTIONS
in Übereinstimmung mit den Bestimmungen der Amtsblatt-Verfügung
1046/1984 funktentstört ist.

Der Deutschen Bundespost wurde das Inverkehrbringen dieses Gerätes angezeigt und die Berechtigung zur Überprüfung der Serie auf Einhalten der Bestimmungen eingeräumt.

TEKTRONIX

NOTICE to the user/operator:

The German Postal Service requires that Systems assembled by the operator/user of this instrument must also comply with Postal Regulation, Vfg. 1046/1984, Par. 2, Sect. 1.

HINWEIS für den Benutzer/Betreiber:

Die vom Betreiber zusammengestellte Anlage, innerhalb derer dies Gerät eingesetzt wird, muß ebenfalls den Voraussetzungen nach Par. 2, Ziff. 1 der Vfg. 1046/1984 genügen.

NOTICE to the user/operator:

The German Postal Service requires that this equipment, when used in a test setup, may only be operated if the requirements of Postal Regulation, Vfg. 1046/1984, Par. 2, Sect. 1.7.1 are complied with.

HINWEIS für den Benutzer/Betreiber:

Deses Gerät darf in Meßaufbauten nur betrieben werden, wenn die Voraussetzungen des Par. 2, Ziff. 1. &.1 der Vfg. 1046/1984 eingehalten werden.

TABLE OF CONTENTS

	Page
LIST OF ILLUSTRATIONS	v
LIST OF TABLES	vi
OPERATORS SAFETY SUMMARY	vii
Section 1 YOUR NEW OSCILLOSCOPE	
1.1 FEATURES	1-1
1.2 SPECIFICATION SUMMARY	1-2
1.3 STANDARD ACCESSORIES	1-4
1.4 OPTIONAL ACCESSORIES	1-4
Section 2 GETTING STARTED	
2.1 SAFETY	2-1
2.2 BATTERY-CHARGER ADAPTER	2-1
2.3 EXTERNAL SUPPLY VOLTAGE	2-1
2.4 BATTERY OPERATION	2-2
2.5 FIRST TIME BATTERY OPERATION	2-3
2.6 START-UP	2-4
2.7 AUTO TIMEOUT	2-4
2.8 VIEWING A SIGNAL QUICKLY	2-4
Section 3 WHAT THE CONTROLS DO	
3.1 CONTROL REFERENCE TABLES	3-1
3.2 ON-SCREEN READOUT LOCATIONS	3-6
3.3 EXPANDED CONTROLS INFORMATION	3-8
3.4 CRT DISPLAY, MENU BUTTONS, AND POWER	3-8
3.5 VERTICAL CONTROLS	3-10
3.6 HORIZONTAL CONTROLS	3-12
3.7 TRIGGER CONTROLS	3-14
3.8 TOP PANEL BUTTONS	3-16
3.9 REAR PANEL CONTROLS AND CONNECTORS	3-19

Section 4 HOW IT WORKS

4.1	TURN ON	4-1
4.2	AUTO SETUP	4-1
4.3	MENU SELECTION	4-2
4.4	STORE OR NONSTORE DISPLAY MODE SELECTION	4-3
4.5	MENU AND SAVED WAVEFORM DISPLAYS CLEARING	4-3
4.6	CHANNEL SELECTION	4-3
4.7	VERTICAL INPUT COUPLING	4-4
4.8	VOLTS/DIV SCALING	4-5
4.9	VERTICAL POSITIONING	4-5
4.10	VARIABLE VOLTS/DIV CONTROL	4-6
4.11	CH1 AND CH2 INVERTED DISPLAY	4-6
4.12	SEC/DIV SCALING	4-7
4.13	HORIZONTAL POSITIONING	4-8
4.14	X10 MAGNIFICATION	4-8
4.15	TRIGGER LEVEL SETTING	4-9
4.16	TRIGGER SLOPE SELECTION	4-9
4.17	TRIGGER MODE SETTING	4-10
4.18	TRIGGER SOURCE SELECTION	4-11
4.19	SAVING WAVEFORMS	4-12
4.20	RECALLING SAVED WAVEFORMS	4-13
4.21	SAVING FRONT-PANEL SETUPS	4-14
4.22	RECALLING FRONT-PANEL SETUPS	4-16
4.23	CLEARING SAVED FRONT-PANEL SETUPS ..	4-17
4.24	SETTING TRIGGER POSITION	4-17
4.25	ACQUISITION MODE SELECTION	4-20
4.26	X-Y OR Y-T DISPLAY MODE SELECTION	4-21
4.27	READOUT ON OR OFF	4-21
4.28	AUTO TIMEOUT	4-22
4.29	SETTING BAUD RATE	4-24
4.30	DISPLAY XY ROTATION ALIGNMENT	4-25
4.31	SELF CALIBRATION	4-27
4.32	FIRMWARE VERSION IDENTIFICATION	4-30

Section 5 MAKING MEASUREMENTS

5.1	SIGNAL TRACING WITH AUTO SETUP	5-1
5.2	GRATICULE MEASUREMENTS	5-1
5.3	FLOATING MEASUREMENTS	5-6
5.4	DIFFERENTIAL MEASUREMENTS	5-6
5.5	SINGLE SWEEP OPERATION	5-8

Section 6 MORE ON HOW IT WORKS

6.1	AUTO SETUP	6-1
6.2	PROBES	6-3
6.3	STORE AND NONSTORE DISPLAY MODES	6-5
6.4	VERTICAL INPUT COUPLING	6-5
6.5	DEFAULT ACQUISITION MODES	6-6
6.6	TRIGGER MODES	6-10
6.7	TRIGGER SOURCE	6-12
6.8	TRIGGER POSITION	6-12
6.9	TRIGGER LEVEL/AUTO LVL: PUSH	6-13
6.10	ACQUISITION MODES	6-13
6.11	TIPS ON BATTERY CARE	6-14
6.12	ALTERNATE METHOD FOR BATTERY CHARGING	6-15
6.13	BATTERY REPLACEMENT	6-15
6.14	REPACKAGING FOR SHIPMENT	6-17

Section 7 OPTIONS AND ACCESSORIES

7.1	INTRODUCTION	7-1
7.2	STANDARD ACCESSORIES	7-1
7.3	OPTIONAL ACCESSORIES	7-1
7.4	OPTIONS	7-2
7.5	PARTS SUPPLIED WITH THE 222ACC FIELD ACCESSORIES KIT	7-2

Section 8 PERFORMANCE SPECIFICATIONS

8.1	INTRODUCTION	8-1
8.2	RECOMMENDED PERFORMANCE CHECK SCHEDULE	8-1

8.3	DETAILED SPECIFICATIONS	8-1
8.3.1	Vertical Deflection System	8-1
8.3.2	Trigger System	8-6
8.3.3	Horizontal System	8-6
8.3.4	X-Y Operation	8-8
8.3.5	RS-232 Interface	8-8
8.3.6	External Power Requirements	8-8
8.3.7	Internal Batteries	8-9
8.4	ENVIRONMENTAL SPECIFICATIONS	8-10
8.5	MECHANICAL SPECIFICATIONS	8-12

Appendix A CHECKING YOUR INSTRUMENT'S PERFORMANCE

A.1	INTRODUCTION	A-1
A.2	TEST EQUIPMENT REQUIRED	A-1
A.3	PERFORMANCE CONDITIONS	A-3
A.4	PERFORMANCE CHECK INTERVAL	A-3
A.5	PREPARATION	A-4
A.6	INDEX TO PERFORMANCE CHECKS	A-5
A.7	DISPLAY CHECKS	A-6
A.8	VERTICAL	A-8
A.9	HORIZONTAL	A-15
A.10	TRIGGER	A-17

INDEX

CHANGE INFORMATION

LIST OF ILLUSTRATIONS

2-1	External Power Input	2-2
3-1	Front-Panel controls	3-1
3-2	Top-Panel buttons	3-3
3-3	Rear Panel	3-4
3-4	On-screen readout locations	3-6
3-5	CRT display, menu buttons, and power	3-8
3-6	Probes and Vertical controls	3-10
3-7	Horizontal controls	3-12
3-8	Trigger controls	3-14
3-9	Top-Panel buttons	3-16
3-10	Rear Panel	3-19
4-1	ALIGN XY test pattern	4-27
5-1	Peak-to-peak voltage measurement	5-2
5-2	Voltage with respect to ground	5-3
5-3	Time measurement	5-4
5-4	Rise Time measurement	5-5
5-5	Common-mode rejection with differential inputs	5-7
6-1	Probes and probe accessories	6-4
8-1	Maximum rated normal-mode voltage versus frequency derating curve	8-4
8-2	Maximum rated common-mode voltage versus frequency derating curve	8-5
A-1	Trigger jitter check	A-22

LIST OF TABLES

-- Qservice -- Hyperlinked Page Scroll Up or Down Left click to select -- Qservice --

Table	Page
3-1	Front-Panel Controls Quick Reference 3-1
3-2	Top-Panel Controls Quick Reference 3-3
3-3	Rear-Panel Controls Quick Reference 3-4
3-4	On-Screen Readouts 3-7
6-1	AUTO SETUP Defaults 6-2
6-2	Default Acquisition Modes 6-7
6-3	Repetitive Store Fill 6-10
6-4	AUTO LVL Trigger Interval Limits 6-11
A-1	Test Equipment Required A-2
A-2	VOLTS/DIV Accuracy Settings A-12

-- Qservice -- Hyperlinked Page Scroll Up or Down Left click to select -- Qservice --

OPERATORS SAFETY SUMMARY

The safety information in this summary is for operating personnel. Warnings and cautions will also be found throughout the manual where they apply.

Terms in this Manual

CAUTION statements identify conditions or practices that could result in damage to the equipment or other property.

WARNING statements identify conditions or practices that could result in personal injury or loss of life.

Terms as Marked on Equipment

CAUTION indicates a personal injury hazard not immediately accessible as one reads the markings, or a hazard to property, including the equipment itself.

DANGER indicates a personal injury hazard immediately accessible as one reads the marking.

Symbols in this Manual



Indicates where applicable cautionary or other information is to be found. For maximum input voltage ratings, see the Specifications.

Symbols as Marked on Equipment



DANGER – High voltage.



ATTENTION – Refer to manual.



DOUBLE INSULATED – No safety ground required.

Safety Grounding

This instrument is double insulated and does not use or require a safety-grounding conductor.

Do Not Operate in an Explosive Atmosphere

To avoid explosion, do not operate this product in an explosive atmosphere unless it has been certified.

Do Not Remove Covers or Panels

To avoid personal injury, do not remove the product covers or panels. Do not operate the product without the covers and panels properly installed.

SECTION 1

YOUR NEW OSCILLOSCOPE

*This Document is a complete Scan from the original
Tektronix manual
For enquiries about our complete
High quality line of technical Manuals in PDF
mailto : Qservice@otenet.gr*

**SEE
OTHER
SIDE**

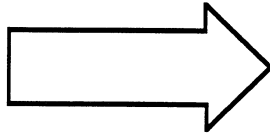

SECTION 1

YOUR NEW OSCILLOSCOPE

1.1 FEATURES





The 222 Digital Storage Oscilloscope is a portable, hand-held instrument. It is lightweight and battery operated for remote-site servicing. Its total portability makes waveform testing easy in locations difficult or impossible to reach with a standard-sized oscilloscope. The 222 has the following features:

- DC to 10 MHz signal bandwidth
- 10 megasample per second digitizing rate
- 1 MHz single-shot storage bandwidth
- 10 MHz repetitive storage bandwidth
- Fully isolated dual vertical channels
- 5 mV to 50 V per division vertical deflection sensitivity
- 50 ns to 20 sec per division time base
- On-screen readouts
- Auto setup and auto level triggering
- Minimum two hour operating time with a fully charged battery
- Three hour recharge time with instrument off
- Auto time out when not in active use
- Envelope mode peak detect for glitch capture
- Averaging for smoothing of last four waveform acquisitions
- Continuous envelope mode for monitoring signal changes
- Four front-panel setup save memories
- Four waveform save memories
- Fully configurable front panel and waveform transfers via the RS-232 communication port

1.2 SPECIFICATION SUMMARY

The complete instrument specifications are given in Section 8.

DC Accuracy	$\pm 3\%$
Horizontal Display Accuracy	
X1	$\pm 2\%$
X10 MAG	$\pm 5\%$
Sample Rate Accuracy	0.01%
Record Length	512 data points (50 per division)
Vertical Resolution	8-bits, 25 levels per vertical division. 10.24 divisions dynamic range
Useful Bandwidth	
Sample Mode (Single-shot sampling)	$\frac{5}{\text{Timebase}} \text{ Hz.}$ <p>The maximum sampling rate of 10 MHz is reached at a SEC/DIV setting of 5 $\mu\text{s}/\text{div}$.</p>
Repetitive Mode	
Greater than 0.5 $\mu\text{s}/\text{div}$	$\frac{5}{\text{Timebase}} \text{ Hz.}$
0.5 $\mu\text{s}/\text{div}$ or Less	10 MHz.
	The analog bandwidth is limited to 10 MHz by the vertical system.
Peak Detect Mode (ENV and CONT ENV)	
Sine Wave Capture	1 MHz.
Pulse Width Amplitude Capture	100 ns.

- | | | |
|---|--|--|
|  | <p>Maximum Rated Normal-Mode Voltage (probe tip to probe common)</p> | <p>400 V (dc + peak ac) to 2 MHz. See Figure 8-1 for frequency derating curve.</p> |
|  | <p>Maximum Rate Common-Mode Voltage (probe common to chassis)</p> | <p>400 V (dc + peak ac) to 1 kHz. See Figure 8-2 for frequency derating curve.</p> |
|  | <p>Maximum Rated Potential Between Channels</p> | <p>800 V (dc + peak ac).</p> |
|  | <p>Maximum Rated Potential Between Either Power Pin and EXT TRIG COMM or RS-232 Common</p> | <p>-0.5 to 42 V peak.</p> |



If either the EXT TRIG COMM connector or the RS-232 cable is connected to an external earth ground or external power is applied, the oscilloscope chassis cannot be elevated.

Weight

Without accessories 4.4 lbs (2 kg).

Dimensions

Length 9.9 in (252 mm).

Height 3.4 in (86.4 mm).

Width 6.25 in (158.8 mm).

Battery-Charger Adapter 18 Vrms.

Battery Sealed lead-acid battery with four cells. 8.8 V open-circuit EMF at full charge.

Operating Time	Two hours minimum with a fully charged battery.
Charging Time	Three hours with the oscilloscope turned off. Battery charging takes place while the oscilloscope is running with the battery-charger adapter supplying power.
External Power Requirements	
AC	16–20 Vac, 16 VA: 47 to 400 Hz.
DC	12–28 Vdc, 15 Watts.
CRT Graticule Dimensions	8 X 10 divisions of 0.5 cm square (diagonal size approximately 2.5 inches).

1.3 STANDARD ACCESSORIES (refer to Section 7 for part numbers)

The instrument is shipped with the following standard accessories:

- 1 Operators Manual
- 1 Quick Reference Guide
- 1 RS-232 Interface Guide
- 1 Instrument Carrying Pouch
- 1 Battery-Charger Adapter (wall transformer)
- 1 Probe Accessories Kit
- 1 Cabinet Feet Accessory Kit

1.4 OPTIONAL ACCESSORIES (refer to Section 7 for part numbers)

- Spare Battery
- Accessory Pouch for Battery or Battery-Charger Adapter (attaches to the instrument carrying case)
- RS-232 Interconnection Cable
- BNC-female-to-dual-banana Adapter
- RS-232 Demonstration Disk
- P6122 Probe
- Field Accessories Kit

SECTION 2

GETTING STARTED

*This Document is a complete Scan from the original
Tektronix manual
For enquiries about our complete
High quality line of technical Manuals in PDF
mailto : Qservice@otenet.gr*

**SEE
OTHER
SIDE**

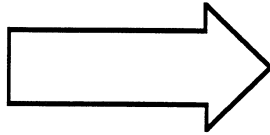

SECTION 2

GETTING STARTED

2.1 SAFETY

Refer to the Operator's Safety Summary (located in front of section 1 of this manual) for safety information about the use of this instrument. Before connecting the instrument to a power source, read this section and the Operator's Safety Summary.

2.2 BATTERY-CHARGER ADAPTER

Instruments are shipped with a detachable battery-charger adapter (wall transformer) that plugs into an ac power-source outlet. The adapter converts the power-source ac voltage to the 16 to 20 Vac input voltage needed to operate the instrument (with or without the battery installed) and charge the oscilloscope's internal battery. Use the battery-charger adapter to operate the oscilloscope when an ac line voltage source is available to maintain battery charge for use when totally portable operation of the oscilloscope is needed. Use the appropriate battery charger adapter for the available power source voltage (115 Vac and 230 Vac). The adapter plugs into the instrument's external power receptacle as shown in Figure 2-1. An optional accessory pouch to carry either the battery-charger adapter (U.S. model only) or a spare battery may be ordered (see section 7 for the part number). The accessory pouch attaches to the instrument carrying case.

2.3 EXTERNAL SUPPLY VOLTAGE

The 222 operates on an external supply voltage of either 12 to 28 Vdc or 16 to 20 Vac (47 to 400 Hz) from a supply that provides at least 15 watts or 16 volt-amperes. If the battery charge state is very low, the current drawn by a charging battery from the supplied battery-charger adapter (wall transformer) is current limited, and the crt display may not be stable. If this effect is seen, either charge the battery for 1 hour before operating the oscilloscope or operate without the battery installed until it can be charged.

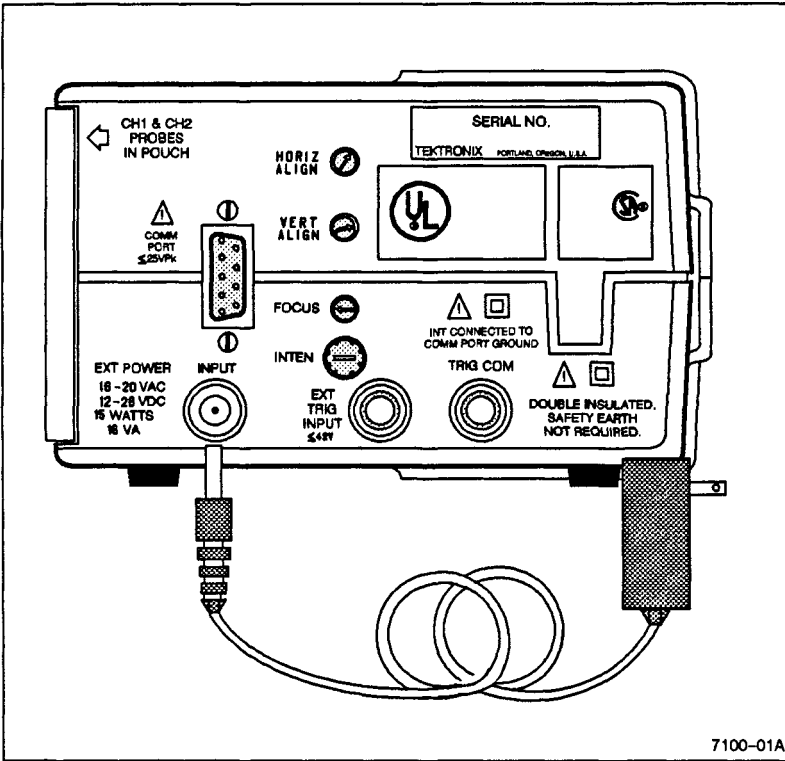



Figure 2-1. External Power Input.

2.4 BATTERY OPERATION

The internal battery of the instrument is a sealed lead-acid type with four cells. The sealed cells are rechargeable using the battery-charger adapter supplied with the instrument. Operating time is at least two hours with a fully charged battery. When the charge level reaches a point that only a short amount of operating time remains, a low-battery indicator () is displayed in the upper right corner of the readout. The oscilloscope turns off automatically when the battery voltage drops below + 7.32 V.

If the charge level of the battery is less than about 20%, the instrument will not come on without the external power provided by the battery-charger adapter. Typical worst-case operating time for an instrument with fully charged batteries is two hours at normal room temperature with the AUTO TIMEOUT feature turned off.

One or two charged batteries may be carried in optional pouches that attach to the carrying case for extended use away from an ac power source. See Section 6, para 6.13 for the battery removal and replacement instructions.

An external-power-on indicator () appears in the upper right corner of the readout when external power is on. The battery is charging anytime external power is being supplied and will charge while the instrument is operating. However, the battery charges faster when the instrument is not operating. Completely recharge the battery as soon as possible after each discharge cycle.

Refer to Section 6, para 6.11 for tips on battery care to extend the operating lifetime of the battery.



When storing the instrument for periods longer than two months, fully charge the batteries; then remove the batteries and store them in a cool place. Storing partially discharged batteries for an extended time or in high temperatures can deplete the remaining charge, leading to a deep-discharge condition. Refer to Section 6, para 6.11 for information on restoring a deep-discharged battery.

2.5 FIRST TIME BATTERY OPERATION

The battery supplied with the oscilloscope is charged at the factory and shipped unplugged to preserve its shelf life. However, the state of battery charge at the time you receive it will be unknown. It is recommended that you charge the battery for three hours before operating the oscilloscope the first time.

2.6 START-UP

Press the **ON** button to enable the display and acquisition system. Pressing the **ON** button a second time turns off the oscilloscope operation but does not disconnect the battery or external power source.

2.7 AUTO TIMEOUT

There is an AUTO TIMEOUT feature that extends the oscilloscope operating time on battery operation. With a two-minute period of no front panel control activity, the oscilloscope turns off. The acquisition and display can be turned back on by pressing the **ON** button. The AUTO TIMEOUT feature does not turn off the oscilloscope when external power is applied. The feature may also be disabled from turning off the oscilloscope when operating on battery power alone. See Section 4, para. 4.28 for operating instructions.

2.8 VIEWING A SIGNAL QUICKLY

Connect one or both of the probe tips to the signals to be viewed.

Press **AUTO SETUP**. This gives you a quick setup of the front-panel controls to view the signals applied to the probe tip(s). A channel that does not have a signal connected is turned off (except CH 1 will not be turned off if neither channel has a signal). If signals are applied to both channels, each will be autoranged vertically (setting the VOLTS/DIV and vertical position for each), but the signal applied to channel 1 will determine the SEC/DIV and Trigger LEVEL settings. If only channel 2 has a signal applied, that signal is used to determine the SEC/DIV setting and Trigger LEVEL.

NOTE

AUTO SETUP does not set the SEC/DIV setting into the ROLL region (0.1 s/div and slower). The practical low frequency for using the AUTO SETUP feature is about 20 Hz.

**WHAT THE
CONTROLS
DO**

*This Document is a complete Scan from the original
Tektronix manual*

*For enquiries about our complete
High quality line of technical Manuals in PDF*

mailto : Qservice@otenet.gr

**SEE
OTHER
SIDE**

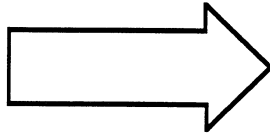

SECTION 3

CONTROLS AND INDICATORS

3.1 CONTROL REFERENCE TABLES

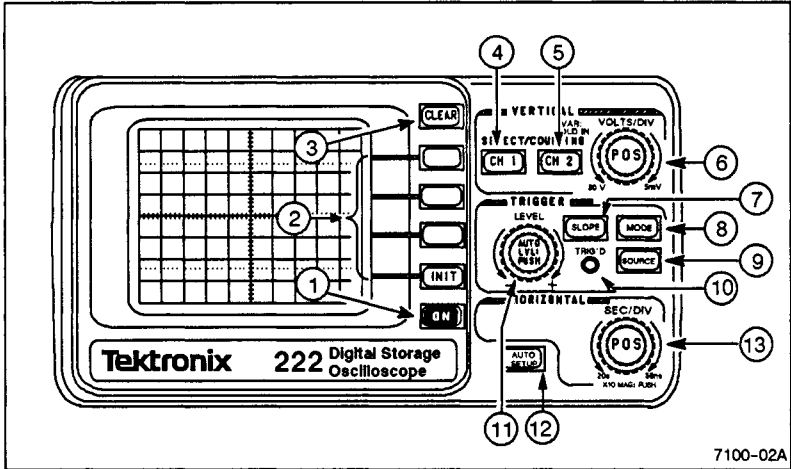

Figure 3-1. Front-Panel controls.

Table 3-1
Front-Panel Controls Quick Reference

Figure Reference	Control Name	Function	Reference Para.
1	ON	Turns the oscilloscope on and off.	3.4, 4.1
2	Menu Selects	Selects the menu items when one of the control menus is displayed.	3.4, 4.3
3	CLEAR	Removes menus and/or saved waveforms from the display.	3.4, 4.5
4	CH 1	Selects CH 1 to respond to the Vertical controls. A second press calls up the CH 1 coupling menu.	3.5, 4.6 4.7, 6.4

Table 3-1 (cont)

Figure Reference	Control Name	Function	Reference Para.
5	CH 2	Selects CH 2 to respond to the Vertical controls. A second press calls up the CH 2 coupling menu.	3.5, 4.6, 4.7, 6.4
6	POSITION	Inner knob vertically positions the active channel trace.	3.5, 4.9
	VOLTS/DIV	Outer knob sets VOLTS/DIV of the active channel.	3.5, 4.8
	VARIABLE	Inner knob is variable VOLTS/DIV control when held in and rotated.	3.5, 4.10
7	SLOPE	Selects triggering on either rising (+) or falling (-) slope of the trigger signal.	3.7, 4.16
8	MODE	Displays the TRIG MODE menu.	3.7, 4.17, 6.6
9	SOURCE	Displays the TRIGGER SOURCE menu.	3.7, 4.18, 6.7
10	TRIG'D	Indicates oscilloscope is triggered when lit.	3.7
11	Trigger LEVEL	Outer knob sets the trigger level threshold when rotated.	3.7, 4.15, 6.9
	AUTO LVL: PUSH	Inner button finds the trigger peaks and sets Trigger LEVEL to midpoint when pressed.	3.7, 4.15, 6.9
12	AUTO SETUP	Autoranges volts, time, and trigger to give the user a quick display of the signal at the probe tip.	3.6, 4.2, 6.1
13	SEC/DIV	Outer knob sets the time scaling (SEC/DIV).	3.6, 4.12, 6.5
	POSITION	Inner knob positions the waveform display horizontally.	3.6, 4.13
	X10 MAG	Inner knob turns X10 MAG on and off when pressed.	3.6, 4.14

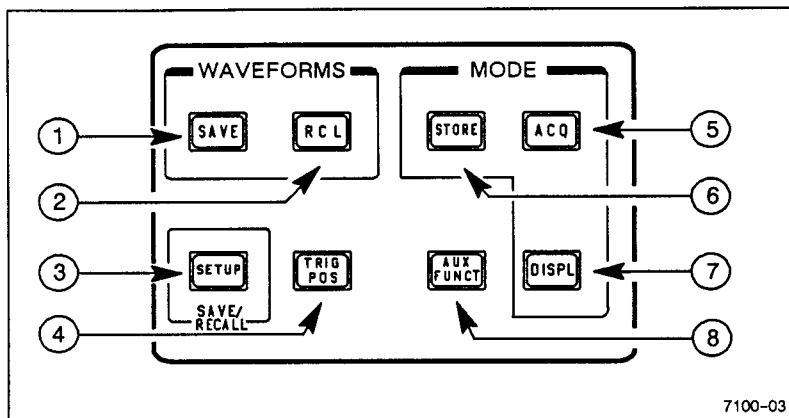

Figure 3-2. Top-Panel buttons.

Table 3-2
Top-Panel Controls Quick Reference

Figure Reference	Control Name	Function	Reference Para.
1	SAVE	Displays the SAVE WV menus.	3.8, 4.19
2	RCL	Displays the RECALL WVFRM menu.	3.8, 4.20
3	SETUP	Displays the SETUP menu used to STORE, RECALL, or ERASE front-panel setups.	3.8, 4.21, 4.22, 4.23
4	TRIG POS	Displays the TRIG POS menu.	3.8, 4.24, 6.8
5	ACQ	Calls up the menu for selecting acquisition mode.	3.8, 4.25, 6.5, 6.10
6	STORE	Switches between STORE and NONSTORE display modes.	3.8, 4.4, 6.3
7	DISPL	Calls up the display mode menu.	3.8, 4.11, 4.26, 4.27
8	AUX FUNCT	Calls up the auxiliary functions menu.	3.8, 4.28-4.32

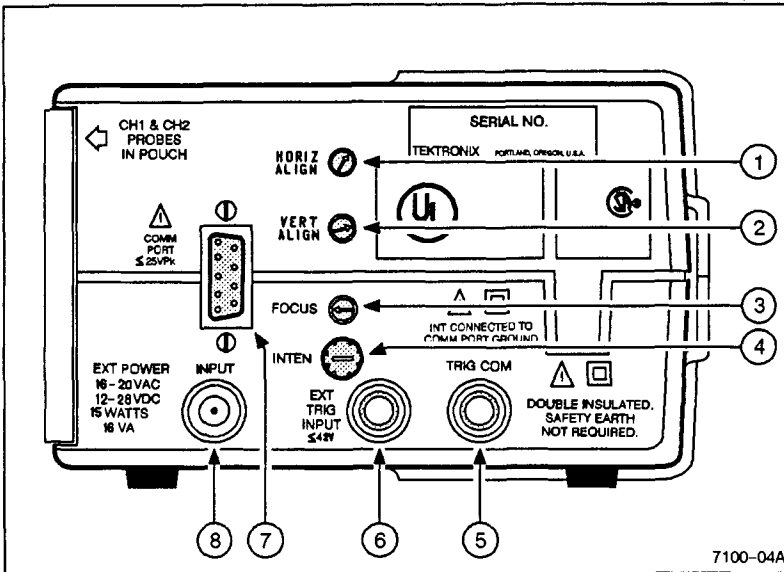

Figure 3-3. Rear Panel.

Table 3-3
Rear-Panel Controls Quick Reference

Figure Reference	Control Name	Function	Reference Para.
1	HORIZ ROTATION	Adjusts display for best horizontal alignment with the graticule.	3.9, 4.30
2	VERT ROTATION	Adjusts display for best vertical alignment with the graticule.	3.9, 4.30
3	FOCUS	Adjusts for best display sharpness.	3.9
4	INTEN	Adjusts for best viewing intensity.	3.9
5	TRIG COM	Provides common reference point for trigger signals.	3.9

Table 3-3 (cont)

Figure Reference	Control Name	Function	Reference Para.
6	EXT TRIG INPUT	Provides connection point for applying external trigger signals.	3.9
7	COMM PORT	Provides RS-232 input/output port for digital communication.	3.9, 4.29
8	EXT POWER INPUT	Connection Point for the battery-charger adapter.	3.9

3.2 ON-SCREEN READOUT LOCATIONS

On-screen readout locations are keyed in Figure 3-4. Menus and waveform readouts are shown superimposed in the illustration; they are displayed separately in actual use. The figure callouts correspond to the figure references in Table 3-4.

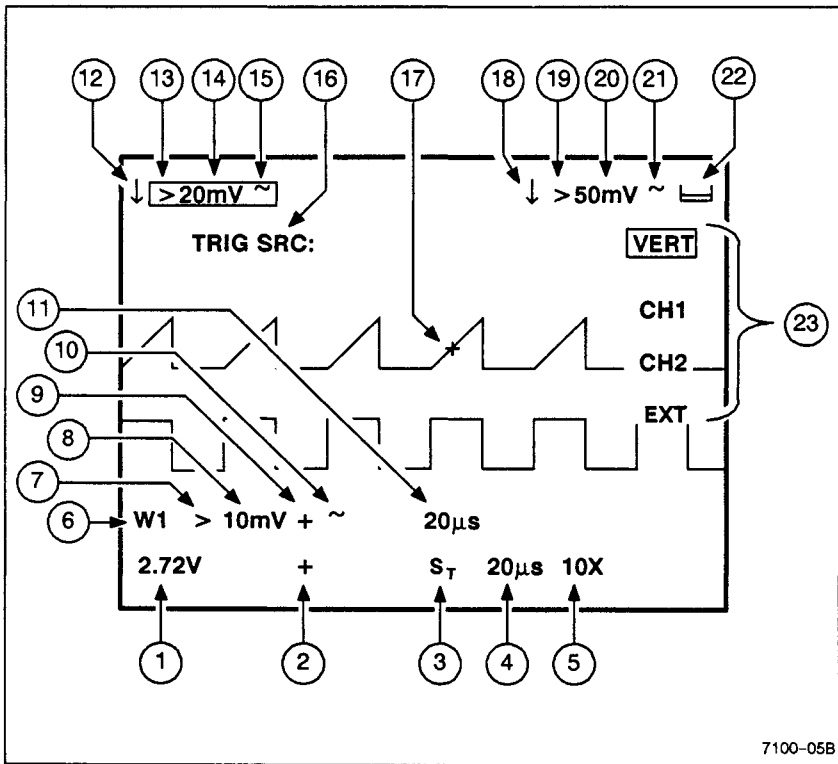

Figure 3-4. On-screen readout locations.

Table 3-4
On-Screen Readouts

Figure Reference	Readout Definition
1	Trigger LEVEL in volts.
2	Trigger SLOPE indicator (+ or -).
3	STORE/NONSTORE indicator. Blank for NONSTORE mode.
4	SEC/DIV readout.
5	X10 MAG indicator.
6	Memory number of the latest recalled waveform.
7	Variable VOLTS/DIV indicator for the last recalled waveform.
8	VOLTS/DIV readout for the latest recalled waveform. In X-Y mode, this location displays the VOLTS/DIV readout for the saved CH 1 waveform.
9	SLOPE indicator for the latest recalled waveform.
10	Coupling indicator for the latest recalled waveform.
11	SEC/DIV readout for the latest recalled waveform. In X-Y mode, this location displays the VOLTS/DIV readout for the saved CH 2 waveform.
12	CH1 invert indicator.
13	Variable VOLTS/DIV indicator for CH1.
14	CH1 VOLTS/DIV readout. The box indicates that CH 1 will respond to vertical control changes. "OFF" appears here when CH 1 is off.
15	CH1 input coupling indicator.
16	Menu label. Each menu has its own name for reference.
17	Trigger point indicator on the waveform.
18	CH2 invert indicator.
19	Variable VOLTS/DIV indicator for CH2.
20	CH2 VOLTS/DIV readout. "OFF" appears here when CH 2 is off.
21	CH2 input coupling indicator.
22	Low-battery indicator. External power applied indicator appears here with external power on.
23	Menu selection choices. A selected choice is boxed in the display.

3.3 EXPANDED CONTROLS INFORMATION

The following descriptions provide the user with an expanded description of the operation of the oscilloscope's controls. Examples of how the controls function are given in Section 4. Detailed operating information for selected front-panel and top-panel controls is given in Section 6.

3.4 CRT DISPLAY, MENU BUTTONS, AND POWER

See Figure 3-5 for the location of the following items.

- ① **CRT**—displays the waveforms, menus, and front-panel control readouts. Parallax viewing errors are eliminated by the internally etched graticule lines on the face of the cathode-ray tube (crt). The display is calibrated to the 4 cm by 5 cm (8 divisions by 10 divisions) graticule lines for making waveform measurements.

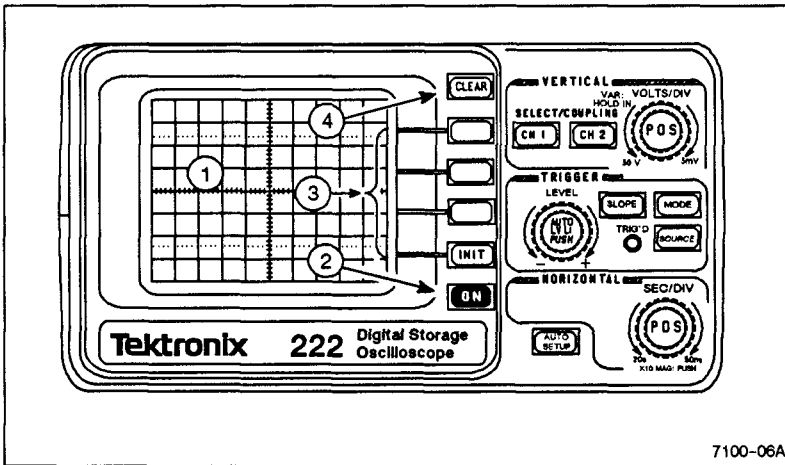







Figure 3-5. CRT display, menu buttons, and power.

- ②  **Button**—pressed to start the oscilloscope. Pressing it again turns off the acquisition and display activity; battery power is always connected.

The oscilloscope has an automatic time out feature that conserves battery power. The AUTO TIMEOUT feature may be turned on and off from the CONFIG menu called up by a press of the  button (see Section 4, para. 4.28).

- ③  **Buttons (menu select)**—used to make menu selections. When control menus are displayed, pressing the bezel button next to the control menu choice selects that menu item and clears the menu from the display. When menus are not displayed, pressing the menu button labeled  resets the acquisition for all trigger modes.

- ④  **Button**—used to clear menus and stored waveforms from the display. Menus and stored waveforms are cleared in a two-step priority when both are displayed, with menus being cleared on the first press and stored waveforms on the second press.

3.5 VERTICAL CONTROLS

Refer to Figure 3-6 for the following items.

- 1 **Probes**—used to connect signals to the vertical inputs. The two channels are fully isolated and independently floatable. The probes are permanently connected to the oscilloscope. When not in use, they can be stored in the probe pouch along the right side of the instrument. A small channel identifier label is located on the cable at the probe. See para. 6.12 for the use of the various probe tip accessories provide with the oscilloscope.

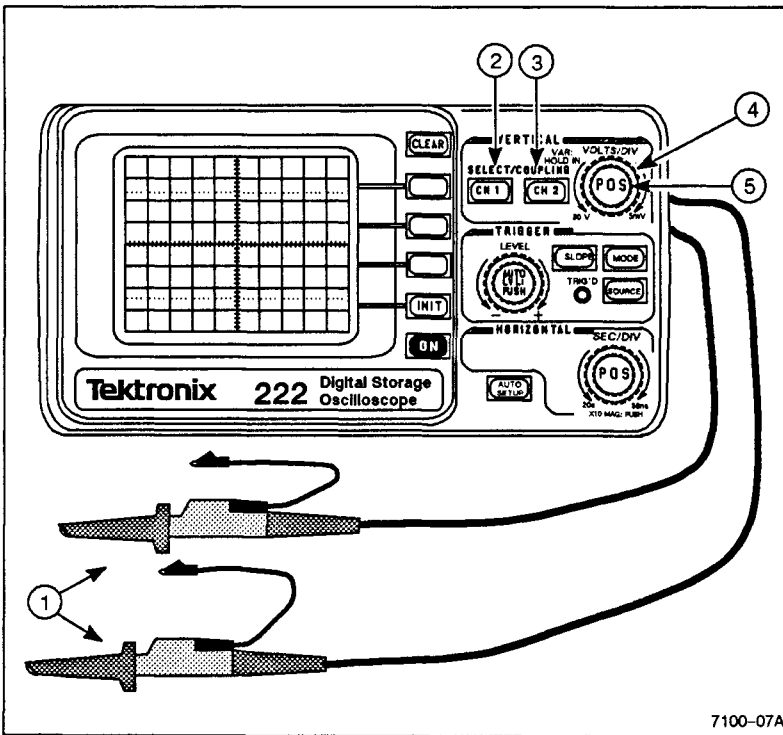

Figure 3-6. Probes and Vertical controls.

- ② **SELECT/COUPLING** CH 1 **Button**—selects CH 1 to respond to the vertical control changes. The selected channel has its VOLTS/DIV readout boxed in the display.

A second press after the channel is selected calls up the control menu needed to select the CH 1 input coupling (DC, AC, GND, and CH1 OFF). While the menu is displayed, further presses of the button cycle through the coupling choices except OFF. The CH1 OFF choice must be made using the menu-select button. If the channel display is turned off, the word "OFF" appears in place of the VOLTS/DIV readout for that channel. The effect of the vertical controls shifts to channel 2 at the time channel 1 is turned off as indicated by the VOLTS/DIV readout for channel 2 being boxed.

- ③ **SELECT/COUPLING** CH 2 **Button**—same as for the CH 1 button, but for channel 2.

- ④ **VERTICAL POSITION and Variable VOLTS/DIV Control (inner knob)**—positions the selected channel vertically. If the selected channel is "OFF," the effects of any control changes take effect when the trace is turned back on. The position of stored waveforms are not affected by this control. When held in and turned, it is the Variable VOLTS/DIV control for the selected channel.

In XY display mode, select CH 1 to position the display horizontally; select CH 2 to position the display vertically.

- ⑤ **VOLTS/DIV Switch (outer knob)**—controls the VOLTS/DIV scaling of the channel selected by the CH 1 or CH 2 button. The VOLTS/DIV settings for both channels are displayed in the top line of readout, and the selected channel's VOLTS/DIV readout is boxed. If the channel trace is turned off, the word "OFF" appears in place of the VOLTS/DIV readout for that channel. VOLTS/DIV changes made to an "OFF" channel take effect when the trace is turned back on.

3.6 HORIZONTAL CONTROLS

Refer to Figure 3-7 for the location of the following items.

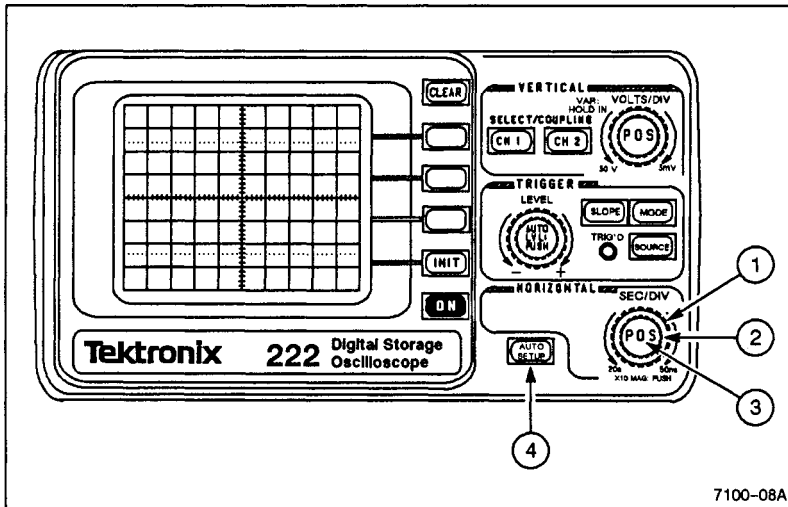

Figure 3-7. Horizontal controls.

- ① **SEC/DIV Switch (outer knob)**—sets the horizontal time scaling (seconds per division) of the acquisition and display in a 1-2-5 switching sequence. The scaling range is from 50 nanoseconds per division to 20 seconds per division (X10 MAG decreases the time per division scaling by a factor of 10). The SEC/DIV switch setting is displayed in the bottom line of readout.

There are default acquisition and display modes that are selected by the SEC/DIV switch depending on the Trigger MODE in effect. See the Supplementary Information in Section 6, para. 6.5.

- ② **Horizontal POSITION Control (inner knob)**—used to move the waveform displays horizontally. The traces may be positioned to the left or right up to one half the trace length.

When X10 MAG is on, the control scrolls through the expanded waveform. If the trigger point is positioned off screen to the left or right, the Trigger Position “+” indicator remains at the edge of the display area to help you locate your position in the expanded waveform. In XY display mode, the Horizontal Position control does not position the display. Use the CH 1 POSITION control to move the display horizontally.

- ③ **X10 MAG Switch (inner knob)** – switches between normal and X10 horizontal magnification when pressed.

With X10 MAG on, the portion of the display at the center horizontal graticule line is expanded by ten times. When X10 MAG is on, a X10 character is seen in the bottom line of the readout, and the SEC/DIV readout reflects the horizontal scaling of the magnified waveform display.

- ④  **Button** – auto ranges on the signals at the probe tips when pressed to provide the user with a quick setup for viewing the waveforms. If a channel has a signal applied, it will be turned on and vertically auto ranged.

See the Supplementary Info in Section 6, para. 6.1, for the events that occur with an AUTO SETUP.

3.7 TRIGGER CONTROLS

Refer to Figure 3-8 for the location of the following items.

- ① **Trigger LEVEL Control**—sets the voltage threshold that a trigger signal must cross to produce triggering. The Trigger LEVEL readout is displayed in the bottom line of readout.

The LEVEL control has enough range to trigger on any portion of a signal that is within the dynamic range of the vertical amplifier.

- ② **AUTO LVL: PUSH Button**—finds the peak values of the trigger signal when pressed and sets the Trigger LEVEL setting at the midpoint of the trigger signal amplitude.

- ③ **Trigger SLOPE Button**—switches between triggering on the rising slope or the falling slope of the trigger signal. The selected slope is shown in the bottom line of the readout as a “+” or a “-” symbol following the Trigger LEVEL readout.

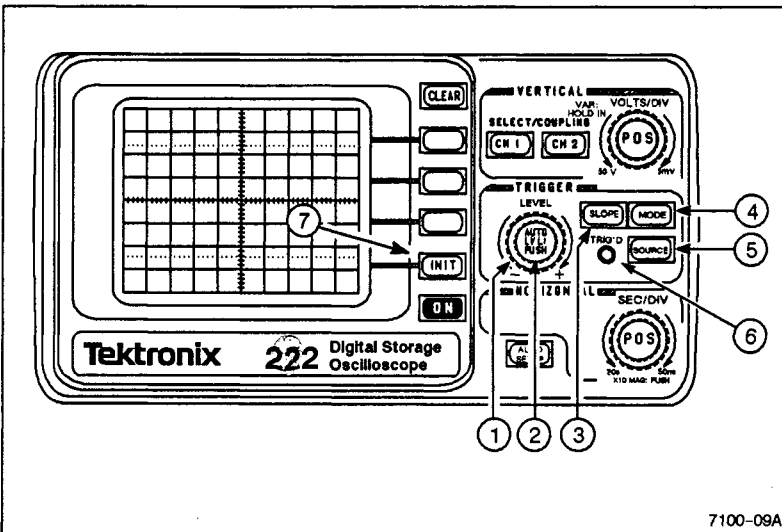







Figure 3-8. Trigger controls.

- ④ **Trigger  Button** – displays the TRIG MODE menu to make the trigger mode selection. The selected mode is boxed in the menu list.

Press the  button repeatedly to cycle through the menu choices while leaving the menu displayed. You may also select a new mode by pressing the menu-select button next to the menu item. The TRIG MODE menu is removed from the screen after selecting a mode with one of the menu-select buttons. Pressing  or calling up another menu also removes the menu from the display.

- ⑤ **Trigger  Button** – displays the TRIG SRC control menu. The current trigger source selection will be boxed in the menu.

Press the  button repeatedly to cycle through the menu choices while leaving the menu displayed. You may also select a new mode by pressing the menu-select button next to the menu item. The TRIG SRC menu is removed from the screen after selecting a mode with one of the menu-select buttons. Pressing  or calling up another function also removes the menu from the display.

- ⑥ **TRIG'D Indicator** – indicates that the oscilloscope is being triggered by the selected trigger source signal when lit.

- ⑦ ** Button** – resets the acquisition and display any time it is pressed when menus are not displayed. This button is used specifically for rearming the SSEQ trigger mode for a new acquisition. Pressing it also resets the AVG and CONT ENV mode displays and restarts the acquisition.

3.8 TOP PANEL BUTTONS

See Figure 3-9 for the location of the following items.

- ① **WAVEFORMS** **SAVE** Button—halts the acquisition in progress and freezes the waveform display. The control menu used to save waveform data for future reference is also called up. Four nonvolatile memory locations are available for saving displayed waveforms. The menu title will be SAVE CH 1 WW, SAVE CH 2 WW, or SAVE XY WW depending on the selected channel and display mode. When CH 1 and CH 2 traces are both displayed, choose the one to be saved in a selected memory location using the **CH 1** or **CH 2** button before selecting a save location. When a memory location button is pressed, an audible alarm will sound and nothing will be saved if the channel selected for saving is off.

Waveform will be saved according to the display mode (YT or XY) in effect.

- ② **WAVEFORMS** **RCL** Button—calls up the RECALL WVFRM menu for displaying saved waveforms. Recalled waveforms are displayed in the same type of display they were saved with (YT or XY). Displayed traces will be boxed in the menu.

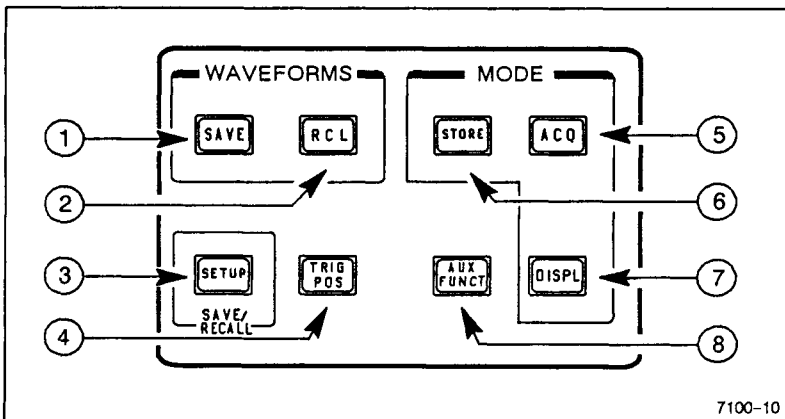





Figure 3-9. Top-Panel buttons.

- ③ **SAVE/RECALL**  **Button**—calls up a menu for saving a current front-panel setup, recalling one of four previously saved setups, or erasing one or all four of the saved setups. See Section 4, paragraphs 4.21 and 4.22 for operating instructions.
- ④  **Button**—displays the TRIG POS control menu for selecting the trigger position in STORE mode displays. The selected choice is boxed in the menu. Further presses of the button with the menu displayed cycle through the menu choices. You may select the data acquisition window around the trigger position directly by pressing the menu-select button for the setting you want (POST, MID, or PRE, see Section 6, para. 6.8). Direct selection clears the menu from the display.



In NONSTORE mode, the trigger position is always at the sixth data point of the waveform acquisition regardless of the position selected in the TRIG POS menu. The acquired waveform data (except for the first five data points) will therefore be post trigger data points (after the trigger event).

- ⑤ **MODE**  **Button**—displays the menu for selection of the acquisition mode. The selected mode is boxed in the menu. Choose the acquisition mode you want (NORM, ENV, AVG, or CONT ENV, see Section 6, para. 6.10) either by pressing the button to cycle through the choices or by pressing the menu-select button next to that choice. ENV and CONT ENV acquisition modes are in effect for SEC/DIV settings of 20 μ s per division and slower. At faster SEC/DIV settings, the acquisition mode reverts to NORM.
- ⑥ **MODE**  **Button**—toggles the display mode between STORE and NONSTORE. Both modes are digital acquisition; the difference is in how the displays are updated.

In STORE mode, traces will remain displayed between trigger events. In NONSTORE mode, traces are held only to the next display update (about 30 ms) if not triggered (except in SSEQ

Trigger Mode, the trace remains displayed after the acquisition has completed). The NONSTORE mode display acts in a manner similar to the display seen when using a conventional (non-digitizing) oscilloscope with the trigger point at the beginning of the trace.

- ⑦ **MODE**  **Button**—displays a menu used to make several display mode changes. The selections control the channel 1 and channel 2 invert modes (INV1 and INV2), the X-Y or Y-T display mode choice, and the readout display (RO OFF). The DISPLAY Mode menu is cleared when a selection is made.

- ⑧  **Button**—calls up the auxiliary functions menu (AUX). The AUX Menu controls several diverse features. The ALIGN choice displays a test pattern useful for making crt adjustments. The pattern remains on screen until  is pressed or another control is activated. The SELF CAL menu choice provides several self-calibration routines.

The menu called up by CONFIG is used to turn the AUTO TIMEOUT feature on or off and control the baud rate for communicating via the RS-232 interface. The final choice, IDENT, provides the user with a means to find out the version of firmware installed in the instrument. (See Section 4 for operation of the auxiliary functions.)

NOTE

With external power applied, the AUTO TIMEOUT feature is disabled, and the oscilloscope remains on until turned off using the  button.

3.9 REAR PANEL CONTROLS AND CONNECTORS

See Figure 3-10 for the following items.

- ① **HORIZ ALIGN**—a screwdriver adjustment used to align the display with the horizontal graticule lines. The ALIGN test pattern available in the AUX Functions menu provides a display to aid in adjusting this control.
- ② **VERT ALIGN**—a screwdriver adjustment used to align the display with the vertical graticule lines. Use the ALIGN test pattern available in the AUX Functions menu as an aid in adjusting this control.
- ③ **FOCUS**—a screwdriver adjustment used to adjust for best focus tracking during intensity changes.

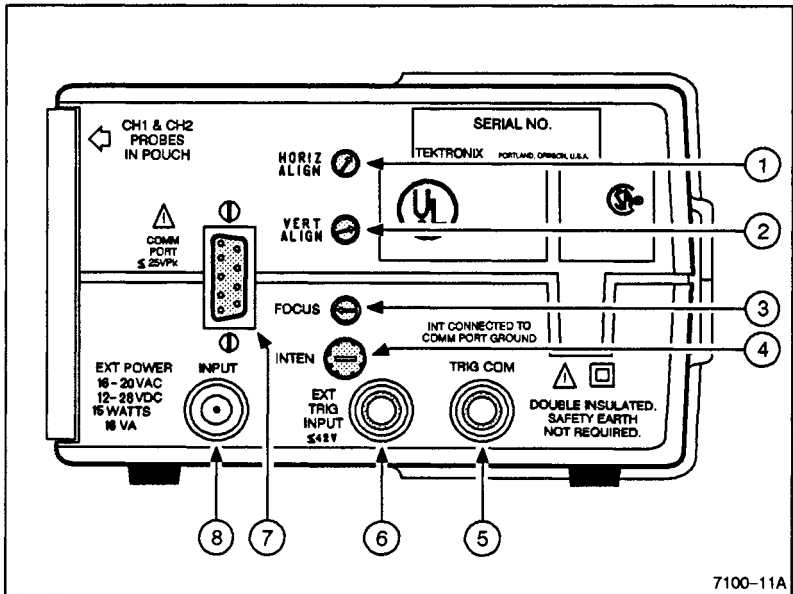

Figure 3-10. Rear Panel.

- ④ **INTEN**—used to adjust the brightness of the display for the best viewing level.
- ⑤ **TRIG COM Connector**—used to provide a trigger common reference connection point. The TRIG COM connector may be elevated to a maximum of 42 V peak.



If either the EXT TRIG COMM connector or the RS-232 cable is connected to an external earth ground or external power is applied, the oscilloscope chassis cannot be elevated.

- ⑥ **EXT TRIG INPUT Connector**—used to connect an external trigger signal to the oscilloscope.
- ⑦ **COMM PORT Connector**—provides an RS-232 compatible signal port. The limited command set to which the 222 responds allows waveforms and front-panel setups to be uploaded or down loaded via the port. Refer to the RS-232 Interface Guide for operating information and a list of the commands.
- ⑧ **EXT POWER INPUT Connector**—used to apply external power to the instrument. Either a 16 to 20 Vac (at 47 to 400 Hz) or 12 to 28 Vdc power source supplying at least 15 watts or 16 volt-amperes may be connected to run the oscilloscope and charge the internal battery. The battery-charger adapter supplied with the oscilloscope normally produces about 18 Vac, depending on the mains supply voltage and load current. When external power is connected, a small indicator (\triangleleft) appears at the right end of the top readout line.

SECTION 4

HOW IT WORKS

*This Document is a complete Scan from the original
Tektronix manual
For enquiries about our complete
High quality line of technical Manuals in PDF
mailto : Qservice@otenet.gr*

**SEE
OTHER
SIDE**

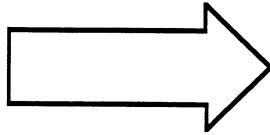

SECTION 4

HOW IT WORKS

4.1 TURN ON

Press  to start the oscilloscope. An audible beep is sounded when the oscilloscope comes on. A few seconds are needed to warm the crt heater before a display becomes visible.

Press again to turn it off; battery power is always connected.

NOTE

If the AUTO TIMEOUT feature is on, the oscilloscope turns itself off to conserve battery power if there is no control activity in a two-minute period. The AUTO TIMEOUT feature is disabled when an external source is used to power the oscilloscope.

4.2 AUTO SETUP

Press  to auto range on the signal(s) at the probe tip(s).

A channel that has no signal applied is turned off (except if neither channel has a signal applied, then CH 1 remains on). If a channel that is off has a signal applied, Auto Setup turns the channel on. The Vertical controls default to the "on" channel when only one is on, and the SEC/DIV and Trigger LEVEL settings are autoranged to that channel's applied signal. Channel 1 is the default channel if both channels have a signal applied. See Section 6, para. 6.1 for the default control settings and events that occur with an auto setup.

NOTE

AUTO SETUP does not set the SEC/DIV setting into the ROLL region (0.1 s/div and slower). The practical low frequency for using the AUTO SETUP feature is about 20 Hz.

4.3 MENU SELECTION

When one of the top-panel or front-panel buttons requiring a control menu is pressed, the menu choices are shown on the crt screen to the left of the bezel buttons (←). When a menu is called up, selected choices are indicated by a box around the menu item.

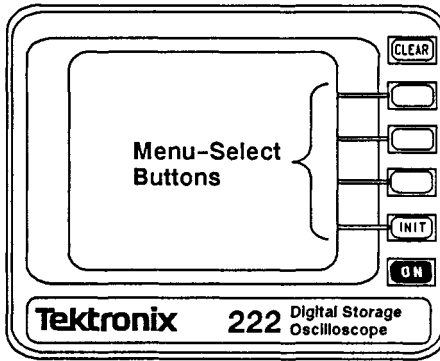

Press (menu item)← to select that menu item and clear the menu display. For many control menus, you may also press the menu call-up button repeatedly to cycle through the displayed choices while the menu is displayed. Press the button to remove the menu display after the correct selection has been made.

The fourth menu-select button acts as the button when a menu is not displayed. Pressing causes any acquisition in progress to reset and start over. It is specifically used to initialize the acquisition for SSEQ Trigger MODE.

4.4 STORE OR NONSTORE DISPLAY MODE SELECTION

Press the  button to toggle the display mode between STORE and NONSTORE.



Both modes are digital acquisition; the difference is in how the displayed waveforms are updated. A STORE mode display is held between trigger events. The NONSTORE mode display is similar to the display of a conventional (nondigitizing) oscilloscope and is blanked between triggers. The effects on the display are most noticeable in NORM Trigger MODE. The trigger point of a NONSTORE display is near the beginning of the trace.

4.5 MENU AND SAVED WAVEFORM DISPLAYS CLEARING

Press the  bezel button to remove menus and saved waveforms from the display.

Menus and saved waveforms are cleared in a two-step priority when both are displayed. Menu are cleared on the first press, and saved waveforms on the second press. A displayed menu is also cleared when a menu-select button is pressed or another control function is selected.

4.6 CHANNEL SELECTION

Press the  or  SELECT/COUPLING button to switch the effects of the front-panel vertical control changes between CH 1 and CH 2.

The selected channel has its VOLTS/DIV readout boxed in the display whether on or off; but, if off, the word "OFF" is displayed in place of a VOLTS/DIV setting. A second press of the button after the channel is selected displays the Input Coupling menu (see para. 4.7).

4.7 VERTICAL INPUT COUPLING

Press the **CH 1** or **CH 2** SELECT/COUPLING button to select the active channel. Press the button a second time to display the coupling menu for that channel.

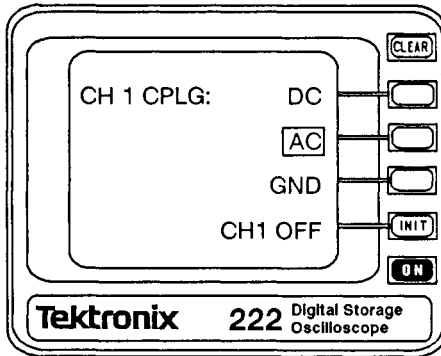

Press the button repeatedly to cycle through the coupling choices (except channel OFF) while the menu is displayed. After the correct choice is selected, press **CLEAR** to remove the menu from the display.



OR

Press **DC** , **AC** , or **GND** to select that input coupling directly. The menu is cleared when a direct choice is made using a menu-select button. See Section 6, para. 6.4 for a discussion of the coupling types.

Press **CH1 OFF** (or **CH2 OFF**) to turn the selected channel's trace off; channel OFF is not selected when switching through the input coupling choices using the channel-select buttons. When a channel's trace is off, the word "OFF" is displayed in place of the VOLTS/DIV readout for that channel. Both channel traces may be turned off. If a signal is applied to a channel that is off, that channel will be turned back on again when using the Auto Setup feature.

4.8 VOLTS/DIV SCALING

The VOLTS/DIV switch controls the amplitude scaling of the selected channel only. The display amplitude of the selected channel changes as the VOLTS/DIV setting increases or decreases. The larger the display amplitude needed, the smaller the deflection factor you need and vice versa. The on-screen VOLTS/DIV readout changes in step with the switch from 5 mV to 50 V until either range limit is reached. Continuing to turn the knob past the range limit causes no further readout change.



Press the  or  SELECT/COUPLING button to select the channel to be scaled if its VOLTS/DIV readout is not boxed in the display.

VOLTS/DIV



Rotate the knob (outer knob of the two concentric knobs in the Vertical section) to scale the selected channel vertically.

4.9 VERTICAL POSITIONING

Press the  or  SELECT/COUPLING button to select the channel trace to be positioned (if that trace is not the active channel).

VOLTS/DIV



Rotate the Vertical knob (inner knob of the two concentric Vertical control knobs) to position the channel trace vertically.

The positions of saved waveforms are not affected by this control. If the trace being positioned is the trigger source, the trigger point “+” indicator will follow the waveform (even when the trace is turned off). If the trigger source trace is positioned off screen, the “+” will be at the top or bottom of the screen to indicate the direction to the off-screen trace.

4.10 VARIABLE VOLTS/DIV CONTROL

Select the active channel using the **CH 1** or **CH 2** SELECT COUPLING button if the VOLTS/DIV setting of the channel you want to vary is not boxed in the readout display.

VOLTS/DIV



Press and hold in the knob (inner knob) while turning it counterclockwise.

The uncal symbol (>) is displayed in front of the VOLTS/DIV readout of the affected channel when the Variable control is out of the detent setting. The knob must be held in while turning it to change the variable gain setting for the channel.

VOLTS/DIV



Press and hold in the knob again while turning it clockwise until a beep is heard.

The calibrated VOLTS/DIV setting is then restored for the selected channel.

One use the Variable VOLTS/DIV control is to set a waveform display amplitude to a specific number of divisions between the calibrated settings.

4.11 CH1 AND CH2 INVERTED DISPLAY

Press the top-panel **DISPL** button to call up the Display menu. An inverted choice is boxed in the menu when called up.

Press **INV1**— or **INV2**— to switch that channel's display between inverted and noninverted. The menu clears when the selection is made, and a small down arrow is displayed in front of the VOLTS/DIV readout for an inverted channel.

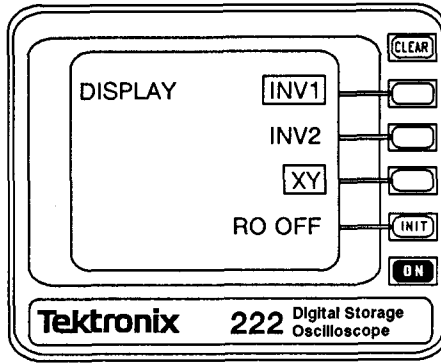

4.12 SEC/DIV SCALING

SEC/DIV





Rotate the knob (outer knob of the two concentric Horizontal Control knobs) to set the horizontal time scaling (seconds per division).

The range steps are in a 1–2–5 switching sequence from 50 ns per division to 20 sec per division. With the X10 MAG feature on, the times per division decrease by a factor of 10 (5 ns per division to 2 sec per division). The SEC/DIV switch setting is displayed in the bottom line of readout and changes with knob rotation until either range limit is reached. Continuing to turn the knob past the range limit causes no further readout change.

At some frequencies the display may be aliased. An alias waveform is one that is formed by under sampling. The sampling rate at a particular SEC/DIV setting is too low to capture enough data points to define the signal period. The result is a waveform display composed of samples taken from different periods of the signal. An indication that a waveform may be an alias is an unstable display that cannot be stabilized by adjusting the Trigger LEVEL control. Increase the SEC/DIV setting to eliminate the alias.



4.13 HORIZONTAL POSITIONING

SEC/DIV
 Rotate the Horizontal  knob (inner concentric knob) to move the waveform displays horizontally.

The traces may be positioned to the left or right up to one half the trace length. Turning the knob to the right (clockwise) moves the trace to the right. Readout positions are not affected by the Horizontal POSITION control. X-Y displays are positioned horizontally using the Vertical POSITION Control with CH 1 selected (X-AXIS horizontal positioning).

When X10 MAG is on, the Horizontal POSITION control is used to scroll through the expanded waveform display. The “+” trigger position indicator only moves as far as either edge of the display area. It remains there as a pointer to show you the direction to the trigger point in the expanded waveform.

4.14 X10 MAGNIFICATION

SEC/DIV
 Press in the Horizontal  knob (inner concentric knob) to magnify the display by 10 times around the center vertical graticule line.

Each press toggles the horizontal magnification feature on or off when in Y-T display mode. If X-Y display mode is active, an audible alarm is sounded, and the display is not magnified. When magnified, each division contains 5 data points horizontally instead of the normal 50.

To magnify a selected portion of a waveform, position the point of interest in the unmagnified display to the center vertical graticule line, then press the X10 MAG button.

When magnification is on, **10X** is seen following the SEC/DIV setting in the bottom line of the readout, and the SEC/DIV readout reflects the horizontal scaling of the magnified waveform. Character readouts and sampling rate of the acquisition system are not affected, just the time per division of the displayed waveform.

4.15 TRIGGER LEVEL SETTING

Rotate the Trigger  knob.

The control sets the voltage threshold that a trigger signal must cross to produce triggering. The Trigger LEVEL readout appears in the lower left corner of the display area.

The LEVEL control has enough range to trigger on any portion of a signal that is within the dynamic range of the vertical amplifier. If the trigger signal is off screen, the “+” indicator will be at the top or bottom of the screen to show the direction (if the oscilloscope is triggered).

Press the center  button to force a manual Trigger AUTO LVL. When it is pressed in, the trigger signal is checked for its peak values, and the Trigger LEVEL control setting is placed at the midpoint between the peaks. This feature is useful for quickly finding a Trigger LEVEL setting that triggers the display in NORM, AUTO BL, and SSEQ Trigger MODES. If you have the Trigger LEVEL set for a particular voltage that the trigger signal must cross to trigger the acquisition, don't press the AUTO LVL button as this will change the setting to trigger on whatever signal appears at the probe tip.

4.16 TRIGGER SLOPE SELECTION

Press  to toggle the trigger slope.

Each press switches between triggering on the rising slope or the falling slope of the trigger signal. The selected slope is shown in the bottom line of the readout as a “+” or a “-” symbol for rising and falling slopes respectively.

Switching between + and - slope while viewing a pulse signal lets you view the rising and falling edges of an expanded signal with only a single control change.

4.17 TRIGGER MODE SETTING

Press the Trigger **MODE** button to display the TRIG MODE menu. The selected mode is boxed in the menu display.

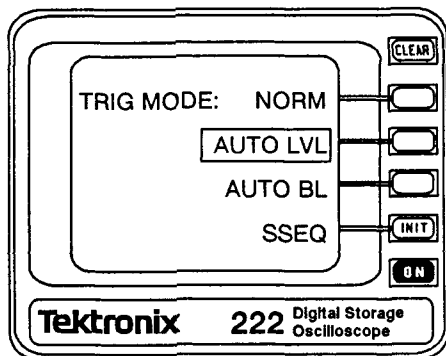

Press the **MODE** button repeatedly to cycle through the choices while the menu is displayed. The menu will remain displayed. Press **CLEAR** to remove the menu display when the desired Trigger MODE is selected.

OR

Press **NORM** , **AUTO LVL** , **AUTO BL** , or **SSEQ** button to select that mode directly. The menu clears when the selection is made.

NOTE

Use either NORM or SSEG Trigger MODE when AVG or CONT ENV acquisition mode is in effect for SEC/DIV settings of 0.1 sec and slower. AVG and CONT ENV acquisition display do not scroll; a complete record is obtained before the waveform is updated. If the acquisition is untriggered (AUTO LVL and AUTO BL in ROLL mode), the data obtained with each update will be different.

See Section 6, para. 6.6, for a description of the different trigger modes.

4.18 TRIGGER SOURCE SELECTION

Press the Trigger **SOURCE** button to display the Trigger SOURCE control menu. The selected source is boxed in the menu.

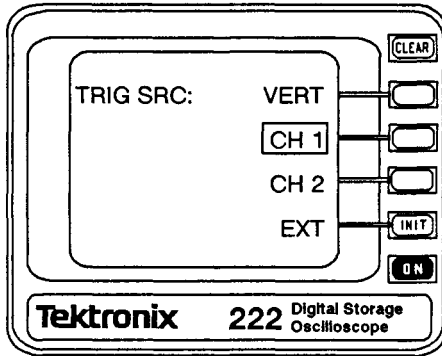

Press the **SOURCE** button repeatedly to cycle through the choices while the menu is displayed. Press **CLEAR** to remove the menu display when the desired Trigger SOURCE is selected.

OR

Press **VERT** , **CH1** , **CH2** , or **EXT** to make the choice directly and clear the menu.

VERT uses the channel 1 signal as the trigger source if both channels are displayed and the channel 2 signal when only channel 2 is displayed.

4.19 SAVING WAVEFORMS

There are four nonvolatile memory locations for saving displayed waveforms and their acquisition readout values. The Save Waveforms menu permits the user to save waveforms in a selected waveform memory. The menu title will be either SAVE CH 1 WV, SAVE CH 2 WV, or SAVE XY WV depending on the selected channel and display mode. When CH 1 and CH 2 traces are both displayed, choose the one to be saved in a selected memory location using the **CH 1** and **CH 2** buttons before selecting a save location. When a memory location button is pressed, an audible alarm will sound and nothing will be saved if the channel selected for saving is off. Waveforms are saved in the same display mode that is in effect at the time of saving (either Y-T or X-Y).

Acquire the waveform at the vertical position where you want it to be displayed when saved.

The waveform acquisition in progress is stopped when the **SAVE** button is pressed.

Press **SAVE**, **1**  to save the CH 1 waveform in memory in location 1.

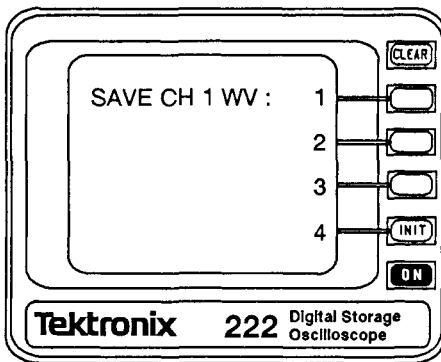

NOTE

When the SAVE location has been selected, the saved waveform trace is also displayed along with the acquisition waveform.



The Save Waveform menu remains displayed until the **CLEAR** button is pressed, another menu is selected, or a front panel control that affects the acquisition is changed (SEC/DIV, VOLTS/DIV, AUTO LVL: PUSH, X10 MAG ON). When the menu is cleared, waveform acquisition restarts.

The saved waveform remains displayed at the vertical position at which it was saved. Position the active trace away from the saved trace to view the saved waveform. Turn off the saved waveform trace(s) by pressing the **CLEAR** button a second time.

4.20 RECALLING SAVED WAVEFORMS

Recall saved waveforms from the RECALL WFRM menu. The menu displays four memory locations.

Once saved, a waveform may be recalled for display at any time. Waveforms saved in Y-T display format will be recalled in Y-T format; those saved in X-Y format will be recalled for display in X-Y format. The parameters of the latest recalled waveform are also displayed (see Figure 3-4).

Press **RCL**, **1**   to recall the waveform saved in memory 1 for display. Displayed waveform memories are boxed in the menu display.

NOTE

Attempting to recall a waveform from an empty memory causes an audible alarm to sound, and the menu remains displayed.

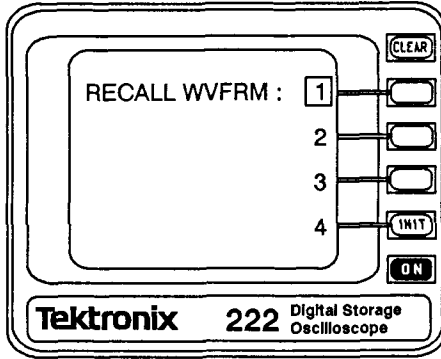

The recalled waveform will be displayed along with any acquisition waveforms. While the RECALL WFRM menu is displayed, pressing the menu select button for a boxed choice turns that saved trace off. If more than one saved waveform has been recalled for display, the parameters displayed are for the last waveform recalled. (If the trace for the last waveform recalled is turned off, the readout reverts to the previously recalled waveform.)

In X-Y display mode, the normal SEC/DIV readout location in the saved waveform parameters displays the VOLTS/DIV scale factor of the Y-Axis (Channel 2) signal. The first VOLTS/DIV readout in the line is the scale factor for the X-Axis (Channel 1) signal.

Saved waveforms may be cleared from the display by pressing the **CLEAR** button when the RECALL WFRM menu is not being displayed.

4.21 SAVING FRONT PANEL SETUPS

The SET UP menu permits you to save a current front-panel setup, recall one of four previously saved setups, or erase one or all of the saved setups. To save a setup, set up the controls so the waveform is acquired and displayed as needed for your application.

You may use the AUTO SETUP feature to autorange and autoposition when the signal you want to view is applied to either of the channel inputs. Make any further control changes needed to produce the display you want.

When the setup for your application is correct:

Press **SETUP**, **SAVE** , **1** to save the setup into location 1.

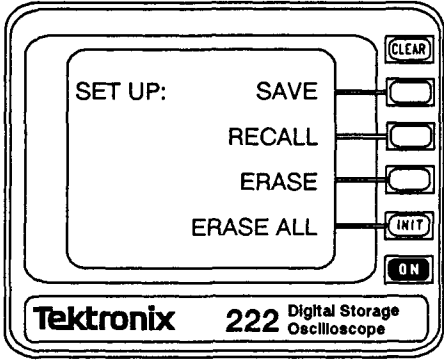

NOTE

A memory location that has data saved is boxed in the SAVE SET UP menu that is called up when SAVE is selected. A boxed location is overwritten by the new setup data when that memory is selected for saving.

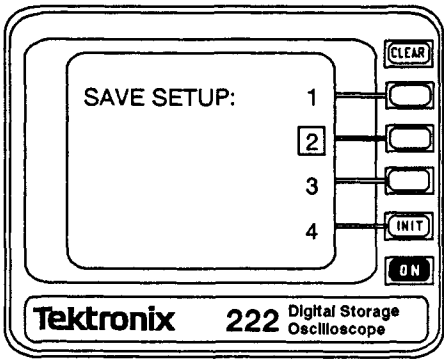

Selecting a storage location saves the setup and clears the menu.

NOTE

Vertical and Horizontal POSITION control settings and the Trigger LEVEL control setting are not saved. These controls may require adjustment to position the waveforms as needed after recalling the front-panel setup.

4.22 RECALLING FRONT PANEL SETUPS

Saved front-panel setups may be recalled to restore those control settings.

NOTE

You may want to keep a reference list of what is in the setup locations to refer to when recalling a previously saved setup.

When you want to recall a saved setup from location 1:

Press  , RECALL  ,  

NOTE

If an empty memory location is selected, an audible alarm beeps, and the menu remains displayed. The front-panel control settings do not change.

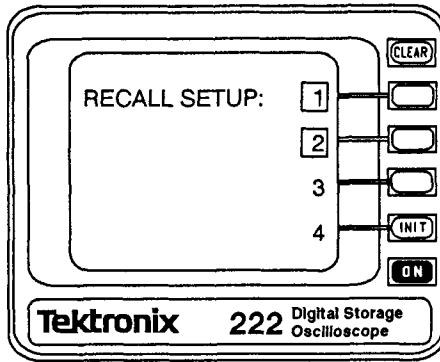

When a boxed memory location is selected, the menu clears, and the oscilloscope readouts and traces return with the saved front-panel settings in effect.

4.23 CLEARING SAVED FRONT PANEL SETUPS

A selected memory may be cleared or all four memories may be cleared at once. Filled memory locations are boxed in the menu.

To erase setup memory 1:

Press **SETUP**, **ERASE**—, **1**—

The menu clears when the selection is made.

Pressing **CLEAR** or calling up another menu prior to making a selection also removes the menu from the display.

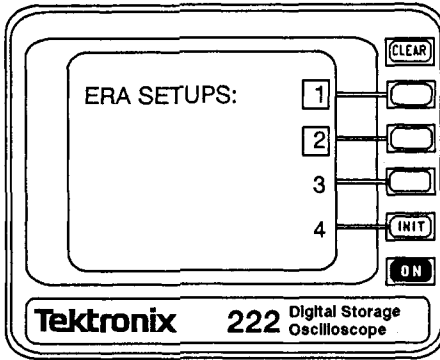

To erase all the setup memories at once:

Press **SETUP**, **ERASE ALL** — **INIT**

The menu clears when the ERASE ALL selection is made.

4.24 SETTING TRIGGER POSITION

The distribution of waveform data points around the trigger event is determined by the TRIG POS setting for waveforms acquired in STORE mode. Trigger position is selected from the TRIG POS menu. In NONSTORE mode, the trigger position is always set at the sixth data point; it is not adjustable. Changes made to the TRIG POS setting in NONSTORE mode will take effect when STORE mode is selected again.

To display the menu:

Press the **TRIG POS** button.

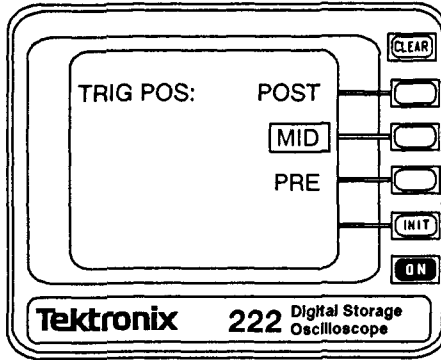

Press the **TRIG POS** button repeatedly with the menu displayed to cycle through the menu choices. Press **CLEAR** to remove the menu after the correct selection has been made. Calling up another menu also removes the TRIG POS menu from the display.

OR

Press **POST** to acquire the majority of data points after the trigger event.

Press **MID** to acquire data points divided evenly on both sides of the trigger event.

Press **PRE** to acquire the majority of data points from prior to the trigger event.

The menu clears and the normal acquisition readouts return when a direct selection has been made.

The current TRIG POS selection will be boxed in the menu choice list and indicated in the display by a “+” indicator at the Trigger LEVEL and position in the waveform data. If the trigger signal is displayed, the indicator will appear on the trigger signal waveform at the trigger position unless that signal is positioned off-screen. In that case, it will be displayed at the top or bottom of the screen to indicate the direction to the trigger signal trace.

4.25 ACQUISITION MODE SELECTION

The acquisition mode is controlled by the ACQ MODE menu. The selected mode is boxed in the menu.

Press **ACQ** to call up the menu.

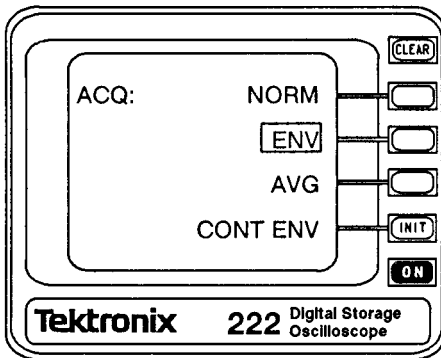

Press the **ACQ** button to cycle through the choices while the menu is being displayed. The selected mode is boxed in the menu.

OR

Press **NORM** , **ENV** , **AVG** , or **CONT ENV** to select that mode directly.

The ACQ menu is cleared when a selection is made using the menu-select buttons. Pressing **CLEAR** or calling up another menu also removes the menu from the screen. See Section 6, para. 6.10 for a description of the different acquisition modes.

4.26 X-Y OR Y-T DISPLAY MODE SELECTION

Press **DISPL** to call up the display menu.

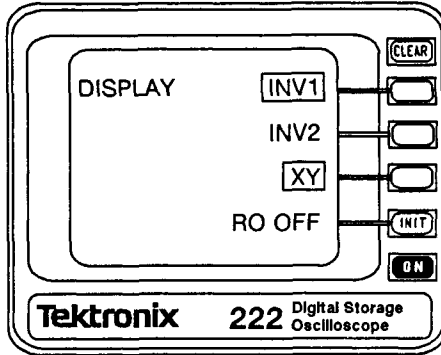

Press **X-Y**  to switch display modes.

X-Y mode displays Channel 2 (vertical) against Channel 1 (horizontal) and Y-T mode displays both vertical channels against a horizontal time base set by the SEC/DIV switch.

In X-Y mode, the vertical position and horizontal position of the display is controlled by the Vertical POSITION knob. Select CH 2 to position the display vertically and select CH 1 to position it horizontally. X-Y is boxed in the menu list when that display mode is selected and unboxed for Y-T mode.

The CH 1 and CH 2 traces are both turned on (if off) when X-Y mode is selected, and they cannot be turned off while X-Y display mode is in effect.

4.27 READOUT ON OR OFF

When several waveforms are being displayed or a series of waveforms are being viewed and a constant readout is not required, the readout may be turned off to unclutter the display. The readout is controlled from the Display Mode menu.

Press **DISPL** to call up the menu. The **RO OFF** menu choice is boxed when the readout displays are off.

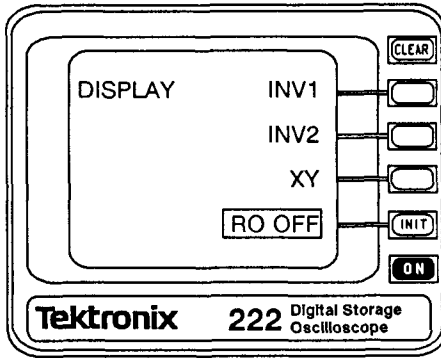

Press **RO OFF**—**INIT** to switch the readout display on and off. (Menu displays are not affected by RO OFF.)

Pressing the menu-select button when the choice is boxed turns the readouts back on and clears the menu.

The DISPL Mode menu is also removed when **CLEAR** is pressed or another menu is selected.

4.28 AUTO TIMEOUT

The Auto Timeout feature conserves battery power by turning the oscilloscope off when it is not in active use. With AUTO TIMEOUT disabled or with external power applied, the oscilloscope remains on until the **ON** button is pressed to turn it off.

Press **AUX FUNC** to call up the Auxiliary Functions menu.

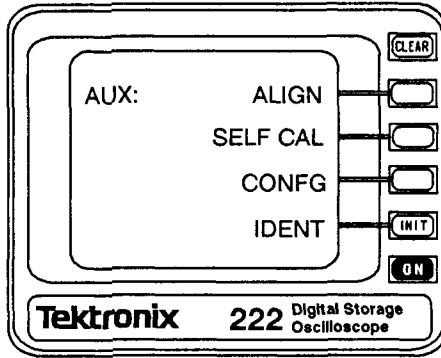

Press **CONFG** to bring up the control menu for the AUTO TIMEOUT selection. **AUTO TIMEOUT** is boxed in the menu when the feature is enabled. Press **CLEAR** to exit from the menu if the selection is already as you want.

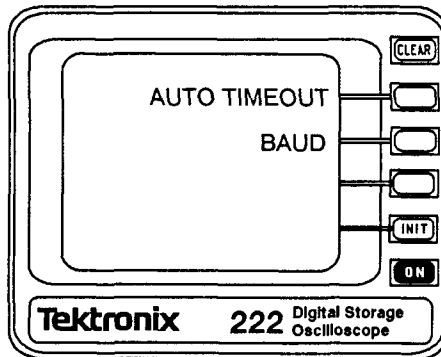



Press **AUTO TIMEOUT** to turn the AUTO TIMEOUT feature on or off. The menu clears after the choice is made.

4.29 SETTING BAUD RATE

Before communication between the 222 and a terminal or PC can be established, the baud rate must be set appropriately. The available choices are 300, 1200, 2400, and 9600 baud. Baud rate for the 222 is set from the Auxiliary Functions menu. See the terminal or PC instruction manual for setting the baud rate on those devices. See the RS-232 Interface Guide for information about using the serial port.

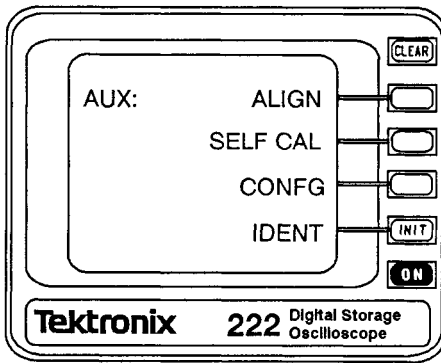
Press  to call up the menu.



Press **CONFIG**  to bring up the control choice for setting the baud rate.

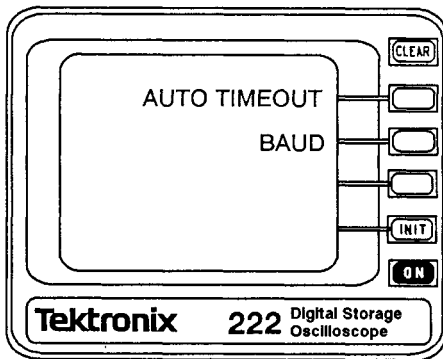

Press **BAUD**  to call the baud rate choices and make the correct menu selection for your application. The selected choice is boxed in the BAUD menu when called up. The menu clears when a selection button is pressed.

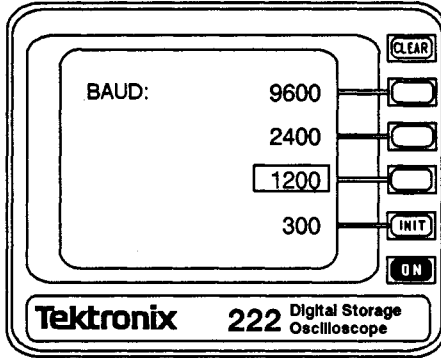

4.30 DISPLAY XY ROTATION ALIGNMENT

A test pattern used to adjust the horizontal and vertical display alignment is available in the AUX Functions menu.

Press  to call up the menu.

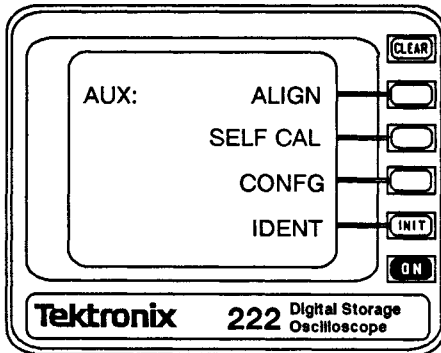

The ALIGN function of the AUX Functions menu calls up a second menu.

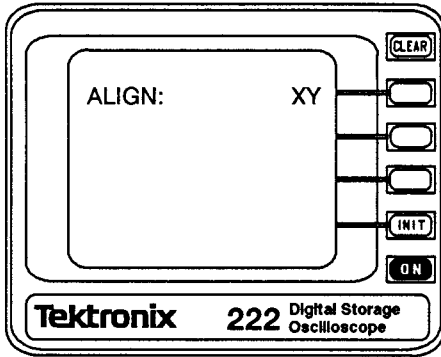

Press **XY**  to display a test pattern that is useful in making crt adjustments (see Figure 4-1).

Adjust the **HORIZ ALIGN** and **VERT ALIGN** controls (screwdriver adjustment located on the rear panel) to align the lines of the test pattern with the horizontal and vertical graticule lines.

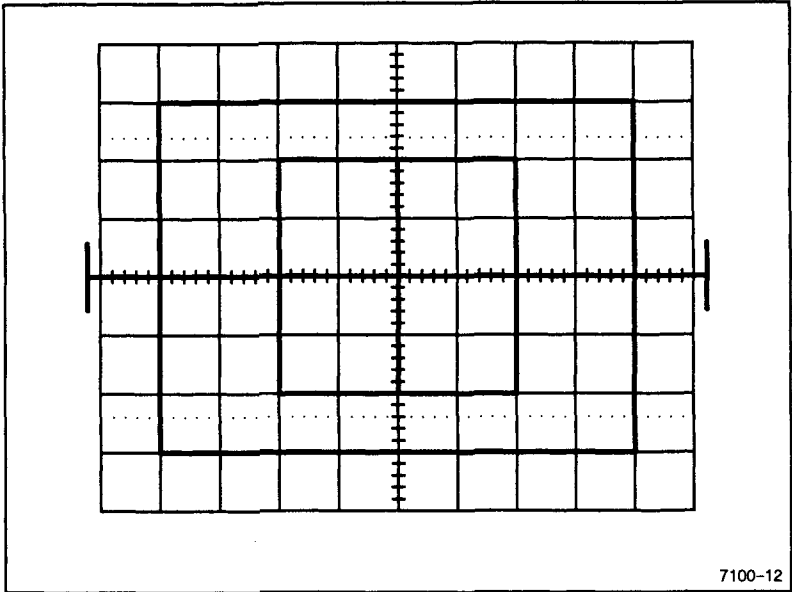

Figure 4-1. ALIGN XY test pattern.

Use the **CLEAR** button to remove the pattern from the display when you have completed the display adjustments.

4.31 SELF CALIBRATION

From the AUX FUNCT menu, the SELF CAL choice calls up an additional menu used to run the self calibration routines. A terminal or a PC operating in terminal mode, may be connected to determine the testing results of the routines, but it is not required. A PASS/FAIL indication is displayed on the crt when a test is finished.

NOTE

Disconnect both the CH 1 and CH 2 Probes from any signal source before performing the SELF CALIBRATION routines.

Press **SELF CAL**  to call up the calibration menu.

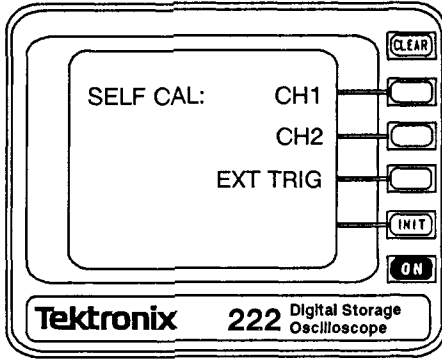

Press **CH 1**  to start the Channel 1 self calibration.

When the PASS/FAIL message is displayed the first routine is done.

Press **CH 2**  to start the Channel 2 self calibration.

When the PASS/FAIL message is displayed the second routine is done.

Press **EXT TRIG**  to bring up the menu for running the external trigger self calibration.

NOTE

For this self calibration, the EXT TRIG COMM and EXT TRIG INPUT connectors must be connected together. A short jumper with banana plug connectors may be used to make the connection.

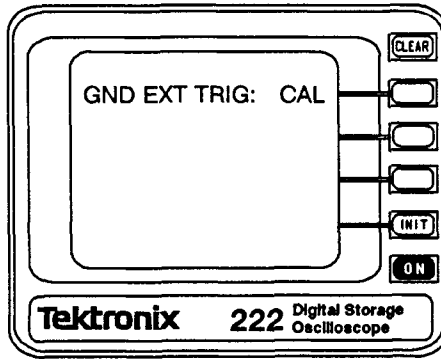

Press **CAL**  to start the External Trigger self calibration routine when the EXT TRIG COMM and EXT TRIG INPUT connectors are joined. A PASS/FAIL message is displayed when the routine is done.

Press the  button at the completion of the self calibration routines to return to normal oscilloscope operation.

If a self calibration step fails, the currently stored calibration constants are not changed. Rerun the failed routine again. If the failure persists, refer the oscilloscope to a qualified service person.

A coded error message is output when an error occurs. Further information about the nature of the failure may be found by connecting the RS-232 interface port to a terminal and rerunning the failed self calibration routine. See Section 7 of this manual or the RS-232 Interface Guide for the part number of the interconnection cable required. Tables and other information needed to decode the error messages are in the RS-232 Interface Guide.

4.32 FIRMWARE VERSION IDENTIFICATION

Identify the version of firmware installed using the AUX FUNCT menu.

Press **AUX FUNCT** to call up the menu.

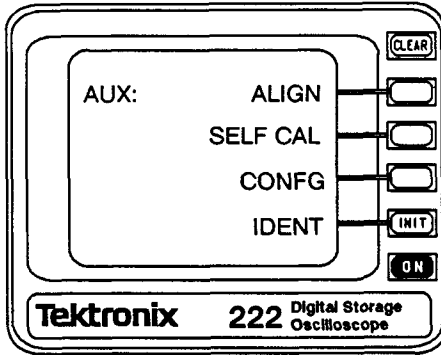

Select **IDENT**—**INIT** to display the firmware version installed in your instrument. The IDENT display is superimposed on the displayed waveforms and readouts and remains displayed until the **CLEAR** button is pressed to remove it from the display. A typical IDENT display is shown below; X.XX is the firmware version number location.

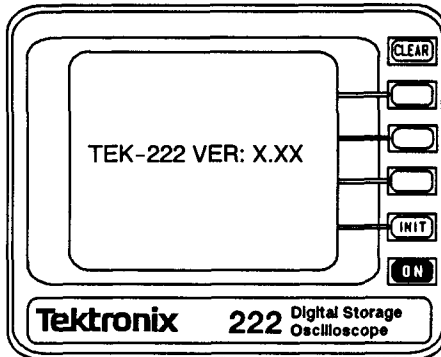

SECTION **5**

**MAKING
MEASUREMENTS**

*This Document is a complete Scan from the original
Tektronix manual
For enquiries about our complete
High quality line of technical Manuals in PDF
mailto : Qservice@otenet.gr*

**SEE
OTHER
SIDE**

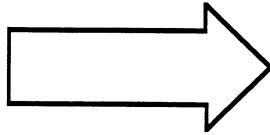

SECTION 5

MAKING MEASUREMENTS

5.1 SIGNAL TRACING WITH AUTO SETUP

The AUTO SETUP feature of the 222 Oscilloscope is very useful for getting a quick setup to view unknown signals at the probe tips of the two vertical channels. Pressing the  button performs many functions for the user. It sets the vertical and horizontal scaling to display the signal with several divisions of amplitude and 1 to 5 waveform periods if possible. The trigger peak values are determined, and the LEVEL control is set to the midpoint. The traces are positioned vertically to provide an on-screen display. The Trigger MODE is set to AUTO LVL and the Trigger SOURCE is set to VERT MODE. Both probe tips are checked for a signal. If either channel display is off, it will be turned on if a signal is found. If a signal is not found on either of the probes, only the Channel 1 trace is turned on. (See Section 6, para. 6.1 for a complete list of the default control settings.)

To use the auto setup feature for signal tracing, connect the probe tip to the test point for the unknown signal. Then just press the AUTO SETUP button. If a signal is applied to both probes, both channels will be auto set vertically; only the trigger channel will be auto set horizontally. If both signals are time related, both waveform displays will be stable.

5.2 GRATICULE MEASUREMENTS

The graticule is internally marked on the crt face to provide parallax-free viewing. The graticule has eight vertical and ten horizontal major divisions. Major divisions are further divided into five sub-divisions of 0.2 division each, marked along the center vertical and horizontal graticule lines. Two dotted graticule lines mark the 10% and 90% points of a six-division signal. These lines aid the user in making rise- and fall-time measurements. Vertical deflection factors and horizontal timing are calibrated to the crt graticule for making accurate measurements. The VOLTS/DIV and SEC/DIV settings are

read directly from the crt to determine the scaling factors for waveform measurements.

VOLTAGE MEASUREMENTS. Waveform voltages are found by first counting the vertical graticule divisions and partial divisions occupied by the vertical portion of the display. Then simply multiply that number by the VOLTS/DIV scale factor of the channel that is displaying the waveform. To improve the accuracy of the measurement, position the waveform both vertically and horizontally to take advantage of the minor divisions of the center vertical graticule line.

For example, in Figure 5-1 the peak-to-peak amplitude of the sine-wave signal is 5 divisions with a VOLTS/DIV readout of 0.2 V. Multiplying 0.2 V times 5 divisions gives a peak-to-peak voltage of 1 V.

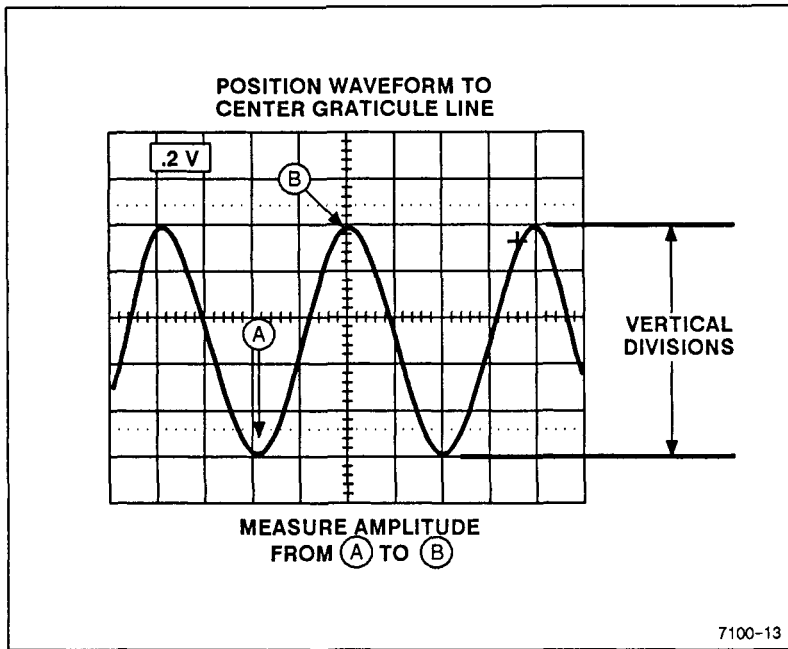

Figure 5-1. Peak-to-peak voltage measurement.

Voltage with respect to ground is found by first setting a ground reference level. Select GND coupling for the measurement channel and position the baseline trace to a reference graticule line. If the signal being measured is positive with respect to ground, the bottom graticule line makes a good ground reference. After setting the position of ground, switch to DC coupling to make the measurement. Do not change Vertical POSITION setting after switching back to DC coupling or you will lose your ground reference.

Find the number of vertical divisions from the ground reference to the measurement point on the signal and multiply by the VOLT/DIV setting. The result is the voltage at the measurement point with respect to ground.

In the figure 5-2, the ground level reference is the bottom graticule line. From the ground reference to the most negative point on the signal is 3.5 divisions up. Multiplying that number by the 5 V per division scale factor gives a dc level of 17.5 V at the measurement point.

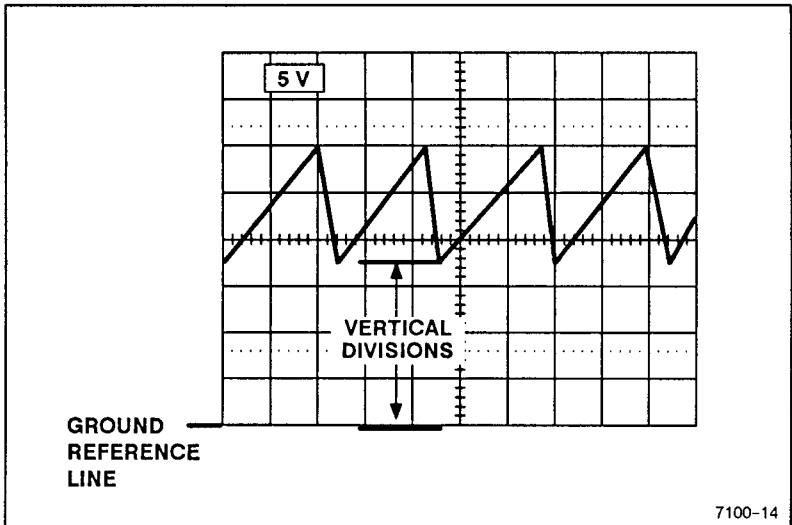

Figure 5-2. Voltage with respect to ground.

TIME MEASUREMENTS. Time measurements are made by first determining the horizontal divisions (including any partial division) between the measurement points. Then multiply that number by the SEC/DIV scale factor; the horizontal scaling is the same for either channel display.

NOTE

If a saved waveform is being measured, the scale factors for the saved waveform must be used for the calculations for both voltage and time measurements. The VOLTS/DIV and SEC/DIV readouts for the active channel may be unrelated to the saved display.

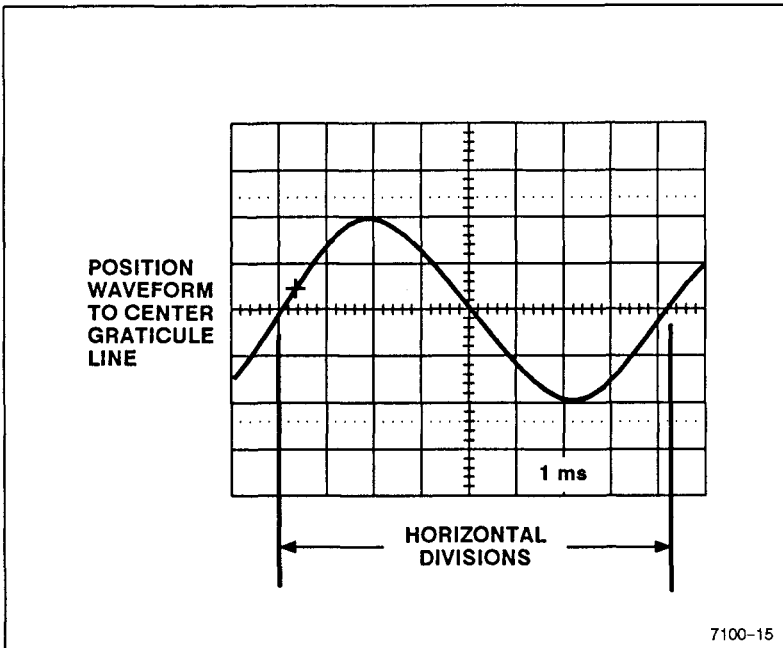

Figure 5-3. Time measurement.

Again, as with the voltage measurement, accuracy is improved by positioning the waveform to take advantage of the minor divisions of the center horizontal graticule line.

For example, in Figure 5-3 the horizontal spacing for one sine-wave period is 8.2 divisions with a SEC/DIV readout of 1 ms. Multiplying 1 ms times 8.2 divisions gives a period of 8.2 ms.

RISE TIME MEASUREMENT. Using the graticule to measure the rise time or fall time of a signal requires some signal scaling so that the 10% and 90% dotted graticule lines may be used for making the measurement. Basically, the scaling involves selecting a VOLT/DIV setting that produces more than the required 6 division of vertical deflection, then adjusting the Variable VOLTS/DIV control to set the deflection for exactly 6 divisions. The signal is positioned vertically to set the baseline and peak amplitude of the signal as shown in Figure 5-4.

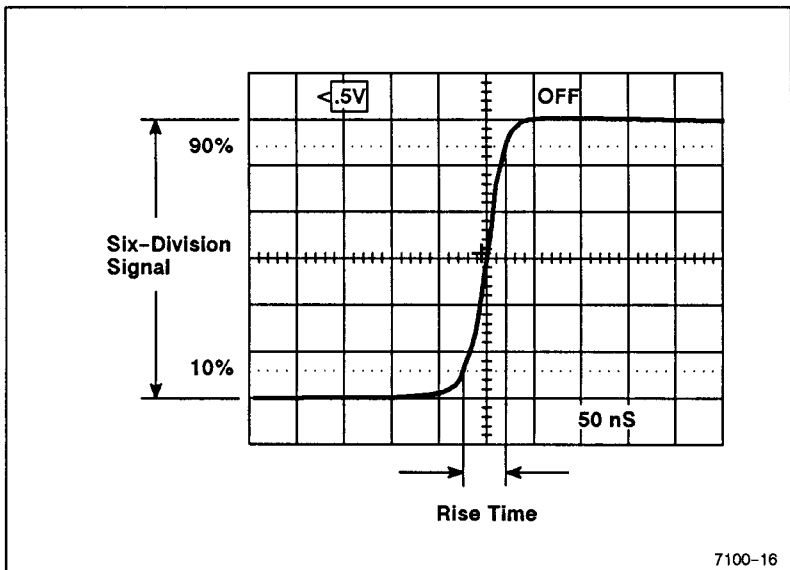

Figure 5-4. Rise Time measurement.

In the example illustration, the horizontal distance between the cross-over points for 10% and 90% is about 0.9 division. Multiply that by the SEC/DIV readout to obtain a rise time of approximately 45 ns. A trigger position of MID is shown in the example to display the complete rising edge of the signal. If fall time is to be measured, use negative Trigger SLOPE to view the falling edge of the signal.

5.3 FLOATING MEASUREMENTS

The vertical inputs and probe reference leads of the 222 Digital Storage Oscilloscope are completely isolated from the chassis, external ground, and from each other. This feature makes it ideal for making waveform measurements directly across circuit components without regard to the ground reference. This type of measurement is not possible using a grounded oscilloscope without special isolation adapters. The double-insulated construction also permits safe use of the 222 for making elevated voltage measurements (up to the safe input limits given in the Specifications).



If either the EXT TRIG COMM connector or the RS-232 cable is connected to an external earth ground or external power is applied, the oscilloscope chassis cannot be elevated.

5.4 DIFFERENTIAL MEASUREMENTS

The differential vertical inputs make it possible to perform in-circuit measurements while rejecting common-mode noise found in many power supply and low-level signal circuit. A typical use for rejecting common-mode noise is shown in Figure 5-5.

In 5-5A, the common-mode noise completely hides the audio signal of interest. With the 222 isolated differential vertical input, the underlying signal, in this case the dial tone on a typical telephone system, is free of the noise as seen in 5-5B.

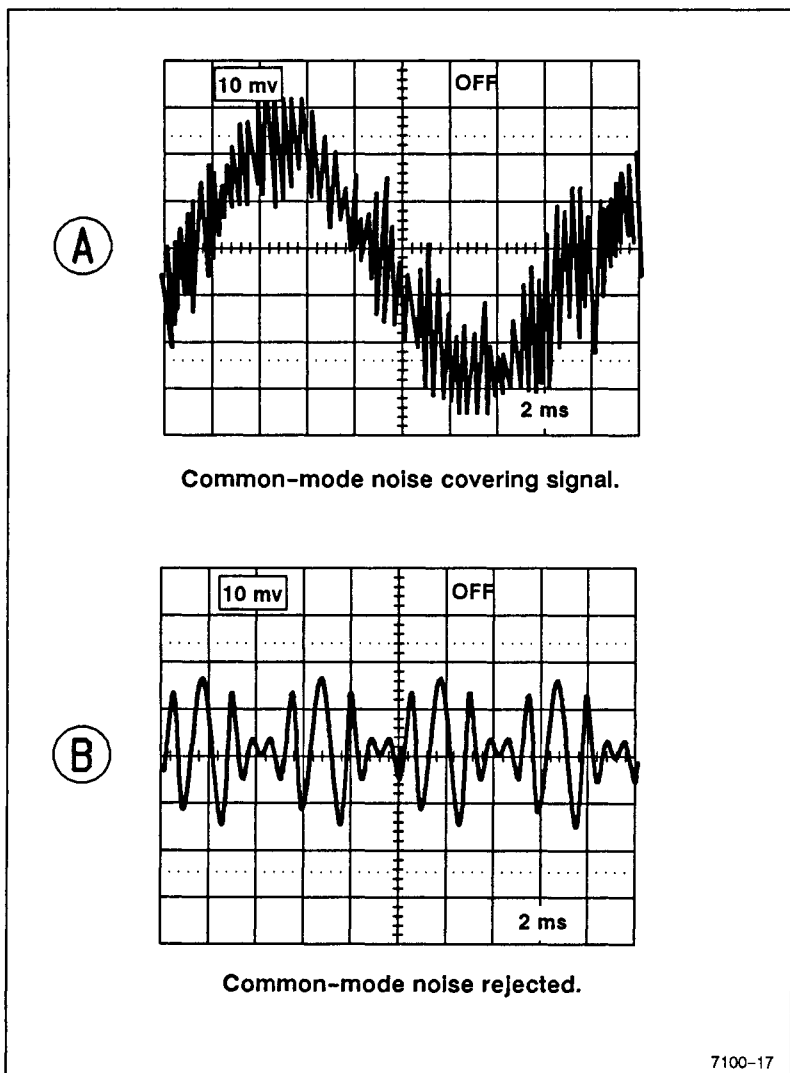

Figure 5-5. Common-mode rejection with differential inputs.

5.5 SINGLE SWEEP OPERATION

1. Preset the instrument controls and obtain a baseline display.

NOTE

The critical part of single-sequence operation is setting the trigger point to get a sweep on a random event. Determine the characteristics of the signal that you want to trigger the sweep so that you can set the trigger control correctly. Determine the correct slope to trigger on and set the Trigger SLOPE to match.

2. Apply a test signal to the CH1 input to use for setting the Trigger LEVEL control. The test signal should be of the same amplitude and general type (negative or positive pulse or sinusoidal) as the signal you want to trigger on.
3. Press AUTO SETUP to obtain a quick front-panel control setup for the test signal. If the vertical or horizontal scaling result is not what you want to view, adjust the VOLTS/DIV and SEC/DIV controls as you wish. You may also want to set the Vertical POSITION differently.
4. Switch the Trigger MODE to NORM and the Trigger SOURCE to CH 1. Then, adjust the Trigger LEVEL control carefully for a stable display.
5. Now switch the Trigger MODE to SSEQ and check that the sweep triggers each time the **INIT** button is pressed. If it does not, readjust the Trigger LEVEL control slightly so that the sweep does trigger with each press of the **INIT** button.
6. Disconnect the test signal from the oscilloscope and apply the random signal to the input.
7. Press the **INIT** button to initialize the trigger system for the SSEQ acquisition. The TRIG'D indicator lights when the event triggers.

8. When the single sequence has been triggered and completed, another acquisition is started when the **INIT** button is pressed again to rearm the trigger circuit.

NOTE

Changing a control that affects the acquisition (VOLTS/DIV, SEC/DIV, etc.) also reinitializes the SSEQ, and a new acquisition is done.

In ROLL mode, SSEQ Trigger Mode is very useful for capturing an event that occurs either randomly or infrequently. If the event is also very narrow, use the ENV acquisition mode as well. ENV acquisition mode samples the signal at the maximum sampling rate and displays the peaks found. Initialize the SSEQ and let the oscilloscope watch for the event. Data will be continually acquired up to the trigger point. When the trigger event happens, the remaining data needed to fill the rest of the display is acquired. At that point the acquisition is halted and the waveform (with triggering event captured) remains displayed until reinitialized.

*This Document is a complete Scan from the original
Tektronix manual
For enquiries about our complete
High quality line of technical Manuals in PDF
mailto : Qservice@otenet.gr*

**SEE
OTHER
SIDE**

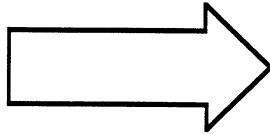

SECTION 6

**MORE ON
HOW IT WORKS**

*This Document is a complete Scan from the original
Tektronix manual
For enquiries about our complete
High quality line of technical Manuals in PDF
mailto : Qservice@otenet.gr*

**SEE
OTHER
SIDE**

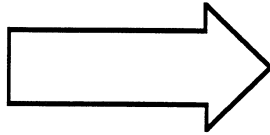

SECTION 6

MORE ON HOW IT WORKS

The detailed explanations contained in this section are for reference when the user requires more information on certain controls and features. The reference paragraphs are indicated in Tables 3-1, 3-2, and 3-3, the Operator's Quick Reference tables.

6.1 AUTO SETUP

The VOLTS/DIV, SEC/DIV, and Vertical POSITION controls are set to provide the user with a quick setup for viewing the waveform when AUTO SETUP is used. Autoranging takes place on a priority basis, with channel 1 having the number one priority when signals are applied to both channel probes. If a signal is applied to only one probe, autoranging for VOLTS/DIV, SEC/DIV, Trigger LEVEL, and vertical position occurs on that signal, and the channel without a signal applied is turned off (except channel 1 will not be turned off if neither channel has a signal applied). When a signal is applied to both channels, the channel 1 signal determines the SEC/DIV setting and Trigger LEVEL; both signals are autoranged vertically and positioned within the crt display area. The channel 1 signal is positioned in the top half of the graticule area, and the channel 2 signal is positioned in the bottom half. The Vertical input coupling is set to ON, and the trigger level is set for triggering on the signal. See Table 6-1 for a list of all the default settings that occur when an auto setup is done.

Auto Setup will not set the SEC/DIV setting into the SCAN or ROLL ranges (0.1 sec per division and slower). The practical lower frequency limit is about 20 Hz. Signals having a too low frequency or repetition rate, will not be auto ranged correctly. Signals of too high a frequency will be autoranged vertically but will require further setting of the SEC/DIV control to produce a usable display of the signal's wave shape.

Table 6-1
AUTO SETUP Defaults

Control	Default Setting	Control	Default Setting
CH1/CH2 VOLTS/DIV	As determined by signal level.	Trigger SOURCE	VERT
CH1/CH2 VOLTS/DIV Variable	Calibrated (in detent)	Trigger MODE	AUTO LVL
CH1/CH2 Coupling	AC if in AC when selected. DC if in DC, GND, or OFF, unless there is no signal, then it is OFF.	Trigger POS	POST
Acquisition Mode	NORM	Trigger SLOPE	Plus
STORE/ NONSTORE	NONSTORE	Trigger LEVEL	Midrange in the Trigger signal
CH1/CH2 INV	OFF (noninverted)	X10 MAG	OFF
XY Display	Off (Y-T)	Readout	ON
SEC/DIV	As determined by signal frequency	Channel SELECT	CH1 if sufficient signal on CH1 input or no signal on CH2.

6.2 PROBES



The exposed probe tips are very sharp to aid in probing through resist and oxide layers. When placing the probes in the side pouch, use care not to stick your fingers or the material of the pouch with the probe tips.

The two probes are permanently connected to the oscilloscope. When not in use, they can be stored in the probe pouch along the right side of the instrument.

The two channels are fully isolated and independently floatable. A label on the probe cable next to the probe body identifies the vertical channel (CHANNEL 1 or CHANNEL 2). The probe attenuation factor is 3 and is automatically reflected in the VOLTS/DIV readouts.

Probe accessories include a retractable hook tip, a probe common shroud, an IC lead protection shroud, and a detachable probe common lead for each probe (see Figure 6-1). The hook tip permits hands free operation when connecting to easily assessible test points (usually a component lead or test point connector). When probing circuit board runs and other points in tight access locations, install the probe common shroud after removing the hook tip. The exposed sharp probe tip will connect through resist and oxide layers while the shroud prevents accidental contact of the probe common lead to adjacent circuitry. Use the IC lead protection shroud on the probe tip when testing integrated circuit devices. The shroud leaves the sharp probe tip exposed, but it prevents either the probe tip itself or the probe common contact from shorting across adjacent IC leads.

The detachable probe common lead is used to connect the oscilloscope input common to the reference point of the circuit being tested. The probe common lead is not chassis ground and may be connected to an active circuit component. A true voltage waveform across a component may be viewed (see para. 5.3).

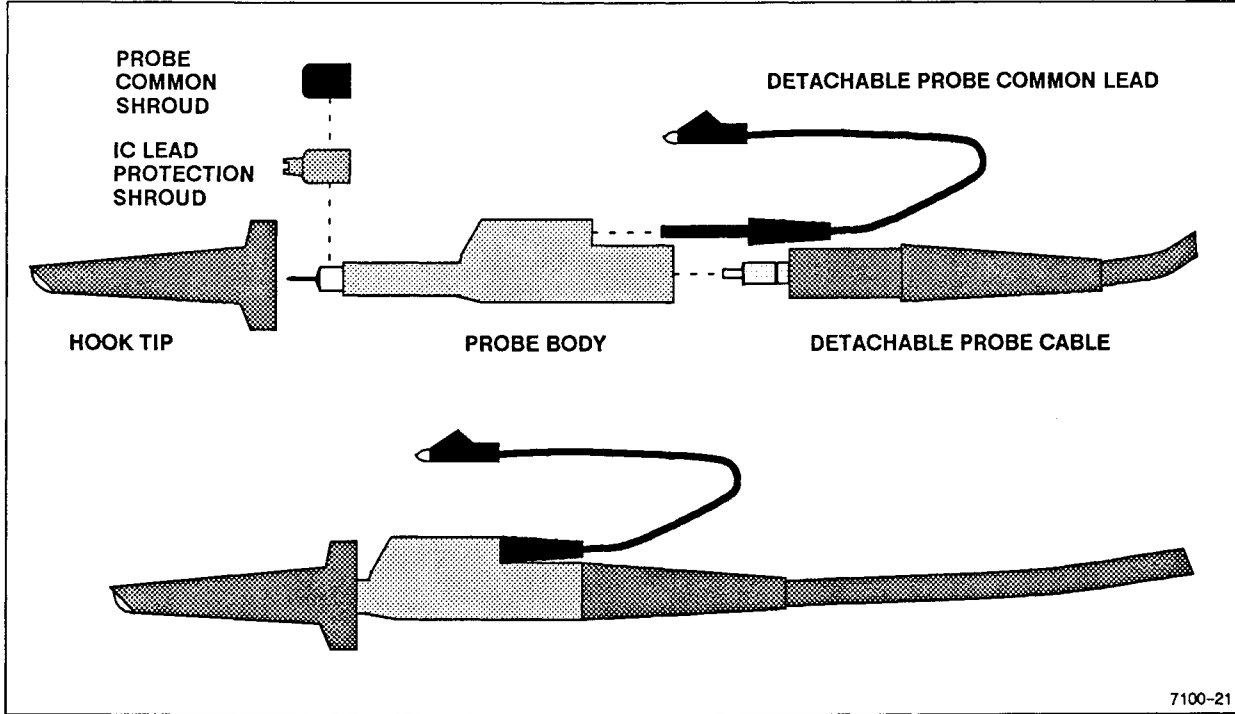

7100-21

Figure 6-1. Probe and probe accessories.

6.3 STORE AND NONSTORE DISPLAY MODES

In STORE mode, traces will remain displayed between trigger events. When STORE mode is active, an St symbol is seen in the bottom line of the readout. The space is blank in NONSTORE mode. (See Figure 3-4 for the location of the readouts.)

In NONSTORE mode traces are held only to the next display update (about 30 ms). If a trigger has not happened before the update, the trace is blanked until a new acquisition occurs. However, in AUTO BL (auto baseline) Trigger MODE, a trigger will be forced if one does not occur, and the data captured will be displayed.

6.4 VERTICAL INPUT COUPLING

The vertical channel input coupling is controlled from the CLPG menu called up by pressing a channel SELECT/COUPLING button twice (or once if the channel is already selected).

DC: Passes all frequency components of the input signal (up to the vertical bandwidth) to the attenuator of the selected channel. Select DC input coupling when the complete waveform content (dc + ac) is to be viewed.

AC: Capacitively couples the input signal to the attenuator of the selected channel; dc is blocked. Select AC input coupling when viewing most waveforms to reduce the amount of vertical positioning needed from waveform to waveform.

GND: Disconnects the input signal and grounds the input of the selected channel. Select GND coupling to set a ground reference level for dc waveform measurements.

CH1 OFF or CH2 OFF: Turns off the display of the selected channel. Select OFF to remove an unused trace from the display. Both active channels may be turned off to reduce the clutter for viewing saved waveforms. If a channel is off, "OFF" is displayed in the VOLTS/DIV readout location for that channel.

NOTE

Changes to the Vertical POSITION, VOLTS/DIV, or Variable VOLT/DIV control setting for a selected

channel that is "OFF" take effect when the trace is turned back on.

6.5 DEFAULT ACQUISITION MODES

The default modes possible are: SCROLL, SCAN-ROLL-SCAN, SCAN-ROLL-SCAN-SAVE, RECORD, and REPETITIVE.

As the SEC/DIV switch is rotated, the method of acquisition changes at predetermined settings. In general, the switching is as follows. At the very slow sweep speeds (20 sec to 0.1 sec per division) a version of ROLL mode (dependent on the Trigger MODE in effect) is selected. When the sweep speeds are faster (50 ms to 5 μ s per division), full-record sampling is done. At the fastest sweep speeds (2 μ s to 50 ns per division), equivalent-time sampling of the applied signal(s) occurs. Table 6-2 shows this information.

SCROLL Mode: In NORM and ENV acquisition mode, with either AUTO LVL or AUTO BL Trigger Mode selected, the display mode for SEC/DIV settings of 20 second per division to 0.1 second per division is Scroll mode (continuous ROLL). No trigger is accepted, and each data point is displayed as it is acquired, starting with the first data at the left end of the trace. Only valid data points are displayed, and the trace is blanked at the end of the valid points. After the display is filled, the data points are shifted left one position for each new data point acquired. The new data point is added at the first position at the right end of the trace, giving the effect of scrolling the waveform across the display area. Pressing the INIT button at any point restarts the acquisition and display. AVG and CONT ENV acquisitions mode displays do not scroll; they are updated as full-records only. At the slower SEC/DIV settings you may prefer to use NORM or ENV acquisition mode for your application. Also, if NONSTORE display mode is selected, the trace will be blanked immediately after the display updates. Use STORE mode to retain the waveform displays between updates.

Table 6-2
Default Acquisition Modes

SEC/DIV Setting	Trigger Mode	Acquisition Mode
20 s to 0.1 s	AUTO LVL or AUTO BL	Continuous SCROLL (AVG and CONT ENV ¹ modes do not scroll; they update as a full record and are not triggered.)
	NORM ²	SCAN-ROLL-SCAN (AVG and CONT ENV modes update as a full record only and are triggered.)
	SSEQ ²	SCAN-ROLL-SCAN-SAVE (AVG and CONT ENV modes update as a full record only and are triggered.)
50 ms to 5 μ s	AUTO LVL, NORM, AUTO BL, or SSEQ ²	RECORD ³ (Continuous Full-Record Acquisition)
2 μ s to 50 ns	AUTO LVL, NORM, AUTO BL, or SSEQ ²	REPETITIVE ³ (Equivalent-Time Sampling). ENV and CONT ENV modes are not active at these SEC/DIV settings.

¹At the slow SEC/DIV settings, AVG and CONT ENV modes update slowly.

²Press INIT to reset the display and restart the acquisition.

³If NONSTORE mode is selected, the display blanks between acquisitions; in STORE mode (and SSEQ) the display is held between acquisitions.

NOTE

For the very long acquisition times (more than two minutes) at the slow SEC/DIV settings, turn off the automatic Timeout feature so that the acquisition may be completed before the timeout occurs. This is only necessary when operating on battery power alone. With external power applied, the oscilloscope does not time out.

SCAN-ROLL-SCAN Mode: When NORM Trigger Mode is selected, the trigger system is active. For SEC/DIV settings of 20 sec per division to 0.1 sec per division in NORM and ENV acquisition modes, the data points are displayed as they are acquired from left to right up to the trigger position. When the pretrigger data points fill, the trigger system can accept a trigger. Until a trigger occurs, new data points are continually acquired and added to the pretrigger display at the trigger position as in ROLL mode. When a trigger occurs, the post-trigger data points are acquired, starting at the trigger point and filling the display to the right. As soon as the display is filled, it is erased and the fill-roll-fill sequence begins again. Pressing INIT at any point resets the display system and restarts the acquisition sequence. As in Scroll mode, AVG and CONT ENV waveform acquisitions update only as a full record and do not scroll.

SCAN-ROLL-SCAN-SAVE Mode: This mode is the default for SEC/DIV settings from 20 sec per division to 0.1 sec per division when single-sequence (SSEQ) Trigger MODE is active. The acquisition and display occurs just as for SCAN-ROLL-SCAN Mode with NORM and ENV acquisition modes, but the acquisition halts as soon as the display is full, and the waveform is held displayed. The INIT button must be pressed to rearm and restart the single-sequence acquisition. It may be pressed at any point during the acquisition to restart the single-sequence. (Changing a control that affects the acquisition parameters also resets the SSEQ mode, and a new acquisition is started at the changed settings.) AVG and CONT ENV acquisitions are again acquired as a complete record, and the display is updated all at once.

RECORD Mode: For SEC/DIV settings from 5 μ s per division to 50 ms per division, the default acquisition mode is continuous RECORD. When a trigger occurs, a full record of waveform data is acquired and displayed; the Trigger MODE selected does not matter. How the waveform display acts does depend on the Trigger MODE and whether STORE or NONSTORE display mode is selected. The trace is held displayed between triggers for STORE Mode and in SSEQ Trigger Mode. In NONSTORE display mode, the trace is blanked after the display is updated until another trigger occurs (except in SSEQ Trigger MODE where the display is held until the **INIT** button is pressed to start another sequence).

When the display memory is filled, the Trigger MODE selection and the setting of the STORE/NONSTORE function determines how the acquisition and display continues.

If STORE is active, and the Trigger MODE is not SSEQ, the display is held from trigger to trigger and new data points obtained simply overwrite the previous data points. Placement of the new data points in the display will follow any ac or dc movement of the waveform, but the old data points are not changed until they are overwritten.

If NONSTORE display mode is selected, the waveform is cleared as soon as the display memory is full, and the trace is blanked until a trigger occurs to acquire new data points. If the Trigger MODE is SSEQ, the waveform display is maintained until the **INIT** button is pressed to restart the single-sequence acquisition or another Trigger MODE is selected. In AUTO BL Trigger mode, a trigger is forced if one does not occur, the data captured is displayed.

REPETITIVE STORE (Equivalent-Time Storage): For SEC/DIV settings of 50 ns per division to 2 μ s per division, the default acquisition mode is REPETITIVE for NORM and AVG acquisition modes only. At the start of an acquisition, the display memory is cleared. Then, with continued triggering on a repetitive waveform, the display memory is filled with data points. The waveform display is maintained as the data points are obtained so that the fill rate can be observed. Each data point obtained is seen as a dot in the display until the 512 point

record is filled; then vectors are drawn between the data points. Data points that are obtained on each trigger are not adjacent; they are spaced at equal intervals throughout the length of the record. The number of points obtained on each trigger and the “stride” (spacing between the data points) depends on the SEC/DIV setting (see Table 6-3).

Table 6-3
Repetitive Store Fill

SEC/DIV Setting	Sample Rate	Number of Points	Stride
50 ns	10 MHz	5	100
0.1 μ s	10 MHz	10	50
0.2 μ s	10 MHz	20	25
0.5 μ s	10 MHz	50	10
1.0 μ s	10 MHz	100	5
2.0 μ s	5 MHz	100	5

6.6 TRIGGER MODES

Trigger modes affect how the acquisition and display respond to the trigger events.

NORM: NORM Trigger MODE does not permit a digital acquisition or waveform display until a trigger signal occurs. The Trigger LEVEL control must be adjusted to set the triggering threshold to a level that will produce a trigger.

The way the display reacts after each update depends on whether the display mode is set to STORE or to NONSTORE:

NONSTORE mode produces a display behavior similar to that of an analog oscilloscope; if there is no trigger, a waveform is not displayed. In NONSTORE mode, the display of an acquired waveform is maintained for one update period only. If a new trigger has not occurred by the end of the display period (about 30 ms), the trace will be blanked until the next trigger.

AUTO LVL: This is the autolevel Trigger MODE. The positive and negative peaks of the selected trigger signal are found, and the Trigger LEVEL is set to the midpoint between those two levels. If a trigger is not received after the update period has finished, an auto trigger is generated. The resulting waveform is displayed, and the new signal peaks are acquired to reset the trigger hysteresis band at the midpoint between the two peak limits.

Table 6-4
AUTO LVL Trigger Interval Limits

SEC/DIV Setting	Trigger Interval for Autoleveling
5 ms/div or less	30 ms or less
10 ms/div to 50 ms/div	4 times the SEC/DIV setting or less
100 ms/div or more	200 ms or less

Autoleveling on the trigger signal is done at the following times:

- when AUTO LVL Trigger MODE is entered,
- when a trigger is not received within a certain time limit after the trigger system is armed (see Table 6-4)
- when the AUTO LVL: PUSH knob is pressed.

Autoleveling may not produce a valid trigger if the signal amplitude is less than the trigger hysteresis (1/4 of a minor division) or if the trigger events do not occur often enough (see Table 6-4).

AUTO BL: The auto baseline Trigger MODE causes a trigger to be forced if one does not occur so that a trace may be seen. Whatever data captured by the forced acquisition is displayed. With an appropriate trigger signal applied, acquisition and display occurs the same as in NORM Trigger MODE.

The STORE/NONSTORE mode selection determines how the display will behave between trigger events. In STORE mode, the waveform is held displayed between triggers. With NONSTORE display mode

selected, the previous waveform is displayed only until the display is updated (about 30 ms). If a trigger has not occurred in that time, a trigger is forced and whatever data is captured is displayed. At the slower SEC/DIV settings, blanking of the trace between the forced trigger and the display update will be visible to the user.

SSEQ: In SSEQ (single-sequence) MODE, one triggered acquisition is made. The display is then held, and no further SSEQ acquisitions occur until the trigger system is rearmed. Press the **INIT** button to rearm for another acquisition. Changing a control that affects the acquisition parameter also resets the SSEQ trigger mode, and a new acquisition is started at the changed setting.

6.7 TRIGGER SOURCE

Trigger SOURCE selects the signal source of the trigger events (VERT, CH 1, CH 2, or EXT). With VERT selected, the lowest numbered channel displayed is the source of the trigger signal. Select CH1 or CH2 if a specific channel signal is wanted as the trigger signal source. The channel selected need not be displayed to supply the trigger signal. Trigger coupling follows the coupling of the channel signals for VERT, CH1, and CH2 Trigger SOURCE. Trigger input coupling for EXT Trigger is always “dc”.

6.8 TRIGGER POSITION

For STORE display mode waveforms, the trigger position in the acquired waveform is selectable. The three choices permit the user to examine a different time window around a trigger event.

POST: Post-trigger means that most of the waveform data is displayed after the trigger position. There are only 64 data points displayed before the trigger position.

MID: Mid-trigger places the trigger position in the middle of the display with 256 data points displayed before the trigger position.

PRE: Pretrigger means that most of the waveform data is displayed before the trigger position. There are 448 data points displayed before the trigger position.

The trigger point for a waveform displayed in NONSTORE mode occurs at the sixth data point.

If the Trigger SOURCE waveform is off screen, the trigger point indicator (+) is placed at the top or bottom of the display area to show the direction to the off-screen waveform.

6.9 TRIGGER LEVEL/AUTO LVL: PUSH

The Trigger LEVEL control sets the voltage threshold that the signal must cross to produce triggering. When the trigger signal is displayed, the trigger point indicator “+” will be located on that waveform at the Trigger LEVEL and Trigger POS settings. The trigger signal need not be positioned within the graticule area to be used as the Trigger SOURCE. When the oscilloscope is triggered by a signal that is out of the graticule area, the trigger indicator “+” will be seen either at the top or bottom of the graticule to show the direction to the off-screen trigger signal. In AUTO LVL Trigger MODE, the Trigger LEVEL is set to the midpoint between the peak-to-peak limits of the trigger signal each time the trigger signal is lost. For other Trigger MODES, the Trigger LEVEL control may be set to any level within the vertical amplifier dynamic range for a particular VOLTS/DIV setting.

In any Trigger MODE, the AUTO LVL: PUSH button may be pressed to set the LEVEL setting to the midpoint value of the trigger signal.

6.10 ACQUISITIONS MODES

A choice is made by first pressing the **ACQ** button to display the acquisition mode menu. Further presses of the button cycles through the choices while the menu is being displayed. The selected mode is boxed in the menu. Direct selection of the acquisition mode is made by pressing the menu-select button next to that choice.

NORM: One sample point is acquired and displayed for each sample interval.

ENV: The positive and negative peak signal values that occur during a sample interval are acquired and displayed. ENV acquisition mode is available for SEC/DIV settings from 20 μ s to 20 sec per division. The sample rate for ENV mode acquisition is 10 MHz.

AVG: The waveform displayed is a moving four-point average of the last four acquisitions.

CONT ENV: Signal variation over time are displayed by CONT ENV mode. At SEC/DIV settings of 20 μ s per division and slower, positive and negative waveform peaks that occur during a sample interval are accumulated in the display until reset by changing the acquisition parameters or pressing the **INIT** button. Use NORM Trigger MODE to prevent the AUTO LVL or AUTO BL forced trigger from resetting the acquisition at the slower SEC/DIV settings.

NOTE

The AVG and CONT ENV displays do not roll at SEC/DIV settings from 0.1 SEC/DIV and slower. The entire record is acquired and updated. In NORM and SSEQ Trigger MODES, the acquired displays must be triggered. AUTO LVL and AUTO BL Trigger MODES cause the triggers to be ignored in ROLL mode, and the data captured will not be synchronized with a trigger event.

6.11 TIPS ON BATTERY CARE

The battery in your instrument is a sealed lead-acid type battery with four cells. These useful tips will help extend the battery life.

1. Completely recharge the battery after each discharge cycle. Continued partial recharges shorten the battery life. The battery is on charge any time external power is used to operate the instrument. However, the battery recharges faster when the instrument is not operating.

2. Avoid situations that can lead to deep discharge of the battery.

If the instrument starts and remains on only briefly before shutting off, the battery charge state is low. The instrument will not start on battery if the voltage drops below 7.32 V. The battery must be recharged as soon as possible when it is in this state. Do not store the battery or instrument with the battery installed in a discharged state. Extended storage or storage in high temperatures will deplete the remaining charge, leading to deep discharge. When deep discharge occurs, the battery accepts charge very slowly, and in some cases may not recharge.

3. If a deep-discharge condition occurs, it may be possible to recover the battery with the following procedure.

Leave the battery on charge for 24 hours. If it still does not accept a charge, remove it from the instrument and attempt to charge it using a 20 V power supply that is current limited to 100 milliamperes. When attempting to recover the battery using an external power supply, check the battery frequently for the current-limit state. If the battery recovers from the deep-discharge state, it will pull the power supply into current limit. When this happens, reinstall it in the instrument and charge it normally. Do not leave the battery on the external power supply for long periods of time without checking it. If the battery does not recover, dispose of it safely.

4. When storing the instrument for an extended period of time, fully charge the battery and remove it from the instrument. Store the fully charged battery in a cool place. For short periods of storage, the battery may remain installed. During “sleep” mode the current drawn from the battery is less than 1 mA. With the battery installed, the data stored in nonvolatile memory will remain stored and be available when the oscilloscope is turned on again.

5. The instrument will operate from the battery-charger adapter or other suitable ac or dc power source with the battery removed from the instrument.

6.12 ALTERNATE METHOD FOR BATTERY CHARGING

Batteries may be charged outside the instrument using the External Battery Charger accessory (see section 7 for part number) or a user provided dc power supply. The lead-acid cells of the battery require a constant charging voltage as provided by the External Battery Charger accessory. An alternate charger must supply 9.8 Vdc at 20°C with the supply current limited to 1 ampere. For best results over a wide temperature range, the charging voltage should be thermally compensated for -10 mV per degree C. For example, at 50°C, the charging voltage should be:

$$9.80 \text{ V} + [(50 - 20) \times -10 \text{ mV}] = 9.50 \text{ V}.$$

6.13 BATTERY REPLACEMENT

If you must often operate the oscilloscope using battery only, you may wish to obtain one or two extra batteries and carry them in a fully charged condition to the servicing site. Spare batteries may be car-

ried in an optional accessory pouch that attaches to the instrument carrying case (see section 7 for the part number). The accessory pouch may also be used to carry the standard U.S. battery-charger adapter (wall transformer) when operating the instrument on battery only.

When the charge level on the battery in the oscilloscope reduces to the shutoff level, one of the spare charged batteries may be used to provide more operating time.

The battery is in a compartment behind the probe pouch. To remove and replace it, follow this procedure:

1. Open the probe pouch and take the probes out of the pouch. This allows the battery compartment cover freedom to move away from the oscilloscope.
2. Place the oscilloscope on its right side and slide the battery compartment cover toward the rear to disengage the locking tabs. The hole for the probe leads makes a convenient place to apply the needed force with your finger.
3. Lift the battery compartment cover up and slide it down the probe leads enough to be able to lay the cover down.
4. Disconnect the 3-wire battery connector.

NOTE

If you reconnect power to the battery connector from the charged battery in less than 30 seconds, the saved waveforms and front-panel setups will not be lost.

5. Lift the battery pack out of the battery compartment.
6. Place the charged replacement battery into the battery compartment with the battery leads on the bottom side facing toward the rear.
7. Reconnect the battery plug.
8. Slide the battery compartment cover back up the probe leads and place the cover locking tabs into the matching slots in the battery compartment. Make sure the locking tab are all the way into the slots

on both the top and bottom of the cover. If the tabs don't seat easily seat the top tabs first then press on the bottom of the cover to seat the bottom tabs.

9. Push forward on the rear of the battery compartment cover to engage the locking tabs.
10. Remember to recharge the low battery at the first opportunity. This prevents it from going into a deep discharge state (see para. 6.11).

6.14 REPACKAGING FOR SHIPMENT

Save the original shipping carton and packing material in case it is ever necessary to reship the instrument by a commercial transport carrier. If the original materials are unfit or not available, then repackage the instrument using the following procedure.

1. Use a corrugated cardboard shipping carton with a test strength of at least 275 pounds and an inside dimension at least six inches greater than the instrument dimensions.
2. If instrument is being shipped to a Tektronix Service Center, enclose the following information: owner's address, name and phone number of a contact person, type and serial number of the instrument, reason for returning, and a complete description of the service required.
3. Completely wrap the instrument with polyethylene sheeting or equivalent to protect the outside finish and keep harmful substances out of the instrument.
4. Cushion the instrument on all sides with three inches of padding material or urethane foam, tightly packed between the carton and the instrument.
5. Seal the shipping carton with an industrial stapler or strapping tape.
6. Mark the address of the Tektronix Service Center and your own return address on the shipping carton.

*This Document is a complete Scan from the original
Tektronix manual
For enquiries about our complete
High quality line of technical Manuals in PDF
mailto : Qservice@otenet.gr*

**SEE
OTHER
SIDE**

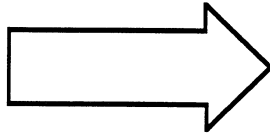

SECTION 7

**OPTIONS
AND ACCESSORIES**

*This Document is a complete Scan from the original
Tektronix manual
For enquiries about our complete
High quality line of technical Manuals in PDF
mailto : Qservice@otenet.gr*

**SEE
OTHER
SIDE**

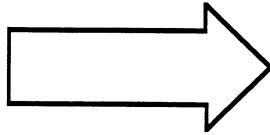

SECTION 7

OPTIONS AND ACCESSORIES

7.1 INTRODUCTION

This section contains a list of instrument accessories and available options. Tektronix part numbers are provided. More information about instrument options and accessories can be obtained from the current Tektronix Product Catalog or your local Tektronix Field Office or representative. In the United States, instruments or accessories may also be ordered by calling the Tektronix National Marketing Center toll-free number, 1-800-427-2200.

7.2 STANDARD ACCESSORIES

The standard accessories come with the instrument.

Qty	Description	Part Number
1	Operators Manual	070-7100-00
1	Quick Reference Guide	070-7099-00
1	RS-232 Interface Guide	070-7533-00
1	Battery Charger Adapter	120-1807-00
1	Carrying Pouch	016-1024-00
1	Probe Accessories Kit	020-1711-00
1	Cabinet Feet Accessory Kit	020-1752-00

7.3 OPTIONAL ACCESSORIES

The optional accessories may be ordered separately.

Description	Part Number
Spare Battery	146-0075-00
Accessory Pouch (for spare battery or U.S. battery-charger adapter)	016-0993-00
RS-232 Cable	174-1453-00
BNC-female-to-dual-banana Adapter	103-0090-00
RS-232 Demonstration Disk	063-0070-00
Field Accessories Kit	222ACC
P6122 Probe with accessories	P6122
222 Preliminary Service Manual	063-0066-00
Miniature Probe Tip to BNC Adapter	013-0084-01

7.4 OPTIONS

The following Battery-Charger Adapter Options are available:

Description	Part Number
Option 02 Instrument supplied without the battery-charger adapter	
Option A1 European 220V	120-1826-00
Option A2 UK 240V	120-1827-00

7.5 PARTS SUPPLIED WITH THE 222ACC FIELD ACCESSORIES KIT

Qty	Description	Part Number
1	External Battery Charger	013-0256-00
2	Accessory Pouch	016-0993-00
1	Viewing Hood	016-1021-00
1	Battery Charger Data Sheet	063-0118-00
1	Spare battery for the 222	146-0075-00
1	Cigarette lighter adapter power cable	174-1734-00
1	Accessory Kit Data Sheet	063-0193-00

SECTION 8

**PERFORMANCE
SPECIFICATIONS**

*This Document is a complete Scan from the original
Tektronix manual
For enquiries about our complete
High quality line of technical Manuals in PDF
mailto : Qservice@otenet.gr*

**SEE
OTHER
SIDE**

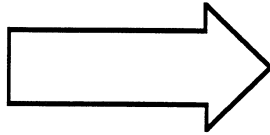

SECTION 8

PERFORMANCE SPECIFICATIONS

8.1 INTRODUCTION

Electrical characteristics in para. 8.3 apply when the instrument has been self calibrated within $\pm 5^{\circ}\text{C}$ of the ambient temperature and is operating in an ambient temperature between -10°C and $+55^{\circ}\text{C}$ (unless otherwise noted).

Items listed in the Detailed Specifications are verifiable limits that define the measurement capabilities of the instrument.

Environmental Specifications are given in para. 8.4 and Mechanical Specifications are given in para. 8.5.

8.2 RECOMMENDED PERFORMANCE CHECK SCHEDULE

Check the performance of this instrument at least once each year to determine if adjustment is needed. If used in a severe operating environment, a more frequent performance check schedule is recommended. If repairs are made, affected circuits may need to be readjusted.

8.3 DETAILED SPECIFICATIONS

8.3.1 Vertical Deflection System

Deflection Factor

5 mV per division to 50 V per division in a 1-2-5 sequence.¹

Vertical Resolution

8-bits, 25 levels per division. 10.24 divisions of dynamic range.¹

¹Performance Requirement not checked in manual.

DC Accuracy

-10°C to +55°C

±3% (when the self calibration has been done within ±5°C of the ambient temperature).

VOLTS/DIV Variable Control

Increases the deflection factor by 2.5 to 1.

Aberrations

+6%, -6%. 6% p-p or less.¹

Measured with a 5-division reference signal, from a 50-Ω source driving a 50-Ω load at the probe tip. Vertically center the top of the reference signal.

Useful Rise Time

$$\frac{\text{SEC/DIV} \times 1.6}{50} \text{ } ^1$$

Rise time is limited to 35 ns by the vertical amplifier response.

Useful Bandwidth

SAMPLE (20 s/div to 5 μs/div) $\frac{5}{\text{SEC/DIV}}$ Hz.¹

Useful-storage bandwidth is limited to the frequency where there are 10 samples per sine-wave signal period at the maximum sampling rate. This yields a maximum amplitude error of 5%. Maximum sampling rate is 10 MHz at 5 μs per division.

Accuracy at the useful-storage-bandwidth limit is measured with respect to a 6-division, 50-kHz sine wave.

REPETITIVE

0.5 μs/div to 50 ns/div	10 MHz.
1 μs/div	5 MHz. ¹
2 μs/div	2.5 MHz. ¹

¹Performance Requirement not checked in manual.

Repetitive bandwidth is limited to 10 MHz by the analog system.

PEAK DETECT (ENV and CONT ENV acquisition modes at 20 μ s/div and slower)

Sine-wave Amplitude Capture (5% p-p maximum amplitude uncertainty)	1 MHz.
--	--------

Pulse Width Amplitude Capture (50% p-p maximum amplitude uncertainty).	100 ns.
--	---------

A/D Converter Linearity

Monotonic with no missing codes.¹

Position Control Range

± 12 divisions.

Input Linear Range

± 20 divisions.¹

DC Balance

0.2 division or less trace shift when switching between VOLTS/DIV switch settings when the ambient temperature is within $\pm 5^\circ\text{C}$ of the temperature at which the last self calibration was done.¹

INVERT Balance

0.4 division or less trace shift when switching between INVERT and non-INVERT displays when the ambient temperature is within $\pm 5^\circ\text{C}$ of the temperature at which the last self calibration was done.¹

¹Performance Requirement not checked in manual.

Input Current

2.5 nA or less (0.5 division or less trace shift when switching between DC and GND input coupling with the VOLTS/DIV switch at 5 mV per division).¹

Input R and C

Input Resistance 1 M Ω \pm 10%.¹

Input Capacitance 27 pF \pm 3 pF.¹

These R and C characteristics include the probe.

Common-to-Chassis

Capacitance Less than 150 pF.¹

Maximum Rated Normal-Mode Input Voltage (probe tip to probe common)

400 V (dc + peak ac) to 2 MHz.¹

See Figure 8-1 for voltage versus frequency derating curve.

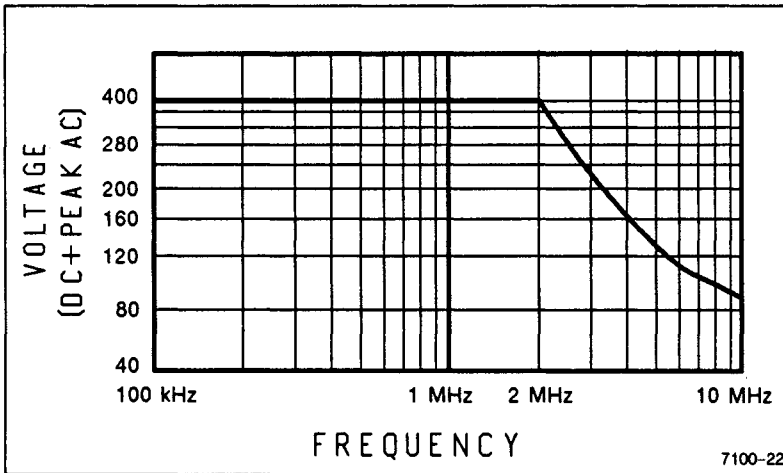

Figure 8-1. Maximum normal-mode voltage versus frequency derating curve.

¹Performance Requirement not checked in manual.

Isolation: Channel Common to Channel Signal

DC-to-1 kHz	80 dB or more. ¹
1 kHz-to-100 kHz	60 dB or more. ¹

8.3.2 Trigger System

Internal

Sensitivity	0.5 division to 20 MHz.
Level	± 20 divisions. ¹

External

Sensitivity	200 mV to 10 MHz.
Level	± 2.3 V.
Input Resistance	1 M Ω ±10%. ¹
Input Capacitance	18 pF ±5 pF. ¹

Trigger Jitter

2 μ s/div to 50 ns/div (5 ns/div in X10 MAG)

X1	1/50th division ±2 ns. ¹
X10 MAG	1/5th division ±2 ns.

8.3.3 Horizontal System

Range

50 ns per division to 20 s per division.¹

The X10 MAG control extends the maximum sweep speed to 5 ns per division.

¹Performance Requirement not checked in manual.

Displayed Accuracy

X1	$\pm 2\%$.
X10	$\pm 5\%$.

Accuracy is over 10 divisions.

Sample Rate

NORM	$\frac{50}{\text{SEC/DIV}}$ Hz. ¹
PEAKDET (ENV and CONT ENV)	10 MHz. ¹
REPETITIVE	
50 ns/div to 1 μ s/div	10 MHz. ¹
2 μ s/div	5 MHz. ¹
ACCURACY	0.01%. ¹

Sample accuracy is based on the accuracy of the internal 20-MHz oscillator.

Record Length

512 data points; calibrated to 50 points per division¹.

POSITION Control Range

Start of the first division and end of the tenth division can be positioned past the center vertical graticule.

Displayed Trace Length

10.24 divisions.¹

¹Performance Requirement not checked in manual.

8.3.4 X-Y Operation

Accuracy

Same as the Vertical system.¹

Useful Bandwidth

$$\frac{5}{\text{SEC/DIV}} \text{ Hz.}^1$$

Skew Between CH 1 and CH 2

5 ns.¹

8.3.5 RS-232 Interface

Maximum Applied Voltage (any pin)

25 V (dc + peak ac).¹

Baud Rates

300, 1200, 2400, 9600; 0.1% accuracy based on the micro-processor clock.¹

Signals

RD, TD, and SGND. SGND is connected internally to EXTERNAL TRIG COM. DSR and CTS are always high, and DTR and RTS are ignored.¹

Levels

Compatible with RS-232C.

8.3.6 External Power Requirements

Voltage Range

Pin-to-pin

AC 16 to 20 Vac at 47 to 400 Hz.¹

¹Performance Requirement not checked in manual.

DC	12 to 28 Vdc. ¹
Either Power Pin-to-EXT TRIG COMM or RS-232 COMM	-0.5 V to +42 V peak. ¹

Current

1 ampere maximum when charging batteries.¹

Maximum Power Consumption

15 watts or 16 volt-amperes (when charging batteries).¹

8.3.7 Internal Batteries

Battery

Sealed, lead-acid battery.¹

Charge Time

Three hours for full charge with oscilloscope not operating.¹

Battery Excessive Discharge Protection

Instrument operation is automatically interrupted when battery charge drops to 7.32 V.¹

Typical Operating Time

Two hours at maximum sample rate, no trigger, and auto timeout defeated.¹

Battery Capacity versus Temperature

-10°C	20°C to 30°C	55°C
80%	100%	110%

¹Performance Requirement not checked in manual.

8.4 ENVIRONMENTAL SPECIFICATIONS

Environmental Requirements

Instrument will meet the requirements of Tektronix Standard 062-2853-00, Class 3.

The instruments meets all the following MIL-T-28800D requirements for Type III, Class 3 equipment, except where noted otherwise.

Temperature

Operating -10°C to $+55^{\circ}\text{C}$ ($+14^{\circ}\text{F}$ to $+131^{\circ}\text{F}$).¹

Nonoperating -51°C to $+71^{\circ}\text{C}$ (-60°F to $+160^{\circ}\text{F}$).¹

Tested to MIL-T-28800D, para 4.5.5.1.3 and 4.5.5.1.4 except that in para 4.5.5.1.3, steps 4 and 5 are performed before step 2 (-51°C nonoperating test). Equipment shall remain off upon return to room-ambient temperature during step 6. Excessive condensation shall be removed before operating during step 7.¹

Altitude

Operating 4,570 meters (15,000 feet). Maximum operating temperature decreases 1°C per 1,000 feet above 5,000 feet.¹

Nonoperating To 15,240 meters (50,000 feet).¹

¹Performance Requirement not checked in manual.

Humidity
(Operating
and Non-
operating)

Five cycles (120 hours) referenced to MIL-T-28800D para 4.5.5.1.2 for type III, Class 3 instruments. Operating and nonoperating at 95% (-5%, 0%) relative humidity. Operating at +30°C and +55°C for all modes of operation; nonoperating at +30°C and +60°C.¹

Vibration (operating)

15 minutes along each of 3 major axes at a total displacement of 0.025 inch p-p (3.8 g at 55 Hz) with frequency varied from 10 Hz to 55 Hz in 1-minute sweeps. Hold for 10 minutes at 55 Hz in each of the three major axes. All major resonances must be above 55 Hz.¹

Shock (operating and nonoperating)

50 g, half-sine, 1-ms duration, 3 shocks per axis each direction, for a total of 18 shocks.¹

EMI (Electromagnetic Interference)

Meets radiated and conducted emission requirements per VDE 0871, Class B; and Part 15, FCC Rules and Regulations, Subpart J.¹

To meet EMI regulations and specifications, use the specified shielded cable and metal connector housing with the housing grounded to the cable shield on the RS-232 connector.

¹Performance Requirement not checked in manual.

8.5 MECHANICAL SPECIFICATIONS

Weight

Without accessories	4.4 lbs (2 kg).
With accessories	6 lbs (2.73 kg).
Domestic Shipping Weight	7 lbs (3.2 kg).

Dimensions

Length	9.9 in (252 mm).
Height	3.4 in (86.4 mm).
Width	6.25 in (158.8 mm).

Cooling

There are no cooling vents provided.

Finish

Tektronix Blue pebble finish with black synthetic rubber hand grips and black vinyl probe pouch.

Construction

Plastic cabinet. Glass-laminate circuit boards with surface-mounted components.

CRT

CRT graticule area is 8 divisions high by 10 divisions wide. The divisions are 0.5 cm on a side, and the diagonal size is 6.4 cm (approximately 2.5 inches). A special low-reflectance surface on the crt face aids viewing in high-ambient light areas.

APPENDIX

CHECKING YOUR INSTRUMENT'S PERFORMANCE

*This Document is a complete Scan from the original
Tektronix manual
For enquiries about our complete
High quality line of technical Manuals in PDF
mailto : Qservice@otenet.gr*

**SEE
OTHER
SIDE**

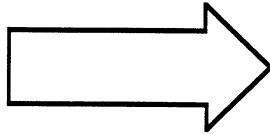

APPENDIX

CHECKING YOUR INSTRUMENT'S PERFORMANCE

A.1 INTRODUCTION

This Performance Check Procedure verifies the Performance Requirements of the 222 DSO as listed in the Section 8. These checks may be used as an acceptance test or as a preliminary troubleshooting aid to help determine the need for repair or readjustment.

You do not have to remove the instrument cabinet to do these checks. All checks can be made with operator accessible controls and connectors.

A.2 TEST EQUIPMENT REQUIRED

Table A-1 lists all the test equipment required to do the Performance Check Procedure. Test equipment specifications described are the minimum necessary to provide accurate results. For test equipment operation information, refer to the appropriate test equipment instruction manual.

When you use equipment other than that recommended, you may have to make some changes to the test setups. If the exact example equipment in Table A-1 is not available, use the Minimum Specification column to determine if any other available test equipment might be adequate to do the check.

Table A-1
Test Equipment Required

Description	Minimum Specification	Use	Example of Test Equipment
Leveled Sine-Wave Generator	Frequency: 50 kHz to above 10 MHz. Output amplitude: variable from 10 mV to 5 V p-p. Output impedance: 50 Ω. Amplitude accuracy: constant within 1.5% of reference frequency to 20 MHz.	Vertical, triggering and bandwidth checks.	TEKTRONIX SG503 Leveled Sine-Wave Generator. ^a
Calibration Generator	Standard-amplitude signal levels (Dc and Square wave): 5 mV to 50 V. Accuracy: 5 mV to 50 V ± 0.25%. High-amplitude signal levels: 1 V to 60 V. Repetition rate: 1 kHz. Fast-rise signal level: 1 V. Repetition rate: 1 MHz. Rise time: 1 ns or less. Flatness: ± 0.5%.	Gain and transient response checks.	TEKTRONIX PG506 Calibration Generator. ^a
Time-Mark Generator	Marker outputs: 5 ns to 0.5 s. Marker accuracy: ± 0.1%.	Horizontal checks.	TEKTRONIX TG501 Time-Mark Generator. ^a
Coaxial cable	Connectors: BNC. Impedance: 50 Ω. Length: 42 inch.	External trigger checks.	Tektronix Part Number 012-0057-01
Termination	Impedance: 50 Ω. Connectors: BNC	Signal termination.	Tektronix Part Number 011-0049-01.
Adapter	Connectors: BNC male-to-miniature-probe tip.	Signal inter-connection.	Tektronix Part Number 013-0084-02.
Adapter	Connectors: BNC female-to-dual-banana.	External trigger check.	Tektronix Part Number 103-0090-00.

^a Requires a TM500-series power Module.

Table A-1 (cont)

Description	Minimum Specification	Use	Example of Test Equipment
T-Connector	Connectors: BNC.	Signal inter-connection.	Tektronix Part Number 103-0030-00.
Small, Flat-tip screwdriver.	Length: 3-in shaft. Bit size: 1/8 inch.	Adjust Horizontal and Vertical display alignment. Adjust intensity and focus controls.	
Jumper Wire	Connectors: Banana; length 3-inches or more.	External trigger self calibration.	

A.3 PERFORMANCE CONDITIONS

The performance limits in this performance check are valid under the following conditions:

An instrument self calibration must have been done within $\pm 5^{\circ}\text{C}$ of the present ambient operating temperature.

The instrument must be checked at an ambient temperature between -10°C and $+55^{\circ}\text{C}$.

A.4 PERFORMANCE CHECK INTERVAL

It is recommended that a complete performance check be done on the instrument at least once each year. A more frequent interval is advised if the instrument is used under severe conditions. If the checks indicate a need for readjustment or repair, refer the instrument to the nearest Tektronix repair center.

A.5 PREPARATION

This procedure is divided into subsections to let you check individual sections of the instrument when it is not necessary to do the complete Performance Check. An Equipment Required block at the beginning of each subsection lists the equipment from Table A-1 that is needed to do the checks in that subsection.

The initial control settings at the beginning of each subsection prepare the instrument for the first step of the subsection. Do each of the steps in a subsection completely and in order to ensure the correct control settings for the steps that follow. Let the instrument and test equipment warm up for 10 minutes to obtain a valid performance check to the accuracies stated in the Specifications (Section 8).

Set-Up

- a. Plug the wall transformer into the ac power source.
- b. Plug in the low voltage ac power cord from wall transformer to the EXTERNAL POWER INPUT of the oscilloscope.
- c. Press the ON button of the oscilloscope to toggle it into the operating mode.
- d. Turn on the test equipment and allow a 10-minute warm up period to obtain a stable operating temperature.
- e. After the warm up, run the instrument's self calibration routines. Directions for doing a self calibration are in Section 4, para. 4.31.

A.6 INDEX TO PERFORMANCE CHECKS

A.7 DISPLAY CHECKS	Page
1. Check/Adjust INTENSITY Control	A-6
2. Adjust Focus Control	A-6
3. Check/Adjust X-Axis Alignment	A-7
4. Check/Adjust Y-Axis Alignment	A-7

A.8 VERTICAL

1. Check Input Current	A-9
2. Check Input Coupling	A-9
3. Check Vertical POSITION Range	A-10
4. Check Variable VOLTS/DIV Range	A-10
5. Check VOLTS/DIV Accuracy	A-11
6. Check Probe Compensation	A-12
7. Check Analog Bandwidth	A-13

A.9 HORIZONTAL

1. Check X1 SEC/DIV Accuracy	A-15
--	------

A.10 TRIGGER

1. Check Trigger Sensitivity	A-16
2. Check Trigger LEVEL Control	A-16
3. Check External Trigger Sensitivity	A-18
4. Check External Level Range	A-18
5. Check Trigger Jitter	A-19

PERFORMANCE CHECKS

A.7 DISPLAY CHECKS

Equipment Required (See Table A-1)

Battery-Charger Adapter
(wall transformer)

Small Flat-blade Screwdriver

INITIAL CONTROL SETTINGS

Power and Display

External Power ON
Power ON

Front-Panel Controls

Auto Setup Press for initial setup

1. Check/Adjust INTENSITY Control

- a. Adjust the INTENSITY control (located on the rear panel) counterclockwise (CCW).
- b. CHECK – that the crt beam cuts off (no intensity).
- c. Adjust the INTENSITY control clockwise for normal viewing.

2. Adjust FOCUS Control

- a. Press the AUX FUNCT button on the top panel.
- b. Select the ALIGN menu choice, then the XY menu choice.
- c. Adjust the FOCUS control (located on the rear panel) for the best definition of the ALIGN XY pattern.

3. Check/Adjust HORIZ ALIGN Alignment

a. CHECK—that the HORIZ ALIGN adjustment (accessible from the rear) will align the horizontal lines of the pattern with the horizontal graticule lines.

b. ADJUST—HORIZ ALIGN adjustment to align the horizontal pattern lines with the horizontal graticule lines.

4. Check/Adjust VERT ALIGN Alignment

a. CHECK—that the VERT ALIGN adjustment (accessible from the rear) will align the vertical lines of the box with the vertical graticule lines.

b. ADJUST—the VERT ALIGN adjustment to align the vertical pattern lines with the vertical graticule lines.

c. Press the CLEAR button to remove the display pattern and return to normal operation.

A.8 VERTICAL

Equipment Required (See Table A-1)

Leveled Sine-Wave Generator	BNC-male-to-probe-tip Adapter
Calibration Generator	Battery-Charger Adapter (wall transformer)
50-Ω BNC Termination	

INITIAL CONTROL SETTINGS

Power and Display

External Power	ON
Power	ON

Vertical

CH 2 Input Coupling	GND
CH 2 VOLTS/DIV	5 mV
CH 2 Variable	CAL
CH 1 Input Coupling	GND
CH 1 VOLTS/DIV	5 mV
CH 1 Variable	CAL

Horizontal

SEC/DIV	1 ms
X10 MAG	OFF

Trigger

Trigger MODE	AUTO BL
Trigger SOURCE	VERT
Trigger SLOPE	+

Top Panel Controls

Trigger POS	POST
STORE/NON-STORE	STORE
CH 1 and CH 2 INVERT	OFF
XY MODE	OFF
READOUT	ON
ACQUISITION MODE	NORM

1. Check Input Current

- a. Connect the probe reference leads to their associated probe tips.
- b. Vertically position the CH 1 trace to the center horizontal graticule line.
- c. Set the CH 1 Coupling to DC.
- d. CHECK—for 0.5 division or less shift from center horizontal graticule line.
- e. Set CH 1 Coupling OFF.
- f. Repeat parts b, c, and d for CH 2.

2. Check Input Coupling

- a. SET: CH 2 VOLTS/DIV 50 mV
 SEC/DIV 0.5 ms
 Trigger MODE AUTO LVL
- b. CONNECT—the Calibration Generator AMPL output via a BNC-to-male probe-tip adapter to the CH 2 probe tip.
- c. Set the Calibration Generator for a STD AMPL output at 0.2 V.
- d. Vertically position the bottom of the signal to the center horizontal graticule line.
- e. Set the CH 2 Coupling to AC.
- f. CHECK—for the display to be vertically centered about the center horizontal graticule line.
- g. SET: CH 2 Coupling CH2 OFF
 CH 1 Coupling DC
 CH 1 VOLTS/DIV 50 mV
- h. Disconnect the Channel 2 probe tip from the test equipment and connect the Channel 1 probe tip.
- i. Repeat parts d, e, and f for CH 1.

3. Check Vertical POSITION Range

- a. Set the CH 1 VOLTS/DIV setting to 0.2 V.
- b. Set the Calibration Generator to output a 5-V, standard-amplitude signal.
- c. Adjust the Vertical POSITION control fully clockwise.
- d. CHECK—for the bottom of the signal to be no more than 2 divisions below the center horizontal graticule line.
- e. Adjust the Vertical POSITION control fully counterclockwise.
- f. CHECK—for the top of the signal to be no more than 2 divisions above the center horizontal graticule line.
- g. SET:

CH 1 Coupling	CH1 OFF
CH 2 Coupling	AC
CH 2 VOLTS/DIV	0.2 V
- h. Disconnect the Channel 1 probe tip from the test equipment and connect the Channel 2 probe tip.
- i. Repeat parts c, d, e, and f for CH 2.

4. Check Variable VOLTS/DIV Range

- a. SET:

CH 2 Coupling	DC
CH 2 VOLTS/DIV	50 mV
- b. Set the Calibration Generator for a standard-amplitude output of 0.2 V.
- c. Position the bottom of the signal on the center vertical graticule line.
- d. Press in and rotate the Vertical POSITION knob (VAR VOLTS/DIV control when held in) counterclockwise until the display amplitude stops decreasing.
- e. CHECK—for less than 1.6 division of signal amplitude.

NOTE

The Variable knob must be held in as it is rotated or it reverts to its Vertical POSITION function.

f. Set the CH 2 Variable VOLTS/DIV to CAL (press and hold in the Vertical POSITION knob and rotate it cw until an audible beep is heard and the uncal indicator is cleared from in front of the VOLTS/DIV readout).

g. SET:	CH 2 Coupling	CH2 OFF
	CH 1 Coupling	DC
	CH 1 VOLTS/DIV	50 mV

h. Disconnect the Channel 2 probe tip from the test equipment and connect the Channel 1 probe tip.

i. Repeat parts c, d, e, and f for CH 1.

5. Check VOLTS/DIV Accuracy

a. Set the CH 1 VOLTS/DIV to 5 mV.

b. Set Calibration Generator for a standard-amplitude output signal of 20 mv.

c. Vertically center the display.

d. CHECK—all positions of the VOLTS/DIV settings for correct signal-to-graticule accuracy using the VOLTS/DIV and Calibration Generator settings and Amplitude Limits given in Table A-2.

e. Return the Calibration Generator output to 20 mV.

f. SET:	CH 1 Coupling	CH1 OFF
	CH 2 Coupling	DC
	CH 2 VOLTS/DIV	5 mV

g. Disconnect the Channel 1 probe tip from the test equipment and connect the Channel 2 probe tip.

h. Repeat part d for CH 2.

i. Disconnect the test equipment from the oscilloscope and return the Calibration Generator output to 20 mV.

Table A-2
VOLTS/DIV Accuracy Settings

VOLTS/DIV	CALIBRATION GENERATOR	AMPLITUDE LIMITS
5 mv	20 mV	3.88 div – 4.12 div
10 mv	50 mV	4.85 div – 5.15 div
20 mv	0.1 V	4.85 div – 5.15 div
50 mv	0.2 V	3.88 div – 4.12 div
0.1 V	0.5 V	4.85 div – 5.15 div
0.2 V	1 V	4.85 div – 5.15 div
0.5 V	2 V	3.88 div – 4.12 div
1 V	5 V	4.85 div – 5.15 div
2 V	10 V	4.85 div – 5.15 div
5 V	20 V	3.88 div – 4.12 div
10 V	50 V	4.85 div – 5.15 div
20 V	100 V	4.85 div – 5.15 div
50 V	100 V	1.94 div – 2.06 div

6. Check Probe Compensation

- a. SET: CH 2 VOLTS/DIV 50 mV
 SEC/DIV 0.2 ms.
 Trigger POS MID

b. Connect the Calibration Generator positive-going, FAST-RISE output via a 50- Ω termination and a BNC-to-male probe-tip adapter to the CH 2 probe tip.

c. Set the Calibration Generator to output a FAST RISE signal with a 1 ms period.

d. Vertically position the top of the square wave on the second horizontal graticule line above the center.

e. Adjust the Calibration Generator output for a 5-division display amplitude.

f. Position the rising edge at the trigger position to the center vertical graticule line.

g. CHECK—for 0.1 division or less of rolloff or overshoot at the front corner.

h. SET:	CH 2 Coupling	CH2 OFF
	CH 1 Coupling	DC
	CH 1 VOLTS/DIV	50 mV

i. Disconnect the Channel 2 probe tip from the test equipment and connect the Channel 1 probe tip.

j. Vertically center the display.

k. Repeat part g for CH 1.

l. Disconnect the test equipment from the oscilloscope.

7. Check Analog Bandwidth

a. SET:	CH 1 VOLTS/DIV	0.5V
	SEC/DIV	5 μ s

b. Connect the Leveled Sine-Wave Generator output via a 50- Ω termination and BNC-to-male probe-tip adapter to the CH 1 Probe tip.

c. Set the Leveled Sine-Wave Generator for a display amplitude of 6 divisions at 50 kHz.

d. Set the SEC/DIV to 50 ns.

e. Set the Leveled Sine-wave generator output frequency to 10 MHz.

f. CHECK—for at least 4.2 divisions of display amplitude.

g. Return the Sine-Wave Generator output frequency back to 50 kHz.

h. SET:	CH 1 Coupling	CH1 OFF
	CH 2 Coupling	DC
	CH 2 VOLTS/DIV	0.5 V
	SEC/DIV	5 μ s

- i. Disconnect the Channel 1 probe tip from the test equipment and connect the Channel 2 probe tip.
- j. Vertically center the display.
- k. Repeat parts c, d, e, and f for CH 2.
- l. Disconnect the test equipment from the oscilloscope.

A.9 HORIZONTAL

Equipment Required (See Table A-1)

Time-Mark Generator	BNC-male-to-probe-tip Adapter
50-Ω BNC Termination	Battery-Charger Adapter (wall transformer)

INITIAL CONTROL SETTINGS

Power and Display

External Power	ON
Power	ON

Vertical

CH 2 Input Coupling	CH2 OFF
CH 1 Input Coupling	DC
CH 1 VOLTS/DIV	0.1 V
CH 1 Variable	CAL

Horizontal

SEC/DIV	1 ms
X10 MAG	OFF

Trigger

Trigger MODE	AUTO LVL
Trigger SOURCE	VERT
Trigger SLOPE	+

Top Panel Controls

Trigger POS	POST
STORE/NON-STORE	STORE
CH 1 and CH 2 INVERT	OFF
XY MODE	OFF
READOUT	ON
ACQUISITION MODE	NORM

1. Check X1 SEC/DIV Accuracy

- a. Connect the Time Mark Generator via a 50- Ω termination and BNC-to-male probe-tip adapter to CH 1 probe tip.
- b. Set the Time Mark Generator to output 1 ms time markers.
- c. Vertically position the baseline of the time-mark signal to the center horizontal graticule line.
- d. Horizontally position the left time marker with the first vertical graticule line.
- e. CHECK – that the leading edge of each time marker is aligned to a vertical graticule line within 2% (± 0.1 division).
- f. Disconnect the test equipment from the oscilloscope.

A.10 TRIGGER

Equipment Required (See Table A-1)

Leveled Sine-Wave Generator	BNC-male-to-probe-tip Adapter
Calibration Generator	50- Ω BNC Termination
BNC-female-to-dual-banana Adapter	Battery-Charger Adapter (wall transformer)
	BNC Coaxial Cable

INITIAL CONTROL SETTINGS

Power and Display

External Power	ON
Power	ON

Vertical

CH 2 Coupling	CH2 OFF
CH 2 Variable	CAL
CH 1 Coupling	DC
CH 1 VOLTS/DIV	5 mV
CH 1 Variable	CAL

Horizontal

X10 MAG	OFF
SEC/DIV	50 ns

Trigger

Trigger MODE	AUTO LVL
Trigger SLOPE	+
Trigger SOURCE	VERT

Top Panel Controls

Trigger POS	POST
STORE/NON-STORE	STORE
CH 1 and CH 2 INVERT	OFF
XY MODE	OFF
READOUT	ON
ACQUISITION MODE	NORM

1. Check Trigger Sensitivity

- a. Connect the Leveled Sine-Wave Generator via a 50- Ω termination and a BNC-to-male probe-tip adapter to the CH 1 probe tip.
- b. Set the Sine-Wave Generator for a 5-division display amplitude at 20 MHz.
- c. Set the CH 1 VOLTS/DIV to 50 mV for a 0.5 division display amplitude.
- d. CHECK—for a stable display with the TRIG'D indicator on.

2. Check Trigger LEVEL Control

- a. SET:

CH 1 VOLTS/DIV	0.2 V
SEC/DIV	5 μ s
Trigger MODE	AUTO BL
- b. Set the Sine-Wave Generator for a 5-division display amplitude at the 50 kHz reference frequency.
- c. Adjust the Trigger LEVEL control for a stable trigger.
- d. CHECK—that the signal remains triggered while the trigger point indicator “+” is on the positive slope when rotating the Trigger LEVEL control through its range.
- e. Set the Trigger SLOPE to “-.”
- f. CHECK—that the signal remains triggered while the trigger point indicator “+” is on the negative slope when rotating the Trigger LEVEL control through its range.
- g. Set the CH 1 VOLTS/DIV to 50 mV.
- h. Set the Trigger LEVEL control to position the trigger indicator (+) to 1 division below the positive peak of the signal. (Use the Vertical POSITION control to bring the peak of the signal on screen to see the trigger position on the waveform.)
- i. Position the waveform vertically to place the bottom of the signal 1 division above the center horizontal graticule line.
- j. CHECK—that the signal remains triggered with the TRIG'D indicator light on.

k. Use the Trigger LEVEL control to place the trigger indicator 1 division above the negative peak of the signal while maintaining a stable triggered display.

l. Position the waveform vertically to place the top of the signal 1 division below the center horizontal graticule line.

m. CHECK—that the signal remains triggered with the TRIG'D indicator light on.

n. Disconnect the CH 1 probe tip from the BNC-to-male probe-tip adapter and connect the CH 2 probe tip.

o. SET:	CH 1 Coupling	CH1 OFF
	CH 2 Coupling	DC
	CH 2 VOLTS/DIV	0.2 V
	Trigger SLOPE	+
	Trigger LEVEL	For a stable display

p. CHECK—that the signal remains triggered while the trigger point indicator “+” is on the positive slope when rotating the Trigger LEVEL control through its range.

q. Set the Trigger SLOPE to “-.”

r. CHECK—that the signal remains triggered while the trigger point indicator “+” is on the negative slope when rotating the Trigger LEVEL control through its range.

s. Set the CH 2 VOLTS/DIV to 50 mV.

t. Set the Trigger LEVEL control to position the trigger indicator (+) 1 division below the positive peak of the signal. (Use the Vertical POSITION control to bring the peak of the signal on screen to see the trigger position on the waveform.)

u. Position the waveform vertically to place the bottom of the signal 1 division above the center horizontal graticule line.

v. CHECK—that the signal remains triggered with the TRIG'D indicator light on.

w. Use the Trigger LEVEL control to place the trigger indicator 1 division above the negative peak of the signal.

- x. Position the waveform vertically to place the top of the signal 1 division below the center horizontal graticule line.
- y. CHECK—that the signal remains triggered with the TRIG'D indicator light on.
- z. Disconnect the test equipment from the CH 2 probe tip.

3. Check External Trigger Sensitivity

- a. SET: CH 2 Coupling GND
 CH 1 Coupling DC
 CH 1 VOLTS/DIV 50 mV
 Trigger SOURCE EXT
 SEC/DIV 50 ns
 STORE/NONSTORE NONSTORE

b. Connect the Leveled Sine-Wave Generator output via a 50- Ω termination, a BNC T-connector, and a BNC-to-male probe-tip adapter to the CH 1 probe tip.

c. Connect the other side of the T-connector via a 50- Ω coaxial cable and BNC-female-to-dual banana connector to the EXT TRIG and EXT TRIG COMM inputs.

d. Vertically center the display.

e. Set the Sine-Wave Generator for 4 divisions of amplitude at 10 MHz.

f. CHECK—that the display is stably triggered with the TRIG'D indicator light on.

4. Check External Trigger Level Range

- a. SET: CH 1 VOLTS/DIV 1 V
 SEC/DIV 5 μ s

b. Adjust the Leveled Sine-Wave Generator for maximum output at 50 kHz (just over a 5-division display amplitude).

c. Vertically center the display and horizontally position the beginning of the sweep at the second vertical graticule line.

d. CHECK—that the beginning of the signal moves at least 2.3 divisions below the center horizontal graticule line as the Trigger LEVEL control is rotated counterclockwise.

e. CHECK—that the beginning of the signal moves at least 2.3 divisions above the center horizontal graticule line as the Trigger LEVEL control is rotated clockwise.

f. Disconnect the test equipment from the oscilloscope.

5. Check Trigger Jitter

a. Press the AUX FUNCT button on the top keypad.

b. Select ALIGN to display the ALIGN menu with the XY choice.

c. Press menu button 2 (next one down under the XY menu choice; it is a hidden menu choice that is not labeled) to start the clock calibration procedure.

d. CHECK—that the trigger position indicator (+) remains within the center two horizontal divisions (see Figure A-1). An occasional jump outside the center two divisions is alright.

e. Press CLEAR when finished with the trigger jitter check procedure. This will start the automatic Clock Delay routine.

NOTE

The Clock Delay program takes 15 to 20 seconds to do the automatic portion of the CLOCK DELAY calibration. When the routine finishes, the display returns to normal if the calibration is successful. If a "FAIL" message appears, the first attempt at the Clock Delay calibration did not succeed. Run the procedure again. If the FAIL message does not go away, refer your instrument to a qualified service person for repairs.

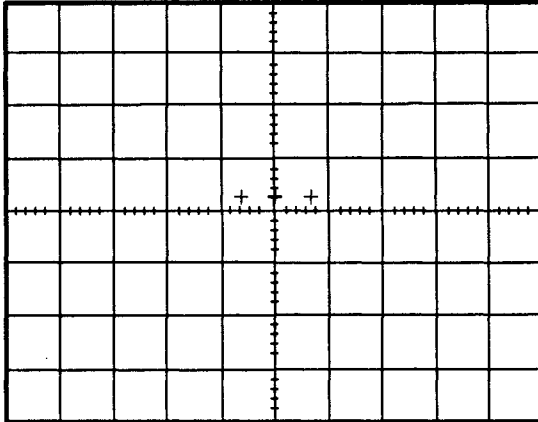

Normal Trigger Jitter, less than 1 division from the center vertical graticule line.

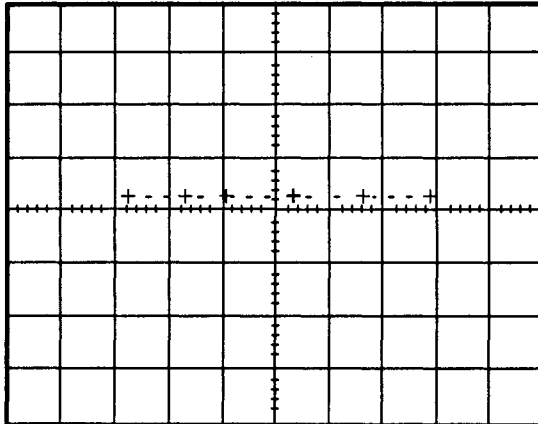

Excessive Trigger Jitter, 1 division or more from the center vertical graticule line.

7100-20A

Figure A-1. Trigger jitter check.

INDEX

A

- A/D converter linearity, 8-3
- Aberrations, 8-2
- AC Coupling, 6-5
- Accessories, standard, 1-4
- Accessory pouch, 6-16
- Acquisition MODE, selection, 4-20
- Acquisition Mode
 - button, 3-17
 - choices, 6-13
 - defaults, 6-6
 - ranges, 6-6
 - selection, 4-20
- ALIGN, 3-18
- Alarm, 4-13, 4-16
- Altitude
 - nonoperating, 8-10
 - operating, 8-10
- AUTO BL, 4-9, 4-10, 6-11
- AUTO LVL, 6-11, 6-13
- AUTO LVL:PUSH
 - button, 3-14, 4-9
 - operation, 6-13
- AUTO TIMEOUT, 4-23
- Auto Setup
 - button, 3-13
 - defaults, 6-1
 - for quick signal viewing, 2-4
 - for signal tracing, 5-1
 - low frequency limit, 2-4
 - operation, 4-1
- Auto Timeout
 - operation, 4-22
 - with battery power only, 2-4
 - with external power applied, 2-4
 - with long acquisition times, 6-8

Auxiliary Functions

- button, 3-18
- menu, 4-24

- AVG acquisition, 3-17, 4-20, 6-6, 6-13

B

- BAUD, 4-25, 8-8

Bandwidth

- limit, 8-3
- peak detect, 8-3
- repetitive, 8-2
- sample, 8-2
- xy mode, 8-8

Battery

- capacity versus temperature, 8-9
- charging, 2-3, 6-14
- charging time, 1-4, 8-9
- deep-discharge state, 2-3, 6-14
- recovery from, 6-15
- excessive discharge protection, 8-9
- remove and replace, 2-3, 6-15
- storage, 2-3, 6-14
- tips on care, 6-14
- type, 1-3, 8-9

- Battery carrying pouch, 6-15

Battery Charger Adapter

- operation with, 2-1
- output voltage, 1-3

- Battery charging, 6-15

Battery Operation

- description of, 2-2
- first time operation, 2-3
- low battery indicator, 2-2
- operating time, 1-4, 2-2, 2-3, 8-9

- Baud Rate, 4-24

C

- Calibration constants, 4-29
- CH 1 SELECT, 4-3
- CH 2 SELECT, 4-3
- CH1 and CH2 Self Cal, 4-28
- CH1OFF and CH2OFF, 6-5
- Channel isolation, 8-5
- CLEAR button, 3-9, 4-2
- Clearing
 - menus, 4-3
 - saved waveforms, 4-3
- COMM PORT connector, 3-20
- CONFIG, 3-18, 4-23, 4-24
- CONT ENV acquisition, 3-17, 4-20, 6-6, 6-14
- Common-mode noise, 5-6
- Common-mode potential, 8-5
- Common-mode rejection ratio, 8-5
- Common-to-ground capacitance, 8-4
- Construction, 8-12
- Controls and Connectors, 3-1, 3-8
 - reference tables, 3-1-3-5
- Cooling, 8-12
- CRT, 3-8, 8-12
 - graticule dimensions, 1-4
- Current required, when charging batteries, 8-9

D

- Data points, 6-9
- DC accuracy, 1-2, 8-2
- DC Balance, 8-3
- DC Coupling, 6-5
- Deflection factor, 8-1
- Differential Measurements, 5-6
- Dimensions, 1-3
 - height, 8-12

- length, 8-12
- width, 8-12

- Display alignment pattern, 4-25
- Display MODE menu, 4-21
- Display Mode
 - button, 3-18
 - menu, 4-21
- Display update, 6-5

E

- ENV acquisition, 3-17, 4-20, 5-9, 6-13
- Environmental Specifications,
 - 8-10
 - requirements, 8-10
- Equivalent-Time Storage, 6-9
- Erasing Front Panel Setups, 4-17
- ERASE ALL, 4-18
- EXT TRIG INPUT
 - connector, 3-20
 - self calibration, 4-28
- Ext Trigger
 - coupling, 6-12
 - source, 6-12
- External battery charger, 6-15
- External Power connector, 3-20
- External Power input current, 8-9
- External Supply Voltage
 - ac, 1-4
 - dc, 1-4
 - external power indicator, 2-3
 - ranges, 3-20, 2-1, 8-8

F

- Features, summary of, 1-1
- Finish, 8-12
- Firmware Version, 4-30
- Floating Measurements, 5-6
- Focus control, 3-19
- Front-panel setups
 - recall, 4-16
 - save, 4-14

G

- GND Coupling, 6-5
- Graticule Measurements, 5-1

H

- Horiz alignment, 3-19, 4-26
- Horizontal
 - display accuracy, 1-2
 - SEC/DIV range, 8-6
- Horizontal Controls, 3-12
- Horizontal POSITION control,
 - 3-12, 4-8
 - range, 8-7
- Horizontal POSITIONING, 4-8
- Horizontal System
 - displayed accuracy, 8-7
 - sample rate, 8-7
 - specifications, 8-6
- Humidity, operating and nonoperating, 8-11

I

- IDENT, 3-18, 4-30
- INIT button, 3-9, 4-2
- INVERT Balance, 8-3
- Input Coupling, 3-11, 4-4, 6-5
- Input current, 8-4
- Input linear range, 8-3
- Intensity control, 3-20
- Introduction, 7-1
- Invert Display MODE, 4-6

L

- Lead-acid cells, 6-15
- LEVEL, 4-9, 6-13

M

- Magnification, 4-8

- Maximum applied voltage on RS-232 interface, 8-8
- Maximum common-mode voltage, 1-3
- Maximum normal-mode voltage, 1-3
- Maximum potential between channels, 1-3
- Maximum potential between power and common, 1-3
- Maximum power consumption, 8-9
- Maximum rated common-mode potential, 8-5
- Maximum rated input voltage, 8-4
- Maximum rated potential between channels, 8-5
- Measurements
 - differential, 5-6
 - floating, 5-6
 - rise time, 5-5
 - time, 5-4
 - using the graticule markings, 5-1
 - voltage, 5-2
- Menu Selections, 4-2
- Menu-select buttons, 3-9, 4-2
- MID Trigger, 4-19, 6-12
- MODE
 - acquisition, 6-6
 - display, 6-5
 - trigger, 4-10

N

- NONSTORE Mode, 4-3, 6-5
- NORM, 4-9, 4-10
 - acquisition, 6-13
 - trigger mode, 6-10
- NORM acquisition, 3-17, 4-20
 - sample rate, 8-7
- Nonvolatile memory, 6-15

O

ON button, 3-9, 4-1
On-Screen Readouts, 3-6
Optional Accessories, 7-2
Options, 7-2
operating temperature, 8-1

P

PASS/FAIL, 4-27, 4-29
Peak detect, sample rate, 8-7
Performance Check, 8-1
 conditions, A-3
 index to procedures, A-5
 preparation for, A-4
 procedures, A-1
 schedule, A-3, 8-1
POST Trigger, 4-19, 6-12
Positioning
 horizontal, 4-8
 vertical, 4-5
 XY, 4-8
Power connector, 3-20
PRE Trigger, 4-19, 6-12
Probe tip accessories, 6-3
Probes, 3-10, 6-3
 attenuation factor, 6-3
potential between channels, 8-5
power consumption, 8-9

Q

Quick reference tables
 Front Panel controls, 3-1
 Rear Panel controls, 3-4
 Top Panel controls, 3-3

R

Rated input voltage, 8-4
READOUT ON/OFF, 4-21
RECALL
 front panel setups, 3-17, 4-16

 saved waveforms, 3-16, 4-13
RECALL WVFRM menu, 4-14
RECORD Mode, 6-9
 as affected by Trigger Mode,
 6-9
REPETITIVE Mode, 6-9
Readout locations, 3-6
Rear Panel Controls, 3-19
Record Length, 1-2, 8-7
Repackaging for shipment, 6-17
ROLL Mode, 5-9, 6-1
RS-232 Interface, 8-8
 maximum applied voltage, 8-8
RS-232 Port
 for communication, 3-20
 for self calibration errors, 4-29
 levels, 8-8
 signals, 8-8

S

SAVE
 front panel setups, 3-17, 4-14
 Waveforms
 button, 3-16
 operation, 4-12
SAVE/RECALL, button, 3-17
Safety, 2-1
Sample Rate, 8-7
 accuracy, 1-2
SCAN mode, 6-1
SCAN-ROLL-SCAN Mode, 6-8
SCAN-ROLL-SCAN-SAVE
 Mode, 6-8
Scroll Mode, 6-6
SEC/DIV switch, 3-12
 range, 4-7
 scaling, 4-7
SELECT/COUPLING, 3-11, 4-3
SELF CAL, 3-18, 4-28
Self Calibration, 4-27
 errors, 4-29
 PASS/FAIL, 4-27
Shipping carton, 6-17

- Shock, operating and nonoperating, 8-11
- Single Sweep Operation, 5-8
- SLOPE, 4-9
- Sleep mode, 6-15
- SOURCE, 4-11
- Specifications
 - detailed, 8-1
 - summary of, 1-2
- SSEQ, 4-9, 4-10, 5-8, 6-12
- STORE MODE, button, 3-17
- STORE Mode, 4-3, 6-5
- Standard Accessories, 7-1
- Stride, 6-10

T

- Temperature range, 8-10
 - nonoperating (storage), 8-10
 - operating, 8-10
- Test equipment required, A-1
- Time Measurements
 - period, 5-4
 - rise time, 5-5
- Top Panel Buttons, 3-16
- TRIG COMM connector, 3-20
- TRIG POS
 - button, 3-17
 - indicator, 4-20, 6-13
 - NONSTORE Mode, 6-12
 - STORE Mode, 6-12
 - setting, 4-18
- TRIG'D indicator, 3-15
- Trace length, 8-7
- Trace shift, 8-3, 8-4
- Trigger
 - external sensitivity, 8-6
 - input C, 8-6
 - input R, 8-6
 - internal sensitivity, 8-6
 - jitter, 8-6
 - LEVEL

- control, 3-14
- external range, 8-6
- operation, 6-13
- setting, 4-9
- MODE
 - button, 3-15
 - setting, 4-10
- SLOPE
 - button, 3-14
 - selection, 4-9
- SOURCE, 6-12
 - button, 3-15
 - selection, 4-11
- specifications, 8-6
- TRIG POS, 3-17
- TRIG'D indicator, 3-15

Trigger Controls, 3-14

Trigger Modes, 6-10

U

- Useful bandwidth, 1-2
- Useful rise time, 8-2
- useful bandwidth, 8-2

V

- Variable VOLTS/DIV, 3-11, 4-6, 8-2
- Vectors, 6-10
- Vert alignment, 3-19, 4-26
- Vert trigger source, 6-12
- Vertical Controls, 3-10
- Vertical Deflection System, 8-1
- Vertical input R and C, 8-4
- Vertical POSITION, 3-11, 4-5
 - control range, 8-3
- Vertical resolution, 1-2, 8-1
- Vibration, operating, 8-11
- VOLTS/DIV switch, 3-11-3-12, 4-5
- Voltage Measurements
 - peak-to-peak, 5-2
 - with respect to ground, 5-3

W

Waveform RECALL

- button, 3-16
- operation, 4-13

Waveform SAVE, 3-16, 4-12

Weight, 1-3

- domestic shipping, 8-12
- with accessories, 8-12
- without accessories, 8-12

X

X10 MAG, 3-13, 4-8

- fastest sweep speed, 8-6

XY Display Mode, 4-14, 4-21

XY operation, 8-8

- accuracy, 8-8
- skew between channels, 8-8
- useful bandwidth, 8-8

XY positioning, 4-8

XY rotation alignment, 4-25

*This Document is a complete Scan from the original
Tektronix manual
For enquiries about our complete
High quality line of technical Manuals in PDF
mailto : Qservice@otenet.gr*

**SEE
OTHER
SIDE**

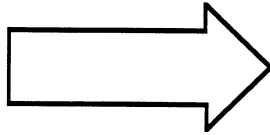

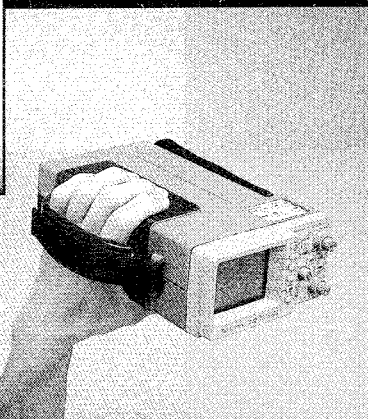
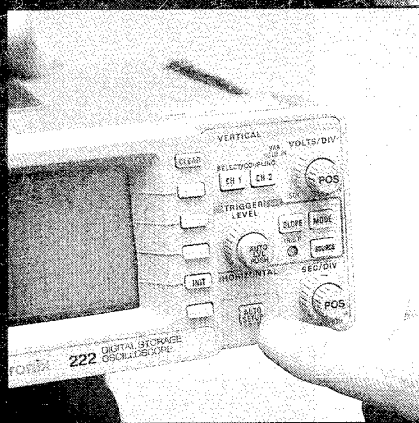
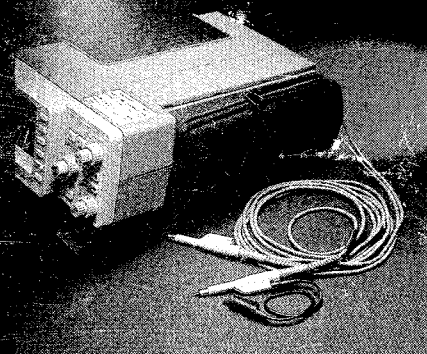

Tektronix®
COMMITTED TO EXCELLENCE

KEY FEATURES

- Enables remote control of Tek's 222 oscilloscope via PC and modem
- Simplifies data collection and storage
- Easy-to-use graphical interface
- Works with all Hayes-compatible modems
- No programming required

TYPICAL APPLICATIONS

Field Service
Plant Maintenance
Telecommunications
General Equipment
Maintenance
Education

CAT200 Virtual Instrument Software recreates the front panel of a Tek 222 digital storage oscilloscope on the IBM PC, PS/2 and compatibles. When connected to a remote 222, the CAT200 package lets you control and collect waveform data from the scope with your computer.

GET UP TO SPEED FAST.

No programming skills or advanced training are required to use CAT200 software. If you know basic PC operation and are familiar with the 222 front panel, you can quickly take advantage of all the features built into the CAT200 package.

CAT 200 VIRTUAL INSTRUMENT SOFTWARE

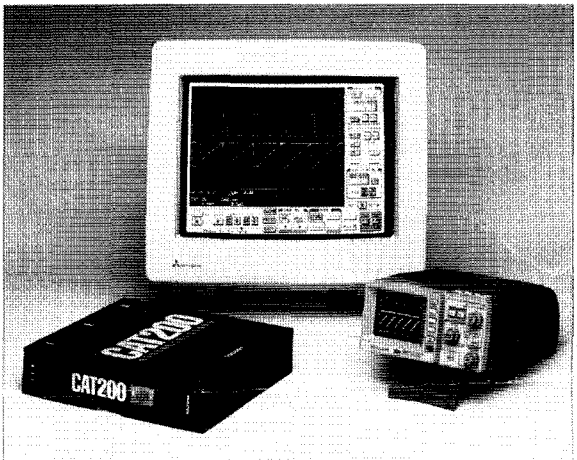

EXTENDS THE REACH OF THE 222.

There are numerous applications for CAT200. For example, it allows measurement at hazardous sites without endangering a human operator. In field calibration or checkout, a service engineer can download front panel setups or reference waveforms to a remote 222 from the office. And CAT200 also lets you quickly provide accurate waveform data from technicians working in the field.

EXPANDS THE CAPABILITIES OF THE 222.

In addition to extending the reach of the 222 oscilloscope, CAT200 also expands its capabilities. It automates measurement with delta cursors. It simplifies documentation by providing hardcopy support. And CAT200 software gives the 222 access to virtually unlimited memory for storing waveform data.

Tektronix[®]
COMMITTED TO EXCELLENCE

SYSTEM REQUIREMENTS

- IBM PC/XT/AT, PS/2 or compatible
- EGA or VGA compatible graphics adapter
- Tektronix 222 Portable Digital Oscilloscope
- Standard RS-232 serial port configured as COM1 or COM2
- RS-232 cable (9 pin - 25, P/N 174-1453-00)

SYSTEM OPTIONS

- Hayes-compatible modem
- Microsoft or compatible mouse

WAVEFORM STORAGE

Acquired waveforms can be stored to either floppy or hard disk. Waveform data are stored in ASCII format and are compatible with the 222 instrument driver for LabWindows®.

LICENSING AND WARRANTY

Licensing for this software package is "break the seal." The software is sealed in an envelope with the license agreement printed on the outside. The license states: "Retention of this program for more than thirty (30) days, or use of the program in any manner, will constitute acceptance of all license terms."

The 90-day warranty period extends to the product's media and encoding only.

ORDERING INFORMATION

CAT200 includes:

- User's manual
- Two (2) 5 1/4" diskettes
- One (1) 3 1/2" diskette

For further information, contact:

U.S.A., Asia, Australia, Central & South America, Japan
Tektronix, Inc.
P.O. Box 1700
Beaverton, Oregon 97075
For additional literature, or the address and phone number of the Tektronix Sales Office nearest you, contact:
(800) 835-9433 ext. 170
TWX: (910) 467-8708
TLX: 151754

France, Africa
Phone: 33 (169) 86 81 81

Federal Republic of Germany
Phone: 49 (221) 77220

United Kingdom
Phone: 44 (6284) 6000

Italy
Phone: 39 (2) 84441

Other Europe Areas
Phone: 31 (02503) 13300

Eastern Europe, Austria and Middle East
Phone: 43 (222) 68-66-02-0

Canada
Phone: (705) 737-2700

Tektronix sales and service offices around the world:
Algeria, Argentina, Australia, Austria, Bahrain, Bangladesh, Belgium, Bolivia, Brazil, Canada, People's Republic of China, Chile, Colombia, Costa Rica, Denmark, Ecuador, Egypt, Federal Republic of Germany, Finland, France, Greece, Hong Kong, Iceland, India, Indonesia, Ireland, Israel, Italy, Japan, Jordan, Korea, Kuwait, Lebanon, Malaysia, Mexico, The Netherlands, New Zealand, Nigeria, Norway, Oman, Pakistan, Panama, Peru, Philippines, Poland, Portugal, Qatar, Republic of South Africa, Saudi Arabia, Singapore, Spain, Sri Lanka, Sweden, Switzerland, Syria, Taiwan, Thailand, Turkey, Tunisia, United Arab Emirates, United Kingdom, Uruguay, Venezuela, Zimbabwe.

Copyright © 1989, Tektronix, Inc. All rights reserved. Printed in U.S.A. Tektronix products are covered by U.S. and foreign patents, issued and pending. Information in this publication supersedes that in all previously published material. Specification and price change privileges reserved. TEKTRONIX, TEK, PLOT 10, TEKTEST, SCOPE-ARCIBLE and  are registered trademarks. For further information, contact: Tektronix Inc., Corporate Offices P.O. Box 500, Beaverton, OR 97077. Phone: (503) 627-7111. TWX: (910) 467-8708. TLX: 151754. Subsidiaries and distributors worldwide.

Tektronix®
COMMITTED TO EXCELLENCE



Top Panel Keys

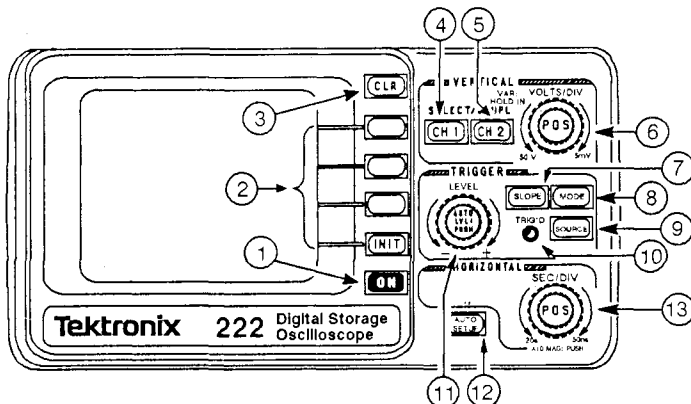
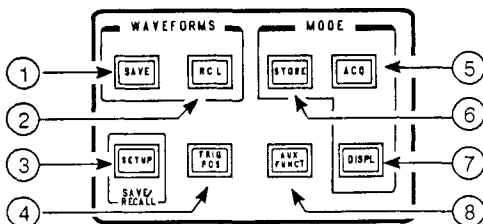

Front Panel Controls

FRONT PANEL CONTROLS

1. Turns the oscilloscope functions On and Off; turns off automatically when not being used.
2. Selects from displayed menus. Button four is the INIT button for SSEQ trigger mode.
3. Clears menus and stored waveform displays.
4. Selects CH 1 to respond to control changes. Calls up the CH 1 input coupling menu (DC, GND, AC, CH 1 OFF) on the second press. CH 1 OFF may only be selected using the menu select button.
5. Same as the CH 1 button but for CH 2.
6. Outer knob sets VOLTS/DIV on selected channel (50V to 5 mV). Inner knob positions active channel vertically and is the VAR knob when held in and rotated.
7. Select Trig SLOPE (+ or -).
8. Calls up the Trig MODE menu (NORM, AUTO LVL, AUTO BL, SSEQ).
9. Calls up the Trig SOURCE menu (VERT, CH 1, CH 2, EXT).
10. Trigger indicator; triggered when on.
11. Outer knob sets Trig LEVEL. Inner button auto levels on the trigger signal when pressed.
12. Autoranges on the active channel signal(s) when pressed. VOLTS/DIV, SEC/DIV, vertical position, and Trigger LEVEL are set.

13. Outer knob sets SEC/DIV (20s to 50 ns). Inner knob positions horizontally; it turns X10 MAG on and off when pressed.

NOTE: Menu callup buttons also scroll through the menu selections when pressed repeatedly.

TOP PANEL KEYS

1. Halts the acquisition and calls up the SAVE CH1 WV, SAVE CH2 WV, or SAVE XY WV menu to save waveforms in nonvolatile memory.
2. Calls up the RECALL WVFRM menu to select saved waveforms from nonvolatile memory for display.
3. Calls up the setup SAVE/RECALL menu (SAVE, RECALL, ERASE, ERASE ALL). Up to four front-panel setups may be saved for later recall. Stored setups may be erased singly or all at once.
4. Calls up the TRIG POS menu (PRE, MID, POST) for STORE MODE trigger position.
5. Calls up the Acquisition Mode menu (NORM, ENV, AVG, and CONT ENV).
6. Switches between STORE (display frozen between triggers) and NONSTORE (display blanks between triggers).
7. Calls up the Display Mode menu (INV1, INV2, X-Y, RO OFF).
8. Calls up the Auxiliary Functions menu. See the Operators Manual for details.

ON-SCREEN READOUT LOCATIONS

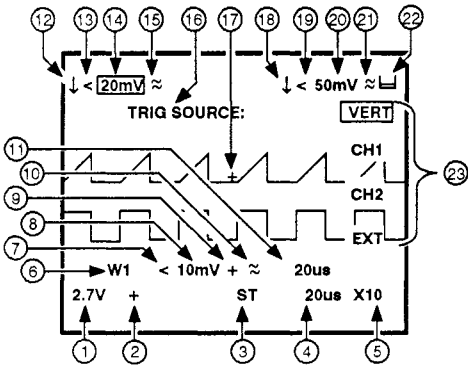

1. Trigger Level setting.
2. Trig SLOPE (+ or -).
3. STORE/NONSTORE indicator.

4. SEC/DIV of acquisition.
5. X10 MAG indicator.
6. Recalled waveform number.
7. VAR symbol of recalled waveform.
8. VOLTS/DIV of recalled waveform.
9. SLOPE indicator of recalled waveform.
10. Channel coupling of recalled waveform.
11. SEC/DIV of recalled waveform.
12. CH1 INVERT symbol.
13. CH1 VAR symbol.
14. CH1 VOLTS/DIV.
15. CH1 coupling symbol.
16. Menu name.
17. Trigger position indicator on the waveform.
18. CH2 INVERT symbol.
19. CH2 VAR symbol.
20. CH2 VOLTS/DIV.
21. CH 2 coupling symbol.
22. External charge and battery indicator.
23. Menu selects.

SELECTING THE ACTIVE CHANNEL

Press **CH 1** or **CH 2** to select the channel that responds to the front panel control changes. The VOLTS/DIV readout of the active channel is boxed. A second press selects the input coupling menu for that channel.

SELECTING STORE/NONSTORE MODE

1. Press **STORE** to switch between STORE and NONSTORE mode. "ST" is displayed in the readout when STORE mode is on.
2. In STORE mode, the acquired waveform is displayed between triggers. In NONSTORE mode, a waveform is held only to the first display update after being acquired unless triggered.

SELECTING TRIG POSITION

Press **TRIG POS** to cycle the trigger position "+" to POST, MID, or PRE in STORE mode. The "+" is displayed at the Trigger LEVEL setting and is seen on the trigger channel if displayed.

SELECTING ACQUISITION MODE

1. Press **ACQ** to select NORM, ENV, AVG, or CONT ENV acquisition mode.
2. ENV acquisition is valid for SEC/DIV settings from 20 s to 20 μ s. Signal peaks in each sampling interval are displayed. AVG mode gives a moving average of the last four acquisitions. CONT ENV accumulates peak variations of the input signal.

SAVING A WAVEFORM TO MEMORY

1. Acquire the waveform you want to save.

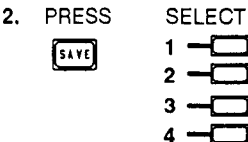

3. Acquisition stops when **SAVE** is pressed, and the waveform is displayed when saved. If both channels are displayed, choose the one to save using the channel select buttons before saving.

RECALLING A WAVEFORM FROM MEMORY

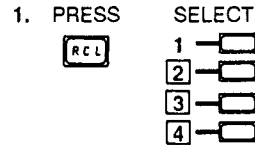

NOTE: Selecting an empty memory will sound a beep and leave the menu displayed.

NOTE: A box around the menu choice indicates that the waveform is being displayed.

USING FRONT-PANEL STORE/RECALL

1. To save a setup, set all the controls to make your measurement, select STORE in the SETUP menu, then a memory location. To recall a stored setup, select RECALL, then a memory location.



NOTE: A memory with data stored is boxed. It will be overwritten with new data if stored to.

NOTE: Selecting an empty memory will sound a beep and leave the menu displayed.

3. Select ERASE to clear a stored memory. Press **CLR** to remove the menu display after you finish erasing.

4. Selecting ERASE ALL, erases all four memory locations and exits the menu.

TEK 222

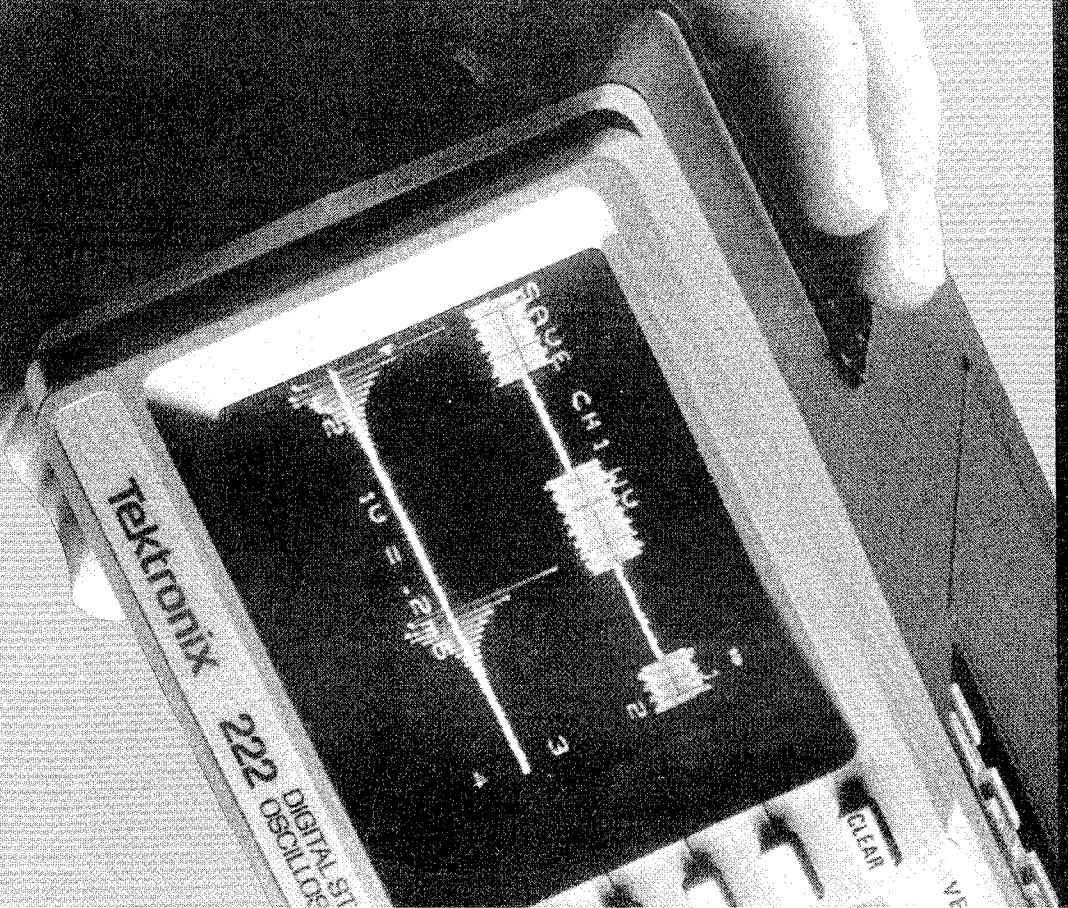

Welcome to the 222

Tektronix
COMMITTED TO EXCELLENCE

Dear Customer,

Thanks for choosing Tek's 222—and congratulations! You now own the world's most powerful handheld oscilloscope, an instrument that combines digital storage, 10-MHz bandwidth, automatic setups and more in a package weighing less than 4.5 pounds. I'm sure it will be a welcome addition to your test-and-measurement arsenal.

And to help you get up to speed with your new 222, I'd like to offer you two valuable gifts, absolutely free.

The first is a diskette of sample software programs. As you know, the 222 can be programmed with a personal computer through its RS-232 port. You'll find a number of sample programs on the disk, along with drivers for several popular software languages. There are no copyrights or implied agreements associated with this disk—you're free to use it any way you like.

Second, you can subscribe to 222Tips, which are application notes developed just for the 222. They'll cover a wide variety of troubleshooting techniques for all kinds of electronic and electro-mechanical systems.

These gifts will help you get the most from your 222. To take advantage of my offer, just supply the necessary information on the enclosed reply card.

Thanks again for selecting Tek!

Sincerely,

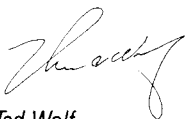
A handwritten signature in black ink, appearing to read "Ted Wolf". The signature is fluid and cursive, with the first letter of each word being capitalized and prominent.

*Ted Wolf
Product Marketing Manager*



Dear 222 Customer,

I would like to take the time to tell you about 3 new exciting offerings from Tektronix. We have just introduced the P2000 X100 slip on attenuator, the 222ACC field kit, the CAT200 Virtual Instrument software package. These are all designed around the popular 222 HandHeld digital storage oscilloscope. We are offering these products based upon feedback from you, our customers.

P2000 Price \$125

The P2000 is a X100 slip on attenuator . Maximum input voltage is 1000V peak.

222ACC Price \$200

The 222ACC is a field portability kit for the 222. It contains the following items:
1 External Battery Charger, 1 222 Battery, 1 Cigarette lighter adapter, 1 Viewing Hood, and 2 222 Accessory Pouches. This package represents a 25% savings over the piece prices.

CAT200 Price \$350

The CAT200 is a Virtual Instrument SW package designed for Tektronix and the 222 by National Instruments, and is available exclusively from Tektronix and their authorized distributors. It allows for complete unattended operation of the 222. It contains ΔV and ΔT cursors, allows for mass waveform storage, display of up to 6 waveforms, contains drivers for most printers and utilizes Hayes compatible modems.

If you have any questions about these or any other Tektronix products, please feel free to call today at 1-800-426-2200.

Sincerely,

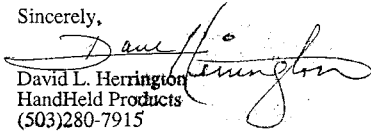
David L. Herrington
HandHeld Products
(503)280-7915