

INSTRUCTION MANUAL

Serial Number _____



Tektronix, Inc.

S.W. Millikan Way • P. O. Box 500 • Beaverton, Oregon 97005 • Phone 644-0161 • Cables: Tektronix
070-0434-02 369

WARRANTY

All Tektronix instruments are warranted against defective materials and workmanship for one year. Tektronix transformers, manufactured in our own plant, are warranted for the life of the instrument.

Any questions with respect to the warranty mentioned above should be taken up with your Tektronix Field Engineer.

Tektronix repair and replacement-part service is geared directly to the field, therefore all requests for repairs and replacement parts should be directed to the Tektronix Field Office or representative in your area. This procedure will assure you the fastest possible service. Please include the instrument Type and Serial or Model Number with all requests for parts or service.

Specifications and price change privileges reserved.

Copyright © 1965, new material copyrights 1966 and 1969 by Tektronix, Inc., Beaverton, Oregon. Printed in the United States of America. All rights reserved. Contents of this publication may not be reproduced in any form without permission of the copyright owner.

CONTENTS

Section 1	Characteristics
Section 2	Operating Instructions
Section 3	Circuit Description
Section 4	Maintenance
Section 5	Performance Check
Section 6	Calibration
	Abbreviations and Symbols
	Parts Ordering Information
Section 7	Electrical Parts List
	Mechanical Parts List Information
Section 8	Mechanical Parts List
Section 9	Diagrams
	Mechanical Parts List Illustrations
	Accessories
Section 10	Rackmounting

Abbreviations and symbols used in this manual are based on or taken directly from IEEE Standard 260 "Standard Symbols for Units", MIL-STD-12B and other standards of the electronics industry. Change information, if any, is located at the rear of this manual.

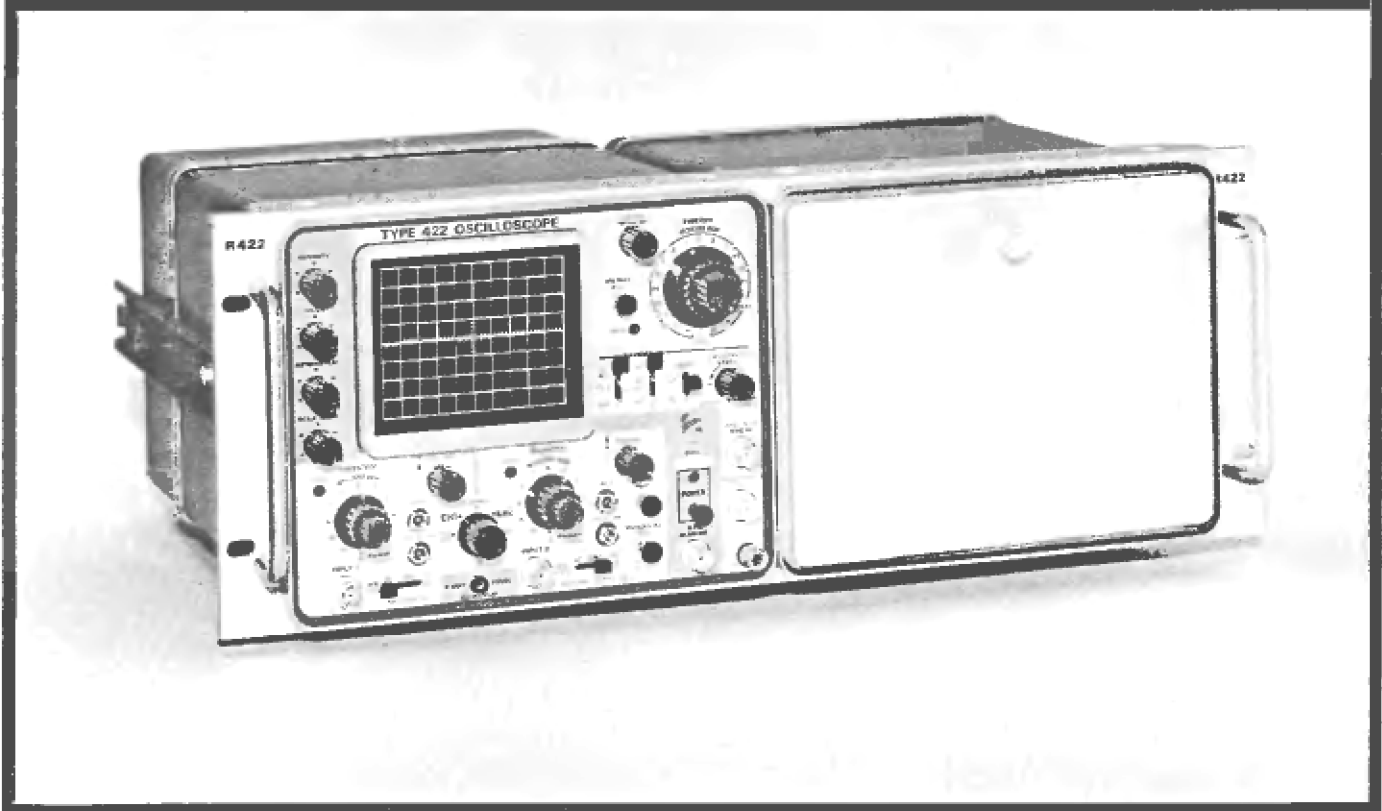
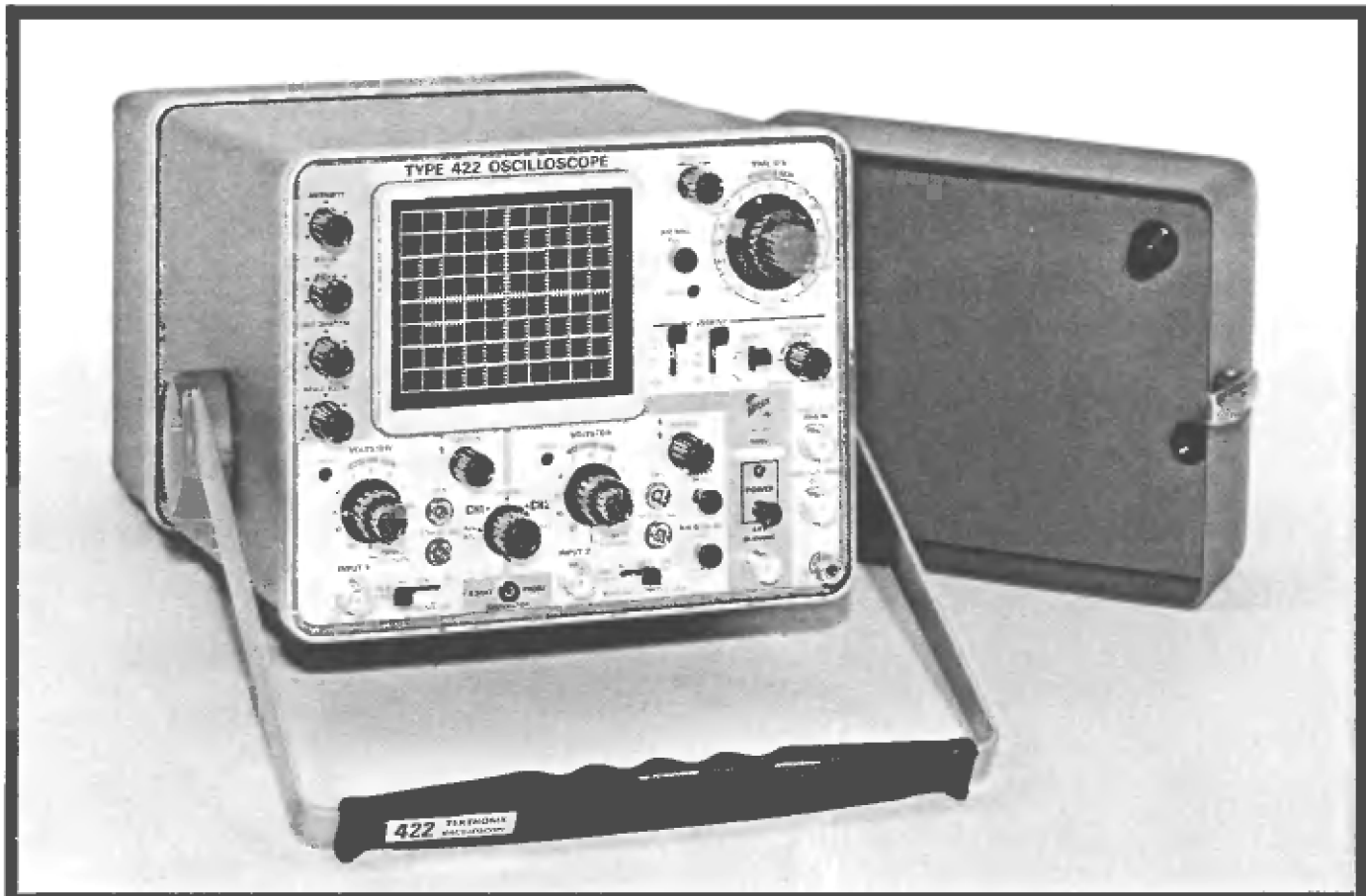

Fig. 1-1. Type 422 and Type R422 Oscilloscope shown with the 016-0072-00 AC Power Supply.

Type 422/R422 (SN 100-19,999)

©I

SECTION 1

CHARACTERISTICS

Introduction

The Tektronix Type 422 Oscilloscope is a transistorized portable oscilloscope designed to operate in a wide range of environmental conditions. The light weight and small size of the Type 422 allow it to be easily transported, while providing the performance necessary for accurate measurements. The dual-channel, DC to 15 MHz vertical system provides calibrated deflection factors from 0.01 to 20 volts/division (0.001 volts/division minimum, Channel 2 only with reduced frequency response). The trigger circuits provide stable triggering over the full range of vertical frequency response. The horizontal circuits provide a maximum sweep rate of 0.5 microseconds/division (0.05 microseconds/division using $\times 10$ magnifier).

A detachable power supply section allows the instrument to be powered from a variety of power sources. With the Type 422 AC Power Supply (016-0072-00) the instrument can be operated from an AC power source. The Type 422 AC-DC Power Supply (016-0073-00) provides operation from either AC or DC power sources or internal batteries. Information in this manual applies to the Type 422 Indicator only.

For information on the power supplies, refer to the applicable instruction manual.

Information given in this instruction manual also applies to the Type R422 (with AC Power Supply only) unless otherwise noted. The Type R422 is electrically identical to the Type 422 but is adapted for rackmounting in a standard 19-inch rack. Rackmounting instructions, a mechanical parts list and a dimensional drawing for the Type R422 are provided in Section 10 of this manual.

The characteristics which follow are divided into two categories. Characteristics listed in the Performance Requirement column are checked in the Performance Check and Calibration sections of this manual. Items listed in the Supplemental Information column are provided for reference use and do not directly reflect the measurement capabilities of this instrument. The Performance Check procedure given in Section 5 of this manual provides a convenient method of checking the Performance Requirements listed in this section. The following characteristics apply over an ambient temperature range of -15°C to $+55^{\circ}\text{C}$, except as otherwise indicated. Warm-up time for given accuracy is 20 minutes.

VERTICAL DEFLECTION SYSTEM

Characteristic	Performance Requirement	Supplemental Information
Deflection Factor Channels 1 and 2 ($\times 1$)	10 millivolts/division to 20 volts/division in 11 calibrated steps	Steps in 1-2-5 sequence
Channel 2 only ($\times 10$)	1 millivolt/division to 2 volts/division with $\times 10$ GAIN AC switch pulled out	
Deflection Accuracy Channels 1 and 2 ($\times 1$)	Within 3% of indicated deflection factor	VARIABLE control fully clockwise
Channel 2 only ($\times 10$)	Within 7.5% of indicated deflection factor	VARIABLE control fully clockwise and $\times 10$ GAIN AC switch pulled out
Variable Deflection Factor	Uncalibrated deflection factor to 2.5 times or greater, the indicated deflection factor	Maximum deflection factor 50 volts/division or greater in 20 VOLTS/DIV position
Frequency Response (-3 dB point) Channels 1 and 2 ($\times 1$)	DC to 15 MHz or greater	Risetime 23 nanoseconds or less
Channel 2 only ($\times 10$)	5 Hz or less to 5 MHz or greater	Risetime 70 nanoseconds or less
AC Low-Frequency Response (-3 dB point)		2 Hz or less, AC GND DC switch set to AC
Input RC Characteristics		1 megohm ($\pm 2\%$) paralleled by approximately 30 pF. Time constant of both channels matched within 1% in calibration procedure
Maximum Input Voltage		300 volts combined DC and peak AC
Input Coupling Modes	AC or DC, selected by front-panel switch	
Vertical Linearity (low frequency)	0.2 division or less expansion or compression of a two-division display when positioned to vertical extremes of display area	Includes CRT linearity
Trace Shift Due To Input Grid Current	0.2 division or less at 10 millivolts/division (2 nanoamps or less)	

VERTICAL DEFLECTION SYSTEM (cont)

Characteristic	Performance Requirement	Supplemental Information
Vertical Display Modes	Algebraically added Channel 1 only Dual-trace chopped between channels Channel 2 only Dual-trace, alternate between channels	
Chopped Repetition Rate	100 kHz, $\pm 20\%$	
Channel Isolation Rejection Ratio	100:1 or greater at 50 kHz	With optimum GAIN adjustment at 1 kHz. Channels centered vertically with eight divisions or less of 50 kHz signal applied.
Trace Drift with Time		Typically 1 division or less in 24 hours at 10 millivolts/division after 20-minute warm up.
Signal Delay		Approximately 150 nanosecond internal delay line.

TRIGGERING

Source	Internal from Channel 1 and 2 Internal from Channel 1 only External	
Coupling	AC AC low-frequency reject DC	
Polarity	Sweep can be triggered from positive-going or negative-going portion of trigger signal	
Mode	Automatic triggering Adjustable triggering at desired level Free running	
Internal Trigger Sensitivity AC	0.2 division of deflection, minimum 50 Hz to 5 MHz; increasing to one division at 15 MHz	Typical -3 dB point, 25 Hz
AC LF REJ	0.2 division of deflection, minimum, 50 kHz to 5 MHz; increasing to one division at 15 MHz	Typical -3 dB point, 25 kHz
DC	0.2 division of deflection, minimum, DC to 5 MHz; increasing to one division at 15 MHz	
AUTO	0.8 division of deflection, minimum, 50 Hz to 4 MHz; increasing to 2.5 divisions at 15 MHz	
External Trigger Sensitivity AC	125 millivolts, minimum, 50 Hz to 5 MHz; increasing to 0.6 volt at 15 MHz	Typical -3 dB point, 25 Hz
AC LF REJ	125 millivolts, minimum, 50 kHz to 5 MHz; increasing to 0.6 volt at 15 MHz	Typically -3 dB at 25 kHz
DC	125 millivolts, minimum, DC to 5 MHz; increasing to 0.6 volt at 15 MHz	
AUTO	0.6 volt, minimum, 50 Hz to 7 MHz; increasing to 1.2 volts at 15 MHz	
Maximum External Trigger Input Voltage AC and AC LF REJ		DC component ± 250 volts or less with AC component 100 volts or less, RMS
DC		Maximum of 100 volts RMS or peak voltage of ± 250 volts

TRIGGERING (cont)

Characteristic	Performance Requirement	Supplemental Information
External Trigger Input RC Characteristics		Approximately 100 kilohms paralleled by about 35 pF
AUTO Repetition Rate	Sweep Trigger circuit automatically re-triggers Sweep Generator at 40 to 55 Hz repetition rate in absence of trigger signal (LEVEL control set to AUTO)	

HORIZONTAL DEFLECTION SYSTEM

Sweep Rates	0.5 microsecond/division to 0.5 second/division in 19 calibrated steps	Steps in 1-2-5 sequence
Sweep Accuracy	Within 3% of indicated sweep rate over middle eight divisions of display	VARIABLE control fully clockwise and $\times 10$ MAG switch pushed in
Variable Sweep Rate	Uncalibrated sweep rate 2.5 times, or greater, the indicated sweep rate	Slowest sweep rate 1.25 seconds/division, or greater, in 0.5 SEC position
Sweep Length	10.4 to 12.1 divisions	
Sweep Magnification	Each sweep rate can be increased 10 times. Center division of display is expanded to provide magnified display	Extends fastest sweep rate to 50 nanoseconds/division
Magnified Sweep Accuracy	Within 5% of magnified sweep rate	VARIABLE control fully clockwise
Magnified Sweep Linearity	$\pm 1\%$ for any eight division portion of magnified sweep length at all sweep rates except 50 nanoseconds/division. $\pm 3\%$ at 50 nanoseconds/division (excluding first division, 1%, of total sweep)	
Normal/Magnified Registration	± 0.2 division or less trace shift at graticule center when switching $\times 10$ MAG switch from on to off	
Gate Output Signal		
Waveshape	Rectangular pulse	
Polarity	Negative going	
Amplitude	0.5 volt or greater	
Duration	About 10.4 to 12.1 times the TIME/DIV switch setting	
Output resistance		Approximately 600 ohms
External Horizontal Amplifier		
Deflection factor ($\times 1$)	10 volts/division, $\pm 25\%$, with $\times 10$ MAG switch pushed in	HORIZ ATTEN control (Triggering LEVEL) fully clockwise
Deflection Factor ($\times 10$)	1 volt/division, $\pm 25\%$, with $\times 10$ MAG switch pulled out	
Variable deflection factor	Deflection factor decreased 10 times or greater when HORIZ ATTEN control is fully counterclockwise	
Frequency Response (—3 dB point)	DC to 500 kHz or greater	
Input RC Characteristics		Approximately 300 kilohms paralleled by approximately 30 pF

CALIBRATOR

Wave shape	Square wave	
Polarity	Negative going with baseline near zero volts	
Output Voltage		
Calibrator jack	2 volts	
Internal	0.2 volt	Internally applied to vertical amplifier in CALIBRATE 4 DIVISIONS position of VOLTS/DIV switches

CALIBRATOR (cont)

Characteristic	Performance Requirement		Supplemental Information
Voltage Accuracy Calibrator jack	+25° C	−15° C to +50° C	
	Within ±2.7%	Within ±3.5%	
	Internal	Within ±0.7%	
Repetition Rate	1 kHz, ±20%		
Duty Cycle	45% to 55%		
Output Resistance (at jack)			Approximately 2 kilohms

EXTERNAL BLANKING

Sensitivity	Two volts completely blanks CRT	Blanking signal connected to unblanking deflection plates. Does not provide intensity modulation
Polarity of Operation	Positive-going signal required	
Input Coupling	DC coupled	
Input Resistance at DC		Approximately 235 ohms

CATHODE-RAY TUBE (CRT)

Tube Type	T4220-31-1 rectangular, glass envelope	
Phosphor	P31 standard. Others available on special order	
Accelerating Potential		Approximately 6 kilovolts (gun potential, −1400 volts)
Graticule Type	Internal	
Area	8 divisions vertical by 10 divisions horizontal. Each division equals 0.8 centimeter	
Illumination	Variable edge lighting	
Unblanking	Deflection type, DC coupled	
Geometry Raster Distortion	±0.1 division or less horizontal and vertical	

ENVIRONMENTAL CHARACTERISTICS

The following environmental test limits apply when tested in accordance with the recommended test procedure. This instrument will meet the electrical performance requirements

given in this section following environmental tests. Complete details on environmental test procedures, including failure criteria, etc., may be obtained from Tektronix, Inc. Contact your local Tektronix Field Office or representative.

Characteristic	Performance Requirement	Supplemental Information
Temperature Operating	−15° C to +55° C	Safe operating temperature maintained by convection cooling. Thermal cutout protects instrument from overheating
	Non-operating	
Altitude Operating	15,000 feet maximum	May be tested during non-operating temperature tests
	Non-operating	
Humidity Non-operating	Perform five cycles (120 hours) of Mil-Std-202B, Method 106A	Exclude freezing and vibration

Characteristic	Performance Requirement	Supplemental Information
Vibration Operating	Vibrate for 15 minutes along each axis at a total displacement of 0.025 inch, ± 0.003 inch, (4 g at 55 c/s) from 10-55-10 in one-minute cycles. Hold for three minutes at 55 c/s. Total vibration time, 55 minutes	Instrument secured to vibration platform during test
Non-operating	Perform resonant searches along each axis at a total displacement of 0.030 inch from 10-55-10 c/s. All major resonances should be above 55 c/s	
Shock Operating	Two shocks of 30g, one-half sine, 11-millisecond duration each direction along each of the major axes. Total of twelve shocks	Guillotine type shock
Non-operating	One shock, 60g, one-half sine, 11-millisecond duration along each major axis. Total of six shocks	
Electromagnetic Interference Operating	Use test procedures and limits described in Mil-I-6181D and Mil-I-16910A, paragraph 3.6.1.1.5.1. Check for radiated interference within the specified limits over a range of 14 kHz to 1000 MHz, and conducted interference within the specified limits from 150 kHz to 25 MHz	Tests performed within electrically shielded enclosure with CRT mesh filter installed
Transportation Package vibration	Meets National Safe Transit type of test when correctly packaged. Vibrate for one hour slightly in excess of 1g	Package should just leave vibration surface
Package drop	Drop from a height of 30 inches on one corner, all edges radiating from that corner and all flat surfaces	Total of 10 drops

MECHANICAL CHARACTERISTICS

Characteristic	Information		
Construction			
Chassis	Aluminum alloy		
Cabinet	Aluminum alloy with blue-vinyl finish		
Panel	Aluminum alloy with anodized finish		
Circuit boards	Glass-epoxy laminate		
Overall Dimensions (Type 422)	Measured at maximum point		
Height	422 only	422 with AC Power supply	422 with AC-DC Power Supply
Width	6.75 inches	6.75 inches	6.75 inches
Depth	10.0 inches	10.0 inches	10.0 inches
Depth	—	17.8 inches	20.7 inches
Overall Dimensions (Type R422)			
Height	7 inches		
Width	19 inches		
Depth	16.125 inches		
Connectors			
Front-panel (except CALIBRATOR jack)	BNC		
CALIBRATOR jack	tip jack		

ACCESSORIES

Standard accessories supplied with the Type 422 are listed on the last pullout page of the Mechanical Parts List illus-

trations. Standard accessories supplied with the Type R422 are given in Section 10. For optional accessories available for use with this instrument, see the current Tektronix, Inc. catalog.

SECTION 2

OPERATING INSTRUCTIONS

General

To effectively use the Type 422, the operation and capabilities of the instrument must be known. This section describes the operation of the front-panel controls, gives first-time and general operating information and lists some basic applications for this instrument.

Front Cover and Handle

The front cover furnished with the Type 422 provides a dust-tight seal around the front panel. Use the cover to protect the front panel when storing or transporting the instrument. The cover also provides storage for the probes, power cord and other accessories (see Fig. 2-1).

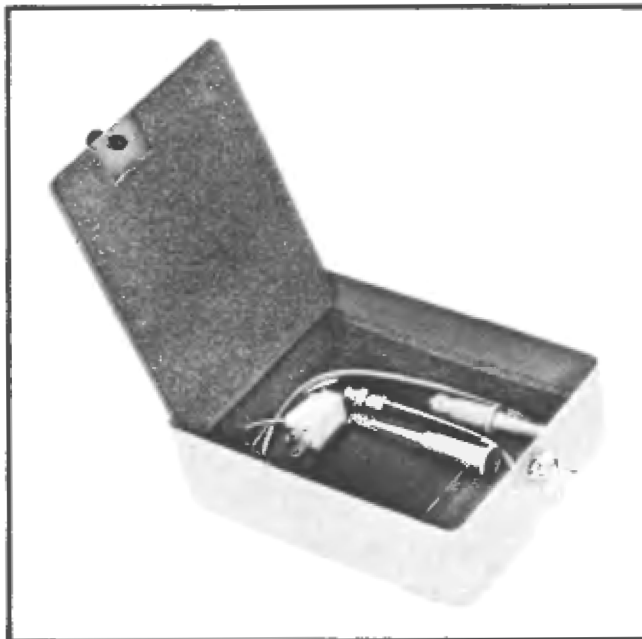

Fig. 2-1. Accessory storage provided in front cover.

The handle of the Type 422 can be positioned for carrying or as a tilt-stand for the instrument. To position the handle, press in at the pivot points (see Fig. 2-2) and turn the handle to the desired angle. Several positions are provided for convenient carrying or viewing. The instrument may also be set on the rear-panel feet for operation or storage.

Cooling

The Type 422 requires very little air circulation for proper operation. A thermal cutout in the instrument provides thermal protection and disconnects the instrument power if the internal temperature exceeds a safe operating level.

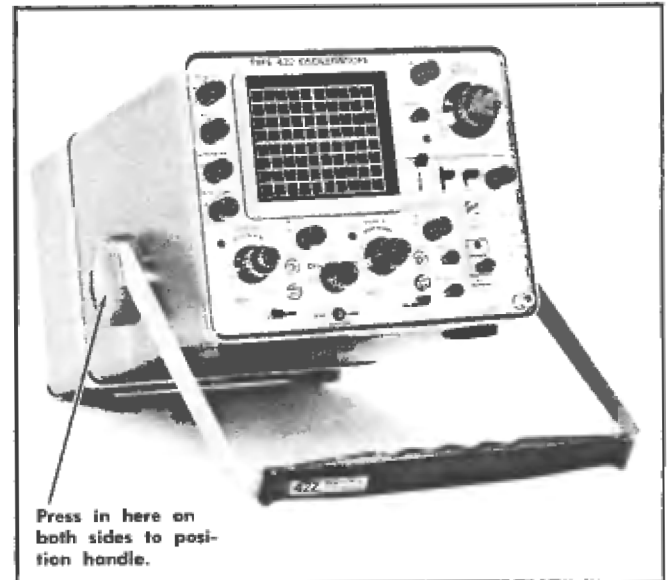

Fig. 2-2. Pivoting the carrying handle to provide a stand for the Type 422.

Power is automatically restored when the temperature returns to a safe level.

Rackmounting

Complete information for mounting the Type R422 in a cabinet rack is given in Section 10 of this manual.

FRONT-PANEL CONTROLS AND CONNECTORS

A brief description of the function or operation of the front-panel controls and connectors follows (see Fig. 2-3). More detailed information is given in this section under General Operating Information.

Cathode-Ray Tube (CRT)

INTENSITY	Controls brightness of display.
FOCUS	Provides adjustment to obtain a well-defined display.
ASTIGMATISM	Used in conjunction with the FOCUS control to obtain a well-defined display.
SCALE ILLUM	Controls graticule illumination.

Vertical (both channels if applicable)

VOLTS/DIV	Selects vertical deflection factor (VARIABLE control must be in CAL position for indicated deflection).
-----------	---

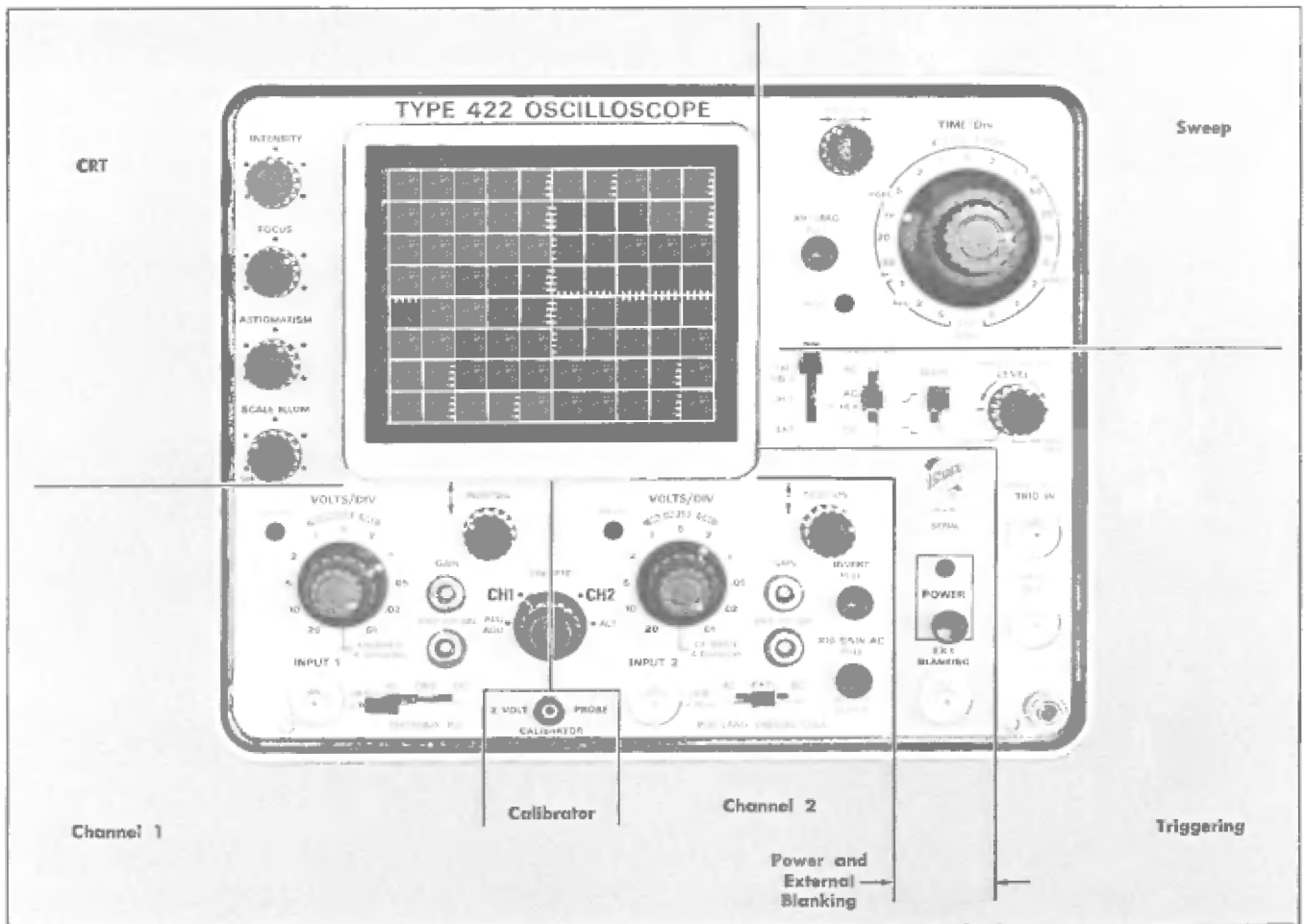



Fig. 2-3. Front-panel controls and connectors.

<p>VARIABLE Provides continuously variable deflection factor to about 2.5 times setting of the VOLTS/DIV switch.</p> <p>UNCAL Light indicates that VARIABLE control is not set to CAL.</p> <p>POSITION Controls vertical position of the display.</p> <p>GAIN Screwdriver adjustment to set the gain of the vertical input amplifier.</p> <p>STEP ATT BAL Screwdriver adjustment to set the balance of the input amplifier in the .02, .05 and .1 positions of the VOLTS/DIV switch.</p> <p>INPUT Input connector for vertical deflection signal.</p> <p>AC GND DC Selects method of coupling input signal to grid of input amplifier. AC: DC component of input signal is blocked. Low frequency limit (-3 dB point) is about two hertz. GND: Input circuit is grounded (does not ground applied signal). DC: All components of the input signal are passed to the input amplifier.</p>	<p>Mode (not labeled) Selects vertical mode of operation. ALG ADD: Channel 1 and 2 signals are algebraically added and the algebraic sum is displayed on the CRT. CH 1: The Channel 1 signal is displayed. CHOPPED: Dual trace display of signal on both channels. Approximately four-microsecond segments from each channel displayed at a repetition rate of about 100 kilohertz. CH 2: The Channel 2 signal is displayed. ALT: Dual trace display of signal on both channels. Display switched between channels at end of each sweep.</p> <p>INVERT Inverts the Channel 2 display when pulled out.</p> <p>X10 GAIN AC Increases AC gain of Channel 2 amplifier ten times when pulled out (decreases deflection factor 10 times).</p> <p>Calibrator 2-VOLT PROBE Output connector providing two-volt square-wave signal for compensating and checking gain of a probe.</p>
--	---

Triggering

Source (not labeled) Selects source of trigger signal.
 CH 1 & 2: Internal trigger signal obtained from displayed channel(s).
 CH 1: Internal trigger signal obtained only from Channel 1.
 EXT: Sweep triggered from signal applied to TRIG IN connector.

Coupling (not labeled) Determines method of coupling trigger signal.
 AC: Rejects DC and attenuates signals below about 50 hertz.
 AC LF REJ: Rejects DC and attenuates signals below about 50 kilohertz.
 DC: Accepts both AC and DC signals.

SLOPE Selects portion of trigger signal which triggers sweep.
 : Sweep triggered from positive-going portion of trigger signal.
 : Sweep triggered from negative-going portion of trigger signal.

LEVEL Selects amplitude point on trigger signal where sweep is triggered. When turned fully counterclockwise to the AUTO position, the sweep is automatically triggered. In the FREE RUN position, fully clockwise, the sweep free runs.

TRIG IN Input connector for external trigger signal.

GATE OUT Output connector providing a 0.5 volt or greater negative-going rectangular pulse which is time-coincident with the sweep.

Sweep

POSITION Controls horizontal position of the display.

×10 MAG Increases sweep rate to 10 times setting of TIME/DIV switch by expanding center division of the display.

TIME/DIV Selects sweep rate of the sweep circuit (VARIABLE control must be in CAL position for indicated sweep rate). In the EXT HORIZ position, horizontal deflection is provided by a signal connected to the HORIZ IN connector.

VARIABLE Provides continuously variable sweep rate to at least 2.5 times setting of the TIME/DIV switch. Sweep rate is calibrated only when control is set fully clockwise to the CAL position.

UNCAL Light indicates that VARIABLE control is not set to CAL.

HORIZ ATTEN (Triggering LEVEL) Provides approximately 10:1 attenuation for external horizontal signals connected to the HORIZ IN connector when the TIME/DIV switch is set to EXT HORIZ.

HORIZ IN (TRIG IN) Input connector for external horizontal signal when TIME/DIV switch is set to EXT HORIZ.

Power and External Blanking

POWER Light: Indicates that POWER switch is on and the instrument is connected to a power source.

Switch: Applies power to the instrument.

EXT BLANKING Input connector for external blanking signal.

FIRST-TIME OPERATION

The following steps will demonstrate the use of the controls and connectors of the Type 422. It is recommended that this procedure be followed completely for first time familiarization with the instrument.

1. Set the front-panel controls as follows:

Vertical controls (both channels where applicable)

VOLTS/DIV	CALIBRATE 4 DIV
VARIABLE	CAL
AC GND DC	GND
POSITION	Midrange
Mode	CH 1
INVERT	Pushed in
×10 GAIN AC	Pushed in

Horizontal controls

POSITION	Midrange
TIME/DIV	.5 mSEC
VARIABLE	CAL
×10 MAG	Pushed in

Triggering Controls

Source	CH 1 & 2
Coupling	AC
SLOPE	Positive going ()
LEVEL	AUTO

Other Controls

INTENSITY	Counterclockwise
FOCUS	Centered
ASTIGMATISM	Centered
SCALE ILLUM	Any position
POWER	Pulled out

2. Connect the Type 422 to a power source that meets the voltage and frequency requirements of the instrument.

3. Advance the INTENSITY control until the trace is at the desired viewing level (about midrange).

4. Adjust the FOCUS and ASTIGMATISM controls for a sharp, well-defined display over the entire trace length.

5. Set the Channel 1 VOLTS/DIV switch to .01.

6. Position the trace with the Channel 1 POSITION control so it coincides with one of the horizontal graticule lines.

TYPE 422 CONTROL SETUP CHART

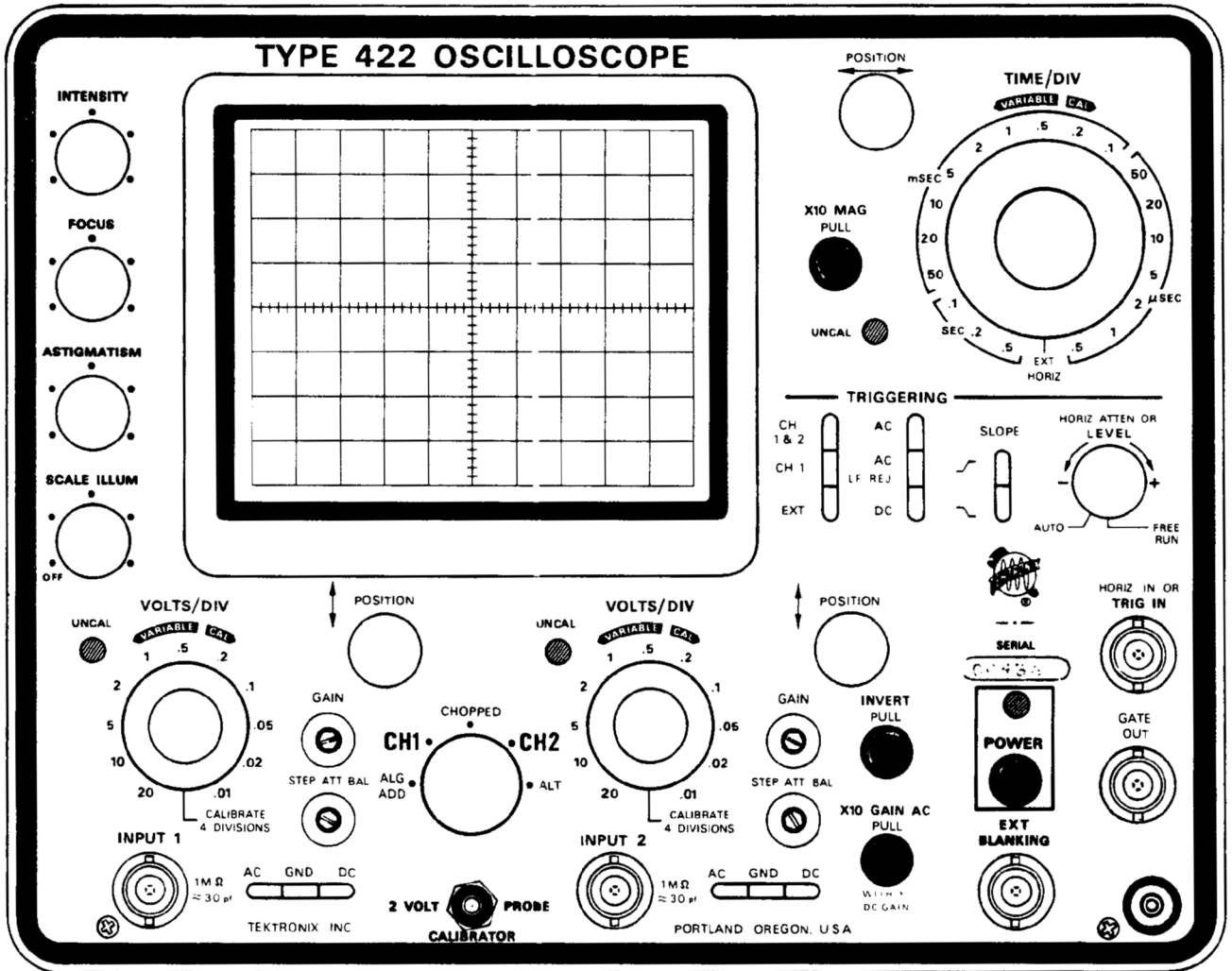

If the trace is not parallel with the graticule line, see Trace Alignment Adjustment in this section.

7. Return the Channel 1 VOLTS/DIV switch to the CALIBRATE 4 DIVISIONS position.

8. The display should be a four-division square wave showing about five cycles of the signal. If the display is not four divisions in amplitude, adjust the front-panel GAIN adjustment as described under Vertical Gain Adjustment in this section. The step attenuator balance should also be checked as described under Step Attenuator Balance Adjustment in this section.

9. Turn the Channel 1 VARIABLE control throughout its range. Note that the UNCAL light comes on when the VARIABLE control is moved from the CAL position (fully clockwise). The uncalibrated vertical deflection factor is about 2.5 times the indicated deflection factor in the counterclockwise position. Return the VARIABLE control to CAL.

10. Turn the Channel 1 POSITION control to move the display toward the top of the graticule.

11. Set the Mode switch to CH 2.

12. The Channel 2 display should be similar to Channel 1. Gain and step attenuator balance can be checked in the same manner as for Channel 1. The Channel 2 VARIABLE control operates in the same manner as for Channel 1.

13. Turn the Channel 2 POSITION control to move the display toward the bottom of the graticule.

14. Pull the INVERT switch. The trace is now at the top of the graticule area. Push the INVERT switch in.

15. Set the Mode switch to ALT; the Channel 1 and 2 displays as set up in steps 10 and 13 should be seen. Turn the TIME/DIV switch throughout its range. Notice that the flicker between traces decreases as the sweep rate is increased. Return the TIME/DIV switch to .5 mSEC.

16. Set the Mode switch to CHOPPED. Note that the triggering is unstable in the CH 1 & 2 Triggering Source switch position.

17. Set the Triggering Source switch to CH 1; the display should be identical to that obtained in ALT (step 15). Turn the TIME/DIV switch to 10 μ SEC, set both VOLTS/DIV switches to .01 and the Triggering Source switch to CH 1 & 2. Notice the switching between channels as shown by the segmented traces. Reduce the sweep rate slowly and notice that the traces appear solid at about .2 mSEC. Best results in the CHOPPED mode are obtained at sweep rates below this setting. Return the VOLTS/DIV switches to CALIBRATE 4 DIVISIONS and the Triggering Source switch to CH 1. Continue to reduce the sweep rate and note that a usable display is presented down to the slowest sweep rate provided. Return the TIME/DIV switch to .5 mSEC.

18. Set the Mode switch to ALG ADD. The display should be eight divisions in amplitude. The Channel 1 and 2 signals are added for this display. Note that either POSITION control will move the display.

19. Pull the INVERT switch and center both POSITION controls. The display should be a straight line indicating that the algebraic sum of the two signals is zero.

20. Set either VOLTS/DIV switch to .01. The square-wave display indicates that the algebraic sum of the two signals is no longer zero. Return the Mode switch to CH 1 and both VOLTS/DIV switches to CALIBRATE 4 DIVISIONS. Push in the INVERT switch.

21. Turn the LEVEL control clockwise to the FREE RUN position. The trace should appear as two lines four divisions apart (free running).

22. Rotate the LEVEL control counterclockwise until a stable display appears. This indicates that the sweep is triggered. Continue to turn the LEVEL control counterclockwise and note that more of the leading edge is shown (leading edge of trace appears to move negative) as the LEVEL control is turned toward —. Turn the control fully counterclockwise to the AUTO position. The trace should again appear stable.

23. Set the SLOPE switch to the negative-going position. The trace should start with the negative part of the square wave. Return the switch to the positive-going position; the trace should start with the positive part of the square wave.

24. With the Triggering Coupling switch set to AC, the display should be stable both in AUTO and with the LEVEL control set at about the middle of rotation. In the AC LF REJ position, triggering may be unstable in AUTO but should be stable using the LEVEL control. Now switch to DC. With the Triggering Source switch set to CH 1 & 2, adjust the LEVEL control for a stable display. Now turn the Channel 1 POSITION control and note that the trace disappears when it is moved several divisions. Set the Source switch to CH 1 and rotate the vertical POSITION control to move the display up and down the screen. The display will remain triggered at any vertical POSITION setting. Also note that the display is stable with AUTO triggering in either Triggering Source position. Return the Triggering Coupling switch to AC.

25. Set the Triggering Source switch to CH 1 & 2. The display should be the same as in the CH 1 position. Turn the Mode switch to CH 2 and the Channel 1 VOLTS/DIV switch to .01. The Channel 2 signal should be displayed and be triggered. Set the Triggering Source switch back to the CH 1 position. The display is now unstable because it is not triggered. Return the Mode switch to CH 1 and the Channel 1 VOLTS/DIV switch to the CALIBRATE 4 DIVISIONS position.

26. If an external signal is available (0.6-volt peak-to-peak minimum, 50 Hz—15 MHz) the EXT function of the Triggering Source switch can be demonstrated. Connect the external signal to both the INPUT 1 and TRIG IN connectors. Set the Channel 1 AC GND DC switch to DC and set the VOLTS/DIV switch to a position that will provide about a six-division display. Operation of the Triggering Coupling switch, SLOPE switch and LEVEL control should be the same in the EXT position as described in steps 21 through 24 (with six divisions of deflection). Return the Channel 1 VOLTS/DIV switch to CALIBRATE 4 DIVISIONS and the Triggering Source switch to CH 1.

27. Set the TIME/DIV switch to 5 mSEC. Pull the $\times 10$ MAG switch. The display should show about one cycle/two divisions. Push in the $\times 10$ MAG switch and return the TIME/DIV switch to .5 mSEC. The display should be similar

Operating Instructions—Type 422/R422 (SN 100-19,999)

to that obtained with the TIME/DIV switch at 5mSEC and the magnifier on.

28. Turn the horizontal POSITION control so the display starts at about the center of the graticule. Now turn the POSITION control in the opposite direction. Notice that for about 60° of rotation the trace moves slowly to the left and the control turns easily. Then, the drag on the control increases slightly and the trace begins to move much faster to the left. This control provides a combination of coarse and fine adjustment. To use the control effectively, turn it slightly past the desired point of adjustment (coarse adjust). Then reverse the direction of rotation and use the fine adjustment to establish more precise positioning. Return the start of the trace to the left edge of the graticule.

29. If an external signal is available (1 volt to 10 volts), the function of the external horizontal amplifier can be demonstrated. Turn the INTENSITY control to a lower setting to protect the CRT phosphor. Then set the TIME/DIV switch to EXT HORIZ and turn the HORIZ ATTEN control (LEVEL) fully clockwise. Connect the external horizontal signal to the HORIZ IN connector (TRIG IN). Now set the INTENSITY control to provide an adequate display. The display should be rectangular, four divisions vertically with the horizontal length of the display variable with the HORIZ ATTEN control (vertical deflection provided by Type 422 Calibrator signal and horizontal deflection provided by external signal). Turn the HORIZ ATTEN control so the display is less than one division horizontally. Pull the $\times 10$ MAG switch. Re-position the display on to the viewing area if necessary and notice that the display is about 10 times larger horizontally. Push the $\times 10$ MAG switch.

30. If an external signal is available (+2 volts peak, minimum) the function of the EXT BLANKING circuit can be demonstrated. Connect the external signal to the INPUT 1 connector. Set the AC GND DC switch to DC and set the Channel 1 VOLTS/DIV switch to display about five cycles of the signal. Connect the vertical input signal to the EXT BLANKING connector also, and notice that the positive peaks of +2 volts or greater are blanked out.

31. This completes the basic operation procedure for the Type 422. More detailed information, where necessary will follow.

CONTROL SETUP CHART

Fig. 2-4 shows the front panel of the Type 422. This chart may be reproduced and used as a test-setup record for special measurements, applications or procedures, or it may be used as a training aid for familiarization with this instrument.

GENERAL OPERATING INFORMATION

Removing the Power Supply

The power supply can be removed from the Type 422 indicator for maintenance, calibration or remote operation. Loosen the four screws located on the rear of the power supply and then separate the units by sliding the power supply to the rear, off the support rods.

Operating the Power Supply Remotely

The Type 422 can be operated with the power supply removed. The interconnecting plug on the rear of the indi-

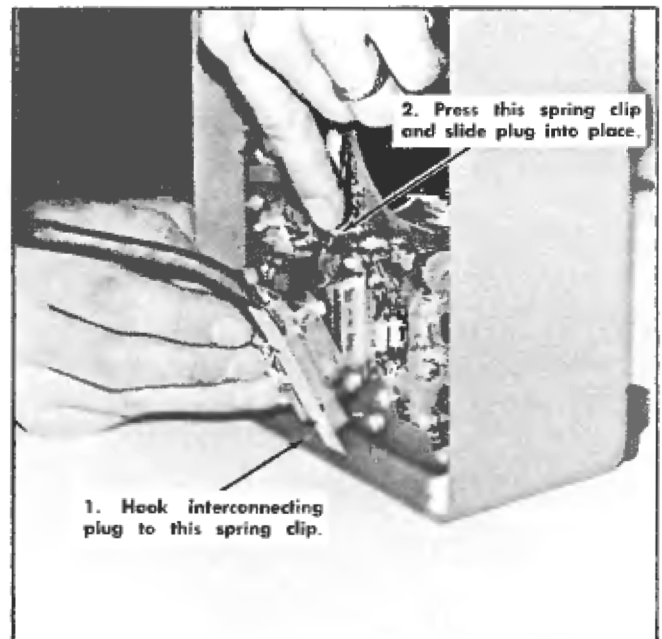

Fig. 2-5. Securing the power cable to the power supply for remote operation.

cator can be detached and used as an extension cable. The instrument will not operate correctly with any extension cable longer than the one provided with it. To remove the interconnecting plug, loosen the three screws holding it to the indicator and slide it up slightly; then move it away from the rear of the unit. Unwrap the power cable from the rear of the indicator. The two spring clips (see Fig. 2-5) on the power supply are provided to lock the power cable to the power supply for remote operation. To use the clips, hook one spring clip into the hole provided in the interconnecting plug. (Be sure the POWER switch is set to off.) Slide the plug into place while depressing the other spring clip. To remove the plug, reverse the order in which it was attached.

CAUTION

Do not bend the spring clips so they latch without using the procedure described above. If bent in this manner, they will latch when the power supply is remounted on the indicator and will be difficult to remove without damage to the instrument.

Intensity Control

The setting of the INTENSITY control may affect the correct focus and astigmatism of the display. To protect the CRT phosphor, do not turn the INTENSITY control higher than necessary to provide a satisfactory display. Also, be careful that the INTENSITY control is not set too high when changing from a fast to a slow sweep rate or when setting the TIME/DIV switch to the EXT HORIZ position.

Trace Alignment Adjustment

If a free-running trace is not parallel with the horizontal graticule lines, set the Trace Rotation adjustment as follows.

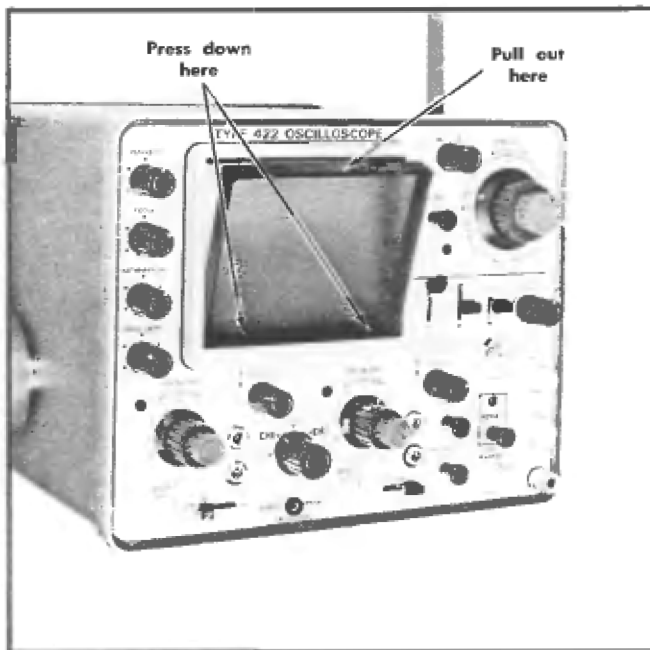

Fig. 2-6. Removing the light filter or faceplate protector.

1. Position the trace to the graticule centerline.
2. Adjust the Trace Rotation adjustment (the power supply must be operated remotely for access to this adjustment) so the trace is parallel with the horizontal graticule lines.

Light Filter

The mesh filter provided with the Type 422 provides shielding against radiated RFI (radio-frequency interference radiation) from the face of the CRT. It also serves as a light filter to make the trace more visible under high ambient light conditions. To remove the filter, press down at the bottom of the frame and pull the top of the filter away from the CRT faceplate (see Fig. 2-6).

A tinted light filter is also supplied. This filter minimizes light reflections from the face of the CRT to improve contrast when viewing the display under high ambient light conditions. A clear plastic faceplate protector is provided for use when neither the mesh nor the tinted filter is used. The clear faceplate protector provides the best display for waveform photographs. It is also preferable for viewing high writing rate displays.

A filter or faceplate protector should be used at all times to protect the CRT faceplate from scratches. The faceplate protector and the tinted light filter mount in the same holder; press it out to the rear. Either one can be replaced by snapping it back into the holder.

Signal Connections

In general, 10× attenuator probes offer the most convenient means of connecting a signal to the input of the Type 422. A 10× attenuator probe offers a higher input impedance and allows the circuit under test to operate more closely to actual operating conditions. However, the 10× probe

also attenuates the input signal 10 times. The probe is shielded to prevent pickup of electrostatic interference. High-frequency response when using a Tektronix 10× probe is affected only slightly. Low-frequency response with AC input coupling is extended to about 0.2 hertz.

In some cases, the signal can be connected to the Type 422 with short unshielded leads. This is particularly true with high-level, low-frequency signals. When such leads are used, be sure to establish a common ground between the Type 422 and the equipment under test. Attempt to position the leads away from any source of interference to avoid errors in the display. If interference is excessive with unshielded leads, use a coaxial cable or a probe.

In high-frequency applications requiring maximum overall bandwidth, use coaxial cables terminated in their characteristic impedance at the Type 422 input.

Loading Effect of the Type 422

As nearly as possible, simulate actual operating conditions in the equipment under test. Otherwise, the equipment under test may not produce a normal signal. The 10× attenuator probes mentioned previously offer the least circuit loading. Tektronix 10× attenuator probes have an input resistance of about 10 megohms with very low shunt capacitance.

When the signal is coupled directly to the input of the Type 422, the input impedance is about one megohm paralleled by about 30 pF. When the signal is coupled to the input of the Type 422 through a coaxial cable, the input capacitance is greatly increased. Just a few feet of coaxial cable can increase the input capacitance to well over 100 pF.

Vertical Gain Adjustment

Check. To Check the gain of either channel, set the VOLTS/DIV switch to the CALIBRATE 4 DIVISIONS position and the VARIABLE control to CAL. The vertical deflection should be exactly four divisions. If not, adjust as follows.

Adjust. Front-panel GAIN control for exactly four divisions of deflection.

NOTE

If the gain of the two channels must be closely matched (such as for ALG ADD operation), use the adjustment procedure given in the Calibration Procedure.

Step Attenuator Balance Adjustment

Check. To check the step attenuator balance of either channel, set the AC GND DC switch to GND and the Triggering LEVEL control to AUTO. Change the VOLTS/DIV switch from .05 to .01. If the trace moves vertically, adjust the STEP ATT BAL adjustment as follows.

Adjust. This procedure can be used to adjust the step attenuator balance of either channel. Set the Vertical Mode switch to display the desired channel. Allow about ten minutes warm up before performing this adjustment.

1. With the controls set as for the check, turn the POSITION control to midrange.

2. Set the VARIABLE control to CAL and adjust the STEP ATT BAL adjustment to bring the trace near graticule center.

3. Adjust the STEP ATT BAL adjustment so there is no trace shift as the VOLTS/DIV switch is changed from .05 to .01. This may take several readjustments of the STEP ATT BAL adjustment.

Vertical Channel Selection

Either of the input channels can be used for single-trace displays. Apply the signal to the desired INPUT connector and set the MODE switch to display the channel used. However, the invert and $\times 10$ AC gain features of this instrument are provided only for Channel 2. To use these features, the signal must be connected to INPUT 2. For dual-trace displays, connect the signals to both INPUT connectors and set the MODE switch to one of the dual-trace positions.

Input Coupling

The Channel 1 and 2 AC GND DC switches allow a choice of input coupling. The type of display desired will determine the coupling used. The GND position on this switch provides a convenient method of obtaining a DC ground reference.

The DC position can be used for most applications. However, if the DC component of the signal is much larger than the AC component, the AC position will probably provide a better display. DC coupling should be used to display AC signals below about 20 hertz (2 hertz with a $10\times$ probe) as they will be attenuated in the AC position.

In the AC position, the DC component of the signal is blocked by a capacitor in the input circuit. The low-frequency response in the AC position is about 2 hertz (-3 dB point). Therefore, some low-frequency attenuation can be expected near this frequency limit. Attenuation in the form of waveform tilt will also appear in square waves which have low-frequency components.

The GND position provides a ground reference at the input of the Type 422. The signal applied to the input connector is internally disconnected but not grounded. The input circuit is held at ground potential, eliminating the need to externally connect the input to ground to establish a DC ground reference.

Deflection Factor

The amount of vertical deflection produced by a signal is determined by the signal amplitude, the attenuation factor of the probe (if used), the setting of the VOLTS/DIV switch and the setting of the VARIABLE VOLTS/DIV control. The calibrated deflection factors indicated by the VOLTS/DIV switches apply only when the VARIABLE control is set to the CAL position.

The VARIABLE VOLTS/DIV control provides variable (uncalibrated) vertical deflection between the calibrated settings of the VOLTS/DIV switch. The VARIABLE control extends the maximum vertical deflection factor of the Type 422 to at least 50 volts/division (20 volts/division position).

When the $\times 10$ GAIN AC switch in Channel 2 is pulled out, the deflection factor indicated by the VOLTS/DIV switch must be divided by 10 to obtain the true deflection factor.

Channel 2 $\times 10$ Gain

The $\times 10$ GAIN AC switch provides 10 times gain for the Channel 2 amplifier to extend the minimum deflection factor to 0.001 volt/division in the .01 VOLTS/DIV switch position. The DC component of the applied signal is not amplified. For best results when using the $\times 10$ GAIN AC switch, the AC GND DC switch should be in the AC position.

Dual-Trace Operation

Alternate Mode. The ALT position of the Vertical Mode switch produces a display which alternates between Channel 1 and 2 with each sweep of the CRT. Although the ALT mode can be used at all sweep rates, the CHOPPED mode provides a more satisfactory display at sweep rates below about 0.5 millisecond/division. At these slower sweep rates, alternate mode switching becomes visually perceptible.

Proper internal triggering in the ALT mode can be obtained in either the CH 1 & 2 or the CH 1 position of the Triggering Source switch. When in the CH 1 & 2 position, the sweep will be triggered from the signal on each channel. This provides a stable display of two unrelated signals, but does not indicate the time relationship between the signals. In the CH 1 position, the two signals will be displayed showing true time relationship. If the signals are not time related, the Channel 2 waveform will be unstable in the CH 1 source switch position.

Chopped Mode. The CHOPPED position of the MODE switch produces a display which is electronically switched between channels. In general, the CHOP mode provides the best display at sweep rates slower than about 0.2 millisecond/division or whenever dual-trace, non-repetitive phenomena is to be displayed. At faster sweep rates the chopped switching may become apparent and interfere with the display.

Proper internal triggering for the CHOPPED mode is provided with the Triggering Source switch set to CH 1. If the CH 1 & 2 position is used, the sweep circuits will be triggered from the between-channel switching signal and both waveforms will be unstable. External triggering will provide the same result as CH 1 triggering.

Two signals which are time-related can be displayed in the CHOPPED mode showing true time relationship. If the signals are not time-related, the Channel 2 display will appear unstable.

Two non-repetitive, transient or random signals which occur within the time interval determined by the TIME/DIV switch (ten times sweep rate) can be compared using the CHOPPED mode. To trigger the sweep correctly, the Channel 1 signal must precede the Channel 2 signal. Since the signals show true time relationship, time-difference measurements can be made.

Algebraic Addition

The ALG ADD position of the Mode switch can be used to display the sum or difference of two signals or for common-mode rejection to remove an undesired signal (about 100:1 rejection).

The gain of the two channels is matched in the Calibration Procedure. However, the deflection in the various positions

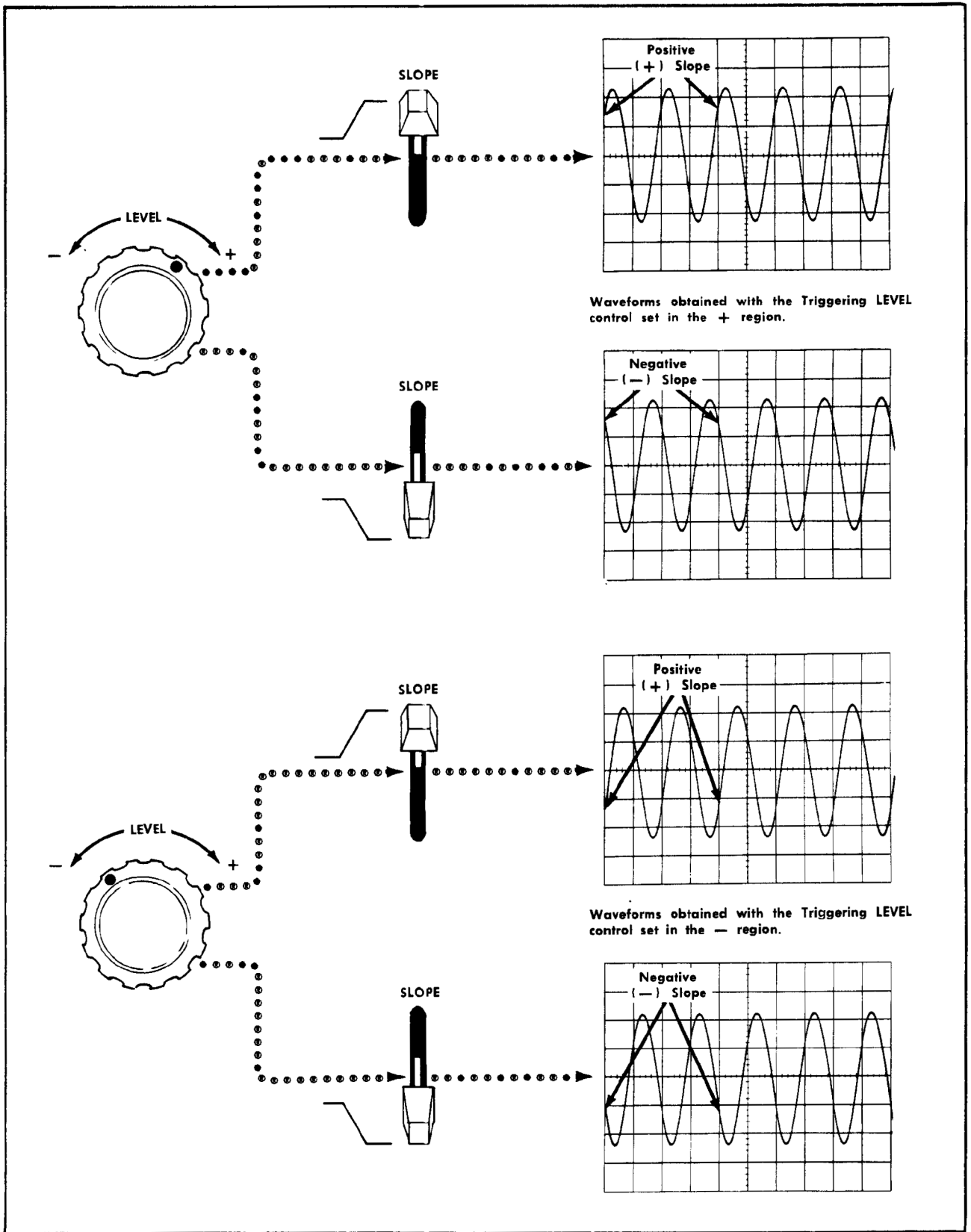

Waveforms obtained with the Triggerring LEVEL control set in the + region.

Waveforms obtained with the Triggerring LEVEL control set in the - region.

Fig. 2-7. Effect of the Triggerring LEVEL control and SLOPE switch on the CRT display.

of the VOLTS/DIV switches may vary slightly due to tolerance of the input attenuators involved. The deflection at any setting of the VOLTS/DIV switch can be closely matched by applying a signal to both inputs and inverting the Channel 2 signal with the INVERT switch. Adjust the VARIABLE VOLTS/DIV control in the channel with the largest deflection until a straight line is produced.

The following general precautions should be observed when using the ALG ADD mode.

1. Do not exceed the input voltage rating of the Type 422.
2. Do not apply signals that exceed an equivalent of about 8 times the VOLTS/DIV switch settings. As an example, with the VOLTS/DIV switch set to 1, the voltage applied to that channel should not exceed about 8 volts. Larger signals may distort the display.
3. Use vertical POSITION control settings which most nearly position the signal of each channel to mid-screen when viewed in either the CH 1 or CH 2 positions of the MODE switch. This will insure the greatest dynamic range for ALG ADD mode operation.

Sweep Triggering

Proper sweep triggering is essential for a stable presentation of an input signal. For a stable display, the sweep must be triggered by a signal that is time-related to the displayed signal. The following considerations will help to obtain correct triggering.

Trigger Source

CH 1 & 2. In the CH 1 & 2 position of the Triggering Source switch, the trigger signal is obtained from the displayed signal. This position provides the most convenient operation when displaying single channel displays. However, for dual-trace displays, special considerations must be made to provide the correct display. See Dual-Trace Operation in this section for dual-trace triggering information.

CH 1. The CH 1 position of the Triggering Source switch provides a trigger signal from only the signal applied to the INPUT 1 connector. This position provides a stable display of the Channel 1 signal and is useful for certain dual-trace applications (see Dual-Trace Operation).

EXT. An external signal connected to the TRIG IN connector can be used to trigger the sweep in the EXT position of the Source switch. The external signal must be time-related to the displayed signal for a stable display. An external trigger signal can be used to provide a triggered display when the internal signal is too low in amplitude for correct triggering or contains signal components on which it is not desired to trigger. It is also useful when signal tracing in amplifiers, phase-shift networks, wave-shaping circuits, etc. The signal from a single point in the circuit can be connected to the TRIG IN connector through a signal probe or cable. The sweep is then triggered by the same signal at all times and allows amplitude, time relationship or wave shape changes of signals at various points in the circuit to be examined without resetting the triggering controls.

Trigger Coupling

Three methods of coupling the trigger signal to the trig-

ger circuits can be selected with the Triggering Coupling switch. Each position permits selection or rejection of the frequency components of the trigger signal which trigger the sweep.

AC. The AC position blocks the DC component of the trigger signal. Signals with low-frequency components below about 50 hertz will be attenuated. In general, AC coupling can be used for most applications. However, if the signal contains unwanted low-frequency signals or if the sweep is to be triggered at a DC level, one of the remaining Coupling switch positions will provide a better display.

The triggering point in the AC position depends on the average voltage level of the trigger signals. If the trigger signals occur at random, the average voltage level will vary, causing the triggering point to vary also. This shift of the triggering point may be enough so it is impossible to maintain a stable display. In such cases, use DC coupling.

AC LF REJ. In the AC LF REJ position, all DC and low-frequency signals below about 50 kilohertz are rejected or attenuated. Then, the sweep is triggered only by the higher-frequency components of the trigger signal. This position is particularly useful for providing stable triggering if the trigger signal contains line-frequency components. Also, in the ALT position of the Mode switch the AC LF REJ coupling position provides the best display at high sweep rates when comparing two unrelated signals (triggering from both Channel 1 and Channel 2).

DC. DC coupling can be used to provide stable triggering with low-frequency signals which would be attenuated in the AC position, or with low-repetition rate signals. The LEVEL control can be adjusted to provide triggering at the desired DC level on the waveform. In the CH 1 & 2 position of the Source switch, the setting of the vertical POSITION controls affects the DC trigger level.

DC trigger coupling should not be used in the ALT dual-trace mode if the Triggering Source switch is set to CH 1 & 2. If used, the sweep will trigger on the DC level of one trace and then either lock out completely or free run on the other trace. Correct DC triggering for this mode can be obtained with the Triggering Source switch set to CH 1.

Trigger Slope

The Triggering SLOPE switch determines whether the trigger circuit responds to the positive-going or negative-going portion of the trigger signal. When the SLOPE switch is in the positive-going (—) position, the display starts with the positive-going portion of the waveform; in the negative-going (—) position, the display starts with the negative-going portion of the waveform (see Fig. 2-7). When several cycles of a signal appear in the display, the setting of the SLOPE switch is probably unimportant. However, if you wish to look at only a certain portion of a cycle, the setting of the SLOPE switch insures that the display starts on the desired slope of the input signal.

Trigger Level

The Triggering LEVEL control determines the voltage level on the triggering waveform at which the sweep is triggered. When the LEVEL control is set in the + region, the trigger cir-

cuit responds at a more positive point on the trigger signal. In the — region the trigger circuit responds at a more negative point on the trigger signal. Fig. 2-7 illustrates this effect with different settings of the SLOPE switch.

To set the LEVEL control, first select the Triggering Source, Coupling and SLOPE. Then, rotate the LEVEL control fully counterclockwise to the AUTO position (operation in the AUTO position is discussed below). Now turn the LEVEL control clockwise until the sweep appears and is stable. Further rotation in the clockwise direction causes the sweep to trigger at a more positive point on the triggering waveform. In the extreme clockwise position, the sweep free runs.

Trigger Mode

Automatic Triggering. Automatic triggering is obtained by rotating the Triggering LEVEL control fully counterclockwise to the AUTO position. In this position, triggering occurs at the average voltage point of the applied waveform. If a trigger signal is not present, the sweep is automatically retriggered at a 40 to 55 Hz rate to provide a reference trace. Automatic triggering can be used with both internal and external trigger signals. Best operation is provided for signals with repetition rates above 55 hertz.

Automatic triggering is particularly useful when observing a series of waveforms since it is not necessary to reset the Triggering LEVEL control for each observation. Therefore, this mode can be used for most applications and the remaining modes used when special applications are necessary or stable triggering is not obtainable in the AUTO mode.

Free Running. When the Triggering LEVEL control is rotated fully clockwise, the sweep free runs independent of any trigger signal. One difference between the free running traces produced in the AUTO and FREE RUN positions is the repetition rate. The repetition rate in the FREE RUN position is dependent upon the setting of the TIME/DIV switch and the trace appears at essentially the same intensity at all sweep rates. The repetition rate in the AUTO position is fixed at 40 to 55 hertz.

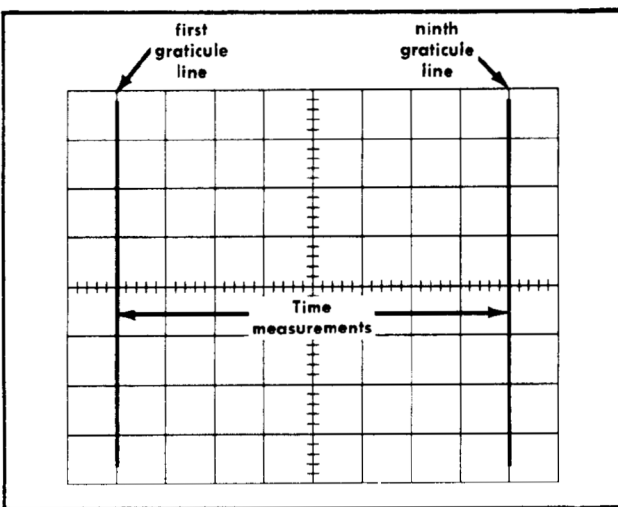

Fig. 2-8. Area of graticule used for accurate time measurements.

Selecting Sweep Rate

The TIME/DIV switch provides 19 calibrated sweep rates ranging from 0.5 microsecond to 0.5 second/division. The VARIABLE control provides continuously variable sweep rates between the settings of the TIME/DIV switch. Whenever the UNCAL light is on, the sweep rate is not calibrated.

When making time measurements from the graticule, the area between the first and ninth graticule lines provides the most linear time measurement (see Fig. 2-8). Therefore, the first and last divisions of the display should not be used when making accurate time measurements. Position the start of the timing area to the first graticule line and adjust the TIME/DIV switch so the end of the timing area falls between the first and ninth graticule lines.

Horizontal Position Control

The horizontal POSITION control used on the Type 422 provides a combination of a coarse and fine adjustment in one control. When this control is rotated, fine positioning is provided for a range of about 60° and the trace can be precisely positioned. Then, after the fine range is exceeded, the coarse adjustment comes into effect to provide rapid positioning of the trace. To use this control effectively for precise positioning, first turn the control to move the trace slightly beyond the desired position (coarse range). Then reverse the direction of rotation to use the fine range to establish the precise position desired.

Sweep Magnification

The sweep magnifier expands the center division of the display 10 times (see Fig. 2-9). To use this feature, first move the portion of the display you wish to expand to the center of the graticule. Then, pull the X10 MAG switch. The POSITION control can be adjusted to position the magnified waveform for correct viewing. Any portion of the original

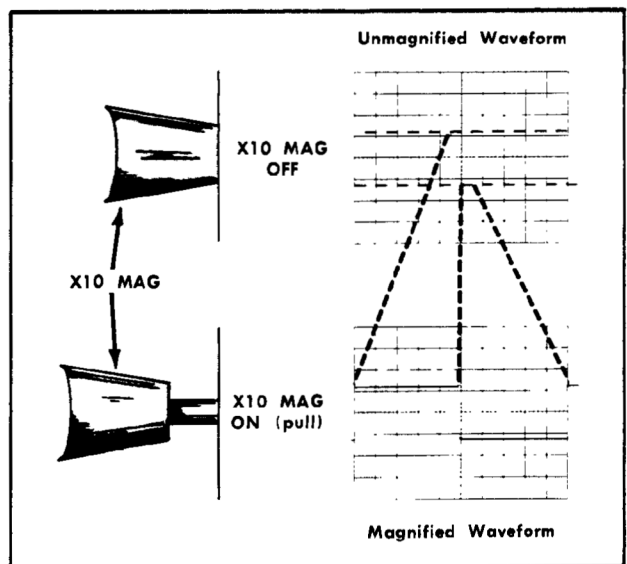

Fig. 2-9. Operation of the sweep magnifier.

Operating Instructions—Type 422/R422 (SN 100-19,999)

waveform can be viewed by adjusting the POSITION control to bring the desired portion onto the viewing area.

With the $\times 10$ MAG switch pulled out, the sweep rate is obtained by dividing the TIME/DIV switch setting by 10. For example, if the TIME/DIV switch is set to 5 mSEC, the magnified sweep rate is 0.5 millisecond/division. The magnified sweep rate must be used for all time measurements with the $\times 10$ MAG switch pulled out. The magnified sweep rate is calibrated when the UNCAL light is off.

External Horizontal Input

In some applications it is desirable to display one signal versus another signal rather than against time (internal sweep). The EXT HORIZ position of the TIME/DIV switch provides a means for applying an external signal to the horizontal amplifier for this type of display.

Connect the external horizontal signal to the HORIZ IN connector (TRIG IN). With the HORIZ ATTEN control (Triggering LEVEL) fully clockwise and the magnifier off, the horizontal deflection factor will be about 10 volts/division. Deflection factor with the magnifier on is about one volt/division. The HORIZ ATTEN control provides at least 10:1 variable attenuation within the above ranges.

External Blanking

The CRT display of the Type 422 can be externally blanked by a signal connected to the EXT BLANKING connector. External blanking signals are direct-coupled to the blanking deflection plates. A two-volt positive signal connected to the EXT BLANKING connector on the front panel will completely blank the display at any INTENSITY setting. For external blanking, the CRT display cannot be satisfactorily intensity modulated but is either turned on or off. Deflection blanking systems (as used in the Type 422) provide a poor "gray scale".

Calibrator

The internal calibrator of the Type 422 provides a convenient signal for checking vertical gain. This signal is internally connected to the Input Amplifiers when the VOLTS/DIV switches are set to the CALIBRATE 4 DIVISIONS position. The Calibrator signal is also very useful for checking and adjusting probe compensation as described in the probe instruction manual. In addition, the Calibrator can be used as a convenient signal source for application to external equipment.

BASIC APPLICATIONS

The following information describes the procedure and technique for making basic measurements with a Type 422 Oscilloscope. No attempt has been made to describe these applications in detail, as each application must be adapted to the individual requirements. Familiarity with the Type 422 will enable the operator to apply these basic techniques to a wide variety of uses.

Peak-to-Peak Voltage Measurements—AC

To make peak-to-peak voltage measurement, use the following procedure:

1. Apply the signal to either INPUT connector.
2. Set the Mode switch to display the channel used.
3. Set the VOLTS/DIV switch to display about six divisions of the waveform.
4. Set the AC GND DC switch to AC.

NOTE

For low-frequency signals below about 20 Hz use the DC position to prevent attenuation.

5. Set the Triggering controls to obtain a stable display. Set the TIME/DIV switch to a position that displays several cycles of the waveform.

6. Turn the vertical POSITION control so the lower portion of the waveform coincides with one of the graticule lines below the centerline, and the top of the waveform is on the viewing area. With the horizontal POSITION control, move the display so one of the upper peaks lies near the graticule center vertical line (see Fig. 2-10).

7. Measure the divisions peak to peak of vertical deflection. Make sure the VARIABLE VOLTS/DIV control is in the CAL position.

NOTE

This technique may also be used to make measurements between two points on the waveform rather than peak to peak.

- B. Multiply the distance measured in step 7 by the VOLTS/DIV setting. Also include the attenuation factor of the probe, if any.

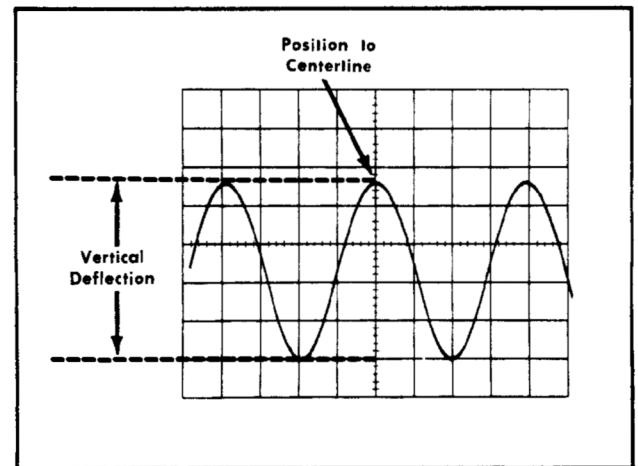

Fig. 2-10. Measuring peak-to-peak voltage of a waveform.

Example. As an example of this method of measurement, assume that the peak-to-peak vertical deflection is 4.6 divisions (see Fig. 2-10) using a $10\times$ attenuator probe and a VOLTS/DIV switch of .5.

$$\text{Volts Peak to Peak} = \text{vertical deflection (divisions)} \times \text{VOLTS/DIV setting} \times \text{probe attenuation factor}$$

Substituting the given values:

$$\text{Volts Peak to Peak} = 4.6 \times 0.5 \text{ volts} \times 10$$

The peak-to-peak voltage is 23 volts.

Voltage Measurements—Instantaneous DC

To measure the DC level at a given point on a waveform, use the following procedure:

1. Connect the signal to either INPUT connector.
2. Set the Mode switch to display the channel used.
3. Set the VOLTS/DIV switch to display about six divisions of the waveform.
4. Set the AC GND DC switch to GND.
5. Set the Triggering LEVEL control to AUTO.
6. Position the trace to the bottom line of the graticule or other reference line. If the voltage is negative with respect to ground, position the trace to the top line of the graticule. Do not move the vertical POSITION control after this reference line has been established.

NOTE

To measure a voltage level with respect to a voltage other than ground, make the following changes in step 6. Set the AC GND DC switch to DC. Apply the reference voltage to the INPUT connector and position the trace to the reference line.

7. Set the AC GND DC switch to DC. The ground reference line can be checked at any time by switching to the GND position.

8. Set the Triggering controls to obtain a stable display. Set the TIME/DIV switch to a setting that will display the desired waveform.

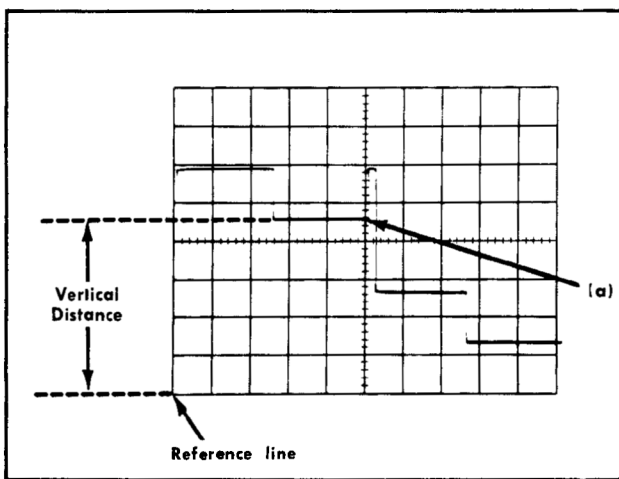

Fig. 2-11. Measuring instantaneous DC voltage with respect to a reference.

9. Measure the distance in divisions between the reference line and the point on the waveform at which the DC level is to be measured. For example, in Fig. 2-11 the measurement is made between the reference line and point A.

10. Establish the polarity of the signal. If the waveform is above the reference line the voltage is positive; below the line, negative.

11. Multiply the distance measured in step 9 by the VOLTS/DIV switch setting. Include the attenuation factor of the probe, if any.

Example: As an example of this method of measurement, assume that the vertical distance measured is 4.6 divisions (see Fig. 2-11) and the waveform is above the reference line using a 10X attenuator probe and a VOLTS/DIV switch setting of 2.

Using the formula:

$$\text{Instantaneous Voltage} = \text{vertical distance (divisions)} \times \text{polarity} \times \text{VOLTS/DIV setting} \times \text{probe attenuation factor}$$

Substituting the given values:

$$\text{Instantaneous Voltage} = 4.6 \times +1 \times 2 \text{ volts} \times 10$$

The instantaneous voltage is +92 volts.

Voltage Comparison Measurements

In some applications it may be necessary to establish a set of vertical deflection factors other than those available on the VOLTS/DIV switch. This is useful for comparing signals to a reference voltage amplitude. To establish a set of deflection factors based upon some specific reference amplitude, proceed as follows:

1. Apply a reference signal of known amplitude to the INPUT connector and adjust the size of the display for an exact number of graticule divisions using the VOLTS/DIV switch and VARIABLE control. Do not change the VARIABLE control after obtaining the desired deflection.

2. Divide the amplitude of the reference signal (volts) by the product of the deflection in divisions (established in step 1) and the VOLTS/DIV switch setting. This is the Deflection Conversion Factor.

$$\text{Deflection Conversion Factor} = \frac{\text{reference signal amplitude (volts)}}{\text{deflection (divisions)} \times \text{VOLTS/DIV setting}}$$

3. To calculate the Adjusted Deflection Factor at any setting of the VOLTS/DIV switch, multiply the VOLTS/DIV switch setting by the Deflection Conversion Factor established in step 2.

$$\text{Adjusted Deflection Factor} = \text{VOLTS/DIV setting} \times \text{Deflection Conversion Factor}$$

This Adjusted Deflection Factor applies only to the channel used and is correct only if the VARIABLE control is not moved from the position set in step 1.

4. To determine the peak-to-peak amplitude of a signal compared to a reference, disconnect the reference and apply the signal to the input connector.

5. Set the VOLTS/DIV switch to a setting that provides sufficient deflection to make the measurement. Do not re-adjust the VARIABLE VOLTS/DIV control.

6. Measure the vertical deflection in divisions and determine the amplitude by the following formula:

$$\text{Signal Amplitude} = \frac{\text{Adjusted Deflection Factor}}{\text{Factor}} \times \text{deflection (divisions)}$$

Example. As an example of this method of measurement, assume a reference signal amplitude of 30 volts, a VOLTS/DIV setting of 5 and a deflection of four divisions. Substituting these values in the Deflection Conversion Factor formula (step 2):

$$\text{Deflection Conversion Factor} = \frac{30}{4 \times 5} = 1.5$$

Then, with a VOLTS/DIV switch setting of 10 the Adjusted Deflection Factor (step 3) would be:

$$\text{Adjusted Deflection Factor} = 10 \times 1.5 = 15 \text{ volts/division}$$

To determine the peak-to-peak amplitude of an applied signal which produces a vertical deflection of 4.5 divisions, use the Signal Amplitude formula (step 6):

$$\text{Signal Amplitude} = 15 \times 4.5 = 67.5 \text{ volts}$$

Time Duration Measurements

To measure time between two points on a waveform, use the following procedure:

1. Connect the signal to one of the INPUT connectors.
2. Set the Mode switch to display the channel used.

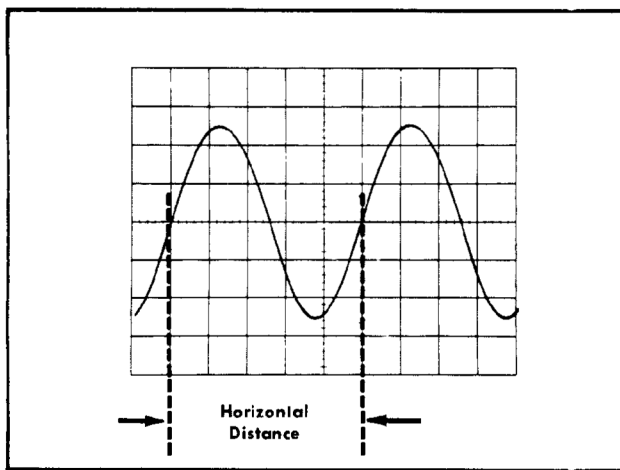

Fig. 2-12. Measuring time duration between points on a waveform.

3. Set the VOLTS/DIV switch to display about five divisions of the waveform.

4. Set the Triggering LEVEL control to AUTO.

5. Set the TIME/DIV switch to the fastest sweep rate that displays less than eight divisions between the time measurement points (see Fig. 2-12). See Selecting Sweep Rate in this section concerning nonlinearity of first and last division of display.

6. Adjust the vertical POSITION control to move the points between which the time measurement will be made to the center horizontal line.

7. Adjust the horizontal POSITION control to move the starting point of the time measurement to the first graticule line.

B. Measure the horizontal distance between the time measurement points. Be sure the VARIABLE TIME/DIV control is set to CAL.

9. Multiply the distance measured in step 8 by the setting of the TIME/DIV switch. If sweep magnification is used, divide this answer by 10.

Example. As an example of this method of measurement, assume that the distance between the time measurement points is five divisions (see Fig. 2-12) and the TIME/DIV switch is set to .1 mSEC with the magnifier off. Using the formula:

$$\text{Time Duration} = \frac{\text{horizontal distance (divisions)} \times \text{TIME/DIV setting}}{\text{magnification}}$$

Substituting the given values:

$$\text{Time Duration} = \frac{5 \times 0.1 \text{ ms}}{1}$$

The time duration is 0.5 milliseconds.

Frequency Measurements

The frequency of a periodically recurrent waveform can be determined as follows:

1. Measure the time duration of one cycle of the waveform as described in the previous application.
2. Frequency of a signal is the reciprocal of the time duration of one cycle.

Example. As an example of this method of measurement, the frequency of the signal shown in Fig. 2-12 having a time duration of 0.5 millisecond is:

$$\text{Frequency} = \frac{1}{\text{time duration}} = \frac{1}{0.5 \text{ ms}} = 2 \text{ kilohertz}$$

Risetime Measurements

Risetime measurements employ basically the same techniques as time-duration measurements. The main difference is the points between which the measurement is made. The following procedure gives the basic method of measuring risetime between the 10% and 90% points of the waveform.

1. Connect the signal to one of the INPUT connectors.
2. Set the Mode switch to display the channel used.
3. Set the VOLTS/DIV switch and VARIABLE control to produce a display an exact number of divisions in amplitude.
4. Set the TIME/DIV switch to the fastest sweep rate that will display less than eight divisions between the 10% and 90% points on the waveform.
5. Determine the 10% and 90% points on the rising portion of the waveform. The figures given in Table 2-1 are for the points 10% up from the start of the rising portion and 10% down from the top of the rising portion (90% point).
6. Adjust the horizontal POSITION control to move the 10% point of the waveform to the first graticule line. For example with a six division display, the 10% point would be 0.6 division up from the start of the rising portion (see Fig. 2-13).
7. Turn the vertical POSITION control to move the 90% point down to the graticule center horizontal line.
8. Measure the horizontal distance between the 10% and 90% points. Be sure the VARIABLE TIME/DIV control is set to CAL.

TABLE 2-1

Divisions of Display	10% and 90% points
4	0.4 division
5	0.5 division
6	0.6 division
7	0.7 division
8	0.8 division

9. Multiply the distance measured in step 8 by the setting of the TIME/DIV switch. If sweep magnification is used, divide this answer by 10.

Example. As an example of this method of measurement, assume that the distance between the 10% and 90% points is 6 divisions (see Fig. 2-13) and the TIME/DIV switch is set to 1 μSEC with the magnifier on.

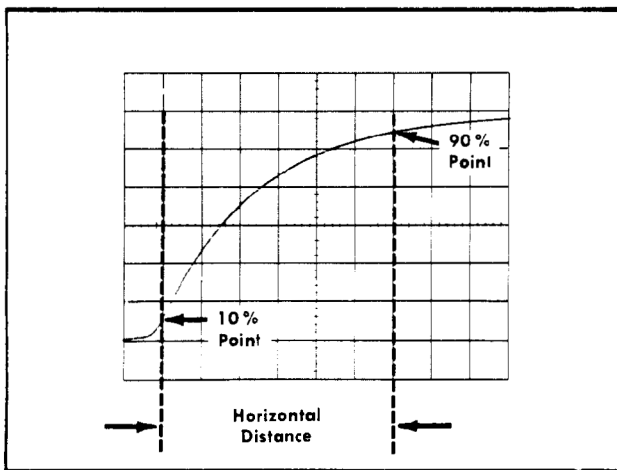

Fig. 2-13. Measuring risetime.

Using the time duration formula to find risetime:

$$\text{Time Duration (Risetime)} = \frac{\text{horizontal distance (divisions)} \times \text{TIME/DIV setting}}{\text{magnification}}$$

Substituting the given values:

$$\text{Risetime} = \frac{6 \times 1 \mu\text{s}}{10}$$

Time Difference Measurements

The calibrated sweep rate and dual-trace features of the Type 422 allow measurement of time difference between two separate events. To measure time difference use the following procedure:

1. Set the AC GND DC switches to the same position, depending on the type of coupling desired.
2. Set the Mode switch to either CHOPPED or ALT. In general, CHOPPED is more suitable for low-frequency signals and the ALT position is more suitable for high-frequency signals. More information on determining the mode is given under Trigger Source and Dual-Trace Operation in this section.
3. Set the Triggering Source switch to CH 1.
4. Connect the reference signal to INPUT 1 and the comparison signal to INPUT 2. The reference signal should precede the comparison signal in time. Use coaxial cables or probes which have equal time delay to connect the signals to the INPUT connectors.
5. If the signals are of opposite polarity, pull out the INVERT switch to invert the Channel 2 display.
6. Set the VOLTS/DIV switches to produce four or five division displays.
7. Set the Triggering LEVEL control for a stable display.
8. Set the TIME/DIV switch for a sweep rate which shows three or more divisions between the two waveforms.
9. Adjust the vertical POSITION controls to center each waveform (or the points on the display between which the measurement is being made) in relation to the horizontal centerline.
10. Adjust the horizontal POSITION control so the Channel 1 (reference) waveform crosses the horizontal centerline at a vertical graticule line.
11. Measure the horizontal distance between the Channel 1 waveform and the Channel 2 waveform (see Fig. 2-14).
12. Multiply the measured distance by the setting of the TIME/DIV switch. If sweep magnification is used, divide this answer by 10.

Example. For example, assume that the TIME/DIV switch is set to 50 μSEC, the magnifier is on and the horizontal distance between waveforms is 4.5 divisions (see Fig. 2-14).

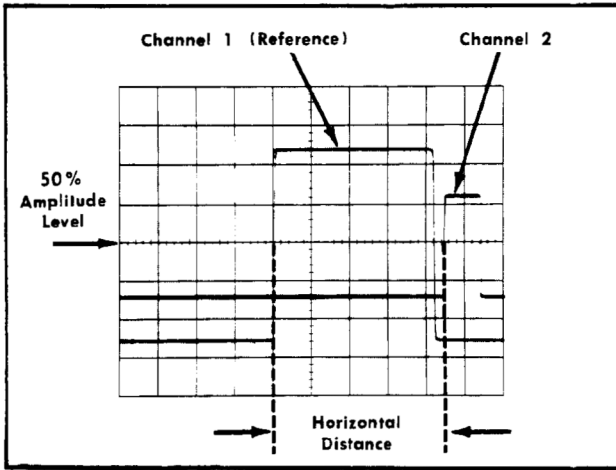

Fig. 2-14. Measuring time difference between two pulses.

Using the formula:

$$\text{Time Delay} = \frac{\text{TIME/DIV setting} \times \text{horizontal distance (divisions)}}{\text{magnification}}$$

Substituting the given values:

$$\text{Time Delay} = \frac{50 \mu\text{s} \times 4.5}{10}$$

The time delay is 22.5 microseconds.

Multi-Trace Phase Difference Measurements

Phase comparison between two signals of the same frequency can be made using the dual-trace feature of the Type 422. To make the comparison, use the following procedure:

1. Follow steps 1 through 7 of Time-Difference Measurements.
2. Set the TIME/DIV switch to a sweep rate which produces slightly less than one cycle of the waveform.
3. Adjust the VARIABLE VOLTS/DIV control so the displays are equal and about six divisions in amplitude. Reset the VOLTS/DIV switches if necessary, to obtain equal amplitude displays.
4. Move the waveforms to the center of the graticule with the vertical POSITION controls.
5. Turn the VARIABLE TIME/DIV control until one cycle of the reference signal (Channel 1) occupies exactly nine divisions horizontally (see Fig. 2-15). Each division of the graticule represents 40° of the cycle ($360^\circ \div 9 \text{ divisions} = 40^\circ/\text{division}$). The sweep rate can be stated in terms of degrees as $40^\circ/\text{division}$.
6. Measure the horizontal distance between corresponding points on the waveforms. Note whether the Channel 2 waveform is leading or lagging the reference waveform on Channel 1.

7. Multiply the measured distance (in divisions) by $40^\circ/\text{division}$ (sweep rate) to obtain the exact amount of phase difference.

Example. Assume a horizontal distance of 0.6 divisions with a sweep rate of $40^\circ/\text{division}$ as shown in Fig. 2-15.

Using the formula:

$$\text{Phase Difference} = \text{horizontal distance (divisions)} \times \text{sweep rate (degrees/division)}$$

Substituting the given values:

$$\text{Phase Difference} = 0.6 \times 40^\circ$$

The phase difference is 24° .

More Accurate Phase Measurements. More accurate phase measurements can be made by increasing the TIME/DIV switch setting. One of the easiest ways to increase the sweep rate is with the magnifier. The magnified sweep rate is determined by dividing the sweep rate obtained previously by the increase in sweep rate.

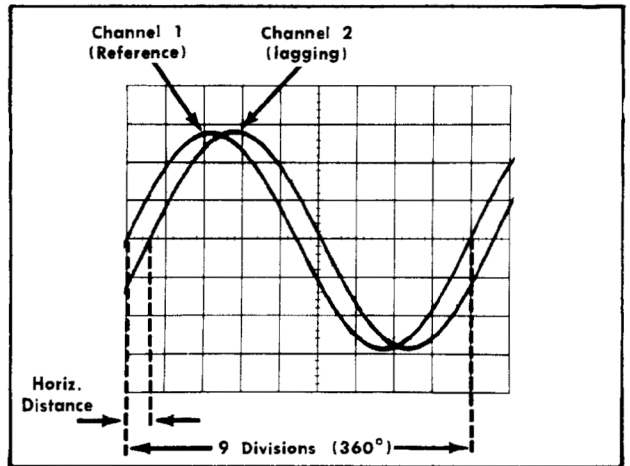

Fig. 2-15. Measuring phase difference.

Example. For example, if the sweep rate were increased 10 times with the magnifier, the magnified sweep rate would be $40^\circ \div 10 = 4^\circ/\text{division}$. Fig. 2-16 shows the same signals as used in Fig. 2-15 but with the magnifier on. With a horizontal distance of six divisions, the phase difference is:

$$\text{Phase Difference} = \text{horizontal distance (divisions)} \times \text{magnified sweep rate (degrees/div)}$$

Substituting the given values:

$$\text{Phase Difference} = 6 \times 4^\circ$$

The phase difference is 24° .

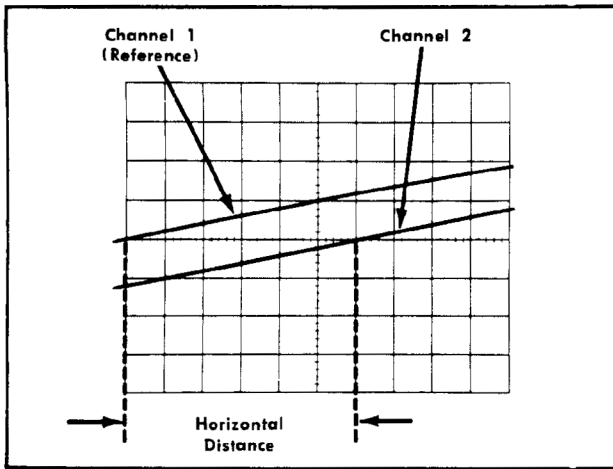

Fig. 2-16. More accurate phase measurement with increased sweep rate.

Type 422 as a Trigger Source

Ordinarily, the signal to be displayed also provides the trigger signal for the oscilloscope. In some instances, it may be desirable to reverse this situation and have the oscilloscope trigger the signal source. This can be done by connecting the GATE OUT signal of the Type 422 to the input of the signal source. Set the Triggering LEVEL control to FREE RUN and adjust the TIME/DIV switch for the desired display. Since the signal source is being triggered by a signal that has a fixed time relationship to the Type 422 sweep, the output of the signal source will produce a stable display on the CRT as through the Type 422 were triggered in the normal manner.

Common-Mode Rejection

The ALG ADD feature of the Type 422 can be used to display signals which contain undesirable components. These undesirable components can be eliminated through common mode rejection. The precautions given under Algebraic Addition should be observed.

1. Connect the signal containing both the desired and undesired information to the INPUT 1 connector.
2. Connect a signal similar to the unwanted portion of the Channel 1 signal to the INPUT 2 connector. For example, in Fig. 2-17 a line-frequency signal is connected to Channel 2 to cancel out the line-frequency component of the Channel 1 signal.
3. Set both AC GND DC switches to DC (AC if DC component of input signal is too large).
4. Set the Mode switch to ALT. Set the VOLTS/DIV switches so the signals are about equal in amplitude.
5. Set the Triggering Source switch to CH 1 & 2.
6. Set the Mode switch to ALG ADD. Pull the INVERT switch so the common-mode signals are of opposite polarity.
7. Adjust the Channel 2 VOLTS/DIV switch and VARIABLE control for maximum cancellation of the common-mode signal.
8. The signal which remains should be only the desired portion of the Channel 1 signal. The undesired signal is cancelled out.

Example. An example of this mode of operation is shown in Fig. 2-17. The signal applied to Channel 1 contains unwanted line-frequency components (Fig. 2-17A). A corresponding line-frequency signal is connected to Channel 2 (Fig. 2-17B). Fig. 2-17C shows the desired portion of the signal as displayed when common-mode rejection is used.

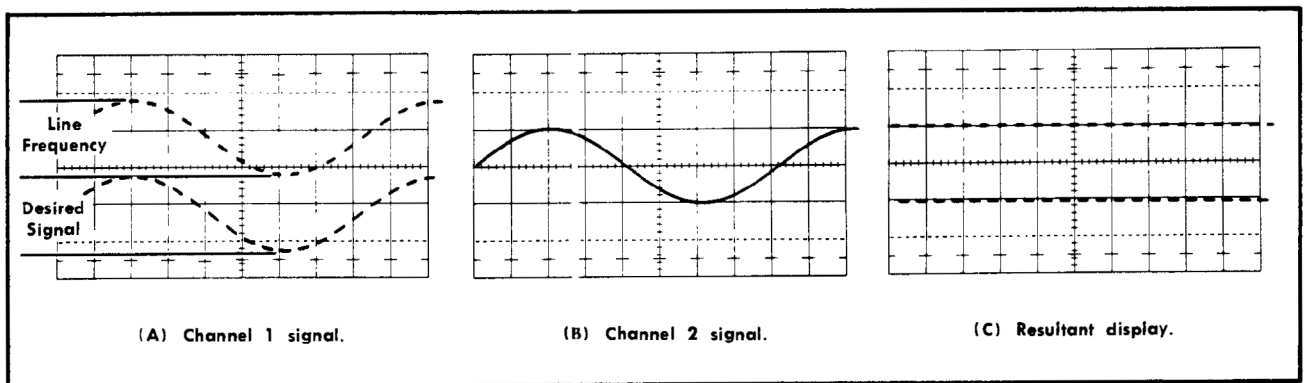

Fig. 2-17. Using the ALG ADD feature for common-mode rejection. (A) Channel 1 signal contains desired information along with line-frequency component. (B) Channel 2 signal contains line-frequency only, (C) Resultant CRT display using common-mode rejection.

SECTION 3

CIRCUIT DESCRIPTION

General

In the following circuit description, a detailed block diagram will be given for each major circuit in this instrument. The complete block diagram given in the Diagrams section shows the overall relationship between the major circuits in the instrument.

Complete electrical diagrams are also given in the Diagrams section. Refer to these diagrams for electrical values and relationship throughout the following circuit description.

Block Diagram

The block diagram given in Section 9 of this manual shows the main circuits of the Type 422 Oscilloscope. Signals to be displayed are connected to one of the INPUT connectors on the front panel of the Type 422. Large signals may be attenuated the desired amount (up to 400 times) by the attenuator networks. Signals are amplified in the Input Amplifiers and coupled push-pull through the dual-trace switching network to the output amplifier. The dual-trace switching network determines whether the output signal of Channel 1 or 2 passes on to the Output Amplifier. The Output Amplifier couples the signal directly to the vertical deflection plates of the CRT.

Two trigger-pickoff circuits in the vertical system obtain a sample of the input signal for the time-base circuit to provide internal triggering. Either the Channel 1 trigger-pickoff signal or the composite trigger-pickoff signal from the Output Amplifier may be selected.

External or internal signals of widely varying shapes, frequency and amplitude may be applied to the Sweep Trigger circuit to initiate the sweep. The Sweep Trigger circuit produces constant-amplitude output pulses which start the sweep at the proper time to insure a stable display of the signal of interest.

The Sweep Generator produces a linear rising sawtooth voltage that is used to sweep the electron beam across the CRT at a selected rate. Output of the Sweep Generator is coupled to the Horizontal Amplifier.

The Horizontal Amplifier amplifies the sawtooth (or the signal applied to the HORIZ IN connector when the TIME/DIV switch is in EXT HORIZ position) and converts the signal to push-pull for application to the horizontal CRT deflection plates. Gain of the Horizontal amplifier may be increased ten times by pulling the $\times 10$ MAG switch.

The Calibrator circuit produces a square-wave output of constant amplitude which can be used to check the gain of the vertical system or to compensate probes. A 200-millivolt peak to peak, square wave signal is coupled internally to the channel 1 & 2 Input Amplifiers when the VOLTS/DIV switches are set to the CALIBRATE 4 DIVISIONS positions. If the GAIN adjustments on the front-panel are properly set, this produces a display of exactly four divisions, providing the VARIABLE control is set to CAL (fully clockwise). A two volt peak-to-peak square wave is available at the CALIBRATOR jack on the front panel; this waveform can be used to compensate an attenuator probe.

VERTICAL PREAMP

(see Fig. 3-1)

Input Coupling

Input signals applied to either the INPUT 1 or the INPUT 2 connector can be AC-coupled, DC-coupled or internally disconnected. When the AC GND DC switch (SW1 or SW101) is in the DC position, the input signal is directly coupled to the VOLTS/DIV attenuators. In the AC position, the input signal is passed through a blocking capacitor (C1 or C101). This prevents the DC component of the signal from passing to the amplifiers. In the GND position, the applied signal path is broken and the input to the amplifier is grounded. This provides a ground reference without the need to disconnect the applied signal.

Input Attenuator

The overall effective deflection factor of the vertical deflection system of the Type 422 is controlled by the VOLTS/DIV switches. In all positions of the VOLTS/DIV switches except .01 and .02, the basic deflection factor of the vertical system is 0.05 volt per division of deflection on the CRT. To make the instrument useful for a wide range of input voltages, precision attenuators are used to increase this basic deflection factor. In the .01 and .02 positions of the VOLTS/DIV switches, attenuation is not used in the input circuit. Instead, the amount of negative feedback in the Feedback Amplifier, Q34-Q44 (Q134-Q144 in Channel 2), is changed to decrease the deflection factor.

For all VOLTS/DIV switch positions higher than the .05 position, the Attenuators are switched into the circuit singly or in tandem pairs to produce the vertical deflection factor indicated on the front panel. These attenuators are frequency-compensated voltage dividers. For DC and low-frequency signals they are predominantly resistance dividers and the amount of voltage attenuation is determined by the resistance in the circuit. The impedance of the capacitors in the circuit is so high at low frequencies that their effect in the circuit is negligible. However, at higher frequencies, the impedance of the capacitors in the circuit decreases and the circuit becomes primarily a capacitance voltage divider.

In addition to providing proper attenuation, the Attenuators are designed to maintain the same input resistance (1 megohm) regardless of the setting of the VOLTS/DIV switches. Also, the variable capacitor at the input of each network provides a means for adjusting the input time constant so that it remains at the same value (nominally $30 \text{ pF} \times 1 \text{ megohm}$) for all settings of the VOLTS/DIV switches.

Input Cathode Followers

The novistors, V13 in Channel 1 and V113 in Channel 2, are used as cathode follower input stages for the two channels. This stage presents a high input impedance to the input circuit and isolates the input circuit from the remaining amplifier circuitry R10 (R110) in the grid circuit of V13 (V113) is the input resistor for the .01, .02 and .05 VOLTS/DIV switch

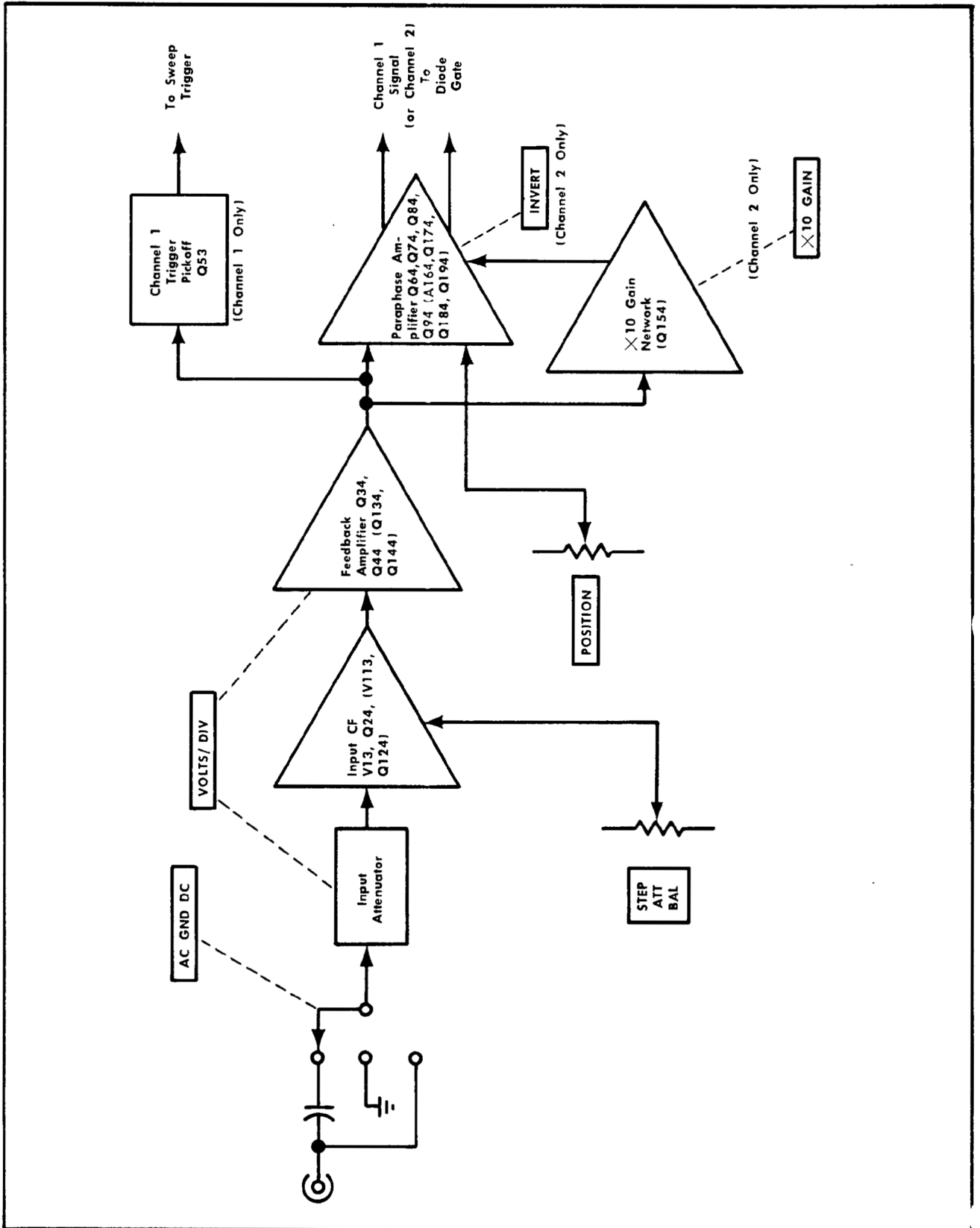

Fig. 3-1. Block diagram of Vertical Preamp circuit (Channel 2 circuit numbers shown in parenthesis).

positions. This resistor becomes part of the Attenuation network at all VOLTS/DIV switch settings above .05. C12 (C112) is part of the frequency compensation network. The neon bulb B12 (B112) protects V13 (V113) if a high amplitude negative signal is applied.

The diode arrangements in the cathode circuits of the Input Cathode Followers D14, D15 and D17 (Channel 1) and D114, D115 and D117 (Channel 2) are voltage limiting devices that protect Q34 and Q134 from excess voltage. D16 (D116) is a temperature compensation diode. Quiescent voltage at the collector of Q24 (Q124) is near zero volts.

Transistor Q24 (Q124) is a constant current source for the Input Cathode Follower. Zener diode D21 (D121) helps minimize any ripple or noise riding on the current supplied by Q24 (Q124).

The STEP ATT BAL adjustment sets the emitter of Q34 (Q134) to zero volts. This insures that the output DC level of Q44 (Q144) does not change with changes in gain of the stage in the .01, .02 and .05 positions of the VOLTS/DIV switch. The effect of the Variable Balance adjustment is described under Feedback Amplifier.

Channel 2 contains a variable capacitor, C114, in the cathode circuit of V113. This capacitor is provided to match the transient response of Channel 2 to that of Channel 1.

Feedback Amplifier

The Feedback Amplifier is a single-ended amplifier consisting of Q34 and Q44 (Q134 and Q144 in Channel 2). Gain switching is used in this stage to provide the correct overall gain in the .01, .02 and .05 positions of the VOLTS/DIV switch. The gain is determined by R39 (R139) and the resistor R_e between the emitter of Q34 (Q134) and ground. The gain can be represented by the formula:

$$\text{Gain} = \frac{R_e + R39 (R139)}{R_e}$$

Therefore, when R_e is infinity (0.05 position), the gain of the feedback amplifier is one. When R_e is 340 ohms (0.02 position, the gain of the feedback amplifier is 2.5, etc.).

The Variable Balance adjustments (R35 in Channel 1 and R135 in Channel 2) set the output DC level of the first amplifier stages so there is no current flow between the emitters of the paraphase amplifier stage (Q84-Q94 in Channel 1 and Q184-Q194 in Channel 2) during quiescence. This insures that the DC level of the display will not shift as the VARIABLE control is rotated.

Channel 1 Trigger Pickoff

The Channel 1 Input Amplifier contains a Trigger Pickoff circuit that supplies a sample of the Channel 1 signal to the time-base circuit for internal triggering from Channel 1. This signal is coupled to the time-base circuit when the Trigger Source switch is set to CH 1. The Trigger Pickoff circuit is an emitter follower with a high input impedance. The high input impedance is desirable so that the output of Q44 is loaded as lightly as possible.

×10 Gain Network

The Channel 2 Input Amplifier contains an additional capacitively coupled amplifier stage that is switched in ar

out of the circuit with the front-panel ×10 GAIN AC switch, SW150. Gain of the Q154 stage is ×9. This ×9 gain, algebraically added to the normal ×1 gain through the other side of the push-pull network, gives a total gain of ×10. However, the signal is DC coupled through the ×1 side of the push-pull circuit and AC coupled through the side with the ×9 amplifier. To avoid a confusing display in regard to DC level, the AC GND DC switch should be in the AC position when using the ×10 gain feature.

Paraphase Amplifier

The Paraphase Amplifier consists of Q84 and Q94 in Channel 1 and Q184 and Q194 in Channel 2. The Paraphase Amplifier converts the single-ended output of the previous stage to push-pull. Gain of the Paraphase Amplifier is controlled by emitter degeneration. As the impedance between the emitters of Q84 and Q94 (Q184 and Q194 in Channel 2) is increased, emitter degeneration increases, resulting in less gain of the stage. The POSITION controls (R60 and R160) vary the base drive to Q64 and Q74 (Q164 and Q174). Q64 and Q74 (Q164 and Q174) supply the emitter current for the last stage of the Vertical Preamp.

VERTICAL SWITCHING (see Fig. 3-2)

General

The switching circuit determines which of the Vertical Preamp output signals is connected to the Output Amplifier. In the dual-trace positions of the MODE switch, the output of each channel is alternately coupled to the Output Amplifier and displayed on the screen. In the CHOPPED position, this alternating action occurs at a fixed repetition rate of about 100 kilohertz. In the ALT position of the Mode switch, the channel displayed changes at the end of each sweep.

Diode Gates

The Diode Gates consisting of D201 through D208 can be thought of as switches that allow one or the other Vertical Preamp output signal to be coupled to the Output Amplifier. These diode switching gates are controlled by the Dual-Trace Switching Multivibrator Q265 and Q275.

CH 1 and 2. In the CH 1 position of the Mode switch (see Fig. 3-3), +12 volts is applied through R273 to the junction of D206 and D207 (Channel 2 diode gate). This forward biases D206 and D207 and back biases D205 and D208. Therefore, Channel 2 signal is clamped by D205 and D208 and cannot pass to the Output Amplifier.

The junction of D202 and D203 in the Channel 1 diode gate, on the other hand, is coupled to the -12-volt supply through R265. This voltage holds D202 and D203 back biased while D201 and D204 are forward biased. Therefore, Channel 1 signal current passes to the Output Amplifier. In the CH 2 position of the Mode switch, opposite conditions prevail. That is, the Channel 1 Diode Gate blocks the Channel 1 signal and the Channel 2 Diode Gate allows the signal to pass to the Output Amplifier.

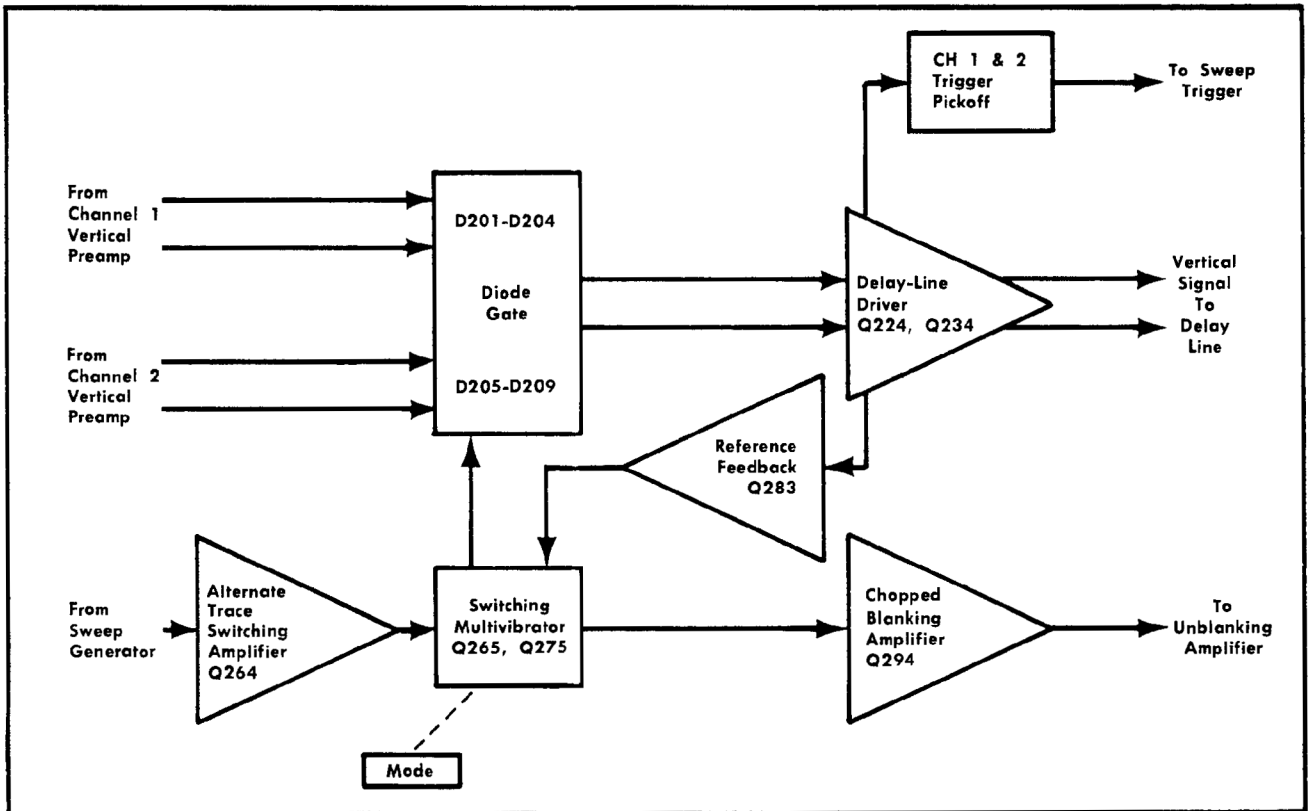

Fig. 3-2. Block diagram of Vertical Switching circuit.

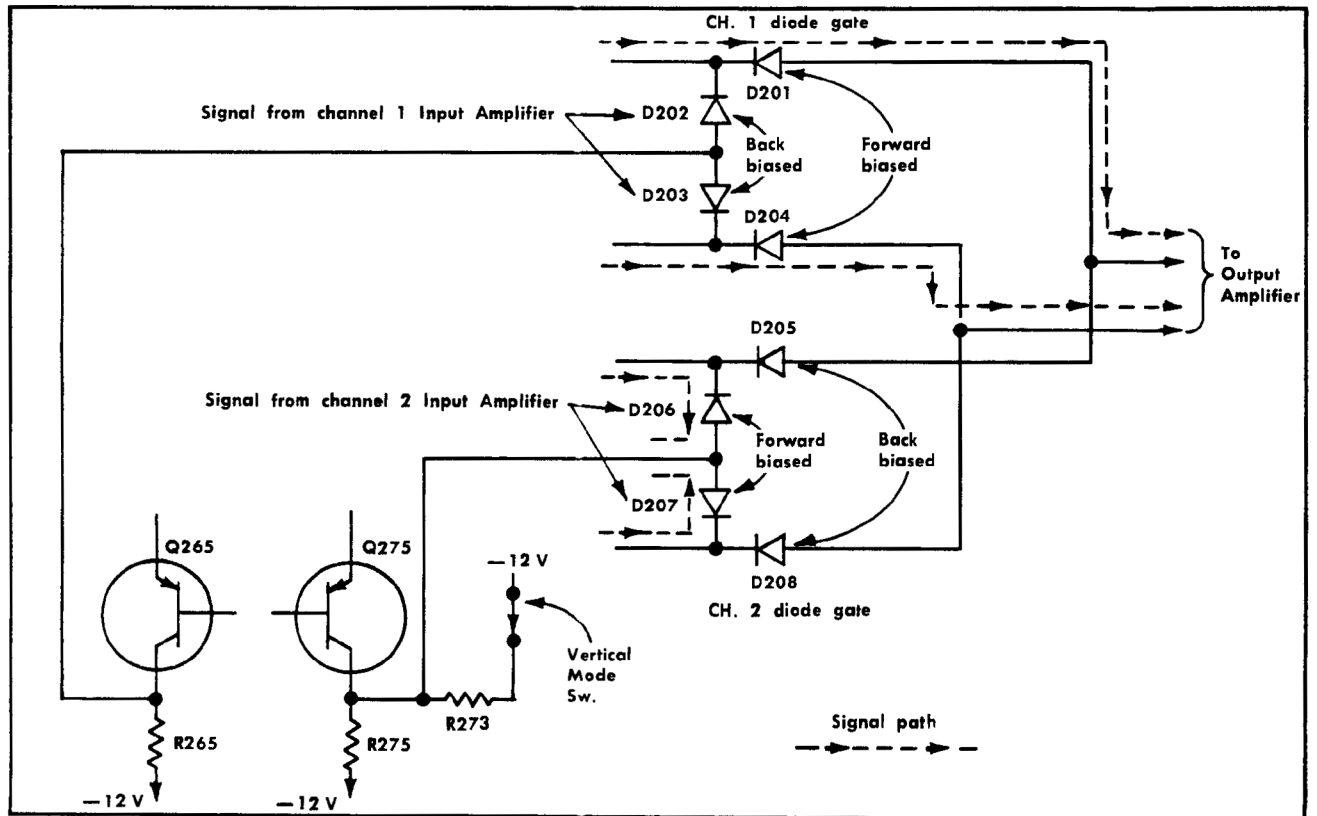

Fig. 3-3. Illustration of the effect of the diode gates on the signal path in CH 1 position of the Mode switch.

Alt. In the ALT position of the Mode switch, the Alternate Sweep Pulse Amplifier, Q264 is connected to the +12 volt supply. Q264 is normally off and the current through the collector resistor of Q264 from the +12-volt supply passes to the emitter of the on side of the Switching Multivibrator. For example, if Q265 is on and Q275 is off, a more positive voltage is applied to the junction of D202 and D203 and a more negative potential is applied to the junction of D206 and D207. This turns off the Channel 1 diode gate and turns on the Channel 2 diode gate.

At the end of the sweep, Q264 is turned on by the alternate trace sync pulse and momentarily diverts the current through R260 away from the switching multivibrator. This turns off the on transistor and allows the multivibrator to switch. For example, if Q265 were on, the change in current would pull its collector negative. This change is connected to the base of Q275 through R269 and C269 to set the base of Q275 more negative than the base of Q265. When Q264 turns off after the alternate trace sync pulse, current again is connected to the multivibrator. Then, Q275 turns on since its base is more negative than the base of Q265. The collector of Q275 rises positive and Q265 is held off through R279 and C279. With Q275 conducting and Q265 cut off, a more positive voltage is developed at the collector of Q275, and D206 and D207 in the Channel 2 Diode Gate are forward biased. Also, Q265 now has a more negative voltage on its collector, and D202 and D203 in the Channel 1 Diode Gate is now passing the signal on to the Output Amplifier and the Channel 2 Diode Gate is blocking the Channel 2 signal from the Output Amplifier.

Chopped. In the CHOPPED position of the Mode Switch, the Switching Multivibrator is allowed to free run at a frequency of about 100 kilohertz. In this position of the Mode switch, +12 volts is applied to the emitters of Q265 and Q275 through R264 and R274. At the time of transition, the off transistor is turned on by the increasing positive-going charge on its emitter due to the exponential charge of C267. Once the emitter voltage of the transistor (for example, Q265) rises far enough positive to make it conduct, its collector goes positive to about 1.5 volts. This voltage is coupled to the base of Q275 through R269 and C269 and turns Q275 off. When Q275 turns off, its emitter attempts to follow the

base. The emitter voltage, however, cannot rise immediately since C267 must charge at an exponential rate through R274. C267 is charging toward +12 volts and the base of Q275 is at about +5.2 volts. When C267 charges to a voltage slightly more positive than the base voltage, Q275 conducts and the Switching Multivibrator again changes states to begin another cycle.

The switching transients from the emitters of Q265 and Q275 are coupled through C266 and C276 to the base of Q294. The Chopped Blanking Amplifier, Q294, blanks the trace on the CRT so the switching transients turn the stage off each time the Switching Multivibrator changes states. The collector signal of Q294 is coupled to the emitter of Q864 in the CRT circuit.

Alg Add. In the ALG ADD position of the Mode switch, the Switching Multivibrator is out of the circuit and both diode gates allow the signal current to pass. Since both channels are supplying current to the Output Amplifier simultaneously, twice the normal current is present. To keep the current to the Output Amplifier at its normal level, one half of the current is shunted through R210 and R211 to the +12-volt supply. The resultant signal at the output is the algebraic sum of the two channels.

Delay-Line Driver

Diodes D210 and D211 are protection devices that prevent Q84, Q94, Q184 and Q194 from being driven into saturation during switching in the ALT dual-trace mode. The diode arrangement of D213 and D214 limits the voltage swing between the inputs of the amplifier by acting as an increasingly lower shunt impedance to larger amplitude signals. To normal amplitude signals, D213 and D214 are high impedance.

The Common Mode Current adjustment, R215, sets the common-emitter voltage of Q224 and Q234 to near zero.

The Delay-Line Driver stage (Q224 and Q234) is a push-pull operational amplifier. The feedback network (R221, R224, R227, C227, R228, C228, R237, C239, R231 and R234) provide high-frequency compensation for the delay line. R226 and R236 along with the output impedance of this stage comprise the main reverse termination for the delay line.

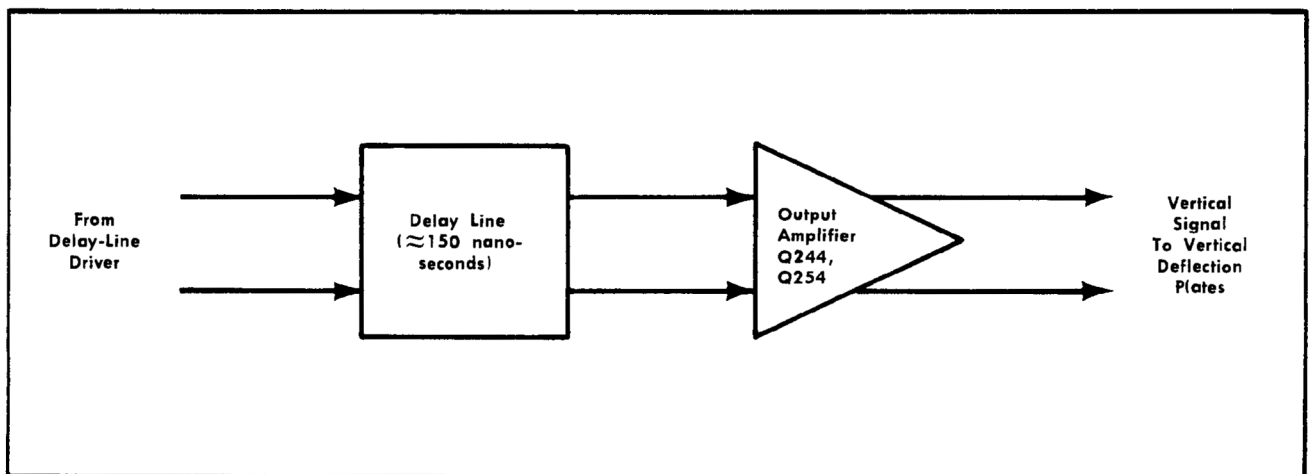

Fig. 3-4. Block diagram of Vertical Output Amplifier circuit.

Circuit Description—Type 422/R422 (SN 100-19,999)

An internal trigger pickoff circuit is connected to the collector of Q224. The vertical signal is sampled at this point and coupled to the Sweep Trigger circuit for use as the CH 1 and 2 trigger signal.

C217 in the Trigger Pickoff circuit allows the high-frequency compensation of the circuit to be matched to that of the Channel 1 Trigger Pickoff circuit. The network of C235 and R235 presents an impedance at the collector of Q234 that is equivalent to the Trigger Pickoff circuit on Q224 and thus balances the circuit.

VERTICAL OUTPUT AMPLIFIER

(see Fig. 3-4)

The vertical signal from the Q224-Q234 stage passes through the delay line to the next stage. The delay line delays the vertical signal enough to allow the Sweep Generator time to start a sweep before the signal reaches the vertical deflection plates.

The Q244-Q254 stage is a push-pull grounded-base amplifier. The delay line forward termination signal current (through R242, R252) is coupled to the emitters. L245 and L255 are high-frequency peaking adjustments.

SWEEP TRIGGER

(see Fig. 3-5)

Trigger Source

The Triggering Source switch (SW305) determines the source of the trigger signal. In the CH 1 position the signal from the Channel 1 Trigger Pickoff circuit is coupled to the Sweep Trigger circuit. In the CH 1 and 2 position of the Trigger Source switch the signal from the CH 1 and 2 Trigger Pickoff is coupled to the Sweep Trigger circuit. In the EXT position of the Triggering Source switch the signal from the TRIG IN connector is coupled to the Sweep Trigger circuit in all positions of the TIME/DIV switch except EXT HORIZ. The external triggering circuit is high-frequency compensated by variable capacitor C302.

Trigger Coupling

The Triggering Coupling switch (SW310) offers a means of accepting or rejecting certain frequency components of the trigger signal. In the AC and AC LF REJ positions, the DC component of the trigger signal is blocked by coupling capacitors. In the AC position, trigger signal frequency components below about 50 hertz are attenuated. In the AC LF REJ position, frequency components below about 50 kilohertz are attenuated. The DC position passes all frequency components down to DC. The Channel 1 trigger signal passes through a separate set of coupling capacitors (C308 and C309) in the AC position. This matches the time constant of the Channel 1 coupling network to the Channel 1 and 2 coupling network.

When the LEVEL switch is in the AUTO position, the trigger signal is AC coupled through C306 or C309 in the AC position and C305, C306 or C308, C309 in the AC LF REJ position. The trigger signal cannot be DC coupled in the AUTO position.

Sweep Trigger (non-auto)

The essential active components in the Sweep Trigger circuit are Q323, Q324, Q343, Q364 and D375. The function of the Sweep Trigger circuit is to derive a pulse that is consistent in amplitude and risetime from widely varying input trigger pulse shapes. The LEVEL control and SLOPE switch determine the point on the input waveform at which the trigger pulse is initiated.

Q323 and Q324 form an operational amplifier with non-linear feedback. A combination Si-Ge diode circuit (D331, D332, D333 and D334) limits the output voltage swing of the operational amplifier to approximately ± 0.3 volt, and is determined by the difference in forward drop of the Si and Ge diodes. Gain of the operational amplifier from the external input is about 1.3 before limiting and 0.13 beyond limiting.

The trigger signal passes from the emitter of the Q323 stage to the base of the trigger amplifier stage, Q324. The output of Q324 is coupled to the base of Q364 through Zener diode D325. D325 drops the DC level close to ground potential without appreciable attenuation of the trigger signal. The negative feedback current to the base of Q323 originates from the output of the Q324 stage by way of R353 when the output swing is less than ± 0.3 volts.

The Q364 stage switches the tunnel diode D375 which originates a constant-amplitude, fast-rise pulse that starts the Sweep Generator. Since R377 shunts some current around D375, Q364 must also supply this added current to switch D375. With the SLOPE switch in the negative-going position (Fig. 3-6A), the sum of the currents through Q364 and R374 equals the current delivered to D375 and R377. Before a triggering signal arrives, Q364 and R374 are supplying about 10 milliamps to the D375-R377 circuit, which is not enough to switch D375 to its high voltage state. When a triggering signal arrives and drives Q364 further into conduction, D375 switches to its high voltage state. The very fast switching transient of D375 is transformer-coupled to the Sweep Generator to initiate the sweep.

When the SLOPE switch is in the positive-going position (Fig. 3-6B), Q364 is connected as a current-shunting device with respect to D375. In this case, Q364 must be driven towards cutoff in order to increase the current through D375. A positive-going signal at the base of Q323 drives Q364 towards cutoff and the current through R372 is diverted to D375. This current increase through D375 causes it to switch and thus generate the pulse that starts the sweep.

Once D375 switches to its high voltage state, it stays there until the level of the triggering signal ultimately falls to a low enough value to reset D375 to its low voltage state. This resetting level is always lower than the original current level that caused D375 to switch to its high voltage state. The difference in voltage between these levels is known as the hysteresis level of the circuit. The amplitude (ΔV) of the triggering signal must always exceed the hysteresis level difference of the circuit for effective triggering.

The LEVEL control varies the DC current to the input of the Sweep Trigger circuit and in so doing, sets the quiescent current level through D375. The LEVEL control thereby sets the point on the triggering signal where triggering occurs

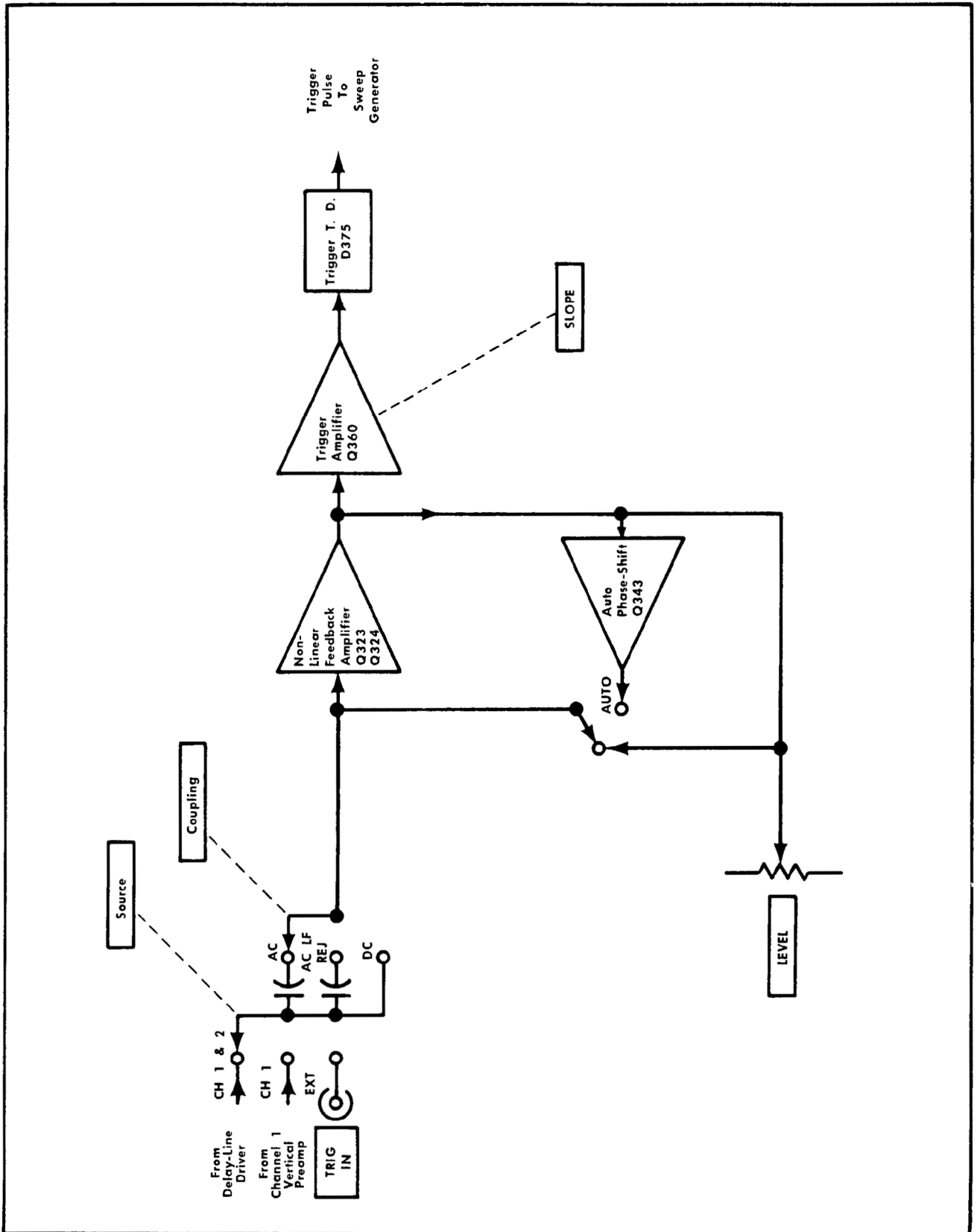

Fig. 3-5. Block diagram of Sweep Trigger circuit.

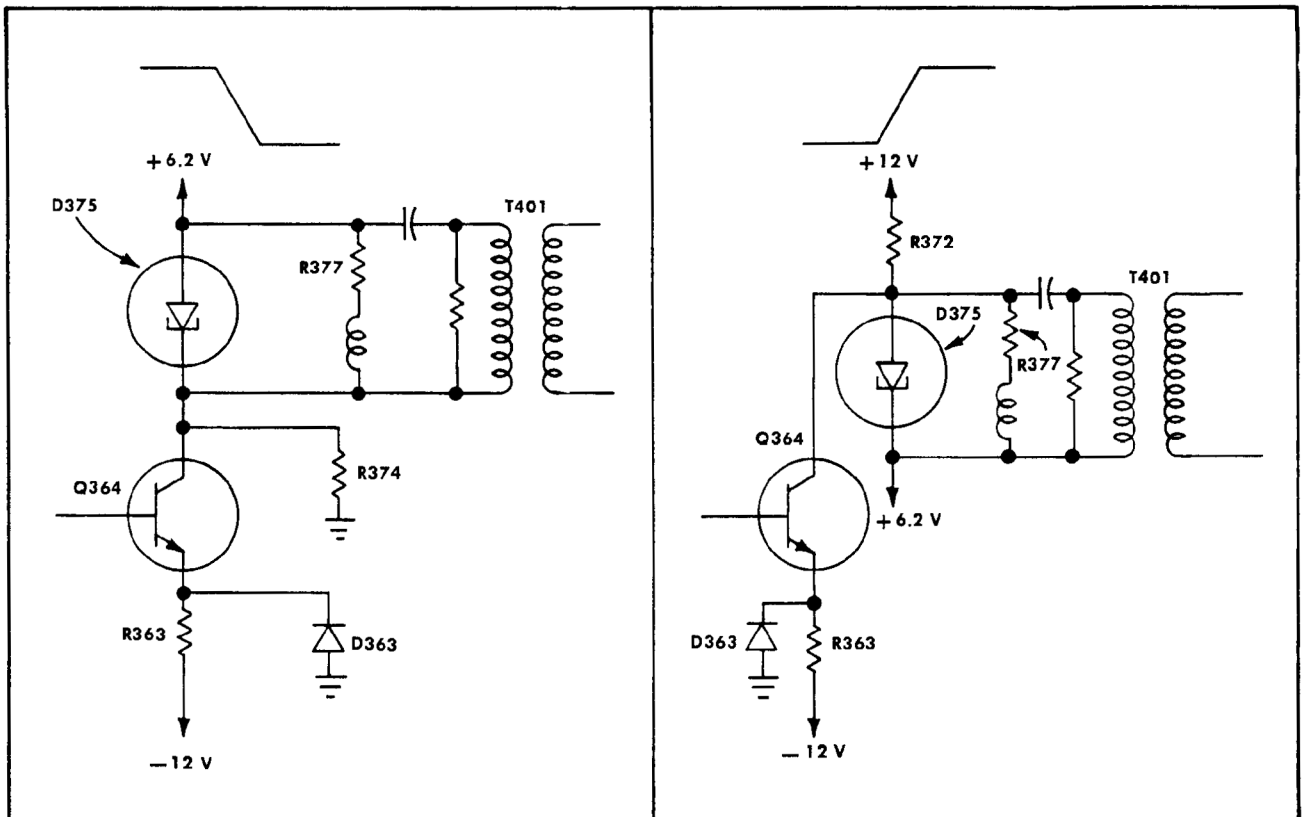

Fig. 3-6. Relationship between Q364 and D375 for (A) negative-going slope and (B) positive-going slope positions of the SLOPE switch.

to start the sweep. C353 is a high-frequency compensation adjustment.

Automatic Triggering

When the LEVEL control is set to AUTO, the operational amplifier (Q323 and Q324) is converted to a 45-hertz phase-shift oscillator by replacing R353 with a RC phase-shift feedback network in the emitter circuit of Q343.

Phase shift through the operational amplifier is 180° , and phase shift through the RC network is 180° giving a total phase shift of 360° at 45 hertz. The voltage limiting feedback network of diodes D331 through D344 limits the positive and negative excursions of the phase-shift oscillator. In the absence of a triggering signal the circuit runs continuously as a free-running 45-hertz oscillator and switches the tunnel diode D375 to produce a base-line display when a triggering signal is not present. The Auto Center adjustment, R350, sets the average DC level of the phase-shift oscillator so it is in the middle of the limit levels of the diode feedback network D331, D332, D333 and D334.

A normal amplitude triggering signal of 45 hertz or higher drives the amplifier into the limiting region at the triggering frequency. Because of the limiting action, no 45-hertz component can now exist in the output and the 45-hertz oscillation ceases. Furthermore, the phase-shift network is also a low-pass network (18 dB/octave) so that above 45 hertz there is no significant feedback.

SWEEP GENERATOR (see Fig. 3-7)

Sweep Gate

The trigger pulses produced by the Sweep Trigger circuit are transformer-coupled through T401 and initiate the sawtooth of the Sweep Generator. D401 in the secondary circuit of T401 allows the positive spikes to pass to the gating tunnel diode, D405, when the collector of Q434 is clamped by D435-D436.

When the Sweep Generator circuit is ready to be triggered, the state of each essential active component is as follows: D405 is conducting a small amount of current and it is in its low-voltage state; Q414 is biased off; Q473 is biased off and the CRT is blanked; Q424 and Q434 are both on; disconnect diodes D430 and D439 are forward biased and keep C440 from developing a charge; V443 is conducting heavily and its cathode is positive; this positive voltage biases Q441 on hard and its collector is at about +3 volts; this voltage is coupled back to tunnel diode D455 to hold it in its low-voltage state; Q464 is biased off; with Q464 off, R464, R406 and R405 allow a small amount of current to flow through tunnel diode D405 as mentioned above.

When a trigger signal is coupled through T401 to the Sweep Generator, D401 allows the positive spikes to pass to D405. This energy is sufficient to switch D405 to its high-voltage state which saturates D414. When Q414 saturates it shunts the current from the emitters of Q424 and Q434.

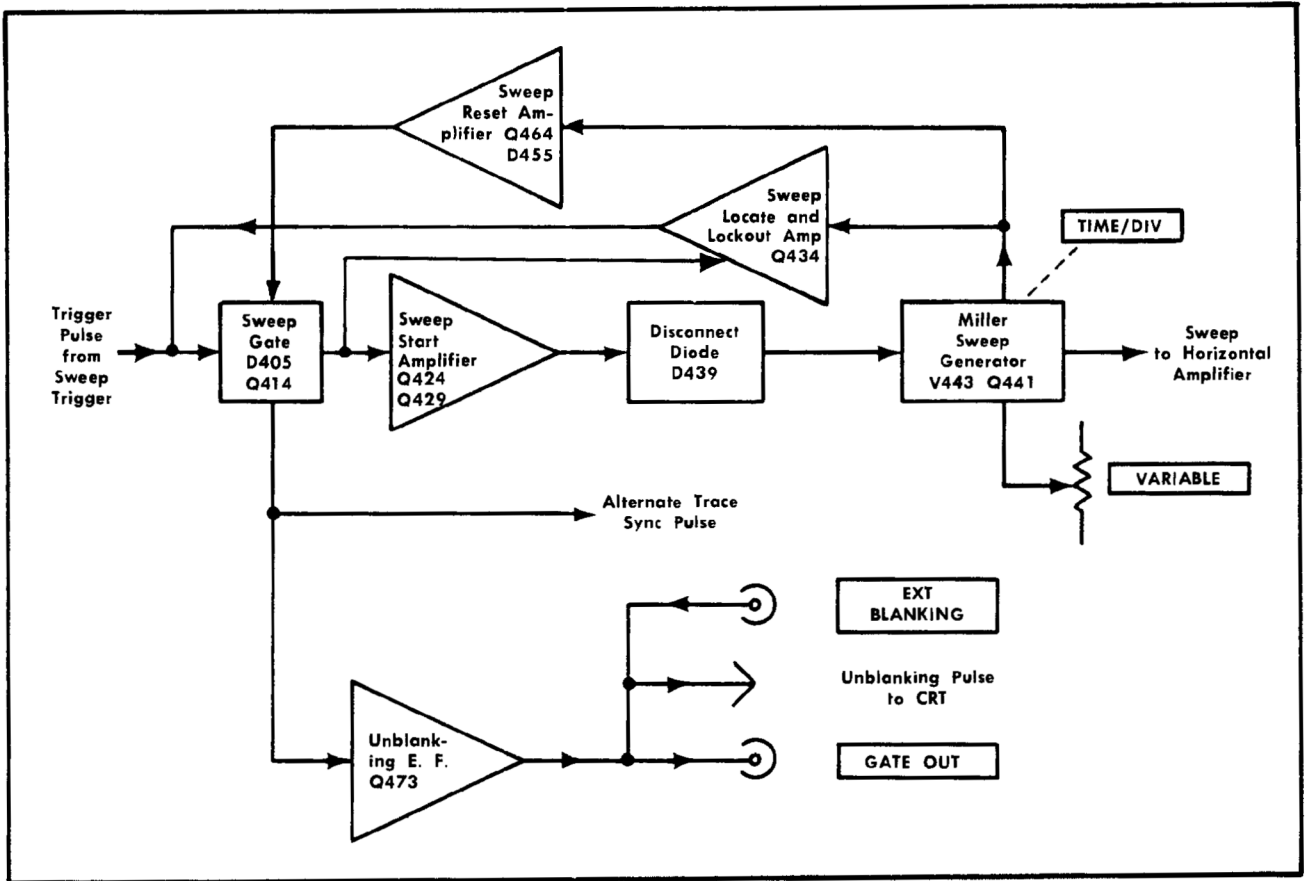

Fig. 3-7. Block diagram of Sweep Generator circuit.

The more negative collector voltage of Q414 turns Q473 on to produce a signal that unblanks the CRT.

When Q424 turns off, D439 becomes back biased and switches the charging current to the timing capacitor C440. When Q434 turns off, its collector moves toward -12 volts. This voltage is coupled back by way of the secondary of T401 and holds D401 biased to block any incoming trigger pulses.

Sweep Generator

The basic sweep generator circuit is a Miller Integrator¹. To produce a linear sawtooth output, the voltage increase across C440 (timing capacitor) is held constant. This is accomplished as follows. Because of the negative feedback from Q441 through C440 to the grid of V443, any tendency for the voltage at the grid of V443 to change is opposed and only a small change occurs. Therefore, the charging current through R440 remains constant. Since the current through R440 is constant, the charging current to C440 is also constant and the output voltage increases at a constant rate to reproduce a linear sawtooth. A higher current through R440 requires that the output voltage change at a

faster rate for a given value of C440. A current of opposite direction causes the output voltage to change in the opposite direction—this is what occurs during sweep reset.

Sweep Reset

As the voltage at the collector of Q441 rises, an increasing current is applied to tunnel diode D455 through R451. When the current through tunnel diode D455 exceeds its switching level, it switches to its high voltage state and more positive voltage appears on the base of Q464. This saturates Q464, and the drop in collector voltage decreases the current through the sweep gating tunnel diode, D405. D405 then resets to its low voltage state which turns off the Sweep Gate stage, Q414, diverting its collector current to Q424. A large part of the collector current now flows through D439 to the timing circuit. Since this current is larger and of opposite direction to the timing resistor current, the output voltage at Q441 must change at a fast rate in a negative direction (see earlier discussion of timing circuit action.) When the collector of Q441 falls to about +3 volts, Q434 conducts (removing reverse bias from D401) and direct coupled feedback from the output of Q441 through Q434 and Q424 to the grid of V443 holds the output at about +3 volts. When the Sweep Gate stage turns off, the unblanking pulse also ends and the CRT is blanked out during sweep reset and holdoff.

¹Jacob Millman and Herbert Taub, "Pulse, Digital and Switching Waveforms," McGraw-Hill, New York, 1965, pp. 540-548.

Circuit Description—Type 422/R422 (SN 100-19,999)

The Sweep Generator, having completed one sweep and reset, is now ready for, and will accept (through D401), another trigger pulse.

Sweep Generator Output Signals

When Q414 turns off at the end of the sweep a positive pulse is coupled from its collector to the dual-trace switching circuit. This pulse switches the Switching Multivibrator at the end of each sweep when in the alternate mode. The change at the collector of Q414 is also connected to the GATE OUT connector on the front panel through emitter follower Q473.

Free Running Operation

With the LEVEL control in the FREE RUN position, the cathodes of D435 and D436 are released from ground and R435 is placed in series with R434. This allows the collector of Q434 to go further positive following sweep reset to provide additional current back through D401 and D405. The increased current is sufficient to switch D405 back into its high-voltage state as soon as the sweep resets. The sweep will be recurrent regardless of the triggering signal from the Sweep Trigger circuit.

External Horizontal

When the TIME/DIV switch is in the EXT HORIZ position, the Sweep Generator is disabled. This is done by applying a holding current to D405 through D403 and R403.

HORIZONTAL AMPLIFIER (see Fig. 3-8)

Input Circuit

The Horizontal Amplifier has two inputs: (1) from the Sweep Generator output signal through R511-C511 and (2) from the HORIZ IN (TRIG IN) connector when the TIME/DIV switch is set to EXT HORIZ. The HORIZ ATTEN (Trigger LEVEL) con-

rol provides 10:1 variable attenuation of an externally applied horizontal input signal.

The Sweep Cal potentiometer, R512, is a variable current divider that varies the current drive to the summing point of the operational amplifier (for internal sweep only) Q513. This varies the displayed sweep rate of the trace. Variable capacitor C511 is a compensation device that improves the sweep linearity at the faster sweep rates.

The POSITION controls vary the output voltage of the Horizontal Amplifier for horizontal positioning.

Amplifier Circuits

Q513, Q524 and Q543 form an operational amplifier. The input emitter follower Q513 is current driven by the signal from the input circuit. D512 and D513 are protection diodes that limit the voltage swing at the base of Q513. The output of the emitter follower Q513 drives the base of Q524. A portion of the output of the Q524 stage is coupled back to the base of Q513 as negative feedback. In the $\times 1$ position of the $\times 10$ MAG switch, maximum feedback occurs between the collector of Q524 and the base of Q513. When the $\times 10$ MAG switch is set to $\times 10$, the gain of the Q513-Q524 stage is increased 10 times. The Mag Register adjustment is set in the $\times 1$ position of the $\times 10$ MAG switch to match the mid-screen DC level of the $\times 1$ display to the $\times 10$ display.

Emitter follower Q543 drives the Paraphase Amplifier Q544-Q554. The Paraphase Amplifier converts the single-ended signal to push-pull for application to the CRT deflection plates. Zener diodes D549 and D559 provide a DC voltage shift so the horizontal and vertical output voltage (average) are more nearly the same.

External Horizontal

External horizontal signals applied to the HORIZ IN connector are amplified by the Horizontal Amplifier when the

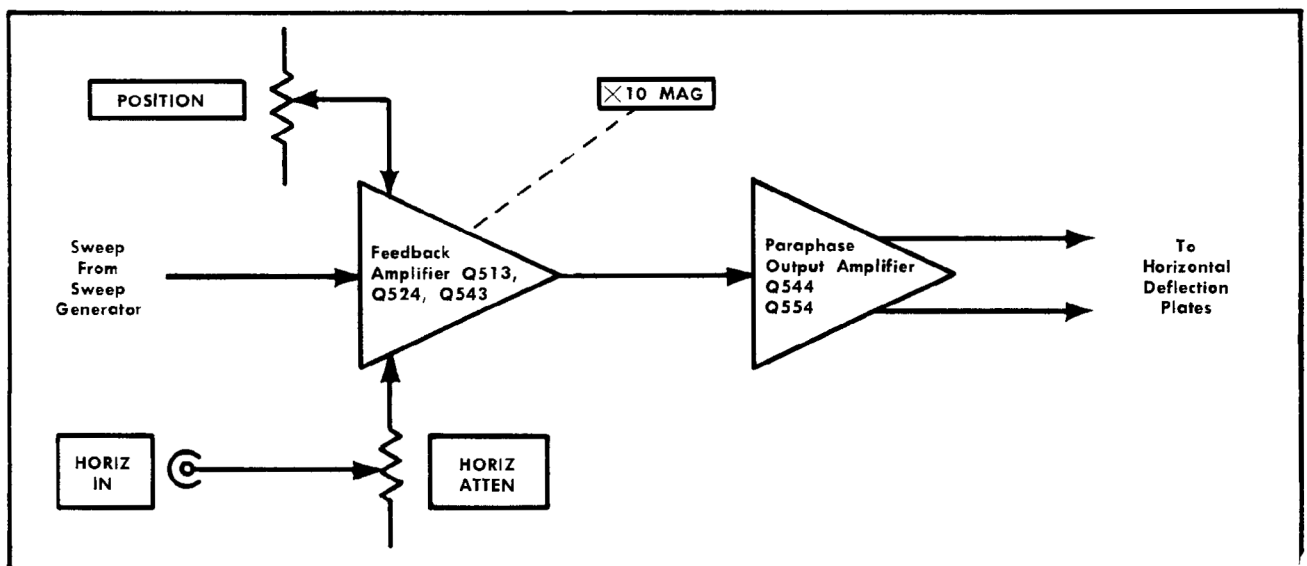

Fig. 3-8. Block diagram of Horizontal Amplifier circuit.

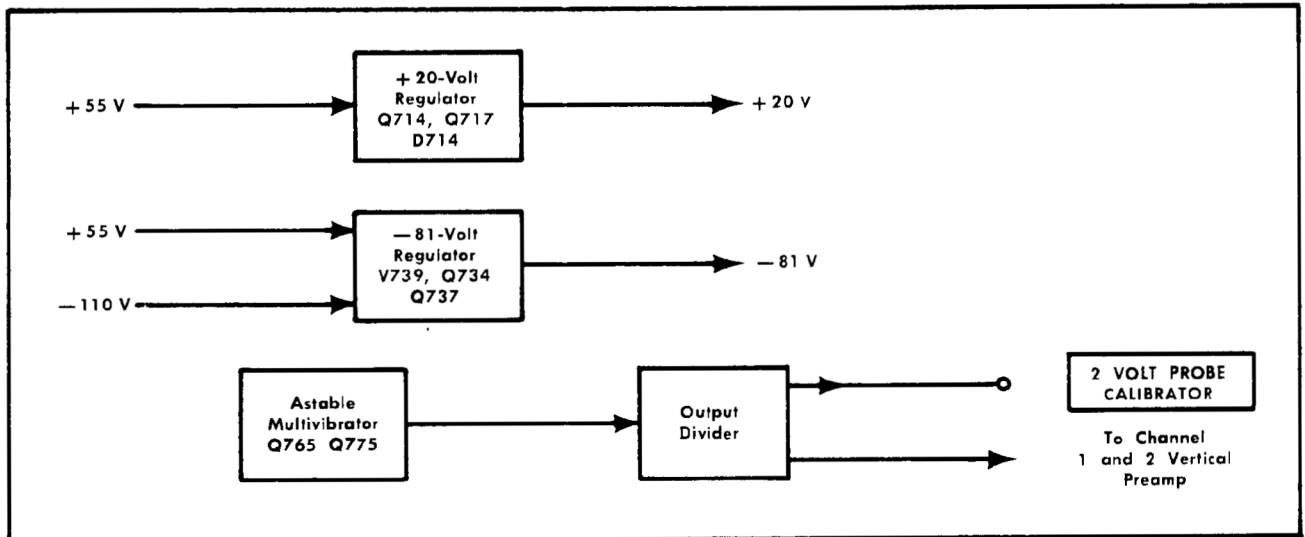

Fig. 3-9. Block diagram of Calibrator and Regulator circuits.

TIME/DIV switch is set to EXT HORIZ. A DC offset current is applied to the summing point of operational amplifier Q513 through R515 and R516. This DC current positions the display to the center of the CRT (when Horizontal POSITION control is centered). Also, in the Sweep Generator circuit, a holding current is applied to D405 to prevent the Sweep Generator from operating. Current is also applied to the unblanking circuit through D404 to unblank the CRT.

CALIBRATOR AND REGULATORS (see Fig. 3-9)

Amplitude Calibrator

The Calibrator circuit provides an accurate amplitude square-wave voltage for setting the gain of the vertical Input Amplifiers and high-frequency compensation of attenuator probes. Frequency of the Calibrator circuit is about 1 kilohertz.

The Calibrator circuit is an astable (free running) common-emitter multivibrator. The multivibrator maintains sustained oscillation due to the collector to base coupling between the transistors. Assuming that Q765 is just turning on, a positive-going pulse develops at its collector. This positive-going pulse is coupled to the base of Q775 and it turns off. However, since the positive-going voltage change is AC coupled through C765, the voltage change at the base of Q775 is not sustained and starts decaying at an exponential rate. The level on the base of Q775 drops to a point where it can conduct again. When Q775 conducts, a positive pulse is coupled to the base of Q765 and it turns off. Again the pulse is AC coupled and the voltage at the base of Q765 ultimately falls negative to a point where Q765 can conduct again.

The signal from the collector of Q775 is coupled to the Input Amplifiers and the CALIBRATOR jack through voltage divider R783, R786 and R787. Output amplitude of the Calibrator is set by the Cal Ampl adjustment, R780.

Regulators

The +20- and -81-volt Regulator circuits provide stable voltages for several circuits in the Type 422. The -81-volt Regulator circuit is referenced to voltage regulator tube V739. The +20-volt Regulator circuit is referenced to Zener diode D713.

In the -81-volt Regulator circuit, Q734 acts as a regulated current source for the voltage regulator tube V739. The nominal voltage drop of V739 is about 81 volts. This voltage is connected to the base of Q737. Emitter follower Q737 supplies current to the -81-volt load.

The network R735 and D735 insures that V739 will have sufficient voltage across it to fire during turn-on. Before V739 fires, D735 is back biased and the anode of V739 sets at about +55 volts. This voltage plus the voltage on the cathode of V739 is adequate to insure that V739 fires. Once V739 fires, D735 is forward biased and the anode of V739 drops to a voltage near ground.

The output level of the +20-Volt Regulator circuit is determined by voltage divider R718-R719. Any change at the emitter of Q717 due to a change in output voltage is connected to the base of Q714. This feedback changes the collector voltage of Q714 and the base voltage of Q717 to correct for the original error in the voltage at the emitter of Q717.

CRT CIRCUIT (see Fig. 3-10)

High Voltage Circuit

T801 is a voltage step-up transformer with a voltage output of about 700 volts peak across the secondary winding. Diodes D810 through D816 and D821 through D823 along with the associated capacitors from the high-voltage rectifier/multiplier circuit. The positive voltage output of the multiplier is about +4900 volts while the negative voltage output is about -2100 volts (negative voltage regulated to -1400 volts).

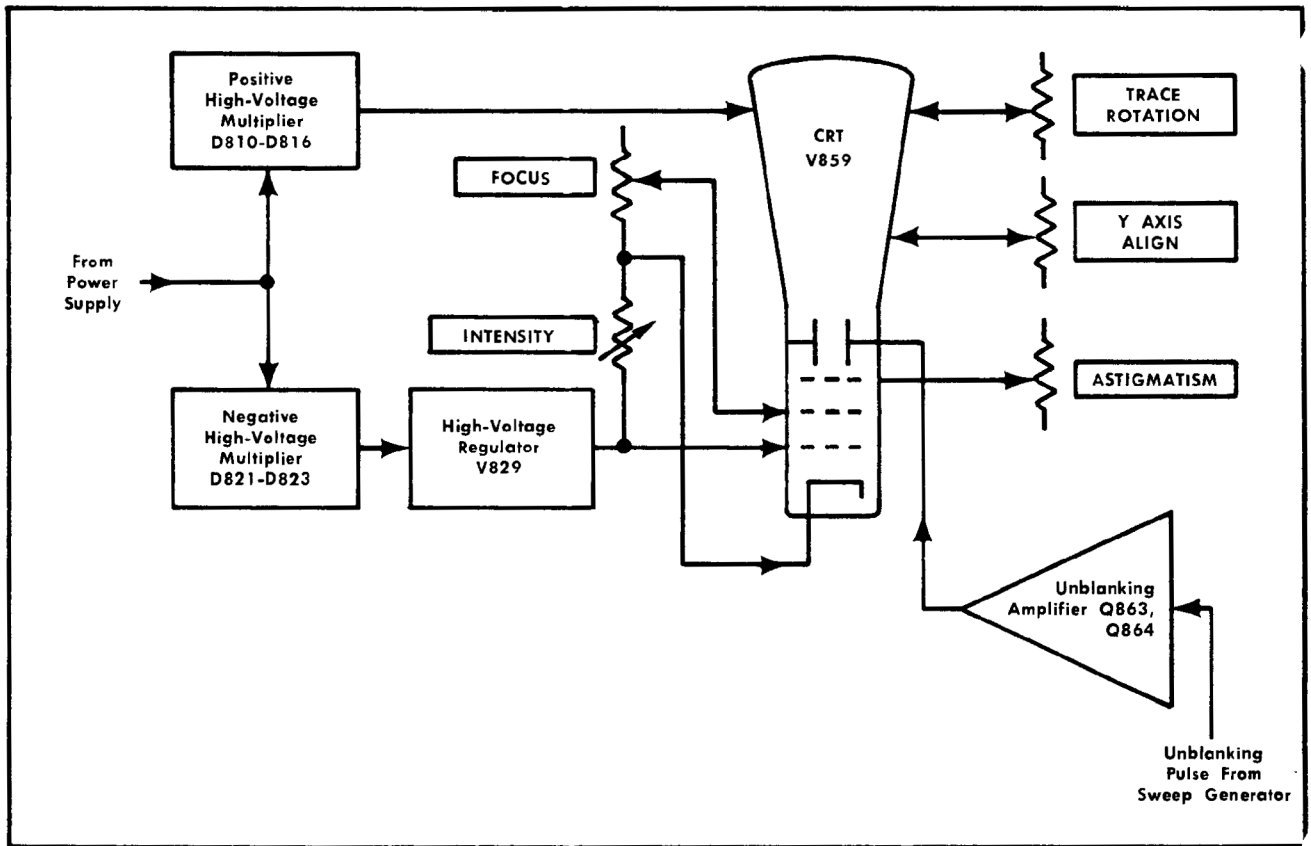

Fig. 3-10. Block diagram of CRT circuit.

The negative high voltage is regulated by the -1400-volt shunt regulator, V829. The negative voltage is applied to the CRT gun circuit. Beam current is varied by the INTENSITY control, R837, which controls display intensity.

Blanking Circuit

If there is small, or no voltage difference between the deflection blanking plates, the CRT is unblanked. When the voltage difference between the plates is significant, the CRT is blanked and virtually no electrons strike the phosphor. The fixed blanking plate (pin 7) is connected to the +55 volt supply through D841. This places a nominal voltage of about +17 volts on pin 7. Quiescently, Q864 conducts only a small amount of current as determined by the Unblanking Center network. This places pin 12 a few volts more negative than the +55 volt supply and the CRT is blanked.

NOTE

Both pin 7 and pin 12 are floating on the +55 volt supply. Pin 12 is isolated from ground by the high output impedance of Q864. Therefore, the ripple on the +55 volt supply will appear on both blanking plates. Since this ripple is common to both plates however, it will not deflect the electron beam passing between the plates.

Q743 (in Sweep Generator) turns on during sweep time and supplies current to Q864. This current brings Q864 and

Q863 into conduction and the voltage at pin 12 drops to a voltage very near to the level of pin 7. With the voltage on both blanking plates near the same level, the CRT is unblanked. The Unblanking Center adjustment, R869, is adjusted for maximum beam current (maximum trace brightness).

The display may be blanked during sweep time or when displaying on external horizontal signal by connecting a two volt or greater positive signal to the EXT BLANKING connector. This signal diverts current from Q864 and allows its collector to rise positive. Then, pin 12 also rises positive and the CRT beam is deflected by the blanking plates to blank the desired portion of the display.

Trace Rotation

The Trace Rotation circuit is provided to allow alignment of the horizontal trace with the graticule lines. The Trace Rotation adjustment, R851, varies the magnetic strength of a coil around the CRT. The connections to the coil may be reversed at the circuit board to reverse the adjustment range.

The Y Axis Align adjustment, R856, varies the magnetic strength of coil L856. This circuit provides vertical alignment of the trace. The connections to this coil may also be reversed at the circuit board (an potentiometer) to reverse the adjustment range.

SECTION 4

MAINTENANCE

Introduction

This section of the manual contains maintenance information for use in preventive maintenance, corrective maintenance or troubleshooting of the Type 422.

Cabinet Removal

The cabinet can be removed from the Type 422 as follows:

1. First remove the power supply from the rear of the indicator as follows:
 - a. Loosen the four securing screws located in the rear feet of the power supply.
 - b. Separate the two units by sliding the power supply to the rear, off the support rods.
2. Remove the three screws which hold the cabinet to the rear of the indicator.
3. Slide the cabinet to the rear and off the support rods.

The Type R422 can be removed from the cabinet in a similar manner if the instrument is first pulled out of, or removed from the rack.

PREVENTIVE MAINTENANCE

General

Preventive maintenance consists of cleaning, visual inspection, lubrication, etc. Preventive maintenance performed on a regular basis may prevent instrument breakdown and will improve the reliability of this instrument. The severity of the environment to which the Type 422 is subjected will determine the frequency of maintenance. A convenient time to perform preventive maintenance is preceding recalibration of the instrument.

Cleaning

The Type 422 should be cleaned as often as operating conditions require. Accumulation of dirt in the instrument can cause overheating and component breakdown. Dirt on components acts as an insulating blanket and prevents efficient heat dissipation. It also provides an electrical conduction path.

The cabinet provides protection against dust in the interior of the instrument. Operation without the cabinet in place necessitates more frequent cleaning. The front cover provides dust protection for the front panel and the CRT face. The front cover should be installed for storage or transportation.

CAUTION

Avoid the use of chemical cleaning agents which might damage the plastics used in this instrument. Avoid chemicals which contain benzene, toluene, xylene, acetone or similar solvents.

Exterior. Loose dust accumulated on the outside of the Type 422 can be removed with a soft cloth or small paint brush. The paint brush is particularly useful for dislodging dirt on and around the front-panel controls. Dirt which remains can be removed with a soft cloth dampened in a mild detergent and water solution. Abrasive cleaners should not be used.

Clean the light filter, face plate protector and CRT face with a soft, lint-free cloth dampened with denatured alcohol.

Interior. Dust in the interior of the instrument should be removed occasionally due to its electrical conductivity under high-humidity conditions. The best way to clean the interior is to blow off the accumulated dust with dry, low-velocity air. Remove any dirt which remains with a soft paint brush or a cloth dampened with a mild detergent and water solution. A cotton-tipped applicator is useful for cleaning in narrow spaces or for cleaning ceramic terminal strips and circuit boards.

The high-voltage circuits, particularly parts located in the high-voltage compartment and the area surrounding the post-deflection anode connector, should receive special attention. Excessive dirt in these areas may cause high-voltage arcing and result in improper instrument operation.

Lubrication

General. The reliability of potentiometers, rotary switches and other moving parts can be maintained if they are kept properly lubricated. Use a cleaning-type lubricant (e.g., Tektronix Part No. 006-0218-00) on shaft bushings and switch contacts. Lubricate switch detents with a heavier grease (e.g., Tektronix Part No. 006-0219-00). Potentiometers which are not permanently sealed should be lubricated with a lubricant which will not affect electrical characteristics (e.g., Tektronix Part No. 006-0220-00). Do not over lubricate. A lubrication kit containing the necessary lubricants and instructions is available from Tektronix, Inc. Order Tektronix Part No. 003-0342-00.

Visual Inspection

The Type 422 should be inspected occasionally for such defects as broken connections, broken or damaged ceramic strips, improperly seated transistors or nuvistors, damaged circuit boards and heat damaged parts.

The corrective procedure for most visible defects is obvious; however, particular care must be taken if heat-damaged components are found. Over-heating usually indicates other trouble in the instrument; therefore, it is important that the cause of overheating be corrected to prevent a recurrence of the damage.

Transistor and Nuvistor Checks

Periodic checks of the transistors and nuvistors in the Type 422 are not recommended. The best check of transistor or

nuvistor performance is its actual operation in the instrument. More details on checking transistor and nuvistor operation is given under Troubleshooting.

Recalibration

To assure accurate measurements, check the calibration of this instrument after each 1000 hours of operation or every six months if used infrequently. In addition, replacement of components may necessitate recalibration of the affected circuits. Complete calibration instructions are given in the Calibration section.

The calibration procedure can also be helpful in localizing certain troubles in the instrument. In some cases, minor troubles may be revealed and/or corrected by recalibration.

TROUBLESHOOTING

Introduction

The following information is provided to facilitate troubleshooting of the Type 422 if trouble develops. Information contained in other sections of this manual should be used along with the following information to aid in locating the defective component. An understanding of the circuit operation is very helpful in locating troubles. See the Circuit Description section for complete information.

Troubleshooting Aids

Diagrams. Circuit diagrams are given in foldout pages in Section 9. The component number and electrical value of each component in this instrument are shown on the diagrams. Each main circuit is assigned a series of component numbers. Table 4-1 lists the main circuits in the Type 422 and the series of component numbers assigned to each. Important voltages and waveforms are also shown on the diagrams. The portions of the circuit mounted on circuit boards are enclosed with a blue line.

Switch Wafer Identification. Switch wafers shown on the diagrams are coded to indicate the position of the wafer in the complete switch assembly. The numbered portion of the code refers to the wafer number counting from the front, or mounting end of the switch, toward the rear. The letters F and R indicate whether the front or rear of the wafer performs the particular switching function. For example, a wafer designated 2R indicates that the rear of the second wafer is used for this particular switching function.

Circuit Boards and Cards. Figs. 4-8 through 4-15 show the circuit boards used in the Type 422. Fig. 4-17 shows the location of each board within the instrument. Each electrical component on the boards is identified by its circuit number. The circuit boards and cards are also outlined on the diagrams with a blue line. These pictures used along with the diagrams will aid in locating the components mounted on the circuit boards.

Wiring Color-Code. All insulated wire and cable used in the Type 422 is color-coded to facilitate circuit tracing. Signal carrying leads are identified with one or two colored stripes. Voltage supply leads are identified with three stripes to indicate the approximate voltage using the EIA resistor

**TABLE 4-1
CIRCUIT NUMBERS**

Circuit Numbers on Schematic	Circuit
1-99	Ch 1 Input Amplifier
100-199	Ch 2 Input Amplifier
200-299	Switching and Output Amplifier
300-399	Sweep Trigger
400-499	Sweep Generator
500-599	Horizontal Amplifier
600-699	AC Power Supply
700-799	Calibrator and Regulators
800-899	CRT Circuit
1000-1299	AC-DC Power Supply

color code. A white background color indicates a positive voltage and a tan background indicates a negative voltage. Table 4-2 gives the wiring color-code for the power-supply voltages used in the Type 422.

Resistor Color-Code. In addition to the brown composition resistors, some metal-film resistors (identifiable by their gray body color) and some wire-wound resistors (usually light blue or gray-green) are used in the Type 422. The resistance values of composition resistors and metal-film resistors are color-coded on the components (some metal-film resistors may have the value printed on the body) with EIA color-code. The color-code is read starting with the stripe nearest the end of the resistor. Composition resistors have four stripes which consist of two significant figures, a multiplier and a tolerance value (see Fig. 4-1). Metal-film resistors have five stripes consisting of three significant figures, a multiplier and a tolerance value.

**TABLE 4-2
WIRING COLOR CODE**

Supply	Back-ground Color	1st Stripe	2nd Stripe	3rd Stripe
-110 volt	Tan	Brown	Black	Brown
-81 volt	Tan	Gray	Black	Black
-12 volt	Tan	Brown	Red	Black
+12 volt	White	Brown	Red	Black
+20 volt	White	Red	Black	Black
+55 volt	White	Green	Green	Black
+95 volt	White	Brown	Black	Brown

Capacitor Marking. The capacitance values of common disc capacitors and small electrolytics are marked in microfarads on the side of the component body. The white ceramic capacitors used in the Type 422 are color coded in picofarads using a modified EIA code (see Fig. 4-1).

Diode Color Code. The cathode end of each glass-encased diode is indicated by a stripe, a series of stripes or a dot. For most silicon or germanium diodes with a series of stripes, the color-code also indicates the type of diode and identifies the Tektronix Part Number using the resistor color-code system (e.g., a diode color-coded blue-brown-gray-

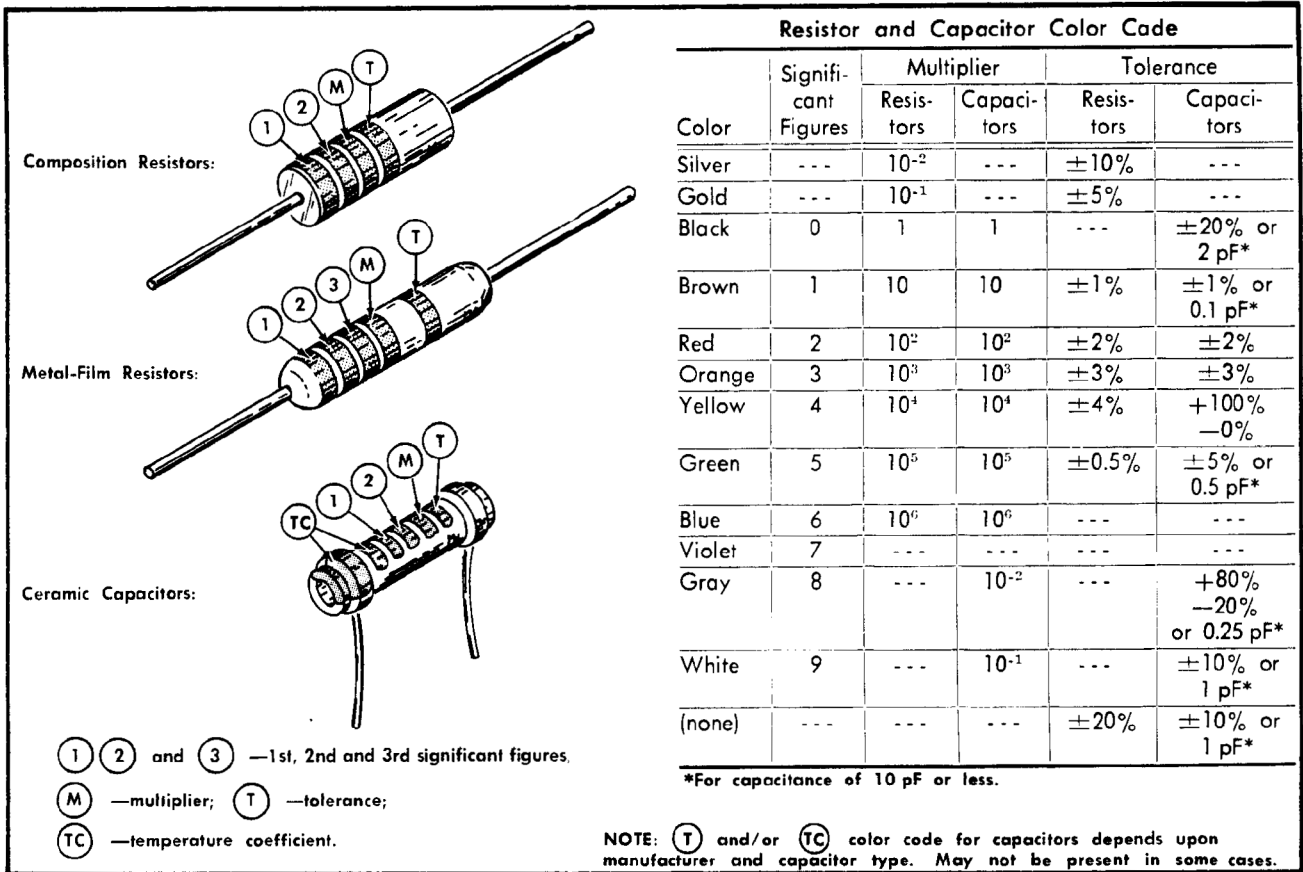

Fig. 4-1. Color-code for resistors and ceramic capacitors.

green indicates diode type 6185 with Tektronix Part Number 152-0185-00). The cathode and anode end of metal-encased diodes can be identified either by the diode symbol marked on the body.

Troubleshooting Equipment

The following equipment is useful for troubleshooting the Type 422.

1. Transistor Tester
Description: Tektronix Type 575 Transistor-Curve Tracer or equivalent.
Purpose: to test the semiconductors used in this instrument.
2. Volt-ohmmeter
Description: 20,000 ohms/volt. 0-500 volts DC (5000 volts to check high-voltage circuits). Accurate within 3%. Test prods must be well insulated.
3. Test Oscilloscope
Description: DC to 15 MHz frequency response, 5 millivolts to 50 volts/division deflection factor. Use a 10X probe.
Purpose: To check waveforms in the instrument.

Troubleshooting Techniques

This troubleshooting procedure is arranged in an order which checks the simple trouble possibilities before proceeding with extensive troubleshooting. The first few checks assure proper connection, operation and calibration. If the trouble is not located by these checks, the remaining steps aid in locating the defective component. When the defective component is located, it should be replaced following the replacement procedures given under Corrective Maintenance.

1. Check Control Settings. Incorrect control settings can indicate a trouble that does not exist. If there is any question about the correct function or operation of any control, see the Operating Instructions section of this manual.

2. Check Associated Equipment. Before proceeding with troubleshooting of the Type 422, check that the equipment used with this instrument is operating correctly. Check that the signal is properly connected and that the interconnecting cables are not defective. Also, check the power source.

3. Check Instrument Calibration. Check the calibration of this instrument, or the affected circuit if the trouble exists in one circuit. The apparent trouble may only be a result of misadjustment or may be corrected by calibration. Complete calibration instructions are given in the Calibration Section of this manual.

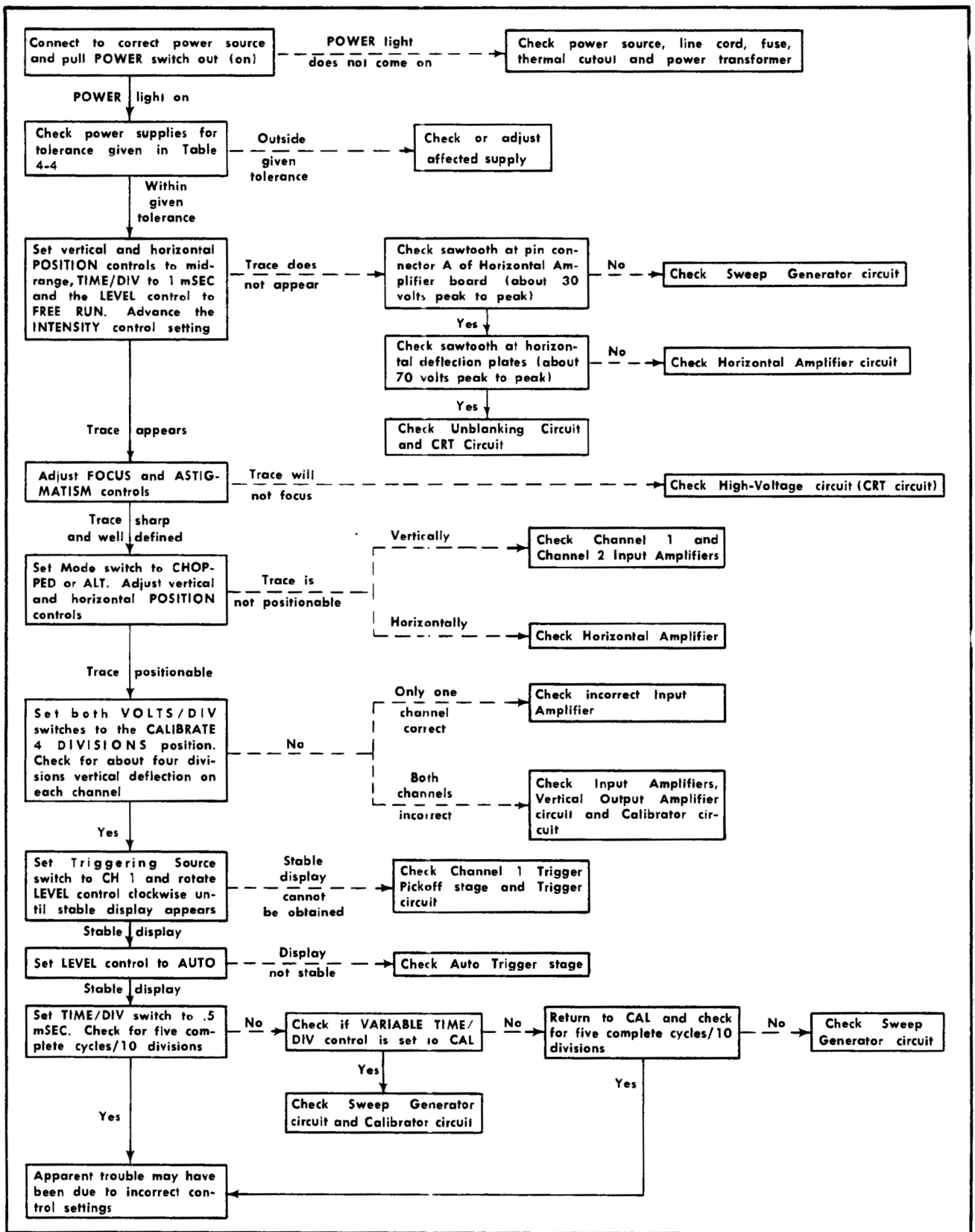

Fig. 4-2. Circuit Isolation Troubleshooting Guide.

4. Visual Check. Visually check the portion of the instrument in which the trouble is located. Many troubles can be located by visual indications such as unsoldered connections, broken wires, damaged circuit boards, damaged components, etc.

5. Isolate Trouble to a Circuit. To isolate a trouble to a circuit, note the trouble symptom. The symptom often identifies the circuit in which the trouble is located. For example, poor focus indicates that the CRT circuit (includes high voltage) is probably at fault. When trouble symptoms appear in more than one circuit, check all affected circuits by taking voltage and waveform readings. Also check for the correct output signals at the front-panel output connectors with a test oscilloscope. If the signal is correct the circuit is working correctly up to that point. For example, correct amplitude and time of the gate out waveform indicates that the Sweep Trigger and Sweep Gate circuits are operating correctly.

Incorrect operation of all circuits indicates trouble in the power supply. Check first for correct voltage of the individual supplies. However, a defective component elsewhere in the instrument can appear as a power-supply trouble and may also affect the operation of other circuits. Table 4-3 lists the tolerances of the power supplies in this instrument. If a power-supply voltage is within the listed tolerance, the supply can be assumed to be working correctly. If outside the tolerance, the supply may be misadjusted or operating incorrectly. Use the procedure given in the Calibration section to adjust the power supplies.

Fig. 4-2 provides a guide to aid in locating the defective circuit. This chart may not include checks for all possible defects; see steps 6-8 in such cases. Start from the top of the chart and perform the given checks on the left side of the page until a step is found which is not correct. Further checks and/or the circuit in which the trouble is located are listed to the right of this step.

After the defective circuit has been located, proceed with steps 6 through 8 to locate the defective component(s).

6. Check Circuit Board Interconnections. After the trouble has been isolated to a particular circuit, check the pin connectors on the circuit board for correct connection. Figs. 4-8 through 4-15 show the correct connections for each board.

The pin connectors used in this instrument also provide a convenient means of circuit isolation. For example, a short in a power supply can be isolated to the power supply itself by disconnecting the pin connectors for that voltage at the boards.

TABLE 4-3
POWER SUPPLY TOLERANCES

Power Supply	Tolerance
-81 volt	± 1 volt
-12 volt	± 0.12 volt
+12 volt	± 0.24 volt
+20 volt	± 1.4 volt

7. Check Voltages and Waveforms. Often the defective component can be located by checking for the correct voltage or waveform in the circuit. Typical voltages and waveforms are given on the diagrams.

NOTE

Voltages and waveforms given on the diagrams are not absolute and may vary slightly between instruments. To obtain operating conditions similar to those used to take these readings, see the first diagram page.

8. Check Individual Components. The following procedures describe methods of checking individual components in the Type 422. Components which are soldered in place can be checked most easily by disconnecting one end. This eliminates incorrect measurements due to the effects of surrounding circuitry.

A. TRANSISTORS AND NUUVISTORS. The best check of transistor or nuuvistor operation is actual performance under operating conditions. If a transistor or nuuvistor is suspected of being defective, it can best be checked by substituting a new component or one which has been checked previously. However, be sure that circuit conditions are not such that a replacement transistor or nuuvistor might also be damaged. If substitute transistors or nuuvistors are not available, use a dynamic tester (such as Tektronix Type 570 or 575). Static-type testers are not recommended, since they do not check operation under simulated operating conditions.

B. DIODES. A diode can be checked for an open or shorted condition by measuring the resistance between terminals. With an ohmmeter scale having an internal source of about 1.5 volts, the resistance should be very high in one direction and very low when the leads are reversed.

CAUTION

Do not use an ohmmeter scale that has a high internal current. High currents may damage the diode. Do not measure tunnel diodes with an ohmmeter; use a dynamic tester (such as a Tektronix Type 575 Transistor-Curve Tracer).

C. RESISTORS. Resistors can be checked with an ohmmeter. Check the Electrical Parts List for the tolerance of the resistors used in this instrument. Resistors normally do not need to be replaced unless the measured value varies widely from the specified value.

D. INDUCTORS. Check for open inductors by checking continuity with an ohmmeter. Shorted or partially shorted inductors can usually be found by checking the waveform response when high-frequency signals are passed through the circuit. Partial shorting often reduces high-frequency response (roll-off).

E. CAPACITORS. A leaky or shorted capacitor can best be detected by checking resistance with an ohmmeter on the highest scale. Do not exceed the voltage rating of the capacitor. The resistance reading should be high after initial charge of the capacitor. An open capacitor can best be detected with a capacitance meter or by checking whether the capacitor passes AC signals.

9. Repair and Readjust the Circuit. If any defective parts are located, follow the replacement procedures given earlier in this section. Be sure to check the performance of any circuit that has been repaired or that has had any electrical components replaced.

CORRECTIVE MAINTENANCE

General

Corrective maintenance consists of component replacement and instrument repair. Special techniques required to replace components in this instrument are given here.

Obtaining Replacement Parts

Standard Parts. All electrical and mechanical part replacements for the Type 422 can be obtained through your local Tektronix Field Office or representative. However, many of the standard electronic components can be obtained locally in less time than is required to order them from Tektronix, Inc. Before purchasing replacement parts, check the parts lists for value, tolerance, rating and description.

NOTE

When selecting replacement parts, it is important to remember that the physical size and shape of a component may affect its performance in the instrument, particularly at high frequencies. All replacement parts should be direct replacements unless it is known that a different component will not adversely affect instrument performance.

Special Parts. In addition to the standard electronic components, some special parts are used in the Type 422. These parts are manufactured or selected by Tektronix, Inc. to meet specific performance requirements, or are manufactured for Tektronix, Inc. in accordance with our specifications. These special parts are indicated in the parts list by an asterisk preceding the part number. Most of the mechanical parts used in this instrument have been manufactured by Tektronix, Inc. Order all special parts directly from your local Tektronix Field Office or representative.

Ordering Parts. When ordering replacement parts from Tektronix, Inc., include the following information:

1. Instrument Type.
2. Instrument Serial Number.
3. A description of the part (if electrical, include circuit number).
4. Tektronix Part Number.

Soldering Techniques

WARNING

Disconnect the instrument from the power source before soldering.

Circuit Boards. Use ordinary 60/40 solder and a 35 to 40-watt pencil type soldering iron on the circuit boards. The tip of the iron should be clean and properly tinned for best heat transfer to the solder point. A higher wattage soldering iron may separate the wiring from the base material.

The following technique should be used to replace a component on a circuit board. Most components can be replaced without removing the boards from the instrument.

1. Grip the component lead with long-nose pliers. Touch the soldering iron to the lead at the solder connection. Do not lay the iron directly on the board as it may damage the board.

2. When the solder begins to melt, pull the lead out gently. This should leave a clean hole in the board. If not, the hole can be cleaned by reheating the solder and placing a sharp object such as a toothpick into the hole to clean it out.

3. Bend the leads of the new component to fit the holes in the board. If the component is replaced while the board is mounted in the instrument, cut the leads so they will just protrude through the board. Insert the leads into the holes in the board so the component is firmly seated against the board (or as positioned originally). If it does not seat properly, heat the solder and gently press the component into place.

4. Touch the iron to the connection and apply a small amount of solder to make a firm solder joint; do not apply too much solder. To protect heat-sensitive components, hold the lead between the component body and the solder joint with a pair of long-nose pliers or other heat sink.

5. Clip the excess lead that protrudes through the board.

6. Clean the area around the solder connection with a flux-remover solvent. Be careful not to remove information printed on the board.

Ceramic Terminal Strips. Solder used on the ceramic terminal strips should contain about 3% silver. Use a 40- to 75-watt soldering iron with a $\frac{1}{8}$ inch wide wedge-shaped tip. Ordinary solder can be used occasionally without damage to the ceramic terminal strips. However, if ordinary solder is used repeatedly or if excessive heat is applied, the solder-to-ceramic bond may be broken.

A sample roll of 3% silver solder is mounted on the rear of this instrument. Additional silver solder should be available locally, or it can be purchased from Tektronix, Inc.; order by Tektronix Part No. 251-0514-00.

Observe the following precautions when soldering to ceramic terminal strips.

1. Use a hot iron for a short time. Apply only enough heat to make the solder flow freely.

2. Maintain a clean, properly tinned tip.

3. Avoid putting pressure on the ceramic terminal strip.

4. Do not attempt to fill the terminal-strip notch with solder; use only enough solder to cover the wires adequately.

5. Clean the flux from the terminal strip with a flux-remover solvent.

Metal Terminals. When soldering metal terminals (e.g., switch terminals, potentiometers, etc.), ordinary 60/40 solder can be used. Use a soldering iron with a 40- to 75-watt rating and a $\frac{1}{8}$ -inch wide wedge-shaped tip.

Observe the following precautions when soldering metal terminals:

1. Apply only enough heat to make the solder flow freely.
2. Apply only enough solder to form a solid connection. Excess solder may impair the function of the part.
3. If a wire extends beyond the solder joint, clip off the excess.
4. Clean the flux from the solder joint with a flux-remover solvent.

Component Replacement

WARNING

Disconnect the instrument from the power source before replacing components.

Ceramic Terminal Strip Replacement. A complete ceramic terminal strip assembly is shown in Fig. 4-3. Replacement strips (including studs) and spacers are supplied under separate part numbers. However, the old spacers may be re-used if they are not damaged. The applicable Tektronix Part Numbers for the ceramic strips and spacers used in this instrument are given in the Mechanical Parts List.

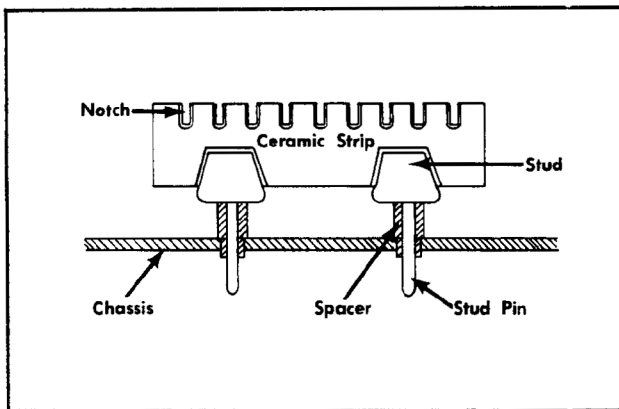

Fig. 4-3. Ceramic terminal strip assembly.

To replace a ceramic terminal strip use the following procedure:

REMOVAL:

1. Unsolder all components and connections on the strip. To aid in replacing the strip, it may be advisable to mark each lead or to draw a sketch to show location of the components and connections.
2. Pry or pull the damaged strip from the chassis. Be careful not to damage the chassis.
3. If the spacers come out with the strip, remove them from the stud pins for use on the new strip (spacers should be replaced if they are damaged).

REPLACEMENT:

1. Place the spacers in the chassis holes.

2. Carefully press the studs of the strip into the spacers until they are completely seated. If necessary, use a soft mallet and tap lightly, directly over the stud, to seat the strip completely.

3. If the stud extends through the spacers, cut off the excess.

4. Replace all components and connections. Observe the soldering precautions given under Soldering Techniques in this section.

Circuit Board Replacement. If a circuit board is damaged beyond repair, either the entire assembly including all soldered-on components, or the board only, can be replaced. Part numbers are given in the Mechanical Parts List for either the completely wired or the unwired board. Most of the components mounted on the circuit boards can be replaced without removing the boards from the instrument. Observe the soldering precautions given under Soldering Techniques in this section. However, if the bottom side of the board must be reached or if the board must be moved to gain access to other areas of the instrument, only the mounting screws need to be removed. The interconnecting wires on most of the boards are long enough to allow the board to be moved out of the way or turned over without disconnecting the pin connectors.

GENERAL:

Most of the connections to the circuit boards are made with pin connectors. However, several connections are soldered to the Input Amplifier Board. See the special removal instructions for this board. All connections are soldered to the high-voltage circuit boards. These boards generally need to be completely removed only to replace the boards.

Use the following procedure to remove a circuit board:

1. Disconnect all pin connectors from the board and unsolder any soldered connections (see the information which follows to remove the Input Amplifier board and the Attenuator as a unit).
2. Remove all screws holding the board to the chassis.
3. Lift the circuit board out of the instrument. Do not force or bend the board.
4. To replace the board, reverse the order of removal. Correct location of the pin connectors is shown in Figs. 4-8 through 4-15. Replace the pin connectors carefully so they mate correctly with the pins. If forced into place incorrectly positioned, the pin connectors may be damaged.

INPUT AMPLIFIER UNIT REMOVAL:

The Input Amplifier boards and Attenuators can be removed from the Type 422 as a unit or the circuit boards can be removed separately. To remove the board only, follow the procedure described under GENERAL. To remove as a unit, proceed as follows:

1. Unsolder the wire from the AC GND DC switch and the ground lead from the BNC connector (see Fig. 4-4).
2. Remove the front-panel VOLTS/DIV and VARIABLE knobs.

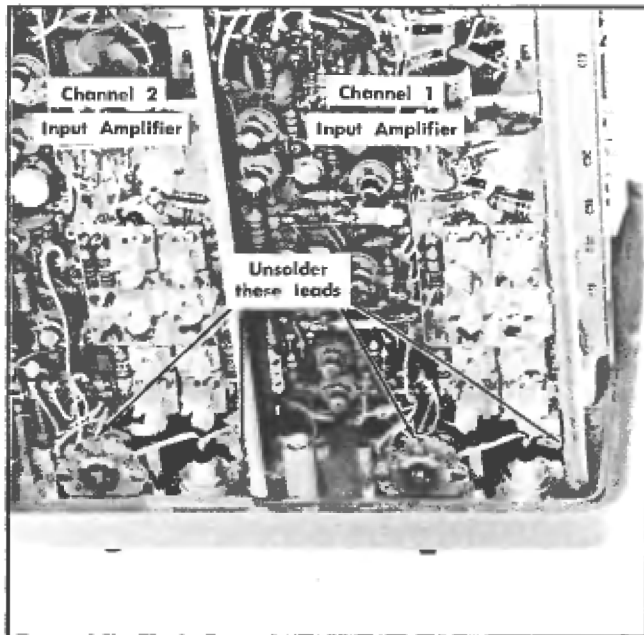

Fig. 4-4. Leads to unsolder to remove attenuator unit.

3. Remove the securing nuts on the VOLTS/DIV switch and the GAIN control.

4. Remove the two screws located at the rear of the Attenuator which secure the assembly to the chassis.

5. Disconnect all pin connectors on the board. Do not unsolder the soldered connections.

6. Lift up the rear of the assembly and slide it out of the instrument. (To remove the Channel 1 attenuator, remove the support rod from the lower left side of the instrument. A nut-driver or socket wrench should be used to remove this rod. An open-end wrench may damage the rod, preventing the power supply from being secured properly.)

7. The Input Amplifier circuit board can now be removed from the unit as follows:

a. Unsolder the remaining connections between the Attenuator and the circuit board.

b. Remove the three screws which hold the circuit board to the Attenuator unit.

8. To replace the unit, reverse the order of removal. When replacing the Channel 2 attenuator assembly, be sure the INVERT and $\times 10$ GAIN AC switches fit properly in the actuating assemblies.

Transistor and Nuvisor Replacement. Transistors and nuvisors should not be replaced unless actually defective. If removed from their sockets during routine maintenance, return them to their original sockets. Unnecessary replacement of transistors or nuvisors may affect the calibration of this instrument. When transistors or nuvisors are replaced, check the operation of that part of the instrument which may be affected.

Replacement transistors or nuvisors should be of the original type or a direct replacement. Remount the transistors in the same manner as the original. Transistors which are mounted on the chassis use silicone grease to increase heat transfer. Replace the silicone grease when replacing these transistors.

WARNING

Handle silicone grease with care. Avoid getting it in the eyes. Wash hands thoroughly after use.

Cathode-Ray Tube Replacement. Use care when handling a CRT. Protective clothing and safety glasses should be worn. Avoid striking it on any object which might cause it to crack or implode. When storing a CRT, place it face down on a smooth surface. A protective cover or soft mat should be placed under the faceplate to protect it from scratches.

The following procedure outlines the removal and replacement of the cathode-ray tube:

REMOVAL:

1. Remove the indicator cabinet as described on page 4-1.
2. Remove the light filter or faceplate protector.
3. Disconnect the CRT anode connector. Ground this lead to the chassis to discharge any stored charge.
4. Disconnect the trace rotation coil at the pin connectors on the Horizontal Amplifier board. Also disconnect the pin connector from terminal 3 of the Y-Axis Alignment control.
5. Disconnect the four deflection-plate connectors. Be careful not to bend the deflection-plate pins.
6. Remove the CRT socket shield.
7. Disconnect the CRT socket.
8. Remove the two lock-nuts holding the front of the CRT shield to the sub-panel.
9. Slide the graticule lights off the studs and move them away from the shield.
10. Remove the remaining two screws holding the shield bracket to the rear of the instrument.
11. Slide the CRT assembly to the rear of the instrument until the shield clears the mounting studs. Then, lift the CRT assembly straight up and out of the instrument (see Fig. 4-5).
12. Loosen the clamp near the shield bracket.
13. Holding the left hand on the CRT faceplate, push forward on the CRT base with the right hand. As the CRT starts out of the shield, grasp it firmly with the left hand. When the CRT is free of the clamp, slide the shield off the CRT. Be careful not to bend the neck pins.

REPLACEMENT:

1. Insert the CRT into the shield. Be careful not to bend the neck pins. Push the CRT firmly into the shield.
2. Tighten the CRT clamp.

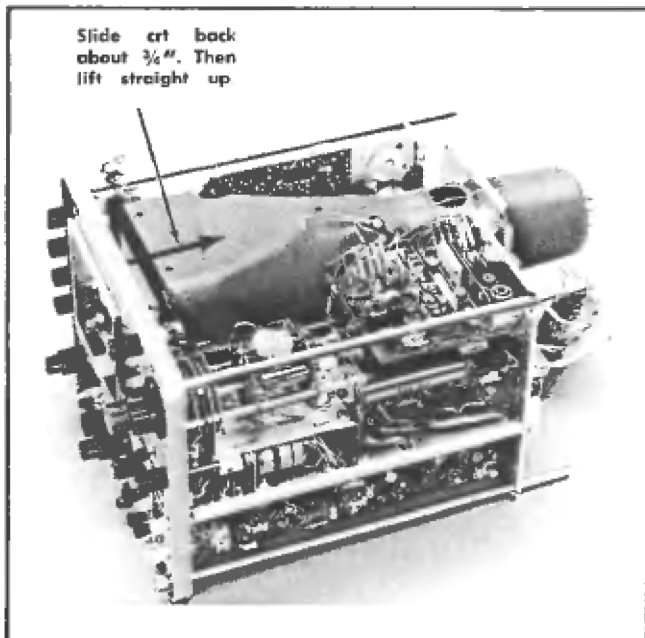

Fig. 4-5. Removing the cathode-ray tube.

3. Place the light shield over the faceplate.
 4. Using a method similar to that for removal (step 11), reinsert the CRT assembly into the instrument. Be sure the CRT faceplate seats properly in the subpanel.
 5. Replace the two lower screws in the shield bracket.
 6. Replace the graticule lights and the lock-nuts.
 7. Replace the CRT socket and socket shield.
- B. Reconnect the anode connector. Align the plug on the CRT and the jack in the connector and press firmly on the insulating cover to snap the jack into place.
9. Reconnect the trace alignment leads. Correct location of these wires is shown in Fig. 4-12. Also reconnect the pin connector to terminal 3 of the Y-Axis Alignment control.
 10. Reconnect the deflection-plate connectors. Correct location of the leads is shown on the CRT shield.
 11. Adjust the Geometry, Trace Rotation, Y-Axis Alignment and Unblinking Center adjustments (see the Calibration section for adjustment procedure).

NOTE

If the Trace Rotation adjustment does not have enough range to make the trace parallel with the graticule lines, reverse the connection of the leads at the Horizontal Amplifier board.

Rotary Switches. Individual wafers or mechanical parts of rotary switches are normally not replaceable. If a switch is defective, replace the entire assembly. Replacement switches can be ordered either wired or unwired; refer to the Parts List for the applicable part numbers.

When replacing a switch, tag the leads and switch terminals with corresponding identification tags as the leads are disconnected. Then, use the old switch as a guide for installing the new one. An alternative method is to draw a sketch of the switch layout and record the wire color at each terminal. When soldering to the new switch be careful that the solder does not flow beyond the rivets on the switch terminals. Spring tension of the switch contact can be destroyed by excessive solder.

High-Voltage Compartment. The components located in the high-voltage compartment can be reached for maintenance or replacement by using the following procedure.

1. Remove the cabinet from the instrument as described earlier in this section.
2. Turn the instrument over so the bottom side is up.
3. Remove the two screws which hold the high-voltage compartment to the chassis.
4. Lift the complete high-voltage compartment away from the chassis.
5. Slide the shield off the high-voltage housing. The two pins on the bottom of the housing must be freed from the holes in the shield before the shield can be slid off.
6. Remove the cover of the high-voltage housing.
7. To replace the high-voltage compartment, reverse the order of removal. When placing the circuit boards back into the compartment, be sure the insulator sheet is installed in the proper place. Fig. 4-6 shows the correct location of the circuit boards and the insulator sheet.

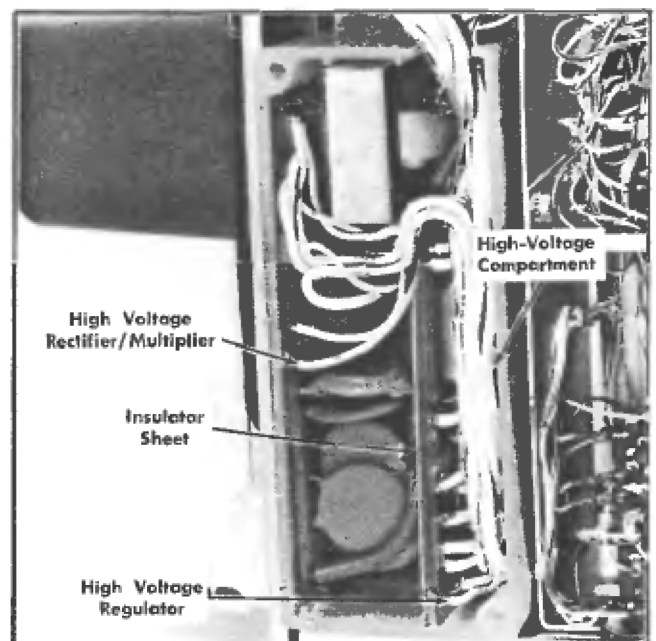

Fig. 4-6. Correct location of circuit boards in high-voltage compartment.

Recalibration After Repair

After any electrical component has been replaced, the calibration of that particular circuit should be checked, as well as the calibration of other closely related circuits. Since

the low-voltage supply affects all circuits, calibration of the entire instrument should be checked if work has been done in the low-voltage supply or if the power transformer has been replaced. The Performance Check procedure in Section 5 provides a quick and convenient means of checking instrument operation.

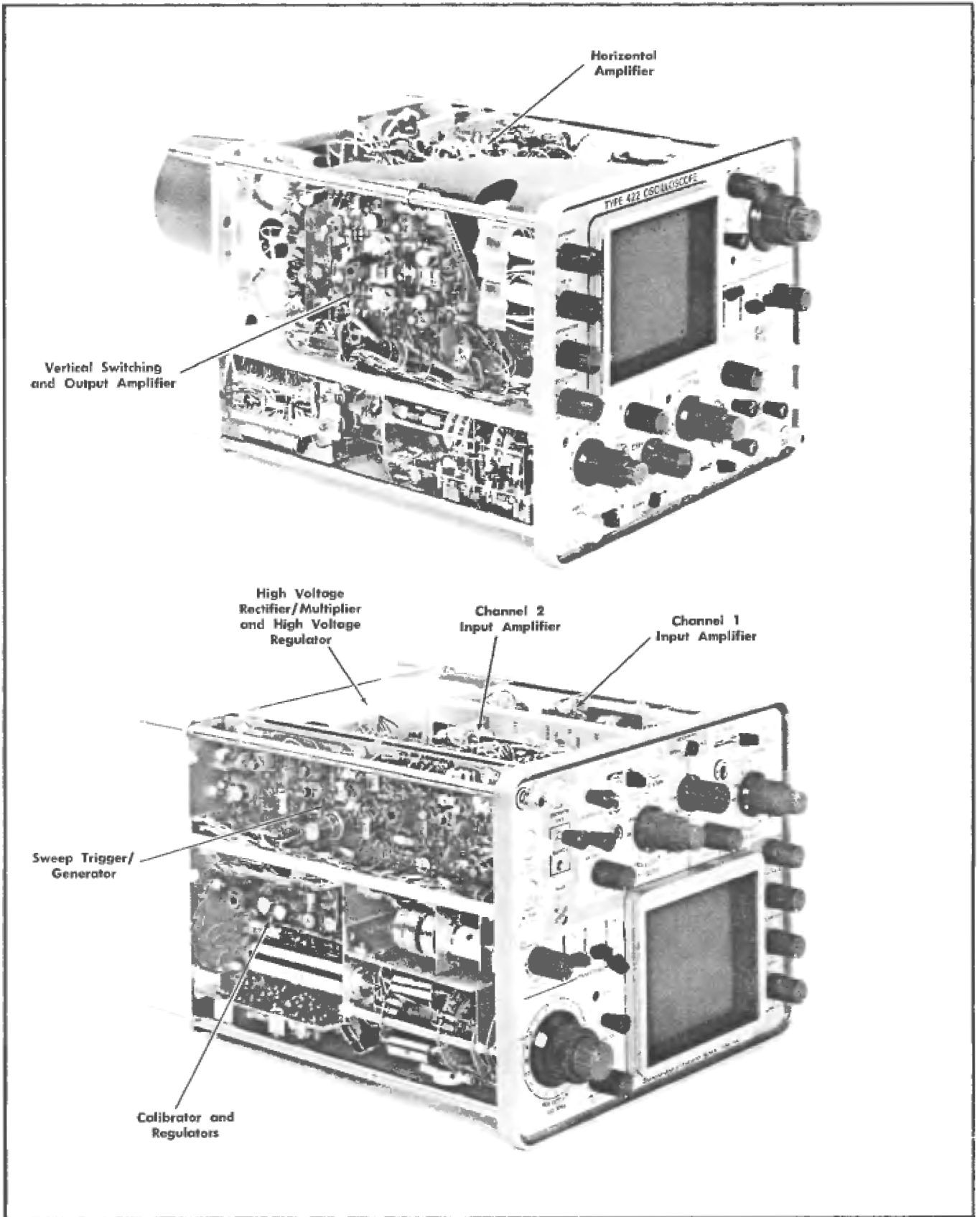

Fig. 4-7. Location of circuit boards in the Type 422.

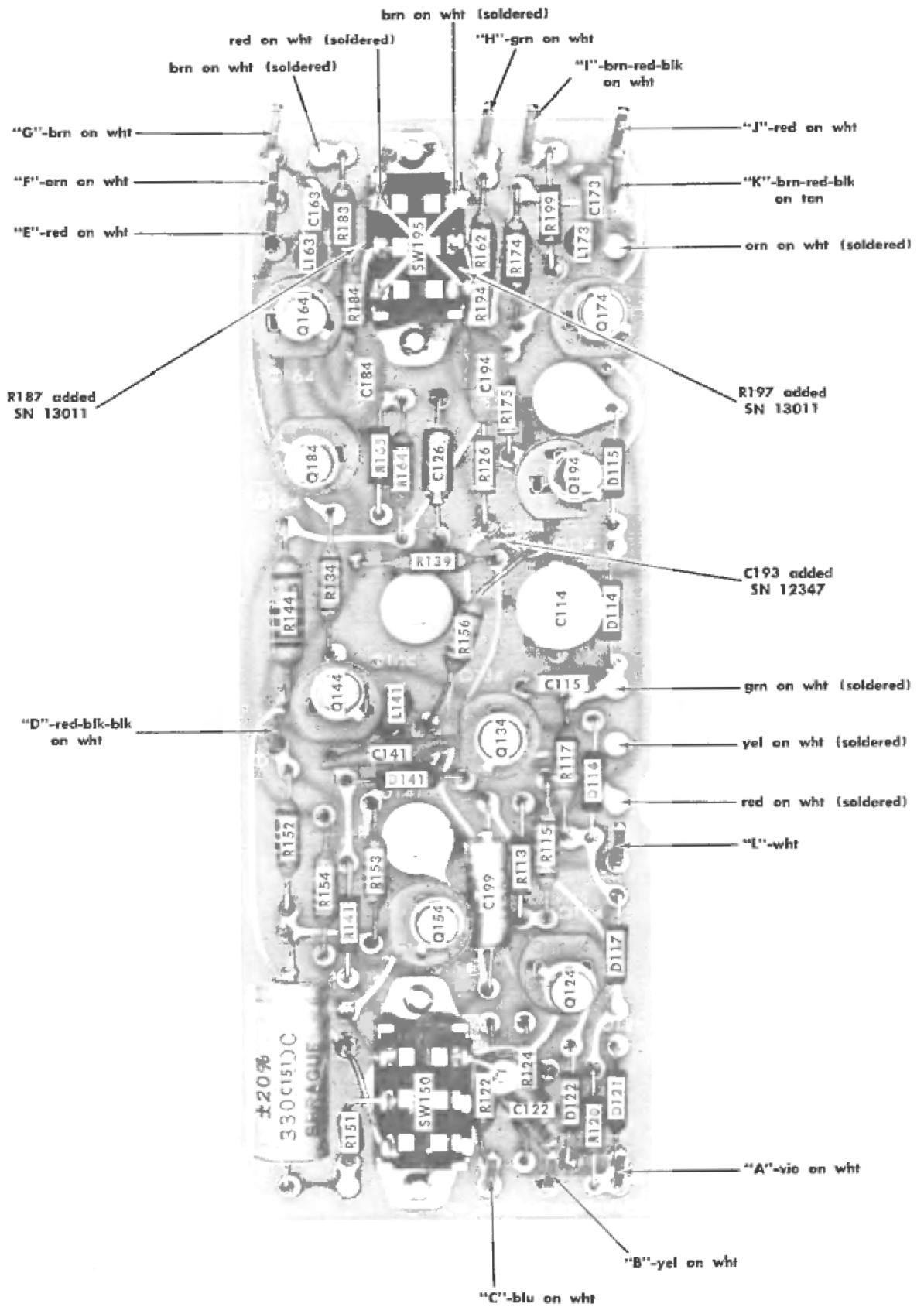

Fig. 4-9. Channel 2 Input Amplifier circuit board.

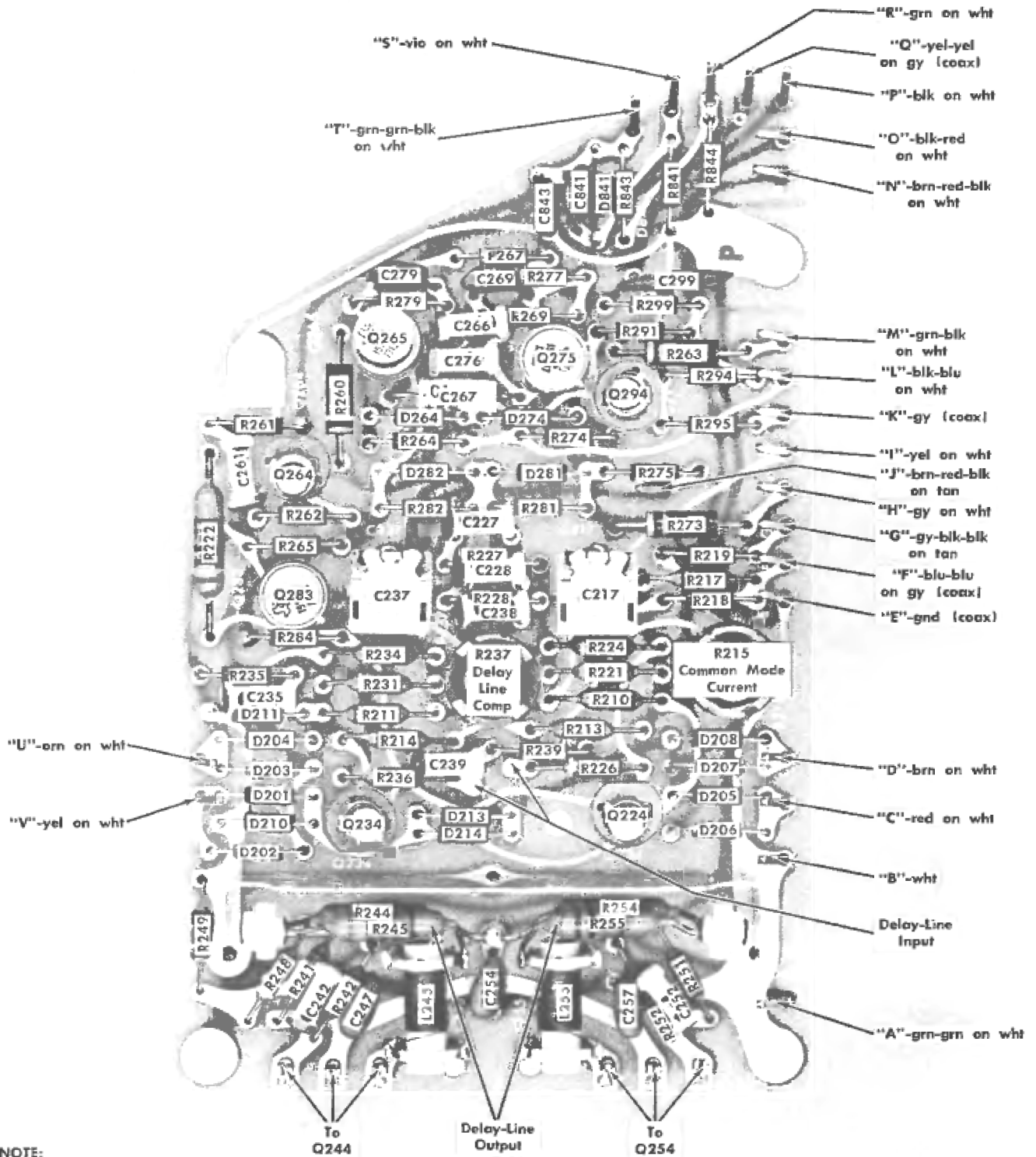

Fig. 4-10. Vertical Switching and Output Amplifier circuit board.

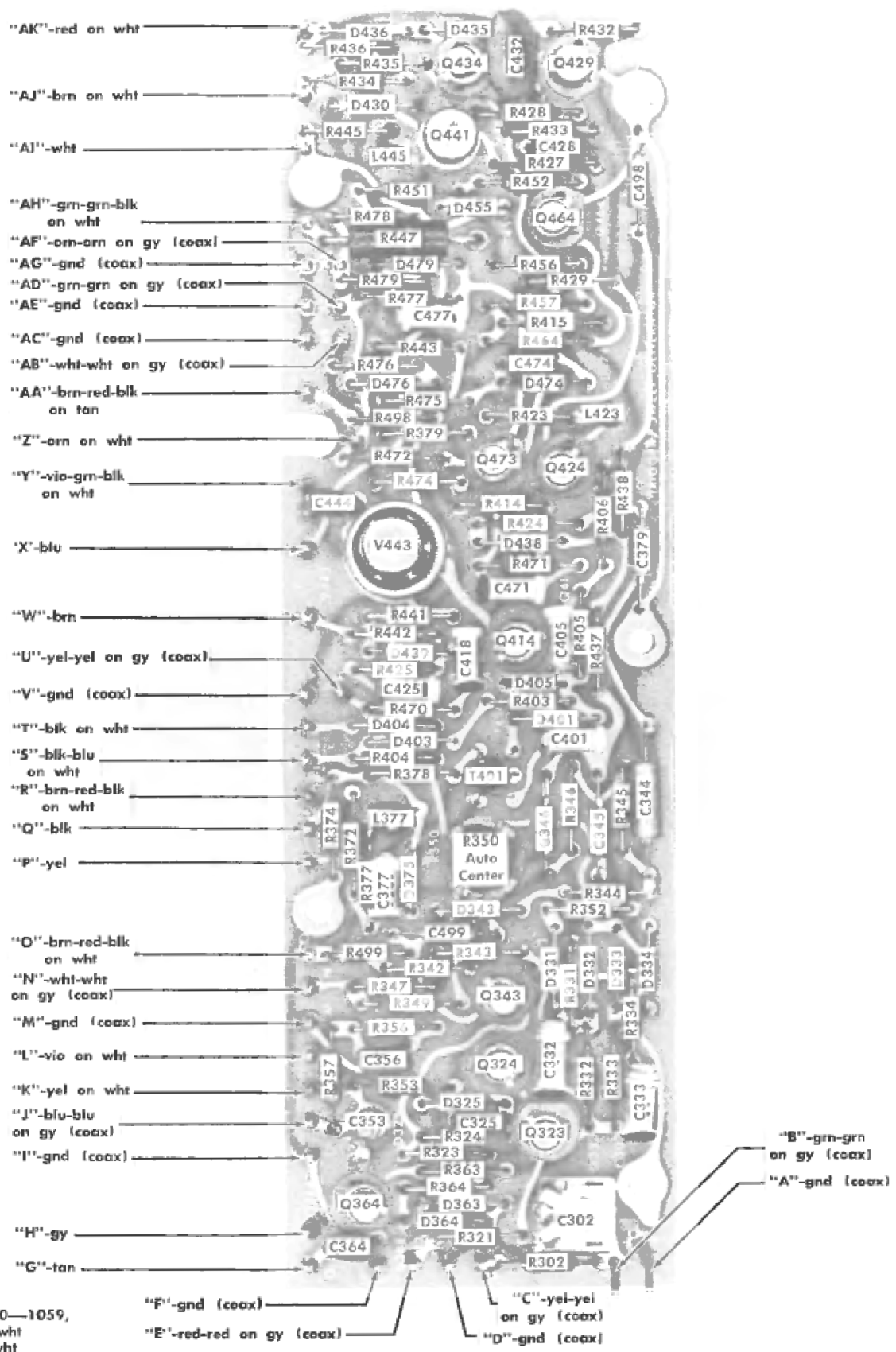

Fig. 4-11. Sweep Trigger/Generator circuit board.

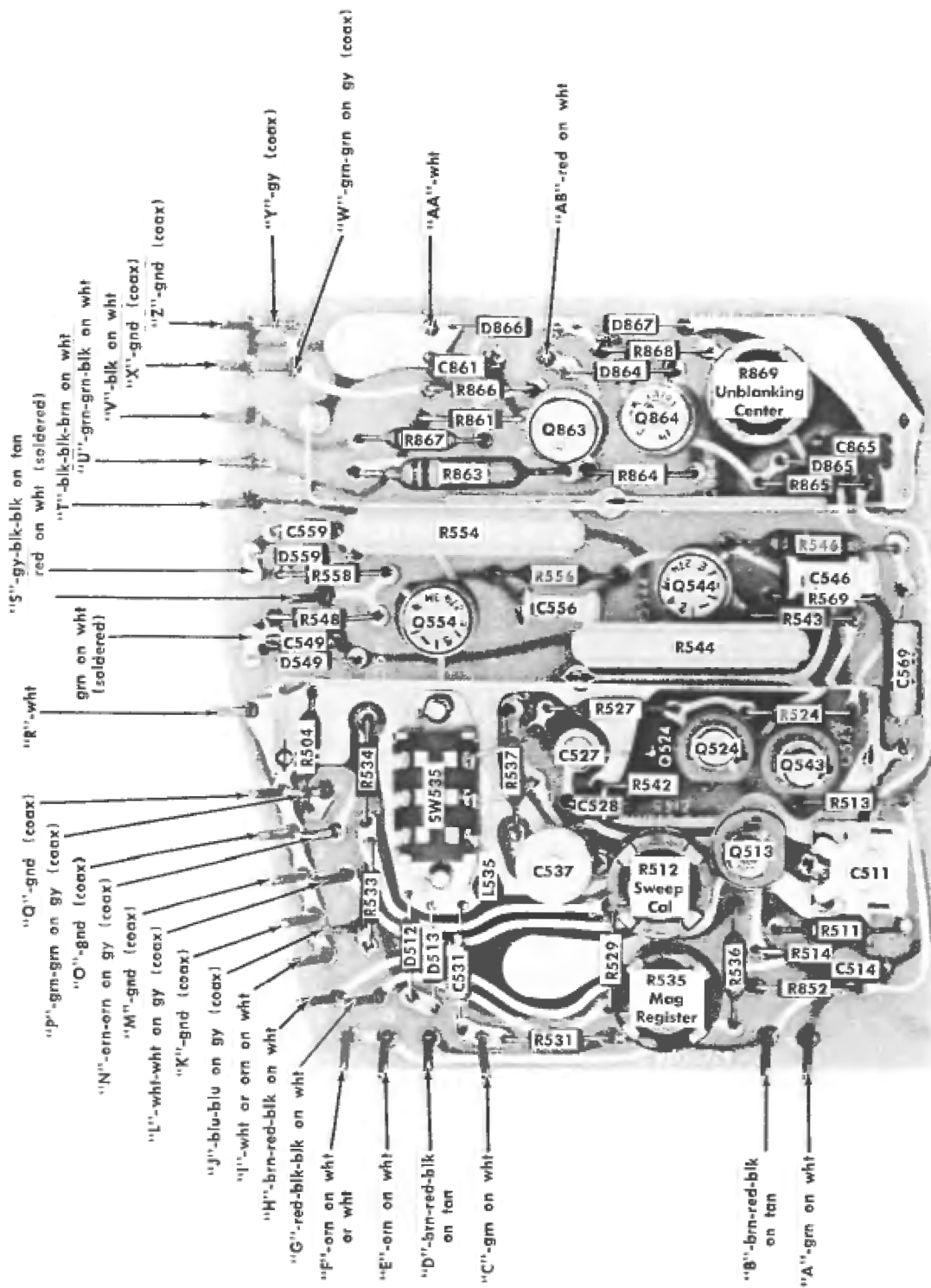
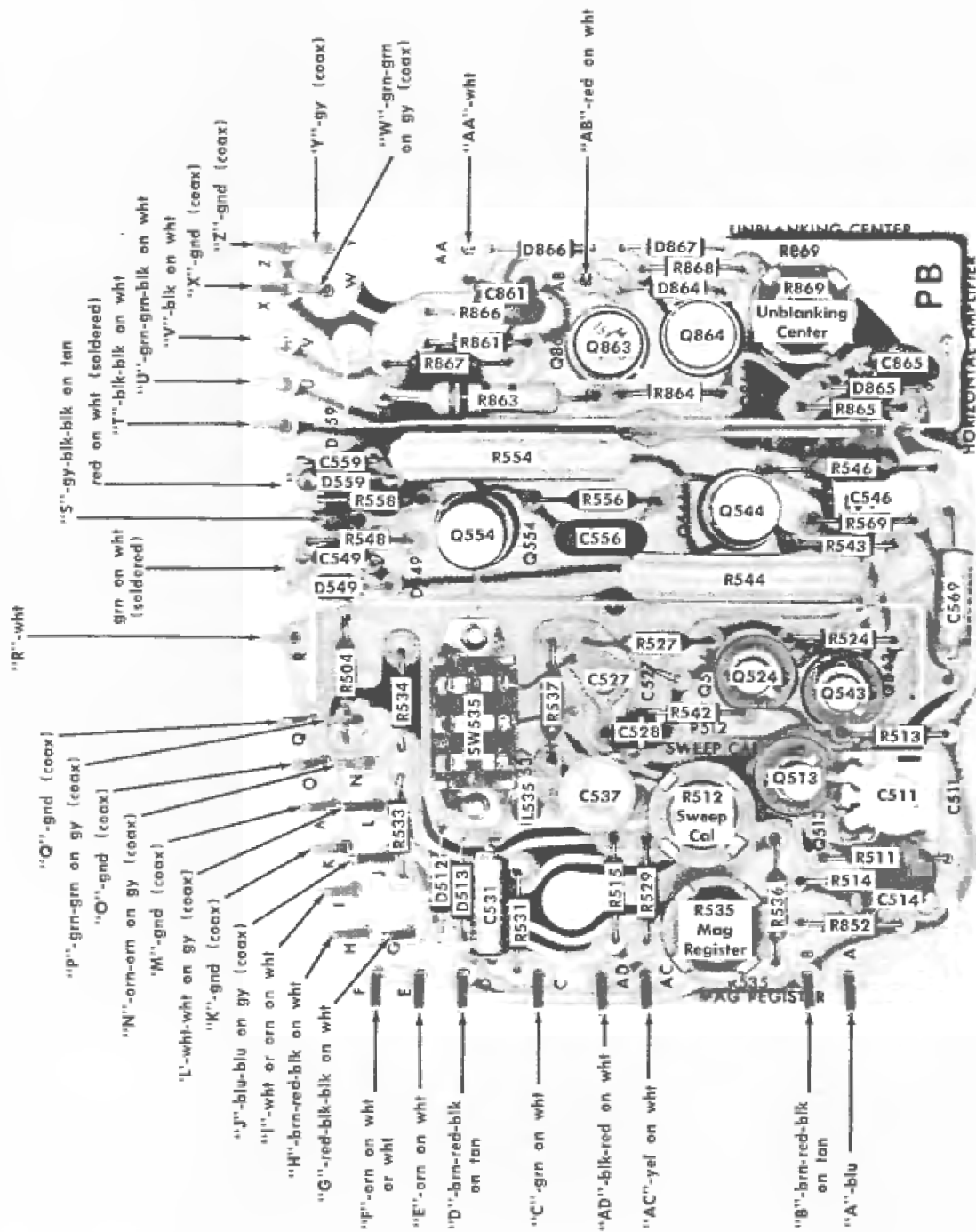

Fig. 4-12A. Horizontal Amplifier circuit board. Serial number 100-599.



NOTE: SN1055-4134,
 D512 and D524 mounted
 on rear of board.
 SN600-1059, A-grn on wht.

Fig. 4-126. Horizontal Amplifier circuit board. Serial number 600-4134.

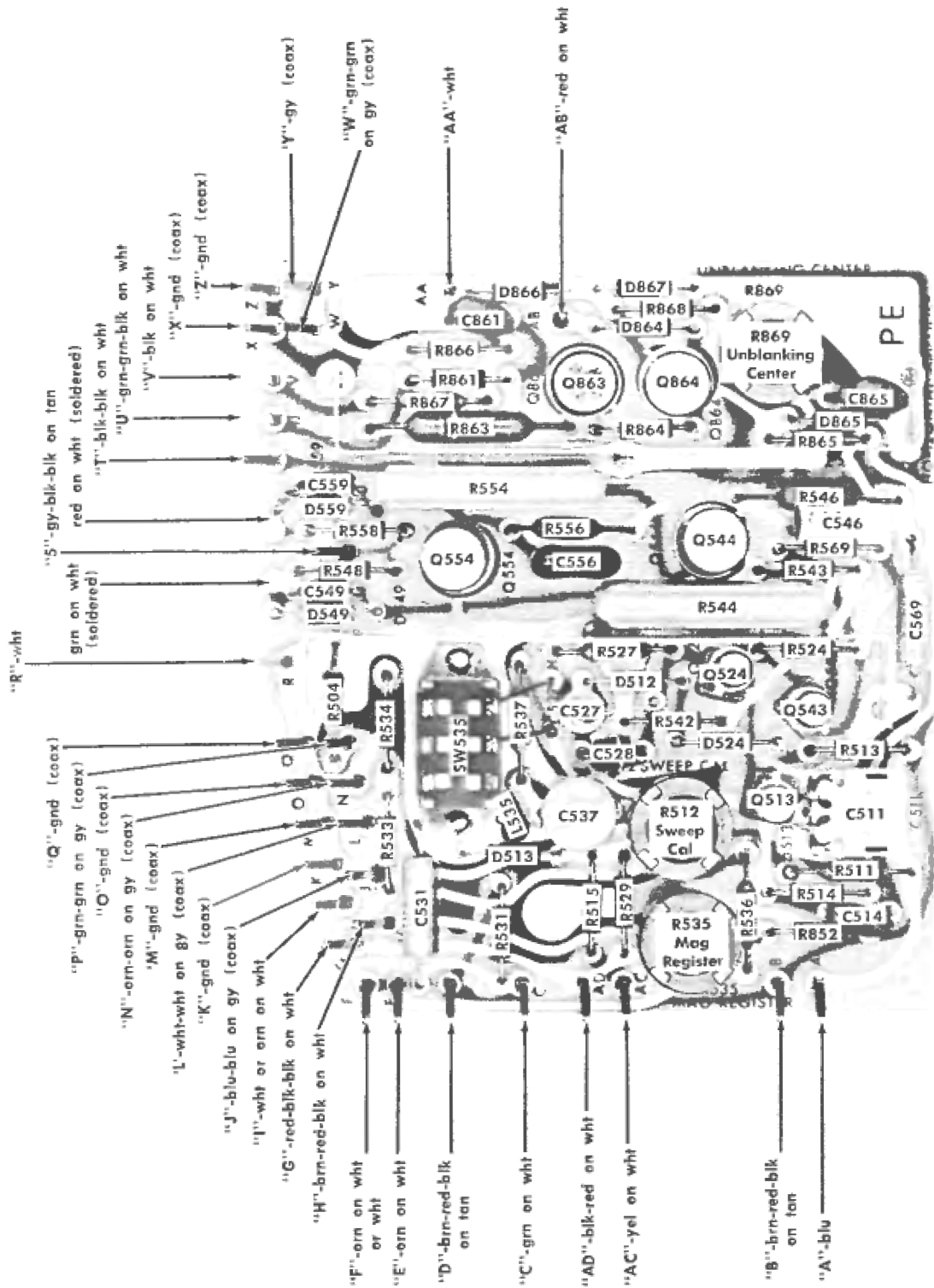

Fig. 4-12C. Horizontal Amplifier circuit board. Serial number 4135-9562.

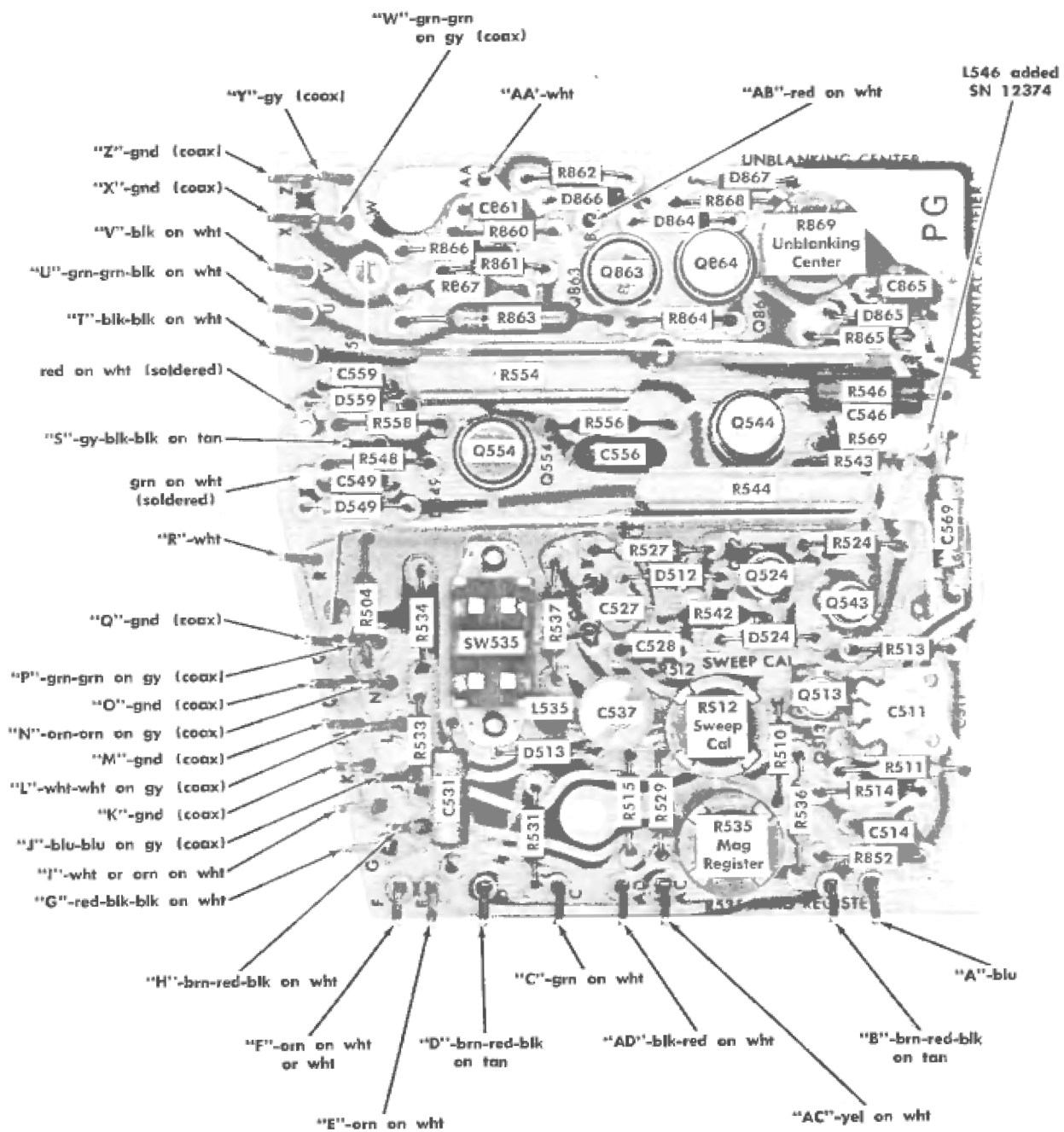

Fig. 4-12D. Horizontal Amplifier circuit board. Serial number 9563 and up.

SECTION 5

PERFORMANCE CHECK

Introduction

This section of the manual provides a procedure for rapidly checking the performance of the Type 422. This procedure checks the operation of the instrument without removing the cabinet or making internal adjustments. However, screw-driver adjustments which are located on the front panel are adjusted in this procedure.

If the instrument does not meet the performance requirements given in this procedure, internal checks and/or adjustments are required. See the Calibration section. All performance requirements given in this section correspond to those given in the Characteristics section.

NOTE

All waveforms shown in this section are actual waveform photographs taken with a Tektronix Oscilloscope Camera System.

Recommended Equipment

The following equipment is recommended for a complete performance check. Specifications given are the minimum necessary to perform this procedure. All equipment is assumed to be calibrated and operating within the given specifications. If equipment is substituted, it must meet or exceed the specifications of the recommended equipment.

For the most accurate and convenient performance check, special calibration fixtures are used in this procedure. These calibration fixtures are available from Tektronix, Inc. Order by part number through your local Tektronix Field Office or representative.

1. Test oscilloscope. Bandwidth, DC to 15 megahertz; minimum deflection factor, 0.2 volt/division. Tektronix Type 422 Oscilloscope recommended.

2. 10× probe with BNC connector. Tektronix P6006 recommended.

3. Standard amplitude calibrator. Amplitude accuracy, within 0.25%; signal amplitude, 50 millivolts to 100 volts; output signal, one-kilohertz square wave and negative DC voltage. Tektronix calibration fixture 067-0502-00 recommended.

4. Square-wave generator. Frequency, 1, 10 and 100 kilohertz; risetime, one nanosecond or less from fast-rise output; output amplitude, about 120 volts unterminated or 12 volts into 50 ohms. Tektronix Type 106 Square-Wave Generator recommended.

5. Constant amplitude sine-wave generator. Frequency, 50 kilohertz and 350 kilohertz to 15 megahertz; output amplitude, variable from five millivolts to five volts; amplitude accuracy, $\pm 3\%$ from 50 kilohertz to 15 megahertz. Tektronix Type 191 Constant Amplitude Signal Generator recommended.

6. Time-mark generator. Marker outputs, 0.5 second to 50 nanoseconds; marker accuracy, within 0.3%. Tektronix Type 184 Time-Mark Generator recommended.

7. Low-frequency sine-wave generator. Frequency, 50 hertz; output amplitude, 40 millivolts to 0.6 volt. For example, Heathkit IG-72 Audio Generator.

8. 10× attenuator (two). Impedance, 50 ohms; accuracy, $\pm 3\%$; connectors, GR. Tektronix Part No. 017-0078-00.

9. Cable (two). Impedance, 50 ohms; type, RG-58A/U; length 42 inches; connectors, BNC. Tektronix Part No. 012-0057-00.

10. BNC T connector. Tektronix Part No. 103-0030-00.

11. Cable. Impedance, 50 ohms; type RG-8A/U; length, five nanoseconds (for use with Type 106 and 191); connectors, GR874. Tektronix Part No. 017-0502-00.

12. In-line termination. Impedance, 50 ohms; accuracy, $\pm 3\%$; connectors, GR input with BNC male output. Tektronix Part No. 017-0083-00.

13. Adapter. Connectors, BNC female and two alligator clips. Tektronix Part No. 013-0076-00.

14. Screwdriver. Three-inch shaft. Tektronix Part No. 003-0192-00.

PERFORMANCE CHECK PROCEDURE

General

In the following procedure, control settings or test equipment connections should not be changed except as noted. If only a partial check is desired, refer to the preceding step(s) for setup information. Type 422 front-panel control titles referred to in this procedure are capitalized (e.g., POSITION).

The following procedure uses the equipment listed under Recommended Equipment. If equipment is substituted, control settings or setup may need to be altered to meet the requirements of the equipment used.

Preliminary Procedure

1. Connect the Type 422 to a power source which meets the voltage and frequency requirements of this instrument.

2. Set the Type 422 controls as follows:

CRT controls

INTENSITY	Counterclockwise
FOCUS	See step 1
ASTIGMATISM	See step 1
SCALE ILLUM	As desired

Vertical controls (both channels if applicable)

VOLTS/DIV	.01
VARIABLE	CAL

Performance Check—Type 422/R422 (SN 100-19,999)

AC GND DC	GND
POSITION	Midrange
Mode	CH 1
INVERT	Pushed in
×10 GAIN AC	Pushed in

Triggering controls

Source	CH 1 & 2
Coupling	AC
SLOPE	Positive going
LEVEL	AUTO

Sweep controls

POSITION	Midrange
TIME/DIV	1 mSEC
VARIABLE	CAL
×10 MAG	Pushed in

Other

POWER	Pushed in
-------	-----------

3. Set the POWER switch to ON (pulled out). Allow at least 20 minutes warm up before proceeding.

1. Check Trace Rotation

REQUIREMENT—Trace parallel to horizontal graticule lines.

- Set the INTENSITY control to midrange.
- Set the FOCUS and ASTIGMATISM controls for a focused display.
- Position the trace to the center horizontal line with the Channel 1 POSITION control.
- CHECK—Trace parallel to the horizontal graticule lines.

2. Check CRT Geometry

REQUIREMENT—Alignment of markers within 0.1 division of the vertical graticule lines; alignment of trace within 0.1 divisions of the horizontal graticule lines.

- Set the AC GND DC switch to AC.
- Connect the time mark generator to the INPUT 1 connector through a 50-ohm BNC cable.
- Set the time-mark generator for output markers of one millisecond and 0.1 millisecond.
- Set the Triggering LEVEL control for a stable display.
- Set the Channel 1 VOLTS/DIV switch so the large markers extend beyond the bottom and top of the graticule area.
- Set the Horizontal POSITION and the VARIABLE TIME/DIV controls so a large marker coincides with each graticule line.
- CHECK—CRT display for less than 0.1 division bowing of the markers at the left and right edges of the graticule (see Fig. 5-1).

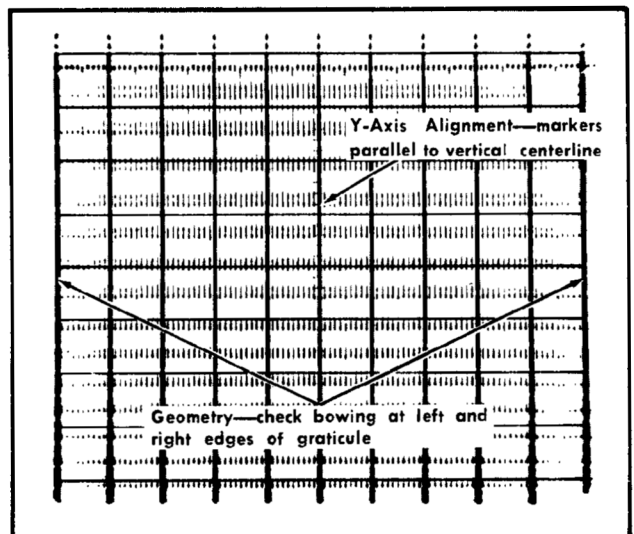

Fig. 5-1. Typical CRT display showing good geometry and Y-axis alignment.

- Disconnect the time-mark generator.
- Position the trace to the top graticule line.
- CHECK—Deviation from straight line should not exceed 0.1 division.
- Position the trace to the bottom graticule line.
- CHECK—Deviation from straight line should not exceed 0.1 division.

3. Check Channel 1 Step Attenuator and Variable Balance

REQUIREMENT—No trace shift as the Channel 1 VOLTS/DIV switch is changed from .05 to .01; two divisions or less trace shift as the Channel 1 VARIABLE VOLTS/DIV control is rotated throughout its range.

- Set the Triggering LEVEL control to FREE RUN.
- Set the Channel 1 AC GND DC switch to GND.
- Vertically center the trace with the Channel 1 POSITION control.
- CHECK—Change the Channel 1 VOLTS/DIV switch from .05 to .01. Trace should not move vertically.
- ADJUST—Channel 1 STEP ATT BAL adjustment, (on front panel), for no trace shift as the Channel 1 VOLTS/DIV switch is changed from .05 to .01.
- Return the Channel 1 VOLTS/DIV switch to .05.
- CHECK—Rotate the Channel 1 VARIABLE VOLTS/DIV control throughout its range. Trace should not move more than two divisions vertically.

4. Check Channel 2 Step Attenuator and Variable Balance

REQUIREMENT—No trace shift as the Channel 2 VOLTS/DIV switch is changed from .05 to .01; two division or less

trace shift as the Channel 2 VARIABLE VOLTS/DIV control is rotated throughout its range.

- a. Set the Mode switch to CH 2.
- b. Set the Channel 2 AC GND DC switch to GND.
- c. Vertically center the trace with the Channel 2 POSITION control.
- d. CHECK—Change the Channel 2 VOLTS/DIV switch from .05 to .01. Trace should not move vertically.
- e. ADJUST—Channel 2 STEP ATT BAL adjustment, (on front panel), for no trace shift as the Channel 2 VOLTS/DIV switch is changed from .05 to .01.
- f. Return the Channel 2 VOLTS/DIV switch to .05.
- g. CHECK—Rotate the Channel 2 VARIABLE VOLTS/DIV control throughout its range. Trace should not move more than two divisions vertically.

5. Check Alternate Operation

REQUIREMENT—Trace alternation at all sweep rates.

- a. Set the Mode switch to ALT.
- b. Position the traces about two divisions apart.
- c. Turn the TIME/DIV switch throughout its range.
- d. CHECK—Trace alternation between Channel 1 and 2 at all sweep rates. At faster sweep rates, alternation is not apparent; display will appear as two traces on screen.

6. Check Channel 1 and 2 Gain

REQUIREMENT—Vertical deflection within $\pm 3\%$ of VOLTS/DIV switch indication.

- a. Change the following control settings:

VOLTS/DIV (both channels)	.05
AC GND DC	AC
Mode	CH 1
TIME/DIV	.5 mSEC
- b. Connect the standard amplitude calibrator output connector to the INPUT 1 connector through a BNC cable and the BNC T connector. Connect the output of the BNC T connector to INPUT 2 with a BNC cable.
- c. Set the standard amplitude calibrator for a 0.2-volt square-wave output.
- d. Position the display to the center of the graticule with the Channel 1 POSITION control.
- e. CHECK—CRT display four divisions ± 0.12 division, in amplitude (error $\pm 3\%$; see Fig. 5-2).
- f. ADJUST—Channel 1 GAIN adjustment (on front panel) for exactly four divisions of deflection.

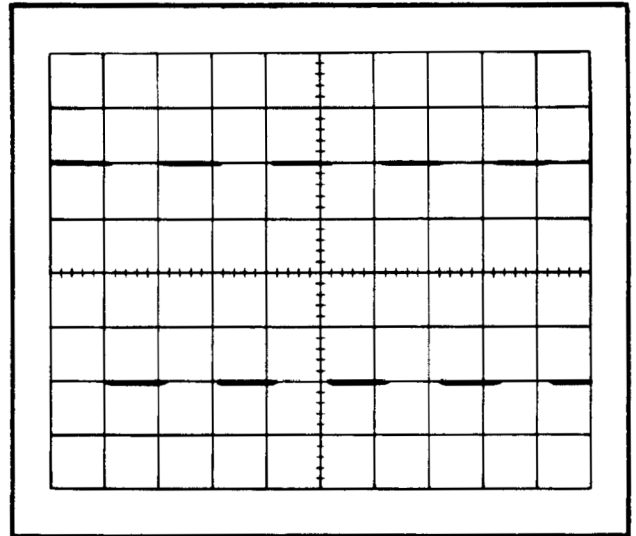

Fig. 5-2. Typical CRT display showing correct vertical gain. Vertical deflection, 0.05 volts/division.

- g. Pull the INVERT switch.
- h. Set the Mode switch to ALG ADD and position the display to the center of the graticule with the Channel 2 POSITION control.
- i. CHECK—CRT display straight line.
- j. ADJUST—Channel 2 GAIN adjustment (on front panel), for a straight line display.

7. Check Added Mode Operation

REQUIREMENT—Correct signal addition within $\pm 3\%$.

- a. Push in the INVERT switch.
- b. Set the standard amplitude calibrator for a 0.1-volt square-wave output.
- c. CHECK—CRT display four divisions in amplitude, ± 0.12 division.

8. Check Channel 1 and 2 Deflection Accuracy

REQUIREMENT—Vertical deflection within $\pm 3\%$ of the VOLTS/DIV switch indication.

- a. Set the Mode switch to CH 1.
- b. Set the Channel 2 AC GND DC switch to GND.
- c. CHECK—Using the Channel 1 VOLTS/DIV switch and standard amplitude calibrator settings given in Table 5-1, check vertical deflection within $\pm 3\%$ at each position of the Channel 1 VOLTS/DIV switch.
- d. Set the Mode switch to CH 2.
- e. Set the Channel 1 AC GND DC switch to GND and the Channel 2 AC GND DC switch to DC.

Performance Check—Type 422/R422 (SN 100-19,999)

f. CHECK—Using the Channel 2 VOLTS/DIV switch and standard amplitude calibrator settings given in Table 5-1, check vertical deflection within $\pm 3\%$ at each position of the Channel 2 VOLTS/DIV switch.

TABLE 5-1

Vertical Deflection Accuracy

VOLTS/DIV Switch Setting	Standard Amplitude Calibrator Square-Wave Output	Vertical Deflection in Divisions	Maximum Error For $\pm 3\%$ Accuracy (divisions)
.01	50 millivolts	5	± 0.15
.02	0.1 volt	5	± 0.15
.05	0.2 volt	4	± 0.12
.1	0.5 volt	5	± 0.15
.2	1 volt	5	± 0.15
.5	2 volts	4	± 0.12
1	5 volts	5	± 0.15
2	10 volts	5	± 0.15
5	20 volts	4	± 0.12
10	50 volts	5	± 0.15
20	100 volts	5	± 0.15

9. Check Channel 2 $\times 10$ Gain

REQUIREMENT—Correct Channel 2 deflection within $\pm 7.5\%$ when the $\times 10$ GAIN AC switch is pulled out.

- Set both VOLTS/DIV switches to .05.
- Set the standard amplitude calibrator for a 20-millivolt square-wave output.
- Pull the $\times 10$ GAIN AC switch out.
- CHECK—CRT display four divisions in amplitude, ± 0.3 division ($\pm 7.5\%$).
- Push in the $\times 10$ GAIN AC switch.

10. Check Channel 1 and 2 Variable Volts/Division Range

REQUIREMENT—At least 2.5:1 reduction in vertical deflection when fully counterclockwise.

- Set the standard amplitude calibrator for a 0.2-volt square-wave output (four divisions of deflection).
- CHECK—Turn the Channel 2 VARIABLE VOLTS/DIV control fully counterclockwise. Display should be reduced to 1.6 divisions or less (reduction in amplitude by a factor of at least 2.5:1; see Fig. 5-3). Channel 2 UNCAL light must be on when VARIABLE control is not in CAL position.
- Set the Mode switch to CH 1.
- Set the Channel 1 AC GND DC switch to DC.
- CHECK—TURN the Channel 1 VARIABLE VOLTS/DIV control fully counterclockwise. Display should be reduced to 1.6 divisions or less (reduction in amplitude by a factor of at least 2.5:1; see Fig. 5-3). Channel 1 UNCAL light must be on when VARIABLE control is not in CAL position.

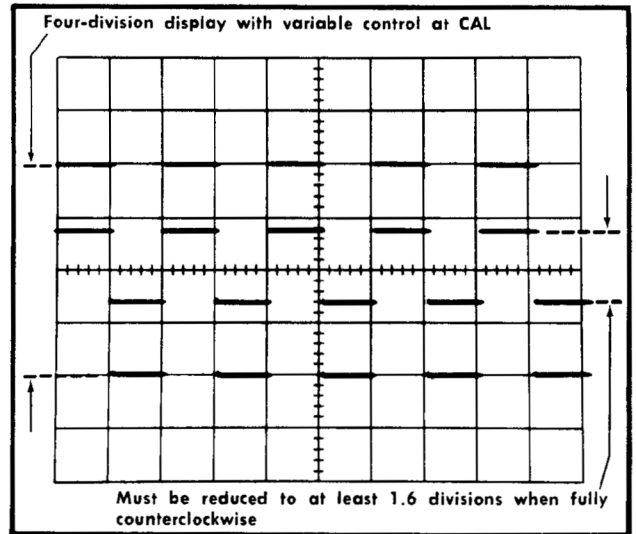

Fig. 5-3. Typical CRT display showing correct VARIABLE VOLTS/DIV control range (double exposure).

11. Check Vertical Linearity

REQUIREMENT—Less than 0.2 division compression or expansion at extremes of display area.

- Set the standard amplitude calibrator for a 0.2-volt square-wave output.
- Position the display to the center of the graticule with the Channel 1 POSITION control.
- Set the Channel 1 VARIABLE VOLTS/DIV control for exactly two divisions of deflection (see Fig. 5-4B).
- Position the top of the display to the top graticule line.
- CHECK—Compression or expansion not to exceed 0.2 division (see Fig. 5-4).
- Position the bottom of the display to the bottom graticule line.
- CHECK—Compression or expansion not to exceed 0.2 division (see Fig. 5-4).
- Set the Mode switch to CH 2.
- Position the display to the center of the graticule with the Channel 2 POSITION control.
- Set the Channel 2 VARIABLE VOLTS/DIV control for exactly two divisions of deflection (see Fig. 5-4).
- Position the top of the display to the top graticule line.
- CHECK—Compression or expansion not to exceed 0.2 division (see Fig. 5-4).
- Position the bottom of the display to the bottom graticule line.

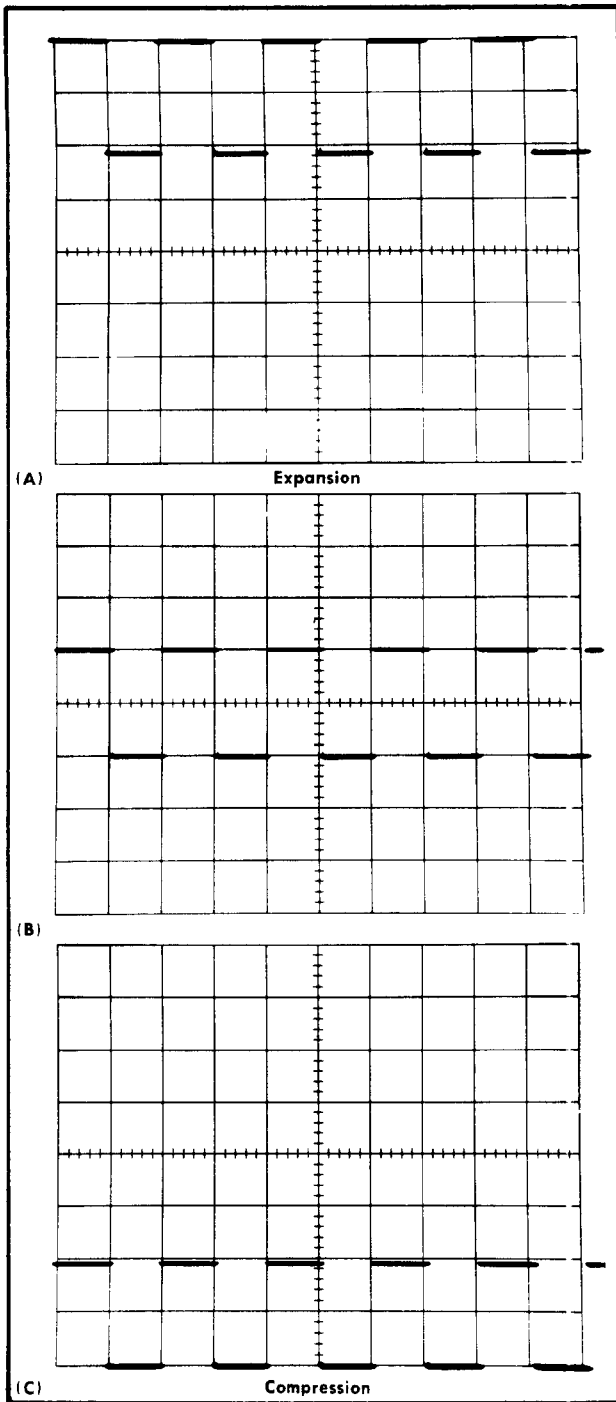

Fig. 5-4. Typical CRT display showing acceptable compression and expansion. Waveform (A) shows expansion; waveform (C) shows compression.

n. CHECK—Compression or expansion not to exceed 0.2 division (see Fig. 5-4).

12. Check Channel 1 and 2 AC GND DC Switch Operation

REQUIREMENTS—Correct signal coupling in each position.

- a. Return both VARIABLE VOLTS/DIV controls to CAL.
- b. Position display with the Channel 2 POSITION control so the bottom of the square-wave is at the center horizontal line.
- c. Set the Channel 2 AC GND DC switch to AC.
- d. CHECK—CRT display centered about centerline.
- e. Set the Channel 2 AC GND DC switch to GND.
- f. CHECK—CRT display for a straight line near the centerline.
- g. Set the Mode switch to CH 1.
- h. Position display with the Channel 1 POSITION control so the bottom of the square-wave is at the center horizontal line.
- i. Set the Channel 1 AC GND DC switch to AC.
- j. CHECK—CRT display centered about centerline.
- k. Set the Channel 1 AC GND DC switch to GND.
- l. CHECK—CRT display for a straight line near the centerline.

13. Check Trace Shift Due to Input Grid Current

REQUIREMENT—Trace shift 0.2 division or less at .01 VOLTS/DIV switch position.

- a. Set both VOLTS/DIV switches to .01.
- b. Set the Triggering LEVEL control to FREE RUN.
- c. Position the trace to the center horizontal line with the Channel 1 POSITION control.
- d. CHECK—Set the Channel 1 AC GND DC switch to DC; trace shift 0.2 division or less.
- e. Set the Mode switch to CH 2.
- f. Position the trace to the horizontal centerline with the Channel 2 POSITION control.
- g. CHECK—Set the Channel 2 AC GND DC switch to DC; trace shift 0.2 division or less.

14. Check Channel 1 and 2 Input Capacitance

REQUIREMENT—Channel 1 and 2 time constant matched within 1% in .05 position of VOLTS/DIV switches (with some probe).

- a. Change the following control settings:

VOLTS/DIV (both channels)	.05
Mode	CH 1

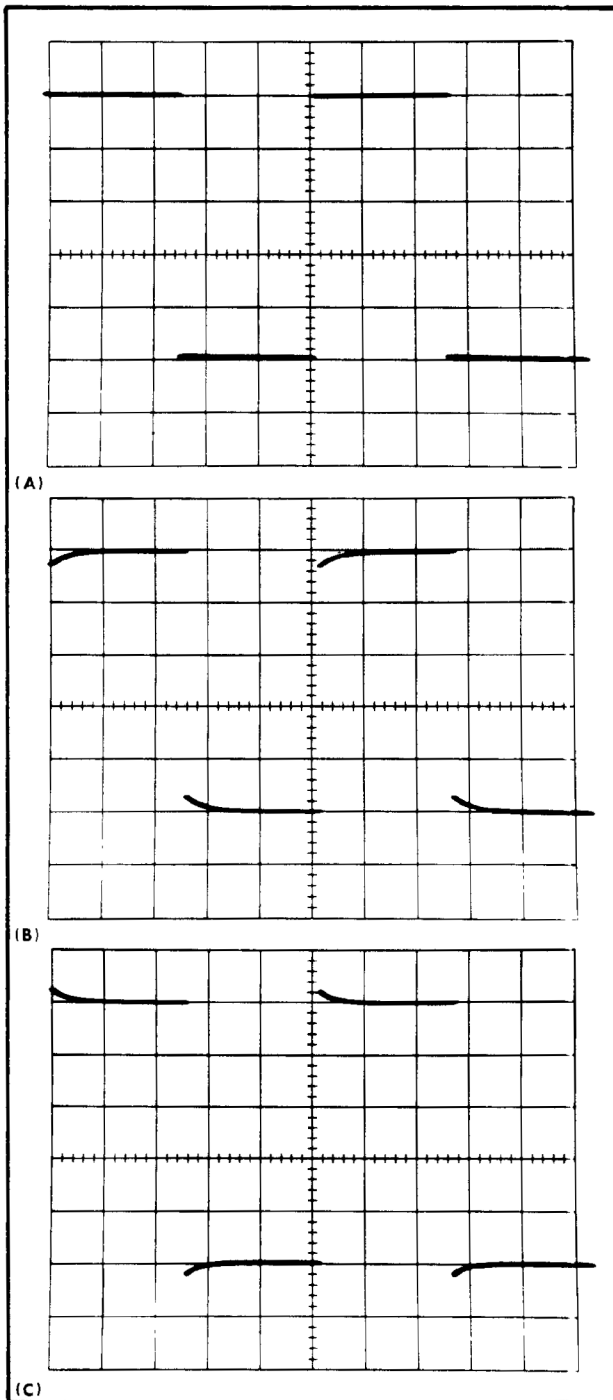

Fig. 5-5. (A) Typical CRT display showing correct input capacitance adjustment; (B) and (C) incorrect.

LEVEL Adjust for stable display
 TIME/DIV .2 mSEC

- b. Connect the 10X probe to the INPUT 1 connector
- c. Connect the probe tip to the square-wave generator high-amplitude output connector. Connect the ground lead to chassis ground.

- d. Set the square-wave generator output frequency to one kilohertz and the output amplitude for five divisions of deflection.
- e. Compensate the probe as described in the probe instruction manual.
- f. Remove the probe from the INPUT 1 connector and connect it to the INPUT 2 connector.
- g. Set the Mode switch to CH 2.
- h. CHECK—CRT display for less than 0.05 division overshoot or rounding (matched within 1%; see Fig. 5-5).

15. Check Channel 1 and 2 Volts/Division Switch Compensation

REQUIREMENT—3% or less overshoot, rounding or tilt in all positions of the VOLTS/DIV switches.

- a. Remove the probe from the INPUT 2 connector and connect it to the INPUT 1 connector.
- b. Set the Mode switch to CH 1.
- c. CHECK—CRT display at each Channel 1 VOLTS/DIV switch setting listed in Table 5-2 for 3% or less overshoot, or rounding or tilt (see Fig. 5-6).

TABLE 5-2
 VOLTS/DIV COMPENSATION

VOLTS/DIV Switch Setting	Divisions of Deflection	Maximum Overshoot, Rounding or Tilt for 3% Accuracy (divisions)
.1	5	0.15
.2	5	0.15
.5	5	0.15
5	2	0.06

- d. Set the Mode switch to CH 2.
- e. Remove the probe from the INPUT 1 connector and connect it to the INPUT 2 connector.
- f. Compensate the probe as described in the probe instruction manual to provide the correct response from Channel 2.
- g. CHECK—CRT display at each Channel 2 VOLTS/DIV switch setting listed in Table 5-2 for 3% or less overshoot, rounding or tilt (see Fig. 5-6).
- h. Remove the 10X probe.

16. Check High-Frequency Compensation

REQUIREMENT—3% or less aberrations with 100 kilohertz input signal.

- a. Connect the positive-going fast-rise output of the square-wave generator to the INPUT 1 connector through the five-nanosecond GR cable and the 50-ohm in-line termination.
- b. Change the following control settings:

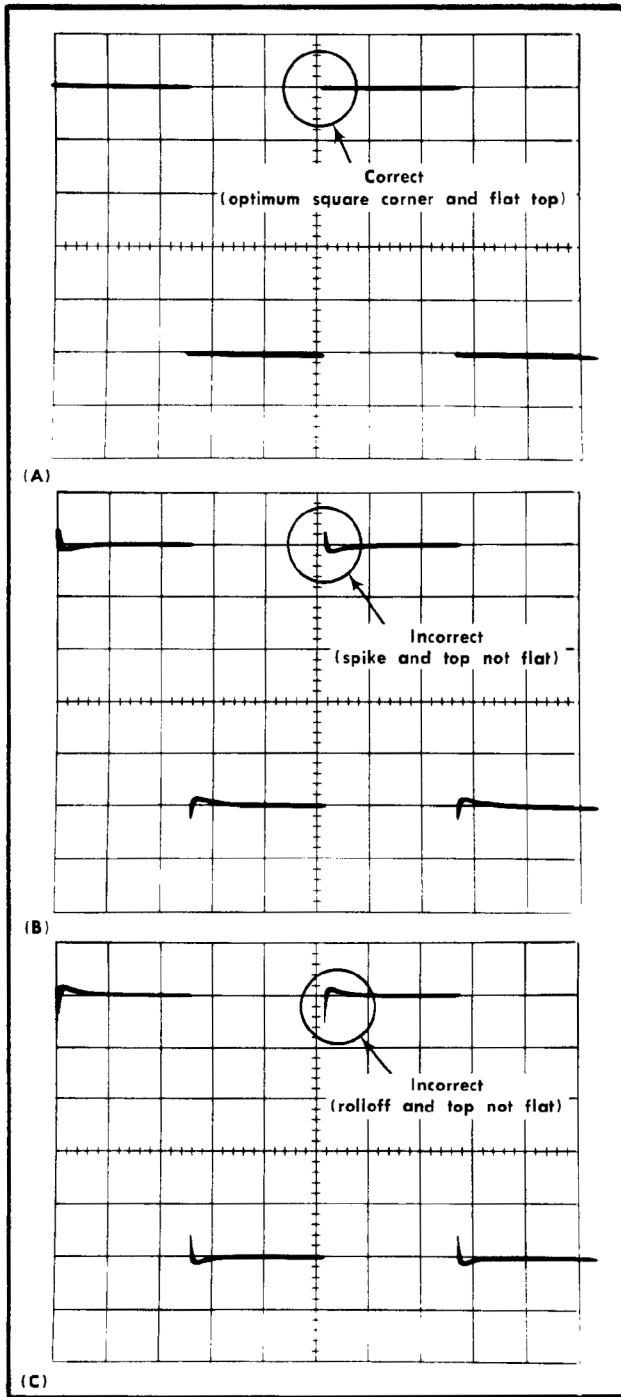

Fig. 5-6. (A) Typical CRT display showing correct VOLTS/DIV switch compensation; (B) and (C) incorrect compensation.

VOLTS/DIV (both channels)	.05
Mode	CH 1
TIME/DIV	.5 μ SEC
$\times 10$ MAG	Pulled out

c. Set the square-wave generator for five divisions of deflection at 100 kilohertz.

d. CHECK—CRT display for ± 0.15 division or less overshoot, rounding, ringing or tilt (see Fig. 5-7).

e. Set the Mode switch to CH 2.

f. Connect the positive-going fast-rise output of the square-wave generator to the INPUT 2 connector through the five nanosecond GR cable and the 50-ohm in-line termination.

g. CHECK—CRT display for ± 0.15 division or less overshoot, rounding, ringing or tilt (see Fig. 5-7).

h. Disconnect all test equipment.

17. Check Channel 1 and 2 Frequency Response

REQUIREMENT—Not more than -3 dB at 15 megahertz.

a. Change the following control settings.

Mode	CH 1
LEVEL	FREE RUN
TIME/DIV	.5 mSEC
$\times 10$ MAG	Pushed in

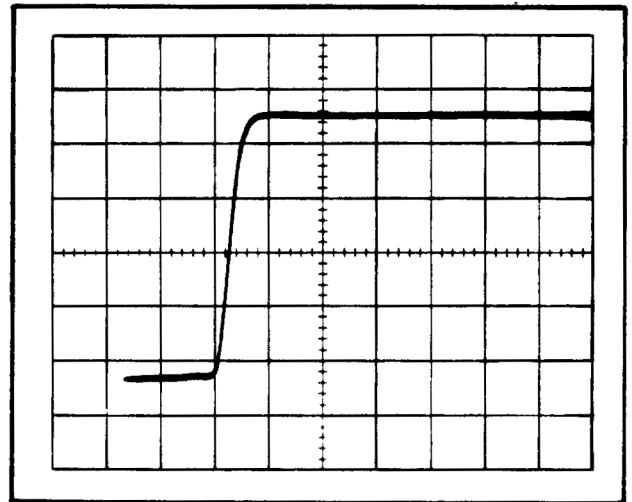

Fig. 5-7. Typical CRT display showing correct high-frequency compensation.

b. Connect the constant-amplitude sine-wave generator to the INPUT 1 connector through the five-nanosecond GR cable and the 50-ohm in-line termination.

c. Set the constant-amplitude generator for six divisions of deflection at 50 kilohertz.

d. Without changing the output amplitude, increase the output frequency of the constant-amplitude generator until the display is reduced to 4.2 divisions (-3 dB point; see Fig. 5-8).

e. CHECK—Output frequency of the constant-amplitude generator must be 15 megahertz or higher.

Performance Check—Type 422/R422 (SN 100-19,999)

- f. Set the Mode switch to CH 2.
- g. Connect the constant-amplitude generator to the INPUT 2 connector through the five-nanosecond GR cable and the 50-ohm in-line termination.
- h. Set the constant-amplitude generator for six divisions of deflection at 50 kilohertz.
- i. Without changing the output amplitude, increase the output frequency of the constant-amplitude generator until the display is reduced to 4.2 divisions (-3 dB point; see Fig. 5-8).
- j. CHECK—Output frequency of the constant-amplitude generator must be 15 megahertz or higher.

18. Check Channel 2 $\times 10$ Gain Frequency Response

REQUIREMENT—Not more than -3 dB at five megahertz.

- a. Set the Channel 2 AC GND DC switch to AC.
- b. Pull the X10 GAIN AC switch.
- c. Set the constant-amplitude generator for six divisions of deflection at 50 kilohertz.

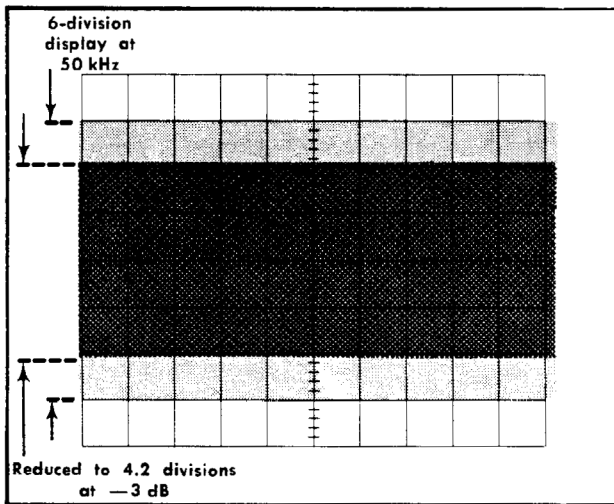

Fig. 5-8. Typical CRT display when checking vertical frequency response.

- d. Without changing the output amplitude, increase the output frequency of the constant-amplitude generator until the display is reduced to 4.2 divisions (-3 dB point; see Fig. 5-8).
- e. CHECK—Output frequency of the constant-amplitude generator must be five megahertz or higher.

19. Check Common-Mode Rejection Ratio

REQUIREMENT—At least 100:1 at 50 kilohertz.

- a. Connect the constant-amplitude generator to the INPUT 1 connector through the five-nanosecond GR cable, 50-ohm in-line termination and the BNC T connector. Connect the output of the BNC T connector to INPUT 2 with 50-ohm BNC cable.
- b. Set the constant-amplitude generator for eight divisions of deflection at 50 kilohertz.
- c. Change the following control settings:

Mode	ALG ADD
INVERT	Pulled out
$\times 10$ GAIN AC	Pushed in
- d. CHECK—CRT display 0.1 division or less (100:1 or greater; see Fig. 5-9).
- e. Disconnect all test equipment.

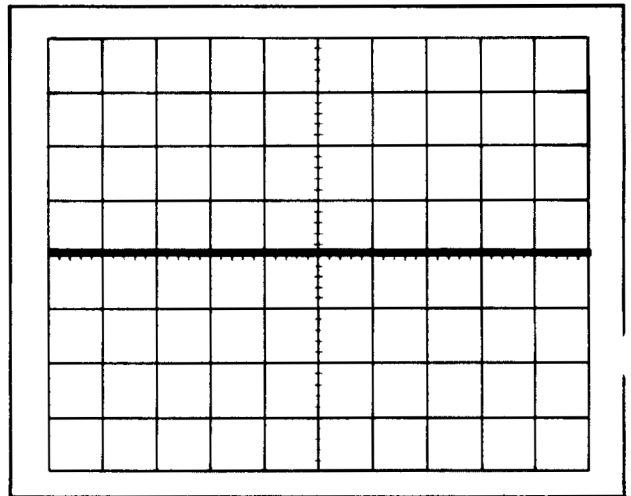

Fig. 5-9. Typical CRT display showing correct common-mode rejection ratio.

20. Check Channel Isolation Ratio

REQUIREMENT—100,000:1 or greater at one kilohertz.

- a. Change the following control settings:

VOLTS/DIV	.01
(both channels)	
Mode	CH 2
INVERT	Pushed in
- b. Connect the standard amplitude calibrator to the INPUT 1 connector with the BNC cable.
- c. Set the Channel 1 VOLTS/DIV switch to 20.
- d. Set the Channel 2 AC GND DC switch to GND.
- e. Set the standard amplitude calibrator for 100-volt square-wave output.
- f. CHECK—CRT display 0.1 division or less in amplitude (channel isolation ratio 100,000:1 or greater; see Fig. 5-10).
- g. Change the following control settings:

Channel 1 VOLTS/DIV	.01
Channel 2 VOLTS/DIV	20
Channel 1 AC GND DC	GND
Channel 2 AC GND DC	DC
Mode	CH 1

- h. Connect the standard amplitude calibrator to the INPUT 2 connector with the BNC cable.
- i. CHECK—CRT display 0.1 division or less in amplitude (channel isolation ratio 100,000:1 or greater; see Fig. 5-10).

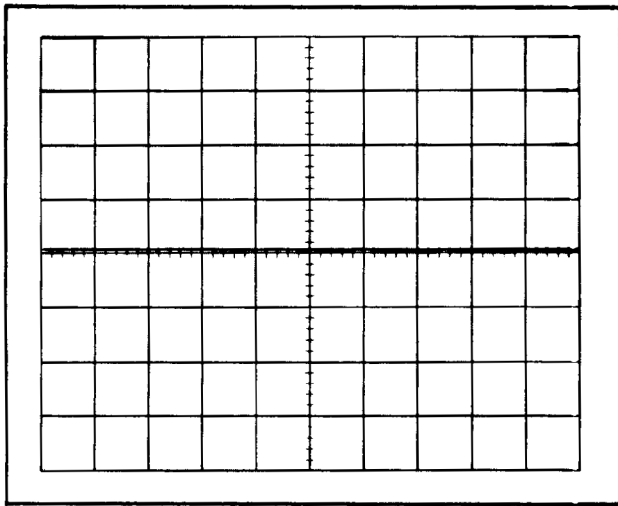

Fig. 5-10. Typical CRT display showing correct channel isolation ratio.

21. Check Internal Calibrator Amplitude

REQUIREMENT—Four divisions of deflection in CALIBRATE 4 DIVISIONS position of VOLTS/DIV switch.

- a. Change the following control settings:

VOLTS/DIV	CALIBRATE 4 DIVISIONS
LEVEL	Adjust for stable display.
- b. CHECK—CRT display for four divisions of deflection.

NOTE

Internal accuracy of Calibrator given in the Characteristics section can only be checked by the procedure given in the Calibration Procedure; see Section 6.

- c. Set the Mode switch to CH 2.
- d. CHECK—CRT display for four divisions of deflection.

22. Check Calibrator Amplitude at Front-Panel Jack

REQUIREMENT—Two volts, $\pm 2.7\%$.

- a. Connect the CALIBRATOR jack to the unknown input of the standard amplitude calibrator with a jumper lead. The 1X probe can be used for this purpose.

- b. Set the standard amplitude calibrator for a —DC output in the mixed mode.

- c. Connect the standard amplitude calibrator output to the input of the test oscilloscope.

- d. Set the test oscilloscope for a vertical deflection of 0.2 volt/division, DC coupled at a sweep rate of five milliseconds/division.

- e. Set the standard amplitude calibrator output voltage to off and position the top of the display on the screen. Set the triggering controls for a stable display.

- f. Note the difference between the standard amplitude calibrator output (zero-volt level) and the Type 422 CALIBRATOR output level (see Fig. 5-11).

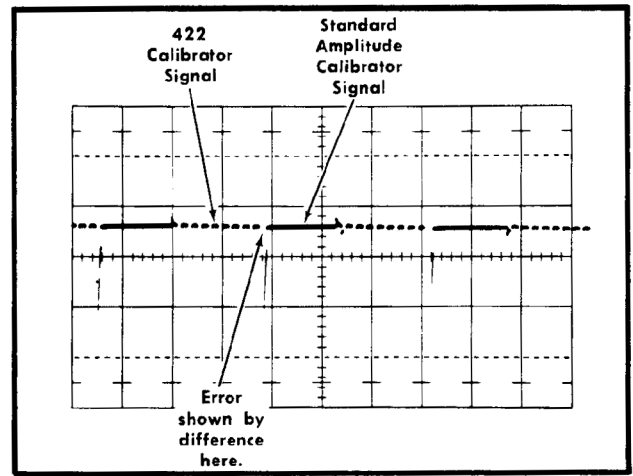

Fig. 5-11. Typical Test oscilloscope display when checking Calibrator amplitude at front-panel jack. Vertical deflection, 0.2 volt/division; sweep rate, five milliseconds/division.

- g. Set the standard amplitude calibrator output voltage to two volts and position the bottom of the display on the screen. Reset the triggering controls for a stable display.

- h. CHECK—Difference between the standard amplitude calibrator output and the Type 422 CALIBRATOR output levels within ± 0.27 division of the difference measured in step f ($\pm 2.7\%$).

- i. Disconnect the standard amplitude calibrator.

23. Check Calibrator Repetition Rate and Duty Cycle

REQUIREMENT—Repetition rate, one kilohertz, $\pm 20\%$; duty cycle, 45% to 55%.

- a. Connect the CALIBRATOR jack to the input of the test oscilloscope with a jumper lead. The 1X probe can be used for this purpose.

- b. Set the test oscilloscope for a vertical deflection of 0.5 volt/division and a sweep rate of 0.2 millisecond/division.

- c. CHECK—Test oscilloscope display for duration of one complete cycle between 4.15 and 6.25 divisions (one kilohertz, $\pm 20\%$; see Fig. 5-12A).

Performance Check—Type 422/R422 (SN 100-19,999)

- d. Set the test oscilloscope sweep rate to 50 microseconds/division and set the VARIABLE TIME/DIV control for one complete cycle in ten divisions.
- e. CHECK—Test oscilloscope display for length of the positive segment of the square wave between 4.5 and 5.5 divisions (45% to 55%; see Fig. 5-12B).
- f. Disconnect all test equipment.

24. Check Internal Trigger Sensitivity

REQUIREMENT—Stable display in AC, AC LF REJ and DC positions of Triggering Coupling switch with 0.2-division deflection at five megahertz and one-division deflection at 15 megahertz; stable display in AUTO position of LEVEL control with 0.8-division deflection at four megahertz and 2.5 divisions deflection at 15 megahertz.

- a. Change the following control settings:

VOLTS/DIV	0.2
Mode	CH 1
SLOPE	Positive going
LEVEL	Midrange
TIME/DIV	.5 μ SEC

- b. Connect the constant-amplitude sine-wave generator to the INPUT 1 connector through the five-nanosecond GR cable, 50-ohm in-line termination and the BNC T connector. Connect the output of the BNC T connector to the TRIG IN connector through a 50-ohm BNC cable.
- c. Set the constant-amplitude generator for a 0.2 division CRT display at five megahertz.
- d. CHECK—Stable CRT display can be obtained with the Triggering Coupling switch set to AC, AC LF REJ and DC. Adjust the LEVEL control as necessary to obtain a stable display.

- e. Set the constant-amplitude generator for a one division CRT display at 15 megahertz.
- f. Pull the $\times 10$ MAG switch.
- g. CHECK—Stable CRT display can be obtained with the Triggering Coupling switch set to AC, AC LF REJ and DC. Adjust the LEVEL control as necessary to obtain a stable display.
- h. Set the LEVEL control to the AUTO position.
- i. Push in the $\times 10$ MAG switch.
- j. Set the constant-amplitude generator for a 0.8 division CRT display at four megahertz.
- k. CHECK—CRT display is stable.
- l. Set the constant-amplitude generator for a 2.5 division CRT display at 15 megahertz.
- m. Pull the $\times 10$ MAG switch.
- n. CHECK—CRT display is stable.
- o. Set the Triggering Source switch to CH 1 and repeat steps c through n.

25. Check External Trigger Sensitivity

REQUIREMENT—Stable display in AC, AC LF REJ and DC positions of Triggering Coupling switch with 0.125-volt input signal at five megahertz and 0.6-volt input signal at 15 megahertz; stable display in AUTO position of LEVEL control with 0.6-volt input signal at seven megahertz and 1.2-volt input signal at 15 megahertz.

- a. Set the Triggering Source switch to EXT.
- b. Push in the $\times 10$ MAG switch.
- c. Set the constant-amplitude generator for a three division CRT display at 50 kilohertz.

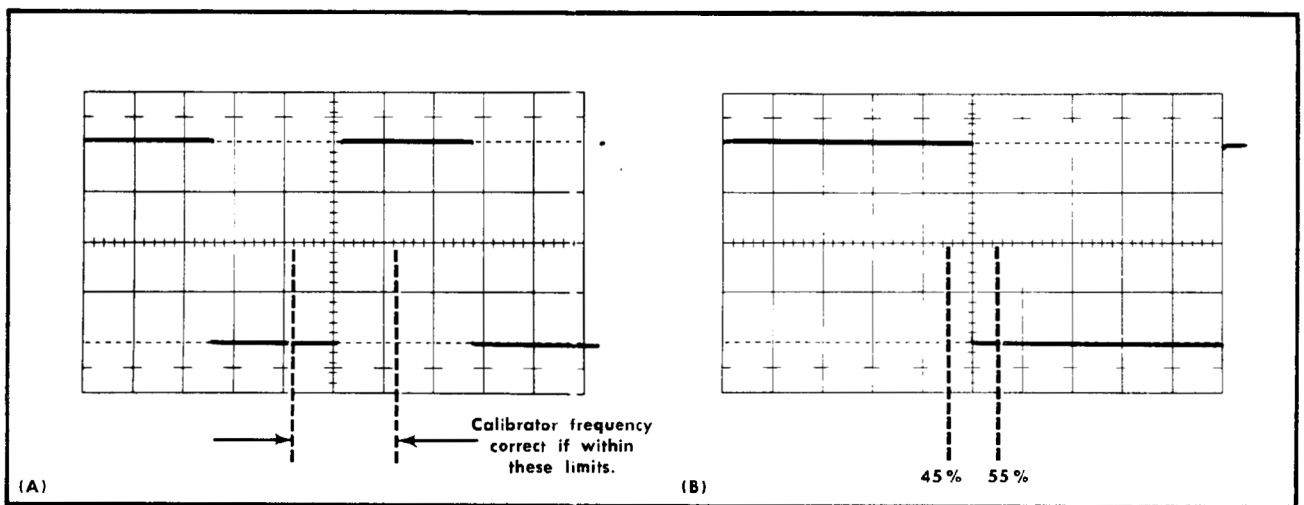

Fig. 5-12. Typical test oscilloscope display when checking (A) Calibrator repetition rate, (B) Duty cycle. Vertical deflection, 0.5 volt/division; sweep rate, 0.2 millisecond/division.

- d. Set the constant-amplitude generator output frequency to seven megahertz.
- e. Set the TIME/DIV switch to .5 μ SEC.
- f. CHECK—CRT display is stable.
- g. Set the constant-amplitude generator for a six division CRT display (1.2 volts) at 50 kilohertz.
- h. Without changing the output amplitude, set the constant-amplitude generator output frequency to 15 megahertz.
- i. Pull the $\times 10$ MAG switch.
- j. CHECK—CRT display is stable.
- k. Set the Channel 1 VOLTS/DIV switch to .05.
- l. Push in the $\times 10$ MAG switch.
- m. Set the constant-amplitude generator for a 2.5 division CRT display (0.125 volt) at 50 kilohertz.
- n. Without changing the output amplitude, set the constant-amplitude generator output frequency to five megahertz.
- o. CHECK—Stable CRT display can be obtained with the Triggering Coupling switch set to AC, AC LF REJ and DC. Adjust the LEVEL control as necessary to obtain a stable display.
- p. Set the Channel 1 VOLTS/DIV switch to .1.
- q. Set the constant-amplitude generator for a six division CRT display (0.6 volt) at 50 kilohertz.
- r. Without changing the output amplitude, set the constant-amplitude generator output frequency to 15 megahertz.
- s. Pull the $\times 10$ MAG switch.
- t. CHECK—Stable CRT display can be obtained with the Triggering Coupling switch set to AC, AC LF REJ and DC. Adjust the LEVEL control as necessary to obtain a stable display.
- u. Disconnect all test equipment.

26. Check Low-Frequency Triggering and Low-Frequency Reject Operation

REQUIREMENT—Internal, stable display in AC and DC positions of Triggering Coupling switch with 0.2-division deflection at 50 hertz; stable display in AUTO position of LEVEL control with 0.8-division deflection at 50 hertz; does not trigger in AC LF REJ position of Triggering Coupling switch. External, stable display in AC and DC positions of Triggering Coupling switch with 0.125-volt input signal at 50 hertz; stable display in AUTO position of LEVEL control with 0.6-volt input signal at 50 hertz; does not trigger in AC LF REJ position of Triggering Coupling switch.

- a. Change the following control settings:

VOLTS/DIV	.05
Coupling	AC
TIME/DIV	5 mSEC
$\times 10$ MAG	Pushed in
- b. Connect the low-frequency sine-wave generator to both the INPUT 1 connector and the TRIG IN connector through

- a BNC T connector and two BNC cables (use the BNC to alligator clip adapter to connect the generator output to the BNC cable).
- c. Set the low-frequency sine-wave generator for a 2.5-division display (0.125 volt) at 50 hertz.
- d. CHECK—Stable CRT display can be obtained with the Triggering Coupling switch set to AC and DC. Adjust the LEVEL control as necessary to obtain a stable display.
- e. Set the Triggering Coupling switch to AC LF REJ.
- f. CHECK—Stable CRT display cannot be obtained at any setting of the LEVEL control.
- g. Set the LEVEL control to AUTO.
- h. Set the VOLTS/DIV switch to .1.
- i. Set the low-frequency sine-wave generator for a six-division display (0.6 volt) at 50 hertz.
- j. CHECK—CRT display is not stable.
- k. CHECK—CRT display is stable in the AC and DC positions of the Triggering Coupling switch.
- l. Set the Triggering Source switch to CH 1 & 2.
- m. Set the low-frequency sine-wave generator for a 0.8-division display at 50 hertz.
- n. CHECK—CRT display is stable in the AC and DC positions of the Triggering Coupling switch.
- o. Set the Triggering Coupling switch to AC LF REJ.
- p. CHECK—CRT display is not stable.
- q. Set the low-frequency sine-wave generator for a 0.2-division display at 50 hertz (AC position of Triggering Coupling switch must be used to set display amplitude; return switch to AC LF REJ position).
- r. CHECK—Stable CRT display cannot be obtained at any setting of the LEVEL control.
- s. CHECK—Stable CRT display can be obtained with the Triggering Coupling switch set to AC and DC. Adjust the LEVEL control as necessary to obtain a stable display.

27. Check Slope Switch Operation

REQUIREMENT—Display starts on correct slope of triggering signal.

- a. Set the low-frequency sine-wave generator for a four-division display.
- b. CHECK—CRT display starts on the positive-going slope of the waveform (see Fig. 5-13A).
- c. Set the SLOPE switch to the negative-going position.
- d. CHECK—CRT display starts on the negative-going slope of the waveform (see Fig. 5-13B).
- e. Disconnect all test equipment.

28. Check Timing Accuracy

REQUIREMENT—Within $\pm 3\%$ of TIME/DIV switch setting.

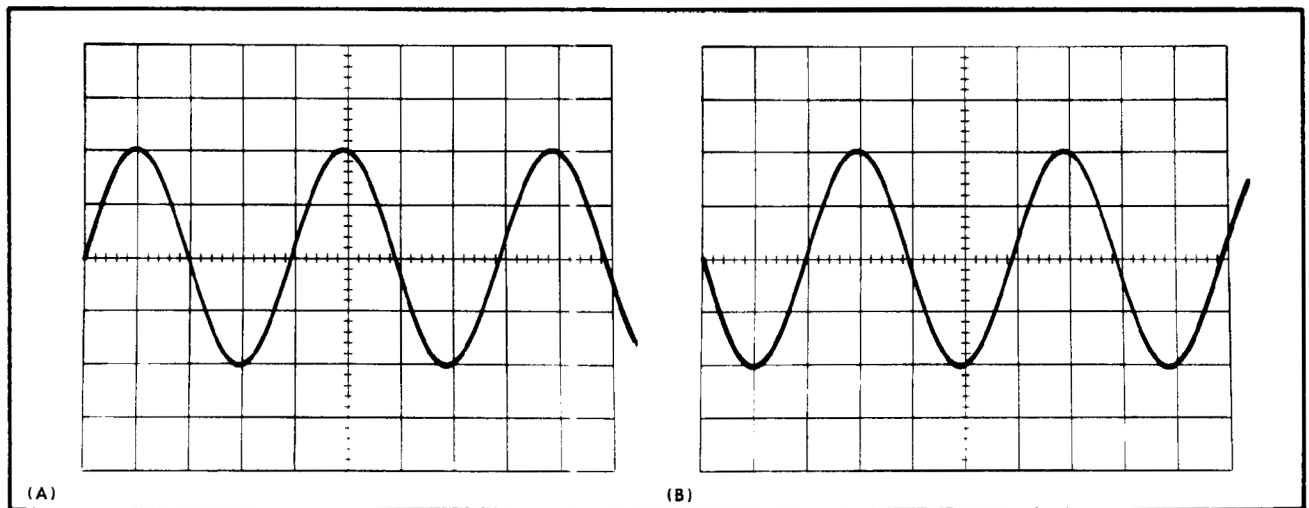

Fig. 5-13. Typical CRT display showing correct operation of SLOPE switch. (A) SLOPE switch set for positive-going triggering, (B) SLOPE switch set for negative-going triggering.

TABLE 5-3
TIME/DIV Accuracy

TIME/DIV Switch Setting	Time-Mark Generator Output	CRT Display (Markers/Division)
.5 μ SEC	0.5 microsecond	1
1 μ SEC	1 microsecond	1
2 μ SEC	1 microsecond	2
5 μ SEC	5 microsecond	1
10 μ SEC	10 microsecond	1
20 μ SEC	10 microsecond	2
50 μ SEC	50 microsecond	1
.1 mSEC	0.1 millisecond	1
.2 mSEC	0.1 millisecond	2
.5 mSEC	0.5 millisecond	1
1 mSEC	1 millisecond	1
2 mSEC	1 millisecond	2
5 mSEC	5 millisecond	1
10 mSEC	10 millisecond	1
20 mSEC	10 millisecond	2
50 mSEC	50 millisecond	1
.1 SEC	0.1 second	1
.2 SEC	0.1 second	2
.5 SEC	0.5 second	1

- a. Change the following control settings:

VOLTS/DIV	.2
Coupling	AC
SLOPE	Positive going
- b. Connect the time-mark generator to the INPUT 1 connector through a 50-ohm BNC cable and a 50-ohm termination.
- c. Set the LEVEL control for a stable display.

- d. CHECK—Using the TIME/DIV switch and time-mark generator settings given in Table 5-3, check sweep timing within ± 0.24 division over the middle eight divisions of the display ($\pm 3\%$).

CAUTION

To prevent permanent damage to the CRT phosphor at slow sweep rates, position the baseline of the marker display below the viewing area.

29. Check Sweep Length

REQUIREMENT—10.4 to 12.1 divisions.

- a. Set the time-mark generator for output markers of one millisecond and 0.1 millisecond.
- b. Set the TIME/DIV switch to 1 mSEC.
- c. Position the tenth marker to the center vertical line with the Horizontal POSITION control (see Fig. 5-14).
- d. CHECK—sweep length between 10.4 and 12.1 divisions, as shown by 0.4 to 2.1 divisions of display to the right of the vertical center line (see Fig. 5-14). Large markers in the display indicate divisions and small markers 0.1 division.

30. Check Normal/Magnified Registration

REQUIREMENT—Less than 0.2-division shift when switching $\times 10$ MAG switch from on (pulled out) to off.

- a. Pull the $\times 10$ MAG switch out.
- b. Position the first marker to the center vertical line with the Horizontal POSITION control. Use the fine range of the POSITION control for precise positioning (see Operating Instructions section for operation).
- c. Push the $\times 10$ MAG switch in.
- d. CHECK—First marker within 0.2 division of the center vertical line.

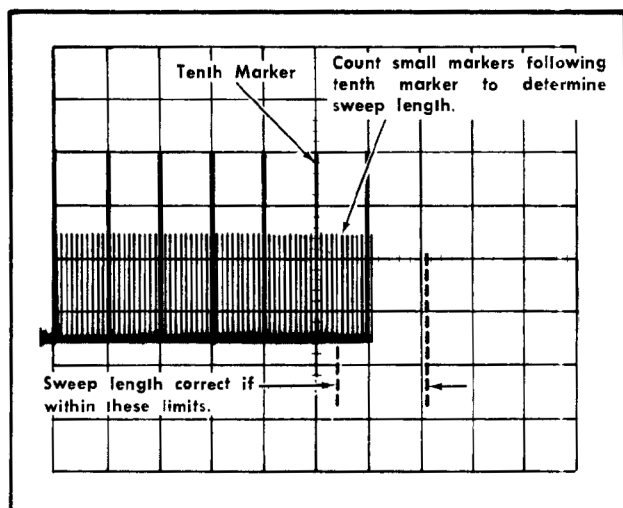

Fig. 5-14. Typical CRT display when checking sweep length.

31. Check Magnifier Timing and Linearity

REQUIREMENT—Timing, within $\pm 5\%$ of magnified sweep rate; linearity, within $\pm 1\%$ for any eight division portion of magnified sweep length (except in $0.5 \mu\text{SEC}$ position).

- Pull the $\times 10$ MAG switch out.
- Position the first large marker to the left graticule line.
- CHECK—CRT display for one small marker each division between the first and ninth graticule line (see Fig. 5-15). With the second marker positioned to the first graticule line, the tenth marker must be within 0.4 division of the ninth graticule line (timing within $\pm 5\%$).
- CHECK—Each marker in CRT display must be within 0.08 division of its respective graticule line (1% linearity; see Fig. 5-15).

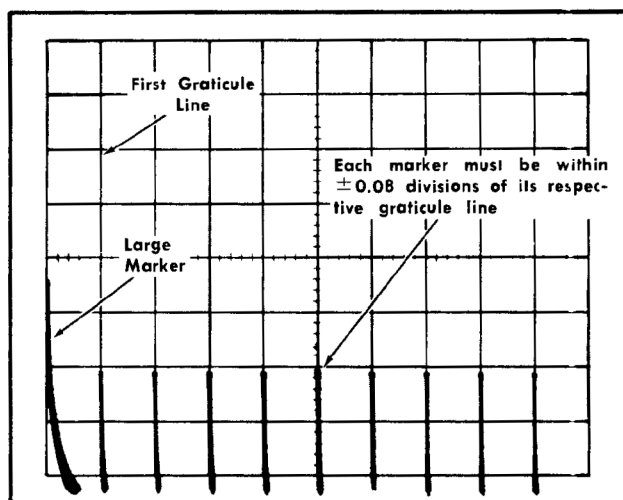

Fig. 5-15. Typical CRT display when checking magnifier timing and linearity.

- Repeat check for each eight division portion of the magnified sweep.

32. Check Variable Time/Division Control Range

REQUIREMENT—At least 2.5:1 reduction in sweep rate.

- Push the $\times 10$ MAG switch in.
- Set the time-mark generator for 10-millisecond markers.
- Position the two markers on the display to the left and right graticule lines with the Horizontal POSITION control.
- Turn the VARIABLE TIME/DIV control fully counterclockwise.
- CHECK—CRT display for four-division maximum spacing between markers (2.5:1 range; see Fig. 5-16). UNCAL light must be on when VARIABLE TIME/DIV control is not in CAL position.

33. Check Chopped Operation

REQUIREMENT—Chopped repetition rate, 100 kilohertz, $\pm 20\%$. Switching transients blanked.

- Change the following control settings:

Mode	CHOPPED
LEVEL	AUTO
TIME/DIV	$2 \mu\text{SEC}$
VARIABLE	CAL

- Position the traces about four divisions apart with the Vertical POSITION controls.
- CHECK—CRT display for duration of each cycle between 4.2 and 6.2 divisions (100 kilohertz, $\pm 20\%$; see Fig. 5-17).

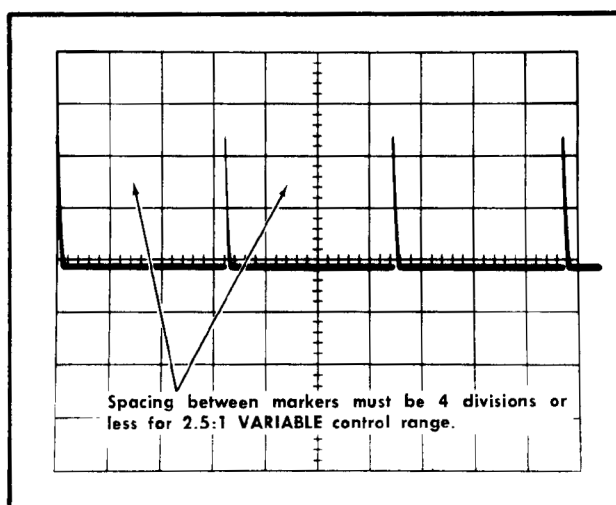

Fig. 5-16. Typical CRT display showing adequate VARIABLE TIME/DIV control range.

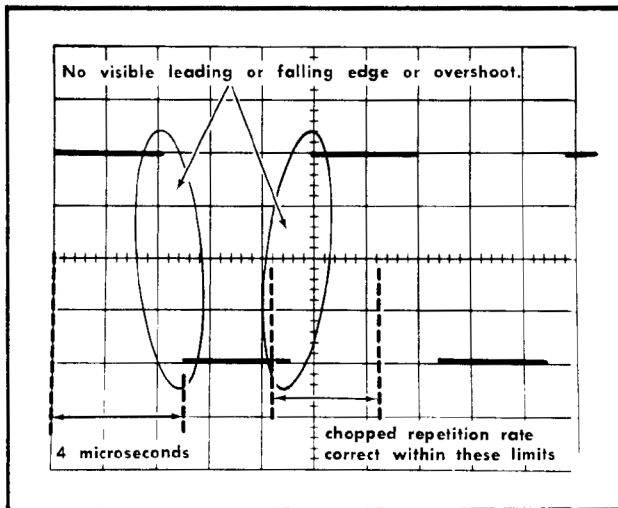

Fig. 5-17. Typical CRT display when checking chopped operation.

d. CHECK—CRT display for complete blanking of switching transients between chopped segments (see Fig. 5-17).

34. Check External Horizontal Deflection Factor and Horizontal Attenuator Control Range

REQUIREMENT—Deflection factor: $\times 10$ MAG switch pushed in, 10 volts/division, $\pm 25\%$; $\times 10$ MAG switch pulled out, one volt/division, $\pm 25\%$. Attenuator control range, 10:1 or greater.

a. Change the following control settings:

Made	CH 1
HORIZ ATTEN (LEVEL)	Clockwise
TIME/DIV	EXT HORIZ

b. Connect the standard amplitude calibrator to the HORIZ IN (TRIG IN) connector with the BNC cable.

c. Set the standard amplitude calibrator for a 50-volt square-wave output.

CAUTION

To prevent permanent damage to the CRT phosphor, reduce the INTENSITY control setting if a halo forms around the dots.

d. CHECK—CRT display for horizontal deflection between 3.75 and 6.25 divisions (10 volts/division, $\pm 25\%$; see Fig. 5-18).

e. Pull the $\times 10$ MAG switch out.

f. Set the standard amplitude calibrator for a five-volt square-wave output.

g. Reposition the display to the center of the CRT.

h. CHECK—CRT display for horizontal deflection between 3.75 and 6.25 divisions (one volt/division, $\pm 25\%$).

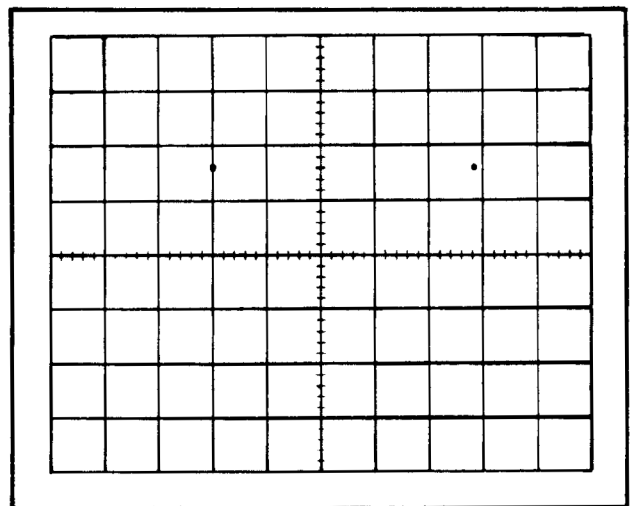

Fig. 5-18. Typical CRT display when checking external horizontal operation.

i. Set the standard amplitude calibrator for a 50-volt square-wave output.

j. Set the HORIZ ATTEN control fully counterclockwise.

k. CHECK—CRT display for horizontal deflection equal to or less than obtained in step h (10:1 or greater range).

35. Check External Horizontal Frequency Response

REQUIREMENT—Not more than -3 dB at 500 kilohertz.

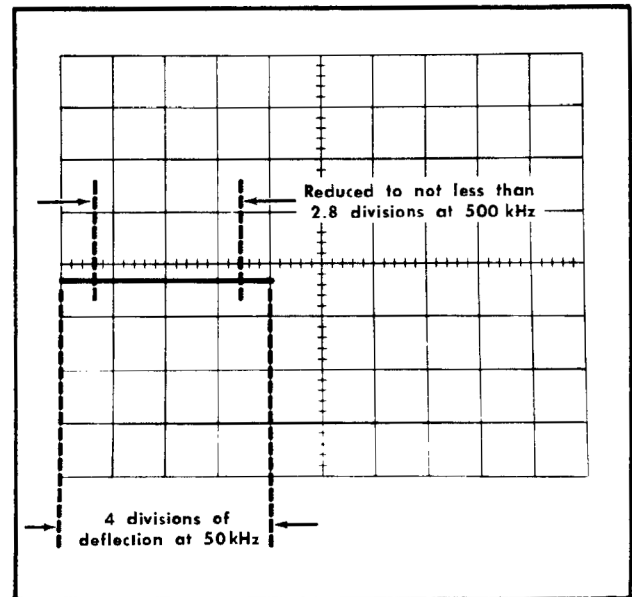

Fig. 5-19. Typical CRT display when checking external horizontal frequency response.

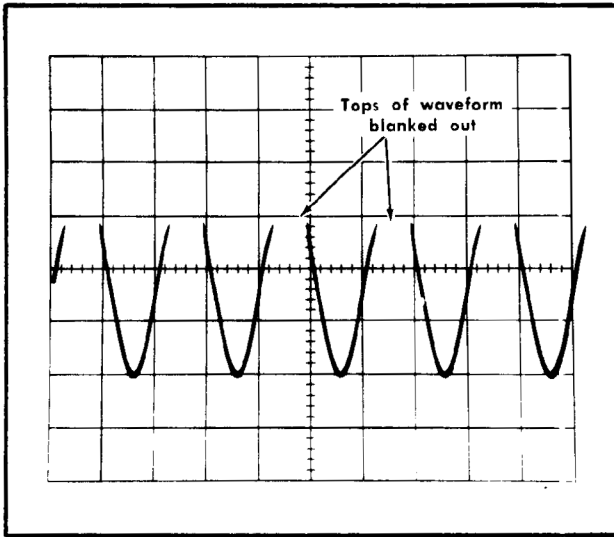

Fig. 5-20. Typical CRT display showing correct external blanking.

- a. Turn the HORIZ ATTEN (LEVEL) control fully clockwise.
- b. Connect the constant-amplitude sine-wave generator to the HORIZ IN (TRIG IN) connector through the five-nanosecond GR cable and the 50-ohm in-line termination.
- c. Set the constant-amplitude generator for four divisions of horizontal deflection at 50 kilohertz.
- d. Without changing the output amplitude, increase the output frequency of the constant-amplitude generator until the display is reduced to 2.8 divisions (−3 dB point; see Fig. 5-19).
- e. CHECK—Output frequency of the constant-amplitude generator must be 500 kilohertz or higher.

36. Check External Blanking

REQUIREMENT—Two-volt positive signal blanks trace.

a. Connect the constant-amplitude sine-wave generator to the INPUT 1 connector through the five-nanosecond GR cable, 50-ohm in-line termination and the BNC T connector. Connect the output of the BNC T connector to the EXT BLANKING connector through a 50-ohm BNC cable.

b. Change the following control settings:

VOLTS/DIV	1
LEVEL	AUTO
TIME/DIV	10 μSEC
×10 MAG	Pushed in

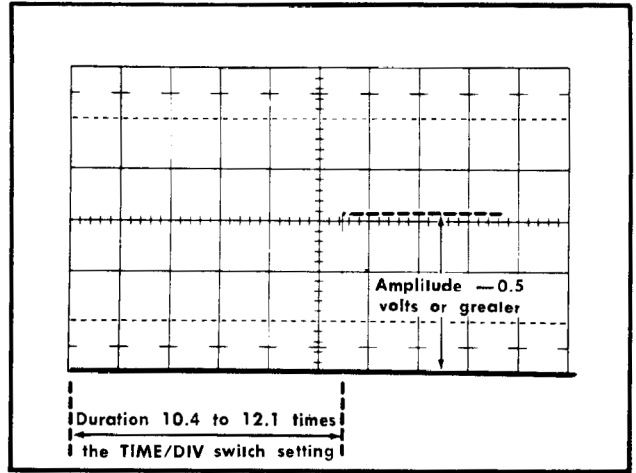

Fig. 5-21. Typical test oscilloscope display when checking the gate output signal. Vertical deflection, 0.2 volts/division; sweep rate, 2 milliseconds/division.

- c. Set the constant-amplitude generator for a four-division display.
- d. CHECK—The positive peaks of the displayed signal should be blanked with a normal INTENSITY control setting (see Fig. 5-20).
- e. Disconnect all test equipment.

37. Check Gate Output Signal

REQUIREMENT—Amplitude, −0.5 volt or greater negative-going rectangular pulse; duration, 10.4 to 12.1 times the TIME/DIV switch setting.

a. Change the following control settings:

LEVEL	FREE RUN
TIME/DIV	1 mSEC

b. Connect the GATE OUT connector to the input of the test oscilloscope with the BNC cable.

c. Set the test oscilloscope for a vertical deflection of 0.2 volts/division and a sweep rate of 2 milliseconds/division.

d. CHECK—Test oscilloscope display for 2.5 divisions or greater amplitude with the top of the waveform at the zero volt level. Gate duration should be 5.2 to 6.05 divisions (−0.5 volt or greater amplitude with duration of 10.4 to 12.1 times the TIME/DIV switch setting; see Fig. 5-21).

e. Disconnect all test equipment.

This completes the performance check procedure for the Type 422. If the instrument has met all performance requirements given in this procedure it is correctly calibrated and within the specified tolerances.

SECTION 6

CALIBRATION

Introduction

Complete calibration information for the Type 422 is given in this section. This procedure calibrates the instrument to the performance requirements listed in the Characteristics section. The Type 422 can be returned to original performance standards by completion of each step in this procedure. If it is desired to merely touch up the calibration, perform only those steps entitled "Adjust . . .". A short-form calibration procedure is also provided in this section for the convenience of the experienced calibrator.

The Type 422 should be checked, and recalibrated if necessary, after each 1000 hours of operation, or every six months if used infrequently, to assure correct operation and accuracy. The Performance Check section of this manual provides a complete check of instrument performance without making internal adjustments. Use the performance check procedure to verify the calibration of the Type 422 and determine if recalibration is required.

Test Equipment Required

General

The following test equipment, or its equivalent, is required for complete calibration of the Type 422 (see Fig. 6-1). Specifications given are the minimum necessary for accurate calibration of this instrument. All test equipment is assumed to be correctly calibrated and operating within the given specifications. If equipment is substituted, it must meet or exceed the specifications of the recommended equipment.

For the quickest and most accurate calibration, special calibration fixtures are used where necessary. All calibration fixtures listed here can be obtained from Tektronix, Inc. Order by part number through your local Tektronix Field Office or representative.

1. DC voltmeter. Minimum sensitivity, 20,000 ohms/volt; range, 0 to 1500 volts; accuracy, checked to within 1% at -81 volts and within $\pm 3\%$ at -1400 volts. For example, Simpson Model 262.

2. Test oscilloscope. Bandwidth, DC to 15 megahertz; minimum deflection factor, one millivolt/division. Tektronix Type 422 Oscilloscope recommended (use $\times 10$ Gain feature for one millivolt minimum deflection factor).

3. $1\times$ probe with BNC connector. Tektronix P602B Probe recommended.

4. $10\times$ probe with BNC connector. Tektronix P6006 Probe recommended.

5. Variable autotransformer. Must be capable of supplying at least 75 volt amperes over a range of 103.5 to 126.5 volts (207 to 253 volts for 230-volt nominal line). (If autotransformer does not have an AC voltmeter to indicate output voltage, monitor output with an AC voltmeter with range of at least 126.5 or 253 volts, RMS). For example, General Radio W10MT3W Metered Variac Autotransformer (note that the full current capabilities of this unit are not required).

6. Standard amplitude calibrator. Amplitude accuracy, within 0.25%; signal amplitude, 50 millivolts to 100 volts; output signal, one-kilohertz square wave and negative DC voltage. Tektronix calibration fixture 067-0502-00 recommended.

7. Square-wave generator. Frequency, 1, 10 and 100 kilohertz; risetime, one nanosecond or less from fast-rise output; output amplitude, about 120 volts unterminated or 12 volts into 50 ohms. Tektronix Type 106 Square-Wave Generator recommended.

8. Constant amplitude sine-wave generator. Frequency, 50 kilohertz and 350 kilohertz to 15 megahertz; output amplitude, variable from five millivolts to five volts; amplitude accuracy $\pm 3\%$ from 50 kilohertz to 15 megahertz. Tektronix Type 191 Constant Amplitude Signal Generator recommended.

9. Time-mark generator. Marker outputs, 0.5 second to 50 nanoseconds; marker accuracy, within 0.1%. Tektronix Type 1B4 Time-Mark Generator recommended.

10. Low-frequency sine-wave generator. Frequency, 50 hertz; output amplitude, 10 millivolts to 0.6 volt. For example, Heathkit IG-72 Audio Generator.

11. $10\times$ attenuator (two). Impedance, 50 ohms; accuracy, $\pm 3\%$; connectors, GR. Tektronix Part No. 017-0078-00.

12. Cable (two). Impedance, 50 ohms; Type RG-58A/U; length 42 inches; connectors, BNC. Tektronix Part No. 012-0057-00.

13. BNC T connector. Tektronix Part No. 103-0030-00.

14. Cable. Impedance, 50 ohms; Type RG-BA/U; length five nanoseconds; connectors, GR874. Tektronix Part No. 017-0502-00.

15. In-line termination. Impedance, 50 ohms; accuracy, $\pm 3\%$; connectors, GR input with BNC male output. Tektronix Part No. 017-0083-00.

16. Capacitor. Capacitance, five microfarads; minimum VDC, 10 volts. Tektronix Part No. 290-0026-00.

17. Adapter. Connectors, BNC female and two alligator clips. Tektronix Part No. 013-0076-00.

18. Checked Type 422 power supply (not shown).

19. Adjustment tools (see Fig. 6-2).

Description	Tektronix Part No.
a. Insulated screwdriver, $1\frac{1}{2}$ inch shaft, non-metallic	003-0000-00
b. Screwdriver, 3-inch shaft	003-0192-00
c. Tuning tool Handle Insert, for $\frac{5}{64}$ inch (ID) hex cores	003-0307-00

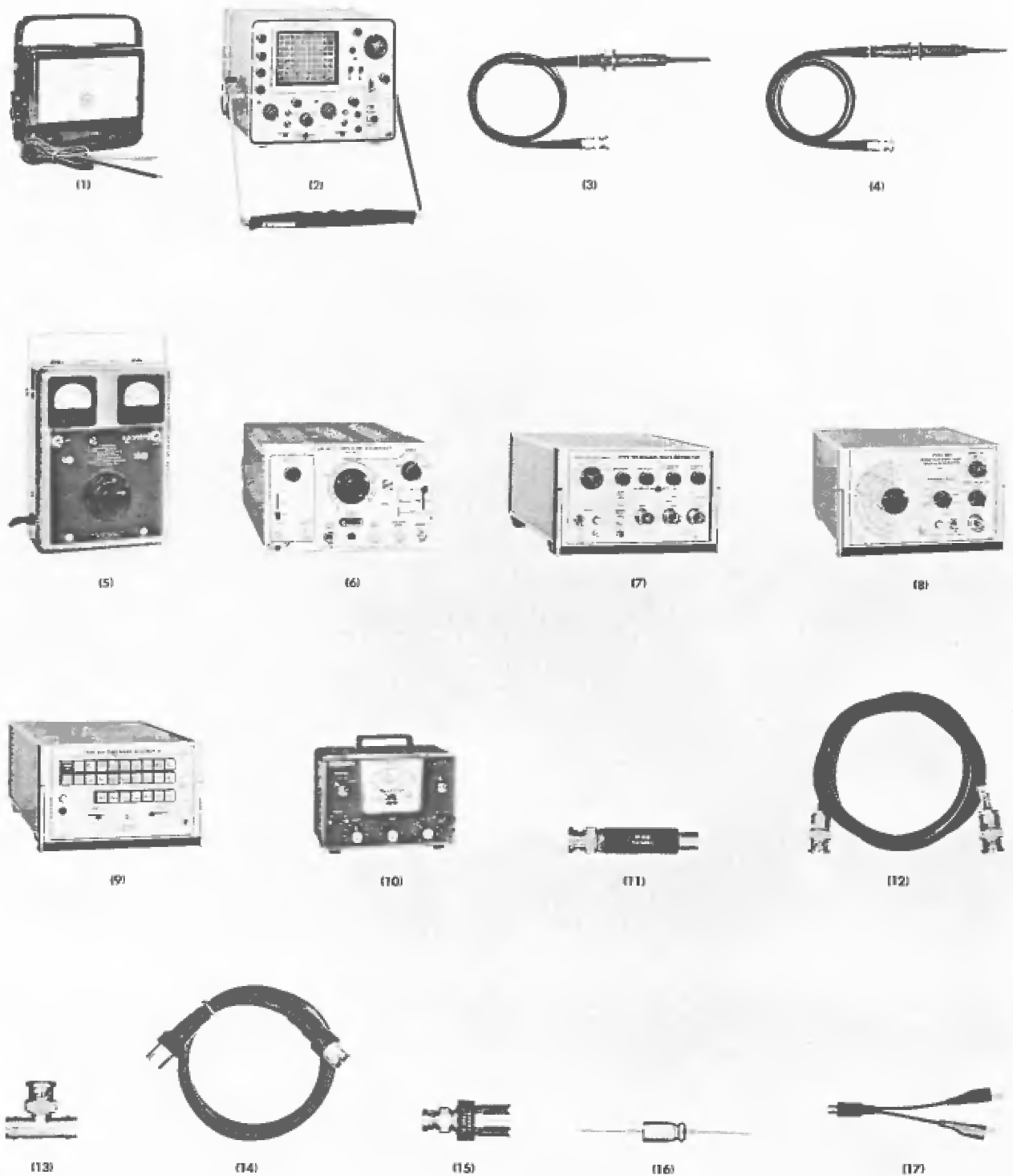

Fig. 6-1. Recommended calibration test equipment.

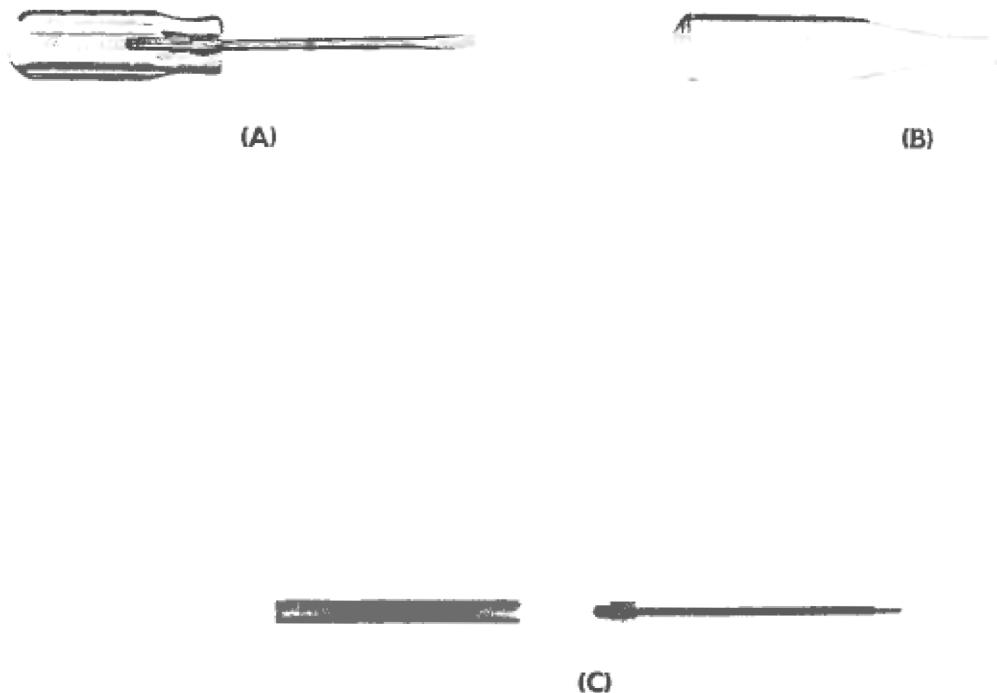

Fig. 6-2. Adjustment tools.

CALIBRATION PROCEDURE

General

The following procedure is arranged in a sequence which allows the Type 422 to be calibrated with the least interaction of adjustments and reconnection of equipment. However, some adjustments affect the calibration of other circuits within the instrument. In this case, it will be necessary to check the operation of other parts of the instrument. When a step interacts with others, the steps which need to be checked are noted under "INTERACTION . . ."

Any needed maintenance should be performed before proceeding with calibration. Troubles which become apparent during calibration should be corrected using the techniques given in the Maintenance section.

The steps titled "Adjust . . . ①" in the following procedure provide a check of instrument performance, whenever possible, before the adjustment is made. The symbol ① is used to identify the steps in which an adjustment is made. To prevent recalibration of other circuits when performing a partial calibration, readjust only if the listed tolerance is not met. However, when performing a complete calibration, best overall performance will be provided if each adjustment is made to the exact setting, even if the "CHECK— . . ." is within the allowable tolerance.

In the following procedure, a test equipment setup picture is shown for each major group of adjustments and checks.

Beneath each setup picture is a complete list of front-panel control settings for the Type 422. To aid in locating individual controls which have been changed during complete calibration, these control names are printed in bold type. If only a partial calibration is performed, start with the nearest setup preceding the desired portion. Type 422 front-panel control titles referred to in this procedure are capitalized (e.g., VOLTS/DIV). Internal adjustment titles are initial-capitalized only (e.g., Unblanking Center).

The following procedure uses the equipment listed under Equipment Required. If equipment is substituted, control settings or test equipment setup may need to be altered to meet the requirements of the equipment used.

NOTE

All waveforms shown in this procedure are actual waveform photographs taken with a Tektronix Oscilloscope Camera System.

CALIBRATION RECORD AND INDEX

This short-form calibration procedure is provided to aid in checking the operation of the Type 422. It may be used as a calibration guide by the experienced calibrator, or it may be used as a record of calibration. Since the step numbers and titles used here correspond to those used in the complete procedure, this procedure also serves as an index to locate a step in the complete Calibration Procedure. Performance

Calibration—Type 422/R422 (SN 100-19,999)

requirements correspond to those given in the Characteristics section.

Type 422, Serial No. _____

Calibration Date _____

Calibration Technician _____

- 1. Check—81-Volt and +20-Volt Power Supplies. Page 6-6
 -81 volts, +2 volts, -1 volt.
 +20 volts, ± 1.4 volts.
- 2. Check High-Voltage Supply. Page 6-7
 -1385 volts, ± 69.5 volts.
- 3. Check—81-Volt and +20-Volt Power Supply Ripple. Page 6-8

	Line Frequency	Calibrator Frequency
-81 volt	2 millivolts	5 millivolts
+20 volt	1 millivolt	
- 4. Adjust Unblanking Center (R869). Page 6-9
 Maximum trace intensity.
- 5. Adjust Trace Rotation (R851). Page 6-9
 Trace parallel to horizontal graticule lines.
- 6. Adjust Y Axis Alignment (R856). Page 6-11
 Markers parallel to center vertical line.
- 7. Adjust CRT Geometry (R854). Page 6-11
 Alignment of markers within ± 0.1 division of the vertical graticule lines; alignment of trace within ± 0.1 division of the top and bottom graticule lines.
- 8. Adjust Channel 1 Step Attenuator and Variable Balance (R21, R35). Page 6-12
 No trace shift as the Channel 1 VOLTS/DIV switch is changed from .05 to .01 or the VARIABLE VOLTS/DIV control is rotated.
- 9. Adjust Channel 2 Step Attenuator and Variable Balance (R121, R135). Page 6-13
 No trace shift as the Channel 2 VOLTS/DIV switch is changed from .05 to .01 or the VARIABLE VOLTS/DIV control is rotated.
- 10. Check Alternate Operation. Page 6-13
 Trace alternation at all sweep rates.
- 11. Adjust Common-Mode Current (R215). Page 6-14
 Optimum common-mode current balance within ± 0.6 volts of zero.
- 12. Adjust Channel 1 and 2 Gain (R80, R180). Page 6-16
 Correct vertical deflection as indicated by VOLTS/DIV switches.

- 13. Check Added Mode Operation. Page 6-16
 Correct signal addition within $\pm 3\%$.
- 14. Check Channel 1 and 2 Deflection Accuracy. Page 6-17
 Vertical deflection within $\pm 3\%$ of the VOLTS/DIV switch indication.
- 15. Check Channel 2 $\times 10$ Gain. Page 6-17
 Correct Channel 2 deflection within $\pm 7.5\%$ when the $\times 10$ GAIN AC switch is pulled out.
- 16. Check Channel 1 and 2 Variable Volts/Division Range. Page 6-17
 At least 2.5:1 reduction in vertical deflection when fully counterclockwise.
- 17. Check Vertical Linearity. Page 6-18
 Less than 0.2 division compression or expansion at extremes of display area.
- 18. Check Channel 1 and 2 AC GND DC Switch Operation. Page 6-18
 Correct signal coupling in each position.
- 19. Check Trace Shift Due to Input Grid Current. Page 6-19
 0.2 division or less at .01 VOLTS/DIV switch position.
- 20. Adjust Input Capacitance (C12, C112). Page 6-20
 Channel 1 and 2 input capacitance matched within 1% in .05 VOLTS/DIV switch positions.
- 21. Adjust Channel 1 and 2 Volts/Division Switch Compensation. Page 6-21
 3% or less overshoot, rounding or tilt in all positions of the VOLTS/DIV switches.
- 22. Adjust High-Frequency Compensation (R237, C237, L245, L255). Page 6-22
 3% or less aberrations with 100 kilohertz input signal.
- 23. Check Channel 1 and 2 Frequency Response. Page 6-24
 Not more than -3 dB at 15 megahertz.
- 24. Check Channel 2 $\times 10$ Gain Frequency Response. Page 6-25
 Not more than -3 dB at five megahertz.
- 25. Check Common-Mode Rejection Ratio. Page 6-25
 At least 100:1 at 50 kilahertz
- 26. Check Channel Isolation Ratio. Page 6-26
 100,000:1 or greater at one kilahertz.
- 27. Adjust Calibrator Amplitude (R7B0). Page 6-27
 Four divisions of deflection, $\pm 0.7\%$, in CALIBRATE 4 DIVISIONS position of VOLTS/DIV switch.

- 28. Check Calibrator Amplitude at Front-Panel Jack. Page 6-27
Two volts, $\pm 2.7\%$.
- 29. Check Calibrator Repetition Rate and Duty Cycle. Page 6-27
Repetition rate, one kilohertz, $\pm 20\%$; duty cycle, 45% to 55%.
- 30. Adjust Internal Trigger Compensation (C353, C217). Page 6-29
Optimum square-wave response for CH 1 and CH 1 & 2 triggering.
- 31. Adjust External Trigger Compensation (C302). Page 6-30
Optimum square-wave response for EXT triggering.
- 32. Check Trigger Limiting. Page 6-30
10:1 or greater at extremes of LEVEL control rotation.
- 33. Adjust Auto Center (R350). Page 6-30
Correct AUTO triggering operation; see Calibration Procedure.
- 34. Check Internal Trigger Sensitivity. Page 6-32
Stable display in AC, AC LF REJ, and DC positions of Triggering Coupling switch with 0.2-division deflection at five megahertz and one-division deflection at 15 megahertz; stable display in AUTO position of LEVEL control with 0.8-division deflection at four megahertz and 2.5 divisions deflection at 15 megahertz.
- 35. Check External Trigger Sensitivity. Page 6-33
Stable display in AC, AC LF REJ and DC positions of Triggering Coupling switch with 0.125-volt input signal at five megahertz and 0.6-volt input signal at 15 megahertz; stable display in AUTO position of LEVEL control with 0.6-volt input signal at seven megahertz and 1.2-volt input signal at 15 megahertz.
- 36. Check Low-Frequency Triggering and Low-Frequency Reject Operation. Page 6-34
Internal, stable display in AC and DC positions of Triggering Coupling switch with 0.2-division deflection at 50 hertz; stable display in AUTO position of LEVEL control with 0.8-division deflection at 50 hertz; does not trigger in AC LF REJ position of Triggering Coupling switch. External stable display in AC and DC positions of Triggering Coupling switch with 0.125-volt input signal at 50 hertz; stable display in AUTO position of LEVEL control with 0.6-volt signal at 50 hertz; does not trigger in AC LF REJ position of Triggering Coupling switch.
- 37. Check Slope Switch Operation. Page 6-35
Display starts on correct slope of triggering signal.
- 38. Adjust Sweep Calibration (R512). Page 6-36
Correct timing at 1 mSEC position of VOLTS/DIV switch.
- 39. Check Sweep Length. Page 6-36
10.4 to 12.1 divisions.
- 40. Adjust Normal/Magnified Registration (R535). Page 6-37
Less than ± 0.2 -division shift when switching $\times 10$ MAG switch from on (pulled out) to off.
- 41. Check Magnifier Timing and Linearity. Page 6-37
Timing, within $\pm 5\%$ of magnified sweep rate; linearity, within $\pm 1\%$ for any eight division portion of magnified sweep length.
- 42. Check Variable Time/Division Control Range. Page 6-37
At least 2.5:1 reduction in sweep rate.
- 43. Adjust 10 Microsecond Timing (C440A). Page 6-38
Correct timing at 10 μ SEC position of VOLTS/DIV switch.
- 44. Adjust 0.5 Microsecond Timing (C537). Page 6-38
Correct timing at 0.5 μ SEC position of VOLTS/DIV switch.
- 45. Adjust 0.5 Microsecond $\times 10$ Magnifier Timing (C511, C527). Page 6-38
Correct timing at start and center of sweep at 0.5 μ SEC position of VOLTS/DIV switch with magnifier on.
- 46. Check 0.5 Microsecond $\times 10$ Magnifier Linearity. Page 6-39
Within $\pm 3\%$ for any eight division portion of magnified sweep length.
- 47. Check Timing Accuracy. Page 6-40
Within $\pm 3\%$ of TIME/DIV switch setting.
- 48. Check Chopped Operation. Page 6-42
Chopped repetition rate, 100 kilohertz, $\pm 20\%$. Switching transients blanked.
- 49. Check External Horizontal Deflection Factor and Horizontal Attenuator Control Range. Page 6-42
Deflection factor: $\times 10$ MAG switch pushed in, 10 volts/division, $\pm 25\%$; $\times 10$ MAG switch pulled out, one volt/division, $\pm 25\%$. Attenuator control range, 10:1 or greater.
- 50. Check External Horizontal Frequency Response. Page 6-44
Not more than -3 dB at 500 kilohertz.
- 51. Check External Blanking. Page 6-45
Two-volt positive signal blanks trace.
- 52. Check Gate Output Signal. Page 6-46
Amplitude, -0.5 volt or greater; duration, 10.4 to 12.1 times the TIME/DIV switch setting.

Preliminary Procedure

1. Remove the cabinet from the Type 422.
2. Connect the power supply for remote operation.
3. Connect the autotransformer to a suitable power source.
4. Connect the Type 422 to the autotransformer output.
5. Set the autotransformer output voltage to 115 (or 230) volts.
6. Set the Type 422 POWER switch to ON. Allow at least 20 minutes warm up at 25°C, ±5°C, for checking the instrument to the given accuracy.

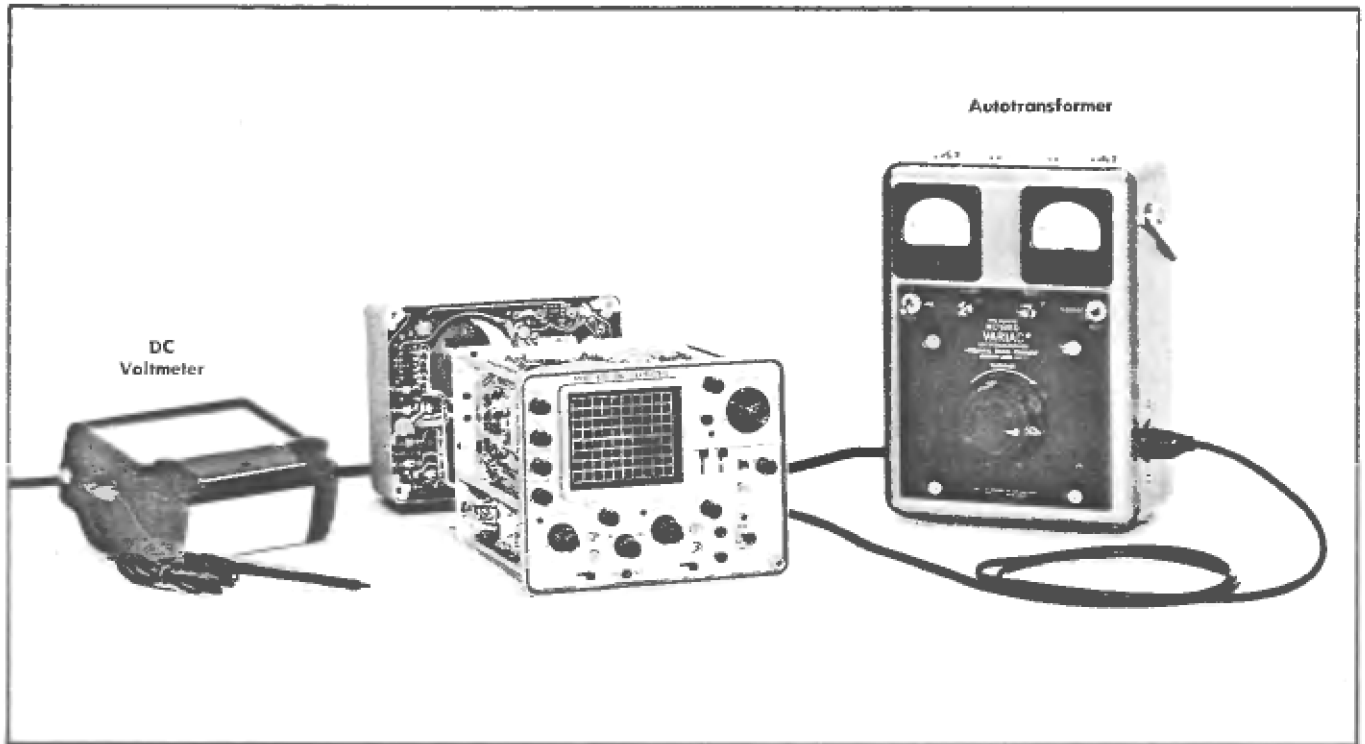

Fig. 6-3. Initial test equipment setup for steps 1 and 2.

CRT controls

INTENSITY	Counterclockwise
FOCUS	Any position
ASTIGMATISM	Any position
SCALE ILLUM	As desired

Sweep controls

POSITION	Midrange
TIME/DIV	1 mSEC
VARIABLE	CAL
×10 MAG	Pushed in

Vertical controls (both channels if applicable)

VOLTS/DIV	.01
VARIABLE	CAL
AC GND DC	GND
POSITION	Midrange
Mode	CH 1
INVERT	Pushed in
×10 GAIN AC	Pushed in

Other

POWER	On (at power supply)
-------	----------------------

Triggering controls

Source	CH 1 & 2
Coupling	AC
SLOPE	Positive going
LEVEL	Midrange

1. Check —81-Volt and +20-Volt Power Supplies

- a. Test equipment setup is shown in Fig. 6-3.
- b. Connect the DC voltmeter from the —81-volt test point (see Fig. 6-4) to chassis ground.
- c. CHECK—Meter reading; —81 volts, +2 volts or —1 volt.
- d. Connect the DC voltmeter from the +20-volt test point (see Fig. 6-4) to chassis ground.
- e. CHECK—Meter reading; +20 volts, ±1.4 volts.

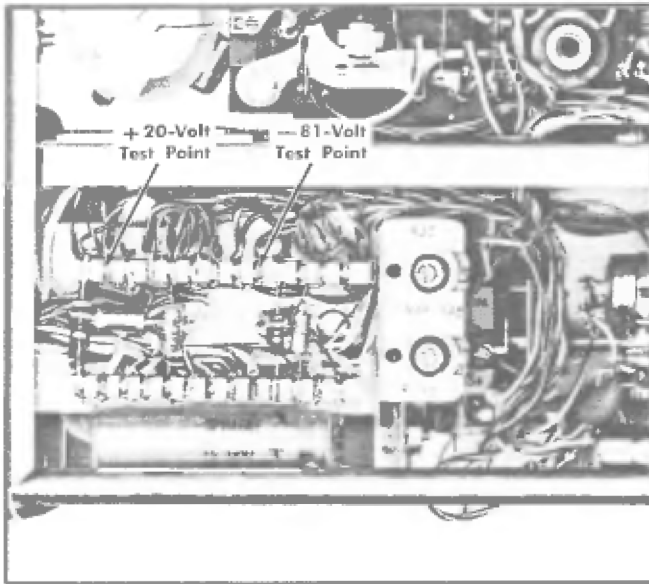

Fig. 6-4. Location of power-supply test points (left side).

2. Check High-Voltage Supply

- a. Remove the plastic cover from the CRT socket on the rear of the indicator (turn power off before removing).
- b. Connect the DC voltmeter from the high-voltage test point (pin 3 of CRT socket, see Fig. 6-5) to chassis ground.

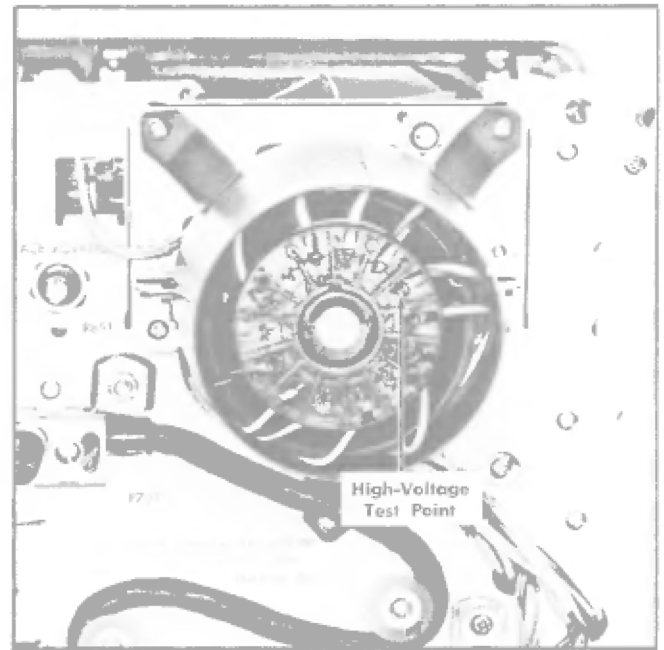

Fig. 6-5. Location of high-voltage test point (rear panel, protective cover removed).

- c. CHECK—Meter reading; -1385 volts, ± 69.5 volts.
- d. Disconnect the DC voltmeter and replace plastic cover.

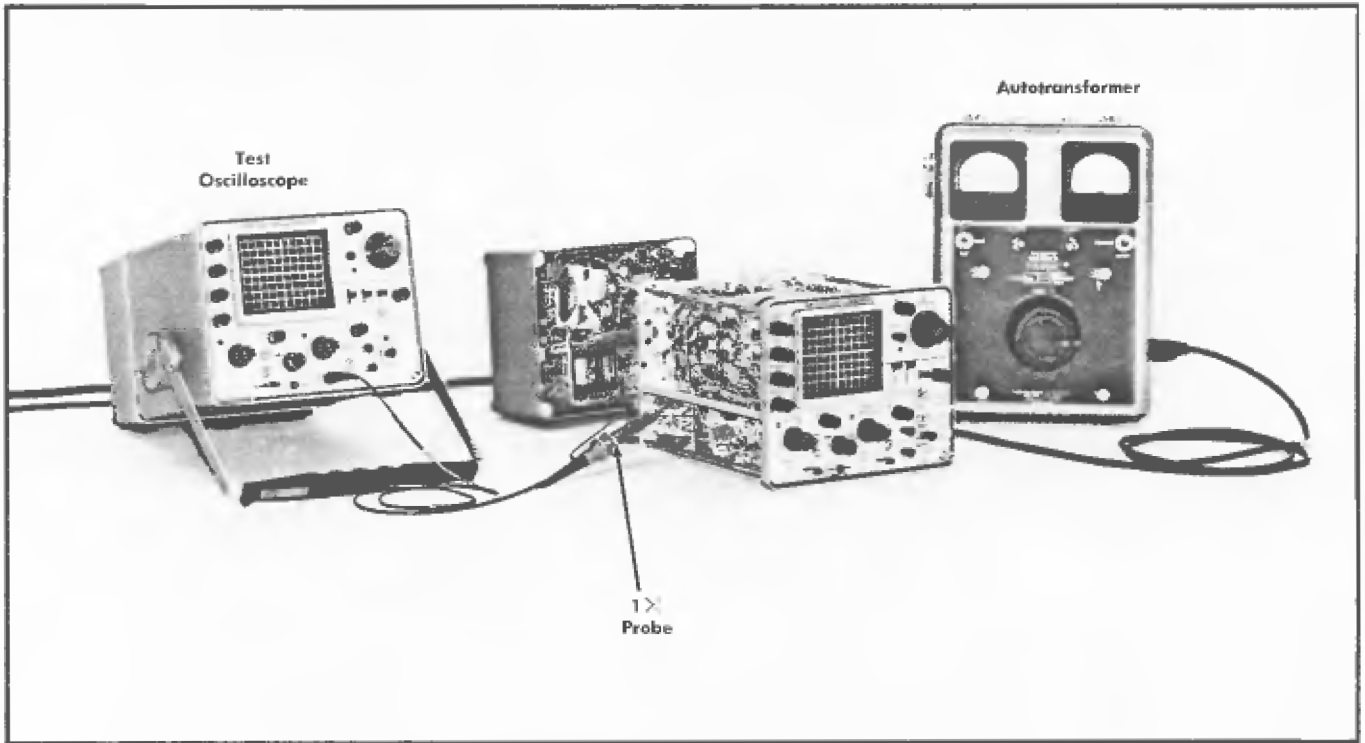

Fig. 6-6. Initial test equipment setup for steps 3—5.

CRT controls

INTENSITY	Counterclockwise
FOCUS	Any position
ASTIGMATISM	Any position
SCALE ILLUM	As desired

Vertical controls (both channels if applicable)

VOLTS/DIV	.01
VARIABLE	CAL
AC GND DC	GND
POSITION	Midrange
Mode	CH 1
INVERT	Pushed in
×10 GAIN AC	Pushed in

Triggering controls

Source	CH 1 & 2
Coupling	AC
SLOPE	Positive going
LEVEL	Midrange

Sweep controls

POSITION	Midrange
TIME/DIV	1 mSEC
VARIABLE	CAL
×10 MAG	Pushed in

Other controls

POWER	On (at power supply)
-------	----------------------

3. Check —81-Volt and +20-Volt Power-Supply Ripple

- a. Test equipment setup is shown in Fig. 6-6.
- b. Connect the 1X probe to the test oscilloscope input connector.
- c. Set the test oscilloscope for a vertical deflection of one millivolt/division, AC coupled, at a sweep rate of five milliseconds/division.
- d. Connect the probe tip to the —81-volt test point (see Fig. 6-4).
- e. CHECK—Test oscilloscope display for two divisions or less line-frequency ripple (two millivolts or less; see Fig. 6-7) while varying the autotransformer output voltage between 103.5 and 126.5 volts (207 and 253 volts for 230-volts nominal).
- f. Set the test oscilloscope vertical deflection to two millivolts/division and the sweep rate to 0.5 millisecond/division.
- g. CHECK—Test oscilloscope display for 2.5 divisions or less one-kilohertz ripple (five millivolts or less) while varying the autotransformer output voltage between 103.5 and 126.5 volts (207 and 253).
- h. Set the test oscilloscope vertical deflection to one millivolt/division and the sweep rate to five milliseconds/division.
- i. Connect the probe tip to the +20 volt test point (see Fig. 6-4).

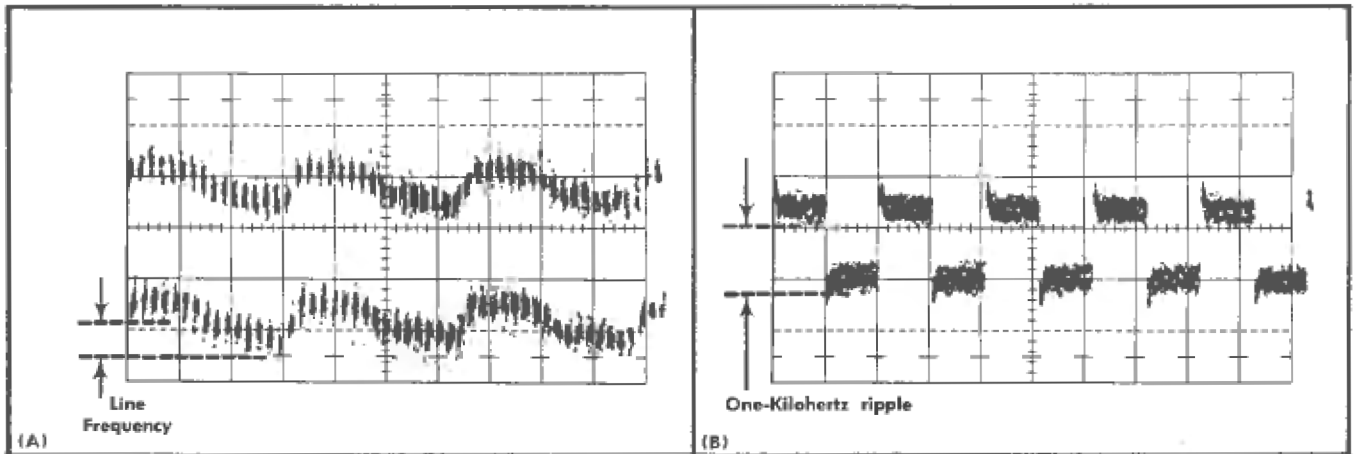

Fig. 6-7. Typical test-oscilloscope display of power-supply ripple. (A) Low-frequency (60-cycle line): vertical deflection, one millivolt/division; sweep rate 5 milliseconds/division. (B) high-frequency (calibrator): vertical deflection, one millivolt/division; sweep rate 0.5 milliseconds/division.

j. CHECK—Test oscilloscope display for one division or less line frequency ripple (one millivolt or less) while varying the autotransformer output voltage between 103.5 and 126.5 volts (207 and 253).

k. Return autotransformer output voltage to 115 (230) volts. (If the line voltage is near 115 (230) volts, the instrument may be connected directly to the line; otherwise, leave the instrument connected directly to the autotransformer for the remainder of this procedure).

l. Disconnect all test equipment.

4. Adjust Unblanking Center

a. Set the Triggering LEVEL control to FREE RUN.

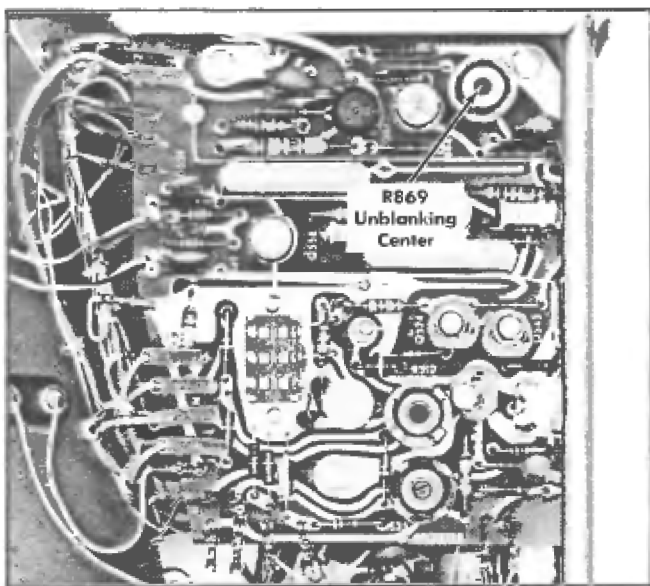

Fig. 6-8. Location of Unblanking Center adjustment (Horizontal Amplifier board).

b. Set the INTENSITY control to midrange.

c. ADJUST—Unblanking Center adjustment, R869 (see Fig. 6-8), for maximum trace intensity. This should occur near the center of control rotation.

5. Adjust Trace Rotation

a. Position the trace to the center horizontal line with the Channel 1 POSITION control.

b. CHECK—The trace should be parallel with the centerline.

c. ADJUST—Trace Rotation adjustment, R851 (see Fig. 6-9), so the trace is parallel with the horizontal graticule lines.

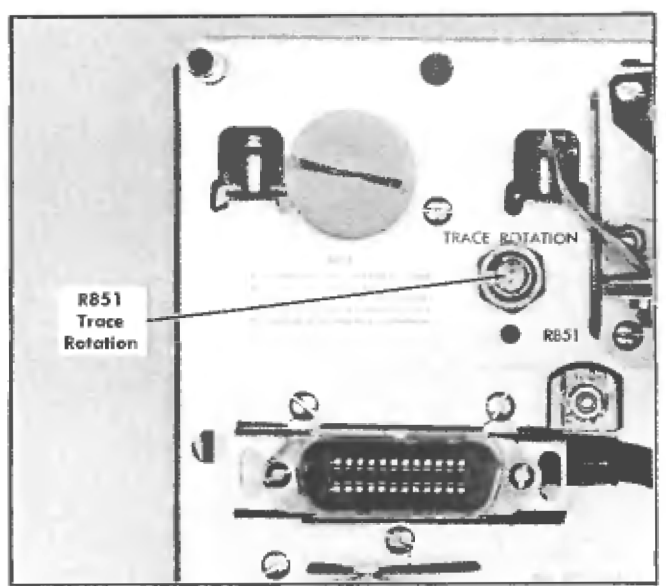

Fig. 6-9. Location of Trace Rotation adjustment (rear panel).

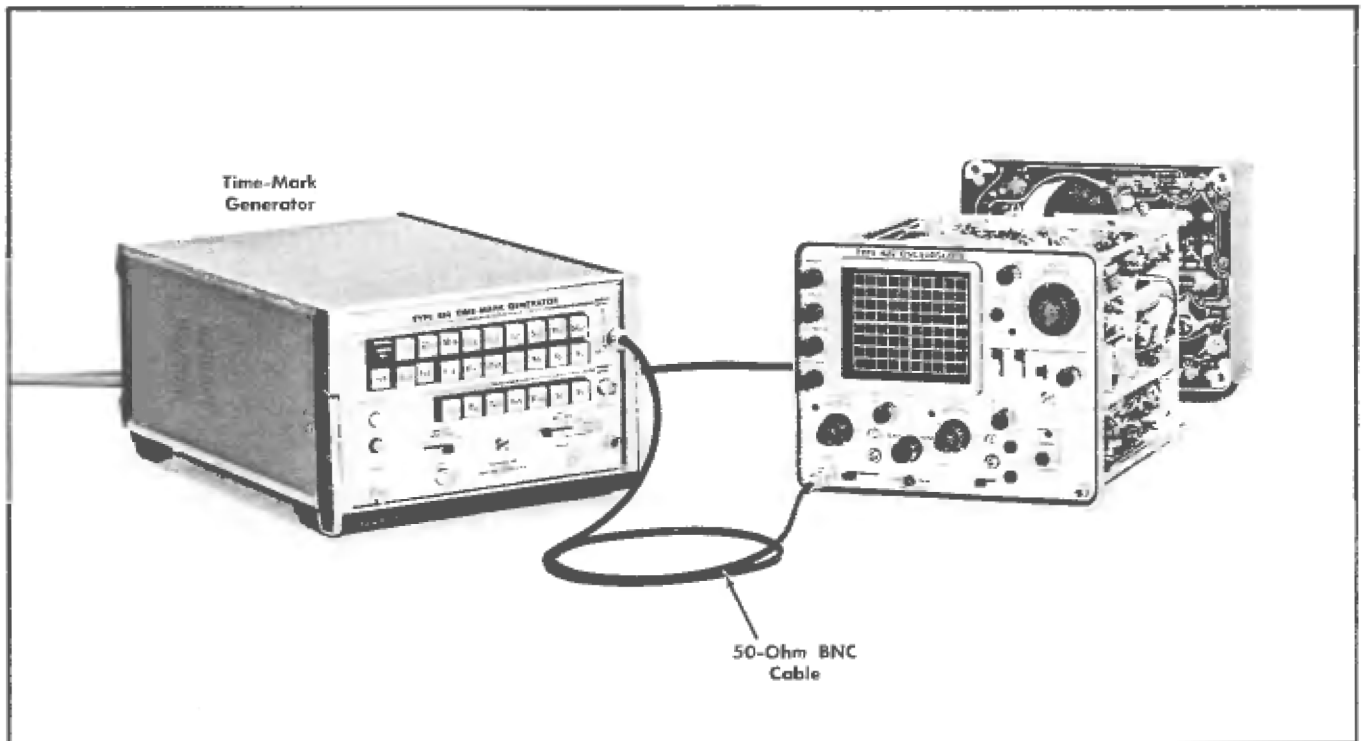

Fig. 6-10. Initial test equipment setup for steps 6—10.

CRT controls

INTENSITY Midrange
 FOCUS Adjust for correct display
 ASTIGMATISM Adjust for correct display
 SCALE ILLUM As desired

Other controls

POWER On (at power supply)

Vertical controls (both channels if applicable)

VOLTS/DIV .01
 VARIABLE CAL
 AC GND DC AC
 POSITION Midrange
 Mode CH 1
 INVERT Pushed in
 X10 GAIN AC Pushed in

Triggering Control

Source CH 1 & 2
 Coupling AC
 SLOPE Positive going
 LEVEL Midrange

Sweep controls

POSITION Midrange
 TIME/DIV 1 mSEC
 VARIABLE CAL
 X10 MAG Pushed in

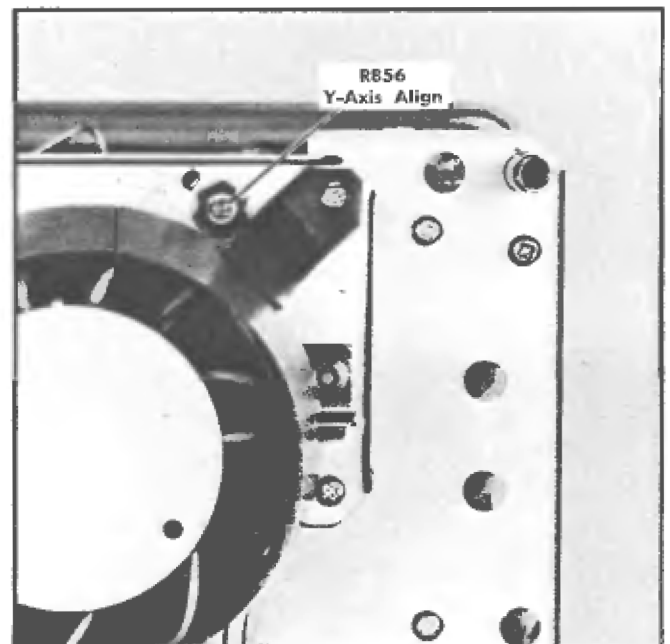

Fig. 6-11. Location of Y Axis adjustment (rear panel).

6. Adjust Y Axis Alignment



- Test equipment setup is shown in Fig. 6-10.
- Connect the time-mark generator to the INPUT 1 connector through the 50-ohm BNC cable.
- Set the time-mark generator for output markers of one millisecond and 0.1 millisecond.
- Set the Triggering LEVEL control for a stable display.
- Set the Channel 1 VOLTS/DIV switch so the large markers extend beyond the bottom and top of the graticule area.
- CHECK—The markers should be parallel to the center vertical line.
- ADJUST—Y Axis Align adjustment, R856 (see Fig. 6-11), to align the markers with the centerline.

7. Adjust CRT Geometry



- Set the Horizontal POSITION and the VARIABLE TIME/DIV controls so a large marker coincides with each graticule line.
- CHECK—CRT display for minimum bowing of the markers at the left and right edges of the graticule. Fig. 6-12 shows a typical display of good geometry as well as examples of poor geometry.
- ADJUST—Geom adjustment, R854 (see Fig. 6-12D), for minimum curvature of the markers at the left and right edges of the graticule.
- INTERACTION—Recheck step 6.
- Disconnect the time-mark generator.
- Position the trace to the top graticule line.

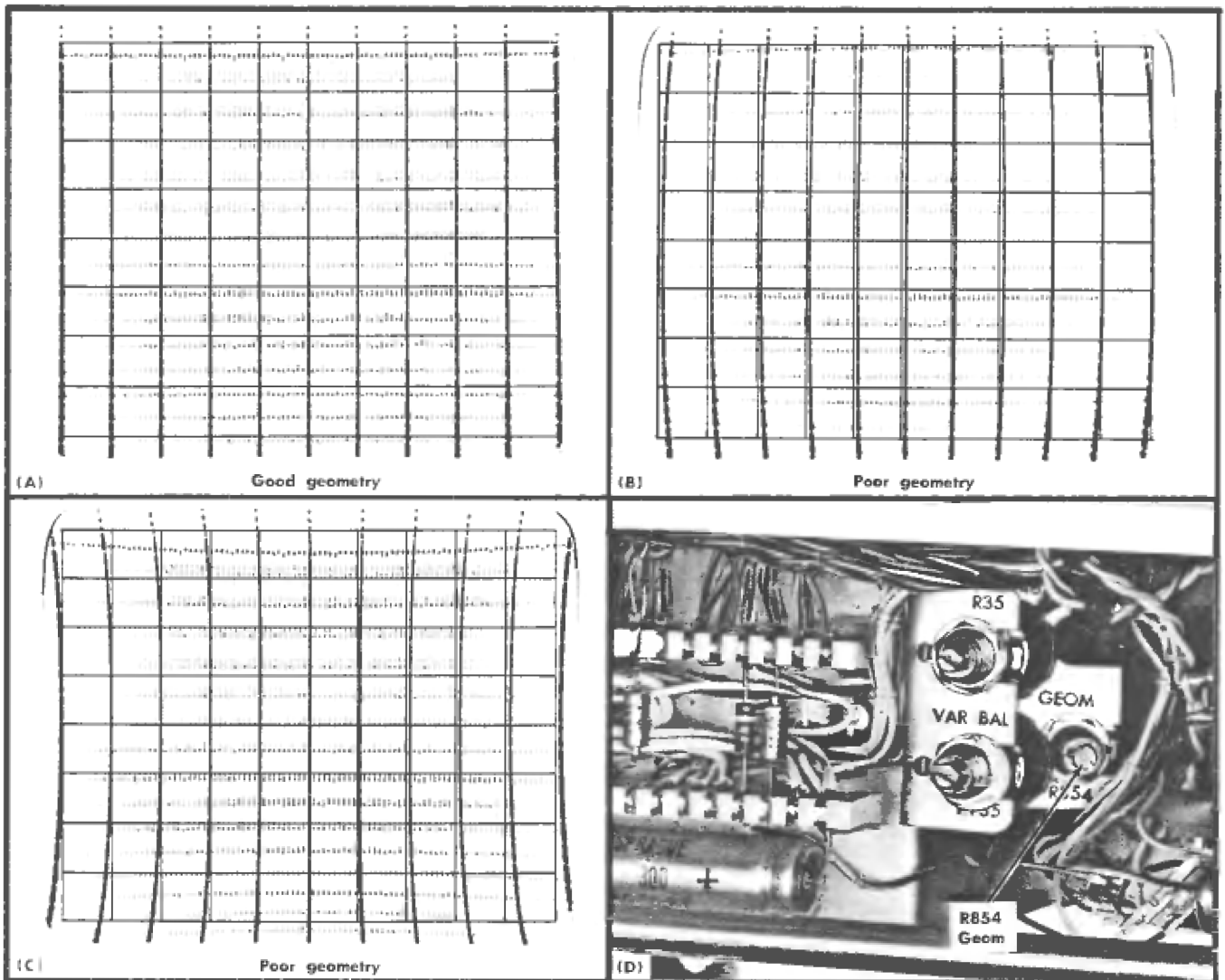

Fig. 6-12. (A) Typical CRT display of good geometry; (B) and (C) poor geometry; (D) location of Geom adjustment (left side).

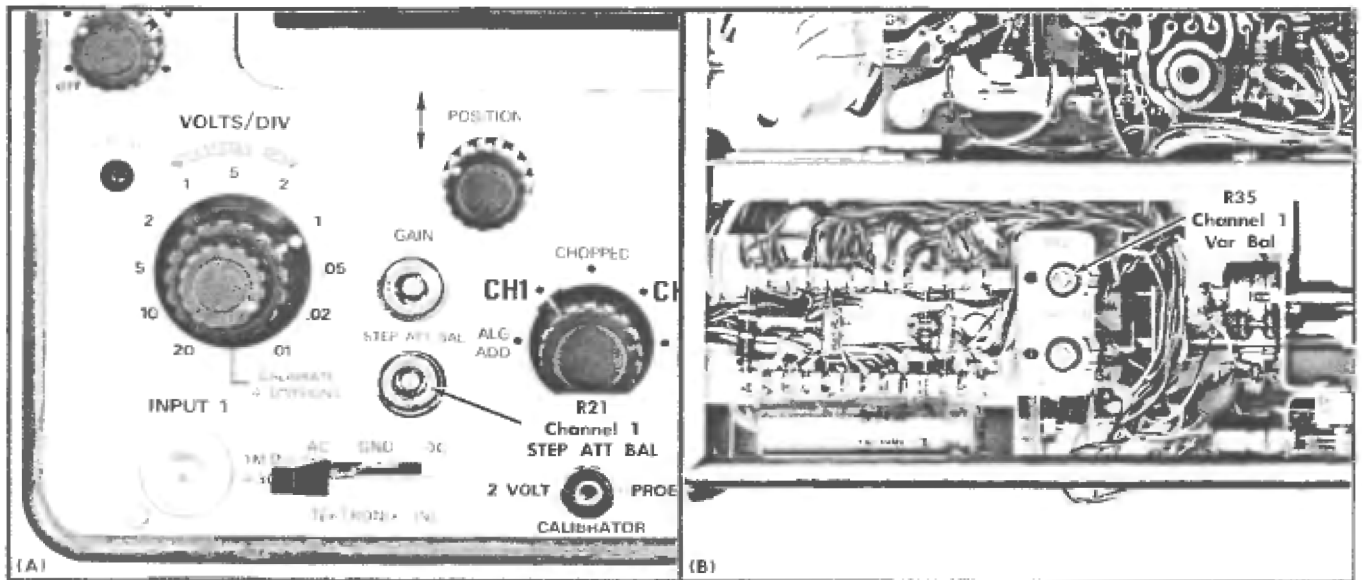

Fig. 6-13. (A) Location of Channel 1 STEP ATT BAL adjustment (front panel) (B) location of Channel 1 Var Bal adjustment (left side).

- g. CHECK—Deviation from straight line should not exceed ± 0.1 division.
- h. Position the trace to the bottom graticule line.
- i. CHECK—Deviation from straight line should not exceed ± 0.1 division.

8. Adjust Channel 1 Step Attenuator and Variable Balance

- a. Set the Triggering LEVEL control to FREE RUN.
- b. Set the Channel 1 AC GND DC switch to GND.

c. Position the trace to the center horizontal line with the Channel 1 POSITION control.

d. CHECK—Change the Channel 1 VOLTS/DIV switch from .05 to .01. Trace should not move vertically.

e. ADJUST—Channel 1 STEP ATT BAL adjustment, R21 (see Fig. 6-13A), for no trace shift as the Channel 1 VOLTS/DIV switch is changed from .05 to .01.

f. Return the Channel 1 VOLTS/DIV switch to .05.

g. CHECK—Rotate the Channel 1 VARIABLE VOLTS/DIV control throughout its range. Trace should not move vertically.

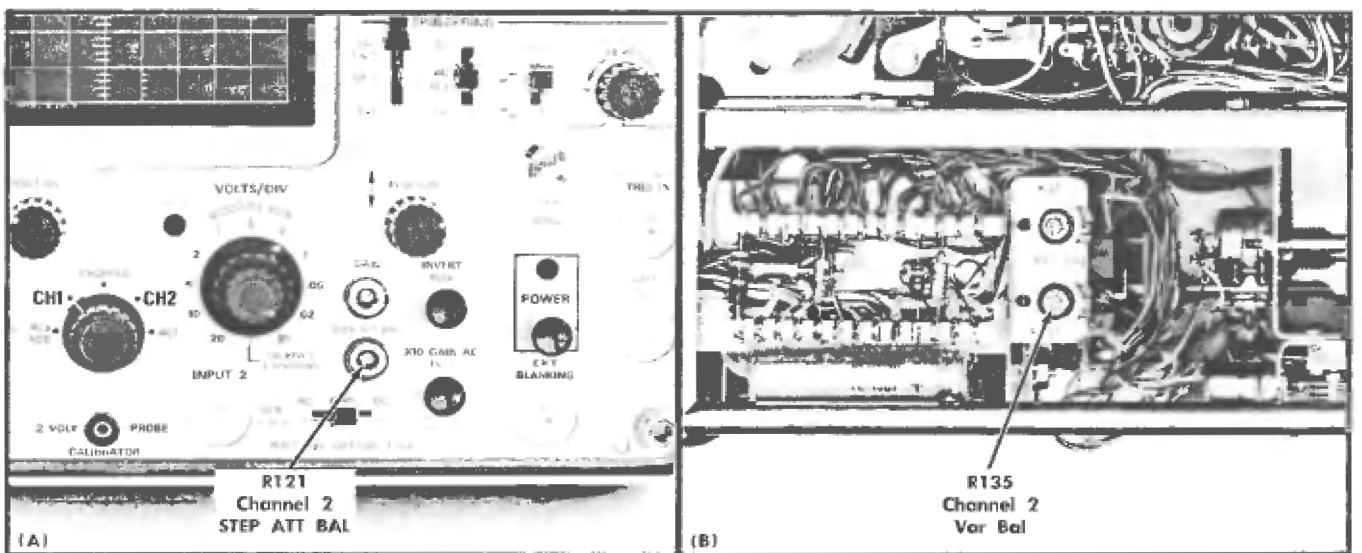

Fig. 6-14. (A) Location of Channel 2 STEP ATT BAL adjustment (front panel); (B) location of Channel 2 Var Bal adjustment (left side).

h. ADJUST—Channel 1 Var Bal adjustment, R35 (see Fig. 6-13B), for no trace shift as the Channel 1 VARIABLE VOLTS/DIV control is rotated throughout its range.

i. Repeat steps c through h until there is no trace shift for check d or g.

9. Adjust Channel 2 Step Attenuator and Variable Balance

a. Set the Mode switch to CH 2.

b. Set the Channel 2 AC GND DC switch to GND

c. Position the trace to the center horizontal line with the Channel 2 POSITION control.

d. CHECK—Change the Channel 2 VOLTS/DIV switch from .05 to .01. Trace should not move vertically.

e. ADJUST—Channel 2 STEP ATT BAL adjustment, R121 (see Fig. 6-14A), for no trace shift as the Channel 2 VOLTS/DIV switch is changed from .05 to .01.

f. Return the Channel 2 VOLTS/DIV switch to .05.

g. CHECK—Rotate the Channel 2 VARIABLE VOLTS/DIV control throughout its range. Trace should not move vertically.

h. ADJUST—Channel 2 Var Bal adjustment, R135 (see Fig. 6-14B), for no trace shift as the Channel 2 VARIABLE VOLTS/DIV control is rotated throughout its range.

i. Repeat steps c through h until there is no trace shift for check d or g.

10. Check Alternate Operation

a. Set the Mode switch to ALT.

b. Position the traces about two divisions apart.

c. Turn the TIME/DIV switch throughout its range.

d. CHECK—Trace alternation between Channel 1 and 2 at all sweep rates. At faster sweep rates, alternation will not be apparent; display will appear as two traces on screen.

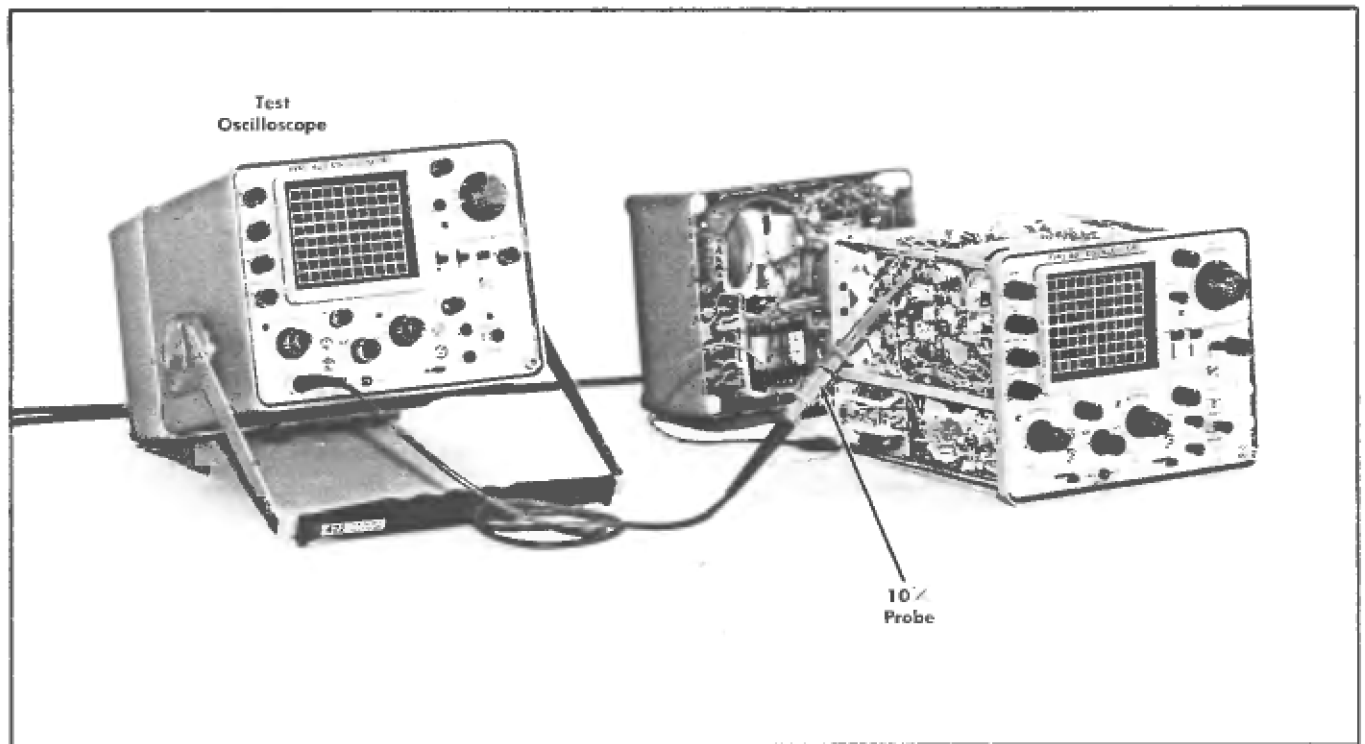

Fig. 6-15. Test equipment setup for step 11.

CRT controls

INTENSITY	Midrange
FOCUS	Adjust for correct display
ASTIGMATISM	Adjust for correct display
SCALE ILLUM	As desired

Vertical controls (both channels if applicable)

VOLTS/DIV	.05
VARIABLE	CAL
AC GND DC	GND
POSITION	Midrange
Mode	ALT
INVERT	Pushed in
×10 GAIN AC	Pushed in

Triggering controls

Source	CH 1 & 2
Coupling	AC
SLOPE	Positive going
LEVEL	FREE RUN

Sweep controls

POSITION	Midrange
TIME/DIV	.5 mSEC
VARIABLE	CAL
×10 MAG	Pushed in

Other controls

POWER	On (at power supply)
-------	----------------------

11. Adjust Common-Mode Current

- a. Test equipment setup is shown in Fig. 6-15.
- b. Position both traces to the center horizontal line with the Channel 1 and 2 POSITION controls.
- c. Connect the 10X probe to the input of the test oscilloscope.
- d. Set the test oscilloscope for a vertical deflection of 0.02 volt/division (0.2 volt including 10× probe), DC coupled, at a sweep rate of 5 milliseconds/division.
- e. Ground the input of the test oscilloscope and position the trace to the center horizontal line.
- f. Connect the 10× probe tip to the common-mode current test point (common emitters of Q224 and Q234, see Fig. 6-16A).
- g. CHECK—Test oscilloscope display for ±3 divisions or less offset from the center horizontal line (see Fig. 6-16B).
- h. ADJUST—Common-Mode Current adjustment, R215 (see Fig. 6-16A), for optimum balance of common-mode current in each channel as shown by equal spacing from the center horizontal line. Balance must occur within ±3 divisions of the centerline (see Fig. 6-16B).
- i. INTERACTION—Check steps 12-14.
- j. Disconnect all test equipment.

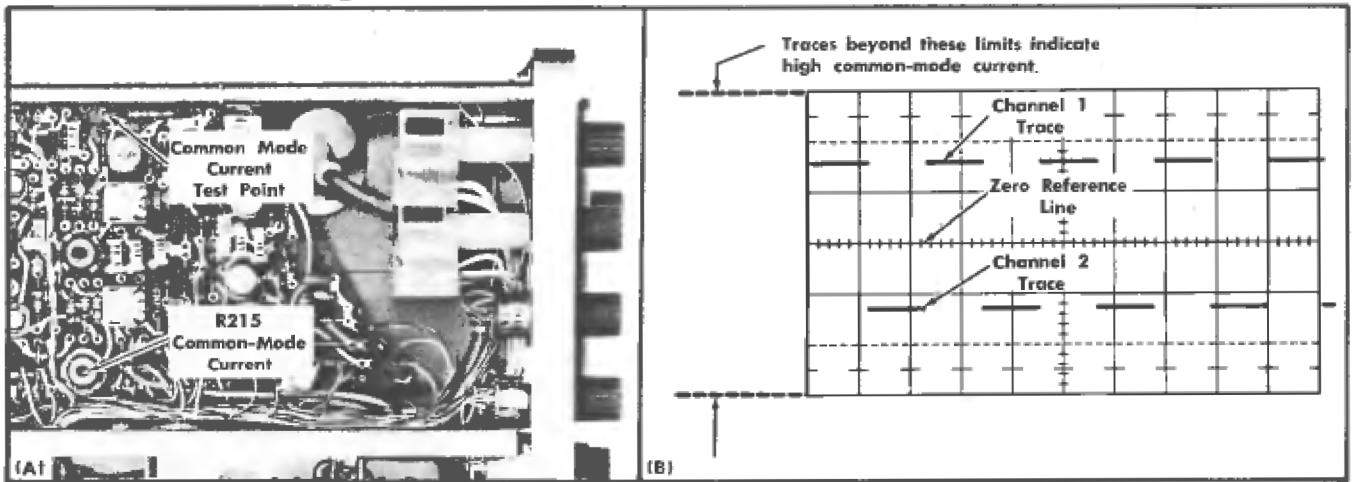

Fig. 6-16. (A) Common-mode current test point and adjustment (Vertical Switching and Output Amplifier board); (B) typical test oscilloscope display showing test limits. Vertical deflection, 0.2 volt/division; sweep rate, five milliseconds/division.

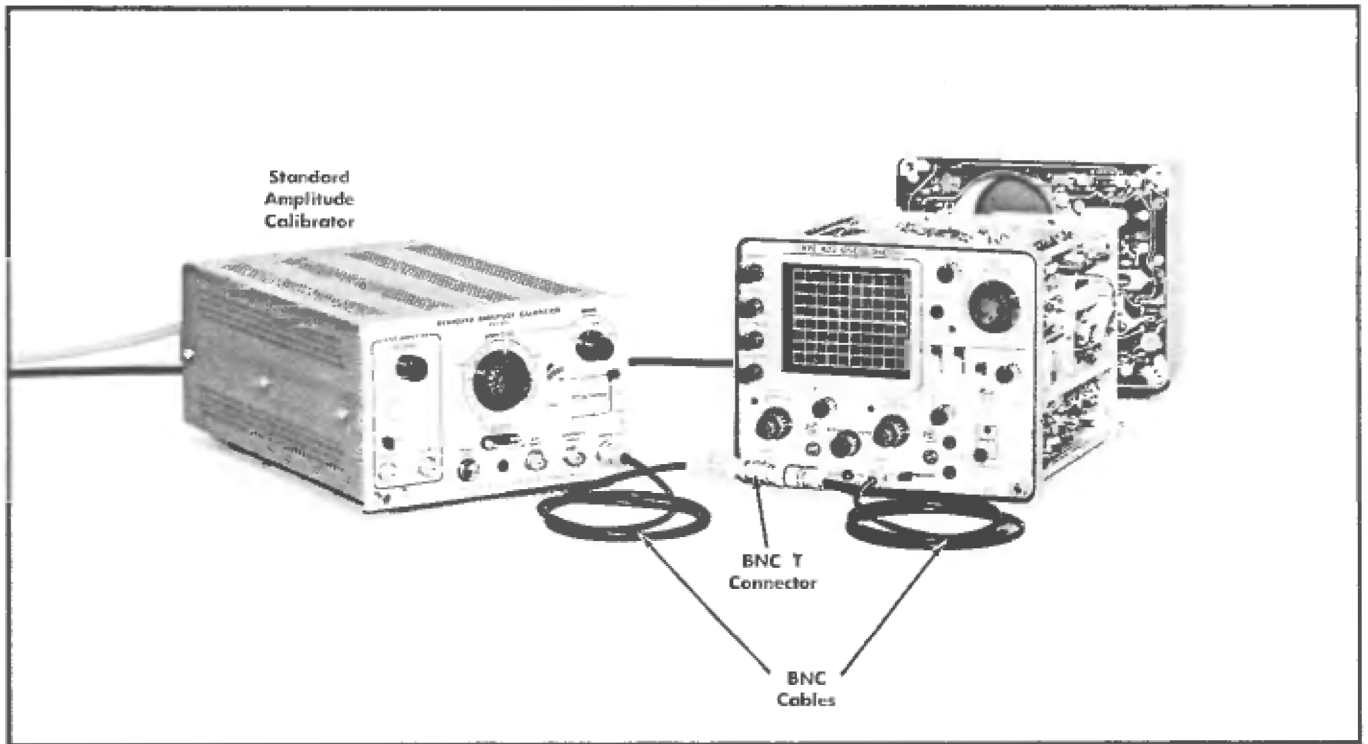

Fig. 6-17. Initial test equipment setup for steps 12—19.

CRT controls

INTENSITY	Midrange
FOCUS	Adjust for correct display
ASTIGMATISM	Adjust for correct display
SCALE ILLUM	As desired

Vertical controls (both channels if applicable)

VOLTS/DIV	.05
VARIABLE	CAL
AC GND DC	AC
POSITION	Midrange
Mode	CH 1
INVERT	Pushed in
×10 GAIN AC	Pushed in

Triggering controls

Source	CH 1 & 2
Coupling	AC
SLOPE	Positive going
LEVEL	Midrange

Sweep controls

POSITION	Midrange
TIME/DIV	.5 mSEC
VARIABLE	CAL
×10 MAG	Pushed in

Other controls

POWER	On (at power supply)
-------	----------------------

12. Adjust Channel 1 and 2 Gain

- a. Test equipment setup is shown in Fig. 6-17.
- b. Connect the standard amplitude calibrator output connector to the INPUT 1 connector through a BNC cable and the BNC T connector. Connect the output of the BNC T connector to INPUT 2 with a BNC cable.
- c. Set the standard amplitude calibrator for a 0.2-volt square-wave output.
- d. Position the display to the center of the graticule with the Channel 1 POSITION control.
- e. CHECK—CRT display amplitude four divisions, ± 0.12 division, (accuracy within $\pm 3\%$; see Fig. 6-18A).
- f. ADJUST—Channel 1 GAIN adjustment, R80 (see Fig. 6-18B), for exactly four divisions of deflection.
- g. Set the Mode switch to ALG ADD.
- h. Pull the INVERT switch.
- i. CHECK—CRT display straight line.
- j. ADJUST—Channel 2 GAIN adjustment, R180 (see Fig. 6-18B), for a straight line display.

13. Check Added Mode Operation

- a. Push in the INVERT switch.
- b. Set the standard amplitude calibrator for a 0.1-volt square-wave output.

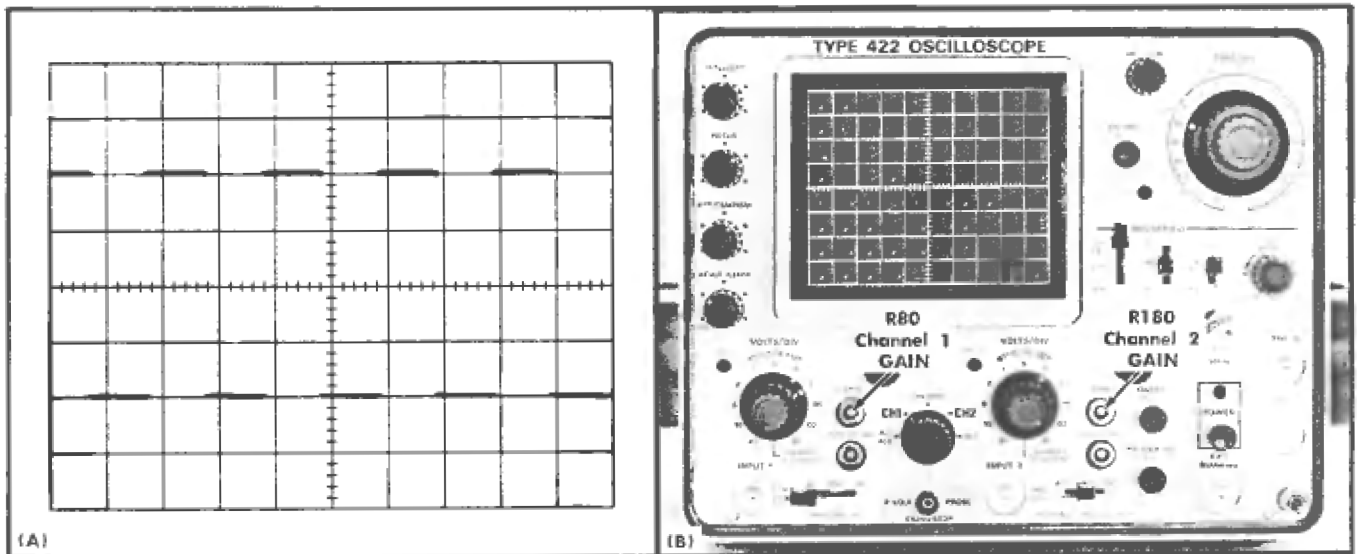

Fig. 6-18. (A) Typical CRT display showing correct gain adjustment; (B) location of Channel 1 and 2 GAIN adjustments (front panel).

c. CHECK—CRT display four divisions in amplitude, ± 0.12 division.

14. Check Channel 1 and 2 Deflection Accuracy

- a. Set the Mode switch to CH 1.
- b. Set the Channel 2 AC GND DC switch to GND.
- c. CHECK—Using the Channel 1 VOLTS/DIV switch and standard amplitude calibrator settings given in Table 6-1, check vertical deflection within $\pm 3\%$ at each position of the Channel 1 VOLTS/DIV switch.
- d. Set the Mode switch to CH 2.
- e. Set the Channel 1 AC GND DC switch to GND and the Channel 2 AC GND DC switch to DC.

f. CHECK—Using the Channel 2 VOLTS/DIV switch and standard amplitude calibrator settings given in Table 6-1, check vertical deflection within $\pm 3\%$ at each position of the Channel 2 VOLTS/DIV switch.

15. Check Channel 2 $\times 10$ Gain

- a. Set both VOLTS/DIV switches to .05.
- b. Set the standard amplitude calibrator for a 20-millivolt square-wave output.
- c. Pull the $\times 10$ GAIN AC switch out.
- d. CHECK—CRT display four divisions in amplitude, ± 0.3 division ($\pm 7.5\%$).
- e. Push in the $\times 10$ GAIN AC switch.

TABLE 6-1

Vertical Deflection Accuracy

VOLTS/DIV Switch Setting	Standard Amplitude Calibrator Square Wave Output	Vertical Deflection In Divisions	Maximum Error For $\pm 3\%$ Accuracy (divisions)
.01	50 millivolts	5	± 0.15
.02	0.1 volt	5	± 0.15
.05	0.2 volt	4	± 0.12
.1	0.5 volt	5	± 0.15
.2	1 volt	5	± 0.15
.5	2 volts	4	± 0.12
1	5 volts	5	± 0.15
2	10 volts	5	± 0.15
5	20 volts	4	± 0.12
10	50 volts	5	± 0.15
20	100 volts	5	± 0.15

16. Check Channel 1 and 2 Variable Volts/Division Range

- a. Set the standard amplitude calibrator for a 0.2-volt square-wave output.
- b. CHECK—Turn the Channel 2 VARIABLE VOLTS/DIV control fully counterclockwise. Display should be reduced to 1.6 divisions or less (representing a control attenuation range of 2.5:1 or greater; see Fig. 6-19). Channel 2 UNCAL light must be on when VARIABLE control is not in CAL position.
- c. Set the Mode switch to CH 1.
- d. Set the Channel 1 AC GND DC switch to DC.
- e. CHECK—Turn the Channel 1 VARIABLE VOLTS/DIV control fully counterclockwise. Display should be reduced to 1.6 divisions or less (control range of 2.5:1 or greater; see Fig. 6-19). Channel 1 UNCAL light must be on when VARIABLE control is not in CAL position.

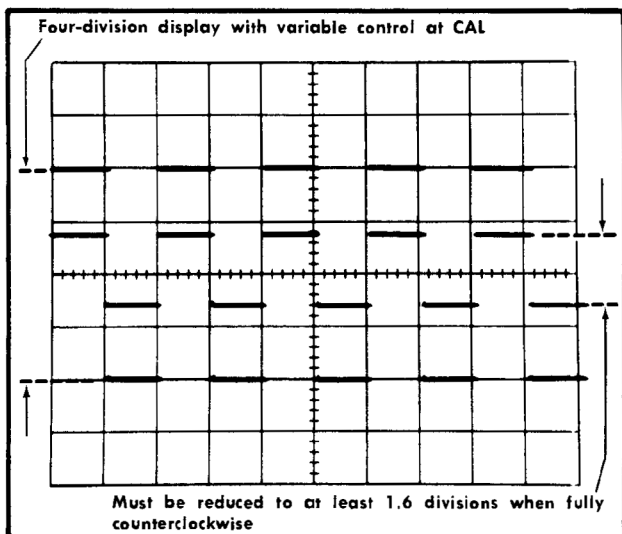

Fig. 6-19. Typical CRT display when checking VARIABLE VOLTS/DIV control range (double exposure).

17. Check Vertical Linearity

- a. Set the standard amplitude calibrator for a 0.2-volt square-wave output.
- b. Position the display to the center of the graticule with the Channel 1 POSITION control.
- c. Set the Channel 1 VARIABLE VOLTS/DIV control for exactly two divisions of deflection (see Fig. 6-20B).
- d. Position the top of the display to the top graticule line.
- e. CHECK—Compression or expansion not to exceed 0.2 division (see Fig. 6-20).
- f. Position the bottom of the display to the bottom graticule line.
- g. CHECK—Compression or expansion not to exceed 0.2 division (see Fig. 6-20).
- h. Set the Mode switch to CH 2.
- i. Position the display to the center of the graticule with the Channel 2 POSITION control.
- j. Set the Channel 2 VARIABLE VOLTS/DIV control for exactly two divisions of deflection (see Fig. 6-20B).
- k. Position the top of the display to the top graticule line.
- l. CHECK—Compression or expansion not to exceed 0.2 division (see Fig. 6-20).
- m. Position the bottom of the display to the bottom graticule line.
- n. CHECK—Compression or expansion not to exceed 0.2 division (see Fig. 6-20).

18. Check Channel 1 and 2 AC GND DC Switch Operation

- a. Return both VARIABLE VOLTS/DIV controls to CAL.

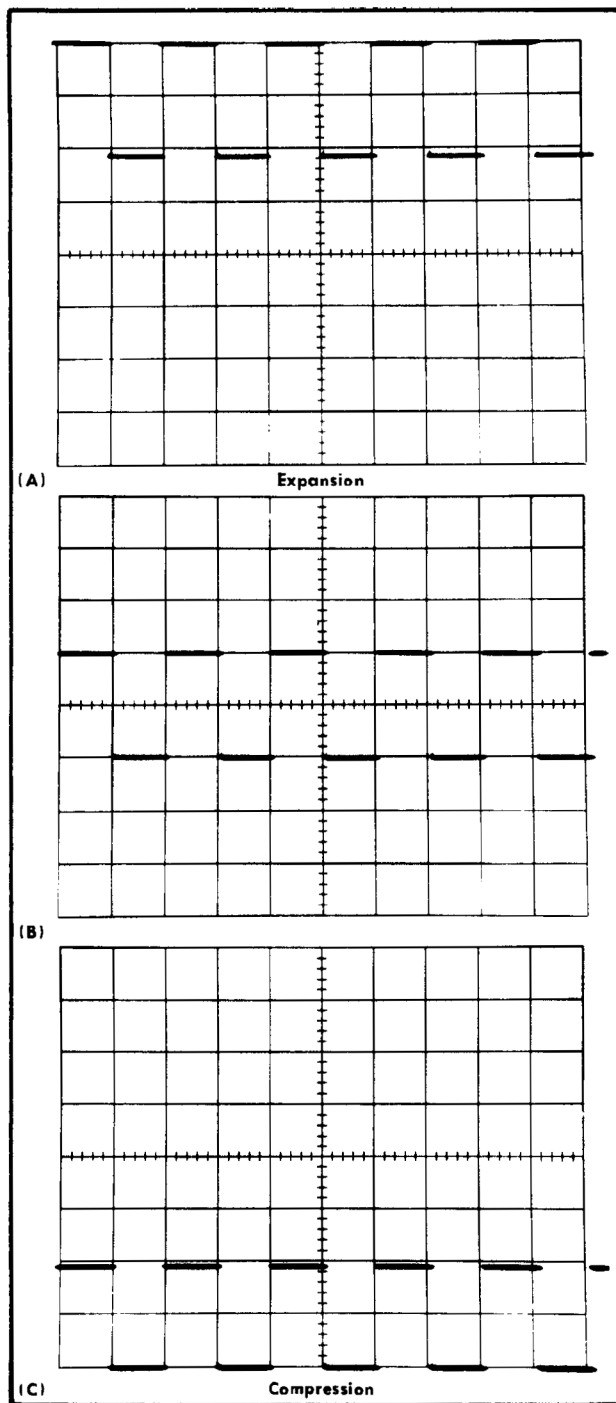

Fig. 6-20. Typical CRT display showing acceptable vertical compression and expansion. Waveform (A) shows expansion; waveform (C) shows compression.

- b. Position display with the Channel 2 POSITION control so the bottom of the square wave is at the center horizontal line.

- c. Set the Channel 2 AC GND DC switch to AC.

- d. CHECK—CRT display centered about centerline.
- e. Set the Channel 2 AC GND DC switch to GND.
- f. CHECK—CRT display for a straight line near the centerline.
- g. Set the Mode switch to CH 1.
- h. Position display with the Channel 1 POSITION control so the bottom of the square wave is at the horizontal centerline.
- i. Set the Channel 1 AC GND DC switch to AC.
- j. CHECK—CRT display centered about centerline.
- k. Set the Channel 1 AC GND DC switch to GND.
- l. CHECK—CRT display for a straight line near the centerline.
- m. Disconnect all test equipment.

19. Check Trace Shift Due to Input Grid Current

- a. Set both VOLTS/DIV switches to .01.
- b. Set the Triggering LEVEL control to FREE RUN.
- c. Position the trace to the center horizontal line with the Channel 1 POSITION control.
- d. CHECK—Set the Channel 1 AC GND DC switch to DC; trace shift 0.2 division or less.
- e. Set the Mode switch to CH 2.
- f. Position the trace to the center horizontal line with the Channel 2 POSITION control.
- g. CHECK—Set the Channel 2 AC GND DC switch to DC; trace shift 0.2 division or less.

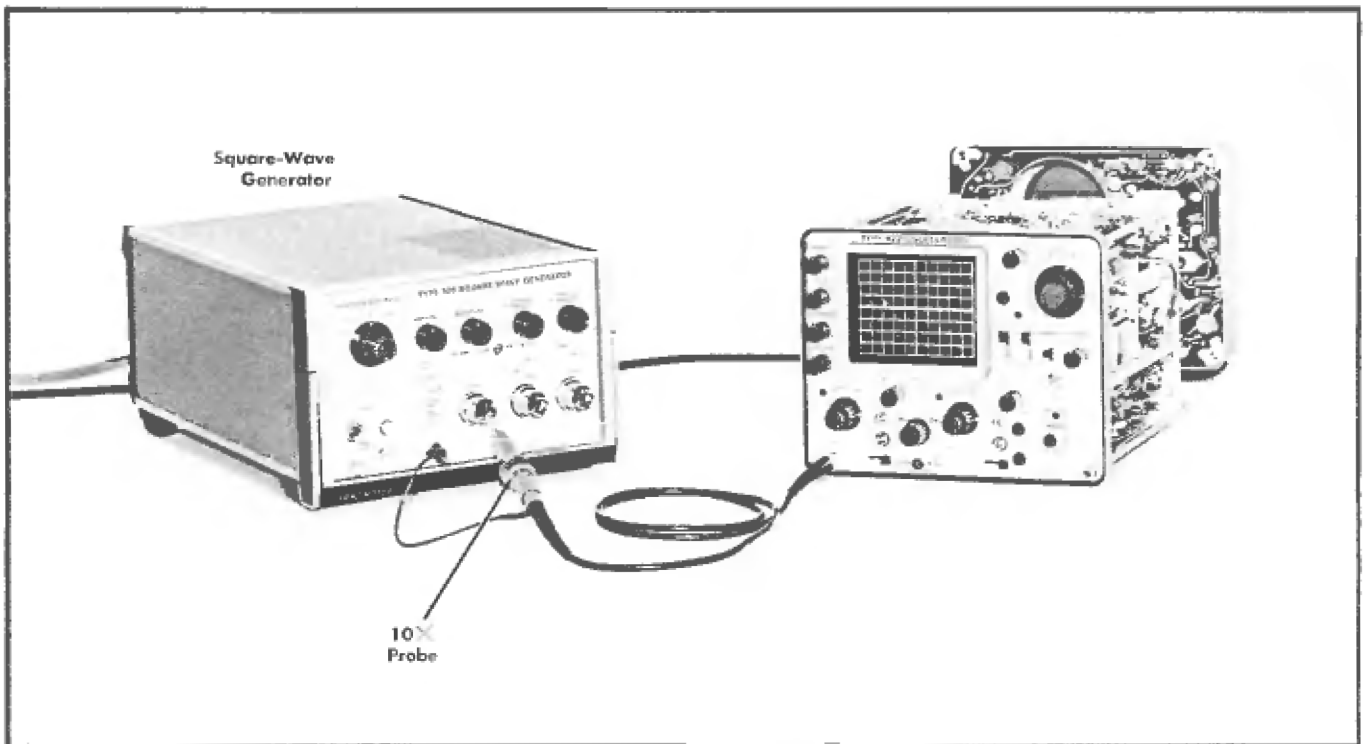

Fig. 6-21. Initial test equipment setup for steps 20—22.

CRT controls

INTENSITY	Midrange
FOCUS	Adjust for correct display
ASTIGMATISM	Adjust for correct display
SCALE ILLUM	As desired

Vertical controls (both channels if applicable)

VOLTS/DIV	.05
VARIABLE	CAL
AC GND DC	DC
POSITION	Midrange
Mode	CH 1
INVERT	Pushed in
×10 GAIN AC	Pushed in

Triggering controls

Source	CH 1 & 2
Coupling	AC
SLOPE	Positive going
LEVEL	Adjust for stable display

Sweep controls

POSITION	Midrange
TIME/DIV	.2 mSEC
VARIABLE	CAL
×10 MAG	Pushed in

Other controls

POWER	On (at power supply)
-------	----------------------

20. Adjust Input Capacitance

- a. Test equipment setup is shown in Fig. 6-21.
- b. CHECK—Mechanical adjustment of C12 (see Fig. 6-22A) C12 should not be at either extreme of adjustment.
- c. ADJUST—C12 to midrange (see Fig. 6-22B). To avoid readjustment of all compensation adjustments, do not readjust C12 unless it is near one of the extremes of adjustment.
- d. Connect the 10× probe to the INPUT 1 connector.
- e. Place the 50-ohm in-line termination on the square-wave generator high amplitude output and connect the probe tip to the output of the termination. Connect the ground lead to chassis ground.
- f. Set the square-wave generator output frequency to one kilohertz and the output amplitude for five divisions of deflection.
- g. Compensate the probe as described in the probe instruction manual.
- h. Remove the probe from the INPUT 1 connector and connect it to the INPUT 2 connector.
- i. Set the Mode switch to CH 2.
- j. CHECK—CRT display for less than 0.05 division overshoot or rounding ($\pm 1\%$; see Fig. 6-22C, D and E).
- k. ADJUST—C112 (see Fig. 6-22A) for optimum flat top.
- l. Remove the in-line termination and connect the probe tip directly to the high-amplitude output connector.
- m. INTERACTION—Check step 21.

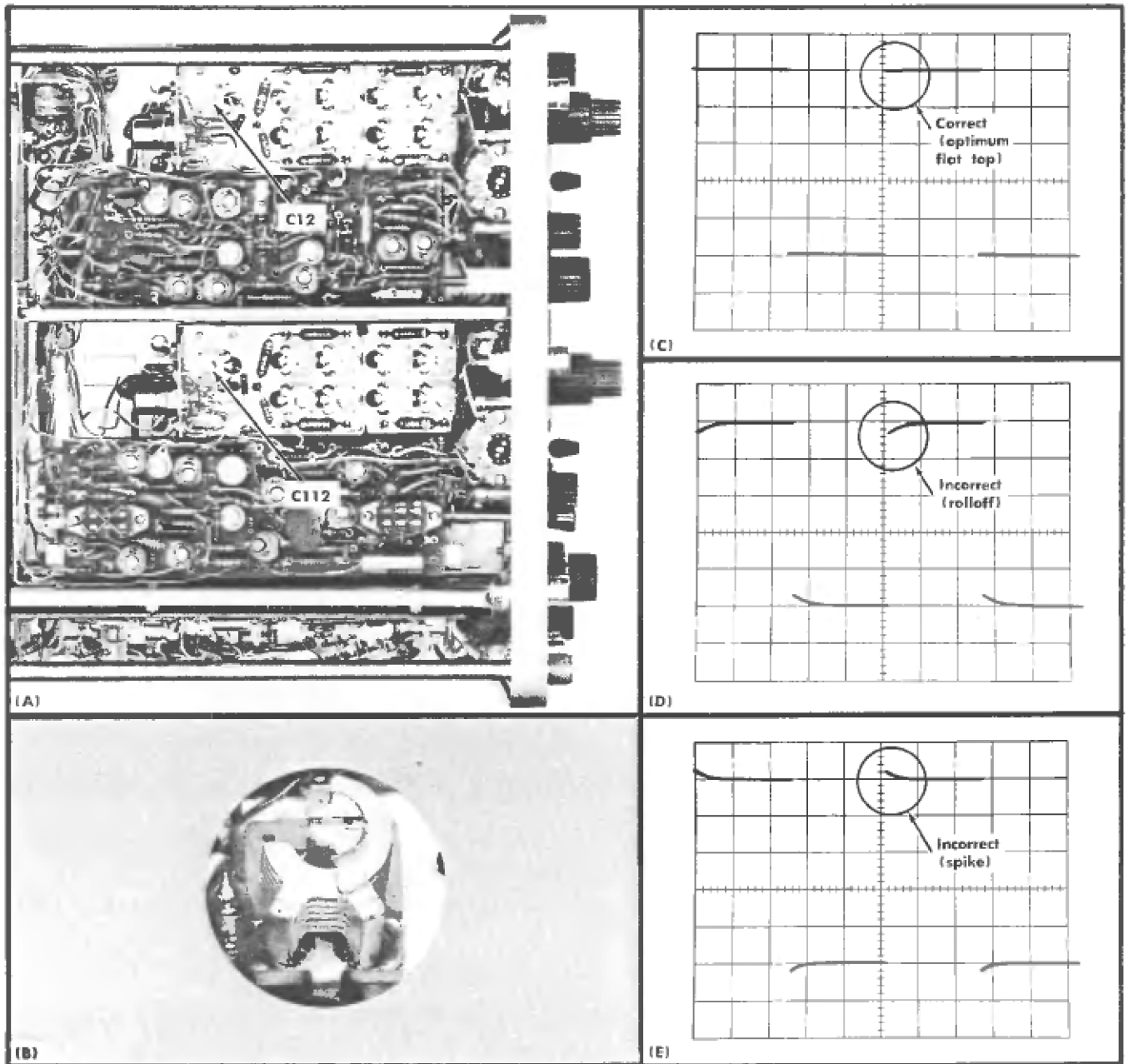

Fig. 6-22. (A) Location of C12 and C112 (bottom view); (B) midrange adjustment of C12; (C) typical CRT display showing correct input capacitance adjustment; (D) and (E) incorrect input capacitance adjustment.

21. Adjust Channel 1 and 2 Volts/Division Switch Compensation

a. CHECK—CRT display at each Channel 2 VOLTS/DIV switch setting listed in Table 6-2 for 3% or less overshoot, rounding or tilt (see Fig. 6-23A, B and C).

b. ADJUST—Channel 2 VOLTS/DIV compensation as shown in Table 6-2. First adjust for optimum square corner on the display and then for optimum flat top. Readjust the generator output with each setting of the VOLTS/DIV switch to provide a five-division display (except in 5 position). Fig. 6-23D shows the location of each variable capacitor.

TABLE 6-2
VOLTS/DIV COMPENSATION

VOLTS/ DIV Switch Setting	Channel 1 Adjust for Optimum		Channel 2 Adjust for Optimum	
	Square Corner	Flat Top	Square Corner	Flat Top
.1	C3C	C3B	C103C	C103B
.2	C4C	C4B	C104C	C104B
.5	C5C	C5B	C105C	C105B
5	C6C	C6B	C106C	C106B

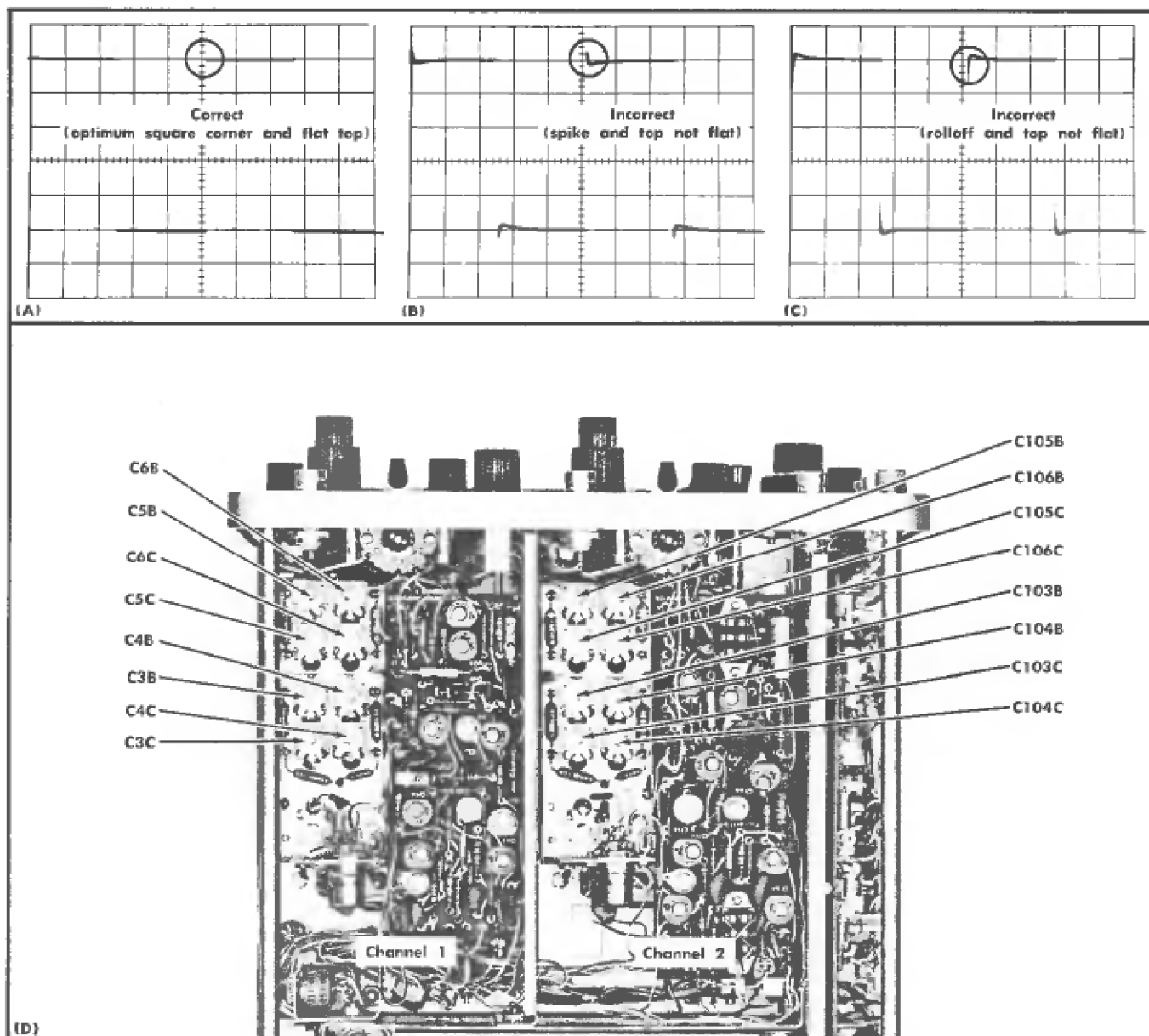

Fig. 6-23. (A) Typical CRT display showing correct VOLTS/DIV compensation; (B) and (C) incorrect compensation; (D) location of variable capacitors (bottom view).

- c. Set the Mode switch to CH 1.
- d. Connect the 10X probe to the INPUT 1 connector.
- e. CHECK—CRT display at each Channel 1 VOLTS/DIV switch setting listed in Table 6-2 for 3% or less overshoot, rounding or tilt (see Fig. 6-23A, B and C).
- f. ADJUST—Channel 1 VOLTS/DIV compensation as shown in Table 6-2. First adjust for optimum square corner on the display and then for optimum flat top. Readjust the generator output with each setting of the VOLTS/DIV switch to provide a five-division display (except in 5 position). Fig. 6-23D shows the location of each variable capacitor.
- g. Disconnect the 10X probe.

22. Adjust High-Frequency Compensation ①

- a. Connect the positive-going fast-rise output of the square-wave generator to the INPUT 1 connector through the five-nanosecond GR cable and the 50-ohm in-line termination.
- b. Change the following control settings:

VOLTS/DIV (both channels)	.05
TIME/DIV	.5 μSEC
×10 Mag	Pulled out

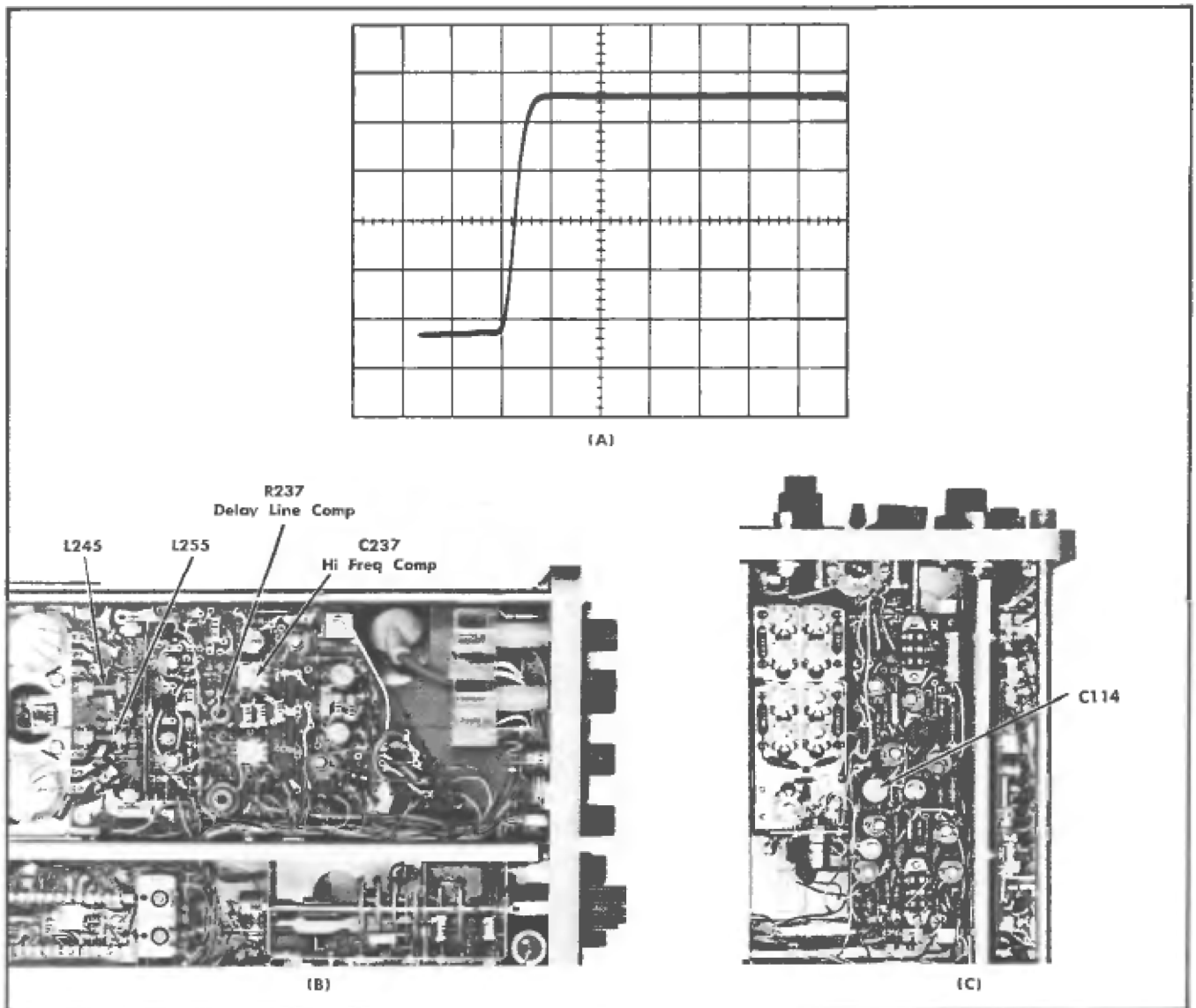

Fig. 6-24. (A) Typical CRT display showing correct high-frequency compensation; (B) location of high-frequency compensation adjustments (Vertical Switching and Output Amplifier board); (C) location of C114 (Channel 2 Input Amplifier board).

- c. Set the square-wave generator for five divisions of deflection at 100 kilohertz.
- d. CHECK—CRT display for optimum square corner and flat top (see Fig. 6-24A).
- e. ADJUST—R237, C237, L245 and L255 in listed order for optimum square corner and flat top. Fig. 6-24B shows the location of these adjustments. Since these adjustments interact, readjust until optimum square corner and flat top are obtained.
- f. Set the Mode switch to CH 2.

- g. Connect the positive-going fast-rise output of the square-wave generator to the INPUT 2 connector through the five-nanosecond GR cable and the 50-ohm in-line termination.
- h. CHECK—CRT display for optimum square-wave response similar to Channel 1 response.
- i. ADJUST—C114 (see Fig. 6-24C) for optimum Channel 2 response similar to Channel 1 response.
- j. Disconnect all test equipment.

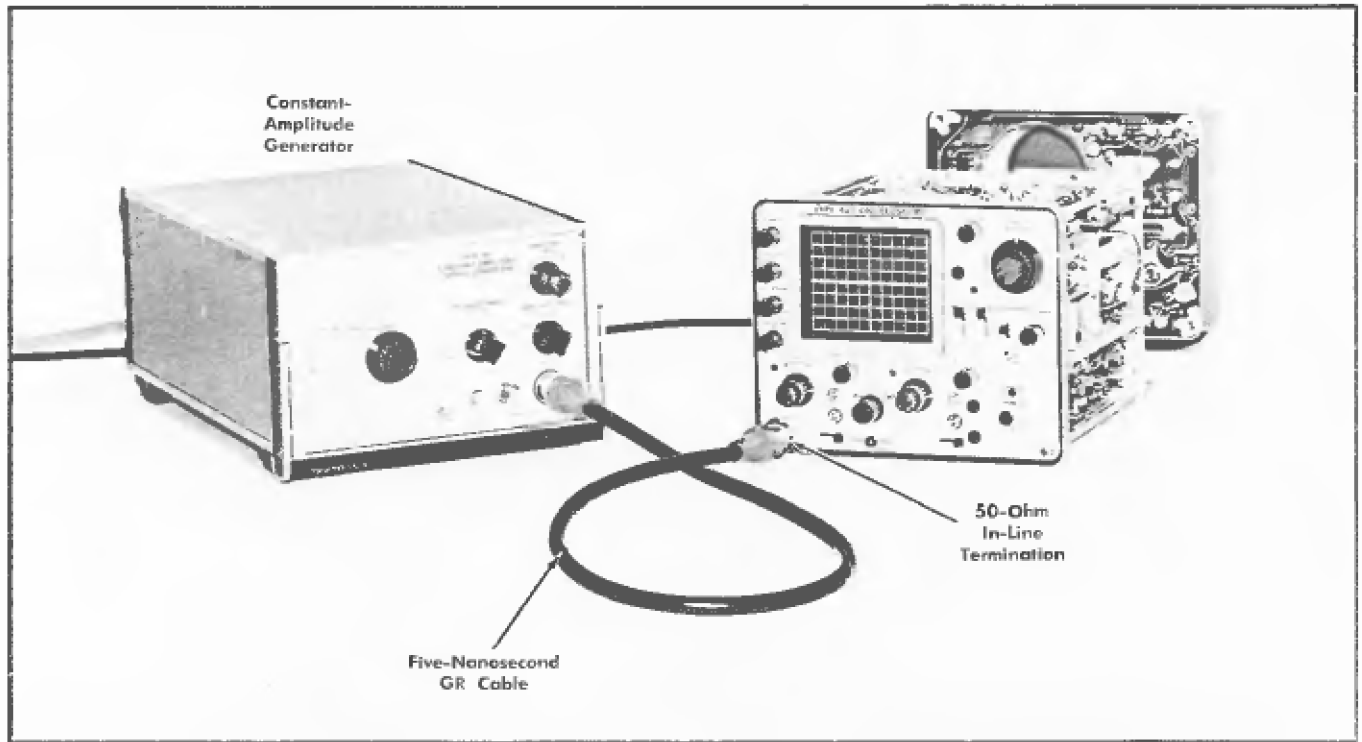

Fig. 6-25. Initial test equipment setup for steps 23—25.

CRT controls

INTENSITY	Midrange
FOCUS	Adjust for correct display
ASTIGMATISM	Adjust for correct display
SCALE ILLUM	As desired

Vertical controls (both channels if applicable)

VOLTS/DIV	.05
VARIABLE	CAL
AC GND DC	DC
POSITION	Midrange
Mode	CH 1
INVERT	Pushed in
×10 GAIN AC	Pushed in

Triggering controls

Source	CH 1 & 2
Coupling	AC
SLOPE	Positive going
LEVEL	FREE RUN

Sweep controls

POSITION	Midrange
TIME/DIV	.5 mSEC
VARIABLE	CAL
×10 MAG	Pushed in

Other controls

POWER	On (at power supply)
-------	----------------------

23. Check Channel 1 and 2 Frequency Response

- a. Test equipment setup is shown in Fig. 6-25.
- b. Connect the constant-amplitude sine-wave generator to the INPUT 1 connector through the five-nanosecond GR cable and the 50-ohm in-line termination.
- c. Set the constant-amplitude generator for six divisions of deflection at 50 kilohertz.
- d. Without changing the output amplitude, increase the output frequency of the constant-amplitude generator until the display is reduced to 4.2 divisions (−3 dB point; see Fig. 6-26).
- e. CHECK—Output frequency of the constant-amplitude generator must be 15 megahertz or higher.
- f. Set the Mode switch to CH 2.
- g. Connect the constant-amplitude generator to the INPUT 2 connector through the five-nanosecond GR cable and the 50-ohm in-line termination.
- h. Set the constant-amplitude generator for six divisions of deflection at 50 kilohertz.
- i. Without changing the output amplitude, increase the output frequency of the constant-amplitude generator until the display is reduced to 4.2 divisions (−3 dB point; see Fig. 6-26).
- j. CHECK—Output frequency of the constant-amplitude generator must be 15 megahertz or higher.

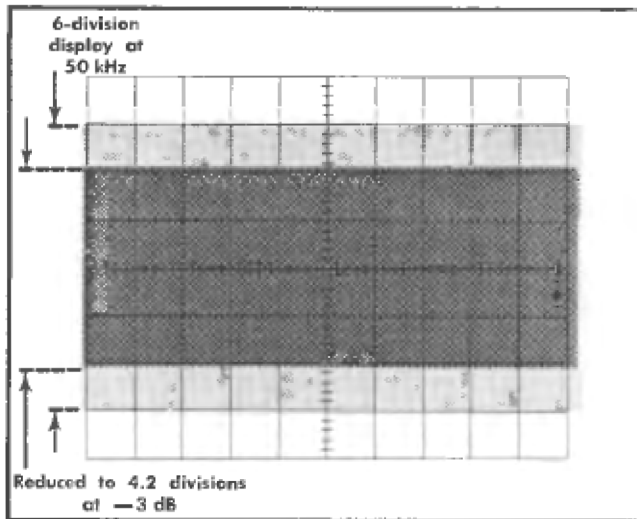

Fig. 6-26. Illustration of CRT display when checking vertical frequency response.

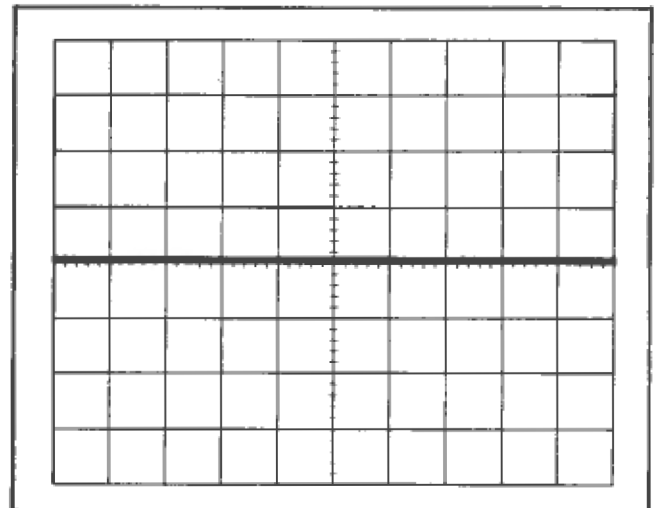

Fig. 6-27. Typical CRT display showing correct common-mode rejection.

24. Check Channel 2 $\times 10$ Gain Frequency Response

- Set the Channel 2 AC GND DC switch to AC.
- Pull the $\times 10$ GAIN AC switch.
- Set the constant-amplitude generator for six divisions of deflection at 50 kilohertz.
- Without changing the output amplitude, increase the output frequency of the constant-amplitude generator until the display is reduced to 4.2 divisions (-3 dB point; see Fig. 6-26).
- CHECK—Output frequency of the constant-amplitude generator must be five megahertz or higher.

25. Check Common-Mode Rejection Ratio

- Connect the constant-amplitude generator to the INPUT 1 connector through the five-nanosecond GR cable, 50-ohm in-line termination and the BNC T connector. Connect the output of the BNC T connector to INPUT 2 with a 50-ohm BNC cable.
- Set the constant-amplitude generator for eight divisions of deflection at 50 kilohertz.
- Change the following control settings:

Mode	ALG ADD
INVERT	Pulled out
$\times 10$ GAIN AC	Pushed in
- CHECK—CRT display 0.1 division or less (common-mode rejection ratio of 100:1 or greater; see Fig. 6-27).
- Disconnect all test equipment.

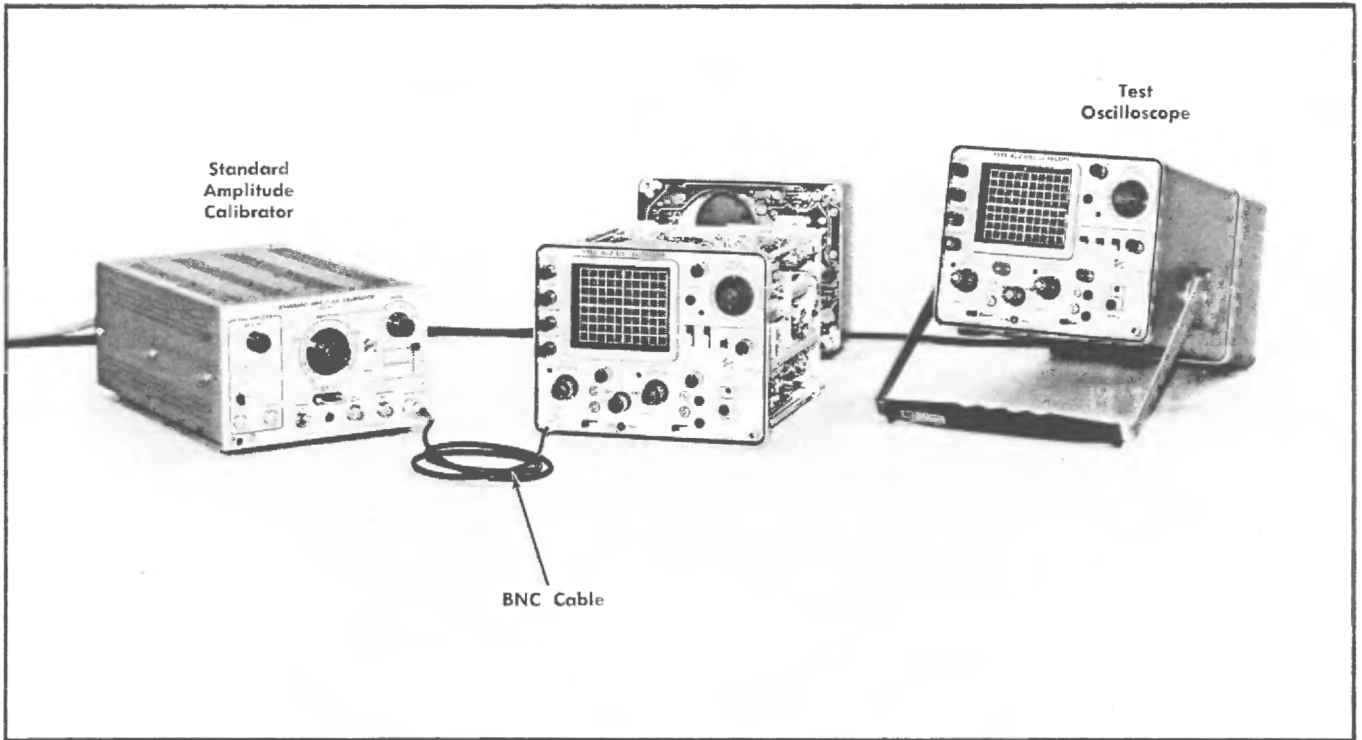

Fig. 6-28. Initial test equipment setup for steps 26 and 27.

CRT controls

INTENSITY	Midrange
FOCUS	Adjust for correct display
ASTIGMATISM	Adjust for correct display
SCALE ILLUM	As desired

Vertical controls (both channels if applicable)

VOLTS/DIV	.01
VARIABLE	CAL
AC GND DC	DC
POSITION	Midrange
Mode	CH 2
INVERT	Pushed in
×10 GAIN AC	Pushed in

Triggering controls

Source	CH 1 & 2
Coupling	AC
SLOPE	Positive going
LEVEL	FREE RUN

Sweep controls

POSITION	Midrange
TIME/DIV	.5 mSEC
VARIABLE	CAL
×10 MAG	Pushed in

Other controls

POWER	On (at power supply)
-------	----------------------

26. Check Channel Isolation Ratio

- Test equipment setup is shown in Fig. 6-28.
- Connect the standard amplitude calibrator to the INPUT 1 connector with the BNC cable.
- Set the Channel 1 VOLTS/DIV switch to 20.
- Set the Channel 2 AC GND DC switch to GND.
- Set the standard amplitude calibrator for a 100-volt square-wave output.

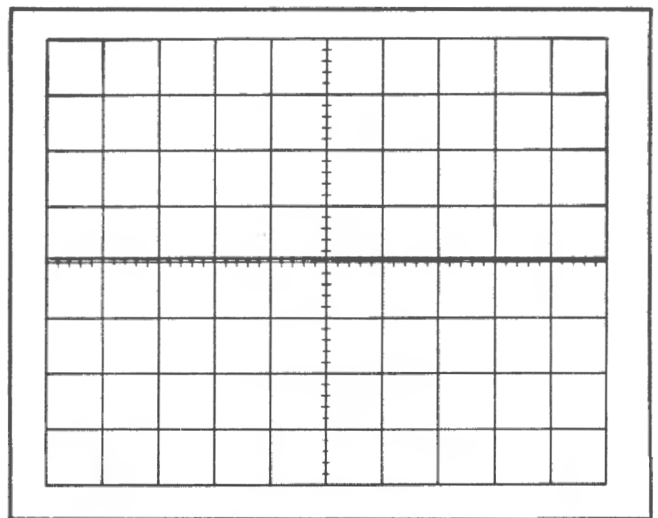

Fig. 6-29. Typical CRT display showing correct channel isolation.

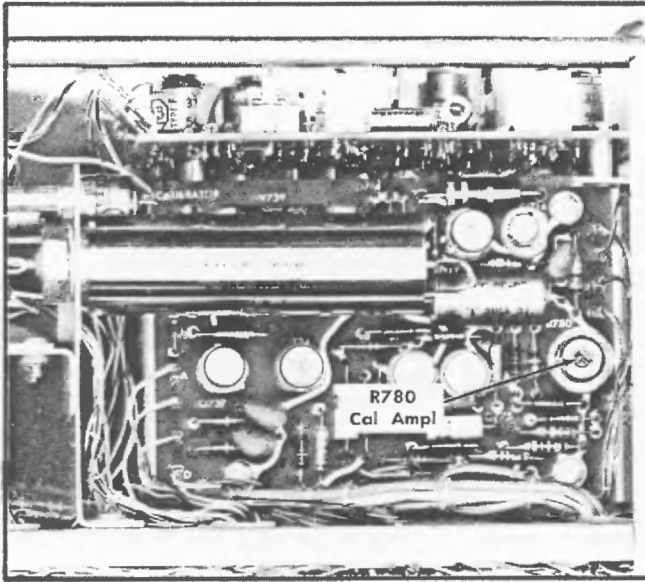

Fig. 6-30. Location of Cal Ampl adjustment (Calibrator and Regulators board).

- f. CHECK—CRT display 0.1 division or less in amplitude (channel isolation 100,000:1 or greater; see Fig. 6-29).
- g. Change the following control settings:

Channel 1 VOLTS/DIV	.01
Channel 2 VOLTS/DIV	20
Channel 1 AC GND DC	GND
Channel 2 AC GND DC	DC
Mode	CH 1
- h. Connect the standard amplitude calibrator to the INPUT 2 connector with the BNC cable.
- i. CHECK—CRT display 0.1 division or less in amplitude (channel isolation 100,000:1 or greater; see Fig. 6-29).

27. Adjust Calibrator Amplitude

- a. Connect the standard amplitude calibrator to the INPUT 1 connector with the BNC cable.
- b. Set the standard amplitude calibrator for a 0.2-volt square-wave output.
- c. Change the following control settings:

VOLTS/DIV	.05
AC GND DC	DC
LEVEL	Adjust for stable display
- d. Note the amplitude of the CRT display. Then, set the Channel 1 VOLTS/DIV switch to the CALIBRATE 4 DIVISIONS position.
- e. CHECK—CRT display for same deflection as obtained in step d.
- f. ADJUST—Cal Ampl adjustment, R780 (see Fig. 6-30) for exactly the same deflection as obtained in step d.

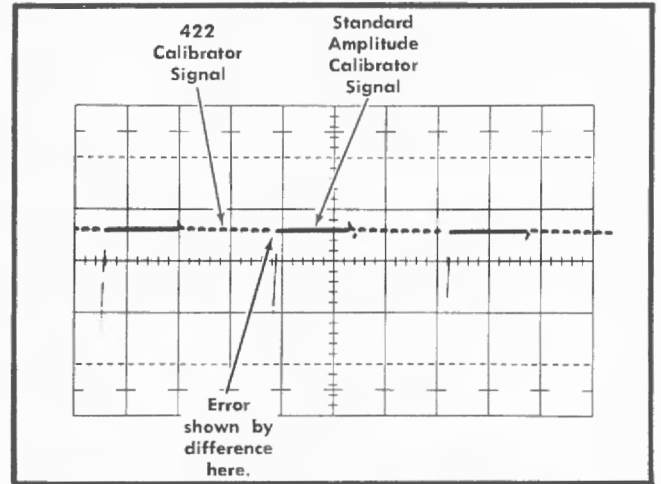

Fig. 6-31. Typical test oscilloscope display when checking external calibrator. Vertical deflection, 0.2 volt/division; sweep rate, five milliseconds/division.

28. Check Calibrator Amplitude at Front-Panel Jack

- a. Connect the CALIBRATOR jack to the unknown input of the standard amplitude calibrator with a jumper lead. The 1X probe can be used for this purpose.
- b. Set the standard amplitude calibrator for a —DC output in the mixed mode.
- c. Connect the standard amplitude calibrator output to the input of the test oscilloscope.
- d. Set the test oscilloscope for a vertical deflection of 0.2 volts/division, DC coupled at a sweep rate of five milliseconds/division.
- e. Set the standard amplitude calibrator output voltage to off and position the top of the display on the screen. Set the triggering controls for a stable display.
- f. Note the difference between the standard amplitude calibrator output (zero-volt level) and the Type 422 CALIBRATOR output level (see Fig. 6-31).
- g. Set the standard amplitude calibrator output voltage to two volts and position the bottom of the display on the screen. Reset the triggering controls for a stable display.
- h. CHECK—Difference between the standard amplitude calibrator output and the Type 422 CALIBRATOR output level within ± 0.27 division of the difference measured in step f ($\pm 2.7\%$).
- i. Disconnect the standard amplitude calibrator.

29. Check Calibrator Repetition Rate and Duty Cycle

- a. Connect the CALIBRATOR jack to the input of the test oscilloscope with a jumper lead. The 1X probe can be used for this purpose.
- b. Set the test oscilloscope for a vertical deflection of 0.5 volt/divisions and a sweep rate of 0.2 millisecond/division.

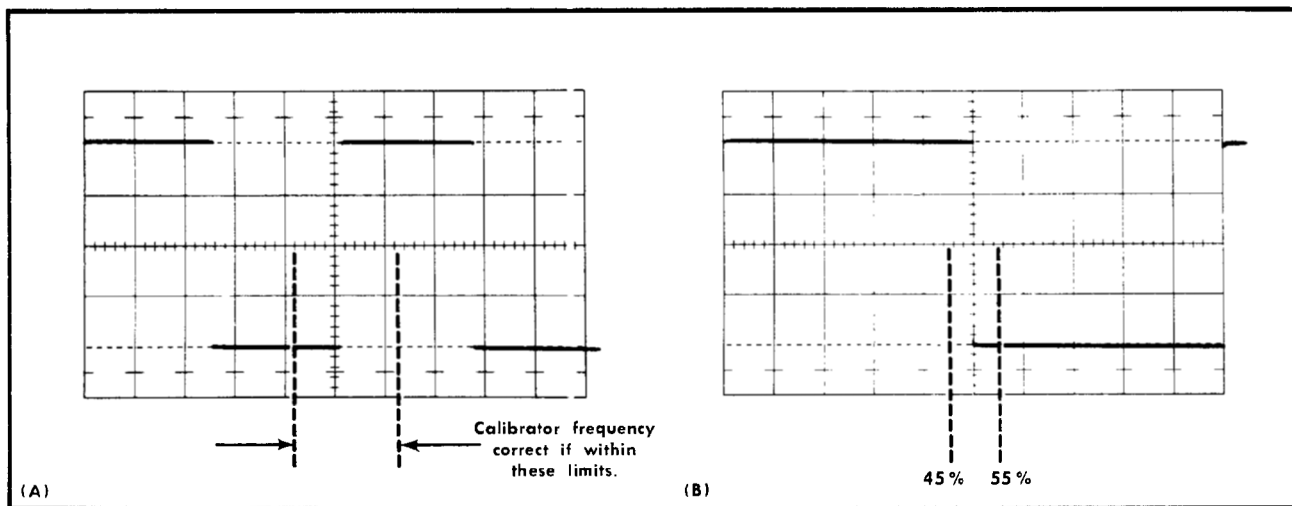

Fig. 6-32. Typical test oscilloscope display when checking (A) calibrator repetition rate: Vertical deflection, 0.5 volts/division; sweep rate, 0.2 milliseconds/division. (B) Duty cycle: Vertical deflection, 0.5 volts/division; sweep rate, 50 microseconds/division.

c. CHECK—Test oscilloscope display for duration of one complete cycle between 4.15 and 6.25 divisions (1 kilohertz, $\pm 20\%$; see Fig. 6-32A).

d. Set the test oscilloscope sweep rate to 50 microseconds/division and set the VARIABLE TIME/DIV control for one

complete cycle in ten divisions.

e. CHECK—Test oscilloscope display for length of the positive segment of the square wave between 4.5 and 5.5 divisions (duty cycle 45% to 55%; see Fig. 6-32B).

f. Disconnect all test equipment.

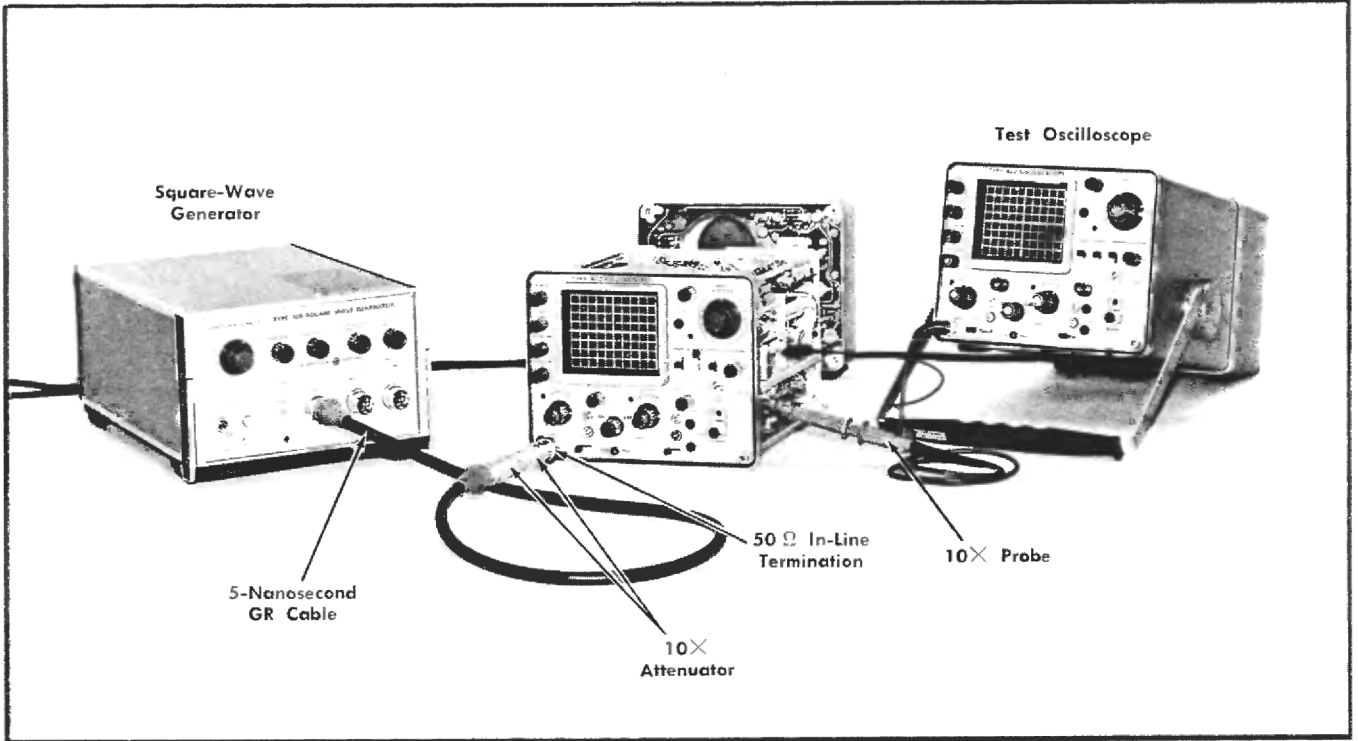

Fig. 6-33. Initial test equipment setup for steps 30—33.

CRT controls

INTENSITY	Midrange
FOCUS	Adjust for correct display
ASTIGMATISM	Adjust for correct display
SCALE ILLUM	As desired

Vertical controls (both channels if applicable)

VOLTS/DIV	.05
VARIABLE	CAL
AC GND DC	GND
POSITION	Midrange
Mode	CH 1
INVERT	Pushed in
×10 GAIN AC	Pushed in

Triggering controls

Source	CH 1
Coupling	AC
SLOPE	Positive going
LEVEL	Midrange

Sweep controls

POSITION	Midrange
TIME/DIV	.5 mSEC
VARIABLE	CAL
×10 MAG	Pushed in

Other controls

POWER	On (at power supply)
-------	----------------------

30. Adjust Internal Trigger Compensation

- a. Test equipment setup is shown in Fig. 6-33.
- b. Remove Q364 from its socket (see Fig. 6-34A).
- c. Connect the square-wave generator high-amplitude output to the INPUT 1 connector through the five-nanosecond GR cable, two 10× attenuators and the 50-ohm in-line termination.
- d. Set the square-wave generator output frequency to 10 kilohertz.
- e. Connect the 10× probe to the input of the test oscilloscope. Connect the probe tip to the Trigger Compensation Test Point (base of Q364; see Fig. 6-34A). Be sure the probe is compensated.
- f. Set the test oscilloscope for a vertical deflection factor of 0.05 volt/division at a sweep rate of 20 microseconds/division.
- g. Establish the zero-volt level on the test oscilloscope CRT (use the ground position of input switch). Then set the LEVEL control to provide a zero-volt level at the Trigger Compensation Test Point.
- h. Set the Channel 1 AC GND DC switch to DC.
- i. Set the square-wave generator for about two divisions of display on the test oscilloscope.
- j. CHECK—Test oscilloscope display for optimum square-wave response (see Fig. 6-34B).
- k. ADJUST—C353 (see Fig. 6-34A) for optimum square-wave response.

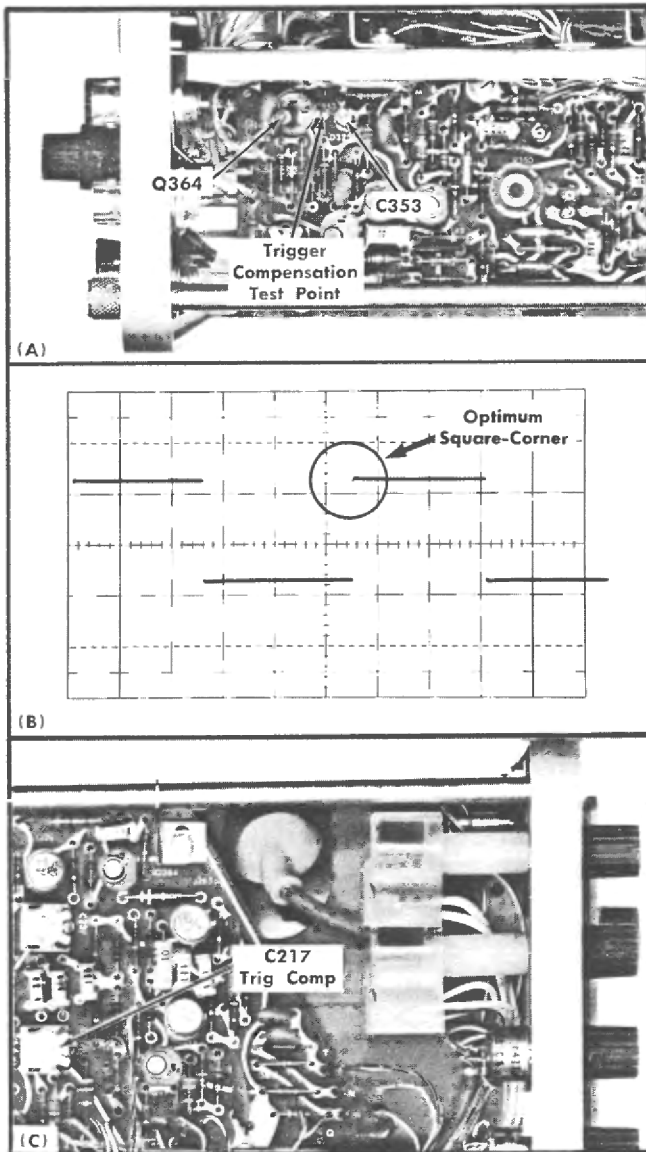

Fig. 6-34. (A) Location of trigger compensation test point and adjustment (Trigger/Sweep Generator board); (B) typical test oscilloscope display showing correct compensation; (C) location of C217 (Vertical Switching and Output Amplifier board).

- l. Set the Triggering Source switch to CH 1 & 2.
- m. CHECK—Test oscilloscope display for optimum square-wave response (see Fig. 6-34B).
- n. ADJUST—C217 (see Fig. 6-34C) for optimum square-wave response.

31. Adjust External Trigger Compensation ①

- a. Disconnect the square-wave generator from the INPUT 1 connector and connect it to the TRIG IN connector through the five-nanosecond GR cable, 10× attenuator and the 50-ohm in-line termination.
- b. Set the Triggering Source switch to EXT.

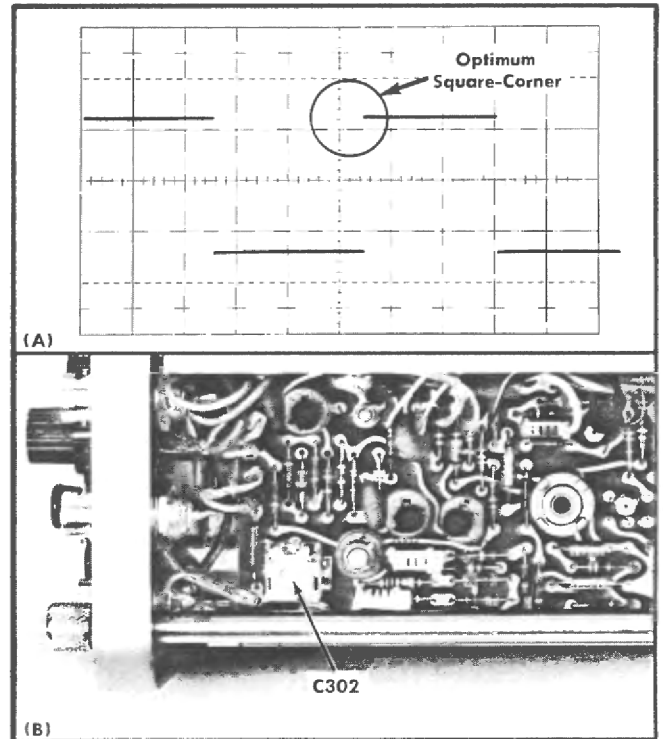

Fig. 6-35. (A) Typical test oscilloscope display showing correct compensation; (B) location of C302 (Trigger/Sweep Generator board).

- c. Set the square-wave generator for about two divisions of display on the test oscilloscope.
- d. CHECK—Test oscilloscope display for optimum square-wave response (see Fig. 6-35A).
- e. ADJUST—C302 (see Fig. 6-35B) for optimum square-wave response.

32. Check Trigger Limiting

- a. Turn the LEVEL control fully clockwise (not in FREE RUN detent).
- b. CHECK—Test oscilloscope display reduced to 0.2 division or less (trigger limiting 10:1 or greater).
- c. Turn the LEVEL control fully counterclockwise (not in AUTO detent).
- d. CHECK—Test oscilloscope display reduced to 0.2 division or less (trigger limiting 10:1 or greater).
- e. Replace Q364 and disconnect the square-wave generator.

33. Adjust Auto Center ①

- a. Set the Triggering Source switch to CH 1 & 2.
- b. Set the LEVEL control to AUTO.
- c. Set the test oscilloscope for a vertical deflection of 10 millivolts/division at a sweep rate of five milliseconds/division.

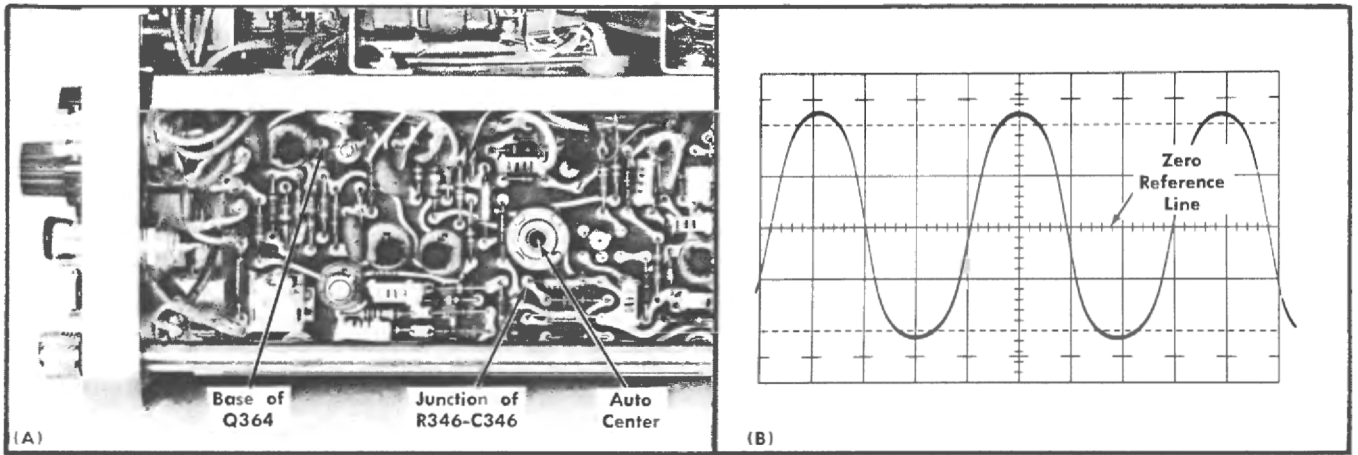

Fig. 6-36. (A) Location of auto trigger test points and Auto Center adjustment (Trigger/Sweep Generator board); (B) typical test oscilloscope display of auto trigger waveform.

- d. Establish the zero-volt level on the test oscilloscope CRT (use ground position of input switch).
- e. Connect the $5\ \mu\text{F}$ capacitor between the base of Q364 and the junction of R346-C346 (see Fig. 6-36A).
- f. CHECK—Test oscilloscope trace at zero volt level.
- g. ADJUST—Auto Center adjustment, R350 (see Fig. 6-36A),

for zero volt indication on test oscilloscope.

- h. Remove the $5\ \mu\text{F}$ capacitor.
- i. CHECK—Test oscilloscope display for waveform amplitude of at least 1.6 divisions above zero reference level and at least two divisions below zero reference level (see Fig. 6-36B).
- j. Disconnect all test equipment.

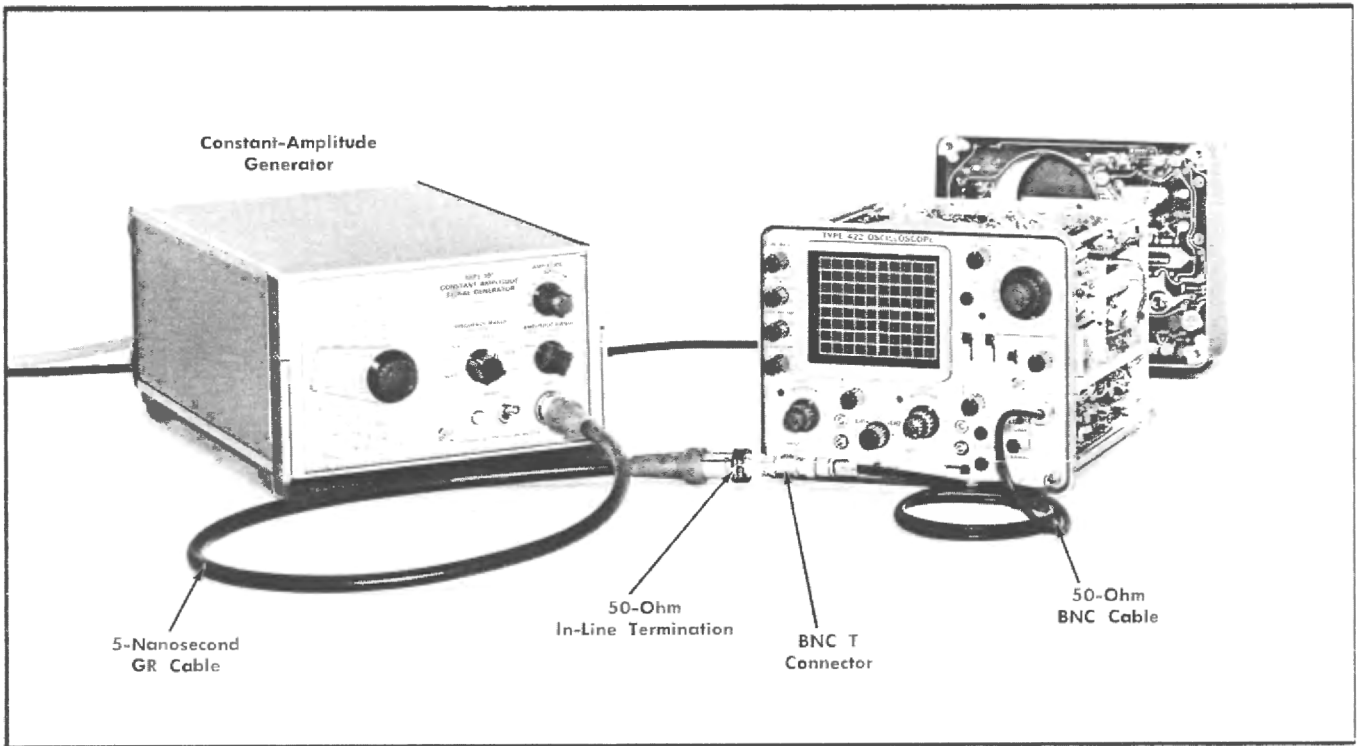

Fig. 6-37. Initial test equipment setup for steps 34 and 35.

CRT controls

INTENSITY	Midrange
FOCUS	Adjust for correct display
ASTIGMATISM	Adjust for correct display
SCALE ILLUM	As desired

Vertical controls (both channels if applicable)

VOLTS/DIV	0.2
VARIABLE	CAL
AC GND DC	DC
POSITION	Midrange
Mode	CH 1
INVERT	Pushed in
×10 GAIN AC	Pushed in

Triggering controls

Source	CH 1 & 2
Coupling	AC
SLOPE	Positive going
LEVEL	Midrange

Sweep controls

POSITION	Midrange
TIME/DIV	.5 μSEC
VARIABLE	CAL
×10 MAG	Pushed in

Other controls

POWER	On (at power supply)
-------	----------------------

34. Check Internal Trigger Sensitivity

- a. Test equipment setup is shown in Fig. 6-37.
- b. Connect the constant-amplitude sine-wave generator to the INPUT 1 connector through the five-nanosecond GR cable, 50-ohm in-line termination and the BNC T connector. Connect the output of the BNC T connector to the TRIG IN connector through a 50-ohm BNC cable.
- c. Set the constant-amplitude generator for a 0.2- division CRT display at five megahertz.
- d. CHECK—Stable CRT display can be obtained with the Triggering Coupling switch set to AC, AC LF REJ and DC (see Fig. 6-38A). Adjust the LEVEL control as necessary to obtain a stable display.
- e. Set the constant-amplitude generator for a one-division CRT display at 15 megahertz.
- f. Pull the ×10 MAG switch.
- g. CHECK—Stable CRT display can be obtained with the Triggering Coupling switch set to AC, AC LF REJ and DC (see Fig. 6-38B). Adjust the LEVEL control as necessary to obtain a stable display.
- h. Set the LEVEL control to the AUTO position.
- i. Push in the ×10 MAG switch.
- j. Set the constant-amplitude generator for a 0.8-division CRT display at four megahertz.

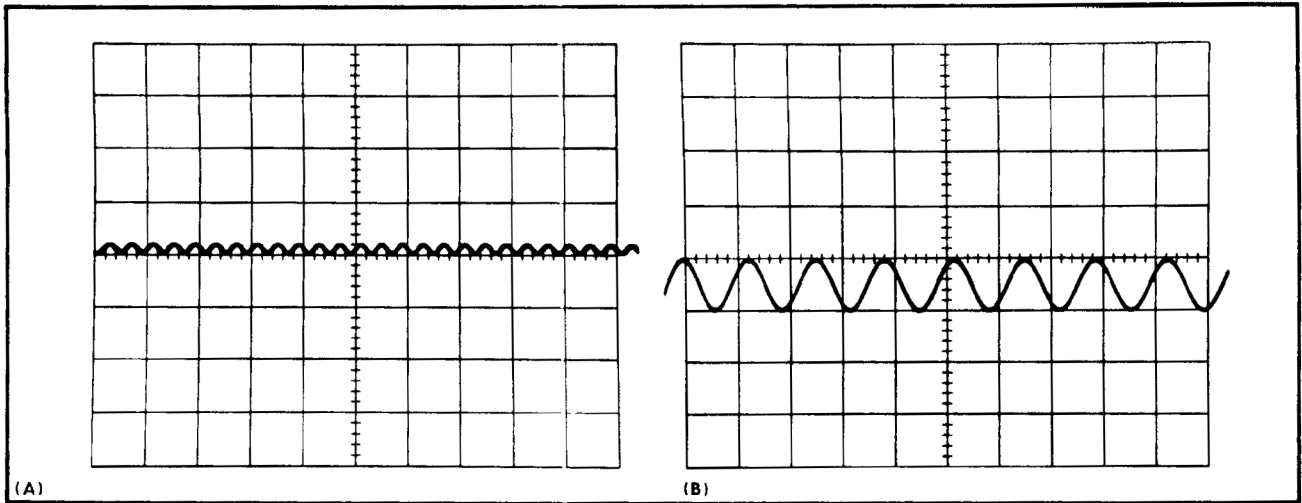

Fig. 6-38. (A) Typical CRT display when checking internal triggering at five megahertz; (B) typical CRT display when checking internal triggering at 15 megahertz.

- k. CHECK—CRT display is stable.
- l. Set the constant-amplitude generator for a 2.5-division CRT display at 15 megahertz.
- m. Pull the $\times 10$ MAG switch.
- n. CHECK—CRT display is stable.

35. Check External Trigger Sensitivity

- a. Set the Triggering Source switch to EXT.
- b. Push in the $\times 10$ MAG switch.
- c. Set the constant-amplitude generator for a three-division CRT display (0.6 volt) at 50 kilohertz.
- d. Set the constant-amplitude generator output frequency to seven megahertz.
- e. Set the TIME/DIV switch to $.5 \mu\text{SEC}$.
- f. CHECK—CRT display is stable.
- g. Set the constant-amplitude generator for a six-division CRT display (1.2 volts) at 50 kilohertz.
- h. Without changing the output amplitude, set the constant-amplitude generator output frequency to 15 megahertz.
- i. Pull the $\times 10$ MAG switch.

- j. CHECK—CRT display is stable.
- k. Set the Channel 1 VOLTS/DIV switch to .05.
- l. Push in the $\times 10$ MAG switch.
- m. Set the constant-amplitude generator for a 2.5-division CRT display (0.125 volt) at 50 kilohertz.
- n. Without changing the output amplitude, set the constant-amplitude generator output frequency to five megahertz.
- o. CHECK—Stable CRT display can be obtained with the Triggering Coupling switch set to AC, AC LF REJ and DC. Adjust the LEVEL control as necessary to obtain a stable display.
- p. Set the Channel 1 VOLTS/DIV switch to .1.
- q. Set the constant-amplitude generator for a six-division CRT display (0.6 volt) at 50 kilohertz.
- r. Without changing the output amplitude, set the constant-amplitude generator output frequency to 15 megahertz.
- s. Pull the $\times 10$ MAG switch.
- t. CHECK—Stable CRT display can be obtained with Triggering Coupling switch set to AC, AC LF REJ and DC. Adjust the LEVEL control as necessary to obtain a stable display.
- u. Disconnect all test equipment.

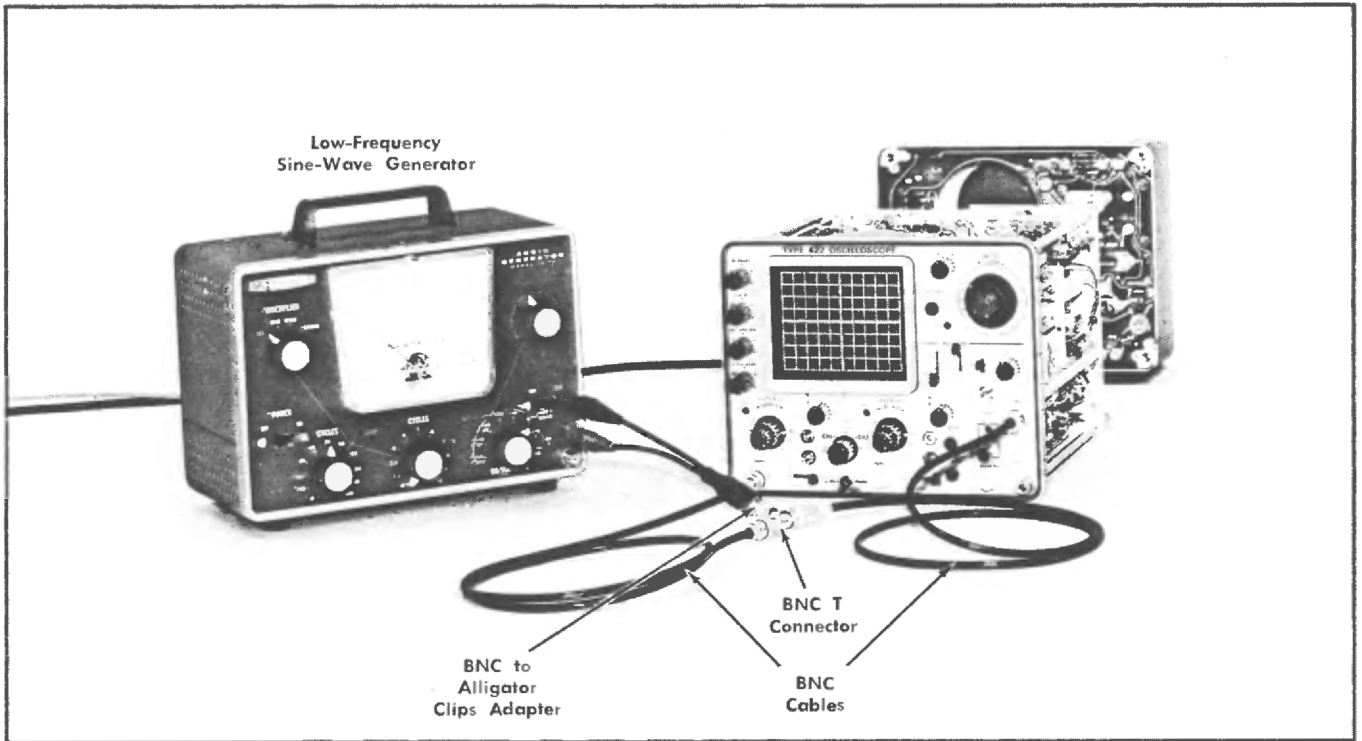

Fig. 6-39. Initial test equipment setup for steps 36 and 37.

CRT controls

INTENSITY	Midrange
FOCUS	Adjust for correct display
ASTIGMATISM	Adjust for correct display
SCALE ILLUM	As desired

Vertical controls (both channels if applicable)

VOLTS/DIV	.05
VARIABLE	CAL
AC GND DC	DC
POSITION	Midrange
Mode	CH 1
INVERT	Pushed in
×10 GAIN AC	Pushed in

Triggering controls

Source	EXT
Coupling	AC
SLOPE	Positive going
LEVEL	Midrange

Sweep controls

POSITION	Midrange
TIME/DIV	5 mSEC
VARIABLE	CAL
×10 MAG	Pushed in

Other controls

POWER	On (at power supply)
-------	----------------------

36. Check Low-Frequency Triggering and Low-Frequency Reject Operation

- a. Test equipment setup is shown in Fig. 6-39.
- b. Connect the low-frequency sine-wave generator to both the INPUT 1 connector and the TRIG IN connector through a BNC T connector and two BNC cables (use the BNC to alligator clips adapter to connect the generator output to the BNC cable).
- c. Set the low-frequency sine-wave generator for a 2.5-division display (0.125 volt) at 50 hertz.
- d. CHECK—Stable CRT display can be obtained with the Triggering Coupling switch set to AC and DC. Adjust the LEVEL control as necessary to obtain a stable display.
- e. Set the Triggering Coupling switch to AC LF REJ.
- f. CHECK—Stable CRT display cannot be obtained at any setting of the LEVEL control.
- g. Set the LEVEL control to AUTO.
- h. Set the VOLTS/DIV switch to .1.
- i. Set the low-frequency sine-wave generator for a six-division display (0.6 volt) at 50 hertz.
- j. CHECK—CRT display is not stable.
- k. CHECK—CRT display is stable in the AC and DC positions of the Triggering Coupling switch.
- l. Set the Triggering Source switch to CH 1 & 2.

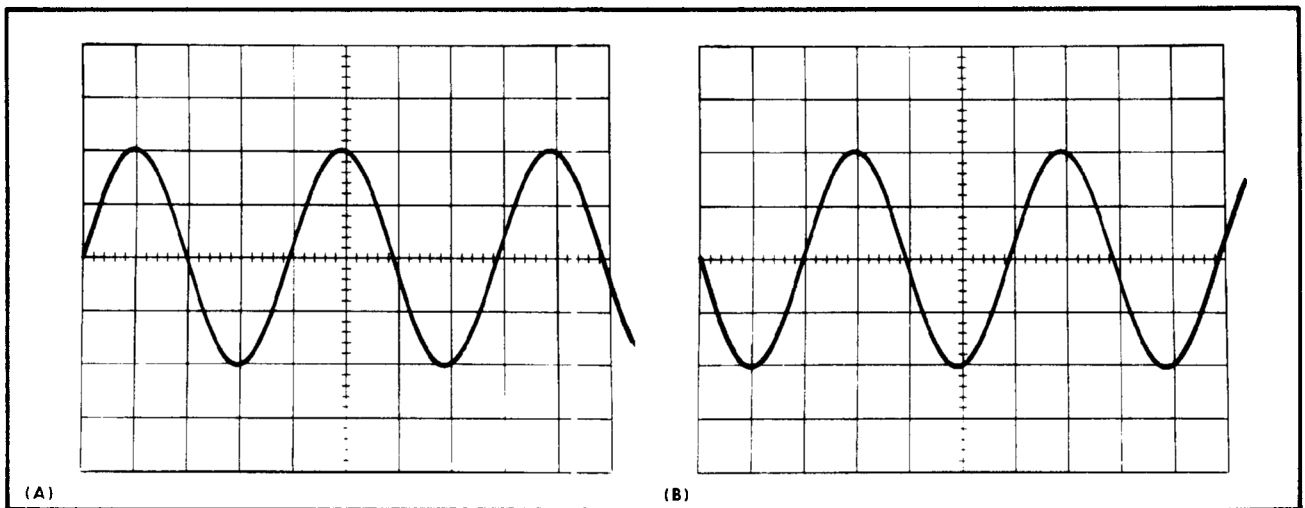

Fig. 6-40. Typical CRT display when checking SLOPE switch operation; (A) positive going; (B) negative going.

- m. Set the low-frequency sine-wave generator for a 0.8-division display at 50 hertz.
- n. CHECK—CRT display is stable in the AC and DC positions of the Triggering Coupling switch.
- o. Set the Triggering Coupling switch to AC LF REJ.
- p. CHECK—CRT display is not stable.
- q. Set the low-frequency sine-wave generator for a 0.2-division display at 50 hertz (AC position of Triggering Coupling switch must be used to set display amplitude; return switch to AC LF REJ position).
- r. CHECK—Stable CRT display cannot be obtained at any setting of the LEVEL control.

s. CHECK—Stable CRT display can be obtained with the Triggering Coupling switch set to AC and DC. Adjust the LEVEL control as necessary to obtain a stable display.

37. Check Slope Switch Operation

- a. Set the low-frequency sine-wave generator for a four-division display.
- b. CHECK—CRT display starts on the positive-going slope of the waveform (see Fig. 6-40A).
- c. Set the SLOPE switch to the negative-going position.
- d. CHECK—CRT display starts on the negative-going slope of the waveform (see Fig. 6-40B).
- e. Disconnect all test equipment.

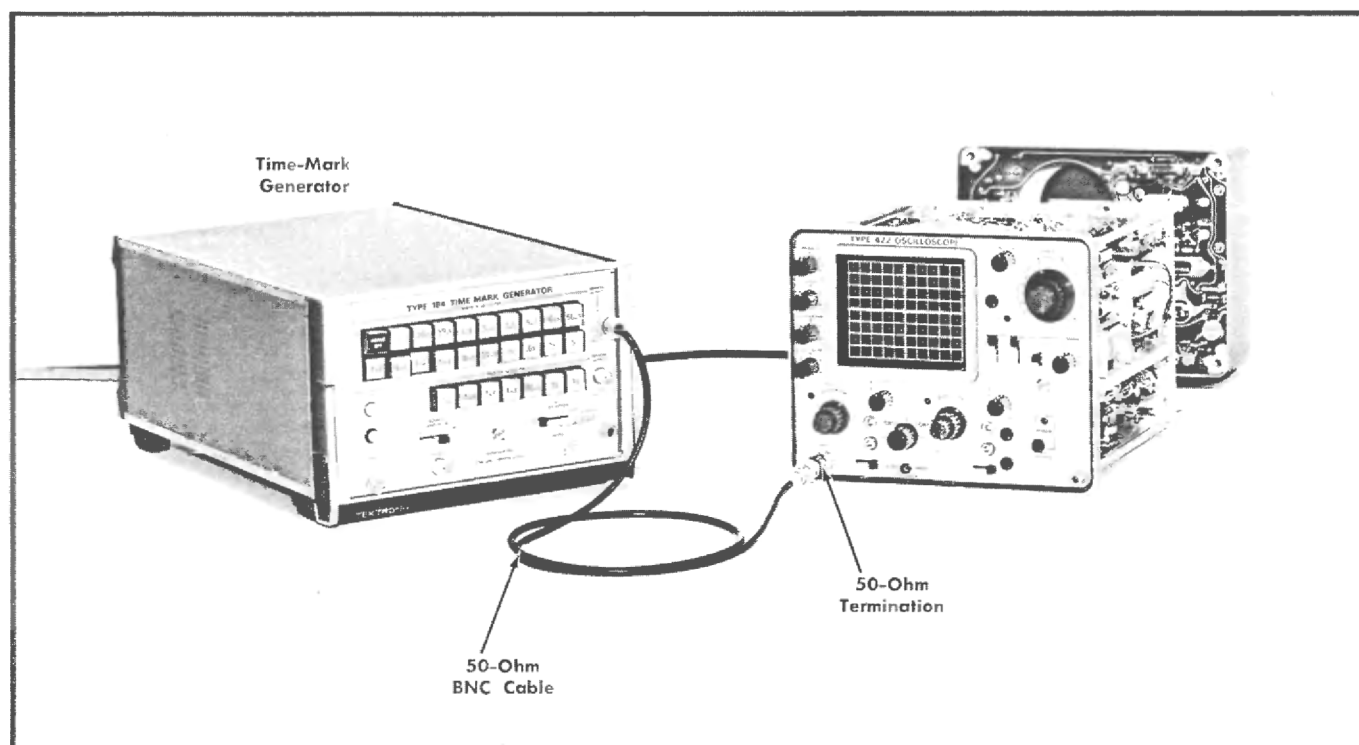

Fig. 6-41. Initial test equipment setup for steps 38—47.

CRT controls

INTENSITY	Midrange
FOCUS	Adjust for correct display
ASTIGMATISM	Adjust for correct display
SCALE ILLUM	As desired

Vertical controls (both channels if applicable)

VOLTS/DIV	.5
VARIABLE	CAL
AC GND DC	DC
POSITION	Midrange
Mode	CH 1
INVERT	Pushed in
×10 GAIN AC	Pushed in

Triggering controls

Source	CH 1 & 2
Coupling	AC
SLOPE	Positive going
LEVEL	Stable display

Sweep controls

POSITION	Midrange
TIME/DIV	1 mSEC
VARIABLE	CAL
×10 MAG	Pushed in

Other controls

POWER	On (at power supply)
-------	----------------------

38. Adjust Sweep Calibration

- a. Test equipment setup is given in Fig. 6-41.
- b. Connect the time-mark generator to the INPUT 1 connector through a 50-ohm BNC cable and a 50-ohm termination.
- c. Set the time-mark generator for one-millisecond and 0.1-millisecond markers.
- d. Set the LEVEL control for a stable display.
- e. CHECK—CRT display for one large marker each division between the first and ninth graticule lines (see Fig. 6-42A). With the second marker positioned to the first graticule line, the tenth marker must be within ± 0.24 division of the ninth graticule line (within $\pm 3\%$).
- f. ADJUST—Sweep Cal adjustment, R512 (see Fig. 6-42B) for one large marker each division between the first and ninth graticule lines.
- g. INTERACTION—Check steps 39 to 47.

39. Check Sweep Length

- a. Position the tenth marker to the center vertical line with the Horizontal POSITION control (see Fig. 6-43).
- b. CHECK—Sweep length between 10.4 and 12.1 divisions as shown by 0.4 to 2.1 divisions of display to the right of the vertical center line (see Fig. 6-43). Large markers in the display indicate divisions and small markers 0.1 division.

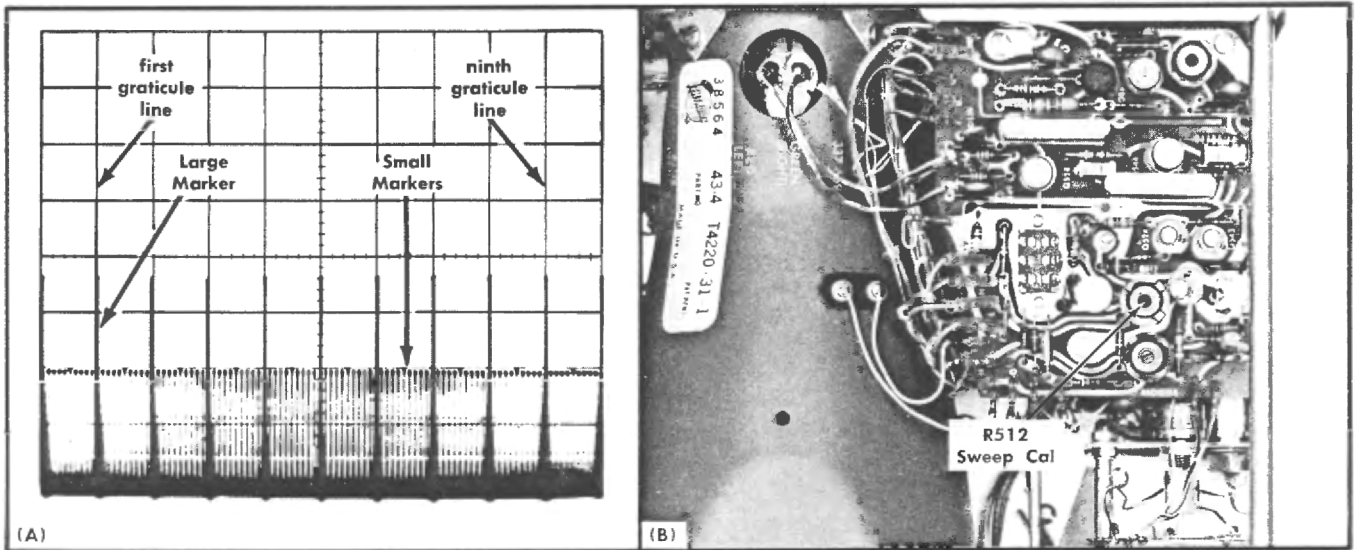

Fig. 6-42. (A) Typical CRT display showing correct sweep calibration; (B) location of Sweep Cal adjustment (Horizontal Amplifier board).

40. Adjust Normal/Magnified Registration

- a. Pull the $\times 10$ MAG switch out.
- b. Position the first marker to the center vertical line (see Fig. 6-44A) with the Horizontal POSITION control. Use the fine range of the POSITION control for precise positioning (see Operating Instructions for operation).
- c. Push the $\times 10$ MAG switch in.
- d. CHECK—First marker within ± 0.2 division of the center vertical line (see Fig. 6-44B).
- e. ADJUST—Mag Register adjustment, R535 (see Fig. 6-44C) to position the first marker to the center vertical line.
- f. Repeat steps a through e until no trace shift occurs when the MAG switch is pushed in.
- g. Pull the $\times 10$ MAG switch out.
- h. Position the sixth marker to the center vertical line.
- i. Push the $\times 10$ MAG switch in.
- j. CHECK—Sixth marker within ± 0.2 division of the center vertical line.

41. Check Magnified Timing and Linearity

- a. Pull the $\times 10$ MAG switch out.
- b. Position the first large marker to the left graticule line.
- c. CHECK—CRT display for one small marker each division between the first and ninth graticule line (see Fig. 6-45). With the second marker positioned to the first graticule line, the tenth marker must be within ± 0.16 division of the ninth graticule line (timing within $\pm 2\%$ when normal sweep calibration, step 38, is adjusted correctly; otherwise check within $\pm 5\%$).

d. CHECK—Each marker in CRT display must be within ± 0.08 division of its respective graticule line (linearity within 1%; see Fig. 6-45).

e. Repeat check for each eight division portion of the magnified sweep.

42. Check Variable Time Division Control Range

- a. Push the $\times 10$ MAG switch in.
- b. Set the time-mark generator for 10-millisecond markers.
- c. Position the two markers on the display to the left and right graticule lines with the Horizontal POSITION control.
- d. Turn the VARIABLE TIME/DIV control fully counterclockwise.

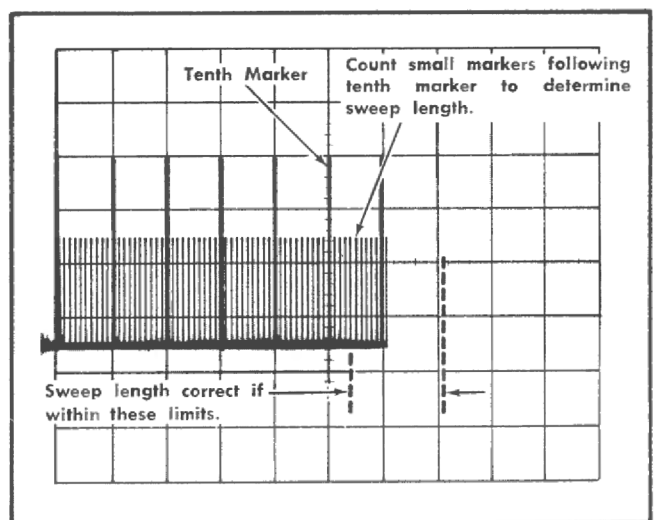

Fig. 6-43. Typical CRT display when checking sweep length.

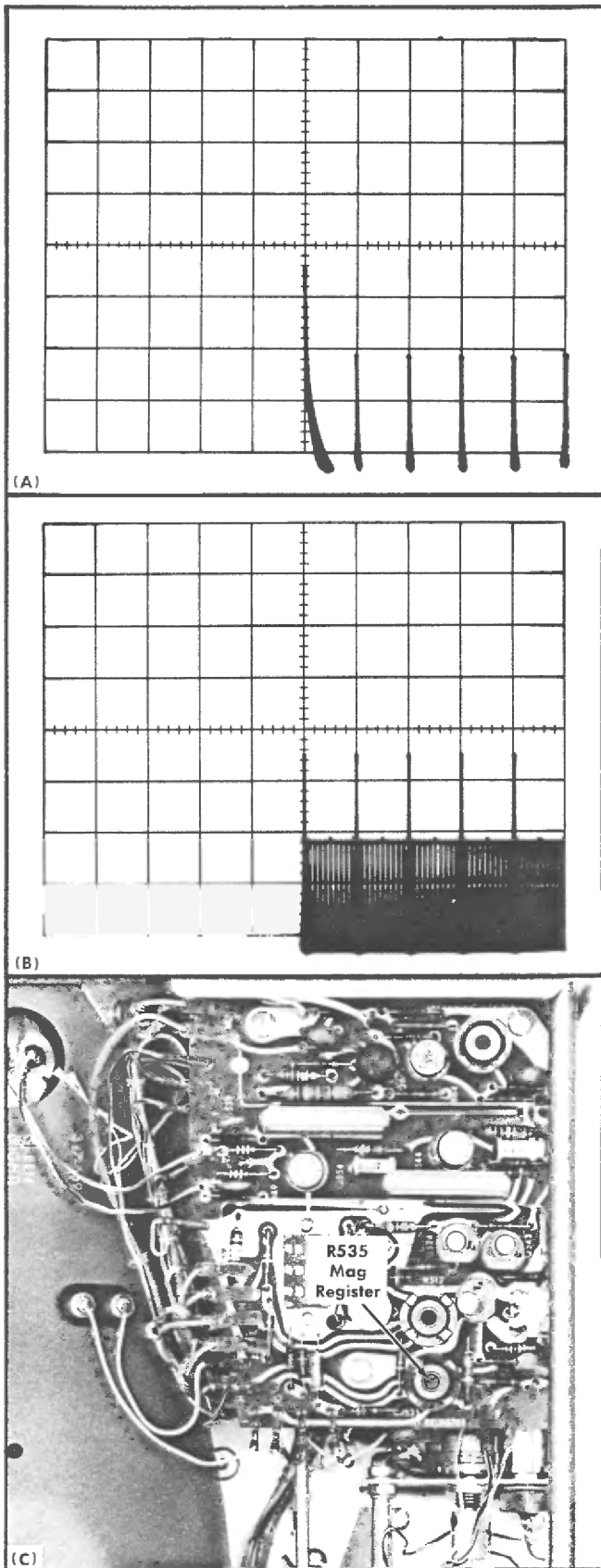

Fig. 6-44. Typical CRT display showing correct magnifier register. (A) $\times 10$ MAG switch pulled out; (B) $\times 10$ MAG switch pushed in; (C) location of Mag Register adjustment (Horizontal Amplifier board).

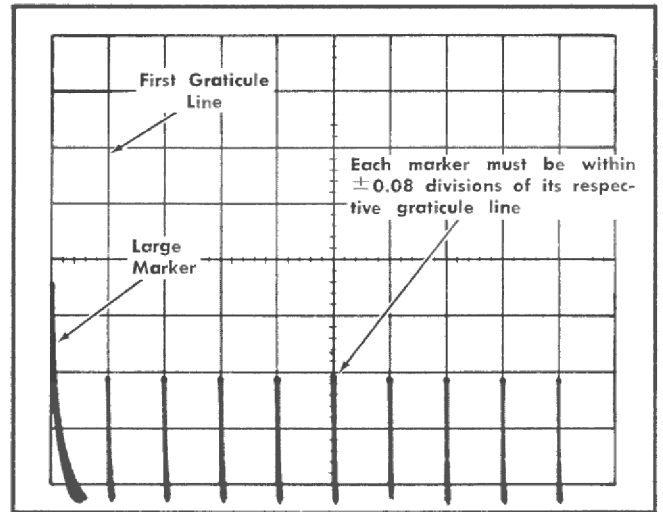

Fig. 6-45. Typical CRT display when checking magnifier timing and linearity.

- e. CHECK—CRT display for four-division maximum spacing between markers (2.5:1 range; see Fig. 6-46). UNCAL light must be on when VARIABLE TIME/DIV control is not in CAL position.

43. Adjust 10 Microsecond Timing ①

- a. Set the time-mark generator for 10-microsecond markers.
- b. Set the TIME/DIV switch to 10 μ SEC.
- c. Set the VARIABLE VOLTS/DIV control to CAL.
- d. CHECK—CRT display for one marker each division between first and ninth graticule lines (see Fig. 6-47A).
- e. ADJUST—C440A (see Fig. 6-47B) for one marker each division between the first and ninth graticule lines.

44. Adjust 0.5 Microsecond Timing ①

- a. Set the time-mark generator for 0.5-microsecond markers.
- b. Set the TIME/DIV switch to .5 μ SEC.
- c. CHECK—CRT display for one marker each division between the first and ninth graticule lines (see Fig. 6-48A).
- d. ADJUST—C537 (see Fig. 6-48B) for one marker each division between the first and ninth graticule lines.
- e. Set the TIME/DIV switch to 1 μ SEC.
- f. CHECK—CRT display for two markers each division between the first and ninth graticule lines. If necessary, compromise the setting of C537 for minimum timing error in the .5 μ SEC and 1 μ SEC positions (adjustment has greatest effect on first division of display in the .5 μ SEC position).

45. Adjust 0.5 Microsecond $\times 10$ Magnifier Timing ①

- a. Set the time-mark generator for 50-nanosecond markers.
- b. Set the TIME/DIV switch to .5 μ SEC.

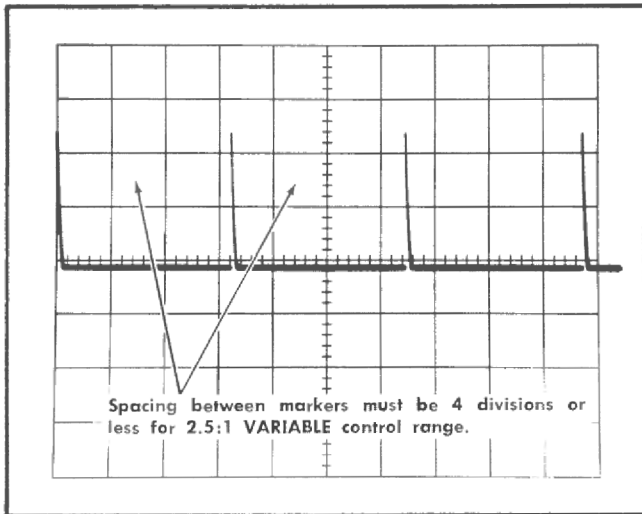

Fig. 6-46. Typical CRT display when checking VARIABLE TIME/DIV control range.

- c. Pull the $\times 10$ MAG switch out.
- d. Position the display so the first marker starts at the first graticule line (see Fig. 6-49A).
- e. CHECK—CRT display for one marker each division between the first and ninth graticule lines (see Fig. 6-49A).
- f. ADJUST—C511 (see Fig. 6-49C) for one marker each division between the first and ninth graticule lines.
- g. Position the display so the center portion of the sweep is magnified (see Fig. 6-49B).
- h. CHECK—CRT display for one marker each division between the first and ninth graticule lines (see Fig. 6-49B).
- i. ADJUST—C527 (see Fig. 6-49C) for one marker each division between the first and ninth graticule lines.
- j. Repeat steps d through i until the correct timing is obtained.

46. Check 0.5 Microsecond $\times 10$ Magnifier Linearity

- a. Position the first marker to the first graticule line.

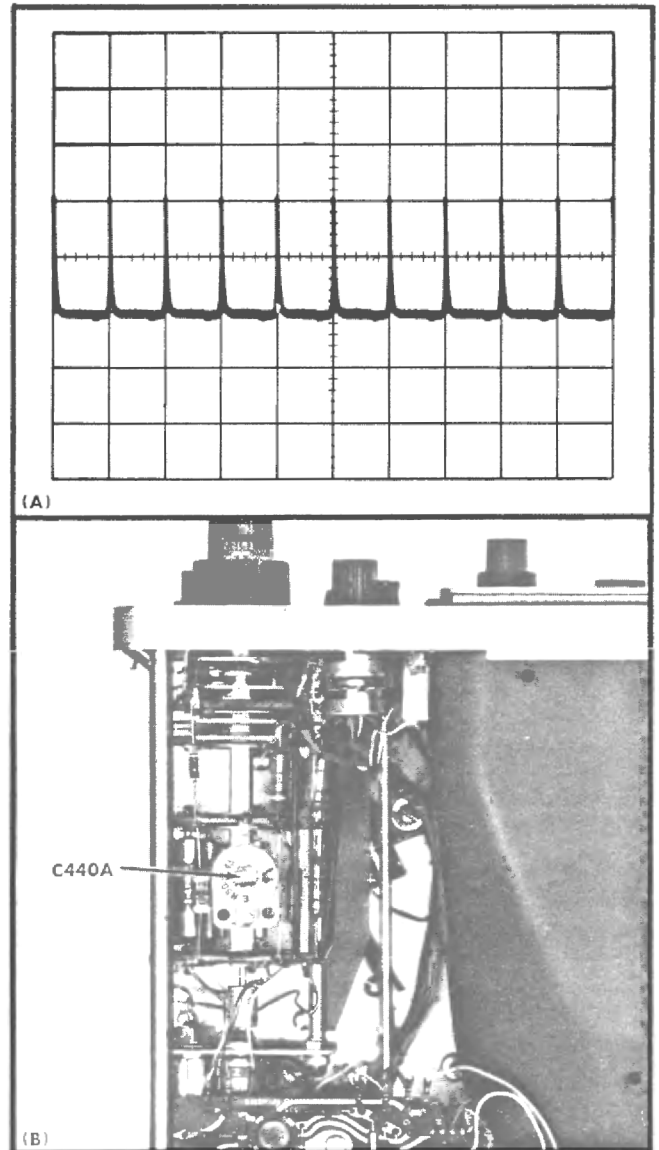

Fig. 6-47. (A) Typical CRT display showing correct 10 μ SEC timing; (B) location of C440A (top view).

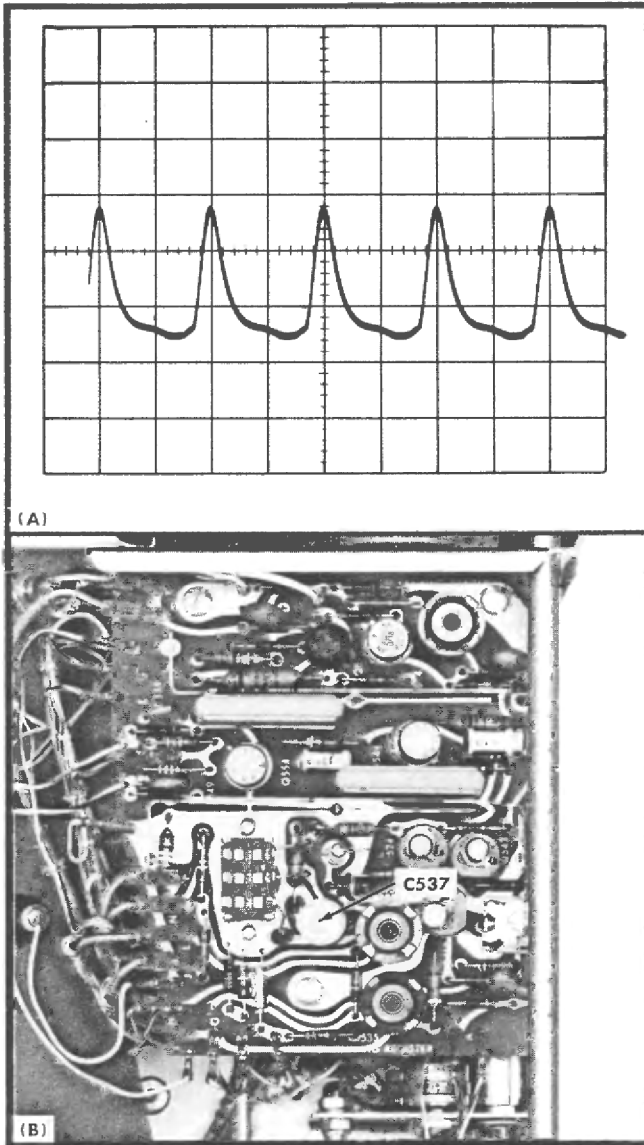

Fig. 6-48. (A) Typical CRT display showing correct .5 μ SEC timing; (B) location of C537 (Horizontal Amplifier board).

b. If the ninth marker does not fall on the ninth graticule line, adjust the VARIABLE TIME/DIV control to align the marker or recheck the timing in step 44.

c. CHECK—CRT display for each marker within ± 0.24 division of its respective graticule line ($\pm 3\%$; see Fig. 6-50).

d. Repeat check for each eight-division portion of the magnified sweep.

47. Check Timing Accuracy

- a. Push the $\times 10$ MAG switch in.

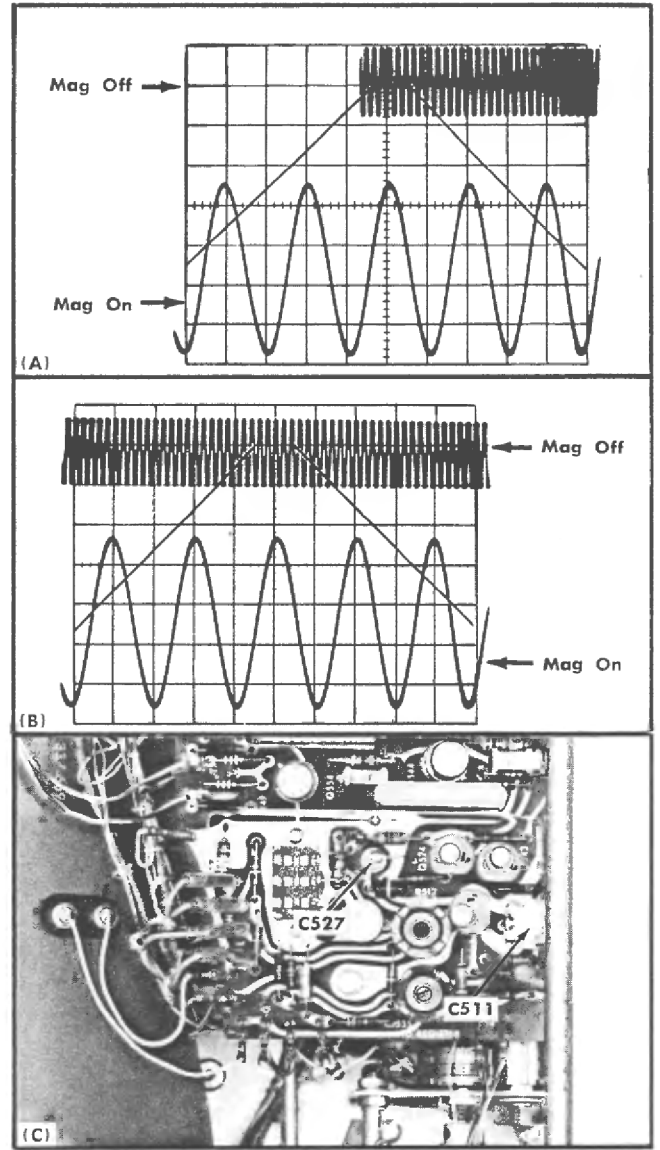

Fig. 6-49. Typical CRT display when adjusting (A) C551, (B) C527 (double exposures); (C) location of C511 and C527 (Horizontal Amplifier board).

b. CHECK—Using the TIME/DIV switch and time-mark generator settings given in Table 6-3, check sweep timing within ± 0.24 division over the middle eight divisions of the display ($\pm 3\%$).

CAUTION

To prevent permanent damage to the CRT phosphor at slow sweep rates, position the baseline of the marker display below the viewing area.

- c. Disconnect all test equipment.

TABLE 6-3
TIME/DIV Accuracy

TIME/DIV Switch Setting	Time-Mark Generator Output	CRT Display (Markers/Division)
.5 μ SEC	0.5 microsecond	1
1 μ SEC	1 microsecond	1
2 μ SEC	1 microsecond	2
5 μ SEC	5 microsecond	1
10 μ SEC	10 microsecond	1
20 μ SEC	10 microsecond	2
50 μ SEC	50 microsecond	1
.1 mSEC	0.1 millisecond	1
.2 mSEC	0.1 millisecond	2
.5 mSEC	0.5 millisecond	1
1 mSEC	1 millisecond	1
2 mSEC	1 millisecond	2
5 mSEC	5 millisecond	1
10 mSEC	10 millisecond	1
20 mSEC	10 millisecond	2
50 mSEC	50 millisecond	1
.1 SEC	0.1 second	1
.2 SEC	0.1 second	2
.5 SEC	0.5 second	1

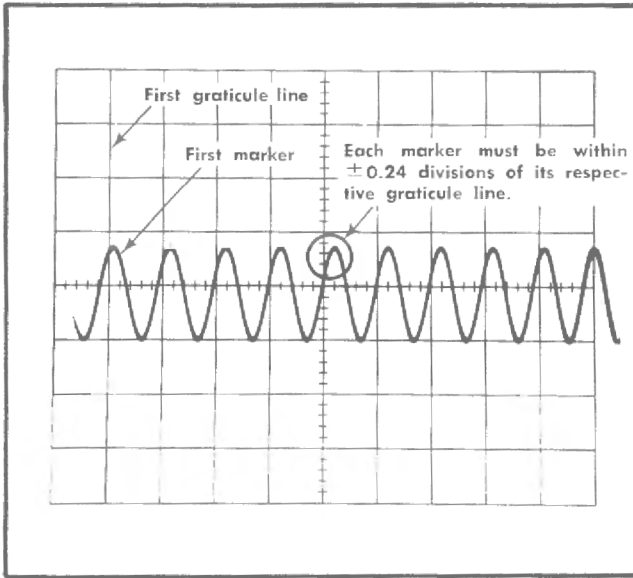

Fig. 6-50. Typical CRT display when checking 0.5 microsecond \times 10 magnifier linearity.

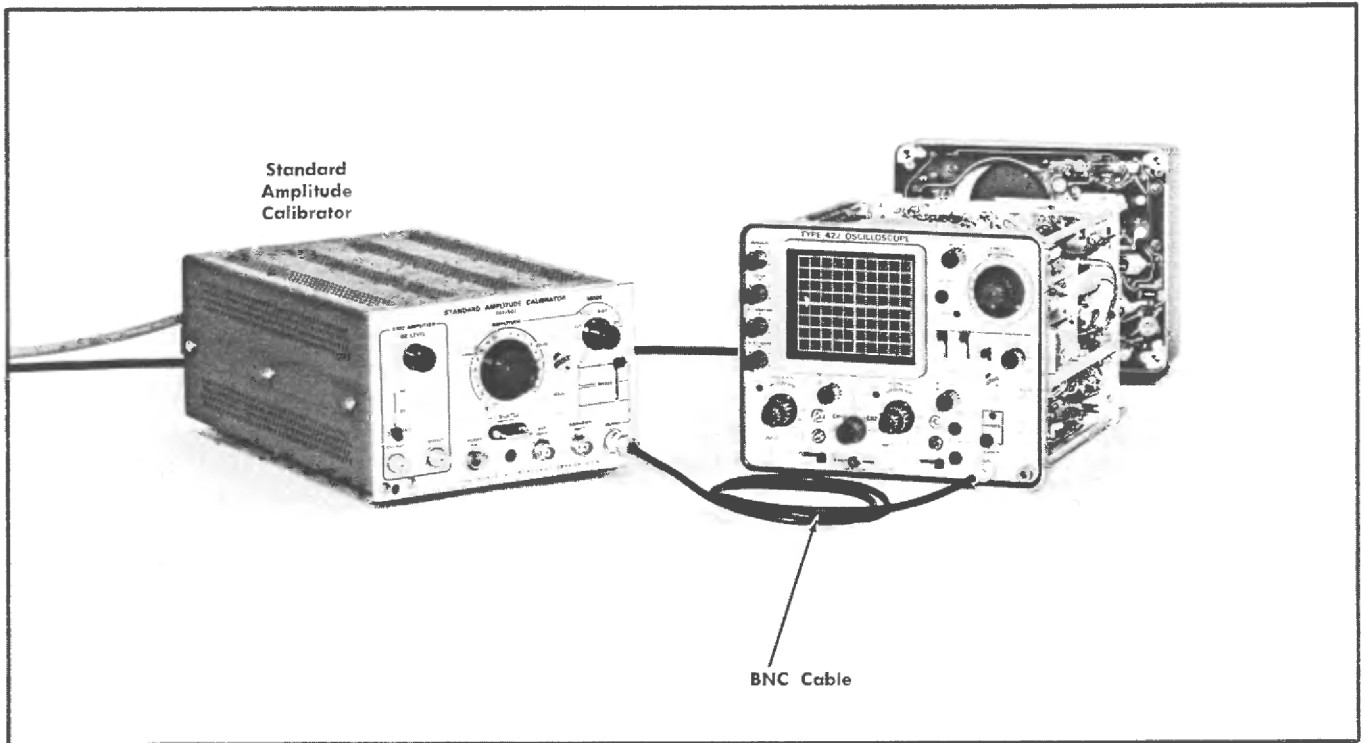

Fig. 6-51. Initial test equipment setup for steps 48 and 49.

CRT controls

INTENSITY	Midrange
FOCUS	Adjust for correct display
ASTIGMATISM	Adjust for correct display
SCALE ILLUM	As desired

Vertical controls (both channels if applicable)

VOLTS/DIV	.2
VARIABLE	CAL
AC GND DC	DC
POSITION	Midrange
MODE	CHOPPED
INVERT	Pushed in
×10 GAIN AC	Pushed in

Triggering controls

Source	CH 1 & 2
Coupling	AC
SLOPE	Positive going
LEVEL	AUTO

Sweep controls

POSITION	Midrange
TIME/DIV	2 μSEC
VARIABLE	CAL
×10 MAG	Pushed in

Other controls

POWER	On (at power supply)
-------	----------------------

48. Check Chopped Operation

- a. Position the traces about four divisions apart with the Vertical POSITION controls.
- b. CHECK—CRT display for duration of each cycle between 4.2 and 6.25 divisions (100 kilohertz, ±20%; see Fig. 6-52).
- c. CHECK—CRT display for complete blanking of switching transients between chopped segments (see Fig. 6-52).

49. Check External Horizontal Deflection Factor and Horizontal Attenuator Control Range

- a. Test equipment setup is shown in Fig. 6-51.
- b. Connect the standard amplitude calibrator to the HORIZ IN (TRIG IN) connector with the BNC cable.
- c. Set the standard amplitude calibrator for a 50-volt square-wave output.
- d. Change the following control settings:

Mode	CH 1
HORIZ ATTEN (LEVEL)	Clockwise
TIME/DIV	EXT HORIZ

CAUTION

To prevent permanent damage to the CRT phosphor, reduce the INTENSITY control setting if a halo forms around the dots.

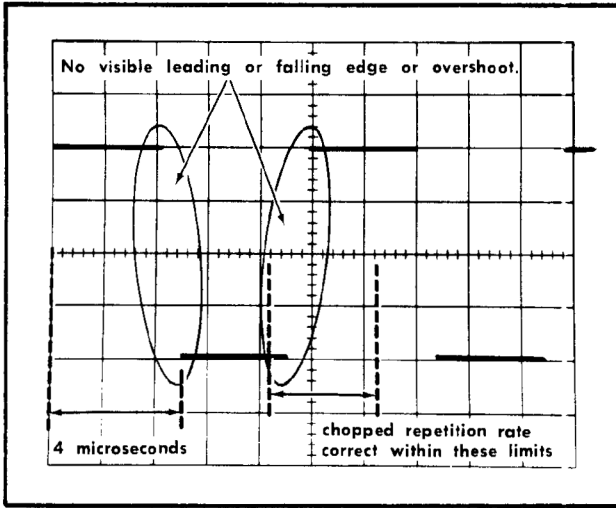

Fig. 6-52. Typical CRT display when checking chopped repetition rate and blanking. Sweep rate, two microseconds/division.

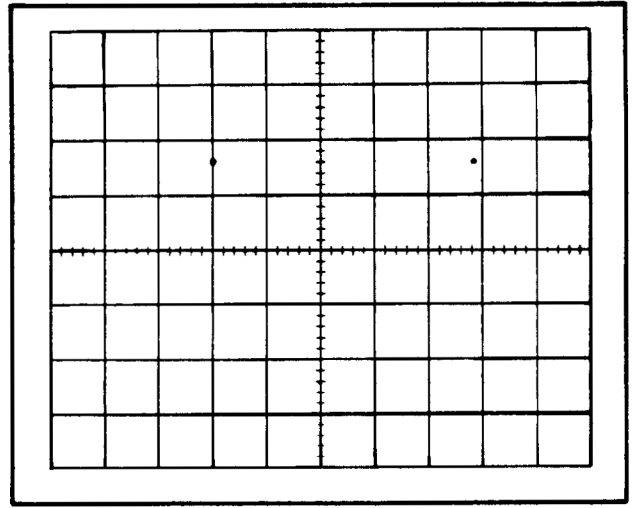

Fig. 6-53. Typical CRT display when checking external horizontal deflection factor.

e. CHECK—CRT display for horizontal deflection between 3.75 and 6.25 divisions (10 volts/division, $\pm 25\%$; see Fig. 6-53).

f. Pull the $\times 10$ MAG switch out.

g. Set the standard amplitude calibrator for a five-volt square-wave output.

h. Reposition the display to the center of the CRT.

i. CHECK—CRT display for horizontal deflection between 3.75 and 6.25 divisions (one volt/division, $\pm 25\%$).

j. Set the standard amplitude calibrator for a 50-volt square-wave output.

k. Set the HORIZ ATTEN control fully counterclockwise.

l. CHECK—CRT display for horizontal deflection equal to or less than obtained in step i (10:1 or greater range).

m. Disconnect all test equipment.

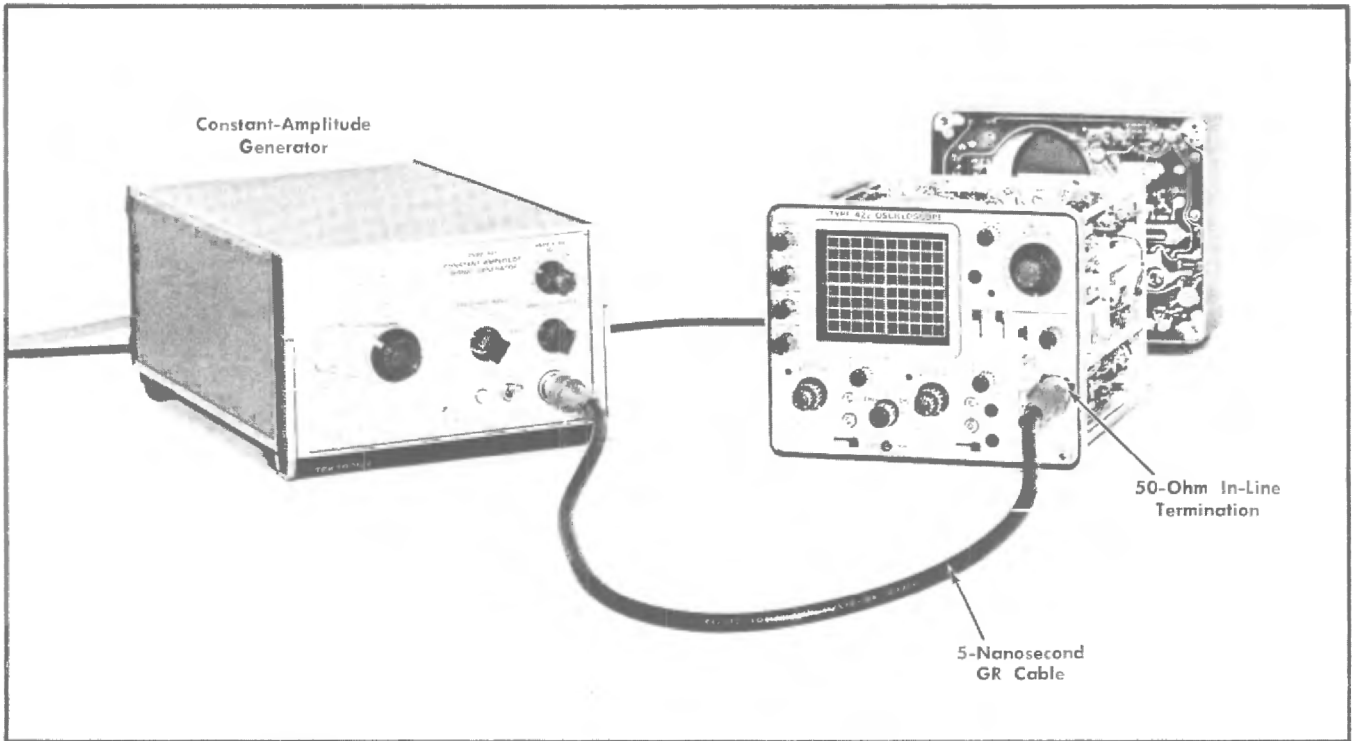

Fig. 6-54. Initial test equipment setup for steps 50 and 51.

CRT controls

INTENSITY	Midrange
FOCUS	Adjust for correct display
ASTIGMATISM	Adjust for correct display
SCALE ILLUM	As desired

Vertical controls (both channels if applicable)

VOLTS/DIV	.01
VARIABLE	CAL
AC GND DC	DC
POSITION	Midrange
Mode	CH 1
INVERT	Pushed in
×10 GAIN AC	Pushed in

Triggering controls

Source	CH 1 & 2
Coupling	AC
SLOPE	Positive going
HORIZ ATTEN (LEVEL)	Clockwise

Sweep controls

POSITION	Midrange
TIME/DIV	EXT HORIZ
VARIABLE	CAL
×10 MAG	Pulled out

Other controls

POWER	On (at power supply)
-------	----------------------

50. Check External Horizontal Frequency Response

- a. Test equipment setup is shown in Fig. 6-54.
- b. Connect the constant-amplitude sine-wave generator to the HORIZ IN (TRIG IN) connector through the five-nanosecond GR cable and the 50-ohm in-line termination.

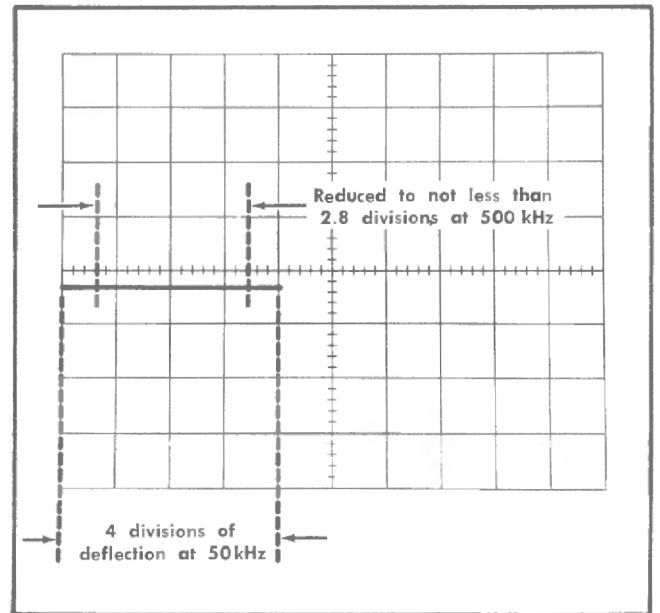

Fig. 6-55. Typical CRT display when checking external horizontal frequency response.

- c. Set the constant-amplitude generator for four divisions of horizontal deflection at 50 kilohertz.
- d. Without changing the output amplitude, increase the output frequency of the constant-amplitude generator until the display is reduced to 2.8 divisions (—3 dB point; see Fig. 6-55).
- e. CHECK—Output frequency of the constant-amplitude generator must be 500 kilohertz or higher.

51. Check External Blanking

- a. Connect the constant-amplitude sine-wave generator to the INPUT 1 connector through the five-nanosecond GR cable, 50-ohm in-line termination and the BNC T connector.
- b. Change the following control settings:

VOLTS/DIV	1
LEVEL	AUTO
TIME/DIV	10 μ SEC
$\times 10$ MAG	Pushed in
- c. Set the constant-amplitude generator for a four-division display at 50 kilohertz.
- d. Connect the output of the BNC T connector to the EXT BLANKING connector through a 50-ohm BNC cable.

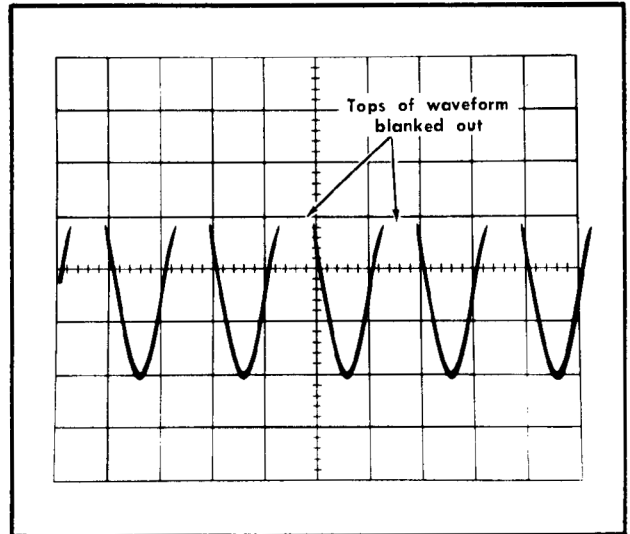

Fig. 6-56. Typical CRT display when checking external blanking.

- e. CHECK—The positive peaks of the displayed signal should be blanked with a normal INTENSITY control setting (see Fig. 6-56).
- f. Disconnect all test equipment.

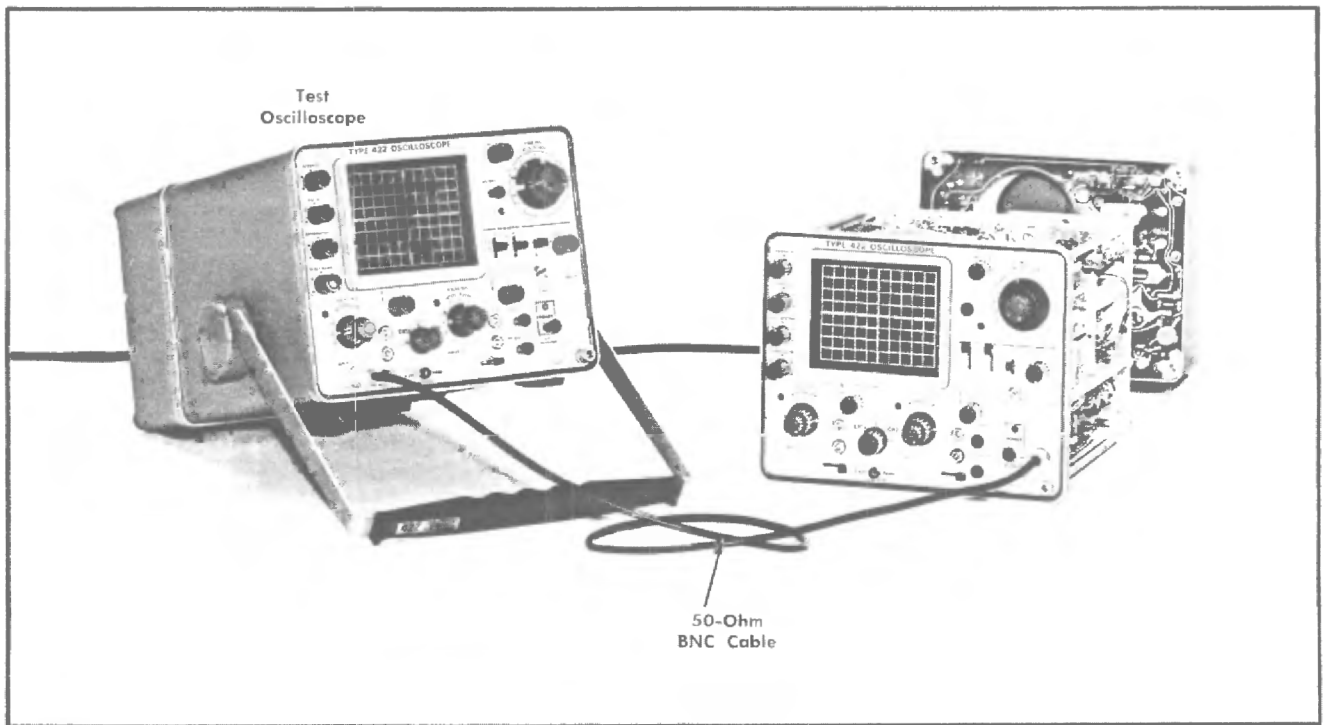

Fig. 6-57. Test equipment setup for step 52.

CRT controls

INTENSITY	Midrange
FOCUS	Adjust for correct display
ASTIGMATISM	Adjust for correct display
SCALE ILLUM	As desired

Vertical controls (both channels if applicable)

VOLTS/DIV	1
VARIABLE	CAL
AC GND DC	DC
POSITION	Midrange
Mode	CH 1
INVERT	Pushed in
×10 GAIN AC	Pushed in

Triggering controls

Source	CH 1 & 2
Coupling	AC
SLOPE	Positive going
LEVEL	FREE RUN

Sweep controls

POSITION	Midrange
TIME/DIV	1 mSEC
VARIABLE	CAL
×10 MAG	Pushed in

Other controls

POWER	On (at power supply)
-------	----------------------

52. Check Gate Output Signal

- a. Test equipment setup is shown in Fig. 6-57.
- b. Connect the GATE OUT connector to the input of the test oscilloscope with the 50-ohm BNC cable.
- c. Set the test oscilloscope for a vertical deflection of 0.2 volts/division and a sweep rate of two milliseconds/division.

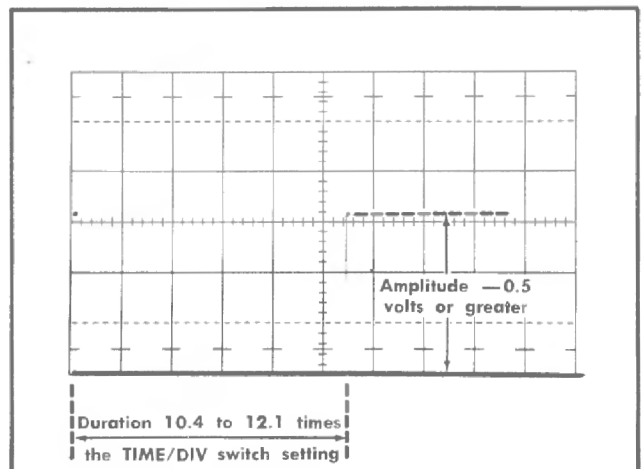

Fig. 6-58. Typical test oscilloscope display of GATE OUT signal. Vertical deflection, 0.2 volts/division; sweep rate, two milliseconds/division.

- d. CHECK—Test oscilloscope display for 2.5 division or greater amplitude with the top of the waveform at the zero volt level. Gate duration should be 5.2 to 6.05 divisions (—0.5 volt or greater amplitude with duration of 10.4 to 12.1 times the TIME/DIV setting; see Fig. 6-58).
- e. Disconnect all test equipment.

This completes the calibration procedure for the Type 422. Replace the cabinet and re-attach the power supply to the indicator. If the instrument has been completely checked and adjusted to the tolerances given in this procedure, it will meet the performance requirements given in the Characteristics section of this Instruction Manual.

PARTS LIST ABBREVIATIONS

BHB	binding head brass	int	internal
BHS	binding head steel	lg	length or long
cap.	capacitor	met.	metal
cer	ceramic	mtg hdw	mounting hardware
comp	composition	OD	outside diameter
conn	connector	OHB	oval head brass
CRT	cathode-ray tube	OHS	oval head steel
csk	countersunk	PHB	pan head brass
DE	double end	PHS	pan head steel
dia	diameter	plstc	plastic
div	division	PMC	paper, metal cased
elect.	electrolytic	poly	polystyrene
EMC	electrolytic, metal cased	prec	precision
EMT	electrolytic, metal tubular	PT	paper, tubular
ext	external	PTM	paper or plastic, tubular, molded
F & I	focus and intensity	RHB	round head brass
FHB	flat head brass	RHS	round head steel
FHS	flat head steel	SE	single end
Fil HB	fillister head brass	SN or S/N	serial number
Fil HS	fillister head steel	SW	switch
h	height or high	TC	temperature compensated
hex.	hexagonal	THB	truss head brass
HHB	hex head brass	thk	thick
HHS	hex head steel	THS	truss head steel
HSB	hex socket brass	tub.	tubular
HSS	hex socket steel	var	variable
ID	inside diameter	w	wide or width
incd	incandescent	WW	wire-wound



PARTS ORDERING INFORMATION

Replacement parts are available from or through your local Tektronix, Inc. Field Office or representative.

Changes to Tektronix instruments are sometimes made to accommodate improved components as they become available, and to give you the benefit of the latest circuit improvements developed in our engineering department. It is therefore important, when ordering parts, to include the following information in your order: Part number, instrument type or number, serial or model number, and modification number if applicable.

If a part you have ordered has been replaced with a new or improved part, your local Tektronix, Inc. Field Office or representative will contact you concerning any change in part number.

SPECIAL NOTES AND SYMBOLS

- ×000 Part first added at this serial number
- 00× Part removed after this serial number
- *000-0000-00 Asterisk preceding Tektronix Part Number indicates manufactured by or for Tektronix, Inc., or reworked or checked components.
- Use 000-0000-00 Part number indicated is direct replacement.
-  Screwdriver adjustment.
-  Control, adjustment or connector.

SECTION 7

ELECTRICAL PARTS LIST

Values are fixed unless marked Variable.

Ckt. No.	Tektronix Part No.	Description	S/N Range			
Bulbs						
B12	150-0035-00	Neon, A1D				
B112	150-0035-00	Neon, A1D				
B725	150-0044-00	Incandescent #33 ϕ	100-7189			
B725	150-0059-00	Incandescent #38 ϕ	7190-up			
B726	150-0044-00	Incandescent #33 ϕ	100-7189			
B726	150-0059-00	Incandescent #38 ϕ	7190-up			
B728	150-0035-00	Neon, A1D				
POWER						
B741	150-0035-00	Neon, A1D	UNCAL CH 1 (Volts/Div)			
B743	150-0035-00	Neon, A1D	UNCAL CH 2 (Volts/Div)			
B745	150-0035-00	Neon, A1D	UNCAL (Time/Div)			
B820	150-0035-00	Neon, A1D				
B846	150-0035-00	Neon, A1D				
Capacitors						
Tolerances $\pm 20\%$ unless otherwise indicated.						
C1	*285-0672-00	0.1 μ F	MT	600 V	+5%-15%	
C3B	281-0099-00	1.3-5.4 pF	Air	Var		
C3C	281-0102-00	1.7-11 pF	Air	Var		
C3D	281-0572-00	6.8 pF	Cer		500 V	± 0.5 pF
C4B	281-0102-00	1.7-11 pF	Air	Var		
C4C	281-0102-00	1.7-11 pF	Air	Var		
C5A	281-0501-00	4.7 pF	Cer		500 V	± 1 pF
C5B	281-0102-00	1.7-11 pF	Air	Var		
C5C	281-0099-00	1.3-5.4 pF	Air	Var		
C5E	281-0509-00	15 pF	Cer		500 V	10%
C6A	281-0544-00	5.6 pF	Cer		500 V	10%
C6B	281-0102-00	1.7-11 pF	Air	Var		
C6C	281-0099-00	1.3-5.4 pF	Air	Var		
C6E	283-0606-00	250 pF	Mica		500 V	10%
C10 ¹	281-0529-00	1.5 pF (nominal value)		Selected		
C11	283-0068-00	0.01 μ F	Cer		500 V	10%
C12	281-0102-00	1.7-11 pF	Air	Var		100-759
C12	281-0099-00	1.3-5.4 pF	Air	Var		760-up
C13	290-0188-00	0.1 μ F	EMT		35 V	1%
C15	283-0078-00	0.001 μ F	Cer		500 V	
C22	290-0246-00	3.3 μ F	EMT		15 V	10%
						100-1549
C22	290-0247-00	5.6 μ F	EMT		6 V	10%
C30	281-0511-00	22 pF	Cer		500 V	10%
C41	283-0081-00	0.1 μ F	Cer		25 V	
C54	283-0113-00	56 pF	Cer		500 V	1%
C60	290-0267-00	1 μ F	EMT		35 V	

¹Added if necessary.

①

Capacitors (Cont)

Ckt. No.	Tektronix Part No.		Description			S/N Range
C63	283-0078-00	0.001 μ F	Cer		500 V	
C73	283-0078-00	0.001 μ F	Cer		500 V	
C78	281-0512-00	27 pF	Cer		500 V	10%
C84	283-0068-00	0.01 μ F	Cer		500 V	
C94	283-0068-00	0.01 μ F	Cer		500 V	
C98	290-0246-00	3.3 μ F	EMT		15 V	10%
C99	290-0187-00	4.7 μ F	EMT		35 V	
C101	*285-0672-00	0.1 μ F	MT		600 V	+5%-15%
C103B	281-0099-00	1.3-5.4 pF	Air	Var		
C103C	281-0102-00	1.7-11 pF	Air	Var		
C103D	281-0572-00	6.8 pF	Cer		500 V	± 0.5 pF
C104B	281-0102-00	1.7-11 pF	Air	Var		
C104C	281-0102-00	1.7-11 pF	Air	Var		
C105A	281-0501-00	4.7 pF	Cer		500 V	± 1 pF
C105B	281-0102-00	1.7-11 pF	Air	Var		
C105C	281-0099-00	1.3-5.4 pF	Air	Var		
C105E	281-0509-00	15 pF	Cer		500 V	10%
C106A	281-0544-00	5.6 pF	Cer		500 V	10%
C106B	281-0102-00	1.7-11 pF	Air	Var		
C106C	281-0099-00	1.3-5.4 pF	Air	Var		
C106E	283-0606-00	250 pF	Mica		500 V	10%
C110 ²	281-0529-00	1.5 pF	(nominal value)	Selected		
C111	283-0068-00	0.01 μ F	Cer		500 V	
C112	281-0102-00	1.7-11 pF	Air	Var		100-759
C112	281-0099-00	1.3-5.4 pF	Air	Var		760-up
C113	289-0188-00	0.1 μ F	EMT		35 V	10%
C114	281-0093-00	5.5-18 pF	Cer	Var		
C115	283-0078-00	0.001 μ F	Cer		500 V	
C122	290-0134-00	22 μ F	EMT		15 V	100-490
C122	290-0114-00	47 μ F	EMC		6 V	491-up
C126	290-0246-00	3.3 μ F	EMT		15 V	10%
C141	283-0081-00	0.1 μ F	Cer		25 V	
C151	290-0138-00	330 μ F	EMT		6 V	
C160	290-0267-00	1 μ F	EMT		35 V	
C163	283-0078-00	0.001 μ F	Cer		500 V	
C173	283-0078-00	0.001 μ F	Cer		500 V	
C184	283-0068-00	0.01 μ F	Cer		500 V	
C193	281-0529-00	1.5 pF	Cer		500 V	± 0.25 pF
C194	283-0068-00	0.01 μ F	Cer		500 V	X12347-up
C199	290-0134-00	22 μ F	EMT		15 V	
C217	281-0077-00	1.3-5.4 pF	Air	Var		
C227	281-0504-00	10 pF	Cer		500 V	10%
C227	281-0503-00	8 pF	Cer		500 V	± 0.5 pF
C228	281-0504-00	10 pF	Cer		500 V	10%
C228	281-0505-00	12 pF	Cer		500 V	10%
C235	281-0544-00	5.6 pF	Cer		500 V	10%
C235	281-0503-00	8 pF	Cer		500 V	± 0.5 pF

²Added if necessary.

Capacitors (Cont)

Ckt. No.	Tektronix Part No.	Description	S/N Range
C237	281-0078-00	1.4-7.3 pF	Air Var
C238	281-0544-00	5.6 pF	Cer 500 V 10% 100-539
C238	281-0534-00	3.3 pF	Cer 500 V ±0.25 pF 540-2709X
C239	281-0511-00	22 pF	Cer 500 V 10%
C242	281-0542-00	18 pF	Cer 500 V 10% 100-759
C242	281-0592-00	4.7 pF	Cer ±0.5 pF 760-up
C247	283-0068-00	0.01 μF	Cer 500 V 100-12346X
C252	281-0542-00	18 pF	Cer 500 V 10% 100-759
C252	281-0592-00	4.7 pF	Cer ±0.5 pF 760-up
C254	283-0068-00	0.01 μF	Cer 500 V
C257	283-0068-00	0.01 μF	Cer 500 V
C261	281-0525-00	470 pF	Cer 500 V
C266	281-0518-00	47 pF	Cer 500 V
C267	285-0598-00	0.01 μF	PTM 100 V 5%
C269	283-0080-00	0.022 μF	Cer 25 V
C276	281-0518-00	47 pF	Cer 500 V
C279	283-0080-00	0.022 μF	Cer 25 V
C299	283-0081-00	0.1 μF	Cer 25 V
C302	281-0077-00	1.3-5.4 pF	Air Var
C305	283-0599-00	98 pF	Mica 500 V 5%
C306	*285-0610-00	0.1 μF	MT 600 V 10%
C308	281-0536-00	0.001 μF	Cer 500 V 10%
C309	283-0059-00	1 μF	Cer 25 V
C325	283-0068-00	0.01 μF	Cer 500 V
C332	281-0632-00	35 pF	Cer 500 V 1%
C333	281-0632-00	35 pF	Cer 500 V 1%
C344	290-0261-00	6.8 μF	EMT 35 V
C345	290-0246-00	3.3 μF	EMT 15 V 10%
C346	290-0263-00	2.7 μF	EMT 15 V
C353	281-0064-00	0.25-1.5 pF	Tub. Var
C356	283-0068-00	0.01 μF	Cer 500 V
C364	283-0068-00	0.01 μF	Cer 500 V
C377	281-0523-00	100 pF	Cer 350 V
C379	290-0267-00	1 μF	EMT 35 V
C401	281-0536-00	0.001 μF	Cer 500 V 10%
C405	281-0546-00	330 pF	Cer 500 V 10%
C418	281-0504-00	10 pF	Cer 500 V 10%
C425	281-0513-00	27 pF	Cer 500 V
C428	283-0068 00	0.01 μF	Cer 500 V
C432	283-0010-00	0.05 μF	Cer 50 V
C440A	281-0012-00	7-45 pF	Cer Var
C440B	285-0006-00	68 pF	Glass 500 V 5%
C440C	*295-0079-00	0.001 μF	Timing Capacitor
C440D		0.01 μF	
C440E		0.1 μF	
C440F		1 μF	

Electrical Parts List—Type 422/R422 (SN 100-19,999)

Capacitors (Cont)

Ckt. No.	Tektronix Part No.		Description			S/N Range
C440H	283-0068-00	0.01 μ F	Cer	500 V		
C440T	281-0516-00	39 μ F	Cer	500 V	10%	
C444	283-0068-00	0.01 μ F	Cer	500 V		
C471	281-0620-00	21 pF	Cer	500 V	1%	
C474	283-0068-00	0.01 μ F	Cer	500 V		
C477	281-0630-00	390 pF	Cer	500 V	5%	
C498	290-0267-00	1 μ F	EMT	35 V		
C499	290-0267-00	1 μ F	EMT	35 V		
C511	281-0076-00	1.2-3.5 pF	Air			
C514	283-0068-00	0.01 μ F	Cer	500 V		
C527	281-0064-00	0.25-1.5 pF	Tub.			
C528	281-0538-00	1 pF	Cer	500 V		
C531	290-0246-00	3.3 μ F	EMT	15 V	10%	100-157
C531	290-0134-00	22 μ F	EMT	15 V		158-up
C537	281-0092-00	9-35 pF	Cer			
C546	281-0512-00	27 pF	Cer	500 V	10%	
C549	283-0000-00	0.001 μ F	Cer	500 V		
C556	281-0546-00	330 pF	Cer	500 V	10%	100-2599
C556	283-0604-00	304 pF	Cer	300 V	2%	2600-up
C559	283-0000-00	0.001 μ F	Cer	500 V		
C569	290-0167-00	10 μ F	EMT	15 V		
C715	290-0255-00	20 μ F	EMT	50 V	+75%-10%	
C718	283-0068-00	0.01 μ F	Cer	500 V		
C721	290-0188-00	0.1 μ F	EMT	35 V	10%	
C723	290-0267-00	1 μ F	EMT	35 V		
C727	290-0267-00	1 μ F	EMT	35 V		
C735	283-0068-00	0.01 μ F	Cer	500 V		X8761-up
C736	283-0068-00	0.01 μ F	Cer	500 V		
C737	283-0068-00	0.01 μ F	Cer	500 V		
C739	290-0188-00	0.1 μ F	EMT	35 V	10%	
C741	283-0068-00	0.01 μ F	Cer	500 V		
C743	283-0068-00	0.01 μ F	Cer	500 V		
C762	290-0267-00	1 μ F	EMT	35 V		
C765	285-0598-00	0.01 μ F	PTM	100 V	5%	
C769	290-0136-00	2.2 μ F	EMT	20 V		
C775	285-0598-00	0.01 μ F	PTM	100 V	5%	
C810	283-0105-00	0.01 μ F	Cer	2000 V		
C811	283-0105-00	0.01 μ F	Cer	2000 V		
C812	283-0105-00	0.01 μ F	Cer	2000 V		
C813	283-0105-00	0.01 μ F	Cer	2000 V		
C814	283-0105-00	0.01 μ F	Cer	2000 V		
C815	283-0105-00	0.01 μ F	Cer	2000 V		
C816	283-0105-00	0.01 μ F	Cer	2000 V		
C820	283-0105-00	0.01 μ F	Cer	2000 V		
C821	*283-0112-00	0.01 μ F	Cer	2000 V		
C822	*283-0112-00	0.01 μ F	Cer	2000 V		

Capacitors (Cont)

Ckt. No.	Tektronix Part No.		Description		S/N Range
C823	*283-0112-00	0.01 μ F	Cer	2000 V	
C828	283-0105-00	0.01 μ F	Cer	2000 V	
C829	290-0117-00	50 μ F	EMT	50 V	+75%-10%
C839	283-0008-00	0.1 μ F	Cer	500 V	
C841	283-0068-00	0.01 μ F	Cer	500 V	
C843	283-0068-00	0.01 μ F	Cer	500 V	
C846	283-0105-00	0.01 μ F	Cer	2000 V	
C848	283-0105-00	0.01 μ F	Cer	2000 V	
C849	290-0248-00	150 μ F	EMT	15 V	100-157
C849	290-0248-01	150 μ F	EMT	15 V	158-up
C861	283-0068-00	0.01 μ F	Cer	500 V	
C865	283-0068-00	0.01 μ F	Cer	500 V	

Diodes

D14	*152-0185-00	Silicon	Replaceable by 1N4152		
D15	*152-0185-00	Silicon	Replaceable by 1N4152		
D16	*152-0185-00	Silicon	Replaceable by 1N4152		
D17	*152-0185-00	Silicon	Replaceable by 1N4152		
D21	152-0195-00	Zener	1N751A 0.4 W, 5.1 V, 5%		
D22	*152-0185-00	Silicon	Replaceable by 1N4152		
D41	152-0166-00	Zener	1N753A 0.4 W, 6.2 V, 5%		
D78	152-0166-00	Zener	1N753A 0.4 W, 6.2 V, 5%		
D114	*152-0185-00	Silicon	Replaceable by 1N4152		
D115	*152-0185-00	Silicon	Replaceable by 1N4152		
D116	*152-0185-00	Silicon	Replaceable by 1N4152		
D117	*152-0185-00	Silicon	Replaceable by 1N4152		
D121	152-0195-00	Zener	1N751A 0.4 W, 5.1 V, 5%		100-1289
D121	152-0226-00	Zener	1N751A 0.4 W, 5.1 V, 5%		1290-up
D122	*152-0185-00	Silicon	Replaceable by 1N4152		
D141	152-0166-00	Zener	1N753A 0.4 W, 6.2 V, 5%		100-1289
D141	152-0227-00	Zener	1N753A 0.4 W, 6.2 V, 5%		1290-up
D201	*152-0185-00	Silicon	Replaceable by 1N4152		100-3079
D201	*152-0233-00	Silicon	Tek Spec		3080-up
D202	*152-0075-00	Germanium	Tek Spec		
D203	*152-0075-00	Germanium	Tek Spec		
D204	*152-0185-00	Silicon	Replaceable by 1N4152		100-3079
D204	*152-0233-00	Silicon	Tek Spec		3080-up
D205	*152-0185-00	Silicon	Replaceable by 1N4152		100-3079
D205	*152-0233-00	Silicon	Tek Spec		3080-up
D206	*152-0075-00	Germanium	Tek Spec		
D207	*152-0075-00	Germanium	Tek Spec		
D208	*152-0185-00	Silicon	Replaceable by 1N4152		100-3079
D208	*152-0233-00	Silicon	Tek Spec		3080-up
D210	*152-0185-00	Silicon	Replaceable by 1N4152		

Diodes (Cont)

Ckt. No.	Tektronix Part No.		Description	S/N Range
D211	*152-0185-00	Silicon	Replaceable by 1N4152	
D213	*152-0185-00	Silicon	Replaceable by 1N4152	
D214	*152-0185-00	Silicon	Replaceable by 1N4152	
D264	*152-0185-00	Silicon	Replaceable by 1N4152	
D274	*152-0185-00	Silicon	Replaceable by 1N4152	
D281	*152-0185-00	Silicon	Replaceable by 1N4152	
D282	*152-0185-00	Silicon	Replaceable by 1N4152	
D318	*152-0185-00	Silicon	Replaceable by 1N4152	
D319	*152-0185-00	Silicon	Replaceable by 1N4152	
D325	152-0076-00	Zener	1N4372 0.4 W, 3 V, 10%	100-12819
D325	152-0278-00	Zener	1N4372A 0.4 W, 3 V, 5%	12820-up
D331	152-0141-00	Silicon	1N4152	100-13869
D331	152-0141-02	Silicon	1N4152	13870-up
D332	*152-0075-00	Germanium	Tek Spec	
D333	*152-0075-00	Germanium	Tek Spec	
D334	152-0141-00	Silicon	1N4152	100-13869
D334	152-0141-02	Silicon	1N4152	13870-up
D343	*152-0185-00	Silicon	Replaceable by 1N4152	
D363	152-0141-00	Silicon	1N4152	100-13869
D363	152-0141-02	Silicon	1N4152	13870-up
D364	152-0166-00	Zener	1N753A 0.4 W, 6.2 V, 5%	
D375	152-0182-00	Tunnel	1N3719 10 mA, 2.5%	
D401	*152-0185-00	Silicon	Replaceable by 1N4152	100-3079
D401	*152-0233-00	Silicon	Tek Spec	3080-up
D403	*152-0185-00	Silicon	Replaceable by 1N4152	
D404	*152-0185-00	Silicon	Replaceable by 1N4152	
D405	152-0081-00	Tunnel	1N3714 2.2 mA, 10%	
D430	*152-0185-00	Silicon	Replaceable by 1N4152	100-3079
D430	*152-0233-00	Silicon	Tek Spec	3090-up
D435	*152-0185-00	Silicon	Replaceable by 1N4152	100-3079
D435	*152-0233-00	Silicon	Tek Spec	3080-up
D436	*152-0185-00	Silicon	Replaceable by 1N4152	100-3079
D436	*152-0233-00	Silicon	Tek Spec	3080-up
D438	*152-0185-00	Silicon	Replaceable by 1N4152	
D439	*152-0173-00	Silicon	Replaceable by 1N4152	100-3070
D439	*152-0249-00	Silicon	Assembly	3080-up
D455	152-0181-00	Tunnel	1N3713 1 mA, 2.5%	
D474	152-0166-00	Zener	1N753A 0.4 W, 6.2 V, 5%	
D476	*152-0185-00	Silicon	Replaceable by 1N4152	
D479	*152-0185-00	Silicon	Replaceable by 1N4152	100-3079
D479	*152-0233-00	Silicon	Tek Spec	3080-up
D512	*152-0185-00	Silicon	Replaceable by 1N4152	
D513	*152-0185-00	Silicon	Replaceable by 1N4152	
D524	*152-0233-00	Silicon	Tek Spec	X1055-up
D549	152-0031-00	Zener	1N718A 0.25 W, 15 V, 5%	100-12819
D549	152-0243-00	Zener	1N965B 0.4 W, 15 V, 5%	12820-up
D559	152-0031-00	Zener	1N718A 0.25 W, 15 V, 5%	100-12819
D559	152-0243-00	Zener	1N965B 0.4 W, 15 V, 5%	12820-up
D713	152-0166-00	Zener	1N753A 0.4 W, 6.2 V, 5%	100-1289
D713	152-0227-00	Zener	1N753A 0.4 W, 6.2 V, 5%	1290-up
D714	152-0166-00	Zener	1N753A 0.4 W, 6.2 V, 5%	

Diodes (Cont)

Ckt. No.	Tektronix Part No.	Description	S/N Range
D729	152-0215-00	Zener	
D735	*152-0185-00	Silicon	100-3079
D735	*152-0233-00	Silicon	3080-up
D739	152-0166-00	Zener	
D760	*152-0185-00	Silicon	
D761	*152-0185-00	Silicon	
D762	*152-0185-00	Silicon	
D769	*152-0185-00	Silicon	
D770	*152-0185-00	Silicon	
D773	*152-0185-00	Silicon	
D779	*152-0185-00	Silicon	100-3079
D779	*152-0233-00	Silicon	3080-up
D810	152-0170-00	Silicon	
D811	152-0170-00	Silicon	
D812	152-0170-00	Silicon	
D813	152-0170-00	Silicon	
D814	152-0170-00	Silicon	
D815	152-0170-00	Silicon	
D816	152-0170-00	Silicon	
D821	152-0170-00	Silicon	
D822	152-0170-00	Silicon	
D823	152-0170-00	Silicon	
D839	152-0255-00	Zener	X4330-up
D841	152-0167-00	Zener	100-1059
D841	152-0234-00	Zener	1060-12819
D841	152-0283-00	Zener	12820-up
D849	*153-0007-00	Silicon	100-157
D849	152-0179-00	Silicon	158-4329
D849A, B, C, D	152-0260-00	Silicon	4330-up
D864	*152-0185-00	Silicon	
D865	*152-0185-00	Silicon	100-3079
D865	*152-0233-00	Silicon	3080-up
D866	*152-0185-00	Silicon	
D867	*152-0185-00	Silicon	

Inductors

L1	276-0541-00	Core, Ferrite	
L30	*108-0170-00	0.5 μ H	
L41	276-0532-00	Core, Shield Bead	100-5699
L41	276-0507-00	Core, Ferramic Suppressor	5700-up
L63	276-0532-00	Core, Shield Bead	100-5699
L63	276-0507-00	Core, Ferramic Suppressor	5700-up
L73	276-0532-00	Core, Shield Bead	100-5699
L73	276-0507-00	Core, Ferramic Suppressor	5700-up
L101	276-0541-00	Core, Ferrite	
L141	276-0532-00	Core, Shield Bead	100-5699
L141	276-0507-00	Core, Ferramic Suppressor	5700-up
L163	276-0532-00	Core, Shield Bead	100-5699
L163	276-0507-00	Core, Ferramic Suppressor	5700-up
L173	276-0532-00	Core, Shield Bead	100-5699
L173	276-0507-00	Core, Ferramic Suppressor	5700-up
L240	*119-0037-00	Delay Line Assembly	100-2709

Inductors (Cont)

Ckt. No.	Tektronix Part No.	Description	S/N Range
L240	*119-0037-01	Delay Line Assembly	2710-up
L245	*114-0181-00	10-20 μ H Var	Care 276-0506-00
L255	*114-0180-00	10-20 μ H Var	Care 276-0506-00
L377	*120-0379-00	Toroid, 2 turns, single	
L423	276-0532-00	Core, Shield Bead	
L445	276-0543-00	Core, Ferrite	
L535	276-0507-00	Core, Ferramic Suppressor	
L546	276-0532-00	Core, Shield Bead	X12374-up
L856	*108-0350-00	Coil, Y Axis Alignment	X1890-up
L859	*108-0320-00	Trace Rotation	100-12349
L859	*108-0320-01	Trace Rotation	12350-up

Transistors

Q24	*151-0108-00	Silicon	Replaceable by 2N2501
Q34	*151-0108-00	Silicon	Replaceable by 2N2501
Q44	*151-0133-00	Silicon	Selected from 2N3251
Q53	*151-0108-00	Silicon	Replaceable by 2N2501
Q64	*151-0108-00	Silicon	Replaceable by 2N2501
Q74	*151-0108-00	Silicon	Replaceable by 2N2501
Q84	*151-0108-00	Silicon	Replaceable by 2N2501
Q94	*151-0108-00	Silicon	Replaceable by 2N2501
Q124	*151-0108-00	Silicon	Replaceable by 2N2501
Q134	*151-0108-00	Silicon	Replaceable by 2N2501
Q144	*151-0133-00	Silicon	Selected from 2N3251
Q154	*151-0133-00	Silicon	Selected from 2N3251
Q164	*151-0108-00	Silicon	Replaceable by 2N2501
Q174	*151-0108-00	Silicon	Replaceable by 2N2501
Q184	*151-0108-00	Silicon	Replaceable by 2N2501
Q194	*152-0108-00	Silicon	Replaceable by 2N3251
Q224	*151-0127-00	Silicon	Selected from 2N2369
Q234	*151-0127-00	Silicon	Selected from 2N2369
Q244	*151-0121-00	Silicon	Selected from 2N3118
Q254	*151-0121-00	Silicon	Selected from 2N3118
Q264	*151-0108-00	Silicon	Replaceable by 2N2501
Q265	*151-0087-00	Silicon	Replaceable by 2N1131
Q275	*151-0087-00	Silicon	Replaceable by 2N1131
Q283	*151-0087-00	Silicon	Replaceable by 2N1131
Q294	*151-0108-00	Silicon	Replaceable by 2N2501
Q323	*151-0133-00	Silicon	Selected from 2N3251
Q324	*151-0108-00	Silicon	Replaceable by 2N2501
Q343	*151-0108-00	Silicon	Replaceable by 2N2501
Q364	*151-0108-00	Silicon	Replaceable by 2N2501
Q414	*151-0108-00	Silicon	Replaceable by 2N2501
Q424	*151-0133-00	Silicon	Selected from 2N3251
Q429	151-0157-00	Silicon	RCA 40232
Q434	*151-0133-00	Silicon	Selected from 2N3251
Q441	*151-0103-00	Silicon	Replaceable by 2N2219
Q464	*151-0108-00	Silicon	Replaceable by 2N2501

Transistors (Cont)

Ckt. No.	Tektronix Part No.	Description	S/N Range	
Q473	*151-0133-00	Silicon	Selected from 2N3251	
Q513	*151-0126-00	Silicon	Replaceable by 2N2484	
Q524	*151-0133-00	Silicon	Selected from 2N3251	
Q543	*151-0133-00	Silicon	Selected from 2N3251	
Q544	*151-0124-00	Silicon	Selected from 2N3119	
Q554	*151-0124-00	Silicon	Selected from 2N3119	
Q714	151-0157-00	Silicon	RCA 40232	
Q717	*151-0136-00	Silicon	Replaceable by 2N3053	
Q734	*151-0136-00	Silicon	Replaceable by 2N3053	
Q737	*151-0134-00	Silicon	Replaceable by 2N2905	100-8760
Q737	151-0208-00	Silicon	2N4036	8761-up
Q765	*151-0087-00	Silicon	Replaceable by 2N1131	
Q775	*151-0087-00	Silicon	Replaceable by 2N1131	
Q863	*151-0103-00	Silicon	Replaceable by 2N2219	
Q864	*151-0121-00	Silicon	Selected from 2N311B	

Resistors

Resistors are fixed, composition, $\pm 10\%$ unless otherwise indicated.

R3C	322-0610-00	500 k Ω	$\frac{1}{4}$ W	Prec	1%	100-5699
R3C	322-0610-01	500 k	$\frac{1}{4}$ W	Prec	$\frac{1}{2}\%$	5700-up
R3E	322-0481-00	1 M Ω	$\frac{1}{4}$ W	Prec	1%	100-5699
R3E	322-0481-01	1 M Ω	$\frac{1}{4}$ W	Prec	$\frac{1}{2}\%$	5700-up
R4C	322-0469-00	750 k Ω	$\frac{1}{4}$ W	Prec	1%	100-5699
R4C	322-0469-01	750 k Ω	$\frac{1}{4}$ W	Prec	$\frac{1}{2}\%$	5700-up
R4E	321-0628-00	333 k Ω	$\frac{1}{8}$ W	Prec	1%	100-5699
R4E	321-0628-01	333 k Ω	$\frac{1}{8}$ W	Prec	$\frac{1}{2}\%$	5700-up
R5C	322-0621-00	900 k Ω	$\frac{1}{4}$ W	Prec	1%	100-5699
R5C	322-0621-01	900 k Ω	$\frac{1}{4}$ W	Prec	$\frac{1}{2}\%$	5700-up
R5E	321-0617-00	111 k Ω	$\frac{1}{8}$ W	Prec	1%	100-5699
R5E	321-1389-01	111 k Ω	$\frac{1}{8}$ W	Prec	$\frac{1}{2}\%$	5700-up
R6C	322-0624-00	990 k Ω	$\frac{1}{4}$ W	Prec	1%	100-5699
R6C	322-0624-01	990 k Ω	$\frac{1}{4}$ W	Prec	$\frac{1}{2}\%$	5700-up
R6E	321-0614-00	10.1 k Ω	$\frac{1}{8}$ W	Prec	1%	100-5699
R6E	321-1289-01	10.1 k Ω	$\frac{1}{8}$ W	Prec	$\frac{1}{2}\%$	5700-up
R9	315-0470-00	47 Ω	$\frac{1}{4}$ W		5%	
R10	322-0481-00	1 M Ω	$\frac{1}{4}$ W	Prec	1%	100-5699
R10	322-0481-01	1 M Ω	$\frac{1}{4}$ W	Prec	$\frac{1}{2}\%$	5700-up
R11	315-0105-00	1 M Ω	$\frac{1}{4}$ W		5%	
R12	315-0101-00	100 Ω	$\frac{1}{4}$ W		5%	
R13	315-0101-00	100 Ω	$\frac{1}{4}$ W		5%	
R14	321-0149-00	348 Ω	$\frac{1}{8}$ W	Prec	1%	
R15	321-0345-00	38.3 k Ω	$\frac{1}{8}$ W	Prec	1%	
R20	315-0102-00	1 k Ω	$\frac{1}{4}$ W		5%	
R21	311-0328-00	1 k Ω		Var		
R22	321-0205-00	1.33 k Ω	$\frac{1}{8}$ W	Prec	1%	
R24	321-0198-00	1.13 k Ω	$\frac{1}{8}$ W	Prec	1%	
R30	321-0107-00	127 Ω	$\frac{1}{8}$ W	Prec	1%	
R32	321-0148-00	340 Ω	$\frac{1}{8}$ W	Prec	1%	
R34	321-0182-00	768 Ω	$\frac{1}{8}$ W	Prec	1%	
R35	311-0461-00	250 Ω		Var		
R39	321-0165-00	511 Ω	$\frac{1}{8}$ W	Prec	1%	
R41	315-0102-00	1 k Ω	$\frac{1}{4}$ W		5%	

Electrical Parts List—Type 422/R422 (SN 100-19,999)

Resistors (Cont)

Ckt. No.	Tektronix Part No.	Description	S/N Range	
R44	322-0170-00	576 Ω	1%	
R51	315-0221-00	220 Ω	5%	
R53	315-0182-00	1.8 kΩ	5%	
R54	321-0273-00	6.81 kΩ	1%	
R56	321-0333-00	28.7 kΩ	1%	
R59	315-0101-00	100 Ω	5%	
R60	311-0545-00	2 x 1 kΩ	Var	
R61	321-0183-00	787 Ω	1%	
R62	321-0121-00	178 Ω	1%	
R64	321-0150-00	357 Ω	1%	
R65	315-0622-00	6.2 kΩ	5%	
R74	321-0151-00	365 Ω	1%	
R75	315-0432-00	4.3 kΩ	5%	
R77	321-0167-00	536 Ω	1%	
R78	321-0148-00	340 Ω	1%	
R79	315-0431-00	430 Ω	5%	
R80	311-0169-00	100 Ω	Var	
R81	315-0101-00	100 Ω	5%	
R83	321-0069-00	51.1 Ω	1%	
R84	321-0145-00	316 Ω	1%	
R90 ³	311-0385-00	250 Ω	Var	100-11369
R90 ³	311-0385-01	250 Ω	Var	11370-up
R91	315-0102-00	1 kΩ	5%	
R94	321-0145-00	316 Ω	1%	
R98	315-0330-00	33 Ω	5%	
R99	307-0104-00	3.3 Ω	5%	
R103C	322-0610-00	500 kΩ	1%	100-5699
R103C	322-0610-01	500 kΩ	1/2%	5700-up
R103E	322-0481-00	1 MΩ	1%	100-5699
R103E	322-0481-01	1 MΩ	1/2%	5700-up
R104C	322-0469-00	750 kΩ	1%	100-5699
R104C	322-0469-01	750 kΩ	1/2%	5700-up
R104E	321-0628-00	333 kΩ	1%	100-5699
R104E	321-0628-01	333 kΩ	1/2%	5700-up
R105C	322-0621-00	900 kΩ	1%	100-5699
R105C	322-0621-01	900 kΩ	1/2%	5700-up
R105E	321-0617-00	111 kΩ	1%	100-5699
R105E	321-1389-01	111 kΩ	1/2%	5700-up
R106C	322-0624-00	990 kΩ	1%	100-5699
R106C	322-0624-01	990 kΩ	1/2%	5700-up
R106E	321-0614-00	10.1 kΩ	1%	100-5699
R106E	321-1289-01	10.1 kΩ	1/2%	5700-up
R109	315-0470-00	47 Ω	5%	
R110	322-0481-00	1 MΩ	1%	100-5699
R110	322-0481-01	1 MΩ	1/2%	5700-up
R111	315-0105-00	1 MΩ	5%	
R112	315-0101-00	100 Ω	5%	
R113	315-0101-00	100 Ω	5%	
R115	321-0345-00	38.3 kΩ	1%	
R117	321-0149-00	348 Ω	1%	
R120	315-0302-00	3 kΩ	5%	

³Furnished as a unit with SW741.

Resistors (Cont)

Ckt. No.	Tektronix Part No.	Description	S/N Range			
R121	311-0328-00	1 kΩ		Var		
R122	321-0205-00	1.33 kΩ	1/8 W		Prec	1%
R124	321-0198-00	1.13 kΩ	1/8 W		Prec	1%
R126	307-0106-00	4.7 Ω	1/4 W			5%
R130	321-0107-00	127 Ω	1/8 W		Prec	1%
R132	321-0148-00	340 Ω	1/8 W		Prec	1%
R134	321-0182-00	768 Ω	1/8 W		Prec	1%
R135	311-0461-00	250 Ω		Var		
R139	321-0165-00	511 Ω	1/8 W		Prec	1%
R141	315-0102-00	1 kΩ	1/4 W			5%
R144	322-0170-00	576 Ω	1/4 W		Prec	1%
R151	321-0136-00	255 Ω	1/8 W		Prec	1%
R152	321-0318-00	20 kΩ	1/8 W		Prec	1%
R153	321-0237-00	2.87 kΩ	1/8 W		Prec	1%
R154	321-0223-00	2.05 kΩ	1/8 W		Prec	1%
R156	321-0121-00	178 Ω	1/8 W		Prec	1%
R160	311-0545-00	2 x 1 kΩ		Var		
R161	321-0183-00	787 Ω	1/8 W		Prec	1%
R162	321-0121-00	178 Ω	1/8 W		Prec	1%
R164	321-0150-00	357 Ω	1/8 W		Prec	1%
R165	315-0622-00	6.2 kΩ	1/4 W			5%
R174	321-0151-00	365 Ω	1/8 W		Prec	1%
R175	315-0432-00	4.3 kΩ	1/4 W			5%
R180	311-0169-00	100 Ω		Var		
R181	315-0101-00	100 Ω	1/4 W			5%
R183	321-0069-00	51.1 Ω	1/8 W		Prec	1%
R184	321-0145-00	316 Ω	1/8 W		Prec	1%
R187	315-0470-00	47 Ω	1/4 W			5%
R190 ¹	311-0385-00	250 Ω		Var		X13011-up
R190 ¹	311-0385-01	250 Ω		Var		100-11369
R191	315-0102-00	1 kΩ	1/4 W			11370-up
R194	321-0145-00	316 Ω	1/8 W		Prec	1%
R197	315-0470-00	47 Ω	1/4 W			5%
R199	315-0330-00	33 Ω	1/4 W			5%
R206	315-0470-00	47 Ω	1/4 W			5%
R207	315-0470-00	47 Ω	1/4 W			5%
R210	321-0217-00	1.78 kΩ	1/8 W		Prec	1%
R211	321-0217-00	1.78 kΩ	1/8 W		Prec	1%
R213	321-0229-00	2.37 kΩ	1/8 W		Prec	1%
R214	321-0229-00	2.37 kΩ	1/8 W		Prec	1%
R215	311-0462-00	1 kΩ		Var		
R217	321-0369-00	68.1 kΩ	1/8 W		Prec	1%
R218	315-0102-00	1 kΩ	1/4 W			5%
R219	315-0185-00	1.8 MΩ	1/4 W			5%
R221	321-0159-00	442 Ω	1/8 W		Prec	1%
R222	323-0154-00	392 Ω	1/2 W		Prec	1%
R224	321-0161-00	464 Ω	1/8 W		Prec	1%
R226	321-0094-00	93.1 Ω	1/8 W		Prec	1%
R227	315-0912-00	9.1 kΩ	1/4 W			5%
R228	315-0243-00	24 kΩ	1/4 W			5%
R231	321-0159-00	442 Ω	1/8 W		Prec	1%
R234	321-0161-00	464 Ω	1/8 W		Prec	1%
R235	315-0102-00	1 kΩ	1/4 W			5%
R236	321-0094-00	93.1 Ω	1/8 W		Prec	1%

¹Furnished as a unit with SW743.

Electrical Parts List—Type 422/R422 (SN 100-19,999)

Resistors (Cont)

Ckt. No.	Tektronix Part No.	Description	S/N Range	
R237	311-0496-00	2.5 kΩ	Var	100-2709
R237	311-0463-00	5 kΩ	Var	2710-up
R239	315-0201-00	200 Ω	1/4 W	5%
R241	321-0194-00	1.02 kΩ	1/8 W	Prec 1%
R242	321-0097-00	100 Ω	1/8 W	Prec 1%
R244	323-0186-00	845 Ω	1/2 W	Prec 1%
R245	323-0186-00	845 Ω	1/2 W	Prec 1%
R248	321-0189-00	909 Ω	1/8 W	Prec 1%
R249	321-0208-00	1.43 kΩ	1/8 W	Prec 1%
R251	321-0194-00	1.02 kΩ	1/8 W	Prec 1%
R252	321-0097-00	100 Ω	1/8 W	Prec 1%
R254	323-0186-00	845 Ω	1/2 W	Prec 1%
R255	323-0186-00	845 Ω	1/2 W	Prec 1%
R260	301-0361-00	360 Ω	1/2 W	5%
R261	315-0102-00	1 kΩ	1/4 W	5%
R262	315-0222-00	2.2 kΩ	1/4 W	5%
R263	301-0431-00	430 Ω	1/2 W	5%
R264	315-0681-00	680 Ω	1/4 W	5%
R265	315-0272-00	2.7 kΩ	1/4 W	5%
R267	315-0472-00	4.7 kΩ	1/4 W	5%
R269	315-0222-00	2.2 kΩ	1/4 W	5%
R273	301-0431-00	430 Ω	1/2 W	5%
R274	315-0681-00	680 Ω	1/4 W	5%
R275	315-0272-00	2.7 kΩ	1/4 W	5%
R277	315-0472-00	4.7 kΩ	1/4 W	5%
R279	315-0222-00	2.2 kΩ	1/4 W	5%
R281	315-0152-00	1.5 kΩ	1/4 W	5%
R282	315-0152-00	1.5 kΩ	1/4 W	5%
R284	315-0271-00	270 Ω	1/4 W	5%
R291	315-0223-00	22 kΩ	1/4 W	5%
R294	315-0122-00	1.2 kΩ	1/4 W	5%
R295	315-0471-00	470 Ω	1/4 W	5%
R299	315-0330-00	33 Ω	1/4 W	5%
R302	321-0385-00	100 kΩ	1/8 W	Prec 1%
R321	315-0151-00	150 Ω	1/4 W	5%
R323	315-0163-00	16 kΩ	1/4 W	5%
R323	315-0562-00	5.6 kΩ	1/4 W	5%
R324	315-0122-00	1.2 kΩ	1/4 W	5%
R331	315-0103-00	10 kΩ	1/4 W	5%
R332	321-0289-00	10 kΩ	1/8 W	Prec 1%
R333	321-0289-00	10 kΩ	1/8 W	Prec 1%
R334	315-0103-00	10 kΩ	1/4 W	5%
R342	315-0243-00	24 kΩ	1/4 W	5%
R343	315-0123-00	12 kΩ	1/4 W	5%
R344	315-0102-00	1 kΩ	1/4 W	5%

Resistors (Cont)

Ckt. No.	Tektronix Part No.	Description	S/N Range
R345	315-0202-00	2 k Ω	5%
R346	315-0392-00	3.9 k Ω	5%
R347	315-0472-00	4.7 k Ω	5%
R349	321-0408-00	174 k Ω	1%
R350	311-0464-00	25 k Ω	Var
R352	315-0622-00	6.2 k Ω	5%
R353	321-0414-00	200 k Ω	1%
R355A ⁵	311-0534-00	100 k Ω	Var
R355B		5 k Ω	
R356	315-0103-00	10 k Ω	5%
R357	321-0387-00	105 k Ω	1%
R363	315-0132-00	1.3 k Ω	5%
R364	315-0621-00	620 Ω	5%
R372	321-0154-00	392 Ω	1%
R374	321-0194-00	1.02 k Ω	1%
R377	315-0390-00	39 Ω	5%
R378	315-0431-00	430 Ω	5%
R379	307-0103-00	2.7 Ω	5%
R403	315-0302-00	3 k Ω	5%
R404	315-0104-00	100 k Ω	5%
R405	315-0301-00	300 Ω	5%
R406	321-0255-00	4.42 k Ω	1%
R414	315-0431-00	430 Ω	5%
R415	321-0203-00	1.27 k Ω	1%
R423	315-0180-00	18 Ω	5%
R424	321-0287-00	9.53 k Ω	1%
R424	321-0289-00	10 k Ω	1%
R425	315-0102-00	1 k Ω	5%
R427	321-0299-00	12.7 k Ω	1%
R428	321-0239-00	3.01 k Ω	1%
R429	315-0202-00	2 k Ω	5%
R432	315-0153-00	15 k Ω	5%
R433	315-0473-00	47 k Ω	5%
R434	321-0254-00	4.32 k Ω	1%
R435	315-0432-00	4.3 k Ω	5%
R436	315-0104-00	100 k Ω	5%
R437	315-0102-00	1 k Ω	5%
R438	315-0113-00	11 k Ω	5%
R440A ⁶	311-0468-00	100 k Ω	Var
R440B	315-0473-00	47 k Ω	5%
R440C	323-0401-00	147 k Ω	1%
R440D	323-0430-00	294 k Ω	1%
R440E	323-0459-00	590 k Ω	1%
R440F	323-0497-00	1.47 M Ω	1%
R440F	323-0497-07	1.47 M Ω	0.1%

⁵Furnished as a unit with SW355.⁶Furnished as a unit with SW745.

Electrical Parts List—Type 422/R422 (SN 100-19,999)

Resistors (Cont)

Ckt. No.	Tektronix Part No.		Description			S/N Range
R440G	323-0497-00	1.47 MΩ	1/2 W		Prec	1%
R440H	323-0497-00	1.47 MΩ	1/2 W		Prec	1%
R440J	323-0497-00	1.47 MΩ	1/2 W		Prec	1%
R440K	323-0497-00	1.47 MΩ	1/2 W		Prec	1%
R440L	323-0497-00	1.47 MΩ	1/2 W		Prec	1%
R440M	323-0497-00	1.47 MΩ	1/2 W		Prec	1%
R440N	323-0497-00	1.47 MΩ	1/2 W		Prec	1%
R440P	323-0497-00	1.47 MΩ	1/2 W		Prec	1%
R440R	323-0497-00	1.47 MΩ	1/2 W		Prec	1%
R440T	315-0161-00	160 Ω	1/4 W			5%
R441	315-0270-00	27 Ω	1/4 W			5%
R442	315-0100-00	10 Ω	1/4 W			5%
R443	315-0432-00	4.3 kΩ	1/4 W			5%
R445	307-0106-00	4.7 Ω	1/4 W			5%
R447	303-0752-00	7.5 kΩ	1 W			5%
R451	321-0337-00	31.6 kΩ	1/8 W		Prec	1%
R452	321-0322-00	22.1 kΩ	1/8 W		Prec	1%
R456	315-0821-00	820 Ω	1/4 W			5%
R457	321-0326-00	24.3 kΩ	1/8 W		Prec	1%
R464	321-0255-00	4.42 kΩ	1/8 W		Prec	1%
R470	315-0471-00	470 Ω	1/4 W			5%
R471	321-0274-00	6.98 kΩ	1/8 W		Prec	1%
R472	321-0317-00	19.6 kΩ	1/8 W		Prec	1%
R474	315-0751-00	750 Ω	1/4 W			5%
R475	315-0471-00	470 Ω	1/4 W			5%
R476	315-0471-00	470 Ω	1/4 W			5%
R477	321-0154-00	392 Ω	1/8 W		Prec	1%
R478	315-0102-00	1 kΩ	1/4 W			5%
R479	315-0162-00	1.6 kΩ	1/4 W			5%
R498	307-0104-00	3.3 Ω	1/4 W			5%
R499	307-0104-00	3.3 Ω	1/4 W			5%
R501	315-0334-00	330 kΩ	1/4 W			5%
R501	315-0304-00	300 kΩ	1/4 W			5%
R504	321-0164-00	499 Ω	1/8 W		Prec	1%
R504	321-0154-00	392 Ω	1/8 W		Prec	1%
R510	315-0332-00	3.3 kΩ	1/4 W			5%
R511	321-0385-00	100 kΩ	1/8 W		Prec	1%
R512	311-0496-00	2.5 kΩ		Var		
R512	311-0510-00	10 kΩ		Var		
R513	315-0103-00	10 kΩ	1/4 W			5%
R514	315-0100-00	10 Ω	1/4 W			5%
R515	315-0104-00	100 kΩ	1/4 W			5%
R516	315-0104-00	100 kΩ	1/4 W			5%
R524	315-0302-00	3 kΩ	1/4 W			5%
R527	321-0652-00	145 kΩ	1/8 W		Prec	1/4%
R529	315-0124-00	120 kΩ	1/4 W			5%
R529	315-0334-00	330 kΩ	1/4 W			5%

Resistors (Cont)

Ckt. No.	Tektronix Part No.	Description	S/N Range		
R530A } R530B }	311-0470-00	2 x 50 kΩ	Var		
R531	315-0331-00	330 Ω	1/4 W	5%	100-157
R531	315-0621-00	620 Ω	1/4 W	5%	158-up
R533	315-0273-00	27 kΩ	1/4 W	5%	100-599
R533	315-0363-00	36 kΩ	1/4 W	5%	600-up
R534	315-0104-00	100 kΩ	1/4 W	5%	
R535	311-0497-00	50 kΩ	Var		
R536	321-0384-00	97.6 kΩ	1/8 W	Prec	1%
R537	321-0651-00	15.8 kΩ	1/8 W	Prec	1/4%
R542	307-0113-00	5.1 Ω	1/4 W		100-5699
R542	308-0417-00	5.1 Ω	1/2 W	WW	2%
R543	315-0751-00	750 Ω	1/4 W		5%
R544	*310-0618-00	7.8 kΩ	4 W	Prec	1%
R546	322-0194-00	1.02 kΩ	1/4 W	Prec	1%
R548	315-0334-00	330 kΩ	1/4 W		5%
R554	*310-0619-00	13.5 kΩ	4 W	Prec	1%
R556	321-0178-00	698 Ω	1/8 W	Prec	1%
R558	315-0334-00	330 kΩ	1/4 W		5%
R569	307-0103-00	2.7 Ω	1/4 W		5%
R714	321-0217-00	1.78 kΩ	1/8 W	Prec	1%
R715	315-0222-00	2.2 kΩ	1/4 W		5%
R716	315-0222-00	2.2 kΩ	1/4 W		5%
R717	303-0332-00	3.3 kΩ	1 W		5%
R718	321-0273-00	6.81 kΩ	1/8 W	Prec	1%
R719	321-0245-00	3.48 kΩ	1/8 W	Prec	1%
R721	307-0105-00	3.9 Ω	1/4 W		5%
R725	311-0516-00	150 Ω	Var		
R729	301-0332-00	3.3 kΩ	1/2 W		5%
R733	315-0182-00	1.8 kΩ	1/4 W		5%
R734	315-0432-00	4.3 kΩ	1/4 W		5%
R735	315-0474-00	470 kΩ	1/4 W		5%
R738	315-0102-00	1 kΩ	1/4 W		5%
R741	315-0224-00	220 kΩ	1/4 W		5%
R742	315-0106-00	10 MΩ	1/4 W		5%
R743	315-0224-00	220 kΩ	1/4 W		5%
R744	315-0106-00	10 MΩ	1/4 W		5%
R745	315-0224-00	220 kΩ	1/4 W		5%
R746	315-0106-00	10 MΩ	1/4 W		5%
R761	315-0183-00	18 kΩ	1/4 W		5%
R763	321-0438-00	357 kΩ	1/8 W	Prec	1%
R763	321-0445-00	422 kΩ	1/8 W	Prec	1%
R764	315-0753-00	75 kΩ	1/4 W		5%
R773	321-0445-00	422 kΩ	1/8 W	Prec	1%
R774	315-0104-00	100 kΩ	1/4 W		5%
R775	315-0102-00	1 kΩ	1/4 W		5%
R780	311-0463-00	5 kΩ	Var		100-765X
R780	311-0510-00	10 kΩ	Var		100-319
R781	321-0364-00	60.4 kΩ	1/8 W	Prec	1%

Resistors (Cont)

Ckt. No.	Tektronix Part No.	Description	S/N Range
R783	321-0280-00	8.06 kΩ 1/8 W	Prec 1%
R785	315-0134-00	130 kΩ 1/4 W	5%
R785	321-0399-00	140 kΩ 1/8 W	Prec 1%
R786	321-0641-00	1.8 kΩ 1/8 W	Prec 1%
R787	321-0126-00	200 Ω 1/8 W	Prec 1%
R810	303-0105-00	1 MΩ 1 W	5%
R825	305-0564-00	560 kΩ 2 W	5%
R829	315-0363-00	36 kΩ 1/4 W	5%
R831	303-0225-00	2.2 MΩ 1 W	5%
R832	303-0225-00	2.2 MΩ 1 W	5%
R833	311-0469-00	1 MΩ	Var
R834	303-0185-00	1.8 MΩ 1 W	5%
R837	311-0498-00	500 kΩ	Var
R838	315-0203-00	20 kΩ 1/4 W	5%
R839	321-0418-00	221 kΩ 1/8 W	Prec 1%
R841	315-0752-00	7.5 kΩ 1/4 W	5%
R843	315-0183-00	18 kΩ 1/4 W	5%
R844	315-0433-00	43 kΩ 1/4 W	5%
R846	315-0274-00	270 kΩ 1/4 W	5%
R851	311-0112-00	15 kΩ	Var
R852	315-0622-00	6.2 kΩ 1/4 W	5%
R854	311-0110-00	100 kΩ	Var
R855	311-0467-00	100 kΩ	Var
R856	311-0579-00	20 kΩ	Var
R860	315-0152-00	1.5 kΩ 1/4 W	5%
R861	315-0100-00	10 Ω 1/4 W	5%
R862	315-0301-00	300 Ω 1/4 W	5%
R863	323-0268-00	6.04 kΩ 1/2 W	Prec 1%
R864	315-0101-00	100 Ω 1/4 W	5%
R865	315-0562-00	5.6 kΩ 1/4 W	5%
R866	315-0150-00	15 Ω 1/4 W	5%
R867	321-0226-00	2.21 kΩ 1/8 W	Prec 1%
R868	315-0272-00	2.7 kΩ 1/4 W	5%
R869	311-0508-00	50 kΩ	Var

Switches

Unwired or Wired

SW1	260-0665-00	Lever	CH 1 AC GND DC	
SW10	260-0661-00	Rotary	CH 1 VOLTS/DIV	100-2439
SW10	Wired *262-0709-00	Rotary	CH 1 VOLTS/DIV	100-2439
SW10	260-0661-01	Rotary	CH 1 VOLTS/DIV	2440-13371
SW10	Wired *262-0709-00	Rotary	CH 1 VOLTS/DIV	2440-13371
SW10	260-0661-02	Rotary	CH 1 VOLTS/DIV	13372-up
SW10	Wired *262-0845-01	Rotary	CH 1 VOLTS/DIV	13372-up
SW101	260-0665-00	Lever	CH 2 AC GND DC	
SW110	260-0661-00	Rotary	CH 2 VOLTS/DIV	101-2439
SW110	Wired *262-0710-00	Rotary	CH 2 VOLTS/DIV	101-2439
SW110	260-0661-01	Rotary	CH 2 VOLTS/DIV	2440-13371
SW110	Wired *262-0710-00	Rotary	CH 2 VOLTS/DIV	2440-13371
SW110	260-0661-02	Rotary	CH 2 VOLTS/DIV	13372-up
SW110	Wired *262-0845-02	Rotary	CH 2 VOLTS/DIV	13372-up
SW150	260-0583-00	Slide	X10 GAIN AC	100-299
SW150	260-0583-01	Slide	X10 GAIN AC	300-up
SW195	260-0583-00	Slide	INVERT	100-299
SW195	260-0583-01	Slide	INVERT	300-up

Switches (Cont)

Ckt. No.	Tektronix Part No.	Description	S/N Range
SW260	260-0660-00	Rotary	Mode
SW305	260-0662-00	Lever	Trigger Source
SW310	260-0663-00	Lever	Trigger Coupling
SW315(3)	260-0516-00	Micro	
SW355 ⁷	311-0534-00		
SW315(3) SW355	Wired *262-0712-00		LEVEL
SW365	260-0664-00	Lever	SLOPE
SW440	260-0659-00	Rotary	TIME/DIV
SW440	Wired *262-0711-00	Rotary	TIME/DIV
SW440	260-0659-01	Rotary	TIME/DIV
SW440	Wired *262-0722-00	Rotary	TIME/DIV
SW535	260-0583-00	Slide	X10 MAG
SW535	260-0583-01	Slide	X10 MAG
SW741 ⁸	311-0385-00		CAL (CH 1 VAR VOLTS/DIV)
SW741 ⁸	311-0385-01		CAL (CH 1 VAR VOLTS/DIV)
SW743 ⁹	311-0385-00		CAL (CH 2 VAR VOLTS/DIV)
SW743 ⁹	311-0385-01		CAL (CH 2 VAR VOLTS/DIV)
SW745 ¹⁰	311-0468-00		CAL (VAR TIME/DIV)

Transformers

T201	276-0541-00	Core, Ferrite	
T202	276-0541-00	Core, Ferrite	
T401	*120-0380-00	Toroid, 4 turns, Trifilar	
T801	*120-0378-00	H. V. Power	100-157
T801	*120-0278-01	H. V. Power	158-4329
T801	*120-0378-02	H. V. Power	4330-up

Electron Tubes

V13	154-0417-00	8056	
V113	154-0417-00	8056	
V443	154-0461-00	8393	
V739	154-0370-00	ZZ1000	
V829	*154-0432-00	GV4, S-1400, checked	
V859	*154-0466-00	T4220-31-1 CRT Standard Phosphor	100-1889
V859	*154-0466-05	T4220-31-1 CRT Standard Phosphor	1890-up

⁷Furnished as a unit with R355A, B.

⁸Furnished as a unit with R90.

⁹Furnished as a unit with R190.

¹⁰Furnished as a unit with R440A.

FIGURE AND INDEX NUMBERS

Items in this section are referenced by figure and index numbers to the illustrations which appear on the pullout pages immediately following the Diagrams section of this instruction manual.

INDENTATION SYSTEM

This mechanical parts list is indented to indicate item relationships. Following is an example of the indentation system used in the Description column.

Assembly and/or Component
Detail Part of Assembly and/or Component
mounting hardware for Detail Part
Parts of Detail Part
mounting hardware for Parts of Detail Part
mounting hardware for Assembly and/or Component

Mounting hardware always appears in the same indentation as the item it mounts, while the detail parts are indented to the right. Indented items are part of, and included with, the next higher indentation.

Mounting hardware must be purchased separately, unless otherwise specified.

PARTS ORDERING INFORMATION

Replacement parts are available from or through your local Tektronix, Inc. Field Office or representative.

Changes to Tektronix instruments are sometimes made to accommodate improved components as they become available, and to give you the benefit of the latest circuit improvements developed in our engineering department. It is therefore important, when ordering parts, to include the following information in your order: Part number, instrument type or number, serial or model number, and modification number if applicable.

If a part you have ordered has been replaced with a new or improved part, your local Tektronix, Inc. Field Office or representative will contact you concerning any change in part number.

Change information, if any, is located at the rear of this manual.

ABBREVIATIONS AND SYMBOLS

For an explanation of the abbreviations and symbols used in this section, please refer to the page immediately preceding the Electrical Parts List in this instruction manual.

INDEX OF MECHANICAL PARTS LIST ILLUSTRATIONS

(Located behind diagrams)

FIG. 1	FRONT
FIG. 2	CHASSIS
FIG. 3	ACCESSORIES

SECTION 8

MECHANICAL PARTS LIST

FIG. 1 FRONT

Fig. & Index No.	Tektronix Part No.	Serial/Model No.		Q † Y	Description	
		Eff	Disc			1
1-1	262-0709-00			1	SWITCH, wired—CH 1 VOLTS/DIV	
	- - - - -			-	switch includes:	
	260-0661-00	100	2439	1	SWITCH, unwired	
	260-0661-01	2440		1	SWITCH, unwired	
-2	441-0602-00			1	CHASSIS, attenuator	
	- - - - -			-	mounting hardware: (not included w/chassis)	
	210-0053-00			2	LOCKWASHER, #2, split	
	210-0405-00			2	NUT, hex., 2-56 x 3/16 inch	
-3	407-0107-00			1	BRACKET, attenuator preamplifier	
	- - - - -			-	mounting hardware: (not included w/bracket)	
	210-0053-00	100	2439X	2	LOCKWASHER, #2, split	
	210-0405-00	100	2439X	2	NUT, hex., 2-56 x 3/16 inch	
	213-0055-00			2	SCREW, thread forming, 2-32 x 3/16 inch, PHS	
-4	211-0008-00			2	SCREW, 4-40 x 1/4 inch, PHS	
-5	- - - - -			2	RESISTOR, variable	
	- - - - -			-	mounting hardware for each: (not included w/resistor)	
	210-0940-00			1	WASHER, flat, 1/4 ID x 3/8 inch OD	
	210-0583-00			1	NUT, hex., 1/4-32 x 5/16 inch	
-6	376-0029-00			1	COUPLING, rod	
	- - - - -			-	coupling includes:	
	213-0075-00			2	SCREW, set, 4-40 x 3/32 inch, HSS	
-7	376-0039-00	100	2689	1	COUPLING, rod	
	- - - - -			-	coupling includes:	
	213-0075-00			2	SCREW, set, 4-40 x 3/32 inch, HSS	
	376-0014-00	2690		1	COUPLING, wire	
	103-0049-00	X2690	4929	1	ADAPTER, shaft coupling (long)	
	103-0049-04	4930		1	ADAPTER, shaft coupling (long)	
	103-0050-00	X2690	4929	1	ADAPTER, shaft coupling (short)	
	103-0050-02	4930		1	ADAPTER, shaft coupling (short)	
-8	136-0101-00			1	SOCKET, nuvistor, 5 pin	
	- - - - -			-	mounting hardware: (not included w/socket)	
	213-0055-00			2	SCREW, thread forming, 2-32 x 3/16 inch, PHS	
-9	384-0339-00	100	2689	1	ROD, shaft, attenuator	
	384-0398-00	2690		1	ROD, shaft, attenuator	
-10	131-0344-00			8	CONNECTOR, terminal feed-thru	
	- - - - -			-	mounting hardware for each: (not included w/connector)	
	358-0241-00			1	BUSHING, plastic	
-11	- - - - -			9	CAPACITOR	
	- - - - -			-	mounting hardware for each: (not included w/capacitor)	
	214-0456-00			1	FASTENER, plastic	

FIG. 1 FRONT (cont)

Fig. & Index No.	Tektronix Part No.	Serial/Model No.		Q † y	Description
		Eff	Disc		
					1 2 3 4 5
1-12	337-0716-00			1	SHIELD, attenuator
-13	384-0341-00			1	ROD, shaft, gain
-14	670-0404-00			1	ASSEMBLY, circuit board—CHANNEL 1 PREAMP
	- - - - -			-	assembly includes:
	388-0613-00			1	BOARD, circuit
	- - - - -			-	board includes:
-15	214-0507-00			15	PIN, connector, 45°
-16	136-0183-00			8	SOCKET, transistor, 3 pin
	- - - - -			-	mounting hardware: (not included w/assembly)
-17	211-0097-00	100	2559	3	SCREW, 4-40 x 5/16 inch, PHS
	211-0116-00	2560		3	SCREW, sems, 4-40 x 5/16 inch, PHB
	210-0054-00	100	2559X	3	LOCKWASHER, #4 split
	210-0994-00	100	2559X	3	WASHER, flat, 0.125 ID x 0.250 inch OD
	- - - - -			-	mounting hardware: (not included w/switch)
-18	211-0097-00	100	1059	2	SCREW, 4-40 x 3/16 inch, PHS
	211-0008-00	1060		2	SCREW, 4-40 x 1/4 inch, PHS
	210-0054-00	X1060		2	LOCKWASHER, #4 split
	210-0851-00			2	WASHER, flat, 0.119 ID x 3/8 inch OD
-19	210-0988-00	100	2439	2	WASHER, spherical, 0.406 ID x 0.562 inch OD
	210-0976-00	2440		2	WASHER, flat, 0.390 ID x 0.562 inch OD
	210-0413-00			1	NUT, hex., 3/8-32 x 1/2 inch
-20	366-0250-00			1	KNOB, large charcoal—CH 1 VOLTS/DIV
	- - - - -			-	knob includes:
	213-0004-00			1	SCREW, set, 6-32 x 3/16 inch, HSS
-21	366-0140-00			1	KNOB, small red—VARIABLE CAL
	- - - - -			-	knob includes:
	213-0004-00			1	SCREW, set, 6-32 x 3/16 inch, HSS
-22	366-0153-00			1	KNOB, small charcoal—SCALE ILLUM
	- - - - -			-	knob includes:
	213-0004-00			1	SCREW, set, 6-32 x 3/16 inch, HSS
-23	366-0153-00			1	KNOB, small charcoal—ASTIGMATISM
	- - - - -			-	knob includes:
	213-0004-00			1	SCREW, set, 6-32 x 3/16 inch, HSS
-24	366-0153-00			1	KNOB, small charcoal—FOCUS
	- - - - -			-	knob includes:
	213-0004-00			1	SCREW, set, 6-32 x 3/16 inch, HSS
-25	366-0153-00			1	KNOB, small charcoal—INTENSITY
	- - - - -			-	knob includes:
	213-0004-00			1	SCREW, set, 6-32 x 3/16 inch, HSS
-26	333-0838-00			1	PANEL, front
	- - - - -			-	mounting hardware: (not included w/panel)
	213-0055-00			2	SCREW, thread forming, 2-32 x 3/16 inch, PHS
-27	214-0552-00	100	122X	1	GASKET, rubber
-28	366-0153-00			2	KNOB, small charcoal—POSITION
	- - - - -			-	each knob includes:
	213-0004-00			1	SCREW, set, 6-32 x 3/16 inch, HSS
-29	348-0031-00			7	GROMMET, plastic, 3/32 inch diameter
-30	384-0338-00			1	ROD, assembly, w/plastic knob

FIG. 1 FRONT (cont)

Fig. & Index No.	Tektronix Part No.	Serial/Model No.		Q † Y	Description
		Eff	Disc		
1-31	200-0604-00	100	8579	1	ASSEMBLY, front cover
	200-0604-02	8580		1	ASSEMBLY, front cover
	- - - - -			-	assembly includes:
-32	348-0077-00			1	CUSHION, cover bottom
-33	214-0518-00	100	5339	2	PIN, hinge
	214-0756-00	5340		2	PIN, hinge
-34	214-0531-00			2	LATCH, chrome
-35	348-0013-00			4	FOOT, rubber
-36	200-0603-00	100	8579	1	ASSEMBLY, accessory cover
	200-0603-01	8580		1	ASSEMBLY, accessory cover
	- - - - -			-	assembly includes:
	214-0210-00	X8580		1	ASSEMBLY, solder spool
	- - - - -			-	assembly includes:
	214-0209-00	X8580		1	SPOOL, solder
	- - - - -			-	mounting hardware: (not included w/assembly)
	361-0009-00	X8580		1	SPACER, plastic, 0.188 inch long
-37	348-0071-00			1	CUSHION, accessory cover lid
-38	214-0594-00			2	PIN, actuator
-39	200-0632-00			2	CAP, actuator, black plastic
-40	214-0529-00	100	8579	1	LATCH, plunger
	204-0282-00	8580		1	BODY, latch
-41	214-0530-00	100	8579	1	LATCH, grommet
	214-0787-00	8580		1	STEM, latch
-42	366-0140-00			1	KNOB, small red—VARIABLE CAL
	- - - - -			-	knob includes:
	213-0004-00			1	SCREW, set, 6-32 x 3/16 inch, HSS
-43	366-0250-00			1	KNOB, large charcoal—CH 2 VOLTS/DIV
	- - - - -			-	knob includes:
	213-0004-00			1	SCREW, set, 6-32 x 3/16 inch, HSS
-44	262-0710-00			1	SWITCH, wired—CH 2 VOLTS/DIV
	- - - - -			-	switch includes:
	260-0661-00	100	2439	1	SWITCH, unwired
	260-0661-01	2440		1	SWITCH, unwired
-45	441-0602-00			1	CHASSIS, attenuator
	- - - - -			-	mounting hardware: (not included w/chassis)
	210-0053-00			2	LOCKWASHER, #2, split
	210-0405-00			2	NUT, hex., 2-56 x 3/16 inch
-46	407-0107-00			1	BRACKET, attenuator preamplifier
	- - - - -			-	mounting hardware: (not included w/bracket)
	210-0053-00	100	2439X	2	LOCKWASHER, #2 split
	210-0405-00	100	2439X	2	NUT, hex., 2-56 x 3/16 inch
	213-0055-00			2	SCREW, thread forming, 2-32 x 3/16 inch, PHS
-47	211-0008-00			2	SCREW, 4-40 x 1/4 inch, PHS
-48	- - - - -			2	RESISTOR, variable
	- - - - -			-	mounting hardware for each: (not included w/resistor)
	210-0940-00			1	WASHER, flat, 1/4 ID x 3/8 inch OD
	210-0583-00			1	NUT, hex., 1/4-32 x 3/16 inch
-49	376-0029-00			1	COUPLING, rod
	- - - - -			-	coupling includes:
	213-0075-00			2	SCREW, set, 4-40 x 3/32 inch, HSS
-50	376-0039-00	100	2689	1	COUPLING, rod
	- - - - -			-	coupling includes:
	213-0075-00			2	SCREW, set, 4-40 x 3/32 inch, HSS
	376-0014-00	2690		1	COUPLING, wire
	103-0049-00	X2690	4929	1	ADAPTER, shaft coupling (long)
	103-0049-04	4930		1	ADAPTER, shaft coupling (long)
	103-0050-00	X2690	4929	1	ADAPTER, shaft coupling (short)
	103-0050-02	4930		1	ADAPTER, shaft coupling (short)

FIG. 1 FRONT (cont)

Fig. & Index No.	Tektronix Part No.	Serial/Model No. Eff	No. Disc	Q					Description
				t	1	2	3	4	
1-51	136-0101-00			1					SOCKET, nuvistor, 5 pin
	- - - - -			-					mounting hardware: (not included w/socket)
	213-0055-00			2					SCREW, thread forming, 2-32 x 3/32 inch, PHS
-52	384-0339-00	100	2689	1					ROD, shaft, attenuator
	384-0398-00	2690		1					ROD, shaft, attenuator
-53	131-0344-00			8					CONNECTOR, terminal feed-thru
	- - - - -			-					mounting hardware for each: (not included w/connector)
	358-0241-00			1					BUSHING, plastic
-54	- - - - -			9					CAPACITOR
	- - - - -			-					mounting hardware for each: (not included w/capacitor)
	214-0456-00			1					FASTENER, plastic
-55	337-0716-00			1					SHIELD, attenuator
-56	384-0341-00			1					ROD, shaft, gain
-57	670-0405-00	100	13010	1					ASSEMBLY, circuit board—CHANNEL 2 PREAMP
	670-0405-02	13011		1					ASSEMBLY, circuit board—CHANNEL 2 PREAMP
	- - - - -			-					assembly includes:
	388-0614-00	100	4769	1					BOARD, circuit
	388-0614-01	4700		1					BOARD, circuit
	- - - - -			-					board includes:
-58	214-0507-00			12					PIN, connector, 45°
-59	136-0183-00			8					SOCKET, transistor, 3 pin
-60	260-0583-00	100	299	2					SWITCH, slide
	260-0583-01	300		2					SWITCH, slide
	- - - - -			-					mounting hardware for each: (not included w/switch)
	213-0044-00			2					SCREW, thread forming, 5-32 x 3/16 inch, PHS
	- - - - -			-					mounting hardware: (not included w/assembly)
-61	211-0097-00	100	2559	3					SCREW, 4-40 x 5/16 inch, PHB
	211-0116-00	2560		3					SCREW, sems, 4-40 x 5/16 inch, PHS
	210-0054-00	100	2559X	3					LOCKWASHER, #4 split
	210-0994-00	100	2559X	3					WASHER, flat, 0.125 ID x 0.250 inch OD
	- - - - -			-					mounting hardware: (not included w/switch)
-62	211-0097-00	100	1059	2					SCREW, 4-40 x 5/16 inch, PHS
	211-0008-00	1060		2					SCREW, 4-40 x 1/4 inch, PHS
	210-0054-00	X1060		2					LOCKWASHER, split, #4
	210-0851-00			2					WASHER, flat, 0.119 ID x 3/8 inch OD
-63	210-0988-00	100	2439	2					WASHER, spherical, 0.406 ID x 0.562 inch OD
	210-0976-00	2440		2					WASHER, flat, 0.390 ID x 0.562 inch OD
	210-0413-00			1					NUT, hex., 3/8-32 x 1/2 inch
-64	262-0711-00	100	599	1					SWITCH, wired
	262-0722-00	600		1					SWITCH, wired
	- - - - -			-					switch includes:
	260-0659-00	100	599	1					SWITCH, unwired—TIME/DIV
	260-0659-01	600		1					SWITCH, unwired—TIME/DIV
	131-0371-00	X600		2					CONNECTOR, single contact
-65	384-0217-00			1					ROD, extension
-66	337-0718-00			1					SHIELD, switch
	- - - - -			-					mounting hardware: (not included w/shield)
	211-0008-00			3					SCREW, 4-40 x 1/4 inch, PHS

FIG. 1 FRONT (cont)

Fig. & Index No.	Tektronix Part No.	Serial/Model No.		Q	Description
		Eff	Disc		
				y	1 2 3 4 5
1-67	376-0039-00			1	COUPLING
	- - - - -			-	coupling includes:
	213-0075-00			2	SCREW, set, 4-40 x 3/32 inch, HSS
-68	- - - - -			1	RESISTOR, variable
	- - - - -			-	mounting hardware: (not included w/resistor)
	210-0940-00			1	WASHER, flat, 1/4 ID x 3/8 inch OD
	210-0583-00			1	NUT, hex., 1/4-32 x 5/16 inch
-69	348-0056-00			1	GROMMET, plastic, 3/8 inch diameter
-70	- - - - -			1	CAPACITOR
	- - - - -			-	mounting hardware: (not included w/capacitor)
	210-0018-00			1	LOCKWASHER, internal, 5/16 inch
	210-0524-00			1	NUT, hex., 5/16-24 x 1/2 inch
-71	407-0101-00			1	BRACKET, switch rear
	- - - - -			-	mounting hardware: (not included w/bracket)
	210-0055-00			2	LOCKWASHER, #6, split
	210-0449-00			2	NUT, hex., 5-40 x 1/4 inch
	- - - - -			-	mounting hardware: (not included w/switch)
-72	211-0097-00	100	1059	2	SCREW, 4-40 x 5/16 inch, PHS
	211-0008-00	1060		2	SCREW, 4-40 x 1/4 inch, PHS
	210-0054-00	X1060		1	LOCKWASHER, split, #4
	210-0851-00			2	WASHER, flat, 0.119 x 3/8 inch OD
-73	210-0840-00			1	WASHER, flat, 0.390 ID x 9/16 inch
	210-0413-00			1	NUT, hex., 3/8-32 x 1/2 inch
-74	366-0031-00			1	KNOB, small red—VARIABLE CAL
	- - - - -			-	knob includes:
	213-0004-00			1	SCREW, set, 6-32 x 3/16 inch, HSS
-75	366-0160-00			1	KNOB, large charcoal—TIME/DIV
	- - - - -			-	knob includes:
	213-0004-00			1	SCREW, set, 6-32 x 3/16 inch, HSS
-76	384-0334-00			1	ROD, invert switch, w/knob
-77	384-0332-00			1	ROD, X10, gain AC switch, w/knob
-78	384-0336-00	100	6989	1	ROD, power switch, w/knob
	384-0336-01	6990		1	ROD, power switch, w/knob
-79	366-0153-00			1	KNOB, small charcoal—LEVEL
	- - - - -			-	knob includes:
	213-0004-00			1	SCREW, set, 6-32 x 3/16 inch, HSS
	262-0712-00			1	SWITCH, wired—LEVEL
	- - - - -			-	switch includes:
-80	260-0516-00			3	SWITCH, push
-81	214-0574-00			2	PAD, rubberized
-82	337-0715-00			1	SHIELD
	- - - - -			-	mounting hardware: (not included w/shield)
	211-0111-00			2	SCREW, 2-56 x 1 inch, PHS
-83	210-0201-00			1	LUG, solder, SE #4
	- - - - -			-	mounting hardware: (not included w/lug)
	211-0007-00			1	SCREW, 4-40 x 3/16 inch, PHS
-84	131-0344-00			2	CONNECTOR, terminal feed-thru
	- - - - -			-	mounting hardware for each: (not included w/connector)
	358-0241-00			1	BUSHING, plastic

FIG. 1 FRONT (cont)

Fig. & Index No.	Tektronix Part No.	Serial/Model No.		Q † y	Description
		Eff	Disc		
1-85	- - - - -			1	RESISTOR, variable
	- - - - -			-	resistor includes:
-86	- - - - -			1	ROD, extension
	- - - - -			-	mounting hardware: (not included w/resistor)
	210-0840-00			1	WASHER, flat, 0.390 ID x 3/16 inch OD
	210-0413-00			1	NUT, hex., 3/8-32 x 1/2 inch
-87	407-0098-00			1	BRACKET
-88	401-0026-00			1	CAM
	- - - - -			-	cam includes:
-89	213-0020-00			2	SCREW, set, 6-32 x 1/8 inch, HSS
	- - - - -			-	mounting hardware: (not included w/switch)
	211-0008-00			2	SCREW, 4-40 x 1/4 inch, PHS
-90	384-0637-00			4	ROD, frame
-91	386-0120-00			1	PLATE, front casting
-92	352-0084-00			4	HOLDER, neon
	200-0609-00			4	CAP, lamp, neon holder
	378-0541-00			4	FILTER, lens, neon indicator light
-93	260-0665-00			2	SWITCH, lever—AC GND DC
	- - - - -			-	mounting hardware for each: (not included w/switch)
	220-0413-00			2	NUT, hex., rod, 4-40 x 3/16 x 0.500 inch long
-94	344-0120-00			2	CLIP, capacitor mounting
	- - - - -			-	mounting hardware for each: (not included w/clip)
	211-0087-00			1	SCREW, 2-56 x 3/16 inch, FHS
	210-0405-00			1	NUT, hex., 2-56 x 3/16 inch
-95	210-0255-00			3	LUG, solder, 3/8 inch ID
-96	- - - - -			2	RESISTOR, variable
	- - - - -			-	mounting hardware for each: (not included w/resistor)
-97	358-0251-00			2	BUSHING
-98	358-0054-00			2	BUSHING, banana jack
	- - - - -			-	mounting hardware for each: (not included w/bushing)
	210-0046-00			1	LOCKWASHER, internal, 1/4 ID x 0.400 inch OD
	210-0465-00			1	NUT, hex., 1/4-32 x 3/8 inch
-99	- - - - -			5	RESISTOR, variable
	- - - - -			-	mounting hardware for each: (not included w/resistor)
	210-0940-00			1	WASHER, flat, 1/4 ID x 3/8 inch OD
	210-0583-00			1	NUT, hex., 1/4-32 x 5/16 inch
-100	200-0103-00			1	CAP, ground stem
-101	253-0069-00	100	2069	FT	TAPE, rubber (two 1/2 inch lengths)
	214-0654-00	2070	12175	1	SPRING, filter
	214-0996-00	12176		1	SPRING, filter
-102	260-0662-00			1	SWITCH, lever—Triggering Source
	- - - - -			-	mounting hardware: (not included w/switch)
	220-0413-00			1	NUT, hex., rod, 4-40 x 3/16 x 0.500 inch long

FIG. 1 FRONT (cont)

Fig. & Index No.	Tektronix Part No.	Serial/Model No.		Q † Y	Description
		Eff	Disc		
1-103	260-0663-00 - - - - - 220-0413-00			1 - 2	SWITCH, lever—Triggering Coupling mounting hardware: (not included w/switch) NUT, hex., rod, 4-40 x 3/16 x 0.500 inch long
-104	260-0664-00 - - - - - 220-0413-00			1 - 2	SWITCH, lever—Trigger SLOPE mounting hardware: (not included w/switch) NUT, hex., rod, 4-40 x 3/16 x 0.500 inch long
-105	- - - - - - - - - - 210-0046-00 210-0940-00 210-0583-00			2 - 1 1 1	RESISTOR, variable mounting hardware for each: (not included w/resistor) LOCKWASHER, internal, 1/4 ID x 0.400 inch OD WASHER, flat, 1/4 ID x 3/8 inch OD NUT, hex., 1/4-32 x 5/16 inch
-106	136-0205-00 - - - - - 210-0589-00			2 - 1	SOCKET, graticule light mounting hardware for each: (not included w/socket) NUT, locking, 4-40 x 1/4 inch
-107	200-0608-00			2	COVER, pot
-108	131-0383-00			1	CONNECTOR, anode
-109	331-0141-00	100	759X	1	MASK, graticule (see ref. #115)
-110	437-0076-00 - - - - -			1 -	CABINET, assembly cabinet includes:
-111	348-0069-00 - - - - - 211-0501-00 - - - - - 211-0097-00			2 - 2 - 3	FOOT, bottom mounting hardware for each: (not included w/foot) SCREW, 6-32 x 1/8 inch, PHS mounting hardware: (not included w/cabinet) SCREW, 4-40 x 5/16 inch, PHS
-112	337-0699-00 - - - - - 211-0008-00 210-0054-00			1 - 3 1	SHIELD, CRT, rear mounting hardware: (not included w/shield) SCREW, 4-40 x 1/4 inch, PHS LOCKWASHER, # 4, split
-113	200-0616-00			1	COVER, CRT socket
-114	136-0222-00 - - - - - 136-0202-01 - - - - - 136-0202-00 214-0464-00			1 - 1 - 1 14	ASSEMBLY, CRT socket assembly includes: SOCKET, CRT socket includes: SOCKET, CRT CONTACT, CRT socket
-115	337-0669-00 337-0669-01 - - - - - 354-0258-00 331-0141-00	100 1890 X760	1889	1 1 1 - 1 1	SHIELD, CRT SHIELD, CRT TUBE, cathode ray tube includes: RING, light reflector (not shown) MASK, graticule (see ref. #109)

FIG. 1 FRONT (cont)

Fig. & Index No.	Tektronix Part No.	Serial/Model No. Eff	No. Disc	Q † y						Description
					1	2	3	4	5	
1-116	348-0070-00	100	1399	4						CUSHION, CRT
	348-0070-01	1400		4						CUSHION, CRT
-117	343-0115-00			1						CLAMP, CRT, rear mount (bottom)
-118	124-0170-00	100	1889	2						STRIP, liner
	124-0170-01	1890		2						STRIP, liner
-119	343-0116-00			1						CLAMP, CRT, rear mount (top)
-120	211-0134-00			2						SCREW, 4-40 x 3/8 inch, PHS
-121	407-0105-00	100	1889	1						BRACKET, CRT shield
	407-0105-01	1890		1						BRACKET, CRT shield
	- - - - -			-						mounting hardware: (not included w/bracket)
	211-0113-00	100	1889	2						SCREW, 4-40 x 5/16 inch, PHS
	211-0117-00	1890		2						SCREW, 4-40 x 5/16 inch, FHS
	210-0058-00			6						LOCKWASHER, internal, #4
	220-0438-00			4						NUT, hex., 4-40 x 1/4 inch
-122	211-0008-00			2						SCREW, 4-40 x 1/4 inch, PHS
-123	367-0046-00	100	3199	1						ASSEMBLY, carrying handle
	367-0063-00	3200		1						ASSEMBLY, carrying handle
	- - - - -			-						assembly includes:
-124	200-0602-00			2						COVER, handle
-125	367-0045-00	100	3199	1						HANDLE, carrying
	367-0046-01	3200		1						HANDLE, carrying
	- - - - -			-						mounting hardware: (not included w/handle)
	211-0512-00			4						SCREW, 6-32 x 1/2 inch, 100° csk, FHS
-126	214-0516-00			2						SPRING, handle index
-127	214-0515-00			2						INDEX, hub
-128	214-0513-00			2						INDEX, ring
	- - - - -			-						mounting hardware: (not included w/assembly)
-129	213-0139-00			2						SCREW, 10-24 x 3/8 inch, HHS
	210-0805-00			2						WASHER, flat, 0.204 ID x 0.438 inch OD
-130	131-0352-00			5						CONNECTOR, coaxial, 1 contact, BNC w/hardware
-131	- - - - -	X1890		1						RESISTOR, variable
	- - - - -			-						mounting hardware: (not included w/resistor)
	210-0223-00			1						LUG, solder, 1/4 ID x 7/16 inch OD, SE
	210-0940-00			1						WASHER, flat, 1/4 ID x 3/8 inch OD
	210-0583-00			1						NUT, hex., 1/4-32 x 5/16 inch
-132	388-0678-00	X1890	11929X	1						BOARD, circuit
	- - - - -			-						board includes:
	214-0506-00			3						PIN, connector straight
-133	131-0371-00	X1890	11929X	3						CONNECTOR, single contact
-134	358-0252-00			1						BUSHING, ball, swivel
-135	366-0215-01			5						KNOB, charcoal, lever
-136	136-0187-00			1						SOCKET, 1 pin
	- - - - -			-						mounting hardware: (not included w/socket)
	210-0940-00			1						WASHER, flat, 1/4 ID x 3/8 inch OD
-137	210-0471-00			1						NUT, hex., 1/4-32 x 5/16 x 3/32 inch
-138	366-0225-00			1						KNOB, charcoal—Mode
	- - - - -			-						knob includes:
	213-0020-00			1						SCREW, set, 6-32 x 1/8 inch, HSS

FIG. 2 CHASSIS

Fig. & Index No.	Tektronix Part No.	Serial/Model No. Eff	No. Disc	Q					Description
				†	1	2	3	4	
2-1	179-0941-00	100	157	1					CABLE HARNESS, vertical
	179-0941-01	158		1					CABLE HARNESS, vertical
	- - - - -			-					cable harness includes:
-2	131-0371-00			-					CONNECTOR, single contact
-3	670-0407-00			1					ASSEMBLY, circuit board—SWITCHING & OUTPUT AMPLIFIER
	- - - - -			-					assembly includes:
	388-0616-00	100	10649	1					BOARD, circuit
	388-0616-01	10650		1					BOARD, circuit
	- - - - -			-					board includes:
-4	214-0507-00			22					PIN, connector, 45°
-5	337-0717-00			1					SHIELD, horizontal amplifier
-6	129-0069-00			2					POST, tie-off
	- - - - -			-					mounting hardware for each: (not included w/post)
	361-0008-00			1					SPACER, plastic, 0.281 inch long
-7	344-0119-00			6					CLIP, electrical
-8	136-0183-00			7					SOCKET, transistor, 3 pin
	- - - - -			-					mounting hardware: (not included w/assembly)
-9	211-0097-00	100	2559	4					SCREW, 4-40 x 5/16 inch, PHS
	211-0116-00	2560		4					SCREW, sems, 4-40 x 5/16 inch, PHB
	210-0054-00	100	2559X	4					LOCKWASHER, #4, split
	210-0994-00	100	2559X	3					WASHER, flat, 0.125 ID x 0.250 inch OD
	210-0406-00			1					NUT, hex., 4-40 x 3/16 inch
-10	407-0103-00			1					BRACKET, vertical board
-11	175-0582-00			1					WIRE, crt lead, 0.458 foot, striped brown, w/connector
	175-0583-00			1					WIRE, crt lead, 11 1/2 inches, striped red, w/connector
	175-0584-00			1					WIRE, crt lead, 11 1/2 inches, striped green, w/connector
	175-0596-00			1					WIRE, crt lead, 0.417 foot, striped blue, w/connector
-12	214-0153-00			1					FASTENER, snap, double-pronged
-13	214-0511-00			2					SPRING, transistor mounting
	- - - - -			-					mounting hardware for each: (not included w/spring)
	211-0007-00			1					SCREW, 4-40 x 3/16 inch, PHS
-14	214-0317-00			2					HEAT SINK, insulator disc
-15	352-0082-00			2					HOLDER, transistor mounting
-16	407-0104-00			1					BRACKET, vertical output
	- - - - -			-					mounting hardware: (not included w/bracket)
	211-0008-00			3					SCREW, 4-40 x 1/4 inch, PHS
-17	348-0063-00			5					GROMMET, plastic, 1/2 inch diameter
-18	343-0089-00			2					CLAMP, cable, plastic, size "D"
-19	343-0006-00			1					CLAMP, cable, plastic, 1/2 inch
	- - - - -			-					mounting hardware: (not included w/clamp)
	211-0097-00			1					SCREW, 4-40 x 5/16 inch, PHS
	210-0851-00			1					WASHER, flat, 0.119 ID x 3/8 inch OD
-20	210-0201-00			3					LUG, solder, SE #4
	- - - - -			-					mounting hardware for each: (not included w/lug)
	213-0044-00			1					SCREW, thread forming, 5-32 x 3/16 inch, PHS

FIG. 2 CHASSIS (cont)

Fig. & Index No.	Tektronix Part No.	Serial/Model Eff	No. Disc	Q † y	Description				
					1	2	3	4	5
2-21	441-0601-00	100	677	1	CHASSIS, main frame				
	441-0601-01	678		1	CHASSIS, main frame				
	- - - - -			-	mounting hardware: (not included w/chassis)				
	211-0008-00			3	SCREW, 4-40 x 1/4 inch, PHS				
	210-0586-00			3	NUT, keps, 4-40 x 1/4 inch				
-22	337-0722-00			1	SHIELD, interchannel				
	- - - - -			-	mounting hardware: (not included w/shield)				
	210-0586-00			5	NUT, keps, 4-40 x 1/4 inch				
-23	348-0031-00			1	GROMMET, plastic, 3/32 inch diameter				
-24	260-0660-00			1	SWITCH, unwired—Mode				
	- - - - -			-	mounting hardware: (not included w/switch)				
	210-0940-00			1	WASHER, flat, 1/4 ID x 3/8 inch OD				
	210-0583-00			1	NUT, hex., 1/4-32 x 5/16 inch				
-25	348-0056-00			6	GROMMET, plastic, 3/8 inch diameter				
-26	407-0099-00			3	BRACKET, invert switch				
	- - - - -			-	mounting hardware for each: (not included w/bracket)				
	211-0008-00			2	SCREW, 4-40 x 1/4 inch, PHS				
-27	214-0510-00			3	SPRING, switch detent				
-28	214-0525-00			2	ACTUATOR, invert switch				
-29	670-0409-00			1	ASSEMBLY, circuit board—TRIGGER/SWEEP GENERATOR				
	- - - - -			-	assembly includes:				
	388-0618-00	100	10649	1	BOARD, circuit				
	388-0618-01	10650		1	BOARD, circuit				
	- - - - -			-	board includes:				
-30	214-0507-00			27	PIN, connector 45°				
-31	214-0506-00			10	PIN, connector, straight				
-32	136-0125-00			1	SOCKET, nuvistor, 5 pin				
-33	214-0565-00			2	FASTENER, pin press				
-34	136-0183-00			11	SOCKET, transistor, 3 pin				
-35	387-0603-00	100	1039X	1	PLATE, insulator				
	- - - - -			-	mounting hardware: (not included w/assembly)				
-36	211-0097-00			5	SCREW, 4-40 x 5/16 inch, PHS				
	210-0054-00			5	LOCKWASHER, #4, split				
	210-0994-00			5	WASHER, flat, 0.125 ID x 0.250 inch OD				
-37	179-0940-00			1	CABLE HARNESS, sweep				
	- - - - -			-	cable harness includes:				
-38	131-0371-00			-	CONNECTOR, single contact				
-39	337-0720-00			1	SHIELD, trigger sweep				
	- - - - -			-	mounting hardware: (not included w/shield)				
	211-0008-00			4	SCREW, 4-40 x 1/4 inch, PHS				
	210-0586-00			2	NUT, keps, 4-40 x 1/4 inch				
	210-0851-00	X5800		4	WASHER, flat, 0.119 ID x 3/8 inch OD				

FIG. 2 CHASSIS (cont)

Fig. & Index No.	Tektronix Part No.	Serial/Model No.		Q † y	Description
		Eff	Disc		
2-40	214-0524-00			1	ACTUATOR, X10 gain AC switch
-41	670-0408-00	100	765	1	ASSEMBLY, circuit board—CALIBRATOR
	670-0420-00	766		1	ASSEMBLY, circuit board—CALIBRATOR
	- - - - -			-	assembly includes:
	388-0617-00	100	765	1	BOARD, circuit
	388-0617-01	766	10649	1	BOARD, circuit
	388-0617-02	10650		1	BOARD, circuit
	- - - - -			-	board includes:
-42	214-0506-00			14	PIN, connector, straight
-43	136-0183-00			6	SOCKET, transistor, 3 pin
-44	343-0088-00			1	CLAMP, plastic, cable, size "C"
	- - - - -			-	mounting hardware: (not included w/assembly)
-45	211-0097-00	100	2559	3	SCREW, 4-40 x 5/16 inch, PHS
	211-0116-00	2560		3	SCREW, sems, 4-40 x 5/16 inch, PHB
	210-0054-00	100	2559X	3	LOCKWASHER, #4, split
	210-0994-00	100	2559X	3	WASHER, flat, 0.125 ID x 0.025 inch OD
-46	407-0100-00			1	BRACKET, calibrator mounting
	- - - - -			-	mounting hardware: (not included w/bracket)
	211-0008-00			3	SCREW, 4-40 x 1/4 inch, PHS
-47	179-0942-00			1	CABLE HARNESS, calibrator
	- - - - -			-	cable harness includes:
-48	131-0371-00			-	CONNECTOR, single contact
-49	119-0037-00	100	2709	1	ASSEMBLY, delay line
	119-0037-01	2710		1	ASSEMBLY, delay line
	- - - - -			-	assembly includes:
-50	352-0083-00	100	677	1	HOLDER, delay line
	352-0083-01	678		1	HOLDER, delay line
-51	200-0606-00	100	677	1	COVER, delay line
	200-0606-01	678		1	COVER, delay line
	- - - - -			-	mounting hardware: (not included w/cover)
	213-0088-00	100	677X	2	SCREW, thread forming, 4-40 x 1/4 inch, PHS
	210-0601-01	X678		2	EYELETS, brass
	- - - - -			-	mounting hardware: (not included w/assembly)
	210-0406-00	100	677	2	NUT, hex., 4-40 x 3/16 inch
	210-0589-00	678		4	NUT, locking, 4-40 x 1/4 inch
	210-0851-00	X678		4	WASHER, flat, 0.119 ID x 3/8 inch OD
-52	670-0406-00	100	599	1	ASSEMBLY, circuit board—HORIZONTAL AMPLIFIER
	670-0413-00	600		1	ASSEMBLY, circuit board—HORIZONTAL AMPLIFIER
	- - - - -			-	assembly includes:
	388-0615-00	100	599	1	BOARD, circuit
	388-0615-01	600	4134	1	BOARD, circuit
	388-0615-02	4135	9562	1	BOARD, circuit
	- - - - -			-	board includes:
-53	214-0506-00			2	PIN, connector, straight
-54	214-0507-00			28	PIN, connector, 45°
	388-0615-03	9563		1	BOARD, circuit
	214-0506-00	9563		2	PIN, connector, straight
	214-0507-00	9563		28	PIN, connector, 45°

FIG. 2 CHASSIS (cont)

Fig. & Index No.	Tektronix Part No.	Serial/Model No.		Q	Description					
		Eff	No. Disc							
				t						
				y	1	2	3	4	5	
2-55	136-0183-00			4	SOCKET, transistor, 3 pin					
-56	136-0183-00	100	4134	3	SOCKET, transistor, 3 pin					
	136-0220-00	4135		3	SOCKET, transistor, 3 pin					
-57	337-0717-00			2	SHIELD, horizontal amplifier					
-58	260-0583-00	100	299	1	SWITCH, slide					
	260-0583-01	300		1	SWITCH, slide					
	- - - - -			-	mounting hardware: (not included w/switch)					
	213-0044-00			2	SCREW, thread forming, 5-32 x 3/16 inch, PHS					
	- - - - -			-	mounting hardware: (not included w/assembly)					
-59	211-0097-00	100	2559	3	SCREW, 4-40 x 5/16 inch, PHS					
	211-0116-00	2560		3	SCREW, sems, 4-40 x 5/16 inch, PHB					
	210-0054-00	100	2559X	3	LOCKWASHER, #4, split					
	210-0994-00	100	2559X	3	WASHER, flat, 0.125 ID x 0.250 inch OD					
-60	179-0943-00			1	CABLE HARNESS, horizontal					
	- - - - -			-	cable harness includes:					
-61	131-0371-00			-	CONNECTOR, single contact					
-62	343-0119-00	100	8579	2	CLAMP, cable, black plastic, 3/32 inch					
	343-0144-00	8580		2	CLAMP, loop, 0.125 inch ID					
	- - - - -			-	mounting hardware: (not included w/clamp)					
-63	211-0014-00			1	SCREW, 4-40 x 1/2 inch, PHS					
	210-0851-00			2	WASHER, flat, 0.119 ID x 3/8 inch OD					
	210-0406-00			1	NUT, hex., 4-40 x 3/16 inch					
-64	- - - - -			-	RESISTOR, variable					
	- - - - -			-	mounting hardware for each: (not included w/resistor)					
	210-0940-00			1	WASHER, flat, 1/4 ID x 3/8 inch OD					
	210-0583-00			1	NUT, hex., 1/4-32 x 5/16 inch					
-65	124-0147-00			2	STRIP, ceramic, 7/16 inch, w/13 notches					
	- - - - -			-	each strip includes:					
	355-0046-00			2	STUD, plastic					
	- - - - -			-	mounting hardware for each: (not included w/strip)					
	361-0007-00			2	SPACER, plastic, 0.188 inch long					
-66	337-0719-00	100	1679	1	SHIELD, high-voltage					
	337-0719-01	1680		1	SHIELD, high-voltage					
	- - - - -			-	mounting hardware: (not included w/shield)					
	211-0008-00			3	SCREW, 4-40 x 1/4 inch, PHS					
	210-0586-00			3	NUT, keps, 4-40 x 1/4 inch					
-67	386-0117-00			1	PLATE, rear frame					
-68	343-0004-00			1	CLAMP, cable, plastic, 5/16 inch					
	- - - - -			-	mounting hardware: (not included w/clamp)					
	211-0097-00			1	SCREW, 4-40 x 5/16 inch, PHS					
	210-0851-00			1	WASHER, flat, 0.119 ID x 3/8 inch OD					

FIG. 2 CHASSIS (cont)

Fig. & Index No.	Tektronix Part No.	Serial/Model Eff	No. Disc	Q					Description	
				t	y	1	2	3		4
2-69	358-0244-00			2						BUSHING, flange
	- - - - -			-						mounting hardware for each: (not included w/bushing)
	211-0014-00			1						SCREW, 4-40 x 1/2 inch, PHS
	210-0851-00			1						WASHER, flat, 0.119 ID x 3/8 inch OD
-70	214-0210-00	100	8579X	1						ASSEMBLY, solder spool
	- - - - -			-						assembly includes:
	214-0209-00	100	8579X	1						SPOOL, solder
	- - - - -			-						mounting hardware: (not included w/assembly)
	361-0007-00	100	8579X	1						SPACER, plastic, 0.188 inch long
-71	- - - - -			1						RESISTOR, variable
	- - - - -			-						mounting hardware: (not included w/resistor)
	210-0207-00			1						LUG, solder, 3/8 inch
	210-0012-00			1						LOCKWASHER, internal, 3/8 x 1/2 inch
	210-0840-00			1						WASHER, flat, 0.390 ID x 9/16 inch OD
	210-0413-00			1						NUT, hex., 3/8-32 x 1/2 inch
-72	643-0408-00			1						ASSEMBLY, connector cable
	- - - - -			-						assembly includes:
-73	407-0097-00			1						BRACKET, power connector
-74	343-0004-00			1						CLAMP, cable, plastic, 5/16 inch
	- - - - -			-						mounting hardware: (not included w/clamp)
	210-0863-00			1						WASHER, D shape, 0.191 ID x 33/64 w 33/64 inch lg
	210-0586-00			1						NUT, keps, 4-40 x 1/4 inch
-75	131-0345-00			1						CONNECTOR, male, 24 pin
	- - - - -			-						mounting hardware: (not included w/connector)
	211-0008-00			2						SCREW, 4-40 x 1/4 inch, PHS
	210-0586-00			2						NUT, keps, 4-40 x 1/4 inch
	- - - - -			-						mounting hardware: (not included w/assembly)
-76	211-0008-00			3						SCREW, 4-40 x 1/4 inch, PHS
-77	214-0526-00	100	6989	1						ACTUATOR, toggle switch
	214-0526-01	6990		1						ACTUATOR, toggle switch
-78	214-0533-00	100	6989	1						PIN, escutcheon
	214-0863-00	6990		1						PIN, spiral spring
-79	214-0509-00			1						SPRING, switch actuator
-80	407-0106-00			1						BRACKET, power switch actuator
	- - - - -			-						mounting hardware: (not included w/bracket)
	211-0008-00			2						SCREW, 4-40 x 1/4 inch, PHS
-81	337-0721-00			1						SHIELD, high-voltage power supply



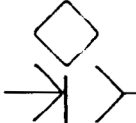
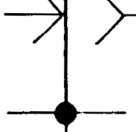
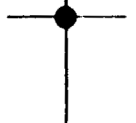

FIG. 2 CHASSIS (cont)

Fig. & Index No.	Tektronix Part No.	Serial/Model No.		Q † y	Description
		Eff	Disc		
2-	621-0423-00			1	ASSEMBLY, high-voltage power
	- - - - -			-	assembly includes:
-82	202-0135-00			1	BOX, high-voltage
-83	670-0410-00			1	ASSEMBLY, circuit board—HIGH-VOLTAGE RECTIFIER
	- - - - -			-	circuit board assembly includes:
	388-0620-00			1	BOARD, circuit
-84	214-0523-00			1	INSULATOR, high-voltage
-85	200-0607-00			1	COVER, high-voltage box
-86	670-0411-00	100	4329	1	ASSEMBLY, circuit board—HIGH-VOLTAGE REGULATOR
	670-0411-01	4330		1	ASSEMBLY, circuit board—HIGH-VOLTAGE REGULATOR
	- - - - -			-	assembly includes:
-87	388-0619-00	100	4329	1	BOARD, circuit
	388-0619-01	4330		1	BOARD, circuit
-88	129-0075-00			1	POST, tie-off
	- - - - -			-	mounting hardware: (not included w/post)
	361-0007-00			1	SPACER, plastic, 0.188 inch long
-89	179-0961-00	100	4329	1	CABLE HARNESS, high voltage
	179-0961-01	4330		1	CABLE HARNESS, high voltage
	- - - - -			-	mounting hardware: (not included w/assembly)
-90	211-0594-00			2	SCREW, 6-32 x 2½ inches, THS
	210-0803-00			2	WASHER, flat, 0.150 ID x ¾ inch OD
-91	343-0003-00			1	CLAMP, cable plastic, ¼ inch
	- - - - -			-	mounting hardware: (not included w/clamp)
	211-0097-00			1	SCREW, 4-40 x 5/16 inch, PHS
	210-0851-00			1	WASHER, flat, 0.119 ID x ¾ inch OD
-92	407-0205-00	100	677X	1	BRACKET, angle
	- - - - -			-	mounting hardware: (not included w/bracket)
	211-0008-00			1	SCREW, 4-40 x ¼ inch, PHS
-93	407-0102-00			1	BRACKET
	- - - - -			-	mounting hardware: (not included w/bracket)
	210-0586-00			2	NUT, keps, 4-40 x ¼ inch

SECTION 9

DIAGRAMS

The following symbols are used on the diagrams:

-  Screwdriver adjustment
-  Front-, side- or rear-panel control or connector
-  Clockwise control rotation in direction of arrow
-  Refer to indicated diagram
-  Connection to circuit board made with pin connector at indicated pin
-  Connection soldered to circuit board
-  Blue line encloses components located on circuit board

HORIZ IN
OR
TRIG IN



SWEEP
TRIGGER

SWEEP
GENERATOR

HORIZONTAL
AMPLIFIER

CHANNEL 1
TRIGGER
PICKOFF

CHANNEL 1 & 2
TRIGGER
PICKOFF

INPUT 1



CHANNEL 1
INPUT
AMPLIFIER

DIODE
GATE

2 VOLT PROBE
CALIBRATOR



CALIBRATOR

SWITCHING
MULTIVIBRATOR

VERTICAL
OUTPUT
AMPLIFIER

INPUT 2



CHANNEL 2
INPUT
AMPLIFIER

DIODE
GATE

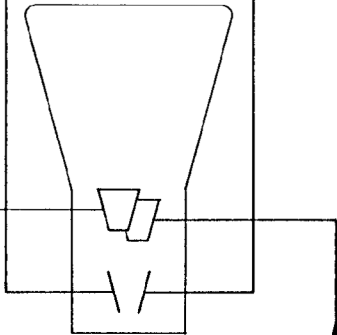

IMPORTANT

VOLTAGE AND WAVEFORM CONDITIONS

Circuit voltages measured with 20,000 Ω /volt VOM. All readings in volts.

Waveforms shown are actual waveform photographs taken with a Tektronix Oscilloscope Camera System and Projected Graticule. Test oscilloscope was DC coupled (except where noted) using a 10 \times Probe.

Voltage and waveform measurements given on the schematics are not absolute and may vary between instruments. Apparent differences between voltage levels measured with the voltmeter and those shown on the waveform are due to circuit loading.

Voltages and waveforms are indicated on the schematics in blue.

Voltage readings and waveforms were obtained under the following conditions:

Vertical Controls (both channels where applicable)

VOLTS/CM	.05
VARIABLE	CAL
AC GND DC	GND
POSITION	Midrange
Mode	CH 1
INVERT	Pushed in
$\times 10$ GAIN AC	Pushed in

Horizontal Controls

POSITION	Midrange
TIME/DIV	.5 mSEC
VARIABLE	CAL
$\times 10$ MAG	Pushed in

Triggering Controls

Source	CH 1 & 2
Coupling	AC
SLOPE	Positive going
LEVEL	Centered (AUTO for waveforms)

Other Controls

INTENSITY	Midrange
FOCUS	Any position
ASTIGMATISM	Any position
SCALE ILLUM	As desired
POWER	On

Line voltage 115 volts

Signal applied None

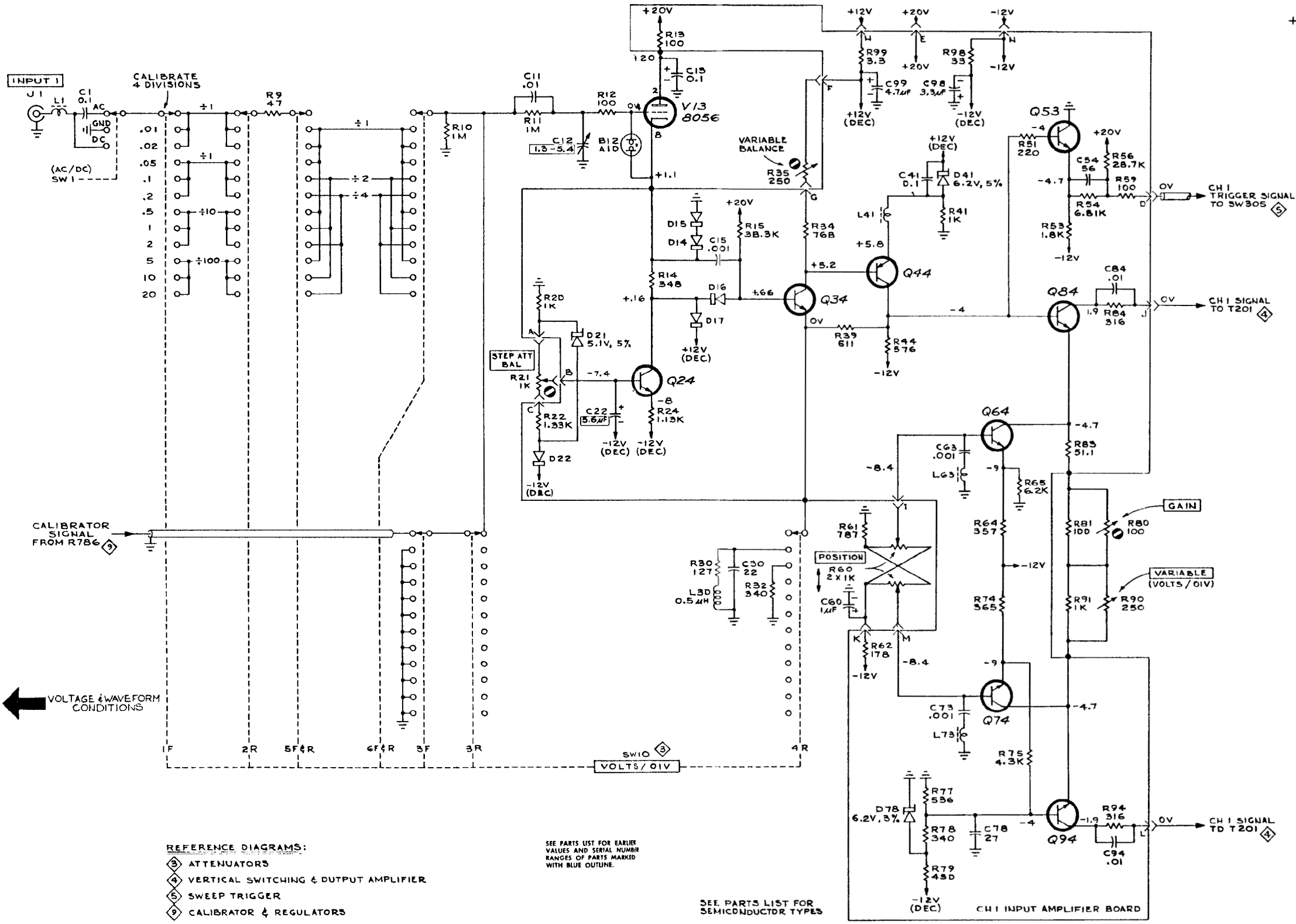

VOLTAGE & WAVEFORM CONDITIONS

REFERENCE DIAGRAMS:

- ③ ATTENUATORS
- ④ VERTICAL SWITCHING & OUTPUT AMPLIFIER
- ⑤ SWEEP TRIGGER
- ⑥ CALIBRATOR & REGULATORS

SEE PARTS LIST FOR EARLIER VALUES AND SERIAL NUMBER RANGES OF PARTS MARKED WITH BLUE OUTLINE.

SEE PARTS LIST FOR SEMICONDUCTOR TYPES

VOLTAGES and WAVEFORMS obtained under conditions given on left side of this diagram.

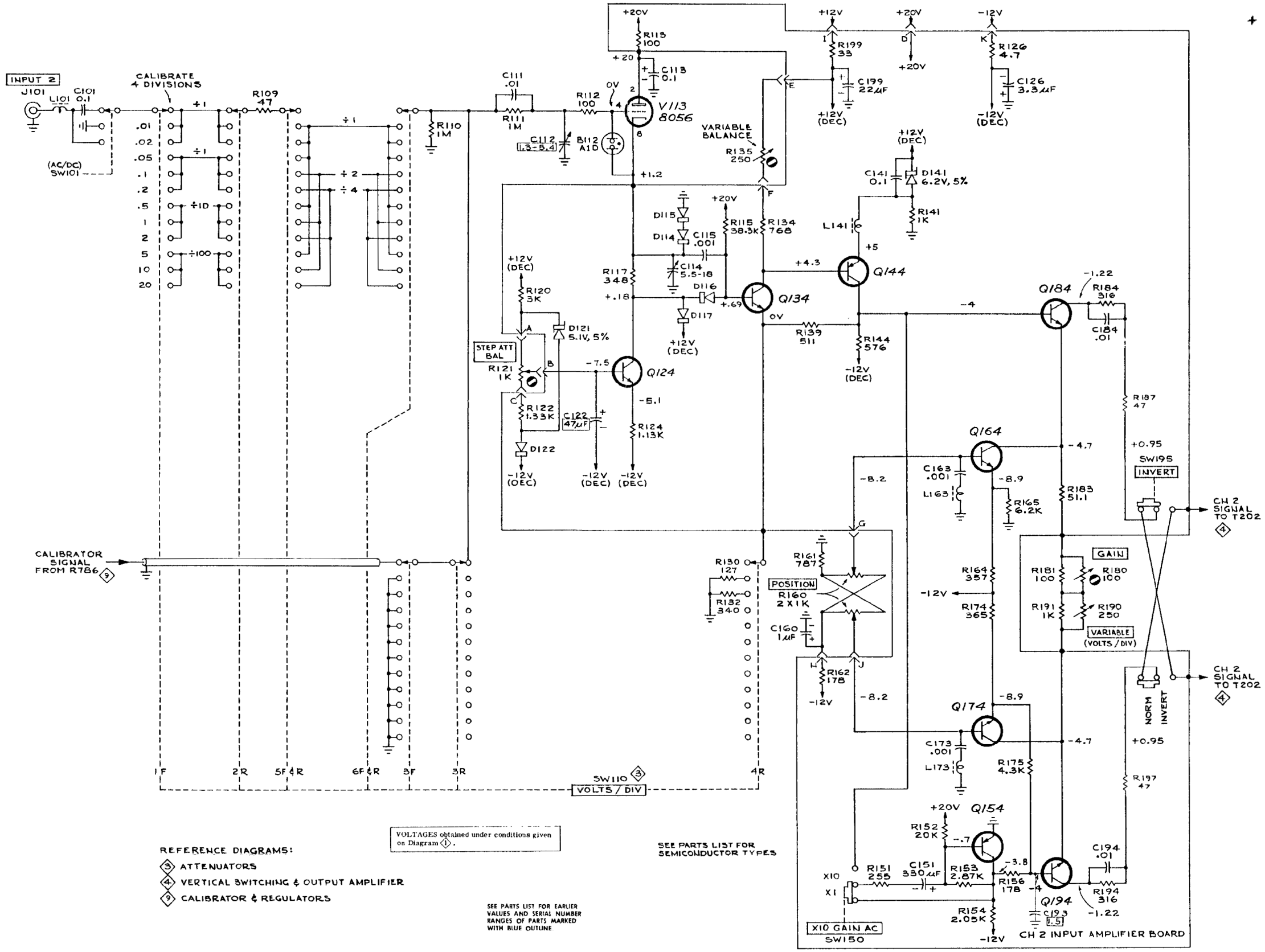

REFERENCE DIAGRAMS:

- ③ ATTENUATORS
- ④ VERTICAL SWITCHING & OUTPUT AMPLIFIER
- ⑤ CALIBRATOR & REGULATORS

VOLTAGES obtained under conditions given on Diagram ①.

SEE PARTS LIST FOR SEMICONDUCTOR TYPES

SEE PARTS LIST FOR EARLIER VALUES AND SERIAL NUMBER RANGES OF PARTS MARKED WITH BLUE OUTLINE

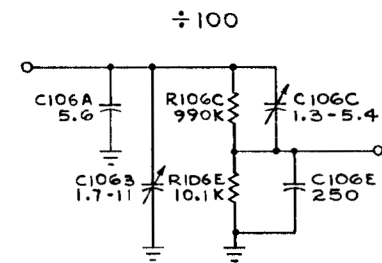
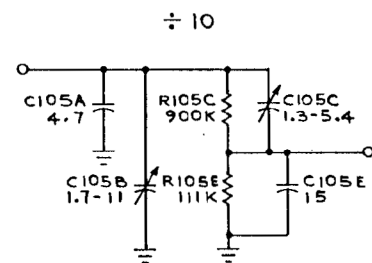
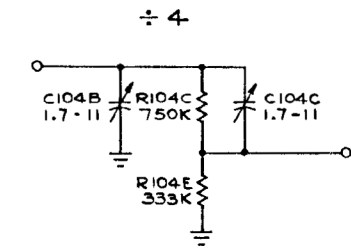
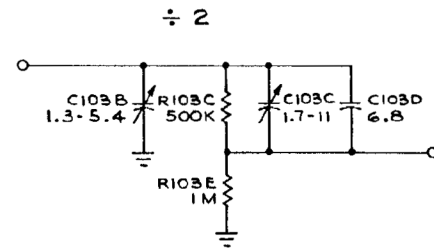
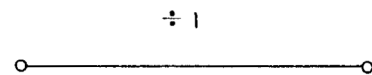
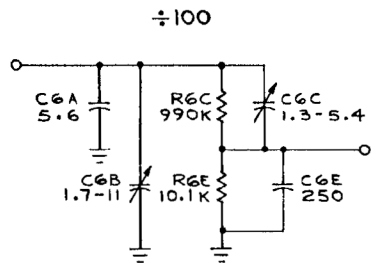
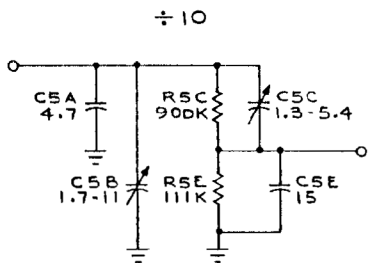
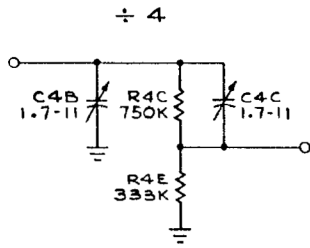
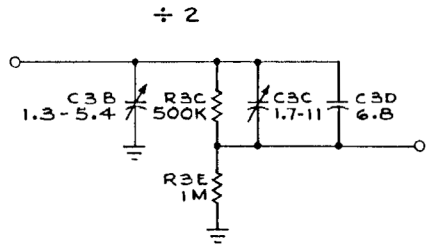
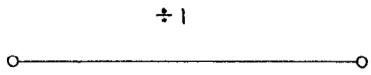

CHANNEL 1

CHANNEL 2

1264
ATTENUATORS
(S/N 100-19,999)

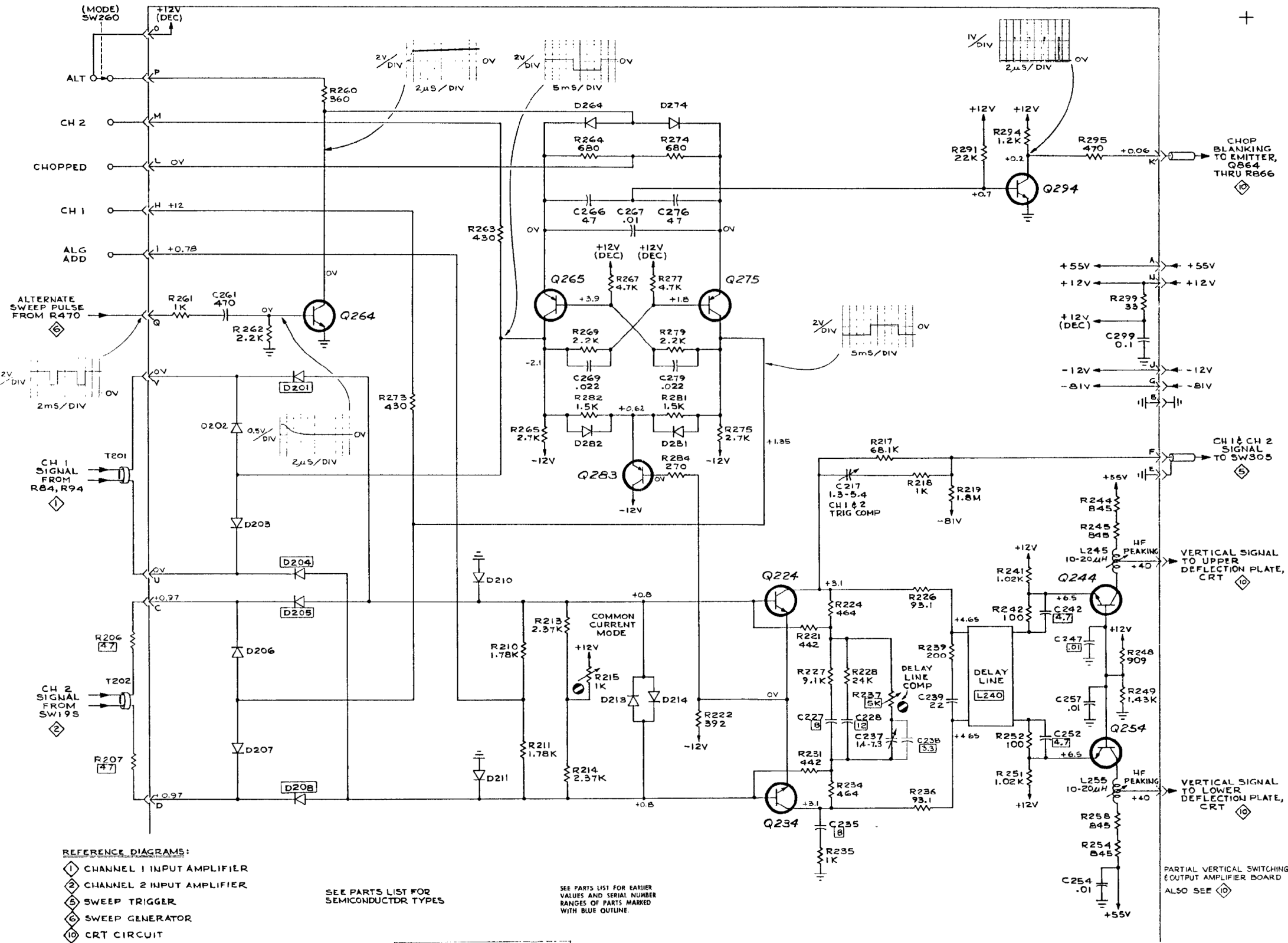

- REFERENCE DIAGRAMS:**
- ① CHANNEL 1 INPUT AMPLIFIER
 - ② CHANNEL 2 INPUT AMPLIFIER
 - ③ SWEEP TRIGGER
 - ④ SWEEP GENERATOR
 - ⑤ CRT CIRCUIT

SEE PARTS LIST FOR SEMICONDUCTOR TYPES

SEE PARTS LIST FOR EARLIER VALUES AND SERIAL NUMBER RANGES OF PARTS MARKED WITH BLUE OUTLINE.

VOLTAGES and WAVEFORMS obtained under conditions given on Diagram (Ⓛ), except as follows:
 MODE.....ALT

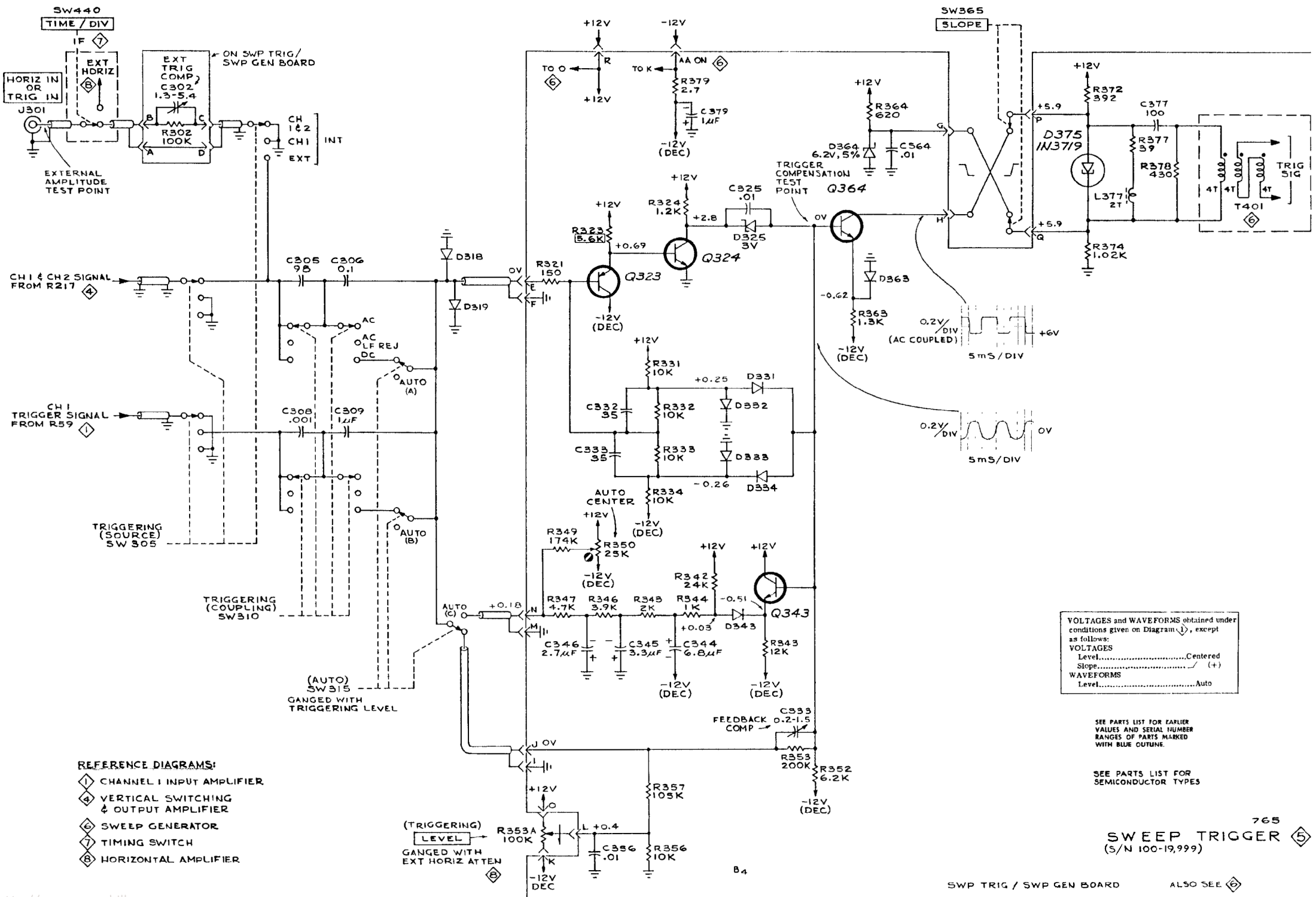

- REFERENCE DIAGRAMS:
- ① CHANNEL 1 INPUT AMPLIFIER
 - ② VERTICAL SWITCHING & OUTPUT AMPLIFIER
 - ③ SWEEP GENERATOR
 - ④ TIMING SWITCH
 - ⑤ HORIZONTAL AMPLIFIER

VOLTAGES and WAVEFORMS obtained under conditions given on Diagram ↓, except as follows:

VOLTAGES
 Level.....Centered
 Slope..... (+)
 WAVEFORMS
 Level.....Auto

SEE PARTS LIST FOR EARLIER VALUES AND SERIAL NUMBER RANGES OF PARTS MARKED WITH BLUE OUTFINE.

SEE PARTS LIST FOR SEMICONDUCTOR TYPES

765
SWEEP TRIGGER ⑤
 (S/N 100-19,999)

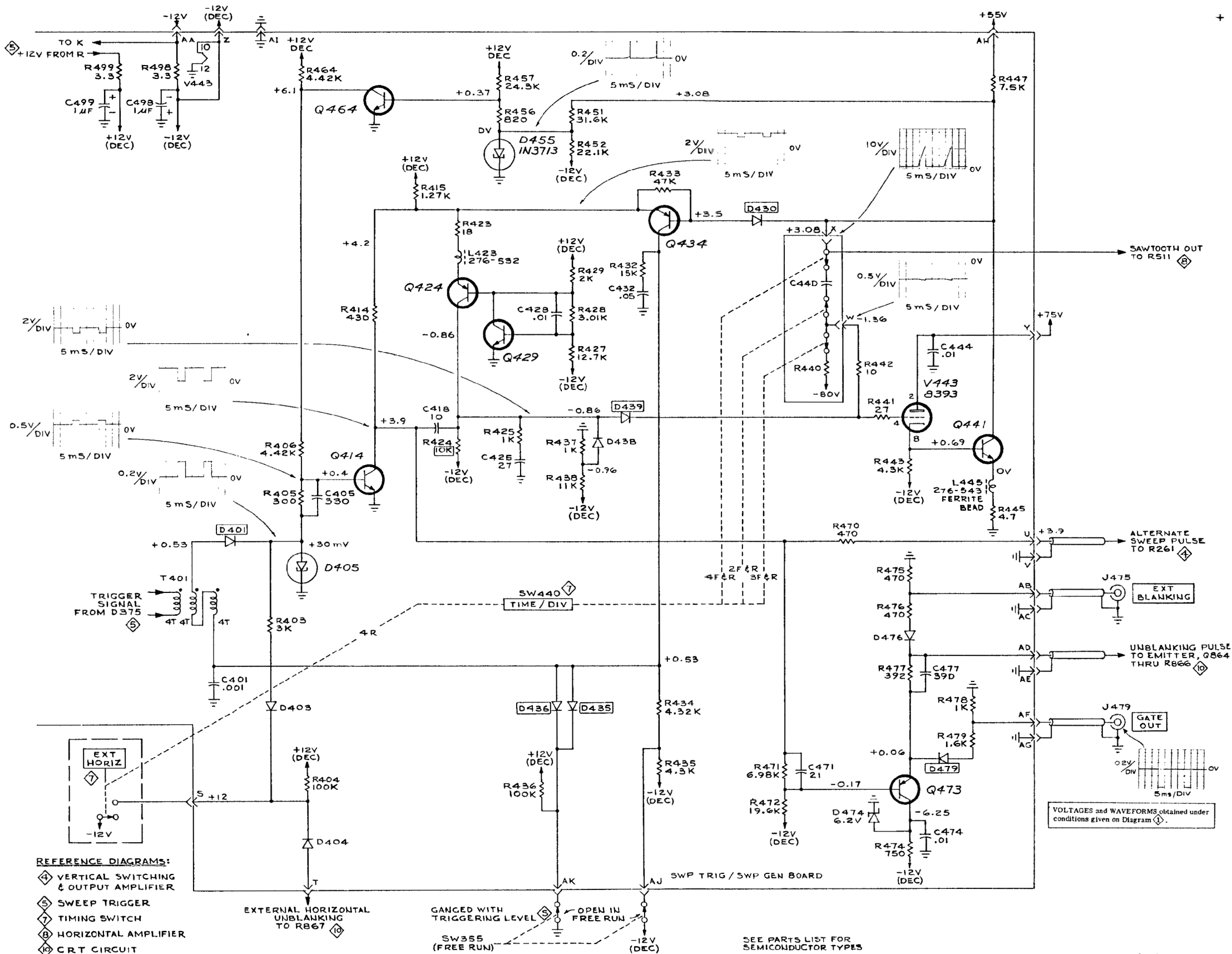

- REFERENCE DIAGRAMS:**
- 1 VERTICAL SWITCHING & OUTPUT AMPLIFIER
 - 2 SWEEP TRIGGER
 - 3 TIMING SWITCH
 - 4 HORIZONTAL AMPLIFIER
 - 5 CRT CIRCUIT

EXTERNAL HORIZONTAL UNBLANKING TO R867

GANGED WITH TRIGGERING LEVEL
 SW355 (FREE RUN)
 OPEN IN FREE RUN

SWP TRIG / SWP GEN BOARD

SEE PARTS LIST FOR SEMICONDUCTOR TYPES

VOLTAGES and WAVEFORMS obtained under conditions given on Diagram (1)

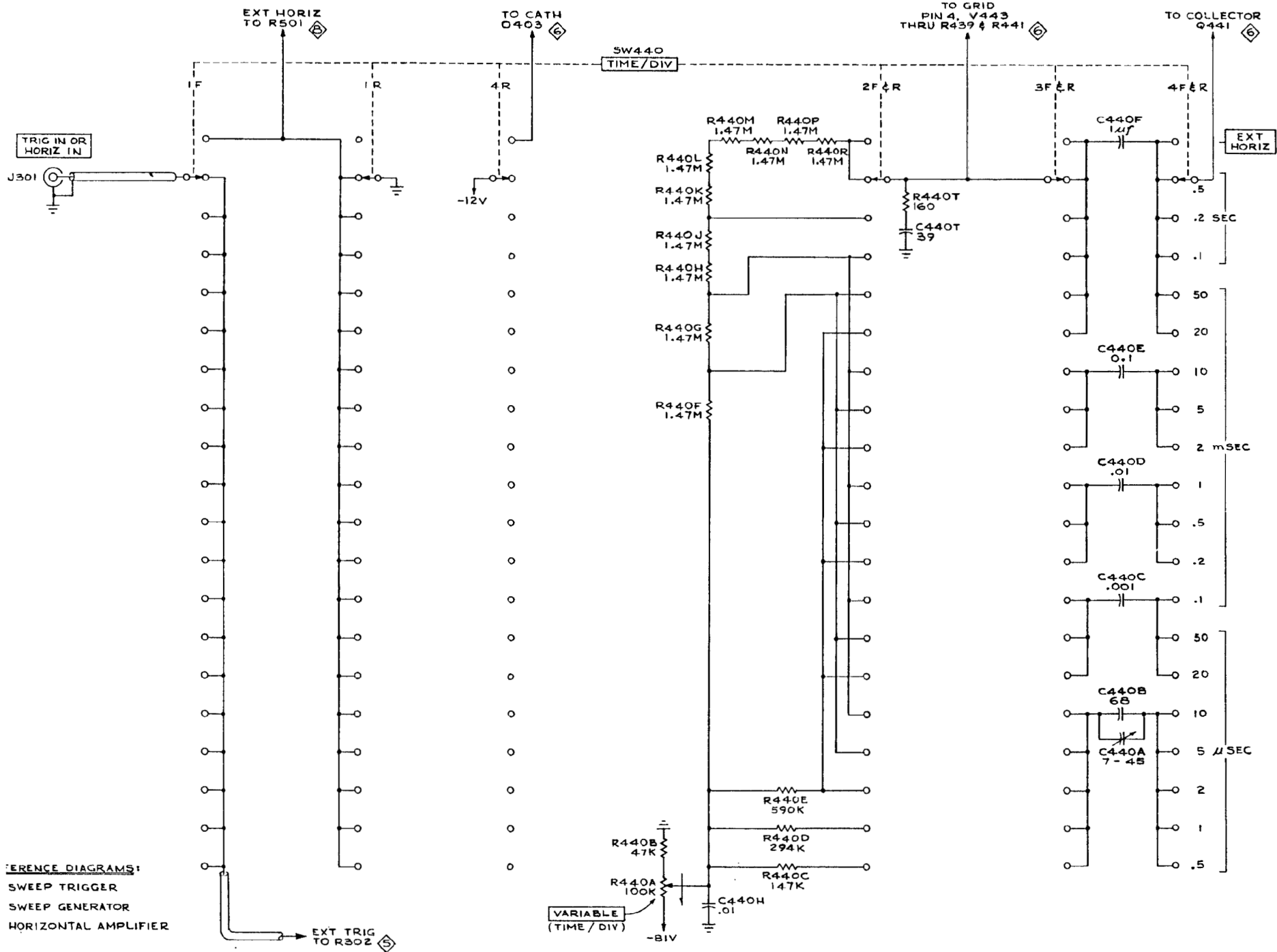

TYPE 422 OSCILLOSCOPE

<http://manoman.sqhill.com>

A₁

1264

TIMING SWITCH 7
(S/N 100-19,999)

REFERENCE DIAGRAMS:

- ⑤ SWEEP TRIGGER
- ⑥ SWEEP GENERATOR
- ⑦ TIMING SWITCH
- ⑩ CRT CIRCUIT

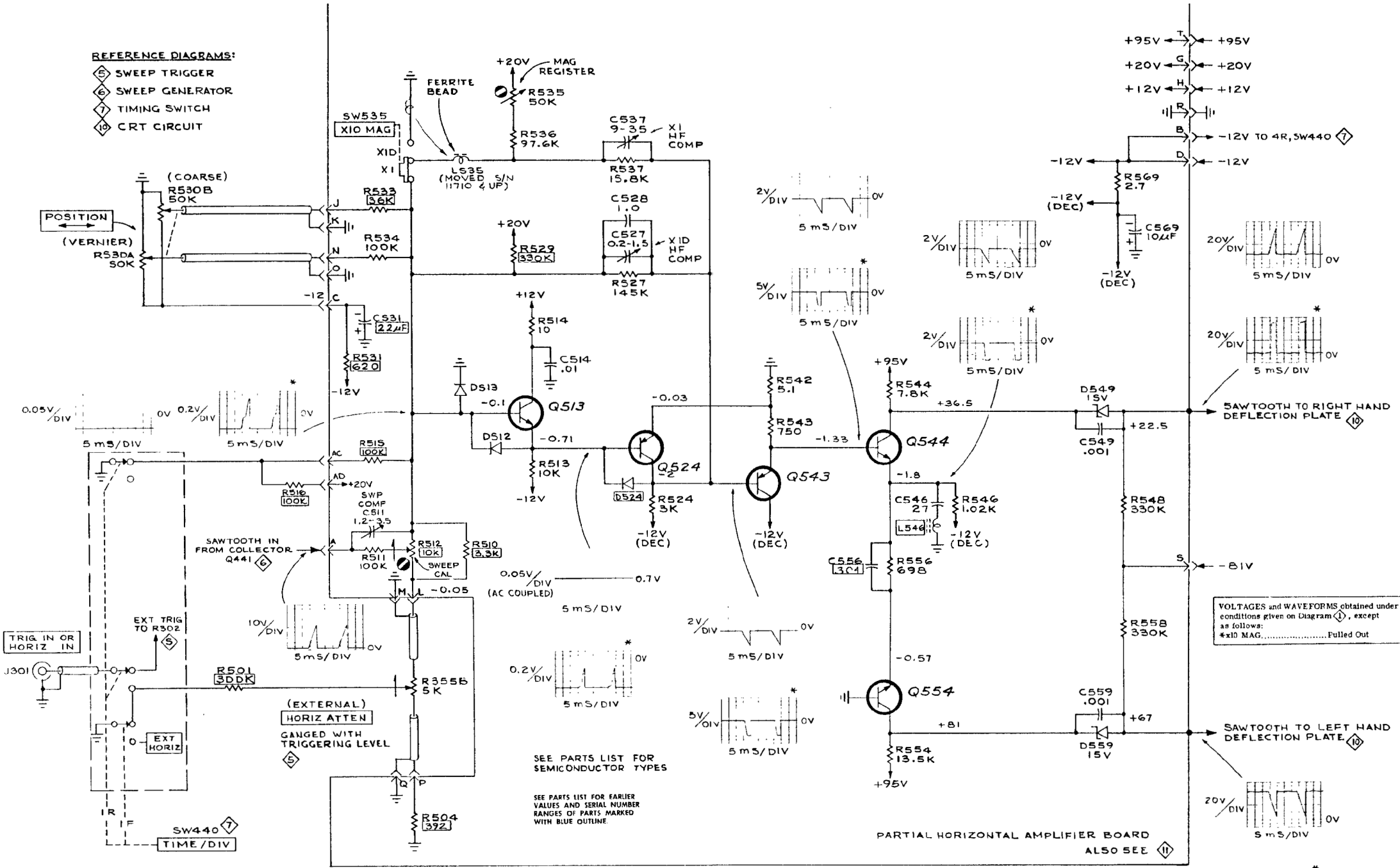

SEE PARTS LIST FOR SEMICONDUCTOR TYPES

SEE PARTS LIST FOR EARLIER VALUES AND SERIAL NUMBER RANGES OF PARTS MARKED WITH BLUE OUTLINE

VOLTAGES and WAVEFORMS obtained under conditions given on Diagram ⑩, except as follows:
 *x10 MAG..... Pulled Out

PARTIAL HORIZONTAL AMPLIFIER BOARD ALSO SEE ⑪

668
 HORIZONTAL AMPLIFIER ⑥
 (S/N 100-19,999)

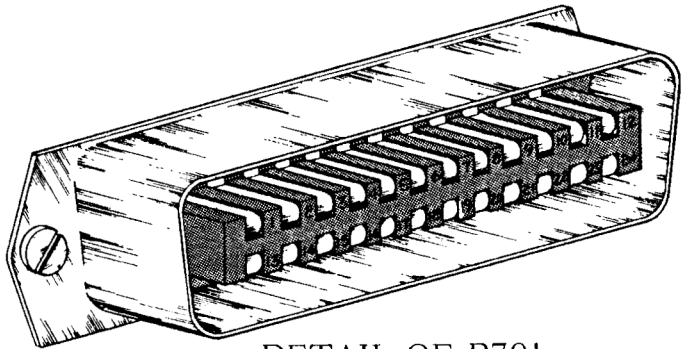

DETAIL OF P701

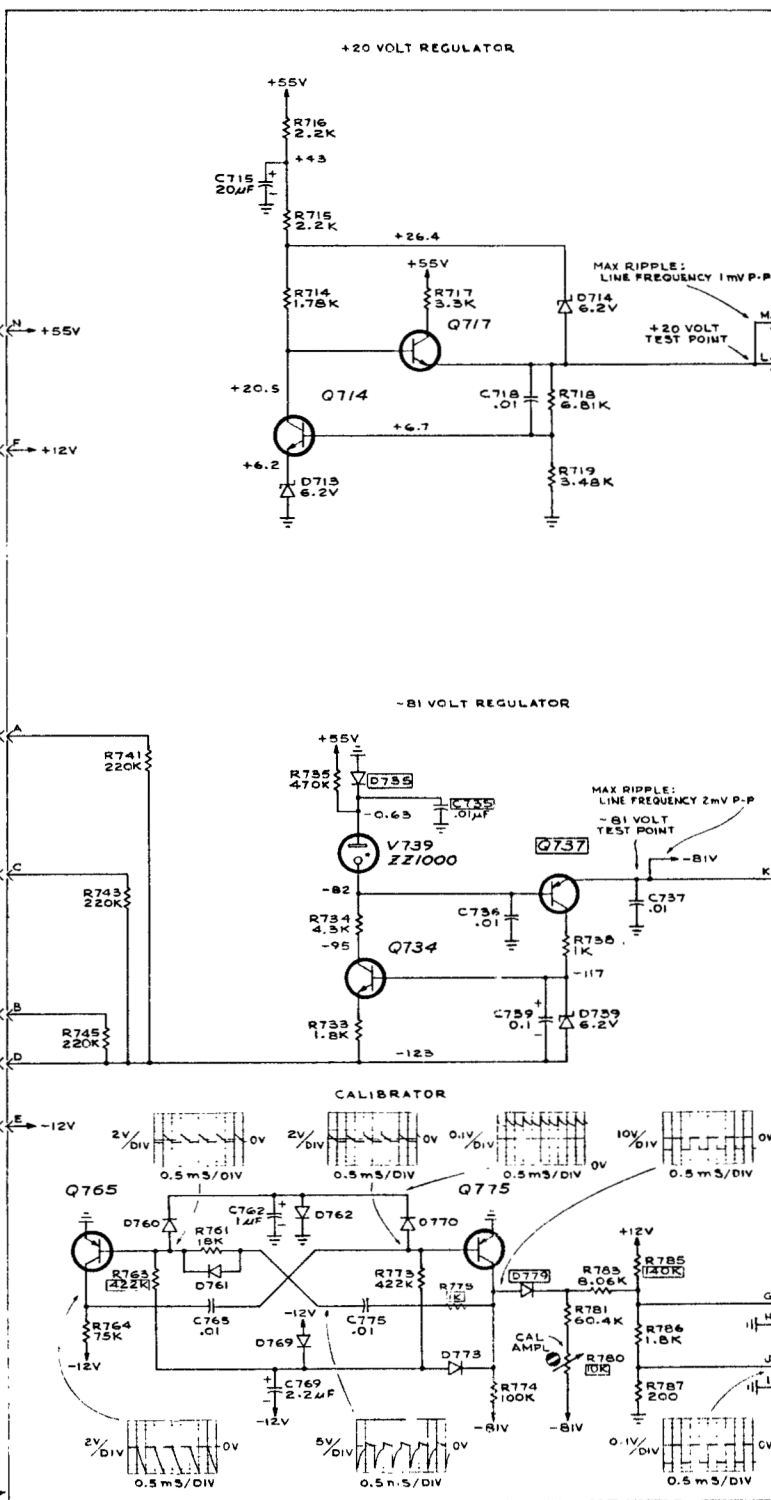
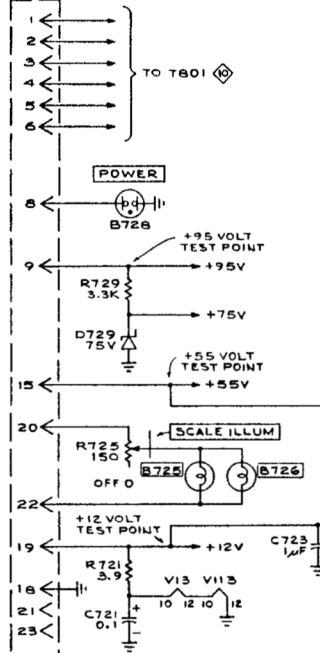

VOLTAGES and WAVEFORMS obtained under conditions given on Diagram ①.

SEE PARTS LIST FOR SEMICONDUCTOR TYPES

- REFERENCE DIAGRAMS
- ① CHANNEL 1 INPUT AMPLIFIER
 - ② CHANNEL 2 INPUT AMPLIFIER
 - ③ HORIZONTAL AMPLIFIER
 - ④ CRT CIRCUIT

SEE PARTS LIST FOR EARLIER VALUES AND SERIAL NUMBER RANGES OF PARTS MARKED WITH BLUE OUTLINE

CALIBRATOR & REGULATORS BOARD

06	70
05	80
04	
03	90
02	100
01	

HIGH VOLTAGE TRANSFORMER TERMINALS

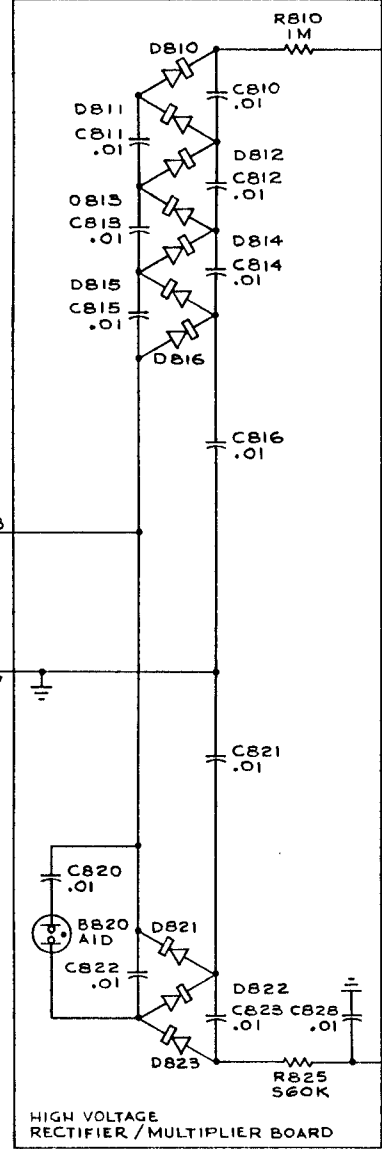
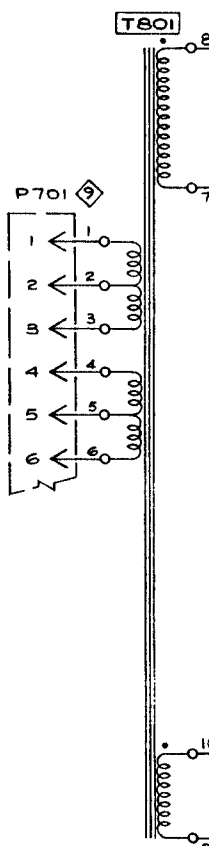

HIGH VOLTAGE RECTIFIER / MULTIPLIER BOARD

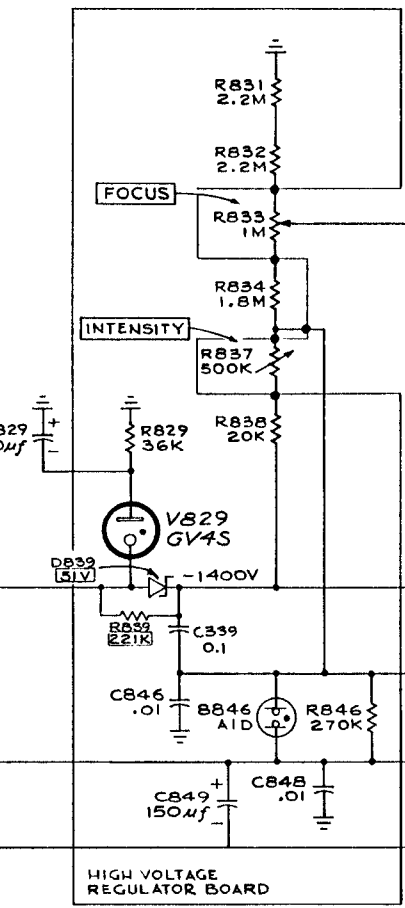

HIGH VOLTAGE REGULATOR BOARD

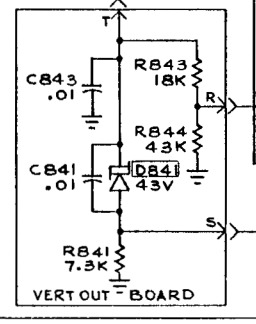

VERT OUT BOARD

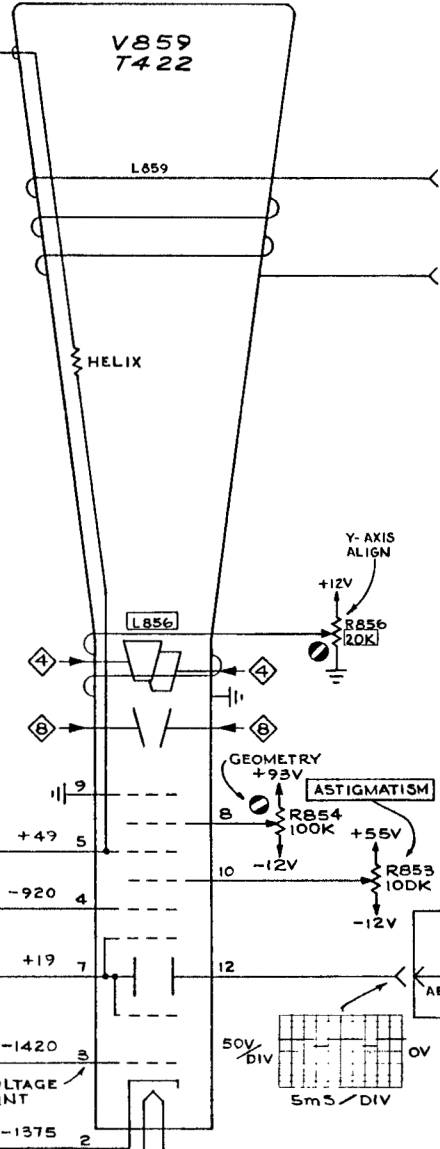

VOLTAGES and WAVEFORMS obtained under conditions given on Diagram 10.

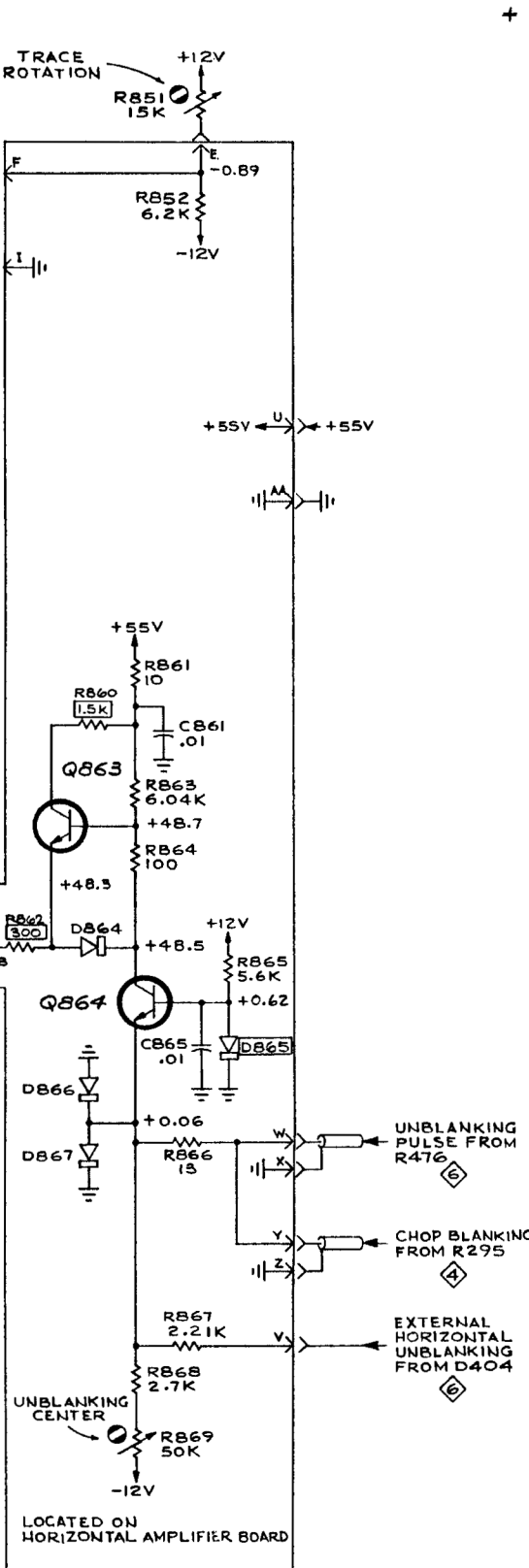

LOCATED ON HORIZONTAL AMPLIFIER BOARD

- REFERENCE DIAGRAMS:
- ④ VERTICAL SWITCHING & OUTPUT AMPLIFIER
 - ⑥ SWEEP GENERATOR
 - ⑧ HORIZONTAL AMPLIFIER
 - ⑨ CALIBRATOR & REGULATORS

SEE PARTS LIST FOR SEMICONDUCTOR TYPES

SEE PARTS LIST FOR EARLIER VALUES AND SERIAL NUMBER RANGES OF PARTS MARKED WITH BLUE OUTLINE.

FIG. 1 FRONT

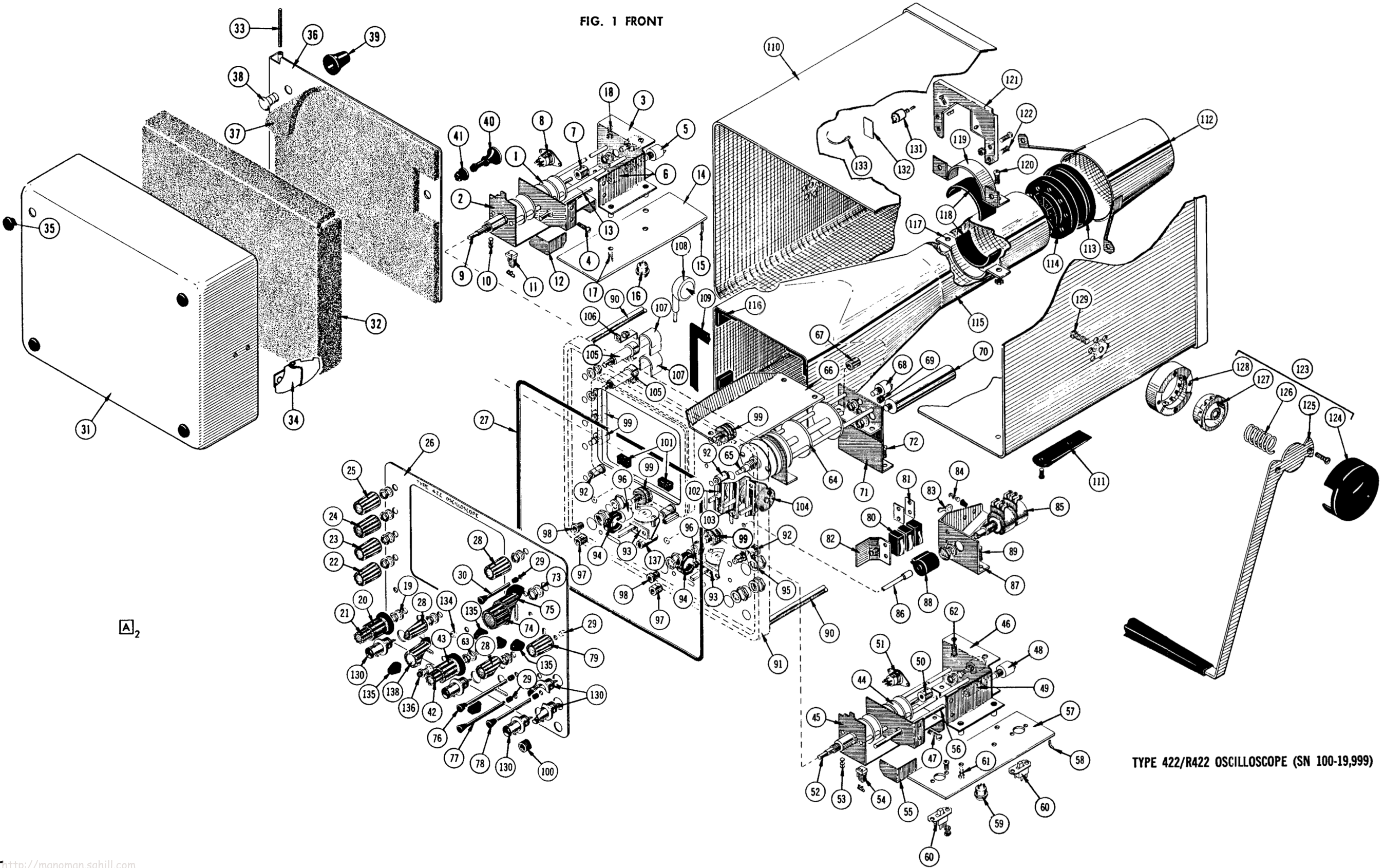

TYPE 422/R422 OSCILLOSCOPE (SN 100-19,999)

FIG. 2 CHASSIS

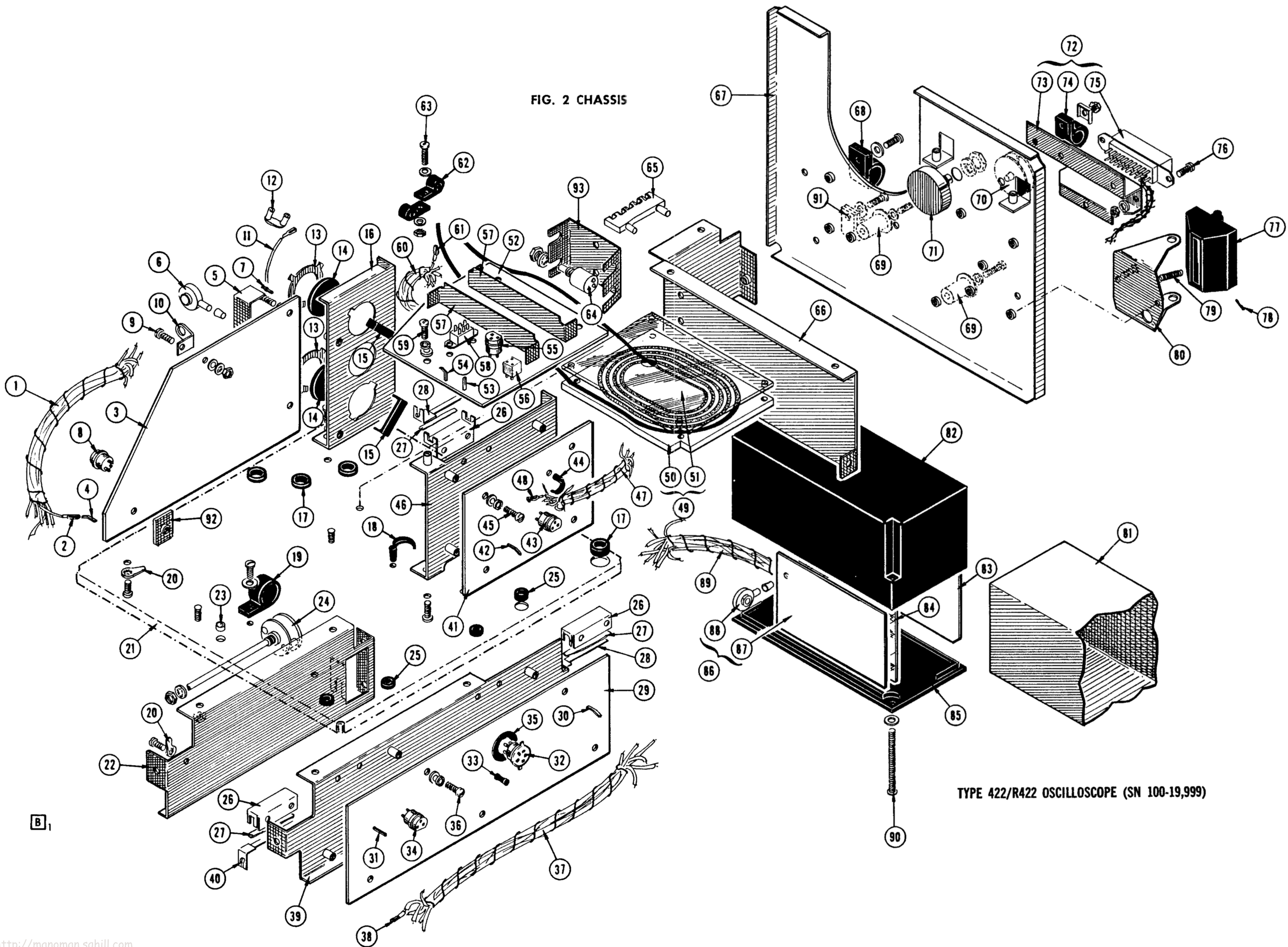

TYPE 422/R422 OSCILLOSCOPE (SN 100-19,999)

B₁

FIG. 3 STANDARD ACCESSORIES

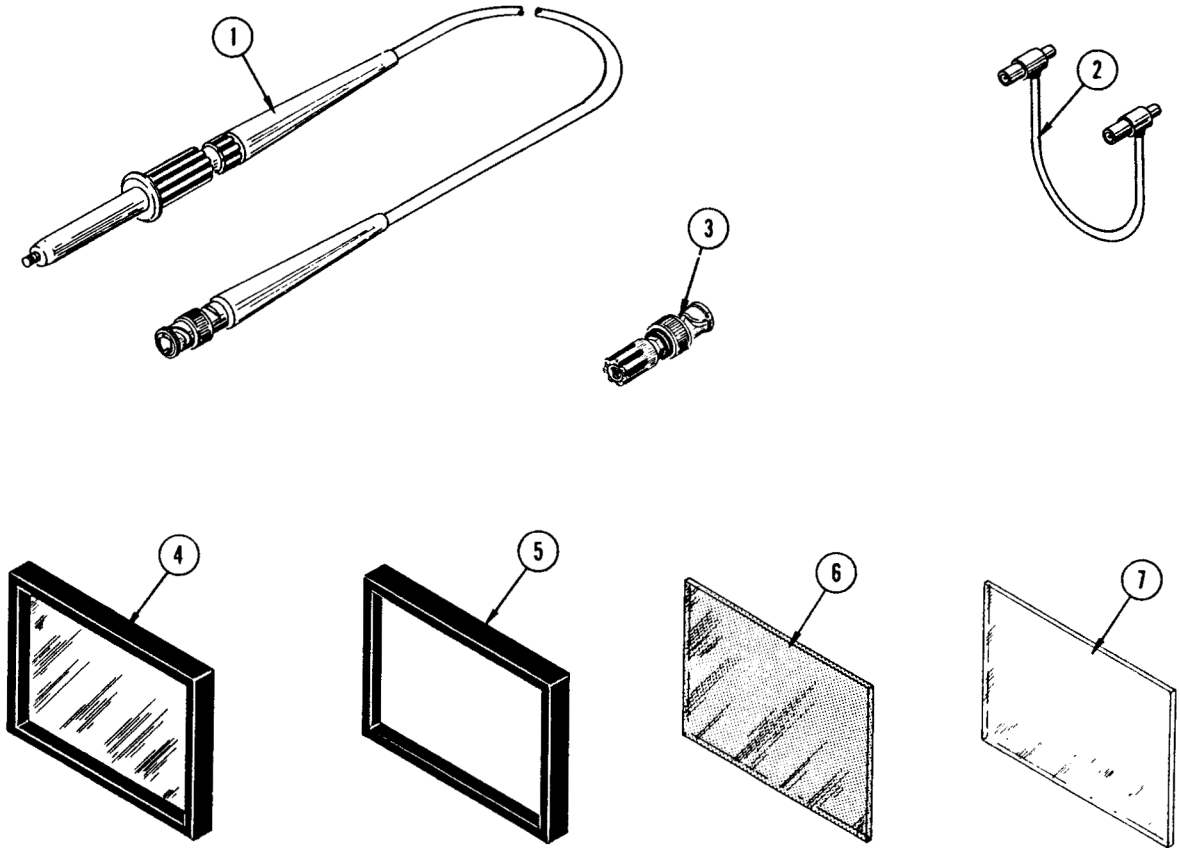

+^A

Fig. & Index No.	Tektronix Part No.	Serial/Model Eff	No. Disc	Qty						Description
					1	2	3	4	5	
3-1	010-0127-00	100	6989	2						PROBE, package, P6006, 10 meg 10X 42 inches, BNC
	010-0203-00	6990		2						PROBE, package, P6012, 10 meg 10X 42 inches, BNC
-2	012-0084-00	100	349X	1						PATCH CORD, BNC to BNC
-3	103-0033-00			1						ADAPTER, BNC to binding post
-4	378-0571-00			1						FILTER, mesh (installed)
-5	354-0248-00			1						RING, ornamental
-6	378-0549-00			1						FILTER, light
-7	386-0118-00			1						PLATE, protector, clear, CRT
--	070-0434-02			2						MANUAL, instruction (not shown)

SECTION 10

RACKMOUNTING

Introduction

The Tektronix Type R422 Oscilloscope is designed to mount in a standard 19-inch rack. When mounted in accordance with the following mounting procedure, this instrument will meet all electrical and environmental characteristics given in Section 1 of this manual.

Rack Dimensions

Width—Minimum width of the opening between the left and right front rails of the rack must be 17.625 inches. This allows room on each side of the instrument for the slide-out tracks to operate freely and permit the instrument to move smoothly in and out of the rack.

Depth—Total depth necessary to mount the Type R422 in a cabinet rack is 14 inches. This allows room for air circulation, power cord connections and the necessary mounting hardware.

Slide-Out Tracks

Fig. 10-1 shows the Type R422 installed in a cabinet-type rack. The slide-out tracks provided with the Type R422 permit it to be extended out of the rack. To operate the Type R422 in the extended position, be sure the power cord and any interconnecting cables are long enough for this purpose. When not extended, the instrument is held in the rack with four securing screws (see Fig. 10-1A).

The slide-out tracks consist of two assemblies—one for the left side of the instrument and one for the right side. Fig. 10-2 shows the complete slide-out track assemblies. The stationary section of each assembly attaches to the front and rear rails of the rack, and the chassis section is attached to the instrument. The intermediate section slides between the stationary and chassis sections and allows the Type R422 to be extended out of the rack. When the instrument is shipped, the stationary and intermediate sections of the tracks are packaged as matched sets and should not be separated. To identify the left or right assembly, note the position of the automatic latch (see Fig. 10-2). When mounted in the rack, the automatic latch should be at the top of both assemblies. The chassis sections are installed on the instrument at the factory.

The hardware provided for mounting the slide-out tracks is shown in Fig. 10-3. Since the hardware is intended to make the tracks compatible with a variety of cabinet racks and installation methods, not all of it will be needed for this installation. Use only the hardware that is required for the mounting method used.

Mounting Procedure

The following mounting procedure uses the rear support kit (see Fig. 10-4) to meet the environmental characteristics

of the instrument (shock and vibration). Two alternative mounting methods are described later in this procedure. However, when mounted according to these alternative methods, the instrument may not meet the given environmental characteristics for shock and vibration.

The front flanges of the stationary sections may be mounted in front of or behind the front rails of the rack, depending on the type of rack. If the front rails of the rack are tapped for 10-32 screws, the front flanges are mounted in front of the rails. If the front rails of the rack are not tapped for 10-32 screws, the front flanges are mounted behind the front rails and a bar nut is used. Fig. 10-5 shows these methods of mounting the stationary sections.

The rear of the stationary sections must be firmly supported to provide a shock-mounted installation. This rear support must be located 13.471 inches, ± 0.031 inches, from the front surface of the front rails when the front flange is mounted in front of the rails, or 13.531 inches, ± 0.31 inches, from the rear surface of the front rails when the front flange is mounted behind the front rails. If the cabinet rack does not have a strong supporting member located the correct distance from the front rails, an additional support must be added. This instrument will not meet the environmental specifications unless firmly supported at this point. Fig. 10-6 illustrates a typical rear installation using the rear support kit and gives the necessary dimensions.

Use the following procedure to install the Type R422 in a rack:

1. Select the proper front-rail mounting holes for the stationary sections using the measurements shown in Fig. 10-7.
 - 2a. If the front flanges of the stationary sections are to be mounted in front of the front rails (rails tapped for 10-32 screws), mount each stationary section as shown in Fig. 10-5A.
 - 2b. If the front flanges of the stationary sections are to be mounted behind the front rails (rails not tapped for 10-32 screws), mount each stationary section as shown in Fig. 10-5B.
3. Attach an angle bracket to both rear rails of the rack through the spacer block, stationary section and into the rear rail of the rack (only one bracket necessary for single instrument). Note that the holes in the spacer block are not centered. Be sure to mount the block with the narrow edge toward the front of the rack; otherwise, the instrument may not slide all the way into the rack. Do not tighten the mounting screws. Fig. 10-4 shows the parts in the rear support kit and the order in which they are assembled.
4. Assemble the support pin to the angle bracket in the order shown in Fig. 10-4. Leave the spacer (washer) off but install the neoprene washer.
5. Refer to Fig. 10-9 to insert the instrument into the rack. Do not connect the power cord or install the securing screws until all adjustments have been made.

6. With the instrument pushed all the way into the rack, adjust the angle brackets so the neoprene washers on the support pins are seated firmly against the rear of the instrument and the support pin is correctly positioned in the support block on the rear of the instrument. Tighten all screws.

7. Pull the instrument partially out of the rack.

8. Remove the neoprene washers from the support pins and place the spacers on the pins. Replace the neoprene washers.

9. Position the instrument so the widest part of the instrument is even with the front rails.

10. Adjust the alignment of the stationary sections according to the procedure outlined in Fig. 10-8. (If the rear alignment is changed, recheck the rear support pins for correct alignment.)

11. After the tracks operate smoothly, connect the power cord to the connector on the rear panel.

12. Push the instrument all the way into the rack and secure the instrument to the rack with the securing screws and washers as shown in Fig. 10-9C.

NOTE

The securing screws are an important part of the shock-mounted installation. If the front rails are not tapped for the 10-32 securing screws, other means must be provided for securing the instrument to the rack.

Alternative Rear Mounting Methods

CAUTION

Although the following methods provide satisfactory mounting under normal conditions, they do not provide solid support at the rear of the instrument. If the instrument is subjected to severe shock or vibration when mounted using the following methods, the instrument may be damaged.

An alternative method of supporting the rear of the instrument is shown in Fig. 10-10. The rear support brackets supplied with the instrument allow it to be mounted in a rack which has a spacing between the front and rear rails of 7 inches to 20 inches. Fig. 10-10A illustrates the mounting method if the rear rails are tapped for 10-32 screws, and Fig. 10-10B illustrates the mounting method if the rear rails are not tapped for 10-32 screws. The rear support kit is not used for this installation.

If the rack does not have a rear rail, or if the distance between the front and rear rails is too large, the instrument may be mounted without the use of the slide-out tracks. Fasten the instrument to the front rail of the rack with the securing screws and washers. This mounting method should be used only if the instrument will not be subjected to shock or vibration and if it is installed in a stationary location.

Removing or Installing the Instrument

After initial installation and adjustment of the slide-out tracks, the Type R422 can be removed or installed by following the instructions given in Fig. 10-10. No further adjustments are required under normal conditions.

Slide-Out Track Lubrication

The slide-out tracks normally require no lubrication. The special finish on the sliding surfaces provide permanent lubrication. However, if the tracks do not slide smoothly even after proper adjustment, a thin coating of paraffin may be rubbed onto the sliding surfaces for additional lubrication.

Instrument Location

The Type R422 is normally supplied with the instrument mounted on the left side and the storage compartment on the right side. However, the positions may be reversed, or two instruments may be mounted in the rack. Be sure that the support block (mounted on rear of power supply) is on the correct side of the instrument for the mounting configuration used.

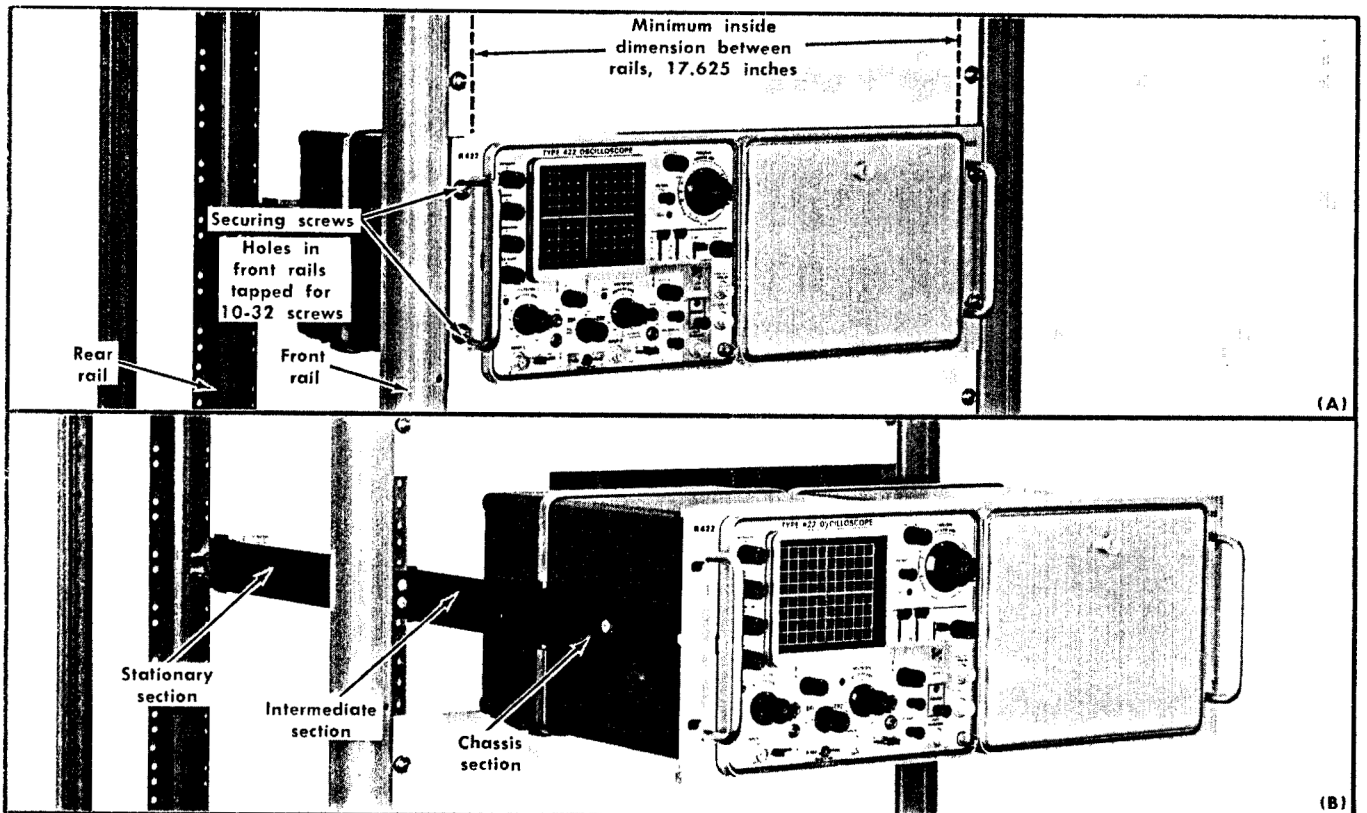

Fig. 10-1. The Type R422 installed in a cabinet rack (slides removed): (A) Held into rack with securing screws; (B) extended on slide-out tracks.

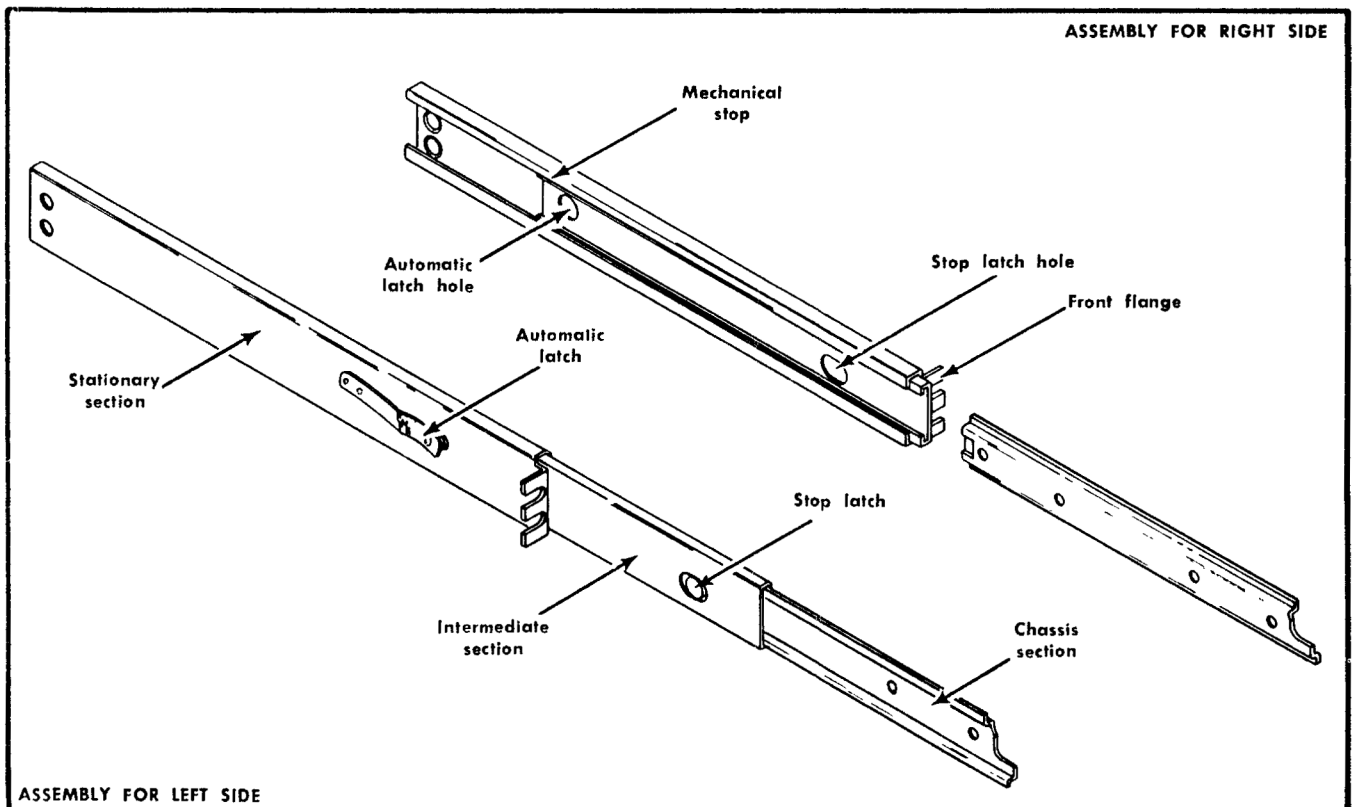

Fig. 10-2. Slide-out track assemblies.

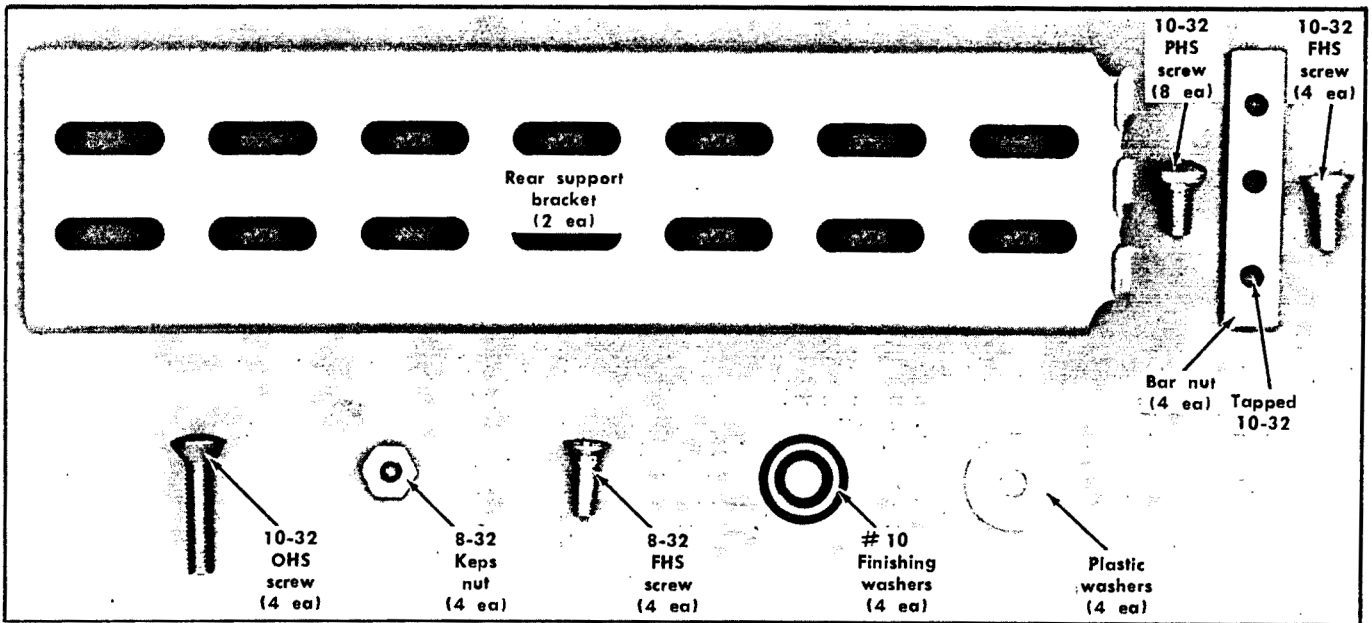

Fig. 10-3. Hardware provided for mounting the instrument in the cabinet rack.

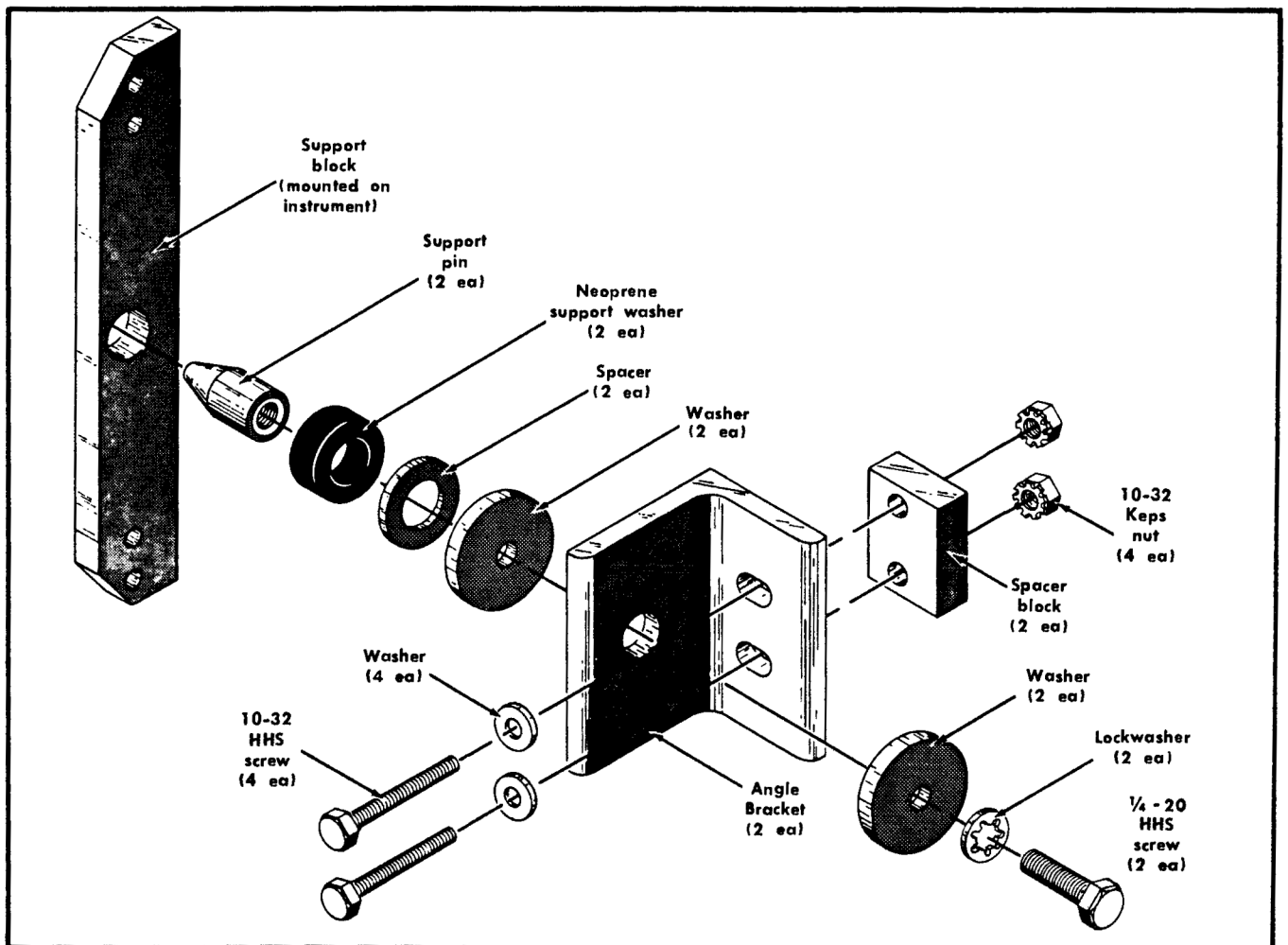

Fig. 10-4. Rear support kit.

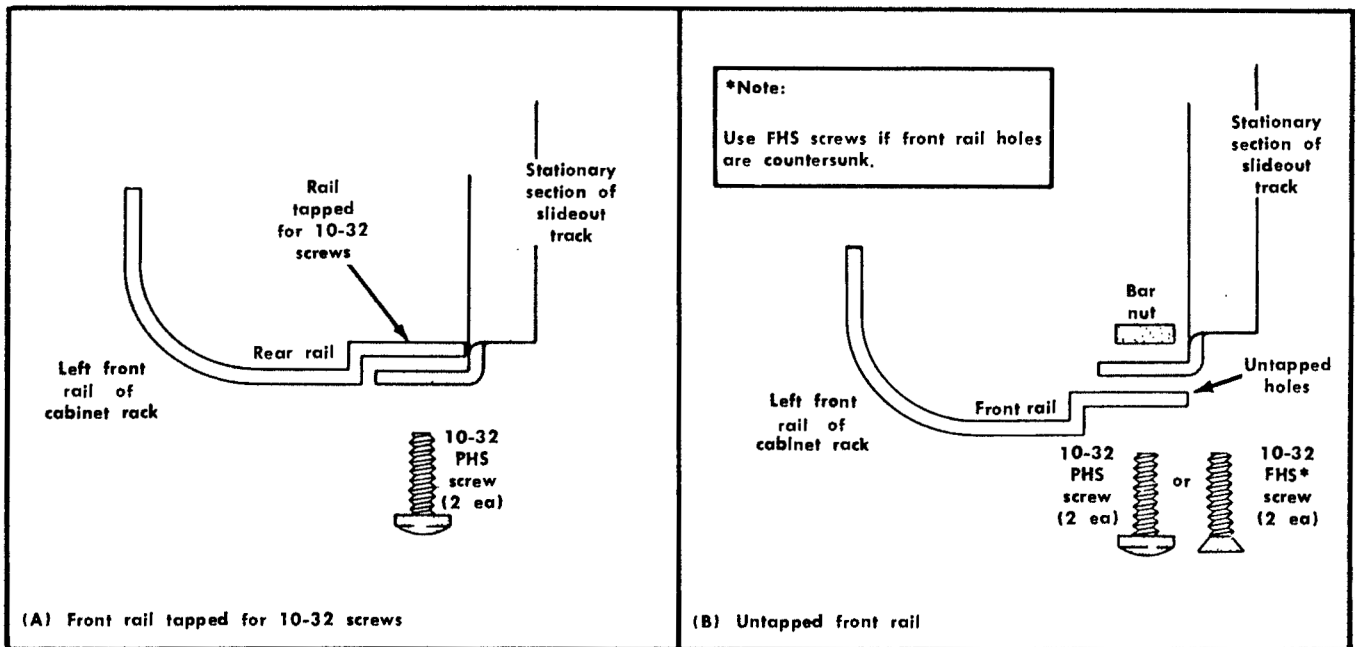

Fig. 10-5. Methods of mounting the stationary section to the front rails.

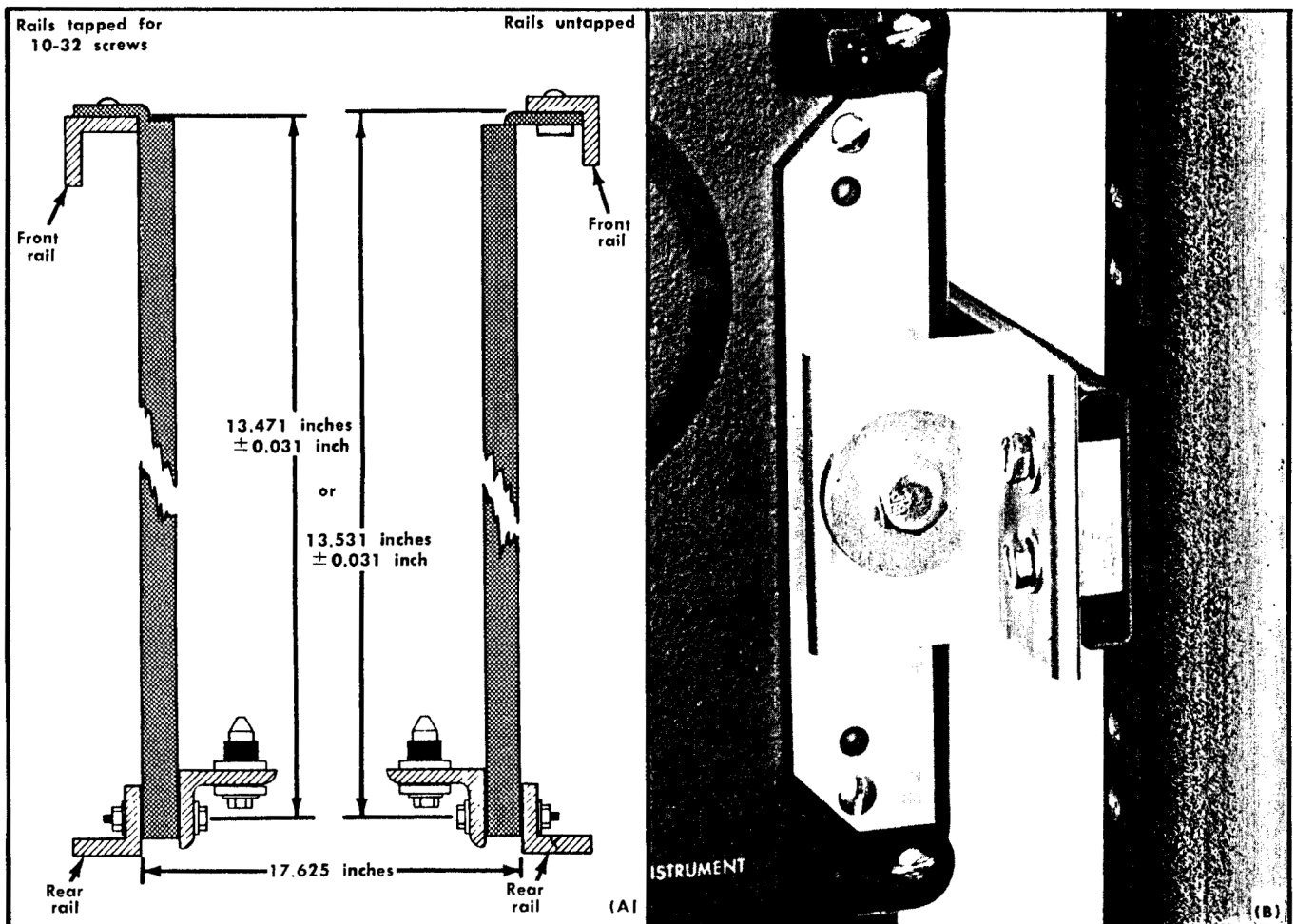

Fig. 10-6. Supporting the rear of the stationary sections; (A) Dimensions necessary; (B) Completed installation.

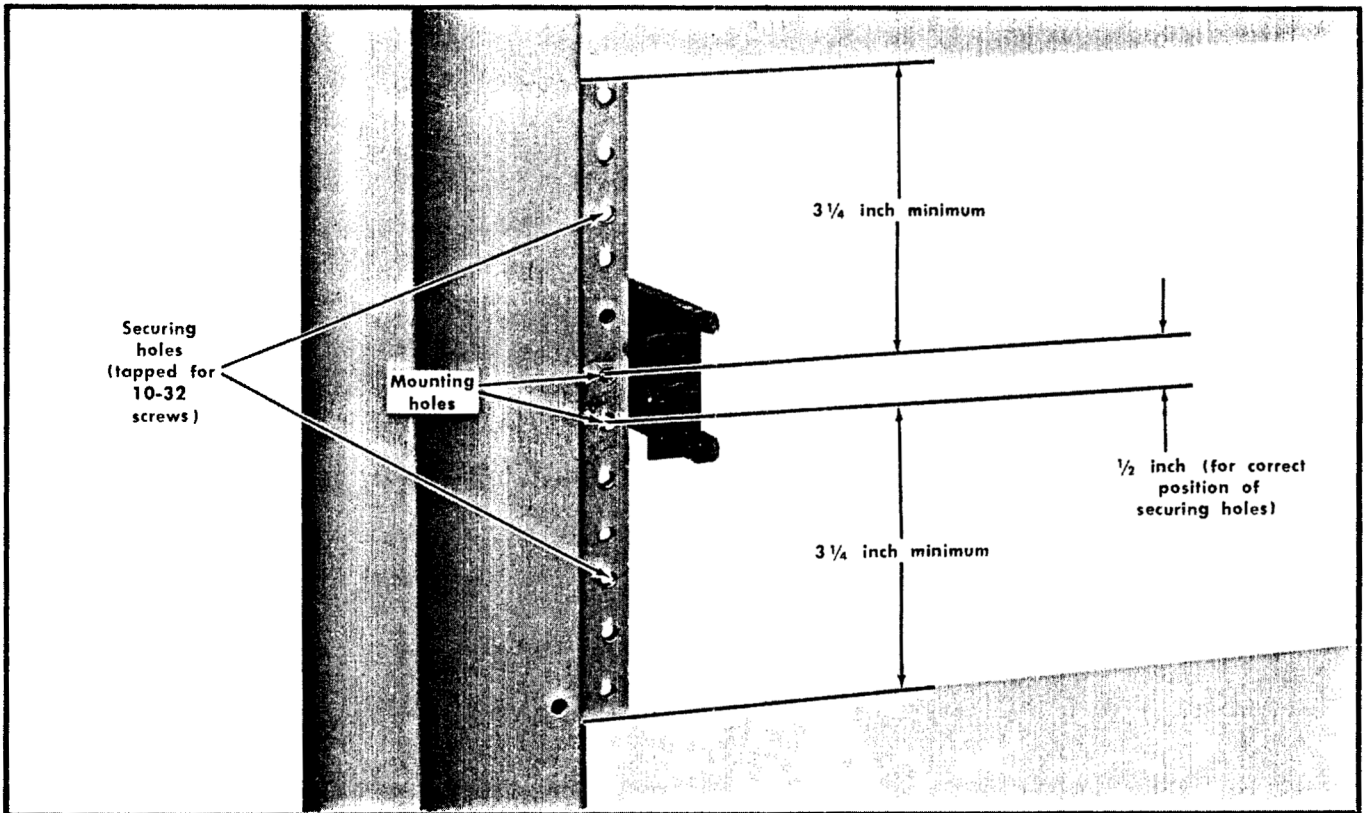

Fig. 10-7. Locating the mounting holes for the left stationary section. Same dimensions apply to right stationary section.

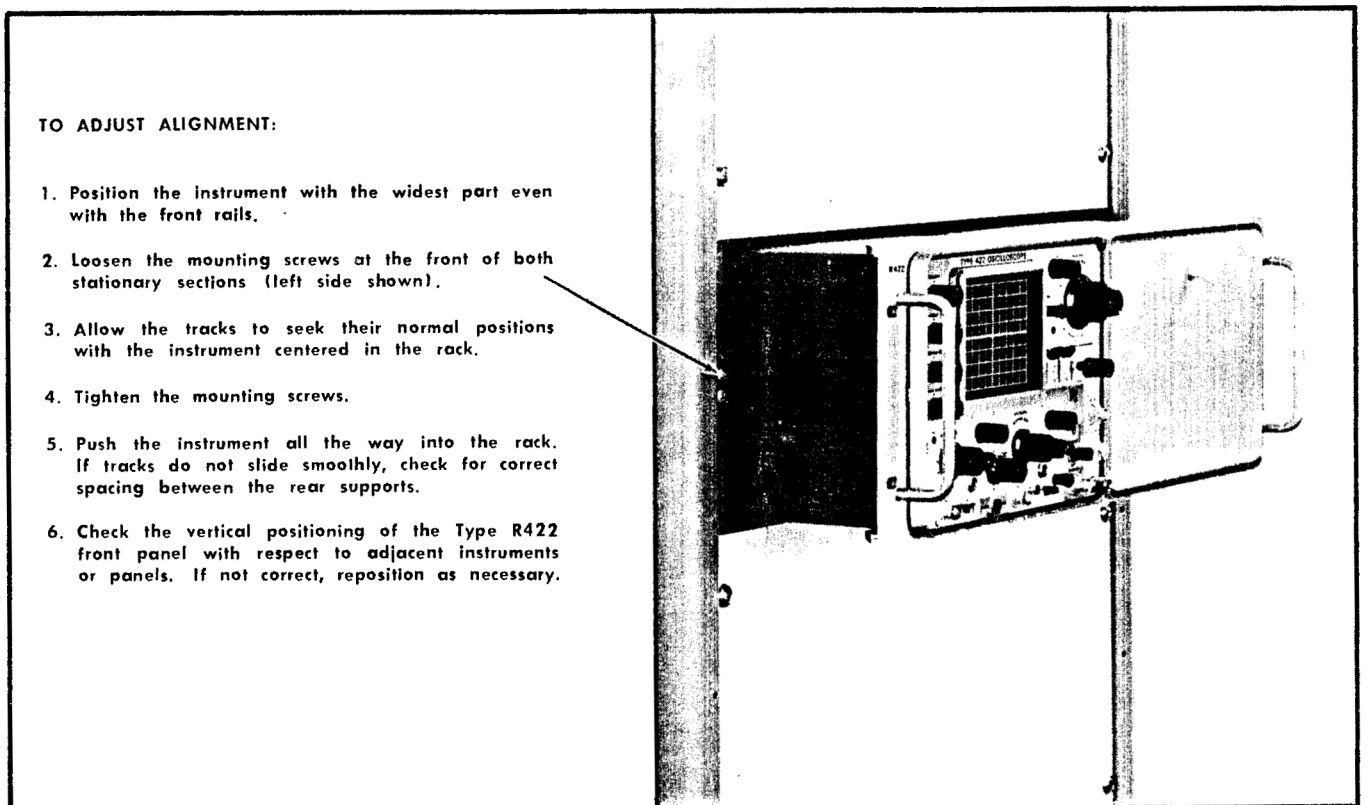

Fig. 10-8. Alignment adjustments for correct operation.

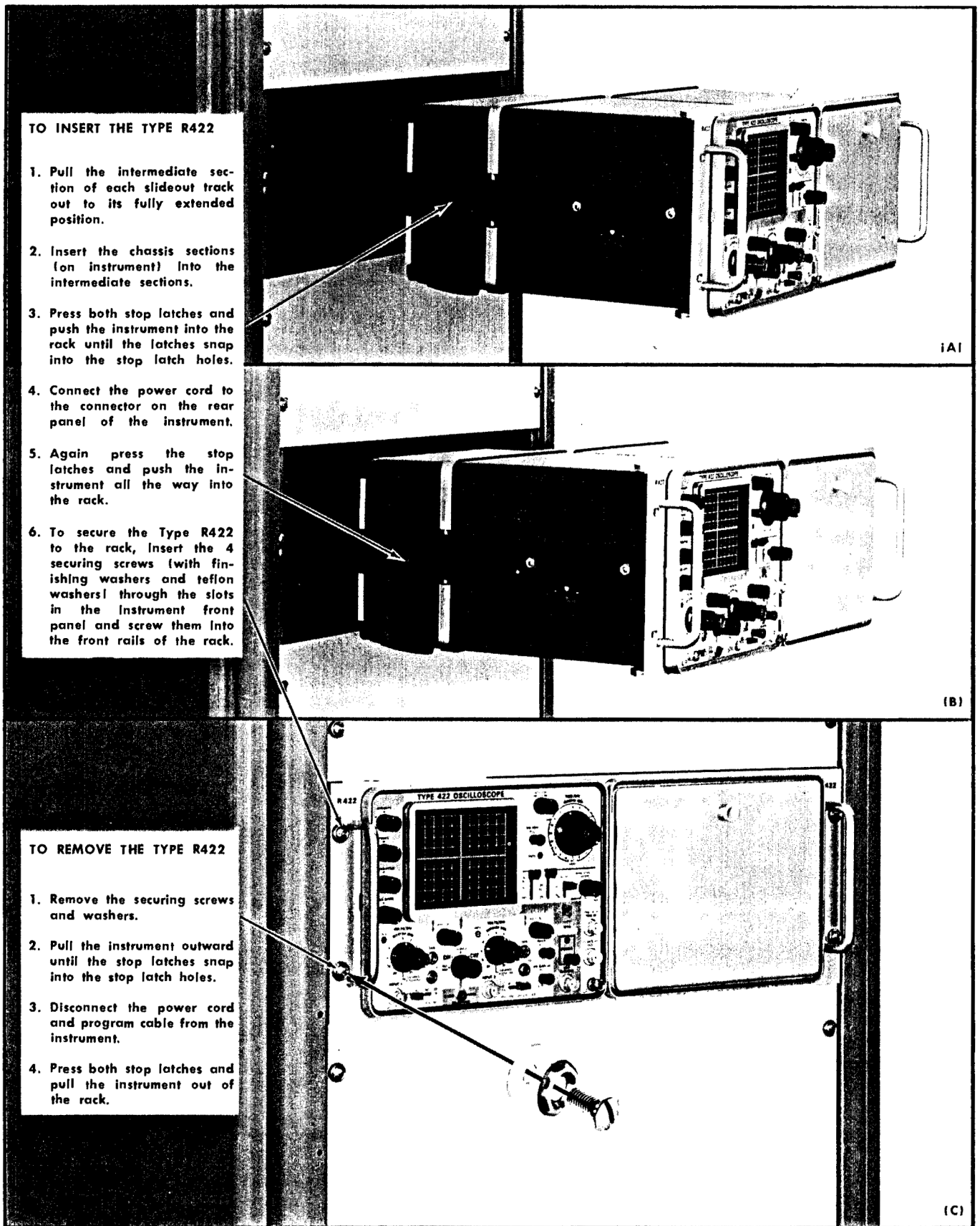

Fig. 10-9. Procedure for inserting or removing the instrument after the slide-out tracks have been installed.

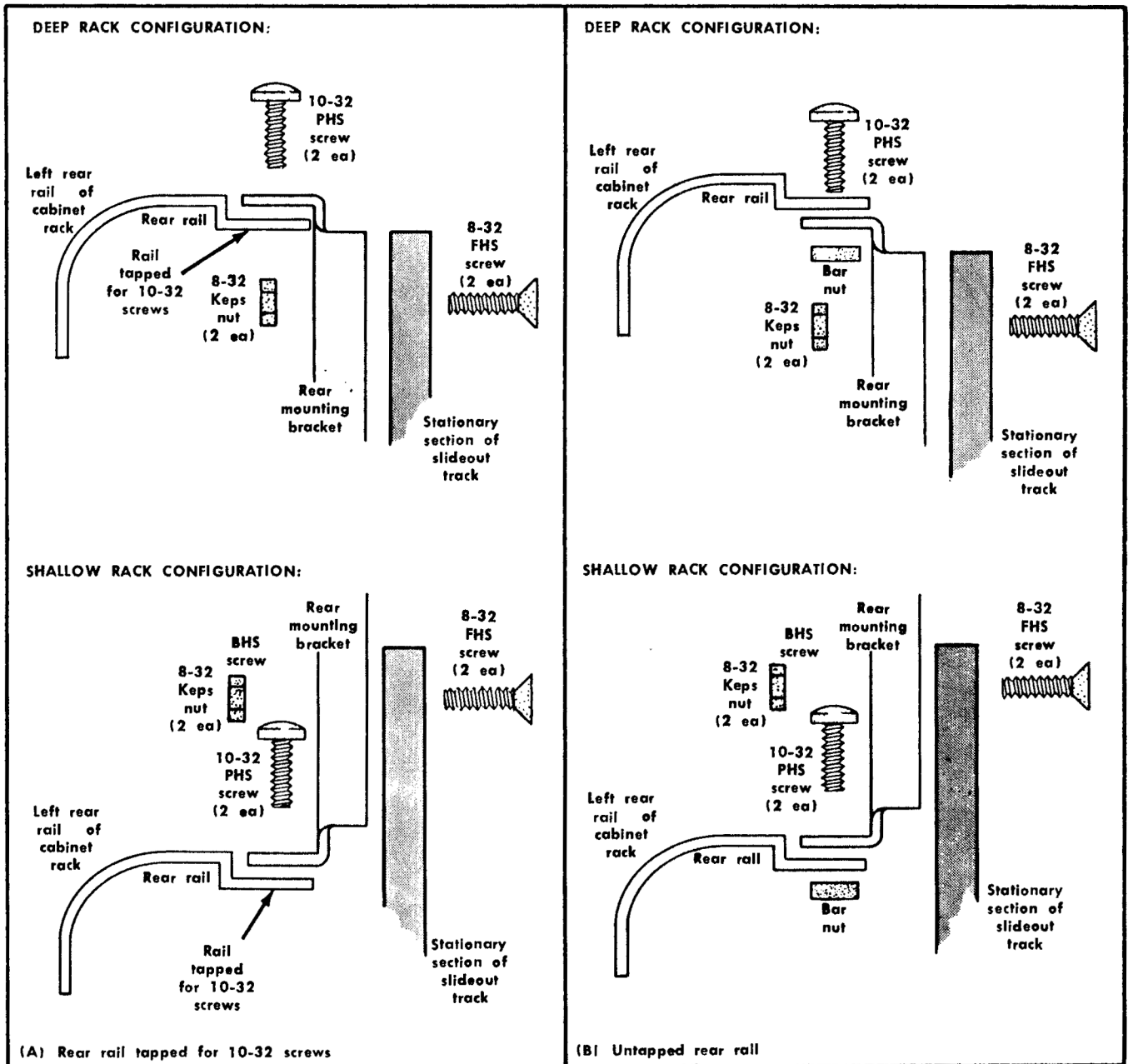
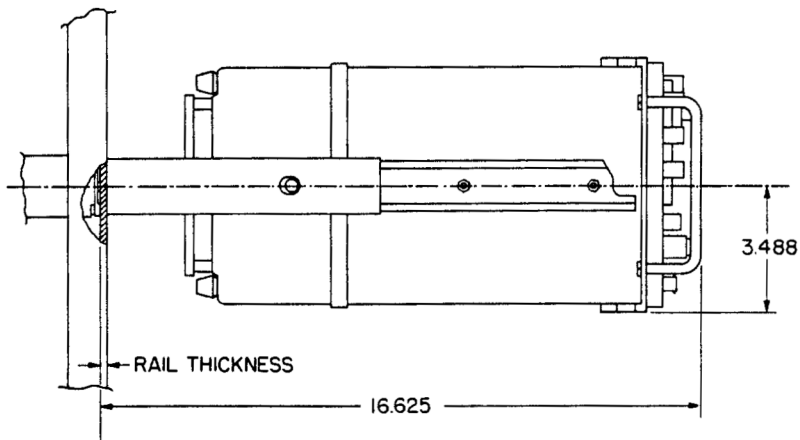
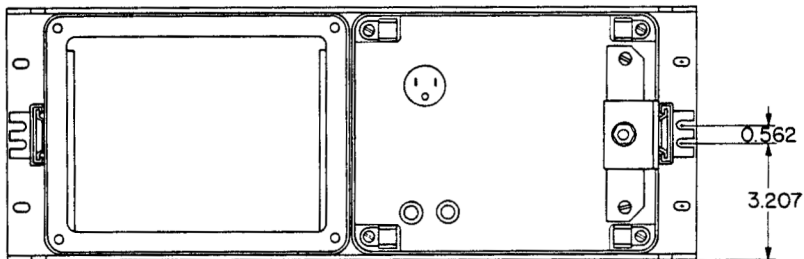
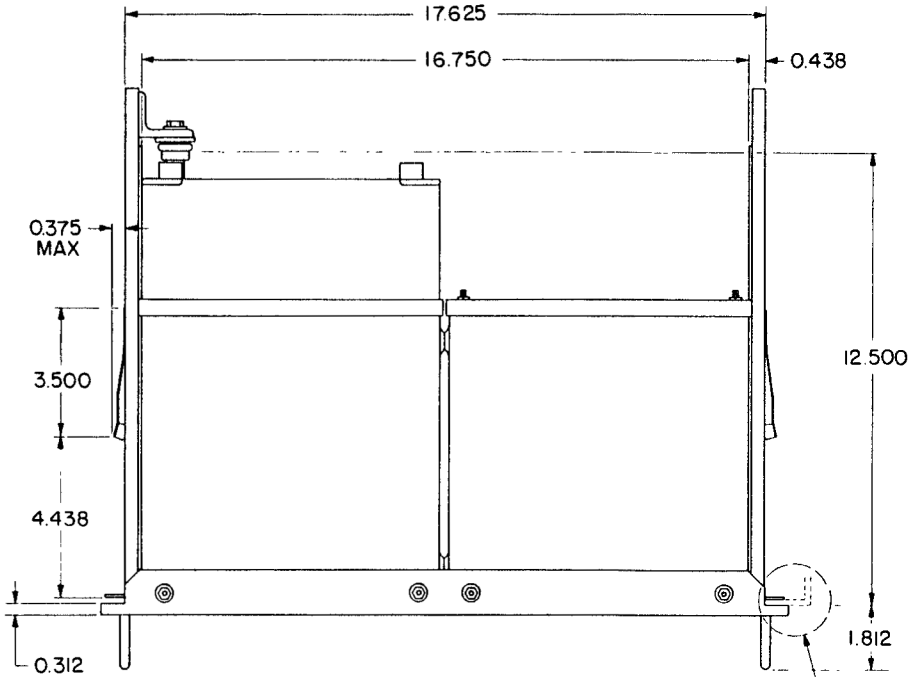
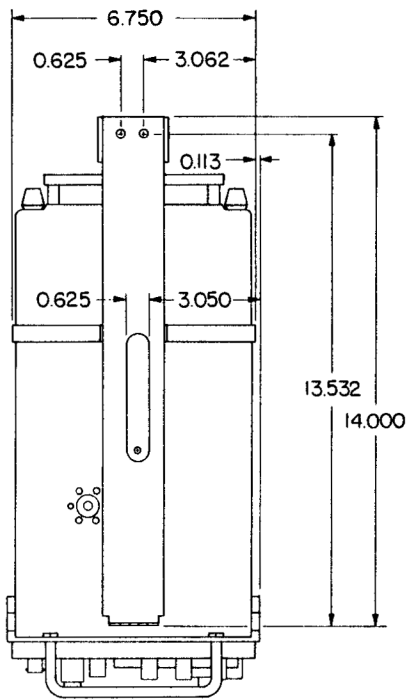

Fig. 10-10. Alternative method of installing the instrument using rear support brackets.

REAR VIEW





SEE SECTION DETAIL "A"

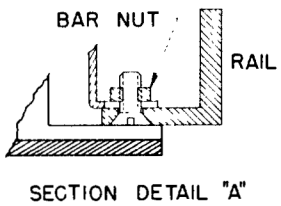
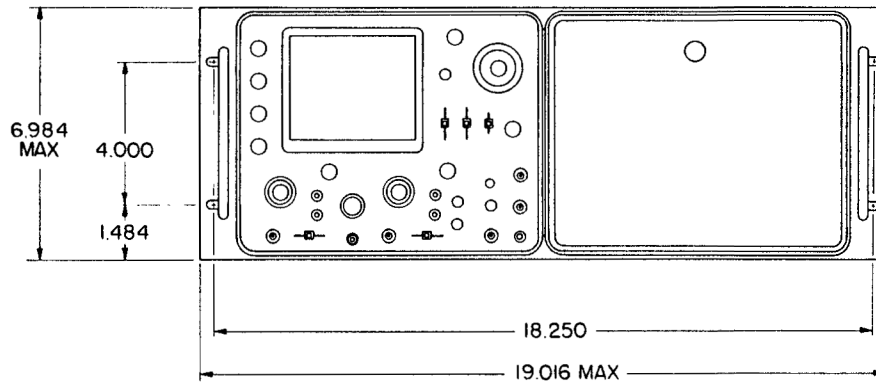

RECOMMENDED MOUNTING

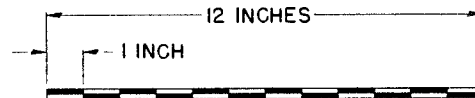

TYPE 422/R422 OSCILLOSCOPE (SN 100-19,999)

FIG. 10-11 MECHANICAL PARTS LIST

Fig. & Index No.	Tektronix Part No.	Serial/Model No. Eff	No. Disc	Q					Description	
				t	y	1	2	3		4
-1	- - - - -			1						TYPE 422 OSCILLOSCOPE & POWER SUPPLY
-2	437-0082-00			1						ASSEMBLY, rack cabinet
	- - - - -			-						assembly includes:
	212-0001-00			4						SCREW, B-32 x 1/4 inch, PHS (not shown)
	210-0458-00			4						NUT, keps, B-32 x 1/32 inch (not shown)
-3	367-0022-00			2						HANDLE
	- - - - -			-						mounting hardware for each: (not included w/handle)
-4	213-0090-00			2						SCREW, 10-32 x 1/2 inch, HHS
-5	351-0104-00			1						SLIDE, (pair, left & right)
	- - - - -			-						mounting hardware: (not included w/slide)
-6	210-0458-00			4						NUT, keps, B-32 x 1/32 inch
	436-0065-00			1						ASSEMBLY, storage compartment
	- - - - -			-						assembly includes:
-7	436-0064-00			1						COMPARTMENT, storage
-B	214-0743-00			1						SPRING, stop, left
	- - - - -			-						mounting hardware: (not included w/spring)
	211-0038-00			2						SCREW, 4-40 x 5/16 inch, FHS
	351-0105-00			2						GUIDE, spring
	210-0851-00			1						WASHER, flat, 0.119 ID x 3/8 inch OD
	210-0834-00			1						WASHER
	214-0771-00			1						PAD
-9	210-0586-00			1						NUT, keps, 4-40 x 1/4 inch
-10	214-0742-00			1						SPRING, stop, right
	- - - - -			-						mounting hardware: (not included w/spring)
-11	211-0038-00			2						SCREW, 4-40 x 5/16 inch, FHS
-12	351-0105-00			2						GUIDE, spring
-13	210-0851-00			1						WASHER, flat, 0.119 ID x 3/8 inch OD
-14	210-0834-00			1						WASHER, plastic
-15	214-0771-00			1						PAD
	210-0586-00			1						NUT, keps, 4-40 x 1/4 inch
-16	348-0023-00			2						FOOT, plastic
-17	385-0109-00			2						ROD, plastic, 5/16 OD x 5/16 inch
	- - - - -			-						mounting hardware: (not included w/rod)
-18	211-0033-00			1						SCREW, sems, 4-40 x 5/16 inch, PHS
-19	253-0056-00			FT.						TAPE, foam (2 pieces, 2 1/2 inches long)
-20	348-0089-00			2						CUSHION, plastic
-21	426-0247-00			1						FRAME
	- - - - -			-						mounting hardware: (not included w/frame)
-22	212-0506-00			4						SCREW, 10-32 x 3/8 inch, FHS
-23	220-0410-00			4						NUT, keps, 10-32 x 3/8 inch

FIG. 10-11 MECHANICAL PARTS LIST (cont)

Fig. & Index No.	Tektronix Part No.	Serial/Model No.		Q t y	Description
		Eff	Disc		
-24	214-0701-00			1	HINGE
-25	211-0504-00			2	SCREW, 6-32 x 1/4 inch, PHS
-26	214-0631-00	100	5339	2	PIN, hinge
	214-0755-00	5340		2	PIN, hinge
-27	200-0666-00			1	COVER, storage compartment
-28	210-0805-00			2	WASHER, flat, 0.204 ID x 0.438 inch OD
-29	210-0410-00			2	NUT, hex., 10-32 x 5/16 inch
-30	386-1066-00			1	PLATE
-31	361-0118-00			2	SPACER, sleeve, 0.50 x 0.512 inch long
-32	210-0803-00			4	WASHER, flat, 0.150 ID x 3/8 inch OD
-33	211-0517-00			4	SCREW, 6-32 x 1 inch, PHS

FIG. 10-11 MECHANICAL PARTS LIST

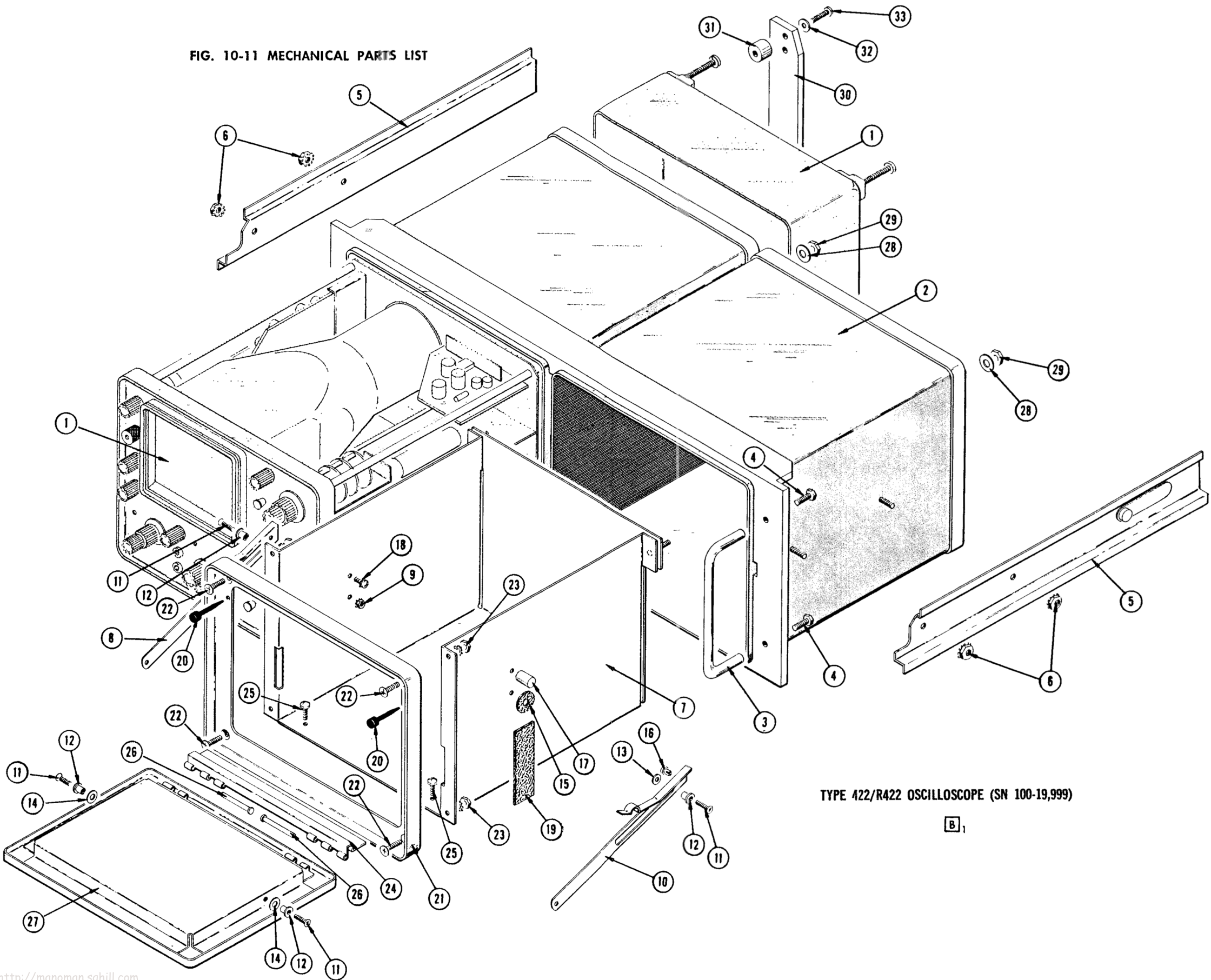

TYPE 422/R422 OSCILLOSCOPE (SN 100-19,999)

B₁

FIG. 10-12 STANDARD ACCESSORIES

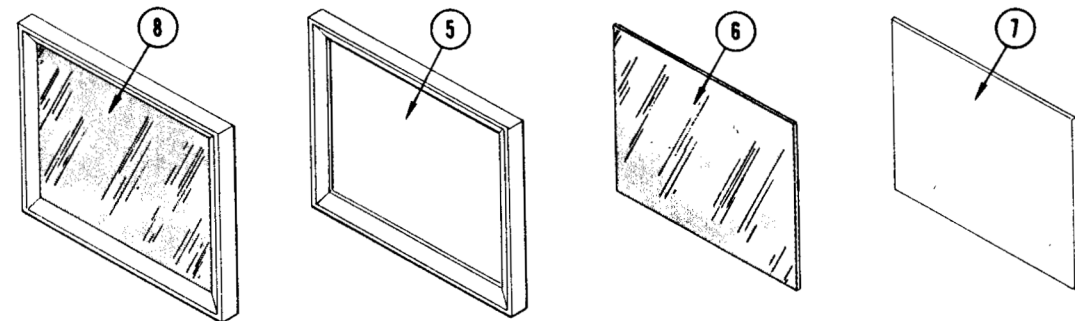
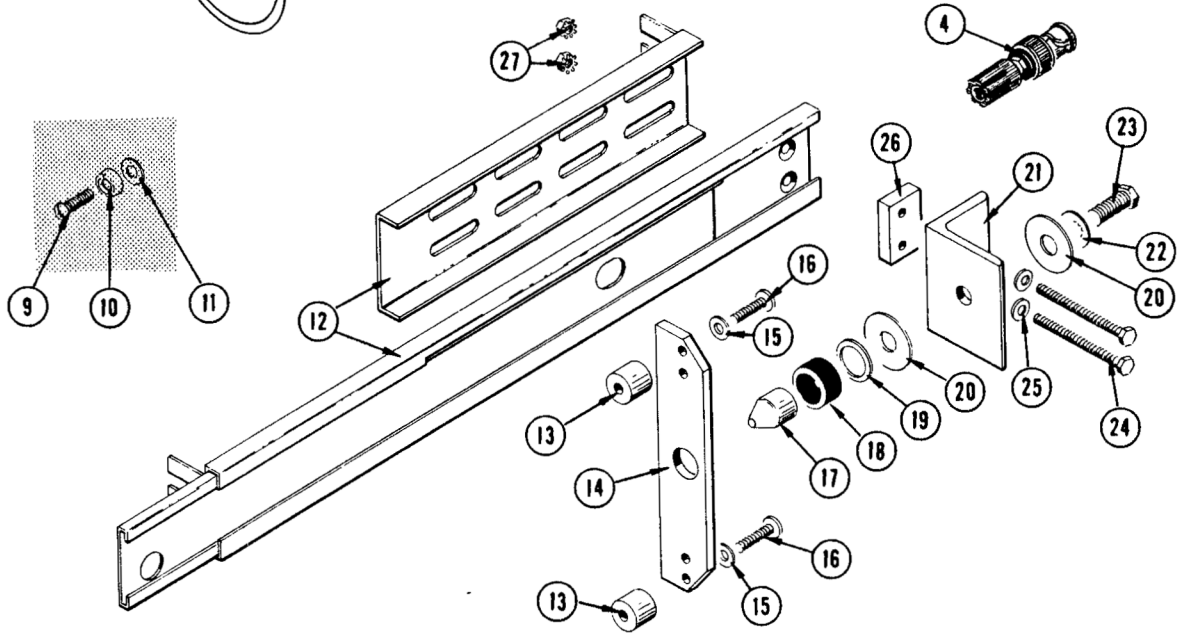
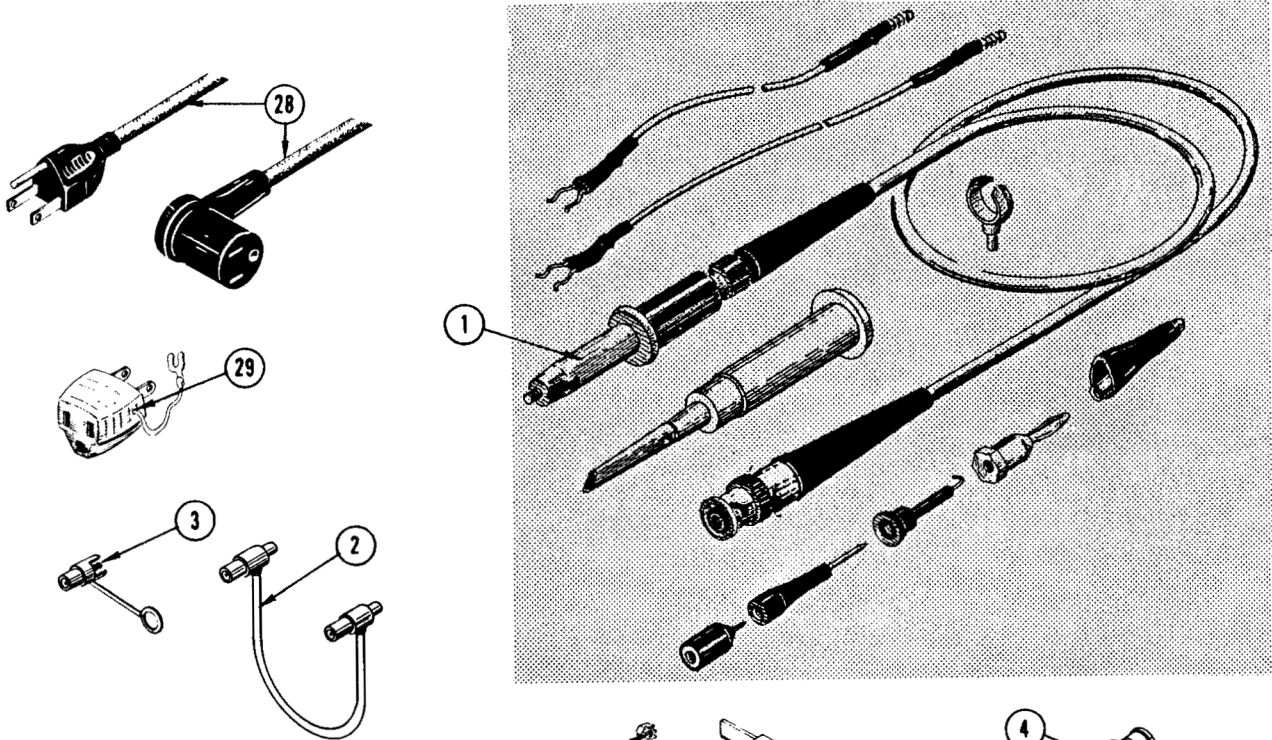

Fig. & Index No.	Tektronix Part No.	Serial/Model Eff	No. Disc	Q					Description	
				t	y	1	2	3		4
-1	010-0127-00	100	6989	2						PROBE PACKAGE, P6006
	010-0203-00	2990		2						PROBE PACKAGE, P6012
-2	012-0084-00	100	349X	1						PATCH CORD, BNC to BNC
-3	220-0410-00			4						NUT, keps, 10-32 x 3/8 inch
-4	103-0033-00			1						ADAPTER, BNC to binding post
-5	354-0248-00			1						RING, ornamental
-6	378-0549-00			1						FILTER, light
-7	386-0118-00			1						PLATE, protector, clear, CRT
-8	378-0571-00			1						FILTER, mesh (installed)
-9	212-0567-00			4						SCREW, 10-32 x 7/8 inch, OHS
-10	210-0833-00			4						WASHER, finishing, #10
-11	210-0917-00			4						WASHER, plastic, 0.191 ID x 5/8 inch OD
-12	351-0100-00			1						GUIDE, slide, stationary and inter-section (pair) w/mounting hardware
-13	361-0118-00			2						SPACER, sleeve, 0.50 ID x 0.512 inch long
-14	386-1066-00			1						PLATE
-15	210-0803-00			2						WASHER, flat, 0.150 ID x 3/8 inch OD
-16	211-0517-00			2						SCREW, 6-32 x 1 inch, FHS
-17	214-0502-00			2						PIN, support
-18	210-0984-00			2						WASHER, rubber, 0.484 ID x 0.828 inch OD
-19	210-0985-00			2						WASHER, flat, 0.512 ID x 7/8 inch OD
-20	210-0866-00			4						WASHER, flat, 0.264 ID x 1 1/8 inch OD
-21	407-0073-00			2						BRACKET, angle support
-22	210-0011-00			2						LOCKWASHER, internal, 1/4 ID x 15/32 inch OD
-23	213-0134-00			2						SCREW, 1/4-20 x 3/4 inch, HHS
-24	212-0520-00			4						SCREW, 10-32 x 1 1/4 inch, HHS
-25	210-0805-00			4						WASHER, flat, 0.204 ID x 0.438 inch OD
-26	361-0119-00			2						SPACER, block
	070-0434-02			2						MANUAL, instruction (not shown)

Ⓢ

TYPE 422/R422 OSCILLOSCOPE (SN 100-19,999)

INSTRUCTION MANUAL

Serial Number _____

TYPE 422
AC-DC
power supply

Tektronix, Inc.

S.W. Millikan Way ● P. O. Box 500 ● Beaverton, Oregon 97005 ● Phone 644-0161 ● Cables: Tektronix
070-0471-01

566



WARRANTY

All Tektronix instruments are warranted against defective materials and workmanship for one year. Tektronix transformers, manufactured in our own plant, are warranted for the life of the instrument.

Any questions with respect to the warranty mentioned above should be taken up with your Tektronix Field Engineer.

Tektronix repair and replacement-part service is geared directly to the field, therefore all requests for repairs and replacement parts should be directed to the Tektronix Field Office or Representative in your area. This procedure will assure you the fastest possible service. Please include the instrument Type and Serial number with all requests for parts or service.

Specifications and price change privileges reserved.

Copyright © 1965, New material 1966 by Tektronix, Inc., Beaverton, Oregon. Printed in the United States of America. All rights reserved. Contents of this publication may not be reproduced in any form without permission of the copyright owner.



CONTENTS

- Section 1 Characteristics
- Section 2 Operating Instructions
- Section 3 Circuit Description
- Section 4 Maintenance
- Section 5 Battery Pack
- Section 6 Calibration
- Section 7 Parts List And Diagrams

A list of abbreviations and symbols used in this manual will be found on page 7-1. Change information, if any, is located at the rear of the manual.

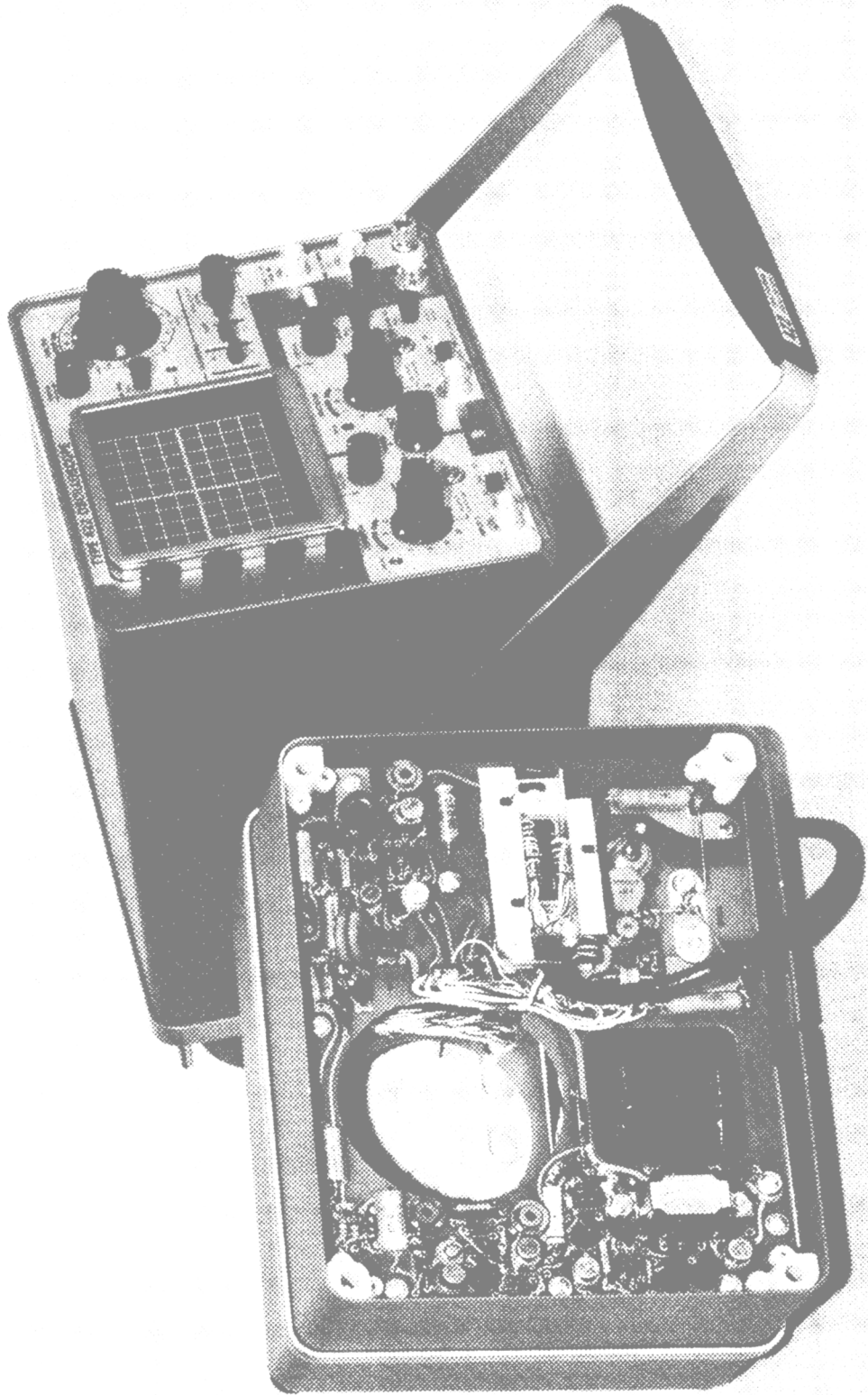

422 AC-DC

Ⓐ

SECTION 1

CHARACTERISTICS

Introduction

The Type 422 AC-DC Power Supply, when supplied with input voltages from either ac, dc external, or dc internal (batteries) sources, will provide all the necessary operating voltages to the Type 422 Indicator.

ELECTRICAL CHARACTERISTICS

Voltage Requirements

AC (Oscilloscope)—115 volts ac $\pm 20\%$, or 230 volts ac $\pm 20\%$, 50 to 440 cycles per second. From 50 to 45 cps the line voltage upper limit must be derated linearly to $\pm 10\%$. The power line total harmonic distortion should not exceed 1% at any frequency. The power supply will function with distortion which exceeds 1%; however, the specified voltage limits will no longer apply.

AC (Battery Charger)—115 volts ac $+10\%$, -20% , or 230 volts ac $+10\%$, -20% , 45 to 440 cps.

DC External—11.5 to 35 volts dc external source voltage supplied to the power supply through furnished dc power cord.

CAUTION

The chassis of the Type 422 must not be elevated more than ± 200 volts from the negative power line potential during dc external operation.

DC Internal (Battery Pack)—24 volts dc supplied by 20, 1.2 volt, 3.5 ampere-hour nickel cadmium cells.

Power Consumption

AC—Typically 27 watts at all input voltages.

DC External—Typically 23 watts.

DC Internal (Battery Pack)—Will provide approximately four hours of running time. Battery operation is limited to fifteen minutes after POWER Light starts blinking.

Thermal Protection

Two automatic-resetting thermal cutouts interrupt instrument power on ac operation if the internal temperature of the power supply exceeds a safe operating level. During dc operation one automatic-resetting thermal cutout interrupts the instrument power if the internal temperature exceeds a safe level.

A third automatic-resetting thermal cutout monitors the temperature of the battery pack in the two Charge Battery positions of the POWER MODE switch, and will limit the battery charge current to 30 ma (trickle charge) if the temperature of the batteries exceeds a safe level for the 400 ma charging current.

Battery Charger

The batteries are charged at approximately a 400 ma constant current rate in the CHARGE BATT 115 V AC and CHARGE BATT 230 V AC positions of the POWER MODE switch. Fully discharged batteries when charged at the 400 ma charge rate will reach full charge in approximately 12 hours.

In the OPERATE 115 V AC and 230 V AC positions of the POWER MODE switch, the batteries are trickle-charged at a 30 ma constant current rate.

ENVIRONMENTAL CHARACTERISTICS

NOTE

All environmental characteristics for the Type 422 Indicator apply to the AC-DC Power Supply except as noted below.

Temperature Without Batteries (Category II)

Operating— -15°C to $+55^{\circ}\text{C}$.

Non-operating— -55°C to $+75^{\circ}\text{C}$.

Temperature With Batteries (Category II)

Operating— -5°C to $+40^{\circ}\text{C}$ (Battery charging temperature range.)

-15°C to $+40^{\circ}\text{C}$ (Battery discharging temperature range.)

Non-operating— -40°C to $+60^{\circ}\text{C}$.

MECHANICAL CHARACTERISTICS

Construction

Aluminum-alloy panel and cabinet.

Glass laminate etched-wiring boards.

Finish

Anodized panel, blue-vinyl painted cabinet.

Overall Dimensions (measured at maximum points)

6.75" high, 10.0" wide, 6.84" long (dimensions do not include power cord).

ACCESSORIES

Information on accessories for use with this instrument is included at the rear of the mechanical parts list.

ACCESSORIES INCLUDED

	Tektronix Part No.
1—3- to 2-wire power cord adapter.	103-0013-00
1—3-wire ac power cord with male and female connectors.	161-0015-00

1—3-wire dc power cord with female connector.	161-0016-00
2—Instruction manuals	070-0471-00

OPTIONAL ACCESSORIES

1—Battery Pack with 20—1.2 volt 3.5 ampere-hour, nickel-cadmium batteries	016-0066-00
---	-------------

SECTION 2

OPERATING INSTRUCTIONS

General

The Type 422 AC-DC Power Supply will operate the Type 422 Indicator from the ac line, from an 11.5- to 35-volt source of external dc, or from a 24-volt internal dc source comprised of twenty 1.2-volt, 3.5 ampere-hour nickel-cadmium batteries.

This section will describe the different positions of the POWER MODE switch, power supply and remote power supply operation.

Information on front-panel controls, first-time operation, general operating information and basic applications will be found in the manual for the Type 422 Indicator.

REAR-PANEL CONTROL FUSE AND CONNECTOR

Fig. 2-1 shows a rear-panel view of the AC-DC Power Supply with a brief description for each position of the POWER MODE switch, and a brief description of the rear power input connector.

Fig. 2-2 shows the power cord connections for ac or external dc operation. The following table indicates the proper fuse sizes for the different ac or dc voltage ranges of the AC-DC Power Supply.

TABLE 2-1
FUSES

AC F1000		DC F1014	
VOLTAGE	FUSE SIZE	VOLTAGE	FUSE SIZE
115	0.75 a Fast Blow	11.5 to 35	3 a Fast Blow
230	0.75 a Fast Blow	Internal Battery	3 a Fast Blow

GENERAL OPERATING INFORMATION

Removing and Attaching the Power Supply

The power supply can be removed from the Type 422 Indicator for maintenance, calibration, or remote operation. Loosen the four power supply securing screws located in the rear feet of the power supply and then separate the units by sliding the power supply to the rear, off the support rods.

To attach the power supply to the Type 422 Indicator reverse the above procedure.

POWER MODE		Function
CHARGE BATT 230 V AC		Used when ac line voltage applied to instrument is 230 volts. Charges batter pack at a 400 ma constant current rate when POWER Switch is on. Indicator does not operate at this switch position.
OPERATE	230 V AC	Used when ac line voltage applied to instrument is 230 volts. Indicator operates and battery pack is charged at a constant current rate of 30 ma when instrument is turned on.
	11.5—35 V DC	Used when instrument is operated from external dc source. Special dc power cord is used to connect instrument to dc voltage. Only indicator operates. No charging of the battery pack.
	INT BATT	Used when instrument is operated from battery pack that has been installed into power supply. Only indicator operates. No charging of the battery pack.
	115 V AC	Used when ac line voltage applied to instrument is 115 volts. Indicator operates and battery pack is charged at a constant current rate of 30 ma when instrument is turned on.
CHARGE BATT 115 V AC		Used when ac line voltage applied to instrument is 115 volts. Charges battery pack at a 400 ma constant current rate when POWER Switch is on. Indicator does not operate at this switch position.

Power Supply Securing Screws—Secure complete power supply to Type 422 indicator.

Battery Pack Securing Screws—Secure battery pack to battery box. Note if battery pack is not installed. Holes are plugged with screws so instrument will meet environmental characteristics.

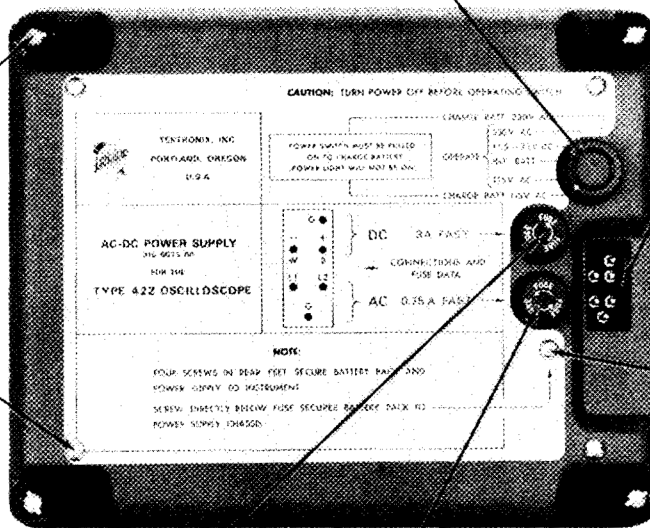

Input Connector (P1000)—Connector into which either the ac power cord or the dc power cord for external dc operation is connected.

Battery Box Attaching Screw—Attaches battery box to switch bracket.

Fuse Holder (F1014)—Fuse for dc operation, also protects battery pack during charging.

Fuse Holder (F1000)—Fuse for ac operation.

Fig. 2-1. POWER MODE control, input connector and fuse locations. Also shows POWER MODE switch functions.

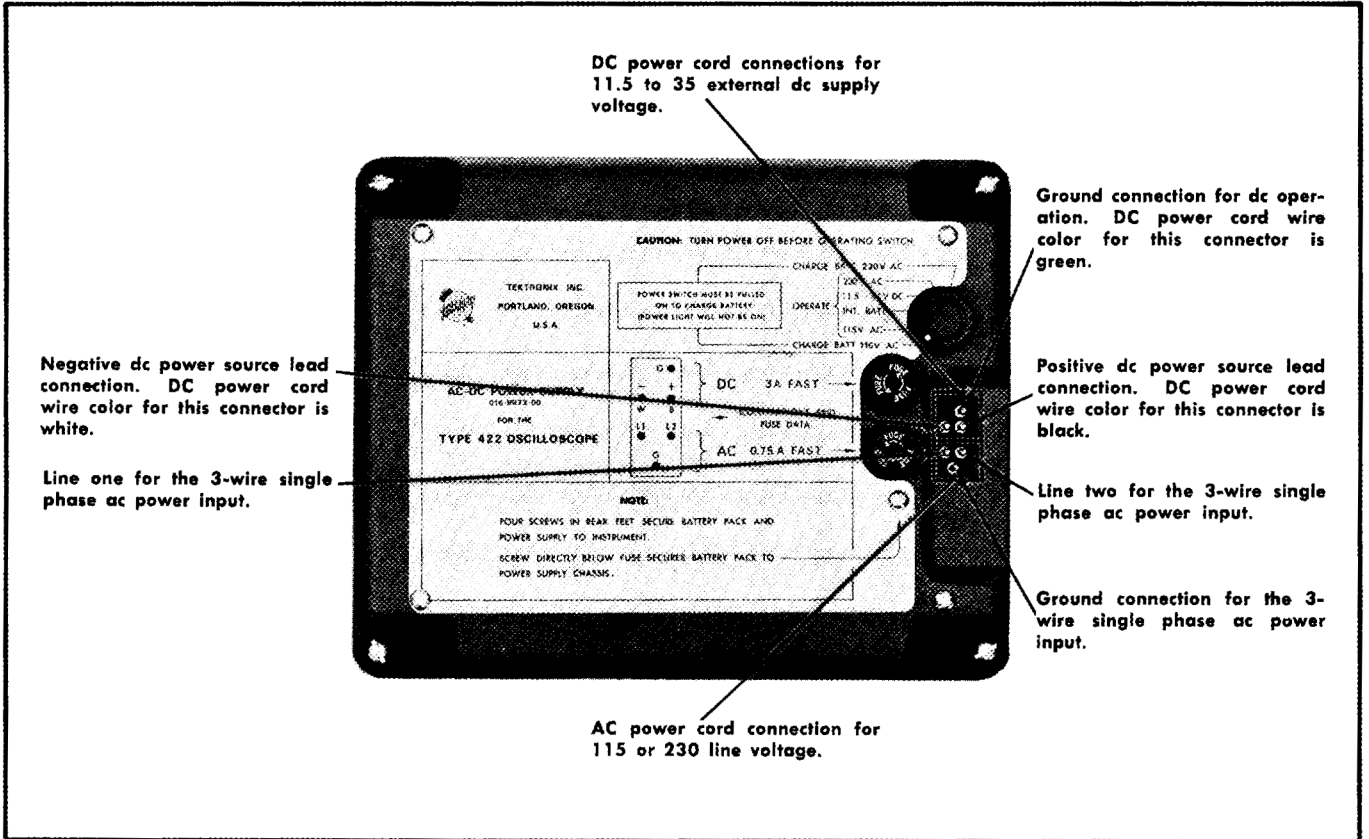

Fig. 2-2. Power cord connections made to P1000 for ac or external dc operation.

OPERATING THE POWER SUPPLY REMOTELY

The Type 422 can be operated with the power supply removed. The interconnecting plug on the rear of the indicator can be detached and used as an extension cable. To remove the interconnecting plug, loosen the three screws holding it to the indicator and slide it up slightly; then move it away from the rear of the unit. Unwrap the power cable from the rear of the indicator. The two spring clips (see Fig. 2-3) on the power supply are provided to lock the power cable to the power supply for remote operation. To use the clips, hook one spring clip into the hole provided in the interconnecting plug. (Be sure the POWER switch is set to off.) Slide the plug into place while depressing the other spring clip. To remove the plug, reverse the order in which it was attached.

CAUTION

Do not bend the spring clips so they latch without using the procedure described above. If bent in this manner, they will latch when the power supply is remounted on the indicator and will be difficult to remove without damage to the instrument.

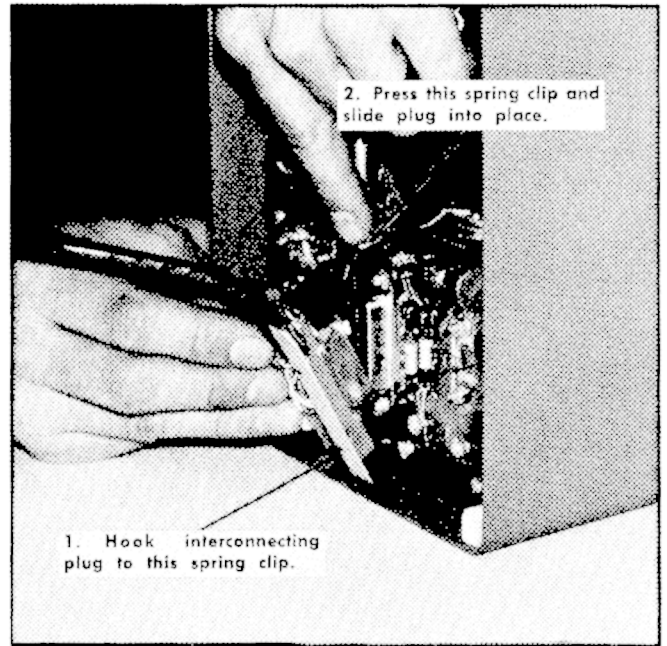

Fig. 2-3. Securing the power cable to the power supply for remote operation.

SECTION 3

CIRCUIT DESCRIPTION

Introduction

The Type 422 AC-DC Power Supply accepts power from 115- or 230-volt ac, external dc, or internal Battery Pack, and converts this power to the regulated voltages required to supply the Type 422 Indicator. Provision is made for charging the internal batteries. Fuses, thermal cutouts and diodes protect the circuitry against incorrect usage and adverse environmental conditions.

Dc power, from an external source or an internal battery, is applied directly to the Dc-Dc Regulator. Ac power is transformed and rectified before application to the Dc-Dc Regulator.

The POWER MODE switch, located on the rear of the power supply, determines the mode of operation according to the power source.

Block Diagram

AC Source

115- or 230-volt ac power from power cord jack P1000 is applied to the primary windings of stepdown transformer T1001 via POWER switch SW1001 and voltage selector sections a and b of the POWER MODE switch SW1030. Fuse F1000 and thermal cutout TK1000 protect the unit against shorts and slow overload, respectively.

The center-tapped secondary winding of transformer T1001 supplies a full-wave rectifier circuit which provides dc power for the Dc-Dc Regulator circuitry.

DC Source

External dc power (11.5- to 35-volts) connected to P1000 is supplied via sections c and d of POWER MODE switch SW1030 through fuse F1014, sections e and g of SW1030, thermal cutout TK1039 and POWER switch SW1001 to the Dc-Dc Regulator circuitry.

Diode D1014 protects the unit by causing F1004 to blow, should the external dc source be connected with the wrong polarity.

Internal Battery

In the OPERATE INT BATT mode, the internal 24 V Battery Pack is selected by sections c and d of the POWER MODE switch SW1030 and fed to the Dc-Dc Regulator circuitry by the same path used for external dc power.

The voltage of the internal Battery Pack is monitored by the Low-Voltage Indicator Circuit (Q1045, Q1055 and associated components) which cause the Type 422 front-panel POWER Light indicator to blink when battery voltage falls below 22 volts. Further discharge will impair battery life.

Battery Charger

The Battery Charger is connected to the Battery Pack through section e of SW1030 in all ac positions of the POWER MODE switch. Diode D1016 disconnects the battery from the charge circuit when the ac power is turned off.

When either charge position of the POWER MODE switch is selected, the batteries are charged at approximately a 400-ma rate selected by section f of SW1030. With the POWER MODE switch in either the OPERATE 230 V AC or 115V AC position, the battery receives a trickle charge at approximately a 30-ma rate.

Thermal cutout TK1033 senses the Battery Pack temperature, and automatically selects the 30-ma charge rate when the Battery Pack temperature rises above 105° F.

DC-DC Regulator

The heart of the Dc-Dc Regulator used in this supply is the "inductive energy pump", shown in simplified form in Fig. 3-1. Its operation is as follows:

Assume there is no current in L1 (SW1 open) but that the storage/filter capacitor C1 is charged to practically the normal load voltage V_L . At the start of a repetition period (time t_0) SW1 is closed, applying the source voltage V_B across the energy storage inductor L1. The charge current increases linearly through L1, storing magnetic energy, until at time t_2 SW1 is opened, and the voltage across L1 swings positive until it exceeds the load voltage V_L . D1 now conducts, discharging the magnetic energy into storage capacitor C1 until, at time t_{11} , current and voltage in L1 drop to zero. C1 is large enough to hold V_L practically constant during the discharge, so that the current decay is also linear. The system is now ready for a new cycle.

The peak current, together with other parameters, determines the load voltage; since the load voltage must be held constant to accommodate variations in source voltage, the "on" time of SW1 may be varied (e.g., by a feedback loop) inversely with the source voltage to insure that the same peak current is always reached.

In practice, a symmetrical double-sided arrangement is used, with the two sides acting alternately. The magnetic energy is stored in the core of T1201, charging through the primary winding and discharging from the secondaries. Dc power from the Power Selector Switch is connected between the primary center tap and ground reference. The two ends of the primary are alternately grounded by saturating switches Q1174, Q1184 through the reverse voltage disconnect diodes D1176 and D1186. The secondary rectifier diodes, filter capacitors and load currents replace D1, C1 and R1 of Fig. 3-1, respectively. Idealized voltage and current waveforms for the circuit are shown in Fig. 3-2 (waveforms 8-11). Filter elements localize large high-speed

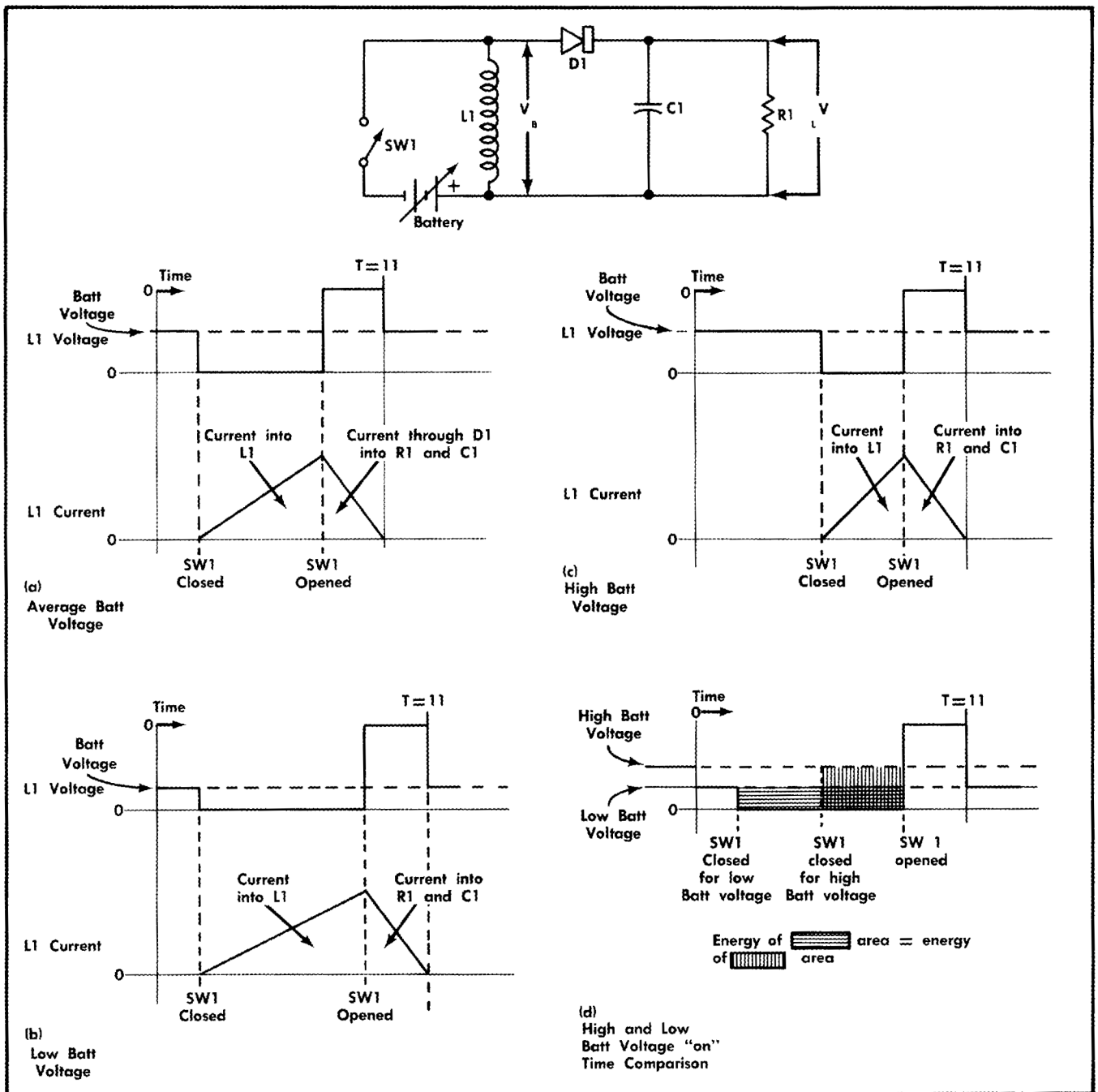

Fig. 3-1. AC-DC Power Supply in an equivalent circuit configuration with associated waveforms. (a) Average Battery voltage. (b) Low Battery voltage. (c) High Battery voltage. (d) Comparing switch "on" time areas for low and high Battery voltages.

current surges and reduce the magnitude of power transients in the switching elements themselves.

Isolated Voltage

In addition to the +95 +55, +12, -12 and 110 volt outputs to the indicator there are several other voltage sources in this power supply which are used only for operation of the regulator circuitry. These sources, +12, -12 volts, and the feedback voltage, are isolated from chassis ground when the instrument is operating from an external dc source. The

common for these voltages is also the negative side of the dc input power. Thus the external dc primary power may have either terminal connected to chassis ground or be elevated as much as ± 200 volts from the chassis ground.

In the following description the sources used for operation of the regulator circuitry will be called "isolated +12 V" or "isolated -12 V", respectively, to distinguish them from the grounded supplies, even though the isolated supplies are in fact grounded in all modes of operation except external dc.

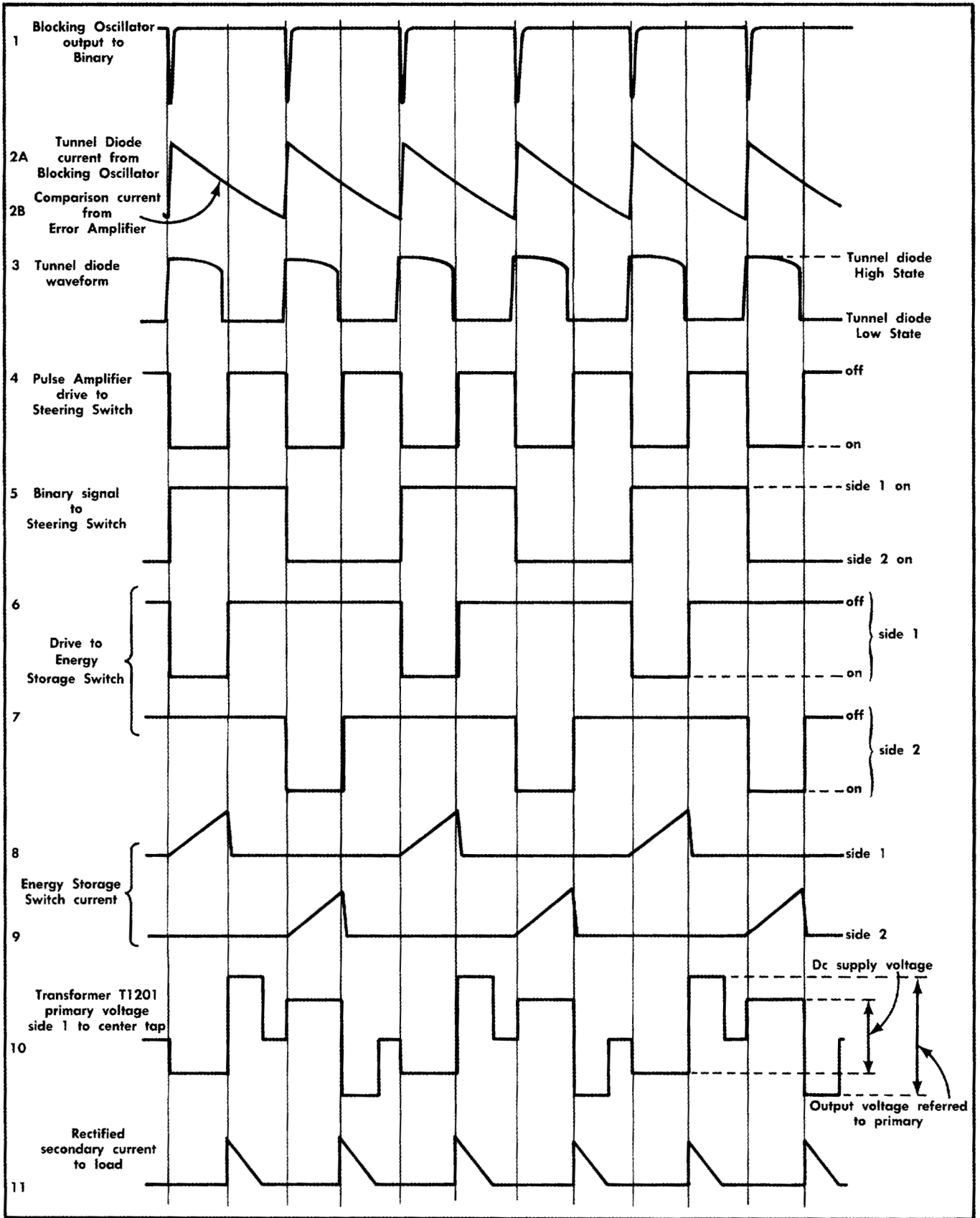

Fig. 3-2. Waveform ladder showing idealized Block Diagram Power Regulator waveform relationships.

Circuit Description—422 AC-DC

Block Layout. The block layout of the entire Dc-Dc Regulator is shown in the Block Diagram, and its associated idealized waveforms in Fig. 3-2. Timing for the converter is provided by a free-running Blocking Oscillator (Q1120), which generates:

- a. A 7-kc train of negative going pulses (waveform 1, Fig. 3-2) which alternately switch the Binary Q1105, Q1115.
- b. An approximately sawtooth current (waveform 2A).

The sawtooth current is compared against the output current (waveform 2B) of the Error Amplifier in the Pulse Width Control Tunnel Diode D1155, which then generates pulses (waveform 3) whose width is approximately proportional to the Error Amplifier output current. These pulses are amplified by Pulse Amplifier Q1164, Q1163 (waveform 4) and alternately steered to side 1 (waveform 6) and side 2 (waveform 7) of the symmetrical charging switch by the Steering Switch Q1104, Q1114, according to the state of the control signal (waveform 5) from the Binary.

The Feedback Rectifier/Filter generates a voltage proportional to the rectified and filtered secondary output. This is compared to a reference voltage (Zener Voltage Reference D1135) in Error Amplifier Q1134, Q1144, Q1154 whose output is the pulse width control current to the Pulse Width Control Tunnel Diode D1155, completing the feedback loop. The sense of the loop is such that any rise in the feedback voltage (due, for example, to a rise in dc power source voltage) causes a reduction in the drive pulse width (waveform 4), and so reduces transfer of energy to keep the output voltage constant.

Operating power for the Dc-Dc Regulator circuitry is taken from a winding of T1201. When dc power is first applied, the Start Circuit (Q1193, Q1194) passes enough raw dc power directly to the Blocking Oscillator, Binary, Steering Switch and Pulse Amplifier to allow operation to begin. As the Dc-Dc Regulator output builds up to near normal, the Start Circuit disconnects the raw dc and allows the more efficient Dc-Dc Regulator to supply the operating power to these circuits from the isolated +12V rectifier/filter.

DETAILED CIRCUIT DESCRIPTION

AC-DC Power Input Circuits

The reader may find it convenient to refer to the Dc-Dc Regulator and Ac-Dc Selector diagrams.

AC Power Input. 115- or 230-volts ac is applied via the ac power cord to P1000. From P1000 the ac power passes through (radio frequency interference) RFI filter T1000 and C1000. One side of the ac line then goes directly to one side of one-half of the primary of T1001. The other side of the ac line goes through one-half of the POWER switch SW1001, ac fuse F1000, and thermal cutout TK1000. It then connects to one end of the other half of T1001 primary. POWER MODE switch SW1030 connects the two primary windings halves to T1001 in series for the CHARGE BATT 230 V AC, and OPERATE 230 V AC switch positions and connects the two primary halves of T1001 in parallel for the OPERATE 115 V AC, and CHARGE BATT 115 V AC switch positions.

The T1001 secondary voltage, typically 35-volts ac, is applied to a rectifier circuit consisting of D1002, D1003,

D1004, and D1005. The output of the rectifier circuit is then filtered by C1002, C1003, and C1004. From the filter circuit, 25 volts dc is applied to the dc-dc regulator circuitry via POWER MODE switch SW1030 while the total 50-volt dc output is applied across the Battery Charger and Battery Pack when the POWER MODE switch SW1030 is in any position other than OPERATE 11.5-35 V DC or OPERATE INT BATT.

DC Power Input. 11.5- to 35-volts dc can be applied via the dc power cord to P1000. From P1000 the dc power passes through a RFI filter T1010, C1010, C1011, and C1012. The negative side of the input dc power connects to the zero reference voltage bus in the power supply via POWER MODE switch SW1030 when the switch is set to OPERATE 11.5-35 V DC. The positive side of the input dc power connects to the dc-dc regulator circuitry through dc fuse F1014 via POWER MODE switch SW1030 when SW1030 is set to OPERATE 11.5-35 V DC. Diode D1014 causes F1014 to open if the input dc power polarity is connected incorrectly.

Battery Power. When POWER MODE switch SW1030 is set to OPERATE INT BATT, the negative side of the 24-volt Battery Pack is connected to the zero reference voltage bus, while the positive side of the Battery Pack is connected via dc fuse F1014 to the dc-dc regulator circuitry.

Battery Charger

The Battery Charger provides two constant current charging rates to the Battery Pack. The constant current charging rate depends upon the position of the POWER MODE switch SW1030. When the POWER MODE switch is set to OPERATE 230 V AC or OPERATE 115 V AC, the Battery Pack is trickle charged at a 30-ma rate. When the POWER MODE switch is set to either CHARGE BATT 230 V AC or CHARGE BATT 115 V AC the Battery Pack will be charged at a 400-ma rate. This 400-ma rate will be automatically decreased to the 30-ma rate by TK1033 if Battery Pack temperature goes above 105° F.

The constant current circuit utilizes the Darlington pair Q1023, Q1033 to maintain across R1033 (and R1031 when not shorted by SW1030 and TK1033) a voltage approximately equal to reference diode D1022 voltage. The value of R1033 then determines the charging current, and R1031 and R1033 set the trickle charge rate.

Low-Voltage Indicator Circuit

The Low-Voltage Indicator Circuit causes the Type 422 front-panel POWER Light to blink when the POWER MODE switch is set to OPERATE INT BATT and the Battery Pack voltage drops to 22 volts, the almost fully discharged state. Further discharge is detrimental to battery life.

The Low-Voltage Indicator Circuit monitors the internal battery. When the battery voltage falls to 22 volts, the voltage at the wiper of R1047, LOW VOLTAGE INDICATOR, (part of a voltage divider comprised of R1046, R1047, and R1048) causes Q1045 to turn on.

The emitter of Q1045 is held at a reference voltage of approximately 10.5 volts by Zener diode D1041, and the battery voltage is applied to its base by the adjustable arm of R1047, an element of voltage divider R1046, R1047,

R1048. When the battery voltage falls below the preset threshold, Q1045 conducts, turning on saturated switch Q1055. This completes the switching action by saturating Q1045 via R1054 and D1054; and effectively grounding one end of C1057. This capacitor, together with R1059 and the POWER neon now form a neon relaxation oscillator, the time constants being selected to give a frequency of approximately one-half cycle per second.

Zener diode D1041 provides the Low-Voltage Indicator Circuit reference. C1041 and R1041 comprise a long time-constant circuit which prevents the Low-Voltage Indicator Circuit from responding to the low voltage which will be present on the Dc-Dc Regulator circuitry power bus at the instant when the instrument is first turned on.

Start Circuit

Power to the Start Circuit is supplied only in the "operate" positions of the POWER MODE switch.

The Start Circuit is a series regulator operated from the input voltage to the Dc-Dc Regulator and supplying voltage to the Dc-Dc Regulator circuitry until the first few cycles of output power have been generated. The isolated +12 V Rectifier/Filter and isolated -12 V Rectifier/Filter circuits are then able to supply the operating voltages.

As the input dc voltage to the Start Circuit rises to about ten volts, D1192 will turn on and hold the base of Q1193 at about 8.2 volts. This will in turn cause the isolated +12-volt bus of the isolated +12 V Rectifier/Filter to be at 7.5 volts. The 7.5 volts starts the Blocking Oscillator, Binary, Steering Switch and Energy Storage Switch circuits operating. Once the above circuits are operating, the isolated +12 V Rectifier/Filter is then able to supply the operating voltages, and will turn the Start Circuit off by reverse biasing the emitter-base junction of Q1193.

Blocking Oscillator

The free-running Blocking Oscillator sets the frequency at which the energy storage switching occurs in the power supply.

The frequency of the free-running Blocking Oscillator is determined by C1121, R1123, R1124 and R1125 (OSC FREQ control). Diodes D1117 and D1118 establish a fixed bias of approximately 1.4 volts at the base of Q1120.

When the emitter voltage of Q1120 drops to 0.7 volt, Q1120 turns on and is driven into saturation by the regenerative feedback applied to its base circuit through T1120. When the Blocking Oscillator fires, the base of Q1120 immediately rises 6 volts, and the collector of Q1120 pulls down 6 volts. This 6-volt change developed across the collector winding of T1120 is negatively coupled to the junction of D1105 and D1115 through a third winding of T1120. This pulse aids the conduction; and the resultant cumulative trigger action discharges C1121 (to approximately 6.6 volts) until Q1120 saturates, and no further discharge is possible. The quickly reducing collector current terminates the positive base voltage pulse, cutting off Q1120 and leaving its emitter voltage to fall exponentially toward ground.

When the Blocking Oscillator fires, Pulse Width Control Tunnel Diode D1155 is pulled into its high state.

C1120 and R1120 provides decoupling for the Blocking Oscillator circuit.

Binary

The Binary determines, via the Steering Switch, which transistor of the Energy Storage Switch will be turned on.

The Binary is a collector triggered, emitter comuted multivibrator consisting of Q1105, Q1115 and associated components. Assume Q1105 conducts the tail current through R1117, and Q1115 is practically cut off. Approximate voltages are:

- Q1105 collector and Q1115 base ... +11.5 volts
- Q1105 base and Q1115 collector ... +12 volts
- Q1105 emitter +11.4 volts
- Q1115 emitter +11.2 volts

The upper end of C1106 is therefore approximately 0.3 volts negative with respect to its lower end.

When the negative trigger pulse from the blocking oscillator arrives at the junction of D1105, D1115, D1115 conducts first and drives the base and the emitter of Q1105 negative; the emitter of Q1115, tied to it through C1106, goes negative until caught by conduction of Q1115. Q1115 is cut off by the rest of the trigger pulse, which is limited by conduction in both Q1104 and Q1114 bases. When the trigger pulse ends, Q1115 maintains conduction; its base goes to near +12 volts and direct coupling via D1116, R1116, R1106, D1106 to the emitter of Q1105 takes over from C1106 the function of keeping Q1105 cut off, allowing C1106 to charge in the opposite direction, ready for the next trigger pulse.

Pulse Width Control Tunnel Diode and Pulse Amplifier

The Pulse Width Control Tunnel Diode D1155 controls the "on" time of the Energy Storage Switch transistor through the Pulse Amplifier.

The total current in the threshold sensing tunnel diode D1155 is made up of fixed components from R1163, R1161; the control current from the collector of Q1154 (error amplifier); and the exponentially decaying C1121 charge current from R1123 (blocking oscillator). At the start of the blocking oscillator cycle, when Q1120 emitter is near 6.6 volts, the net diode current exceeds the peak current and the diode is in its high state. As C1121 charges, the diode current reduces, until, as some instant determined by the Q1154 collector current, D1155 switches to its low state.

With D1155 in its high state Q1164 saturates, turning Q1163 on hard. With Q1163 turned on, one-half of the primary of T1171 is connected across +12 volts through Q1163 and either Q1104 or Q1114.

Steering Switch

The Steering Switch controls which Energy Storage Switch transistor is turned on. Two inputs must be available to the Steering Switch circuit simultaneously to cause the Steering Switch to turn on one of the Energy Storage Switch transistors.

One input is derived from the Pulse Amplifier Q1163 as explained previously. The input from the Pulse Amplifier is the same no matter which transistor is conducting. Conduction in either Q1114 or Q1104 is determined by the Binary. For example: if Q1115 is conducting it turns Q1114 on and a pulse appears on the primary of T1171 and is coupled to the secondary causing one of the Energy Storage Switch transistors to turn on. Diodes D1104 and D1114 act as disconnect diodes, disconnecting the non-conducting transistor from the primary of T1171.

Energy Storage Switch

When the Energy Storage Switch turns on, it applies the input dc power to one-half of the primary of T1201. The Energy Storage Switch is connected in a push-pull configuration across the primary of T1201, alternately storing energy in the core each half cycle.

A drive current is applied from the secondary of T1171 through the action of the Steering Switch turning on one of the Energy Storage Switch transistors, which will permit the current in one half of the primary of T1201 to build up until the Pulse Width Control Tunnel Diode shuts off.

Zener diodes D1174 and D1184 act as protection devices for Q1174 and Q1184 to prevent any collector-to-emitter transient voltages from exceeding 75 volts.

Diodes D1176 and D1186 act as disconnect diodes disconnecting the non-conducting transistor from the primary of T1201. Diodes D1177 and D1187 connect the charging half of T1201 to de-spiking capacitors C1177 and C1187, respectively.

Feedback Rectifier/Filter, Zener Voltage Reference and Error Amplifier

The Feedback Rectifier/Filter, Zener Voltage Reference and Error Amplifier determine the amount of time needed to store energy in T1201 with a given input source voltage. When the Energy Storage Switch turns off a voltage will be induced into the center-tapped secondary windings of T1201, one of which is the feedback winding connected to the Feedback Rectifier/Filter circuit. The Feedback Rectifier/Filter network consists of rectifiers D1232 and D1233 and filter

components C1232, C1233 and R1232. C1232, C1233 and R1232 are chosen to give close tracking between the feedback supply and the other supplies to the Type 422 Indicator. The voltage from the Feedback Rectifier/Filter network is then applied through divider R1131, R1132, and R1130 (—12 VOLTS control) and temperature compensating diode D1132 to the base of comparator transistor Q1134 whose emitter voltage is set by Zener Voltage Reference D1135. Q1134 then sets the conduction levels of Q1144 and Q1154, and hence the bias current for D1155.

The Rectifier and Filter Circuits provide regulated dc voltages to the Type 422 Indicator.

The output voltage from the secondary winding of T1201 is full-wave rectified and then filtered by the different filter networks. From the filter networks regulated dc is supplied to the indicator. An output voltage is also supplied to the Low-Voltage Indicator Circuit in the power supply.

Isolated +12 V Rectifier/Filter and Isolated —12 V Rectifier/Filter

The isolated +12 V Rectifier/Filter and Isolated —12 V Rectifier/Filter furnish the operating voltages for the Power Regulator circuitry after the circuit has been started into operation by the Start Circuit.

Isolated power supplies have been provided to power the regulator circuitry so the input power source (external dc) can be isolated from the chassis potential of the Type 422 Indicator. In external dc operation the negative input to the regulator circuit is floated from chassis ground to allow differences in potential between an external dc source and equipment common of 200 volts maximum.

The output voltage from the T1201 secondary winding is fed to two different full-wave rectifier circuits and filter circuits. The isolated +12 V Rectifier/Filter circuit consists of D1242, D1243, C1195 and C1199, while the isolated —12 V Rectifier/Filter components are D1244, D1245, C1245, C1246 and L1246.

Grounds

C1173, C1181, C1183, C1231 and C1242 provide short high-frequency current paths between ground planes and the zero reference voltage bus.

Due to component location on the etched-wiring board, the collector connection to Q1163 is returned across the board to C1199 in parallel with the +12-volt lead to minimize stray inductance. R1165 damps ringing on Q1163 collector by absorbing reflections along the short-circuited transmission line thus formed.

SECTION 4

MAINTENANCE

General

General maintenance information is given in the Type 422 Indicator manual. The following additional information applies specifically to the AC-DC Power Supply.

CORRECTIVE MAINTENANCE

Component Replacement

Removing the Power Supply Housing. Remove the battery box and the Battery Pack as a unit as per the instructions found in the Operating Instructions section of this manual. Pull the remaining part of the power supply off the indicator support rods and set it down on a flat surface so the interconnecting plug and POWER switch are down.

Remove the four screws located near the corners of the trim casting (see Fig. 4-1). Remove the three screws in the side of the power supply housing near the power supply serial number. After removing the above seven screws, pull the power supply housing off the power supply.

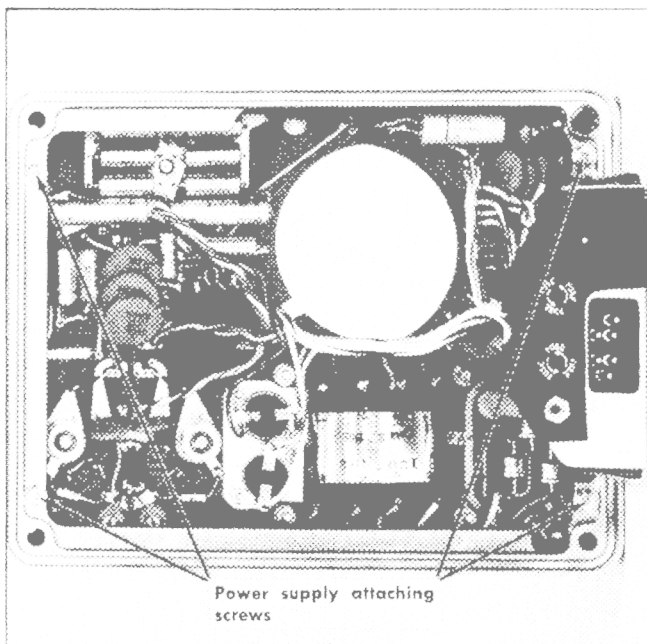

Fig. 4-1. Location of power supply attaching screw in trim casting.

TROUBLESHOOTING

Troubleshooting Aids

Component Numbering. The circuit number of each electrical part is shown on the circuit diagrams. Each main circuit for the Type 422 Indicator is assigned a series of circuit numbers. The series of circuit numbers assigned to the AC-DC Power Supply is numbers 1000 to 1249.

Etched-Wiring Boards. Figs. 4-2 and 4-3 show the etched wiring boards used in the AC-DC Power Supply. Fig. 4-4 shows the location of each board within the power supply. Each electrical component on the boards is identified by its circuit number.

Troubleshooting Techniques

The troubleshooting techniques outlined in the Type 422 Indicator manual can generally be used to troubleshoot the AC-DC Power Supply. Troubleshooting information which applies only to the AC-DC Power Supply is listed below.

NOTE

Table 4-1 gives the resistance readings taken at the interconnecting jack. These readings are typical and may vary between units. All readings were made with the power supply disconnected from the indicator and the power source. The polarity of your ohmmeter will have a definite effect on the resistance values listed in Table 4-1. To avoid confusion, first determine the polarity of your ohmmeter leads by measuring the forward resistance of any good signal diode. The ohmmeter lead connected to the cathode of the diode will be considered the positive ohmmeter lead while the lead connected to the anode of the diode will be considered the negative, or ground ohmmeter lead for the measurements listed in Table 4-1, unless otherwise indicated. All Table 4-1 readings were taken after initial capacitor charge due to ohmmeter voltage. Checking these resistance readings may help to isolate the trouble to the power supply or the circuits in the indicator.

TABLE 4-1

Interconnecting Plug Pin	Ohmmeter Scale	Typical Resistance Reading
1	X 10	0
2	X 10 k	∞
3	X 10	0
4	X 10	0
5	X 10 k	∞
6	X 10	0
7	X 10	*40 Ω
8	X 10 k	100 k
9	X 10	40 Ω
10	X 10 k	∞
11	X 1 k	*8 k
12	X 10 k	∞
13	X 1 k	8 k
14	X 10 k	∞
15	X 10	40 Ω
16	X 10 k	∞
17	X 10	0
18	X 10 k	∞
19	X 10	40 Ω
20	X 10	40 Ω
21	X 10 k	∞
22	X 10	0
23	X 10 k	∞
24	X 10 k	∞

*Reverse ohmmeter leads to obtain the reading.

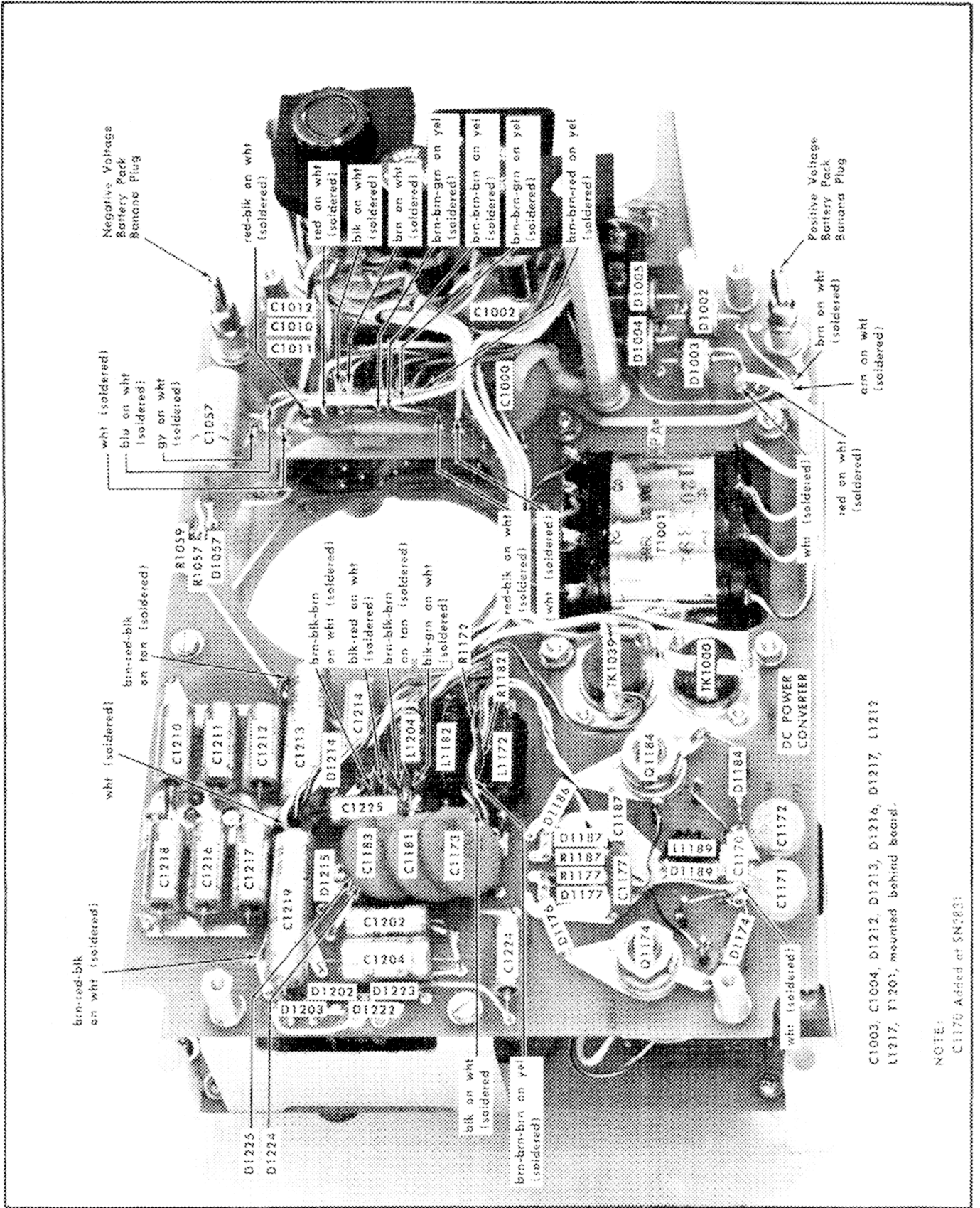

Fig. 4-2. DC Power Converter etched-wiring board

C1002, C1004, D1212, D1213, D1216, D1217, L1217
 L1217, F120, mounted behind board.

NOTE:
 C1170 Added at SN2831

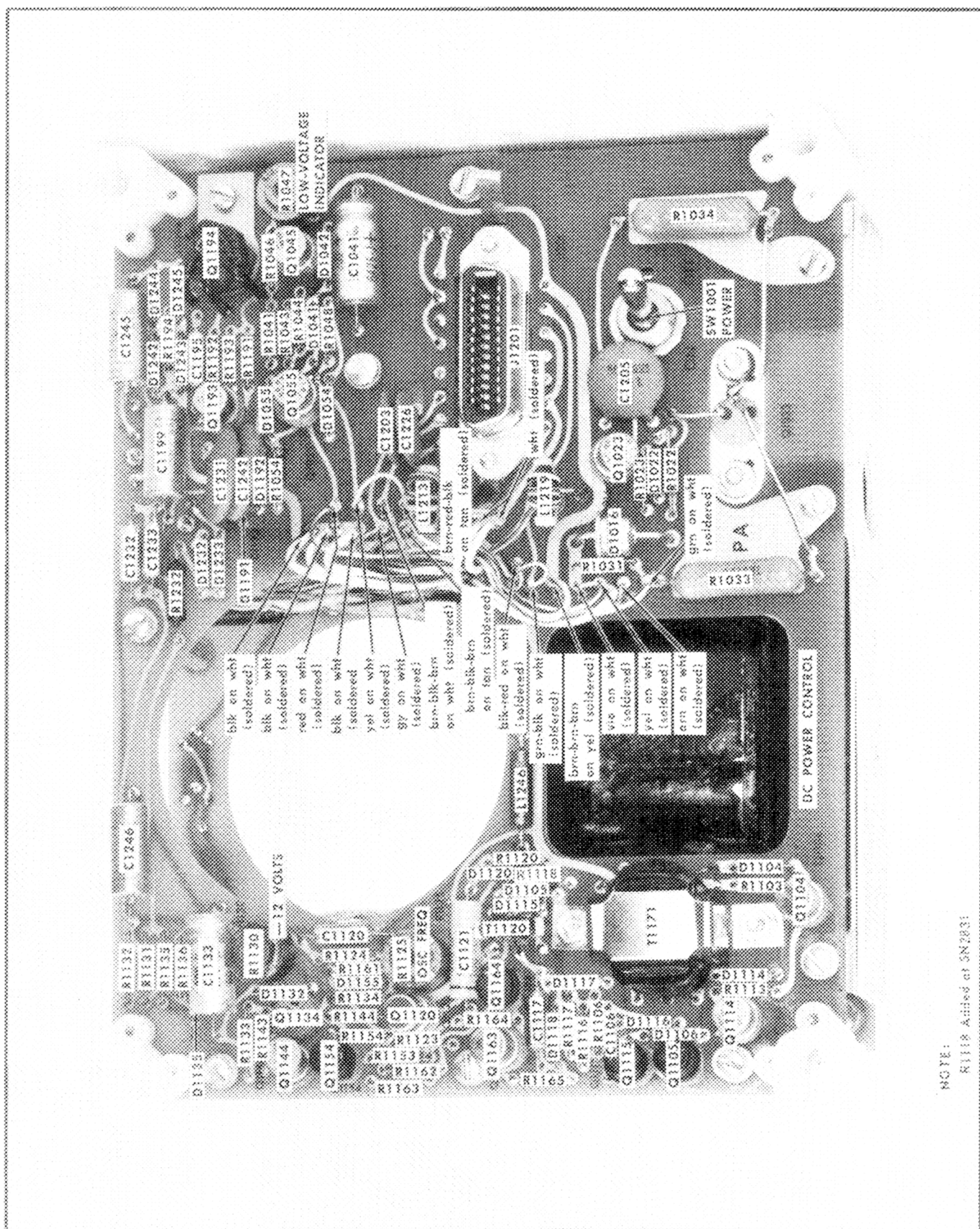

Fig. 4-3. DC Power Control etched-wiring board

NOTE:
R1118 Added at SN2831

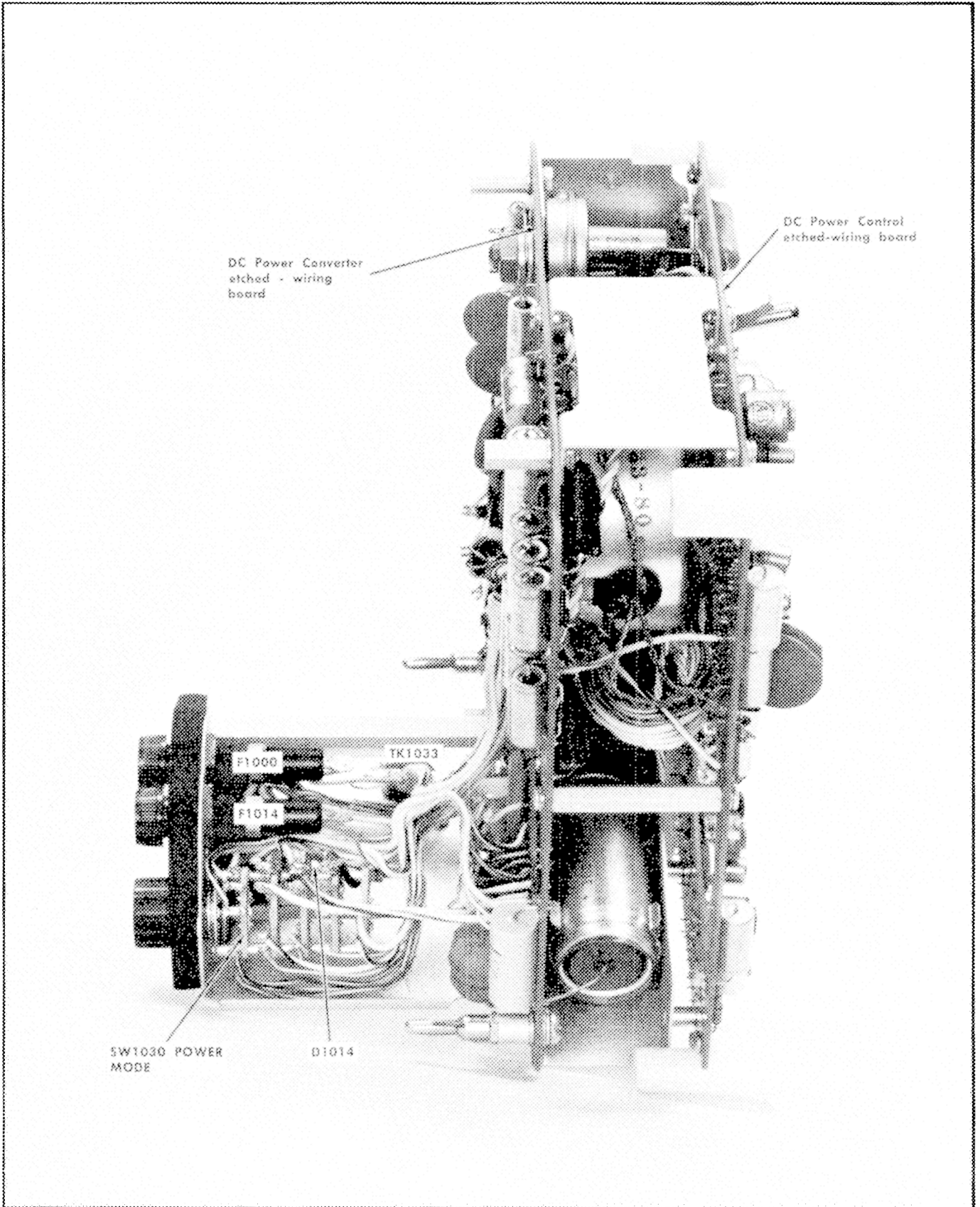

Fig. 4-4. Location of the switch bracket components and of the etched-wiring boards.

SECTION 5

BATTERY PACK

INSTALLATION INSTRUCTIONS

422 BATTERY PACK

1. Removing the Power Supply and Battery Box

a. Loosen and remove the four power supply securing screws located in the rear feet of the instrument.

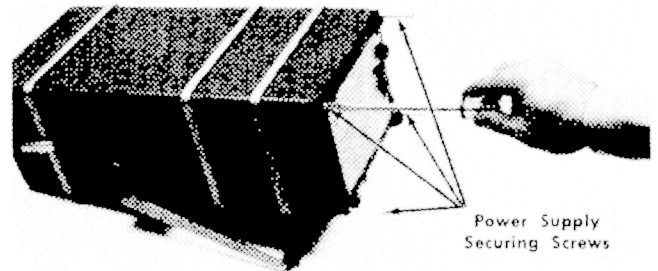

b. Separate the power supply and battery box from the indicator unit by sliding them to the rear and off the support rods.



c. Loosen and remove the screw located just below the fuse holders.

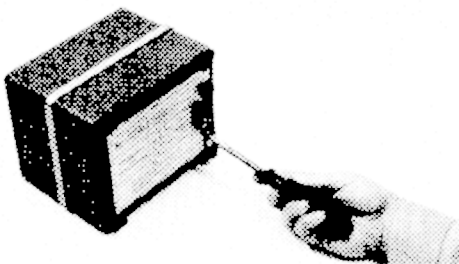

d. Detach the battery box from the power supply.

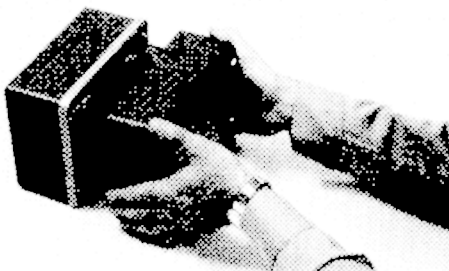

2. Attaching the Battery Pack

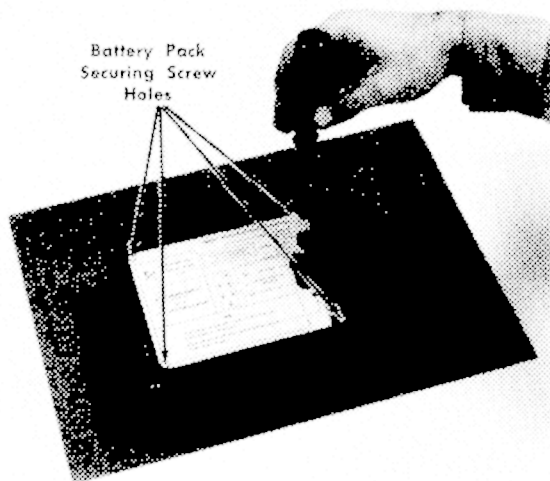

a. Remove and discard the four screws from the Battery Pack securing screw holes.

b. Loosen and remove from the Battery Pack the four long screws which go through it near its corners.

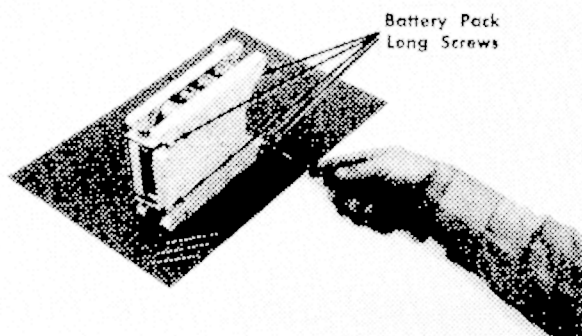

c. Set the Battery Pack on a non-conducting flat surface so it is resting on its interconnecting banana jacks and spring bracket.

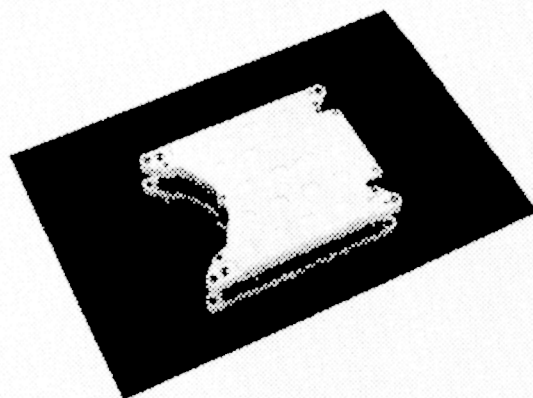

d. Place the battery box over the Battery Pack so that the cutout in the Battery Pack is directly under the knob, fuse and input connector holes in the battery box.

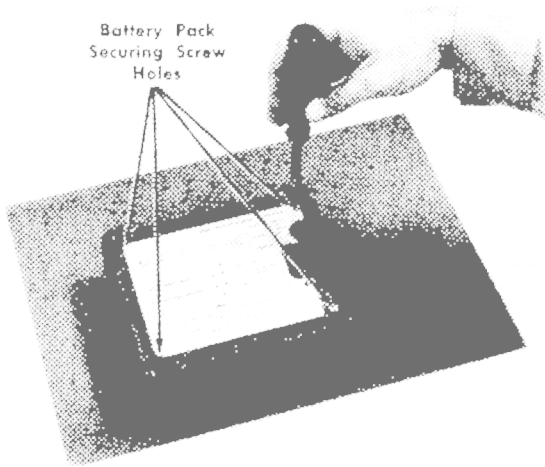
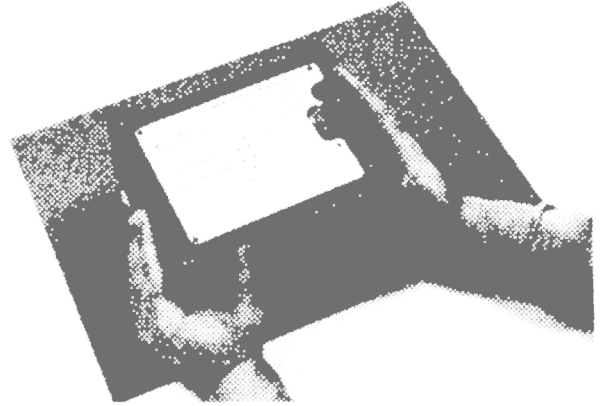

e. Start each of the four long screws, removed from the Battery Pack in step 2b into the four holes indicated, then tighten the four screws securely.

f. Install the battery box/Battery Pack onto the power supply, guiding the interconnecting banana jacks onto the banana plugs of the power supply.

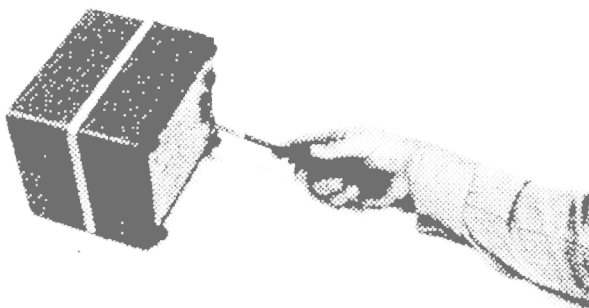
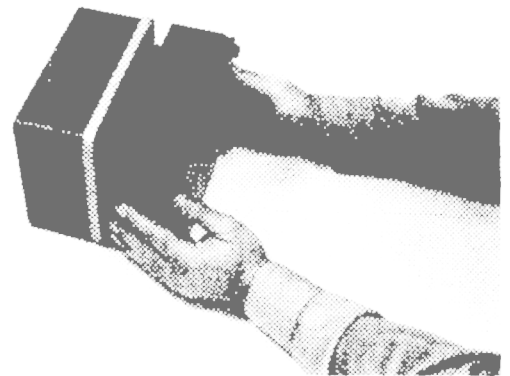

g. Re-install and securely tighten the screw removed in step 1c.

3. Attaching the Power Supply

a. Slide the power supply onto the four support rods protruding from the indicator unit.

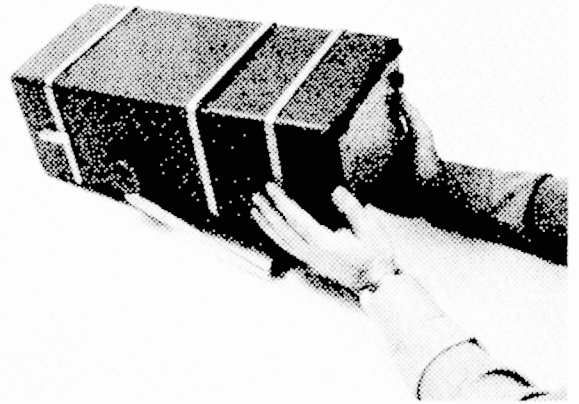

b. Start the four screws removed in step 1a into the holes located in the four rear feet of the power supply; then tighten all four screws securely.

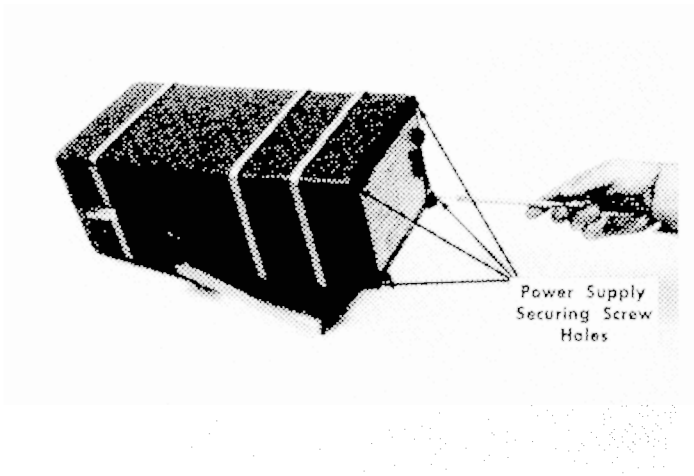

This completes the Battery Pack installation procedure. For more information on the Battery Pack refer to the instruction manual for the Type 422 AC-DC Power Supply.

IMPORTANT INFORMATION ABOUT THE USE OF NICKEL-CADMIUM BATTERIES

General

The Nickel-Cadmium battery cells supplied have been selected as a result of exhaustive engineering evaluation. Each battery cell has been rigidly inspected, has received an ampere hour test, and has met or exceeded the minimum ampere hour storage requirement.

The battery cells used in the battery pack should provide a useful operating life extending over several hundred charge and discharge cycles, providing the precautions listed below are observed:

Precautions

The life of hermetically sealed Nickel-Cadmium battery cells may be shortened by any of the following abuses:

1. If recommended charge rate is exceeded.
2. If battery charger is operated incorrectly.
3. If discharged to a point where one or more battery cells are reverse polarized.

The following information concerning Nickel-Cadmium battery cells should prove helpful in avoiding the problems mentioned above.

Battery Charging Information

During charging, sealed Nickel-Cadmium battery cells normally contain an internal pressure because gas evolution and chemical recombination is taking place. Therefore, as charging current is increased, gas evolution and internal pressure also increases; charging at rates in excess of those recommended should be avoided. Battery cell cases and seals will withstand these excess pressures, but the pressure relief vents may be punctured. If this occurs a portion of the electrolyte may be expelled with the gas, resulting in shorter overall battery cell life.

Periodic inspection of the battery box is recommended. The battery box should be closely inspected for signs of electrolyte leakage. If any electrolyte residue is found in the battery box, it should be cleaned away with a 2% solution of Boric Acid in water, after which all wetted area should be thoroughly dried with a soft cloth. For practical purposes, a 2% solution of Boric Acid can be approximated by dissolving 1¼ level teaspoons of the powder in one cup of water.

The battery pack used in the Type 422 AC/DC Power Supply should be regarded as a single power storage unit rather than as a set of individual cells, since it is not designed to be readily disassembled for repair or inspection. Any service to the battery pack should be referred to your Tektronix Field Engineer or Representative, especially during the battery warranty period when the guarantee may be altered if the sealed case-retaining screws are removed.

Battery Pack Charging Rates

A battery pack containing 20 specially selected battery cells wired in series is provided for use in the Type 422 AC/

DC Power Supply. The battery cells used in the battery pack are special battery cells, having greater ampere hour storage capacity than standard duty battery cells, and having superior high ambient temperature characteristics.

The Type 422 AC/DC Power Supply contains battery charging circuitry that may be operated from either a 115 V AC or 230 V AC power source. In the CHARGE BATT 115 V AC or CHARGE BATT 230 V AC positions of the POWER MODE switch, the battery pack is charged at approximately 400 milliamperes. In the OPERATE 115 V AC or 230 V AC position, the batteries are trickle-charged at a 30 milliamperes constant current rate.

The battery pack should be completely discharged each time before recharging, as noted later in paragraphs on Battery Pack Storage And Shelf Life. The battery pack should then be charged 16 hours at 400 milliamperes to insure it is fully charged. During the charging process thermal cutouts in the 422 AC/DC Power Supply provide protection against overheating the battery pack. In the event the battery pack temperature exceeds the maximum temperature point allowable by the thermal monitor, the charge rate is reduced to 30 milliamperes, the trickle-charge rate. When the battery pack temperature drops sufficiently, the thermal cutout resets and the charger resumes the 400 milliamperes charge rate. If the thermal switch reduces the charge rate to 30 milliamperes for any length of time during charging, the battery pack will not receive a full charge in 16 hours. For this reason, do not assume battery pack failure because of one instance of short operating time obtained from a battery pack.

Battery Pack Storage and Shelf Life

The battery pack is shipped in a charged condition, and should be fully recharged at 3-6 month intervals. For best retention of storage capacity, the battery pack should be discharged through a 100 ohm resistor to 0 volts, and then recharged. Two complete charge-discharge cycles are recommended. One charge-discharge cycle in this manner at 3-6 month intervals also aids battery pack life, whether the battery pack is in storage or in periodic use in the oscilloscope. An alternative is a continuous 30 milliamperes trickle-charge.

WARNING

Fully or partially charged battery packs are capable of delivering a very large current if accidentally short circuited. Care should be exercised to prevent shorting battery terminals with tools, metal work bench or attached wires. A severe burn can be sustained if rings or other jewelry are allowed to short the battery terminals or attached wires.

Charge retention characteristic of Nickel-Cadmium battery cells vary with temperature. They may be stored at any temperature between -40°F and +120°F without damage, but the higher the ambient temperature, the faster will be the self-discharge rate. Battery packs stored at +70°F will lose approximately 50% of their stored charge in 3 months. For this reason an occasional recharge is recommended for battery packs that are in storage. Battery packs stored at

Battery Pack—422 AC-DC

+120°F on the other hand, will be self discharged of all useful energy in 30 days. Due to the greatly accelerated self discharge rate, it is recommended that battery packs in storage at high ambient temperatures be continuously trickle-charged at a 30 milliampere rate.

Nickel-Cadmium Battery Pack Performance Data

The Type 422 oscilloscope may be expected to operate approximately 4 hours on a fully charged battery pack. Derating of this time at extremes of temperature should be expected. Some derating with age and/or after dozens of charge-discharge cycles will also be necessary.

Discharging the battery pack under operating conditions to an excessively low terminal voltage is not recommended, since the likelihood of one or more of the battery cells reversing polarity is greatly increased. The battery pack should never be discharged in use below 22 volts. Below this voltage limit, instrument calibration is not reliable. Care should also be taken to turn the oscilloscope off, or to the charge position when the battery pack is known to be in a low state of charge and the instrument not in use.

If the battery pack is found to fall below the lower voltage limit prematurely, contact your Tektronix Field Engineer or Representative for service immediately.

SECTION 6

CALIBRATION

Introduction

This procedure provides calibration information and a complete operational check for the Type 422 AC-DC Power Supply. The procedure checks the instrument to the performance requirements given in the Characteristics section of this Instruction Manual.

For the quickest and most accurate calibration, specialized calibration equipment is used where applicable. If this equipment is not available, the equipment substituted must equal or exceed the requirements listed under "Equipment Required", which follows. If the equipment does not meet these requirements, the Type 422 AC-DC Power Supply cannot be calibrated to the accuracy given. In such cases, the difference between the accuracy of the equipment used and the specified equipment accuracy must be added to the tolerance listed in the calibration steps.

This procedure may be used as a calibration training aid by following the procedure completely. It can be used to verify instrument operation by checking for the performance requirement or operation listed in each step. It may also be used to make the calibration adjustment by performing only those steps entitled "Adjust . . . ①". The symbol ① is provided to locate the "Adjust" steps.

A verification list is included in this procedure. This list can be used to verify correct calibration and operation of the Type 422. It can also be used as a guide for quick calibration. The step numbers correspond to the steps in the complete calibration procedure.

General Information

Any needed maintenance should be performed before proceeding with calibration. Troubles which become apparent during calibration should be corrected using the techniques given in Section 4 of this Instruction Manual.

NOTE

In case both the power supply and indicator are to be calibrated, the power supply should be calibrated first.

This procedure is arranged in a sequence which allows the instrument to be calibrated with the least interaction of adjustments and reconnection of equipment. If desired, the steps may be performed out of sequence or a step may be performed individually. Each step contains complete information for performing that step. However, some adjustments affect the calibration of other circuits within the instrument. In this case, it will be necessary to check the operation of other parts of the instrument. When there is interaction, the calibration steps which need to be checked are noted at the end of the step.

The location of test points and adjustments is shown for each step. Waveforms which are helpful in determining the correct adjustment or operation are also shown.

EQUIPMENT REQUIRED

The following equipment is required for complete calibration of the Type 422 AC-DC Power Supply (Fig. 6-1 in the Type 422 Indicator Manual shows items 1 through 4).

1. Dc voltmeter. Minimum sensitivity, 20,000 ohms/volt; accuracy, checked to 1% at -12 volts, to 2% at +12 volts, +55 volts and +95 volts, and to 3% at +2 volts, +11.5 volts, +22 volts, +35 volts and -110 volts.

2. Test oscilloscope. Risettime, 23 nanoseconds or less; minimum deflection factor, 0.005 volts/division. For example, Tektronix 540-series oscilloscope with Type B plug-in unit, or a calibrated Type 422.

3. Variable autotransformer. Must be capable of supplying at least 75 volt-amperes over a voltage range of 92 to 138 volts (184 to 276 volts for 230-volt nominal line). If autotransformer does not have an ac voltmeter to indicate output voltage, monitor output with an ac voltmeter (rms) with range of at least 138 (or 276) volts.

4. 1X probe with BNC connector. Tektronix P6028.

5. Test oscilloscope to provide proper loading for the power supply. Tektronix Type 422 properly calibrated.

6. Ohmmeter or similar method for checking continuity.

7. Dc power source; must have a variable output voltage from 11.5 to 35 volts and be capable of supplying 2.5 amperes or more of current. For example, Lambda (LH 125 FM), or Trygon (HR 40-3B) dc power supply.

8. Resistor; 50 ohm, 10 watt, 5%, Tektronix Part No. 308-0362-00.

9. Resistor; 680 ohm, 2 watt, 5%, Tektronix Part No. 305-0681-00.

10. Screwdriver, 3" shaft, Tektronix Part No. 003-0192-00. (See Fig. 6-3 in Type 422 Indicator Manual.)

VERIFICATION LIST

This verification list is provided to aid in checking the operation of the Type 422 AC-DC Power Supply. It may also be used as a guide to calibration. The step numbers and titles used here are the same as those used in the Calibration Procedure. Characteristics are those listed in Section 1 of this Instruction Manual.

Type 422 AC-DC Power Supply, Serial No. _____

Calibration Date _____

- 1. Adjust -12-Volt Supply -12-volts $\pm 1\%$ (11.9 to 12.2 volts) ①
- 2. Adjust Blocking Oscillator Frequency one cycle $\approx 140 \mu\text{sec}$. ①
- 3. Check DC Power Supply Operation Regulation and Ripple

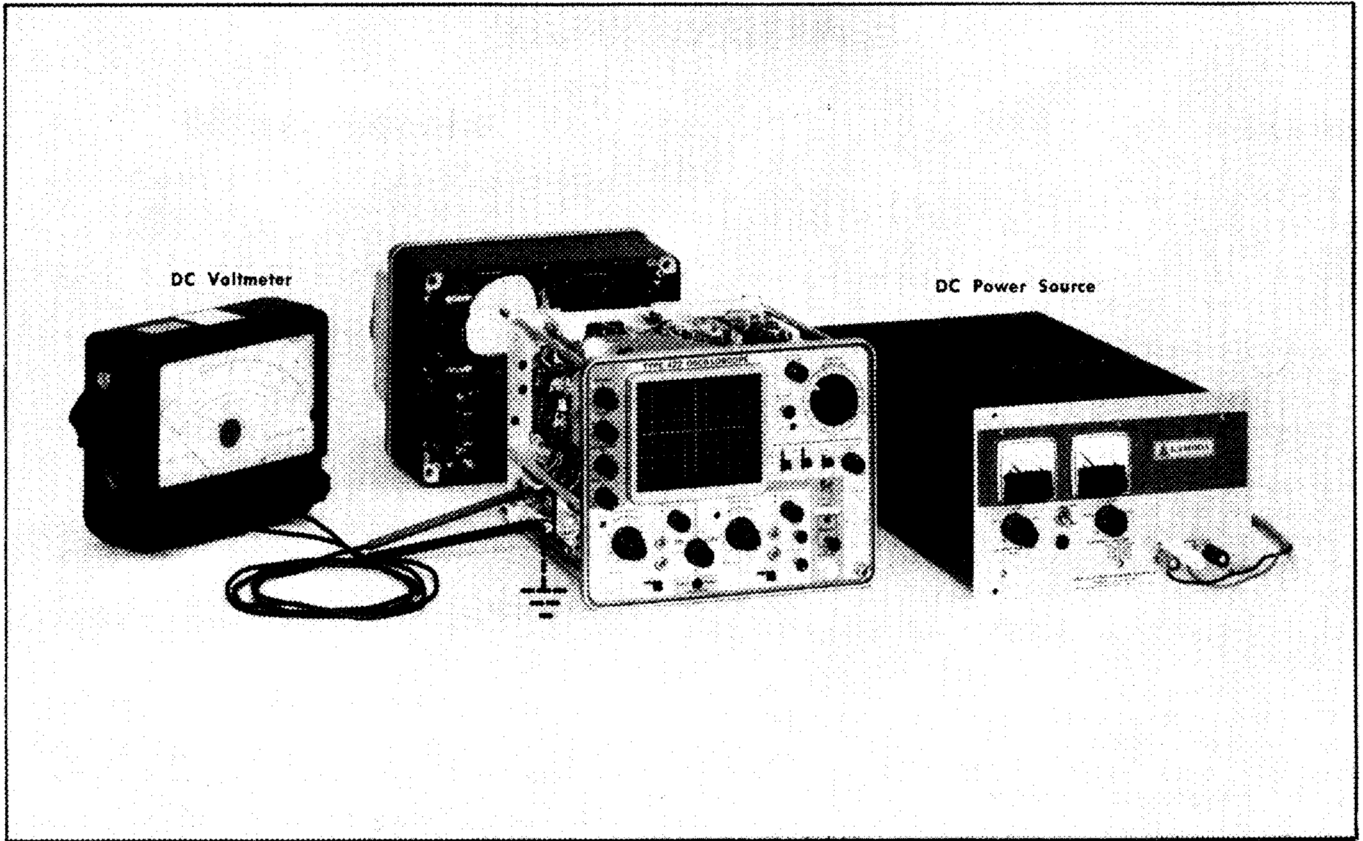

Fig. 6-1. Test equipment setup for —12-volts supply adjustment

Voltage Tolerance		Ripple
-12 volt	±1% (11.9 to 12.2 volts)	20 millivolts
-110 volt	±3% (106.7 to 113.3 volts)	0.5 volt
+12 volt	±2% (11.8 to 12.3 volts)	20 millivolts
+55 volt	±2% (53.9 to 56.1 volts)	0.6 volt
+95 volt	±2% (93.1 to 96.9 volts)	0.8 volt

- 4. Adjust Low-Voltage Indicator POWER Light blinks at 22 volts. ❶
- 5. Check AC Power Supply Operation Regulation and Ripple

Voltage Tolerance		Ripple	
		8 kc	120 cycles
-12 volt	±1% (11.9 to 12.2 volts)	20 mv	5 mv
-110 volt	±3% (106.7 to 113.3 volts)	0.5 v	
+12 volt	±2% (11.8 to 12.3 volts)	20 mv	5 mv
+55 volt	±2% (53.9 to 56.1 volts)	0.6 v	
+95 volt	±2% (93.1 to 96.9 volts)	0.8 v	

- 6. Check Battery Charger Circuit
400 ma charge current across 50-ohm resistor results in 16 and 23 volts.
40 ma charge current across 680-ohm resistor results in 20 and 34 volts.

PRELIMINARY PROCEDURE

1. Remove the power supply from the indicator.
2. Remove the battery box.
3. Remove the indicator cover.
4. Connect the interconnecting cable for remote operation.
5. Connect the Type 422 AC-DC Power Supply to a variable dc power source which will supply 11.5 to 35 volts at 2.5 amperes, via the 3-wire dc power cord.
6. Set the POWER MODE switch to OPERATE 11.5-35 V DC.
7. Turn on the variable dc power source and adjust it for an output voltage of 22 volts.
8. Switch the Type 422 AC-DC Power Supply POWER switch ON.

NOTE

For checking instrument to accuracy given in the Characteristics section of this Instruction Manual, allow at least 20 minutes warm up.

CALIBRATION PROCEDURE

The calibration procedure which follows shows a test equipment setup picture for each major setup change. Once

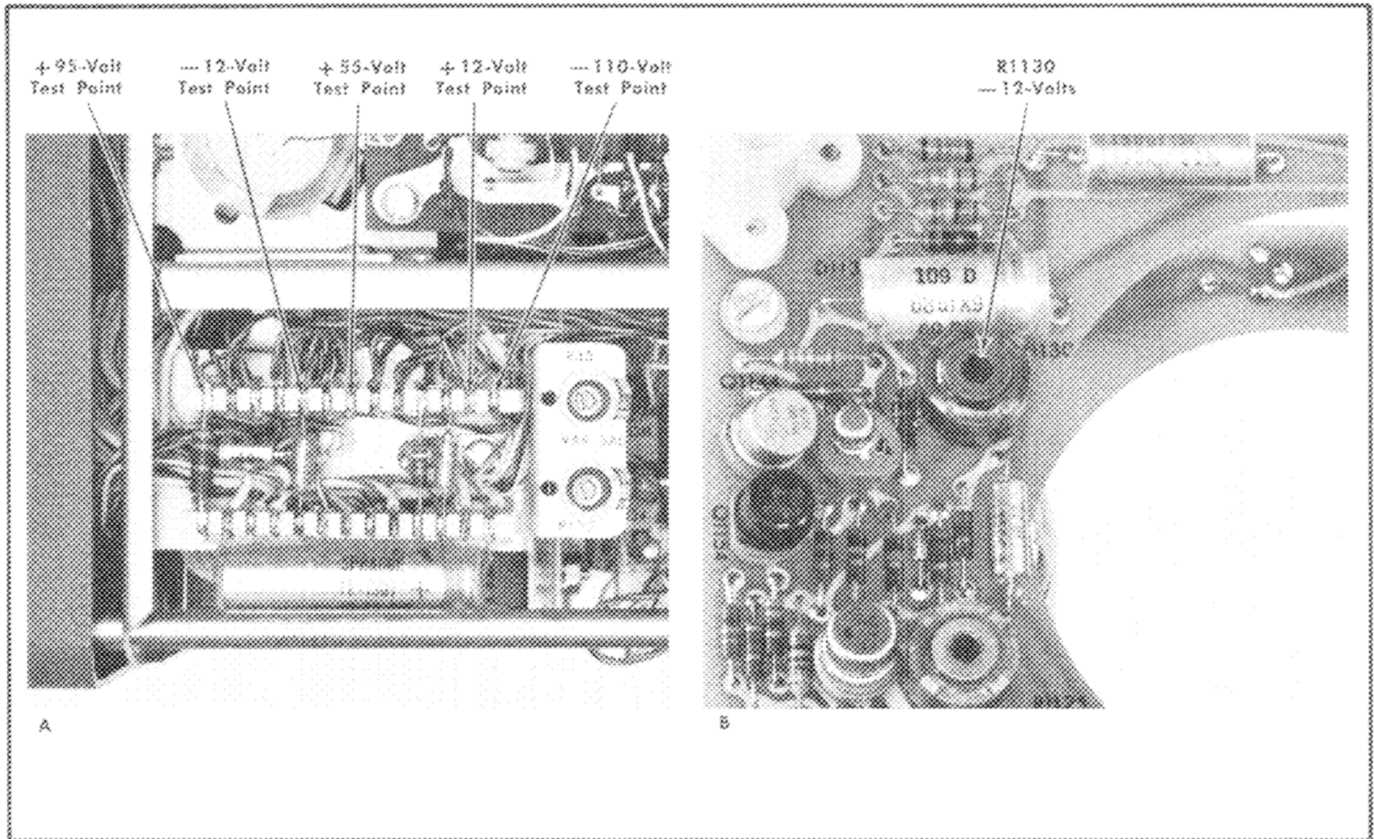

Fig. 6-2. (a) Location of power-supply test points (left side of indicator).
(b) Location of -12-volts adjustment (power supply).

the Type 422 Indicator controls indicated below are set to the positions described, it will not again be necessary to set any of the Type 422 Indicator controls.

Type 422 Indicator

Triggering controls

LEVEL	Adjust so sweep is not triggered.
SCALE ILLUM	Fully clockwise.

1. Adjust -12 Volt Supply

- Test equipment setup is shown in Fig. 6-1.
- Connect the dc voltmeter from the -12-volt test point Fig. 6-2a) to chassis ground.
- Check voltmeter reading for -12 volts $\pm 1\%$ (11.9 to 12.2 volts).
- Adjust R1130 (see Fig. 6-3b), if necessary, to obtain the voltmeter reading indicated in part (c) of this step.

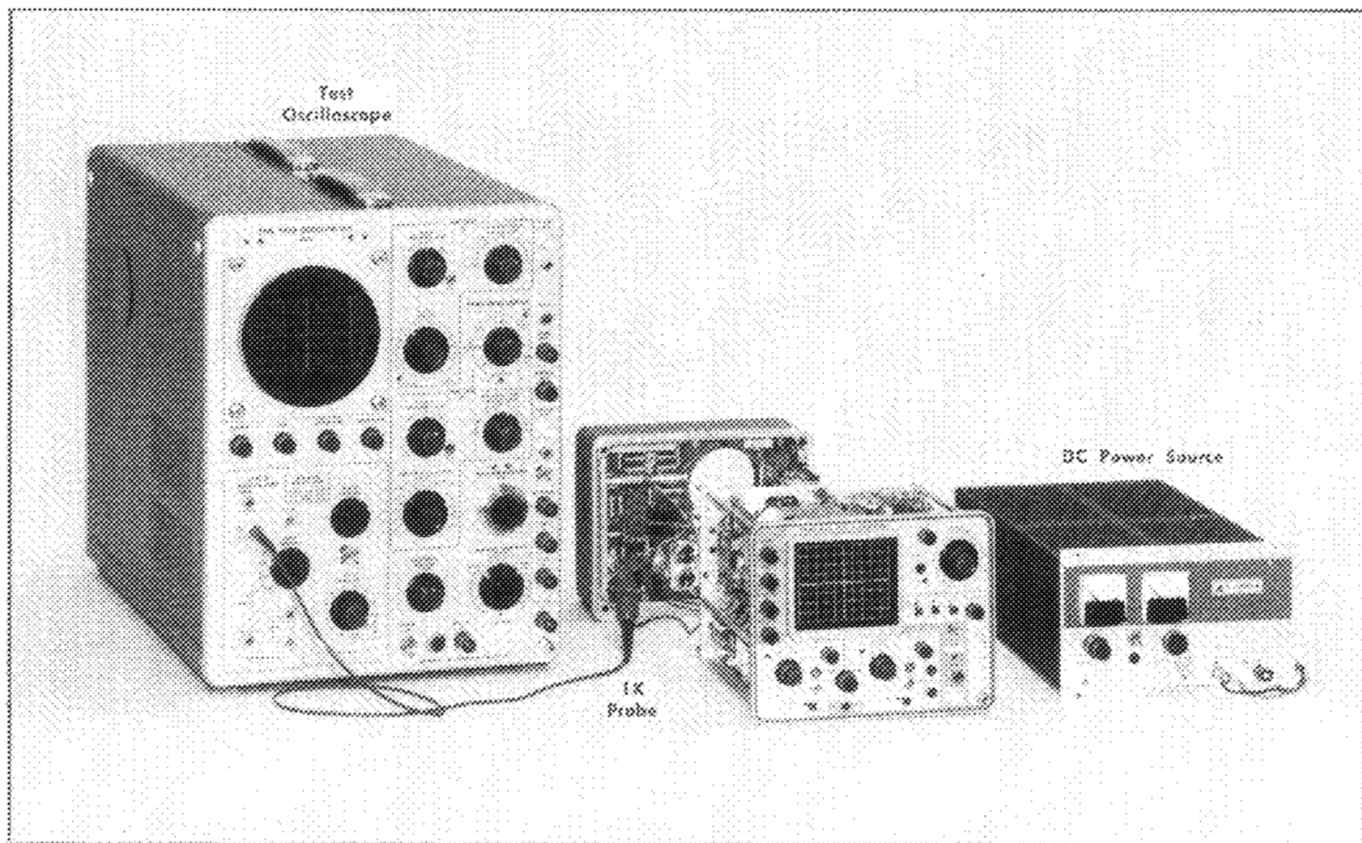

Fig. 6-3. Test equipment setup for Blocking Oscillator Frequency adjustment.

2. Adjust Blocking Oscillator Frequency

- a. Test equipment setup is shown in Fig. 6-3.
- b. Set the variable dc power source for an output voltage of exactly 11.5 volts.

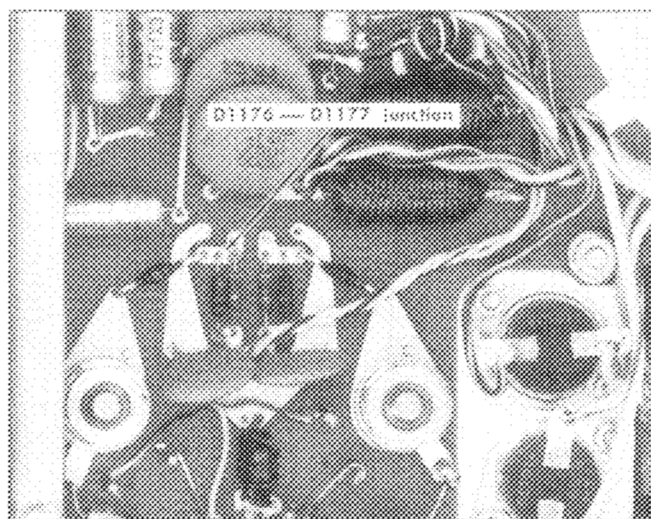

Fig. 6-4. (a) Power supply input voltage measuring test points. (b) Test oscilloscope probe connection.

- c. Connect a 1X probe from the test oscilloscope to the junction of D1176 and D1177 (see Fig. 6-4).
- d. Set the test oscilloscope Time/CM switch to 20 μ Sec, Volts/CM control to 20 and adjust the Triggering Level control for a stable display.
- e. Adjust OSC FREQ control to obtain a waveform similar to the waveform shown in Fig. 6-5.
- f. Recheck step 1 "Adjust -12 Volt Supply".

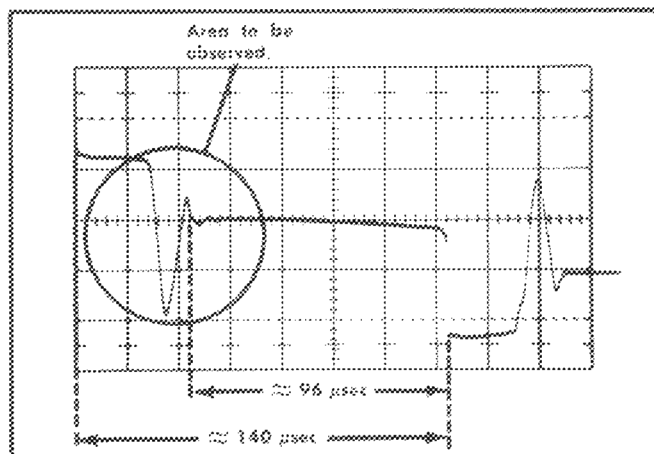

Fig. 6-5. Waveform obtained when OSC FREQ control is correctly adjusted. Oscilloscope controls for waveform were: Time/CM 20 μ Sec, Volts/CM 20.

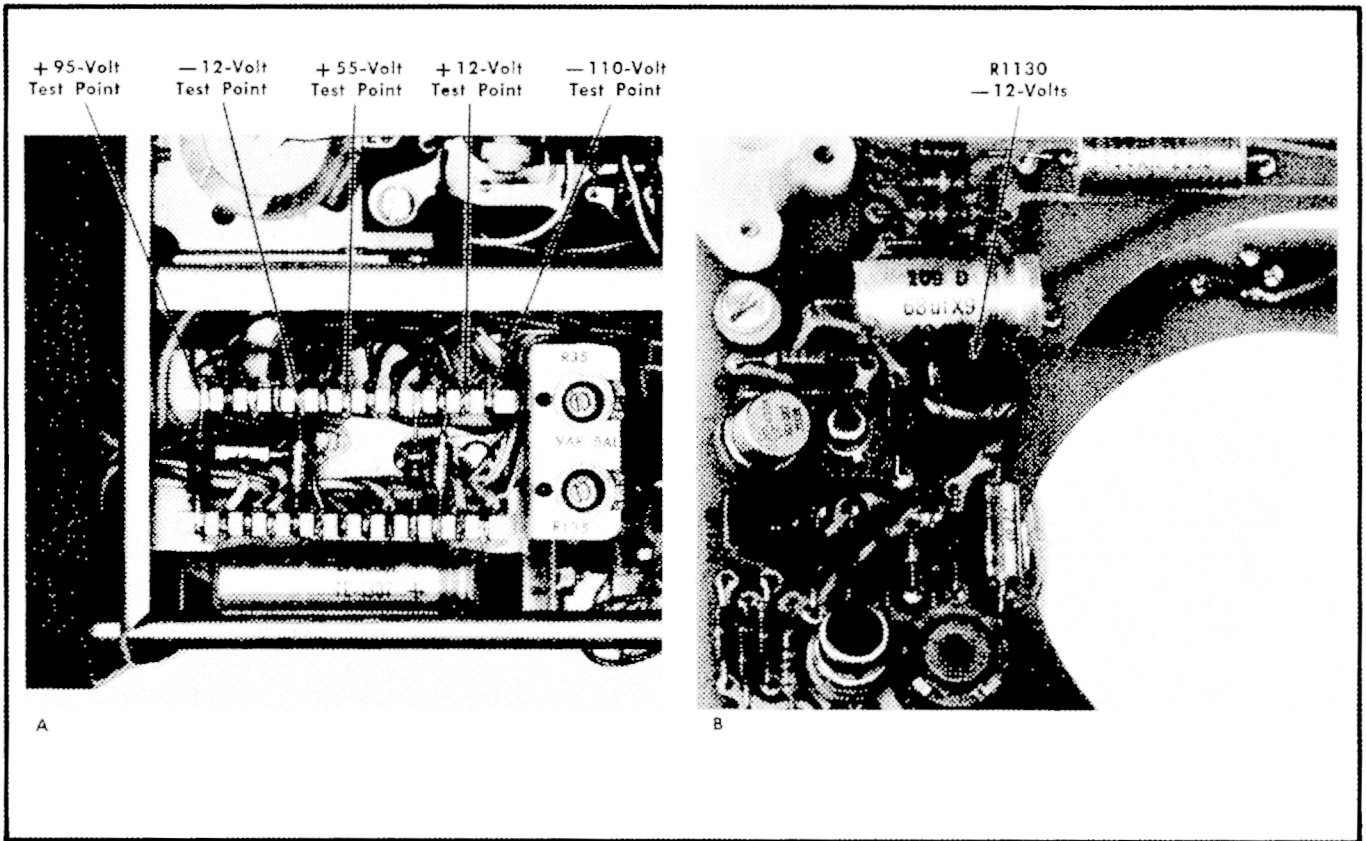

Fig. 6-2. (a) Location of power-supply test points (left side of indicator).
 (b) Location of -12-volts adjustment (power supply).

the Type 422 Indicator controls indicated below are set to the positions described, it will not again be necessary to set any of the Type 422 Indicator controls.

Type 422 Indicator

Triggering controls

- LEVEL Adjust so sweep is not triggered.
- SCALE ILLUM Fully clockwise.

1. Adjust -12 Volt Supply



- a. Test equipment setup is shown in Fig. 6-1.
- b. Connect the dc voltmeter from the -12-volt test point (Fig. 6-2a) to chassis ground.
- c. Check voltmeter reading for -12 volts $\pm 1\%$ (11.9 to 12.2 volts).
- d. Adjust R1130 (see Fig. 6-3b), if necessary, to obtain the voltmeter reading indicated in part (c) of this step.

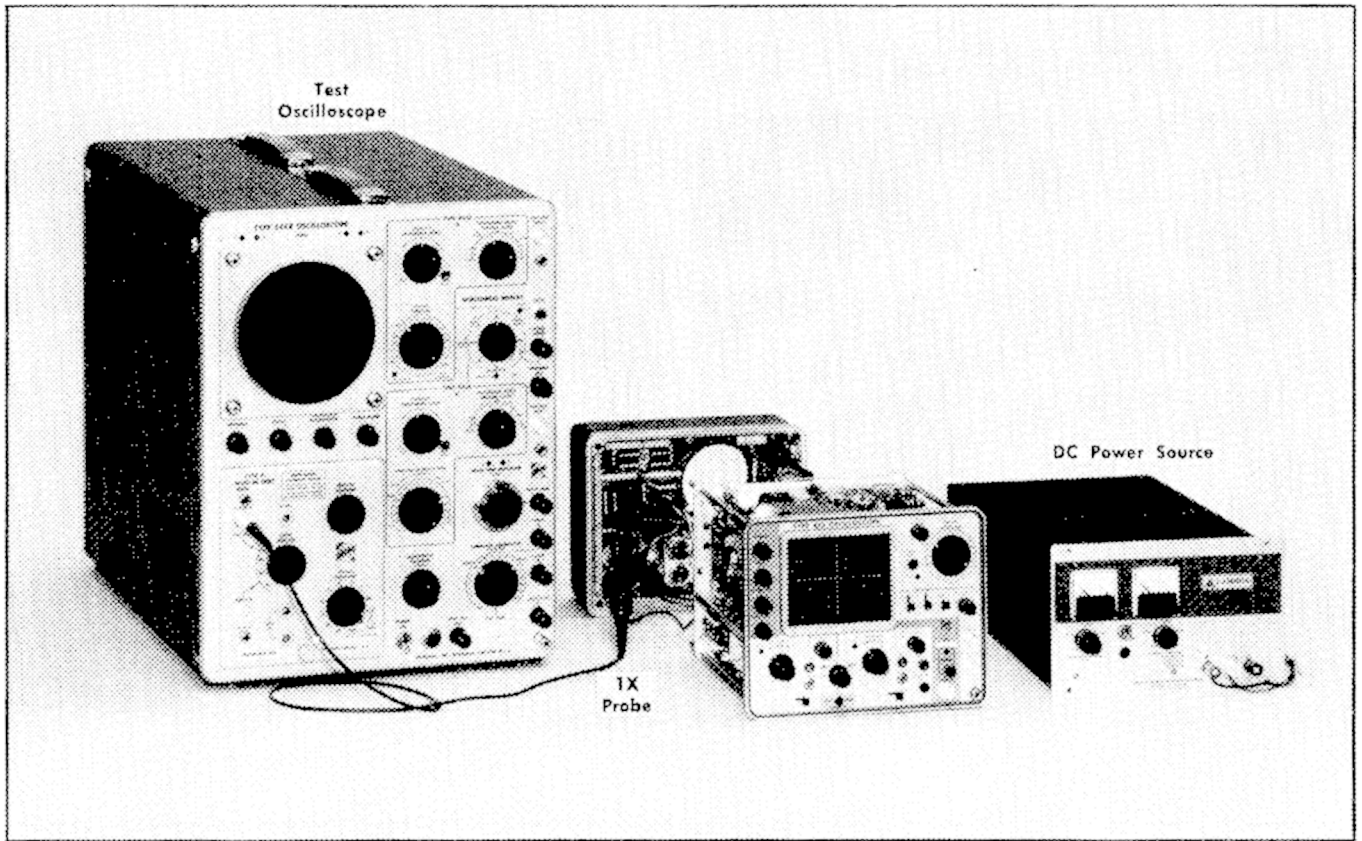

Fig. 6-3. Test equipment setup for Blocking Oscillator Frequency adjustment.

2. Adjust Blocking Oscillator Frequency ❶

- a. Test equipment setup is shown in Fig. 6-3.
- b. Set the variable dc power source for an output voltage of exactly 11.5 volts.



Fig. 6-4. (a) Power supply input voltage measuring test points.
(b) Test oscilloscope probe connection.

- c. Connect a 1X probe from the test oscilloscope to the junction of D1176 and D1177 (see Fig. 6-4).
- d. Set the test oscilloscope Time/CM switch to 20 μ Sec, Volts/CM control to 20 and adjust the Triggering Level control for a stable display.
- e. Adjust OSC FREQ control to obtain a waveform similar to the waveform shown in Fig. 6-5.
- f. Recheck step 1 "Adjust -12 Volt Supply".

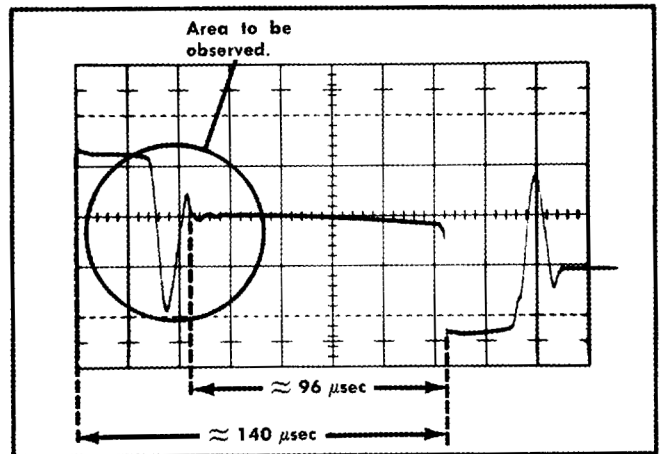

Fig. 6-5. Waveform obtained when OSC FREQ control is correctly adjusted. Oscilloscope controls for waveform were: Time/CM 20- μ Sec, Volts/CM 20.

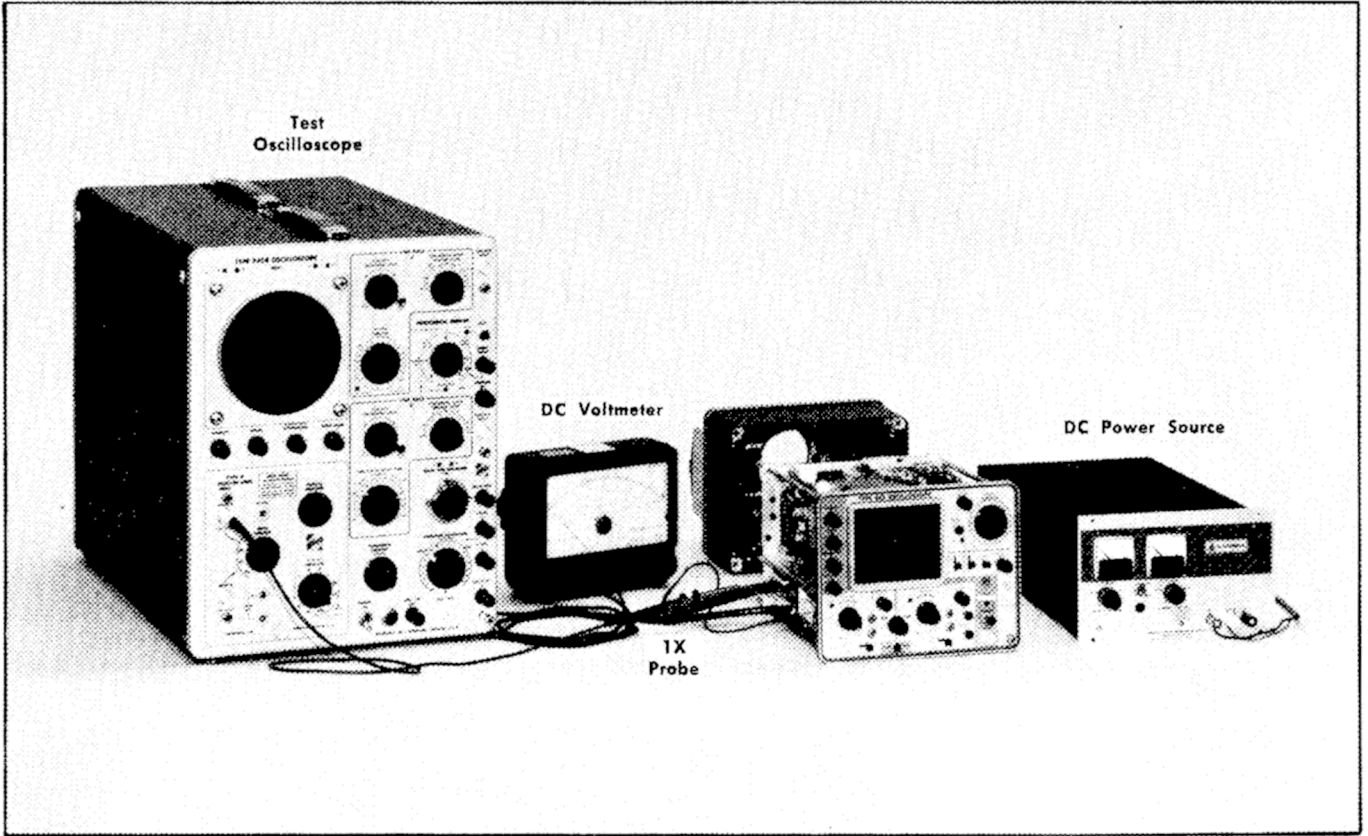

Fig. 6-6. Test equipment setup for checking dc power supply regulation and taking power supply ripple measurements.

3. Check DC Power Supply Operation Regulation and Ripple

- a. Test equipment setup is shown in Fig. 6-6.
- b. Set the variable dc power source for an output voltage of 11.5 volts.
- c. Connect a dc voltmeter to each of the test points shown in Fig. 6-2a and check for the correct voltage as shown in Table 6-1.

TABLE 6-1

Power Supply	Tolerance
-12 volt	±1% (11.9 to 12.2 volts)
-110 volt	±3% (106.7 to 113.3 volts)
+12 volt	±2% (11.8 to 12.3 volts)
+55 volt	±2% (53.9 to 56.1 volts)
+95 volt	±2% (93.1 to 96.9 volts)

d. Set the test oscilloscope Time/CM switch to 0.2 mSec, Volts/CM to 0.005 and vertical input coupling switch to ac.

e. Connect a 1X probe from the test oscilloscope to each of the test points shown in Fig. 6-2a and measure the amplitude of the 8 kc ripple on each supply voltage. Table 6-2 lists the maximum ripple amplitudes for each supply voltage.

TABLE 6-2

Power Supply	Maximum 8 kc Ripple Amplitude
-12 volt	20 millivolts
-110 volt	0.5 volt
+12 volt	20 millivolts
+55 volt	0.6 volt
+95 volt	0.8 volt

f. Set the variable dc power source for an output voltage of 22 volts and repeat parts c, d, and e of this step.

g. Set the variable dc power source for an output voltage of 35 volts and repeat parts c, d, and e of this step.

h. Turn off and disconnect the variable dc power source.

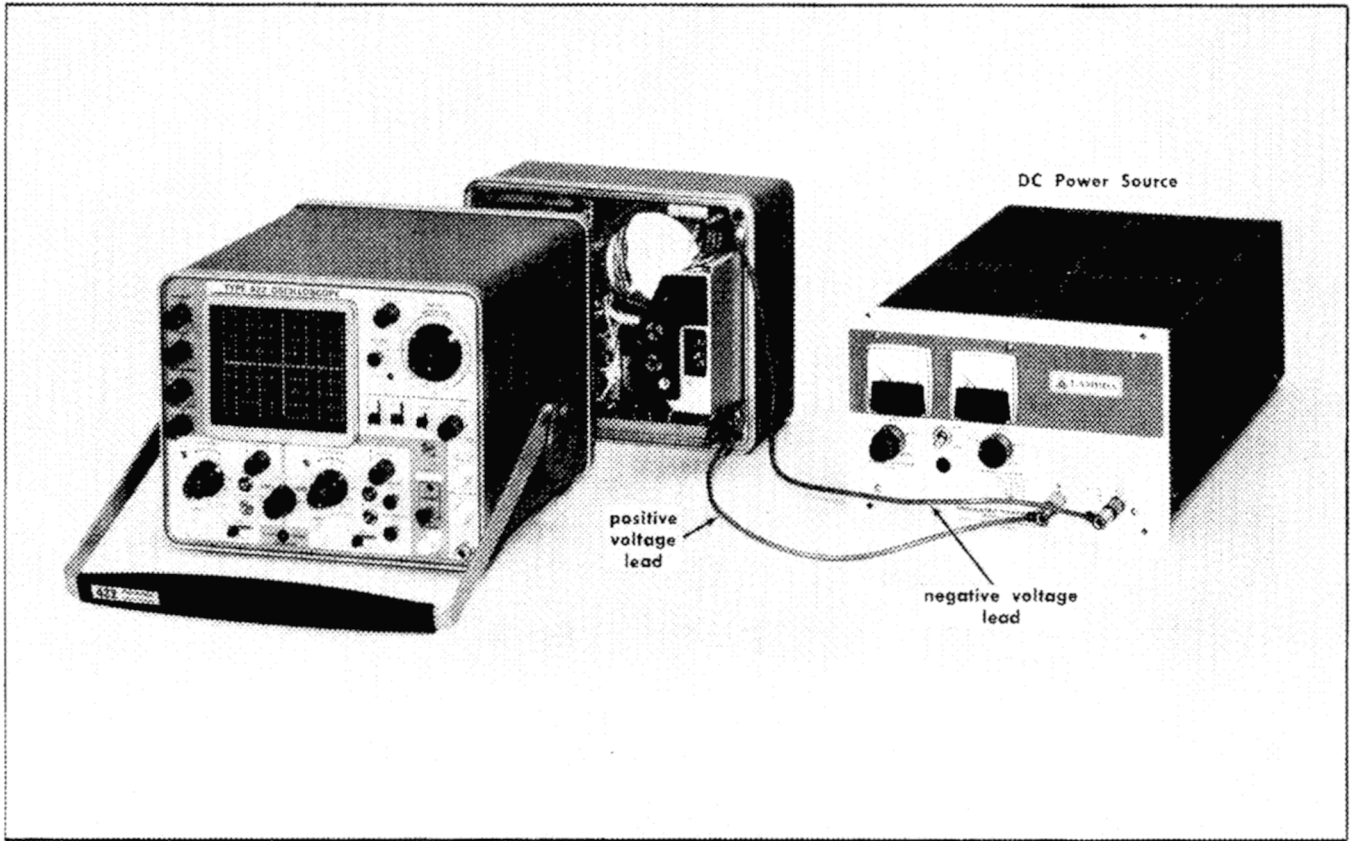

Fig. 6-7. Test equipment setup for Low-Voltage Indicator adjustment.

4. Adjust Low-Voltage Indicator



- a. Test equipment setup is shown in Fig. 6-7.
- b. Set POWER MODE switch to OPERATE INT BATT.
- c. Check that the negative output voltage lead from the variable dc power source is connected to the banana plug near the top of the power supply while the positive voltage lead from the variable dc power source is connected to the lower banana plug.
- d. Turn on the variable dc power source and adjust its output voltage for 35 volts.
- e. Turn the LOW VOLTAGE INDICATOR control, R1047, fully clockwise (see Fig. 6-8), then check the POWER Light on the Type 422 Indicator for a steady light.
- f. Slowly lower the variable dc power source voltage to 22 volts.
- g. Turn the LOW VOLTAGE INDICATOR control, R1047, counterclockwise until the POWER Light just starts blinking.
- h. Reset the variable dc power source output voltage to 35 volts and check for a steady light from the POWER Light.
- i. Slowly decrease the output voltage from the variable dc power source until the POWER Light starts blinking.

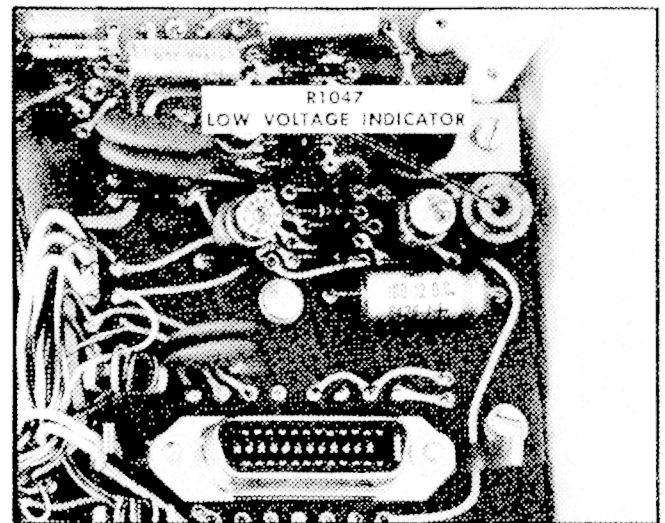

Fig. 6-8. Location of R1047 (LOW VOLTAGE INDICATOR) adjustment.

- j. Check the output voltage of the variable dc power source. It should be 22 volts.
- k. Turn off and disconnect the variable dc power source.

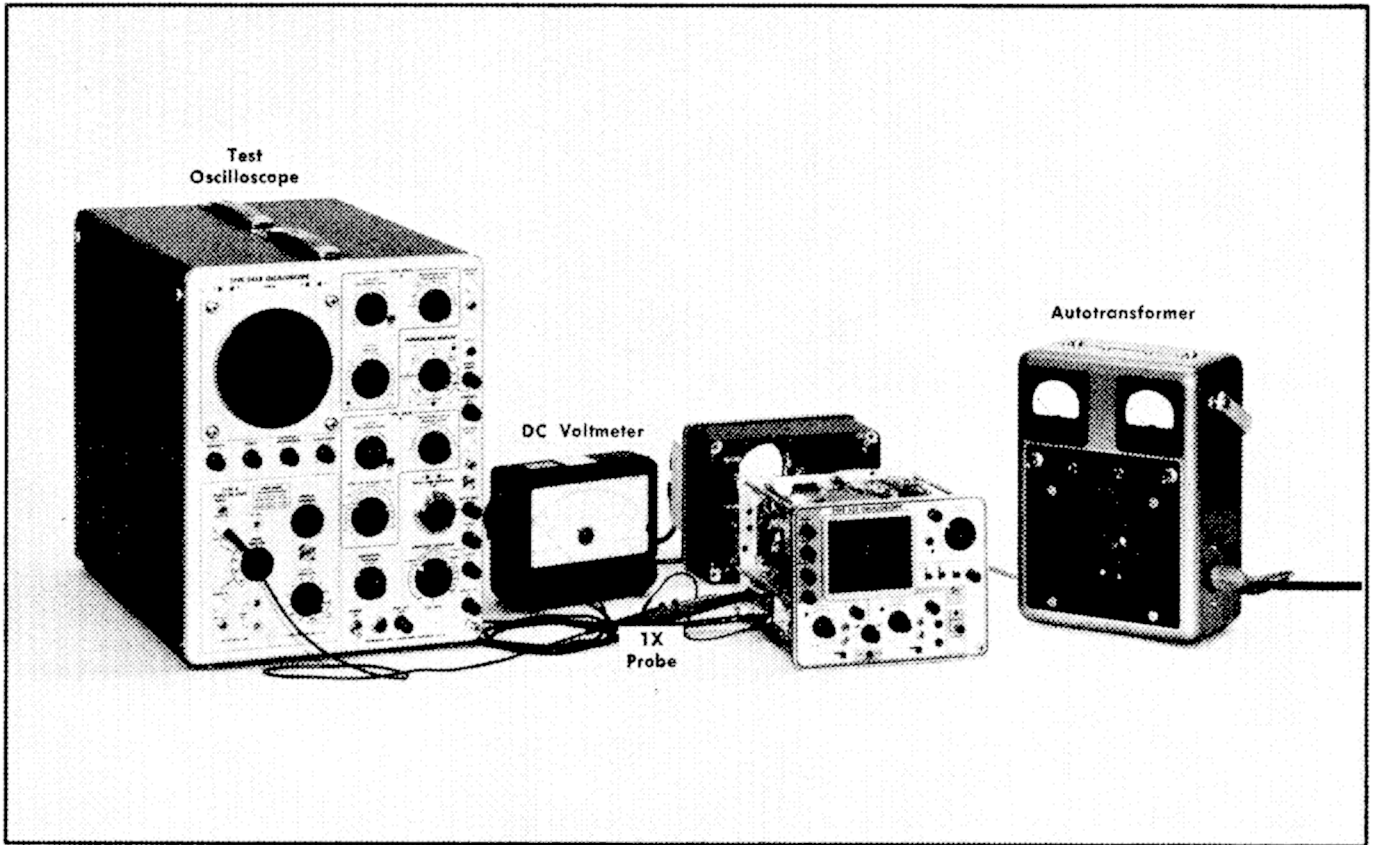

Fig. 6-9 Test equipment setup for checking ac power supply regulation and taking power supply ripple measurements.

5. Check AC Power Supply Operation Regulation and Ripple

- a. Test equipment setup is shown in Fig. 6-9.
- b. Turn the POWER MODE switch to OPERATE 115 V AC (OPERATE 230 V AC).
- c. Turn on the autotransformer and set it for an output voltage of 92 volts (184 volts).
- d. Connect a dc voltmeter to each of the test points shown in Fig. 6-2a and check for the correct voltage as shown in Table 6-1.
- e. Set the test oscilloscope Time/CM switch to 5 mSec to measure 120-cycle and 8-kc ripple.
- f. Set the test oscilloscope Volts/CM switch to 0.005 and the vertical input coupling switch to ac.
- g. Connect a 1X probe from the test oscilloscope to each of the test points shown in Fig. 6-2a and measure the ripple amplitudes for each supply voltage. Table 6-3 lists the maxi-

imum 8-kc and 120-cycle ripple amplitudes for each supply voltage.

TABLE 6-3

Power Supply	Maximum Ripple	
	8 kc	120 cycles
-12 volt	20 millivolts	5 millivolts
-110 volt	0.5 volt	
+12 volt	20 millivolts	5 millivolts
+55 volt	0.6 volt	
+95 volt	0.8 volt	

- h. Set the autotransformer for an output voltage of 115 volts (230 volts) and repeat parts d, e, and f of this step.
- i. Set the auto transformer for an output voltage of 138 volts (276 volts) and repeat parts d, e, and f of this step.
- j. Turn off the autotransformer.

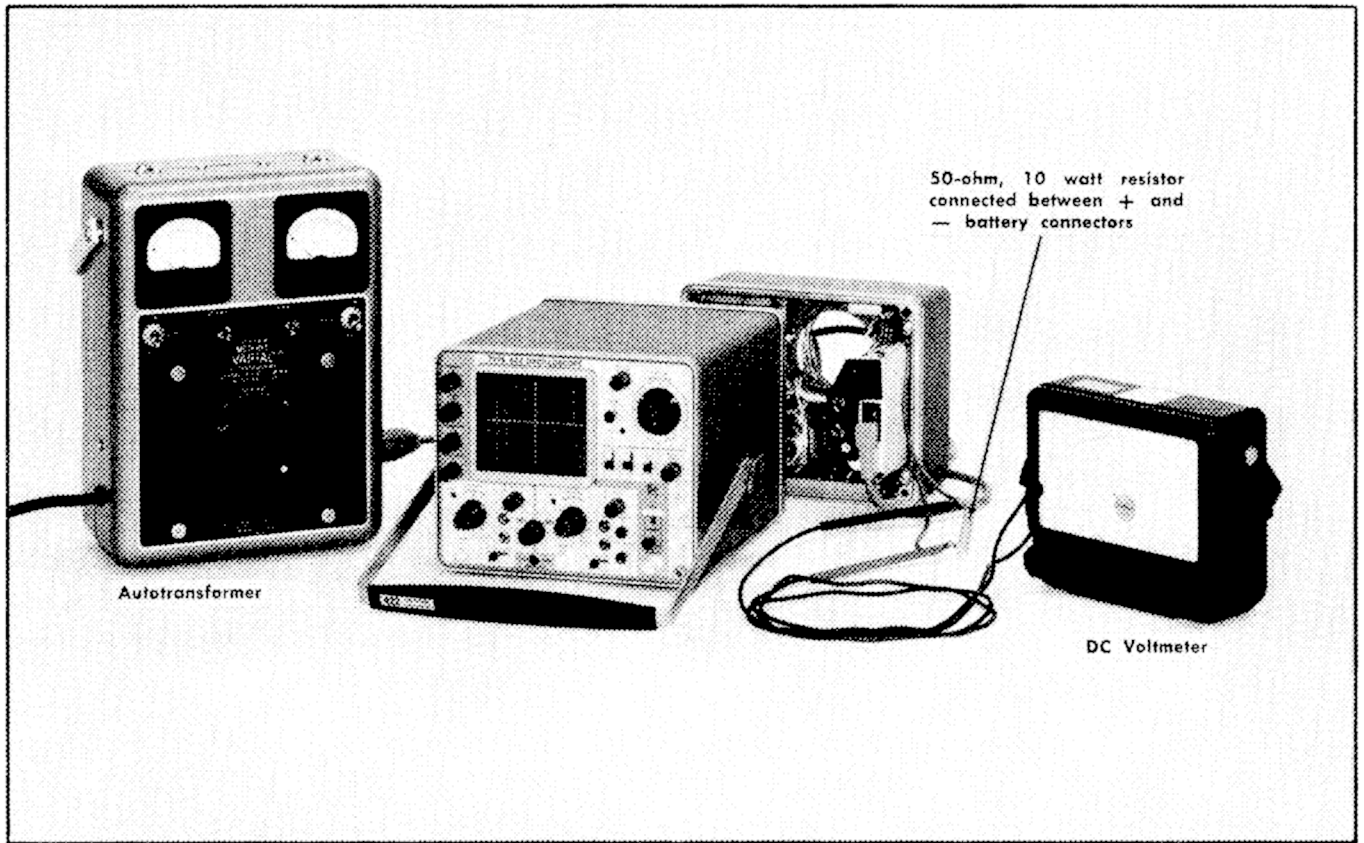

Fig. 6-10. Test equipment setup for checking Battery Charger current.

6. Check Battery Charger Circuit

- a. Test equipment setup is shown in Fig. 6-10.
- b. Set the POWER MODE switch to CHARGE BATT 115 V AC (CHARGE BATT 230 V AC).
- c. Turn on the autotransformer and set it for a 92-volt output.
- d. Check that the reading of the dc voltmeter is at least 16 volts.
- e. Turn off the autotransformer and allow the 50-ohm resistor to cool.
- f. Turn on the autotransformer and set it for a 126.5-volt output.
- g. Check that the reading of the dc voltmeter does not exceed 23 volts.
- h. Turn off the autotransformer and substitute a 680-ohm 2-watt resistor for the 50-ohm 10-watt resistor.
- i. Set the POWER MODE switch to OPERATE 115 V AC (OPERATE 230 V AC).
- j. Turn on the autotransformer and set it for a 92-volt output.
- k. Check the reading of the dc voltmeter for a reading of at least 20 volts.
- l. Set the autotransformer for an output voltage of 126.5 volts.
- m. Check the dc voltmeter for a reading of less than 34 volts.

This completes the calibration of the Type 422 AC-DC Power Supply. Disconnect all test equipment and reassemble the power supply. Replace the indicator cover and re-attach the power supply to the indicator.

SECTION 7

PARTS LIST AND DIAGRAMS

PARTS ORDERING INFORMATION

Replacement parts are available from or through your local Tektronix Field Office.

Changes to Tektronix instruments are sometimes made to accommodate improved components as they become available, and to give you the benefit of the latest circuit improvements developed in our engineering department. It is therefore important, when ordering parts, to include the following information in your order: Part number including any suffix, instrument type, serial number, and modification number if applicable.

If a part you have ordered has been replaced with a new or improved part, your local Tektronix Field Office will contact you concerning any change in part number.

ABBREVIATIONS AND SYMBOLS

a or amp	amperes	mm	millimeter
BHS	binding head steel	meg or M	megohms or mega (10 ⁶)
C	carbon	met.	metal
cer	ceramic	μ	micro, or 10 ⁻⁶
cm	centimeter	n	nano, or 10 ⁻⁹
comp	composition	Ω	ohm
cps	cycles per second	OD	outside diameter
crt	cathode-ray tube	OHS	oval head steel
CSK	counter sunk	p	pico, or 10 ⁻¹²
dia	diameter	PHS	pan head steel
div	division	piv	peak inverse voltage
EMC	electrolytic, metal cased	plstc	plastic
EMT	electrolytic, metal tubular	PMC	paper, metal cased
ext	external	poly	polystyrene
f	farad	Prec	precision
F & I	focus and intensity	PT	paper tubular
FHS	flat head steel	PTM	paper or plastic, tubular, molded
Fil HS	fillister head steel	RHS	round head steel
g or G	giga, or 10 ⁹	rms	root mean square
Ge	germanium	sec	second
GMV	guaranteed minimum value	Si	silicon
h	henry	S/N	serial number
hex	hexagonal	t or T	tera, or 10 ¹²
HHS	hex head steel	TD	toroid
HSS	hex socket steel	THS	truss head steel
HV	high voltage	tub.	tubular
ID	inside diameter	v or V	volt
incd	incandescent	Var	variable
int	internal	w	watt
k or K	kilohms or kilo (10 ³)	w/	with
kc	kilocycle	w/o	without
m	milli, or 10 ⁻³	WW	wire-wound
mc	megacycle		

SPECIAL NOTES AND SYMBOLS

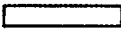
X000	Part first added at this serial number.
000X	Part removed after this serial number.
*000-000	Asterisk preceding Tektronix Part Number indicates manufactured by or for Tektronix, or reworked or checked components.
Use 000-000	Part number indicated is direct replacement.
	Internal screwdriver adjustment.
	Front-panel adjustment or connector.

EXPLODED VIEW

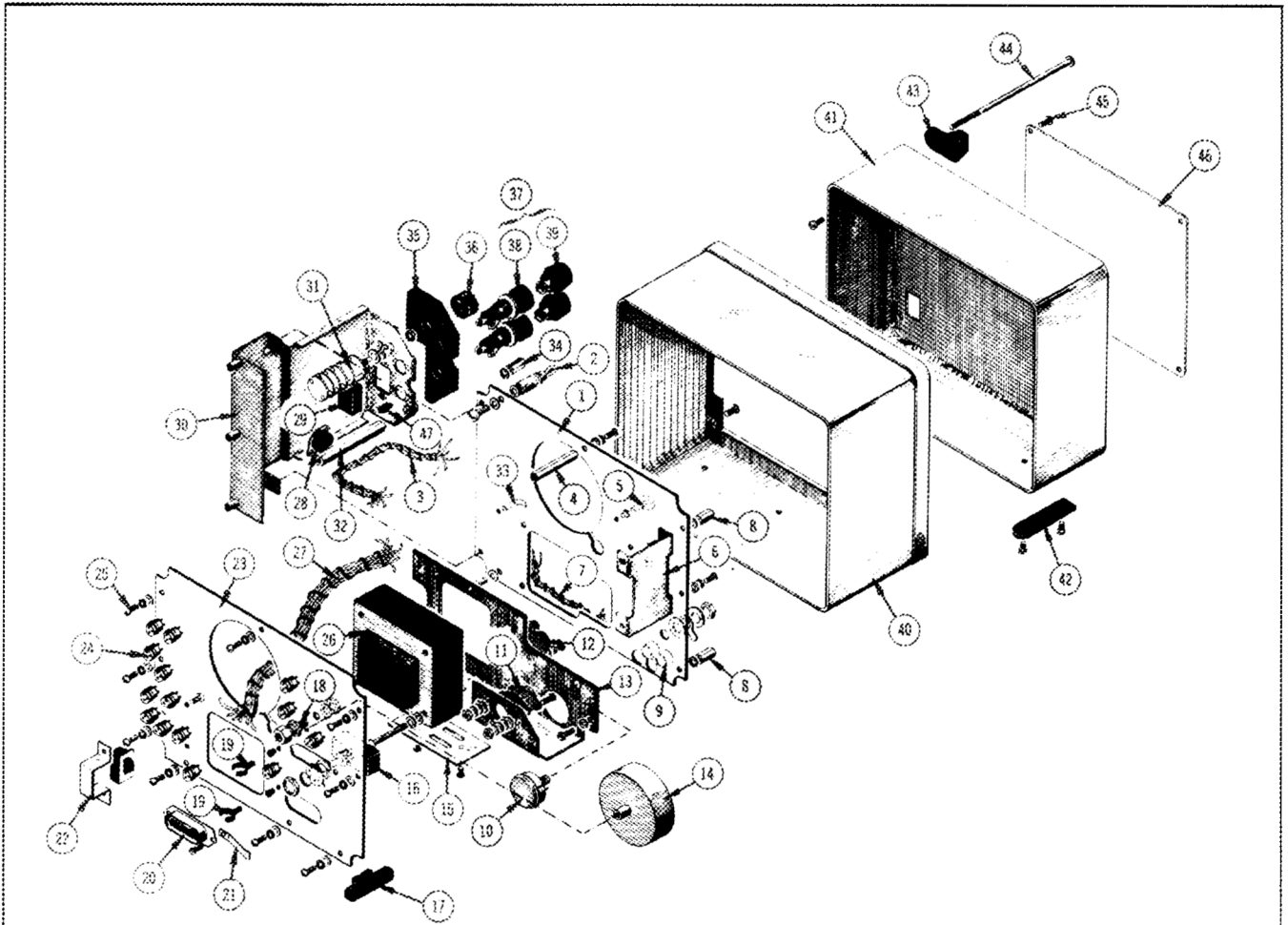

REF. NO.	PART NO.	SERIAL/MODEL NO.		QTY.	DESCRIPTION
		EFF.	DISC.		
1	670-0082-00			1	ASSEMBLY, DC POWER CONVERTER
	- - - - -			-	assembly includes:
	388-0623-00			1	BOARD, etched circuit, rear
2	134-0016-00			2	PLUG, banana, female
	- - - - -			-	mounting hardware for each: (not included w/plug alone)
	212-0570-00			1	SCREW, 10-32 x 5/8 inch PHS phillips
	210-1003-00	X2540		1	WASHER, flat
	210-0056-00	X2540		1	LOCKWASHER, #10 split
	210-1003-00			1	WASHER, flat
	361-0102-00			1	SPACER, tube
3	179-0978-00	100	3911	1	CABLE HARNESS, AC-DC
	179-0978-01	3912		1	CABLE HARNESS, AC-DC
	179-0977-00	X2550	3911	1	CABLE HARNESS, chassis (see ref. #27)
	179-0977-01	3912		1	CABLE HARNESS, chassis
4	385-0183-00			1	ROD, support
	- - - - -			-	mounting hardware: (not included w/rod alone)
	211-0097-00	100	579	1	SCREW, 4-40 x 5/16 inch PHS phillips
	211-0116-00	580		1	SCREW, sems, 4-40 x 5/16 inch PHB phillips
	210-0054-00	100	579X	1	LOCKWASHER, #4 split
	210-0994-00	100	579X	1	WASHER, .125 ID x .250 inch OD
5	462-0121-00			1	MOUNT, toroid
	- - - - -			-	mounting hardware: (not included w/mount alone)
	361-0007-00			1	SPACER, nylon, .063 inch

EXPLODED VIEW (Cont'd)

REF. NO.	PART NO.	SERIAL/MODEL NO.		QTY.	DESCRIPTION
		EFF.	DISC.		
6	407-0125-00			1	BRACKET, side
	- - - - -			-	mounting hardware: (not included w/bracket alone)
	211-0097-00	100	579	1	SCREW, 4-40 x 5/16 inch PHS phillips
	211-0116-00	580		1	SCREW, sems, 4-40 x 5/16 inch PHB phillips
	210-0054-00	100	579X	1	LOCKWASHER, #4 split
	210-0994-00	100	579X	1	WASHER, .125 ID x .250 inch OD
7	179-0979-00			1	CABLE HARNESS, transformer
8	384-0519-00			2	ROD, spacing
	- - - - -			-	mounting hardware for each (not included w/rod alone)
	213-0049-00			1	SCREW, 6-32 x 5/16 inch HHS
	210-0055-00			1	LOCKWASHER, #6 split
	210-0802-00			1	WASHER, 6S x 5/16 inch
9	354-0253-00			2	RING, capacitor mounting
10	- - - - -			2	TRANSISTOR
	- - - - -			-	mounting hardware for each: (not included w/transistor alone)
	210-0996-00			1	WASHER, shouldered, 3/4 OD x 5/16 inch ID
	210-0807-00	100	2539	1	WASHER, 5/16 ID x 5/8 inch OD
	210-0807-01	2540		1	WASHER, 5/16 ID x 5/8 inch OD
	210-0217-00			1	LUG, solder, 5/16 inch
	210-0057-00			1	LOCKWASHER, 5/16 inch split
	210-0524-00	100	2539	1	NUT, hex, 5/16-24 x 1/2 inch
	210-0524-01	2540		1	NUT, hex, 5/16-24 x 1/2 inch
11	- - - - -			1	TRANSISTOR
	- - - - -			-	mounting hardware: (not included w/transistor alone)
	386-0143-00			1	PLATE, mica insulator
	211-0507-00			2	SCREW, 6-32 x 5/16 inch PHS phillips
	210-0983-00			2	WASHER, shouldered, #6
	210-0261-00			1	LUG, solder, high voltage
	210-0802-00			1	WASHER, 6S x 5/16 inch
	210-0055-00			2	LOCKWASHER, #6 split
	210-0407-00			2	NUT, hex, 6-32 x 1/4 inch
12	260-0677-00			2	SWITCH, thermal cutout
	- - - - -			-	mounting hardware for each (not included w/switch alone)
	210-0054-00			2	LOCKWASHER, #4 split
	210-0406-00			2	NUT, hex, 4-40 x 3/16 inch
13	407-0124-00			1	BRACKET, heat sink
14	- - - - -			1	TRANSFORMER
	- - - - -			-	mounting hardware: (not included w/transformer
	213-0041-00	100	349	2	SCREW, thread cutting, 6-32 x 3/8 inch THS phillips
	211-0537-00	350		2	SCREW, 6-32 x 3/8 inch THS phillips
	210-0802-00			2	WASHER, 6S x 5/16 inch
	210-0055-00			2	LOCKWASHER, #6 split
15	386-0191-00			1	PLATE, support
	- - - - -			-	mounting hardware: (not included w/plate)
	211-0038-00			2	SCREW, 4-40 x 5/16 inch FHS phillips
16	260-0676-00			1	SWITCH, toggle—POWER
	- - - - -			-	mounting hardware: (not included w/switch)
	210-0414-00			1	NUT, hex, 15/32-32 x 9/16 inch
	354-0055-00			1	RING, locking, switch
	210-0473-00			1	NUT, switch, 15/32-32 x 5/64 inch, 12 sided

EXPLODED VIEW (Cont'd)

REF. NO.	PART NO.	SERIAL/MODEL NO.		QTY.	DESCRIPTION
		EFF.	DISC.		
17	351-0090-00 ----- 213-0034-00			4 - 2	GUIDE, corner, power supply - mounting hardware for each: (not included w/guide) SCREW, thread cutting, 4-40 x 5/16 inch PHS phillips
18	214-0289-00 ----- 210-0909-00 210-0010-00 210-0410-00	X3195		1 - 1 1 1	HEAT SINK, transistor - mounting hardware: (not included w/heat sink) WASHER, mica, 0.196 ID x 0.625 inch OD LOCKWASHER, internal, #10 NUT, hex., 10-32 x 5/16 inch
19	426-0121-00 ----- 361-0007-00			3 - 1	MOUNT, toroid - mounting hardware for each: (not included w/mount) SPACER, nylon, .063 inch
20	131-0346-00 ----- 211-0034-00 210-0864-00 210-0053-00 210-0405-00			1 - 2 2 2 2	CONNECTOR, 24 pin, female - mounting hardware: (not included w/connector) SCREW, 2-56 x 1/2 inch RHS phillips WASHER, 3/16 ID x 3/8 inch OD LOCKWASHER, #2 split NUT, hex, 2-56 x 3/16 inch
21	214-0566-00			2	SPRING, clip
22	407-0126-00 ----- 211-0504-00 210-0802-00 210-0055-00 210-0407-00			1 - 2 2 2 2	BRACKET, transformer mounting - mounting hardware: (not included w/bracket) SCREW, 6-32 x 1/4 inch PHS phillips WASHER, 6S x 5/16 inch LOCKWASHER, #6 split NUT, hex, 6-32 x 1/4 inch
23	670-0081-00 ----- 388-0624-00			1 - 1	ASSEMBLY, DC POWER CONTROL (see ref #25) - assembly includes: BOARD, etched circuit, front
24	136-0183-00			14	SOCKET, 3 pin transistor
25	----- 211-0097-00 211-0116-00 210-0994-00 210-0054-00	100 580 100 100	579 579X 579X	- 9 9 9 9	- mounting hardware: (not included w/assembly) SCREW, 4-40 x 5/16 inch PHS phillips SCREW, sems, 4-40 x 5/16 inch PHB phillips WASHER, .125 ID x .250 inch OD LOCKWASHER, #4 split
26	----- 211-0530-00 210-0802-00 210-0802-00 210-0983-00 210-0055-00 210-0407-00	100 3720	3719	1 - 2 8 4 4 4 4	TRANSFORMER - mounting hardware: (not included w/transformer) SCREW, 6-32 x 1 3/4 inches PHS phillips WASHER, 6S x 5/16 inch WASHER, 6S x 5/16 inch WASHER, shouldered, #6 LOCKWASHER, #6 split NUT, hex, 6-32 x 1/4 inch
27	179-0977-00	100	2549X	1	CABLE HARNESS, chassis (see ref. #3)
28	260-0678-00 ----- 210-0054-00 210-0406-00			1 - 2 2	SWITCH, thermal cutout - mounting hardware: (not included w/switch) LOCKWASHER, #4 split NUT, hex, 4-40 x 3/16 inch
29	131-0384-00 ----- 210-0054-00 210-0406-00			1 - 2 2	CONNECTOR, AC-DC - mounting hardware: (not included w/connector) LOCKWASHER, #4 split NUT, hex, 4-40 x 3/16 inch

EXPLODED VIEW (Cont'd)

REF. NO.	PART NO.	SERIAL/ MODEL NO.		QTY.	DESCRIPTION
		EFF.	DISC.		
30	407-0123-00			1	BRACKET, support
31	260-0679-00			1	SWITCH, unwired—POWER MODE
	-----			-	mounting hardware: (not included w/switch)
	210-0840-00			1	WASHER, .390 ID x $\frac{3}{16}$ inch OD
	210-0413-00			1	NUT, hex, $\frac{3}{8}$ -32 x $\frac{1}{2}$ inch
32	385-0185-00			1	ROD, support
	-----			-	mounting hardware: (not included w/rod)
	210-0056-00			1	LOCKWASHER, #10 split
	220-0434-00			1	NUT, hex, shouldered, .560 inch long
33	343-0089-00			1	CLAMP, cable, size "D"
34	384-0519-00			2	ROD, spacing
	-----			-	mounting hardware for each: (not included w/rod)
	213-0049-00			1	SCREW, 6-32 x $\frac{3}{16}$ inch HSS
	210-0055-00			1	LOCKWASHER, #6 split
	210-0802-00			1	WASHER, 6S x $\frac{3}{16}$ inch
35	214-0568-00			1	GASKET, switch bracket
36	366-0326-00			1	KNOB, small charcoal—POWER MODE
	-----			-	knob includes:
	213-0004-00			1	SCREW, set, 6-32 x $\frac{3}{16}$ inch HSS
37	352-0002-00			2	ASSEMBLY, fuse holder
	-----			-	assembly includes:
38	352-0010-00			1	HOLDER, fuse
	210-0873-00			1	WASHER, rubber, $\frac{1}{2}$ ID x $1\frac{1}{16}$ inch OD
	-----			-	NUT, fuse holder
39	200-0582-00			1	CAP, fuse
40	380-0079-00			1	HOUSING, power supply
	-----			-	mounting hardware: (not included w/housing)
	211-0507-00			4	SCREW, 6-32 x $\frac{3}{16}$ inch PHS phillips
	211-0565-00			3	SCREW, 6-32 x $\frac{1}{4}$ inch THS phillips
41	202-0138-00			1	BOX, battery, power supply
	-----			-	box includes:
42	348-0069-00			2	FOOT, bottom
	-----			-	mounting hardware for each: (not include w/foot alone)
	211-0501-00			2	SCREW, 6-32 x $\frac{1}{8}$ inch PHS phillips
43	348-0068-00			4	FOOT, rear
	-----			-	mounting hardware for each: (not included w/foot alone)
	213-0034-00			1	SCREW, thread cutting, 4-40 x $\frac{5}{16}$ inch RHS phillips
44	212-0572-00			4	SCREW, 10-32 x $5\frac{1}{2}$ inches RHS
45	211-0542-00			4	SCREW, 6-32 x $\frac{5}{16}$ inch THS phillips
	210-0803-00			4	WASHER, 6L x $\frac{3}{8}$ inch
	210-0457-00			4	NUT, keps, 6-32 x $\frac{5}{16}$ inch
46	334-0959-00			1	TAG, information
	-----			-	mounting hardware: (not included w/tag)
	211-0542-00			1	SCREW, 6-32 x $\frac{5}{16}$ inch THS phillips
47	210-0201-00			1	LUG, solder, SE4
	-----			-	mounting hardware (not included w/lug)
	210-0406-00			1	NUT, hex, 4-40 x $\frac{3}{16}$ inch

ACCESSORIES

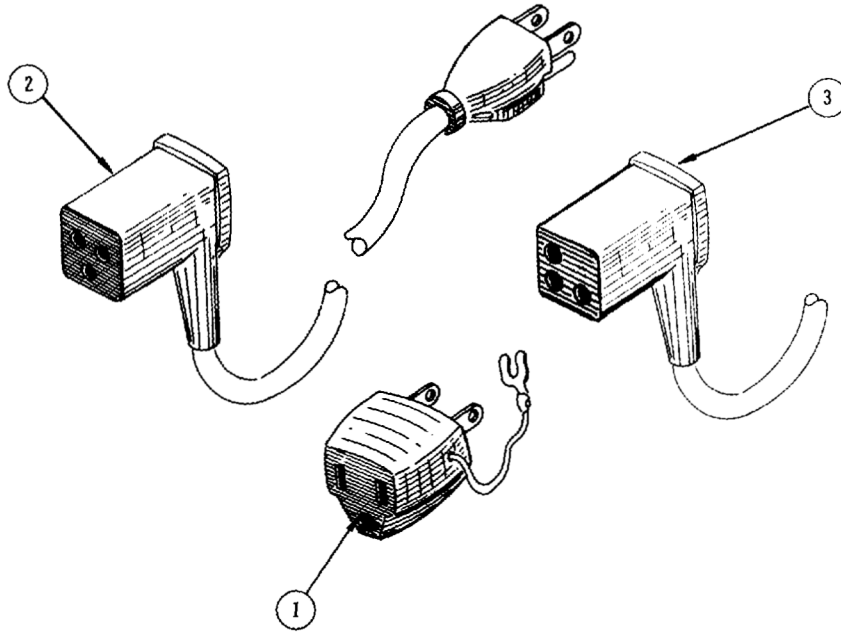

REF. NO.	PART NO.	SERIAL/MODEL NO.		QTY.	DESCRIPTION
		EFF.	DISC.		
	070-0471-01			2	MANUAL, instruction (not shown)
1	103-0013-00			1	ADAPTER, 3- to 2-wire
2	161-0015-01			1	CORD, power, AC
3	161-0016-01			1	CORD, power, DC

ELECTRICAL PARTS

Values are fixed unless marked Variable.

Ckt. No.	Tektronix Part No.		Description		S/N Range
Capacitors					
Tolerance $\pm 20\%$ unless otherwise indicated.					
C1000	283-0022-00	0.02 μf	Cer	1400 v	
C1001	285-0566-00	0.022 μf	PTM	200 v	10%
C1002	290-0259-00	100 μf	EMT	50 v	
C1003	Use 290-0300-00	1300 μf	Cer	40 v	+75%, -10%
C1004	Use 290-0300-00	1300 μf	Cer	40 v	+75%, -10%
C1010	283-0008-00	0.1 μf	Cer	500 v	
C1011	Use 283-0129-00	0.56 μf	Cer	100 v	
C1012	283-0008-00	0.1 μf	Cer	500 v	
C1041	290-0171-00	100 μf	EMT	12 v	
C1057	285-0623-00	0.47 μf	PTM	100 v	
C1106	290-0267-00	1 μf	EMT	35 v	
C1117	290-0134-00	22 μf	EMT	15 v	
C1120	290-0134-00	22 μf	EMT	15 v	
C1121	285-0686-00	0.068 μf	PTM	100 v	10%
C1133	290-0273-00	68 μf	EMT	60 v	10%
C1170	283-0111-00	0.1 μf	Cer	50 v	X2831-up
C1171	290-0274-00	80 μf	EMT	50 v	+75%, -10%
C1172	290-0274-00	80 μf	EMT	50 v	+75%, -10%
C1173	283-0008-00	0.1 μf	Cer	500 v	
C1177	283-0013-00	0.01 μf	Cer	1000 v	
C1181	283-0008-00	0.1 μf	Cer	500 v	
C1183	283-0008-00	0.1 μf	Cer	500 v	
C1187	283-0013-00	0.01 μf	Cer	1000 v	
C1195	290-0134-00	22 μf	EMT	15 v	
C1199	290-0248-01	150 μf	EMT	15 v	
C1202	290-0272-00	47 μf	EMT	50 v	
C1203	283-0013-00	0.01 μf	Cer	1000 v	
C1204	290-0273-00	68 μf	EMT	60 v	10%
C1205	283-0013-00	0.01 μf	Cer	1000 v	
C1210	290-0248-01	150 μf	EMT	15 v	
C1211	290-0248-01	150 μf	EMT	15 v	
C1212	290-0248-01	150 μf	EMT	15 v	
C1213	290-0266-00	290 μf	EMT	15 v	
C1214	290-0248-01	150 μf	EMT	15 v	
C1216	290-0248-01	150 μf	EMT	15 v	
C1217	290-0248-01	150 μf	EMT	15 v	
C1218	290-0248-01	150 μf	EMT	15 v	
C1219	290-0266-00	290 μf	EMT	15 v	
C1224	290-0270-00	8.2 μf	EMT	60 v	
C1225	290-0271-00	9 μf	EMT	125 v	+20%, -15%
C1226	283-0013-00	0.01 μf	Cer	1000 v	
C1231	283-0008-00	0.1 μf	Cer	500 v	

Capacitors (Cont'd)

Ckt. No.	Tektronix Part No.		Description		S/N Range
C1232	290-0187-00	4.7 μ f	EMT	35 v	
C1233	290-0187-00	4.7 μ f	EMT	35 v	
C1242	283-0008-00	0.1 μ f	Cer	500 v	
C1245	290-0248-01	150 μ f	EMT	15 v	
C1246	290-0248-01	150 μ f	EMT	15 v	

Diodes

D1002	152-0198-00	Silicon	MR 1032A	200 v, 3 Amp	(Motorola)
D1003	152-0198-00	Silicon	MR 1032A	200 v, 3 Amp	(Motorola)
D1004	152-0198-00	Silicon	MR 1032A	200 v, 3 Amp	(Motorola)
D1005	152-0198-00	Silicon	MR 1032A	200 v, 3 Amp	(Motorola)
D1014	152-0198-00	Silicon	MR 1032A	200 v, 3 Amp	(Motorola)
D1016	152-0198-00	Silicon	MR 1032A	200 v, 3 Amp	(Motorola)
D1022	152-0127-00	Zener	1N7552	0.4 w, 7.5 v	5%
D1041	152-0055-00	Zener	1N962A	0.4 w, 11 v	5%
D1042	*152-0061-00	Silicon	Tek Spec		
D1054	*152-0061-00	Silicon	Tek Spec		
D1055	*152-0061-00	Silicon	Tek Spec		
D1057	*152-0061-00	Silicon	Tek Spec		
D1104	*152-0061-00	Silicon	Tek Spec		
D1105	*152-0061-00	Silicon	Tek Spec		
D1106	*152-0061-00	Silicon	Tek Spec		
D1114	*152-0061-00	Silicon	Tek Spec		
D1115	*152-0061-00	Silicon	Tek Spec		
D1116	*152-0061-00	Silicon	Tek Spec		
D1117	*152-0061-00	Silicon	Tek Spec		
D1118	*152-0061-00	Silicon	Tek Spec		
D1120	*152-0061-00	Silicon	Tek Spec		
D1132	*152-0061-00	Silicon	Tek Spec		
D1135	152-0123-00	Zener	1N935A	0.4 w, 9.1 v	5% T. C.
D1155	152-0169-00	Tunnel	1N3712	1 MA	
D1174	152-0101-00	Zener	1N3041B	1 w, 75 v	5%
D1176	152-0180-00	Silicon	Fast switching UTR 1112		(Unitrode)
D1177	*152-0061-00	Silicon	Tek Spec		
D1184	152-0101-00	Zener	1N3041B	1 w, 75 v	5%
D1186	152-0180-00	Silicon	Fast switching UTR 1112		(Unitrode)
D1187	*152-0061-00	Silicon	Tek Spec		
D1189	*152-0061-00	Silicon	Tek Spec		
D1191	*152-0061-00	Silicon	Tek Spec		
D1192	152-0127-00	Zener	1N755A	0.4 w, 7.5 v	5%
D1202	152-0224-00	Silicon	UTR 166		(Unitrode)
D1203	*152-0061-00	Silicon	Tek Spec		

Diodes (Cont'd)

Ckt. No.	Tektronix Part No.		Description	S/N Range
D1212	152-0179-00	Silicon	Fast switching UTR 02	(Unitrode)
D1213	152-0179-00	Silicon	Fast switching UTR 02	(Unitrode)
D1214	*152-0061-00	Silicon	Tek Spec	
D1215	*152-0061-00	Silicon	Tek Spec	
D1216	152-0179-00	Silicon	Fast switching UTR 02	(Unitrode)
D1217	152-0179-00	Silicon	Fast switching UTR 02	(Unitrode)
D1222	*152-0061-00	Silicon	Tek Spec	
D1223	152-0224-00	Silicon	UTR 166	(Unitrode)
D1224	*152-0061-00	Silicon	Tek Spec	
D1225	*152-0061-00	Silicon	Tek Spec	
D1232	*152-0061-00	Silicon	Tek Spec	
D1233	*152-0061-00	Silicon	Tek Spec	
D1242	*152-0061-00	Silicon	Tek Spec	
D1243	*152-0061-00	Silicon	Tek Spec	
D1244	*152-0061-00	Silicon	Tek Spec	
D1245	*152-0061-00	Silicon	Tek Spec	

Fuses

F1000	159-0042-00	3/4 Amp	3AG	Fast-Blo	115 v-230 v operation
F1014	159-0015-00	3 Amp	3AG	Fast-Blo	11.5 v-35 v operation (internal battery)

Inductors

L1172	*108-0337-00	25 μ h
L1182	*108-0337-00	25 μ h
L1189	*120-0395-00	Toroid, 3 turns single
L1204	276-0525-00	Core, Ferrite
L1212	*108-0336-00	100 μ h
L1213	276-0525-00	Core, Ferrite
L1217	*108-0336-00	100 μ h
L1219	276-0525-00	Core, Ferrite
L1246	*120-0415-00	Toroid, 8 turns single

Connectors

P1000	131-0384-00	AC/DC Power
J1201	131-0346-00	Chassis mtd., 24 pin, female

Transistors

Q1023	*151-0136-00	Replaceable by 2N3053
Q1033	*151-0148-00	Selected (RCA 40250)
Q1045	*151-0087-00	Selected from 2N1131
Q1055	*151-0096-00	Selected from 2N1893
Q1104	*151-0087-00	Selected from 2N1131

Parts List—422 AC-DC

Transistors (Cont'd)

Ckt. No.	Tektronix Part No.	Description	S/N Range
Q1105	*151-0103-00	Replaceable by 2N2219	
Q1114	*151-0087-00	Selected from 2N1131	
Q1115	*151-0103-00	Replaceable by 2N2219	
Q1120	*151-0103-00	Replaceable by 2N2219	
Q1134	*151-0133-00	Selected from 2N3251	
Q1144	*151-0087-00	Selected from 2N1131	
Q1154	Use *153-0539-00	Selected from 2N2219	
Q1163	*151-0087-00	Selected from 2N1131	
Q1164	*151-0103-00	Replaceable by 2N2219	
Q1174	*151-0163-00	Selected from 2N1899	
Q1184	*151-0163-00	Selected from 2N1899	
Q1193	*151-0103-00	Replaceable by 2N2219	
Q1194	*151-0087-00	Selected from 2N1131	

Resistors

Resistors are fixed, composition, $\pm 10\%$ unless otherwise indicated.

R1022	301-0362-00	3.6 k	1/2 w		5%
R1023	315-0302-00	3 k	1/4 w		5%
R1031	315-0181-00	180 Ω	1/4 w		5%
R1033	308-0166-00	16 Ω	5 w	WW	5%
R1034	308-0166-00	16 Ω	5 w	WW	5%
R1041	315-0682-00	6.8 k	1/4 w		5%
R1043	315-0393-00	39 k	1/4 w		5%
R1044	315-0822-00	8.2 k	1/4 w		5%
R1046	315-0113-00	11 k	1/4 w		5%
R1047	311-0496-00	2.5 k		Var	
R1048	315-0822-00	8.2 k	1/4 w		5%
R1054	315-0822-00	8.2 k	1/4 w		5%
R1057	315-0104-00	100 k	1/4 w		5%
R1059	315-0105-00	1 meg	1/4 w		5%
R1103	315-0471-00	470 Ω	1/4 w		5%
R1106	315-0220-00	22 Ω	1/4 w		5%
R1113	315-0471-00	470 Ω	1/4 w		5%
R1116	315-0220-00	22 Ω	1/4 w		5%
R1117	315-0182-00	1.8 k	1/4 w		5%
R1118	315-0821-00	820 Ω	1/4 w		5%
R1120	315-0100-00	10 Ω	1/4 w		5%
R1123	321-0193-00	1 k	1/8 w	Prec	1%
R1124	315-0332-00	3.3 k	1/4 w		5%
R1125	311-0510-00	10 k		Var	
R1130	311-0496-00	2.5 k		Var	
R1131	321-0235-00	2.74 k	1/8 w	Prec	1%

X2831-up

Resistors (Cont'd)

Ckt. No.	Tektronix Part No.		Description		S/N Range
R1132	321-0314-00	18.2 k	1/8 w	Prec	1%
R1133	321-0330-00	26.7 k	1/8 w	Prec	1%
R1134	315-0103-00	10 k	1/4 w		5%
R1135	321-0139-00	274 Ω	1/8 w	Prec	1%
R1136	315-0330-00	33 Ω	1/4 w		5%
R1143	315-0471-00	470 Ω	1/4 w		5%
R1144	315-0103-00	10 k	1/4 w		5%
R1153	315-0470-00	47 Ω	1/4 w		5%
R1154	315-0272-00	2.7 k	1/4 w		5%
R1161	315-0752-00	7.5 k	1/4 w		5%
R1162	315-0471-00	470 Ω	1/4 w		5%
R1163	315-0123-00	12 k	1/4 w		5%
R1164	315-0223-00	22 k	1/4 w		5%
R1165	307-0103-00	2.7 Ω	1/4 w		5%
R1172	315-0470-00	47 Ω	1/4 w		5%
R1177	315-0471-00	470 Ω	1/4 w		5%
R1182	315-0470-00	47 Ω	1/4 w		5%
R1187	315-0471-00	470 Ω	1/4 w		5%
R1191	315-0432-00	4.3 k	1/4 w		5%
R1192	315-0101-00	100 Ω	1/4 w		5%
R1193	315-0222-00	2.2 k	1/4 w		5%
R1194	315-0330-00	33 Ω	1/4 w		5%
R1232	309-0060-00	4 Ω	1/2 w	Prec	1%

Switches

	Unwired	Wired	
SW1001	260-0676-00		Toggle POWER
SW1030	260-0679-00		Rotary POWER MODE

Thermal Cutouts

TK1000	260-0677-00	158° F
TK1033	260-0678-00	105° F
TK1039	260-0677-00	158° F

Transformers

T1000	*120-0397-00	Toroid, 10 turns bifilar
T1001	*120-0392-00	Power
T1010	*120-0397-00	Toroid, 10 turns bifilar
T1120	*120-0396-00	Toroid, 6 turns trifilar
T1171	*120-0393-00	Driver
T1201	*120-0394-00	Toroid, Pre-Regulator

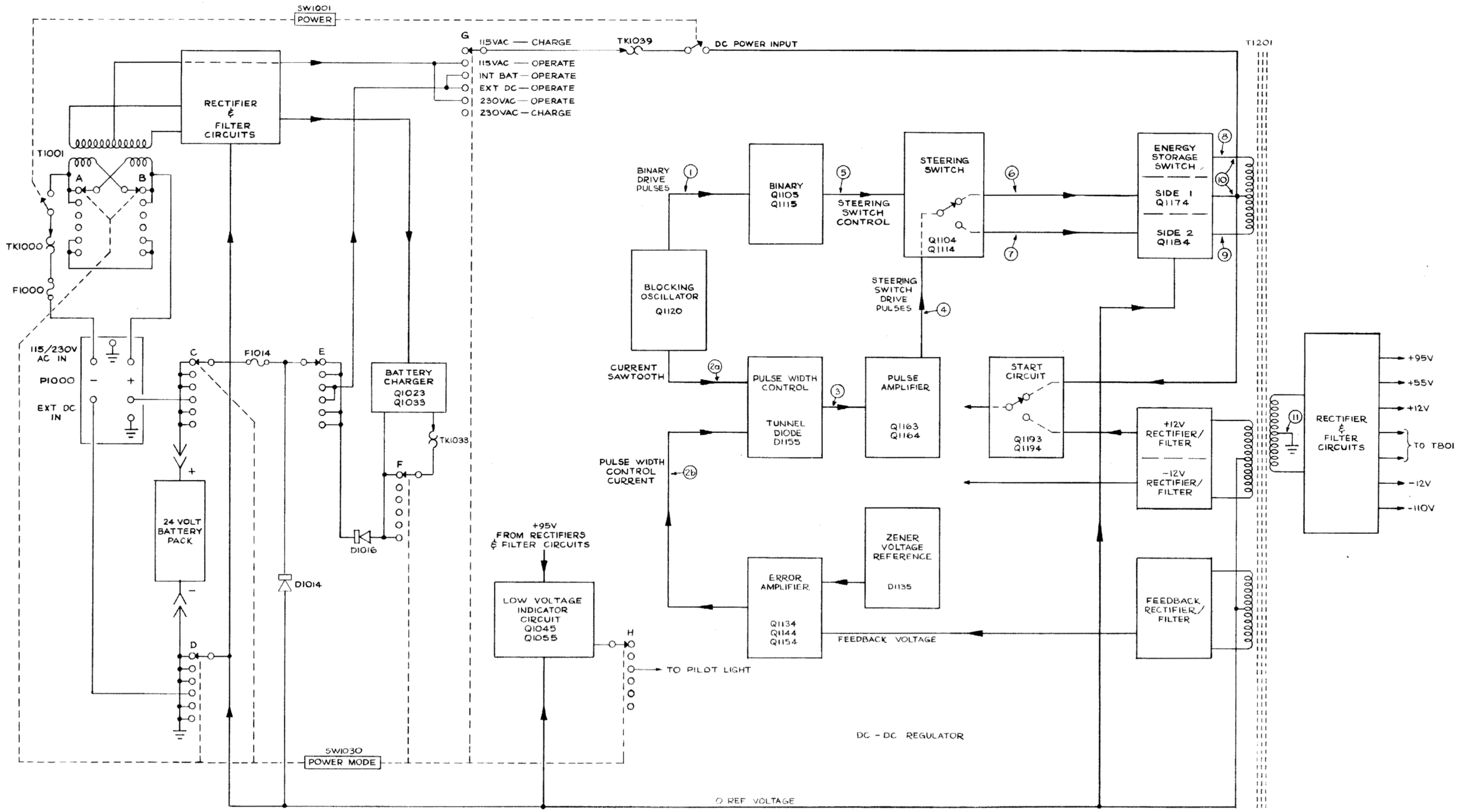

SW1001
POWER

- G 115VAC — CHARGE
- 115VAC — OPERATE
- INT BAT — OPERATE
- EXT DC — OPERATE
- 230VAC — OPERATE
- 230VAC — CHARGE

REF VOLTAGE

AC-DC SELECTOR

+95V FROM RECTIFIERS & FILTER CIRCUITS

TO PILOT LIGHT

DC-DC REGULATOR

- +95V
- +55V
- +12V
- TO T801
- 12V
- 110V

IMPORTANT

VOLTAGE AND WAVEFORM CONDITIONS

Circuit voltages measured with 20,000 Ω /volt VOM. All readings in volts.

Waveforms shown are actual waveform photographs taken with a Tektronix Oscilloscope Camera System and Projected Graticule. Test oscilloscope was dc coupled (except where noted) using a 10X probe.

Voltage and waveform measurements given on the schematics are not absolute and may vary between instruments. Apparent differences between voltage levels measured with the voltmeter and those shown on the waveform are due to circuit loading.

Voltages and waveforms are indicated on the schematics in blue.

Voltage readings and waveforms were obtained under the following conditions using a calibrated Type 422 Indicator.

AC-DC Power Supply

1. Power supply remotely connected to indicator.
2. Battery Pack connected to power supply for Battery Charger voltages only.
3. Power switch ON.
4. POWER MODE switch set to OPERATE 115 V AC.
5. Input power—115-volts ac, 60 cycle.

Type 422 Indicator

1. SCALE ILLUM control set fully clockwise.
2. LEVEL control adjusted so sweep is not triggered.
3. Remaining controls set as desired.

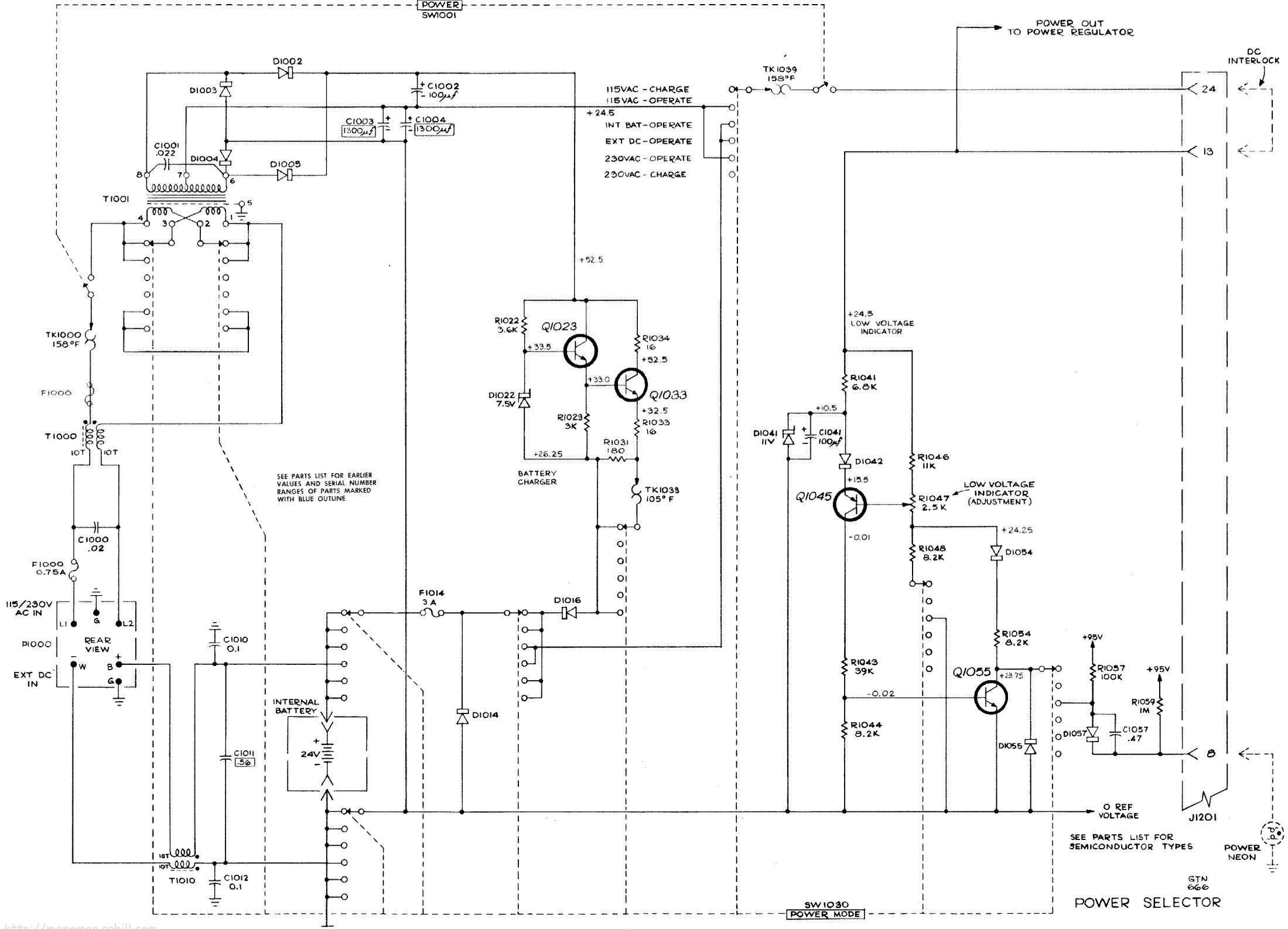

TYPE 422 AC-DC POWER SUPPLY

POWER IN FROM POWER SELECTOR

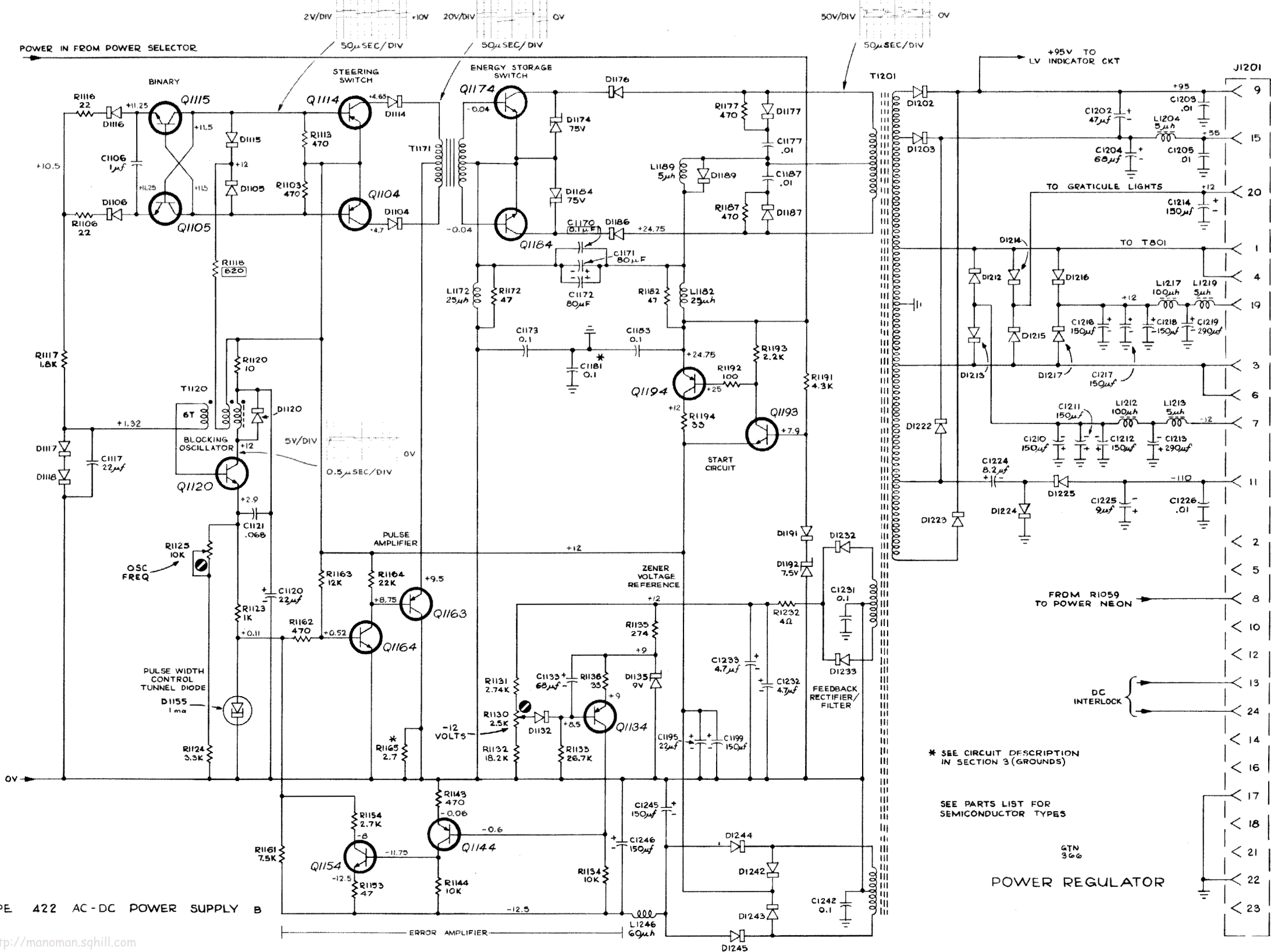

TYPE 422 AC-DC POWER SUPPLY B

POWER REGULATOR

MANUAL CHANGE INFORMATION

At Tektronix, we continually strive to keep up with latest electronic developments by adding circuit and component improvements to our instruments as soon as they are developed and tested.

Sometimes, due to printing and shipping requirements, we can't get these changes immediately into printed manuals. Hence, your manual may contain new change information on following pages. If it does not, your manual is correct as printed.

TEXT CORRECTION

Section 3 - - - Circuit Description

Page 3-5, First column, Start Circuit.

Change 3rd paragraph to read as follows:

As the input dc voltage to the Start Circuit rises to about ten volts, D1192 will turn on and hold the base of Q1193 at about 8.9 volts. This will in turn cause the isolated +12-volt bus of the isolated +12V Rectifier/Filter to be at 8.2 volts. The 8.2 volts starts the Blocking Oscillator, Binary, Steering Switch and Energy Storage Switch circuits operating. Once the above circuits are operating, the isolated +12V Rectifier/Filter is then able to supply the operating voltages, and will turn the Start Circuit off by reverse biasing the emitter-base junction of Q1193.

PARTS LIST CORRECTION

CHANGE TO:

D1192	152-0217-00	Zener	0.4w, 8.2v 5%
-------	-------------	-------	---------------