

INSTRUCTION MANUAL

WARNING

When the POWER-TEST switch is ON, LETHAL voltages appear on the front (test panel) of the Type 570.

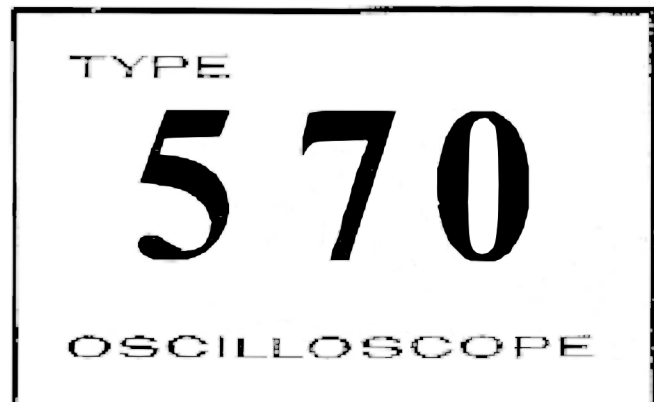

Tektronix, Inc.

5.W. Millikan Way • P. O. Box 500 • Beaverton, Oregon 97005 • Phone 644-0161 • Cables: Tektronix

070-359

7/63

TYPE 570 CHARACTERISTIC-CURVE TRACER

SERIAL 111



VOLTMETER

RANGE DC VOLTS

100 50 25 10 5

250 100 50 25 10 5

500 200 100 50 25 10 5

INDICATION

+DC +AC +RTN

PLATE-SWEEP GENERATOR

PEAK VOLTS

50 100 200 300 400 500

SERIES LOAD
RESISTANCE OHMS

100K 50K 25K 10K 5K 2K 1K 500

TEST POSITION

OFF

GRID A GRID B

GRID-STEP GENERATOR

STEP/RAMP
STEP/TAC

100 200 300 400 500

ZERO
BIAS

START ADJUST
VOLTS/STEP

1 2 3 4 5 6 7 8 9 10

OPERATING VOLTAGES

VARIABLE
HEATER

0.1 0.2 0.3 0.4 0.5 0.6 0.7 0.8 0.9 1.0 1.1 1.2 1.3 1.4

VARIABLE
+DC

20 50 100 200 500

CALIBRATION

POWER

MAIN ON TEST ON

CRT DISPLAY

VERTICAL
MAJ/ DIV

PLATE 1 2 3 4 5 6 7 8 9 10

SCREEN

1 2 3 4 5 6 7 8 9 10

GRID

1 2 3 4 5 6 7 8 9 10

HORIZONTAL
VOLTS/DIV

PLATE 1 2 3 4 5 6 7 8 9 10

GRID

1 2 3 4 5 6 7 8 9 10

1 2 3 4 5 6 7 8 9 10

1 2 3 4 5 6 7 8 9 10

POSITIONING
VERTICAL
HORIZONTAL

1 2 3 4 5 6 7 8 9 10

TEKTRONIX, INC.

PORTLAND, OREGON, U.S.A.

CONTENTS

Section 1	Characteristics
Section 2	Operation Instructions
Section 3	Circuit Description
Section 4	Maintenance
Section 5	Calibration Procedure
Section 6	Parts List and Schematic Diagrams

SECTION 1

CHARACTERISTICS

CHARACTERISTICS

General Description

The Type 570 Characteristic-Curve Tracer presents a graphic analysis of vacuum-tube characteristics under a wide range of operating conditions. Calibrated horizontal and vertical deflection make it possible to measure the characteristics that have been reproduced on a mask over the cathode-ray tube. Front panel switching between two test sockets permits rapid comparisons between two tubes or between two sections of the same tube.

OPERATING CHARACTERISTICS

Vertical Deflection Factor

Eleven steps from .02ma/div. to 50ma/div.
Accuracy: 3%

Horizontal Deflection Factor

Nine steps from .1v/div. to 50v/div.
Accuracy: 3%

Grid-Step Generator

Number of steps per family: 4 to 12.
Number of steps per second: 120 or 240.
Voltage change per step:

Seven positions from .1 to 10 volts/step.
Accuracy: 3%.

A single-family provision permits observation of tube characteristics under unusual conditions without danger of damage to the tube under test.

Maximum current: 50 ma average,
100 ma peak.

A 1/16 amp fuse protects the current measuring resistors in the .02 ma to 1 ma positions of the MA/DIV. switch on instruments above serial number 5001.

Plate Sweep Generator

Peak plate-sweep voltage:

Eight steps from 5 to 500 volts. Nominal voltages depending on line voltage.

Series load resistance:

Eleven steps from 300 ohms to 1 meg-ohm.

Accuracy: 300 ohms, 30%; 1k and 2k, 10%; 5k to 1 meg, 5%.

Maximum current capability

1 amp peak.

.25 amp average.

A 1/2 amp fuse protects the plate-sweep generator. In instruments above serial number 5001 an additional 1/16 amp fuse is inserted to protect the current measuring circuits in the .02 ma to 1 ma positions of the MA/DIV. switch when measuring plate current.

Operating Voltages

Heater Voltages:

Seventeen steps from 1.25 volts to 117 volts, each step adjustable over a range of about $\pm 20\%$.

Maximum Heater Power: 30 watts.

Positive DC Voltage:

Five calibrated steps from 20 to 300 volts, 3% accuracy.

Continuously variable, uncalibrated, from 10 to 300 volts.

Maximum Current From + DC Circuit

150 ma peak.

50 ma average.

Negative DC Voltage:

Continuously variable from 0 to -300 volts.

Voltmeter

Measures positive and negative operating voltages in seven ranges from 7 to 700 volts, full scale.

SECTION 2

OPERATING INSTRUCTIONS

General

The Type 570 Oscilloscope is an extremely versatile instrument which is adaptable to a great number of applications. However, to make full use of the instrument, it is important that you understand the operation and function of the various controls. This section of the manual is designed to give you this information.

NOTE

High voltages can be present at the patch panel. The flexible operational setup facility of the Type 570 requires that potentially dangerous voltages be available at the patch panel. Turn off the POWER-TEST switch when making or changing

connections. Practice safety by connecting each lead first to the adapter plate and then to the patch panel.

Fuses are used to protect some of the circuits supplying power to the patch panel. Damage to other circuits is possible by extended periods of heavy overload. In no case is any provision made to protect the vacuum tube or other device being tested.

PRELIMINARY INSTRUCTIONS

Cooling

A fan maintains safe operating temperature in the Type 570 by circulating filtered air over

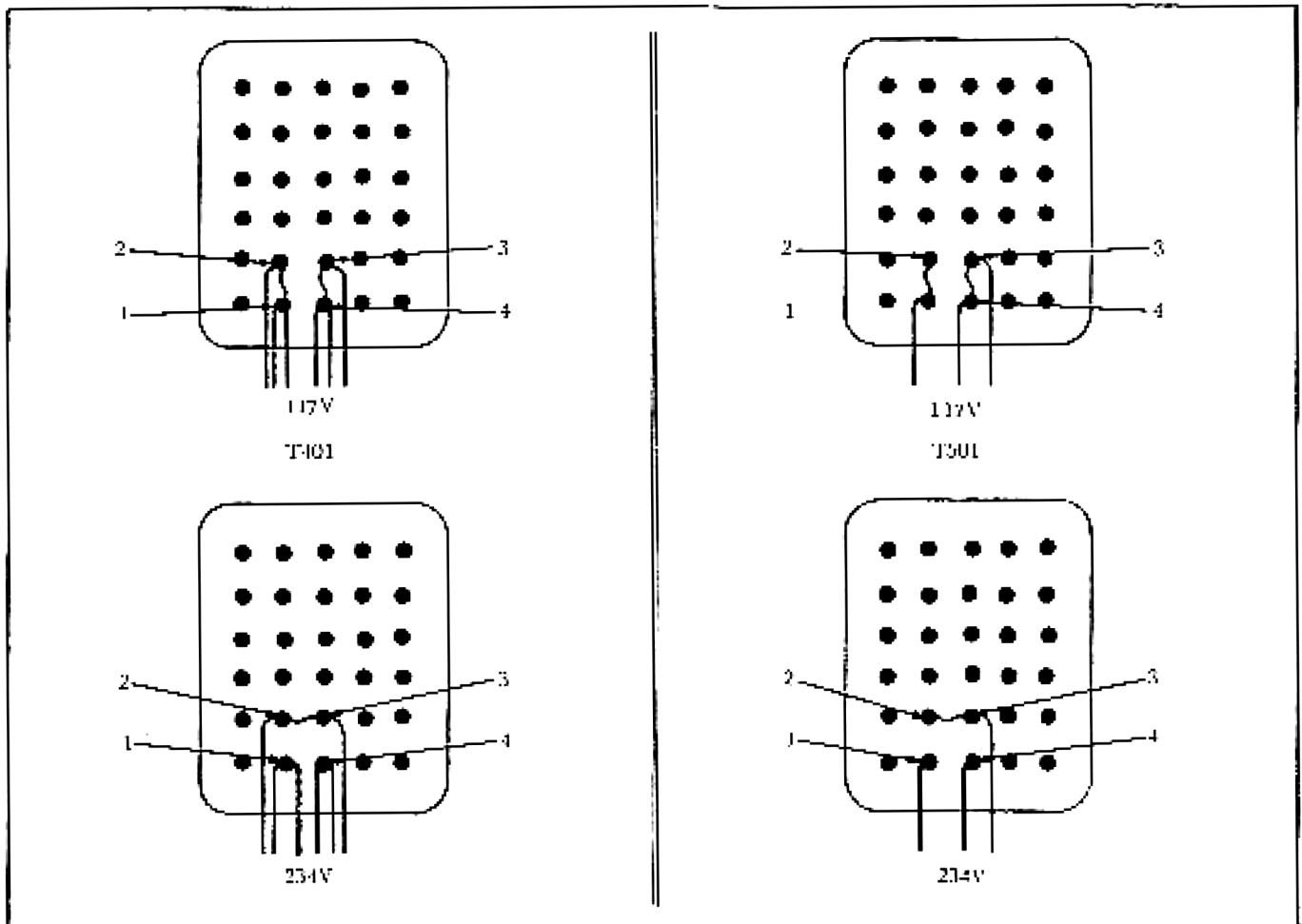

Fig. 2-1. Connections to be made when the Type 570 is connected for 254 (117) volt operation.

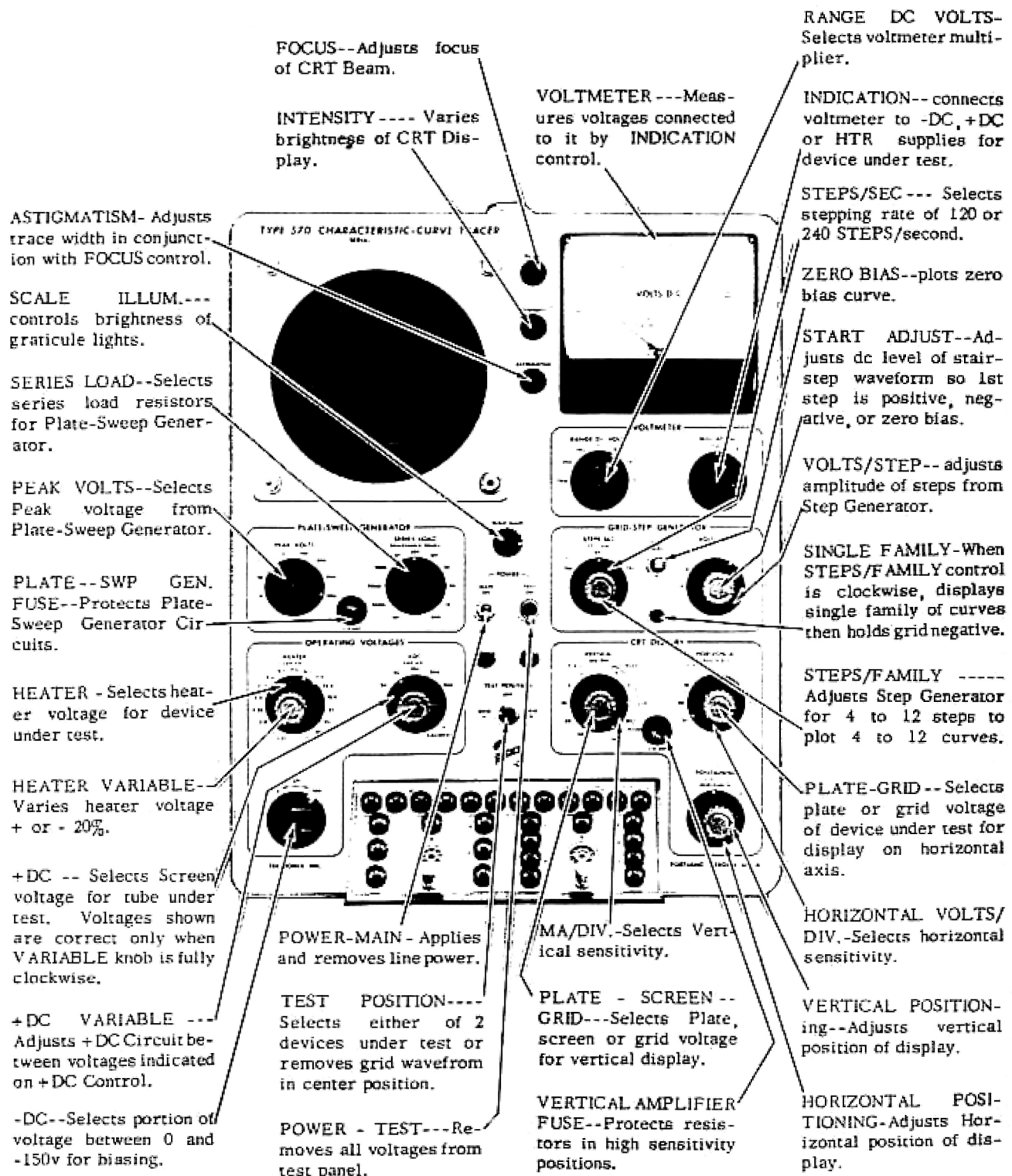

Fig. 2-2. Front-panel controls of the Type 570 Oscilloscope

the rectifiers and other components. When in operation, the instrument must be placed so that the air intake at the back is clear of any obstruction that might impede the flow of air. Side panels should also be in place for proper air circulation. The air filter should be kept clean, in accordance with cleaning instructions found in the Maintenance Section of the manual.

Under no circumstances should your Type 570 oscilloscope be operated without the fan running. Without the fan, inside temperature of the oscilloscope will rise to a dangerous level in five to ten minutes.

Power Requirements

50-Cycle Operation--This instrument is normally calibrated for a 60-cycle line frequency at the factory. If the instrument is to be used for a 50-cycle operation it will be necessary to readjust the step-generator phase controls. See Step 7 in the Calibration Section of this manual.

234-Volt Operation--Unless it is tagged for 234-volt operation this instrument is connected for 117-volt operation. For 234-volt operation it is necessary to change the jumpers on two transformers to connect the primary windings in series.

For 234-volt operation remove the jumpers between pins 1 and 2 and between 3 and 4 on T501. Connect a jumper between pins 2 and 3 on T501. Check to see that the fan is connected electrically to pins 1 and 3 of T501. Remove the jumpers between pin 1 and 2 and between 3 and 4 on T401. Connect a jumper between pins 2 and 3 on T401. Do not change the connections on the other transformers since these are still supplied with 117 volts. Change the power line fuse.

Fuse Data

Fuse data for the power line fuse on oscilloscopes above serial number 5001 is on the rear panel of the instrument adjacent to the fuse holder. On instruments below serial number 5001 see the parts list in this manual. Fuse data for the Plate Sweep Generator (1/2 AMP) and Vertical Amplifier (1/16 AMP) fuses is found near the fuse holders. On instruments with serial numbers of 5000 or below the fuse(s) will be found under the access door located on

top of the cabinet. On instruments with serial numbers above 5000 the fuses are located on the front panel. Use only the recommended fuses for maximum over-current protection.

OSCILLOSCOPE OPERATION INFORMATION

Initial Control Settings

This section describes the procedure for setting up a typical display of the plate-characteristic curve for a triode and a pentode. A type 6U8 triode-pentode is specified. If a different tube type is used the patch-panel connections should be changed as required. Except for the heater voltage, these settings can serve as the starting point for checking most receiving-type tubes. The settings may then be altered as required to obtain a useful presentation.

NOTE

Be sure the HEATER Control is set to the proper range before connecting the heaters of the tube under test.

Also be sure that the heaters of the tube under test are connected to the HTR connectors on the test panel.

Set the oscilloscope controls as follows:

POWER-MAIN	ON
POWER-TEST	OFF
TEST POSITION	OFF
INTENSITY	Midrange
FOCUS	Midrange
ASTIGMATISM	Midrange
PEAK VOLTS	200
SERIES LOAD	10 K
HEATER	6.3
VARIABLE +DC	Counterclockwise
VARIABLE -DC	Counterclockwise
INDICATION	HTR
RANGE DC VOLTS	140
STEPS/FAMILY	Midrange
STEPS/SEC	240
START ADJUST	Counterclockwise
VOLTS/STEP	.5
VERTICAL MA/DIV	1

PLATE-SCREEN-GRID PLATE
HORIZONTAL/ 20
VOLTS
PLATE-GRID PLATE
POSITIONING Midrange
(VERTICAL and
HORIZONTAL)

Now insert the nine-pin-miniature socket adapter into the test panel and connect the patch cords as follows:

Pin No.	Connect to	Tube element
1	P	Triode plate
2	GRID B	Pentode grid
3	+ DC	Pentode screen
4	HTR	Heater
5	HTR	Heater
6	P	Pentode plate
7	K	Pentode cathode and suppressor
8	K	Triode cathode
9	GRID A	Triode grid

Install a type 6U8 tube in the socket adapter and turn the POWER-TEST switch ON. The HEATER VARIABLE should now be adjusted for a reading of 100%. The 100% marking will be found on the 0-140 meter scale. Switch the INDICATION Control to +DC and adjust the +DC VARIABLE Control for a meter reading of 100 volts.

Position the TEST POSITION switch to the GRID A position. Adjust the POSITIONING Controls so that the displayed curves start in the lower left hand corner of the graticule.

Using the display of curves adjust the FOCUS, ASTIGMATISM and INTENSITY Controls for a sharp trace of comfortable brightness.

The ZERO BIAS button should now be depressed and the position of the zero bias curve noted. With the ZERO BIAS button released adjust the START ADJUST until the uppermost curve is superimposed upon the position that the zero bias curve occupied with the button depressed.

You are now displaying the 6U8 triode plate-characteristic curve. Move the STEPS/SEC control to each of the 120 positions and note that the Grid Step Generator switches at only one end of the sweep in each of these positions.

Now move the TEST POSITION switch to GRID B and display the plate-characteristic curves of the 6U8 pentode section. Move the

PLATE-SCREEN-GRID Control to SCREEN. This will result in a display which shows the screen current plotted against plate voltage. Now return the control to the PLATE position.

To expand the display of the first curve reset the following controls:

PEAK VOLTS 20
VERTICAL MA/DIV .1
HORIZONTAL 2
VOLTS/ DIV

You will notice that the curves are not plotted all the way to the origin and that the curves intersect the current axis above the origin. These are normal effects and do not indicate miscalibration of the instrument. The correct horizontal positioning can be determined by momentarily grounding the plate connector, P. The line which results should lie along the current axis. The P connector should not be left connected to ground any longer than is necessary.

The initial velocity of the emitted electrons causes plate current to flow at zero plate voltage as indicated by the curves intersecting the current axis above the origin. This effect is more pronounced with increased series load resistance. A similar effect in the plate-sweep-generator rectifiers prevents the plate sweep voltage from dropping completely to zero.

THERMIONIC DIODE CURVES

To plot diode curves, connect the diode in the normal manner with the cathode to ground, K, and the plate to the Plate Sweep Generator, P. Set the PLATE-SCREEN-GRID Control to PLATE and the PLATE-GRID Control to PLATE. Before turning the POWER-TEST switch on, set the PEAK VOLTS Control to a low voltage. After the POWER-TEST switch is turned ON, wait until the cathode of the tube under test has reached operating temperature before raising the PEAK VOLTS. The voltage can then be raised until maximum operating conditions are reached.

It is sometimes of interest to sweep the plate voltage negative with respect to the cathode, beyond the point of plate current cutoff. This can be done by connecting a battery between the cathode and ground to raise the cathode positive. Three volts is normally sufficient. The +DC Control and test panel connector can be used instead of a battery if the peak plate current is to be less than 50 ma. To use the +DC test panel connector, connect the cathode of the tube under test to +DC. Set the +DC Controls to minimum, about ten volts.

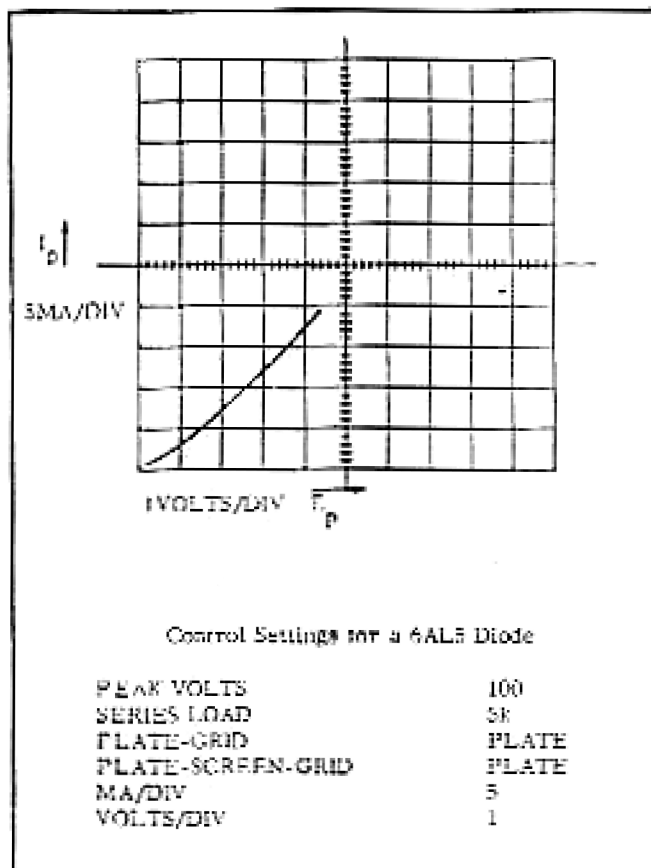

Fig. 2-3. Plate Current vs. Plate Voltage curve for a 6AL5 diode.

Connect a 200 ohm, 2 watt resistor from the cathode to ground to keep the power supply in regulation. The curve can now be plotted in the normal manner. The zero voltage point can be determined by momentarily connecting the plate to the cathode. Be sure the SERIES LOAD switch has put sufficient series resistance in the circuit to limit the current to a safe value when you do this. Position the line which you obtain behind a graticule line. This line will then be the vertical axis.

TRIODE CURVES

By setting the PLATE-SCREEN-GRID and PLATE GRID Controls to the proper positions the following curves can be plotted: plate current versus plate voltage, grid current versus plate voltage, plate current versus grid voltage, and grid current versus grid voltage.

Grid-Step Waveform

Triode curves involve the use of the grid-step generator in addition to the circuits used in plotting diode curves. The grid-step waveform is a stair-step waveform starting at zero or some positive voltage. It can be set to have from four to twelve steps going

negative from ground or it may have as many as eight positive steps above ground. In the latter case the start of the stair-step waveform is above ground. The position of the zero-bias curve can be determined by pushing the ZERO BIAS button.

The STEPS/SEC control provides a means of selecting the stepping point of the step generator. In the right hand position, labeled 120, the generator steps while the plate voltage is at maximum and in the left hand position the generator steps when the plate voltage is at a minimum. In the 240 position, stepping occurs at both maximum and minimum voltage points, and the faster switching rate reduces flicker.

If either end of the plate sweep is particularly important, it is usually better to set the step generator to switch at the opposite end. However, in some cases where no error is introduced, the switching lines help to plot a continuous curve between steps.

Plate Current vs. Plate Voltage

To display plate current versus plate voltage curves the tube to be tested is connected in the normal manner with the cathode to ground, K, the grid to GRID A, or B connectors and the plate to F. Turn the PLATE-SCREEN-GRID and PLATE-GRID Controls to PLATE.

The following control settings should be checked when a particular tube type is being tested the first time:

1. Set the HEATER Control to the correct voltage.
2. Set the START ADJUST Control nearly counterclockwise to avoid a positive grid voltage.
3. Set the PEAK VOLTS Control for a safe voltage.
4. If high plate current is expected, set the VERTICAL MA/DIV Control nearly counterclockwise to protect the small, low-current measuring resistors.

The other controls can be set after the POWER-TEST switch is turned on and the tube cathode has come up to operating temperature. Once the desired settings have been obtained for a given tube type, other tubes of the same type can be inserted without resetting the controls.

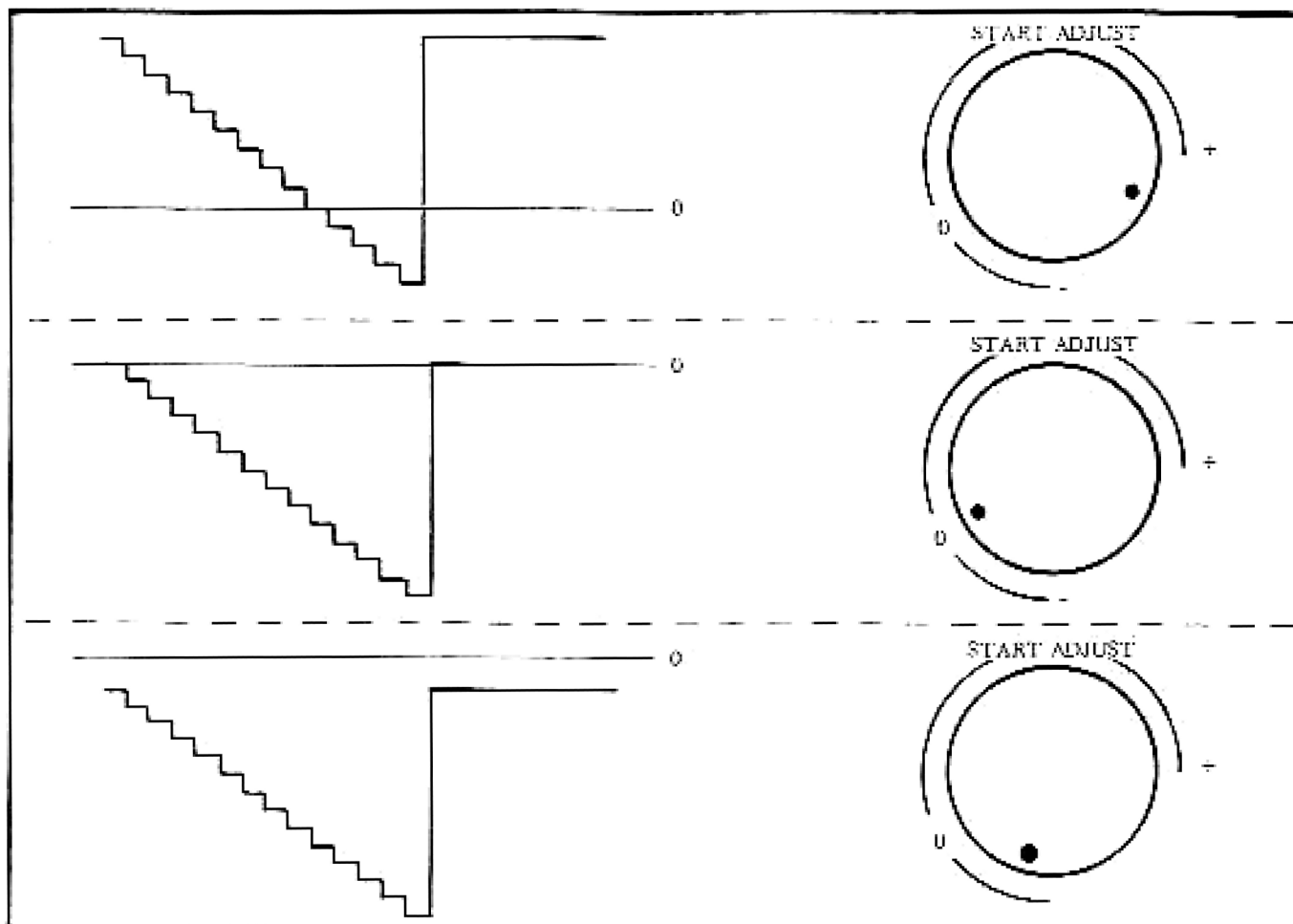

Fig. 2-4. The affect the START ADJUST Control has on the grid-step waveform.

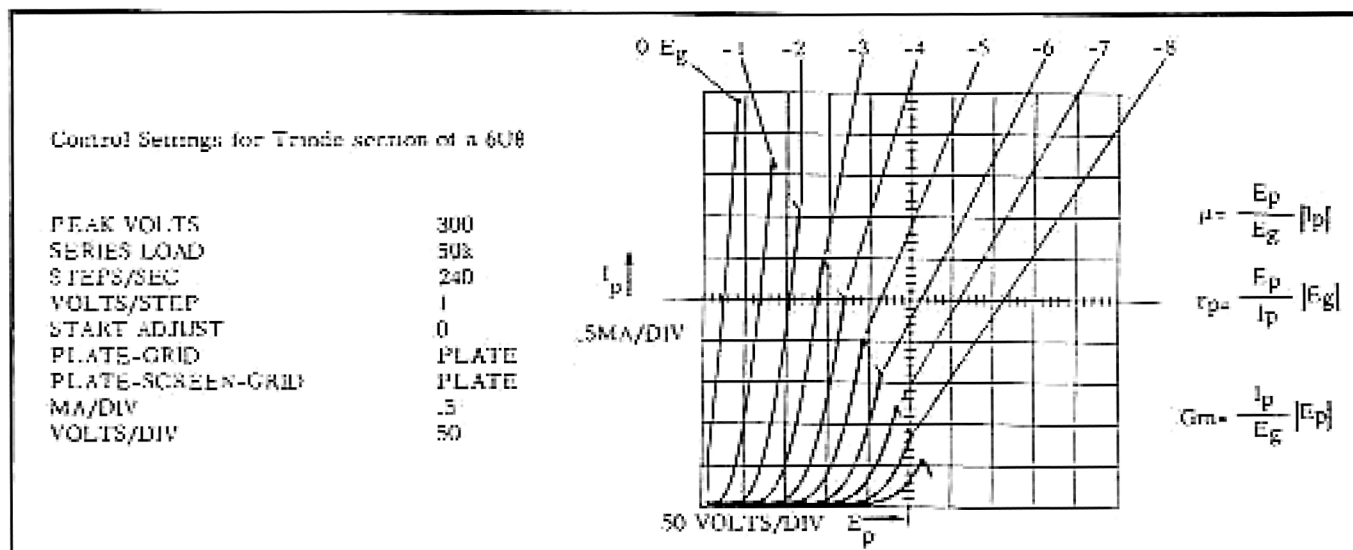

Fig. 2-5. Plate Current vs. Plate Voltage curve for the triode section of a 608

Grid Current vs. Plate Voltage

Grid current can be plotted against plate voltage by setting the controls as for the plate current versus plate voltage display and moving

the PLATE-SCREEN-GRID Control to GRID. Increase the vertical sensitivity with the VERTICAL MA/DIV switch as required. Normally the grid current will not be measurable until the grid approaches zero bias or goes positive.

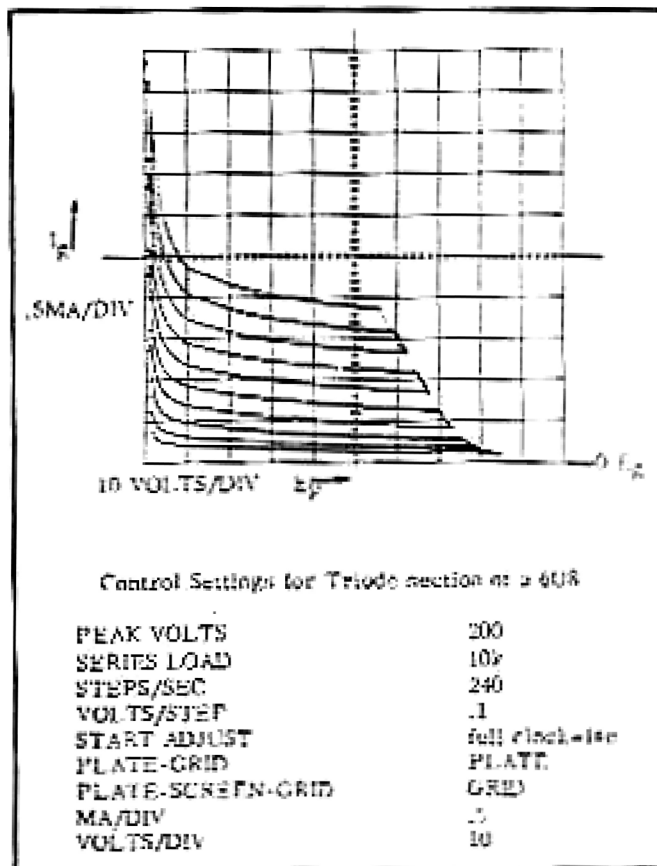

Fig. 2-6. Grid Current vs. Plate Voltage curves for the triode section of a 6U8.

Plate Current vs. Grid Voltage

To display plate current plotted against grid voltage, set the controls as for the plate current versus plate voltage curves and switch the PLATE-GRID Control to GRID. This automatically positions the display to the right. It will normally be necessary to increase the horizontal sensitivity with the HORIZONTAL VOLTS/DIV switch and reposition the display slightly.

The display obtained consists of vertical lines which show the variation of plate current as the plate is swept from zero to maximum voltage. The part of the curve of primary interest is formed by the tops of these lines. This is a dynamic characteristic for the combined tube and load resistance. However, if the SERIES LOAD is set to 300 the effect of the load resistance is very slight.

The voltage from the Plate Sweep Generator depends upon the line voltage and it is not intended that the calibration of the PEAK VOLTS Control be exact. If the actual peak plate

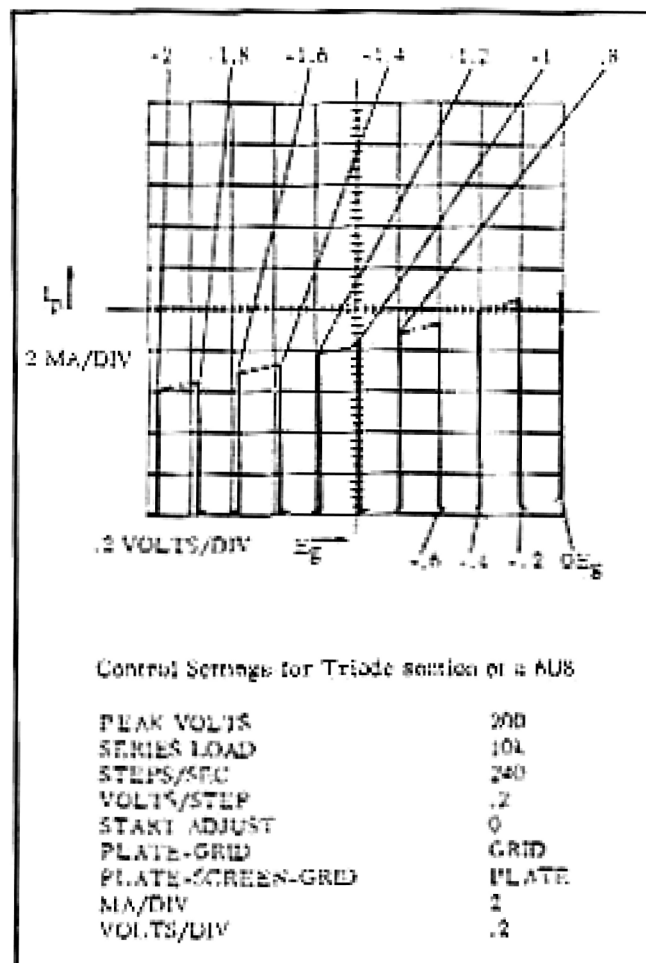

Fig. 2-7. Plate Current vs. Grid Voltage curves for the triode section of a 6U8.

voltage is desired, switch the PLATE-GRID Control to PLATE and read the peak voltage directly from the screen.

A method of plotting a more conventional-looking transfer characteristic is to connect the plate to the +IX connection on the test panel and adjust the +DC Control for the proper voltage. Now if the PLATE-SCREEN-GRID Control is turned to SCREEN the plate current will be plotted. The advantages of this connection are that the vertical lines are not displayed and the plate voltage is continuously variable and indicated by the voltmeter. Disadvantages are that the maximum current and voltage capability of the +DC connection are less than that of the normal P connection and the continuous voltage applied to the tube under test increases the average plate dissipation in the tube.

Grid Current vs. Grid Voltage

After displaying plate current versus grid voltage curves the grid current vs. grid voltage

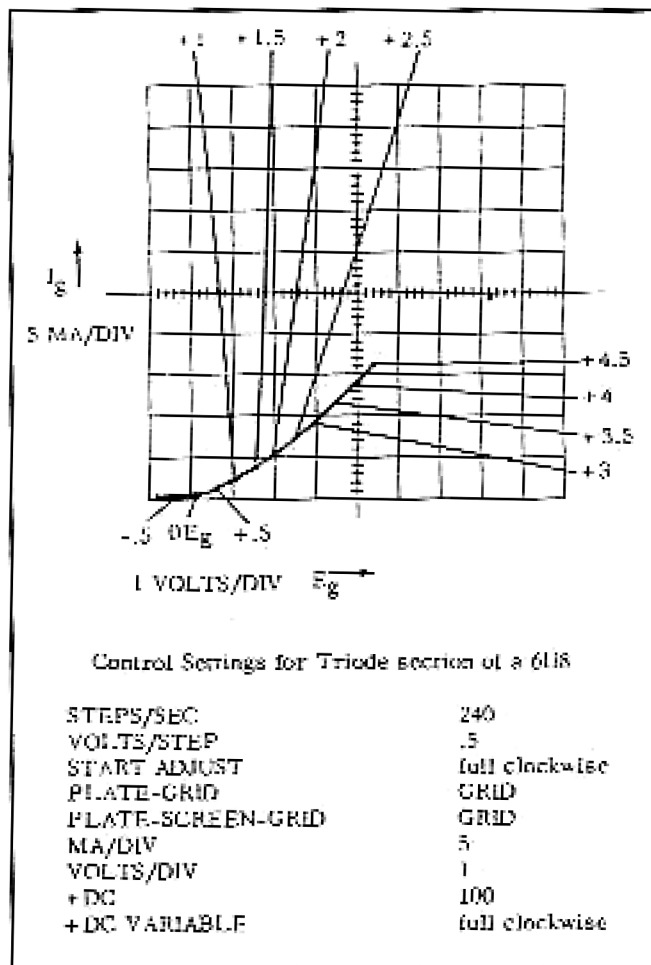

Fig. 2-8. Grid Current vs. Grid Voltage curves for the triode section of a 6U8. Now +DC connector supplied the plate voltage.

display can be obtained by switching the PLATE-SCREEN-GRID Control to GRID. Increased vertical sensitivity may be required. This is accomplished by changing the setting of the VERTICAL MA/DIV Control. The vertical

lines can be eliminated by connecting the plate to the +DC connector as was done to obtain the transfer characteristics.

Tube Switching

Two tubes or two sections of one tube can be connected at the same time for comparison purposes or to speed testing. The one grid should be connected to the GRID A connector and the other grid to GRID B connector. Both plates should be connected to the P connector. The tube to be tested is now selected by the TEST POSITION switch. The other tube is held cutoff by a 10 megohm resistor connected to -300 volts. Occasionally a defective tube will still conduct under these conditions, causing an error in the presentation. If you suspect that this is occurring, switch the TEST POSITION switch to OFF. This connects the grids of both tubes to the 10 megohm resistor. There should now be no indication of plate current on the screen.

PENTODE CURVES

In addition to the curves which can be plotted for a triode, pentode screen current can be plotted against either plate or control-grid voltage. The pentode curves are plotted in the same manner as the triode curves with the +DC connection used for screen voltage. This prevents the alternate connection mentioned in the triode section under plate current versus grid voltage in which the +DC connection is used as the plate supply.

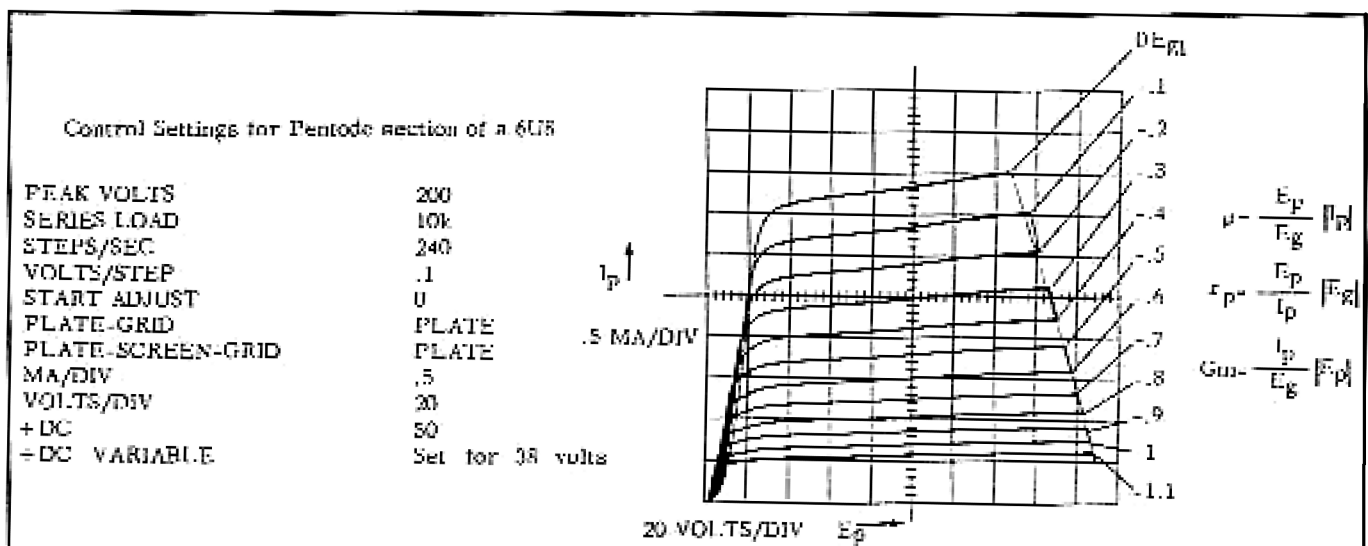

Fig. 2-9. Plate Current vs. Plate Voltage curves for the pentode section of a 6U8.

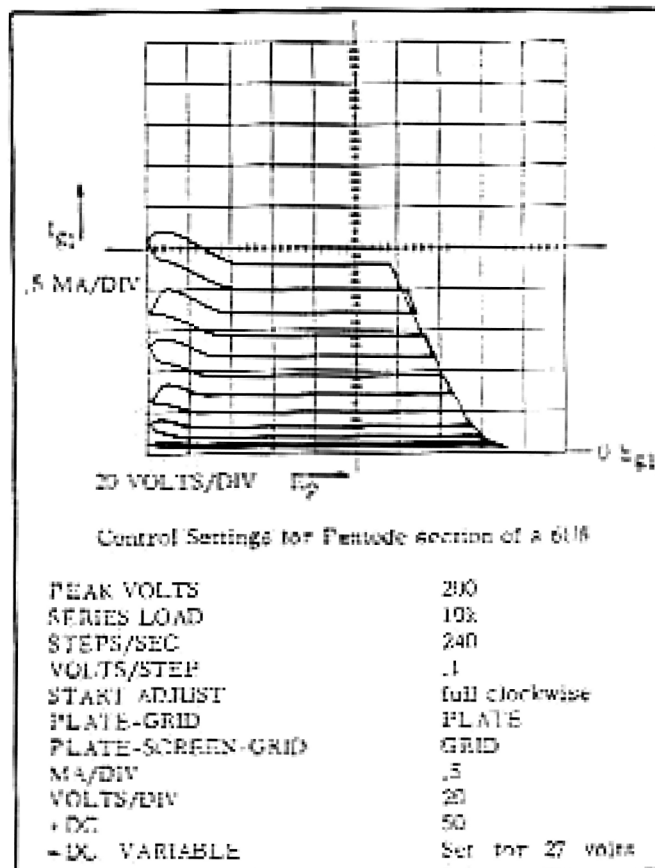

Fig. 2-10. Grid Current vs. Plate Voltage curves for the pentode section of a 6U8.

Screen Current vs. Plate Voltage

This curve can be plotted by setting the controls as for the plate current versus plate voltage display with the exception that the PLATE-SCREEN-GRID Control is set to SCREEN. If switching lines interfere with the display at the left, the STEPS/SEC Control should be moved to the right hand 120 position.

Screen Current vs. Grid Voltage

This curve is similar to the plate current versus grid voltage curve. It is obtained by setting the PLATE-SCREEN-GRID Control to SCREEN and the PLATE-GRID Control to GRID. Adjust the HORIZONTAL VOLTS/DIV as required to obtain a full screen display and position the display as desired. If the STEPS/SEC control is set to the right hand position the switching lines will form a continuous curve indicating the screen current at maximum plate voltage as set by the PEAK VOLTS Control. The vertical lines represent the variation of screen current as the plate voltage is swept from zero to maximum.

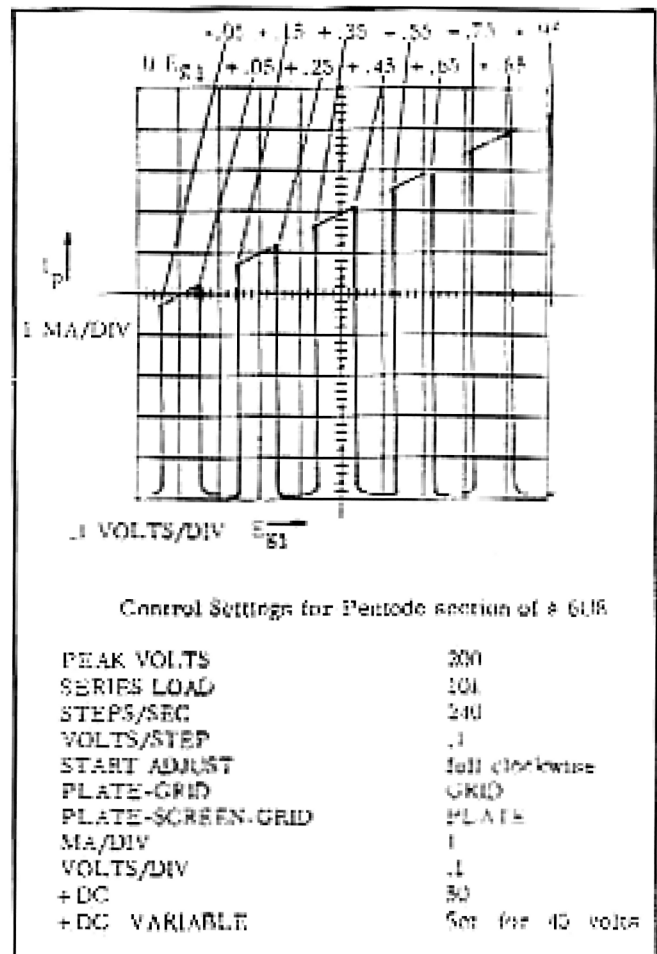

Fig. 2-11. Plate Current vs. Grid Voltage curves for the pentode section of a 6U8.

SINGLE-FAMILY DISPLAY

Characteristics of a tube in the region where its power rating is exceeded can be obtained by means of the single-family feature. When this feature is used, the grid is held negative until the SINGLE FAMILY button is pushed, at which time it runs through one family of curves and again stops with the grid negative.

To use this feature, first set up the controls to plot a family of curves that is within the safe operating limits of the tube. Then turn the STEPS/FAMILY Control clockwise to the stop. Make the desired changes to the operating and generator voltages. As these adjustments are being made push the SINGLE FAMILY button occasionally to determine the operating point that has been reached. When the desired operating point is reached push the SINGLE FAMILY button to obtain the single display.

The maximum voltage swing from the Grid-Step Generator as it plots a family of curves

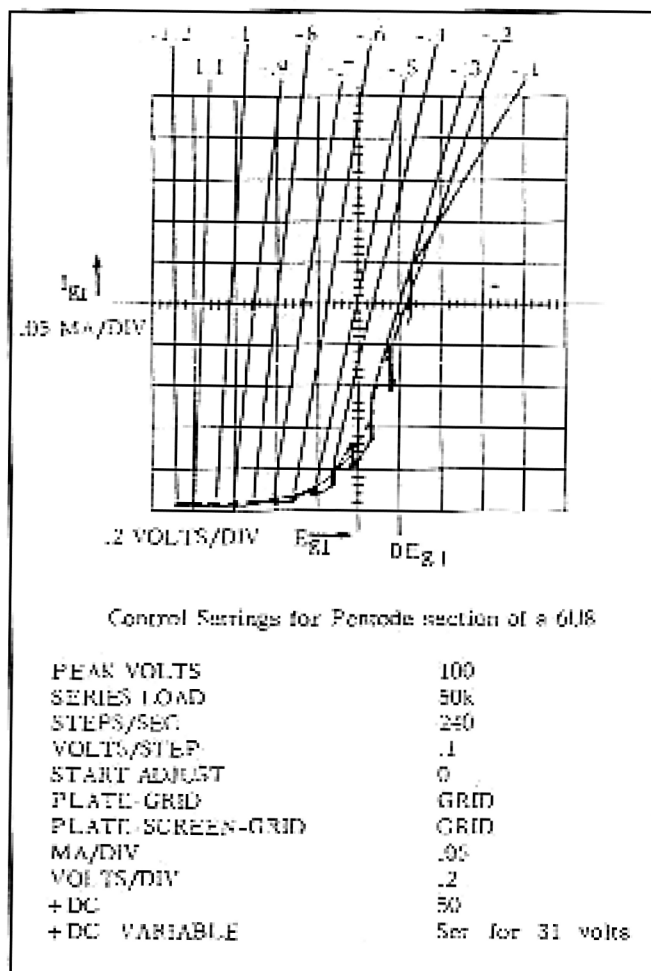

Fig. 2-12. Grid Current vs. Grid Voltage curves for the pentode section of a 6U8.

and comes to rest is equivalent to about 14 steps at any setting of the VOLTS/STEP Control. Thus, if the step generator is set for the maximum number of positive steps with the START ADJUST Control, it will rest five steps negative until the SINGLE FAMILY button is pushed. This will be between .5 volts and 50 volts negative depending on the setting of the VOLTS/STEP Control. In many cases this will not hold a tube cut off but it will usually be in a safe operating region. If the START ADJUST Control is hacked off from its most positive position the voltage at which the grid rests can be increased up to a maximum of 140 volts negative.

The current ratings of the +DC connection and the Grid-Step Generator can also be safely exceeded by use of the single-family feature. The Grid-Step Generator will deliver a peak current of from 200 to 250 ma if a few seconds are allowed between each presentation for the circuits to recover. The +DC connection will deliver 500 ma for a single family with

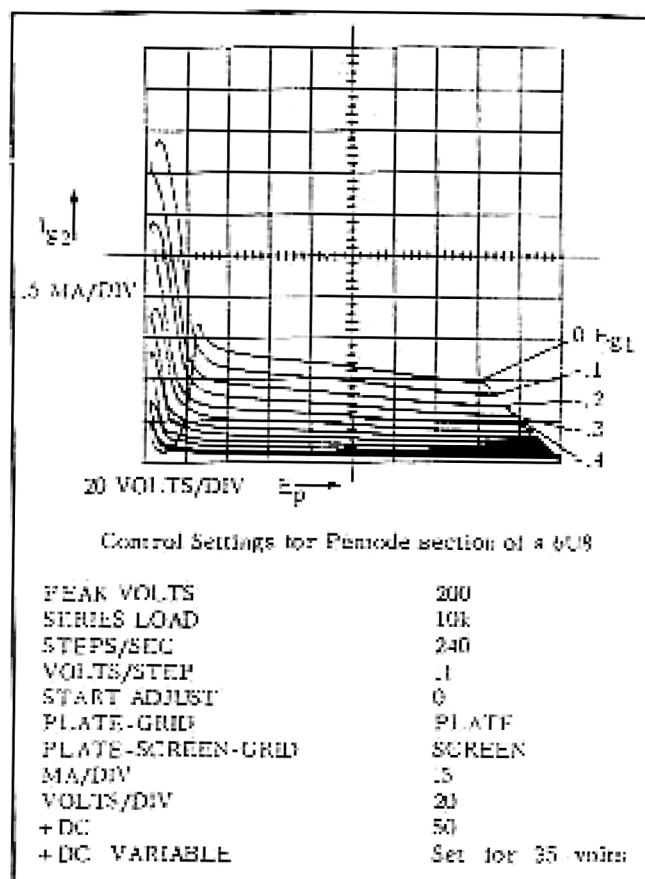

Fig. 2-13. Screen Current vs. Plate Voltage curves for the pentode section of a 6U8.

a voltage drop of less than one volt. A second or two is required for the +DC circuits to recover before a second family can be plotted.

SEMICONDUCTOR DEVICES

The Type 570 was designed for testing vacuum tubes. However, it is useful for plotting semiconductor diode characteristics and some transistor characteristics.

Semiconductor diode curves are plotted in the same way as vacuum tubes described under Thermionic Diodes. To protect the diode, maximum resistance, as set by the SERIES LOAD Control, consistent with adequate voltage swing as set by the PEAK VOLTS should be used. If you connect the diode between the test panel, P, connector and the +DC connector, be sure to load the +DC connection with an external resistor. The +DC circuit will lose regulation if current through the diode exceeds the current through the resistor by more than 2 ma. This resistor should be selected to draw 50 ma or less.

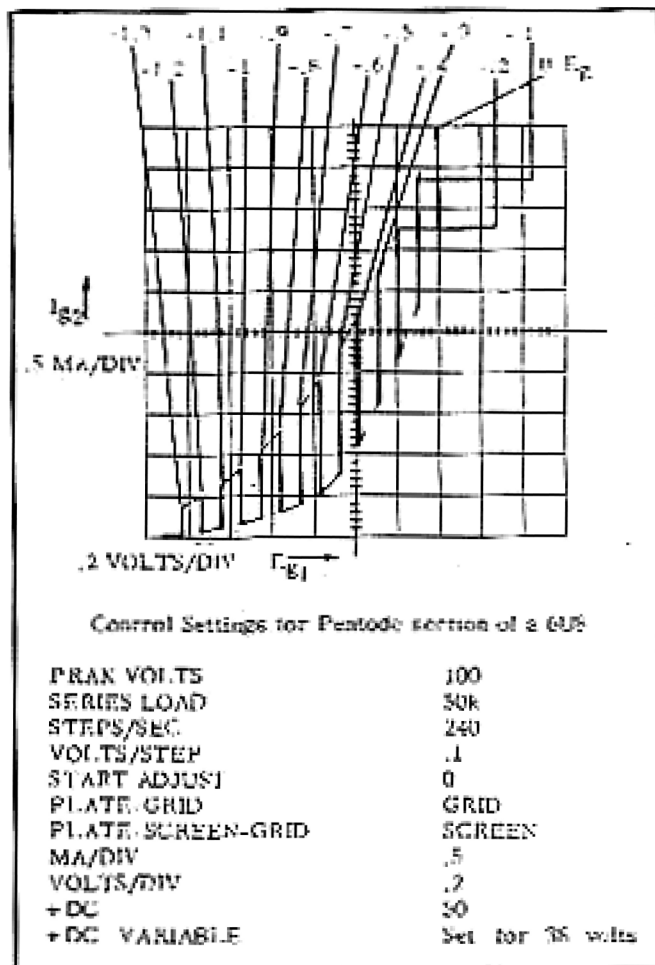

Fig. 2-14. Screen Current vs. Grid Voltage curves for the pentode section of a 6X5.

SPECIAL APPLICATIONS

The Type 570 can be used to display the characteristics of special circuits and tubes. Resistors can be added between cathode and ground to show the effect of degeneration. Two triodes can be connected in a cascade circuit to obtain their characteristics in this connection. Similarly, two triodes can be cascaded although this connection may be less useful.

Curves can be plotted of current versus voltage for gas diodes. For instance, in this way you can obtain the firing potential and voltage drop of a voltage reference tube. Other special applications may occur to you from time to time. Be sure to check the current requirements of a special circuit. The Grid-Step Generator, Plate-Sweep Generator and +DC circuit are designed for electron flow from ground into the circuit only. A certain amount of current can be drawn from these circuits in the reverse direction but they quickly drop

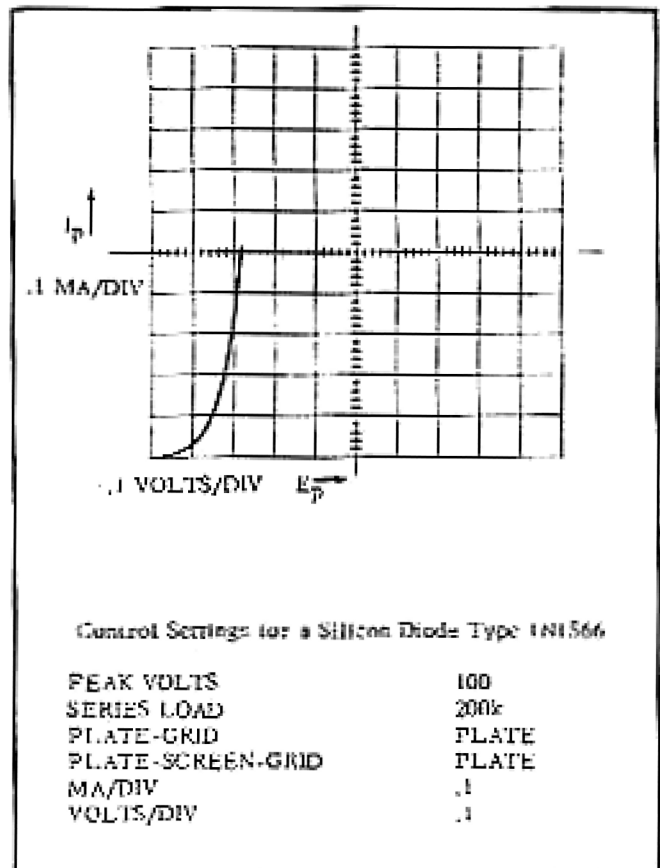

Fig. 2-15. Curve displayed by a type 1N1566 diode.

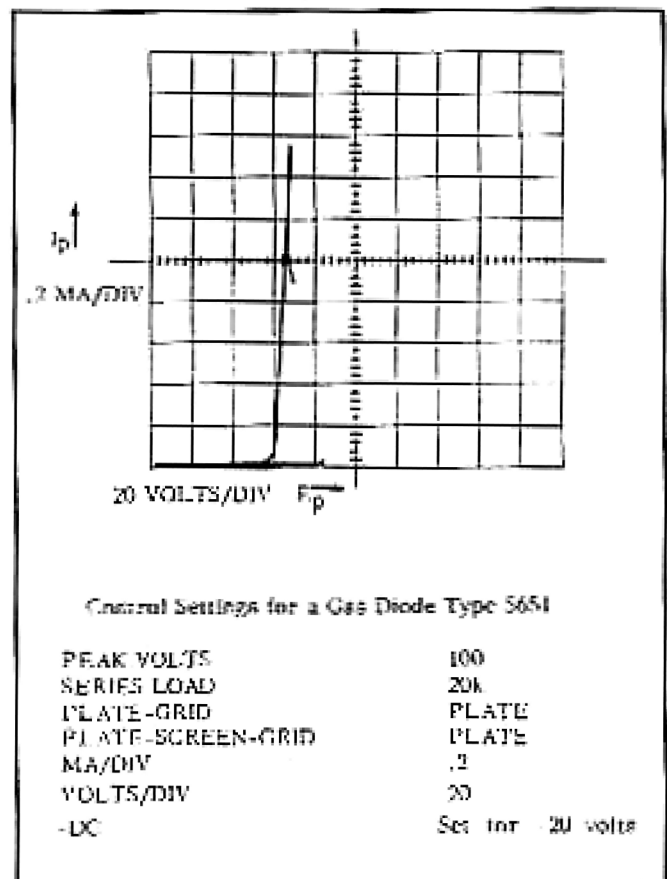

Fig. 2-16. Displaying the firing potential and voltage drop of a type 5651 gas diode. Note the cathode is connected to the -1X' electrode.

out of regulation. The amount of current which can be drawn in the reverse direction can be increased by appropriate external loads such as described under Thermionic Diode Curves.

OSCILLATION OF DISPLAY

Occasionally a tube will oscillate when placed in the test socket. This oscillation will be indicated on the screen by obvious oscillation or by unexplained discontinuities in the display. This will almost certainly occur if two tubes are connected in parallel. For this reason,

parasitic-oscillation-suppression resistors have been built into special patch cords and ferramic beads have been installed on the leads running from the tube socket on the adapter panels. Usually the resistors in the patch cords will prevent any oscillation if they are connected to the control grid of the tube under test. If the special patch cords are used, the effect of any grid current which may flow should be considered when evaluating the curves. The ferramic beads are to prevent oscillation on the display when displaying tube curves of high-gain tubes.

SECTION 3

CIRCUIT DESCRIPTION

BLOCK DIAGRAM

General

The Block Diagram shows interconnections of the functional parts of the instrument, except for the power supplies. Functions of the switches are shown instead of their actual connections.

Step Generator

The Step Generator receives the line frequency waveform, shifts the phase and shapes it to provide a current pulse of a fixed amplitude. The current pulses which are either 120 or 240 pulses per second, depending upon the setting of the STEPS/SEC Control, are fed to a Miller integrator.

The Miller integrator converts the current steps to a series of voltage steps, a staircase waveform.

Step Amplifier

The positive-going waveform from the Step Generator is amplified and inverted by the step amplifier for application to the device under test. Any current drawn from this amplifier by the device under test is measured by the Vertical Amplifier in the GRID position of the PLATE-SCREEN-GRID Control.

+DC Circuit (Floating Power Supply)

The +DC Circuit provides a variable regulated voltage for application to the device under test. Current drawn from this circuit is measured by the Vertical Amplifier in the SCREEN position of the PLATE-SCREEN-GRID Control.

Plate-Sweep Generator

The Plate-Sweep Generator rectifies the transformer waveform to provide positive-going sweeps of plate voltage. Current drawn from this circuit is measured by the Vertical Amplifier in the PLATE position of the PLATE-SCREEN-GRID Control. The SERIES LOAD

Control selects the series resistance for the Plate-Sweep Generator.

Horizontal Amplifier

The PLATE-GRID Control connects the grid or plate of the device under test to the Horizontal Amplifier. The Horizontal Amplifier amplifies the signal and converts it for push-pull application to the deflection plates.

Vertical Amplifier

The Vertical Amplifier amplifies the signal selected by the PLATE-SCREEN-GRID Control and applies it to the vertical deflection plates. For a more complete diagram of the PLATE-SCREEN-GRID Control see the CRT Display Switching diagram.

STEP GENERATOR DIAGRAM

Split-load Phase Inverters

The main power transformer, T401, supplies 35 volts at line frequency to the phase-shifting networks, R6, C6 and R35, C35. PHASE ADJ A has a small range of adjustment to permit this circuit to be adjusted to coincide with the phase of the Plate-Sweep Generator waveform. PHASE ADJ B has additional range to permit its output to be set at 90 degrees with respect to the A circuit. V8A and V8B are Split-Load Phase Inverters with equal resistance in the plate and cathode circuits. The waveform at the plate is 180 degrees out of phase at the cathode. The dc component of the waveform is blocked by coupling capacitors, C8, C10, C18 and C40; and the waveform is rectified by full-wave rectifiers.

Shaper Amplifiers

The output from each pair of rectifiers is applied to a pentode amplifier. The rectifier output is a negative-going rectified sine wave of sufficient amplitude to hold the pentodes cut off except for short pulses as the grids approach ground potential. Since the pen-

odes have a common plate load resistor, the pulses from both pentodes appear at the grid of the shaper cathode follower.

The STEP/SEC switch biases one of the Shaper Amplifiers below cutoff in each of the 120 positions. This eliminates the corresponding pulses and reduces the stepping rate from 240 to 120 steps per second.

The cathode of the Shaper Cathode Follower, V55A, is held positive by divider R55 and R56. The grid of the cathode follower rests at a point selected by the VOLTS/STEP ADJ Control, R25, and a divider consisting of R26 and R27, when the Shaper Amplifiers are cut off. When the Shaper Amplifiers conduct, the grid of the cathode follower is driven below plate-current cut off. The amplitude of the pulse from the cathode follower can therefore be closely controlled by the VOLTS/STEP ADJ Control.

Clamp and Coupling Diodes

The clamp and coupling diodes, V95A and B, differentiate the pulse from the shaper cathode follower. During the positive portion of the pulse waveform the capacitor, C95, is charged through V95B. When the negative-going pulse occurs, this charge is released through V95A and adds to the charge in C85.

Step Generator

Because of their interdependence, the multivibrator, disconnect diodes, step generator and associated circuitry will be considered at one time. To provide a starting place, single-family operation will be considered first.

For the single-family type of presentation the STEPS/FAMILY Control, R91, is turned clockwise so that the arm is at the most negative end of its range. In this condition, the voltage on the cathode of the Step-Control Cathode Follower, V55B, is sufficiently negative to hold one half of the Multivibrator, V65A, cut off. The Multivibrator consists of V65A and V65B in a dc-coupled circuit. In the quiescent state the grid of V65A is held at about -100 volts and the grid of V65B is at about -65 volts. V65B is conducting and its plate rests at -10 volts.

When the SINGLE FAMILY button is pushed, C88 is discharged into C90 and the grid of V65A is raised so that V65A begins to conduct. The Multivibrator switches so that V65A is

conducting and V65B is cut off. The grid of V65A begins to go negative immediately as C90 loses the charge it received and the Multivibrator returns to its quiescent condition. The result is a short positive pulse at the plate of V65B.

In the quiescent condition, the Step Generator tube, V86, is cut off. Its grid is held negative as a result of current flow through V95, V76B and cathode follower V75B. The grid of V75B is held at -10 volts by the Multivibrator, resulting in -8 volts on the grid of V86. The grid and cathode of V75A rest at about 200 volts as a result of the divider action of R81, B80, and R82. C85 is charged to about 210 volts.

The positive pulse from the Multivibrator passes through the cathode follower, V75B, and diode V76B to raise the grid of V86 to ground potential. V86 conducts and its plate voltage drops cutting off cathode follower, V75A. C85 discharges through R85, R91 and R92 until clamped by V76A. When the Multivibrator reverts, both diodes are cut off and the resistors R85, R91 and R92 tend to pull the capacitor and the grid of V86 negative. At this point the plate of V86 resumes control and any tendency of the grid to go negative is compensated for by a rise in plate voltage. The Step Generator is now ready for its first step. The time required for the preceding operation after the SINGLE FAMILY button is pushed is less than the duration of one step.

The step is formed as follows: C95 has charged through V95B. When the negative pulse is applied to C95 it tends to pull the grid of V86 down with it. The rapid rise in the plate voltage of V86 is coupled back through V75A to C85. This reduces the voltage change on the grid to a very small step. The result is a step in the voltage across C85 as the charge from C95 is transferred to C85. Between pulses no current reaches the grid circuit and the output voltage does not change.

The steps are repeated for 12 or 13 steps at which time the plate of V86 loses control, the grid of V86 goes negative to plate-current cut-off and the quiescent condition is reached.

If the recurrent mode of operation is used, the arm of the STEPS/FAMILY Control is set to a more positive position. The stepping waveform is developed across a divider consisting of R85,

R91 and R92. As the waveform goes positive, a point will be reached where the voltage from the Step-Control Cathode Follower, V55B, is sufficient to switch the Multivibrator. When this happens C85 is discharged and the Step Generator starts over again. R85 labeled MIN NO CURVES is normally adjusted so the Step Generator will have four steps when the STEPS/FAMILY Control is counterclockwise.

STEP AMPLIFIER DIAGRAM

Input Cathode Follower

The incoming step waveform passes through a level-setting voltage divider, R112, R115 and R120, and into cathode follower V115B. V115A serves as a voltage regulator to regulate the voltage from the unregulated +400 volt supplies used for this stage.

Input Amplifiers

V110 and V135 are common-cathode, phase-splitter amplifiers. The VOLTS/STEP ZERO ADJ Control, R105, sets the grid level of V110 to balance the amplifier so the zero bias trace does not shift as the VOLTS/STEP Control is rotated. C125 and C126 reduce the bandwidth of this stage to maintain stability with the large amount of feedback used.

Output Amplifiers

The Output Amplifiers, V150A and V150B, amplify the waveform and reconvert it to single-ended output. The network including the neon diode B170 reduces the dc level of the signal at the grid of V150 without attenuation of the signal.

Output Cathode Follower

The Output Cathode Follower, V180, provides the necessary low impedance to drive the grid of the device being tested. The ZERO BIAS switch, SW180, grounds the GRID A or GRID B connector on the test panel to provide a zero-bias reference curve. The TEST POSITION switch connects the output of the Step Amplifier to either the GRID A or GRID B connector on the test panel.

VOLTS/STEP Control

The VOLTS/STEP Control varies the amount of feedback and thus, the gain of the Step

Amplifier is seven fixed steps. This determines the grid-voltage change between the curves in the display.

Grid-Current Measurement

In order to measure grid current in the device being tested, the grid current must flow through the current measuring circuits. Any current used to operate the Step Amplifier must be kept separate. To do this the Output Cathode Follower is supplied with plate and cathode voltage from an ungrounded or Floating Power Supply. The only path through which current will flow from ground into this power supply is from grid to cathode in the device being tested and through the current-measuring resistors.

Since the Input Cathode Follower is connected to the Output Cathode Follower by the feedback resistors, it is also connected to the Floating Power Supply.

HORIZONTAL AMPLIFIER

VOLTS/DIV. Switch

The Input Cathode Follower, V215, presents a high impedance to the circuits being measured and a low impedance to the part of the VOLTS/DIV switch in its cathode circuit. Part of the attenuation of the VOLTS/DIV switch is placed in the grid circuit so that the input voltage will not exceed the capabilities of the Input Cathode Follower. This attenuator in the grid circuit is switched so that the current it draws will not be measured by the current measuring circuits in any position of the PLATE-SCREEN-GRID switch.

The VOLTS/DIV BAL Control R214, adjusts the dc level on the grid of cathode follower V210. This control is set so there is no shift of the zero-voltage line as the VOLTS/DIV Control is rotated. The VOLTS/DIV CAL Control compensates for the loading effect of the attenuator on the cathode follower.

Amplifiers

The first amplifiers, V240 and V241, are common-cathode, phase-splitter amplifiers. The bandwidth of this stage is limited by C242 for stability with feedback. The second stage, V245A and V245B, provides additional gain to drive the crt deflection plates. The HORIZ

GAIN ADJ Control adjusts the overall gain by varying the amount of feedback. The HORIZONTAL POSITIONING Control positions the trace by varying the voltage on the grid at V241. Wafers 3R of the PLATE-GRID selector, SW205, positions the beam to the right in the GRID position.

CRT-DISPLAY SWITCHING DIAGRAM

The CRT-Display Switching diagram shows the PLATE-SCREEN-GRID Control in detail with the associated circuitry shown in block form. The PLATE-GRID Control and the VOLTS/DIV attenuator resistor are shown in the horizontal-amplifier block to show the path of the load current drawn by this resistor.

The Floating, unregulated, Power Supply shown at the left of the diagram is an auxiliary power supply. Its only return to ground is through SW510-5R which connects it to the current measuring resistors in the GRID and SCREEN positions of this switch.

In the GRID position of the PLATE-SCREEN-GRID selector, the Floating Power Supply is connected to circuits in the Step Amplifier which supply current to the grid of the device under test. In the SCREEN position of the PLATE-SCREEN-GRID selector, the Floating Power Supply is connected to the +DC-circuit series regulator and the current which flows through the current measuring resistors in screen current. In the PLATE position of the PLATE-SCREEN-GRID selector, the Floating Power Supply remains connected to the series regulator, but it is now disconnected from the current measuring resistors and grounded by SW510.

The Plate-Sweep Generator is also an ungrounded supply. It is connected to the current measuring resistors in the PLATE position of the PLATE-SCREEN-GRID selector by SW510-5R. In the other two positions of this switch the Plate-Sweep Generator is grounded.

The Horizontal Amplifier is connected to the plate or the grid of the device under test by the PLATE-GRID selector. If the VOLTS/DIV attenuator resistors were grounded, current drawn by this resistor would pass through the current measuring resistors of the Vertical Amplifier. To avoid this, a section of the

PLATE-GRID selector connects the ground return back to appropriate places on the PLATE-SCREEN-GRID selector.

VERTICAL AMPLIFIER DIAGRAM

MA/DIV Switch

The MA/DIV switch selects the resistance to ground in the current measuring circuit and thus selects the sensitivity of the measurement. The grid of the Input Amplifier, V281, is connected to R255 instead of the arm of the switch to prevent any error that might be caused by contact resistance. R254 maintains a current path at all times as the switch is rotated between positions. Fuse F255 added at serial number 5001-up protects the high value resistors in the attenuator but is shorted out in the high-current positions of the switch.

Amplifiers

The Input Amplifiers, V281 and V280, are common cathode, phase-splitter amplifiers. R270 positions the crt display vertically by varying the voltage on the grid of V280. C280 limits the bandwidth of the input stage to maintain stability with the feedback used. The VERT GAIN ADJ Control varies the gain by changing the amount of negative feedback. The Output Amplifiers provide the additional gain necessary to drive the crt deflection plates.

Plate-Sweep and Meter Circuit Diagram

Transformer

The plate-sweep transformer, T310, is supplied from taps on the primary of the main power transformer, T401. Both primary and secondary windings are shielded to provide maximum control over capacitive currents. The PLATE TRANS CURRENT BALANCE Control, C315, balances the stray capacitances to ground which are associated with this winding. These currents would otherwise flow in the current measuring circuits.

SERIES LOAD Control

Full-wave rectification of the incoming sinusoidal waveform occurs in V315 and V316. The resulting waveform is applied to the plate of the tube under test by way of the SERIES LOAD switch. In the 300 ohm position of this

switch, the transformer and rectifiers provide the resistance. Since the rectifiers are non-linear, this resistance varies from more than 30 ohms at low current to less than 200 ohms at maximum current.

Capacitive Current Balance

The Current-Balance Cathode Follower compensates for capacitive current to ground in the SERIES LOAD switch and associated wiring. The plate sweep waveform is applied to the grid of the cathode follower by divider R316 and R317. Current is then added to the negative return lead by C310 and C311 which is opposite in phase to that drawn by the stray capacitance. C311 can be adjusted so no capacitive current flows in the current measuring resistors.

Meter Circuit

The Meter Circuit consists of a 200 μ a meter from serial number 101 to 5120 and a 1 ma meter from serial number 5121 and up. The Meter Circuit also has associated multiplying resistors along with the meter. The INDICATION switch selects either the +DC, -DC or HEATER supplies for application to the meter. The heater voltage is taken from fixed taps on the heater transformer and rectified in D350 and D351. The meter indicates heater voltage as a percentage of the voltage selected by the HEATER switch.

"MAIN" POWER SUPPLY DIAGRAM

Transformer

The "main" power transformer, T401, supplies plate and heater power to all circuitry in the instrument except the floating supply tubes and circuitry. The two primary windings can be connected in series for 234-volt operation or in parallel for 117-volt operation. One primary winding is tapped to supply the voltage required by the plate-sweep transformer.

Negative Supplies

Terminals 7 and 9 connect to V405 in a full-wave circuit to supply voltage to the negative 150 volt supply. A gas-diode Voltage-Reference Tube, V407, establishes the reference voltage for the -150 volt supply. This reference voltage is applied to the cathode of a Comparator

Tube, V410, and is compared with the voltage on a divider connected between the -150-volt bus and ground. R413, labeled -150 ADJ, determines the percentage of voltage that appears at the grid of V410 and thereby determines the total voltage across the divider.

Any variation from the normal grid-to-cathode voltage on V410 appears as an amplified error signal at the plate. This error signal is applied to the grid of the Series Regulator Tube, V412. This dc-coupled error signal controls the plate resistance of the series regulator tube, changing it in the proper direction to compensate for any change in output voltage. C412 increases the ac gain of the feedback loop to reduce the ripple.

V403 is connected in a full wave circuit with its output added to the -150-volt supply to provide a -300-volt unregulated supply. This supply is used to supply other circuits which are insensitive to voltage variations.

Positive Supplies

V483 and V484 supply +400 volts, unregulated, to the positive-voltage supplies and other circuits which are insensitive to voltage variations.

The -150 volt supply is used as the reference voltage for the positive voltage supplies. In the +300 volt supply, the voltage at the junction of R492 and R493, which is located between +300 volts and -150 volts, is compared with ground potential in the Comparator Tube, V489. The amplified error signal is applied to the Series Regulator Tube, V495. R496 reduces the current through the series tube. C492 increases the ac gain of the feedback loop.

The +100 volt supply is similar to the +300 volt supply with V470B as the Comparator Tube and V470A as the Series Regulator.

FLOATING POWER SUPPLY DIAGRAM

Transformer

Transformer T501 supplies plate and heater voltage for the Floating Power Supply. Shields are used around the windings to minimize the effects of capacitive currents.

Non-Regulated Supplies

V505 and V506 supply +400 volts and -300 volts with respect to the common lead. This supply is sometimes grounded directly and at other times connected to the current-measuring resistors as shown on the CRT-Display Switching Diagram. C502 balances the stray capacitive current to ground so that this current does not flow through the current measuring resistors.

+DC Circuit

The +DC Circuit receives +400 volts and -300 volts, unregulated, from either the Main Power Supply or the Floating Power Supply. This is determined by the setting of the PLATE-GRID switch shown in the CRT-Display Switching Diagram. The output of the +DC circuit is variable from approximately +10 volts to +300 volts.

Screen voltage for the Series Regulator Tube, V515, is obtained from the full-wave rectifier, V510. C510A and C510B with R510 reduce the ac ripple on the screen. The negative side of the supply is tied to the cathode of V515 so that the screen to cathode voltage remains the same as the output voltage is changed. C509 balances the capacitive current to ground in the circuit which supplies screen voltage for V515.

Reference voltage for V525B is obtained from the +DC VARIABLE Control which is connected between -150 volt supply and +100V. V540B isolates the reference voltage supply from the Series Regulator so that no current will flow between the two circuits. V525A and V525B are Comparator Tubes. The voltage at a tap on the divider between the output of the Series Regulator

and the reference voltage are compared with ground potential. The amplified error signal at the plate of V525B is applied to the grid of the Series Regulator Tube, V515. B515 and B516 reduces the dc level of signal at this grid without attenuation of the signal.

The +DC switch changes the divider ratio in the divider at the grid of the comparator tube, V525B. The +DC VARIABLE Control changes the reference voltage at the bottom of this divider through V540B. These two controls provide continuous variation of the output of the regulator from approximately +10 volts to +300 volts.

CRT CIRCUIT DIAGRAM

Accelerating voltage for the cathode-ray tube is obtained by rectifying a 60-kc voltage produced by a vacuum tube oscillator. V610 is the oscillator tube with the primary of T620 serving as a tapped inductor. Rectifiers V630 and V631 supply -1700 volts to the crt cathode and +2300 volts to the post acceleration anode for a total of 4 kv accelerating voltage.

The high voltage is adjusted by means of R626 in the regulator circuit. The voltage at this point is compared with -150 volts in V605A. The amplified error signal is applied to the grid of the Shunt Regulator Tube, V605B, which varies the screen voltage of the oscillator tube.

The INTENSITY, FOCUS, and ASTIGMATISM Controls adjust the crt operating voltages for the desired intensity and focus the beam. The GEOM ADJ Control adjusts the voltage on the second anode of the crt for best linearity at the extremes of deflection.

SECTION 4

MAINTENANCE

PREVENTIVE MAINTENANCE

Air Filter

Care must be taken to assure free ventilation of the Type 570 inasmuch as some of the components are operated at dissipation levels such that excessive interior temperatures will result without adequate air circulation. To assure free passage of air the instrument must be placed so that the air intake is not blocked and the filter must be kept clean. Moreover, the side panels and bottom cover must be in place for proper air circulation. Do not remove the covers except during maintenance.

A washable EZ KLEEN filter is used at the air intake part of the instrument. Under normal operating conditions the filter should be inspected and cleaned if necessary every three to four months. More frequent inspection is required when the operating conditions are more severe.

The following cleaning instructions are issued by the filter manufacturer:

- (1) If grease or dirt load is light, remove filter from installation and rap gently on hard surface to remove loose dirt. Flush remaining dirt or grease out of filter with a stream of hot water or steam.
- (2) If load is too heavy for treatment described in (1), prepare mild soap or detergent solution in pan or sink deep enough to cover filter when laid flat. Agitate filter up and down in solution until grease or dirt is loosened and floated off.
- (3) Rinse filter and let dry.
- (4) Dip or spray filter with fresh Filter Coat or Handi-Coater. These products are available from the local representative of the Research Products Corporation and from most air conditioner suppliers.

Fan Motor

The fan motor bearings should be lubricated every three or four months with a few drops

of light machine oil. Failure to lubricate the bearings periodically will cause the fan to slow down or stop, thereby causing the instrument to overheat.

Visual Inspection

You should visually inspect the entire oscilloscope every few months for possible circuit defects. These defects may include such things as loose or broken connections, damaged banana jacks, improperly seated tubes, scorched wires or resistors, or broken terminal strips. For most visual troubles the remedy is apparent; however, particular care must be taken when heat-damaged components are detected. Overheating of parts is often the result of other, less apparent, defects in the circuit. It is essential that you determine the cause of overheating before replacing heat-damaged parts in order to prevent further damage.

Soldering and Ceramic Strips

Many of the components in your Tektronix instruments are mounted on ceramic terminal strips. The notches in these strips are lined with a silver alloy. Repeated use of excessive heat, or use of ordinary tin-lead solder will break the silver-to-ceramic bond. Occasional use of tin-lead solder will not break the bond if excessive heat is not applied.

If you are responsible for the maintenance of a large number of Tektronix instruments, or if you contemplate frequent part changes, we recommend that you keep on hand a stock of solder containing about 3% silver. This type of solder is used frequently in printed circuitry and should be readily available from radio-supply houses. If you prefer, you can order the solder directly from Tektronix in one pound rolls. Order by Tektronix part number 251-514.

Because of the shape of the terminals on the ceramic strips it is advisable to use a wedge-shaped tip on your soldering iron when you

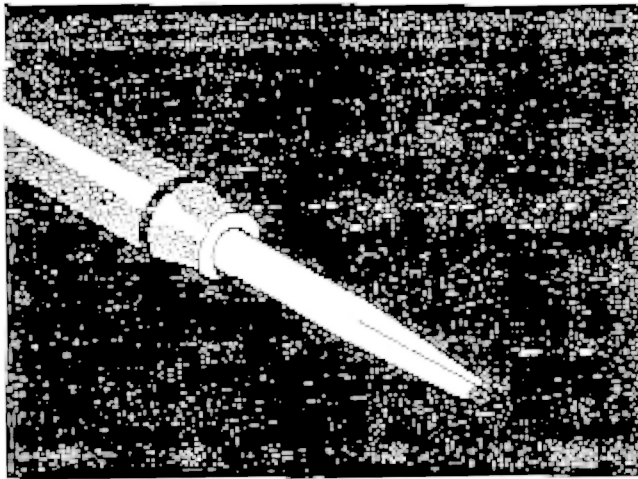

Fig. 4-1. Soldering iron tip properly shaped and tinned.

are installing or removing parts from the strips, Fig. 4-1 will show you the correct shape for the tip of the soldering iron. Be sure to file smooth all surfaces of the iron which will be tinned. This prevents solder from building up on rough spots where it will quickly oxidize.

When removing or replacing components mounted on the ceramic strips you will find that satisfactory results are obtained if you proceed in the manner outlined below.

1. Use a soldering iron of about 75-watt rating.
2. Prepare the tip of the iron as shown in Fig. 4-1.
3. Tin only the first 1/16 to 1/8 inch of the tip. For soldering to ceramic terminal strips tin the iron with solder containing about 3% silver.

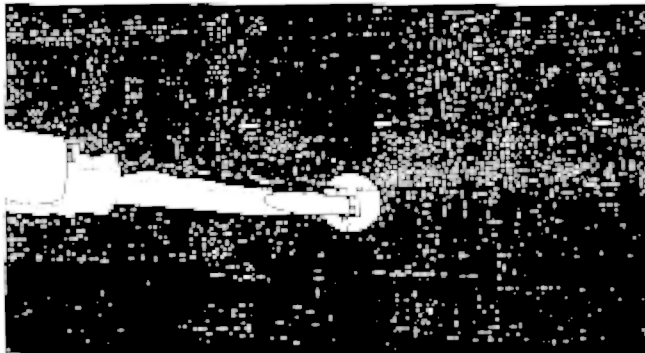

Fig. 4-2. Correct method of applying heat in soldering to a ceramic strip.

4. Apply one corner of the tip to the strip where you wish to solder (see Fig. 4-3).

5. Apply only enough heat to make the solder flow freely.

6. Do not attempt to fill the notch on the strip with solder; instead, apply only enough solder to cover the wires adequately, and to form a slight fillet on the wire as shown in Fig. 4-3.

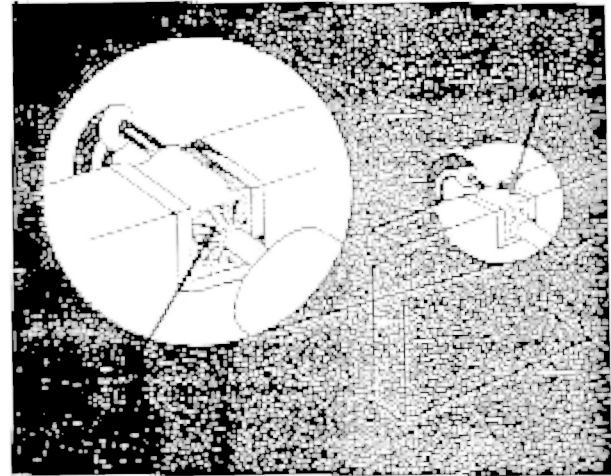

Fig. 4-3. A slight fillet of solder is formed around the wire when it is applied correctly.

In soldering a metal terminal (for example pins on a tube socket) a slightly different technique should be employed. Prepare the iron as outlined above, but tin with ordinary tin-lead solder. Apply the iron to the part to be soldered as shown in Fig. 4-4. Use only enough heat to allow the solder to flow freely along the wire so that a slight fillet will be formed as shown in Fig. 4-4.

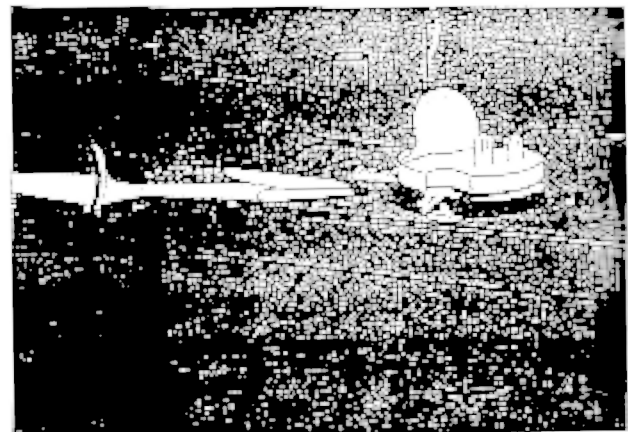

Fig. 4-4. Soldering to a terminal. Note the slight fillet of solder exaggerated for clarity—formed around the wire.

General Soldering Consideration

When replacing wires in terminal slots clip the ends neatly as close to the solder joint as possible. In clipping the ends of wires take care the end removed does not fly across the room as it is clipped.

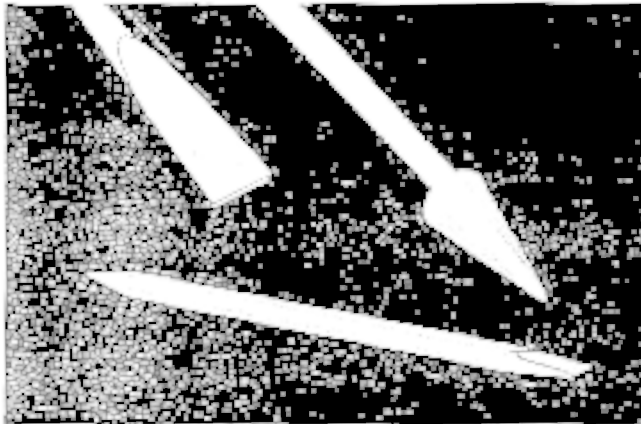

Fig. 4-5. A soldering aid constructed from a 1/4 inch wood dowel.

Occasionally you will wish to hold a bare wire in place as it is being soldered. A handy device for this purpose is a short length of wood dowel with one end shaped as shown in Fig. 4-5. In soldering to terminal pins mounted in plastic rods it is necessary to use some form of "heat sink" to avoid melting the plastic. A pair of long-nosed pliers (see Fig. 4-6) makes a convenient tool for this purpose.

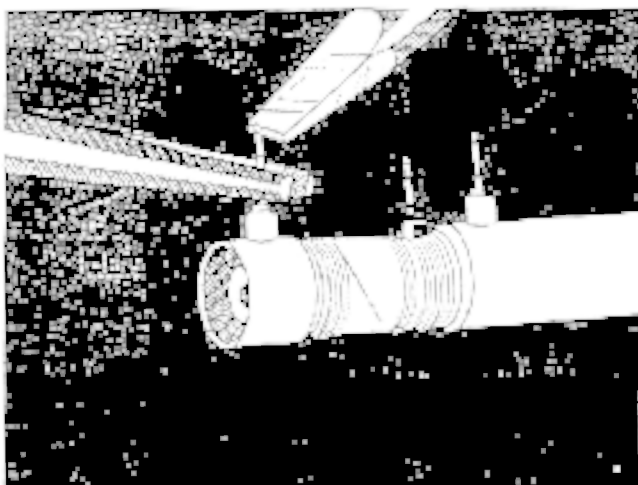

Fig. 4-6. Soldering to a terminal mounted in plastic. Note the use of the long-nosed pliers between the iron and the coil form to absorb the heat.

Ceramic Strips

Two distinct types of ceramic strips have been used in Tektronix instruments. The earlier type mounted on the chassis by means of #2-56 bolts and nuts. The later type is mounted with snap-in, plastic fittings. Both styles are shown in Fig. 4-7.

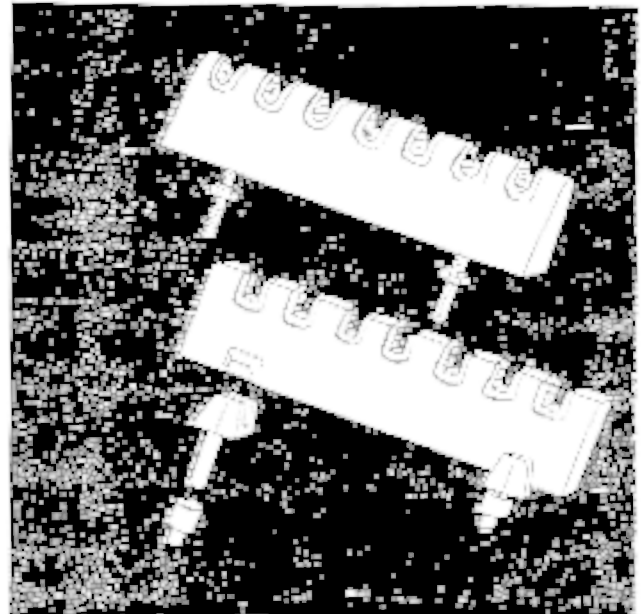

Fig. 4-7. Two types of ceramic strip mounting.

To replace ceramic strips which bolt to the chassis, screw a #2-56 nut into each mounting bolt, positioning the bolt so that the distance between the bottom of the bolt and the bottom of the ceramic strip equals the height at which you wish to mount the strip above the chassis. Insert the bolts through the holes in the chassis where the original strip was mounted, placing a #2 star-washer between each nut and the chassis. Place a second set of #2 flat-washers on the protruding ends of the bolts, and fasten them firmly with another set of #2-56 nuts.

Mounting Later Ceramic Strips

To replace strips which mount with snap-in plastic fittings, first remove the original fittings from the chassis. Assemble the mounting post on the ceramic strip. Insert the nylon collar into the mounting holes in the chassis.

Carefully force the mounting post into the nylon collars. Snip off the portion of the mounting post which protrudes below the nylon collar on the reverse side of the chassis.

NOTE

Considerable force may be necessary to push the mounting rods into the nylon collars. Be sure that you apply this force to that area of the ceramic strip directly above the mounting rods.

TROUBLESHOOTING

This section of the manual contains information for troubleshooting your oscilloscope. Before attempting to troubleshoot the instrument, however, make sure that any apparent trouble is actually due to a malfunction within the instrument and not to improper control settings. Instructions for the operation of the oscilloscope are contained in the Operating Instructions section of this manual.

If your Type 570 Oscilloscope fails to operate, make sure that it is properly connected to a source of power. If the pilot lamp on the front panel, and the fan at the rear of the instrument, do not come on when the instrument is turned on, check the source of power, the power cord connections and the power line fuse.

If the instrument is turned on, but no spot or trace is visible on the crt, check the POSITION and INTENSITY controls. Be sure that the signal is not driving the beam off the screen.

Troubles are usually caused by tube failure, and you can frequently correct them by finding the bad tube and replacing it with a good one. However sometimes a tube burns up resistors or overstresses capacitors when it fails. In these cases you will also have to find the bad components. Sometimes you can find them by visual inspection. One way to find bad tubes is to try replacing suspected tubes with good ones. If possible, replace all suspected tubes at one time, and if the trouble is eliminated, return the old tubes, one at a time, until the offending one is discovered.

Although your Type 570 Oscilloscope is a complex instrument, it can be conveniently divided into basic circuits, as shown on the

Block Diagram. The first circuits to check, for practically any type of trouble, are the low-voltage power supplies. Proper operation of every circuit in the Type 570 Oscilloscope depends on proper operation of the regulated and unregulated power supplies.

All the regulated supplies should be within five per cent of their rated values and should remain steady as the line voltage is varied from 105 to 125 volts or 210 to 250 volts. See the Calibration Procedure for the low-voltage power supply test points.

WARNING

Be careful of the power-supply voltages. The lower-voltage buses are considerably more dangerous than the high voltages in the crt circuit, due to the higher current capabilities and the larger filter capacitors used.

All low-voltage power supply capacitors should be discharged prior to working on the instrument. This procedure must be used when working around or on the Floating Power Supply.

The cathode-ray tube display can help in locating the source of trouble. If there is a horizontal trace on the crt but no vertical deflection, check the Plate Sweep Generator and Vertical Amplifier fuses in the top access panel or on the front panel, depending upon serial range of instrument.

If no spot is visible check the positioning controls. Then advance the INTENSITY Control to see if there is a glow indicating a spot positioned off the crt. If no spot can be obtained short the horizontal deflection plates together and the vertical plates together. If no spot is obtained check the high voltage power supply and the crt.

If the spot is returned to the screen by shorting the deflection plates, check the deflection amplifier concerned.

If an abnormal display is obtained on the crt, the Block Diagram along with the knowledge of how the instrument works, will enable the trouble producing circuit to be determined. The

areas for the different circuits will be found printed on the chassis.

Heater-to-cathode leakage in certain critical tubes will cause vertical hum, especially in the more sensitive positions of the MA/DIV switch. If this appears only in the PLATE position of the PLATE-SCREEN-GRID selector the most likely tubes are V315 and V316 in the Plate-Sweep Generator. If it appears only in the GRID position of the PLATE-SCREEN-GRID

selector, suspect V115 or V180 in the Step Amplifier.

NOTE

After servicing the Type 570 Oscilloscope, it is important to check its calibration. For this, refer to the Calibration Procedure section of this manual.

SECTION 5

CALIBRATION PROCEDURE

The instrument should not require frequent recalibration, but occasional adjustments will be necessary when tubes and other components are changed. Also, a periodic calibration is desirable from the standpoint of preventative maintenance.

Apparent troubles occurring in the instrument are often actually the result of improper calibration of one or more circuits. Consequently this section of the manual should be used in conjunction with the Maintenance section during troubleshooting work.

In the instructions that follow, the steps are arranged in the proper sequence for a complete calibration of the instrument. Each numbered step contains the information required to make one adjustment or a series of related adjustments.

In each calibration step only the required information is given. Controls are assumed to be set at the positions they were in during the previous step unless specific instructions are given to change their settings. All jumpers are disconnected at the end of each step unless instructions are given to the contrary.

It will be necessary for you to refer to the calibration steps immediately preceding the adjustment you wish to make to determine the proper settings for the controls not mentioned in that step. Due to the interaction between adjustments in the horizontal and vertical amplifiers, single adjustments in these circuits usually cannot be made. When amplifier adjustments are required, the entire amplifier should be calibrated. In addition, if either the 150 volt supply or the high voltage power supply is adjusted, the entire instrument must be calibrated.

If you find that a circuit is out of calibration, but you are not aware of which particular adjustment will correct the difficulty, it is usually best to calibrate the entire circuit.

Equipment Required

The following equipment or its equivalent is necessary for a complete calibration of the Type 570 Oscilloscope.

1. DC voltmeter (sensitivity of at least 5000 ohms per volt) with corrected readings within 1% for 100, 150, 300 and 400 volts and within 3% of 1700 volts. Be sure your meter is accurate; few portable test meters have the required accuracy, particularly after a period of use.
2. Accurate rms-reading ac voltmeter, 0-150 volts (0-250 or 0-300 volts for 210- to 250-volt operation).
3. Variable autotransformer, having a rating of at least 500 watts.
4. Oscilloscope, Tektronix Type 503 or 504. If a Type 503 or 504 Oscilloscope is not available, it will be necessary to substitute an oscilloscope with the following specifications: (1) calibrated vertical deflection factors from .01 to 10 volts per division and (2) bandwidth of dc to 500 kilocycles.
5. Jumpers, 6 inch with banana plugs.
6. Socket adapter plate, miniature 9 pin.
7. 6U5 vacuum tube.
8. Alignment tool. See figure 5-1.

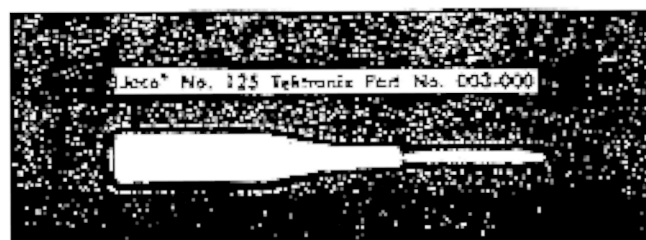

Fig. 5-1. Tool required for calibrating the Type 570 Oscilloscope.

9. 1% resistors making up the values of 495k-1w, 197k-1w, 100k-1w, 50k-1w, 20k-1w, 10k-1w, 5k-2w, 2k-5w and 1k-5w.

10. Ohmmeter with 0-1k, 0-10k and 0-100k scales.

Preliminary

Preset the front-panel controls of the Type 570 as follows:

FOCUS	counterclockwise
INTENSITY	counterclockwise
ASTIGMATISM	counterclockwise
RANGE DC VOLTS	140
INDICATION	± DC
STEPS/FAMILY	midrange
STEPS/SEC	120 counterclockwise
START ADJUST	midrange
VOLTS/STEP	1
PLATE-SCREEN-GRID	PLATE
MA/DIV	1
PLATE-GRID	PLATE
VOLTS/DIV	1
POSITIONING (VERTICAL and HORIZONTAL)	midrange
PEAK VOLTS	100
SERIES LOAD	10k
HEATER	6.5
HEATER VARIABLE	counterclockwise
+DC	100
+DC VARIABLE	clockwise
-DC	counterclockwise
POWER-MAIN	OFF
POWER-TEST	ON
TEST POSITION	OFF

Before applying power to the instrument the resistances of the power supplies should be checked. The typical resistances of the supplies may be found in the chart below.

Also check the -150 27k test panel connector for 27k between the test panel connector and the -150 volt supply.

Connect the power cord and the ac voltmeter to the output of the autotransformer. Turn the POWER-MAIN to the ON position and adjust the autotransformer for an output of 117 volts (or 234 volts). Allow the instrument to warm up for several minutes before proceeding

with the calibration adjustments. During calibration, periodically check the input voltage to the instrument and adjust the autotransformer as necessary to maintain the voltage at 117 or 234 volts except when the power supply regulation is being checked.

NOMINAL RESISTANCES OF POWER SUPPLIES	
POWER SUPPLY	APPROX. RESISTANCE TO GROUND
-150v	10k
+100v	20k
+300v	30k
+400v	30k
FLOATING POWER SUPPLY	
+400v	100k or higher
-300v	100k or higher

CAUTION

Do not reset the -150 ADJ Control unless you are planning to perform a complete calibration of the instrument.

1. Low-Voltage Power Supplies

Connect the dc voltmeter between the +DC connector on the test panel and ground. Set the -150 ADJ for exactly a reading of +100 volts on the voltmeter. Now connect the voltmeter to the -150 volt test point. If the -150 volt reading is not within 2% of -150 then R536 must be paralleled by R537, a selected value.

R537 is selected so that when the -150 ADJ is set for exactly a reading of -100 volts, the 150 volt supply will be within 2% of being -150 volts.

Check to see that the +100 and +300 volt regulated power supplies are within 2% of the proper voltage. Under no condition is the -150 ADJ to be reset after the adjustment described above.

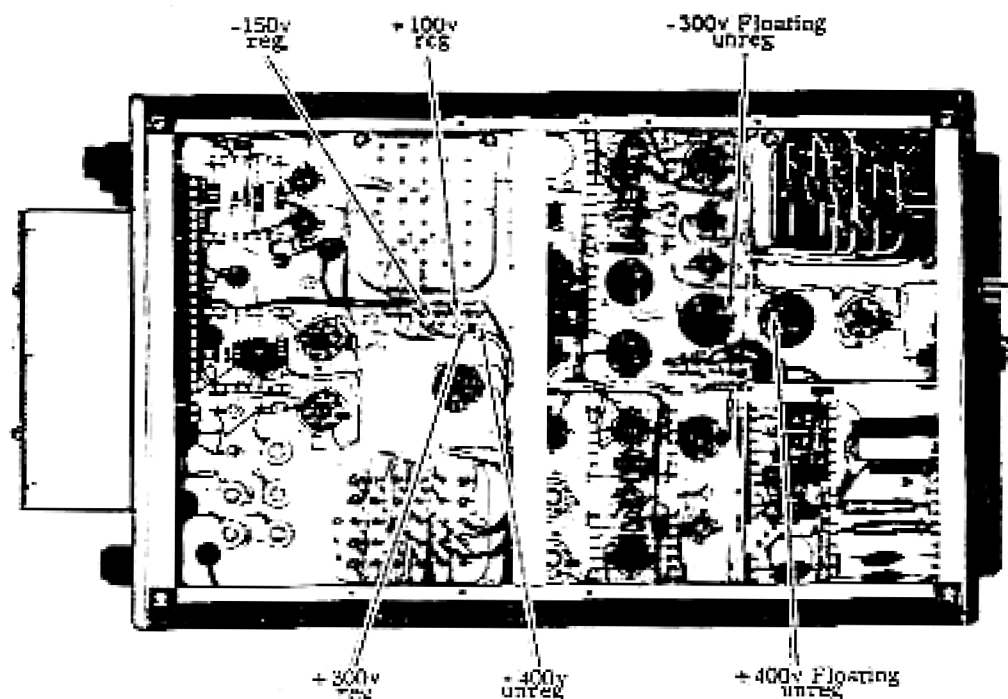

Fig. 5-2 Low-Voltage Power Supply test points.

Now check the +400 volt unregulated supply of the Power Supply and the +400 and -300 volt unregulated supplies of the Floating Power Supply. The unregulated supplies should be within 5% of the proper voltage.

Vary the output of the autotransformer between 105 and 125 volts (or between 210 and 250 volts) to check the regulation of the low voltage power supplies. The power supplies must regulate within 2% (regulated) or 5% (unregulated) of their correct voltages.

TYPICAL RIPPLE AMPLITUDES	
POWER SUPPLY	TYPICAL RIPPLE
-150v	5mv +50% at 105 and 125v
+100v	5mv +50% at 105 and 125v
+300v	30mv +50% at 105 and 125v
+400v	4.5v +50% at 105 and 125v
FLOATING POWER SUPPLY	
+400v	.5v +50% at 105 and 125v
-300v	.5v +50% at 105 and 125v

Using the test oscilloscope, check the ripple voltage at the output of each power supply when the autotransformer is adjusted for 117 volts. Swing the autotransformer output voltage from 105 volts to 125 volts while observing the amount of ripple. It should remain about the same amplitude from low line to high line voltage. Return the line voltage to 117 volts.

2. HV Adjustment

While the Type 570 Oscilloscope is still in a position for access to the underside, the HV will be set. Connect the voltmeter to the high-voltage test point shown in figure 5-3. Adjust the H V ADJ until a reading of -1700 volts is obtained.

The high-voltage regulation is checked by observing the voltage reading while changing the line voltage from 105 to 125 volts. If the reading shows a drop or rise then the high-voltage supply is not regulating properly. Improper regulation will probably be cured by changing V605.

3. Checking +DC Circuit range and Meter accuracy

Connect the accurate voltmeter between the

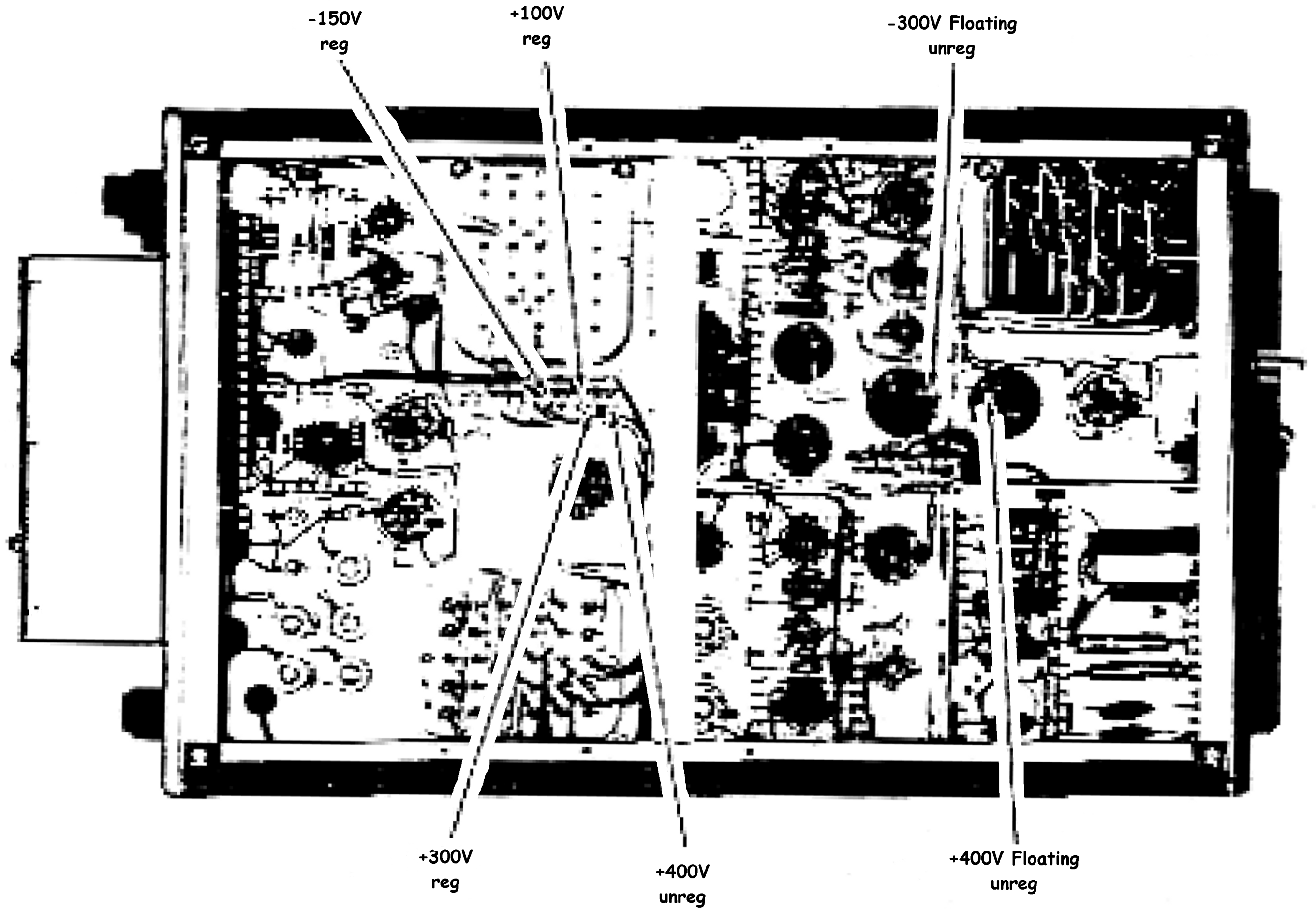

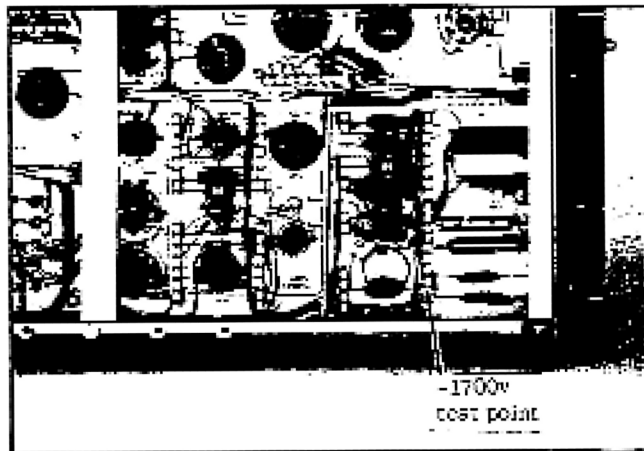

Fig. 5-3. High Voltage test points.

+DC connector on the test panel and ground. Set the +DC Control and the RANGE DC VOLTS Control as called out in the table below.

Using the +DC VARIABLE Control, set the voltage of the +DC connector on the test panel to the value called out in the table. The voltage is set to the proper value by using the accurate voltmeter connected to the +DC connector on the test panel. After the voltage is set then the reading of the meter mounted on the Type 570 is compared to that of the accurate voltmeter. The meter mounted on the Type 570 should not be off the proper reading by more than 2% in any of its ranges.

METER ACCURACY CHECK		
Voltage at +DC Connector (test panel)	+DC Control	RANGE DC VOLTS Control
300v	300	700
300v	300	350
200v	200	350
100v	100	350
100v	100	140
70v	100	140
70v	100	70
35	50	70
35	50	35
14	20	35
14	20	14
7	20	14
7	20	7

NOTE

If the +DC VARIABLE will not reduce the output of the +DC connector to 7 volts then change V540B. By changing this tube it is usually possible to obtain a 7 volt output or less.

4. -DC Control Check

Connect the accurate voltmeter between ground and the -DC connector on the test panel. Turn the -DC Control clockwise and make sure that the voltage output of the -DC connector goes from 0 to -100 volts.

5. Grid A, Grid B and -150 27 k Connector check

Connect the voltmeter between the GRID A connector and ground, the voltmeter should read approximately -108 volts. Now move the TEST POSITION switch to GRID B. The voltmeter should still read -108 volts.

Remove the voltmeter lead from the GRID A connector and connect it to the GRID B connector on the test panel. Move the TEST POSITION switch to the OFF position, the voltmeter will now read approximately -108 volts. Now move the TEST POSITION switch to GRID A position, the voltmeter will once again show the approximate -108 volt reading.

After checking the GRID A and GRID B connectors on the test panel, move the voltmeter lead from the GRID B connector and connect it to the -150 27k connector on the test panel. The voltmeter should read -150 volts from this connector.

6. CRT Alignment

Set the INTENSITY Control to a usable level. Adjust the FOCUS and ASTIGMATISM Controls for a focused spot. Now switch the VOLTS/DIV Control to 10. This will result in a horizontal line across the face of the crt. With the VERTICAL POSITIONING Control, position the line under one of the horizontal graticule lines.

Crt adjustment SN 101-5199

If the trace and graticule line do not coincide over the length of the graticule, loosen

the crt base clamp and rotate the tube with the alignment ring. When the trace and the graticule line are in coincidence, push the tube forward so that it rests snugly against the graticule. Then tighten the crt base clamp. Recheck the alignment after tightening the clamp to be sure it didn't move while the clamp was being tightened.

CRT adjustment SN 5200-up

Loosen the clamp at the base of the crt and push the crt against the graticule, then tighten the clamp. Now with the red knob, near the bottom of the clamp, rotate the crt until the trace runs parallel to the horizontal lines of the graticule.

7. Adjusting PHASE A and B and setting CRT GEOM ADJ Control

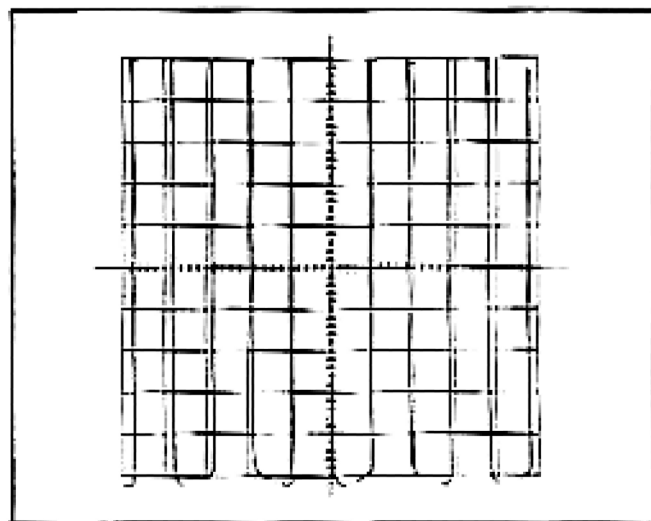

Fig. 5-4. The waveform obtained in the 240 position of the STEPS/SEC Control, which is used to adjust the CRT GEOM ADJ Control.

Set the PLATE-GRID Control to GRID, the VOLTS/DIV Control to 1 and connect a jumper from the P connector on the test panel to ground. Adjust the STEPS/FAMILY Control for 10 vertical lines. Adjust the PHASE A Control for the flattest bottom on the waveform. Now turn the STEPS/SEC Control to the 120 clockwise position and adjust the PHASE B Control for the flattest top on the waveform. Turn the STEPS/SEC Control to the 240 position and check for alternate switching, see figure 5-4.

Using the display obtained in the 240 position of the STEPS/SEC Control, adjust the CRT

GEOM ADJ Control for minimum curvature of the vertical lines at the sides of the crt.

Disconnect the jumpers.

8. Checking Vertical Tube Balance

When the VERTICAL POSITIONING Control is in its midrange position the dots should be between the second and fourth division line as measured from the bottom full graticule line. If the dots do not lie in this area then V280 and V281 should be changed until the near balanced condition is obtained.

9. VERT GAIN Adjustment and Checking MA/DIV Switch

Turn the PLATE-SCREEN-GRID Control to SCREEN, the RANGE DC VOLTS Control to 140 and the INDICATION Control to +DC. On instruments below serial number 5122 turn the MA/DIV Control to .02 while on instruments above serial number 5121 the control is set to 1.

While observing the meter, set the +DC Controls for exactly 140 volts, then switch the INDICATION Control to HTR. Now position the dots to the bottom full graticule line. Switch the INDICATION Control to +DC and adjust the VERT GAIN Control for a deflection of 10 divisions.

Switch back and forth between the +DC and HTR positions of the INDICATION Control to remove interaction in the adjustment. Be sure that the dots are on the bottom graticule line each time you switch after setting the +DC position.

To check the $\pm 3\%$ accuracy of the MA/DIV Control, set the +DC Controls to obtain 100 volts. Be sure to set the INDICATION Control to the HTR position after setting the +DC voltage.

Turn the MA/DIV Control to 50 and position the dots to the bottom full graticule line. Connect the 1k-5w resistor between the +DC connector and ground. The dots will have moved up two divisions. Switch the MA/DIV switch to 20 and check to see that the dots are 5 divisions from the originally set point (the VERTICAL POSITIONING Control is not reset after it is set as above). See the table below for the other settings of the MA/DIV Control.

MA/DIV Accuracy Check

MA/DIV Setting	Resistor Value	Deflection obtained from Bottom Graticule Line
10	1k-5w	10 divisions
5	2k-5w	10 divisions
2	5k-2w	10 divisions
1	10k-1w	10 divisions
.5	20k-1w	10 divisions
.2	50k-1w	10 divisions
.1	100k-1w	10 divisions
.05	197k-1w	10 divisions
.02	495k-1w	10 divisions

Remove all connectors.

10. Adjusting VOLTS/DIV BAL (located under instrument)

Turn the PLATE-GRID Control to PLATE and connect the P and K connectors on the test panel together. Now rotate the VOLTS/DIV Control and at the same time adjust the VOLTS/-DIV Control for no horizontal movement of the spot on the crt. Disconnect the jumper between the P and K connectors on the test panel.

11. Setting VOLTS/STEP ZERO ADJ.

Turn the PLATE-GRID Control to GRID, the VOLTS/DIV Control to .1 and the START ADJUST Control full counterclockwise. With a jumper ground pin 8 of V115. While pressing the ZERO BIAS button position the spot under the center vertical graticule line with the HORIZONTAL POSITIONING Control. Release the ZERO BIAS button and return the spot under the center vertical graticule line with the VOLTS/STEP ZERO ADJ Control. Disconnect the jumper between ground and pin 8 of V115.

12. Setting the Knob Position of the START ADJUST (SN 5200-up)

Press the ZERO BIAS button in and set the spot under a convenient reference line on the graticule. Release the ZERO BIAS button and position the start of the dots under the same reference line using the START ADJUST to do the positioning.

The dot on the knob of the START ADJUST should now be pointing at the 0 in the front panel.

If your instrument is below serial number 5002 and you would like to know the start position then do the above procedure and mark the zero on your front panel in pencil or ink.

13. HOR GAIN Adjustment

Turn the PLATE-GRID Control to PLATE, the VOLTS/DIV Control to 10, the MA/DIV Control to 50 and the SERIES LOAD Control to 1M. Adjust the +DC Controls for 100 volts out of the +DC connector on the test panel as explained earlier in this procedure.

Connect a jumper between the P connector on the test panel and ground. Line up the spot under the far left-hand graticule line. Now connect the jumper between the P connector and the +DC connector on the test panel. Adjust the HOR GAIN Control until the spot is under the far right-hand graticule line. Reconnect the jumper to ground and then to +DC several times to remove interaction. Remove the jumper from the test panel.

14. Setting VOLTS/STEP ADJ

Reset the PLATE-GRID Control to GRID, the VOLTS/DIV Control to .1 and the VOLTS/-STEP Control to .1. Adjust the VOLTS/STEP ADJ until there is one dot per graticule division.

15. Adjusting Volts/Div Cal (R227)

Reset the VOLTS/DIV Control to 10 and the VOLTS/STEP Control to 10. Adjust R227 (see Fig 5-8.) for one dot per graticule division.

If R227 does not have enough range of adjustment, reset the crt display for one dot per graticule division, then R228 may be paralleled by a selected resistor R226.

NOTE

Steps 13, 14 and 15 interact, therefore they should be repeated several times.

After the interaction has been eliminated the VOLTS/STEP and the VOLTS/DIV Controls should be checked against each other for a one dot per graticule division display when the switches are set the same value, i.e., 5 and 5.

16. MIN NO CURVES Adjustment, and Maximum Number of Curves and SINGLE FAMILY Button Check

Turn the STEPS/FAMILY Control full counterclockwise and adjust the MINNO CURVES

for 5 dots. Now turn the STEPS/FAMILY Control clockwise and check to see that at least 13 dots can be seen before you enter the area for the SINGLE FAMILY button.

After checking for at least 13 dots continue to rotate the STEPS/FAMILY Control clockwise into the Single Family area. Push the SINGLE FAMILY button and obtain one sweep each time it is pushed. Rotate the STEPS/FAMILY Control counterclockwise until a constant display of dots is once again displayed.

17. Checking HEATER Control and Adjusting AC Volts Adj. (R350)

Connect an accurate ac voltmeter between the two HTR connectors on the test panel. Adjust the HEATER VARIABLE until a reading of 6.3 volts is obtained on the voltmeter. Now turn the INDICATION Control to HTR and while observing the 0-140 volts scale, on the meter of the Type 370, adjust R350 for a meter reading of 100% (100 volt position). Disconnect the ac voltmeter from the HTR connectors on the test panel.

HEATER Setting	VOLTS/DIV Control	Divisions of Deflection
1.25	.2	5.8
1.4	.2	5.9
2.0	.5	5.6
2.35	.5	6.6
2.5	.5	7.0
3.15	.5	5.9
4.2	1	5.9
4.7	1	6.6
5.0	1	7.0
6.3	1	8.9
7.5	2	5.3
12.6	2	8.9
18.9	5	5.3
25	5	7.0
35	5	9.9
50	10	7.0
117	20	8.3

Remove the jumpers from the test panel.

With a jumper connect the P connector on the test panel to ground, and turn the PLATE-GRID Control to PLATE and the VOLTS/DIV Control to 1. Position the spot under the far left hand graticule line. Now change the jumper from ground to the "hot" HTR connector

on the test panel. A horizontal deflection of 8.9 divisions should be obtained.

When checking through the ranges of the HEATER Control, be sure to maintain the heater voltage at 100% as read on the meter of the Type 370. If the voltage is other than 100% it maybe adjusted to 100% with the HEATER VARIABLE Control. The accuracy of the HEATER Control should be within $\pm 5\%$ in all positions.

18. Checking PEAK VOLTS Control

Reset the VOLTS/DIV Control to .5, the PLATE-GRID Control to PLATE and the SERIES LOAD to 300. Check each of the positions of the PEAK VOLTS Control for the proper deflection ($\pm 5\%$) as in the table below.

VOLTS/DIV Control	PEAK VOLTS Control	Divisions of Deflection
.5	5	10
1	10	10
2	20	10
5	50	10
10	100	10
20	200	10
50	300	6
50	500	10

19. Checking SERIES LOAD Resistor Values

Turn off the POWER-MAIN of the Type 370. Connect an accurate ohmmeter between pin 3 of V315 and the P connector on the test panel. Set the SERIES LOAD Control to each position and read the value on the ohmmeter. The values should be within $\pm 5\%$ of the front panel value.

20. Adjusting Plate Sweep (C311) and Plate Trans (C315) Current Balance Capacitors

Reset the following controls:

MA/DIV	.02
VOLTS/DIV	50
PLATE-SCREEN-GRID	PLATE
PLATE-GRID	PLATE
POWER-MAIN	ON
PEAK VOLTS	500
SERIES LOAD	1M

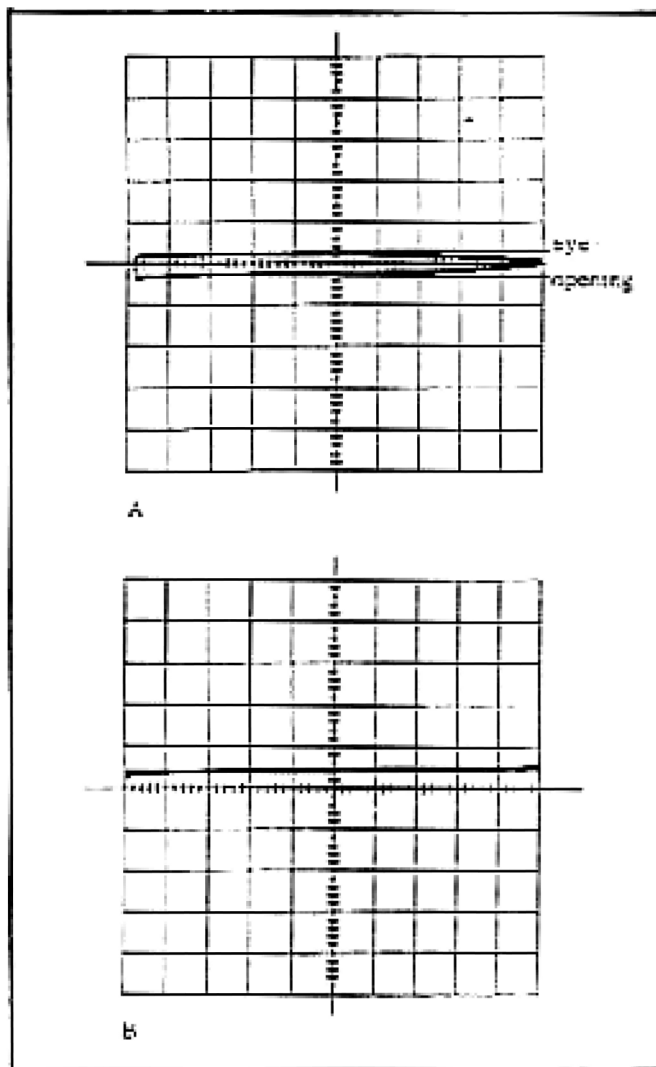

Fig. 1-3. A. The display when both the Current Balancing capacitors are adjusted and connected properly. B. The display with properly connected and adjusted current balancing capacitors.

Allow the instrument to warm up for about 5 minutes. Now observe the eye-opening of the loop on the CRT. If the loop is a straight line then no further adjustment is necessary. If the loop has an eye-opening then one of the following configurations, which brings the loop the closest to a straight line, should be used. The variable capacitors must be adjusted for the smallest eye-opening each time a new configuration is used.

CAUTION

Damage to the instrument may result if an end of C315 and C316 are tied to the same transformer terminal.

T310 Current Balance Capacitor Connections

Configuration	C315	C316
1	Not connected	Connected between terminals 5 and 8
2	Not connected	Connected between terminals 7 and 8
3	Not connected	Not connected
4	Connected to terminal 5	Not connected
5	Connected to terminal 7	Not connected
6	Connected to 5	Connected between terminals 7 and 8
7	Connected to 7	Connected between terminals 5 and 8

21. Adjusting GRID (C502) and SCREEN (C509) Current Balance Capacitors

Turn the PLATE-SCREEN-GRID Control to GRID. C502 is connected and adjusted to give the least eye-opening in the loop.

C502 Connections

Configuration	Connection
1	No connection
2	Lead connected to terminal 14 of T501
3	Lead connected to terminal 16 of T501

Now set the PLATE-SCREEN-GRID Control to SCREEN. Connect and adjust C509 to give the least eye opening.

C509 Connections

Configuration	Connection
1	No connection
2	Lead connected to terminal 7 of T501
3	Lead connected to terminal 9 of T501

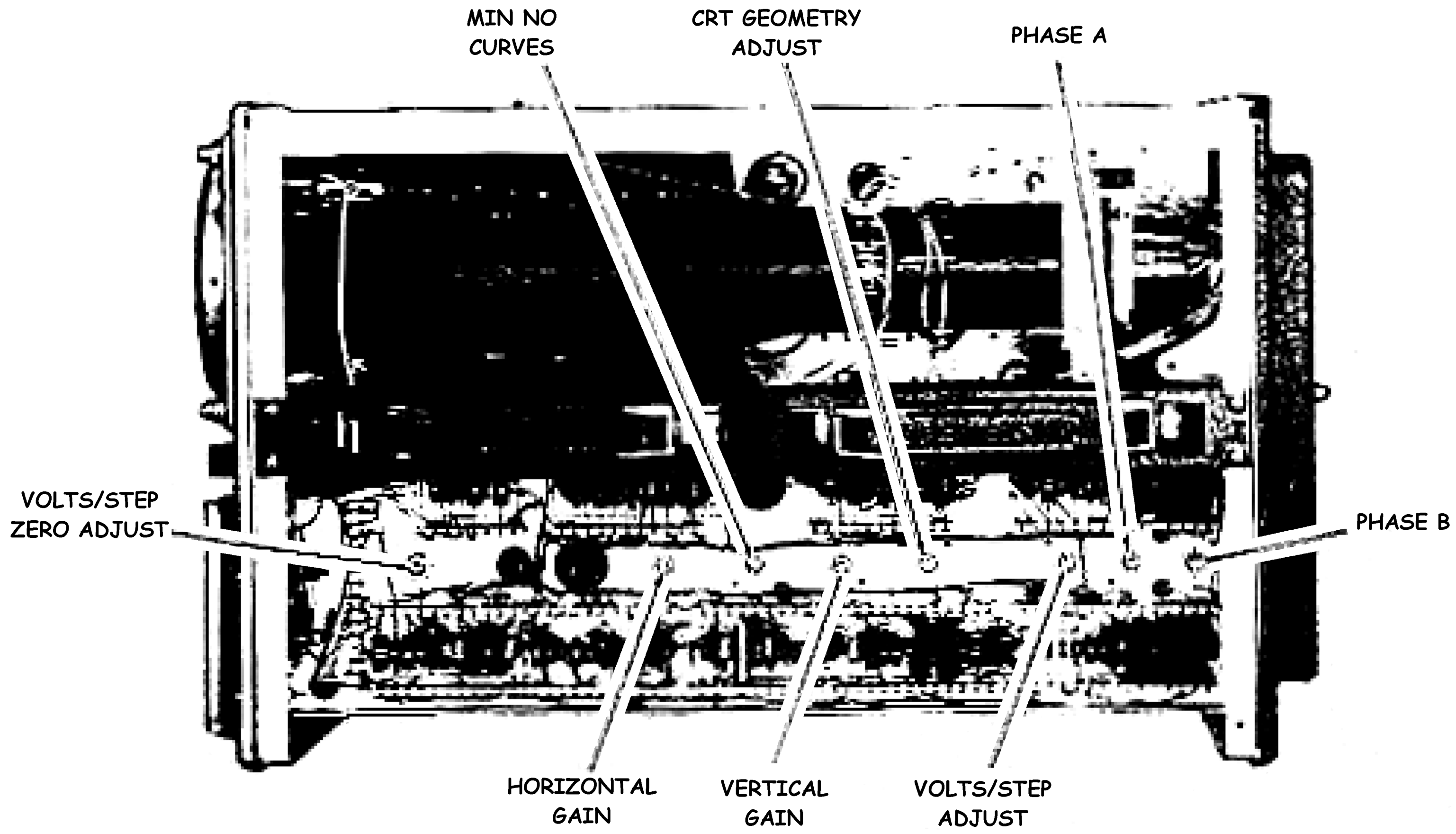

MIN NO
CURVES

CRT GEOMETRY
ADJUST

PHASE A

VOLTS/STEP
ZERO ADJUST

PHASE B

HORIZONTAL
GAIN

VERTICAL
GAIN

VOLTS/STEP
ADJUST

C316

T310

T501

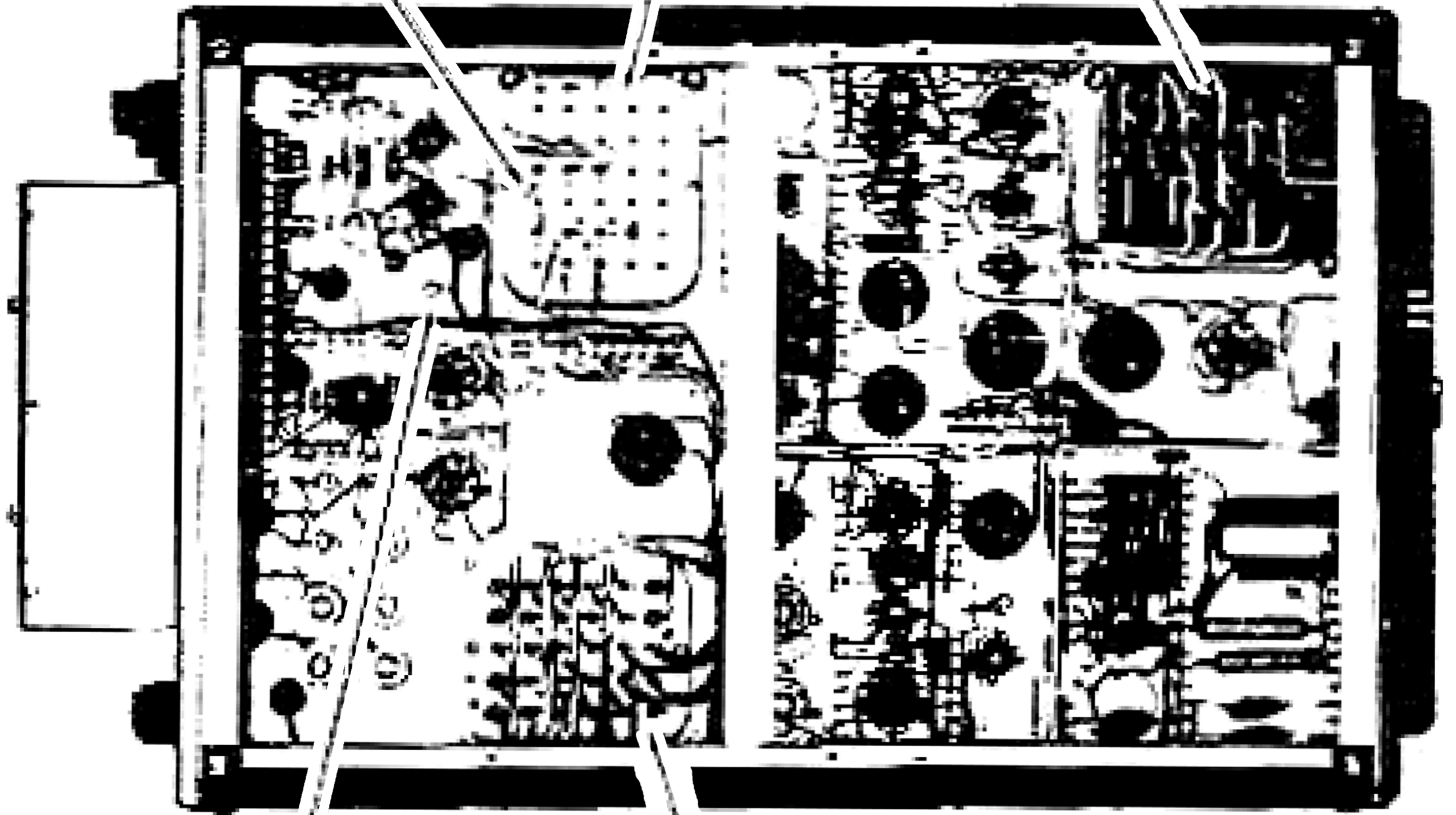

VOLTS/DIV BALANCE

T401

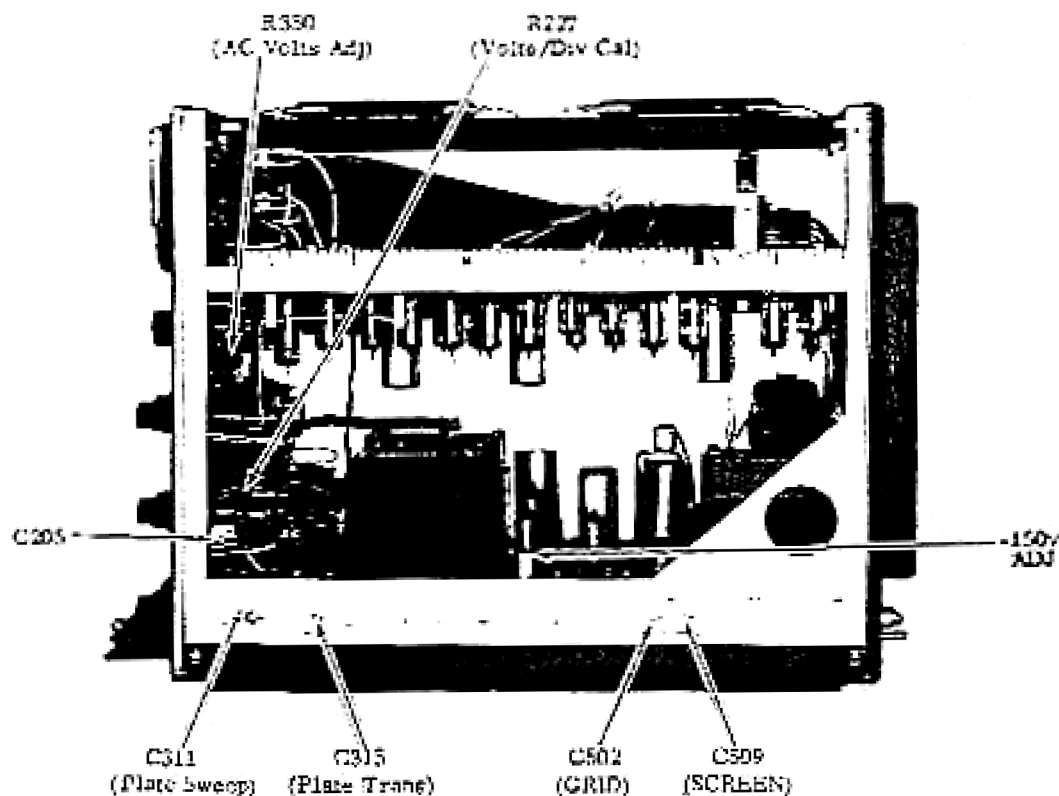

Fig. 3-7. Internal view of Type 570.

22. Adjusting C205

Turn the POWER-TEST switch off and install the nine-pin-miniature socket adapter into the test panel. Connect the patch cords as follows.

6X5 Triode Connections

Pin No.	Connect to	Tube element
1	P	Plate
4	HTR	Heater
5	HTR	Heater
8	K	Cathode
9	GRID A	Grid

Install a Type 6X5 in the socket adapter and turn the POWER-TEST switch ON after the proper heater voltage has been set. Adjust the following controls of the Type 570 to obtain

a normal set of plate current versus plate voltage triode curves.

PLATE-SCREEN	PLATE
GRID	
PLATE-GRID	PLATE
MA/DIV	1
VOLTS/DIV	20
VOLTS/STEP	.5
START ADJUST	0
STEPS/SEC	120 clockwise
STEPS/FAMILY	approximately 5
	steps
TEST POSITION	GRID A
HEATER	6.3
HEATER VARIABLE	adjust for
	100%
PEAK VOLTS	100
SERIES LOAD	5k

Now adjust C205 to obtain optimum retrace (a single line).

R350
(AC Volts Adjust)

R227
(Volts/Div Cal)

C205

-150V
ADJUST

C311
Plate Sweep
Current Balance

C315
Plate Trans
Current Balance

C502
(GRID)

C509
(SCREEN)

SECTION 6

PARTS LIST AND SCHEMATICS

ABBREVIATIONS

Cer.	Ceramic	o	Pico, or 10^{-12}
Comp.	Composition	PMC	Paper, metal cased
EMC	Electrolytic, metal cased	Poly.	Polystyrene
EMT	Electrolytic, metal tubular	Prec	Precision
f	Ferrod	PT	Paper, tubular
F & I	Focus and Intensity	PTM	Paper, tubular, moulded
G	Giga, or 10^9	S/N	Serial number
GMV	Guaranteed minimum value	T	Turns
h	Heavy	TD	Teraic
K or k	Kilohms, or kilo (10^3)	Tub.	Tubular
M or meg	Megohms, or mega (10^6)	v	Working volts DC
μ	Micro, or 10^{-6}	Var.	Variable
m	Milli, or 10^{-3}	w	Watt
n	Nano, or 10^{-9}	wl	With
O	Ohm	WW	Wire-wound

SPECIAL NOTES AND SYMBOLS

X000 Part first added at this serial number.

000X Part removed after this serial number.

*000-000 Asterisk preceding Tektronix Part Number indicates manufactured by or for Tektronix, also reworked or checked components.

Use 000-000 Part number indicated as direct replacement.

ELECTRICAL PARTS LIST

Values are fixed unless marked Variable.

Okt. No.	Tektronix Part No.	Description		S/N Range
Bulbs				
B80	Use 150-027	Neon, NE-23		
B170	Use 150-027	Neon, NE-23		
B350	150-004	Incandescent #328 Miniature	Test Light	
B402	150-001	Incandescent #47	Graticule Light	
B453	150-001	Incandescent #47	Graticule Light	
B404	150-004	Incandescent #328 Miniature	Main Light	
B515	Use 150-027	Neon, NE-23		
B516	Use 150-027	Neon, NE-23		
B644	Use 150-027	Neon, NE-23		
B645	Use 150-027	Neon, NE-23		
Capacitors				
Tolerance $\pm 20\%$, unless otherwise indicated.				
Tolerance of all electrolytic capacitors are as follows: (with exceptions)				
3 V — 50 V = -10% , $+250\%$				
51 V — 350 V = -10% , $+100\%$				
351 V — 450 V = -10% , $+50\%$				
C6	285-519	.047 μ f	MT	400 v
C7	281-536	1000 pf	Cer	500 v
C8	285-519	.047 μ f	MT	400 v
C10	285-519	.047 μ f	MT	400 v
C35	285-519	.047 μ f	MT	400 v
C36	281-536	1000 pf	Cer	500 v
C38	285-519	.047 μ f	MT	400 v
C40	285-519	.047 μ f	MT	400 v
C67	281-526	12 pf	Cer.	500 v
C73	281-525	470 pf	Cer	500 v
C85	Use *291-038	.01 μ f	Polystyrene	300 v
C88	285-512	.015 μ f	MT	400 v
C90	285-519	.047 μ f	MT	400 v
C95	283-535	.0015 μ f	Mica	500 v
C112	281-521	4.7 pf	Cer	500 v
C125	285-506	.0047 μ f	MT	400 v
C126	285-506	.0047 μ f	MT	400 v
C145	281-510	22 pf	Cer	500 v
C165	281-506	12 pf	Cer	500 v
C170	283-000	.501 μ f	Disc Type	500 v
C185A,B	Use 290-007	2 x 15 μ f	EMC	450 v
C205	281-010	4.5-25 pf	Cer	Var
C207	281-523	8 pf	Cer	500 v
C242	281-525	470 pf	Cer	500 v
C280	281-525	470 pf	Cer	500 v

Capacitors (Cont'd)

Ckt. No.	Tektronix Part No.	Description	5/N Range
C310	283-518	330 pf	
C311	281-028	20-125 pf	
C315	281-012	7-45 pf	101-140
	281-010	4.5-25 pf	141-up
C316	281-504	10 pf	8141-up
C403	Use 290-010	2x20 μ f	
C405	Use 290-010	2x20 μ f	
C407	285-510	.01 μ f	
C412	285-519	.047 μ f	
C420	Use 290-010	2x70 μ f	
C478	285-510	.01 μ f	
C484	Use 290-028	80 μ f	
C492	285-510	.01 μ f	
C495A, B	Use 290-010	2 x 20 μ f	
C502	Use 281-012	7-45 pf	
C505	Use 290-028	80 μ f	
C506	Use 290-028	80 μ f	
C509	Use 281-012	7-45 pf	
C510 A, B	290-055	2 x 20 μ f	
C515	283-000	.001 μ f	
C525	285-510	.01 μ f	
C610	Use 285-530	.047 μ f	
C611	285-501	.005 μ f	
C616	285-502	.001 μ f	
C620	285-507	.001 μ f	
C624	283-002	.01 μ f	
C628	285-508	.0068 μ f	
	283-011	.01 μ f	
C630	285-508	.0068 μ f	
	283-034	.025 μ f	
C640	285-508	.0068 μ f	
	283-011	.01 μ f	
C641	285-513	.015 μ f	
	283-011	.01 μ f	

Diodes

D350	152-008	Germanium T12G
D351	152-008	Germanium T12G

Fuses

F255	159-024	1/4 Amp., 3AG, Fast-Blo 117 & 234 v oper.
F310	159-025	1/2 Amp., 3AG, Fast-Blo 117 & 234 v oper.
F402	159-006	5 Amp., 3AG, Slo-Blo 117 v oper.
	159-005	3 Amp., 3AG, Slo-Blo 234 v oper.

Inductors

Ckt. No.	Tektronix Part No.	Description	S/N Range
	†276-507	Core, Ferramic Suppressor	X5520-up

Meter

M1	Use *050-001 149-017 149-0023-00	200 μ Amp. 1 mAmp. 0-1 mAmp	101-5120 5121-5549 5550-up
----	--	---------------------------------------	----------------------------------

Resistors

Resistors are fixed, composition, $\pm 10\%$ unless otherwise indicated.

R4	302-332	3.3 k	$\frac{1}{2}$ w			
R5	302-332	3.3 k	$\frac{1}{2}$ w			
R6	311-018	20 k	2 w	Var	PHASE ADJ.	
R7	302-102	1 k	$\frac{1}{2}$ w			101-5169
	302-684	680 k	$\frac{1}{2}$ w			5170-up
R8	304-103	10 k	1 w			
R9	Use 302-123	12 k	$\frac{1}{2}$ w			
R10	304-473	47 k	1 w			
R15	302-154	150 k	$\frac{1}{2}$ w			
R16	302-154	150 k	$\frac{1}{2}$ w			
R17	302-106	10 meg	$\frac{1}{2}$ w			
R18	302-106	10 meg	$\frac{1}{2}$ w			
R25	311-026	100 k	2 w	Var	VOLTS/STEP ADJ.	
R26	302-105	1 meg	$\frac{1}{2}$ w			
R27	302-105	1 meg	$\frac{1}{2}$ w			
R28	Use 306-104	100 k	2 w			
R29	302-103	10 k	$\frac{1}{2}$ w			
R35	311-032	250 k	2 w	Var	PHASE ADJ. B	
R36	302-102	1 k	$\frac{1}{2}$ w			101-5169
	302-105	1 meg	$\frac{1}{2}$ w			5170-up
R38	304-103	10 k	1 w			
R39	Use 302-123	12 k	$\frac{1}{2}$ w			
R40	304-473	47 k	1 w			
R45	302-154	150 k	$\frac{1}{2}$ w			
R46	302-154	150 k	$\frac{1}{2}$ w			
R47	302-106	10 meg	$\frac{1}{2}$ w			
R48	302-106	10 meg	$\frac{1}{2}$ w			
R52	302-102	1 k	$\frac{1}{2}$ w			
R55	Use 306-473	47 k	2 w			
R56	302-473	47 k	$\frac{1}{2}$ w			
R64	302-102	1 k	$\frac{1}{2}$ w			
R65	302-183	18 k	$\frac{1}{2}$ w			
R66	302-184	180 k	$\frac{1}{2}$ w			
R67	Use 302-124	120 k	$\frac{1}{2}$ w			
R68	302-104	100 k	$\frac{1}{2}$ w			

† Located on socket adapter plates.

Resistors (Cont'd)

Ckt. No.	Tektronix Part No.	Description	S/N Range
R69	Use 304-273	27 k	1 w
R70	302-472	4.7 k	1/2 w
	302-103	10 k	1/2 w
R71	302-107	1 k	1/2 w
R72	302-473	47 k	1/2 w
			X155-up
R73	302-104	100 k	1/2 w
R75	302-102	1 k	1/2 w
R76	302-104	100 k	1/2 w
R80	302-102	1 k	1/2 w
R81	302-155	1.5 meg	1/2 w
			X155-up
R82	304-104	100 k	1 w
R85	Use 311-023	50 k	2 w
R86	302-102	1 k	1/2 w
R88	302-475	4.7 meg	1/2 w
R90	302-594	390 k	1/2 w
			Var
			MIN. NO CURVES
R91	311-018	20 k	2 w
R92	304-103	10 k	1 w
	504-173	12 k	1 w
R94	302-102	1 k	1/2 w
R96	302-104	100 k	1/2 w
			Var
			STEPS/FAMILY
			X155-up
R97	302-102	1 k	1/2 w
R101	302-104	100 k	1/2 w
R102	302-224	220 k	1/2 w
R105	311-034	500 k	2 w
R106	302-155	1.5 meg	1/2 w
			Var
			VOLTS/STEP ZERO ADJ.
R108	302-102	1 k	1/2 w
R109	302-153	15 k	1/2 w
R110	304-224	220 k	1 w
R111	302-274	27 meg	1/2 w
R112	302-155	1.5 meg	1/2 w
			X293-up
R115	302-155	1.5 meg	1/2 w
R116	302-102	1 k	1/2 w
R117	Use 304-474	470 k	1 w
R120	311-026	100 k	2 w
R125	302-104	100 k	1/2 w
			Var
			START ADJUST
R130	309-010	750 k	1/2 w
R131A	309-100	10 k	1/2 w
R131B	309-153	20 k	1/2 w
R131C	309-090	50 k	1/2 w
R131D	309-045	100 k	1/2 w
			Prec
			1%
R131E	309-051	200 k	1/2 w
R131F	309-003	500 k	1/2 w
R131G	309-014	1 meg	1/2 w
R132	302-102	1 k	1/2 w
R135	304-224	220 k	1 w
			Prec
			1%
R145	302-275	2.7 meg	1/2 w
R146	301-105	1 meg	1/2 w
R147	302-102	1 k	1/2 w
R150	Use 304-224	220 k	2 w
R151	304-273	27 k	1 w
			Prec
			1%
			5%

Resistors (Cont'd)

Ckt. No.	Tektronix Part No.		Description		S/N Range
R165	302-275	2.7 meg	1/2 w		
R166	301-105	1 meg	1/2 w		5%
R167	302-102	1 k	1/2 w		
R170	302-104	100 k	1/2 w		
R171	302-155	1.5 meg	1/2 w		
R180	302-102	1 k	1/2 w		
R182	306-124	120 k	2 w		
R185	302-106	10 meg	1/2 w		
R186	306-333	33 k	2 w		
R205	309-087	5 meg	1/2 w	Prec	1%
R206	309-026	3 meg	1/2 w	Prec	1%
R207	309-073	2 meg	1/2 w	Prec	1%
R208	302-102	1 k	1/2 w		X5073-up
R210	306-473	47 k	2 w		
R211	304-473	47 k	1 w		
R214	311-034	500 k	2 w	Var	VOLTS/DIV. BAL.
R215	302-105	1 meg	1/2 w		
R216	302-153	15 k	1/2 w		
R220	309-090	50 k	1/2 w	Prec	1%
R221	309-049	150 k	1/2 w	Prec	1%
R222	305-109	250 k	1/2 w	Prec	1%
R223	309-003	500 k	1/2 w	Prec	1%
R224	309-017	1.5 meg	1/2 w	Prec	1%
R225	309-025	2.5 meg	1/2 w	Prec	1%
R226†		Selected			X5360-up
R227	311-074	5 k	1 w	Var	VOLTS/DIV. CAL
R228	309-473	47 k	1/2 w		
R229	311-018	20 k	2 w	Var	HORIZ. GAIN ADJ.
R230	302-333	33 k	1/2 w		101-5264
	302-273	27 k	1/2 w		5265-up
R237	301-825	8.2 meg	1/2 w		5%
R238	302-225	2.2 meg	1/2 w		
R234††	311-048	2 x 500 k	1/2 w	Var	HORIZ. POSITIONING
R237	302-107	1 k	1/2 w		
R238	309-086	3.5 meg	1/2 w	Prec	1%
R239	302-102	1 k	1/2 w		
R240	301-683	68 k	1/2 w		5%
R241	301-683	68 k	1/2 w		5%
R242	305-473	47 k	2 w		5%
R244	302-102	1 k	1/2 w		
R245	302-102	1 k	1/2 w		
R246	305-104	100 k	2 w		5%
R247	305-104	100 k	2 w		5%
R248	305-823	82 k	2 w		5%
R254	302-104	100 k	1/2 w		

† Installed in Test Department when necessary.

†† One-half of R270

Parts List — Type 570

Resistors (Cont'd)

Ckt. No.	Tektronix Part No.	Description	5/N Range
R255	308-073	3 k 10 w WW	1%
R256	308-073	1 k 5 w WW	1%
R257	308-071	500 Ω 5 w WW	1%
R258	308-070	300 Ω 5 w WW	1%
R259	309-112	100 Ω ½ w Prec.	1%
R260	Use *310-542	50 Ω 6 w Mica Plate	1%
R261	Use *310-540	30 Ω 2 w Mica Plate	1%
R262	Use *310-547	10 Ω 2 w Mica Plate	1%
R263 } R264 } R265 }	Use *050-164	Replacement Kit	101-5050
R263 } R264 } R265 }	*310-546	5 Ω } 3 Ω } 2 Ω }	3 w Mica Plate 1%
R270†	311-048	2 x 500 k ½ w	VERT. POSITIONING 5%
R271	302-275	2.7 meg ¾ w Var	
R272	301-914	910 k ½ w	
R275	301-105	1 meg ½ w	
	309-014	1 meg ½ w Prec	5% 5358-up
	309-149	1.2 meg ½ w Prec	1% 101-5357
R277††	Use 302-223	22 k ½ w	VERT. GAIN ADJ.
R278††	Use 311-018	50 k 2 w Var	
R279	302-102	1 k ½ w	
R280	305-473	47 k 2 w	5%
R281	302-102	1 k ½ w	
R282	301-683	68 k ½ w	5%
R283	301-683	68 k ½ w	5%
R288	302-102	1 k ½ w	
R289	302-102	1 k ½ w	
R290	305-104	100 k 2 w	5%
R291	305-104	100 k 2 w	5%
R292	305-823	82 k 2 w	5%
R310	304-154	150 k 1 w	
R316	306-333	33 k 2 w	
R317	306-223	22 k 2 w	
R319	308-040	1.5 k 25 w WW	5%
R320	308-040	1.5 k 25 w WW	5%
R321	308-065	2 k 25 w WW	5%
R322	308-065	2 k 25 w WW	5%
R323	308-042	3 k 25 w WW	5%
R324	308-073	10 k 10 w WW	5%
R325	308-073	10 k 10 w WW	5%
R326	308-027	30 k 10 w WW	5%
R327	305-104	100 k 2 w	5%
R328	305-104	100 k 2 w	
R329	Use 309-053	333 k ½ w Prec	1%
R330	Use 309-015	1.11 meg ½ w Prec	1%
R340	311-073	250 Ω 25 w Var. WW	VARIABLE

† One-half of R234

†† Below S/N 208, R277 and R278 have to be replaced at the same time.

Resistors (Cont'd)

Ckt. No.	Tektronix Part No.		Description				S/N Range
R350	311-074	5 k	1 w	Var.	WW	AC VOLTS ADJ.	101-5120
	311-131	1 k	1 w	Var.			5121-up
R351	302-153	15 k	1/2 w				101-5120
	302-272	2.7 k	1/2 w				5121-up
R355	311-061	250 k	2 w	Var.		—DC	101-5120
	311-023	50 k	2 w	Var.			5121-up
R356	302-823	82 k	1/2 w				101-5120
	Use 302-152	15 k	1/2 w				5121-up
R357	Use 306-273	27 k	2 w				
R360	309-129	34 k	1/2 w		Prec.	1%	101-5120
	309-262	6.5 k	1/2 w		Prec.	1%	5121-up
R361	309-130	69 k	1/2 w		Prec.	1%	101-5120
	309-263	13.5 k	1/2 w		Prec.	1%	5121-up
R362	309-151	174 k	1/2 w		Prec.	1%	101-5120
	309-030	34.5 k	1/2 w		Prec.	1%	5121-up
R363	309-152	349 k	1/2 w		Prec.	1%	101-5120
	309-264	69.5 k	1/2 w		Prec.	1%	5121-up
R364	309-005	700 k	1/2 w		Prec.	1%	101-5120
	309-265	139.5 k	1/2 w		Prec.	1%	5121-up
R365	309-019	1.75 k	1/2 w		Prec.	1%	101-5120
	309-152	349 k	1/2 w		Prec.	1%	5121-up
R366	309-086	3.5 meg	1/2 w		Prec.	1%	101-5120
	309-008	700 k	1/2 w		Prec.	1%	5121-up
R407	311-055	50 Ω	2 w	Var.	WW	SCALE ILLUM.	
R407	302-333	33 k	1/2 w				
R408	302-101	100 Ω	1/2 w				
R410	302-225	2.2 meg	1/2 w				
R411	308-051	4 k	5 w		WW	5%	
R412	309-090	50 k	1/2 w		Prec.	1%	
R413	311-015	10 k	2 w	Var.	WW	—150 V ADJ.	
R414	Use 309-041	60 k	1/2 w		Prec.	1%	
R465	309-273	27 k	1/2 w				
R466	302-393	39 k	1/2 w				
R470	302-225	2.2 meg	1/2 w				
R472	302-101	100 Ω	1/2 w				
R474	306-154	150 k	2 w				X334-up
R475	309-053	313 k	1/2 w		Prec.	1%	
R479	309-002	490 k	1/2 w		Prec.	1%	
R488	304-184	180 k	1 w				
R489	302-393	39 k	1/2 w				
R490	302-101	100 Ω	1/2 w				
R492	309-014	1 meg	1/2 w		Prec.	1%	
R493	309-002	490 k	1/2 w		Prec.	1%	
R495	302-105	1 meg	1/2 w				
R496	308-021	4.5 k	10 w		WW	5%	
R505	304-334	330 k	1 w				X365-up
R510	306-473	47 k	2 w				
R511	302-474	470 k	1/2 w				

Parts List — Type 570

Resistors (Cont'd)

Ckt. No.	Tektronix Part No.	Description	S/N Range		
R515	302-224	220 k	1/2 w		
R516	302-475	4.7 meg	1/2 w		
R517	302-102	1 k	1/2 w		
R525	302-101	100 Ω	1/2 w		
R526	306-104	100 k	2 w		
R527	302-101	100 Ω	1/2 w		
R528	302-105	1 meg	1/2 w		
R530	305-334	330 k	2 w		
R531	309-155	40 k	1/2 w	Prec. 1%	
R532	309-041	60 k	1/2 w	Prec. 1%	
R533	309-045	100 k	1/2 w	Prec. 1%	
R534	309-051	200 k	1/2 w	Prec. 1%	
R535	309-051	200 k	1/2 w	Prec. 1%	
R536	309-125	300 k	1/2 w	Prec. 1%	
R537†		Selected			
R540	311-018	20 k	2 w	Var. Nominal Value	VARIABLE [Selected]
R541	Use 104-822	8.2 k	1 w		
R542	302-224	220 k	1/2 w		
R543	306-104	100 k	2 w		
R544	302-224	220 k	1/2 w		
R545	302-224	220 k	1/2 w		
R605	302-474	470 k	1/2 w		
R610	304-102	1 k	1 w		
R611	306-104	100 k	2 w		
R615	302-473	47 k	1/2 w		
R616	302-152	1.5 k	1/2 w		
R625	302-185	1.8 meg	1/2 w		
R626	311-042	2 meg	2 w	Var.	H.V. ADJ.
R627	306-475	4.7 meg	2 w		
R628	306-475	4.7 meg	2 w		
R640	302-273	27 k	1/2 w		101-374K
R641	302-102	1 k	1/2 w		
R644	311-043	2 meg	1/2 w	Var	INTENSITY 101-5359
	311-280	2 meg	1/2 w	Var	5360-up
R645	306-155	1.5 meg	2 w		
R646	311-043	2 meg	1/2 w	Var	FOCUS
R647	306-475	4.7 meg	2 w		
R648	306-475	4.7 meg	2 w		
R650	311-026	100 k	2 w	Var	GEOM. ADJ.
R651	311-023	50 k	2 w	Var	ASTIGMATISM
R652	302-273	27 k	1/2 w		X312-up

† Installed in Test Department when necessary.

Switches

Ckt. No.	Tektronix Part No.		Description	S/N Range
	Unwired	Wired		
SW50	260-128	*262-104	Rotary	STEPS/SEC
SW90	260-017		Push Button	SINGLE FAMILY
SW130	260-129	*262-106	Rotary	VOLTS/STEP
SW180	260-136		Push Button	ZERO BIAS
SW190	260-137		Lever	TEST POSITION
SW205†	260-133	*262-105	Rotary	HORIZONTAL
SW210			Rotary	VOLTS/DIV
SW255††			Rotary	VERTICAL MA/DIV
SW310	260-143		Toggle	POWER TEST ON
SW330	260-127	*262-101	Rotary	SERIES LOAD
SW340	260-130	*262-107	Rotary	HEATER
SW350	260-125	*262-100	Rotary	INDICATION 101-5120
	260-125	*262-219	Rotary	INDICATION 5121-up
SW360	260-121	*262-099	Rotary	RANGE DC VOLTS 101-5120
	260-174	*262-218	Rotary	RANGE DC VOLTS 5121-up
SW401	260-126		Rotary	PEAK VOLTS
SW402	260-134		Toggle	POWER MAIN ON
SW510†††	260-132	*262-102	Rotary	PLATE-SCREEN GRID
SW525	260-131	*262-103	Rotary	±DC

Transformers

T310	*120-070	Power Plate Sweep
T340	*120-053	Filament
T401	*120-067	Main Power Supply
T501	*120-062	Floating Power Supply
T620	*170-071	Oscillator

Electron Tubes

V8	154-078	6AN8
V15	154-016	6AL5
V38	154-078	6AN8
V45	154-016	6AL5
V55	154-039	12AT7
V65	154-078	6AN8
V75	154-039	12AT7
V76	154-016	6AL5
V86	154-022	6AU6
V95	154-016	6AL5

† SW205 and SW210 are concentric. Furnished as a unit.

†† Concentric with SW510. Furnished as a unit.

††† Concentric with SW255. Furnished as a unit.

Parts List — Type 570

Electron Tubes (Cont'd)

Ckt. No.	Tektronix Part No.	Description	S/N Range
V110	154-022	6AU6	
V115	154-043	12AU7	
V135	154-022	6AU6	
V150	154-039	12AT7	
V180	154-031	6CL6	
V210	154-022	6AU6	
V215	154-022	6AU6	
V240	154-022	6AU6	
V241	154-022	6AU6	
V245	154-028	6BQ7A	
V280	154-022	6AU6	
V281	154-022	6AU6	
V290	154-028	6BQ7A	
V310	154-022	6AU6	
V315	154-113	6AX4	
V316	154-113	6AX4	
V403	154-035	6X4	
V405	154-035	6X4	
V407	154-052	5651	
V410	154-022	6AU6	
V412	154-044	12B4	
V470	154-078	6AN8	
V483	154-113	6AX4	
V484	154-113	6AX4	
V489	154-022	6AU6	
V495	154-044	12B4	
V505	154-023	6AX5	
V506	154-035	6X4	
V510	154-035	6X4	
V515	154-112	6CD6GA	
V525	154-078	6AN8	
V540	Use 154-039	12AT7	
V605	154-041	12AU7	
V610	154-017	6AQ5	
V630	154-051	5642	
V631	154-051	5642	
V639	Use *154-0343-00	T0570-31 CRT Standard Phosphor	

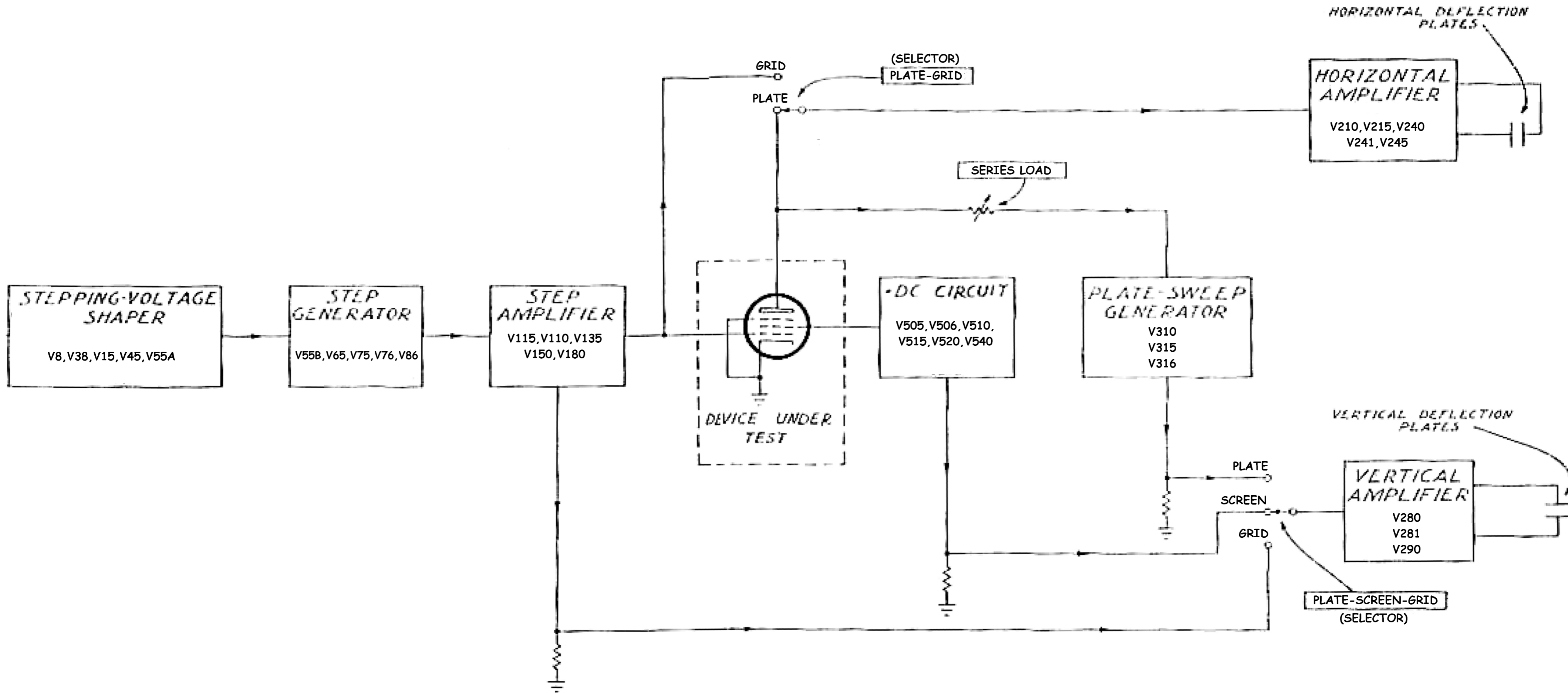

TYPE 570 CHARACTERISTIC-CURVE TRACER

BLOCK DIAGRAM

V8A
V38A
SPLIT-LOAD
PHASE INVERTER

V15
V45
RECTIFIERS

V8B
V38B
SHAPER AMPLIFIERS

V65A
V65B
MULTIVIBRATOR

V75B
MULTIVIBRATOR C.F.

V55B
STEP-CONTROL C.F.

V95A
V95B
CLAMP &
COUPLING DIODE

V86
STEP GENERATOR

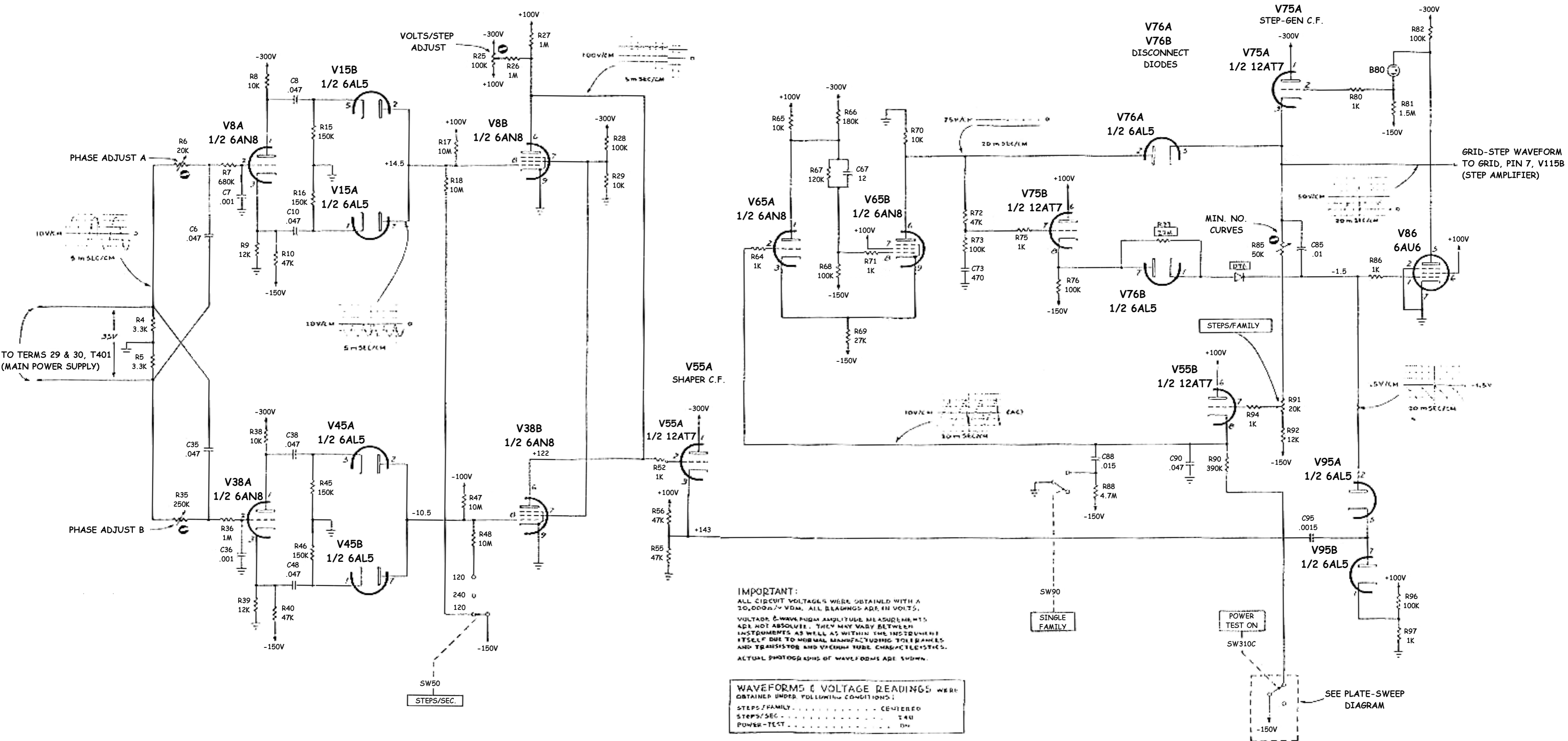

IMPORTANT:
ALL CIRCUIT VOLTAGES WERE OBTAINED WITH A 10,000 Ω VOM. ALL READINGS ARE IN VOLTS.
VOLTAGE & WAVEFORM AMPLITUDE MEASUREMENTS ARE NOT ABSOLUTE. THEY MAY VARY BETWEEN INSTRUMENTS AS WELL AS WITHIN THE INSTRUMENT ITSELF DUE TO MANUFACTURING TOLERANCES AND TRANSISTOR AND VACUUM TUBE CHARACTERISTICS. ACTUAL PHOTOGRAPHS OF WAVEFORMS ARE SHOWN.

WAVEFORMS & VOLTAGE READINGS WERE OBTAINED UNDER FOLLOWING CONDITIONS:
STEPS/FAMILY CENTERED
STEPS/SEC 140
POWER-TEST ON

V115A
V115B
INPUT C.F.

V110
V135
INPUT AMPLIFIERS

V150A
V150B
OUTPUT AMPLIFIERS

V180
OUTPUT C.F.

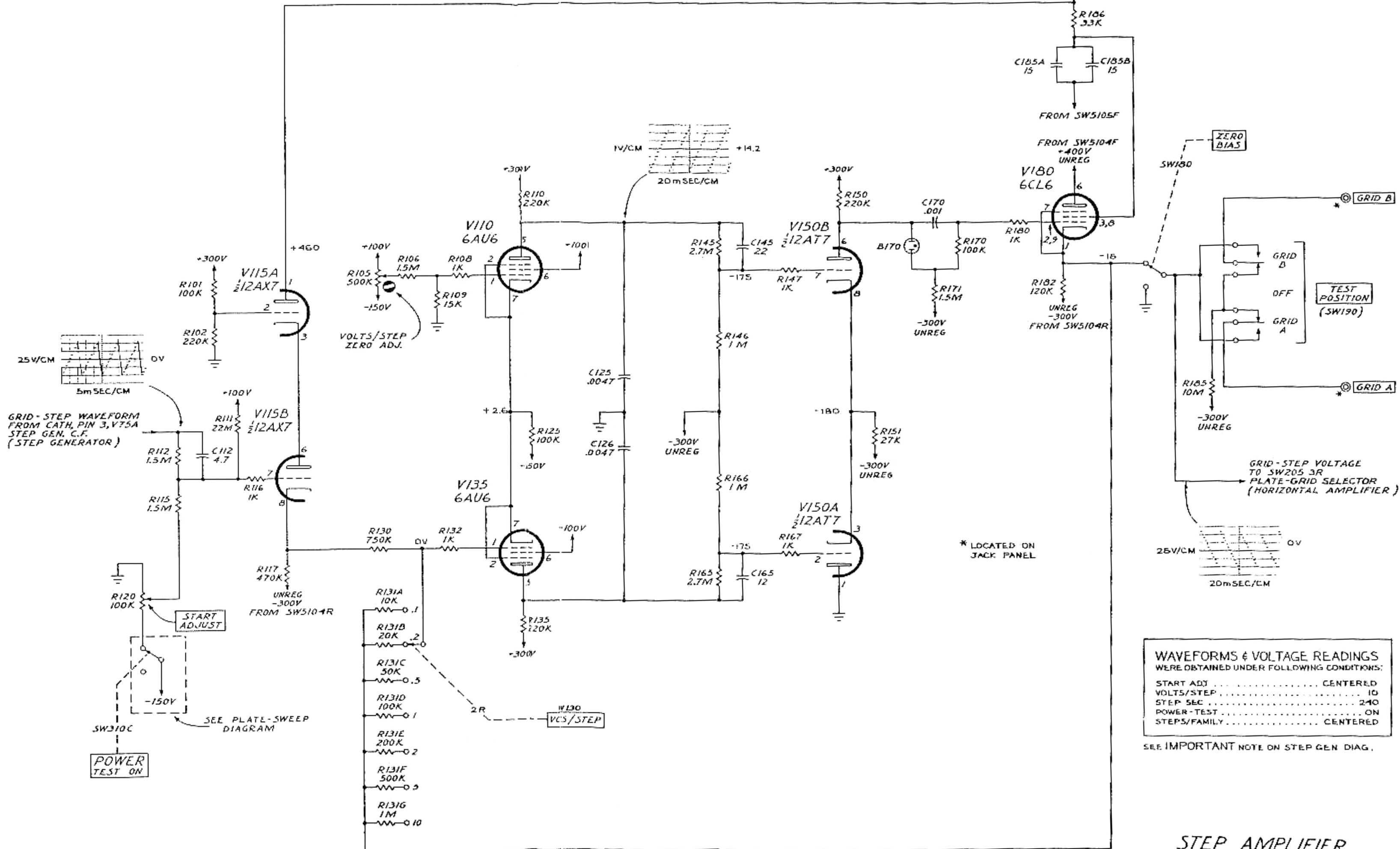

WAVEFORMS & VOLTAGE READINGS
WERE OBTAINED UNDER FOLLOWING CONDITIONS:

START ADJ	CENTERED
VOLTS/STEP	10
STEP SEC	2-10
POWER-TEST	ON
STEPS/FAMILY	CENTERED

SEE IMPORTANT NOTE ON STEP GEN DIAG.

STEP AMPLIFIER

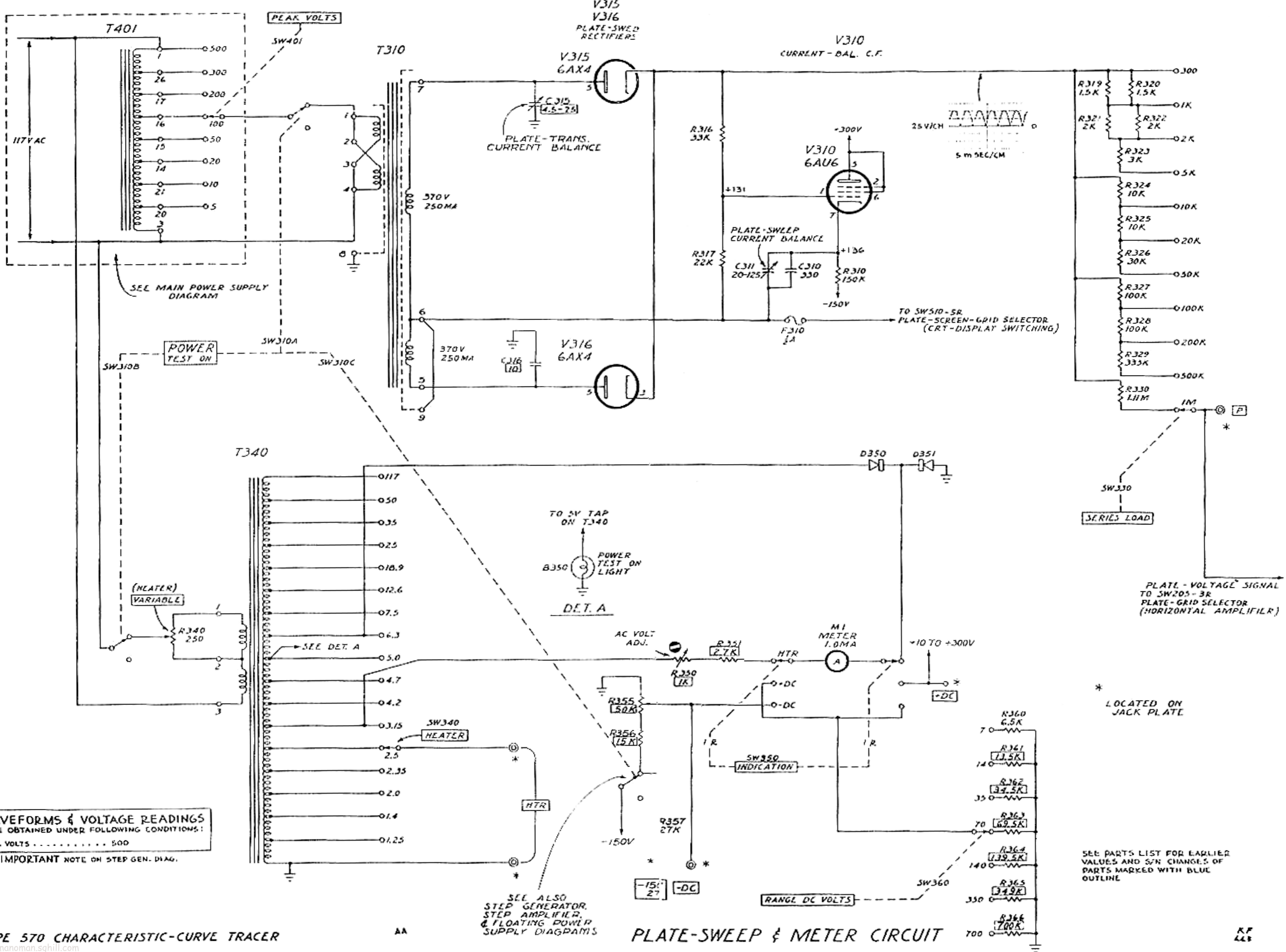

WAVEFORMS & VOLTAGE READINGS
 WERE OBTAINED UNDER FOLLOWING CONDITIONS:
 PEAK VOLTS 500
 SEE IMPORTANT NOTE ON STEP GEN. DIAG.

SEE ALSO
 STEP GENERATOR,
 STEP AMPLIFIER,
 & FLOATING POWER
 SUPPLY DIAGRAMS

*
 LOCATED ON
 JACK PLATE

SEE PARTS LIST FOR EARLIER
 VALUES AND S/N CHANGES OF
 PARTS MARKED WITH BLUE
 OUTLINE

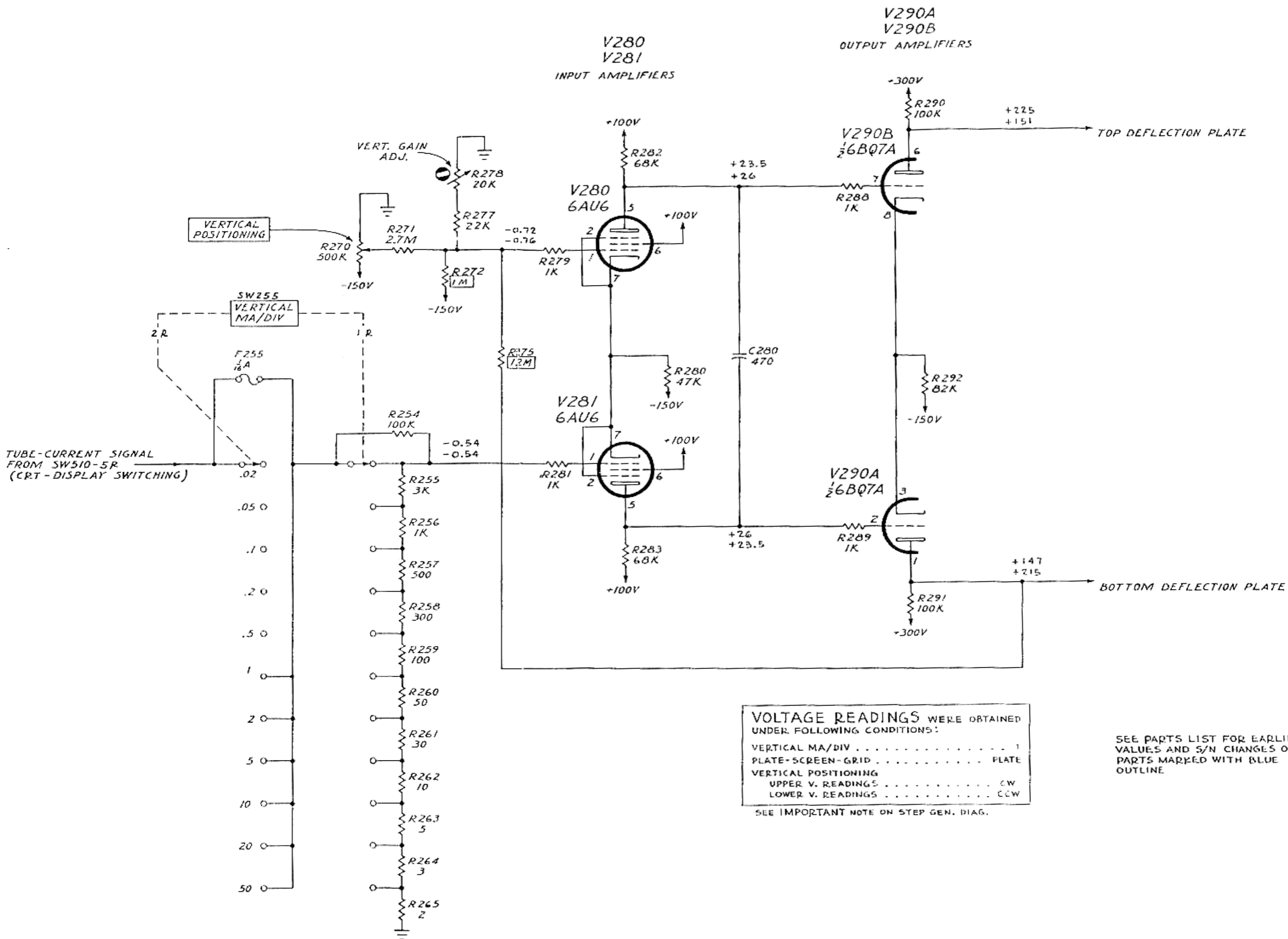

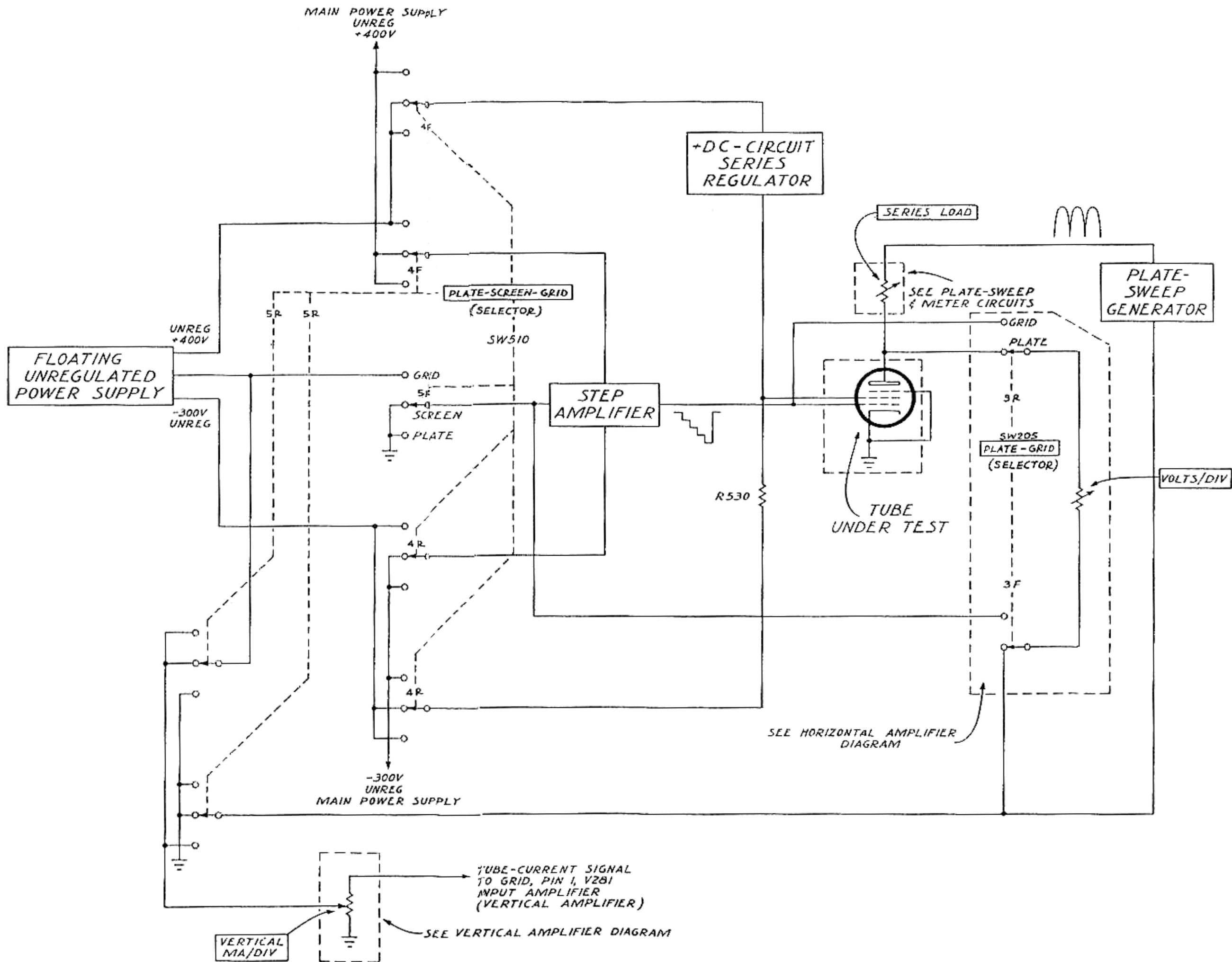

V605B
SHUNT REGULATOR

V610
OSCILLATOR

V605A
COMPARATOR

T620

V630
5642

V639
T52 CRT

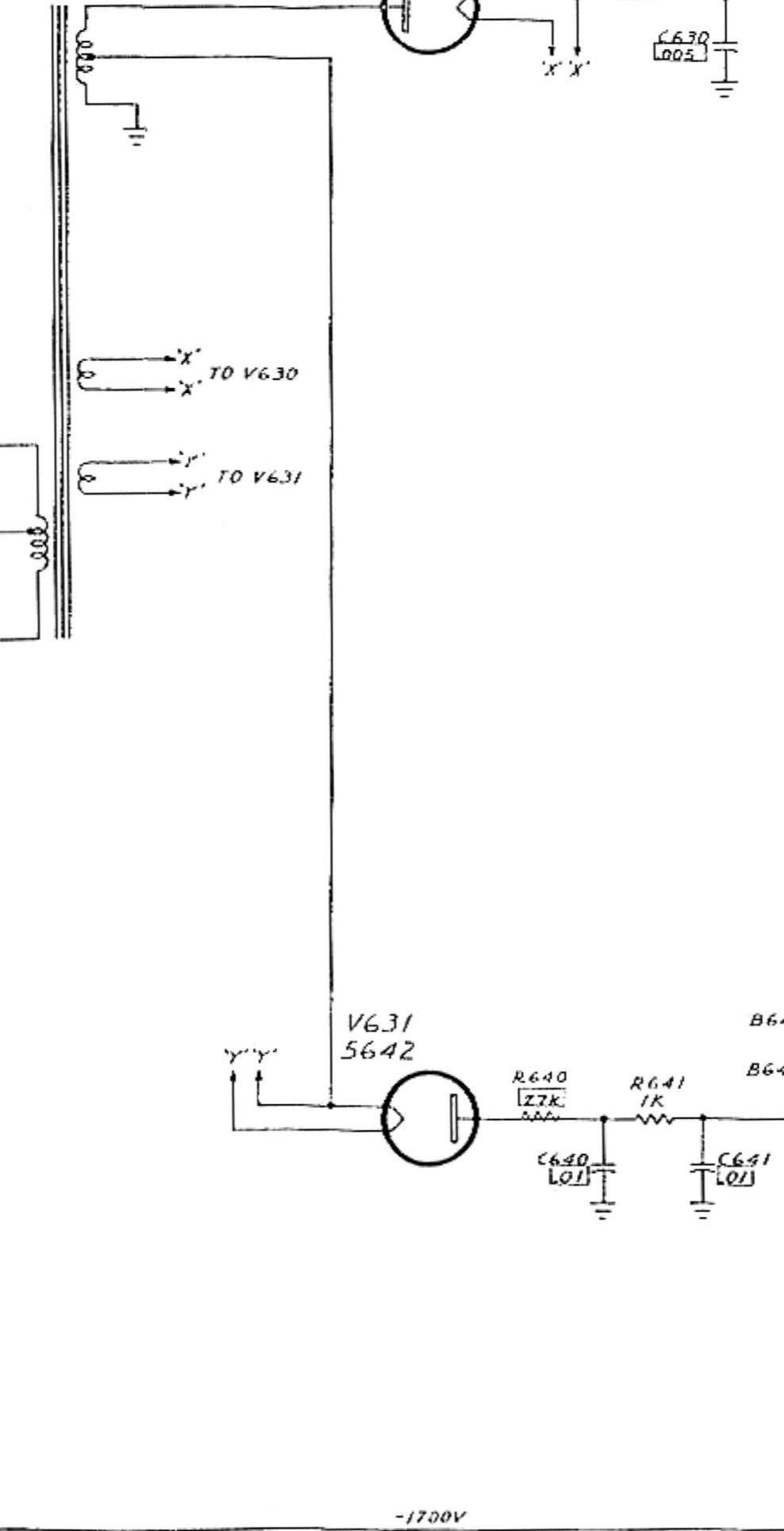
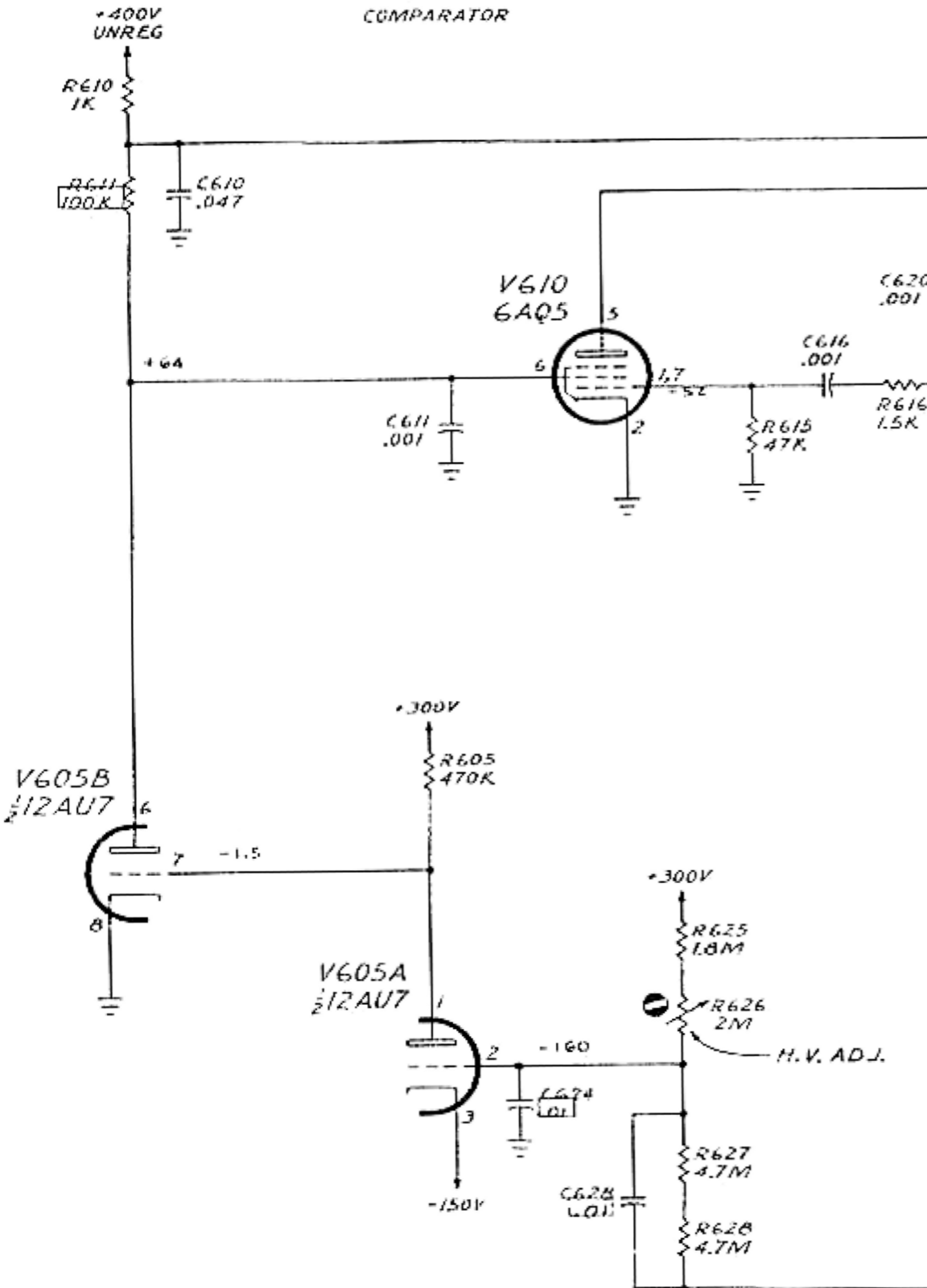

VOLTAGE READINGS WERE OBTAINED
UNDER FOLLOWING CONDITIONS:
INTENSITY CCW
SEE IMPORTANT NOTE ON STEP GEN. DIAG.

SEE PARTS LIST FOR EARLIER
VALUES AND S/N CHANGES OF
PARTS MARKED WITH BLUE
OUTLINE

PLATE-VOLTAGE SIGNAL
FROM PLATE CONNECTOR, P
(PLATE SWEEP)
GRID-STEP VOLTAGE
FROM CATHODE, PIN 1, V180
OUTPUT C.F., VIA SW180
(STEP AMPLIFIER)

FROM SW510
VERTICAL, PLATE-SCREEN-GRID
(CRT-DISPLAY SWITCHING)
FROM SW510 VERTICAL,
PLATE-SCREEN-GRID SELECTOR
(CRT-DISPLAY SWITCHING)

VOLTAGE READINGS WERE OBTAINED
UNDER FOLLOWING CONDITIONS:
VOLTS/DIV. 1
PLATE-GRID PLATE
HORIZONTAL POSITIONING
UPPER V. READINGS CW
LOWER V. READINGS CCW
SEE IMPORTANT NOTE ON STEP GEN. DIAG.

SEE PARTS LIST FOR EARLIER
VALUES AND S/N CHANGES OF
PARTS MARKED WITH BLUE
OUTLINE

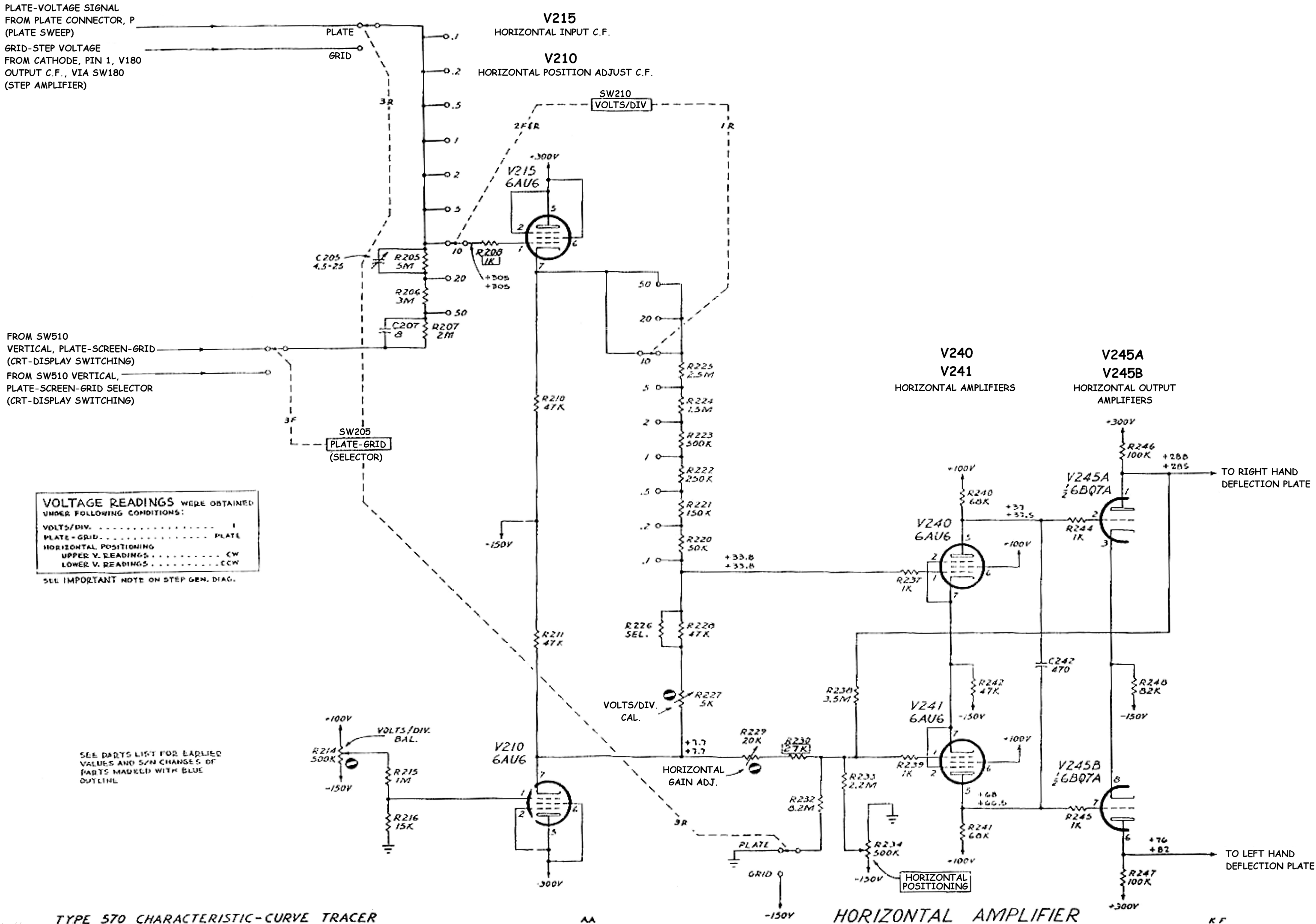

* GRATICULE LIGHTS

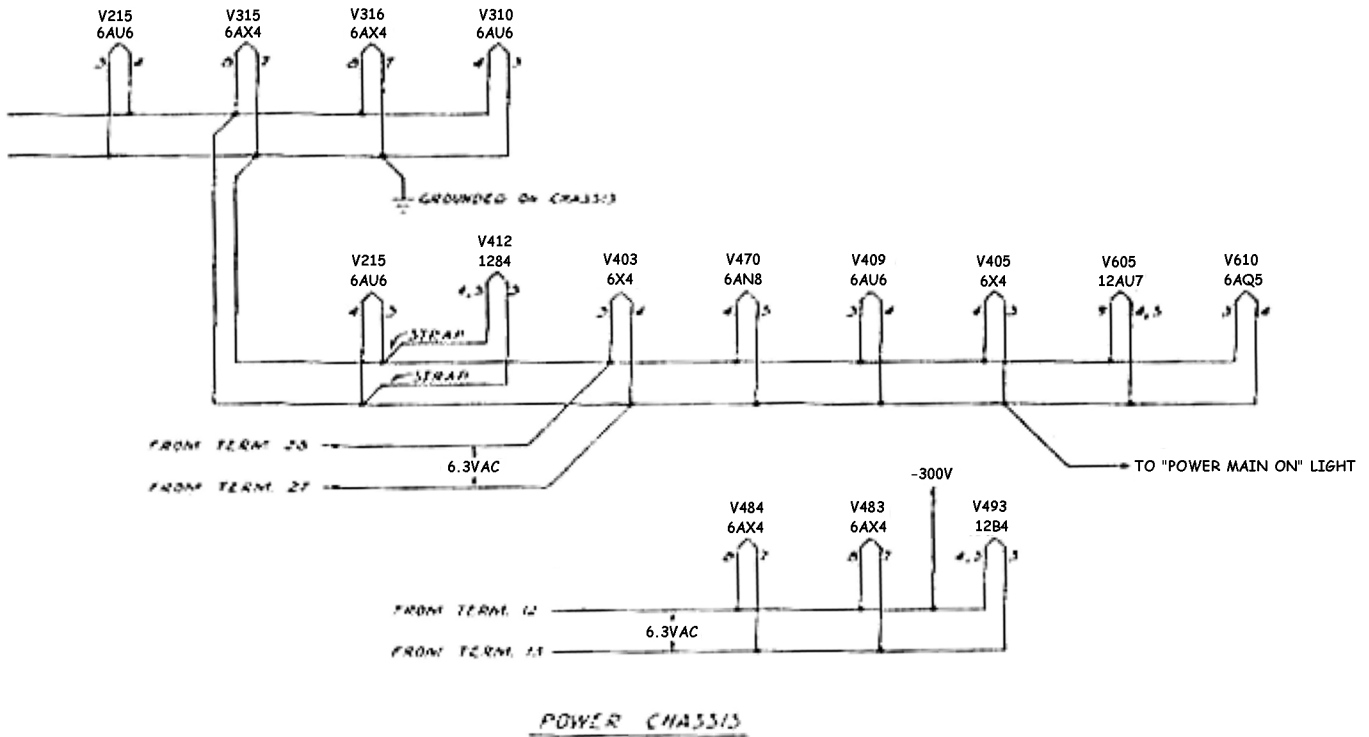
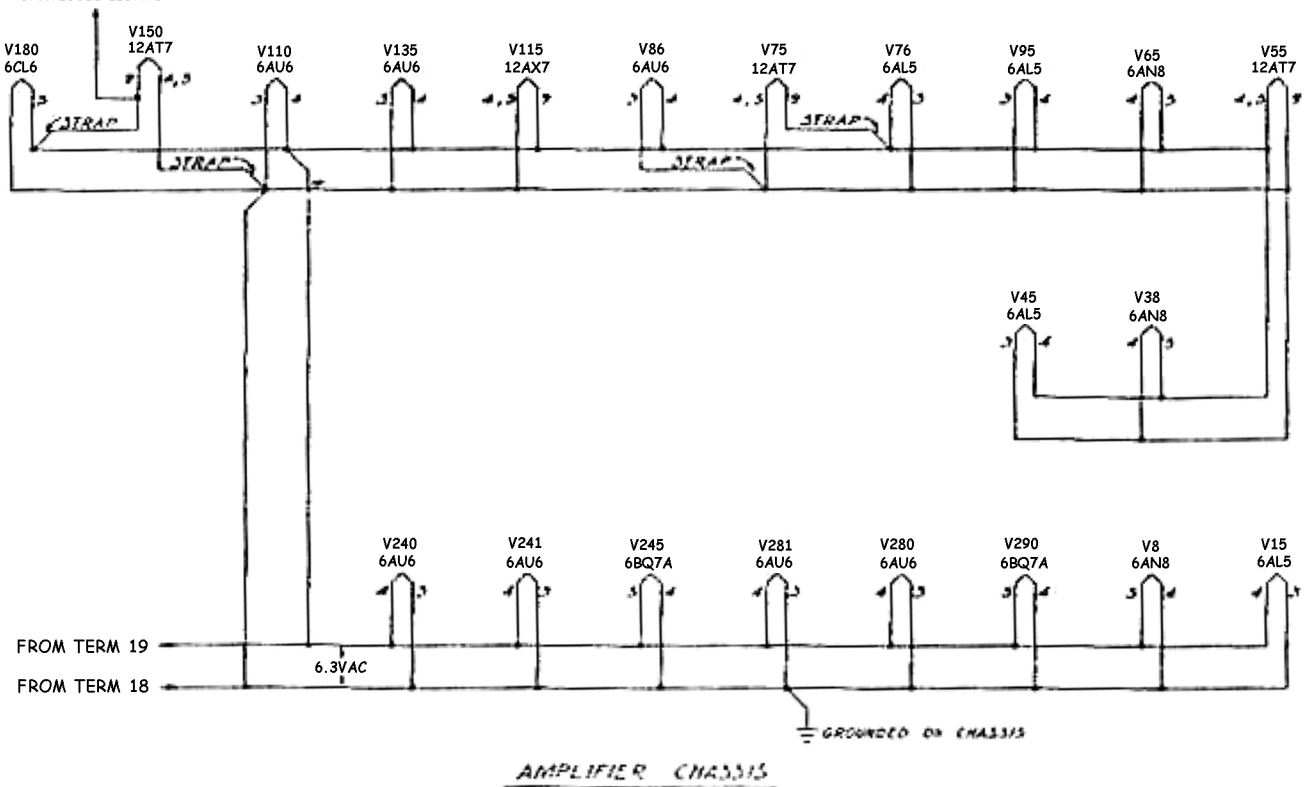

HEATER WIRING DIAGRAM

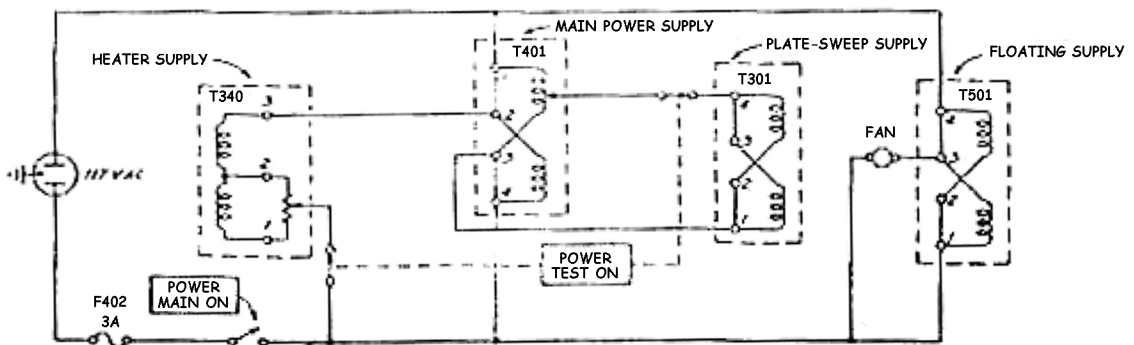

AC WIRING DIAGRAM

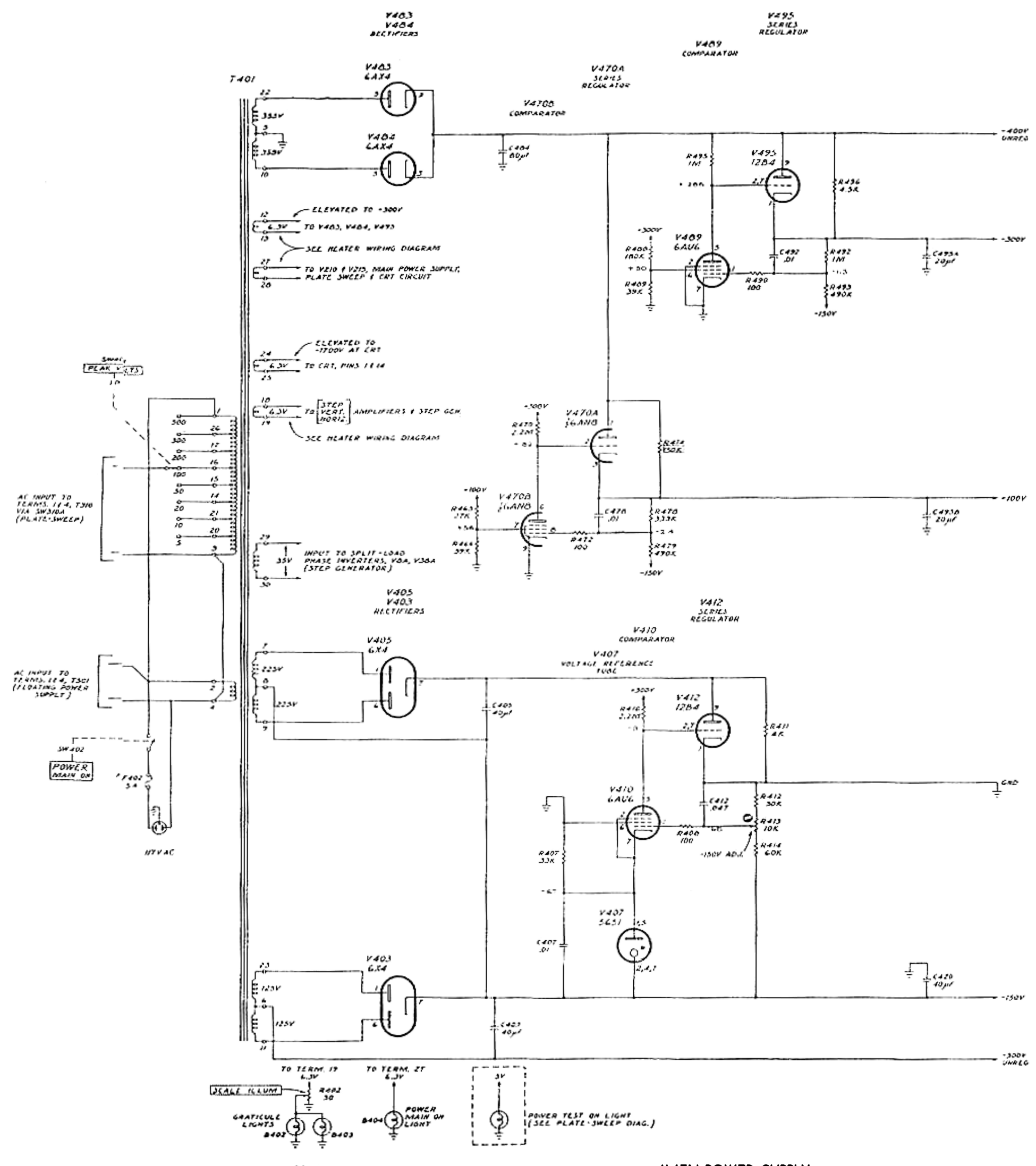

V505
V506
FLOATING-SUPPLY RECTIFIERS

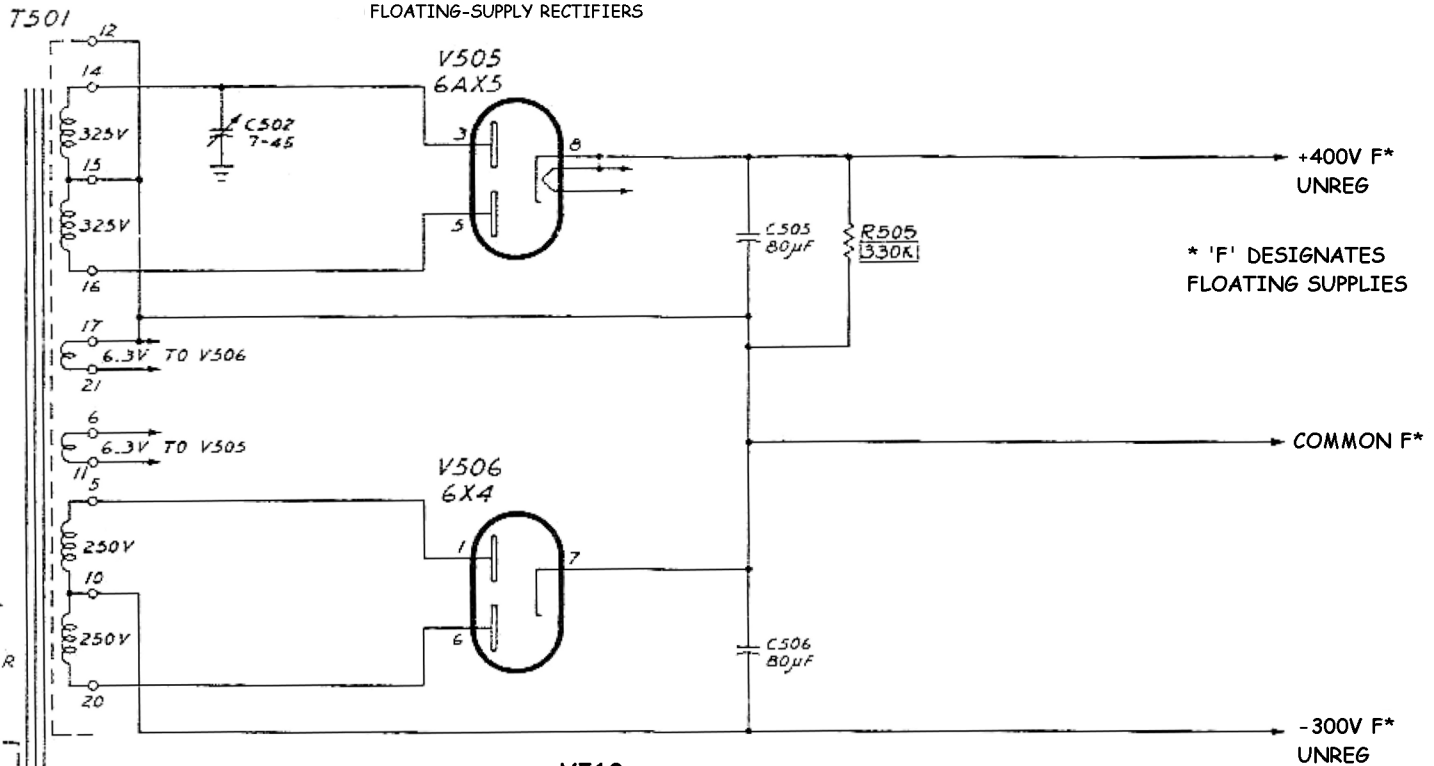

V510
SCREEN-SUPPLY RECTIFIER

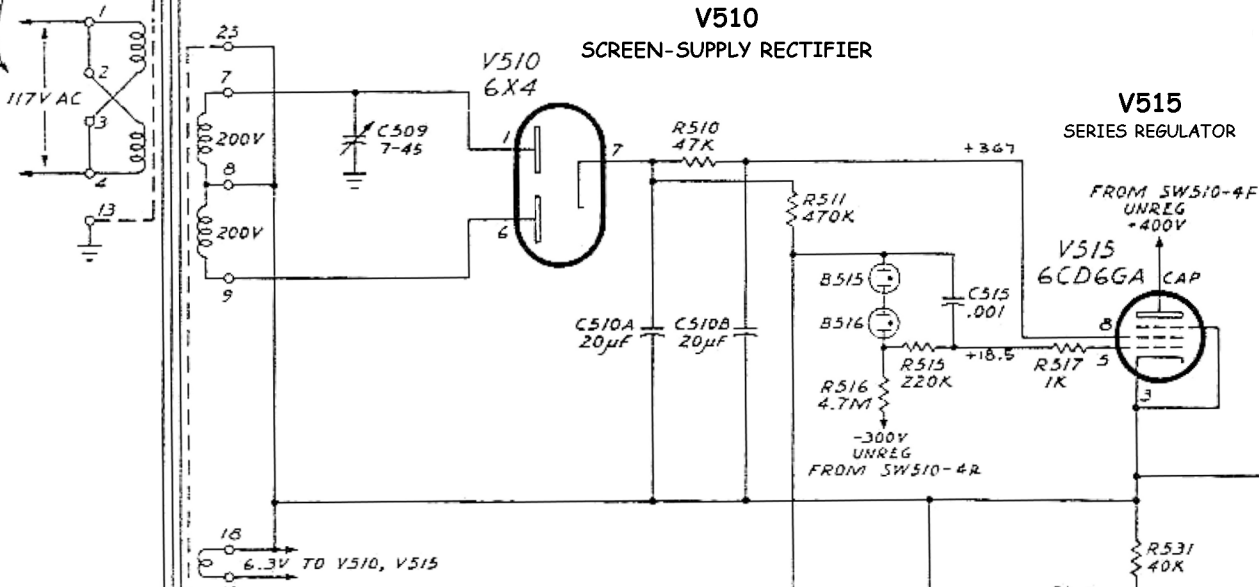

V515
SERIES REGULATOR

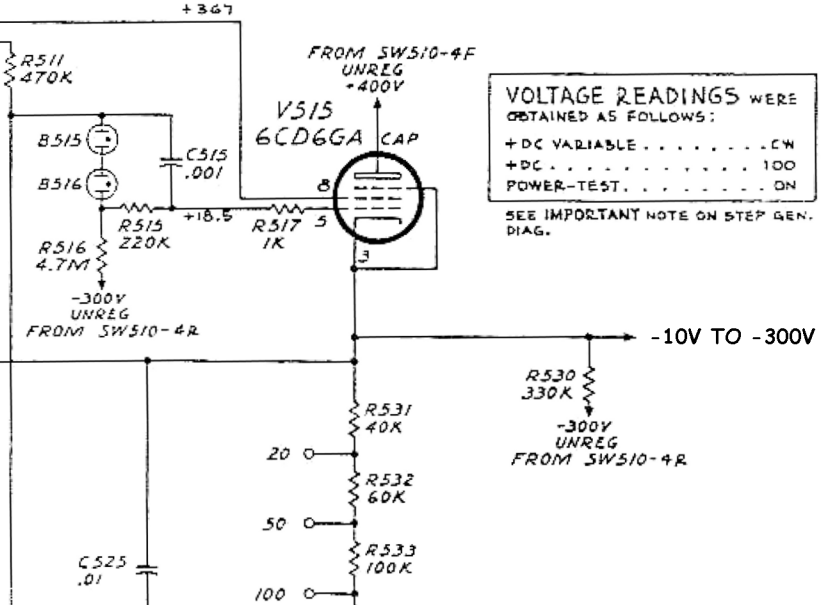

V525A
V525B
COMPARATOR

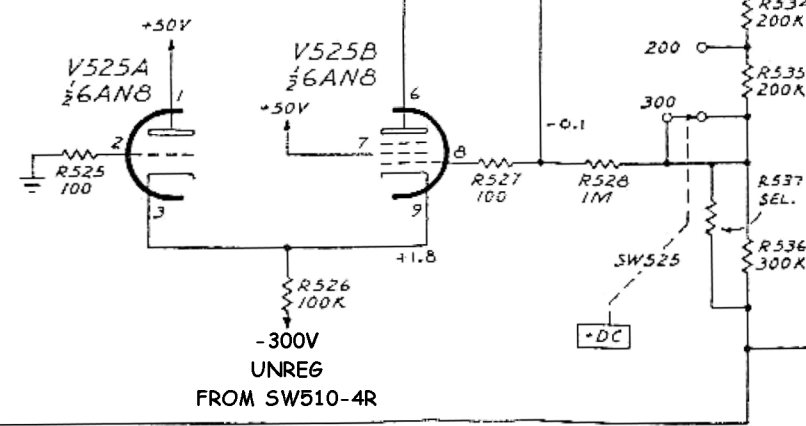

V540A
+50V REGULATOR

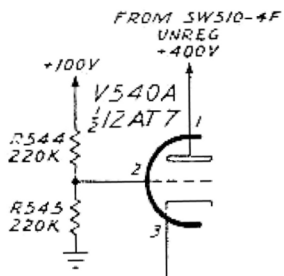

V540B
VOLTAGE SETTING C.F.

