

# 7000 Series Digital Plug-in Applications

time and frequency  
digital delay  
amplitude  
temperature

## Digital Accuracy

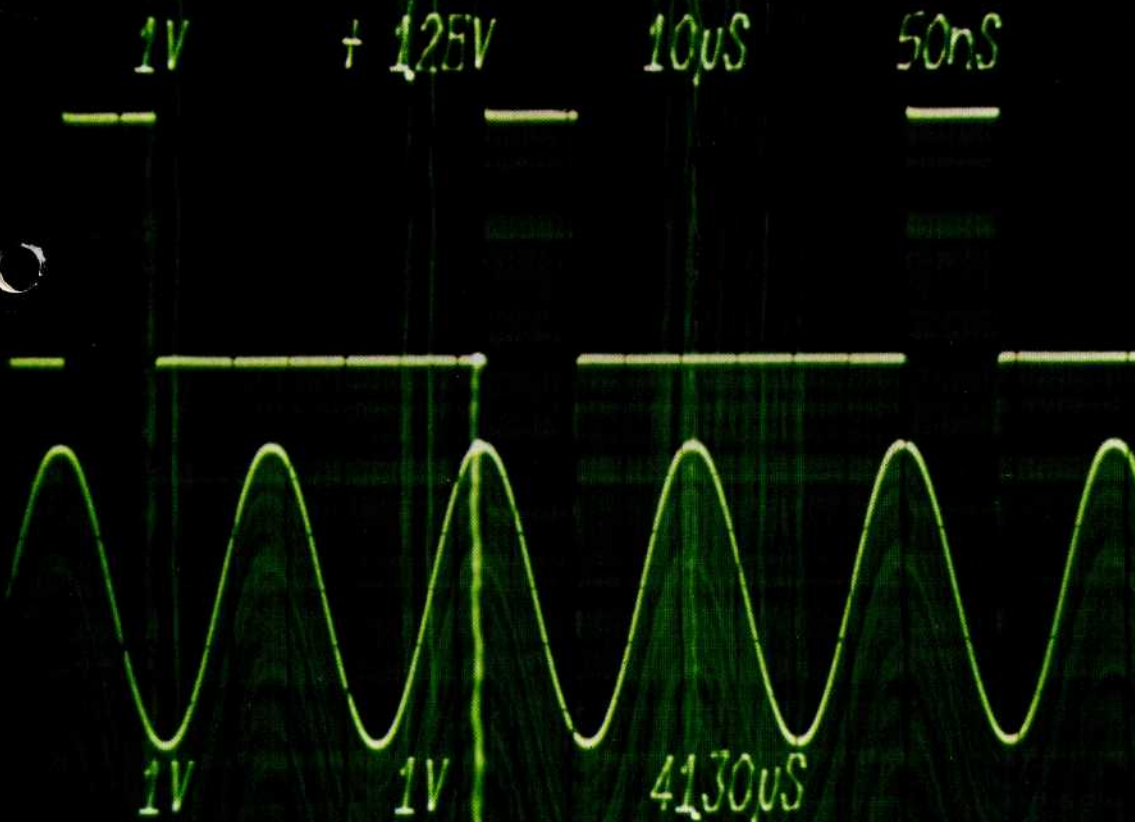

## Analog Interpretation

...more than an oscilloscope

## TABLE OF CONTENTS

---

Introduction .....	Page 3
1A. Timing and Frequency; Introduction to 7D14 Digital Counter and 7D15 Universal Counter/ Timer Plug-ins .....	Pages 4-7
1B. Timing Measurements with the 7D15 .....	Pages 8-12
1C. Frequency Measurements with the 7D14 and 7D15 .....	Pages 12-13
2A. Digital Delay; Intro- duction to the 7D10 and 7D11 Digital Delay Units .....	Pages 14-15
2B. Delay-by-Time Measurements with the 7D11 .....	Pages 15-18
2C. Delay-by-Events with the 7D10 and 7D11 .....	Page 18
<hr/>	
3A. Amplitude and Voltage; Introduction to the 7D12 A/D Converter and 7D13 Digital Multimeter with Modules—M1, Multi- function Module, M2, Sample/Hold Module and M3, Volts Module .....	Page 18
3B. Sample and Hold and True RMS Measure- ments with the 7D12/M2 and 7D12/M3 .....	Pages 19-20
4. Temperature Measure- ments with the 7D12/M2 and 7D13 .....	Page 21
Digital Application Notes, Ordering Information and Business Reply Card .....	Pages 22-23

## The purpose of this booklet . . .

---

. . . is to familiarize you with the Tektronix 7000 Series digital plug-in units, and to show you how they can make your oscilloscope a more versatile, accurate and easy to use measurement tool. The booklet is divided into four sections: Timing and Frequency Measurements, Digital Delay Measurements, Amplitude and Voltage Measurements, and Temperature Measurements, with a helpful cross-index of applications and digital plug-in units.

Each section provides a brief description of the features and operation of the related plug-ins, and some applications to help illustrate the full measurement possibilities that these plug-ins offer.

This booklet will be updated periodically with new applications and other information to help you make fuller use of your digital plug-ins.

The oscilloscope is a popular, time proven electronic measurement tool. Its bandwidth, sensitivity, and the interpretive power inherent in its visual display make it an unparalleled device for acquiring and displaying electronic signals. Yet with its many irreplaceable qualities, the oscilloscope typically cannot compare with a digital instrument such as a DVM or a digital counter for accuracy or resolution.

The plug-in compartments in the Tektronix 7000 Series mainframes and the availability of crt readout, offer a convenient method of adding true digital measurement capability to your oscilloscope. The Tektronix 7000 Series offers a full complement of digital measurement plug-ins. The units include a counter, universal counter/timer, two digital delays, multimeter, sample and hold DVM, and RMS voltmeter.

Including one or more digital plug-ins in your 7000 Series oscilloscope system provides you with the added accuracy and resolution of a digital instrument. It also opens the door to a number of measurements that cannot be made with either an oscilloscope or a digital measurement instrument alone.

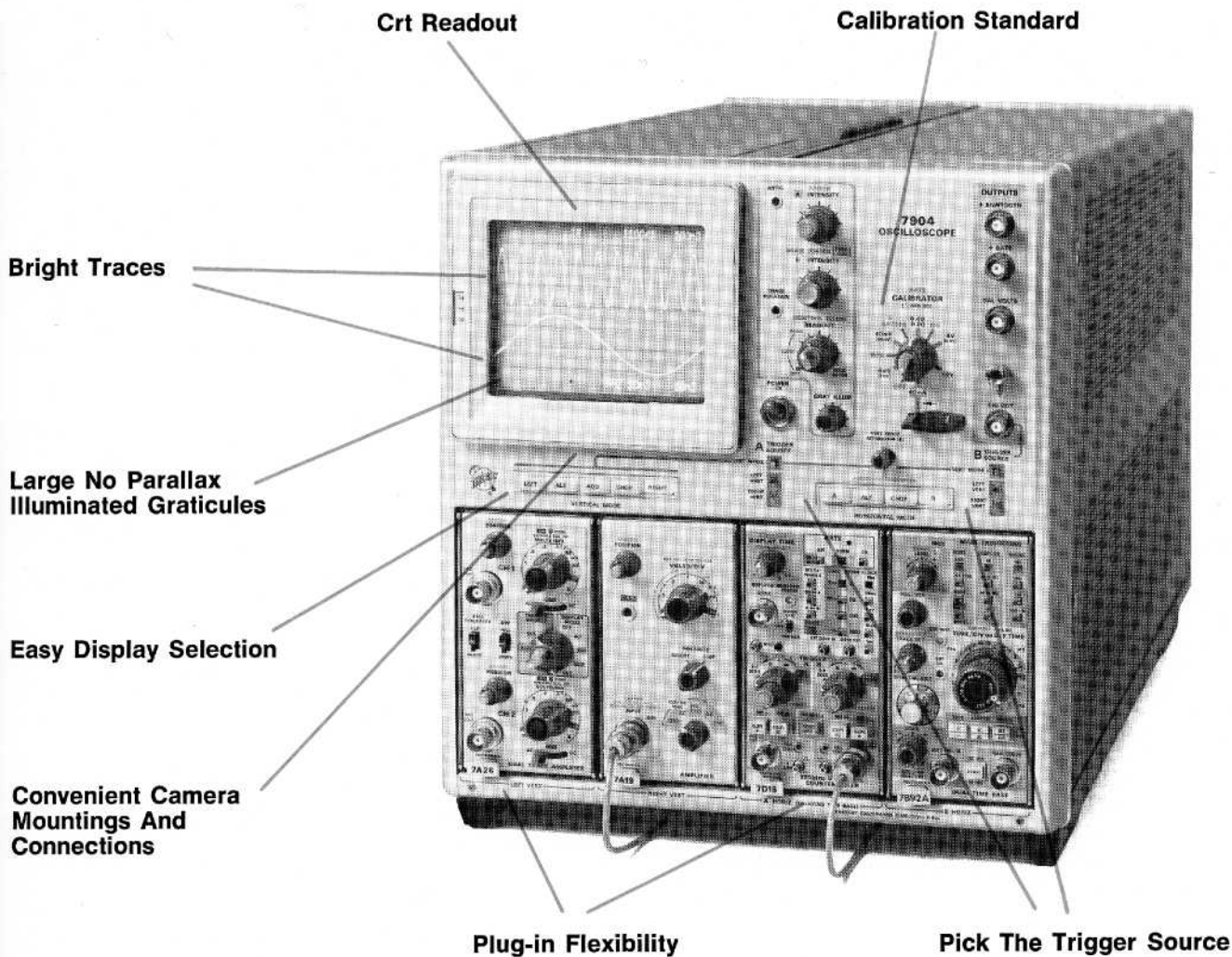

## The 7000 Series...more than an oscilloscope

This is more true today than ever. The 7000 Series continues to offer unmatched value in oscilloscopes—superior performance, wide-ranging flexibility and a strong commitment to your future needs.

With this family of eight oscilloscope mainframes, you can put together a high-performance laboratory instrument package based on your measurement needs.

- Bandwidths range from 25 to 500 MHz.
- Display modes include normal or three types of storage, bistable and fast mesh transfer, both developed by Tektronix, as well as variable persistence. The fast transfer technique, which makes multimode storage possible, provides the fastest writing rates available today.
- Single or dual beam models are available; the dual beam capability features 400 MHz bandwidth with full scan overlap.

With over 35 compatible plug-ins to choose from, you can configure a flexible scope package around your digital application; 7000-series mainframes accept three or four plug-ins:

- Digital plug-ins . . . Opt for unique and accurate solutions to complex measurement problems.
- Vertical amplifiers . . . Select your system bandwidth, number of input channels, vertical sensitivity, input impedance, and single or differential inputs.
- Time bases . . . Choose sweep speed, single or dual sweep, and now delta time capability.

Also,

- Sampling and TDR plug-ins . . . Choose single or dual channel sampling plus time domain reflectometry.
- Special-purpose plug-ins . . . Select logic analyzers, and curve tracers.

*The 7000-Series commitment to superior performance and wide-ranging flexibility merges digital accuracy with analog interpretation. Your timing, frequency, voltage, amplitude, digital delay or temperature measurement is digitally read out directly on the crt. This means a 7000-Series Plug-in Oscilloscope offers you an easy and accurate way to handle your digital applications.*

## INTRODUCTION

### more measurement capability

**Time and Frequency.** With our universal counter/timer you can visually select counter start and stop points on your waveform to measure pulse period, pulse width, or more complex parameters like risetime, the time between non-adjacent events, or the frequency of a gated burst. Two examples of visually selected measurements that you can make are the time between the first and eighth pulse in a data train or the width of a pulse that occurs in the middle of a control sequence. Both our counters provide gate displays of their measurement intervals, which can be displayed on the crt to reduce errors in trigger level adjustments, and make it easier for you to see exactly what measurement you are making. You can also make single-shot measurements with both counters. You might, for example, measure the width of a noise spike in a control sequence to determine the amount of filtering needed in a circuit.

**Digital Delay.** Both of our delay units provide delay-by-events, which allows you to delay your oscilloscope's time base by an exact number of events or clock pulses. This type of delay eliminates any inherent system jitter due to mechanical fluctuations and also allows you to easily examine data trains bit by bit. A very accurate time delay is also available for work in digital logic, radar and sonar.

**Voltage and Amplitude.** We also provide two digital multimeters, a true RMS voltmeter, and sample and hold measurement capability. The sample and hold plug-in allows you to visually select any point on your waveform and accurately measure its voltage with respect to ground, or measure the voltage difference between any two points on the waveform. With this unit you can measure voltage levels in core memory and pulse amplitudes in logic or control circuits.

**Temperature.** Our two multimeter units also measure temperature. With a special voltage insulated probe you can measure the temperature of semiconductor devices under test, double check your heat sink calculations, or quickly troubleshoot a digital logic board.

### easy to use

Tektronix has long recognized the convenience and ease of operation afforded by crt readout of scale factors, test dates, test numbers, and other pertinent test data. The digital plug-ins give you the further convenience of the speed, repeatability, and precision of digital measurements, with the measurement results displayed on the crt. Individual digital plug-ins provide other time saving features. The universal counter/timer, for example, offers finger tip selection of frequency, pulse period, pulse width and time interval measurements. Visual display of the gate waveforms lets you set up measurements quickly and precisely.

### more accuracy

The basic amplitude and time interval measurement accuracy of the conventional oscilloscope is 3%. Delay time measurements can be made at accuracies up to 1%. The 7000 Series digital plug-ins provide great improvement in this basic accuracy. The 7D12/M2 Sample/Hold DVM, for example, gives you direct amplitude measurements at accuracies approaching 0.25%, while the 7D15 Universal Counter measures time intervals with up to 0.0001% accuracy. The 7D11 Digital Delay provides delay time accuracies up to 0.00001%.

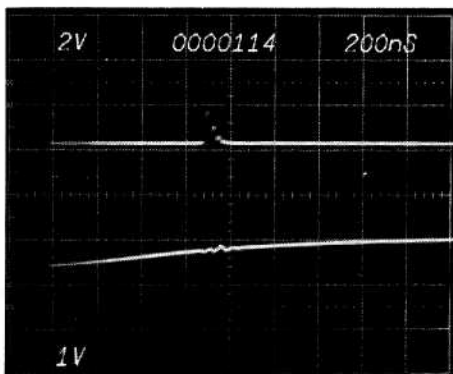
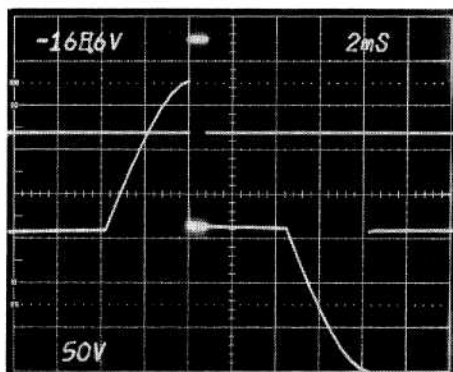
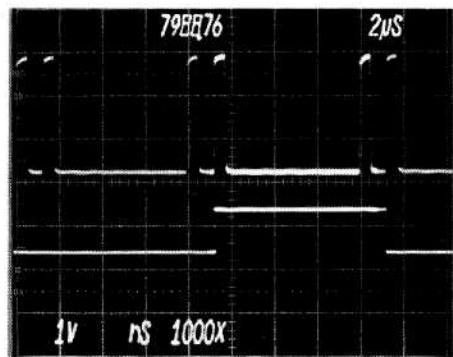
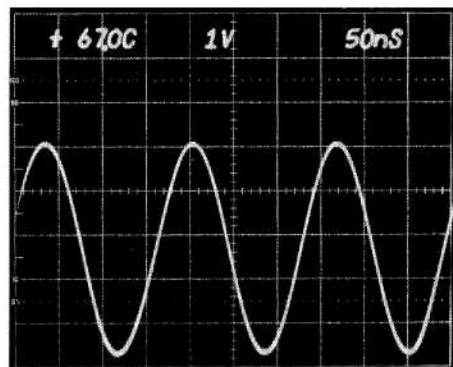

## 1A TIMING AND FREQUENCY

The 7D14 Digital Counter and the 7D15 Universal Counter/Timer give you the kind of *versatility* that lets you solve today's measurement problems as well as tomorrow's. By combining one of these counters with any 7000-Series oscilloscope, you obtain greater *flexibility* and *accuracy* than is possible with either an oscilloscope or a counter alone. The counter gives you *digital accuracy* and *resolution*, while the oscilloscope lets you see what the counter is triggering on. The visual display reduces errors, speeds up measurement time, and allows you to make a greater variety of measurements. This combination also makes possible the unique feature of oscilloscope controlled trigger arming. With trigger arming you can *visually select specific time intervals* for measurement within a repetitive or non-repetitive pulse train. Counter/oscilloscope measurement systems have proved invaluable to engineers and designers in digital electronics, computer electronics, industrial controls, communications and many other fields.

Both the 7D14 and 7D15 measure *frequency* and *events*, making them invaluable tools when working with CW or frequency burst signals. The 7D14 measures frequency directly to 525 MHz; the 7D15 measures frequency up to 225 MHz.

The 7D15 can also provide you with timing measurements with a high degree of accuracy (0.5 ppm) and resolution. A simple touch of a button selects the measurement required, such as *period*, *pulse width*, or *time interval*. Using the delayed sweep of your time base, you can externally arm the trigger circuits which allows you to *visually select the time interval* you want measured. Now you can see if you are false triggering on noise or even measuring the wrong time interval.

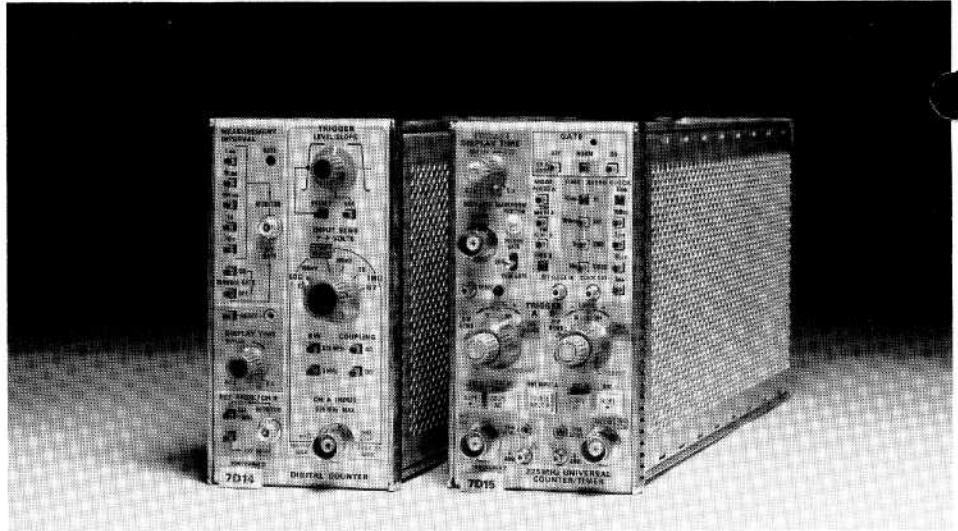

The 7D14 Digital Counter and the 7D15 Universal Counter/Timer

The following section describes the purpose and operation of some of the basic controls on the 7D14 and 7D15, to help you better understand the full measurement capability of the units. Following this General Operation section is a series of detailed applications, which illustrate the measurement of both time and frequency parameters such as width, period, propagation delay, frequency, etc. Each application includes an equipment setup illustration and a cookbook type description of the proper control settings.

### general operation

**Triggering.** *The trigger selectivity of the 7D14 and 7D15 contributes greatly to the measurement flexibility of these units.* Both units provide oscilloscope type trigger controls, which allow the choice of AC or DC coupling, + or - slope, internal or external trigger source, and adjustable trigger level. These controls are located in the green shaded areas of each plug-in. To obtain a trigger signal, the signal to be measured is generally input directly into the counter through a front panel signal input connector. With the counter in a horizontal plug-in compartment, however, you can route a signal from a vertical amplifier plug-in internally through the oscilloscope mainframe to the

counter. The TRIG SOURCE positions of the INPUT SENS (7D14) and the P-P SENS (7D15) switches select this internal trigger source mode. This signal input method reduces circuit loading and provides pre-conditioning of the input signal.

Trigger level preset is also available on both units. With the 7D14, the preset level can be set with a front-panel screwdriver adjustment. When the 7D15 TRIGGER LEVEL controls are set to PRESET, the unit automatically triggers at the 0 volt level. In this position you can also set the trigger level externally (see the following discussion).

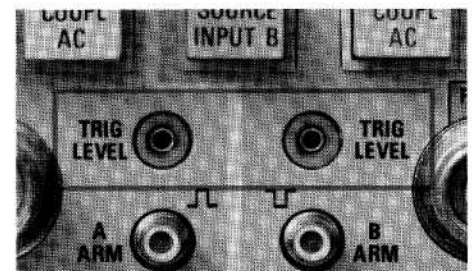

**Trigger Level Jacks.** *The 7D15 provides two front-panel TRIG LEVEL jacks.* The voltage that appears at these jacks is proportional to the actual voltage levels at which the trigger circuits (A and B) have been set to trigger. Table 1 lists the actual trigger level ranges of the trigger circuits for the three positions of the P-P SENS controls and the corresponding outputs at the TRIG LEVEL jacks. Note that for all three trigger level ranges, the output of the TRIG LEVEL jacks is from -0.5 V to +0.5 V.

For the 5 V and 50 V ranges, the TRIG LEVEL output is thus proportional to the actual trigger level voltage. Using a DVM to monitor the voltage at one of these jacks, you can set the respective trigger circuit to trigger on an exact voltage level. For example, if you want to set the A TRIGGER LEVEL to trigger on the +2.5 V level of the A input signal, then measure +0.25 V with a DVM at A TRIG LEVEL OUTPUT. This also means that you need to be on the 1 P-P SENS range. This feature is helpful when trying to measure a parameter like risetime or pulse width, where trigger level is critical.

#### TRIGGER LEVEL RANGES

P-P SENS	Trigger Level Range	TRIG LEVEL Output
0.1	-0.5 V to +0.5 V	-0.5 V to +0.5 V
1	-5 V to +5V	-0.5 V to +0.5 V
10	-50 V to +50 V	-0.5 V to +0.5 V

table 1

When one of the TRIGGER LEVEL controls is set to PRESET, the trigger circuit automatically triggers on the 0 V level of the signal. In the PRESET position, however, you can also set the trigger level externally, by inputting a voltage level through the respective TRIG LEVEL jack. As with the output voltage of the TRIG LEVEL jack, the input voltage range of the jacks is also -0.5 V to +0.5 V. The setting of the P-P SENS switch again sets the trigger level range, and you input a voltage that is proportional to the desired trigger level voltage. For example, if a +15 V trigger level is desired, set the P-P SENS switch to 10 V (the 50 volt range) and apply a DC voltage of +0.15 V to the TRIG LEVEL jack.



**Selective Trigger Arming.** Another useful feature of the 7D15 is the ability to externally arm the counter trigger circuits. This gives you external control of the measurement interval, but more important, it allows you to use the

counter to make highly accurate measurements on selected portions of a repetitive or non-repetitive pulse train. Few other counters offer this feature.

Since the counter is being used in an oscilloscope, the delayed sweep gate, which is readily available from the time base, makes a very convenient external arming signal for the counter. The delayed sweep gate is particularly useful, because both the width and the time position (delay) of this gate can be controlled with the time base Time/Division controls and the Delay Time Multiplier control, respectively. The gate also corresponds to the intensified zone that is seen on the CRT in the A Intensified By B sweep mode.

The arming signals are input into the 7D15 through the A ARM and B ARM connectors. An arming gate amplitude of greater than 0.5 V (a high) arms channel A and an amplitude of less than 0.2 V (a low) arms channel B. When channel A is armed, the counter starts counting as soon as the channel A trigger conditions are met; when channel B is armed, the counter stops counting as soon as the channel B trigger conditions are met.

Fig. 1 shows an example of the measurement of the time between two non-adjacent pulses, using trigger arming. In this case, both the channel A and B trigger controls are set to trigger on the 50% level of the positive-going slope of a pulse. The delayed sweep gate of the oscilloscope is used as the arming gate, and must be connected to both the A ARM and the B ARM connectors. Using the oscilloscope Delay Time Multiplier and the B sweep Time/Division controls, the delayed sweep gate can be adjusted to select the specific pulses to be measured.

Note that when using trigger arming, the arming gate does not affect the accuracy of the measurement. It merely tells the trigger circuits when they should begin looking for the selected start and stop measurement points. The settings of the trigger controls determine the exact trigger points and thus the measurement interval.

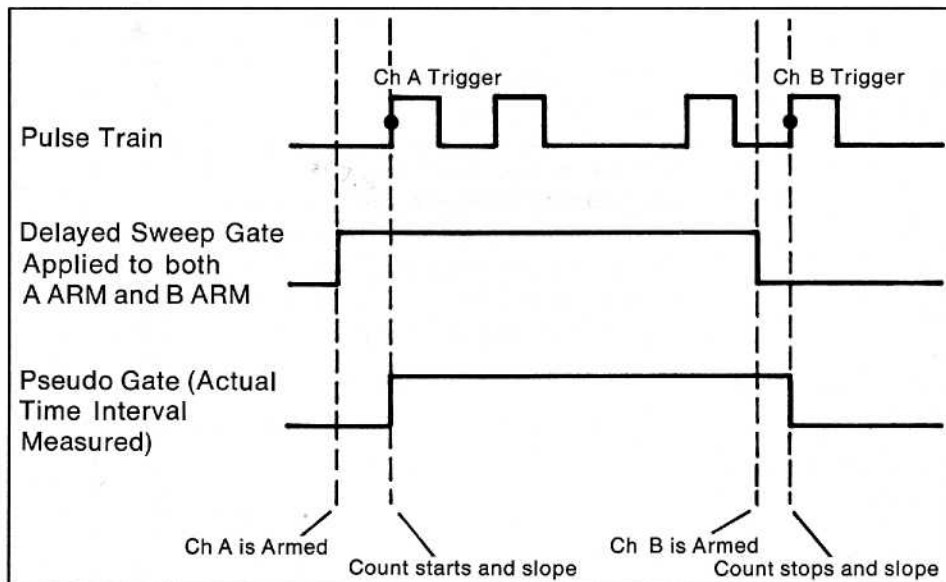
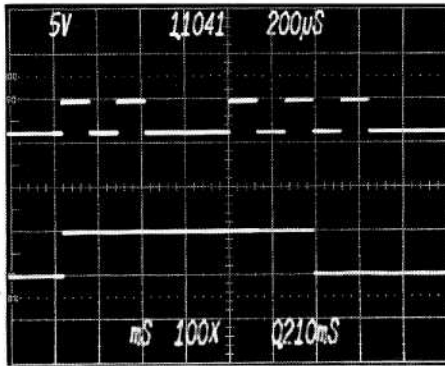

Fig. 1 Measuring the time interval between two non-adjacent pulses using trigger arming.



**Fig. 2. Crt display of time interval measurement. Intensified zone indicates position of arming gate.**

**Counter Gate Displays.** Both the 7D14 and the 7D15 provide the capability of displaying their internal measurement interval gates, which indicate the actual points of a measurement. As is shown in Fig. 2, these gates are different from the external or arming gates. The counter gate displays help to reduce errors, speed set up time, and provide you with greater trigger selectivity.

When the 7D14 and 7D15 are in vertical mainframe compartments, the gated displays are obtained by pressing the appropriate mainframe channel selection switch. In a horizontal compartment, a cable must be connected from either the MONITOR connector (7D14) or the DISPLAYED WAVEFORM OUTPUT connector (7D15) to one channel of a vertical amplifier. When the counter gate is displayed (see Fig. 2), you can see the signal being measured along with the actual interval in which the measurement is being taken. The arming gate is generally not displayed. However, if the delayed sweep gate is being used for trigger arming, its width and position are indicated by the intensified zone on the display.

The 7D15 provides three types of gates. The TRUE GATE is the *actual* gate waveform generated each time the counter takes a measurement. It typically has a low rep rate and is difficult to use, because it is dependent on the setting of the DISPLAY TIME control. The PSEUDO GATE is a high repetition replica of the TRUE GATE, and is the most useful of these two. The PSEUDO GATE has a higher rep rate, because it is generated each time the trigger and arming conditions are met. A third display, CH B, is a conditioned signal that

is derived from the 7D15's CH B trigger circuit. It is useful for setting up the trigger conditions of channel B.

**Externally Gated Frequency Measurements.** Both the 7D14 and 7D15 provide the ability to externally gate the counter for frequency measurements. By displaying this gating waveform along with the signal being measured, you have the unique ability to measure frequency and count events within non-repetitive signals, like gated bursts. As with time interval measurements, the delayed sweep gate from the oscilloscope provides a convenient gating signal.

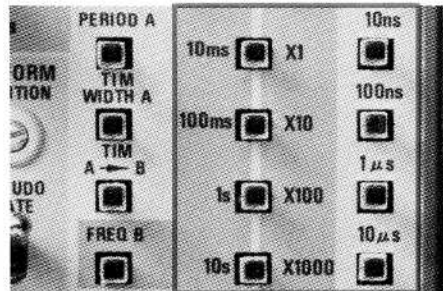

**Selectable Resolution and Accuracy.** Measurement averaging and selectable clock rates on the 7D15 allow you to select the amount of resolution and the maximum accuracy possible for a particular time measurement. This feature also helps you prevent readout overflow when measuring long time intervals.

The CLOCK pushbuttons set the basic resolution of the counter. The 7D15's fastest clock rate is 10 ns, which is the maximum resolution possible for a single shot time measurement. When measuring repetitive signals, resolution can be increased using measurement averaging. Measurement averaging is a statistical method of increasing resolution which involves making a number of measurements and averaging the results. When measuring period, for example, with the X1000 AVERG pushbutton pressed, the counter measures the time for 1000 cycles and divides the result by 1000 to obtain the time of one period. Figs. 3, 4, and 5 show graphs of resolution vs. period, resolution vs. time interval, and resolution vs. frequency for the various settings of the CLOCK and AVERG pushbuttons. Note that for period measurements, resolution is increased 1000 times from the X1 to the

X1000 AVERG setting. For time interval measurements, the maximum resolution is increased from 10 ns to 2 ns (for the 10 ns clock rate)—an increase in resolution of 5 times.

The resolution you select also determines the maximum time interval you can measure without overflowing the 8 digit CRT readout. For example, if a resolution of 10 ns is selected (10 ns clock rate and X1 measurement averaging), the longest time interval that can be measured before overflow occurs is .99999999 second. The selected resolution determines the units of the least significant digit of the display. For a longer time interval, you must select less resolution. This is providing that you care about the most significant digit of the measurement. If you are merely trying to resolve a small time difference, and do not care about the actual time interval, you can overflow the counter and still obtain the maximum resolution desired.

Accuracy is defined as the ratio (in percent) of the worst case error for a measurement to the actual measurement, and is a function of resolution and the accuracy of the crystal controlled clock oscillator. As Figs. 3, 4, and 5 illustrate, accuracy tends to increase with increases in the period, time interval, or frequency being measured. The 7D15 clock oscillator has an accuracy of 0.5 ppm, which provides time measurement accuracies of up to 0.0001% on long time intervals—much greater than the 1% accuracy of an oscilloscope.



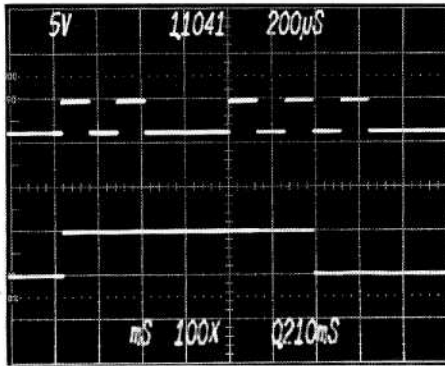

**Fig. 2. Crt display of time interval measurement. Intensified zone indicates position of arming gate.**

**Counter Gate Displays.** Both the 7D14 and the 7D15 provide the capability of displaying their internal measurement interval gates, which indicate the actual points of a measurement. As is shown in Fig. 2, these gates are different from the external or arming gates. The counter gate displays help to reduce errors, speed set up time, and provide you with greater trigger selectivity.

When the 7D14 and 7D15 are in vertical mainframe compartments, the gated displays are obtained by pressing the appropriate mainframe channel selection switch. In a horizontal compartment, a cable must be connected from either the MONITOR connector (7D14) or the DISPLAYED WAVEFORM OUTPUT connector (7D15) to one channel of a vertical amplifier. When the counter gate is displayed (see Fig. 2), you can see the signal being measured along with the actual interval in which the measurement is being taken. The arming gate is generally not displayed. However, if the delayed sweep gate is being used for trigger arming, its width and position are indicated by the intensified zone on the display.

The 7D15 provides three types of gates. The TRUE GATE is the actual gate waveform generated each time the counter takes a measurement. It typically has a low rep rate and is difficult to use, because it is dependent on the setting of the DISPLAY TIME control. The PSEUDO GATE is a high repetition replica of the TRUE GATE, and is the most useful of these two. The PSEUDO GATE has a higher rep rate, because it is generated each time the trigger and arming conditions are met. A third display, CH B, is a conditioned signal that

is derived from the 7D15's CH B trigger circuit. It is useful for setting up the trigger conditions of channel B.

**Externally Gated Frequency Measurements.** Both the 7D14 and 7D15 provide the ability to externally gate the counter for frequency measurements. By displaying this gating waveform along with the signal being measured, you have the unique ability to measure frequency and count events within non-repetitive signals, like gated bursts. As with time interval measurements, the delayed sweep gate from the oscilloscope provides a convenient gating signal.

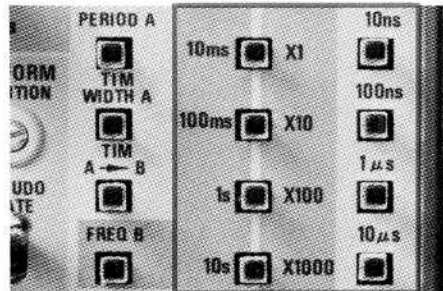

**Selectable Resolution and Accuracy.** Measurement averaging and selectable clock rates on the 7D15 allow you to select the amount of resolution and the maximum accuracy possible for a particular time measurement. This feature also helps you prevent readout overflow when measuring long time intervals.

The CLOCK pushbuttons set the basic resolution of the counter. The 7D15's fastest clock rate is 10 ns, which is the maximum resolution possible for a single shot time measurement. When measuring repetitive signals, resolution can be increased using measurement averaging. Measurement averaging is a statistical method of increasing resolution which involves making a number of measurements and averaging the results. When measuring period, for example, with the X1000 AVERG pushbutton pressed, the counter measures the time for 1000 cycles and divides the result by 1000 to obtain the time of one period. Figs. 3, 4, and 5 show graphs of resolution vs. period, resolution vs. time interval, and resolution vs. frequency for the various settings of the CLOCK and AVERG pushbuttons. Note that for period measurements, resolution is increased 1000 times from the X1 to the

X1000 AVERG setting. For time interval measurements, the maximum resolution is increased from 10 ns to 2 ns (for the 10 ns clock rate)—an increase in resolution of 5 times.

The resolution you select also determines the maximum time interval you can measure without overflowing the 8 digit CRT readout. For example, if a resolution of 10 ns is selected (10 ns clock rate and X1 measurement averaging), the longest time interval that can be measured before overflow occurs is .99999999 second. The selected resolution determines the units of the least significant digit of the display. For a longer time interval, you must select less resolution. This is providing that you care about the most significant digit of the measurement. If you are merely trying to resolve a small time difference, and do not care about the actual time interval, you can overflow the counter and still obtain the maximum resolution desired.

Accuracy is defined as the ratio (in percent) of the worst case error for a measurement to the actual measurement, and is a function of resolution and the accuracy of the crystal controlled clock oscillator. As Figs. 3, 4, and 5 illustrate, accuracy tends to increase with increases in the period, time interval, or frequency being measured. The 7D15 clock oscillator has an accuracy of 0.5 ppm, which provides time measurement accuracies of up to 0.0001% on long time intervals—much greater than the 1% accuracy of an oscilloscope.

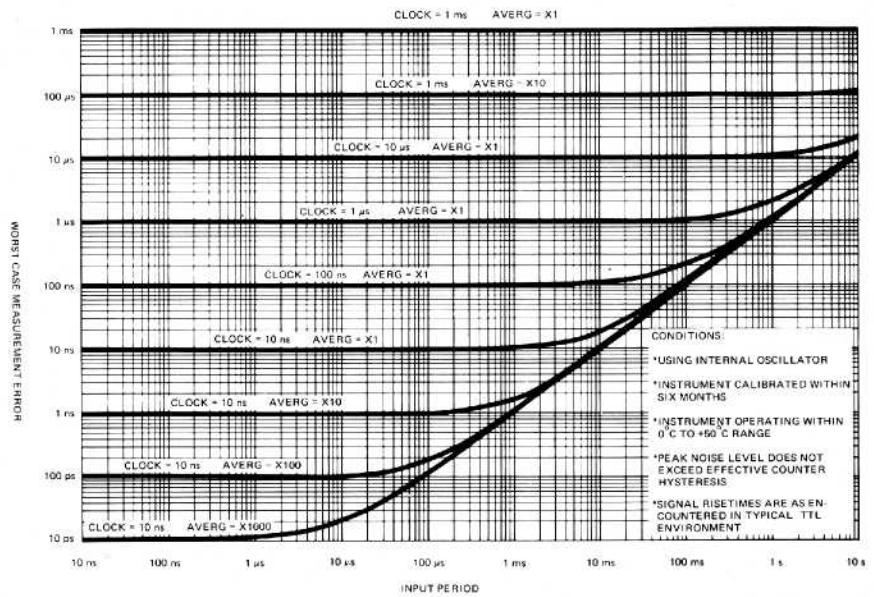

Fig. 3. Resolution vs. Period Interval

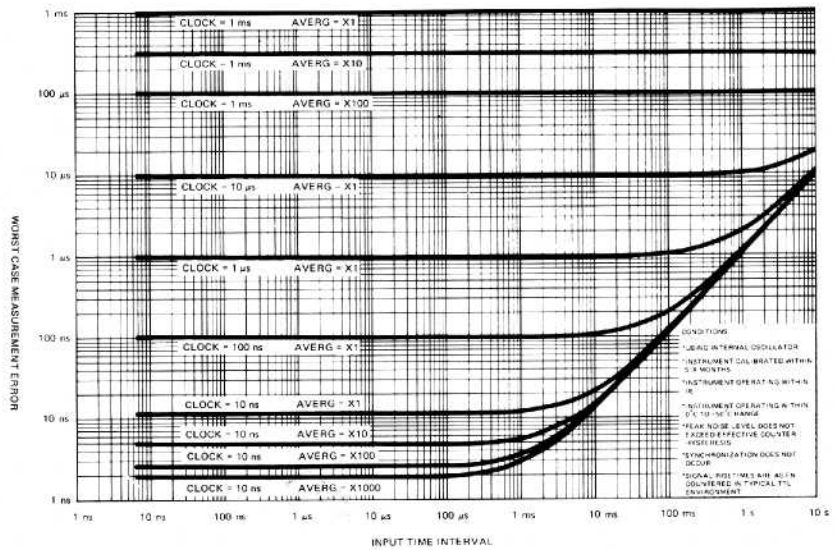

Fig. 4. Resolution vs. Time Interval

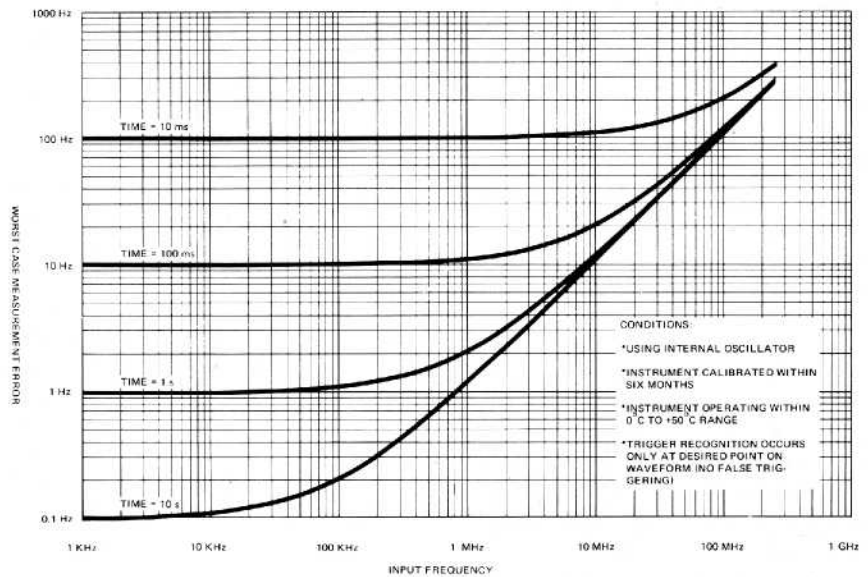

Fig. 5. Resolution vs. Frequency

# 1B TIMING MEASUREMENT

## pulse width

The TIM WIDTH A mode pushbutton on the 7D15 allows you to measure pulse width directly. Only the channel A triggering circuit is used in this measurement. Fig. 6 shows the equipment setup to measure the width of a TTL clock pulse. The 10 ns clock rate and X1000 measurement average provides maximum accuracy and resolution. The display of the PSEUDO GATE indicates the measurement interval.

Width measurements are generally made at the 50% amplitude level of the pulse. For an exact measurement of pulse width at any amplitude level, set the trigger level by monitoring the channel A TRIG LEVEL jack with a DVM. This pulse has a 5 V amplitude. With the P-P SENS control set to 1 V, the trigger level should be set for an output at the A TRIG LEVEL jack of +0.25 V. This voltage yields an actual trigger level of 2.5 V (see Table 1).

Fig. 7 shows the equipment set up to measure the width of a noise spike that is appearing in a logic signal. Using trigger arming, the 7D15 is set to make the width measurement only after the logic signal has gone low.

Connect the delayed sweep gate output to the A ARM connector of the 7D15. The Delay Time Multiplier and the Variable Time/DW control can now be used to position the beginning of the arming gate after the falling edge of the logic signal and to keep the trigger circuit armed for the duration of the low level. The intensified zone indicates the position and width of the arming gate. With this setup, the 7D15 will capture and measure the width of the first positive-going transition that occurs after it is armed.

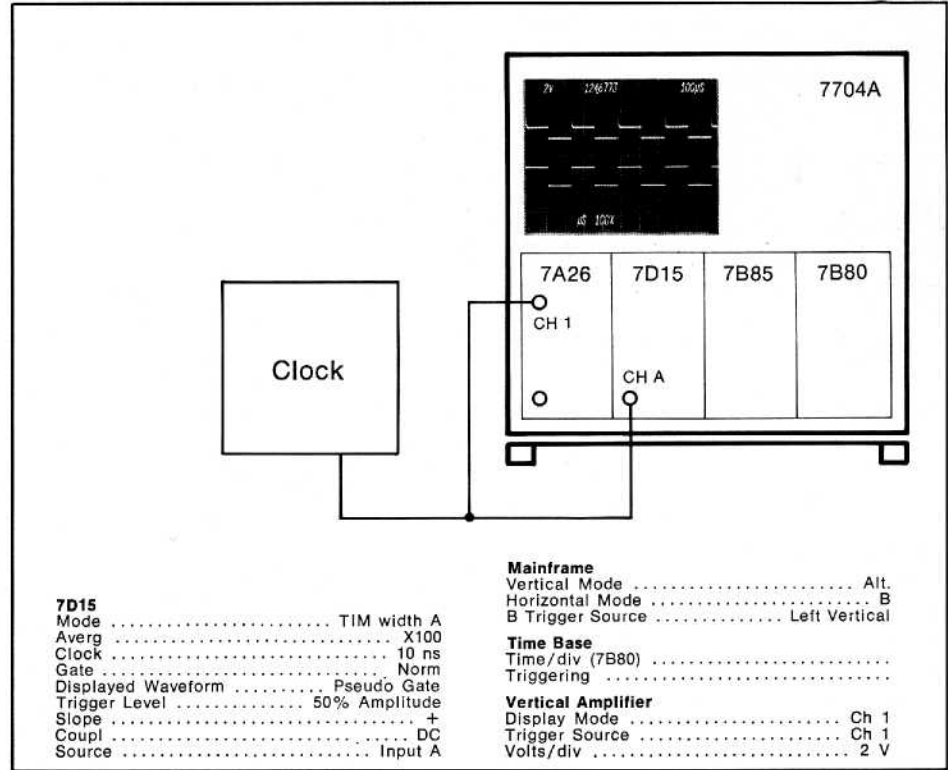

Fig. 6. Equipment setup for typical width measurement.

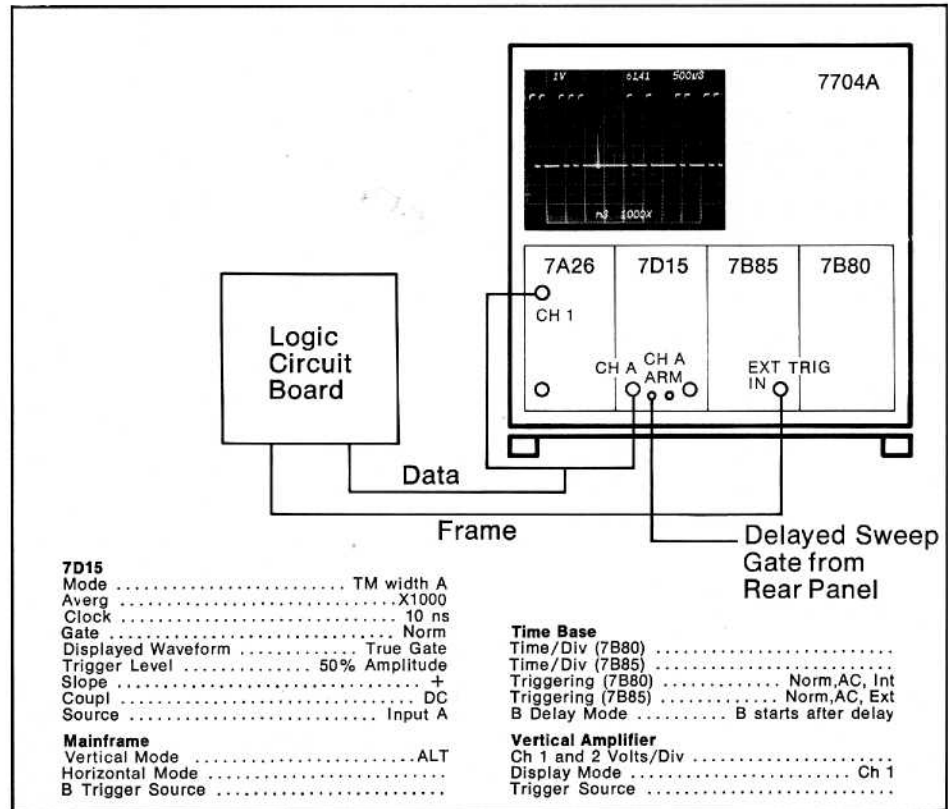
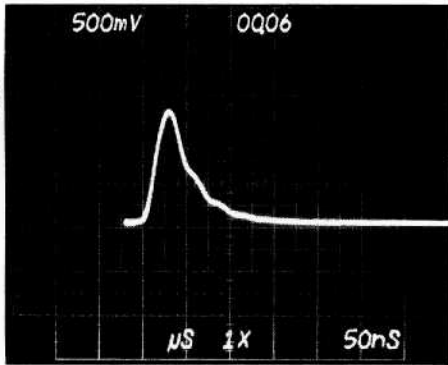

Fig. 7. Equipment set up for transient measurement.



**Fig. 8. Waveform and width measurement readout for destruction test.**

The 7D15 can also measure the width of single-shot events. Fig. 8 shows the waveform photograph of destruction test made with a storage oscilloscope and the 7D15. The width of this pulse was measured simultaneously with the storage of the display. Since the event only occurred once, the arming gate was not required.

### pulse period

Pulse period is just as easy to measure with the 7D15 as width. Using the same set up as shown for the clock pulse width measurement in Fig. 6, press the PERIOD A MODE pushbutton. The period measurement is now read out on the CRT. Merely set the A TRIGGER controls to trigger the counter either on the leading or falling edge of the pulse. The trigger level can be adjusted to meet your specific measurement requirement.

Since the signal being measured is repetitive, X1000 measurement averaging is selected to obtain maximum accuracy and resolution. See the discussion of accuracy and resolution at the beginning of this section.

As with pulse width measurements, trigger arming is not necessary to measure the period of a signal. Arming is useful though when looking at data pulse trains or other signals where a pulse may or may not be present during a given clock cycle.

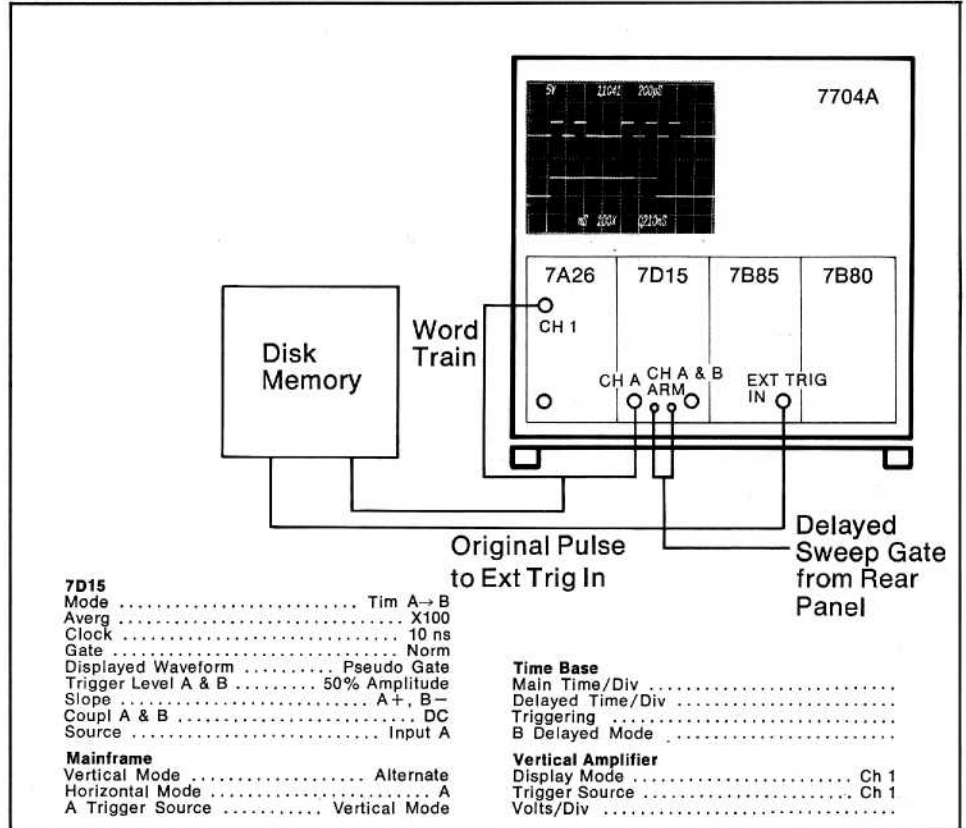

**Fig. 9. Equipment setup for measurement of time between non-adjacent events.**

### time between non-adjacent events

The ability to select a particular pulse in a pulse train for measurement, as was previously illustrated by the pulse width measurement of a noise spike, can also be applied to the measurement of the time-between non-adjacent events. Few other time counters are able to measure width or time between non-adjacent events in repetitive or non-repetitive signals such as digital word pulses from a computer's main storage, CPU, radar IFF responses, etc. In these types of measurements, an oscilloscope is essential.

Fig. 9 shows the equipment set up for a time interval measurement on a serial word train from a disk memory device. The origin pulse in this case is used to trigger the A time base. The delayed sweep gate is again used to arm the counter's trigger circuits. In this case the delayed sweep gate is connected to both the A ARM and B ARM connectors, because the TIM A→B mode is being used.

Once a stable display is obtained, measurements can be made between any two points on the waveform merely by adjusting the trigger levels and

slopes, and by adjusting the position and width of the intensified zone (the delayed sweep gate). The Delay Time Multiplier (DTM) control determines the position of the leading edge of the delayed sweep gate and thus the point of arming the A TRIGGER circuit. The time base Variable Time/Division control sets the width of the delayed sweep gate and thus the position of the falling edge of the gate, or the point of arming for the B TRIGGER circuit. The delayed sweep gate is applied to the A and B ARM inputs, A trigger is armed during the time B trigger is disarmed, and vice versa.

In this example, the counter arming gate is set to measure the time between the falling edge of the first pulse in the display and the leading edge of the last pulse. The waveform photo in Fig. 9 shows the analog waveform display (upper trace), the PSEUDO GATE display of the counter's actual measurement period (lower trace), and the read out of the actual measurement. This particular measurement is 1.1041 ms, which is much better resolution than

can be obtained visually from the analog display. The 100X measurement averaging improves the accuracy and resolution of the measurement. The accuracy in this case is within 4 ns (.00036%).

## time between two voltage levels

Risetime, the time between the 10% and 90% pulse levels, or the time required for a transducer to rise from one level to another, can easily be acquired from the 7D15's TIME A-B Mode.

The 7D15 offers digital readout, accuracy and convenience in making these measurements. For example, if you are making a series of risetime measurements where the 10% and 90% levels are not changing, each risetime is digitally read out on the crt; this eliminates the need to carefully position the waveform, and, then count divisions on the crt.

When making adjustments to your circuitry, you can resolve small changes in risetime with outstanding ease and resolution. However, the 7D15 is not recommended for measuring risetimes faster than 125 ns.

The two separate trigger circuits of the 7D15 and the ability to set exact trigger levels through the two TRIG LEVEL jacks allows you to make very accurate risetime measurements with the 7D15. Again, trigger arming can be used to select a particular pulse in non-repetitive pulse trains.

Fig. 10 shows the equipment set up for measuring the risetime of a clock pulse as it is input into a flip-flop. This is a flip-flop, which requires a clock pulse risetime of 150 ns from the 0.6 V to the 5.4 V level.

The TRIGGER SLOPE controls in this measurement are both set to +. To set the TRIGGER LEVEL controls, connect a DVM to one TRIG LEVEL jack at a time, and set the A trigger level for 0.6 V and B trigger level for 5.4 V. With the TIM A→B MODE pushbutton pressed, the risetime is read directly on the CRT. In this case the risetime measurement is 155.60 ns. The accuracy is within 2 ns or 1.3%.

This method can be easily used for measuring rise and fall times slower

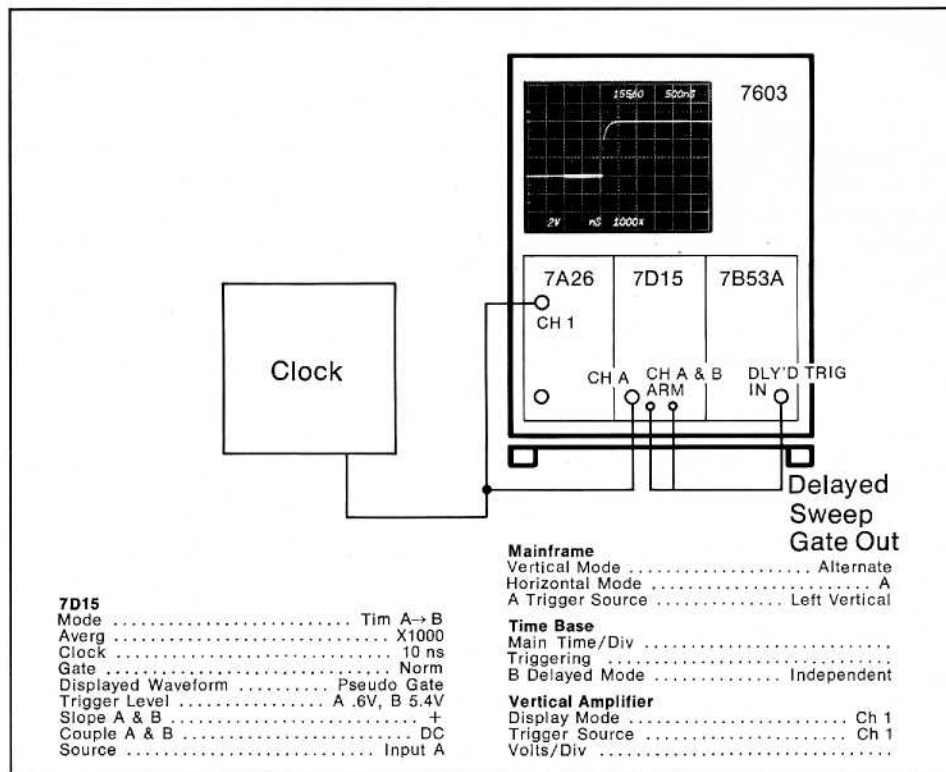

Fig. 10. Equipment setup for risetime measurement.

than 125 ns. The trigger arming gate (the delayed sweep gate) must be connected to both the A ARM and the B ARM connectors. Set the A trigger level control to trigger at the 10% point and the B trigger level control for the 90% point. Now a typical time interval measurement (TIM A→B) can be done by moving the intensified zone from one risetime to another. This allows you to accurately perform selective risetime measurements with greater resolution than with a conventional oscilloscope.

## propagation delay

The two signal inputs to the 7D15 trigger circuits allow you to make propagation delay measurements quickly and easily. Fig. 11 shows the equipment setup required to measure the propagation delay experienced by a clock signal as it passes through seven TTL gates.

In this setup, the undelayed pulse is connected to both channel 1 of the vertical amplifier and channel A of the 7D15; the delayed pulse is connected to channel 2 of the vertical amplifier and channel B of the 7D15. The 7D15's SOURCE INPUT B pushbutton determines the source of the trigger signal for channel B. When out, it receives its

signal from the channel A input (in the TIM A→B mode). When in, each trigger circuit receives its trigger signal from its respective input connector.

Trigger arming is required for this measurement, because channel B must know which pulse to trigger on with respect to the undelayed pulse. Connect the delayed sweep gate to both trigger arming input jacks.

With the oscilloscope vertical mode set for alternate trace sweeps, trigger the scope on the undelayed pulse (channel 1). Now adjust the intensified zone so that it begins before the rise of the undelayed pulse, and ends before the rise of the delayed pulse. The propagation delay is then read out on the CRT. The measurement in this case is 76.60 ns.

For maximum accuracy, both the TRIGGER LEVEL controls should be set for the same voltage level. This can be obtained either by measuring the voltage levels through the TRIG LEVEL jacks with a DVM, or by applying the desired voltage level to each jack (see the discussion of trigger level in the introduction section).

## phase shift

Phase shift is critical in areas like servo, RF or digital system design. The most common method of measuring phase shift is to use an oscilloscope in the X-Y or delayed sweep mode. A more accurate method of measuring phase is with the 7D15. To determine phase, the time between the same voltage level on the leading and lagging signals is measured and divided by a conversion factor (Time/Degree).

For example, if the period of the signal (as measured with the 7D15) is  $2 \mu\text{s}$  (5 MHz), the Time/Degree conversion factor is:  $2 \mu\text{s}/360 \text{ degree} = 5.55 \text{ ns/degree}$ . If the time interval between the two phases is measured at 50 ns, the phase difference is thus:  $50 \text{ ns}/5.55 \text{ ns/degree} = 9.09 \text{ degree}$  of phase shift.

Fig. 12 shows the equipment setup for the measurement of the phase shift of a 5 MHz signal. Like the previous propagation delay measurement, one signal is applied to each trigger input to the 7D15. Again the SOURCE INPUT B pushbutton is pressed to enable both input connectors. Both the channel A and B TRIGGER LEVEL controls are set to PRESET, which means the trigger circuits will trigger on the zero crossover point.

Trigger arming is not required for this measurement. Merely trigger the scope on the negative going slope of channel 1. This assures that the pseudo gate display is on the CRT. The pseudo gate display indicates that the measurement is being made between the two zero crossover points. In this case, the time measured is 75.60 ns for phase shift of  $75.6 \text{ ns}/5.55 \text{ ns/degree} = 13.8 \text{ degrees}$ .

This method of measuring phase shift can be used for singleshot or repetitive signals, with accuracies of  $0.125^\circ$  and  $0.075^\circ$ , respectively at 35 kHz. Several factors affect this accuracy:

1. Amplitude of the two signals—It is more difficult for the 7D15 trigger circuits to detect the zero crossover point on low amplitude signals.
2. Relative amplitude of the two signals—Ideally both signals should be the same amplitude.

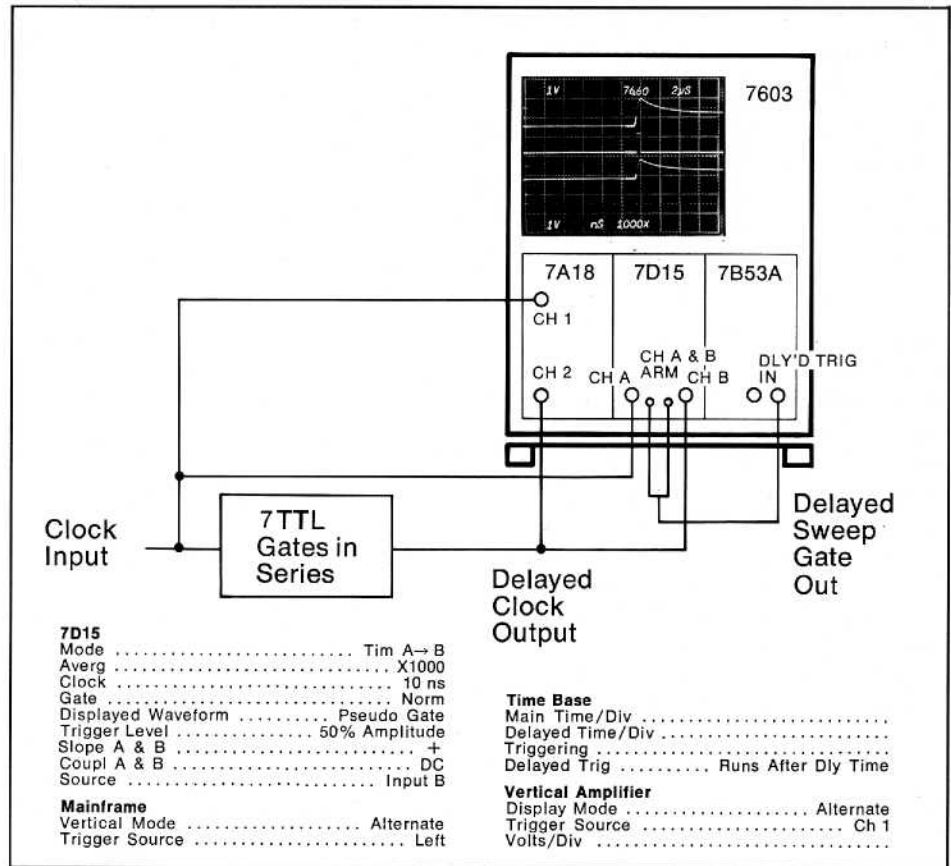

Fig. 11. Equipment setup for propagation delay measurement.

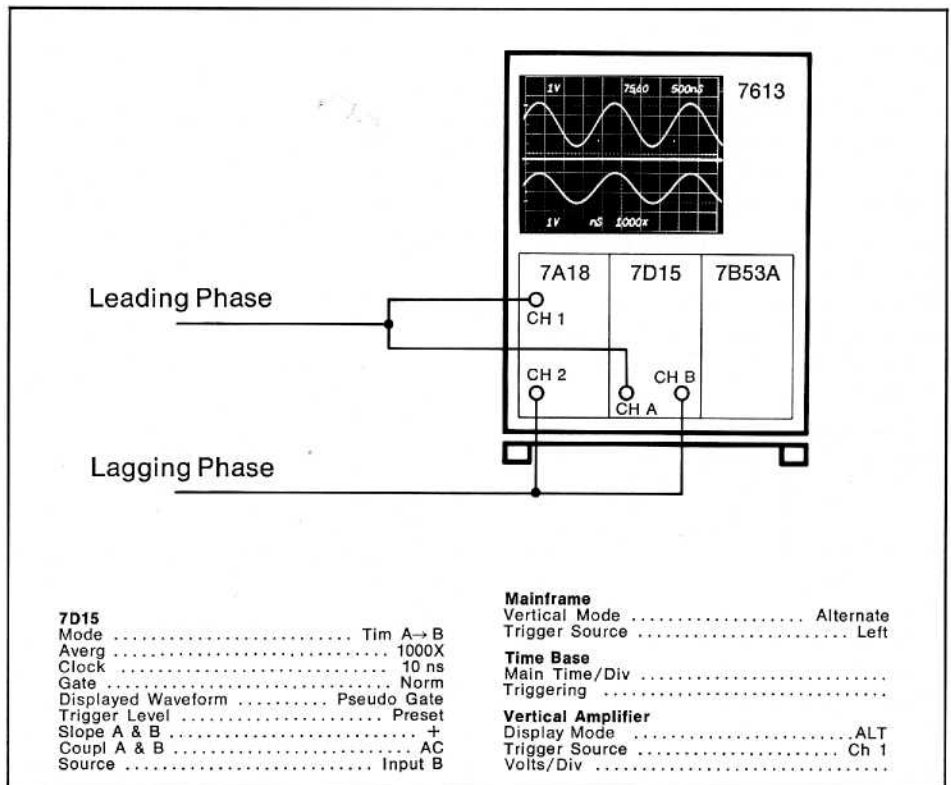

Fig. 12. Equipment setup for phase shift measurement.

3. Noise on the signals—Noise may fire the trigger circuits prematurely causing jitter in the measurement, ultimately affecting the resolution of the readout.

4. Frequency of the signals—The frequency range, for best results, is 60 Hz to 50 MHz.

## 1C FREQUENCY MEASUREMENTS

### frequency

Fig. 13 shows the equipment setup for a basic frequency measurement of a CW signal with the 7D14. For this measurement, the signal to be measured is routed through the vertical amplifier to the 7D15. The MEASUREMENT INTERVAL determines the resolution of the measurement. The longest measurement interval (10 s) provides the highest resolution. In this case, the frequency is 120.055 MHz.

### measuring the frequency of a burst signal

Fig. 14 shows the equipment set up for the measurement of a T.V. Burst signal with the 7D14. (The same measurement can also be made with the 7D15.) Note that the burst signal from the T.V. signal generator is connected to both the 7D14 for measurement and to the vertical amplifier for display on the CRT. The counter measurement interval gate is connected from the 7D14 MONITOR/EXIT GATE connector to the vertical amplifier for display on the CRT. The delayed sweep gate is used in this measurement to trigger the counter, and thus the Delay Time Multiplier determines the point where the frequency measurement begins.

The 7D14 front-panel decade divide buttons select the measurement interval for this measurement. The selected measurement interval must be shorter than the burst time, or a consistently lower frequency reading will occur. Since 1 ms is the shortest measurement

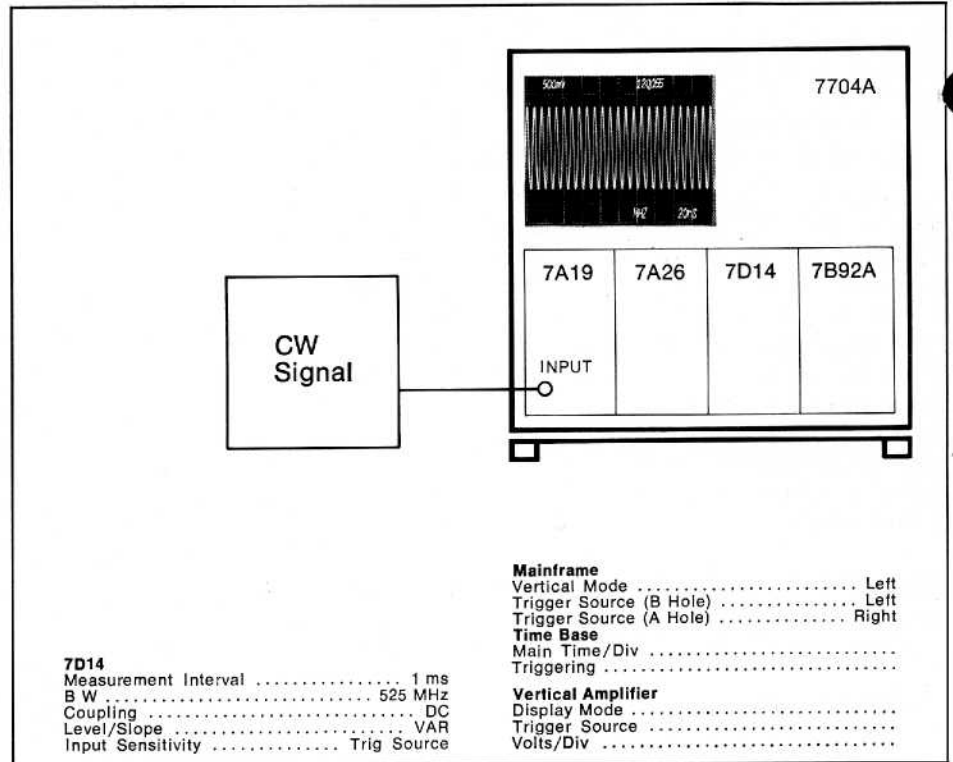

Fig. 13. Equipment setup for frequency measurement.

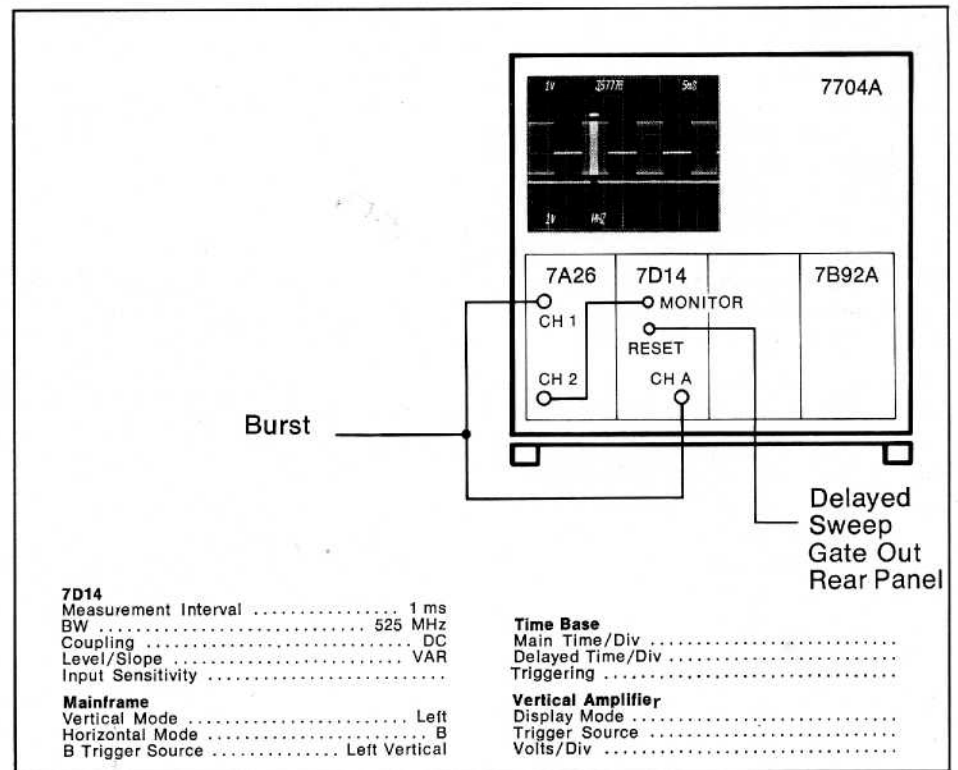

Fig. 14. Equipment setup for measurement of burst frequency.

interval, which can be selected on the 7D14, the burst to be measured must be wider than 1 ms. The resolution of the 7D14 using the 1 ms interval is 1 kHz. Measurement resolution is thus limited on lower frequency signals.

For this burst frequency measurement, the 1 ms MEASUREMENT INTERVAL is selected. The INPUT SENSITIVITY is set to 100 mV and the TRIGGER LEVEL/SLOPE control is set to count on the positive-going slope of each cycle within the burst. Fig. 14 shows a burst frequency measurement of 3.577 MHz. On bursts of 10 ms or greater, the 10-ms MEASUREMENT INTERVAL can be selected to increase the resolution by a factor of ten.

### counting the number of cycles or events in a burst

Fig. 15 shows the equipment set-up for counting the number of cycles in a burst. In this case, the delayed sweep gate sets the measurement interval of the 7D14. Since the delayed sweep gate is not a precision calibrated measurement interval, only the actual count is read out with no frequency units. Once a stable display is obtained, the Delay Time Multiplier and the Variable Time/Division controls are set to obtain a delayed sweep gate that encloses the burst to be measured. (Note that this is the opposite of the frequency measurement.) Since the delayed sweep gate is displayed on the CRT along with the Burst, the position and width of the measurement interval can be set quickly and accurately.

When operating the 7D14 in a vertical plug-in compartment of the oscilloscope, the output of the counter shaper can also be displayed (see Fig. 16). Simultaneous viewing of the 7D14 trigger shaper output with the burst makes it possible to adjust the 7D14 TRIGGER LEVEL control to count only those cycles of the desired amplitude as shown. The mainframe vertical mode switch must be set to alternate or chop to view the trigger shaper output. As the TRIGGER LEVEL control is adjusted for higher levels, the lower amplitude cycles of the burst are not recognized by the 7D14 trigger circuit. The count

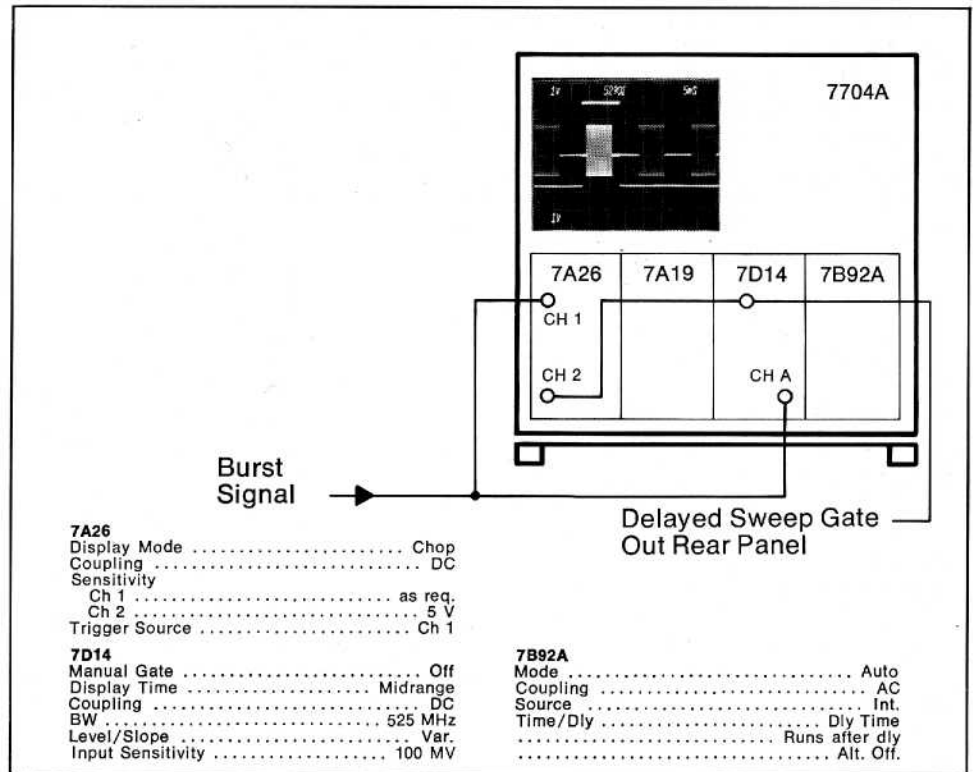

Fig. 15. Equipment setup for counting the number of cycles in a burst.

is displayed in the upper center of the crt. The  $\pm 1$  count ambiguity inherent in counter measurements does not affect the accuracy of this measurement if the counter gate is opened and closed between bursts as shown. Fig. 17 shows

a measurement of 3114 cycles in a burst. The only limitation in making this measurement is that the minimum input cycle width to the CH A INPUT is 10 ns, and the gate input must be at least 500 ns wide.

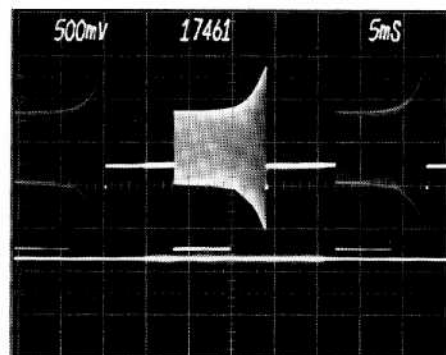

Fig. 16. Display of counter shaper output.

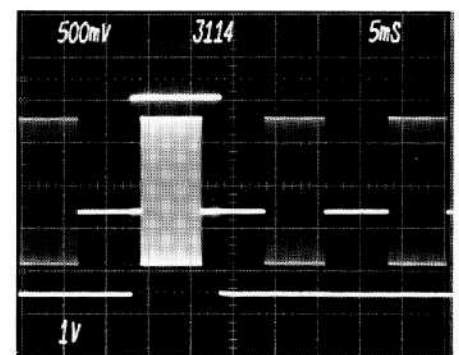

Fig. 17. Display of 3114 cycle burst.



## 2A DIGITAL DELAY MEASUREMENTS

The oscilloscope delaying sweep time base is a standard tool for measuring the time delay between events and for making delayed sweep measurements. Trigger jitter and the 1% accuracy of the delaying sweep ramp, however, often limit the usefulness of this analog type delay. These problems become critical when working with digital logic, computer peripherals, PCM telemetry, radar, sonar, shock tube testing, or delay line measurements, where *low jitter*, *precision time delays* are required. The Tektronix 7D11 Digital Delay and 7D10 Digital Delay units provide solutions to these problems of accuracy and jitter.

### digital delay

At first glance the operation of the 7D11 Digital Delay may seem complicated, but it actually performs the same function as the oscilloscope analog delay. In the 7D11 a precise clock and high resolution counter have been substituted for the delaying sweep ramp and Delay Time Multiplier control, which provides the delay time in an oscilloscope. The 7D11 has two modes of operation, *delay-by-time* and *delay-by-events*, selected with front panel push-buttons. The *delay-by-time* mode duplicates the function of the oscilloscope delaying sweep time base, but with much greater accuracy than is possible with analog delay. The *delay-by-events* mode allows you to delay the sweep for a specific number of counts or clock pulses. (The 7D10 is similar to the 7D11 except that it provides only the delay-by-events mode.)

In the *delay-by-time* mode (see Fig. 18), the 7D11 receives a trigger through the front-panel EXT TRIG IN connector, which signals it to start counting the highly accurate internal clock. At the end of a selected delay time, a delayed trigger signal is delivered both to the front-panel DLY'D TRIG OUT connector and internally to the mainframe, where it can be routed directly to the time base using the mainframe trigger selection pushbuttons.

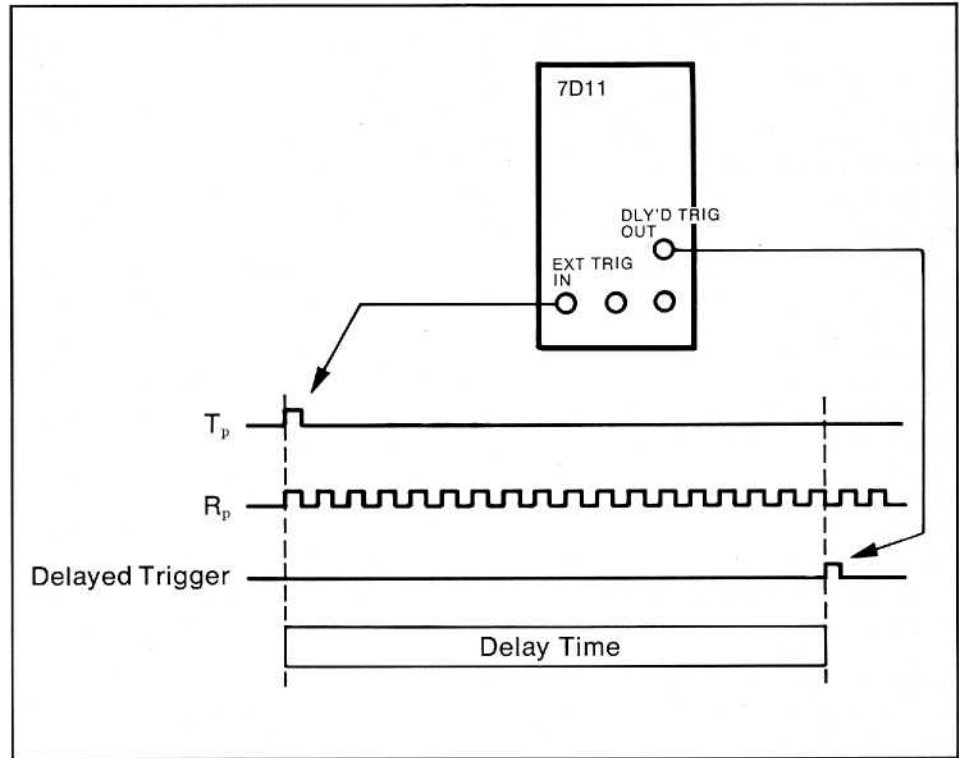

Fig. 18. 7D11 DIGITAL DELAY operating in delay-by-time mode.

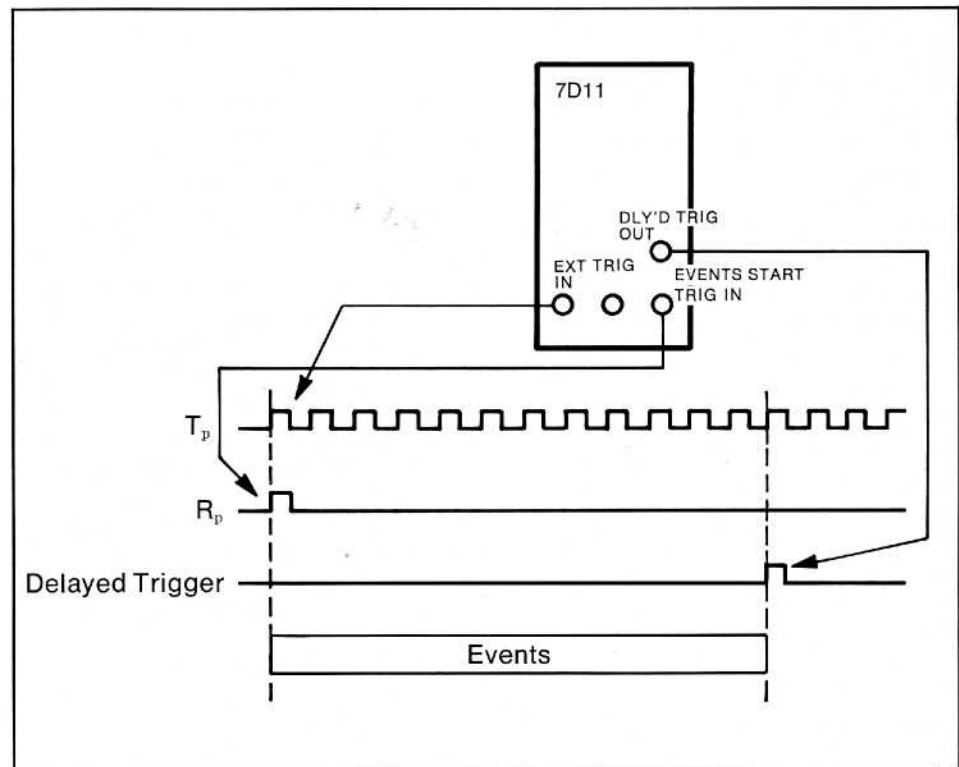

Fig. 19. 7D11 DIGITAL DELAY operating in delay-by-events mode.

The delay time is selected with the front panel DELAY TIME OR EVENTS and FINE DELAY controls. For convenience, the setting of the DELAY TIME OR EVENTS control is displayed on the oscilloscope crt readout.

The 7D11 internal clock provides an accuracy of  $\pm 2$  ns (0.5 ppm), which is much more accurate than can be obtained from an analog delayed sweep time base. If accuracy greater than 0.5 ppm is required, the 7D11 delay-by-time clock can be referenced to an external 1-MHz timing standard input through the EXT 1 MHz IN connector. Jitter with the digital delay is reduced to less than 2.2 ns for delay times as long as 22 ms.

In the delay-by-events mode (see Fig. 19), the 7D10 or 7D11 counts trigger events from an external source, either periodic or aperiodic, and generates a delayed trigger once a preselected count has been reached. Two signals are required to operate the 7D10 or 7D11 in the delay-by-events mode. One signal is input through the EXT TRIG IN connector and provides the events to be counted. The other signal is input through the EVENTS START TRIG IN connector and tells the delay unit when to begin counting. Both connectors have independent trigger controls. Events can be counted at rates up to 50 MHz. When the selected number of events has been counted, a signal is delivered to both the DLY'D TRIG OUT connector and internally to the mainframe. The events count, which is displayed on the crt readout, can be set to any number from 1 to 10 million.

The main reason for using delay-by-events is display stability. Display stability becomes a problem with traditional delay-by-time measurements, when the signal being used to trigger the delay is unstable. Speed variations in a rotation disk memory, for example, cause typical disk timing signals like origin or sector pulses to jitter. When using either analog or digital time delay, where the sweep is delayed by a fixed amount of time, this jitter causes the display to jump back and forth. For high time resolution measurements,

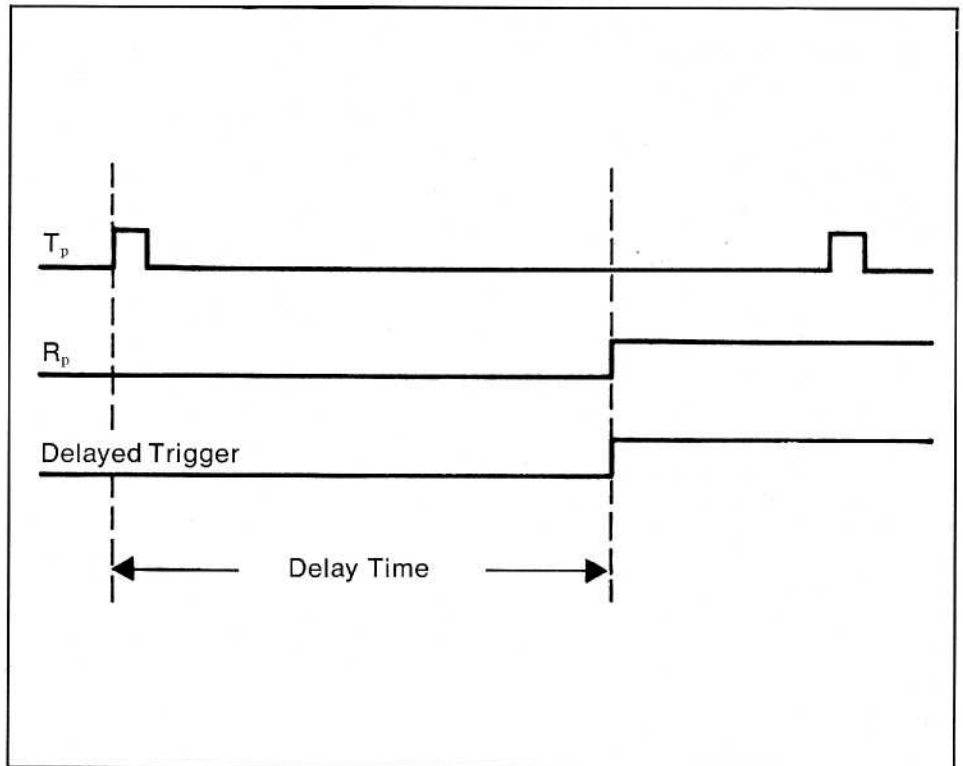

Fig. 20. Radar pulse timing measurement.

this instability can become excessive and make the display unuseable. When using delay-by-events, the oscilloscope is triggered at or near the event to be observed, rather than at the end of a fixed time delay. Timing signal jitter has no effect on the display.

With delay-by-events you have the added convenience of being able to select a particular clock pulse (the 10th pulse, the 256th pulse, etc.) in a long pulse train to trigger the oscilloscope on. This relieves you of the job of visually counting clock pulses on the crt display.

## 2B DELAY-BY-TIME MEASUREMENTS

Testing a radar system is one example of how more accurate measurements can be made with a digital delay unit. The measurement of the delay time between the transmitter pulses ( $T_p$ ) and echo pulses ( $R_p$ ) of a radar system typically calls for the measurement of long delay times with an accuracy of a few nanoseconds. In this example, the 7D11 provides a very accurate time reference for this type of measurement (see Fig. 20). To make this measurement, the transmitter pulse is used to trigger the 7D11. The 7D11 delayed trigger output is then compared on the crt with the echo pulse. Coincidence between the two pulses is obtained by adjusting the 7D11 DELAY TIME OR EVENTS and FINE DELAY controls. The delay time displayed on the CRT readout plus the setting of the FINE DELAY control is the delay time between the transmitter and the echo pulses.

Before making this measurement, the oscilloscope and the delay unit must be calibrated. Fig. 21 shows the equipment setup and waveforms for calibrating this radar pulse measurement system. Initial system calibration is required because the 7D11 and the oscilloscope time base plug-in have independent trigger level controls. For maximum measurement accuracy, both plug-ins must be set to trigger on the same level and slope.

For the most accurate measurements, a time mark generator with a 500-ns time marker should be used for calibration. T-connect the time mark generator output to both the 7D11 EXT TRIG IN connector and CH 1 of the dual-trace vertical amplifier, then connect the 7D11 DLY'D TRIG OUT to CH 2 of the vertical amplifier. Set the vertical amplifier trigger source switch to CH 2, and the mainframe vertical mode, left and trigger source, left. Select a 500-ns delay (0.0005 ms) with the 7D11 DELAY TIME OR EVENTS control, and set the FINE DELAY control to zero. After setting the time base trigger level for a stable display, adjust the 7D11 TRIGGER LEVEL control for exact overlay of the 0.5  $\mu$ s time mark and the 7D11 delayed trigger output pulse as shown in Fig. 21. The system is now calibrated. The 7D11 and time base TRIGGER LEVEL controls must not be readjusted throughout the remainder of the measurement.

If a time mark generator is not available, the method shown in Fig. 22 can be used for calibrating the system at a slight sacrifice in accuracy. This method relies on the accuracy of the analog sweep for the initial calibration. T-connect the transmitter pulse to both the 7D11 EXT TRIG IN connector and CH 1 of the vertical amplifier, then connect the 7D11 DLY'D TRIG OUT connector to CH 2 of the vertical amplifier. Select minimum delay (0.0001 ms) with the 7D11 DELAY TIME OR EVENTS control, and again make sure the 7D11 FINE DELAY control is at zero. Trigger the oscilloscope sweep on the transmitter pulse, then adjust the 7D11 TRIGGER LEVEL control so that 100 ns exists between the leading edges of the transmitter pulse and the 7D11 DLY'D TRIG OUT pulse. The system is now calibrated. Again, the 7D11 and time base TRIGGER LEVEL controls must not be readjusted throughout the remainder of the measurement.

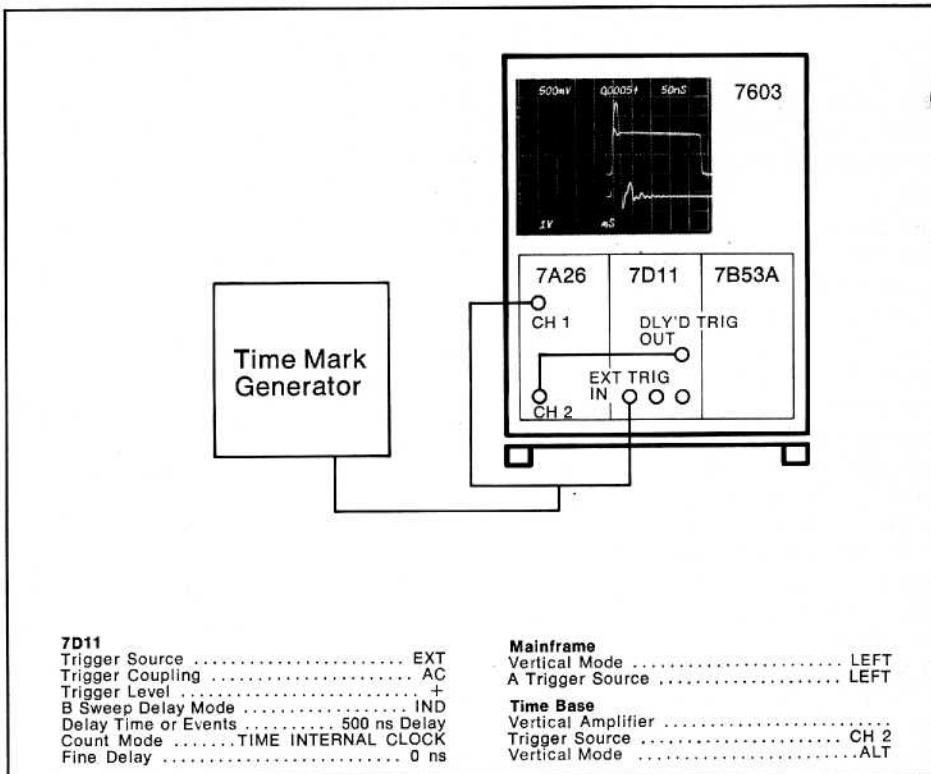

Fig. 21. Equipment setup for initial calibration using a time mark generator.

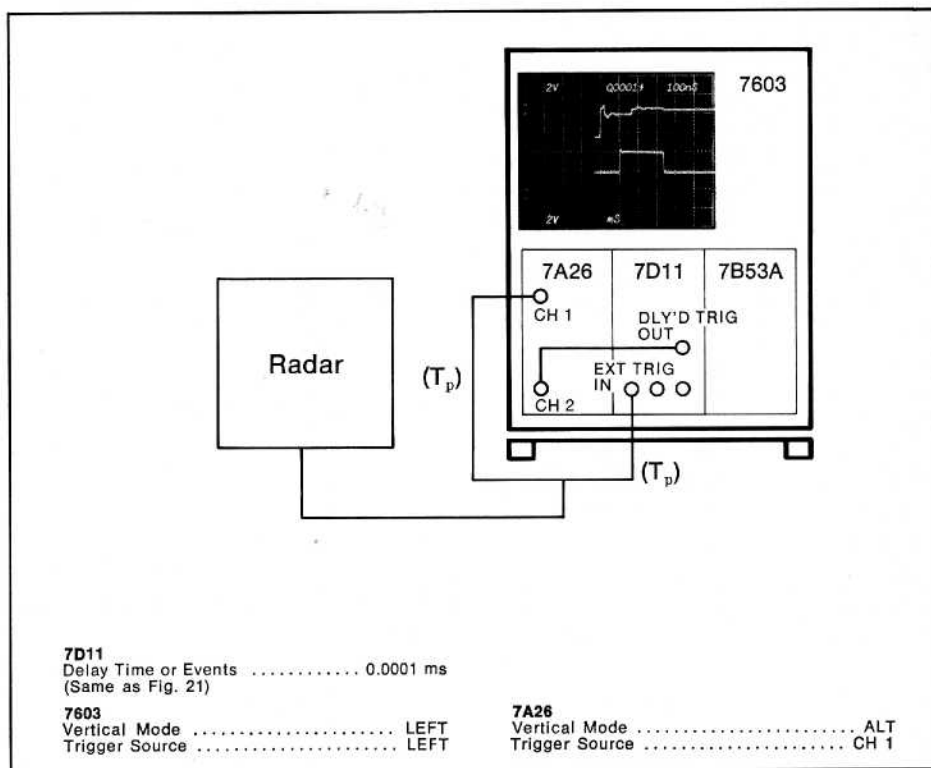

Fig. 22. Alternate method of system calibration using the radar transmission pulse.

The accuracy of the radar pulse measurement when using the calibration method shown in Fig. 21 is 2 ns. Using the method shown in Fig. 22 yields an accuracy of 5 ns or less depending on the accuracy of the analog sweep ramp.

With the system calibrated, the time difference between the transmitter pulse ( $T_p$ ) and the echo pulse ( $R_p$ ) can now be measured with the result displayed on the crt readout. Fig. 23 shows the equipment connected for the actual radar pulse measurement. Connect the transmitter pulse to the 7D11 EXT TRIG IN connector, the echo pulse to CH 1 of the vertical amplifier, and set the vertical amplifier trigger source for CH 2. The 7D11's DLY'D TRIG OUT pulse is now triggering the system. The display is now a calibrated, movable time window controlled by the 7D11 DELAY TIME OR EVENTS control. The 7D11 DLY'D TRIG OUT pulse is the measurement reference point on the display.

Adjust the 7D11 DELAY TIME OR EVENTS knob to move the echo pulse to coincide with the leading edge of the DLY'D TRIG OUT pulse. Use slower sweep speeds at first, then as the waveforms get nearer, switch to faster sweep speeds for better resolution. When the echo pulse is within 100 ns of the rising portion of the DLY'D TRIG OUT pulse, use the 7D11 FINE DELAY dial to align the two pulses (as shown in Fig. 26). When aligned, the actual delay time between transmitter and echo pulses is the sum of the crt readout plus the FINE DELAY setting. For this illustration, the 0.0051 ms crt readout and 75 ns FINE DELAY readout give a total delay of 0.005175 ms. The accuracy of the measurement is within the 7D11 specified accuracy of 2 ns. The same measurement made with the analog delayed sweep, yields an error of approximately 40 ns.

To determine the amount of jitter that will appear on the display, use the chart in Fig. 24. For the above measurement of 0.005175 ms, the display jitter is less than 2.2 ns. This jitter is not noticeable since the sweep speed is 5 ns/DIV. This display jitter is also 20 times better than can be obtained with analog delay.

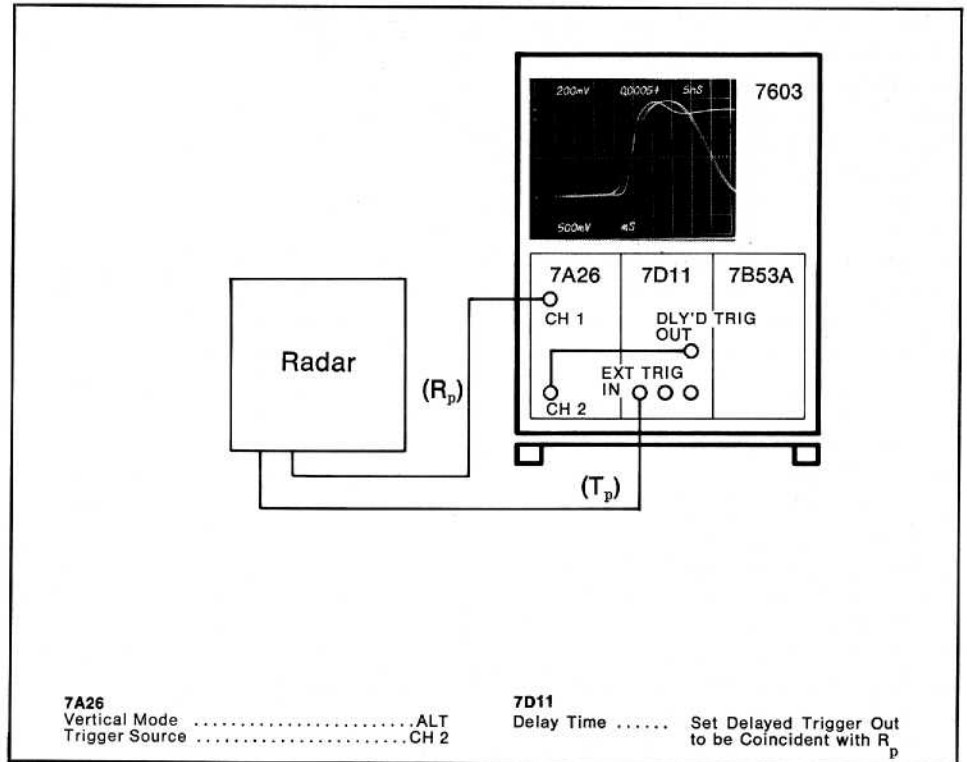

Fig. 23. Equipment setup for radar pulse delay time measurement.

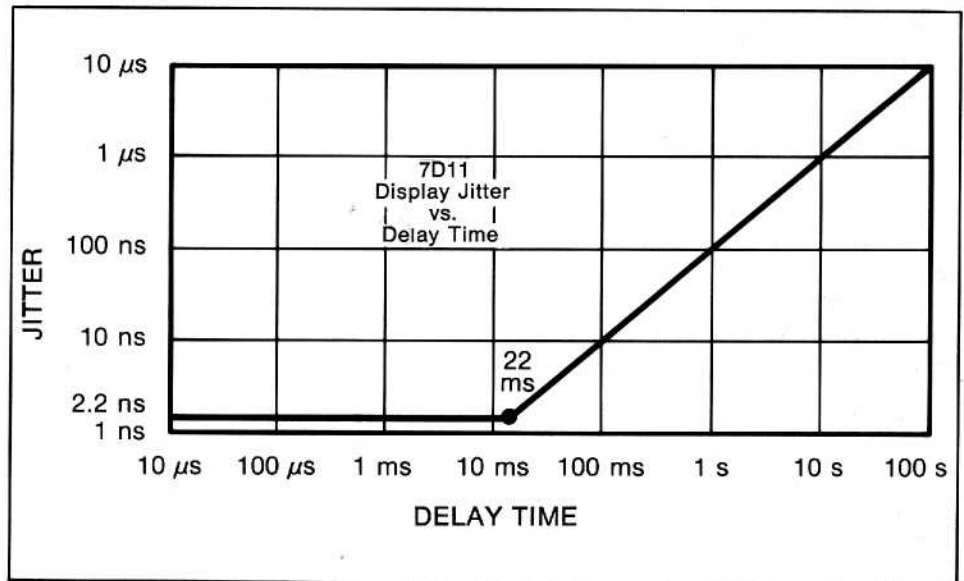

Fig. 24. Chart of 7D11 jitter vs delay time.

An *internal switch* lets you set the 7D11 to indicate half the actual delay time. This mode is convenient for radar ranging or TDR measurements where you are interested in "one-way trip" times.

For better visibility of very low rep-rate pulses, use the 7D11 with a 7633 or 7613 storage oscilloscope in the variable persistence mode. The storage controls are set so that the crt will "integrate up" the fast-rise low-rep-rate pulses.

Radar ranging and radar altimeter time delay measurements are only two examples of applications for the 7D11 Digital Delay Plug-in, where accurate timing measurements are necessary.

## 2C DELAY-BY-EVENTS MEASUREMENTS

Looking at the data lines of a disk memory is one example of the usefulness of delay-by-events. Fig. 25 shows the equipment set up to look at a data line from a floppy disk. The 7D10 is used in this example.

The sector signal is used to start the count and the clock signal is used for the events count. The clock signal is also displayed on the crt along with the data train. With the mainframe trigger selector set to right vertical, the delayed trigger from the 7D10 is routed internally to the time base.

Three trigger adjustments must be made in order to obtain a stable display. The 7D10 EVENTS START TRIGGER control must be set to trigger on the sector pulse; the TRIGGER control must be set to trigger on the clock pulse; and the time base must be set to trigger on the delayed trigger out.

To observe a particular event, once a stable display has been obtained, merely set the EVENTS COUNT control for a particular count. The count displayed on the crt readout corresponds to the first clock pulse displayed on the left of the crt. In the example in Fig. 25, it is believed that a glitch is occurring on or near the 82nd clock cycle of the disk. The 7D10 is set for 82 and the 82nd data pulse is displayed. A glitch is indeed present.

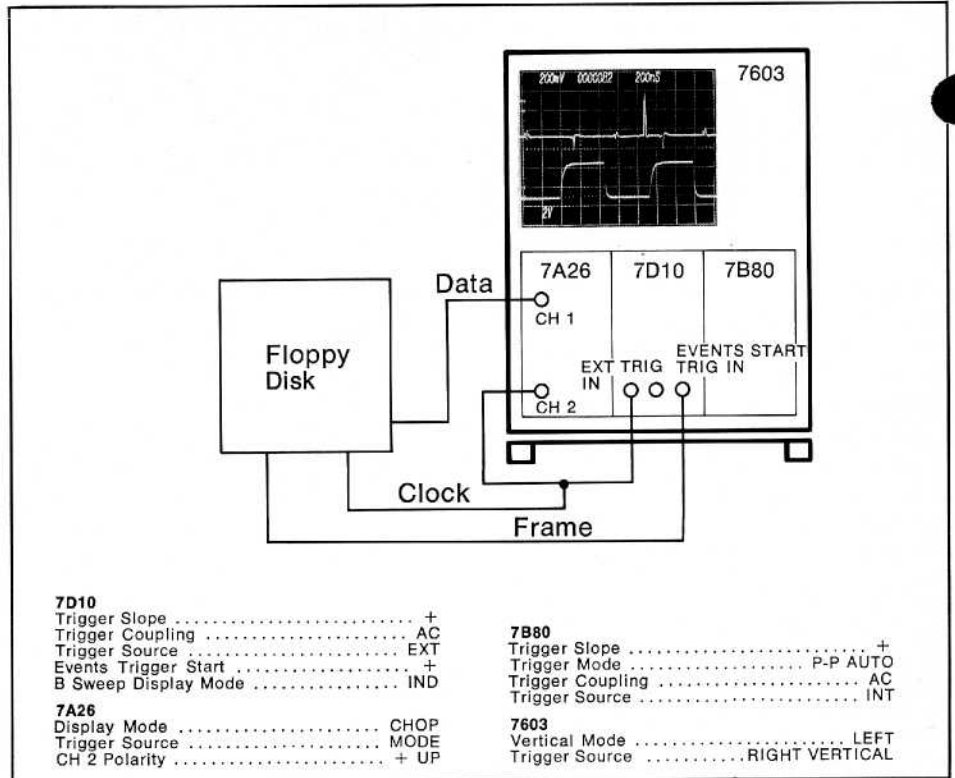

Fig. 25. Equipment setup for floppy disk monitoring.

Delay-by-events is a significant improvement over using absolute time delay, whenever you are observing a signal whose repetition rate is aperiodic or contains cycle-to-cycle variations like flutter, wow, line surges, or data skew.

Another useful application of the 7D10 or 7D11 is in conjunction with a logic analyzer, such as the Tektronix 7D01. Because of the high cost of semiconductor memory, logic analyzers have a limited measurement window, and thus rely on devices like word recognizers and delay units to provide sufficient trigger selectivity to capture the desired event. When using a 7D10 or 7D11 (in the delay-by-events mode) in conjunction with a 7D01, you can easily move the logic analyzer memory window back and forth along a digital waveform such as a data train to look at the data coincident with specific clock pulses.

## 3A AMPLITUDE AND VOLTAGE MEASUREMENTS

The Tektronix 7D12 A/D Converter and the 7D13 Digital Multimeter plug-ins (see Fig. 26), take advantage of the 7000-Series crt readout to give you both signal and dc measurement capability in one mainframe.

The 7D13 is a typical multimeter, which measures *dc voltage*, *dc current* and *resistance*. It also has a unique feature of built-in temperature measurement capability.

The 7D12 provides a modular approach to DVM measurements. *The M1* Multifunction Module provides *dc voltage*, *resistance*, and *temperature* measurement capability; *the M2* Sample/Hold Module measures the *voltage amplitude* of a sampled signal and displays the measurement on the crt readout; *the M3* Volts Module measures *true RMS voltage*.

### 3B SAMPLE/HOLD AND TRUE RMS MEASUREMENTS WITH THE 7D12/M2 AND 7D12/M3

The accuracy of an amplitude measurement made with an oscilloscope varies from 2% for full display amplitude measurements to 10% or greater when using only one or two divisions of the display. This accuracy is often not sufficient, when looking at your power supply circuits, operational amplifiers, or components like SCRs or A/D converters.

The 7D12/M2 Sample/Hold unit offers an easy-to-use solution to the problem of making accurate measurements with the oscilloscope. With the 7D12/M2, the resolution of the measurement is independent of the display amplitude. An accurate measurement can thus be made without magnifying the display beyond the linear limits of the amplifier. Point-to-ground or point-to-point amplitude measurements of complex waveforms, which cannot be resolved visually, can now be resolved digitally.

The measurement of SCR switching levels is one example of how the 7D12/M2 can be used to make accurate amplitude measurements. The true RMS voltage of the SCR signal can also be measured by substituting the M3 RMS Volts Module for the M2 module.

Fig. 27 shows the 7D12/M2 set-up for measuring SCR voltages. The SCR is being used in a light control circuit. The oscilloscope delayed sweep gate is used to trigger the M2 sample and hold circuit. The delayed sweep gate is a convenient measurement gating signal because the position and width of the delayed sweep gate can be set using the time base Delay Time Multiplier and the variable Time/Div control. Other gate signal sources can also be used. The 7D12/M2 displays both the signal being measured and the gate signal. The display of the gate signal makes it easy for you to position the measurement point to the exact position on the waveform where you wish to measure a voltage.

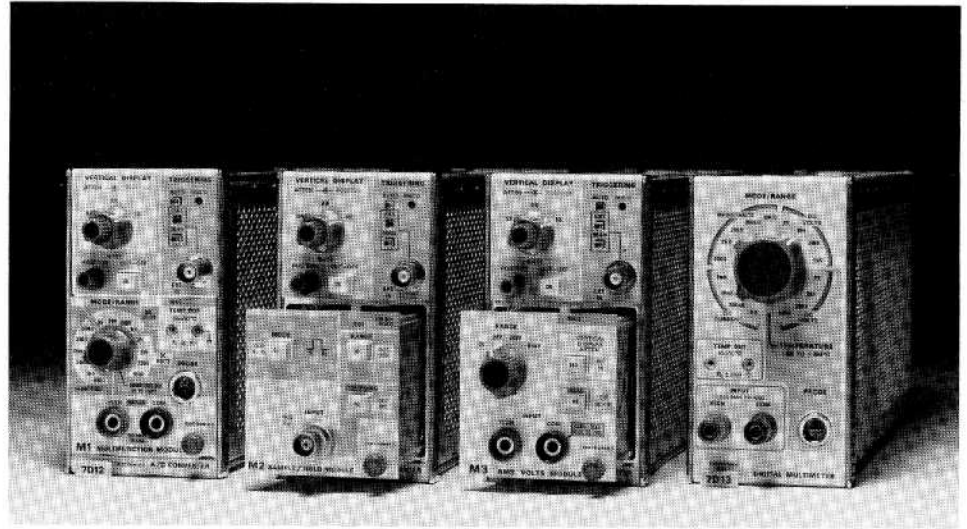

Fig. 26. The 7D13 Digital Multimeter and 7D12 A/D Converter with M1 Multifunction Module, M2 Sample/Hold Module, and M3 RMS Volts Module.

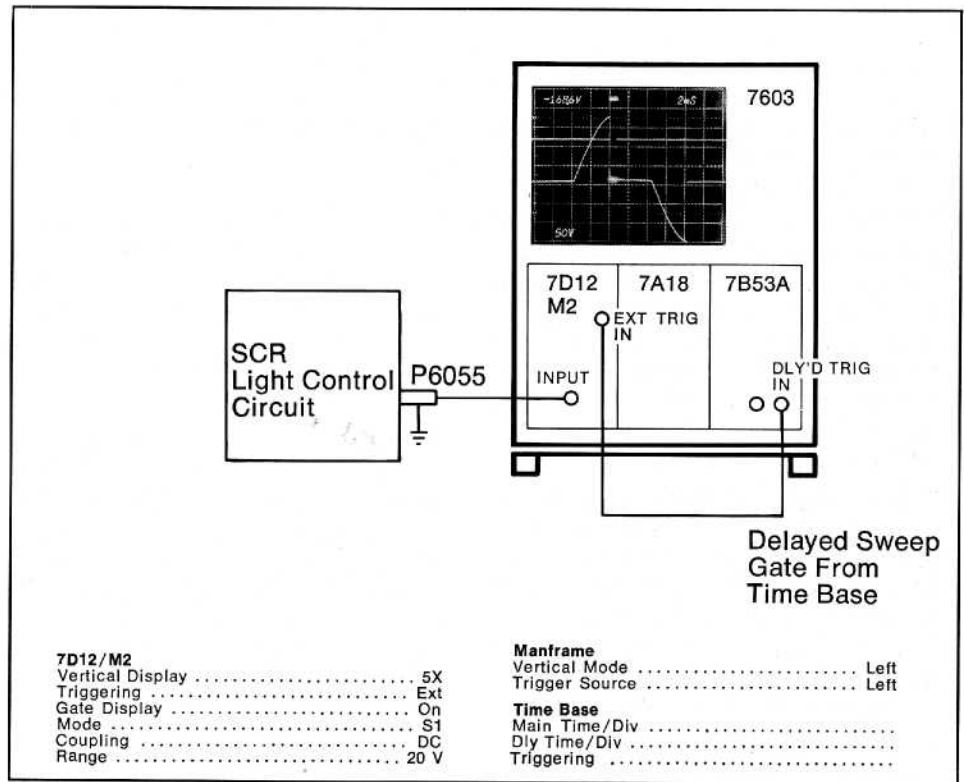

Fig. 27. Equipment setup for measurement of SCR voltages.

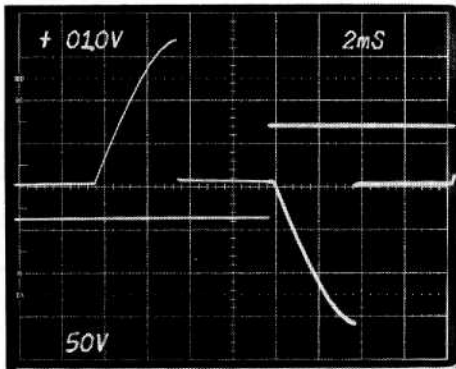

Fig. 28. (A) Measurement of base voltage level.

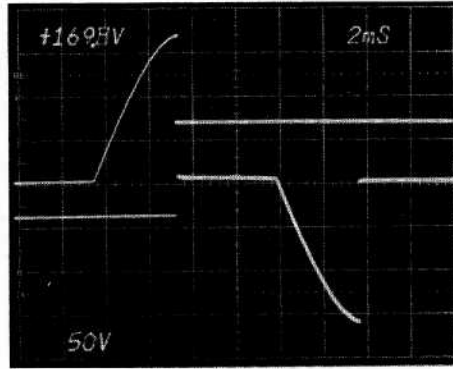

Fig. 28. (B) Measurement of peak voltage.

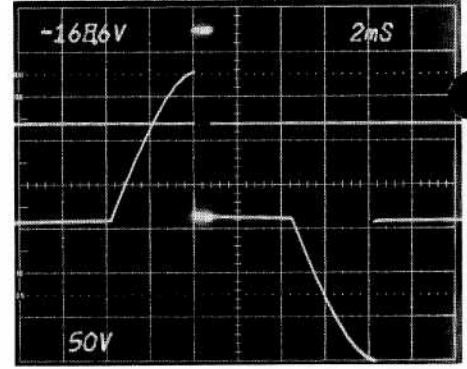

Fig. 29. Measurement of voltage between two sample points.

The voltage from the sample point on the waveform to ground is displayed on the upper left corner of the crt. Fig. 28A shows the dc level (1.0 V) measured just before the SCR switches; Fig. 28B is a measurement of the peak amplitude (+169.8 V) of the waveform. Both measurements are made by positioning the delayed sweep gate rise to the desired sample point on the waveform with the Delay Time Multiplier. In the S1 mode voltage measurements of  $\pm 200$  volts can be measured.

In the S2-S1 mode of the M2 module (see Fig. 29), two samples are taken, one at the leading edge of the delayed sweep gate and one at the falling edge. The difference between the two sample levels is displayed on the crt readout. This mode permits voltage difference measurements up to a maximum of 200 volts with the P6055 10X probe with a resolution of 100 mV.

The P6055 10X probe used in this application is dc adjustable within the probe. Accuracy is not sacrificed as long as the probe is properly adjusted. When the probe is connected to the M2 input, scale factor information is automatically corrected. Without the probe, resolutions of 10 mV and 1 mV are possible on the 20 V and 2 V ranges respectively. Accuracy is 0.5% or better  $\pm 1$  count on all ranges with or without the probe.

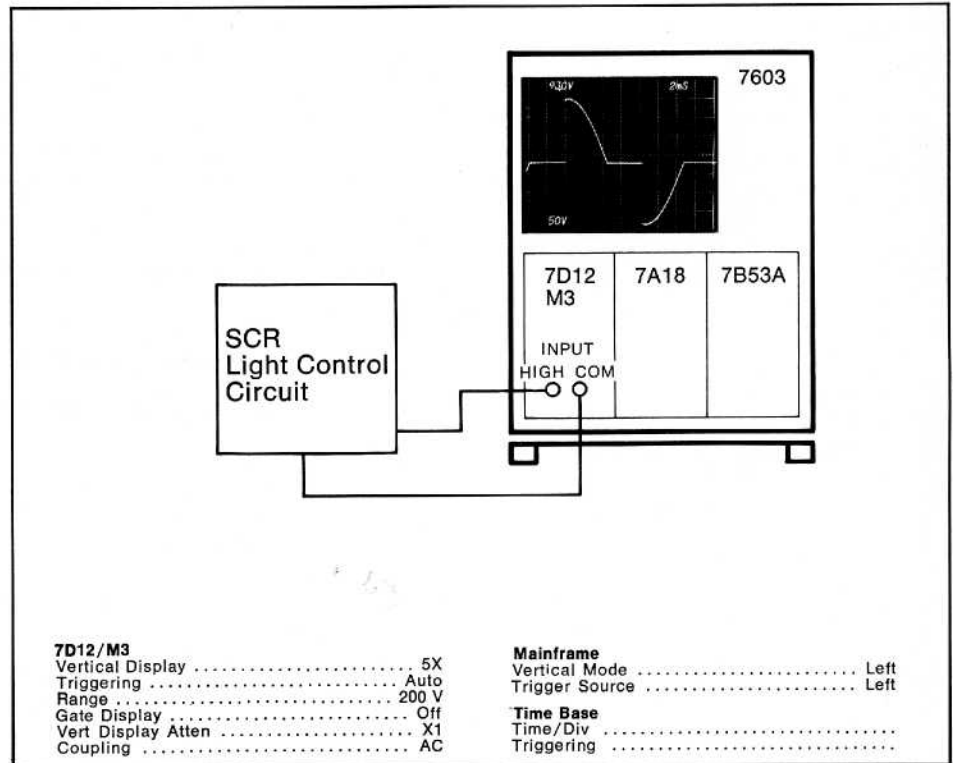

Fig. 30. Equipment setup for measurement of SCR RMS voltage.

Fig. 30 shows the setup for measuring the true RMS value of the SCR waveform using the 7D12/M3 RMS Volts Module. The measurement in this case is 93.0 volts RMS. The M3 module inputs are isolated from the display amplifier, which permits you to view the

signal being measured. The accuracy of the M3 module is within 0.25% between 40 Hz and 4 kHz, and within 0.5% between 4 kHz and 100 kHz up to a crest factor\* of 5.

\*Crest factor is the ratio of the peak voltage to the RMS voltage.

## 4 TEMPERATURE MEASUREMENTS

One of the most common causes of IC or transistor failure is overheating. A typical method of checking the effect of heat on a circuit is to put the circuit in a heat chamber, raise the temperature to the maximum ambient temperature that the circuit was designed to withstand, and wait for failures.

Another method of checking for component heat failures is with the P6058 voltage/temperature probe along with the 7D12/M1 Multifunction unit or the 7D13 Digital Multimeter (see Fig. 31). The P6058 is a combination dc voltage and temperature measuring device. The temperature sensing element consists of a transistor installed in a tip that plugs into the end of the probe body. This probe can be used to measure both ambient and case temperatures up to  $+150^{\circ}\text{C}$ . This temperature measurement is displayed on the crt readout.

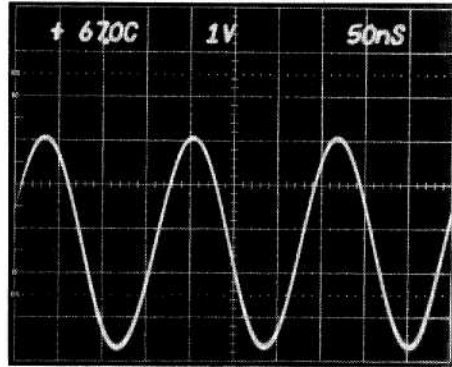

**Fig. 31. Temperature measurement for component heat failures.**

If a temperature chamber is not available, or if you merely wish to make a quick check of the effect of temperatures up to  $+150^{\circ}\text{C}$ , simulate the heat chamber with a heat gun. A piece of cardboard might be used to isolate particular components or parts of the circuit board. To measure the ambient temperature, hold the probe tip in the vicinity of the component to be checked without touching the component. To measure the case temperature, touch

the flat surface of the probe tip to the actual device. The case temperature can be measured even if the case is at a voltage level above or below ground. The temperature probe tip is isolated from voltages up to 250 V.

The temperature probe can also be used to help determine the correct size of a heat sink for a particular device, or for general inspection of a circuit board for hot spots. The settling time of the probe allows you to check all the components on even a large circuit board in a few minutes.



## Digital Application Notes

Use the attached reply card to request any of the application notes listed below.

---

### **Measuring Time Interval Between Non-Adjacent Digital Word Train Pulses or Multi-Echo Radar Pulses.**

This application note describes how the 7D15 Time-Interval plug-in in a 7000-Series Mainframe provides the ability to make selective digital time-interval measurements from any repetitive or non-repetitive pulse. It also describes how this combination can make time-interval measurements between non-adjacent pulses without sacrificing digital counter accuracy.

### **Counting Events in a Burst and Measuring Burst Frequency.**

A procedure shows you how the 7D14, 525 MHz high-frequency counter can be used to measure the frequency or events on any part of a waveform. A delayed gate is used to isolate the portion of the waveform to be measured.

### **Digital Delay in an Oscilloscope Makes Your Radar Pulse Time Delay Measurements Quicker, Easier and More Accurate.**

This application note describes how to easily make delay time measurements to within 2 ns accuracy using the 7D11 Digital Delay Unit.

### **Measuring Memory Core I/O Signals with Digital Accuracy.**

This application note describes how the 7D12/M2 Sample/Hold Module is used to make amplitude measurements on any point on a waveform with accuracies better than 0.5%. It also demonstrates how the time between two points on a waveform can be measured with digital accuracy using the 7D15 225 MHz Universal Counter/Timer Plug-in.

### **Measuring Disc Drive Access Time and Access Voltages with Tektronix 7000-Series Digital Plug-ins.**

This application note demonstrates how the 7D12/M2 Sample/Hold Module makes voltage measurements on any portion of a waveform accurately with digital resolution to 1 mV. It also describes how the time between two points on a waveform can be accurately determined using the 7D15 225 MHz Universal Counter/Timer.

### **SCR Gating Waveform Measurements with High Resolution Digital Accuracy.**

This application note demonstrates how you can measure any point on waveforms up to 220 V p-p with 100 mV resolution and better than 0.5% accuracy using the 7D12/M2 Sample/Hold DVM. It also describes how this is an excellent means to accurately measure the voltages of a waveform and avoid the difficulties of sampling oscilloscopes and overdrive recovery problems of vertical amplifiers.

### **Why Use Digital Events in Your Measurement Applications.**

This application note demonstrates how the 7D11 Digital Delay Unit gives you stable displays, eliminates trigger ambiguity and accurately determines which clock pulse is on screen. For example, you would be able to tell if you were on the 1st clock pulse, the 129th clock pulse or any clock pulse to 107.



Copyright © 1977, Tektronix, Inc.  
All rights reserved. Printed in  
U.S.A. Foreign and U.S.A. Products  
of Tektronix, Inc. are covered by  
Foreign and U.S.A. Patents and/or  
Patents Pending. Information in  
this publication supersedes all  
previously published material.  
Specification and price change  
privileges reserved. TEKTRONIX,  
TEK, SCOPE-MOBILE, TELEQUIP-  
MENT, and  are registered  
trademarks of Tektronix, Inc.  
P.O. Box 500, Beaverton, Oregon  
97077. Phone: (Area Code 503)  
644-0161, TWX: 910-467-8708,  
Cable: TEKTRONIX. Overseas  
Distributors in over 50 Countries.

