

INSTRUCTION MANUAL

**7A13
AMPLIFIER**



MANUFACTURERS OF CATHODE-RAY OSCILLOSCOPES

INSTRUCTION MANUAL

Serial Number B010129

7A13 AMPLIFIER

Tektronix, Inc.

S.W. Millikan Way • P. O. Box 500 • Beaverton, Oregon 97005 • Phone 644-0161 • Cables: Tektronix
070-0978-00

1069



WARRANTY

All Tektronix instruments are warranted against defective materials and workmanship for one year. Tektronix transformers, manufactured in our plant, are warranted for the life of the instrument.

Any questions with respect to the warranty mentioned above should be taken up with your Tektronix Field Engineer.

Tektronix repair and replacement-part service is geared directly to the field, therefore all requests for repairs and replacement parts should be directed to the Tektronix Field Office or representative in your area. This procedure will assure you the fastest possible service. Please include the instrument Type and Serial or Model Number with all requests for parts or service.

Specifications and price change privileges reserved.

Copyright © 1969 by Tektronix, Inc., Beaverton, Oregon. Printed in the United States of America. All rights reserved. Contents of this publication may not be reproduced in any form without permission of the copyright owner.

TABLE OF CONTENTS

SECTION 1 SPECIFICATION	Page	SECTION 3 CIRCUIT DESCRIPTION	Page
Introduction	1-1	Introduction	3-1
Electrical Characteristics	1-1	Block Diagram Description	3-1
Deflection Factor	1-1	Input Mode Switches	3-1
Common Mode Signal Range	1-1	Input Attenuators	3-1
Differential Signal Range	1-1	Input Source and Emitter Followers	3-1
Frequency Response	1-1	Differential and Common Mode Signal Clamps	3-1
Overdrive Recovery	1-1	Differential Comparator	3-1
Common Mode Rejection Ratio	1-1	×1 and ×10 Gain-Switching Amplifier	3-1
Maximum Input Voltage	1-2	×1, ×2 and ×5 Gain-Switching Amplifier	3-1
Input R and C	1-2	Driver Amplifier	3-1
Maximum Gate Current	1-2	Output Amplifier	3-1
DC Drift	1-2	Trigger Amplifier	3-1
Displayed Noise	1-2	Feedback Limiter	3-3
Comparison Voltage	1-2	Readout Logic	3-3
System Characteristics	1-2	Vc Decimal Lamp Driver	3-3
Environmental Characteristics	1-2	Detailed Circuit Description	3-3
Altitude	1-2	Input Mode Switch	3-3
Transportation	1-2	Input Attenuators	3-3
SECTION 2 OPERATING INSTRUCTIONS		Input Source and Emitter Followers	3-3
Introduction	2-1	Differential Signal and Common Mode Signal Clamps	3-4
Front-Panel Description	2-1	Differential Comparator	3-4
Test Setup Chart	2-1	×1 and ×10 Gain-Switching Amplifier	3-4
Familiarization Procedure	2-2	×1, ×2 and ×5 Gain-Switching Amplifier	3-5
First-Time Operation	2-2	Driver Amplifier	3-5
Front Panel Adjustments	2-3	Output Amplifier	3-5
Examples of Voltage/Signal Measurements	2-3	Trigger Amplifier	3-5
Single-ended operation DC Measurement	2-3	Feedback Limiter	3-5
Differential Comparator Operation, DC Measurement	2-4	Readout Logic and Vc Decimal Lamp Driver	3-5
Single-Ended Operation, Waveform Measurement	2-4	Low Voltage Power Supplies	3-5
Differential Amplifier Operation	2-4	Comparison Voltage Generators	3-5
Use of Vc OUT 0-10 V Tip Jack	2-4	SECTION 4 MAINTENANCE	
General Discussion	2-5	Preventive Maintenance	4-1
Common Mode Rejection	2-6	General	4-1
Amplitude and Common Mode Rejection	2-9	Cleaning the Front Panel	4-1
Factors Which Affect CMRR	2-9	Cleaning the Interior	4-1
Differential Amplifier Applications	2-11	Visual Inspection	4-1
X-Y Applications	2-11	Transistor Checks	4-1
Passive Signal Coupling Methods	2-11		

TABLE OF CONTENTS (Cont)

	Page		Page
Calibration	4-1	Check/Adjust Step Attenuator DC Balance	5-8
Corrective Maintenance	4-1	Check/Adjust Position Center	5-8
General	4-1	Check/Adjust Trigger DC Balance	5-9
Obtaining Replacement Parts	4-1	Check/Adjust Signal Output DC Level	5-9
Special Parts	4-2	Check/Adjust Trigger Output DC Level	5-9
Soldering Techniques	4-2	Check/Adjust Gain	5-9
Switch Replacement	4-4	Check Gate Current	5-9
Lamp Replacement	4-5	Preliminary Comparison Voltage Check & Thermal Compensation Adjustment	5-10
Troubleshooting	4-5	Check Comparison Voltage	5-10
Introduction	4-5	Check/Adjust Common Mode Thermal Compensation	5-10
General	4-5	Input Resistance & DC Attenuation Ratio Adjustments	5-11
Indicator Oscilloscope	4-5	Check/Adjust + Input 10× DC Attenuation Ratio	5-11
Operating Procedures and Control Settings	4-5	Check/Adjust + Input 1× DC Input Resistance	5-12
Trouble Symptoms	4-5	Check/Adjust + Input 100× DC Attenuation Ratio	5-13
Visual Inspection	4-6	Check/Adjust — Input 10× DC Attenuation Ratio	5-13
Calibration Check	4-6	Check/Adjust — Input 1× DC Input Resistance	5-14
Detailed Troubleshooting	4-6	High-Frequency Compensation Adjustments	5-15
General	4-6	Check/Adjust High-Frequency Compensation	5-15
Test Equipment Recommended	4-6	Attenuator Compensation Adjustments	5-20
Troubleshooting by Direct Replacement	4-6	Check/Adjust + Input Attenuator Compensation	5-20
Troubleshooting Aids	4-6	Check/Adjust — Input Attenuator Compensation	5-23
Troubleshooting Techniques	4-7	Common Mode Rejection Adjustments	5-25
Component Checks	4-8	Check/Adjust Amplifier High-Frequency Common Mode Rejection	5-25
Instrument Repackaging	4-9	Check/Adjust Attenuator Common Mode Rejection at 100 Hz	5-27
		Check/Adjust Attenuator Common Mode Rejection at 10 kHz	5-28
SECTION 5 PERFORMANCE CHECK/ CALIBRATION		Trigger & Signal Amplifier Response Checks	5-28
Introduction	5-1	Check Trigger Amplifier Gain and Step Response	5-28
Test Equipment Required	5-1	Check Trigger Amplifier High-Frequency Sine Wave Response	5-30
General	5-1		
Test Equipment	5-1		
Short-Form Performance Check/Calibration Procedure	5-3		
Performance Check/Calibration Procedure	5-5		
General	5-5		
Preliminary Procedure	5-6		
DC and Gain Adjustments	5-7		
Check/Adjust Position Center & DC Balance	5-7		
Check/Adjust × 10 DC Balance	5-8		

TABLE OF CONTENTS (Cont)

	Page		Page
Check Signal Amplifier High-Frequency Response	5-31	SECTION 6 ELECTRICAL PARTS LIST	
Check Signal Amplifier 5-MHz Bandwidth Sine Wave Response	5-31	Abbreviations & Symbols	
Comparison Voltage Adjustments	5-31	Parts Ordering Information	
Check/Adjust 10-Volt Calibration	5-32	SECTION 7 DIAGRAMS AND MECHANICAL PARTS ILLUSTRATIONS	
Check/Adjust 1-Volt Calibration	5-33	Diagrams	
Check Comparison Voltage Linearity	5-33	Mechanical Parts Illustrations	
Check Volts Counter Mechanical Backlash	5-33	SECTION 8 MECHANICAL PARTS LIST	
Check Electrical Zero	5-34	Mechanical Parts List Information	
Noise & Overdrive Recovery Checks	5-34	Index of Mechanical Parts Illustrations	
Check Noise	5-35	Mechanical Parts List	
Check Overdrive Recovery Time	5-36	Accessories	

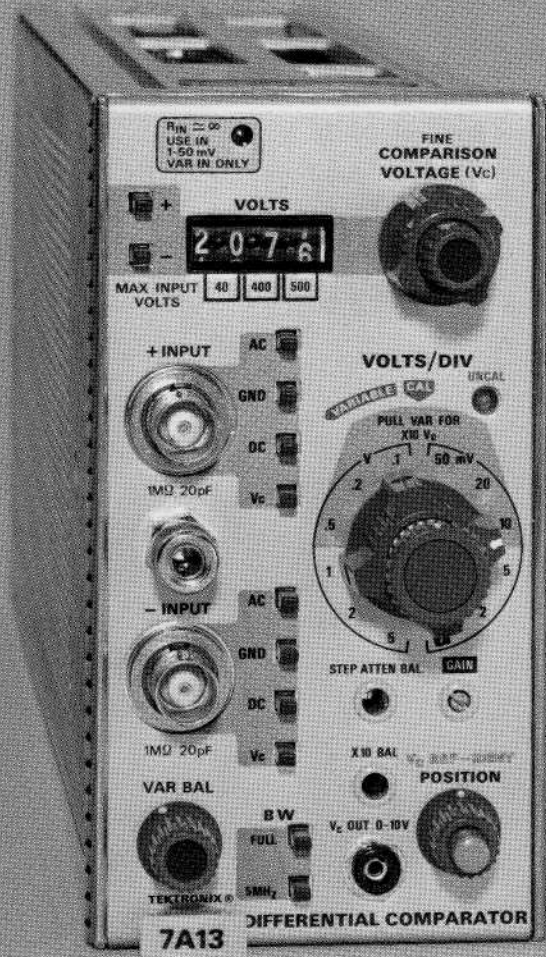

Fig. 1-1. Type 7A13 Differential Comparator.

SECTION 1

SPECIFICATION

Change information, if any, affecting this section will be found at the rear of the manual.

INTRODUCTION

The Type 7A13 Vertical Plug-In is a DC coupled differential comparator with excellent common-mode rejection and medium gain characteristics for medium level applications. The Type 7A13 is designed for use in Tektronix 7000 series oscilloscopes. It may be used as a differential input preamplifier or conventional preamplifier in addition to its use as a comparator.

In the differential input mode, the dynamic range allows the application of common-mode signals up to +10 or -10 volts to be applied to the unit without attenuation. Common-mode rejection ratio of at least 20,000:1 at DC to 100 kHz permits measurements of differential signals less than 1 mV in amplitude on 10 volt common-mode signals.

When used as a differential comparator, the Type 7A13 has an effective offset range of 10,000 divisions.

ELECTRICAL CHARACTERISTICS

The electrical characteristics described in Table 1-1 are valid over the stated environmental range for instruments calibrated at an ambient temperature of +20° C to +30° C and after a 20-minute warmup period unless otherwise noted.

TABLE 1-1
ELECTRICAL CHARACTERISTICS

Characteristic	Performance Requirement
Deflection Factor (VOLTS/DIV) Calibrated Range	1 mV/Div to 5 V/Div, 12 steps in a 1, 2, 5 sequence
Gain Ratio Accuracy	Within 1.5% of GAIN adjusted at 1 mV/Div
Uncalibrated (Variable)	Continuously variable: extends deflection factor to at least 12.5 V/Div
Common Mode Signal Range 1 mV/Div to 50 mV/Div; ×10 Vc In	At least +10 V and -10 V
10 mV/Div to 50 mV/Div; ×10 Vc Out	At least +100 V and -100 V
0.1 V/Div to 0.5 V/Div; ×10 Vc In	
0.1 V/Div to 0.5 V/Div; ×10 Vc Out	At least +500 V and -500 V

Characteristic	Performance Requirement
1 V/Div to 5 V/Div; ×10 Vc In	At least +500 V and -500 V
Differential Signal Range 1 mV/Div to 50 mV/Div; ×10 Vc In	At least 0.8 V
10 mV/Div to 50 mV/Div; ×10 Vc Out	At least 8 V
0.1 V/Div to 0.5 V/Div; ×10 Vc In	
0.1 V/Div to 0.5 V/Div; ×10 Vc Out	At least 80 V
1 V/Div to 5 V/Div; ×10 Vc In	
Frequency Response (8 Div Reference) FULL Bandwidth Upper Limit	See Table 1-2, System Characteristics
AC (Capacitive) Coupled Input Lower Bandwidth Frequency	10 Hz or less
5 MHz Bandwidth	DC to 5 MHz within 500 kHz
Overdrive Recovery (1× Attenuator at 1 mV/Div)	1 μS to recover within 1.5 mV, 0.1 ms to recover within 0.5 mV, following removal of a +10 V or -10 V overdrive signal.
Common Mode Rejection Ratio 1 mV/Div to 50 mV/Div ×10 Vc In DC to 100 kHz	See Fig. 1-2. At least 20,000:1, 20 V P-P or less test signal
100 kHz to 1 MHz	At least 10,000:1, 10 V P-P or less test signal
1 MHz to 10 MHz	CMRR = 10,000/frequency (MHz)
20 MHz	At least 250:1, 1 V P-P or less test signal
10 mV/Div to 50 mV/Div; ×10 Vc Out; 0.1 V/Div to 5 V/Div; ×10 Vc In or Out DC to 10 kHz	At least 2,000:1
AC Coupled at 60 Hz	At least 500:1

Specification—Type 7A13

TABLE 1-1
ELECTRICAL CHARACTERISTICS (cont)

Characteristic	Performance Requirement
Maximum Input Voltage DC (Direct) Coupled DC + Peak AC 1 mV/Div to 50 mV/Div; ×10 Vc In	40 VDC. 40 V Peak AC, 1 kHz or less
10 mV/Div to 50 mV/Div; ×10 Vc Out	400 VDC. 400 V Peak AC, 1 kHz or less
0.1 V/Div to 0.5 V/Div; ×10 Vc In	
0.1 V/Div to 0.5 V/Div; ×10 Vc Out	
1 V/Div to 5 V/Div; ×10 Vc In	500 VDC. 500 V Peak AC, 1 kHz or less
AC (Capacitive) Coupled Input	500 VDC
Input R and C Resistance	1 MΩ within 0.15%
Capacitance	20 pF within 0.4 pF at 1 MHz
R and C Product	Within 1% for all deflection factor settings.
Maximum Gate Current 0° C to +35° C Both Inputs	0.2 nA or less (0.2 Div at 1 mV/Div)
+35° C to +50° C Both Inputs	2 nA or less (2 Div at 1 mV/Div)
DC Drift Drift With Time (Ambient Temperature and Line Voltage Constant)	
Short Term	1 mV P-P or less or 0.1 Div or less (whichever is greater) any 1 minute interval within 1 hour after 20 minutes from turn-on.
Long Term	1 mV P-P or less or 0.1 Div (whichever is greater) during any hour after the first hour and 20 minutes from turn-on.
Drift With Ambient Temperature (Line Voltage Constant)	2 mV/10° C or less, 0.2 Div/10° C (whichever is greater)
Amplifier Crosstalk	1% or less shift within 20 ns of step of fast rise squarewave when switching undriven input from GND to AC or DC

Characteristic	Performance Requirement
Displayed Noise (Tangentially Measured)	400 μV or less at 1 mV/Div in Type 7700-Series or 7500-Series indicator oscilloscope
Comparison Voltage Range	0 V to ±10 V
Accuracy	± (0.1% of setting +5 mV)
Electrical Zero	0.5 mV or less
Vc OUT Resistance	15 kΩ within 5 kΩ

SYSTEM CHARACTERISTICS

The system characteristics listed in Table 1-2 are to specify the performance of the plug-in with various combinations of probes and in various indicator oscilloscopes.

TABLE 1-2

SYSTEM CHARACTERISTICS

Indicator Oscilloscope	Probe	BW (MHz)	T _r (ns)	¹ Accuracy (%)			Sig Out	
				² EXT CAL	³ INT CAL	⁴ INT CAL	BW (MHz)	T _r (ns)
7500 Series	None	75	4.7	1.5	2.5	3.5	55	6.4
	P6053	75	4.7	1.5	2.5	3.5	55	6.4
	P6048							
7700 Series	None	100	3.5	1.5	2.5	3.5	55	6.4
	P6053	100	3.5	1.5	2.5	3.5	55	6.4
	P6048							

¹Accuracy percentages apply to all deflection factors. Plug-in GAIN must be set at the deflection factor designated at the applicable position of the VOLTS/DIV switch. When a probe is used, the GAIN must be set with the calibration signal applied to the probe tip.

²EXTERNAL CALibrator, 0° C to 50° C: The plug-in GAIN is set (within 10° C of the operating temperature) using an external calibrator signal whose accuracy is within 0.25%.

³INTERNAL CALibrator, 15° C to 35° C: The plug-in GAIN is set using the oscilloscope's own calibrator and the instrument is operating within the +15° C to +35° C range.

⁴INTERNAL CALibrator, 0° C to 50° C: The plug-in GAIN is set (within 10° C of the operating temperature) using the oscilloscope's own calibrator, and the instrument is operating within the 0° C to +50° C range.

ENVIRONMENTAL CHARACTERISTICS

TABLE 1-3

Type 7A13 tested alone (separate from indicator oscilloscope)

Characteristic	Information
Altitude Non-Operating	To 50,000 feet and -55° C
Transportation	Qualified under National Safe Transit Committee test procedure 1A, Category II

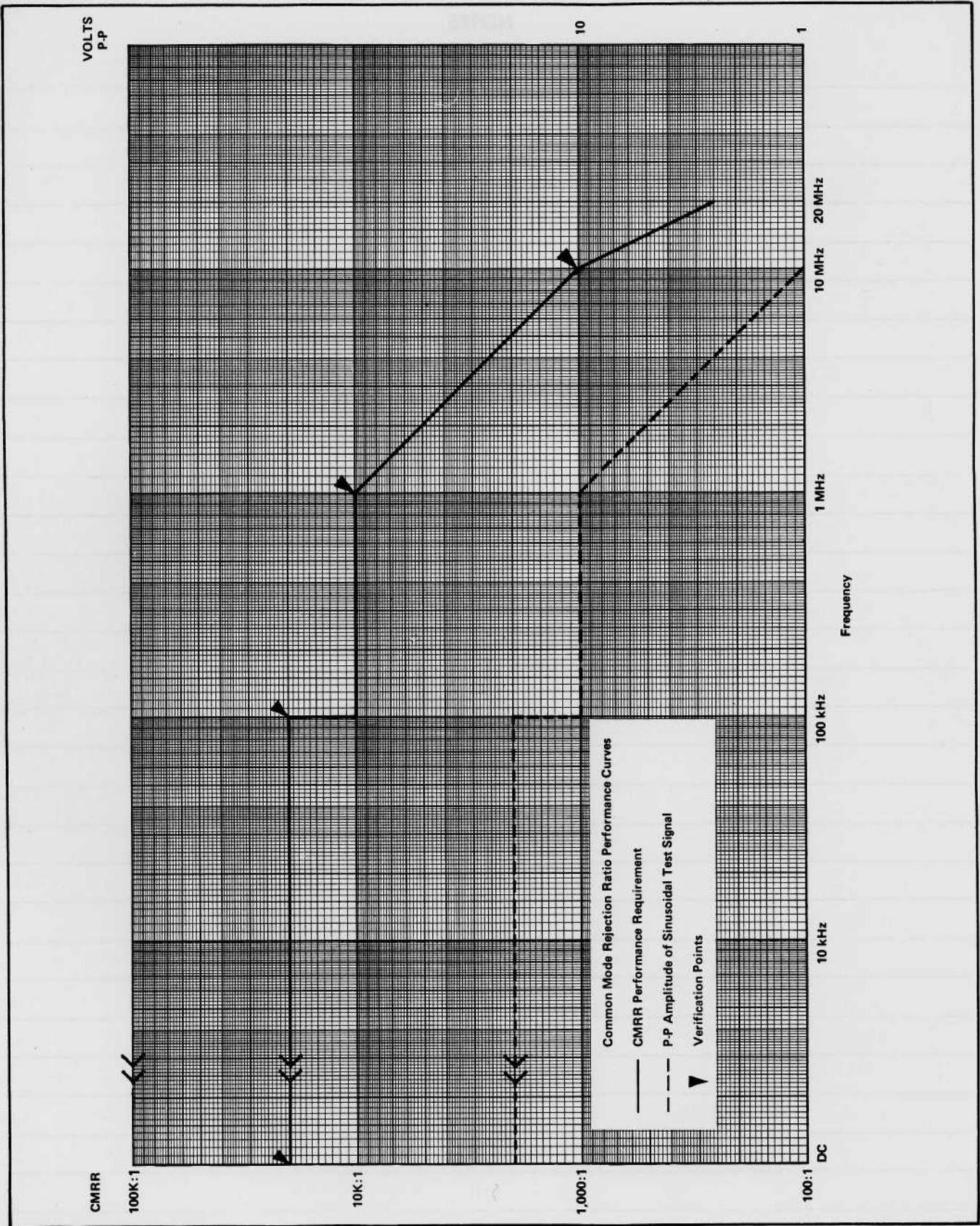

Fig. 1-2. Type 7A13 common mode rejection ratio graph. It pertains to 1 mV/Div through 20 mV/Div deflection factors.

SECTION 2

OPERATING INSTRUCTIONS

Change information, if any, affecting this section will be found at the rear of the manual.

INTRODUCTION

This section opens with a brief functional description of the front panel controls and connectors (see Fig. 2-1). Following the front-panel description is a familiarization procedure and finally a general discussion of the operation of the Type 7A13.

FRONT-PANEL DESCRIPTION

$R_{in} \approx \infty$
1-50 mV
VAR IN ONLY
Lamp

Illuminates when switch S10, located on left side of plug-in, is turned cw. This indicates a + INPUT and -INPUT impedance of approximately infinity whenever the VOLTS/DIV switch is set between 1 and 50 mV, VARIABLE knob is pushed in and 1X probe is used.

NOTE

With VOLTS/DIV switch set from .1 V to 5 V, lamp remains on but input impedance is $\approx 1 M\Omega$ and the input attenuator is uncompensated.

COMPARISON VOLT-AGE (Vc) + and - Pushbuttons	Selects polarity of comparison voltage.
COMPARISON VOLT-AGE (Vc) Counter	Reads out the voltage selected by the COMPARISON VOLTAGE (Vc) selector switch in conjunction with FINE, VOLTS/DIV and PULL VAR for X10 Vc RANGE controls.
COMPARISON VOLT-AGE (Vc) Selector Switch	Selects one of ten voltage ranges from zero to ten volts.
COMPARISON VOLT-AGE (Vc) FINE Control	Selects a comparison voltage somewhere between the lower and upper limits of the selected band above.
+ INPUT Connector	Provides a means of connection for signal measurement. It also contains a third contact for probe attenuation information. This enables proper readout of deflection factor on CRT screen.
+ INPUT Mode Switch	Selects AC, DC, GND or Vc Mode of coupling for the +INPUT channel.
VOLTS/DIV Switch	Selects one of twelve volts per division calibrated deflection factors.
VOLTS/DIV VARIABLE Control	Selects an uncalibrated deflection factor somewhere between the

twelve settings above. A minimum of 2.5 times the VOLTS/DIV switch setting is provided. The UNCAL lamp lights when the VARIABLE control is out of the CAL detent.

PULL VAR FOR X10 Vc RANGE Switch	Selects a Vc Range 10X that which is indicated on the VOLTS/DIV Switch. This only occurs for 10, 20, and 50 mV/DIV and .1, .2 and .5 V/DIV settings of the VOLTS/DIV switch.
-INPUT Connector	Same as for + INPUT connector above.
-INPUT Mode Switch	Selects AC, DC, GND or Vc Mode of coupling for the -INPUT channel.
STEP ATTEN BAL Adjustment	Adjusts for no vertical trace movement as the VOLTS/DIV switch setting is varied from 10 to 50 mV/DIV.
GAIN Adjustment	Adjusts the amplifier gain for display of four divisions upon receipt of a 4-mV signal when the VOLTS/DIV switch is set to 1 mV and the VARIABLE control is set to CAL.
X10 BAL Adjustment	Adjusts for no vertical trace movement as VARIABLE (VOLTS/DIV) knob is pulled out.
VAR BAL CONTROL	Adjusts for no vertical trace movement as VARIABLE (VOLTS/DIV) knob is varied throughout its range.
Release Latch	Pull to withdraw plug-in from indicator oscilloscope.
BW Switch	Selects either the FULL bandwidth or 5 MHz.
Vc OUT 0-10 V Jack	Provides a convenience outlet for the comparison voltage.
POSITION Control	Positions display vertically on the CRT face.
Vc REF-IDENT Pushbutton	Internally disconnects both signals and applies Vc to both inputs.

TEST SETUP CHART

Fig. 2-10 shows a drawing of the front panel controls and connectors. This chart can be reproduced and used as a test setup record for special measurements and applications, or it may be used as a training aid for operation of the Type 7A13.

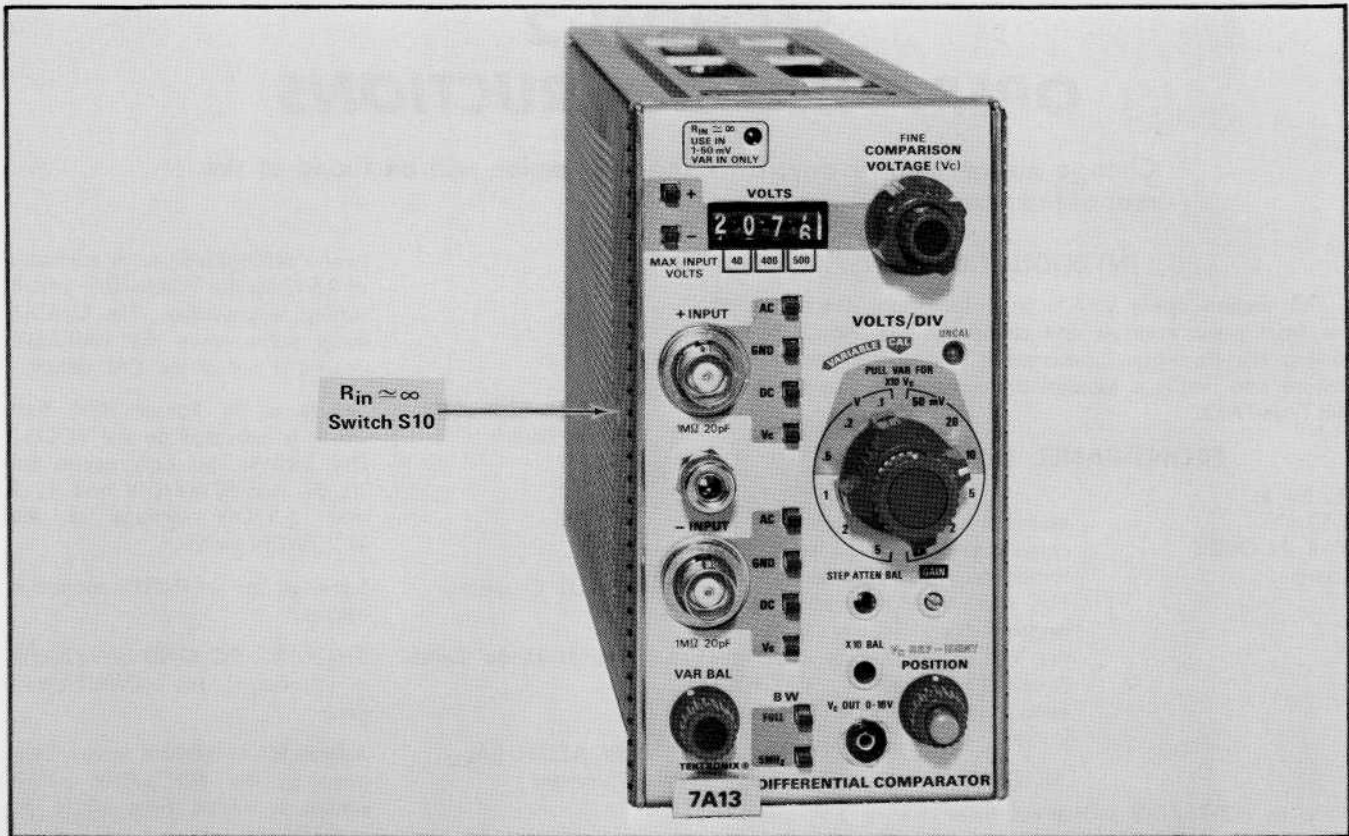

Fig. 2-1. Front panel of Type 7A13 and location of $R_{in} \approx \infty$ switch S10.

FAMILIARIZATION PROCEDURE

First-Time Operation

The following steps are intended to help get the trace on the CRT screen quickly and to prepare the unit for immediate use. These steps are intended to acquaint you with some of the basic functions of the Type 7A13.

1. Insert the unit into the oscilloscope vertical plug-in compartment.

2. Set the Type 7A13 front panel controls as follows:

COMPARISON VOLTAGE (Vc) Polarity	Pushbuttons canceled
COMPARISON VOLTAGE (Vc) Counter	As is
+ INPUT Mode	GND
- INPUT Mode	GND
VOLTS/DIV	1 V
VARIABLE	In (CAL)
STEP ATTEN BAL	As is
GAIN	As is
×10 BAL	As is
VAR BAL	As is
BW	5 MHz
POSITION	Midrange

3. Turn the Intensity control fully counterclockwise and turn the oscilloscope Power ON. Preset the time-base plug-in triggering controls for a .5 ms/div sweep rate and automatic triggering.

4. Wait about five minutes for the Type 7A13 and the oscilloscope to warm up.

NOTE

About five minutes is sufficient warmup time when using the Type 7A13 for short-term DC measurements. For long-term DC measurements using the lower deflection factors, allow at least one hour.

5. Adjust the Intensity control for normal viewing of the trace. The trace should appear near the graticule center.

6. Using the POSITION control, position the trace two divisions below graticule center. Set VOLTS/DIV to 1 mV position.

NOTE

If trace is off screen, perform Front Panel Adjustments outlined below.

7. Apply a 4 mV peak-to-peak calibrator signal through a coaxial cable to the + INPUT connector on the Type 7A13.

8. For DC coupled, single-ended operation, set the + INPUT Mode Switch to DC. The display should be 4 divisions of square wave amplitude with the bottom of the display at the reference established in step 6.

NOTE

If the display amplitude is not 4 divisions, adjust GAIN control until it is.

9. For AC coupled, single-ended operation, re-position the display to place the bottom of the display at the graticule center line.

10. Set the + INPUT Mode switch to AC and note that the display shifts downward about two divisions to its average level.

11. Disconnect the calibrator signal from the + INPUT connector. Set both the + and - INPUT Mode switches to GND.

12. Set the VOLTS/DIV switch to 1 mV. Vary the VARIABLE control throughout its range while observing the CRT trace.

13. Adjust VAR BAL so that there is no trace movement while varying the VARIABLE control.

14. Set the VOLTS/DIV switch to 10 mV. Pull out the PULL VAR FOR $\times 10$ Vc RANGE knob while observing the CRT trace.

15. Adjust $\times 10$ BAL so that there is no trace movement while moving the PULL VAR FOR $\times 10$ Vc RANGE knob in and out.

16. Vary the VOLTS/DIV switch from 20 mV to 1 mV while observing the CRT trace.

17. Adjust STEP ATTEN BAL so that the trace does not move while varying the VOLTS/DIV switch.

18. Repeat steps 12 through 17 until optimum settings are achieved.

19. Push in the PULL VAR FOR $\times 10$ Vc RANGE knob.

Front Panel Adjustments

These adjustments must be accomplished each time the Type 7A13 is placed in a different oscilloscope, and should be checked prior to any critical measurement of waveforms.

Preset Type 7A13 controls as follows:

COMPARISON VOLTAGE	
(Vc) Polarity	Pushbuttons canceled
Counter	As is
+ INPUT Mode	GND
- INPUT Mode	GND
VOLTS/DIV	1 V
VARIABLE	In (CAL)
STEP ATTEN BAL	Midrange or as is
GAIN	As is
$\times 10$ BAL	Midrange or as is
VAR BAL	Midrange or as is
BW	5 MHz
POSITION	Midrange

Allow 20 minutes warmup time.

VAR BAL Adjustment

1. Set the VOLTS/DIV switch to 1 mV.

2. Vary the VARIABLE control throughout its range while observing the CRT trace.

3. Adjust VAR BAL so that there is no trace movement while varying the VARIABLE control.

$\times 10$ BAL Adjustment

1. Set the VOLTS/DIV switch to 10 mV. Pull out the PULL VAR FOR $\times 10$ Vc RANGE knob while observing the CRT trace.

2. Adjust $\times 10$ BAL so that there is no trace movement while moving the knob in and out.

STEP ATTEN BAL Adjustment

1. Vary the VOLTS/DIV switch from 20 mV to 1 mV while observing the CRT trace.

2. Adjust STEP ATTEN BAL so that the trace does not move while varying the VOLTS/DIV switch.

3. Repeat all balance adjustments until optimum settings are achieved.

GAIN Adjustment

1. Using the POSITION control, position the CRT trace two divisions below graticule center.

2. Set VOLTS/DIV to 1 mV position.

3. Apply a 4 mV peak-to-peak calibrator signal through a coaxial cable to the + INPUT connector on the Type 7A13.

4. Set the + INPUT Mode switch to DC.

5. Adjust GAIN control so that the display is four divisions of square wave amplitude with the bottom of the display at the reference established in step 1.

Examples of Voltage/Signal Measurements

The following examples are provided to illustrate some of the various ways to use the Type 7A13. All examples presume that the Type 7A13 front panel adjustments have been made satisfactorily. These examples can be duplicated by an operator to serve as familiarization exercises.

NOTE

In all the following examples the COMPARISON VOLTAGE (Vc) selector switch setting and the VOLTS/DIV switch setting have been set on the basis of a voltage input whose approximate value is known (and is within the maximum input signal range of the Type 7A13). The switch settings can be determined by single ended or differential comparator methods, starting with the least sensitive VOLTS/DIV setting of 5 V.

Example 1

Single-ended operation, DC measurement. Measure the voltage output of 1.5 volt battery. (Any convenient DC source can be substituted by setting the deflection factor of the Type 7A13 accordingly.)

Operating Instructions—Type 7A13

Set the Type 7A13 front panel controls as follows:

COMPARISON VOLTAGE (Vc) Polarity	Either + or —
Counter	As is
+ INPUT Mode	GND
+ INPUT Connector	Connected to battery positive terminal. Negative terminal connected to ground lug on front panel.
— INPUT Mode	GND
VOLTS/DIV	.5 V
VARIABLE	In (CAL)
STEP ATTEN BAL	As is
GAIN	As is
×10 BAL	As is
VAR BAL	As is
BW	5 MHz
POSITION	Midrange

1. Use the POSITION control to set the trace to DC-0 reference.

2. Place the + INPUT Mode switch to DC.

3. Multiply the number of divisions displayed by the deflection factor (3 div \times .5 V = 1.5 V). The input voltage amplitude is 1.5 volts \pm 0.3 Volts.

Note that if the input voltage were applied to the — INPUT connector, with + INPUT Mode switch set to GND and — INPUT Mode switch set to DC, the 3 divisions deflection would be downward, since the — INPUT causes an inverted presentation.

Example 2

Differential Comparator Operation, DC measurement. Measure the voltage output of a 1.5 volt battery.

Type 7A13 control settings are the same as for Example 1 above.

1. Set the COMPARISON VOLTAGE (Vc) Polarity switch to + and set the counter to 0150.

2. Set the VOLTS/DIV switch to 20 mV and pull the VARIABLE knob out.

3. Using the POSITION control, set the trace to DC zero reference (graticule center).

4. Simultaneously place the + INPUT Mode switch to DC and the — INPUT Mode switch to Vc.

5. Using COMPARISON VOLTAGE (Vc) controls, reset the trace to DC zero reference.

6. Read the value of the input voltage on the COMPARISON VOLTAGE (Vc) counter. It should be 1.5 volts \pm 0.3 volts.

7. Disconnect the battery from the Type 7A13.

Example 3

Single-Ended Operation—waveform measurement. Measure the oscilloscope Calibrator + Volts waveform and DC level.

Type 7A13 control settings are same as for examples 1 and 2 except for the + INPUT connector, which should be connected to the Calibrator + VOLTS BNC connector on the oscilloscope via coaxial cable.

1. Set the oscilloscope Calibrator control to 40 mV.

2. Set VOLTS/DIV Switch to 10 mV position.

3. Set + INPUT Mode switch to AC and set the time base plug-in controls for a stable display.

4. Compute AC waveform amplitude using the POSITION control to establish a reference line. (4 divisions deflection times 10 mV/DIV yields 40 mV.)

5. Determine the DC level on which the waveform is riding, using the method shown in either example 1 or 2. Note the DC level of the top or bottom of the waveform as desired.

NOTE

For signals with a high AC to DC ratio, the AC and DC signal components can be evaluated simultaneously by using DC coupling and single-ended operation methods.

6. Disconnect the calibrator signal.

Example 4

Differential Amplifier Operation. Measure the difference between the oscilloscope Calibrator + Volts output and a modified Calibrator + Volts output.

Type 7A13 control settings are the same as example 3 above with the following exception: The — INPUT Mode switch should be set to DC.

1. Set the VOLTS/DIV Switch to 20 mV position.

2. Connect a BNC T adapter to the Calibrator + Volts output of the oscilloscope.

3. Build and connect a voltage divider to the BNC T as illustrated in Fig. 2-2.

4. Connect the junction of the two resistors to the — INPUT connector via coaxial cable.

5. Set the oscilloscope Calibrator + Volts output to 4 V.

6. Simultaneously place the + INPUT and — INPUT Mode switches to GND. Using the POSITION control, set the trace to DC zero reference two divisions below the graticule horizontal centerline.

7. Simultaneously set both the + and — INPUT Mode switches to DC. Adjust the time-base plug-in triggering controls if necessary to obtain a stable waveform.

8. Measure the waveform amplitude. It will be equal to the difference between the two input waveforms. (Approximately 40 mV; this is the voltage drop across the 1 k Ω resistor.)

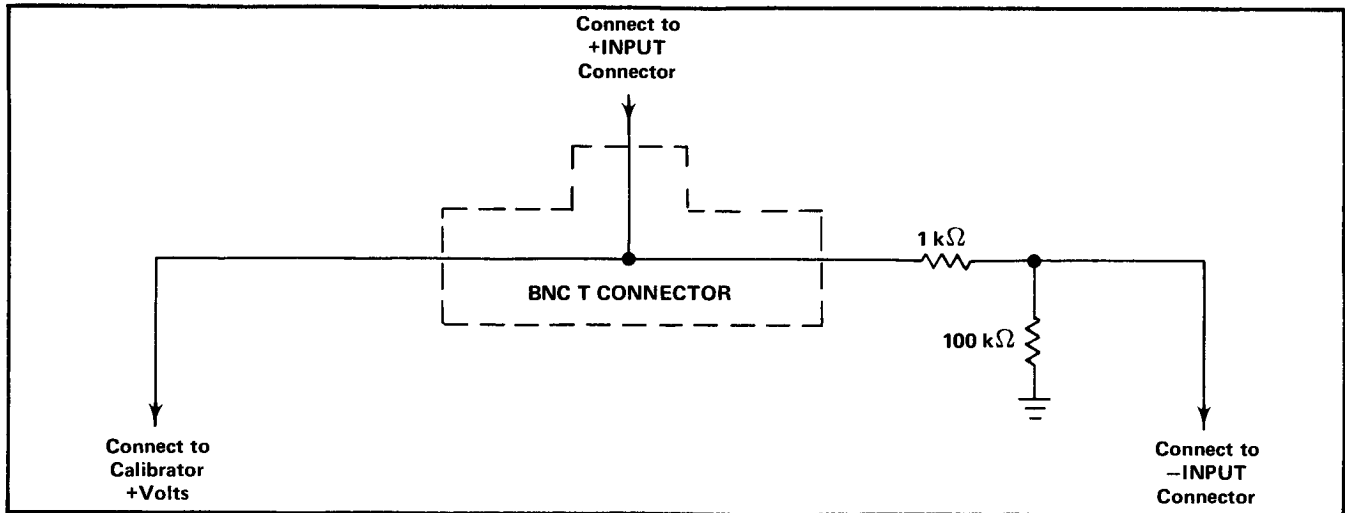

Fig. 2-2. Voltage divider for Example 4.

Use of Vc OUT 0-10 V Tip Jack

COMPARISON VOLTAGE (V_c) can be read on a voltmeter or oscilloscope connected to the V_c OUT 0-10 V tip jack. The reading (or waveform) must be equal to the COMPARISON VOLTAGE V_c switch and FINE control settings. If a high impedance voltmeter (one which draws little or no current from the measured voltage) is used, the measured value will be within $\pm 0.5\%$ or $\pm 5\text{ mV}$ (whichever is greater) of the V_c counter.

If an accurate, low impedance measuring device is used, the value read will be the value applied to the selected input channel, but it will disagree with the COMPARISON VOLTAGE V_c control setting. The amount of difference will be determined by the degree of loading caused by the measuring device. When the load is removed by disconnecting the measuring device, the voltage will return to that indicated by the COMPARISON VOLTAGE V_c control.

The V_c OUT 0-10 output can be used as a voltage source, but the accuracy and value of V_c will vary inversely with the loading effect, just as it does with a measuring device connected to it. This is illustrated in Fig. 2-3.

NOTE

Use shielded leads whenever connecting to the V_c OUT 0-10 tip jack while waveform observations are being made. Stray voltages of 10 mV or more can be picked up by unshielded cables connected to the tip jacks. This induced noise will affect the CRT presentation whenever one of the INPUT Mode switches is in the V_c position.

GENERAL DISCUSSION

An oscilloscope with a differential amplifier is a device that amplifies and displays a voltage difference that exists at every instant between signals applied to its two input channels. The following conclusions can be drawn from this definition when two signals are applied to the input of a differential amplifier.

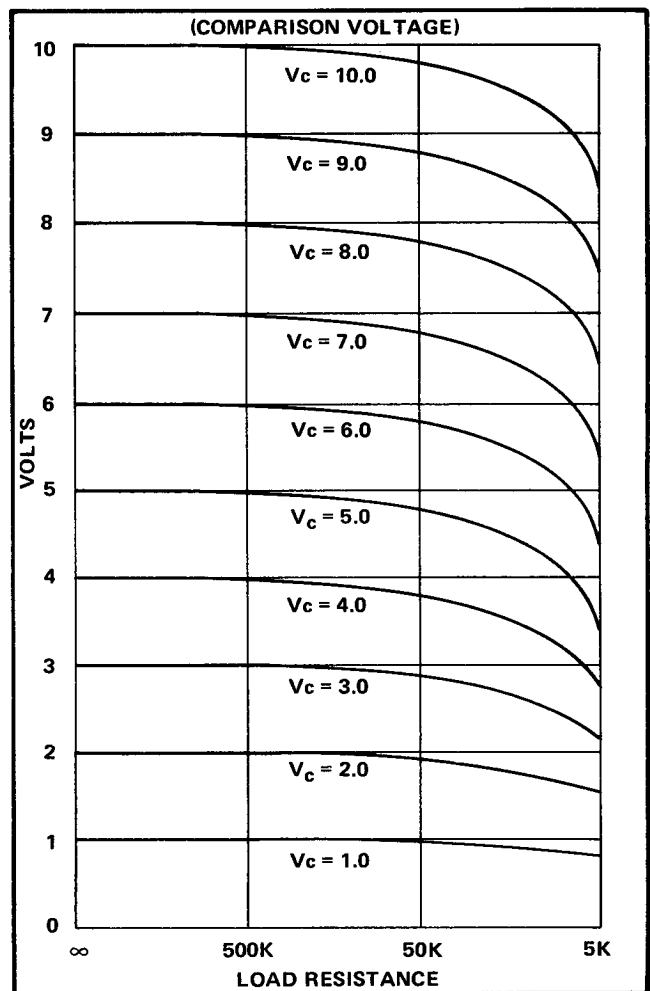

Fig. 2-3. Effect of external load connected to Comparison Voltage V_c OUT 0-10 V jack.

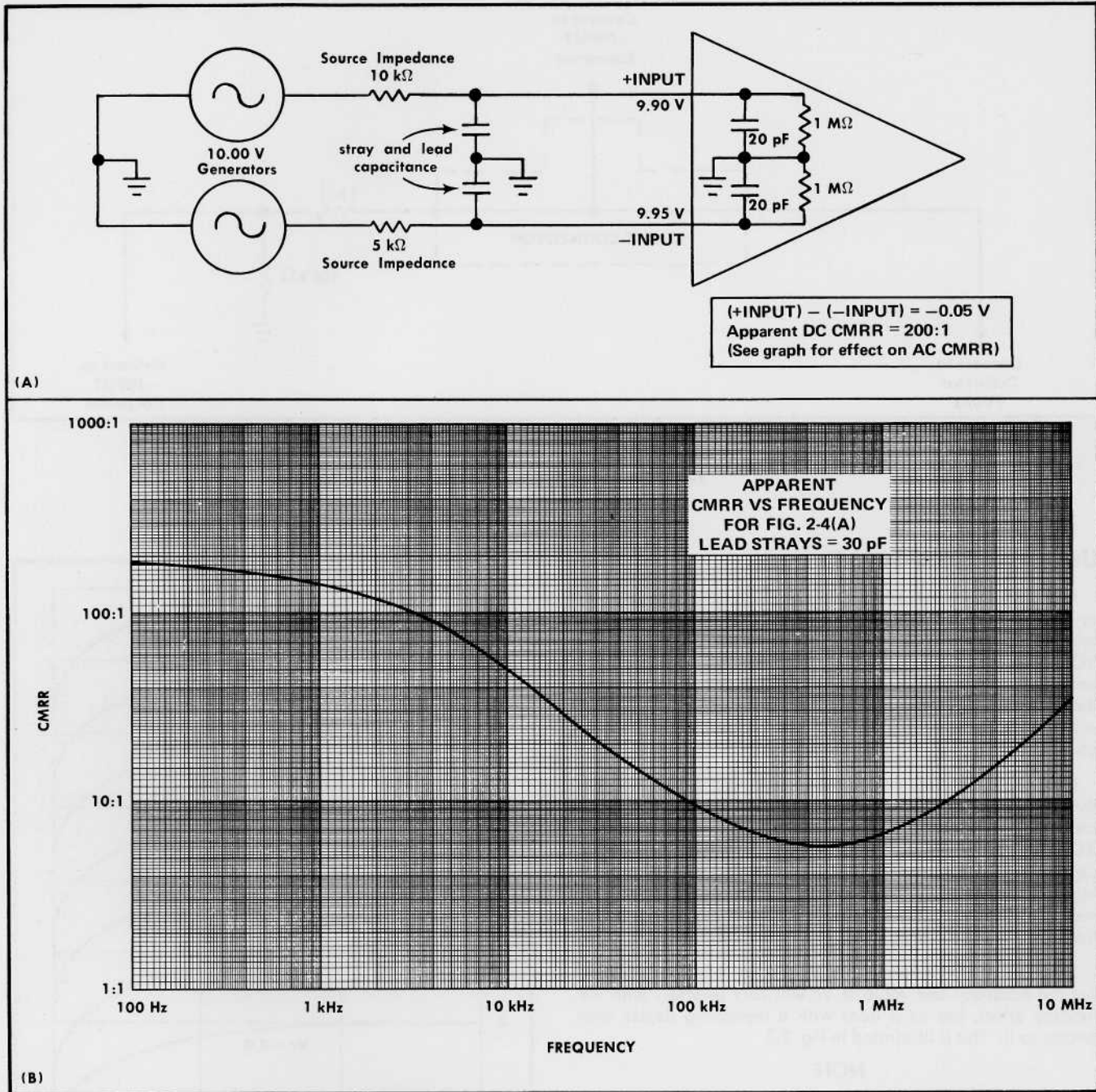

Fig. 2-4. The effect of difference in source impedance upon apparent CMRR. (High impedance sources.)

1. If two signals are in phase and of equal amplitude (hereafter called common-mode), the output will be zero.
2. If the two signals are in phase but of different amplitudes, the output will equal the amplitude difference.
3. If the two signals are out of phase and of equal amplitude the output will be the phasor difference between the two signals. (Sinusoidal signals.)
4. If the two signals are out of phase and of different am-

plitude the output signal is a complex quantity derived from both amplitude and phase differences.

Common Mode Rejection

The definition of the term "differential amplifier" implies a rejection of equal amplitude, coincident signals. This implication is correct. However, the degree of rejection depends primarily on the symmetry of the amplifier inputs. The

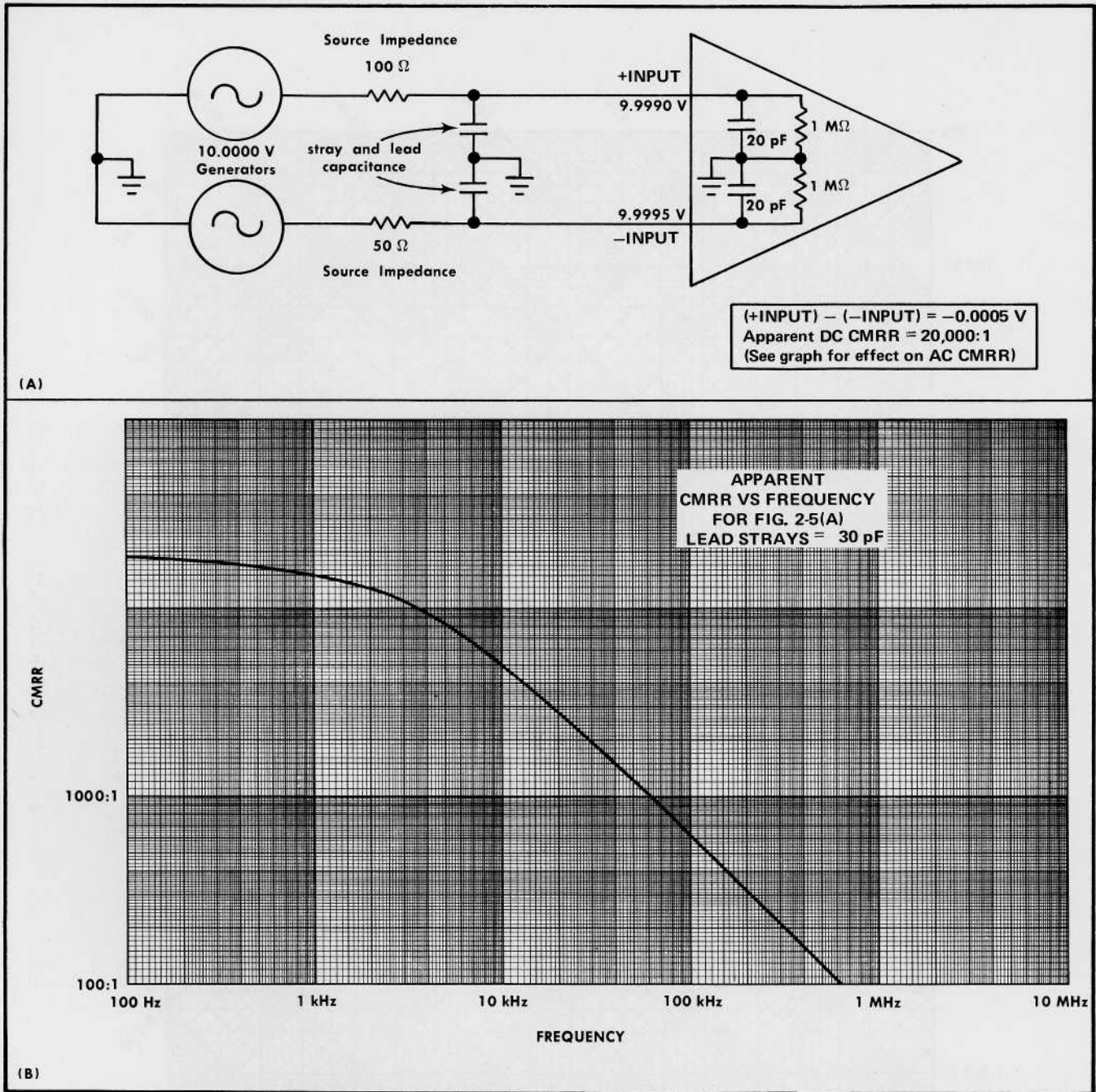

Fig. 2-5. The effect of difference in source impedance upon apparent CMRR. (Low impedance sources.)

amount of difference signal contributed by a particular amplifier at a specific frequency is documented with a mathematical relationship that is called the common-mode rejection ratio (CMRR). This ratio and associated terms are defined as follows:

Common-Mode: Refers to signals that are identical in both amplitude and time. It is also used to identify the respective parts of two signals that are identical in amplitude and time.

Common-Mode Rejection: The ability of a differential amplifier to reject common-mode signals.

Common-Mode Rejection Ratio (CMRR): Ratio of the deflection factor for a common-mode signal to the deflection factor for a differential signal.

NOTE

Since the differential amplifier is part of an oscilloscope, the output signal used to calculate the CMRR is measured from the CRT screen and VOLTS/DIV switch setting. Thus, a differential amplifier that produces a .001 volt output when driven by a 10 volt peak to peak common-mode signal has a CMRR of $10 \div .001$ or 10,000:1.

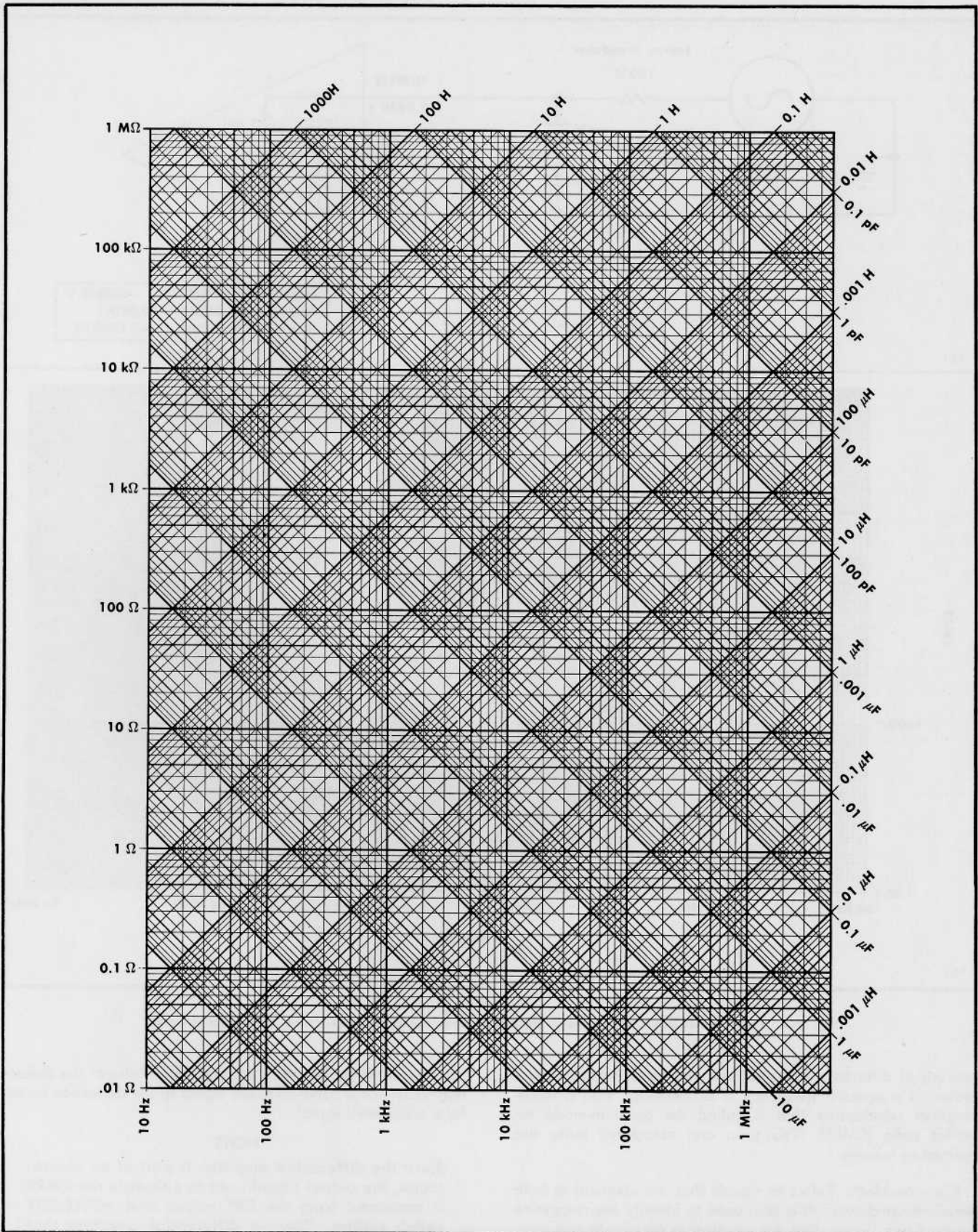

Fig. 2-6. Capacitive and inductive reactance versus frequency.

Amplitude and Common-Mode Rejection

In the text which follows, the term "Input Signal Range" means the common-mode operating range of voltage through which the amplifier will produce a usable output. This should not be confused with the maximum (non-destructive) input voltage, which is related to the breakdown limits of the amplifier components.

Factors Which Affect CMRR

Frequency. Since the common-mode output voltage is a factor of phase differences as well as gain between channels, the frequency of the input common-mode signal has a direct bearing on the CMRR. Generally, as the frequency of the input signal increases, the CMRR decreases. (Exception: with AC-coupled input, the CMRR will become higher as frequency is increased from DC to over 100 Hz.)

Source Impedance. The specified CMRR assumes that the points being measured have identical source impedance. The source impedance and the amplifier input impedance form an RC divider which determines the portion of the signal that appears across the amplifier input, and the apparent effect on CMRR. See Fig. 2-4 and 2-5.

The user may desire to construct a similar graph of CMRR versus frequency for specific applications where the source or signal transporting lead impedances are unbalanced. Fig. 2-6 is included for this purpose.

Signal Transporting Leads. A principal requirement for maximum CMRR is that the signals arrive at the amplifier's two inputs with no change in phase or amplitude. Slight differences in attenuation factors, or phase shift between two input attenuators may reduce the CMRR 20% or more.

Attenuator probes extend the usable voltage range of a differential amplifier by reducing the input signal level below

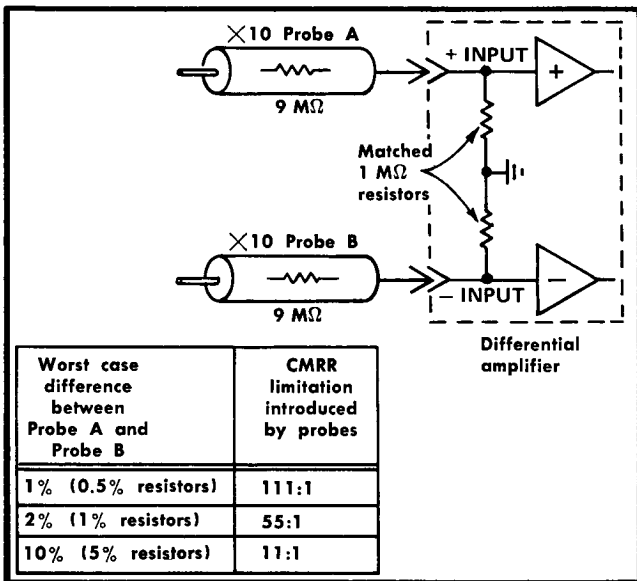

Fig. 2-7. Simplified circuit showing the limitation in CMRR that a difference between attenuator probes can introduce. Differences between probe capacitances add to the effect on AC signals.

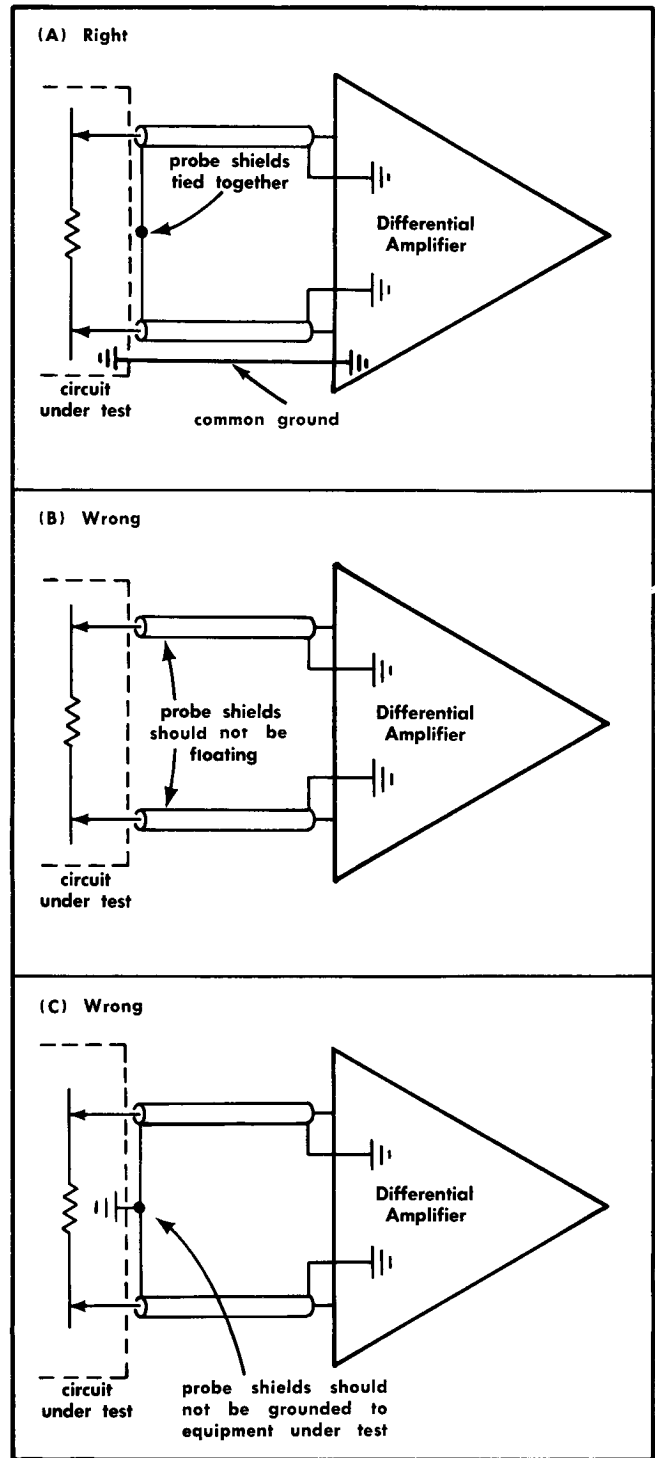

Fig. 2-8. Connecting a differential amplifier across a circuit.

the maximum common-mode input voltage. However, a reduction in the apparent CMRR will usually occur because of component value differences within the probes. For example, Fig. 2-7 illustrates the change in CMRR (apparent) due to $\times 10$ probes that are within 1, 2, and 3% of their attenuation value.

TABLE 2-1
PASSIVE SIGNAL COUPLING METHODS

Method	Advantages	Limitations	Probes or Accessories	Source Loading (7A13 Included)	Precautions
1. Open test leads.	Simplicity.	Limited frequency response. Subject to stray pickup.	BNC to Binding Post adapter (103-0033-00). Two test leads.	1 MΩ and 20 pF at input, plus test leads.	Stray pickup. Insert a 47-ohm resistor in series with the leads.
2. Underterminated coaxial cable.	Full sensitivity.	Limited frequency response. High capacitance of cable.	Coaxial cable with BNC connector(s).	1 MΩ and 20 pF plus cable capacitance.	High capacitive loading.
3. Terminated coaxial cable. Termination at 7A13 input.	Full sensitivity. Total 7A13 bandwidth. Relatively flat response resistive loading. Long cable with uniform response.	Presents R _o (typically 50 Ω) loading at end of coaxial cable. May need blocking capacitor to prevent DC loading or damage to termination.	Coaxial cable with BNC connector(s) R _o termination at 7A13 input. (BNC 50 Ω Termination 011-0049-01).	R _o plus 20 pF at 7A13 end of coaxial cable can cause reflections.	Reflection from 20 pF at input. DC and AC load on test point. Power limit of termination.
4. Same as 3, with coaxial attenuator at termination.	Less reflection from 20 pF at termination.	Sensitivity is reduced (increased deflection factor).	BNC coaxial attenuators.	R _o only.	DC and AC loading on test point. Power limit of attenuator.
5. Tap into terminated coaxial system. (BNC T at 7A13 input.)	Permits signal to go to normal load. DC or AC coupling without coaxial attenuators.	20-pF load at tap point.	BNC T and BNC connectors on signal cables.	1 MΩ and 20 pF at tap point.	Reflection from 20 pF input.
6. 1×, 1 MΩ Probe.	Full sensitivity.	High capacitance of cable. System bandwidth limited to about 33 MHz.	P6011 and P6028 are 1× probes.	1 MΩ and ≈48 pF. 1 MΩ and ≈68 pF.	High capacitance loading.
7. 10× Probe 100× Probe 1000× Probe	Reduces resistive and capacitive loading. Refer to Tektronix Inc. catalog for bandwidths of specific probes.	×0.1 sensitivity. ×0.001 sensitivity.	P6006, P6008, P6010, P6023, P6048 and P6053 are 10× probes. P6007: 100× P6015: 1000×	P6006: ≈7 pF, 10 MΩ. P6008: ≈7.5 pF, 10 MΩ. P6010: ≈10 pF, 10 MΩ. P6023: ≈12 pF, 8 MΩ. P6048: ≈1 pF, 10 MΩ P6053: ≈10 pF, 10 MΩ P6007: ≈2 pF, 10 MΩ P6015: ≈2.7 pF, 100 MΩ.	Check probe frequency compensation. Use square wave frequency less than 5 kHz, preferably 1 kHz.
8. 500 Ω and 5 kΩ probes. (Must be terminated in 50 Ω at 7A13 input.)	Reduces capacitive loading to about 0.7 pF. Bandwidth that of 7A13.	Resistive loading. ×0.1 or ×0.01 sensitivity. May need blocking capacitor to prevent DC loading or damage to termination. Limited low-frequency response when AC coupled.	P6034: 10× P6035: 100×	500 Ω and 0.7 pF. 5 kΩ and 0.6 pF.	DC and AC loading. Voltage rating of probe.
9. Current transformer. Terminated in 50 Ω at 7A13.	Current transformer can be permanent part of test circuit. Less than 2.2 pF to test circuit chassis. Measure signal current in transistor circuits; CT-1—20 A peak. CT-2—100 A peak.	RMS current rating: CT-1—0.5 A CT-2—2.5 A Sensitivity: CT-1—5 mV/mA. CT-2—1 mV/mA.	CT-1: coaxial cable, adapter and BNC termination. CT-2: Additional coaxial cable for either transformer as necessary.	CT-1: Insertion; 1 Ω paralleled by about 5 μH. Up to 1.5 pF. CT-2: Insertion; 0.04 Ω paralleled by about 5 μH. Up to 2.2 pF.	Not a quick-connect device. CT-1: Low-frequency limit about 75 kHz. CT-2: Low Frequency limit about 1.2 kHz, and is 1/5th as sensitive as the CT-1.

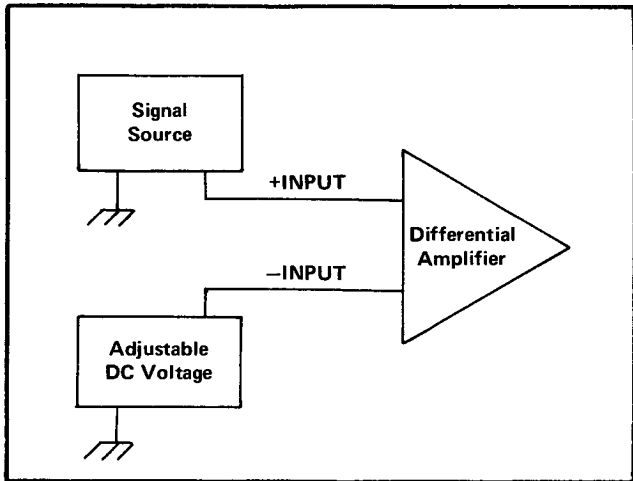

Fig. 2-9. Circuit connections for the slide-back technique described in the text.

In measurements where attenuator probes must be used because of high voltage levels, and at the same time a high (above 100:1) CMRR must be maintained, the Tektronix Type P6023 Probe is recommended. The attenuation factor of this $\times 10$ low capacitance probe is adjustable over a $\pm 2.5\%$ range.

Ground Connections. Proper grounding reduces signals generated from ground loop currents. It is usually best to

electrically connect the probe or signal lead shields together at the probe body or signal source, but not to the instrument ground. See Fig. 2-8.

Differential Amplifier Applications

In differential measurements, each input to the amplifier acts as a reference for the other, and ground connections are only used for safety reasons. Fig. 2-9 illustrates a typical differential measurement application.

In applications such as examining a signal superimposed on some DC level with DC coupling, an offset voltage may be applied to the other input of the differential amplifier to slide the signal back on the CRT screen. For example, if a differential amplifier is set for a vertical sensitivity of 10 mV/div (trace on-screen) and a +1 volt DC voltage is applied to the + INPUT, the trace will be deflected upward off screen. If a +1 volt DC voltage is now applied to the - INPUT, the trace will return on screen, or the signal will slide back on screen as a result of the voltage (slide-back voltage) applied to the - INPUT. The DC voltage applied to - INPUT is, in effect, common-mode with that of the + INPUT; thus, both are rejected by the amplifier.

X-Y Applications

For X-Y applications refer to the indicator oscilloscope instruction manual.

Passive Signal Coupling Methods

See Table 2-1 for passive signal coupling methods.

TYPE 7A13 DIFFERENTIAL COMPARATOR SETUP CHART

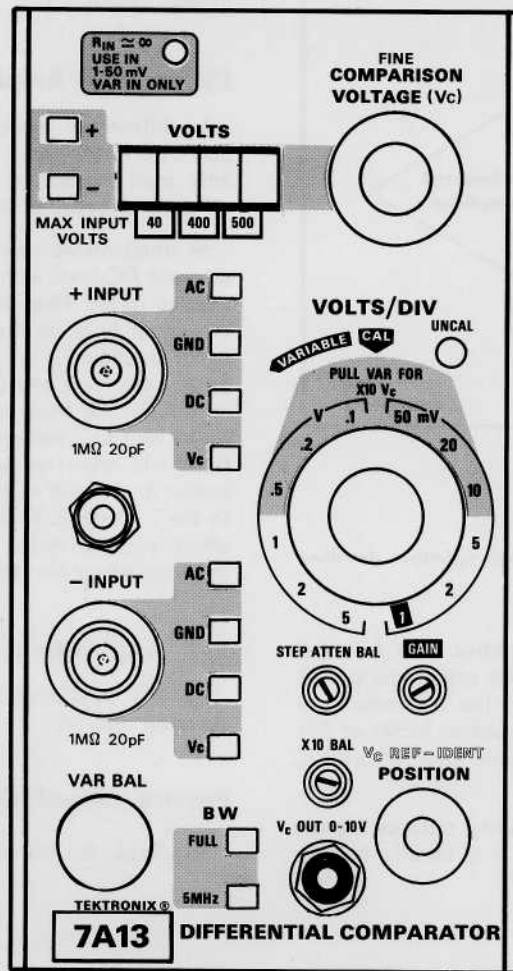

DATA:

SECTION 3

CIRCUIT DESCRIPTION

Change information, if any, affecting this section will be found at the rear of the manual.

INTRODUCTION

A block diagram description covering the general configuration of each circuit in the Type 7A13 is included in this section. Following the block diagram description is a detailed description of each circuit and the function of specific components.

Simplified drawings are provided when necessary for easier circuit understanding. Complete schematic diagrams are included in the Diagrams section. These should be referred to throughout the detailed circuit description.

The values of resistors on the schematics are in ohms unless otherwise specified. Capacitor values are indicated in the following manner unless otherwise noted: Whole numbers indicate the value in pF; decimal numbers indicate the value in μ F. Example, 33 is in pF and 0.1 is in μ F.

BLOCK DIAGRAM DESCRIPTION

(See Block Diagram Pullout preceding schematics.)

INPUT Mode Switches

A signal applied to either the + or — INPUT connector, as shown by the heavy lines on the Block Diagram, passes through the INPUT Mode switches to the Input Attenuators. The signals can be AC coupled, DC coupled or disconnected internally. (See schematic diagram No. 1.)

Input Attenuators

The Input Attenuators for the + and — inputs are identical and are conventional RC type attenuators. The adjustable resistive elements facilitate matching the — and + attenuators to obtain optimum DC common-mode rejection and precise attenuation ratios.

The attenuators (Schematic Diagram No. 1) are frequency compensated voltage dividers which provide constant attenuation at all frequencies within the bandwidth of the instrument. This is done while maintaining the same input time constant (20 μ s) for all positions of the VOLTS/DIV switch.

Input Source and Emitter Followers

The Input Source and Emitter Followers are designed to present a very high input impedance at the attenuator's output. Bootstrapping is incorporated in these stages for each of the + and — inputs. A Current Source is used to supply the proper amount of current for these stages. Each side also contains an overload protection circuit to guard against signals larger than approximately ± 15 volts.

Differential and Common Mode Signal Clamps

The Differential and Common Mode Signal Clamps allow the following Differential Comparator stage to operate linearly for all input conditions. The Differential Mode Signal Clamp limits the output levels to approximately ± 1 volt, whereas the Common Mode Signal Clamp allows a window of at least ± 10 volts.

Differential Comparator

The Differential Comparator operates upon the limited output of the Differential and Common Mode Signal Clamps. The amplified signal is then applied to the $\times 1$ and $\times 10$ Gain Switching Amplifier. The gain of the Differential Comparator is approximately 1.

$\times 1$ and $\times 10$ Gain-Switching Amplifier

The $\times 1$ and $\times 10$ Gain-Switching Amplifier receives the differential signals from the Differential Comparator. Gain switching is accomplished by the VOLTS/DIV switch through relays.

$\times 1$, $\times 2$ and $\times 5$ Gain-Switching Amplifier

$\times 1$, $\times 2$ and $\times 5$ Gain Switching Amplifier receives the differential signals from the $\times 1$ and $\times 10$ Gain-Switching Amplifier. Gain switching is accomplished by the VOLTS/DIV switch through relays.

Driver Amplifier

The Driver Amplifier receives the differential signals from the $\times 1$, $\times 2$ and $\times 5$ Gain-Switching Amplifier. The gain of the Driver Amplifier is approximately 2.5. Its output signals are applied to the Output Amplifier.

Output Amplifier

The Output Amplifier further amplifies the differential signals and then applies them to the input of the oscilloscope through pins A11 and B11 of the interconnecting plug.

Trigger Amplifier

The Trigger Amplifier receives a portion of the Output Amplifier signal in order to provide + and — internal triggers to drive the Trigger Generator circuit in the time-base plug-in unit.

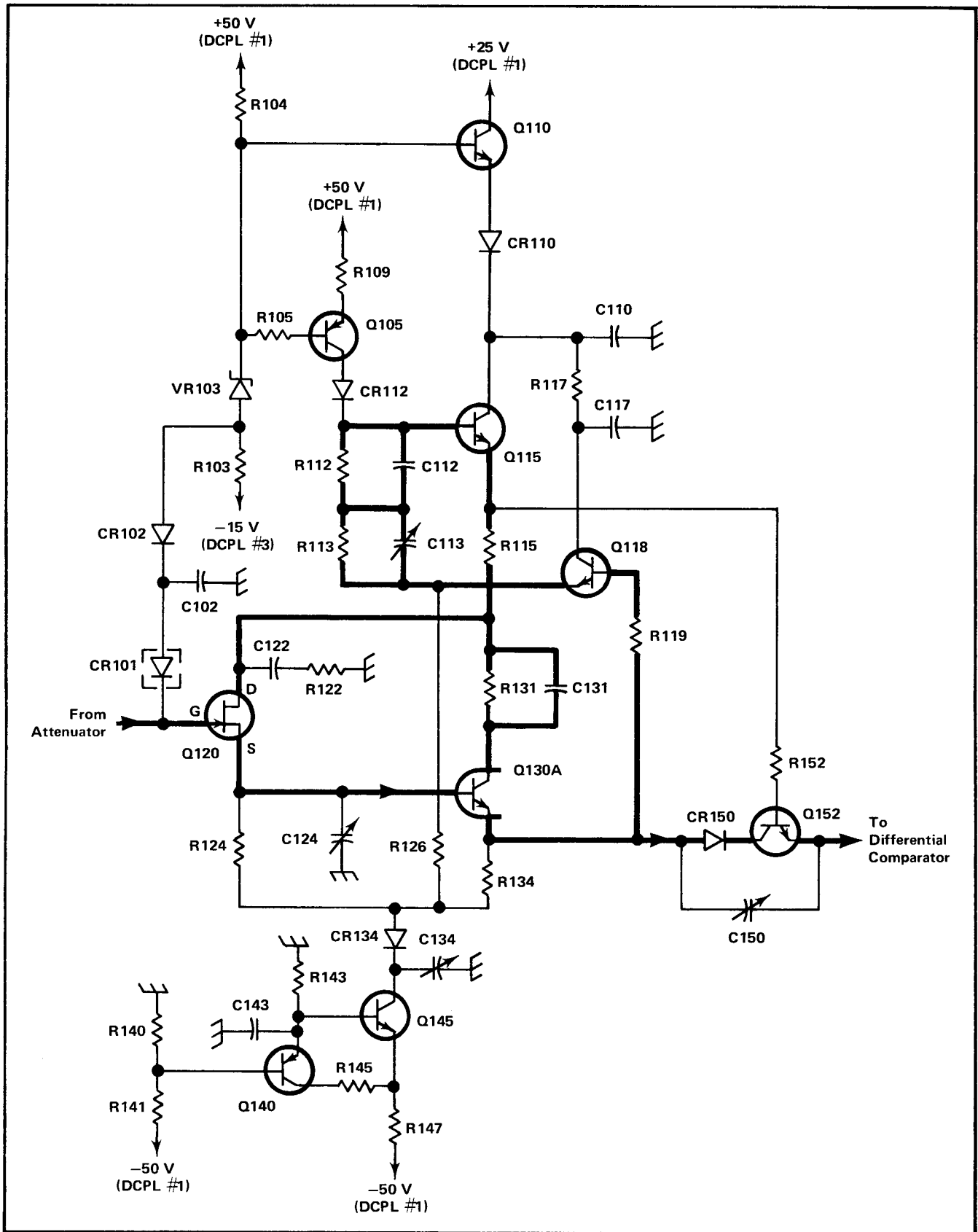

Fig. 3-1. Input Source and Emitter Follower, simplified schematic diagram.

Feedback Limiter

The Feedback Limiter is driven by the Trigger Amplifier output signals. A portion of these signals is re-applied to $\times 1$ and $\times 10$ Gain-Switching Amplifier to limit the incoming signal and prevent any of the amplifier stages from saturating or cutting off.

Readout Logic

The Readout Logic circuit provides the necessary output signals for VOLTS/DIV display on the CRT screen. These output signals are present at several pins of the interconnecting plug. The third contacts of the + and — INPUT connectors sense the attenuation of the probes and provide proper multiplying factors to the readout circuits.

Vc Decimal Lamp Driver

The Vc Decimal Lamp Driver illuminates either the $\times 1$, $\times 10$ or $\times 100$ lamps depending on the attenuation of the probe and internal attenuator.

DETAILED CIRCUIT DESCRIPTION

(See schematic diagram pullouts at rear of manual.)

INPUT Mode Switch

Signals applied to the + or — INPUT connector can be AC coupled, DC coupled or internally disconnected. When the INPUT Mode Switch is in the DC position, the input signal is coupled directly to the Input Attenuator. In the AC position, the AC signal is coupled through capacitor C1 while the DC component is blocked. The GND position internally disconnects the signal from the 7A13 and connects GND to the Input Attenuator. This provides a ground reference for the amplifier without requiring removal of the input probes.

When the Input Mode switch is set to Vc, the signal is internally disconnected while the comparison voltage Vc is applied to the gate of the Input FET. This provides a DC reference for one input of the Differential Comparator while the signal is applied to the other.

Input Attenuators

The Input Attenuators work in conjunction with the VOLTS/DIV switch S50. When the VOLTS/DIV switch is set to the 1, 2, 5, 10, 20 or 50 mV/DIV position, relays K6 and K26 are de-energized, and K7 and K27 are energized. The relays are connected so the signals present at the inputs by-pass both attenuators. (The above description applies only when the VARIABLE VOLTS/DIV is depressed.) When the INPUT Mode switches are not set to the Vc position, the signals above pass through contacts K10-1 and K30-1 to the + and — Input Source and Emitter Followers.

When the VOLTS/DIV switch is set to 0.1, 0.2 or 0.5 V/DIV position, the following occurs: Relays K6 and K26 remain in the same state; however, relays K7 and K27 change their states, thereby causing the two signals above to pass through the second attenuators. The signals then pass through contacts K10-1 and K30-1 as described earlier.

When the VOLTS/DIV switch is set to 1, 2 or 5 V/DIV, the following occurs: Relays K6 and K26 change their states, whereas K7 and K27 remain in the same state. Thus, the two signals must now pass through both attenuators. The signals then pass through contacts K10-1 and K30-1 as described previously. The foregoing three cases of VOLTS/DIV switch settings correspond to attenuation factors of $\times 1$, $\times 10$ and $\times 100$. These attenuators are almost identical for the + and — INPUT channels. They are the conventional RC type attenuators.

The attenuators (Schematic Diagram number 1) are frequency-compensated voltage dividers which provide constant attenuation at all frequencies within the bandwidth of the instrument, while maintaining a constant input time constant (20 μ s) for all positions of the VOLTS/DIV switch.

Each attenuator contains an adjustable capacitor to provide correct attenuation at high frequencies and adjustable shunt capacitance to provide correct input capacitance.

Input Source and Emitter Followers

The Input Source and Emitter Followers provide a very high input impedance so that they do not load down the attenuator circuit elements. These stages are identical for both channels. Therefore, the following description of the + INPUT channel describes the — INPUT also.

The + INPUT Source and Emitter Followers include Q120, Q130A, Q140, Q145, Q118, Q115, Q110 and Q105 and their associated components. Q120 and Q130A are the Source and Emitter Followers. Q140 and Q145 form a Current Source of approximately 18 mA. Q118 is a bootstrapping emitter follower. Q115 and Q110 form overdrive protection circuit along with diodes CR101, CR102, CR110 and CR112. Q105 is a current source.

The input signal appearing at the emitter of Q130A is very close to that which appears at the gate of Q120. That is, the input stage has a voltage gain very close to unity. The bootstrapping and active long tail help to achieve this efficiency.

The Input Source and Emitter Follower provides an extremely high input impedance and a low output impedance. The signal from the attenuator is applied to the gate of FET Q120, which operates a source follower. The source of Q120 is connected to emitter follower Q130 which drives the voltage amplifier through the disconnect circuitry. Q120 source and Q130 emitter are coupled through R124 and R134 respectively, to current source Q145 and Q140. The output of Q130 is also applied to the base of emitter follower Q118. The resistive tails of Q118, Q120, and Q130 all connect to the collector of the current source Q145. The resistive tails effectively parallel to drive the collector capacitance of Q145, so that the voltage differences across R124 and R134 are quite small. This results in a very small signal current through R124 and R134, making their impedance to the signal very high. R126 has negligible effect on the bootstrapped voltage since its impedance is much less than the output impedance of the constant current source.

Q115 is an emitter follower which couples the signal from the emitter of Q118 to the drain of Q120 and the collector of Q130. This allows the drain and collector to follow the input and maintain approximately constant quiescent conditions with large amplitude input signals. This

Circuit Description—Type 7A13

process, called bootstrapping, results in minimal transistor parameter changes and greatly reduced Miller capacitance. The R113-C113 time constant compensates for an effective RL time constant introduced by Q118. R112 and C112 provide high frequency compensation for bootstrap to Q115. C110 serves as a decoupling capacitor for Q118. C117 is for high frequency compensation. R131 and C131 provide thermal compensation for Q130; R131 sets DC quiescent conditions of Q130; R112 sets the DC quiescent point of Q120 and Q130. R122 and C122 provide high frequency compensation to the bootstrap signal to Q120 and Q130 from Q115.

Q105, Q140 and Q145 form current sources for the input amplifier.

C124 and C134 are common mode adjustments which are adjusted for proper phase matching between the two amplifiers.

The protection circuit consists of Q110, CR112, CR110, VR103, CR102, CR134 and CR101. With inputs less than ± 15 V, Q110 is saturated, forward biasing CR110, thus essentially connecting the +25 V to the input amplifier. Q105 is operating as a constant current source for biasing Q115, and CR112 is conducting. Current is returned to the power supply through forward biased CR134 and the constant current source Q145. 47 V zener diode VR103 is in a non-conducting state with an anode-cathode voltage of approximately -41 volts DC. CR102 and CR101 are reverse biased, and thus non-conducting. CR101 is a very low leakage (less than 10 pA) low capacity (less than 1 pF) diode, in order to minimize input loading.

If a positive signal is applied to the input, the current through the Q120 FET increases, thus increasing the source voltage, allowing it to follow the input. The Q120 FET current is ultimately limited by the constant current source Q145 such that when the input exceeds about +15 volts, Q120 FET drain current ceases to increase, and the Q120 FET gate-source junction forward biases. If the input continues to go more positive, the FET source voltage follows the input signal, which is now supplying current to the input amplifier, saturating Q130, Q118, and Q115.

If the voltage of the signal exceeds about +25 volts, the voltage at the base of Q115 approximately equals or exceeds the voltage at the collector of Q105, thus reverse biasing CR12 and essentially disconnecting Q115 base from the constant current source Q105. Similarly, when the collector voltage of saturated Q118 approximately equals or exceeds the emitter voltage of Q110, CR101 is reverse biased, thus disconnecting Q118 from the +25 V supply. This action then allows the input amplifier to float with the input signal at approximately the same potential throughout, isolated from the + power supplied by CR112 and CR110. Q145 has sufficient power, current and voltage specifications to handle signals of approximately +50 volts input. Disconnect transistor Q152 disconnects the input amplifier from the succeeding stages.

If a negative signal is applied to the input, the junction of R124, R126, R134, and CR134 follows. When the voltage at this point is approximately equal to or more negative than the voltage at the collector Q145, CR134 becomes reverse biased and thus disconnects the input amplifier from the supply return. If the signal becomes more negative than about -15 volts, CR101 and CR102 become forward bias-

ed, thus locking the anode end of VR103 to approximately the same potential as the input signal. If the input signal becomes approximately equal to or more negative than about -21 volts, zener diode VR103 begins to conduct, locking the base of Q110 and the base of Q105 to a level about 48 volts above the input signal. As the input signal goes more negative, Q110 goes out of saturation and is turned off. This disconnects the input amplifier from the +25 V supply. Disconnect diode CR150 disconnects the input amplifier from succeeding stages.

Differential Signal and Common Mode Signal Clamps

The disconnect circuit consists of CR150 and Q152, with R152 operating as a constant current source of .5 mA to the base of Q152. The clamp circuit consists of VR155, CR158, CR156, VR157, CR152 and CR154, CR252 and CR254. When the input signal to the 7A13 is between about +12 V and -12 V, CR150 is forward biased and Q152 is saturated. The base of Q152 is fed by a current source so that the base voltage, and hence the emitter voltage, can follow the collector voltage. CR152, CR154, CR252, CR254 serve as clamp diodes, clamping at a level determined by the zener diodes VR155 and VR157.

The voltages at the junction of VR155 and CR156, and at the junction of VR157 and CR158, are constant at about +12 V and -12 V, respectively. When the base voltage of Q152 exceeds +13.5 volts, CR152 and CR156 become forward biased, clamping the base voltage of Q152 at this level. Similarly, the bases of Q152 and Q252 are clamped for negative signals by forward biasing CR154, CR252 and CR158. If the input signal is in excess of +12.1 volts, the base of Q152 becomes clamped and no longer follows the collector voltage. The collector voltage can follow the input up to the Vce breakdown level. If the input signal is in excess of -12.8 volts, the base of Q152 becomes clamped (at -12.1) and CR150 becomes reverse biased, disconnecting the comparator from the input amplifier.

Differential Comparator

The Differential Comparator includes Q160A and B, Q170, Q270, Q255, Q258 and Q165. Q160A and B actually form the comparator, which has a Constant Current Source formed by Q255 and Q258 supplying 25 mA. Bootstrapping is accomplished by Q165. The cascode connections are made to Q170 and Q270.

The gain of the Differential Comparator is approximately one. Capacitors C162, C262, C171 and C271 are adjustable for good high frequency common mode rejection ratio (CMRR). C163 is adjustable for good transient (step) response. Diode VR166 is used as a DC level raising diode. R167 is a thermal compensating potentiometer.

×1-×10 Gain-Switching Amplifier

The ×1-×10 Gain Switching Amplifier consists of Q185A and B, Q195A and B and associated components. When the VOLTS/DIV switch is not in the 1, 2 or 5 V/DIV position and the VAR knob is pulled out, ×10 GAIN relays are set for an attenuation factor of 10. That is, the relay contacts

are in the labeled (on schematic No. 2) X10 positions. This diverts 90% of the signal current through R194, thereby reducing the overall gain by 10 \times . R288 provides an internal DC balance control. R284 is the front panel \times 10 BAL adjustment. C187 and R187 are transient response adjustments.

\times 1- \times 2- \times 5 Gain-Switching Amplifier

The \times 1- \times 2- \times 5 Gain Switching Amplifier is composed of Q300A and B, Q320A and B and their associated components. The amplifier operates in a manner similar to the \times 1- \times 10 Gain-Switching Amplifier. However, there is one additional component; a thermistor-varactor diode thermal network across the emitters of Q300A and B. This is a transient response "fixer" for temperature variations of the many transistor parameters. In effect, the capacitance of the varactor diode CR401 varies in accordance with the thermistor-resistor bias network R300 and R303. This spikes up or rolls off the front corner of the step response waveform as temperature is changed. The net result is a good square-cornered step response.

C319 and R319 provide high frequency compensation.

Driver Amplifier

The Driver Amplifier is a PNP cascode circuit including Q330, Q430, Q340 and Q440 and associated components. The front panel POSITION control is connected to the emitter of Q430 and the position center adjustment to the emitter of Q330. Resistor R439 and capacitor C439 are for high frequency compensation. Adjustable components C432 and R432 also improve the transient response of the amplifier. The amplifier has a voltage gain of approximately 2.7.

Output Amplifier

The Output Amplifier is an NPN cascode amplifier with a voltage gain of approximately 2.7. It includes Q350, Q450, Q360 and Q460 and associated components. Resistor R456 and capacitor C456 are for high frequency compensation. Potentiometer R360 is a Signal DC Level adjustment for the collectors of Q360 and Q460. Diodes CR364 and CR365 limit the output signal swing to \pm 0.6 volts. C364, C464, L364, and L464 form a 3 pole 5 MHz low pass filter whenever the BW switch is set to 5 MHz via relay K490-1 and -2.

Trigger Amplifier

The Trigger Amplifier consists of Q370, Q470, Q380, Q480 and associated components. Resistor R374 and capacitor C374 provide high frequency compensation. C372, R477 and C477 are also added for that reason. Resistor R371 is the trigger DC balance adjustment. Resistor R380 is present to adjust the output trigger DC level at the collectors of Q380 and Q480. The output triggers are applied to the indicator oscilloscope by pins A13 and B13. They are also applied to the Feedback Limiter via pins AN and AV

of the Output Amplifier board and AI and AK of the Input Amplifier board.

Feedback Limiter

The Feedback Limiter includes Q180, Q280, Q182 and Q282 and associated components. This circuit prevents all the amplifiers within the feedback loop from being driven to saturation or cutoff. This is necessary to produce good "recovery time" in the 7A13. (See Section 1, Specification).

Transistors Q180, Q182, Q280 and Q282 are normally biased off. The feedback voltages from Q380 and Q480 of the Trigger Amplifier are approximately zero unless the signal swings increase the voltage to plus and minus 0.6 volt. As the signal swings beyond this excursion, transistors Q180, Q182, Q280 and Q282 start to conduct. This effectively shorts the base of Q185A to the base of Q185B which results in reducing the signal swing that started the cycle. In this manner, the Feedback Limiter controls the signal swing of the Output Amplifier.

Readout Logic and Vc Decimal Lamp Driver

The Readout Logic and Vc Decimal Lamp Logic operate upon the probe attenuation information from the third contacts of the + and - INPUT jacks. The Readout Logic circuit consists of Q40, CR40 through CR43 and associated components. Three wafers of the VOLTS/DIV switch are employed to transmit attenuation information to the indicator oscilloscope. The total information is sent out via pins A30 (m), A32 (\times 1, \times 2 and \times 5), A37 (column), B32 (UNCAL), B29 (VOLTS), B37 (ROW) and B33 (\times 1, \times 10 and \times 100) of the output board. The Vc Decimal Lamp Driver includes Q60, Q65, Q70 and Q75 and associated components. The purpose of this circuitry is to light an appropriate \times 1, \times 10 or \times 100 lamp. The input signal comes from the diode pair CR40 and CR43 of the Readout Logic board.

Low Voltage Power Supplies

The Low Voltage Power Supplies operate upon receipt of +50 V DC, +15 V DC, -15 V DC and -50 V DC to produce the following voltages: +50 V DC, +25 V DC, +14 V DC, +8 V DC, +5 V DC, -8 V DC, -15 V DC and -50 V DC. These voltages are further divided into several decoupled supplies. For example, +15 V DC is decoupled five times, once for each load. Similarly the other DC supplies are decoupled from their loads.

Comparison Voltage Generator

The Comparison Voltage Generator operates upon receipt of + or -50 V DC depending on the Vc polarity switches. Zener diode VR570 is used as an 11.7 volt reference. Approximately 10 mA are supplied through R572 to the zener diode VR570. Potentiometer R575 and R576 set the one volt reference between the two poles of switch SW575. Potentiometer R577 is the variable COMPARISON VOLTAGE (Vc) FINE control.

SECTION 4

MAINTENANCE

Change information, if any, affecting this section will be found at the rear of the manual.

Information which will aid in keeping the Type 7A13 operating at its peak performance is contained in this section. Cleaning, lubricating and visual inspection hints are included under preventive maintenance. The section on corrective maintenance includes troubleshooting and correction procedures. Parts identification and soldering techniques are included where necessary.

PREVENTIVE MAINTENANCE

General

The instrument should be cleaned, lubricated, inspected and recalibrated at regular intervals. A recommended schedule for average operating conditions is every 6 months or every 1000 hours of operation, whichever occurs first.

Cleaning the Front Panel

Loose dust may be removed with cloth and a dry paint brush. Water and mild detergents such as Kelite or Spray-White may be used.

CAUTION

Avoid the use of chemical agents which might damage the plastics used in this unit. Avoid chemicals such as benzene, toluene, xylene, acetone or similar solvents.

Cleaning the Interior

Cleaning of the interior of the unit should precede calibration, since the cleaning process could alter the setting of the calibration adjustments.

To clean the interior, use low-velocity compressed air to blow off the accumulated dust. Very high velocity air streams should be avoided to prevent damage to components.

WARNING

Use an eye-shield when cleaning with pressurized air.

Hardened dirt can be removed with a paint brush, cotton tipped swab or cloth dampened with water and mild detergent solution. Avoid the use of the following chemical cleaning agents that might damage the plastic parts, especially the Attenuator etched circuit board: Acetone, trichloroethylene, chloroethane, and methyl ethyl ketone.

Visual Inspection

The unit should be inspected occasionally for such defects as poor connections, broken or damaged circuit boards, im-

properly seated transistors and heat-damaged parts. The remedy for most visible defects is obvious. But, damage from overheating is usually a symptom of less obvious trouble; and unless the cause is determined before parts are replaced, the damage may be repeated.

Transistor Checks

Periodic preventive maintenance checks on the transistors used in the unit are not recommended. The circuits within the unit generally provide the most satisfactory means of checking transistor usability. Performance of the circuits is thoroughly checked during recalibration, and substandard transistors will usually be detected at that time.

Calibration

To insure accurate measurements, the Type 7A13 calibration should be checked after each 1000 hours of operation or every six months if used intermittently. Complete calibration instructions are contained in Section 5.

The calibration procedure can be helpful in isolating major troubles in the unit. Moreover, minor troubles not apparent during regular operation may be revealed and corrected during calibration.

CORRECTIVE MAINTENANCE

General

Replacement of some parts in the unit should be done by following a definite procedure. Some procedures, such as soldering and replacing components on the circuit board, are outlined in this portion of the manual.

Many electrical components are mounted in a particular way to reduce or control stray capacitance and inductance. When selecting replacement parts, it is important to remember that the physical size and shape of a component may affect its performance at high frequencies. When a repair is made, calibration and performance of the relevant portions of the circuit should be checked. Refer to Table 4-1 and to the Performance Check/Calibration procedure in Section 5 and perform the applicable steps.

Obtaining Replacement Parts

Standard Parts. All electrical and mechanical part replacements for the Type 7A13 can be obtained through your local Tektronix Field Office or representative. However, many of the standard electronic components can be obtained locally in less time than is required to order them from Tek-

TABLE 4-1
RECALIBRATION AFTER REPAIR

Areas of Repair	Checks & Adjustments Affected	Section 5 Calibration Step
Input Mode Switches	Input R and C, attenuator compensation, CMRR low-frequency response	Steps 12 through 16.
Input Attenuators		Steps 18, 19, 21, 22.
Input Amplifier	DC adjustments, gain CMRR, high-frequency compensation	Steps 1 through 9. Steps 11, 17, 20, 25, 32, 33.
Output Amplifier	DC adjustments, gain, CMRR, high-frequency compensation	Steps 1 through 9. Steps 17, 20, 25, 26, 32, 33.
Trigger Amplifier	Gain, high-frequency response	Steps 17 and 20. Steps 23 through 24.
Comparison Voltage	Comparison voltage	Steps 27 through 31.

tronix, Inc. Before purchasing or ordering replacement parts, check the parts list for value, tolerance, rating and description.

NOTE

When selecting replacement parts, it is important to remember that the physical size and shape of the component may affect its performance in the instrument, particularly at high frequencies. All replacement parts should be direct replacements unless it is known that a different component will not adversely affect instrument performance.

Special Parts

Some parts are manufactured or selected by Tektronix to satisfy particular requirements, or are manufactured for Tektronix to our specifications. These and most mechanical parts should be ordered through your Tektronix Field Engineer or Field Office. See Parts Ordering Information and Special Notes and Symbols on the page immediately preceding Section 6.

Soldering Techniques

Attenuator Board. The Attenuator circuit board is made from polyphenylene oxide because of its excellent electrical characteristics. Use more than ordinary care when soldering. The following rules should be observed when removing or replacing parts on this board:

1. Do not apply any mechanical stress to the board.
2. Use a very small soldering iron (not over 15 watts).
3. Use low-temperature solder.
4. Do not apply more heat, or apply heat for a longer time, than is absolutely necessary.
5. Use some form of solder removing device (desoldering tool) especially when removing multi-lead devices.

Input and Output Boards. Use ordinary 60/40 solder and a 15 to 30 watt pencil type soldering iron on the circuit boards. The tip of the iron should be clean and properly tinned for best heat transfer to the solder joint. A higher wattage soldering iron may separate the etched wiring from the base material.

All Circuit Boards. The following technique should be used to replace a component on a circuit board. Many of the components can be replaced without removing the board from the unit.

1. Grip the component lead with long-nose pliers. Touch the soldering iron to the lead at the solder connection. Do not touch the soldering iron tip directly on the board, as it may damage the board.

NOTE

(Alternate procedures for steps 1 and 2)
If the board has been removed so that the soldering iron can be applied to the back side of the board, a solder-removing device is extremely useful for removing solder from the connection to expedite component removal.

2. When the solder begins to melt, pull the lead out gently. This should leave a clean hole in the board. If not, the hole can be cleaned by reheating the solder and placing a sharp object, such as a toothpick or pointed tool, into the hole to clean it out. Another method for cleaning the hole is to use a solder-removing device.

3. Bend the leads of the new component to fit the holes in the board. Cut the leads of the new component to the same length as those of the old component. Insert the leads into the board until the component is firmly seated against the

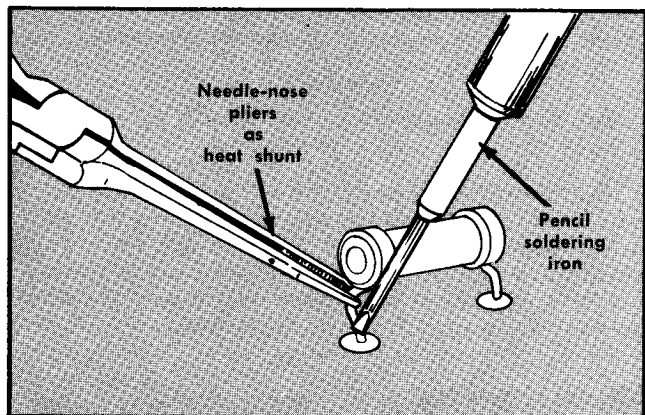

Fig. 4-1. Using needle-nose pliers as a heat sink.

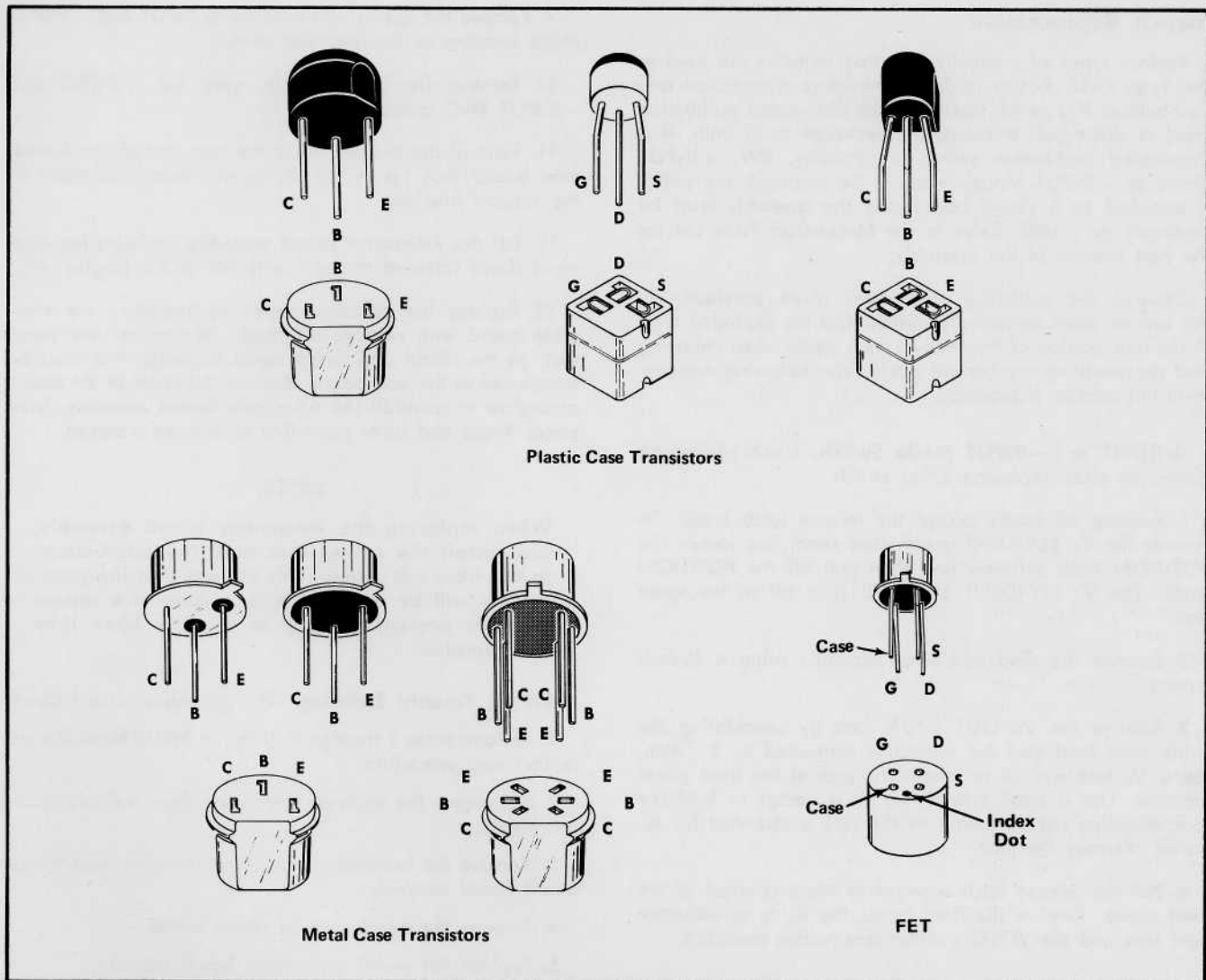

Fig. 4-2. Transistor pin identification.

board, or as positioned originally. If it does not seat properly, heat the joint, and gently press the component into place.

4. Apply the iron and a small amount of solder to the connection to make a firm solder joint. To protect heat-sensitive components, hold the lead between the component body and the solder joint with a pair of long-nose pliers or other heat sink, see Fig. 4-1.

5. Clip the excess lead that protrudes through the board.

6. Clean the area around the soldered connection with flux-remover solvent to maintain good environmental characteristics and appearance. Be careful not to remove information printed on the board.

CAUTION

Silk screen lettering dissolves when contacted by flux-remover.

Metal Terminals. When soldering to metal terminals (interconnecting plug pins, switch terminals, potentiometers, etc.) ordinary 60/40 solder can be used. The soldering iron should have a 40 to 75 watt rating with a $\frac{1}{8}$ inch wide chisel-shaped tip.

Observe the following precautions when soldering to metal terminals:

1. Apply heat only long enough to make the solder flow freely.

2. Apply only enough solder to form a solid connection; excess solder may impair the function of the part.

3. If a wire extends beyond the solder joint, clip the excess close to the joint.

4. Clean the flux from the solder joint with a flux-remover solvent to maintain good environmental characteristics and appearance.

Switch Replacement

Various types of manually-operated switches are used in the Type 7A13: Rotary, slide, subminiature snap-action and pushbutton. If a switch (excluding the illuminated pushbutton type) is damaged, it should be replaced as a unit. If a illuminated pushbutton switch (Vc Polarity, BW, +INPUT Mode or —INPUT Mode) needs to be replaced, the switch is attached to a circuit board and this assembly must be replaced, as a unit. Refer to the Mechanical Parts List for the part number of the assembly.

Observe the soldering precautions given previously in this section when replacing a switch. Use the exploded view in the rear portion of this manual as a guide when removing and reassembling mechanical parts. The following replacement information is provided.

+INPUT or —INPUT Mode Switch. Use the following procedure when replacing either switch.

1. Remove all knobs except the release latch knob. To remove the Vc REF-IDENT pushbutton knob, first loosen the POSITION knob setscrew and then pull off the POSITION knob. The Vc REF-IDENT knob will slide off at the same time.

2. Remove the Gnd connector assembly using a $\frac{3}{8}$ -inch wrench.

3. Remove the Vc OUT 0-10 V jack by unsoldering the cable wire lead and the capacitor connected to it. Then, use a $\frac{5}{16}$ -inch wrench to loosen the jack at the front panel location. Use a small screwdriver as a wedge to hold the rear mounting nut stationary as the jack is loosened for removal. Remove the jack.

4. Pull the release latch outward to allow removal of the front panel. Remove the front panel, the $R_{in} \simeq \infty$ indicator light lens and the VOLTS counter lens holder assembly.

NOTE

The $R_{in} \simeq \infty$ indicator light lens and the VOLTS Counter lens holder assembly fit loosely in the sub panel. Hold the Type 7A13 with the front facing upward to prevent these parts from falling out while removing the front panel.

5. Remove the Attenuator electrical shield cover by removing the two screws that hold it in place.

6. Unsolder the three Attenuator wires where they attach to the front end of the Input board.

7. Unsolder the capacitors and leads where they are attached to the BNC INPUT connectors.

NOTE

To make removal of the Attenuator board assembly easier, the $.019 \mu\text{F}$ coupling capacitors should be completely removed.

8. Make a color-code wiring sketch of the eight wires that connect to the back side of the Attenuator board. Disconnect these wires from their pin connectors.

9. Remove the screws that hold the +INPUT and —INPUT Mode switches to the front sub panel.

10. Remove the $\frac{1}{16}$ -inch nuts from the +INPUT and —INPUT BNC connectors.

11. Remove the two screws at the rear end of the Attenuator board that fasten the Attenuator board assembly to the support bracket.

12. Lift the Attenuator board assembly (includes the electrical shield fastened to the board) out of the plug-in unit.

13. Replace the defective switch by replacing the complete board with switches attached. Be sure to save parts, such as the shield and switch lamp housings, that must be transferred to the new board. Reverse the order of the above procedure to re-install the Attenuator board assembly, front panel, knobs and other parts that have been removed.

NOTE

When replacing the Attenuator board assembly, first install the screws that hold the pushbuttons to the front sub panel. This ensures that the pushbuttons will be centered in their respective square holes to prevent rubbing or binding when they are operated.

BW or Polarity Switches. The procedure is as follows:

1. Perform steps 1 through 4 of the +INPUT Mode Switch replacement procedure.

2. Disconnect the multi-pin connectors from the switch circuit board.

3. Remove the front-panel screw that holds the switch and circuit board assembly.

4. Remove the switch with its circuit board.

5. Replace the switch and circuit board assembly.

6. To re-install the assembly, reverse the order of the above procedure.

COMPARISON VOLTAGE Switch. The following replacement procedure is suggested:

1. Perform steps 1 through 4 of the +INPUT Mode Switch replacement procedure.

2. Disconnect the multi-pin connector from the COMPARISON VOLTAGE switch assembly circuit board and disconnect the 4-pin connector from the Vc Polarity switch board.

3. Use Fig. 4-10 to check the color code of the switch wires where they connect to the pin connectors on the Output board. Make a note of any differences. Disconnect these wires.

4. Remove the two screws that hold the switch to the front sub panel.

5. Remove the switch complete with gear train and VOLTS Counter readout.

VOLTS/DIV Switch. Use the following removal information as a guide.

1. Set the PULL VAR FOR $\times 10$ Vc RANGE knob to its outward position. Remove the VOLTS/DIV and VARIABLE knobs.

2. Make a color code wiring sketch of the VOLTS/DIV switch wires. Unsolder the wires.

3. Loosen the three setscrews that hold the VARIABLE control shaft couplings to the VARIABLE control plastic extension shaft. (Do not loosen the setscrew in the plastic half coupling attached to the VARIABLE control drive shaft but do loosen the setscrew in the front half of this two-piece plastic coupling.)

4. Slide the front half of the plastic coupling forward.

5. Remove the plastic extension shaft with its couplings.

6. Loosen the four $\frac{3}{16}$ -inch nuts on the VOLTS/DIV switch that hold the rear end of the switch to the support bracket.

7. Remove the $\frac{7}{16}$ -inch front panel nut from the VOLTS/DIV switch.

8. Loosen the nuts on the PULL VAR FOR $\times 10$ RANGE slide switch until they are located near the end of their mounting studs. Lift the slide switch to allow removal of the slide switch coupling off the VARIABLE control metal extension shaft. Remove the slide switch coupling.

9. Loosen the setscrew in the VARIABLE control shaft collar. Slide the collar off the metal extension shaft.

10. Remove the two VARIABLE control extension shaft retaining rings located on each side of the rotary switch stop.

11. Remove the switch.

12. When replacing the switch, check that the plastic extension shaft extends about $\frac{1}{16}$ -inch into the plastic half coupling fastened to the VARIABLE control. This enables the shaft to slide smoothly into the coupling when the PULL VAR FOR $\times 10$ RANGE knob is pushed in.

Lamp Replacement

The following procedures describe replacement of the lamps used in this instrument.

UNCAL Lamp. Unsnap the plastic cap from the neon lamp holder. Unsolder the lamp from the cap and install the new lamp.

$R_{in} \simeq \infty$ or Vc Decimal Readout Lamps. Remove the two screws that hold the black plastic lamp cover in place. Remove the lamp cover. Partially remove the circuit board out of the instrument and disconnect the multi-pin connector. Replace the defective lamp.

Vc Polarity or BW Lamp. Remove the screw that holds the metal lamp cover in place. Remove the lamp cover. Replace the defective lamp.

+INPUT or -INPUT Mode Switch Lamp. Perform steps 1 through 12 of the +INPUT Mode Switch replacement procedure. Remove the screw that holds the metal lamp cover in place. Remove the lamp cover. Replace the defective lamp. Re-install the Attenuator board assembly, front

panel, knobs and other parts that have been removed. Be sure the pushbuttons work freely when re-installing the Attenuator board assembly.

TROUBLESHOOTING

Introduction

The following information is provided to facilitate troubleshooting of the Type 7A13. Information contained in other sections of this manual should be used along with the following information to aid in locating the defective component. An understanding of the circuit operation is very helpful in locating troubles. See the Circuit Description section for complete information.

General

If trouble occurs in the Type 7A13, the following procedure is recommended to accomplish rapid and effective repairs.

1. Check that the plug-in unit and the oscilloscope connectors are not damaged, and that the plug-in unit is properly inserted.

2. Inspect the front panel of the Type 7A13 and indicator oscilloscope to be sure that the trouble is not from an incorrect control setting.

3. Insure that the indicator oscilloscope is not at fault by inserting a known properly-operating plug-in unit and checking its operation.

4. Determine all trouble symptoms.

5. Perform a visual inspection of the Type 7A13.

6. Repair or replace obviously defective parts.

7. Troubleshoot the Type 7A13 as necessary.

8. Recalibrate the Type 7A13.

Indicator Oscilloscope

The quickest check of the indicator oscilloscope is to use it with a good plug-in unit, or check the questionable plug-in with another oscilloscope. Refer to the oscilloscope manual to verify proper operation of the oscilloscope.

Operating Procedures and Control Settings

Refer to the Operating Instructions Section to verify operating procedures and front panel control settings of the Type 7A13.

Trouble Symptoms

The Type 7A13 response to all front panel controls should be observed. The First-Time Operation in Section 2 or the Performance Check in Section 5 may be used for this purpose. All trouble symptoms should be evaluated and compared against each other. A circuit failure will often create a combination of symptoms that will enable the trouble to be isolated to a particular area.

Visual Inspection

In physically examining the Type 7A13, take special note of the area indicated by evaluation of symptoms. Look for loose or broken connections, improperly seated transistors and burned or otherwise damaged parts. Repair or replace all obviously defective components.

Calibration Check

Troubles can frequently be located and corrected by recalibrating the instrument. Unless the circuit failure has definitely been isolated to a specific circuit, it is recommended that the calibration procedure in Section 5 be performed to provide a logical circuit troubleshooting sequence.

DETAILED TROUBLESHOOTING

General

If the trouble has not been disclosed and corrected through the procedure outlined, a detailed troubleshooting analysis will have to be performed. The Circuit Description section, the Schematic Diagrams, and the troubleshooting aids contained in this section are designed to expedite troubleshooting.

The Circuit Description section provides a fundamental understanding of circuit operation and is referred to the Schematic Diagrams. The Schematic Diagrams contain voltage and resistance values and signal waveforms. The specified operating conditions should be duplicated before making voltage or waveform comparisons.

NOTE

Voltages and waveforms may vary slightly between instruments. Those given in the schematics should be checked against each instrument while it is operating properly. Deviations should be noted on the schematics for later reference.

Test Equipment Recommended for Troubleshooting

The test equipment listed here should suffice for most troubleshooting jobs. Test equipment required for calibration is listed in the Performance Check/Calibration section of this manual.

High Impedance Voltmeter (20,000 Ω /V DC or greater)

Ohmmeter (2 mA or less current on the $\times 1$ k Ω scale)

Test Oscilloscope and Probes

Plug-In Extender

Dynamic Transistor Tester

If the output DC balance is checked first and is in error, work toward the front until an unbalance no longer exists. This localizes the trouble to the circuitry between the points which are balanced and the points which are unbalanced. The individual components must then be checked.

Troubleshooting by Direct Replacement

Semi-conductor failures account for the majority of electronic equipment troubles. The ease of replacing transistors often makes substitution the most practical means of repair. If this method is used, these guide lines should be followed:

Determine that the circuit is safe for the substitute component.

Use only substitute components that are known to be good.

Remove the plug-in from the oscilloscope before substituting components, to protect both you and the equipment.

Be sure components are inserted properly. Use Fig. 4-2 as an aid.

Check operation after each component is replaced.

Return good components to their original sockets.

Check calibration after a bad component has been replaced (see Table 4-1).

Troubleshooting Aids

Diagrams. Circuit diagrams are shown on foldout pages in Section 8. The circuit number and electrical value of each component in this unit are indicated on the diagrams. Important voltages and waveforms are also shown.

Switch Wafer Identification. Wafers for the switches are coded on the schematic diagrams to indicate the physical location of the wafer on the actual switches. The number portion of the code refers to the wafer number on the switch assembly. Wafers are numbered from the first wafer located behind the detent section of the switch to the last wafer. The letters F and R indicate whether the front or rear of the wafer is used to perform the particular switching function. For example, 3F of the VOLTS/DIV switch indicates that this is the front side of the third wafer when counting back from the front panel.

Wiring Color Code. All insulated wires in the Type 7A13 are color coded to facilitate tracing the wire from one point to another.

Resistor Coding. The Type 7A13 uses a number of very stable metal film resistors usually identified by their gray or light blue background color and color coding.

If a metal-film resistor has three significant figures with a multiplier, the resistor will be EIA color coded according to the sequence illustrated in Fig. 4-3. If the resistor has four significant figures with a multiplier, the value will be printed on the resistor. For example, a 333 k Ω resistor will be color coded, but a 333.5 k Ω resistor will have its value printed on the resistor.

Circuit Board Illustrations. Fig. 4-6 through 4-11 show illustrations of the individual circuit boards, with the circuit numbers for each component identified on the board. In addition, the wiring color code to each pin connector is given. On the diagram the circuit board areas are outlined in blue as an aid to locating components that are associated with a board.

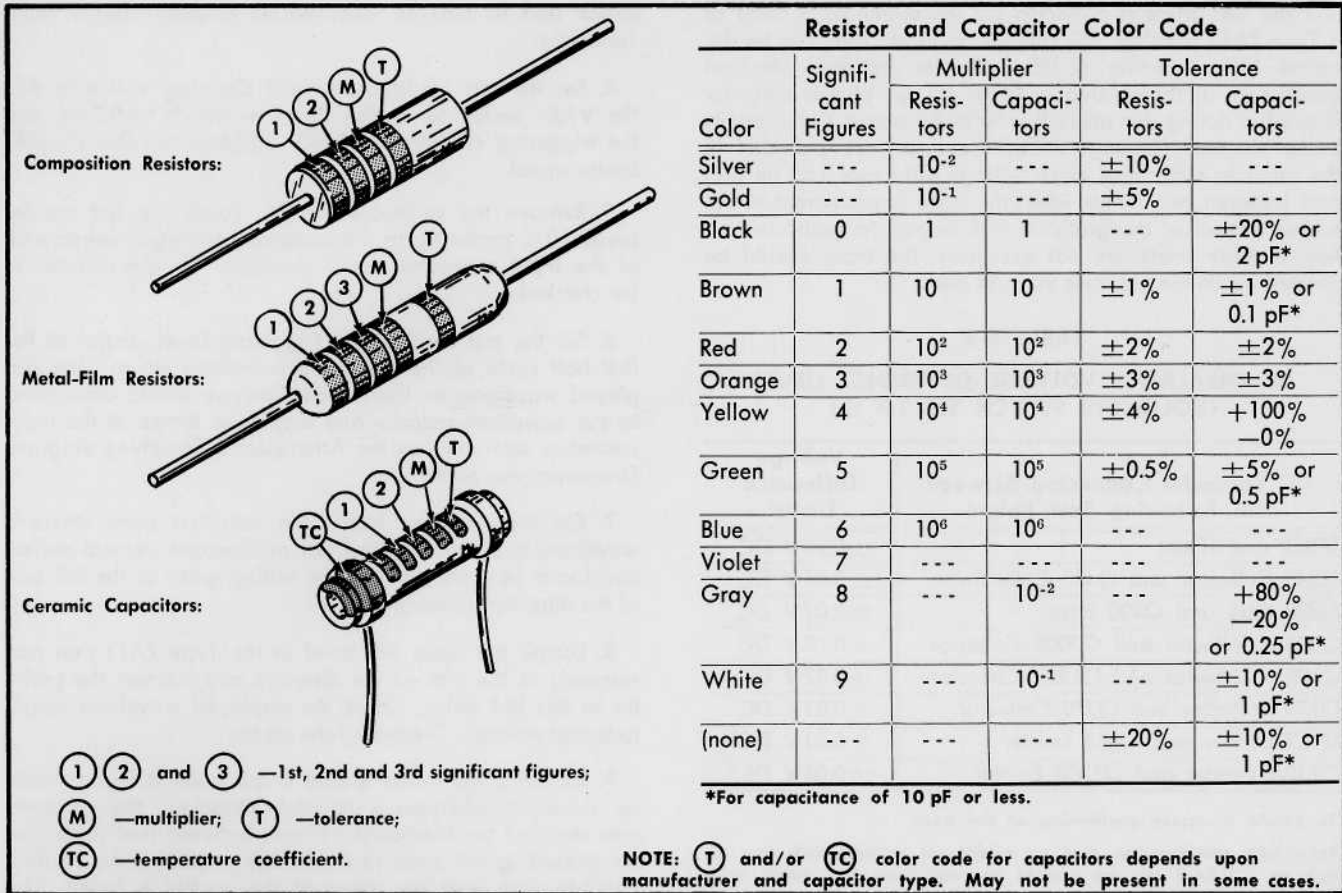

Fig. 4-3. Resistor and capacitor color code.

Troubleshooting Techniques

This troubleshooting procedure is arranged in an order which checks the simple trouble possibilities before proceeding with more detailed troubleshooting. The first few checks assure proper connection, operation and calibration. If the trouble is not located by these checks, the remaining steps aid in isolating the trouble to a particular circuit; then the circuit must be checked to locate the defect in the circuit. When the defect is located, the repair should be made using the information previously provided in the Corrective Maintenance portion of this section.

Check Front-Panel Control Settings. Incorrect control settings can indicate a trouble that does not exist. For example, an incorrect setting of the VARIABLE control appears as incorrect gain. If there is any question about the correct function or operation of any control, see the Operating Instructions section for the Type 7A13 or the associated oscilloscope.

Isolate Trouble to Type 7A13 or Oscilloscope. When following a troubleshooting procedure, it is assumed that the oscilloscope used with the Type 7A13 is operating normally. Since this is not always the case, check the operation of the oscilloscope before attempting to troubleshoot the Type 7A13.

Troubles occurring in the oscilloscope can usually be detected by substituting a normal operating plug-in unit for the Type 7A13. Then, a trouble such as a loss of the internal trigger signal, can be readily isolated to either the plug-in unit or the oscilloscope. If a substitute unit is not available, the trigger signal can be isolated by using another oscilloscope as a test oscilloscope for signal-tracing the Type 7A13.

NOTE

Be sure proper line voltage (that does not exceed harmonic distortion limits of the input power waveform) is applied to the oscilloscope used with the Type 7A13. This assures that the oscilloscope low-voltage power supplies will regulate properly.

Isolating DC Imbalance. A properly operating oscilloscope will have its trace centered vertically on the CRT only when the Type 7A13 has a balanced output. The Type 7A13 is a balanced amplifier when the POSITION control is set to midrange and all the DC balance controls are properly adjusted. With no signal or comparison voltage applied to the FET gates (Q120, Q220), any point in the + Input side of the circuit should have a potential essentially equal (except for a minor voltage difference occurring in the Input Amplifier stages) to that at an identical point in the - Input side of the circuit.

Maintenance—Type 7A13

If the CRT trace is deflected off the screen as a result of a Type 7A13 problem, DC unbalances exist. They can be detected by connecting a DC voltmeter between identical points such as those listed in Table 4-2. (A plug-in extender is needed during this procedure to allow access to the points being checked.) Voltage difference limits are provided in the table to show how much voltage difference can be present between two points when the trace is positioned to the top or bottom of the graticule with respect to graticule center. If these limits are not exceeded, the trace should be present within the graticule viewing area.

TABLE 4-2
DC IMBALANCE VOLTAGE DIFFERENCE LIMITS
(VOLTS/DIV SWITCH SET TO .1)

DC Voltmeter Connected Between the Following Test Points	Voltage Difference Limits ¹
TP360 and TP460	± 0.20 V DC
Q340 Collector and Q440 Collector	± 0.07 V DC
Q330 Base and Q430 Base	± 0.02 V DC
Q300A Collector and Q300B Collector	± 0.10 V DC
Q195A Collector and Q195B Collector	± 0.02 V DC
Q170 Collector and Q270 Collector	± 0.03 V DC
Q152 Emitter and Q252 Emitter	± 0.03 V DC ²
Q130A Emitter and Q130B Emitter	± 0.04 V DC ²

¹To obtain on-screen positioning of the trace.

²Take into consideration that an additional voltage difference as high as ± 0.04 V can be present between these two points in a normal operating plug-in unit.

As a suggested procedure, check the output DC balance first. If it is in error, work toward the input stages until an unbalance no longer is detected. This localizes the trouble to the circuitry between the points providing balance and those providing unbalance.

Signal Tracing. A method is described here for checking waveform amplitude and polarity at the test point shown on the Attenuator & Switching, Input Amplifier and Output Amplifier schematic diagrams. The technique is based on using a plug-in extender to operate the Type 7A13 outside the oscilloscope plug-in compartment. The plug-in extender permits access to the circuits in the Type 7A13 for detailed signal tracing and troubleshooting.

After the faulty stage is located and the trouble found and corrected, then it is easy to remove the extender, insert the plug-in in the oscilloscope and go directly to the Performance Check/Calibration procedure in Section 5 to check frequency compensation and other performance requirements.

To signal trace the Type 7A13 amplifier stages, proceed as follows:

1. Connect a plug-in extender between the Type 7A13 and the indicator oscilloscope.
2. Set the front-panel controls of the Type 7A13 to the same positions as listed in the IMPORTANT note located on the inside portion of the Block Diagram pull-out page.
3. Apply a 4 V peak to peak calibrator signal through a T connector and coaxial cables to the Type 7A13 Input con-

ductor and to the test oscilloscope external Trigger Input connector.

4. Set the test oscilloscope Input Coupling switch to AC, the V/div switch to .1, the Time/cm switch to 0.2 ms, and the triggering controls for +EXT triggering on the 4 V calibrator signal.

5. Remove the attenuator shield. Touch the test oscilloscope 10 \times probe tip to the soldered connection (wired end) of the Input connector center conductor for the channel to be checked.

6. Set the test oscilloscope Triggering Level control so the first half cycle of the waveform is positive going. The displayed waveform on the test oscilloscope should correspond to the waveform polarity and amplitude shown at the Input connector test point on the Attenuator & Switching diagram. Disconnect the probe.

7. On the diagram, locate the next test point where a waveform is shown. Set the test oscilloscope vertical deflection factor to correspond to the setting given at the left side of the diagram waveform.

8. Locate the same test point in the Type 7A13 that corresponds to the one on the diagram and connect the probe tip to this test point. Check the displayed waveform amplitude and polarity. Disconnect the probe.

9. Repeat steps 7 and 8 until a test point is found where an abnormal indication is definitely obtained. Then proceed with detailed troubleshooting checks between that stage and the preceding test point to isolate the trouble to the smallest possible area until the cause of the trouble is found. Detailed checks consist of signal tracing the circuits between the test points to determine where the signal becomes abnormal. Then voltage checks may have to be made; semiconductors and other components may have to be substituted.

Component Checks

Transistors (excluding FET's). The best means of checking a transistor is by using a transistor curve display instrument such as the Tektronix Type 576. If a transistor checker is not readily available, a defective transistor can be located by signal tracing, by making in-circuit voltage checks, by measuring the transistor resistances or by the substitution method previously described.

When troubleshooting using a voltmeter, measure the emitter-to-base and emitter-to-collector voltages to determine whether the voltages are consistent with normal circuit voltages. Voltages across a transistor vary with the device and its circuit function. Some of these voltages are predictable. A silicon transistor will normally be 0.6 V. The collector-emitter voltage will vary with the circuit and circuit conditions, but it should always exceed 0.5 V. The best way of checking these devices is by connecting a voltmeter across the junction and using a sensitive voltmeter setting (see Fig. 4-4).

An ohmmeter can be used to check a transistor if the ohmmeter's voltage source and current are kept within safe limits. 1.5 V and 2 mA are generally acceptable. Selecting the $\times 1$ k Ω scale on most ohmmeters will provide voltage and current below these values.

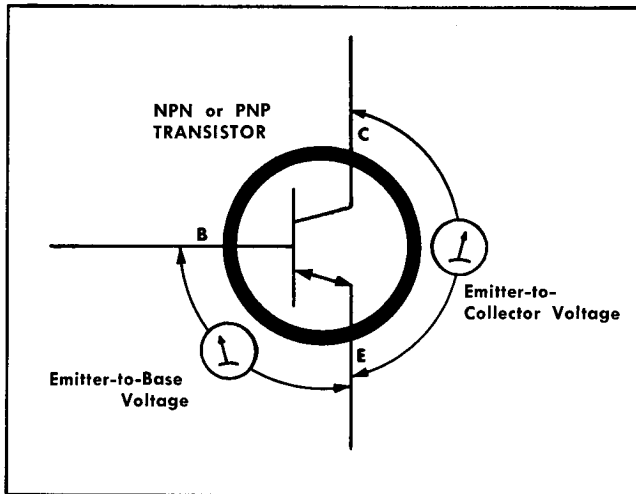

Fig. 4-4. Measuring transistor voltages.

Table 4-3 contains the normal values of resistance to expect when making an ohmmeter check of an otherwise unconnected transistor.

TABLE 4-3

²TRANSISTOR RESISTANCE CHECKS

Ohmmeter Connections	Resistance Reading That Can be Expected Using the R X 1 k Range
Emitter-Collector	High readings both ways
Emitter-Base	High reading one way, low reading the other way
Base-Collector	High reading one way, low reading the other way

²Test prods from the ohmmeter are first connected to the transistor leads and then the test lead connections are reversed. Thus, the effects of the polarity reversal of the voltage applied from the ohmmeter to the transistor can be observed.

Field Effect Transistor Checks. Field Effect Transistors (FET's) can be checked in the same manner as other transistors. However, it should be noted that normal operation in the Type 7A13 has the gate-to-source junction reverse biased just as the control grid-to-cathode is biased in vacuum tubes.

Diodes. Diodes may be checked in much the same manner as transistors by resistance checks. The resistance should be high in one direction and low in the other. Again, care must be taken not to exceed the voltage and current limits.

Some diodes used in the 7A13 are color coded to identify the diode type. The cathode end of each glass-encased diode is indicated by a stripe, a series of stripes or a dot. For most diodes with a series of stripes, the first stripe (either pink or blue) indicates a Tektronix part and the next three stripes indicate the three significant figures of the Tektronix Part Number. Example: a diode color coded blue-brown-gray-

green indicates a diode with Tektronix Part No. 152-0185-00. The cathode and anode of a metal-encased diode can be identified by the diode symbol marked on the body. See Fig. 4-5, Diode Polarity and Color Code.

Resistors. Resistors can be checked with an ohmmeter. Check the Electrical Parts List for the tolerance of the resistors used in this unit. Resistors normally do not need to be replaced unless the measured value is in excess of the specified tolerance.

Capacitors. A leaky or shorted capacitor can be detected by unsoldering one end of the capacitor and then checking resistance with an ohmmeter, using the highest scale that does not exceed the voltage rating of the capacitor. The resistance reading should be high after the initial charge of the capacitor. An open capacitor can be detected with a capacitance meter or by checking whether the capacitor passes AC signals.

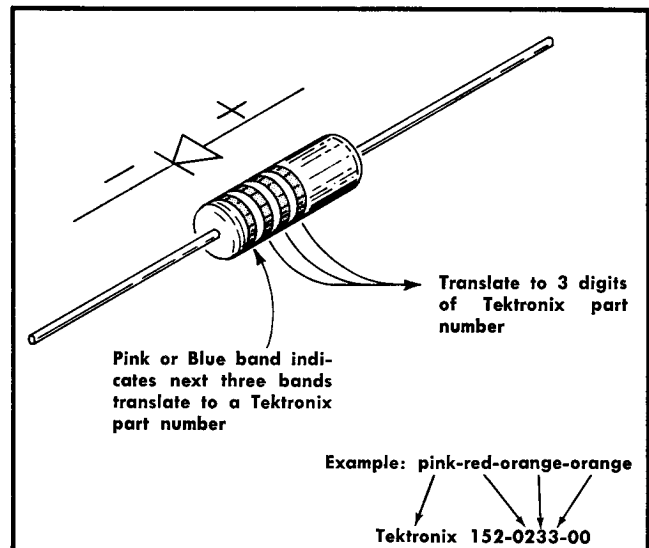

Fig 4-5. Diode polarity and color code.

INSTRUMENT REPACKAGING

If the Type 7A13 is to be shipped for long distances by commercial means of transportation, it is recommended that the instrument be repackaged in the original manner for maximum protection. The original shipping carton can be saved and used for this purpose. Repackaging information and/or new shipping cartons can be obtained from Tektronix, Inc. Contact your local Tektronix Field Office or representative.

NOTE

The plug-ins should not be shipped installed in an oscilloscope. The oscilloscope packaging material is not designed to protect the plug-ins.

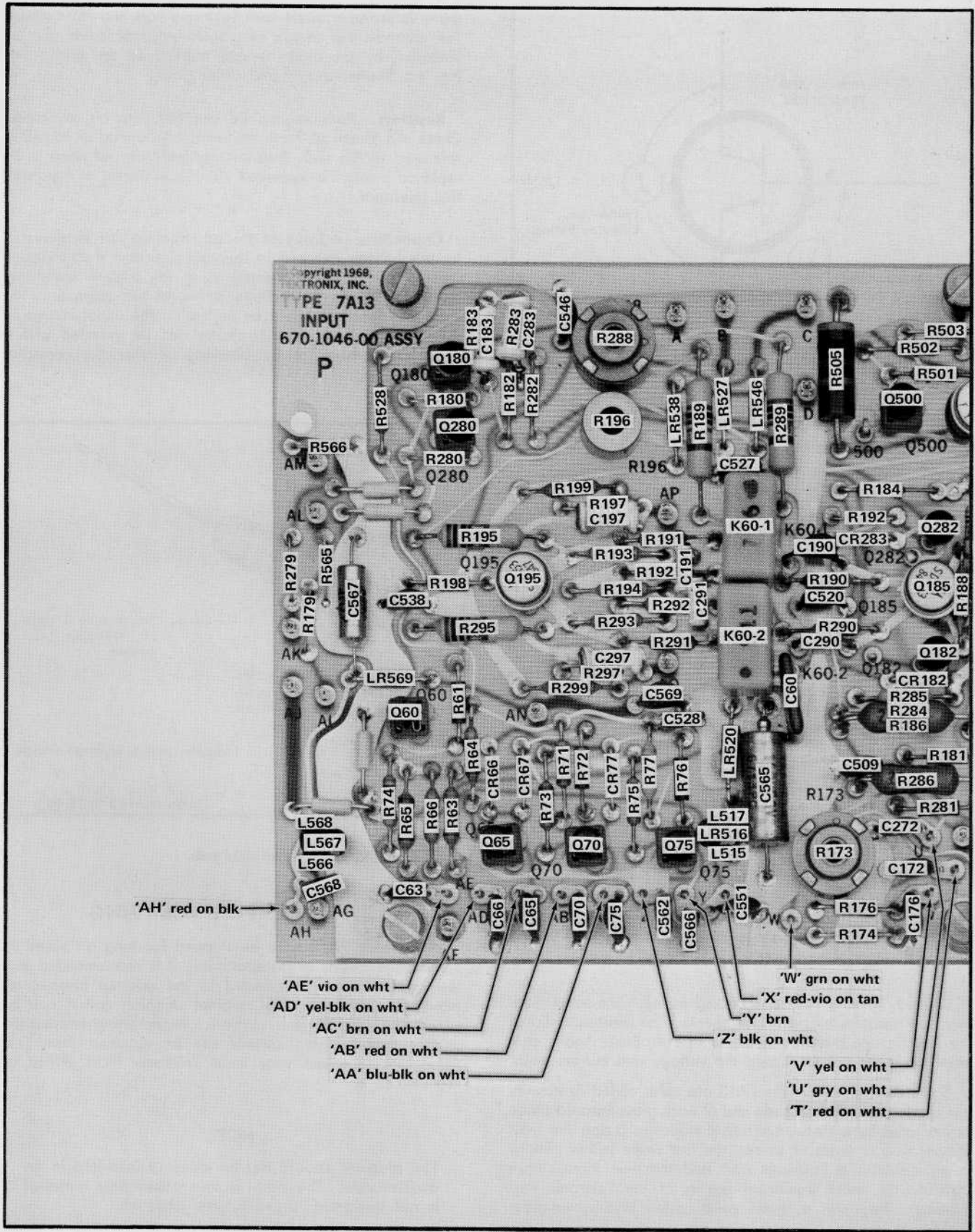
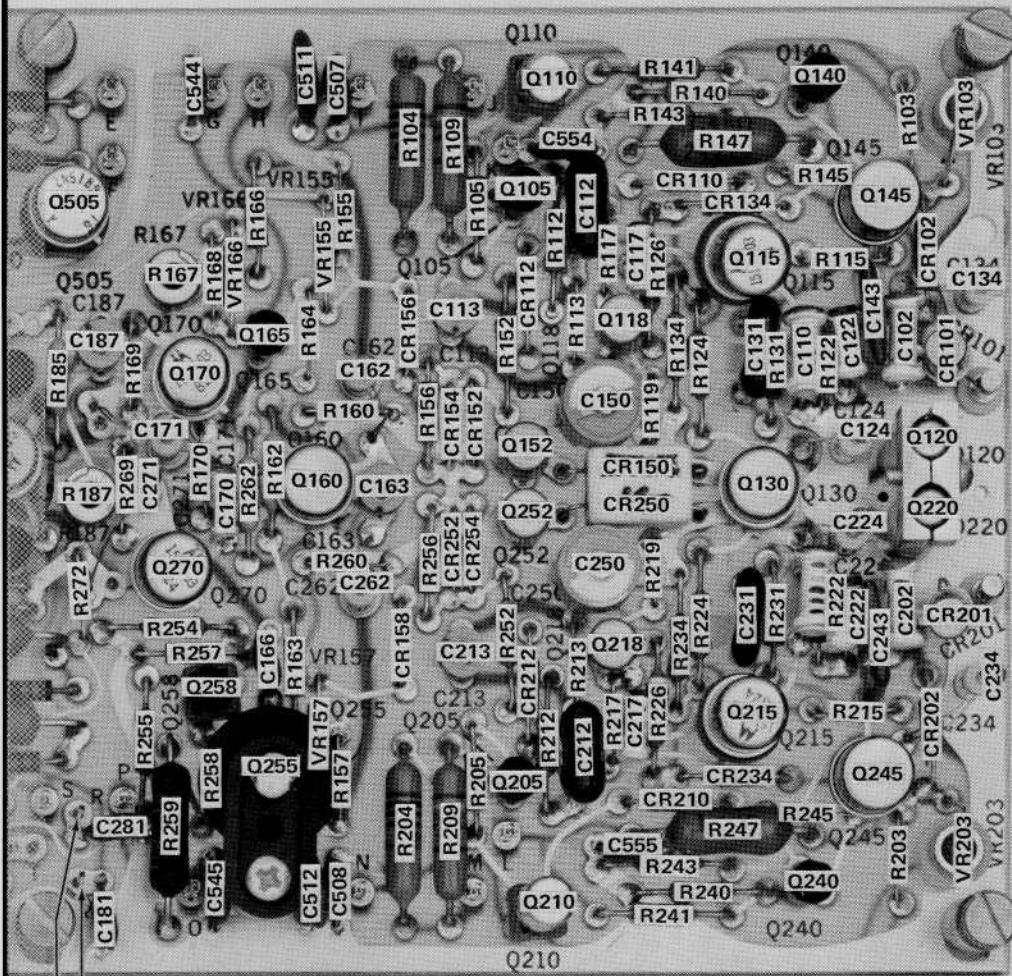

Fig. 4-6. Partial Input Amplifier board showing component locations and wire color code.



'Q' orn on wht
'R' blu on wht

Fig. 4-7. Partial Input Amplifier board showing component locations and wire color code.

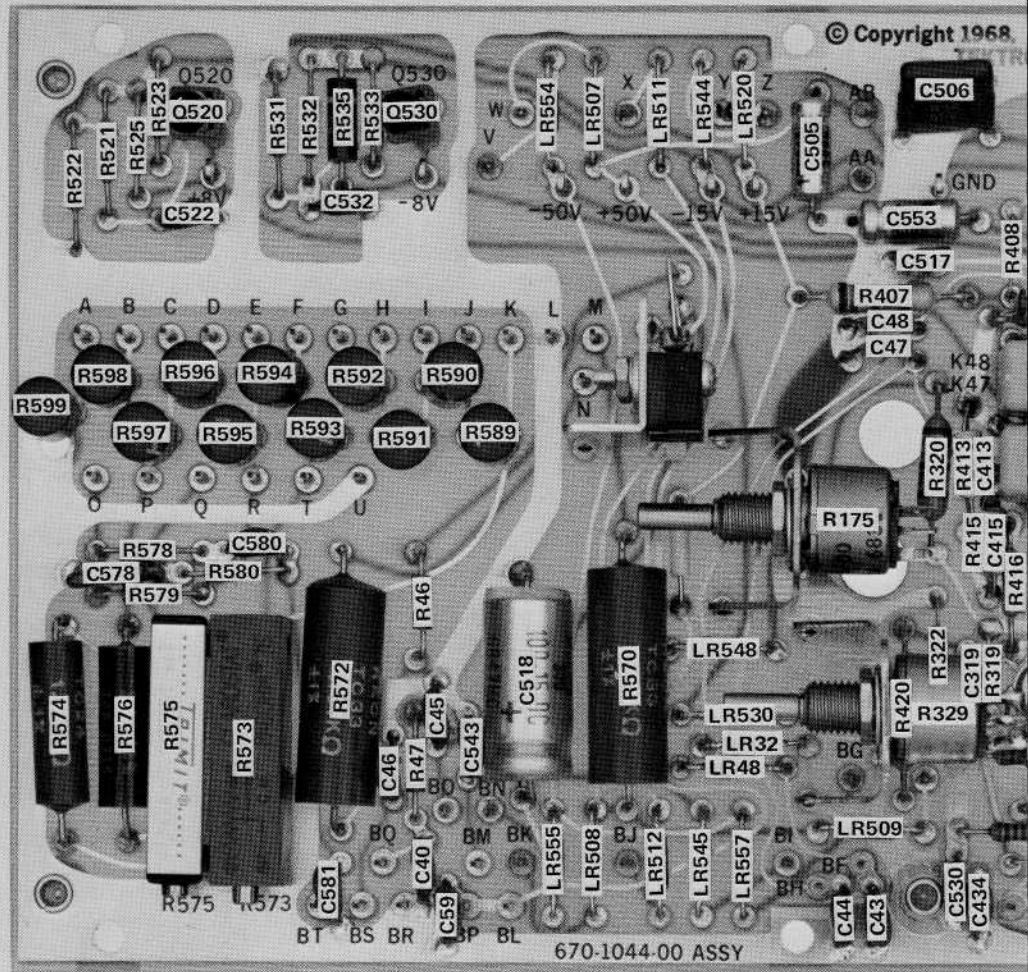

Fig. 4-8. Partial Output Amplifier board showing component locations.

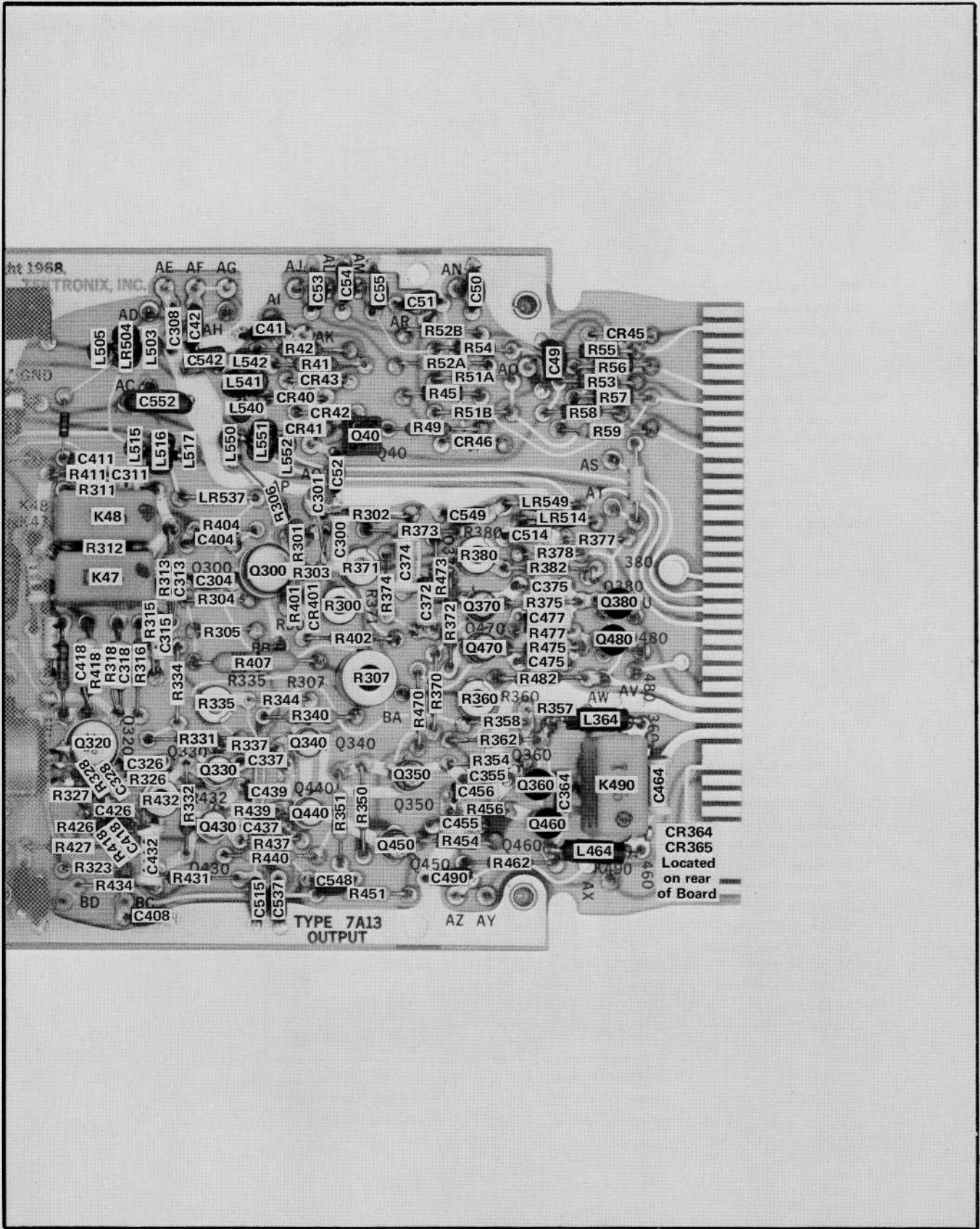

Fig. 4-9. Partial Output Amplifier board showing component locations.

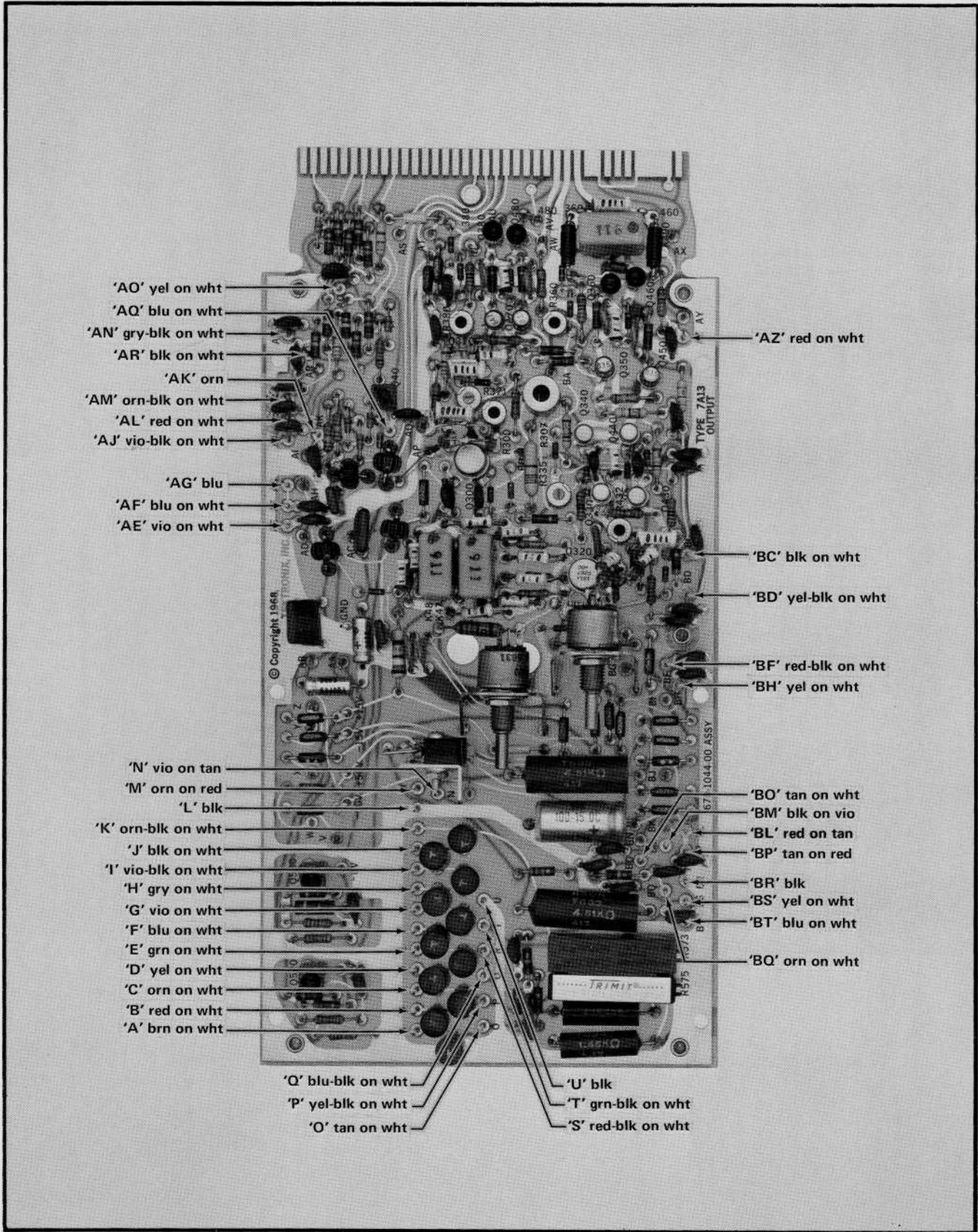

Fig. 4-10. Output Amplifier board showing wire color code.

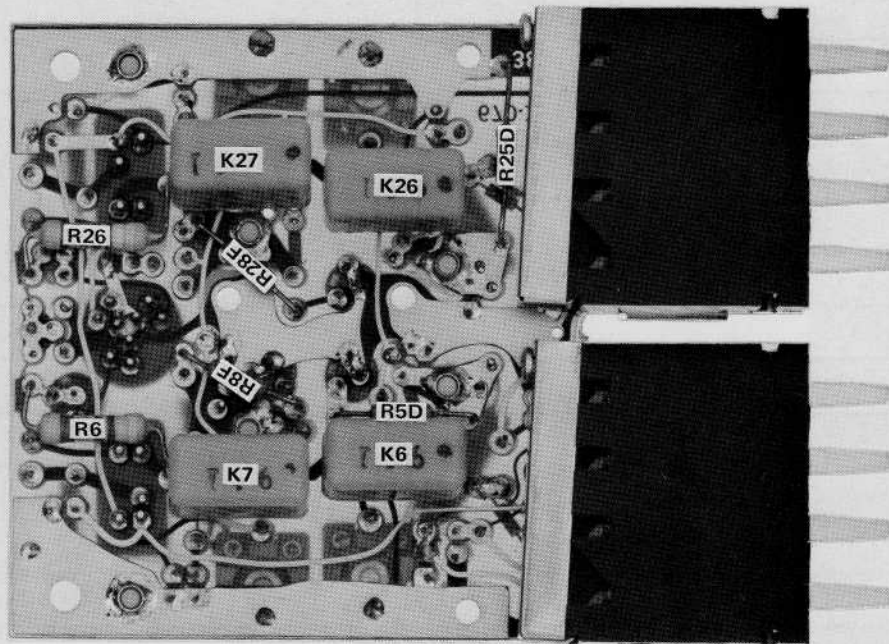
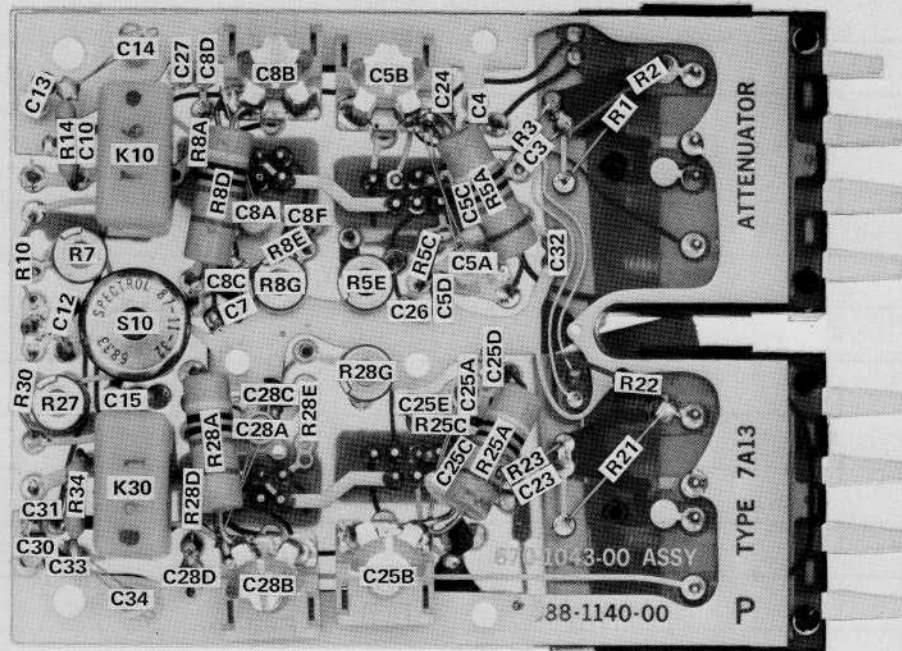

Fig.4-11. Attenuator board showing component locations.

SECTION 5

PERFORMANCE CHECK / CALIBRATION

Change information, if any, affecting this section will be found at the rear of the manual.

Introduction

To assure instrument accuracy, check the calibration of the Type 7A13 every 1000 hours or every six months if used infrequently. Before calibration, thoroughly clean and inspect this unit as outlined in the Maintenance section.

The Performance Check/Calibration Procedure can be used to check instrument performance without removing the side covers or making internal adjustments by performing everything except the ADJUST part of the steps. Screw-driver adjustments which are accessible without removing the covers are adjusted as part of the performance check procedure. Steps 1 through 7, and 12 through 16, are calibration Procedure Only steps and therefore should be excluded when making a performance check.

Completion of each step in the complete Performance Check/Calibration Procedure insures that this instrument meets the electrical specifications given in Section 1. For best overall instrument performance when performing a complete calibration procedure, make each adjustment to the exact setting even if the CHECK is within the allowable tolerance.

A Short-Form Procedure is given prior to the complete procedure. To facilitate instrument calibration for the experienced calibrator, the Short-Form Procedure lists the calibration adjustment necessary for each step and the applicable tolerances. This procedure also includes the step number and title as listed in the complete Performance Check/Calibration Procedure and the page number on which each step begins. Therefore, the Short-Form Procedure can be used as an index to locate a step in the complete procedure. This procedure may be reproduced and used as a permanent record of instrument calibration.

NOTE

All waveforms shown in this procedure were taken with a Tektronix Oscilloscope Camera System using a projected graticule. Limits, tolerances and waveforms in this procedure are given as calibration guides and should not be interpreted as instrument specifications except as stated in Section 1.

A partial calibration is often desirable after replacing a component, or to touch up an adjustment of a particular circuit between major recalibrations. For partial calibration, set the controls as given under Preliminary Procedure and start with the nearest test equipment picture preceding the desired check or checks. If any controls need to be changed

from the preliminary settings for this portion of the calibration procedure, they are listed under "Control Settings" near the equipment-required picture. To prevent unnecessary recalibration of other parts of the instrument, re-adjust only if the tolerance given in the CHECK part of the step is not met. If readjustment is necessary, also check the calibration of any steps listed in the INTERACTION part of the step.

TEST EQUIPMENT REQUIRED

General

The following test equipment and accessories, or equivalent, are required for a complete performance check or calibration of the Type 7A13. Specifications given are the minimum necessary for accurate performance of this instrument. All test equipment is assumed to be correctly calibrated and operating within the given specifications. If equipment is substituted, it must meet or exceed the specifications of the recommended equipment.

For the quickest and most accurate calibration or performance check, special Tektronix calibration fixtures are used where necessary. These special calibration fixtures are available from Tektronix, Inc. Order by description and part number through your local Tektronix Field Office or representative.

NOTE

For performance check, the following items are not needed: Items 9, 12, 17, 18, 26, 28, 30 and 31.

Test Equipment (including calibration fixtures, accessories and tools)

(1) Tektronix 7700 Series Oscilloscope with a 7B series Time Base plug-in unit and a polarized viewer or viewing hood. This procedure assumes the indicator oscilloscope and the time-base unit are calibrated.

A Type 7704 Oscilloscope with a Type 7B70 Time-Base unit was used when preparing this procedure. The indicator oscilloscope 4-mV calibrator signal, having an amplitude tolerance of 1%, is used to set the gain in step 8. If greater accuracy is needed, use a 5-mV P-P signal from a standard amplitude calibrator (Tektronix calibration fixture No. 067-

Performance Check/Calibration—Type 7A13

0502-00) having an amplitude accuracy of 0.25% as the signal source. Set the GAIN control for 5 divisions of deflection.

(2) Square-Wave Generator. Required characteristics: Output repetition rate of 100 Hz to 1 kHz, 10 kHz and 100 kHz. Output impedance of 600 ohms or less. Risetime, 20 ns or faster from high-amplitude output; 1 ns or faster from fast-rise output. High-amplitude output: Variable from 0.5 V to 12 V into a 50-ohm load, about 7 V to 120 V unterminated. Fast-rise output: Variable from 50 mV to 500 mV into a 50-ohm load. Tektronix Type 106 Square-Wave Generator recommended.

(3) Constant Amplitude Sine-Wave Generator. Required characteristics: Output frequencies of 3 MHz and 95 MHz to 125 MHz. Output amplitude, 800 mV into a 50-ohm load. Amplitude accuracy, within $\pm 3\%$ in the 95-to-125 MHz range using the amplitude at 3 MHz for reference. Tektronix Constant Amplitude Signal Generator, 067-0532-00 Calibration Fixture, recommended.

(4) Constant Amplitude Sine-Wave Generator. Required characteristics: Output frequencies of 50 kHz, 1 MHz, 5 MHz, 10 MHz and 20 MHz. Output amplitude, 80 mV into a 50-ohm load at 50 kHz and 5 MHz; up to 2 volts (unterminated) for the other frequencies. Amplitude accuracy, within $\pm 2\%$ at 5 MHz when using the amplitude at 50 kHz as a reference. Tektronix Type 191 Constant Amplitude Signal Generator recommended.

(5) Low-Frequency Sine-Wave Generator. Required characteristics: Output frequencies of 10 kHz and 100 kHz. Output amplitude, more than 20 volts at 10 kHz; 20 volts at 100 kHz.

General Radio Type 1310-A Oscillator, with a specified amplitude of 20 volts or more, was used for this procedure. This particular oscillator had an output of 50 volts peak-to-peak at 10 kHz. Use a generator that can provide this amplitude when performing step 22.

(6) Pulse Generator. Required characteristics: Risetime, 250 picoseconds or less. Amplitude, adjustable from 80 mV to 40 V into a 50-ohm load. Repetition rate, preset between 500 p/s and 720 p/s. Pulse duration, 3.45 ns and approximately 130 ns, when measured at the 50% amplitude level, items 14 and 15 are used as charge lines. Tektronix Type 109 Pulse Generator recommended.

(7) Precision DC Voltmeter. Required characteristics: Non-loading type. Range, 100 mV to 10 volts. Accuracy, 0.02% or better. John Fluke Differential Voltmeter, Model 825A, was used in this procedure.

(8) DC Voltmeter (VOM). Required characteristics: Sensitivity of 20,000 Ω/V DC. Low range, 0 to 3 V or less. Used for setting amplifier DC balance to zero volt. For example, Triplett Model 630 NA with test leads.

(9) Precision DC Divider. Required characteristics: Attenuation, 10 \times and 100 \times . Accuracy, $\pm 0.01\%$.

(10) Input RC Normalizer. Required characteristics: RC = 1 megohm \times 20 pF. Equipped with BNC connectors. Tektronix Part No. 067-0066-00.

(11) Overdrive Recovery Test Fixture. Required characteristics: Reed switch with drive coil for switching 15 volts externally applied. Tektronix Part No. 067-0608-00 Overdrive Recovery test fixture recommended.

(12) Plug-In Extender. For Tektronix Type 7000 series instruments. Tektronix Part No. 067-0589-00.

(13) Long charge line. Required characteristics: Length, 60 ns. Impedance, 50 ohms, $\pm 1\%$. Cable quality, approximately 1.5-dB loss per 100 feet at 1000 MHz; risetime approximately 0.1 ns. Equipped with GR connectors. Tektronix Type 113 Delay Cable for use as a charge line recommended.

(14) Short charge line (Optional). Length, 3.45 ns (double-transit time, see description that follows). Impedance, 50 ohms. GR connector on one end; other end is open. The length of this charge line was obtained by connecting a 2-ns, Type RG58C/U, 50-ohm cable, Tektronix Part No. 017-0505-00, to the Type 109 and using a Tektronix Type 561B/3T2/3S2/S-1 Sampling Oscilloscope to measure the pulse width at the 50% amplitude level. Then, the cable was cut off at the free end until it was the right length to produce a 3.45-ns pulse width display, measured at the 50% amplitude level, on the sampling oscilloscope CRT. Overall length of the charge line used in this procedure was 14- $\frac{1}{8}$ inches. (This length does not apply to all cables because cable length is dependent on cable and generator characteristics.) Use of this charge line is a practical method for measuring risetime more accurately. This charge line is not needed if the conventional method of measuring risetime from the 10% to 90% points is used. However, when the conventional method is used, sweep-timing accuracy, orthogonality, and geometry in the measurement area on the CRT must be taken into consideration.

(15) Coaxial cables (two). Impedance, 50 ohms; length, 5 ns; Type RG213/U; GR connectors. Tektronix Part No. 017-0502-00. Supplied with items 2, 4 and 6.

(16) Coaxial cable. Impedance, 50 ohms; length, 42 inches; BNC connectors. Tektronix Part No. 012-0057-01.

(17) Patch cord. 6 inches long, with a BNC plug and jack on one end and a banana plug and jack on the other end. Red, order Tektronix Part No. 012-0089-00. Black, order Tektronix Part No. 012-0088-00.

(18) Patch cords (two). 6 inches long, with banana plug and jack connectors on each end. Red, order Tektronix Part No. 012-0029-00. Black, order Tektronix Part No. 012-0028-00. Attach one insulated alligator clip (not supplied) to one end of patch cord.

(19) Patch cord. 5 inches long. Consists of a probe ground lead (Tektronix Part No. 175-0124-00) and a probe spring tip (Tektronix Part No. 206-0060-00).

(20) Termination. Impedance, 50 ohms; GR to BNC male; Accuracy, $\pm 1\%$, Tektronix Part No. 017-0083-00. Supplied with items 2 and 4.

(21) $10\times$ attenuators (two). Impedance, 50 ohms; accuracy, $\pm 1\%$ into 50 ohms; GR connectors. Tektronix Part No. 017-0078-00.

(22) $5\times$ attenuator. Impedance, 50 ohms; accuracy, $\pm 1\%$ into 50 ohms; GR connectors. Tektronix Part No. 017-0079-00.

(23) GR-to-BNC male adapter. Tektronix Part No. 017-0064-00.

(24) GR-to-BNC female adapter. Tektronix Part No. 017-0063-00.

(25) Adapter. Dual binding post to BNC male. Tektronix Part No. 103-0035-00.

(26) Adapter. BNC female to clip leads. Tektronix Part No. 013-0076-00.

(27) Flexible T connector. Provides matched signal transfer to both inputs. Tektronix Part No. 067-0525-00.

(28) Resistor. Fixed, 1 megohm, $\frac{1}{2}$ or $\frac{1}{4}$ W, 1% . Tektronix Part No. 323-0481-00 for a $\frac{1}{2}$ -W resistor.

(29) Screwdriver. Three-inch shaft; $\frac{3}{32}$ -inch wide bit for slotted screws. Tektronix Part No. 003-0192-00.

(30) Low-capacitance screwdriver. Rod, all plastic, 5 inches long; has screwdriver tip on one end. Tektronix Part No. 003-0301-00.

(31) Alignment tool. Consists of the following:

Description	Tektronix Part No.
(A) Handle	003-0307-00
(B) Nylon insert with recessed wire pin	003-0308-00
(C) Nylon insert with metal screwdriver tip	003-0334-00

SHORT-FORM PERFORMANCE CHECK/CALIBRATION PROCEDURE

This short-form procedure is provided to aid in checking the performance or calibration of the Type 7A13. It may be used as a guide by the experienced operator or calibrator, or it may be reproduced and used as a permanent record of calibration.

Since the step numbers and titles used here correspond to those used in the complete procedure, this procedure also serves as an index to locate a step in the complete procedure.

Performance requirements that are listed after the word "Requirement" correspond to those given in Section 1. The tolerances, when given after the word "Check", are given as a guide to check the Type 7A13 for correct operation and are not instrument specifications.

Type 7A13, Serial No. _____

Calibration Date _____

Calibrated by _____

DC and GAIN ADJUSTMENTS

- 1. Check/Adjust Position Center (R335) and DC Balance (R173) Page 5-7
Check: Trace positioned within ± 1 division of graticule center and no trace shift as VARIABLE (VOLTS/DIV) control is rotated.
- 2. Check/Adjust $\times 10$ DC Balance (R288) Page 5-8
Check: No trace shift as VARIABLE knob is pulled to its outward position.
- 3. Check/Adjust Step Attenuator DC Balance Page 5-8
Check: No trace shift as VOLTS/DIV switch is set to each position.
Interaction: Repeat step 2.
- 4. Check/Adjust Position Center (R335 final adjustment) Page 5-8
Check: Voltmeter reading of 0 volts between TP360 and TP460.
- 5. Check/Adjust Trigger DC Balance (R371) Page 5-9
Check: Voltmeter reading of 0 volts between TP380 and TP480.
Interaction: Repeat step 4 and then step 5.
- 6. Check/Adjust Signal Output DC Level (R360) Page 5-9
Check: Voltmeter reading of 0 volts between TP360 and chassis ground.
- 7. Check/Adjust Trigger Output DC Level (R380) Page 5-9
Check: Voltmeter reading of 0 volts between TP380 and ground.
- 8. Check/Adjust Gain (R329 front panel) Page 5-9
Requirement: Four divisions vertical deflection at 1 mV/div with 4-mV peak-to-peak 1-kHz square-wave input.
- 9. Check Gate Current Page 5-9
Requirement: Trace shift should not exceed 0.2 division (0.2 mV or 0.2 nA) as the + or - INPUT Mode switch is set from GND to AC. A 50-ohm termination is connected to the input being checked. Check both inputs.

PRELIMINARY COMPARISON VOLTAGE CHECK & THERMAL COMPENSATION ADJUSTMENT

- 10. Check Comparison Voltage Page 5-10
Check: With 10 volts applied from the Type 7A13 Vc OUT 0-10 V jack to the +INPUT connector trace deflection should be 5 divisions within ± 0.5 division when the VOLTS/DIV switch is set to 2 V and the +INPUT switch is set to DC.

Performance Check/Calibration—Type 7A13

11. Check/Adjust Common Mode Thermal Compensation (R167) Page 5-10

Check: With 10 volts applied to the Type 7A13 input circuit via the Vc position of the + or —INPUT MODE switch the trace should return quickly (within one second or less) to graticule center within 0.5 division or less when the appropriate INPUT Mode switch is set to GND. Check both inputs.

INPUT RESISTANCE & DC ATTENUATION RATIO ADJUSTMENTS

12. Check/Adjust +INPUT 10× DC Attenuator Ratio (R8G) Page 5-11

Check: Trace shift should not exceed ± 0.3 division. See procedure for details.

13. Check/Adjust +INPUT 1× DC Input Resistance (R7) Page 5-12

Check: For a null indication with 5 mV on the voltmeter. See procedure for details.

Interaction: Repeat step 12.

14. Check/Adjust +INPUT 100× DC Attenuation Ratio (R5E) Page 5-13

Check: Trace shift should not exceed ± 0.3 division. See procedure for details.

15. Check/Adjust —INPUT 10× Attenuation Ratio (R28G) Page 5-13

Check: Trace shift should not exceed ± 0.3 division. See procedure for details.

16. Check/Adjust —INPUT 1× DC Input Resistance (R27) Page 5-14

Check: For a null indication within 5 mV on the voltmeter. See procedure for details.

Interaction: Repeat step 15.

HIGH-FREQUENCY COMPENSATION ADJUSTMENTS

17. Check/Adjust High-Frequency Compensation (R196, R432, R300, C187, R187, C163, C113, C150, C250, C213; both inputs) Page 5-15

Requirement: System risetime of 3.5 nanosecond or less for all VOLTS/DIV switch positions. Check both inputs.

Check: System aberrations using Table 5-3 in the procedure as a guide. Check both inputs.

ATTENUATOR COMPENSATION ADJUSTMENTS

18. Check/Adjust +INPUT Attenuator Compensation (C14, C8A, C8B, C5A, C5B) Page 5-20

Check: Optimum square corner and flat top within $\pm 1\%$ or ± 0.06 division for a 6-division peak-to-peak display. Refer to Table 5-5.

19. Check/Adjust —INPUT Attenuator Compensation (C34, C28A, C28B, C25A, C25B) Page 5-23

Check: Optimum square corner and flat top within $\pm 1\%$ or ± 0.06 division for a 6-division peak-to-peak display. Refer to Table 5-6.

COMMON MODE ADJUSTMENTS

20. Check/Adjust Amplifier High-Frequency Common-Mode Rejection (C171, C271, C162, C262, C124, C224, C134, C234 and, if necessary, readjust R167) Page 5-25

Requirement: With the VOLTS/DIV switch set at 1 mV, check the common mode difference signal peak-to-peak amplitude using the sequence provided in the following chart.

Sine-Wave Input Signal	Requirement	
	P-P Display Amplitude	CMRR
10 MHz, 1 V	1 mV or less	1,000:1
1 MHz, 10 V	1 mV or less	10,000:1
20 MHz, 1 V	4 mV or less	250:1
5 MHz, 2 V	1 mV or less	2,000:1
100 kHz, 20 V	1 mV or less	20,000:1

Interaction: Repeat step 17 and then step 20.

21. Check/Adjust Attenuator Common Mode Rejection at 100 Hz (R28G, R5E) Page 5-27

Requirement: With a 100-Hz 50-volt square-wave signal applied, peak-to-peak display amplitude should be 0.25 division (25 mV) or less with VOLTS/DIV switch set to .1 V; $\frac{1}{8}$ of a minor division (25 mV) or less with VOLTS/DIV switch set to 1 V. This is equivalent to a CMRR of 2,000:1.

22. Check/Adjust Attenuator Common Mode Rejection at 10 kHz (C28A, C25A) Page 5-28

Requirement: With a 10-kHz 50-volt sine-wave signal applied, peak-to-peak display amplitude should be 0.25 division (25 mV) or less with VOLTS/DIV switch set to .1 V; $\frac{1}{8}$ of a minor division (25 mV) or less with VOLTS/DIV switch set to 1 V. This is equivalent to a CMRR of 2,000:1.

TRIGGER & SIGNAL AMPLIFIER RESPONSE CHECKS

(including a trigger gain check)

23. Check Trigger Amplifier Gain and Step Response Page 5-28

Check: Using the 6-division signal amplifier waveform as a reference, the trigger waveform display should be within 15% (± 0.9 division) of the signal waveform.

Check: System risetime, with the trigger amplifier connected into the system, should be about 0.1 of a nanosecond slower than the risetime obtained when the signal amplifier is connected into the system.

Check: System aberration, with the trigger amplifier connected into the system, should be no greater than +4%, -4%, or a total that does not exceed 6% peak to peak.

24. Check Trigger Amplifier High-Frequency Sine Wave Response Page 5-30

Check: High-Frequency response should not be more than -3 dB at 100 MHz.

25. Check Signal Amplifier High-Frequency Response Page 5-31

Requirement: High frequency response should be not more than -3 dB at 100 MHz.

26. Check Signal Amplifier 5-MHz Bandwidth Sine Wave Response Page 5-31

Requirement: Upper frequency response limit should be -3 dB at 5 MHz within 500 kHz.

COMPARISON VOLTAGE ADJUSTMENTS

27. Check/Adjust 10-Volt Calibration (R573) Page 5-32

Requirement: Null readings at +10 volts and -10 volts within a tolerance of ± 0.015 V; equivalent to $\pm (0.1\%$ of 10 volts plus 5 mV).

28. Check/Adjust 1-Volt Calibration (R575) Page 5-33

Requirement: Null readings at +1 volt and -1 volt within a tolerance of ± 0.006 V.

Interaction: Repeat step 27 and then step 28.

29. Check Comparison Voltage Linearity Page 5-33

Requirement: Measure the voltages at the Vc OUT 0-10 V jack and compare these voltages to the VOLTS Counter indication. Tolerance is $\pm (0.1\%$ of VOLTS Counter indication plus 5 mV). Refer to Table 5-8.

30. Check Volts Counter Mechanical Backlash Page 5-33

Check: One digit or less; see procedure for details.

31. Check Electrical Zero Page 5-34

Requirement: Compare Vc electrical zero to ground reference. Trace shift should be 0.5 mV (0.5 division) or less with the VOLTS/DIV switch set to 1 mV.

NOISE & OVERDRIVE RECOVERY CHECKS

32. Check Noise Page 5-35

Requirement: 400 μ V or less at 1 mV/div tangentially measured.

33. Check Overdrive Recovery Time Page 5-36

Requirement: Trace returns to within 2 divisions (2 mV) of graticule center within a recovery time of 1 microsecond after the removal of a +10-volt or -10-volt pulse; trace returns within 0.5 division (0.5 mV) of graticule center within a recovery time of 0.1 millisecond. Check both inputs.

PERFORMANCE CHECK/CALIBRATION PROCEDURE

General

The following procedure is arranged in a sequence which allows the Type 7A13 to be calibrated with the least interaction of adjustments and reconnection of equipment. The steps in which adjustments are made are identified by the symbol **①** following the title. Instrument performance is checked in the "CHECK" part of the step before an adjustment is made. The "ADJUST" part of the step identifies the point where the actual adjustment is made. This portion of the step is printed in red. Steps listed in the "INTERACTION" part of the step may be affected by the adjustment just performed. This information is particularly helpful when only a partial calibration procedure is performed.

NOTE

To prevent recalibration of other parts of the instrument when performing a partial calibration, readjust only if the tolerances given in the "CHECK" part of the step are not met. However, when performing a complete calibration, best overall performance is obtained if each adjustment is made to the exact setting even if the "CHECK" is within the allowable tolerance.

In the following procedure, a test-equipment setup picture is shown for each major group of checks and adjustments. Each step continues from the equipment setup and control settings used in the preceding step(s) unless otherwise noted. If only a partial calibration or performance check is performed, start with the test equipment setup preceding the desired portion. External controls or adjustments of the Type 7A13 referred to in this procedure are capitalized (e.g. POSITION). Internal adjustment names are initially capitalized only (e.g. Position Center).

All waveforms shown in this procedure are actual waveform photographs taken with a Tektronix Oscilloscope Camera System and Projected Graticule. The following procedure uses the equipment listed under Test Equipment Required. If equipment is substituted, control settings or test equipment setup may need to be altered to meet the requirements of the equipment used. Detailed operating instructions for the test equipment are not given in this procedure. If in doubt as to the correct operation of any of the test equipment, refer to the instruction manual for that unit.

Performance Check/Calibration—Type 7A13

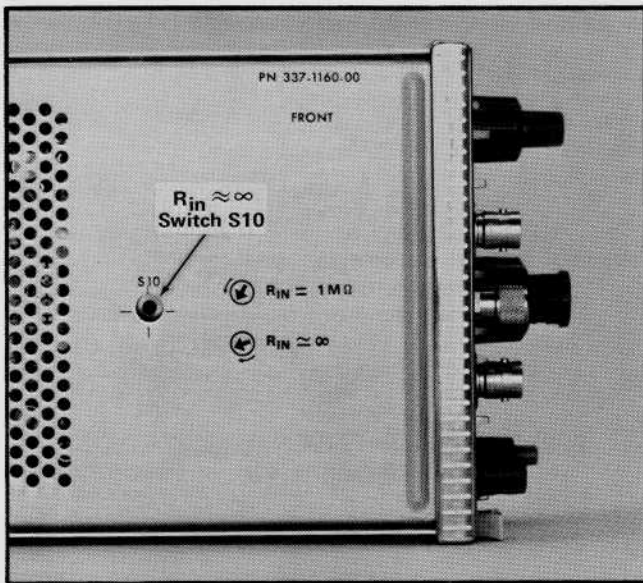

Fig. 5-1. Location of the $R_{in} \approx \infty$ switch S10 on the Attenuator board.

NOTE

It is assumed that performance is checked within a temperature range of 0°C to $+50^\circ\text{C}$ and calibration at $+25^\circ\text{C}$, $\pm 5^\circ\text{C}$. The tolerances given in this procedure are for this temperature range. However, if the procedure is performed at some other temperature, check to the applicable tolerances for that temperature range.

PRELIMINARY PROCEDURE

1. Set the Type 7A13 $R_{in} \approx \infty$ switch, S10 (see Fig. 5-1), to the $R_{in} = 1\text{M}\Omega$ (counterclockwise) position.
2. (Performance Check only.) Insert the Type 7A13 directly into the Left Vert plug-in compartment of the indicator oscilloscope.
3. (Calibration Procedure only.) Remove the left side panel and bottom cover from the indicator oscilloscope. Remove the side covers from the Type 7A13. Insert the Plug-In Extender between the Type 7A13 and the connector in the Left Vert plug-in compartment of the indicator oscilloscope.
4. Insert the time-base unit into the B Horiz plug-in compartment of the indicator oscilloscope.
5. Connect the oscilloscope power cord to the design center operating voltage for which the oscilloscope is wired.
6. Turn on the oscilloscope Power switch. Allow at least 20 minutes warmup before checking the system to the given accuracy. Preset the various front-panel controls to the settings given in the list that follows. This list is also used as a

reference for setting the controls when performing a partial Performance Check/Calibration procedure. Hence, the power and $R_{in} \approx \infty$ control settings are included even though these controls have already been preset in steps 1 and 6 of this Preliminary Procedure.

Indicator Oscilloscope

B Intensity Focus	Set for well-defined trace and normal brightness (after plug-in units are installed and power is turned on).
Calibrator	4 mV
Rate (Calibrator)	1 kHz
Vertical Mode	Left
Horizontal Mode	B
B Trigger Source	Left Vert
Power	On (see Preliminary Procedure, step 6)

Controls not listed are considered less important and can be set as desired for performing the procedure.

Time Base Plug-In

Triggering	
Level/Slope	Positive slope region
Mode	P-P Auto
Coupling	AC
Source	Int
Position	Set so that the trace starts at left side of graticule
Magnifier	$\times 1$
Time/Div	0.5 ms
Variable (Time/Div)	Pushed in
Display Mode	Time Base

Type 7A13

COMPARISON VOLTAGE (V_c)

Polarity	Pushbuttons canceled
VOLTS Counter (Digits set by V_c Selector switch and FINE control)	0.000
+INPUT Mode	GND
-INPUT Mode	GND
VOLTS/DIV	10 mV
VARIABLE (VOLTS/DIV)	CAL (clockwise, in detent)
PULL VAR FOR $\times 10$	Pushed in
V_c RANGE	
VAR BAL	Midrange
BW	5 MHz
POSITION	Midrange
$R_{in} \approx \infty$ (internal switch, S10, see Fig. 5-1)	$R_{in} = \approx 1\text{M}\Omega$ (see Preliminary Procedure, step 1)

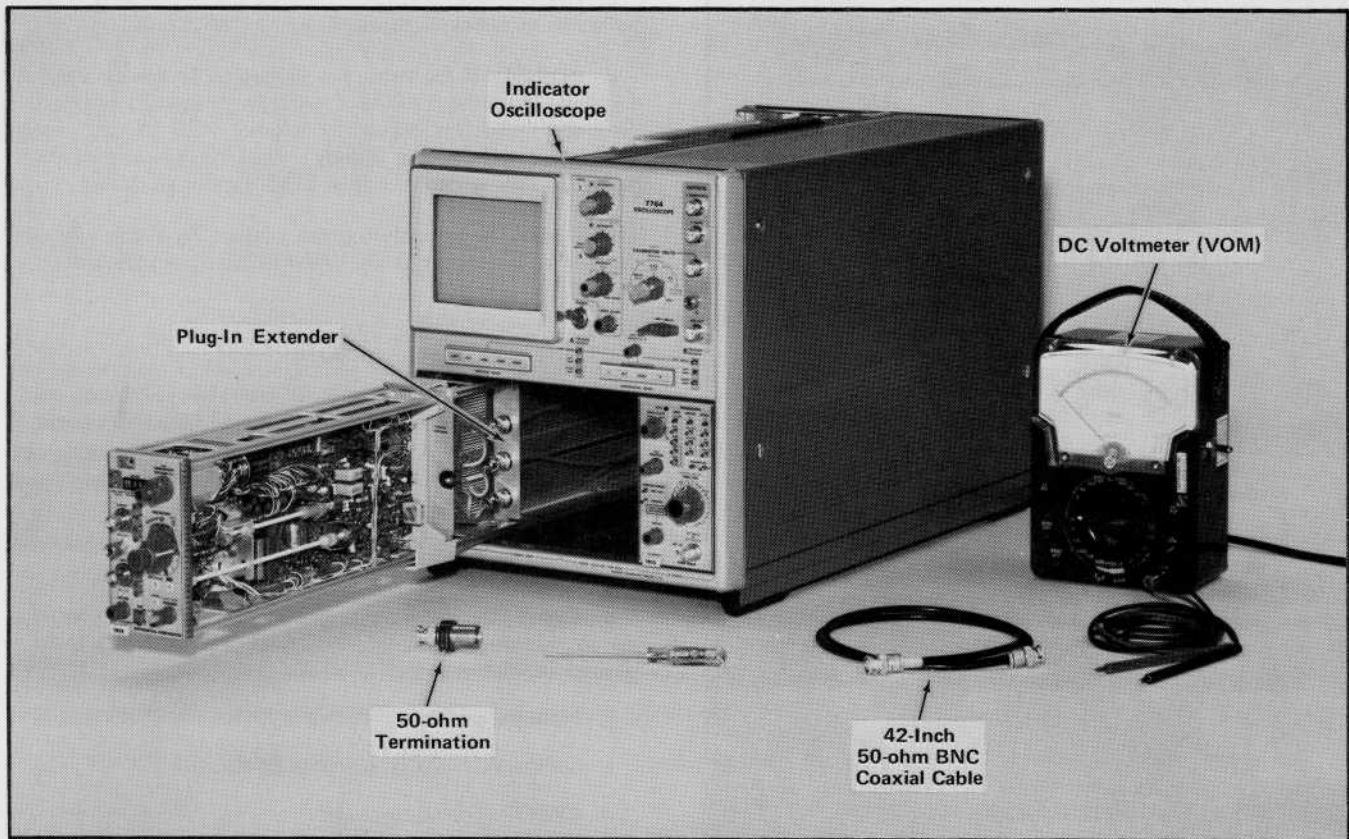

Fig. 5-2. Equipment required when using steps 1 through 9 as a calibration procedure. (The performance check begins with step 8. See text.)

DC AND GAIN ADJUSTMENTS

NOTE

(Performance Check Only)

Steps 1 through 7 are Calibration Procedure Only steps. For a performance check procedure, go to Section 2, Operating Instructions, page 2-3, and perform the Front Panel Adjustments procedure for the VAR BAL, $\times 10$ BAL and STEP ATTEN BAL adjustments. Then start with step 8 (Check/Adjust Gain) in this Performance Check/Calibration procedure to continue checking the performance of the Type 7A13.

1. Check/Adjust Position Center and DC Balance ①

- a. Test equipment setup is shown in Fig. 5-2.
- b. Check that the controls are set as given in the Preliminary Procedure. In addition, preset the Type 7A13 $\times 10$ BAL and STEP ATTEN BAL front panel adjustments to the center of their range.
- c. CHECK—For trace positioned within ± 1 division of graticule center.

d. ADJUST—If trace does not appear on the screen or within ± 1 division of graticule center, adjust the Position Center control R335 (see Fig. 5-3A) to position the trace to graticule center.

NOTE

This is a preliminary adjustment. It is not necessary that the trace appear exactly at graticule center at this time. Final adjustment for R335 occurs in step 4. Leave the front panel POSITION control at mid-range until step 7 has been completed.

e. Rotate the VARIABLE (VOLTS/DIV) control past the detent to its fully counterclockwise position. Note the position of the trace.

f. CHECK—For no trace shift.

g. ADJUST—If the trace shifts as the VARIABLE (VOLTS/DIV) control is rotated, note the direction of the shift. Return the control to its CAL (clockwise, in detent) position. If the trace shift is up, adjust the DC Bal control R173 (see Fig. 5-3B) slightly in a counterclockwise direction until the trace is positioned slightly above the location noted in step 1e. If the shift is down, adjust R173 slightly in a clockwise direction to position the trace slightly below the location noted in step 1e.

h. Repeat the procedure in this step until the trace does not shift as the VARIABLE (VOLTS/DIV) control is rotated back and forth throughout its range of rotation.

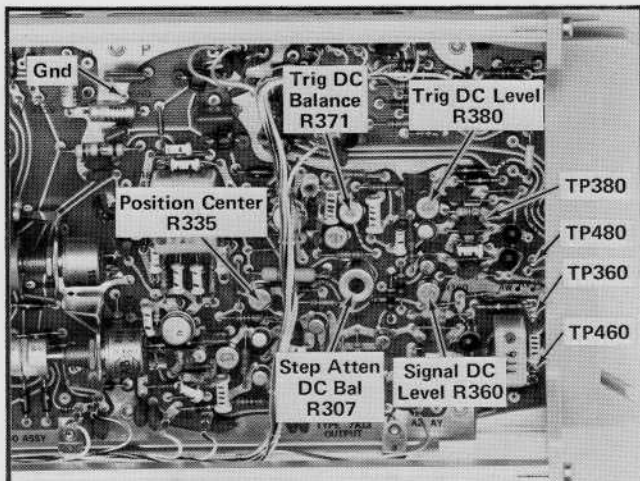

(A) Partial view of Output board.

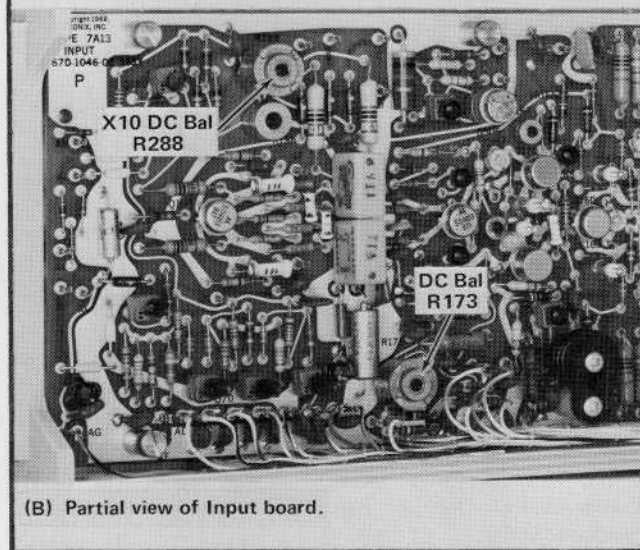

(B) Partial view of Input board.

Fig. 5-3. Adjustments and test point locations used when following the DC and Gain Adjustments procedure.

i. CHECK—As a final check, set the VOLTS/DIV switch to 1 mV. Repeat steps 1e through 1h until there is no trace shift.

NOTE

During the DC Bal adjustment R173 procedure (steps 1e through 1i), it may be necessary to readjust the Position Center control R335 to return the trace to graticule center. Do not use the POSITION control. Instead, use the Position Center control R335 for this purpose.

2. Check/Adjust $\times 10$ DC Balance ①

- a. Set the VOLTS/DIV switch to 10 mV.
- b. Check that the VARIABLE control is set to the CAL position. Pull the VARIABLE (VOLTS/DIV) knob outward to the $\times 10$ Vc position.

c. CHECK—For no trace shift as the VARIABLE knob is pulled to its outward position.

d. ADJUST—If the trace has shifted, note the direction of the shift. Push the VARIABLE knob to its inward position. If the trace shift is up, adjust the internal $\times 10$ DC Bal control R288 (see Fig. 5-3B) in a slightly counterclockwise direction. If the trace shift is down, adjust R288 slightly clockwise.

e. Repeat the procedure given in steps 2b through 2d until there is no trace shift as the VARIABLE knob is pulled out and pushed in.

NOTE

When performing step 2, it may be necessary to readjust the Position Center control R335 to center the trace on the CRT screen.

3. Check/Adjust Step Attenuator DC Balance ①

a. Check that the front panel STEP ATTEN BAL control is set to midrange and the VARIABLE (VOLTS/DIV) knob is pushed in.

b. Note the position of the trace.

c. Set the VOLTS/DIV switch to 50 mV.

d. CHECK—For no trace shift.

e. If the trace shifts, note the direction of the shift and return the VOLTS/DIV switch to the 10 mV position.

f. ADJUST—If the trace shifted up, adjust the internal Step Atten DC Bal control R307 (see Fig. 5-3A) slightly clockwise. If the trace shifted down, adjust R307 slightly counterclockwise.

g. Repeat the procedure in this step until the trace does not shift in any position of the VOLTS/DIV switch; particularly, for any position from 10 mV to 5 V.

If trace shift is noted when setting the VOLTS/DIV switch to the 1, 2, and 5 mV positions, recheck the internal $\times 10$ DC Bal adjustment R288 as described in step 2. Repeat steps 1 through 3, as necessary, to obtain proper DC balance.

4. Check/Adjust Position Center (Final Adjustment) ①

a. Set the VOLTS/DIV switch to 10 mV.

b. Check that the front panel POSITION control is set to midrange.

c. Adjust the internal Position Center control R335 so that the trace coincides with the graticule centerline.

d. Connect a DC voltmeter (VOM), set to its lowest voltage range, from TP360 to TP460 (see Fig. 5-3A). These test points are connected to the Type 7A13 signal output.

e. CHECK—For a voltmeter reading of 0 volts.

f. ADJUST—To obtain a 0-volt reading, readjust the internal Position Center control R335. This is the final adjustment for R335.

g. Disconnect the voltmeter.

5. Check/Adjust Trigger DC Balance ①

a. Connect the DC voltmeter (VOM), set to its lowest voltage range, from TP380 to TP480 (see Fig. 5-3A). These test points are connected to the Type 7A13 trigger output.

b. CHECK—For a voltmeter reading of 0 volts.

c. ADJUST—To obtain a 0-volt reading, adjust the Trig DC Balance control R371 (see Fig. 5-3A).

d. Disconnect the voltmeter.

e. INTERACTION—Repeat steps 4 and 5 as often as necessary to obtain a 0-volt reading at the signal and the trigger output test points.

6. Check/Adjust Signal Output DC Level ①

a. With the DC Voltmeter (VOM) set to its lowest voltage range, connect the voltmeter from TP360 to chassis ground. TP360 (see Fig. 5-3A) is the signal output test point. For a chassis ground connection, use the test point located at the upper center portion of the Output board (see Fig. 5-3A).

b. CHECK—For a voltmeter reading of 0 volts.

c. ADJUST—To obtain a 0-volt reading, adjust the Signal DC Level control R360 (see Fig. 5-3A).

d. Disconnect the voltmeter.

e. INTERACTION: Repeat step 4.

7. Check/Adjust Trigger Output DC Level ①

a. With the DC voltmeter (VOM) set to its lowest voltage range, connect the voltmeter between TP380 (trigger output test point) and ground. Use the ground test point located in the upper center area of the Output board (see Fig. 5-3A).

b. CHECK—For a voltmeter reading of 0 volts.

c. ADJUST—To obtain a 0-volt reading, adjust the Trig DC Level control R380.

d. Disconnect the voltmeter.

e. INTERACTION: Repeat step 5.

8. Check/Adjust Gain ①

a. Apply the 4-mV peak-to-peak square wave from the indicator oscilloscope Cal output connector through a 50-ohm coaxial cable to the Type 7A13 +INPUT connector.

b. Set the Type 7A13 controls as follows:

+INPUT Mode	DC
VOLTS/DIV	1 mV
POSITION	Center the display

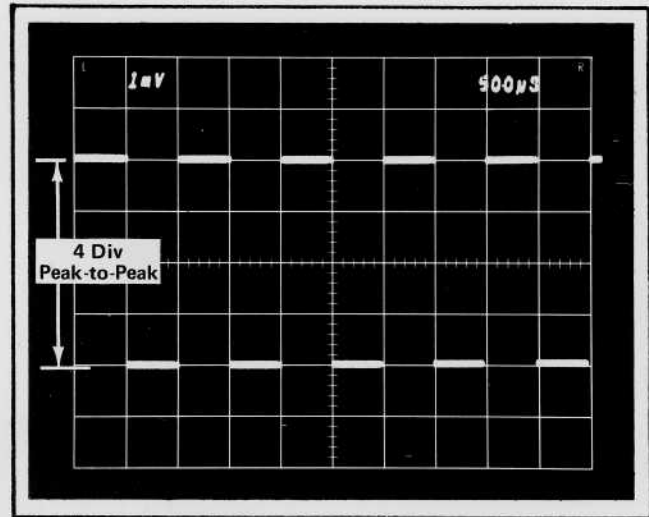

Fig. 5-4. Waveform display obtained showing correct vertical gain at 1 mV/div. Sweep rate: 0.5 ms/div.

c. CHECK—CRT display for exactly 4 divisions of vertical deflection (see Fig. 5-4).

d. ADJUST—The front panel GAIN control (R329) for exactly 4 divisions of vertical deflection.

NOTE

Performance Check: Since the Gain adjustment is an external control, this control may be adjusted as part of the performance check.

e. Disconnect the calibrator signal.

9. Check Gate Current

a. Connect a 50 ohm termination to the +INPUT connector.

b. Set the VOLTS/DIV switch to 1 mV.

c. Check that the +INPUT and -INPUT Mode switches are set to GND.

d. Using the POSITION control, position the trace to coincide with the graticule centerline.

e. Set the +INPUT switch to AC.

f. CHECK—Amount of trace deflection should not exceed 0.2 division (0.2 mV). This is equivalent to 0.2 nA or less ($0.2 \text{ mV} \div 1 \text{ M}\Omega = 0.2 \text{ nA}$).

g. Move the 50 ohm termination from the +INPUT connector to the -INPUT connector.

h. Set the +INPUT Mode switch to GND and check that the trace is centered.

i. Set the -INPUT Mode switch to AC.

j. CHECK—Amount of trace deflection should not exceed 0.2 division.

k. Remove the 50 ohm termination.

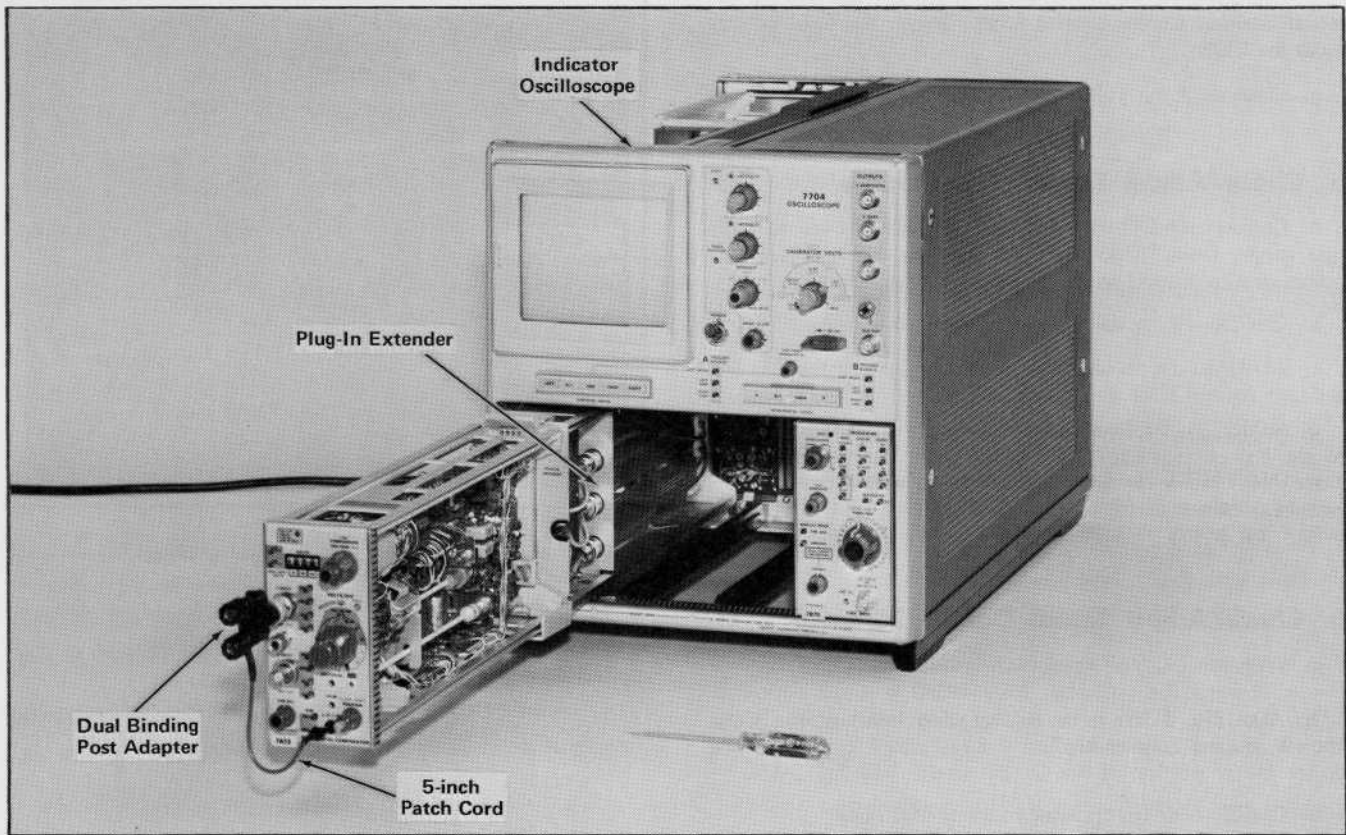

Fig. 5-5. Initial setup showing equipment required for performing steps 10 and 11. For a performance check the Plug-In Extender is not needed.

PRELIMINARY COMPARISON VOLTAGE CHECK & THERMAL COMPENSATION ADJUSTMENT

Control Settings

When performing a complete procedure, change the following control settings and proceed with step 10.

Type 7A13

—INPUT Mode	GND
VOLTS/DIV	2 V
VOLTS Counter	999.9 plus 1 digit to obtain a 900.0 reading and provide 10 volts at the Vc OUT 0-10 V jack.

If the remaining controls need to be checked for proper settings or if step 10 is being used as a starting point for partially calibrating the Type 7A13, refer to the Preliminary Procedure.

10. Check Comparison Voltage

a. Test equipment setup, with connections made at completion of step 10c, is shown in Fig. 5-5.

b. Connect a dual binding post to the +INPUT connector.

c. Connect 5-inch patch cord from the red binding post on the adapter to the Vc OUT 0-10 V jack.

d. Using the Type 7A13 POSITION control, position the trace 3 divisions below graticule center.

e. Depress the +Polarity pushbutton and set the +INPUT Mode switch to DC.

f. CHECK—That the trace is deflected 5 divisions from its original position within a tolerance of ± 0.5 division.

NOTE

This is a quick check to be sure that 10 volts will be available for use in performing step 11. The tolerance is given as a guide to check for correct instrument operation and is not an instrument specification.

g. Set the +INPUT Mode switch to GND.

h. Disconnect the patch cord and the dual binding post adapter.

11. Check/Adjust Common Mode Thermal Compensation

a. Set the VOLTS/DIV switch to 1 mV. Check that the VOLTS Counter is set to read 9.999 plus 1 digit (9.000 or equivalent to a Vc output of 10 V).

b. Using the POSITION control, position the trace to coincide with the graticule centerline.

c. Set the +INPUT Mode switch to Vc.

d. CHECK—Set the +INPUT Mode switch to GND and observe that the trace returns quickly (within one second or less) to graticule center within a tolerance of 0.5 mV (0.5 div) or less.

NOTE

The tolerances given in the CHECK and ADJUST procedures for step 11 are guides to check the instrument for correct operation and are not instrument specifications.

e. ADJUST—If tolerance is exceeded, adjust the Common Mode Bal control R167 (see Fig. 5-6) for quickest return of trace (with minimum final trace drift) to within 0.5 mV from graticule center.

f. Depress the —Polarity pushbutton and set the +INPUT Mode switch to Vc.

g. CHECK—Set the +INPUT Mode switch to GND and observe that the trace returns quickly (as described in step 12d) to graticule center within a tolerance of 0.5 mV or less.

h. ADJUST—If tolerance is exceeded, readjust the Common Mode Bal control R167.

NOTE

It may be necessary to compromise this adjustment setting when performing steps 11b through 11h. The trace should return quickly to its original position within a tolerance of 0.5 mV or less with the Polarity pushbuttons in the + or — positions. This is a preliminary adjustment procedure. Final adjustment of R167 occurs in step 20.

i. Check that the +INPUT Mode switch is set to GND.

j. CHECK—Using step 11b through 11d and steps 11f through 11g as a guide, check the —INPUT circuit of the Type 7A13. The trace should return quickly to graticule center within a tolerance of 0.5 mV or less as the —INPUT Mode switch is set from Vc to GND for each Vc Polarity switch position.

INPUT RESISTANCE & DC ATTENUATION RATIO ADJUSTMENTS

NOTE

Performance Check Only: Go to step 17.

Control Settings

When performing a complete calibration procedure, change the following control settings and proceed with step 12.

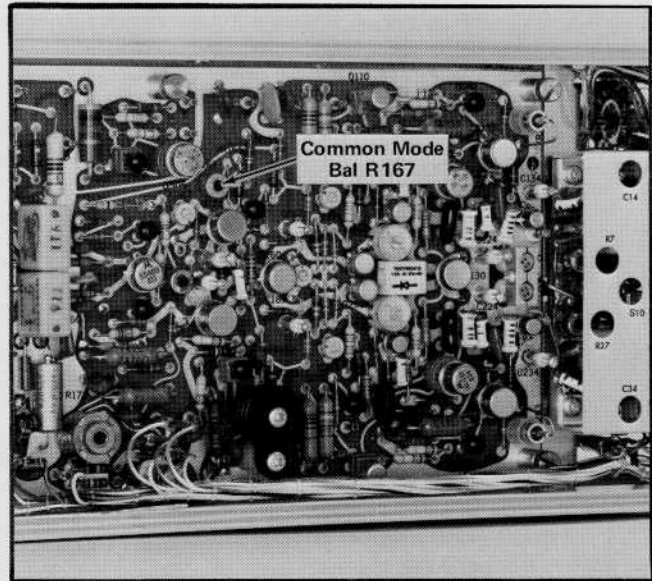

Fig. 5-6. Partial view of Input board showing adjustment location for step 11.

Polarity	Pushbuttons canceled
—INPUT Mode	GND
VOLTS/DIV	.1 V

If the remaining controls need to be checked for proper settings or if step 12 is being used as a starting point for partially calibrating the Type 7A13, refer to the Preliminary Procedure except as follows:

VOLTS Counter	99.99 plus 1 digit (to read 90.00)
---------------	---------------------------------------

NOTE

The tolerances given in the CHECK and ADJUST procedures for steps 12 through 16 are guides to check the instrument for correct operation and are not instrument specifications.

12. Check/Adjust +INPUT 10× DC Attenuation Ratio

a. Test equipment setup, with connections made at completion of step 12g, is shown in Fig. 5-7.

b. Connect a 1-megohm 1% resistor from the Precision DC Divider Voltage Output connector to the Precision DC Divider Gnd connector.

c. Connect a 6-inch patch cord from the Type 7A13 +INPUT connector to the Precision DC Divider Voltage Input connector (see Fig. 5-8).

d. Connect a 6-inch patch cord from the Type 7A13 Gnd connector to the Precision DC Divider Gnd connector.

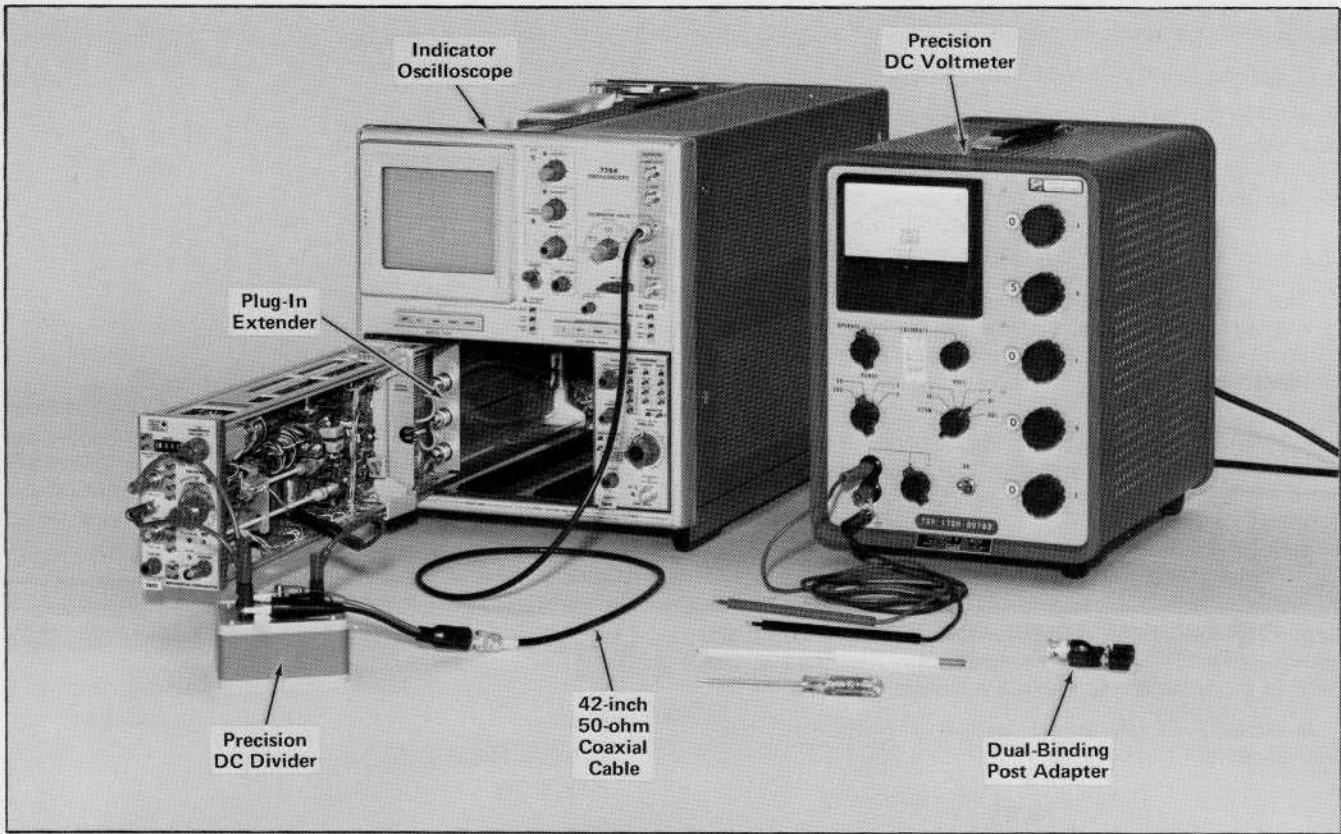

Fig. 5-7. Initial setup showing equipment required for performing calibration steps 12 through 16. To continue the Performance Check procedure, go to step 16A.

e. Disconnect the Type 7A13 brown-on-white wire from pin connector "0" located on the Output board (see Fig. 5-9). This wire disconnects the Vc supply located on the Output board from the Vc input circuit on the Attenuator board but does not disconnect the Vc supply from the Vc OUT 0-10 V jack.

f. Connect a 6-inch patch cord from the Precision DC Divider to the free end of the brown-on-white wire.

CAUTION

Use care when making this connection to prevent the brown-on-white wire from touching chassis ground or becoming disconnected from the pin connector on the Attenuator board.

g. Connect a 42-inch 50-ohm coaxial cable to the indicator oscilloscope Cal output connector. Connect a clip lead adapter to the other end of the cable. Connect the red lead from the clip lead adapter to the Precision DC Divider Voltage Input connector and connect the black lead to the Precision DC Divider Gnd connector.

h. Set the indicator oscilloscope Calibrator Volts switch to 40 V and the Rate (Calibrator) switch to DC Volts.

i. Set the +INPUT and -INPUT Mode switches simultaneously to Vc. Using the POSITION control, position the trace to graticule center.

j. CHECK—Set the +INPUT Mode switch to DC and note the trace shift. Amount of trace shift should not exceed ± 0.3 division.

NOTE

The input impedance of the Precision DC Divider lowers the 40-V DC calibrator output to approximately 15 volts. This is the voltage that is applied to the +INPUT connector. The voltage applied to the brown-on-white lead is exactly one-tenth of the applied voltage at the +INPUT connector.

h. ADJUST—If trace shift exceeds ± 0.3 division, leave the +INPUT Mode switch in the DC position and adjust R8G (see Fig. 5-10) so that the trace is within the given tolerance. Recheck for no trace shift as the +INPUT switch is set from Vc to DC. If necessary, readjust R8G.

i. Simultaneously set both +INPUT and -INPUT Mode switches to GND.

j. Disconnect the Precision DC Divider from the Type 7A13 but leave all other connections unaltered.

k. Leave the brown-on-white wire to pin "0" on the Output board disconnected.

13. Check/Adjust +INPUT 1 X DC Input Resistance

a. Connect the dual binding post adapter to the +INPUT connector.

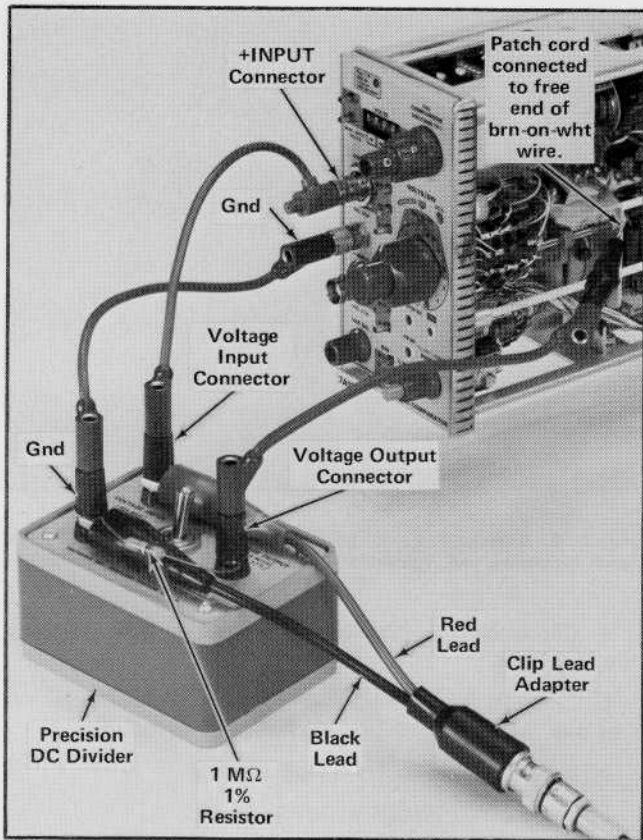

Fig. 5-8. Closeup view of the Precision DC Divider interconnections to the Type 7A13.

b. Remove the 1 megohm 1% resistor from the Precision DC Divider. Connect the resistor between the red binding post on the adapter and the Vc OUT 0-10 V jack on the Type 7A13.

c. Depress the +Polarity pushbutton and set the +INPUT Mode switch to DC.

NOTE

When performing steps 13c through 13i in this procedure, it is normal for the trace to be deflected upward off the CRT.

d. Preset the Precision DC Voltmeter to measure approximately +5 volts.

e. Connect the Precision DC Voltmeter between the red (+) and the black (ground) binding posts on the adapter.

f. Set the voltmeter for a null reading.

g. Set the VOLTS/DIV switch to 50 mV.

h. CHECK—For a null indication within 5 mV on the voltmeter.

i. ADJUST—If a null reading is not obtained, adjust R7 (see Fig. 5-10) for a null indication on the Precision DC Voltmeter.

j. INTERACTION—If R7 was adjusted, repeat step 12.

k. Disconnect the voltmeter.

l. Cancel the + Polarity pushbutton and set the +INPUT Mode switch to GND.

m. Disconnect resistor and binding post adapter.

14. Check/Adjust +INPUT 100× DC Attenuation Ratio

a. Reconnect the Precision DC Divider in the same manner as was described in step 12 and illustrated in Figs. 5-7 and 5-8. Be sure the 1 megohm 1% resistor is connected from the Precision DC Divider Voltage Output connector to Gnd.

b. Set the VOLTS/DIV switch to 1 V.

c. Set the Precision DC Divider switch to 100:1.

d. Simultaneously set both +INPUT and -INPUT Mode switches to Vc.

e. Using the POSITION control, position the trace to coincide with graticule center.

f. CHECK—Set the +INPUT Mode switch to DC and note the trace shift. Amount of trace shift should not exceed ± 0.3 division.

g. ADJUST—If the tolerance is exceeded, leave the +INPUT Mode switch in the DC position and adjust R5E (see Fig. 5-10) for minimum trace shift.

15. Check/Adjust -INPUT 10× Attenuation Ratio

NOTE

No adjustment is provided for the -INPUT 100× DC attenuation ratio.

a. Simultaneously set both +INPUT and -INPUT switches to GND. Set the VOLTS/DIV switch to .1 V.

b. Move the patch cord from the +INPUT connector to the -INPUT connector. Leave the other end of the patch cord connected to the Precision DC Divider Voltage Input connector.

c. Set the Precision DC Divider switch to 10:1.

d. Simultaneously set both +INPUT and -INPUT switches to Vc.

e. Use the POSITION control to center the trace.

f. CHECK—Set the -INPUT Mode switch to DC and check that the trace shift does not exceed ± 0.3 division.

g. ADJUST—If trace shift exceeds ± 0.3 division, leave the -INPUT Mode switch at DC and adjust R28G (see Fig. 5-10) for minimum trace shift.

h. Disconnect the Precision DC Divider from the Type 7A13 and indicator oscilloscope. Reconnect the brown-on-white wire to pin "0" on the output board.

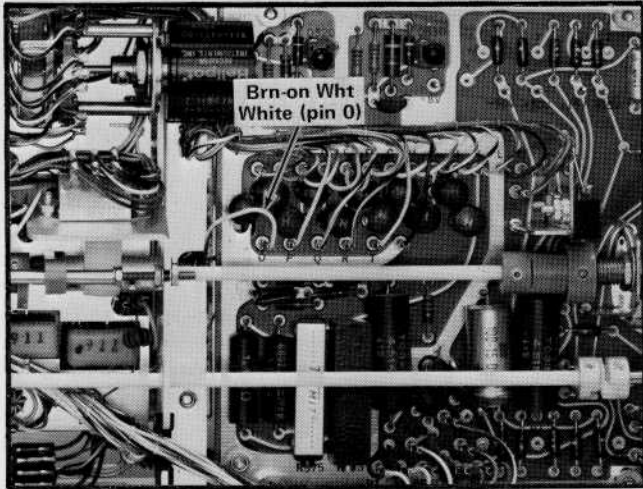

Fig. 5-9. Partial view of Output board showing the Vc input wire and the Vc output pin connector location.

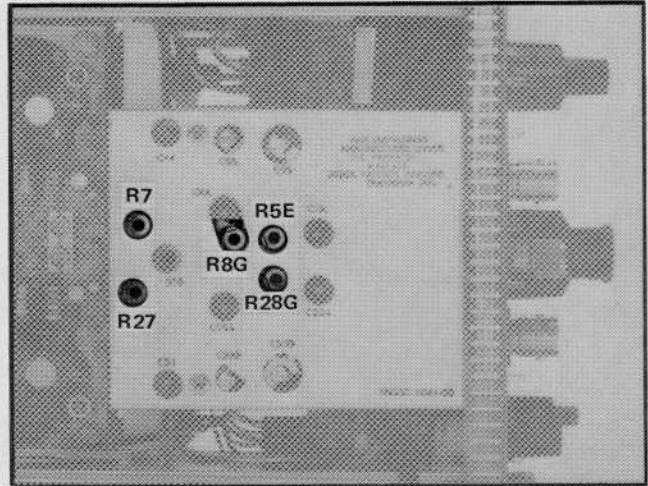

Fig. 5-10. Attenuator board adjustment locations used in the DC Input Resistance and Attenuator Ratio Adjustments procedure.

16. Check/Adjust —INPUT 1 \times DC Input Resistance ①

- a. Set the front panel control as follows:

Indicator Oscilloscope

Calibrator 4 mV
Rate (Calibrator) 1 kHz

Type 7A13

—INPUT Mode GND

- b. Connect the dual-binding post adapter to the —INPUT connector.

- c. Connect the 1 megohm 1% resistor between the red binding post on the adapter and the Vc OUT 0-10 V jack on the Type 7A13.

- d. Set the Polarity switch to + and the —INPUT Mode switch to DC.

NOTE

When performing steps 16d through 16k, the trace will be deflected downward off the CRT.

- e. Check that the Precision DC Voltmeter is set to measure +5 volts.

- f. Connect the Precision DC Voltmeter between the red (+) and the black (–) binding posts on the adapter.

- g. Set the voltmeter for a null reading.

- h. Set the VOLTS/DIV switch to 50 mV.

- i. CHECK—For a null indication within 5 mV on the voltmeter.

- j. ADJUST—If a null reading is not obtained, adjust R27 (see Fig. 5-10) for a null indication on the Precision DC Voltmeter.

- k. INTERACTION—If R27 was adjusted, repeat step 15.

- l. Disconnect the voltmeter.

- m. Set the Type 7A13 controls as follows:

+Polarity	Pushbutton canceled
VOLTS Counter	0.000
—INPUT Mode	GND

- n. Disconnect the resistor and binding post adapter.

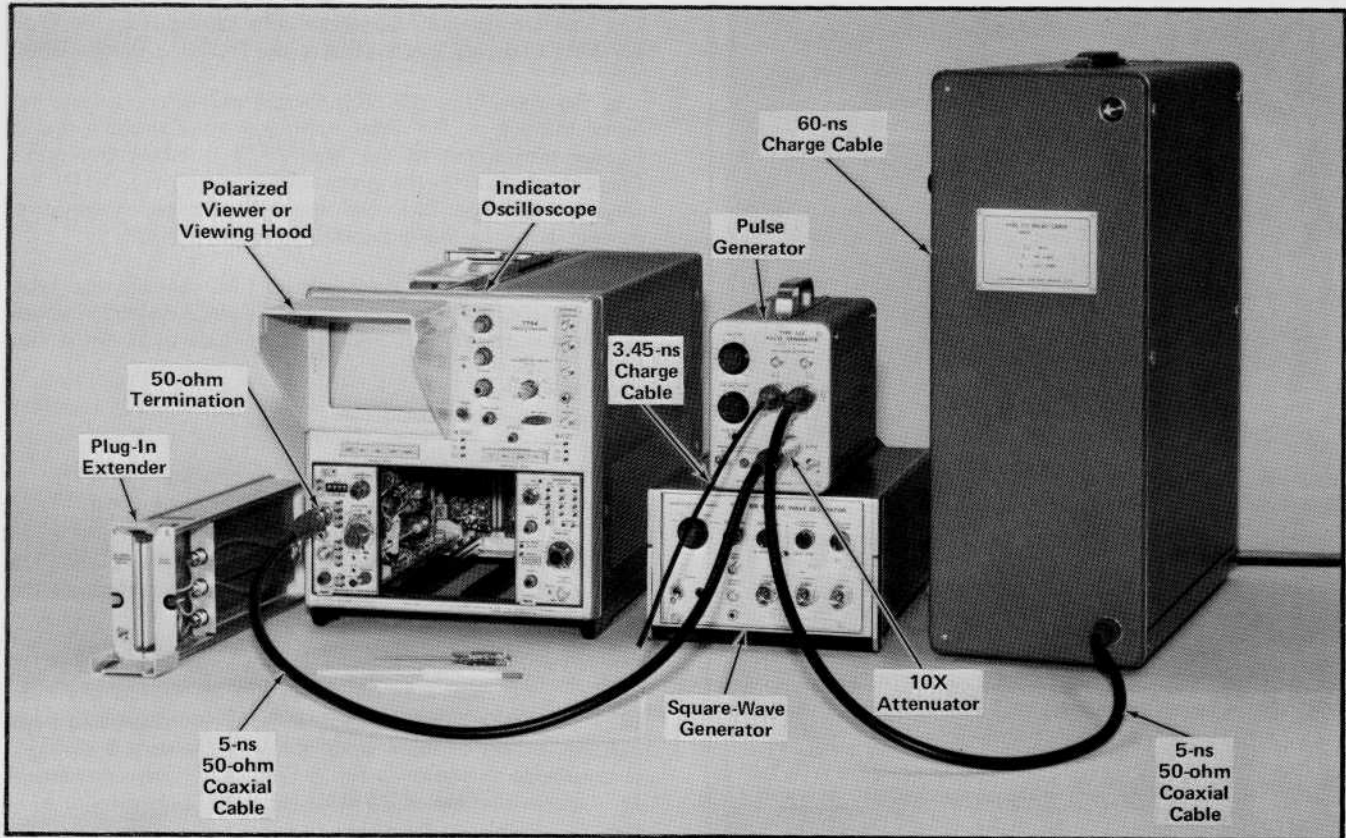

Fig. 5-11. Initial setup showing equipment required for performing the high-frequency compensation calibration checks and adjustments. The plug-in extender is not needed for a performance check.

HIGH-FREQUENCY COMPENSATION ADJUSTMENTS

Control Settings

When performing a complete procedure, change the following control settings and proceed with step 17.

Type 7A13

+INPUT Mode	DC
—INPUT Mode	GND
VOLTS/DIV	10 mV
BW	FULL

Time Base Plug-In

Time/Div	.05 μ s
----------	-------------

If the remaining controls need to be checked for proper settings or if step 17 is being used as a starting point for

partially calibrating the Type 7A13, refer to the Preliminary Procedure.

17. Check/Adjust High-Frequency Compensation (both inputs)

a. Test equipment setup, with connections made at completion of step 17e, is shown in Fig. 5-11.

b. Turn off the indicator oscilloscope. Remove the Plug-in Extender and insert the Type 7A13 directly into the indicator oscilloscope Left Vert plug-in compartment. Turn on the indicator oscilloscope.

c. Set the Type 109 Pulse Generator controls as follows:

Amplitude	9
Voltage Range	5.0
Pulse Polarity	+
Power	On

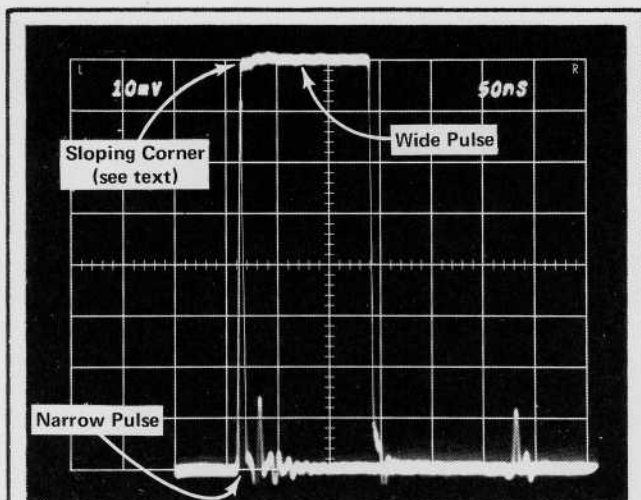

(A) Dual pulse waveform displayed at a sweep rate of .05 μ s/div.

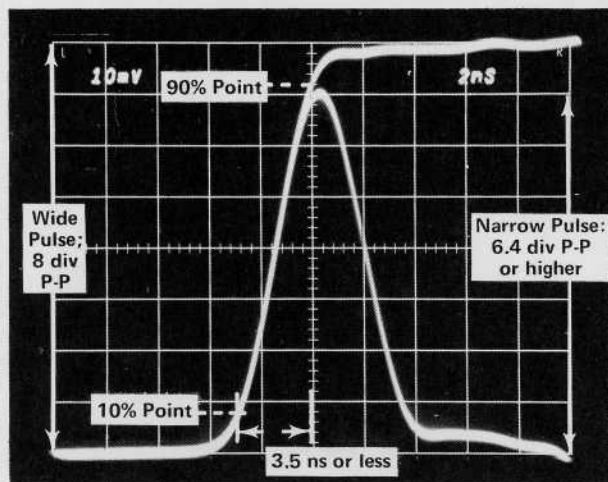

(B) Checking risetime using the narrow pulse technique or the 10%-to-90% method. Sweep rate is 2 ns/div.

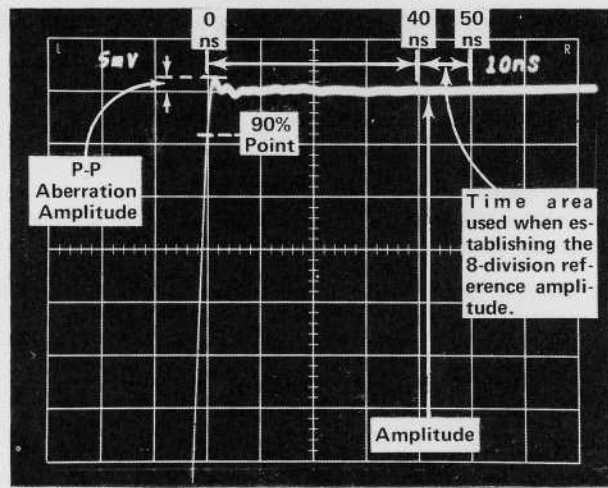

(C) Checking peak-to-peak aberration amplitude. Sweep rate is 10 ns/div. The 8-division reference amplitude was established when the top of the waveform was positioned to the top of the graticule. Then the waveform was positioned downward one division as a vertical position reference location for checking aberrations.

Fig. 5-12. Waveform examples showing correct high-frequency response to a square wave generator by the Type 109 for (A) and (B); generated by the Type 106 for (C). Vertical deflection factor is 10 mV/div for (A) and (B); 5 mV/div for (C).

d. Connect a 3.45-ns charge line to the Type 109 50 Ω Chg Line 1 connector. Connect a 5-ns coaxial from the Type 109 50 Ω Chg Line 2 connector to the Type 113 Delay Cable.

e. From the Type 109 50 Ω Output connector, connect the signal through a 10 \times attenuator, 5-ns coaxial cable and a 50-ohm termination to the Type 7A13 +INPUT connector. Connect all items in the given sequence (see Fig. 5-11). Remove the CRT light filter and mount a polarized viewer or a viewing hood to the indicator oscilloscope bezel.

f. Use the indicator oscilloscope CRT controls, the Type 7A13 POSITION control, and the Type 109 Amplitude control to obtain a display 8 divisions in amplitude as shown in Fig. 5-12A.

NOTE

Use these controls as desired to display the waveform for best viewing when performing step 17.

g. Depress the time base unit $\times 10$ Magnifier pushbutton and use the Position control to position the waveform to the location shown in Fig. 5-12B.

h. CHECK—System risetime and aberrations (+INPUT): Narrow pulse amplitude should be 80% or more of the wide pulse amplitude. This is equal to 6.4 divisions peak to peak (see Fig. 5-12B) or more when the wide pulse is 8 divisions in amplitude as shown in Fig. 5-12A. This is also equivalent to a system risetime of 3.5 ns as measured between the 10% and 90% points on the rising portion of the wide pulse (see Fig. 5-12B) based on an 8-division pulse amplitude (see Fig. 5-12A).

Using Table 5-1 and the procedure that follows as a guide, check the system risetime and aberrations for all the VOLTS/DIV switch settings given in the table.

Calibration Procedure Only: When performing step 17h, check the 50 mV to 1 mV VOLTS/DIV switch settings for both inputs. If the instrument operates properly, check the remaining VOLTS/DIV switch settings. If the instrument needs recalibration, perform the high frequency adjustments as described in the remaining portion of this procedure. Then perform steps 18 through 20. Next, repeat step 17 to recheck the VOLTS/DIV switch settings for both inputs.

Performance Check and/or Calibration Procedure: When checking aberrations, use the information given in Table 5-2 and the NOTE that follows.

NOTE

The aberration tolerance is given as a guide to check the instrument for correct operation and is not in instrument specification. The tolerance measurement excludes the thickness of the trace. Fig. 5-12C shows an example of a waveform obtained when using a Type 106 as a generator. When using the Type 109 as a generator, the tolerance measurement also excludes the sloping front corner of the waveform caused by the characteristics of the Type 113 Delay Cable used as a charge line to produce the wide pulse.

TABLE 5-1

Check Step Response Risetime & Aberrations (both inputs)

Generator	VOLTS/DIV Switch Setting	Use 10× Atten.	Use 50 Ω Term.	CHECK	
				System Risetime ¹	System Aberrations ²
Type 109 Pulse Generator	10 mV	X	X	X	No Check
	5 mV	X	X	X	
	2 mV	X	X	X	
	1 mV	X	X	X	
	20 mV	Not Used	X	X	
	50 mV		X	X	
	.1 V		X	X	X
	.2 V		X	X	X
	.5 V		X	X	X
	1 V		X	X	X
	2 V	X	X	X	No Check
	5 V	X	X	X	
50 mV	X	X	X		
20 mV	X	X	X		
10 mV	X	X	X		
5 mV	X	X	X		
Type 106 Squarewave Generator	2 mV	X	X	X	
	1 mV	X	X	X	

¹To meet the system risetime requirement, the narrow pulse amplitude must be 80% of the wide pulse amplitude. With an 8-division peak-to-peak wide pulse displayed, the narrow pulse amplitude should be 6.4 divisions or more peak to peak.

²Amplitude of the generator output should be maintained at 8 divisions peak to peak. Then the display should be positioned downward one division when applying the signal to the + INPUT connector (as shown in Fig. 5-12C) and the Time/Div switch set to 10 ns/div to permit visual measurement of the aberrations. When the signal is applied to the - INPUT connector, the 8-division waveform should be positioned one division above the bottom of the graticule.

TABLE 5-2

Step Response Aberration Tolerances (both inputs)

Signal Applied to:	VOLTS/DIV Switch Settings	Aberration Tolerance ³ (No greater than)
+INPUT Connector	1 mV to .5 V	+2.5%, -2.5%, or a total of 4% peak to peak
	1 V to 5 V	+7%, -7%, or a total of 10% peak to peak
-INPUT Connector	1 mV to .5 V	+3%, -3%, or a total of 5% peak to peak
	1 V to 5 V	+7%, -7%, or a total of 10% peak to peak

³This is not an instrument specification; see the NOTE in step 17h. When checking the aberrations, use a 10-ns/div sweep rate and measure the total peak-to-peak aberration in the form of overshoot, rounding, ringing, or tilt expressed as a percentage of pulse amplitude. Exclude the thickness of the trace in the measurement. (When using the Type 109 with a Type 113 as a generator, also exclude the front corner slope from the measurement.) The pulse amplitude reference level is the average level in the 40 ns to 50 ns period after the 90% point of the step (see Fig. 5-12C).

When the checks using the Type 109 Pulse Generator as the signal source are completed, turn off the generator and disconnect it from the Type 7A13. To complete the checks listed in Tables 5-1 and 5-2 using the Type 106 Square-Wave Generator as the signal source, set the controls as follows:

Type 106

Repetition Rate Range	100 kHz
Multiplier	1
Symmetry	As is
Amplitude	Not applicable
Hi Amplitude/Fast Rise	Fast Rise
+Transition Amplitude	Fully CCW
-Transition Amplitude	Not applicable
Power	On

Type 7A13

VOLTS/DIV	50 mV
-----------	-------

Performance Check/Calibration—Type 7A13

Time Base Plug-In

Magnifier	×1
Time/Div	5 μs

Apply the signal from the Type 106 +Output connector through a 5-ns coaxial cable and 50-ohm termination to the Type 7A13 +INPUT connector. Set the Type 106 +Transition Amplitude and Symmetry controls for a symmetrical waveform 8 divisions peak to peak in amplitude. Set the time-base unit Magnifier switch to ×10 and the Time/Div switch to .1. Recheck the amplitude of the step waveform and reset the generator +Transition Amplitude control as necessary, to obtain 8 divisions of vertical deflection in the 40 ns to 50 ns region as described earlier (step 17h). Check aberrations for the 50 mV to 1 mV positions of the Type 7A13 VOLTS/DIV switch.

i. After checking the system step response and aberrations with the signal applied to the +INPUT connector, disconnect the signal from the +INPUT connector and apply it to the -INPUT connector.

j. Set the controls as follows:

Type 7A13

+INPUT Mode	GND
-INPUT Mode	DC

Time Base Unit

Level/Slope (Triggering) Negative slope region

k. CHECK—System risetime and aberrations (-INPUT): Use step 17h with Tables 5-1 and 5-2 as guide to check the system step response. The waveforms will appear similar to those shown in Figs. 5-12B and 5-12C except that the waveforms will be negative-going.

l. For Performance Check Only, go to step 18.

m. ADJUST—R196, R432, R300, C187, R187, C163, C113, C150, C250 and C213 (see Figs. 5-13 and 5-14) in the given order for optimum response to a square wave. C250 and C213 are mainly -INPUT adjustments. To perform the adjustments, use the information in the procedure that follows:

n. After performing steps 17a through 17k and it is determined that the Type 7A13 high-frequency square-wave response needs to be improved, a suggested sequence is outlined in Table 5-3. The steps that follow provide additional information based on this sequence. Read the procedure and study the table to determine, if possible, the adjustments that need to be made to restore the Type 7A13 to its required performance.

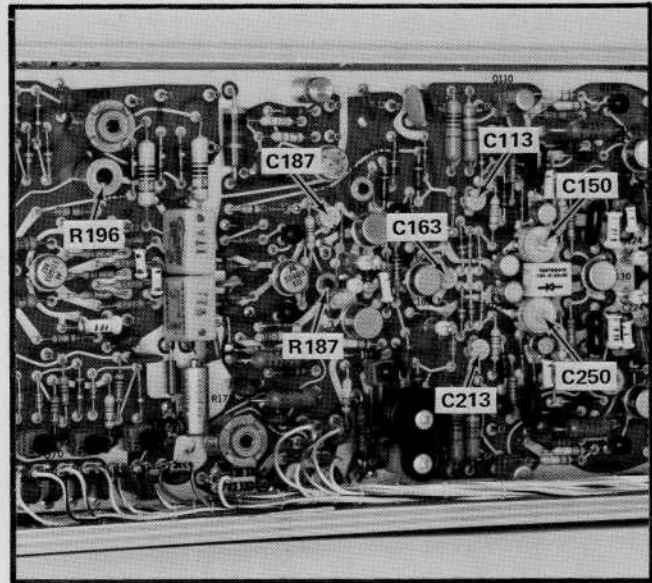

Fig. 5-13. Locations of the high-frequency adjustments on the Input board.

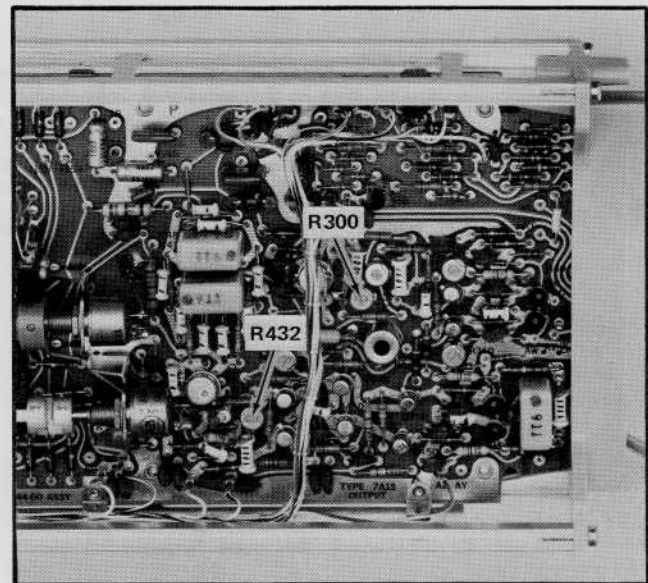

Fig. 5-14. Partial view of the Output board showing locations of the high-frequency adjustments.

o. Turn off the indicator oscilloscope. Insert the Plug-In Extender between the Type 7A13 and the indicator oscilloscope. Turn on the indicator oscilloscope.

TABLE 5-3
High-Frequency Compensation Adjustment Sequence

Type 106 Repetition Rate	Signal Applied to:	Time Base Sweep Rate	Adjustment	Approximate Time Domain ⁴	Procedure
10 kHz	+INPUT Connector	50 μ s/div or 20 μ s/div	R196 ⁵	50 μ s	Turn off the oscilloscope. Insert the Plug-In Extender between the Type 7A13 and indicator oscilloscope. Turn on the indicator oscilloscope. Set the VOLTS/DIV switch to 10 mV and the BW switch to 5 MHz. Adjust for best flat top. Reset BW switch to FULL for remaining adjustments.
100 kHz	+INPUT Connector	1 μ s/div	R432	100 ns	Adjust for optimum square corner. (Ignore fast spike, if any, that may remain on the top front corner.)
		.1 μ s/div	R300	50 ns	Adjust for best flat top.
		5 ns/div or 10 ns/div	C187	5 ns to 10 ns	Turn off indicator oscilloscope. Remove the Plug-In Extender and insert the Type 7A13 directly into the indicator oscilloscope. Turn on indicator oscilloscope. Adjust for optimum square corner. Leave the Type 7A13 inserted directly in the indicator oscilloscope for the remaining adjustments.
			R187	2 ns to 7 ns	
			C163	2 ns	
			C113	2 ns to 4 ns	Adjust for minimum ripple near front corner.
			C150	1 ns to 3 ns	Adjust for optimum square corner. Adjust in equal increments to maintain C150 and C250 at or nearly the same physical positions.
		C250	1 ns to 7 ns		
	-INPUT Connector	10 ns/div	C213	2 ns to 6 ns	Repeat steps 17i and j. Adjust for optimum square corner.
			C250	1 ns to 5 ns	
+INPUT Connector	5 ns/div	C150 C113 C163	Same as given previously	Repeat applicable portions of step 17p. Readjust for optimum square corner.	
-INPUT Connector	5 ns/div	C213 C250	Same as given previously	Repeat steps 17i and j. Readjust for optimum square corner.	
+INPUT Connector	5 ns/div	C163 C113 C150	Same as given previously	Repeat applicable portions of step 17p. Readjust for optimum square corner. Set Type 7A13 for 1 mV and readjust for optimum square corner. Repeat steps 17h through 17k. If a bump is present in the 5 ns to 10 ns region, perform step 20.	
		C187	Same as given previously	After performing step 20, C187 may need to be readjusted. Repeat steps 17h through 17k.	

⁴The 90% point on the rising portion of the waveform (see Fig. 5-15C for location) is the time reference used to determine the time domain or area affected by the adjustment. For example, with the sweep rate set at 5 ns/div, adjustment of C187 will affect the 5-ns to 10-ns area near the top front corner of the waveform when measured with respect to the 90% point on the rising portion of the waveform.

⁵If R196 is adjusted, repeat step 3.

p. Set the controls as follows:

Type 7A13	
+INPUT Mode	DC
-INPUT Mode	GND
VOLTS/DIV	10 mV
BW	5 MHz

Time Base Plug-In	
Level/Slope (Triggering)	Positive slope region
Magnifier	$\times 1$
Time/Div	50 μ s
Type 106	
Repetition Rate Range	10 kHz

Performance Check/Calibration—Type 7A13

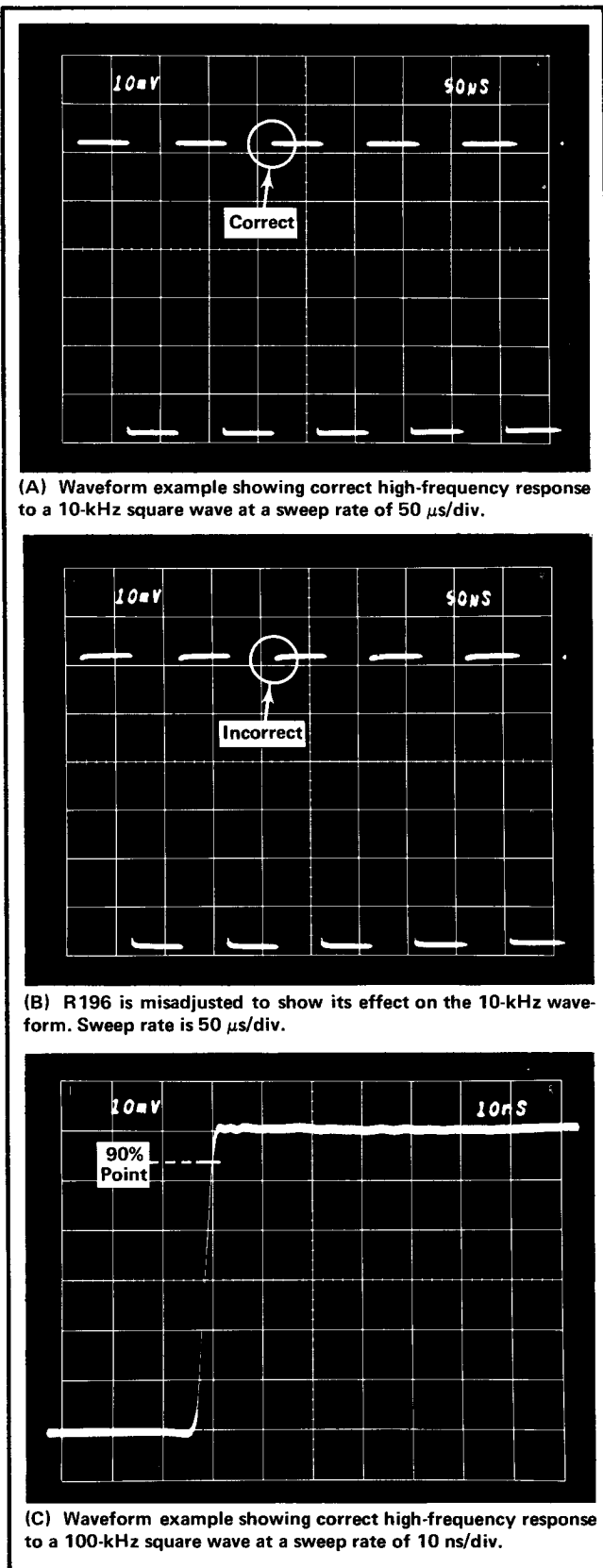

Fig. 5-15. Waveform examples obtained when performing the high-frequency adjustments procedure using the Type 106 as a signal generator. Vertical deflection factor is 10 mV/div.

q. Remove the 10 \times attenuator and connect the 5-ns coaxial cable directly to the Type 106 +OUTPUT connector. Disconnect the Type 106 signal from the Type 7A13 -INPUT connector and apply it to the +INPUT connector.

r. Using Table 5-3 and 5-15 as a guide, perform the high-frequency compensation adjustments. Note that when using the table, the Plug-In Extender is used while adjusting R196, R432 and R300. For all the remaining adjustments, the Plug-In Extender is removed and the Type 7A13 is inserted directly into the indicator oscilloscope. Use a 6-division peak to peak waveform amplitude during the adjustment procedure. Keep the waveform positioned about one division below the top of the graticule when using the +INPUT connector and about one division above the bottom of the graticule when using the -INPUT connector.

s. After completing the high-frequency compensation adjustments and checking that the instrument operates properly for all VOLTS/DIV switch settings from 50 mV to 1 mV, perform steps 18 through 20. Then, repeat step 17 to recheck all the VOLTS/DIV switch settings.

t. Disconnect the signal from the Type 7A13 and leave the generator turned on.

ATTENUATOR COMPENSATION ADJUSTMENTS

Control Settings

When performing a complete procedure, change the following control settings and proceed with step 18.

Type 7A13

+INPUT Mode	DC
-INPUT Mode	GND
VOLTS/DIV	10 mV
BW	5 MHz

Time-Base Plug-In

Level/Slope (Triggering)	Positive slope region
Time/Div	0.5 ms
Magnifier	$\times 1$

If the remaining controls need to be checked for proper settings or if step 18 is being used as a starting point for partially calibrating the Type 7A13, refer to the Preliminary Procedure.

18. Check/Adjust +INPUT Attenuator Compensation

a. Test equipment setup, with connections made at completion of step 18c, is shown in Fig. 5-16.

b. Set the Type 106 Square-Wave Generator controls to the following positions:

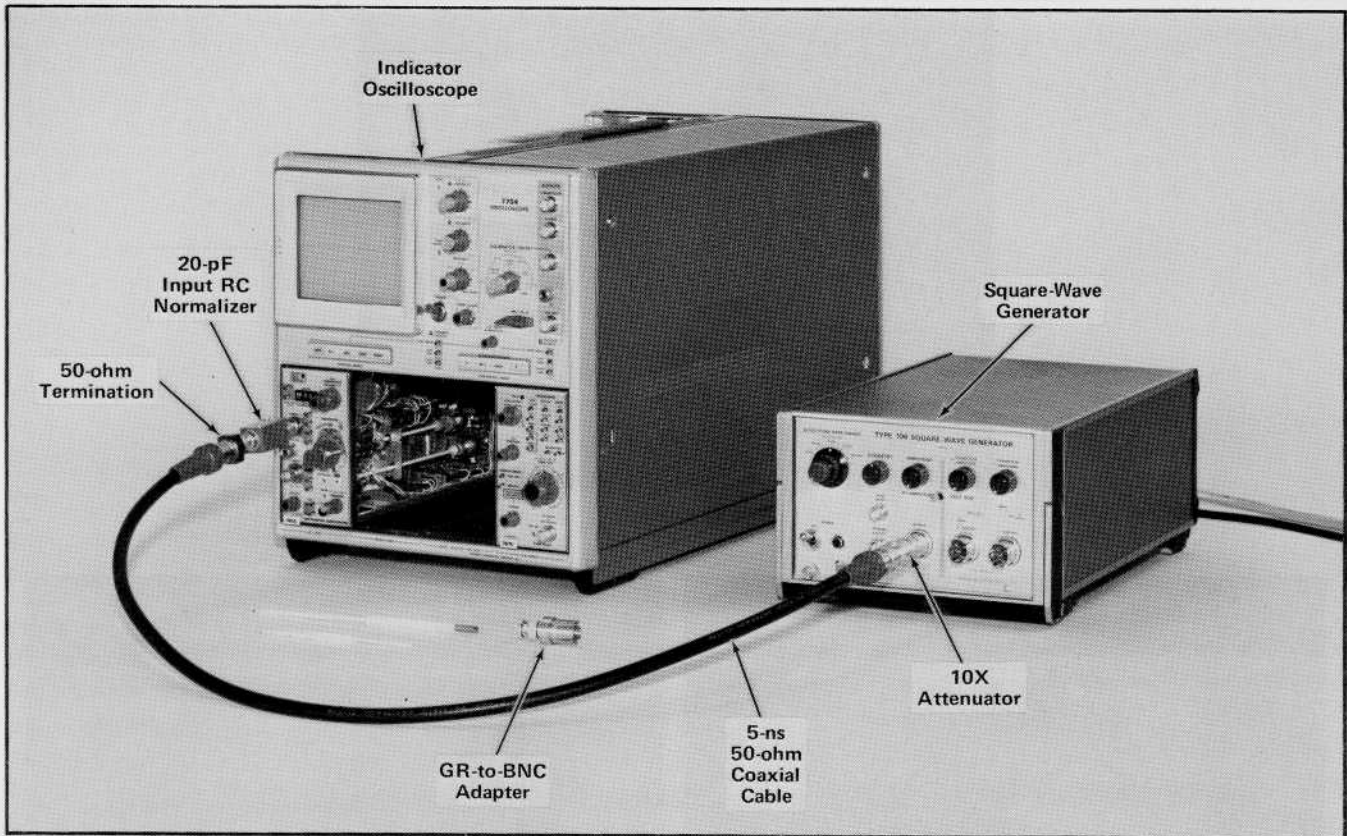

Fig. 5-16. Equipment required when performing steps 18 and 19.

Repetition Rate Range	1 kHz
Multiplier	1
Symmetry	Midrange
Amplitude	Fully CCW
Hi Amplitude/Fast Rise	Hi Amplitude
Fast Rise controls	Not Applicable

c. Apply the 1 kHz signal from the Type 106 high amplitude Output connector through a 10× attenuator, 5-ns coaxial cable, 50-ohm in-line termination and a 20-pF input RC normalizer to the Type 7A13 +INPUT connector.

d. Set the Type 106 Amplitude control to produce a display 6 divisions in amplitude. Use the Type 7A13 POSITION control to center the display.

e. Set the Type 106 Symmetry control for a symmetrical waveshape and, if necessary, reset the Multiplier control to obtain the 1 kHz output repetition rate.

f. CHECK—The waveform should have a flat top similar to the illustration shown in Fig. 5-17A. Aberrations should not exceed $\pm 1\%$ or ± 0.06 division for a 6-division peak-to-peak display.

Using Table 5-4 as a guide, check the waveform for a flat top and square front top corner in the 10 mV to 5 V positions of the VOLTS/DIV switch. Use a 6 division display amplitude for each switch position.

NOTE

The aberration tolerance described in this step is given as a guide to correct instrument operation and is not an instrument specification.

g. ADJUST—The +INPUT shunt capacitance and the attenuator adjustments listed in Table 5-4 for optimum square corner and flat top (see Fig. 5-17A). Readjust the generator output with each setting of the VOLTS/DIV switch to obtain 6 divisions of deflection. Remove the 10× attenuator and the 50-ohm termination when necessary to obtain more signal drive. In the 2 V/DIV position, replace the 50-ohm termination with a GR-to-BNC adapter.

Figs. 5-17B through 5-17E are some waveform examples obtained when the adjustments were misadjusted. Fig. 5-18 shows the location of the adjustments.

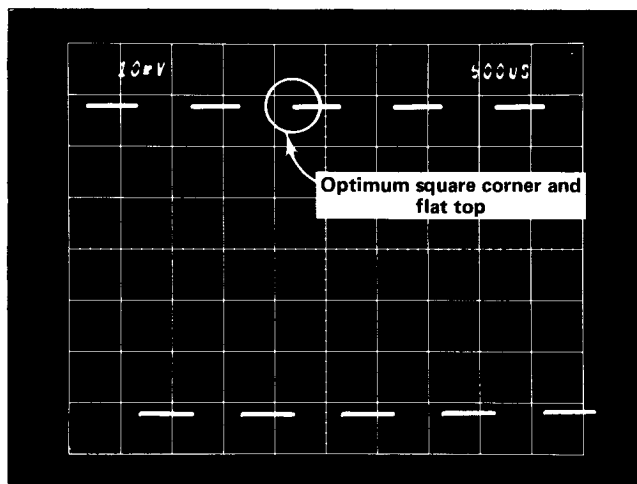

(A) Correct.

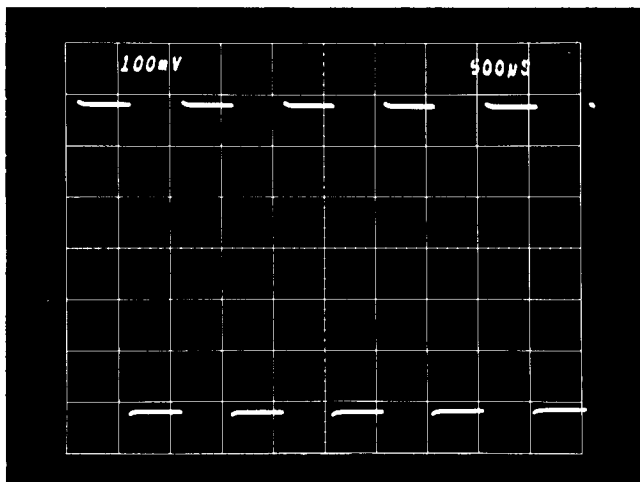

(B) Input shunt capacitance adjustment incorrect.

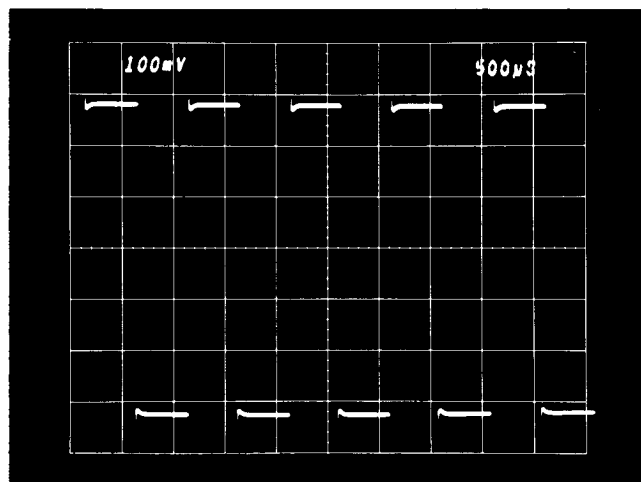

(D) Input attenuator adjustments incorrect.

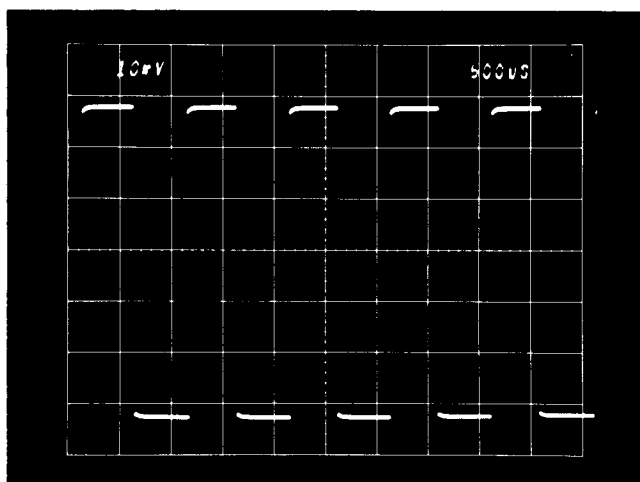

(C) Input shunt capacitance adjustment incorrect.

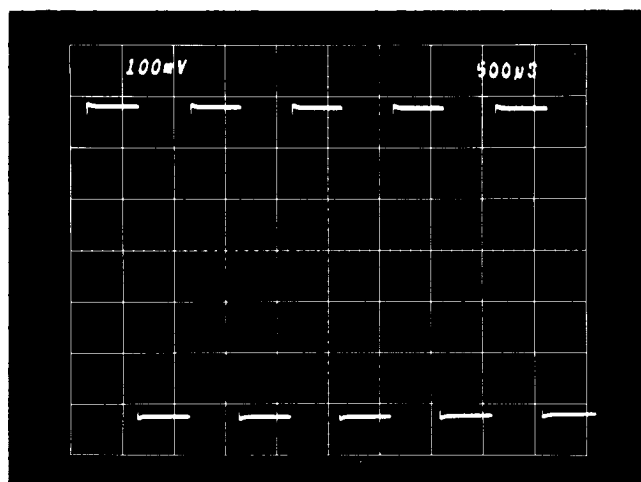

(E) Input attenuator adjustments incorrect.

Fig. 5-17. Examples of waveforms obtained when performing step 18. Sweep rate is 0.5 ms/div.

TABLE 5-4
+ INPUT Attenuator Adjustments

VOLTS/DIV Switch Setting	Use 10× Atten.	Use 50 Ω Term.	Use GR-to-BNC Adapter	Use RC Norm.	Adjust for Optimum		
					Top Front Corner Squareness	Flat Top	
10 mV	×	×	Not Used	×	No Adjustment	C14	
20 mV	×	×		×		Check	
50 mV	×	×		×		Check	
.1 V	Not Used	×		×	C8A	C8B	
.2 V		×		×	Check	Check	
.5 V		×		×	Check	Check	
1 V		×		×	C5A	C5B	
2 V		×		×	×	Check	Check
5 V		×		×	×	Check	Check

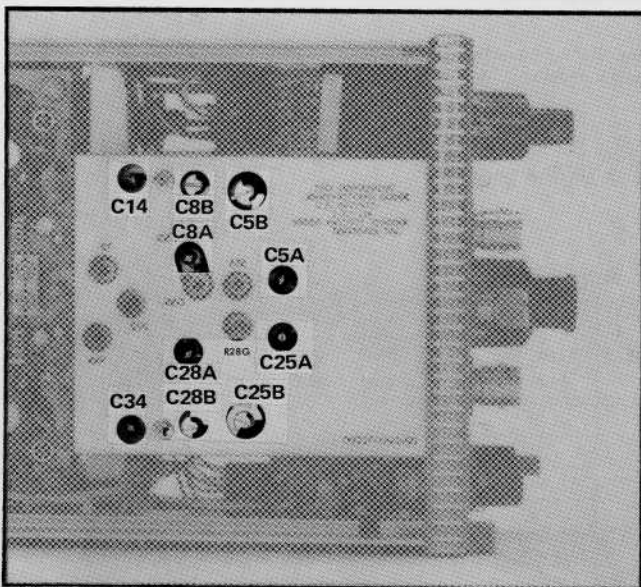

Fig. 5-18. Adjustment locations used in the Attenuator Compensation Adjustments procedure.

19. Check/Adjust —INPUT Attenuator Compensation

a. Set the Type 106 Amplitude control for minimum output.

If the waveform aberrations exceed the $\pm 1\%$ tolerance requirement when performing the "Check" portion of the table, it may be necessary to compromise the adjustment(s) that precede the Check. For example, to minimize the top front corner aberration in the .5 V position, slightly readjust C8A; then recheck the .2 V and .1 V switch positions to determine if the tolerance is within the specified requirement.

When adjusting C8A and C5A, the indicator oscilloscope can be set for a sweep rate of 0.2 ms/div.

b. Disconnect the 20-pF input RC normalizer from the +INPUT connector and connect it to the —INPUT connector.

c. Insert the 50-ohm termination in place of the GR-to-BNC adapter. Reconnect the 10× attenuator between the coaxial cable and Type 106 Output connector. This is the same setup as shown in Fig. 5-16 except the signal is applied to the —INPUT connector.

d. Set the Type 7A13 controls as follows:

+INPUT Mode	GND
—INPUT Mode	DC
VOLTS/DIV	10 mV

Performance Check/Calibration—Type 7A13

- e. Check that the time-base plug-in unit Time/Div switch is set to .5 ms.
 - f. Set the Type 106 Amplitude control to obtain a display 6 divisions in amplitude.
 - g. Set the time base plug-in unit Level/Slope control in the negative slope region.
 - h. CHECK—The waveform should have a flat bottom as illustrated in Fig. 5-19. Aberrations should not exceed $\pm 1\%$ or ± 0.06 division for a 6 division peak-to-peak display.
- Using Table 5-5 as a guide, check the waveform for a flat bottom and square front bottom corner in the 10 mV to 5 V positions of the VOLTS/DIV switch. Use a 6 division display amplitude for each switch position.

NOTE

The aberration tolerance described in this step is given as a guide to correct instrument operation and is not an instrument specification.

- i. ADJUST—The —INPUT shunt capacitance C34 and the attenuator adjustments listed in Table 5-5 for a square lower front corner and flat bottom (see Fig. 5-19). The procedure used here is similar to the procedure used in performing step 18. Fig. 5-18 shows the locations of the adjustments.

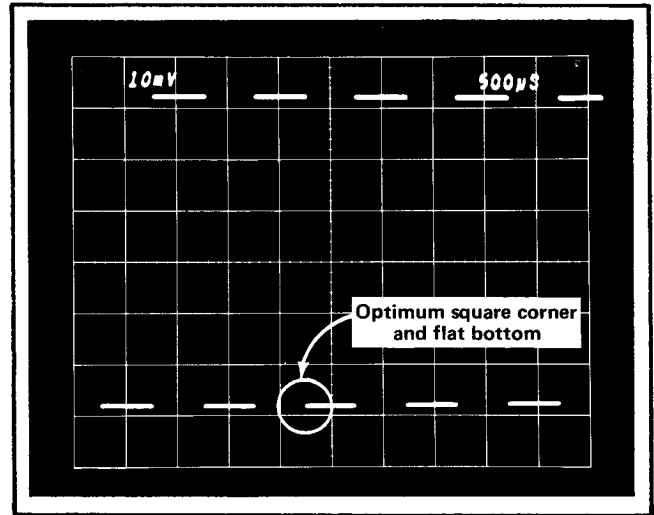

Fig. 5-19. Checking for optimum —INPUT waveform at sweep rate of .5 ms/div.

- j. Disconnect the signal from the —INPUT connector and turn off the generator.

TABLE 5-5
—INPUT Attenuator Adjustments

VOLTS/DIV Switch Setting	Use 10× Atten.	Use 50 Ω Term.	Use GR-to-BNC Adapter	Use RC Norm.	Adjust for Optimum	
					Bottom Front Corner Squareness	Flat Bottom
10 mV	×	×	Not Used	×	No Adjustment	C34
20 mV	×	×		×		Check
50 mV	×	×		×		Check
.1 V	Not Used	×		C28A	C28B	
.2 V		×		Check	Check	
.5 V		×		Check	Check	
1 V		×		C25A	C25B	
2 V		Not		×	Check	Check
5 V		Used	×	Check	Check	

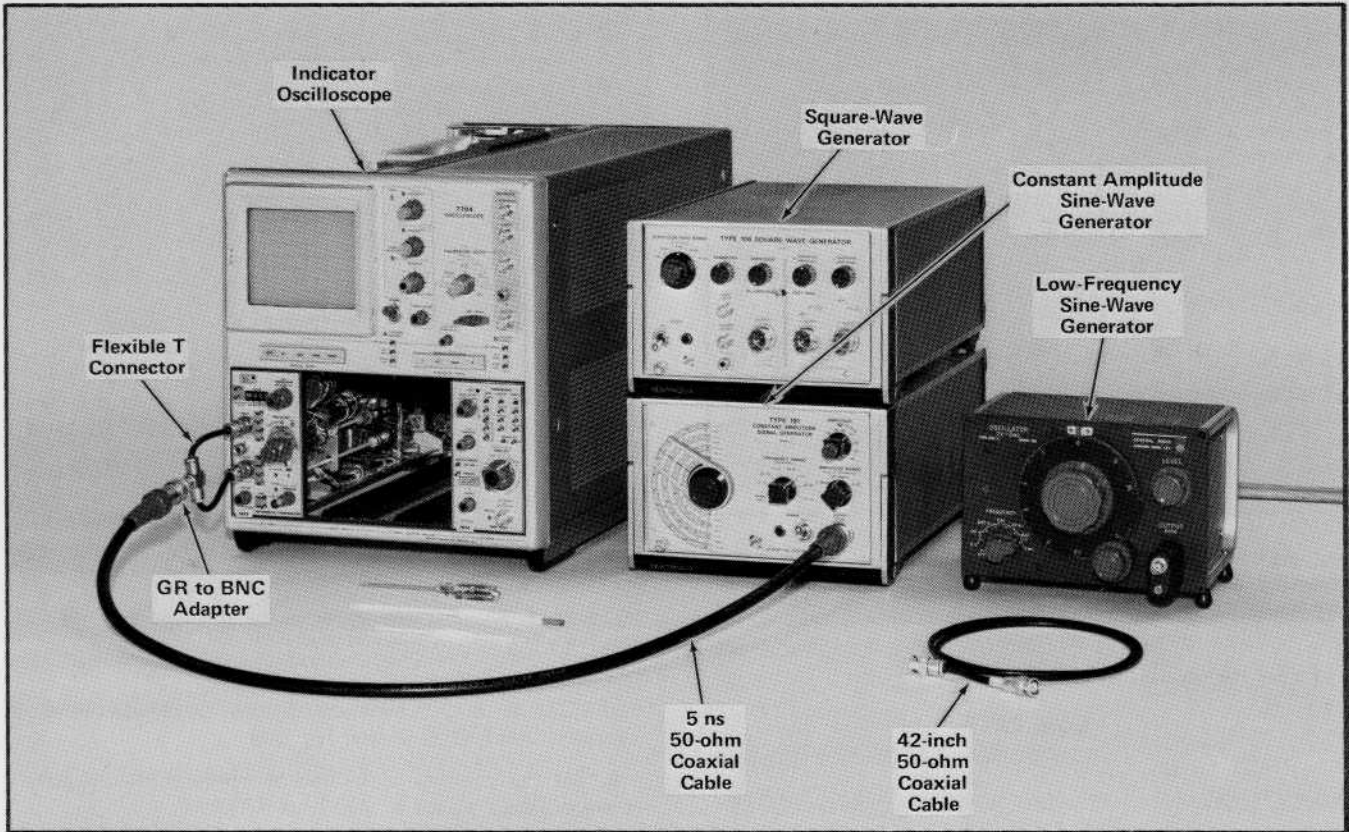

Fig. 5-20. Initial setup showing equipment required for steps 20 through 22.

COMMON MODE REJECTION ADJUSTMENTS

Control Settings

When performing a complete procedure, change the following control settings and proceed with step 20.

Type 7A13	
+INPUT Mode	DC
—INPUT Mode	GND
VOLTS/DIV	.2 V
BW	FULL

Time Base Plug-In

Level/Slope (Triggering)	Positive slope region
Time/Div	50 μ s

If the remaining controls need to be checked for proper settings or if step 20 is being used as a starting point for partially calibrating the Type 7A13, refer to the Preliminary Procedure.

20. Check/Adjust Amplifier High-Frequency Common Mode Rejection

a. Test equipment setup, with connections made at completion of step 20d is shown in Fig. 5-20.

b. Set the Type 191 Constant Amplitude Signal Generator controls as follows:

Frequency dial	10 MHz
Frequency Range	8-18
Amplitude	50
Variable	Cal
Amplitude Range	50-500 mV
Power	On

c. Connect the 10-MHz signal from the Type 191 Output connector through a 5-ns coaxial cable and GR-to-BNC adapter to the flexible T connector.

d. Use the positioning controls to position the display for best viewing.

e. Set the Type 191 Variable control to obtain a display 5 divisions peak to peak in amplitude. This indicates that a 1-volt signal is applied to the Type 7A13.

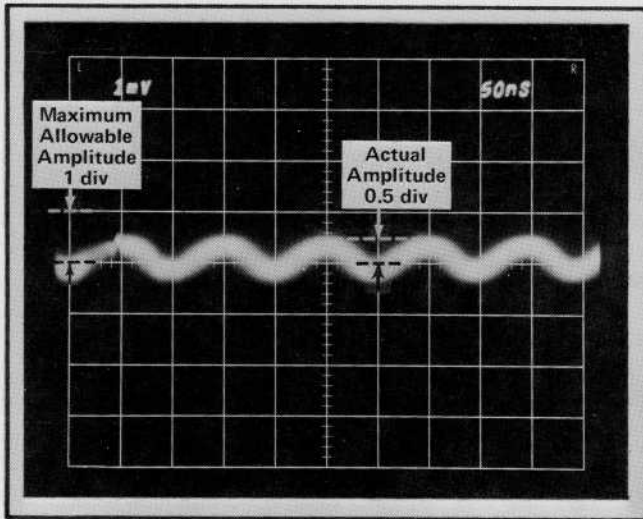

Fig. 5-21. Measuring the peak-to-peak amplitude of a common mode difference signal. Vertical deflection factor: 1 mV/div; sweep rate: .05 μ s/div.

f. Set the controls as follows:

Type 7A13

—INPUT Mode DC
VOLTS/DIV 1 mV

Time Base Plug-In

Time/Div .05 μ s

g. CHECK—One division or less display amplitude. This is equivalent to a CMRR of 1,000:1 or greater. Measure the peak to peak excursion, excluding the trace thickness, as shown in Fig. 5-21.

h. ADJUST—C171, C271, C162, C262, C124 and C224 (see Fig. 5-22) to reduce the display amplitude.

Next, adjust either C134 or C234 (see Fig. 5-22) by turning the slug clockwise several turns. Then, readjust C124 and C224 for minimum display amplitude. If the minimum amplitude thus obtained is not less than the amplitude obtained before C134 or C234 was adjusted, turn C134 or C234 slug (whichever was previously adjusted) to a position that is further outward than the original position. Readjust C124 and C224 for minimum amplitude.

Repeat, if necessary, the procedure for adjusting C134 (or C234), C124 and C224 to obtain minimum display amplitude. Also, if necessary readjust R167 (see Fig. 5-6).

Readjust C124 and C224 for minimum amplitude. Repeat, if necessary, the procedure for adjusting C134 (or C234), C124

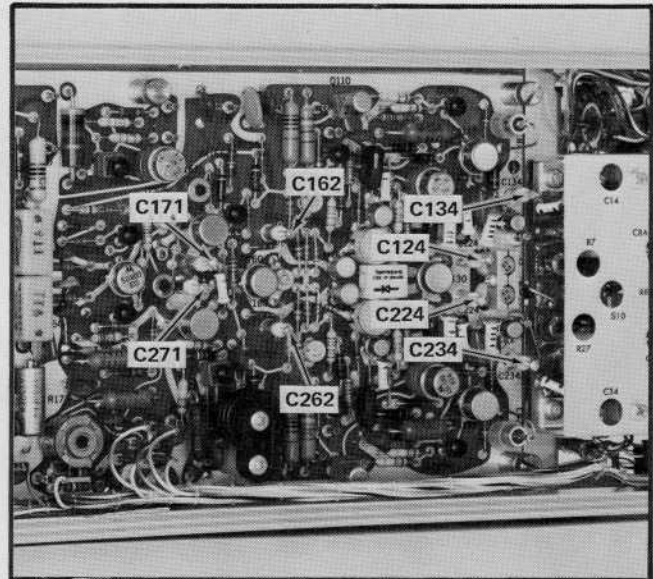

Fig. 5-22. Locations of adjustments on the Input board for the Common Mode Rejection Adjustments procedure.

and C224 to obtain minimum display amplitude. Also, if necessary readjust R167 (see Fig. 5-6).

i. Set the controls as follows to apply a 10-volt 1-MHz common mode signal to the Type 7A13.

Type 191

Frequency dial 1 MHz
Frequency Range .75-1.6
Amplitude Range .5-5 V

Time Base Plug-In

Time/Div .5 μ s

j. CHECK—One division or less display amplitude. This is equivalent to a CMRR of 10,000:1 or greater.

k. ADJUST—If necessary, readjust C162, C262, C171 and C271 to obtain minimum display amplitude.

l. INTERACTION—Repeat steps 20a through 20i using the 1-volt 10-MHz signal. Readjust C134 or C234 (see Fig. 5-22) and R167 (see Fig. 5-6) a slight amount to obtain minimum amplitude. The procedure and all adjustments given in step 20 may need to be readjusted several times to obtain the best compromise between the display amplitude obtained using the 10-MHz signal and the one obtained using the 1-MHz signal.

m. CHECK—Using Table 5-6 as a guide, check the peak-to-peak display amplitude at the given frequencies.

TABLE 5-6

Common Mode Rejection Checks

Generator	Generator		VOLTS/ DIV	Time/Div	P-P Display Amplitude	CMRR
	Frequency	Amplitude				
Type 191	20 MHz	1 V	1 mV	.02 μ s or .05 μ s	4 div or less	250:1
	5 MHz	2 V	1 mV	.1 μ s or .2 μ s	1 div or less	2,000:1
Low-Freq. Sine-Wave Generator	100 kHz	20 V	1 mV	10 μ s or 5 μ s	1 div or less	20,000:1

n. Disconnect the signal from the flexible T connector.

o. INTERACTION—Repeat step 17 and then step 20 as often as necessary to meet the performance requirements.

21. Check/Adjust Attenuator Common Mode Rejection at 100 Hz

a. Set the controls as follows:

Type 7A13

+INPUT Mode	GND
—INPUT Mode	GND
VOLTS/DIV	2 V
Polarity	—
VOLTS Counter	050.0
BW	5 MHz

Time Base Plug-In

Time/Div	5 ms
----------	------

Type 106

Repetition Rate Range	100 Hz
Multiplier	1
Symmetry	Midrange
Amplitude	CCW
Hi Amplitude/Fast Rise	Hi Amplitude
Fast Rise controls	Not Applicable
Power	On

b. Apply the 100-Hz signal from the Type 106 Output connector through a 5-ns coaxial cable and a GR-to-BNC adapter to the flexible T connector attached to the Type 7A13.

c. Using the Type 7A13 POSITION control, position the trace to graticule center.

d. Simultaneously set the +INPUT Mode switch to DC and the —INPUT Mode switch to Vc.

e. Set the Type 106 Amplitude control to position the bottom of the square waves to coincide with graticule center. At this point in the procedure, the Type 106 generator is set for a —50 volts to 0 volt peak amplitude square-wave output signal.

NOTE

To check that the signal is set to the proper amplitude, press the Vc REF-IDENT button and check that the trace is positioned to graticule center. Release the Vc REF-IDENT button. Readjust, if necessary, the generator Amplitude control to position the bottom of the square waves to coincide with graticule center.

f. Set the controls as follows:

Type 7A13

—INPUT Mode	DC
VOLTS/DIV	.1 V

Time Base Plug-In

Time/Div	2 ms
----------	------

g. CHECK—For a 0.25 division (25 mV) or less display amplitude when comparing the flat top and bottom portions of the common mode difference signal. This is equivalent to a CMRR of 2,000:1 or greater. Ignore the spikes on the leading portions of the square waves.

h. ADJUST—R28G (see Fig. 5-9B) for minimum square wave display amplitude when comparing the flat portions of the signal.

i. Set the VOLTS/DIV switch to 1 V.

j. CHECK—For $\frac{1}{8}$ of a minor division (25 mV) or less display amplitude when comparing the flat top and bottom portions of the square wave. This is equivalent to a CMRR of 2,000:1 or greater.

NOTE

$\frac{1}{8}$ minor division (about $\frac{1}{2}$ trace width) is difficult to measure. However, measure the amplitude as closely as possible to determine whether or not the requirement is met.

Calibration Procedure Only: If there is some doubt, slight adjustment of R5E (part k of this step) reduces the amplitude to a straight line so that the Type 7A13 will have a CMRR of 2,000:1 or greater.

k. ADJUST—R5E (see Fig. 5-9B) for minimum square wave display amplitude when comparing the flat portions of the signal.

l. Disconnect the signal from the flexible T connector and turn off the generator.

22. Check/Adjust Attenuator Common Mode Rejection at 10 kHz

a. Set the controls as follows:

Type 7A13

+INPUT Mode	GND
—INPUT Mode	GND
VOLTS/DIV	2 V
VOLTS Counter	025.0

Time Base Plug-In

Time/Div	.5 ms
----------	-------

Low-Frequency Sine-Wave Generator

Frequency switch	2 kHz-20 kHz
Frequency dial	10
Level control	As is

b. Apply the 10 kHz signal from the low frequency sine-wave generator Output connector through a 42-inch 50-ohm coaxial cable to the flexible T connector attached to the Type 7A13.

c. Using the Type 7A13 POSITION control, position the trace to graticule center.

d. Simultaneously set the +INPUT Mode switch to DC and the —INPUT Mode switch to Vc.

e. Set the generator Level control so that the bottom tips of the sine waves coincide with graticule center. At this point in the procedure, the generator is set for a 50-volt peak-to-peak output signal.

NOTE

To check that the signal is set to the proper amplitude, press the Vc REF-IDENT button and check that the trace is positioned to graticule center. Release the Vc REF-IDENT button. Readjust, if necessary, the generator Level control to position the sine wave tips to coincide with graticule center.

f. Set the controls as follows:

Type 7A13

—INPUT Mode	DC
VOLTS/DIV	.1 V

Time Base Plug-In

Time/Div	.2 ms
----------	-------

g. CHECK—For 0.25 division (25 mV) or less display amplitude. This is equivalent to a CMRR of 2,000:1 or greater.

h. ADJUST—C28A (see Fig. 5-9B) slightly for minimum display amplitude.

i. Set the VOLTS/DIV switch to 1 V.

j. CHECK—For $\frac{1}{8}$ of a minor division (25 mV) or less display amplitude. This is equivalent to a CMRR of 2,000:1 or greater.

NOTE

Measure the amplitude as closely as possible. Exclude the thickness of the trace when making the measurement. Calibration Procedure Only: If there is doubt whether or not the display amplitude meets the requirement, slight adjustment of C25A (part k of this step) causes a noticeable effect on the display and it is easy to observe when the minimum amplitude point is reached.

k. ADJUST—C25A (see Fig. 5-9B) slightly for minimum display amplitude.

l. Disconnect the signal and turn off the generator. Remove the flexible T connector from the Type 7A13.

TRIGGER & SIGNAL AMPLIFIER RESPONSE CHECKS

(including a trigger gain check)

Control Settings

When performing a complete procedure, change the following control settings and proceed with step 23.

Type 7A13

—INPUT Mode	GND
VOLTS/DIV	10 mV
VOLTS Counter	0.000
Polarity	Pushbuttons canceled
BW	FULL

Time Base Plug-In

Time/Div	.05 μ s
----------	-------------

If the remaining controls need to be checked for proper settings or if step 23 is being used as starting point for partially calibrating the Type 7A13, refer to the Preliminary Procedure except as follows:

Type 7A13

+INPUT Mode	DC
-------------	----

23. Check Trigger Amplifier Gain and Step Response

a. Test equipment setup, with connections made at completion of step 23c, is shown in Fig. 5-23.

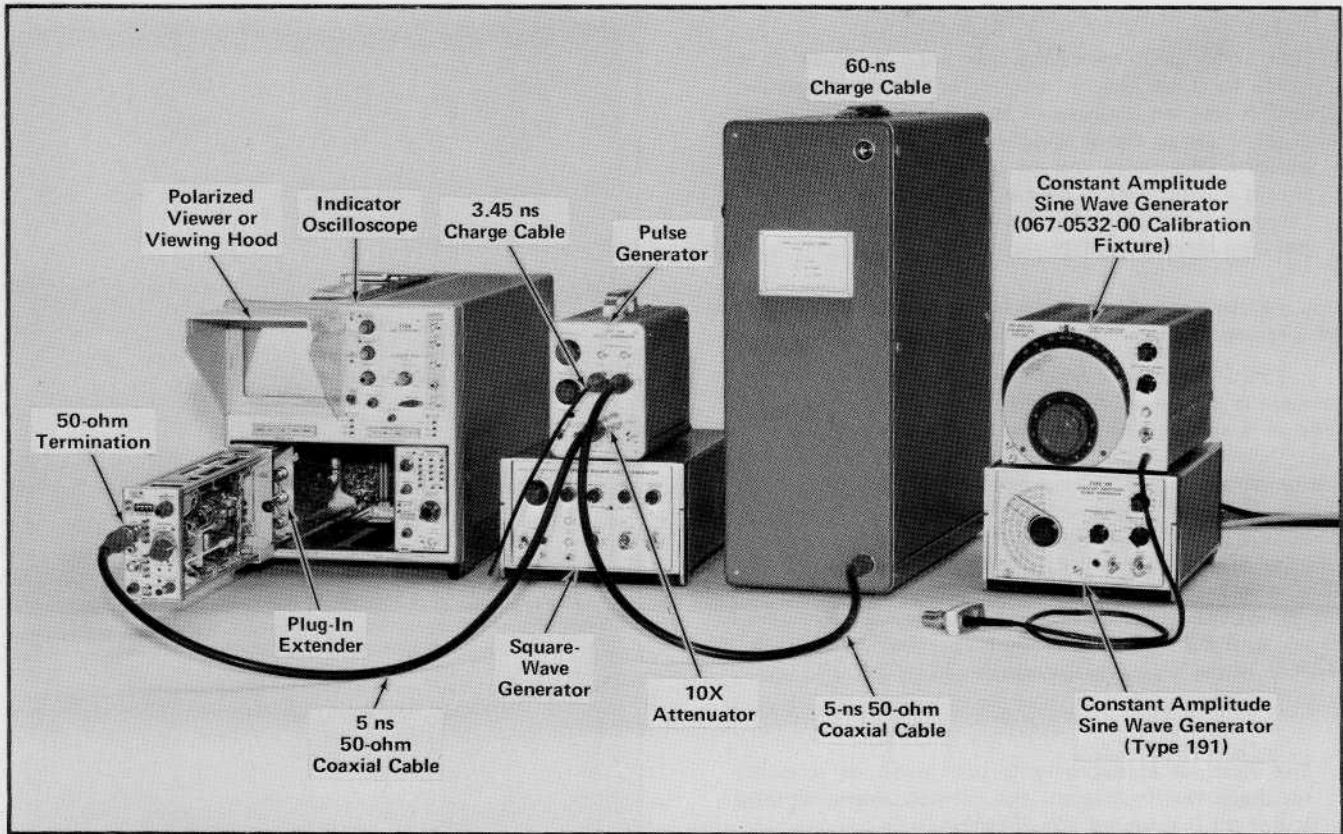

Fig. 5-23. Initial setup and the equipment required for checking the trigger and signal amplifier response described in steps 23 through 26.

b. Insert the Plug-In Extender between the Type 7A13 and the indicator oscilloscope Left Vert plug-in connector.

c. Repeat steps 17c through 17g except that the generator should be set to obtain a 6-division peak-to-peak display amplitude.

d. Note the amplitude of the narrow pulse or check the risetime by measuring the time interval between the 10% and 90% amplitude points on the rising portion of the wide pulse waveform.

e. Partially remove the Plug-In Extender (with Type 7A13 attached). Interchange the signal and trigger coaxial cables on the Plug-In Extender. Fig. 5-24 shows the locations of the coaxial cables on the right side of the Plug-In Extender. The cables on the left side of the extender are in similar locations. (After interchanging the cables, the signal from pins A11 and B11 on the Type 7A13 Output board connector will be applied via the coaxial cables to the trigger connectors on each side of the Plug-In Extender. The trigger from pins A13 and B13 on the Output board will now be applied via the coaxial cables to the signal connectors on each side of the Plug-In Extender).

f. Re-insert the Plug-In Extender (with Type 7A13 attached) into the indicator oscilloscope.

g. Calibration Procedure Only. Check the trigger amplitude to signal amplitude gain matching by measuring the

amplitude of the wide pulse trigger waveform. The amplitude of the wide pulse should be within 15% (± 0.9 division) of the 6-division signal amplitude used as a reference in step 23d.

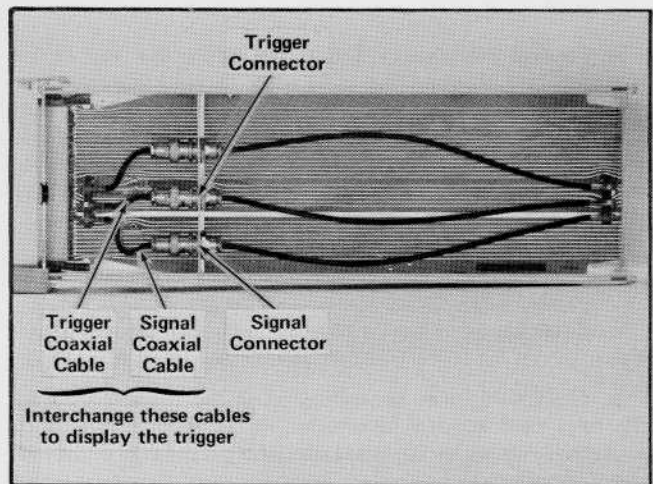

Fig. 5-24. Right side view of the Plug-In Extender showing the locations of the signal and trigger connectors with their associated coaxial cables. Left side view (not shown) is the same.

Performance Check/Calibration—Type 7A13

NOTE

This 15% gain matching tolerance is given as a guide to check the instrument for correct operation and is not an instrument specification. There are other ways to check trigger gain if it is desired to perform this check out of sequence using another signal source. For example, use the indicator oscilloscope 4-mV calibrator as a reference signal and perform the check after step 8.

h. Set the generator output amplitude to obtain a 6-division peak-to-peak wide pulse display amplitude.

i. CHECK—System risetime using the trigger. The measurement is performed as follows: Using a wide pulse amplitude of 6 divisions as a reference, the narrow pulse amplitude should be 0.4 division (or less) lower in amplitude than the amplitude of the pulse noted in step 23d. For example, if step 23d pulse amplitude is 4.9 divisions, the trigger pulse amplitude should be 4.5 divisions or more in amplitude. The risetime of the wide pulse, measured from the 10% to the 90% points, should be about 0.1 ns slower (or less) for the trigger waveform as compared to the signal waveform. For example, if the signal waveform had a risetime of 3.5 ns, the risetime of the trigger waveform should be 3.6 ns or less.

NOTE

The risetime measurements are given as a guide to check the instrument for correct operation and is not an instrument specification.

j. Return the signal and trigger coaxial cables on the Plug-In Extender to their original connections.

k. Set the Type 106 controls to the settings given in step 17h and use step 17h as a guide for applying the signal to the Type 7A13. Leave the VOLTS/DIV switch at 10 mV.

l. Check that the display is 6 divisions peak to peak in amplitude in the 40 ns to 50 ns region when using a sweep rate of 10 ns/div.

m. Position the display 2 divisions below the top of the graticule and measure the total peak to peak aberration in the form of overshoot, rounding, ringing, or tilt, expressed as a percentage of square-wave amplitude. Exclude the thickness of the trace in the measurement. Use this information as a guide to check the trigger aberrations in the procedure that follows.

n. Interchange the signal and trigger coaxial cables on the Plug-In Extender to permit viewing the trigger.

o. Reset the generator to obtain a 6-division display amplitude.

p. CHECK—System aberration using the trigger. Measure the total peak to peak aberration in the form of overshoot, rounding, ringing, or tilt, expressed as a percentage of square-wave amplitude.

The trigger waveform should appear very similar to the signal waveform noted in step 23n. The peak to peak aberration should be no greater than +4%, -4%, or a total that does not exceed 6% peak to peak.

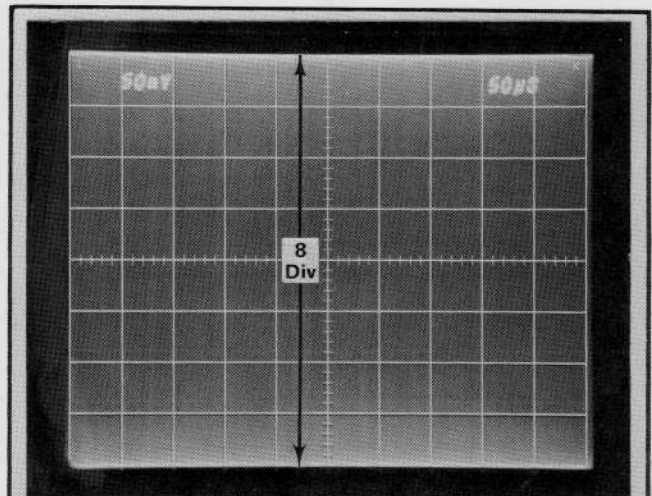

(A) Reference amplitude.

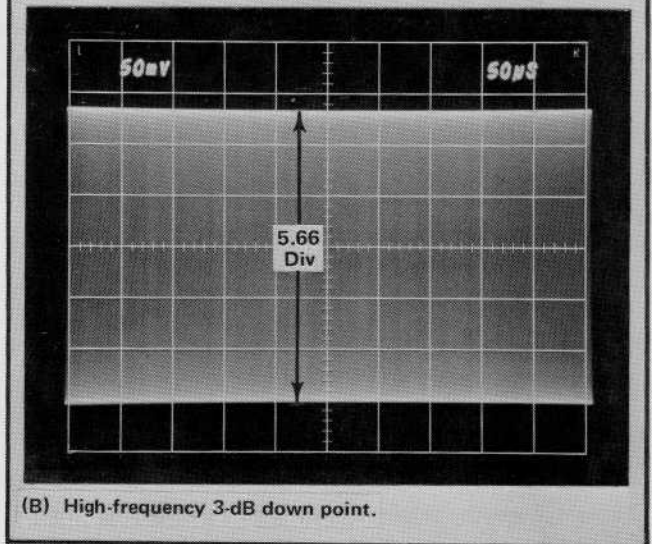

(B) High-frequency 3-dB down point.

Fig. 5-25. CRT display obtained when checking high-frequency upper-limit sine-wave response. Sweep rate is 50 μ s/div.

NOTE

The aberration tolerance is given as a guide to check the instrument for correct operation and is not an instrument specification.

q. Disconnect the signal and turn off the Type 106 generator.

24. Check Trigger Amplifier High-Frequency Sine Wave Response

a. Set the controls as follows:

	Time Base Plug-In	
Magnifier		$\times 1$
Time/Div		50 μ s

**Constant Amplitude Signal Generator
(067-0532-00 Calibration Fixture)**

Frequency dial	95
Amplitude	.5
Variable	Cal
Frequency Range	3.0 (MHz)
Power	On

b. Apply the 3-MHz sine wave signal from the 067-0532-00 generator through a 10× attenuator and 50-ohm termination to the Type 7A13 +INPUT connector.

c. Adjust the generator Variable (Amplitude) control to obtain a display 8 divisions in amplitude. This is the reference amplitude (see Fig. 5-25A).

d. Set the generator Frequency Range switch to 65-500.

e. Without changing the generator output amplitude, increase the output frequency until the vertical deflection of the display is reduced to 5.66 divisions (see Fig. 5-25B). This is the 30% down voltage point that is equivalent to the -3 dB point.

f. CHECK—Output frequency should be 100 MHz or higher.

NOTE

This upper limit bandwidth check is given as a guide to check the instrument for correct operation and is not an instrument specification.

g. Remove the Plug-In Extender and insert the Type 7A13 directly into the Left Vert plug-in compartment of the indicator oscilloscope. Leave the signal applied to the Type 7A13.

h. Interchange the coaxial cables on the Plug-In Extender to return the cables to their respective connectors. The Plug-In Extender will not be needed for the remaining steps.

25. Check Signal Amplifier High-Frequency Sine Wave Response

a. Set the 067-0532-00 generator controls as follows:

Frequency dial	95
Frequency Range	3.0

b. Set the generator Variable (Amplitude) control to obtain a display 8 divisions in amplitude.

c. Set the generator Frequency Range switch to 65-500.

d. Without changing the generator output amplitude, increase the output frequency until the vertical deflection of the display is reduced to 5.66 divisions.

e. CHECK—Output frequency should be 100 MHz or higher.

f. Disconnect the signal and turn off the generator.

26. Check Signal Amplifier 5-MHz Bandwidth Sine Wave Response

a. Set the controls as follows:

Type 7A13

VOLTS/DIV	10 mV
BW	5 MHz

Time Base Plug-In

Time/Div	.5 ms
----------	-------

Type 191

Frequency dial	3.6 MHz
Frequency Range	50 kHz Only
Amplitude	5
Variable	Cal
Amplitude Range	50-500 mV
Power	On

b. Apply the generator signal through a 5-ns coaxial cable and 50-ohm termination to the Type 7A13 +INPUT connector.

c. Set the Type 191 Variable control to obtain a display 8 divisions peak to peak in amplitude. Use the positioning controls to position the display for best viewing.

d. Set the Type 191 Frequency Range switch to 3.6-8.

e. Slowly increase the Type 191 frequency until the amplitude of the display is 5.66 divisions peak to peak in amplitude.

f. CHECK—The setting of the Type 191 Frequency dial. The frequency should be between 4.5 MHz and 5.5 MHz.

g. Disconnect the signal and turn off the generator.

COMPARISON VOLTAGE ADJUSTMENTS

Control Settings

When performing a complete procedure change the following control settings and proceed with step 27.

Type 7A13

VOLTS Counter	9.999 plus 1 digit to indicate 9.000 (equivalent to a Vc output of 10 V)
Polarity	+
+INPUT Mode	GND
VOLTS/DIV	1 mV

If the remaining controls need to be checked for proper settings or if step 27 is being used as a starting point for partially calibrating the Type 7A13, refer to the Preliminary Procedure.

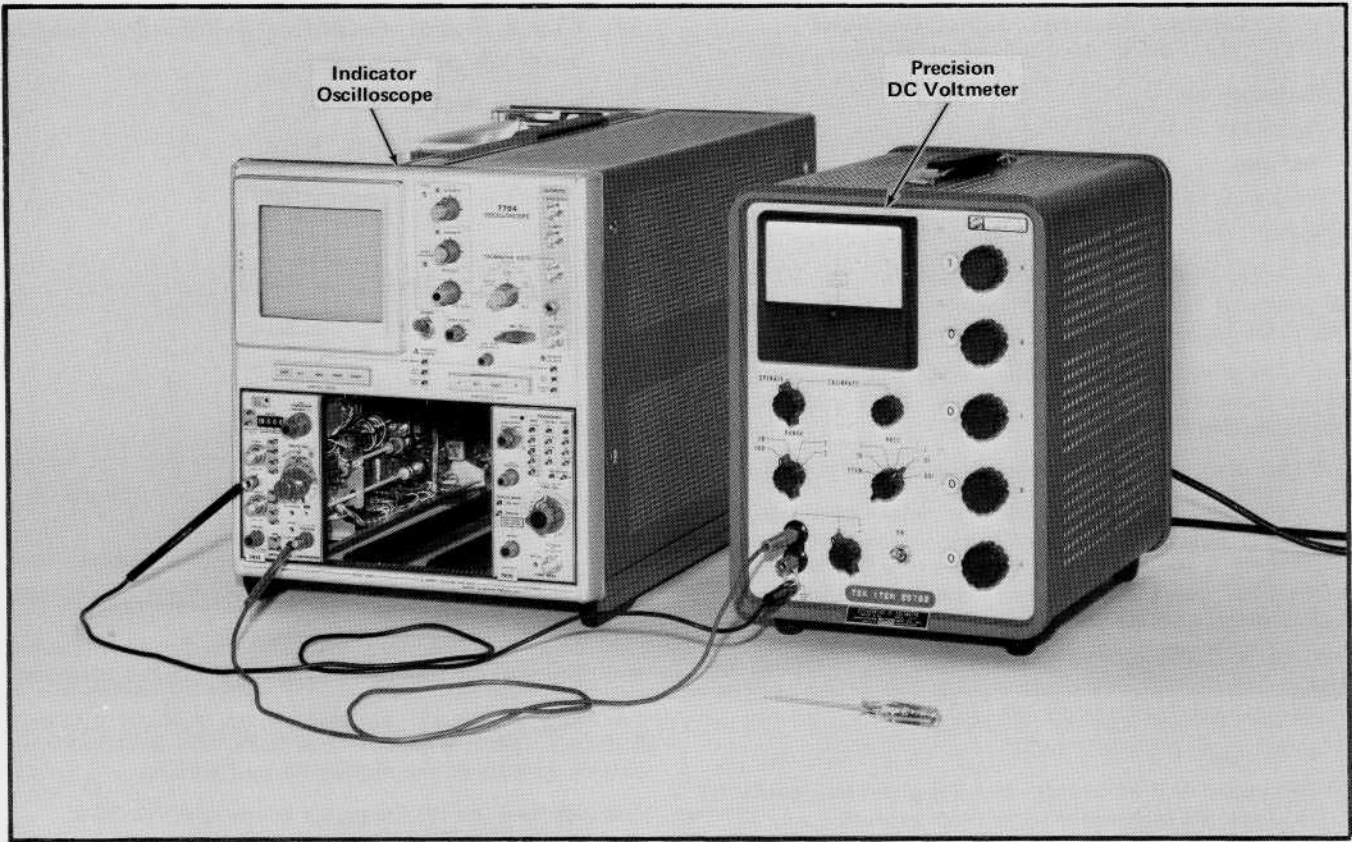

Fig. 5-26. Initial setup showing equipment required for performing steps 27 through 31.

27. Check/Adjust 10-Volt Calibration

a. Test equipment setup, with connections made at completion of step 27d, is shown in Fig. 5-26.

b. Using the POSITION control, position the trace to coincide with the graticule centerline.

c. Preset the Precision DC Voltmeter to measure +10 volts.

d. Connect the Precision DC Voltmeter between the Vc OUT 0-10 V jack and Gnd on the Type 7A13.

e. CHECK—For a null reading at +10 V on the Precision DC Voltmeter, within a tolerance of ± 0.015 V. (This is equivalent to 0.1% times 10 V plus 5 mV.)

f. Simultaneously set the Type 7A13 and Precision DC Voltmeter Polarity switches to —.

g. CHECK—For a null reading at —10 V on the Precision DC Voltmeter, within a tolerance of ± 0.015 V.

h. Calibration Procedure Only. Lay the indicator oscilloscope on its right side.

i. ADJUST—10 V Cal control R573 (see Fig. 5-27) to obtain a null indication on the Precision DC Voltmeter. Simultaneously set the Type 7A13 and Precision DC Voltmeter Polarity switches to +. Repeat steps 27e through 27i. If necessary,

readjust R573 to obtain a compromise setting between the + and — Polarity null indications.

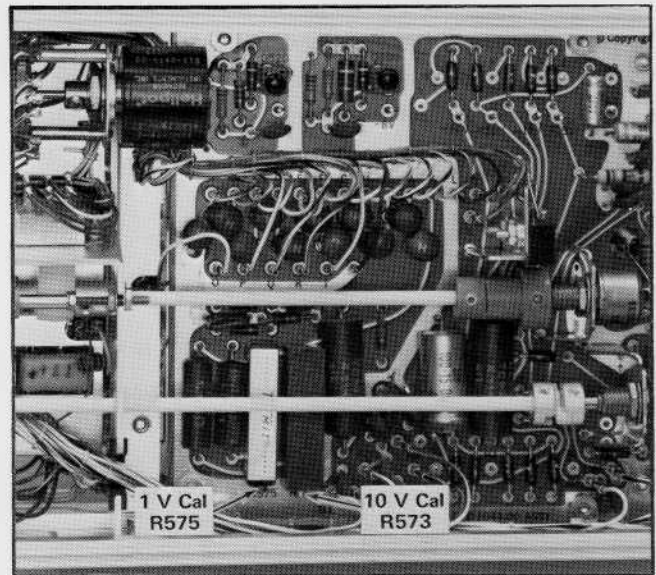

Fig. 5-27. Comparison Voltage adjustment locations on the Output board.

28. Check/Adjust 1-Volt Calibration **①**

a. Decrease the sensitivity of the Precision DC Voltmeter and set it to measure -1 V. Check that the Type 7A13 Polarity switch is set to $-$.

b. Set the Type 7A13 VOLTS Counter to indicate 0.999 plus one digit to provide a V_c output of one volt.

c. Increase the sensitivity of the Precision DC Voltmeter.

d. CHECK—For a null reading at -1 V on the Precision DC Voltmeter, within a tolerance of ± 0.006 V. (This is equivalent to 0.1% times 1 V plus 5 mV.)

e. Simultaneously set the Type 7A13 and Precision DC Voltmeter Polarity switches to $+$.

f. CHECK—For a null reading at $+1$ V on the Precision DC Voltmeter, within a tolerance of ± 0.006 V.

g. ADJUST—1 V Cal control R575 (see Fig. 5-27) to obtain a null indication on the Precision DC Voltmeter. Simultaneously set the Type 7A13 and Precision DC Voltmeter Polarity switches to $-$. Repeat steps 28d through 28g. If necessary readjust R575 to obtain a compromise setting between the $+$ and $-$ Polarity null indications.

h. INTERACTION—Repeat steps 27 and 28 (up to step 28g) several times due to interaction between R573 and R575.

i. Calibration Procedure Only. Place the indicator oscilloscope in its upright position.

29. Check Comparison Voltage Linearity

a. Check that the Type 7A13 and Precision DC Voltmeter Polarity switches are set to $+$.

b. Set the Type 7A13 VOLTS Counter to 0.100 and preset the Precision DC Voltmeter to measure 100 mV.

c. CHECK—Using Table 5-7 as a guide, check the accuracy of the VOLTS Counter readout. Use the Precision DC Voltmeter to measure the voltages. The voltage range given in the table is the tolerance and is derived as follows: 0.1% times the VOLTS Counter indication plus 5 mV.

30. Check Volts Counter Mechanical Backlash

a. Decrease the sensitivity of the Precision DC Voltmeter and set it to measure $+5.5$ V. Check that the Type 7A13 Polarity switch is set to $+$.

b. Set the VOLTS Counter to indicate 5.300.

c. Rotate the Type 7A13 FINE control slowly clockwise toward 5.500. When appropriate, increase the sensitivity of the Precision DC Voltmeter to obtain optimum readout resolution. As the Precision DC Voltmeter reaches the null indication, stop rotating the FINE control in the clockwise direction.

TABLE 5-7

Comparison Voltage Linearity

VOLTS Counter	Voltage Output at V_c OUT 0-10 V Jack
0.100	+0.0949 V to +0.1051 V
0.200	+0.1948 V to +0.2052 V
0.300	+0.2947 V to +0.3053 V
0.400	+0.3946 V to +0.4054 V
0.500	+0.4945 V to +0.5055 V
0.600	+0.5944 V to +0.6056 V
0.700	+0.6943 V to +0.7057 V
0.800	+0.7942 V to +0.8058 V
0.900	+0.8941 V to +0.9059 V
1.000 ^a	+0.994 V to +1.006 V
2.000	+1.993 V to +2.007 V
3.000	+2.992 V to +3.008 V
4.000	+3.991 V to +4.009 V
5.000	+4.990 V to +5.010 V
6.000	+5.989 V to +6.011 V
7.000	+6.988 V to +7.012 V
8.000	+7.987 V to +8.013 V
9.000	+8.986 V to +9.014 V
9.999 plus 1 digit	+9.985 V to +10.015 V

^aFINE control set fully counterclockwise so that the last three digits indicate all zeros for this reading and all remaining readings through 9.000.

NOTE

While performing this step, do not rotate the FINE control counterclockwise at any time. But, do rotate the FINE control slowly in the clockwise direction. As soon as the null point is reached immediately stop rotating the control.

d. Note the exact VOLTS Counter reading; i.e., note the exact position of the last digit by estimating the reading to the 4th decimal place.

e. Decrease the sensitivity of the Precision DC Voltmeter and set the VOLTS Counter to indicate 5.700.

f. Rotate the FINE control slowly counterclockwise toward 5.500. When appropriate, increase the sensitivity of the Precision DC Voltmeter to obtain optimum readout resolution. As the Precision DC Voltmeter reaches the null indication, stop rotating the FINE control in the counterclockwise direction.

g. Note the exact VOLTS Counter reading.

h. CHECK—The difference between the VOLTS Counter reading noted in step 30d and the reading obtained in step 30g should be less than 1 digit. For example, if step 30d reading is 5.5004 (estimated 4th decimal place reading) and step 30g reading is 5.501, the difference between the two readings is 0.0006, which is within the 1 digit tolerance for correct instrument operation.

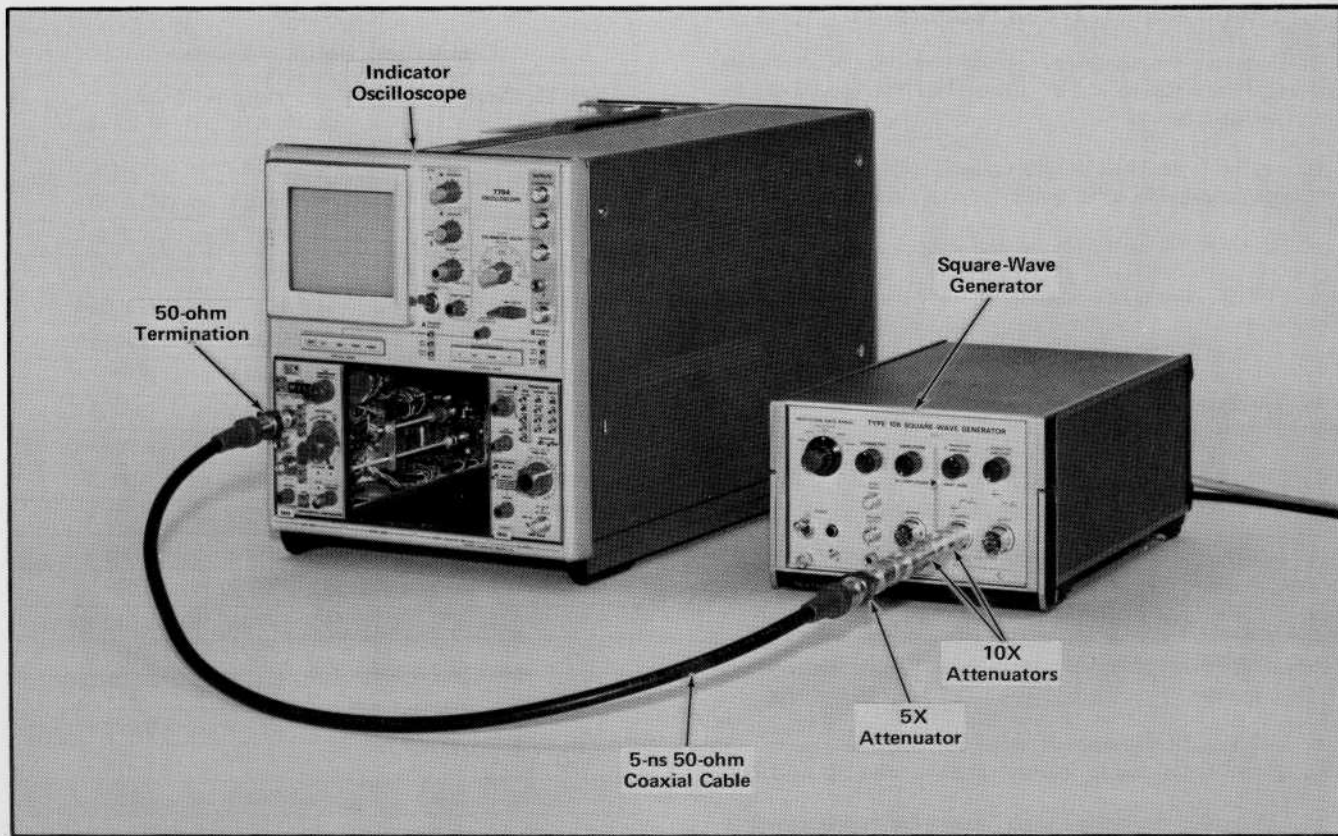

Fig. 5-28. Equipment setup for step 32.

NOTE

The one digit tolerance is given as a guide to correct instrument operation and is not an instrument specification.

i. Disconnect and turn off the Precision DC Voltmeter.

c. Set the +INPUT Mode switch to V_c.

d. CHECK—For trace shift that does not exceed 0.5 division. Exclude the thickness of the trace when making this measurement.

31. Check Electrical Zero

- a. Set the VOLTS Counter to 0.000.
- b. If desired, check the settings of the remaining Type 7A13 controls:

Polarity	+
+INPUT Mode	GND
-INPUT Mode	GND
VOLTS/DIV	1 mV
VARIABLE (VOLTS/DIV)	Cal
PULL VAR FOR $\times 10$ V _c RANGE	Pushed in
VAR BAL	Properly adjusted
BW	5 MHz
POSITION	Trace centered

NOISE & OVERDRIVE RECOVERY CHECKS

Control Settings

When performing a complete procedure, change the following control settings and proceed with step 32.

Type 7A13

Polarity	Pushbuttons canceled
+INPUT Mode	DC
-INPUT Mode	GND
BW	FULL

Time Base Unit

Triggering Mode	Auto
Time/Div	10 μ s

If the remaining controls need to be checked for proper settings or if step 32 is being used as a starting point for partially calibrating the Type 7A13, refer to the Preliminary Procedure except as follows:

Type 7A13

VOLTS/DIV 1 mV

32. Check Noise⁷

a. Test equipment setup, with connections made at completion of step 32c, is shown in Fig. 5-28.

b. Set the Type 106 Square-Wave Generator controls as follows:

Repetition Rate Range	1 kHz
Multiplier	1
Symmetry	Midrange
+Transition Amplitude	Midrange
Hi Amplitude/Fast Rise	Fast Rise
Hi Amplitude	Not applicable
Power	On

c. Apply the 1 kHz signal from the Type 106 +Output connector through two 10× attenuators (connected in series), a 5× attenuator, a 5-ns coaxial cable, and a 50-ohm termination to the Type 7A13 +INPUT connector. Fig. 5-28 shows the connecting sequence for the items.

d. Set the Type 106 +Transition Amplitude control to provide two separate traces on the CRT. Set the Level/Slope on the Time Base unit to obtain a free-running sweep. These traces are caused by the upper and lower excursions of the square waves being presented on the free running sweep.

e. Rotate the +Transition Amplitude control slowly counterclockwise to just eliminate the dark line between the two traces. Use Fig. 5-29A and B as guides.

f. Set the VOLTS/DIV switch to 10 mV.

g. Remove two 10× attenuators so that the 5× attenuator is connected to the Type 106 +Output connector. This increases the signal drive by 100 times, allowing more accurate measurement of displayed noise.

h. CHECK—Noise amplitude. Measure the distance between trace centers in mV (see Fig. 5-29C). This is the free-running square-wave amplitude. Divide the amplitude in mV by 100. The result should be 400 μV, or less, noise tangentially measured. Division by 100 compensates for the removed attenuators.

Using Fig. 5-29C as an example, the actual square-wave amplitude is 2.3 divisions or 23 mV. 23 mV divided by 100 is 0.23 mV or 230 μV of displayed noise. This amplitude is within the 400 μV noise requirement.

i. Disconnect the signal from the Type 7A13.

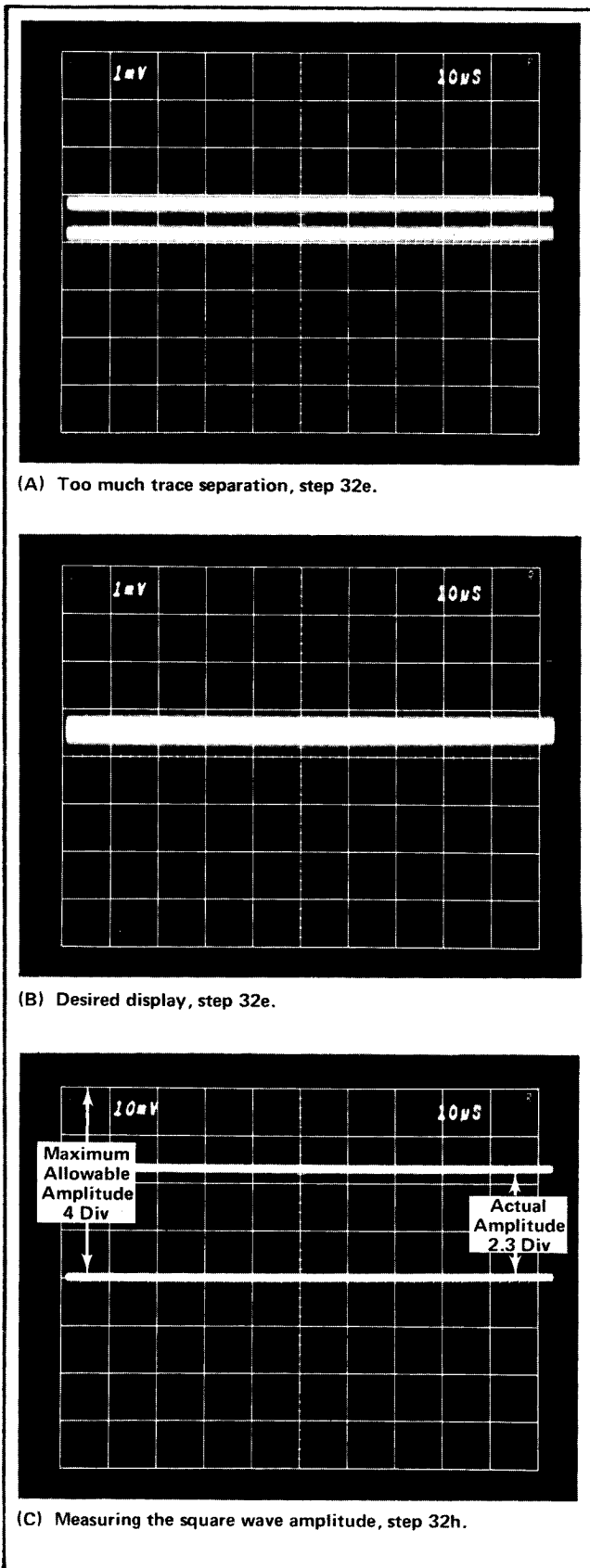

(A) Too much trace separation, step 32e.

(B) Desired display, step 32e.

(C) Measuring the square wave amplitude, step 32h.

Fig. 5-29. Noise measurement displays. Sweep rate: 10 μs/div, free running.

⁷Val Garuts and Charles Samuel, "Measuring Conventional Oscilloscope Noise", Tektronix, Inc., Oregon, 1969. Pages 8-11, April 1969 "Tekscope", Vol. 1, No. 2.

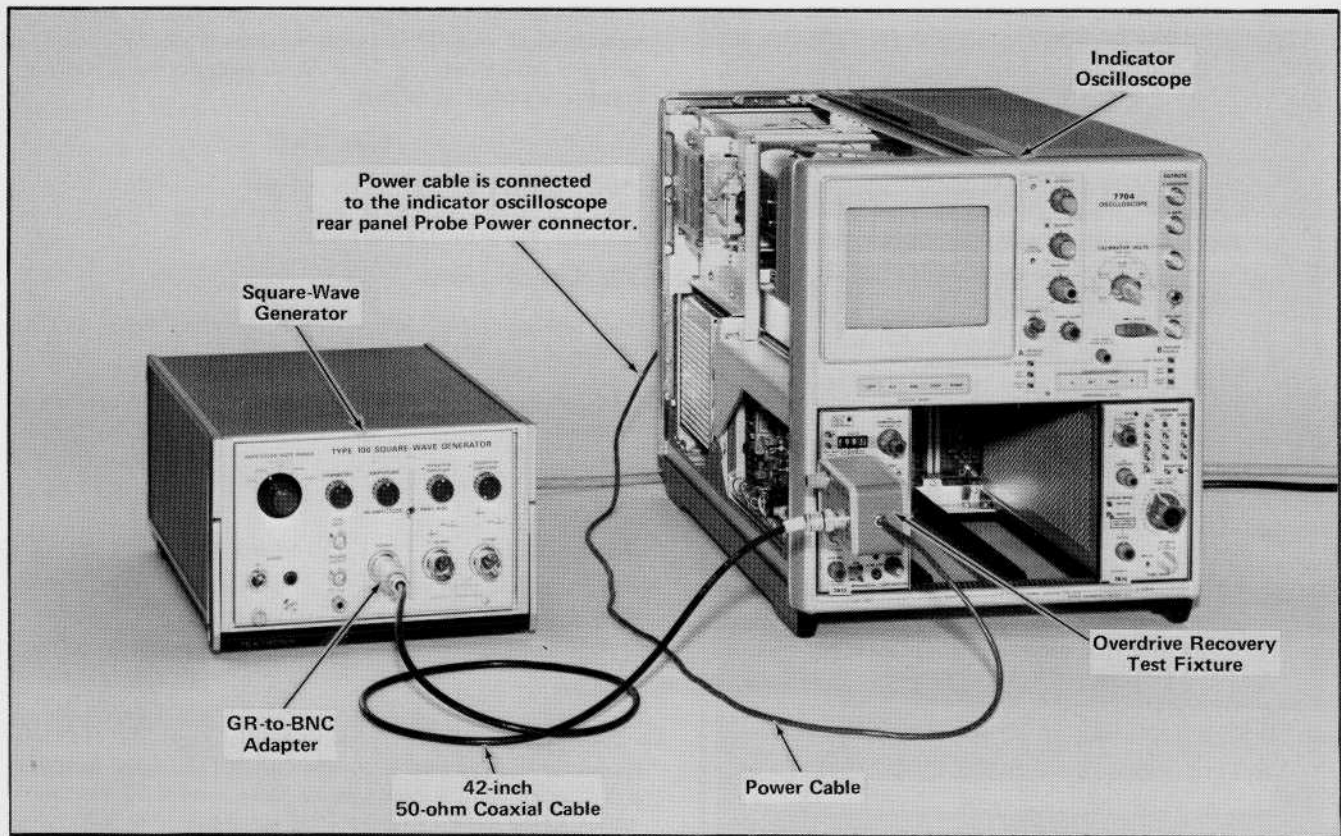

Fig. 5-30. Equipment setup required for performing step 23.

Control Settings

When performing a complete procedure, change the following control settings and proceed with step 33.

Type 7A13

VOLTS/DIV 2 V

Time Base Plug-In

Level/Slope (Triggering) Negative slope region
 Triggering Mode P-P Auto
 Time/Div 1 ms

If the remaining controls need to be checked for proper settings, refer to the Preliminary Procedure except as follows:

Type 7A13

+INPUT Mode DC
 BW FULL

33. Check Overdrive Recovery Time

a. Test equipment setup, with connections made at completion of step 33f, is shown in Fig. 5-30.

b. Connect the Overdrive Recovery test fixture output connector to the Type 7A13 +INPUT connector.

c. Connect the Overdrive Recovery test fixture power cable to the indicator oscilloscope rear panel Probe Power connector.

d. Set the Overdrive Recovery test fixture Polarity switch to + and the Level control to its fully counterclockwise position.

e. Set the Type 106 controls as follows:

Repetition Rate Range	100 Hz
Multiplier	5
Symmetry	Midrange
Amplitude	Midrange
Hi Amplitude/Fast Rise	Hi Amplitude
Fast Rise controls	Not Applicable

f. Apply the signal from the Type 106 high amplitude Output connector through a GR-to-BNC adapter and a 42-inch 50-ohm coaxial cable to the Switch Drive connector on the Overdrive Recovery test fixture.

g. Adjust the Type 106 Symmetry, Multiplier, and (if necessary) the Amplitude controls for audible reed resonance.

NOTE

Do not exceed the midrange setting of the Amplitude control. Excessive amplitude will cause the reed drive coil to overheat.

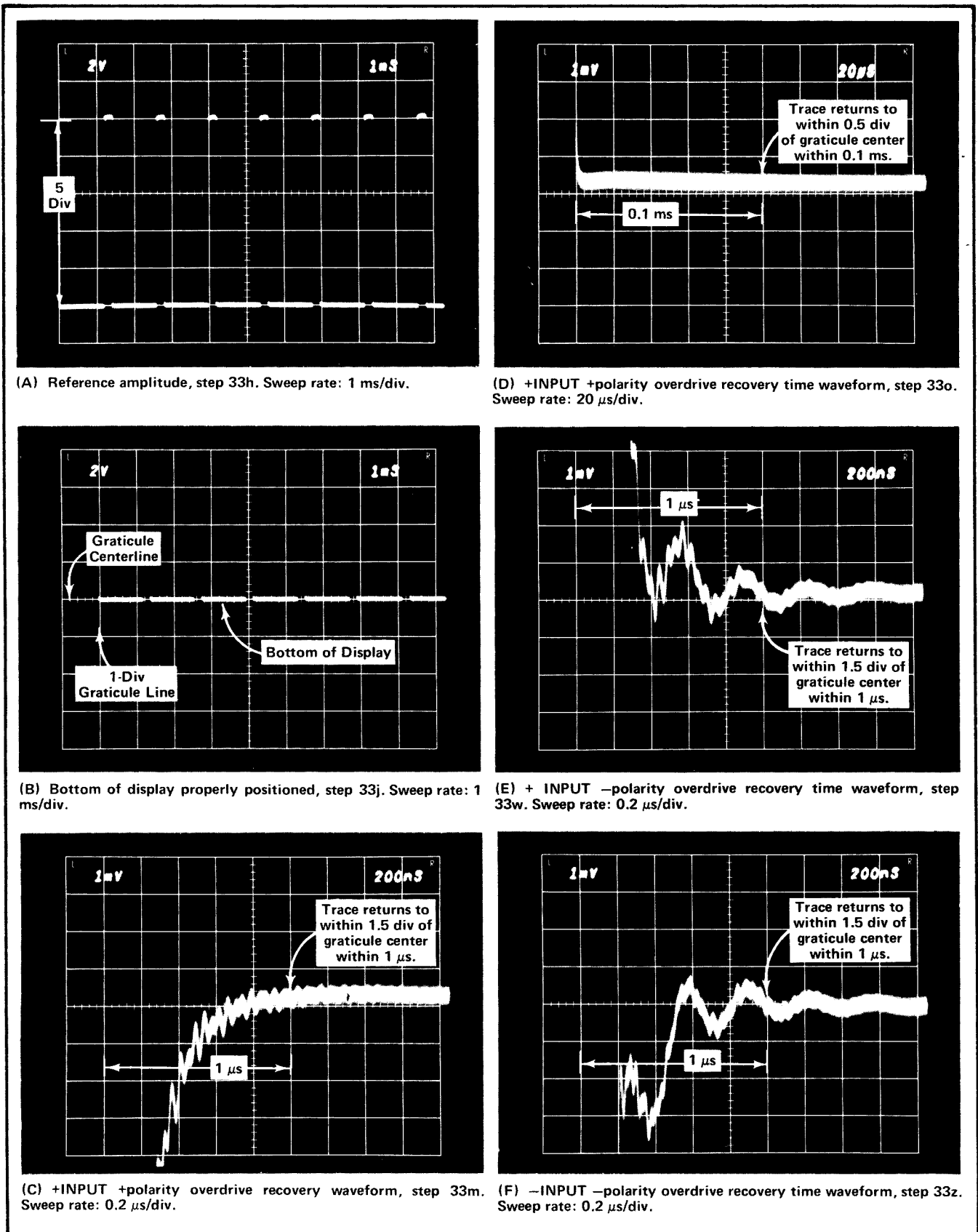

Fig. 5-31. Examples of waveforms obtained when checking override recovery time. Vertical deflection factor for waveforms (A) and (B) is 2 V/div; remaining waveforms are 1 mV/div.

Performance Check/Calibration—Type 7A13

h. Adjust the Overdrive Recovery test fixture Level control to obtain a 5-division display amplitude (see Fig. 5-31A).

i. If necessary, repeat step 33g to obtain a steady display.

j. Using the position controls, position the bottom of the display to coincide with the graticule centerline and to start at the 1-division graticule line (see Fig. 5-31B).

k. Set the Time/Div switch to $.2 \mu\text{s}$, increase the trace intensity and use the time base Position control to reposition if necessary, the bottom front corner of the display to start at the 1-division graticule line that will be used as a time reference.

l. Set the Type 7A13 VOLTS/DIV switch to 1 mV. Set the Overdrive Recovery test fixture Polarity switch to '0' and use the POSITION control to position the trace to graticule center. This is the zero amplitude reference. Set the Overdrive Recovery test fixture Polarity switch to +.

m. CHECK—That the trace returns to within 1.5 divisions of graticule vertical center within a recovery time of $1 \mu\text{s}$ (5 horizontal divisions) when measured with respect to the 1-division graticule line as shown in Fig. 5-31C.

n. Set the Time/Div switch to $20 \mu\text{s}$ and decrease the trace intensity.

o. CHECK—That the trace returns to within 0.5 division of graticule vertical center within a recovery time of 0.1 ms. Recovery time is measured with respect to the 1-division graticule line (see Fig. 5-31D).

p. Set the controls as follows:

Type 7A13

VOLTS/DIV 2 V

Time Base Plug-In

Level/Slope (Triggering) Positive slope region
Time/Div 1 ms

Overdrive Recovery Test Fixture

Polarity

q. Check that the display is 5 divisions in amplitude. If necessary, readjust the Overdrive Recovery test fixture Level control to obtain the proper amplitude.

r. Position the top of the display to coincide with graticule center and to start at the 1-division graticule line.

s. Set the Time/Div switch to $.2 \mu\text{s}$, increase the trace intensity and use the time base Position control to reposition, if necessary, the top front corner of display to start at the 1-division graticule line.

t. Set the Type 7A13 VOLTS/DIV switch to 1 mV. Set the Overdrive Recovery test fixture Polarity switch to '0' and use the POSITION control to position the trace to graticule center. Set the Overdrive test fixture Polarity switch to +.

u. CHECK—That the trace returns to within 1.5 divisions of graticule vertical center within a recovery time of $1 \mu\text{s}$ when measured with respect to the 1-division graticule line (see Fig. 5-31E).

v. Set the Time/Div switch to $20 \mu\text{s}$ and decrease the trace intensity.

w. CHECK—That the trace returns to within 0.5 division of graticule vertical center within a recovery time of 0.1 ms. Recovery time is measured with respect to the 1-division graticule line as described previously. The waveform will be similar to Fig. 5-31D except that it will be inverted.

x. Set the controls as follows:

Type 7A13

+INPUT Mode GND
—INPUT Mode DC
VOLTS/DIV 2 V

Time Base Plug-In

Level/Slope (Triggering) Negative slope region
Time/Div 1 ms

y. Disconnect the Overdrive Recovery test fixture from the +INPUT connector and reconnect it to the —INPUT connector. Do not change any other connections.

z. CHECK—Using step 33h and steps 33j through 33w as a guide, check the overdrive recovery time for the —INPUT. Fig. 5-31F shows an example of a —INPUT —polarity overdrive recovery time waveform.

aa. Disconnect and turn off all equipment.

This completes the Performance Check and/or Calibration procedure. If removed, replace the side covers on the Type 7A13; replace the left side and bottom covers on the indicator oscilloscope. If the Type 7A13 has been completely checked and adjusted to the tolerances given in this procedure, it will meet or exceed the specifications given in Section 1.

PARTS LIST ABBREVIATIONS

BHB	binding head brass	int	internal
BHS	binding head steel	lg	length or long
cap.	capacitor	met.	metal
cer	ceramic	mtg hdw	mounting hardware
comp	composition	OD	outside diameter
conn	connector	OHB	oval head brass
CRT	cathode-ray tube	OHS	oval head steel
csk	countersunk	PHB	pan head brass
DE	double end	PHS	pan head steel
dia	diameter	plstc	plastic
div	division	PMC	paper, metal cased
elect.	electrolytic	poly	polystyrene
EMC	electrolytic, metal cased	prec	precision
EMT	electrolytic, metal tubular	PT	paper, tubular
ext	external	PTM	paper or plastic, tubular, molded
F & I	focus and intensity	RHB	round head brass
FHB	flat head brass	RHS	round head steel
FHS	flat head steel	SE	single end
Fil HB	fillister head brass	SN or S/N	serial number
Fil HS	fillister head steel	SW	switch
h	height or high	TC	temperature compensated
hex.	hexagonal	THB	truss head brass
HHB	hex head brass	thk	thick
HHS	hex head steel	THS	truss head steel
HSB	hex socket brass	tub.	tubular
HSS	hex socket steel	var	variable
ID	inside diameter	w	wide or width
incd	incandescent	WW	wire-wound



PARTS ORDERING INFORMATION

Replacement parts are available from or through your local Tektronix, Inc. Field Office or representative.

Changes to Tektronix instruments are sometimes made to accommodate improved components as they become available, and to give you the benefit of the latest circuit improvements developed in our engineering department. It is therefore important, when ordering parts, to include the following information in your order: Part number, instrument type or number, serial or model number, and modification number if applicable.

If a part you have ordered has been replaced with a new or improved part, your local Tektronix, Inc. Field Office or representative will contact you concerning any change in part number.

SPECIAL NOTES AND SYMBOLS

- ×000 Part first added at this serial number
- 00× Part removed after this serial number
- *000-0000-00 Asterisk preceding Tektronix Part Number indicates manufactured by or for Tektronix, Inc., or reworked or checked components.
- Use 000-0000-00 Part number indicated is direct replacement.
-  Screwdriver adjustment.
-  Control, adjustment or connector.

INDEX OF ELECTRICAL PARTS LIST

Title	Page No.
CHASSIS	6-1
POLARITY Circuit Board Assembly	6-2
ATTENUATOR Circuit Board Assembly	6-2
OUTPUT Circuit Board Assembly	6-5
DECIMAL LIGHTS Circuit Board Assembly	6-11
INPUT Circuit Board Assembly	6-11
BANDWIDTH Circuit Board Assembly	6-18

SECTION 6

ELECTRICAL PARTS LIST

Values are fixed unless marked Variable.

Ckt. No.	Tektronix Part No.	Serial/Model No. Eff	Disc	Description
----------	-----------------------	-------------------------	------	-------------

CHASSIS

Bulb

DS47	150-0084-00		Neon	2AA
------	-------------	--	------	-----

Capacitors

Tolerance $\pm 20\%$ unless otherwise indicated.

C1 ¹	*295-0116-00		0.019 μ F	MT	600 V	
C2	283-0000-00		0.001 μ F	Cer	500 V	2%
C21 ¹	*295-0116-00		0.019 μ F	MT	600 V	2%
C22	283-0000-00		0.001 μ F	Cer	500 V	
C582	283-0000-00		0.001 μ F	Cer	500 V	

Connectors

J1	131-0679-00		BNC, receptacle, electrical			
J21	131-0679-00		BNC, receptacle, electrical			

Inductors

L2	*108-0536-00		165 μ H (blue)			
L4	*108-0535-00		165 μ H (brown)			
L25 ²						
L26 ²						
L27 ²						
L40 ²						
L42 ²						

Resistors

Resistors are fixed, composition, $\pm 10\%$ unless otherwise indicated.

R175	311-0641-00		200 k Ω , Var			
R287	311-0467-00		100 k Ω , Var			
R309	311-0361-00		500 k Ω , Var			
R435 ³	311-0880-00		5 k Ω , Var			

¹C1 and C21 furnished as a matched pair.

²Furnished as a unit with Main Chassis Cable.

³Furnished as a unit with 540.

CHASSIS (cont)

Ckt. No.	Tektronix Part No.	Serial/Model No. Eff	No. Disc	Description
Switches				
	Wired or Unwired			
S40 [†]	311-0880-00			
S50	260-1033-00		Rotary	VOLTS/DIV
S80	260-0816-00		Slide	PULL VAR FOR X10 Vc

POLARITY Circuit Board Assembly

*670-1042-00 Complete Board

Bulb

DS570	*150-0093-01		Incandescent	T3/4, selected
-------	--------------	--	--------------	----------------

Semiconductor Device, Diode

VR570	152-0171-00		Zener	1N944 11.7 V 5%
-------	-------------	--	-------	-----------------

Switch

	Wired or Unwired			
S570 [‡]	*670-1042-00		Pushbutton	Vc POLARITY

ATTENUATOR Circuit Board Assembly

*670-1043-00 Complete Board

Bulbs

DS1	*150-0057-01		Incandescent	7153AS15, selected
DS21	*150-0057-01		Incandescent	7153AS15, selected

Capacitors

Tolerance $\pm 20\%$ unless otherwise indicated.

C3	283-0175-00	10 pF	Cer	200 V	5%
C4	283-0156-00	1000 pF	Cer	200 V	+100%—0%
C5A	281-0064-00	0.25-1.5 pF, Var	Tub.		
C5B	281-0081-00	1.8-13 pF, Var	Air		
C5C	281-0627-00	1 pF	Cer	600 V	

[†]Furnished as a unit with R435.

[‡]See Mechanical Parts List for replacement parts.

ATTENUATOR Circuit Board Assembly (cont)

Kct. No.	Tektronix Part No.	Serial/Model No. Eff	Disc	Description		
Capacitors (cont)						
C5D	283-0159-00		18 pF	Cer	50 V	5%
C6	283-0156-00		1000 pF	Cer	200 V	+100%—0%
C7	283-0156-00		1000 pF	Cer	200 V	+100%—0%
C8A	281-0064-00		0.25-1.5 pF, Var	Tub.		
C8B	281-0080-00		1.7-11 pF, Var	Air		
C8C	283-0159-00		18 pF	Cer	50 V	5%
C8D	283-0160-00		1.5 pF	Cer	50 V	10%
C8E	281-0627-00		1 pF	Cer	600 V	
C10	283-0156-00		1000 pF	Cer	200 V	+100%—0%
C12	283-0156-00		1000 pF	Cer	200 V	+100%—0%
C13	281-0537-00		0.68 pF	Cer	500 V	
C14	281-0064-00		0.25-1.5 pF, Var	Tub.		
C15	283-0156-00		1000 pF	Cer	200 V	+100%—0%
C23	283-0175-00		10 pF	Cer	200 V	5%
C24	283-0156-00		1000 pF	Cer	200 V	+100%—0%
C25A	281-0064-00		0.25-1.5 pF, Var	Tub.		
C25B	281-0081-00		1.8-13 pF, Var	Air		
C25C	281-0661-00		0.8 pF	Cer	500 V	±0.1 pF
C25D	283-0159-00		18 pF	Cer	50 V	5%
C26	283-0156-00		1000 pF	Cer	200 V	+100%—0%
C27	283-0156-00		1000 pF	Cer	200 V	+100%—0%
C28A	281-0064-00		0.25-1.5 pF, Var	Tub.		
C28B	281-0080-00		1.7-11 pF, Var	Air		
C28C	283-0159-00		18 pF	Cer	50 V	5%
C28D	283-0160-00		1.5 pF	Cer	50 V	10%
C28E	281-0627-00		1 pF	Cer	600 V	
C30	283-0156-00		1000 pF	Cer	200 V	+100%—0%
C31	283-0156-00		1000 pF	Cer	200 V	+100%—0%
C32	283-0156-00		1000 pF	Cer	200 V	+100%—0%
C33	281-0537-00		0.68 pF	Cer	500 V	
C34	281-0064-00		0.25-1.5 pF, Var	Tub.		

Relays

K6	*148-0055-00	Grounded Armature, spdt & spst, 15 V DC
K7	*148-0054-00	Grounded Armature, spdt & spst, 15 V DC
K10	*148-0050-00	Grounded Armature, spdt, 15 V DC
K26	*148-0055-00	Grounded Armature, spdt & spst, 15 V DC
K27	*148-0054-00	Grounded Armature, spdt & spst, 15 V DC
K30	*148-0050-00	Grounded Armature, spdt, 15 V DC

ATTENUATOR Circuit Board Assembly (cont)

Ckt. No.	Tektronix Part No.	Serial/Model No. Eff	Disc	Description		
Resistors						
Resistors are fixed, composition, $\pm 10\%$ unless otherwise indicated.						
R1	317-0105-00		110 Ω	$\frac{1}{8}$ W		5%
R2	307-0112-00		4.3 Ω	$\frac{1}{4}$ W		5%
R3	317-0470-00		47 Ω	$\frac{1}{8}$ W		5%
R5A ⁶	325-0004-00		900 k Ω	$\frac{1}{4}$ W	Prec	1/10%
R5C	317-0111-00		110 Ω	$\frac{1}{8}$ W		5%
R5D ⁷	325-0020-00		110.6 k Ω	$\frac{1}{8}$ W	Prec	1/10%
R5E	311-0635-00		1 k Ω , Var			
R6	322-0625-01		995 k Ω	$\frac{1}{4}$ W	Prec	$\frac{1}{2}\%$
R7	311-0607-00		10 k Ω , Var			
R8A ⁸	325-0004-00		900 k Ω	$\frac{1}{4}$ W	Prec	1/10%
R8D	317-0511-00		510 Ω	$\frac{1}{8}$ W		5%
R8E	317-0241-00		240 Ω	$\frac{1}{8}$ W		5%
R8F ⁹	325-0038-00		110.8 k Ω	$\frac{1}{8}$ W	Prec	1/10%
R8G	311-0634-00		500 Ω , Var			
R10	317-0101-00		100 Ω	$\frac{1}{8}$ W		5%
R14	321-0181-00		750 Ω	$\frac{1}{8}$ W	Prec	1%
R21	317-0105-00		1 M Ω	$\frac{1}{8}$ W		5%
R22	307-0112-00		4.3 Ω	$\frac{1}{4}$ W		5%
R23	317-0470-00		47 Ω	$\frac{1}{8}$ W		5%
R25A ⁶	325-0004-00		900 k Ω	$\frac{1}{4}$ W	Prec	1/10%
R25C	317-0201-00		200 Ω	$\frac{1}{8}$ W		5%
R25D ⁷	325-0020-00		111 k Ω	$\frac{1}{8}$ W	Prec	1/10%
R26	322-0625-01		995 k Ω	$\frac{1}{4}$ W	Prec	$\frac{1}{2}\%$
R27	311-0607-00		10 k Ω , Var			
R28A ⁸	325-0004-00		900 k Ω	$\frac{1}{4}$ W	Prec	1/10%
R28D	317-0511-00		510 Ω	$\frac{1}{8}$ W		5%
R28E	317-0151-00		150 Ω	$\frac{1}{8}$ W		5%
R28F ⁹	325-0038-00		110.8 k Ω	$\frac{1}{8}$ W	Prec	1/10%
R28G	311-0634-00		500 Ω , Var			
R30	317-0101-00		100 Ω	$\frac{1}{8}$ W		5%
R34	321-0181-00		750 Ω	$\frac{1}{8}$ W	Prec	1%

Switches

Wired or Unwired

S1 ¹⁰	*670-1043-00	Pushbutton	+ AC-GND-DC
S10 ¹⁰	*670-1043-00	Plug-in	ATTENUATOR
S21 ¹⁰	*670-1043-00	Pushbutton	- AC-GND-DC

⁶R5A and R25A furnished as a matched pair.

⁷R5D and R25D furnished as a matched pair.

⁸R8A and R28A furnished as a matched pair.

⁹R8F and R28F furnished as a matched pair.

¹⁰See Mechanical Parts List for replacement parts.

OUTPUT Circuit Board Assembly

Ckt. No.	Tektronix Part No.	Serial/Model No. Eff	No. Disc	Description		
*670-1044-00		Complete Board				
Capacitors						
Tolerance $\pm 20\%$ unless otherwise indicated.						
C40	283-0000-00		0.001 μF	Cer	500 V	
C41	283-0000-00		0.001 μF	Cer	500 V	
C42	283-0000-00		0.001 μF	Cer	500 V	
C43	283-0000-00		0.001 μF	Cer	500 V	
C44	283-0000-00		0.001 μF	Cer	500 V	
C45	283-0000-00		0.001 μF	Cer	500 V	
C46	283-0000-00		0.001 μF	Cer	500 V	
C47	283-0000-00		0.001 μF	Cer	500 V	
C48	283-0000-00		0.001 μF	Cer	500 V	
C49	283-0000-00		0.001 μF	Cer	500 V	
C50	283-0032-00		470 pF	Cer	500 V	5%
C51	283-0000-00		0.001 μF	Cer	500 V	
C52	283-0032-00		470 pF	Cer	500 V	5%
C53	283-0032-00		470 pF	Cer	500 V	5%
C54	283-0032-00		470 pF	Cer	500 V	5%
C55	283-0000-00		0.001 μF	Cer	500 V	
C300	281-0524-00		150 pF	Cer	500 V	
C301	281-0523-00		100 pF	Cer	350 V	
C304	283-0032-00		470 pF	Cer	500 V	5%
C308	283-0000-00		0.001 μF	Cer	500 V	
C311	281-0616-00		6.8 pF	Cer	200 V	
C313	281-0618-00		4.7 pF	Cer	200 V	± 0.5 pF
C315	281-0645-00		8.2 pF	Cer	500 V	± 0.25 pF
C318	281-0618-00		4.7 pF	Cer	200 V	± 0.5 pF
C319	281-0618-00		4.7 pF	Cer	200 V	± 0.5 pF
C326	283-0108-00		220 pF	Cer	200 V	10%
C328	281-0616-00		6.8 pF	Cer	200 V	
C337	283-0103-00		180 pF	Cer	500 V	5%
C355	283-0000-00		0.001 μF	Cer	500 V	
C364	283-0193-00		510 pF	Cer	100 V	2%
C372	281-0650-00		18 pF	Cer	200 V	10%
C374	281-0523-00		100 pF	Cer	350 V	
C375	283-0000-00		0.001 μF	Cer	500 V	
C404	283-0032-00		470 pF	Cer	500 V	5%
C408	283-0000-00		0.001 μF	Cer	500 V	
C411	281-0616-00		6.8 pF	Cer	200 V	
C413	281-0618-00		4.7 pF	Cer	200 V	± 0.5 pF
C415	281-0645-00		8.2 pF	Cer	500 V	± 0.25 pF
C418	281-0618-00		4.7 pF	Cer	200 V	± 0.5 pF
C426	283-0108-00		220 pF	Cer	200 V	10%

OUTPUT Circuit Board Assembly (cont)

Ckt. No.	Tektronix Part No.	Serial/Model No. Eff	Disc	Description		
Capacitors (cont)						
C428	281-0616-00		6.8 pF	Cer	200 V	
C432	281-0523-00		100 pF	Cer	350 V	
C434	283-0000-00		0.001 μ F	Cer	500 V	
C437	283-0103-00		180 pF	Cer	500 V	5%
C439	281-0612-00		5.6 pF	Cer	200 V	± 0.5 pF
C455	283-0000-00		0.001 μ F	Cer	500 V	
C456	281-0612-00		5.6 pF	Cer	200 V	± 0.5 pF
C464	281-0523-00		100 pF	Cer	350 V	
C4475	283-0000-00		0.001 μ F	Cer	500 V	
C477	281-0612-00		5.6 pF	Cer	200 V	± 0.5 pF
C490	283-0000-00		0.001 μ F	Cer	500 V	
C505	290-0340-00		10 μ F	Elect.	50 V	10%
C505	283-0134-00		0.47 μ F	Cer	50 V	+ 80%—20%
C514	283-0000-00		0.001 μ F	Cer	500 V	
C515	283-0000-00		0.001 μ F	Cer	500 V	
C517	283-0177-00		1 μ F	Cer	25 V	+80%—20%
C518	290-0201-00		100 μ F	Elect.	15 V	
C519	283-0000-00		0.001 μ F	Cer	500 V	
C522	283-0000-00		0.001 μ F	Cer	500 V	
C530	283-0000-00		0.001 μ F	Cer	500 V	
C532	283-0000-00		0.001 μ F	Cer	500 V	
C537	283-0000-00		0.001 μ F	Cer	500 V	
C542	283-0177-00		1 μ F	Cer	25 V	+80%—20%
C543	283-0000-00		0.001 μ F	Cer	500 V	
C548	283-0000-00		0.001 μ F	Cer	500 V	
C549	283-0000-00		0.001 μ F	Cer	500 V	
C552	283-0134-00		0.47 μ F	Cer	50 V	+80%—20%
C553	290-0340-00		10 μ F	Elect.	50 V	10%
C578	283-0059-00		1 μ F	Cer	25 V	+80%—20%
C580	283-0000-00		0.001 μ F	Cer	500 V	
C581	283-0000-00		0.001 μ F	Cer	500 V	

Semiconductor Device, Diodes

CR40	*152-0185-00	Silicon	Replaceable by 1N4152
CR41	*152-0185-00	Silicon	Replaceable by 1N4152
CR42	*152-0185-00	Silicon	Replaceable by 1N4152
CR43	*152-0185-00	Silicon	Replaceable by 1N4152
CR45	*152-0185-00	Silicon	Replaceable by 1N4152
CR46	*152-0185-00	Silicon	Replaceable by 1N4152
CR364	*152-0185-00	Silicon	Replaceable by 1N4152
CR365	*152-0185-00	Silicon	Replaceable by 1N4152
CR401	152-0271-00	Silicon	Voltage Variable Capacitance V-10E

OUTPUT Circuit Board Assembly (cont)

Ckt. No.	Tektronix Part No.	Serial/Model No. Eff Disc	Description
Relays			
K47	*148-0034-00		Armature, dpdt, 15 V DC
K48	*148-0034-00		Armature, dpdt, 15 V DC
K490	*148-0034-00		Armature, dpdt, 15 V DC
Inductors			
L364	*108-0095-01		1.4 μ H
L464	*108-0095-01		1.4 μ H
L503	276-0507-00		Core, ferramic suppressor
L505	276-0507-00		Core, ferramic suppressor
L515	276-0507-00		Core, ferramic suppressor
L517	276-0507-00		Core, ferramic suppressor
L540	276-0507-00		Core, ferramic suppressor
L542	276-0507-00		Core, ferramic suppressor
L550	276-0507-00		Core, ferramic suppressor
L552	276-0507-00		Core, ferramic suppressor
LR47	*108-0520-00		2.2 μ H (wound on a 22 Ω , $\frac{1}{4}$ W, 5% resistor)
LR48	*108-0520-00		2.2 μ H (wound on a 22 Ω , $\frac{1}{4}$ W, 5% resistor)
LR504	*108-0537-00		200 μ H (wound on a 30 Ω , $\frac{1}{8}$ W, 5% resistor)
LR507	*108-0520-00		2.2 μ H (wound on a 22 Ω , $\frac{1}{4}$ W, 5% resistor)
LR508	*108-0520-00		2.2 μ H (wound on a 22 Ω , $\frac{1}{4}$ W, 5% resistor)
LR509	*108-0520-00		2.2 μ H (wound on a 22 Ω , $\frac{1}{4}$ W, 5% resistor)
LR511	*108-0519-00		2.2 μ H (wound on a 10 Ω , $\frac{1}{4}$ W, 5% resistor)
LR512	*108-0519-00		2.2 μ H (wound on a 10 Ω , $\frac{1}{4}$ W, 5% resistor)
LR514	*108-0520-00		2.2 μ H (wound on a 22 Ω , $\frac{1}{4}$ W, 5% resistor)
LR516	*108-0537-00		200 μ H (wound on a 30 Ω , $\frac{1}{8}$ W, 5% resistor)
LR520	*108-0520-00		2.2 μ H (wound on a 22 Ω , $\frac{1}{4}$ W, 5% resistor)
LR530	*108-0520-00		2.2 μ H (wound on a 22 Ω , $\frac{1}{4}$ W, 5% resistor)
LR537	*108-0520-00		2.2 μ H (wound on a 22 Ω , $\frac{1}{4}$ W, 5% resistor)
LR541	*108-0537-00		200 μ H (wound on a 30 Ω , $\frac{1}{8}$ W, 5% resistor)
LR544	*108-0520-00		2.2 μ H (wound on a 22 Ω , $\frac{1}{4}$ W, 5% resistor)
LR545	*108-0520-00		2.2 μ H (wound on a 22 Ω , $\frac{1}{4}$ W, 5% resistor)
LR548	*108-0520-00		2.2 μ H (wound on a 22 Ω , $\frac{1}{4}$ W, 5% resistor)
LR549	*108-0520-00		2.2 μ H (wound on a 22 Ω , $\frac{1}{4}$ W, 5% resistor)
LR551	*108-0537-00		200 μ H (wound on a 30 Ω , $\frac{1}{8}$ W, 5% resistor)
LR554	*108-0520-00		2.2 μ H (wound on a 22 Ω , $\frac{1}{4}$ W, 5% resistor)
LR555	*108-0520-00		2.2 μ H (wound on a 22 Ω , $\frac{1}{4}$ W, 5% resistor)
LR557	*108-0520-00		2.2 μ H (wound on a 22 Ω , $\frac{1}{4}$ W, 5% resistor)
Transistors			
Q40	*150-0190-01		Silicon Tek Spec
Q300	*151-0268-00		Silicon Dual, Tek Spec
Q320	*151-0267-00		Silicon Dual, Tek Spec
Q330	151-0202-00		Silicon 2N4261
Q340	151-0202-00		Silicon 2N4261

OUTPUT Circuit Board Assembly (cont)

Ckt. No.	Tektronix Part No.	Serial/Model No. Eff Disc	Description
Transistors (cont)			
Q350	*151-0212-00	Silicon	Tek Spec
Q370	*151-0259-00	Silicon	Selected from 2N3563
Q380	*151-0212-00	Silicon	Tek Spec
Q430	*151-0259-00	Silicon	Selected from 2N3563
	151-0202-00	Silicon	2N4261
Q440	151-0202-00	Silicon	2N4261
Q450	*151-0212-00	Silicon	Tek Spec
Q460	*151-0259-00	Silicon	Selected from 2N3563
Q470	*151-0212-00	Silicon	Tek Spec
Q480	*151-0259-00	Silicon	Selected from 2N3563
Q520	*151-0190-01	Silicon	Tek Spec
Q530	151-0220-00	Silicon	2N4122

Resistors

Resistors are fixed, composition, $\pm 10\%$ unless otherwise indicated.

R41	321-0215-00	1.69 k Ω	1/8 W	Prec	1%
R42	321-0215-00	1.69 k Ω	1/8 W	Prec	1%
R45	315-0123-00	12 k Ω	1/4 W		5%
R46	315-0363-00	36 k Ω	1/4 W		5%
R47	315-0104-00	100 k Ω	1/4 W		5%
R49	321-0292-00	10.7 k Ω	1/8 W	Prec	1%
R51A	315-0154-00	150 k Ω	1/4 W		5%
R51B	315-0753-00	75 k Ω	1/4 W		5%
R52A	321-0344-00	37.4 k Ω	1/8 W	Prec	1%
R52B	315-0154-00	150 k Ω	1/4 W		5%
R53	315-0753-00	75 k Ω	1/4 W		5%
R54	315-0154-00	150 k Ω	1/4 W		5%
R55	315-0513-00	51 k Ω	1/4 W		5%
R56	315-0753-00	75 k Ω	1/4 W		5%
R57	315-0154-00	150 k Ω	1/4 W		5%
R58	315-0753-00	75 k Ω	1/4 W		5%
R59	321-0344-00	37.4 k Ω	1/8 W	Prec	1%
R177	311-0816-00	2.5 k Ω , Var			
R300	311-0635-00	1 k Ω , Var			
R301	321-0032-00	21 Ω	1/8 W	Prec	1%
R302	321-0182-00	768 Ω	1/8 W	Prec	1%
R303	307-0124-00	5 k Ω	Thermal		
R304	317-0271-00	270 Ω	1/8 W		5%
R305	322-0212-00	1.58 k Ω	1/4 W	Prec	1%
R306	317-0124-00	120 k Ω	1/8 W		5%
R307	311-0827-00	250 Ω , Var			
R308	317-0683-00	68 k Ω	1/8 W		5%
R311	321-0051-00	33.2 Ω	1/8 W	Prec	1%
R312	321-0702-00	30 Ω	1/8 W	Prec	1/4%
R313	325-0043-00	22.5 Ω	1/8 W	Prec	1/4%

OUTPUT Circuit Board Assembly (cont)

Ckt. No.	Tektronix Part No.	Serial/Model No. Eff	Disc	Description		
Resistors (cont)						
R315	321-0039-00		24.9 Ω	$\frac{1}{8}$ W	Prec	1%
R316	321-0793-03		37.5 Ω	$\frac{1}{8}$ W	Prec	$\frac{1}{4}$ %
R318	321-0058-00		39.2 Ω	$\frac{1}{8}$ W	Prec	1%
R319	317-0130-00		13 Ω	$\frac{1}{8}$ W		5%
R320	322-0205-00		1.33 k Ω	$\frac{1}{4}$ W	Prec	1%
R322	317-0561-00		560 Ω	$\frac{1}{8}$ W		5%
R323	317-0332-00		3.3 k Ω	$\frac{1}{8}$ W		5%
R326	317-0471-00		470 Ω	$\frac{1}{8}$ W		5%
R327	321-0097-00		100 Ω	$\frac{1}{8}$ W	Prec	1%
R328	321-0120-00		174 Ω	$\frac{1}{8}$ W	Prec	1%
R329	311-0828-00		5 k Ω , Var			
R331	321-0181-00		750 Ω	$\frac{1}{8}$ W	Prec	1%
R332	321-0055-00		36.5 Ω	$\frac{1}{8}$ W	Prec	1%
R334	315-0512-00		5.1 k Ω	$\frac{1}{4}$ W		5%
R335	311-0607-00		10 k Ω , Var			
R337	317-0391-00		390 Ω	$\frac{1}{8}$ W		5%
R340	321-0088-00		80.6 Ω	$\frac{1}{8}$ W	Prec	1%
R344	317-0101-00		100 Ω	$\frac{1}{8}$ W		5%
R350	321-0039-00		24.9 Ω	$\frac{1}{8}$ W	Prec	1%
R351	321-0168-00		549 Ω	$\frac{1}{8}$ W	Prec	1%
R354	315-0151-00		150 Ω	$\frac{1}{4}$ W		5%
R357	317-0132-00		1.3 k Ω	$\frac{1}{8}$ W		5%
R358	317-0272-00		2.7 k Ω	$\frac{1}{8}$ W		5%
R360	311-0643-00		50 Ω , Var			
R362	321-0147-00		332 Ω	$\frac{1}{8}$ W	Prec	1%
R370	315-0470-00		47 Ω	$\frac{1}{4}$ W		5%
R371	311-0605-00		200 Ω , Var			
R372	321-0024-00		17.4 Ω	$\frac{1}{8}$ W	Prec	1%
R373	321-0153-00		383 Ω	$\frac{1}{8}$ W	Prec	1%
R374	317-0151-00		150 Ω	$\frac{1}{8}$ W		5%
R375	315-0151-00		150 Ω	$\frac{1}{4}$ W		5%
R377	317-0132-00		1.3 k Ω	$\frac{1}{8}$ W		5%
R378	317-0272-00		2.7 k Ω	$\frac{1}{8}$ W		5%
R380	311-0643-00		50 Ω , Var			
R382	321-0147-00		332 Ω	$\frac{1}{8}$ W	Prec	1%
R401	321-0032-00		21 Ω	$\frac{1}{8}$ W	Prec	1%
R402	321-0182-00		768 Ω	$\frac{1}{8}$ W	Prec	1%
R404	317-0271-00		270 Ω	$\frac{1}{8}$ W		5%
R407	322-0215-00		1.69 k Ω	$\frac{1}{4}$ W	Prec	1%
R408	317-0683-00		68 k Ω	$\frac{1}{8}$ W		5%
R411	321-0051-00		33.2 Ω	$\frac{1}{8}$ W	Prec	1%
R413	325-0043-00		22.5 Ω	$\frac{1}{8}$ W	Prec	$\frac{1}{4}$ %
R415	321-0039-00		24.9 Ω	$\frac{1}{8}$ W	Prec	1%
R416	321-0793-03		37.5 Ω	$\frac{1}{8}$ W	Prec	$\frac{1}{4}$ %
R418	321-0058-00		39.2 Ω	$\frac{1}{8}$ W	Prec	1%

OUTPUT Circuit Board Assembly (cont)

Ckt. No.	Tektronix Part No.	Serial/Model No. Eff	Disc	Description		
Resistors (cont)						
R420	322-0205-00		1.33 k Ω	1/4 W	Prec	1%
R426	317-0471-00		470 Ω	1/8 W		5%
R427	321-0097-00		100 Ω	1/8 W	Prec	1%
R428	321-0120-00		174 Ω	1/8 W	Prec	1%
R431	321-0181-00		750 Ω	1/8 W	Prec	1%
R432	311-0609-00		2 k Ω , Var			
R434	315-0302-00		3 k Ω	1/4 W		5%
R437	317-0391-00		390 Ω	1/8 W		5%
R439	317-0121-00		120 Ω	1/8 W		5%
R440	321-0088-00		80.6 Ω	1/8 W	Prec	1%
R451	321-0168-00		549 Ω	1/8 W	Prec	1%
R454	315-0151-00		150 Ω	1/4 W		5%
R456	317-0150-00		15 Ω	1/8 W		5%
R462	321-0147-00		332 Ω	1/8 W	Prec	1%
R470	315-0470-00		47 Ω	1/4 W		5%
R473	321-0153-00		383 Ω	1/8 W	Prec	1%
R475	315-0151-00		150 Ω	1/4 W		5%
R477	317-0047-00		4.7 Ω	1/8 W		5%
R482	321-0147-00		332 Ω	1/8 W	Prec	1%
R521	321-0212-00		1.58 k Ω	1/8 W	Prec	1%
R522	321-0226-00		2.21 k Ω	1/8 W	Prec	1%
R523	315-0241-00		240 Ω	1/4 W		5%
R525	315-0681-00		680 Ω	1/4 W		5%
R531	321-0226-00		2.21 k Ω	1/8 W	Prec	1%
R532	321-0212-00		1.58 k Ω	1/8 W	Prec	1%
R533	315-0241-00		240 Ω	1/4 W		5%
R535	301-0241-00		240 Ω	1/2 W		5%
R570	308-0530-00		4.51 k Ω	1 W	WW	1%
R572	308-0530-00		4.51 k Ω	1 W	WW	1%
R573	311-0558-00		500 Ω , Var			
R574	308-0528-00		1.45 k Ω (nominal value)	Selected		
R575	311-0226-00		500 Ω , Var			
R576	308-0316-00		3.1 k Ω	1/2 W	WW	1%
R578	315-0102-00		1 k Ω	1/4 W		5%
R579	315-0102-00		1 k Ω	1/4 W		5%
R580	315-0103-00		10 k Ω	1/4 W		5%
R589	308-0547-00		1 k Ω		Matched set	
R590						
R591						
R592						
R593						
R594						
R595						
R596						
R597						
R598						
R599						

OUTPUT Circuit Board Assembly (cont)

Ckt. No.	Tektronix Part No.	Serial/Model No. Eff	Disc	Description
Switch				
	Wired or Unwired			
S45	260-0760-00			Micro

DECIMAL LIGHTS Circuit Board Assembly

***670-1045-00 Complete Board**

Bulbs				
DS10	*150-0048-01			Incandescent #683, selected
DS65	*150-0048-01			Incandescent #683, selected
DS70	*150-0048-01			Incandescent #683, selected
DS75	*150-0048-01			Incandescent #683, selected

Resistor

Resistors are fixed, composition, $\pm 10\%$ unless otherwise indicated.

R577 ¹¹	*670-1045-00			5 k Ω , Var
--------------------	--------------	--	--	--------------------

Switch

Wired or Unwired				
R575 ¹¹	*670-1045-00			Rotary COMPARISON

INPUT Circuit Board Assembly

***670-1046-00 Complete Board**

Capacitors

Tolerance $\pm 20\%$ unless otherwise indicated.

C60	283-0059-00	1 μ F	Cer	25 V	+80%—20%
C63	283-0000-00	0.001 μ F	Cer	500 V	
C65	283-0000-00	0.001 μ F	Cer	500 V	
C66	283-0000-00	0.001 μ F	Cer	500 V	
C70	283-0000-00	0.001 μ F	Cer	500 V	
C75	283-0000-00	0.001 μ F	Cer	500 V	
C102	281-0523-00	100 pF	Cer	350 V	
C110	281-0525-00	470 pF	Cer	500 V	
C112	283-0594-00	0.001 μ F	Mica	100 V	1%
C113	281-0123-00	5-25 pF	Cer	100 V	

¹¹See Mechanical Parts List for replacement parts.

Electrical Parts List—Type 7A13

INPUT Circuit Board Assembly (cont)

Ckt. No.	Tektronix Part No.	Serial/Model No. Eff	Disc	Description		
Capacitors (cont)						
C117	281-0672-00		11.4 pF	Cer	500 V	1%
C122	281-0650-00		18 pF	Cer	200 V	10%
C124	281-0064-00		0.25-1.5 pF, Var	Tub.		
C131	283-0651-00		430 pF	Mica	500 V	1%
C134	281-0064-00		0.25-1.5 pF, Var	Tub.		
C143	283-0026-00		0.2 μ F	Cer	25 V	
C150	281-0092-00		9-35 pF, Var	Cer		
C162	281-0064-00		0.25-1.5 pF, Var	Tub.		
C163	281-0122-00		2.5-9 pF, Var	Cer	100 V	
C166	283-0000-00		0.001 μ F	Cer	500 V	
C170	281-0653-00		3.3 pF	Cer	200 V	± 1 pF
C171	281-0064-00		0.25-1.5 pF, Var	Tub.		
C172	283-0000-00		0.001 μ F	Cer	500 V	
C176	283-0000-00		0.001 μ F	Cer	500 V	
C178	281-0650-00		18 pF	Cer	200 V	10%
C181	283-0000-00		0.001 μ F	Cer	500 V	
C183	281-0523-00		100 pF	Cer	350 V	
C187	281-0123-00		5-25 pF, Var	Cer	100 V	
C190	283-0077-00		330 pF	Cer	500 V	5%
C191	281-0609-00		1 pF	Cer	200 V	10%
C197	281-0543-00		270 pF	Cer	500 V	10%
C202	281-0523-00		100 pF	Cer	350 V	
C210	281-0525-00		470 pF	Cer	500 V	
C212	283-0594-00		0.001 μ F	Mica	100 V	1%
C213	281-0123-00		5-25-pF, Var	Cer	100 V	
C217	281-0672-00		11.4 pF	Cer	500 V	1%
C222	281-0650-00		18 pF	Cer	200 V	10%
C224	281-0064-00		0.25-1.5 pF, Var	Tub.		
C231	283-0651-00		430 pF	Mica	500 V	1%
C234	281-0064-00		0.25-1.5 pF, Var	Tub.		
C243	283-0026-00		0.2 μ F	Cer	25 V	
C250	281-0092-00		9-35 pF, Var	Cer		
C262	281-0064-00		0.25-1.5 pF, Var	Tub.		
C271	281-0064-00		0.25-1.5 pF, Var	Tub.		
C272	283-0000-00		0.001 μ F	Cer	500 V	
C278	281-0656-00		22 pF	Cer	200 V	5%
C281	283-0000-00		0.001 μ F	Cer	500 V	
C283	281-0523-00		100 pF	Cer	350 V	
C290	283-0077-00		330 pF	Cer	500 V	5%
C291	281-0609-00		1 pF	Cer	200 V	10%
C297	281-0543-00		270 pF	Cer	500 V	10%
C507	283-0000-00		0.001 μ F	Cer	500 V	
C508	283-0000-00		0.001 μ F	Cer	500 V	
C509	283-0000-00		0.001 μ F	Cer	500 V	
C511	283-0001-00		0.005 μ F	Cer	500 V	

INPUT Circuit Board Assembly (cont)

Ckt. No.	Tektronix Part No.	Serial/Model No. Eff	Disc	Description	
Capacitors (cont)					
C512	283-0001-00		0.005 μ F	Cer	500 V
C520	283-0000-00		0.001 μ F	Cer	500 V
C527	283-0000-00		0.001 μ F	Cer	500 V
C528	283-0178-00		0.1 μ F	Cer	100 V
C538	283-0000-00		0.001 μ F	Cer	500 V
C544	283-0000-00		0.001 μ F	Cer	500 V
C545	283-0000-00		0.001 μ F	Cer	500 V
C546	283-0000-00		0.001 μ F	Cer	500 V
C554	283-0000-00		0.001 μ F	Cer	500 V
C555	283-0000-00		0.001 μ F	Cer	500 V
C557	283-0000-00		0.001 μ F	Cer	500 V
C562	283-0177-00		1 μ F	Cer	25 V
C565	290-0139-00		180 μ F	Elect.	6 V
C566	283-0177-00		1 μ F	Cer	25 V
C567	290-0114-00		47 μ F	Elect.	6 V
C568	283-0177-00		1 μ F	Cer	25 V
C569	283-0000-00		0.001 μ F	Cer	500 V
Semiconductor Device, Diodes					
CR66	*152-0185-00		Silicon	Replaceable by 1N4152	
CR67	*152-0185-00		Silicon	Replaceable by 1N4152	
CR77	*152-0185-00		Silicon	Replaceable by 1N4152	
CR101	*152-0367-00		Silicon	Tek Spec	
CR102	*152-0061-00		Silicon	Tek Spec	
VR103	152-0394-00		Zener	1N3046B, 1 W, 47 V, 5%	
CR110	*152-0061-00		Silicon	Tek Spec	
CR112	*152-0061-00		Silicon	Tek Spec	
CR134	*152-0061-00		Silicon	Tek Spec	
CR150 ^{1,2}	*153-0039-01		Silicon	Tek Spec	
CR152	*152-0185-00		Silicon	Replaceable by 1N4152	
CR154	*152-0185-00		Silicon	Replaceable by 1N4152	
VR155	152-0395-00		Zener	1N749A, 400 mW, 4.3 V, 5%	
CR156	*152-0185-00		Silicon	Replaceable by 1N4152	
VR157	152-0395-00		Zener	1N749A, 400 mW, 4.3 V, 5%	
CR158	*152-0185-00		Silicon	Replaceable by 1N4152	
VR166	152-0395-00		Zener	1N749A, 400 mW, 4.3 V, 5%	
CR182	*152-0185-00		Silicon	Replaceable by 1N4152	
CR201	*152-0367-00		Silicon	Tek Spec	
CR202	*152-0061-00		Silicon	Tek Spec	
VR203	152-0394-00		Zener	1N3036B 1 W, 47 V, 5%	
CR210	*152-0061-00		Silicon	Tek Spec	
CR212	*152-0061-00		Silicon	Tek Spec	
CR234	*152-0061-00		Silicon	Tek Spec	
CR250 ^{1,2}	*153-0039-01		Silicon	Tek Spec	

^{1,2}CR150 and CR250 furnished as a matched pair.

INPUT Circuit Board Assembly (cont)

Ckt. No.	Tektronix Part No.	Serial/Model No. Eff	Disc	Description
Semiconductor Device, Diodes (cont)				
CR252	*152-0185-00		Silicon	Replaceable by 1N4152
CR254	*152-0185-00		Silicon	Replaceable by 1N4152
CR282	*152-0185-00		Silicon	Replaceable by 1N4152
Relays				
K60A	*148-0035-00		Armature, spdt, 15 V DC	
K60B	*148-0035-00		Armature, spdt, 15 V DC	
Inductors				
L278	276-0507-00		Core, ferramic suppressor	
L563	276-0507-00		Core, ferramic suppressor	
L564	*120-0382-00		Toroid, 14 turns single	
L565	276-0507-00		Core, ferramic suppressor	
L566	276-0507-00		Core, ferramic suppressor	
L567	*120-0382-00		Toroid, 14 turns single	
L568	276-0507-00		Core, ferramic suppressor	
LR527	*108-0520-00		2.2 μ H (wound on a 22 Ω , 1/4 W, 5% resistor)	
LR538	*108-0520-00		2.2 μ H (wound on a 22 Ω , 1/4 W, 5% resistor)	
LR546	*108-0520-00		2.2 μ H (wound on a 22 Ω , 1/4 W, 5% resistor)	
LR569	*108-0520-00		2.2 μ H (wound on a 22 Ω , 1/4 W, 5% resistor)	
Transistors				
Q60	*151-0192-00		Silicon	Replaceable by MPS 6521
Q65	151-0254-00		Silicon	TO-98 D16P4
Q70	151-0254-00		Silicon	TO-98 D16P4
Q75	151-0254-00		Silicon	TO-98 D16P4
Q105	151-0220-00		Silicon	2N4122
Q110	151-0250-00		Silicon	2N5184
Q115	*151-0103-00		Silicon	Replaceable by 2N2219
Q118	*151-0230-00		Silicon	Selected from 40235
Q120 ¹³	*153-0559-00		FET	Tek Spec
Q130	*151-0268-00		Silicon	Dual, Tek Spec
Q140	151-0220-00		Silicon	2N4122
Q145 ¹⁴	*153-0576-00		Silicon	Selected from SE7056
Q152 ¹⁵	*153-0575-00		Silicon	Selected from 40235
Q160	*151-0268-00		Silicon	Dual, Tek Spec
Q165	151-0220-00		Silicon	2N4122

¹³Furnished as a matched pair with Q220.

¹⁴Furnished as a matched pair with Q245.

¹⁵Furnished as a matched pair with Q252.

INPUT Circuit Board Assembly (cont)

Kct. No.	Tektronix Part No.	Serial/Model No. Eff	Disc	Description
Transistors (cont)				
Q170 ¹⁶	*153-0574-00		Silicon	Selected from 2N2219
Q180	*151-0190-01		Silicon	Tek Spec
Q182	151-0221-00		Silicon	2N4258
Q185	*151-0272-00		Silicon	Dual, Tek Spec
Q195	*151-0272-00		Silicon	Dual, Tek Spec
Q205	151-0220-00		Silicon	2N4122
Q210	151-0250-00		Silicon	2N5184
Q215	*151-0103-00		Silicon	Replaceable by 2N2219
Q218	*151-0230-00		Silicon	Selected from 40235
Q220 ¹⁷	*153-0559-00		FET	Tek Spec
Q240	151-0220-00		Silicon	2N4122
Q245 ¹⁸	*153-0576-00		Silicon	Selected from SE7056
Q252 ¹⁹	*153-0575-00		Silicon	Selected from 40235
Q255	*151-0103-00		Silicon	Replaceable by 2N2219
Q258	151-0220-00		Silicon	2N4122
Q270 ¹⁶	*153-0574-00		Silicon	Selected from 2N2219
Q280	*151-0190-01		Silicon	Tek Spec
Q282	151-0221-00		Silicon	2N4258
Q500	151-0220-00		Silicon	2N4122
Q505	151-0260-00		Silicon	2N5189

Resistors

Resistors are fixed, composition, $\pm 10\%$ unless otherwise indicated.

R61	315-0822-00	8.2 k Ω	1/4 W		5%
R63	321-0271-00	6.49 k Ω	1/8 W	Prec	1%
R64	321-0352-00	45.3 k Ω	1/8 W	Prec	1%
R65	321-0404-00	158 k Ω	1/8 W	Prec	1%
R66	321-0434-00	324 k Ω	1/8 W	Prec	1%
R71	321-0349-00	42.2 k Ω	1/8 W	Prec	1%
R72	315-0302-00	3 k Ω	1/4 W		5%
R73	321-0281-00	8.25 k Ω	1/8 W	Prec	1%
R74	321-0377-00	82.5 k Ω	1/8 W	Prec	1%
R75	321-0297-00	12.1 k Ω	1/8 W	Prec	1%
R76	315-0512-00	5.1 k Ω	1/4 W		5%
R77	321-0347-00	40.2 k Ω	1/8 W	Prec	1%
R103	317-0104-00	100 k Ω	1/8 W		5%
R104	323-0318-00	20 k Ω	1/2 W	Prec	1%

¹⁶Q170 and Q270 furnished as a matched pair.¹⁷Furnished as a matched pair with Q120.¹⁸Furnished as a matched pair with Q145.¹⁹Furnished as a matched pair with Q152.

INPUT Circuit Board Assembly (cont)

Ckt. No.	Tektronix Part No.	Serial/Model No. Eff	Disc	Description		
Resistors (cont)						
R105	315-0221-00		220 Ω	1/4 W		5%
R109	323-0304-00		14.3 kΩ	1/2 W	Prec	1%
R112	321-0276-00		7.32 kΩ	1/8 W	Prec	1%
R113	317-0750-00		75 Ω	1/8 W		5%
R115	317-0101-00		100 Ω	1/8 W		5%
R117	317-0222-00		2.2 kΩ	1/8 W		5%
R119	317-0181-00		180 Ω	1/8 W		5%
R122	317-0111-00		110 Ω	1/8 W		5%
R124	321-0212-00		1.58 kΩ	1/8 W	Prec	1%
R126	321-0190-00		931 Ω	1/8 W	Prec	1%
R131	315-0681-00		680 Ω	1/4 W		5%
R134	321-0195-00		1.05 kΩ	1/8 W	Prec	1%
R140	321-0356-00		49.9 kΩ	1/8 W	Prec	1%
R141	321-0356-00		49.9 kΩ	1/8 W	Prec	1%
R143	321-0308-00		15.8 kΩ	1/8 W	Prec	1%
R145	317-0101-00		100 Ω	1/8 W		5%
R147	308-0527-00		1.4 kΩ	3 W	WW	1%
R152	321-0314-00		18.2 kΩ	1/8 W	Prec	1%
R155	317-0472-00		4.7 kΩ	1/8 W		5%
R156	315-0103-00		10 kΩ	1/4 W		5%
R157	317-0472-00		4.7 kΩ	1/8 W		5%
R160	317-0562-00		5.6 kΩ	1/8 W		5%
R162	321-0099-00		105 Ω	1/8 W	Prec	1%
R163	315-0301-00		300 Ω	1/4 W		5%
R164	317-0331-00		330 Ω	1/8 W		5%
R166	315-0163-00		16 kΩ	1/4 W		5%
R167	311-0609-00		2 kΩ, Var			
R168	317-0202-00		2 kΩ	1/8 W		5%
R169	317-0200-00		20 Ω	1/8 W		5%
R170	317-0300-00		30 Ω	1/8 W		5%
R172	317-0203-00		20 kΩ	1/8 W		5%
R173	311-0497-00		50 kΩ, Var			
R174	315-0393-00		39 kΩ	1/4 W		5%
R176	315-0304-00		300 kΩ	1/4 W		5%
R178	321-0077-00		61.9 kΩ	1/8 W	Prec	1%
R179	317-0221-00		220 Ω	1/8 W		5%
R180	317-0752-00		7.5 kΩ	1/8 W		5%
R181	315-0513-00		51 kΩ	1/4 W		5%
R182	315-0103-00		10 kΩ	1/4 W		5%
R183	315-0302-00		3 kΩ	1/4 W		5%
R184	321-0093-00		90.9 Ω	1/8 W	Prec	1%
R185	321-0047-00		30.1 Ω	1/8 W	Prec	1%
R186	308-0526-00		2.37 kΩ	3 W	WW	1%
R187	311-0622-00		100 Ω, Var			
R188	321-0095-00		95.3 Ω	1/8 W	Prec	1%

INPUT Circuit Board Assembly (cont)

Ckt. No.	Tektronix Part No.	Serial/Model No. Eff	Disc	Description		
Resistors (cont)						
R189	323-0193-00		1 k Ω	$\frac{1}{2}$ W	Prec	1%
R190	321-0150-00		357 Ω	$\frac{1}{8}$ W	Prec	1%
R191	321-0072-00		54.9 Ω	$\frac{1}{8}$ W	Prec	1%
R192	321-0072-00		54.9 Ω	$\frac{1}{8}$ W	Prec	1%
R193	321-0794-03		67.5 Ω	$\frac{1}{8}$ W	Prec	$\frac{1}{4}$ %
R194	325-0042-00		15 Ω	$\frac{1}{8}$ W	Prec	$\frac{1}{4}$ %
R195	322-0193-00		1 k Ω	$\frac{1}{4}$ W	Prec	1%
R196	311-0704-00		500 Ω , Var			
R197	315-0271-00		270 Ω	$\frac{1}{4}$ W		5%
R198	315-0101-00		100 Ω	$\frac{1}{4}$ W		5%
R199	321-0120-00		174 Ω	$\frac{1}{8}$ W	Prec	1%
R203	317-0104-00		100 k Ω	$\frac{1}{8}$ W		5%
R204	323-0318-00		20 k Ω	$\frac{1}{2}$ W	Prec	1%
R205	315-0221-00		220 Ω	$\frac{1}{4}$ W		5%
R209	323-0304-00		14.3 k Ω	$\frac{1}{2}$ W	Prec	1%
R212	321-0276-00		7.32 k Ω	$\frac{1}{8}$ W	Prec	1%
R213	317-0750-00		75 Ω	$\frac{1}{8}$ W		5%
R215	317-0101-00		100 Ω	$\frac{1}{8}$ W		5%
R217	317-0222-00		2.2 k Ω	$\frac{1}{8}$ W		5%
R219	317-0181-00		180 Ω	$\frac{1}{8}$ W		5%
R222	317-0111-00		110 Ω	$\frac{1}{8}$ W		5%
R224	321-0212-00		1.58 k Ω	$\frac{1}{8}$ W	Prec	1%
R226	321-0190-00		931 Ω	$\frac{1}{8}$ W	Prec	1%
R231	315-0681-00		680 Ω	$\frac{1}{4}$ W		5%
R234	321-0195-00		1.05 k Ω	$\frac{1}{8}$ W	Prec	1%
R240	321-0356-00		49.9 k Ω	$\frac{1}{8}$ W	Prec	1%
R241	321-0356-00		49.9 k Ω	$\frac{1}{8}$ W	Prec	1%
R243	321-0308-00		15.8 k Ω	$\frac{1}{8}$ W	Prec	1%
R245	317-0101-00		100 Ω	$\frac{1}{8}$ W		5%
R247	308-0527-00		1.4 k Ω	3 W	WW	1%
R252	321-0314-00		18.2 k Ω	$\frac{1}{8}$ W	Prec	1%
R254	321-0356-00		49.9 k Ω	$\frac{1}{8}$ W	Prec	1%
R255	321-0356-00		49.9 k Ω	$\frac{1}{8}$ W	Prec	1%
R256	315-0103-00		10 k Ω	$\frac{1}{4}$ W		5%
R257	315-0243-00		24 k Ω	$\frac{1}{4}$ W		5%
R258	317-0101-00		100 Ω	$\frac{1}{8}$ W		5%
R259	308-0496-00		1 k Ω	2.5 W	WW	1%
R260	317-0562-00		5.6 k Ω	$\frac{1}{8}$ W		5%
R262	321-0099-00		105 Ω	$\frac{1}{8}$ W	Prec	1%
R269	317-0200-00		20 Ω	$\frac{1}{8}$ W		5%
R272	317-0203-00		20 k Ω	$\frac{1}{8}$ W		5%
R278	321-0077-00		61.9 Ω	$\frac{1}{8}$ W	Prec	1%
R279	317-0221-00		220 Ω	$\frac{1}{8}$ W		5%
R280	317-0752-00		7.5 k Ω	$\frac{1}{8}$ W		5%
R281	315-0513-00		51 k Ω	$\frac{1}{4}$ W		5%

INPUT Circuit Board Assembly (cont)

Ckt. No.	Tektronix Part No.	Serial/Model No. Eff	Disc	Description		
Resistors (cont)						
R282	315-0103-00		10 kΩ	1/4 W		5%
R283	315-0302-00		3 kΩ	1/4 W		5%
R284	321-0093-00		90.9 Ω	1/8 W	Prec	1%
R285	321-0047-00		30.1 Ω	1/8 W	Prec	1%
R286	308-0526-00		2.37 kΩ	3 W	WW	1%
R288	311-0433-00		100 Ω, Var			
R289	323-0193-00		1 kΩ	1/2 W	Prec	1%
R290	321-0150-00		357 Ω	1/8 W	Prec	1%
R291	321-0072-00		54.9 Ω	1/8 W	Prec	1%
R292	321-0072-00		54.9 Ω	1/8 W	Prec	1%
R293	321-0794-03		67.5 Ω	1/8 W	Prec	1/4 %
R295	322-0193-00		1 kΩ	1/4 W	Prec	1%
R297	315-0271-00		270 Ω	1/4 W		5%
R299	321-0120-00		174 Ω	1/8 W	Prec	1%
R501	321-0327-00		24.9 kΩ	1/8 W	Prec	1%
R502	321-0327-00		24.9 kΩ	1/8 W	Prec	1%
R503	315-0822-00		8.2 kΩ	1/4 W		5%
R505	303-0301-00		300 Ω	1 W		5%
R528	321-0143-00		301 Ω	1/8 W	Prec	1%
R563	*308-0433-00		1 Ω	1/4 W	WW	
R565	317-0510-00		51 Ω	1/8 W		5%
R566	317-0510-00		51 Ω	1/8 W		5%

BANDWIDTH Circuit Board Assembly

*670-1073-00

Complete Board

Bulb

DS490 *150-0093-01

Incandescent T3/4, selected

Switch

Wired or Unwired

S490²⁰ *670-1073-00

Pushbutton BW

²⁰See Mechanical Parts List for replacement parts.

SECTION 7 DIAGRAMS and MECHANICAL PARTS ILLUSTRATIONS

The following special symbols are used on the diagrams:

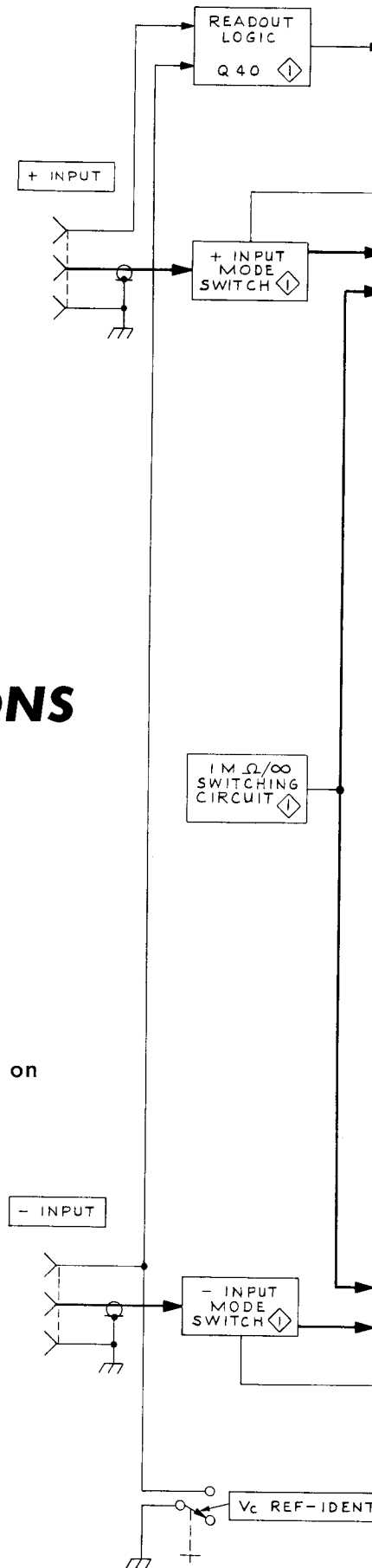
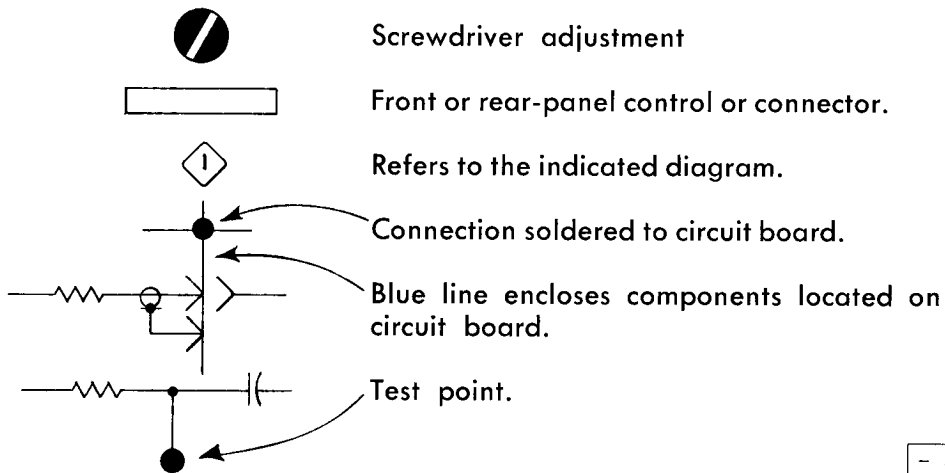

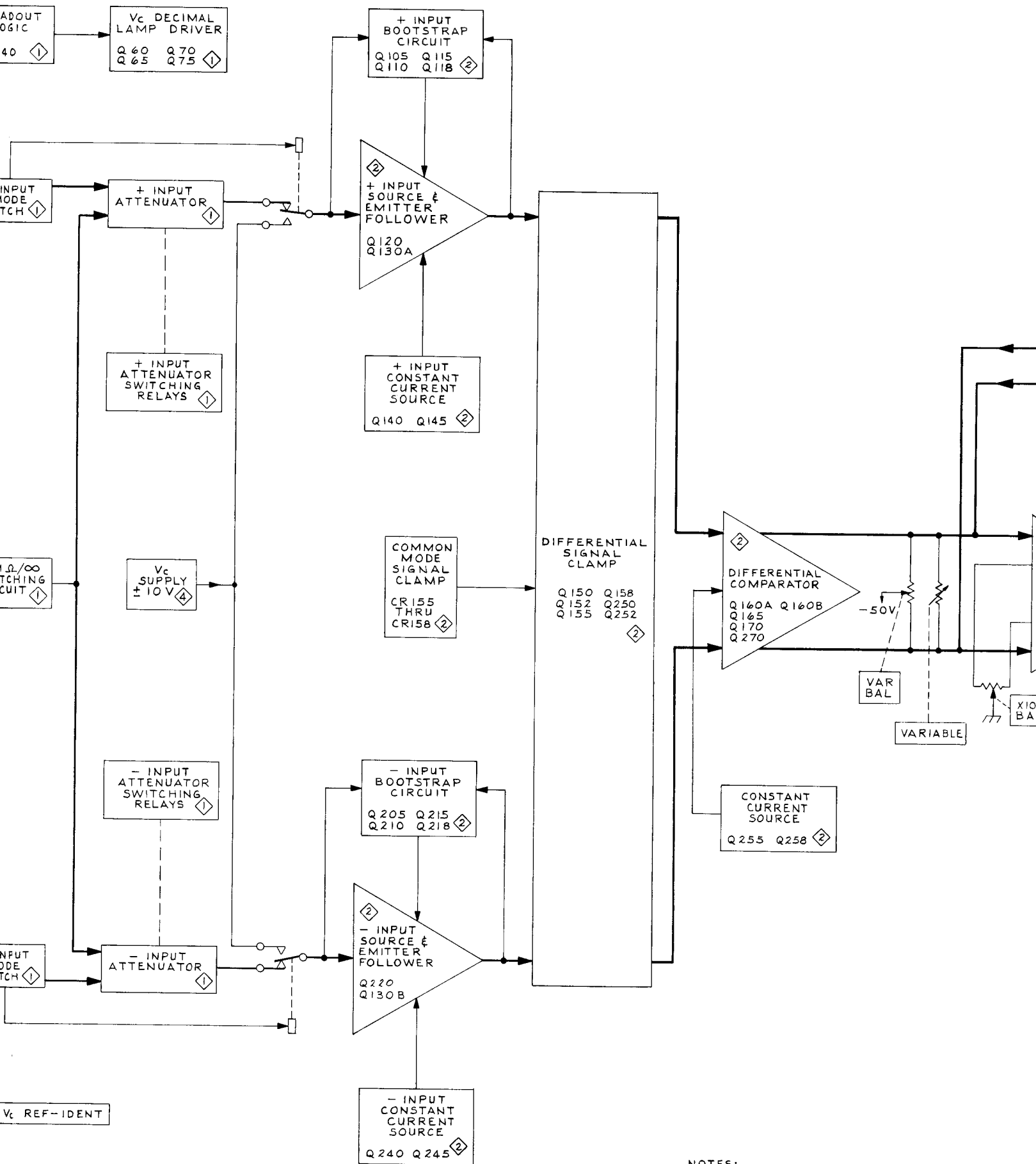

NOTES:

1. HEAVY LINES SHOW SIGNAL & TRIGGER FLOW
2. + INPUT MODE SWITCH IS SET TO DC & - INPUT MODE SWITCH IS SET TO GND.

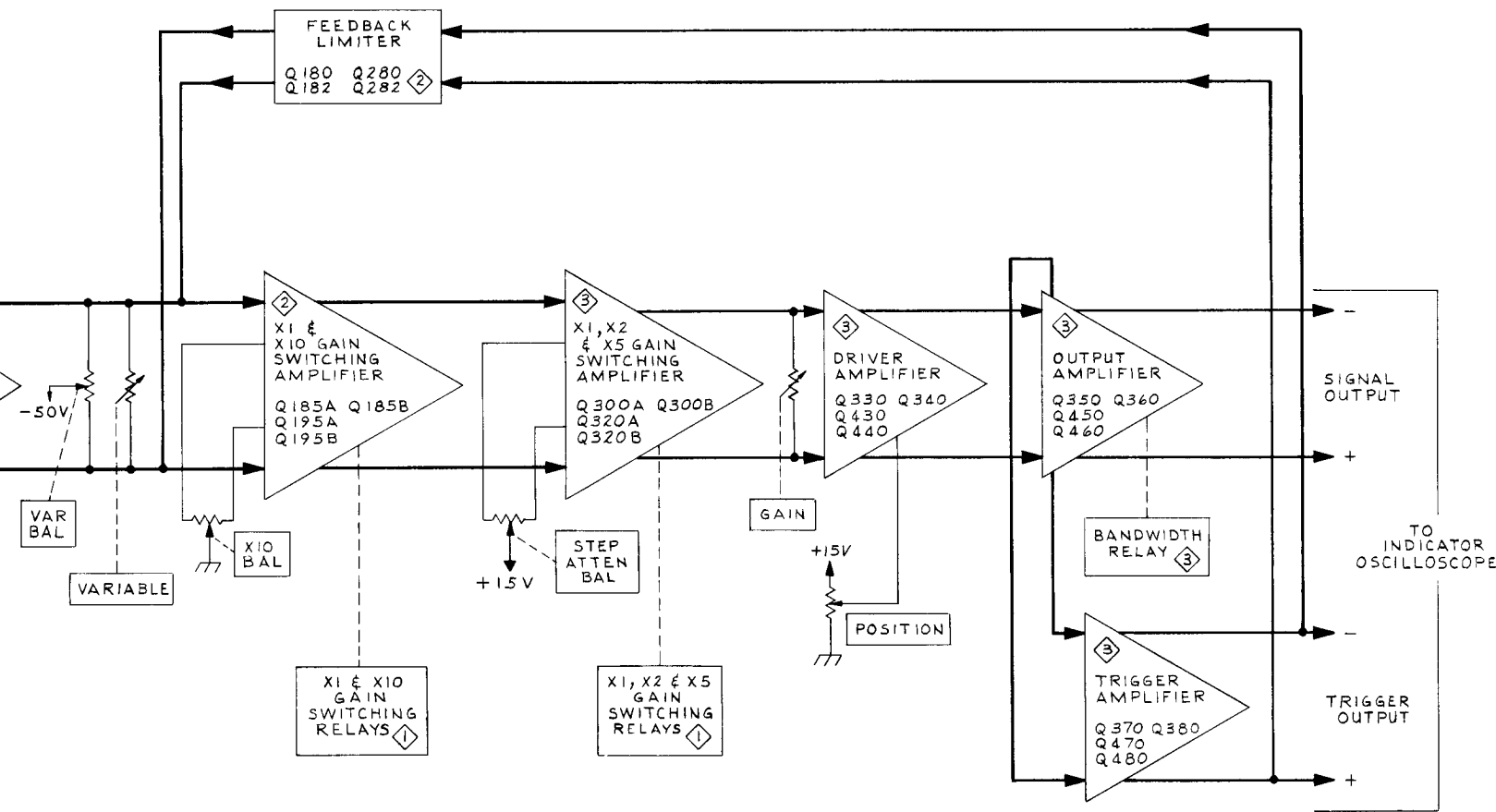

SHOW SIGNAL & TRIGGER FLOW.
 SWITCH IS SET TO DC & - INPUT
 TO GND.

(A)

VOLTAGE AND WAVEFORM CONDITIONS

DC circuit voltages were measured with a digital multimeter having an accuracy of 0.1%; input impedance is greater than 1 kM Ω on the 1.500 volt range and 10 M Ω on the higher ranges. All voltages were measured with respect to chassis ground unless noted otherwise.

Waveforms shown are actual photographs taken with a Tektronix Oscilloscope Camera System and Projected Graticule. Test oscilloscope* deflection factor and sweep rate conditions are noted adjacent to each waveform. AC coupling was used to obtain photographs of the waveform amplitudes. The test oscilloscope was externally triggered by the 4 V calibrator signal that was applied from the Indicator oscilloscope* to the Type 7A13 and Test oscilloscope. External triggering enables the waveform polarity to be shown with respect to the input signal.

The test oscilloscope used for obtaining the waveform photographs had the following minimum characteristics: Deflection factor, 1 mV/div to .1 V/div (10 mV/div to 1 V/div with a 10X probe); AC coupled input; frequency response, 2 Hz to 10 MHz; sweep rate, 0.2 ms/div.

Type 7A13 Control Settings

COMPARISON VOLTAGE (V _c)	
Polarity	Pushbuttons released
Selector	As is
FINE	As is
+INPUT Mode	AC (for waveforms)
-INPUT Mode	GND (for voltages)
VOLTS/DIV	GND
VARIABLE (VOLTS/DIV)	1 V
PULL VAR FOR X10 V _c RANGE	CAL (CW, in detent)
VAR BAL	Pushed in
BW	As is
POSITION	5 MHz
	For centered trace
	or display
R _{in} \approx ∞ (see Fig. 2-1, Operating Instructions)	R _{in} = \approx 1 M Ω

*The test oscilloscope is used for signal tracing and obtaining waveform photographs. The indicator oscilloscope is the oscilloscope that accepts the Type 7A13 Plug-In Unit.

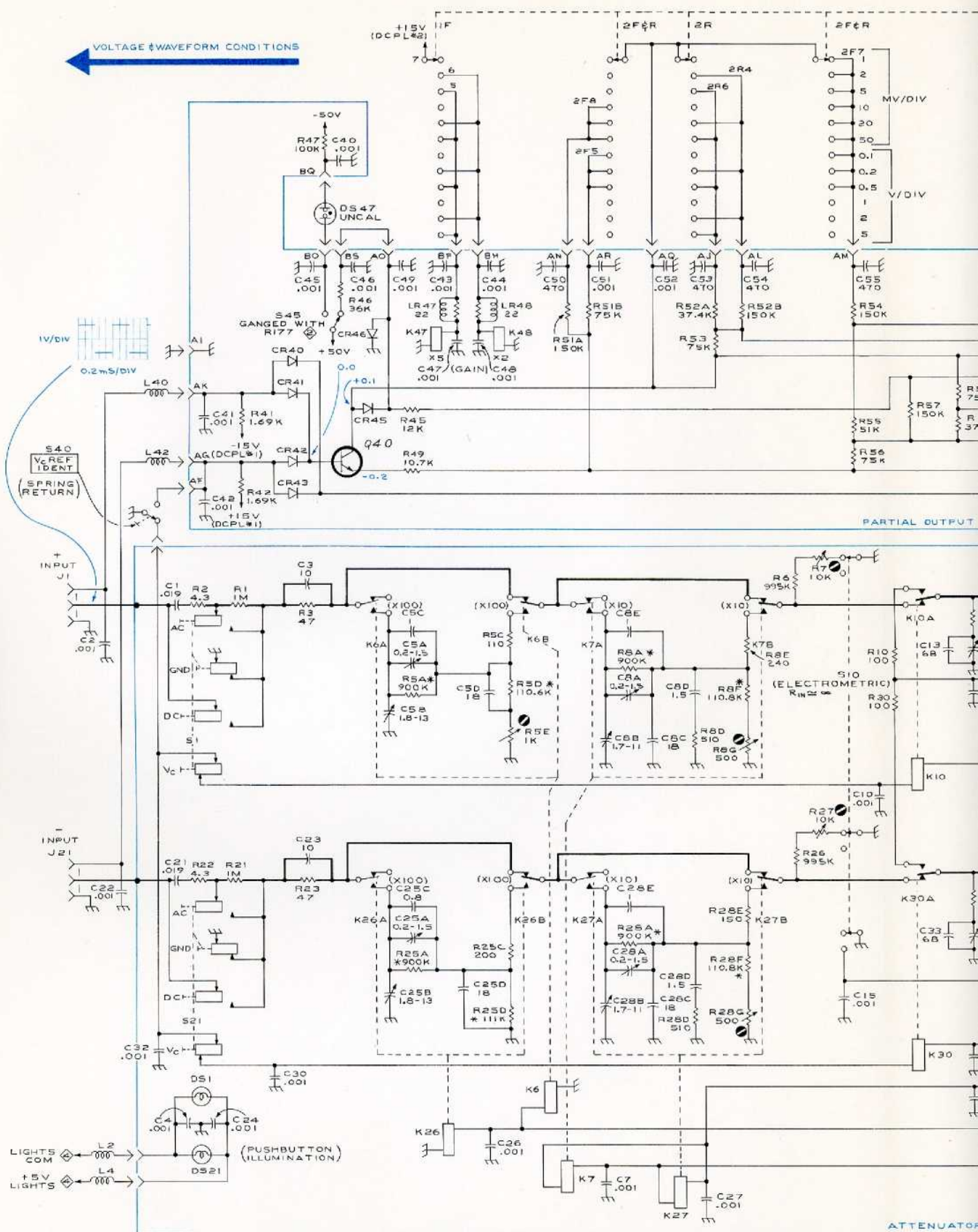

VOLTAGE & WAVEFORM CONDITIONS

1V/DIV
0.2ms/DIV

PARTIAL OUTPUT

ATTENUATOR

NOTE:
1. SEE PARTS LIST FOR SEMICONDUCTOR TYPES
2. *MATCHED COMPONENTS
3. HEAVY LINES DENOTE SIGNAL FLOW

REFERENCE I
INPUT AM
DISTRIBUT
COMPARIS
GENERATOR

TYPE 7A13

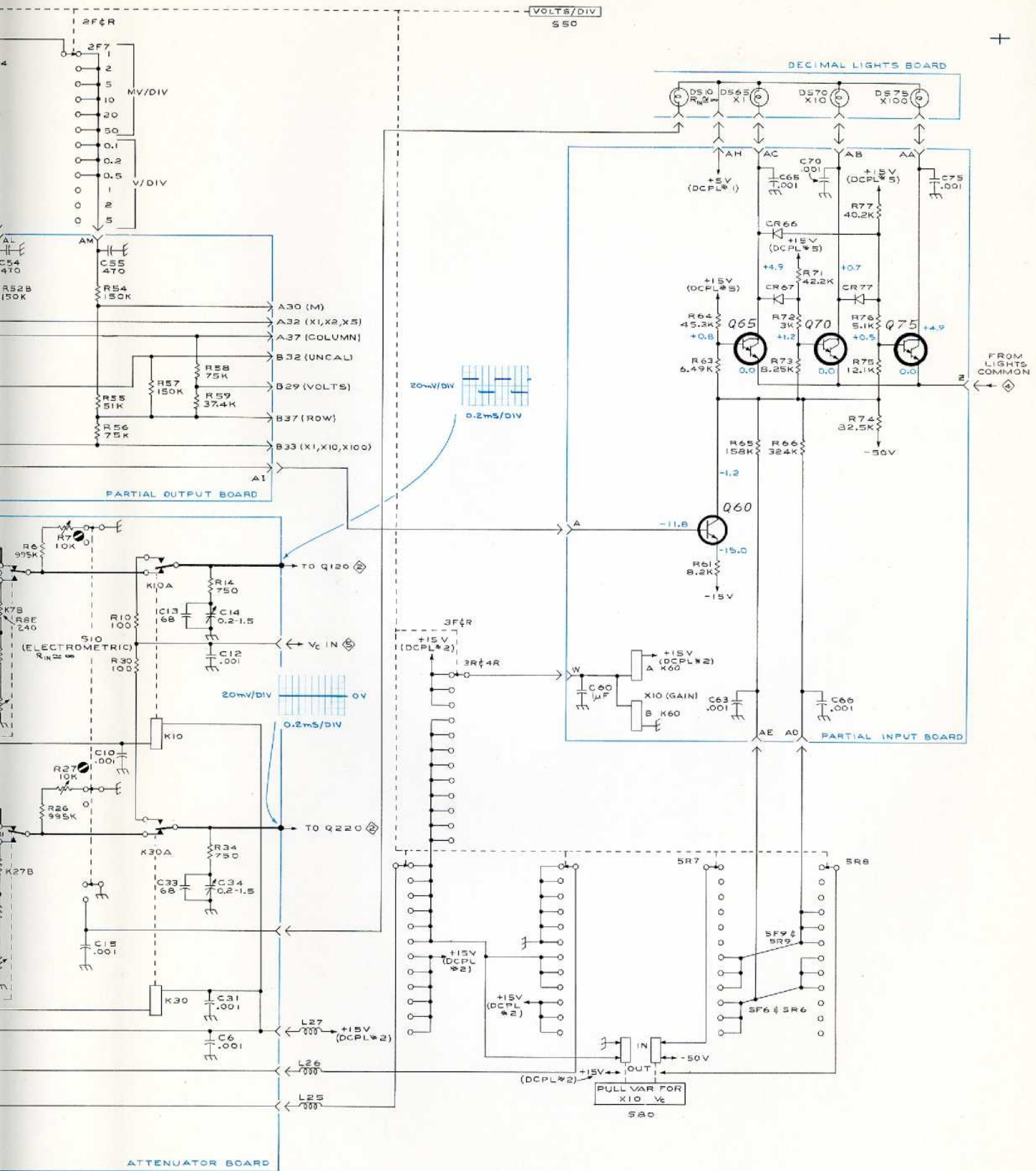

- REFERENCE DIAGRAM
- ◆ INPUT AMPLIFIER
 - ◆ DISTRIBUTION DIAGRAM
 - ◆ COMPARISON VOLTAGE GENERATOR

ATTENUATOR & SWITCHING

VRS 1069

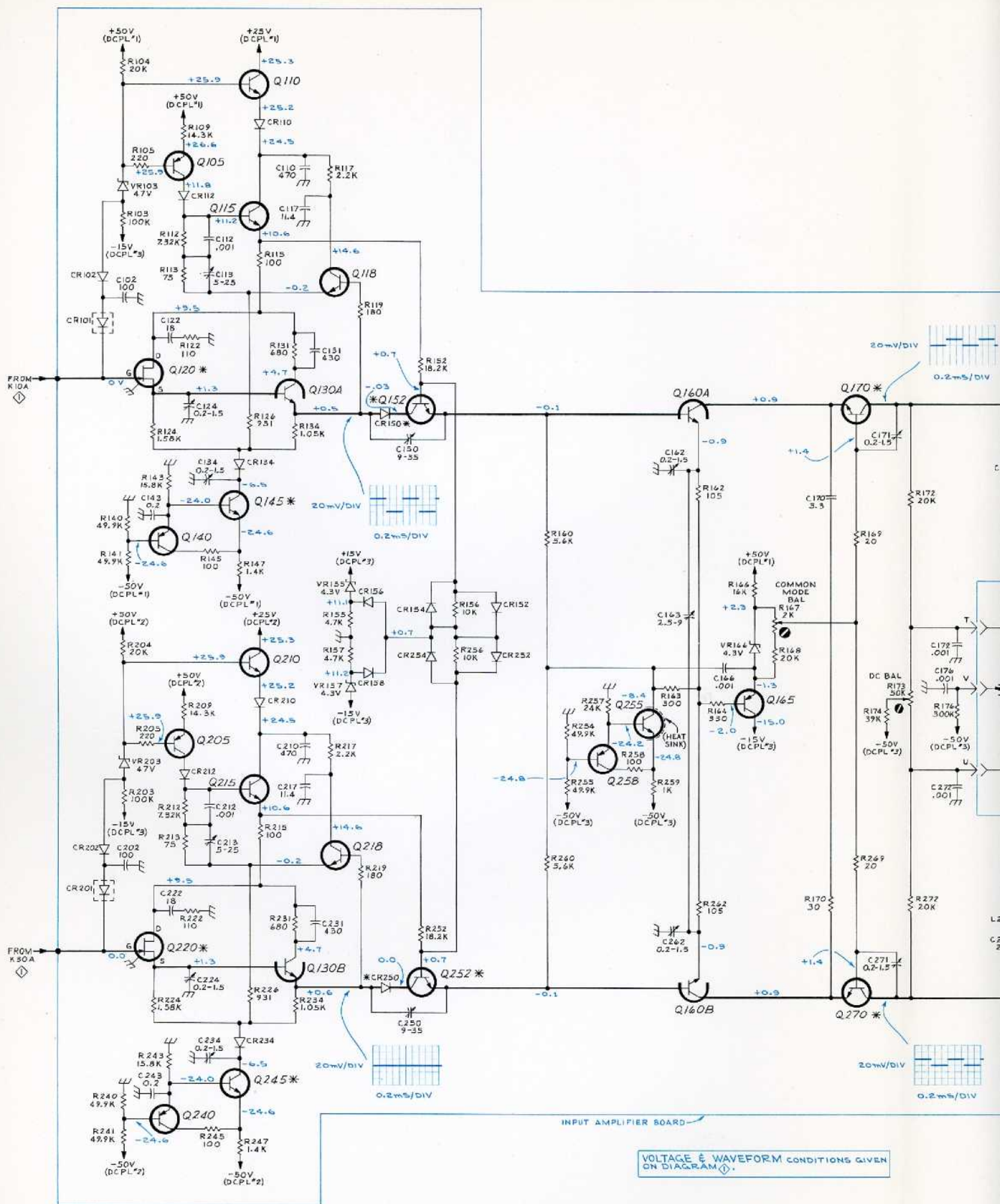

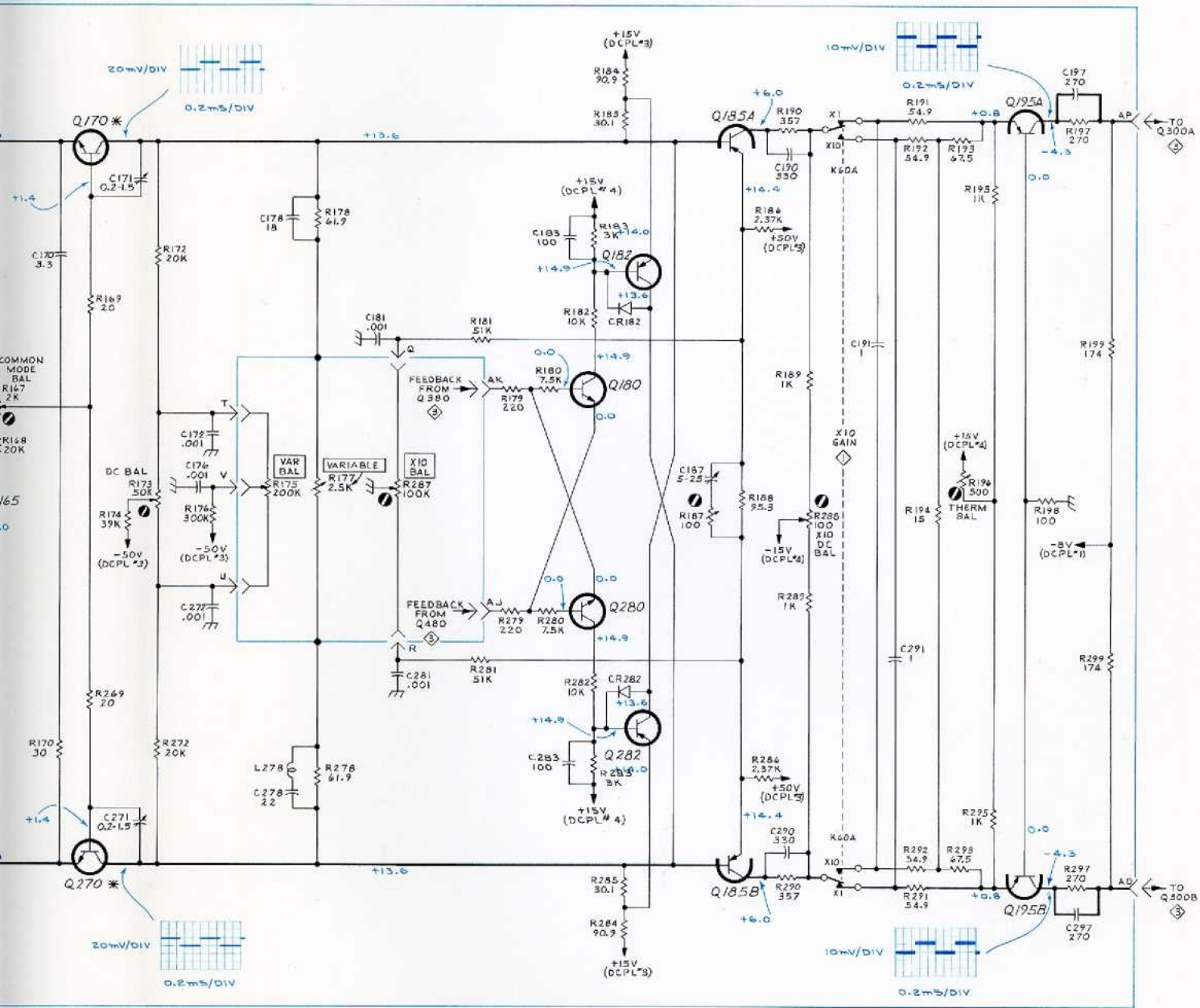

NOTE:
 1. MATCHED PAIR (*)
 2. HEAVY LINES DENOTE SIGNAL FLOW
 3. SEE PARTS LIST FOR SEMICONDUCTOR TYPES

REFERENCE DIAGRAMS
 ① ATTENUATOR & SWITCHING
 ② OUTPUT AMPLIFIER

CONDITIONS GIVEN

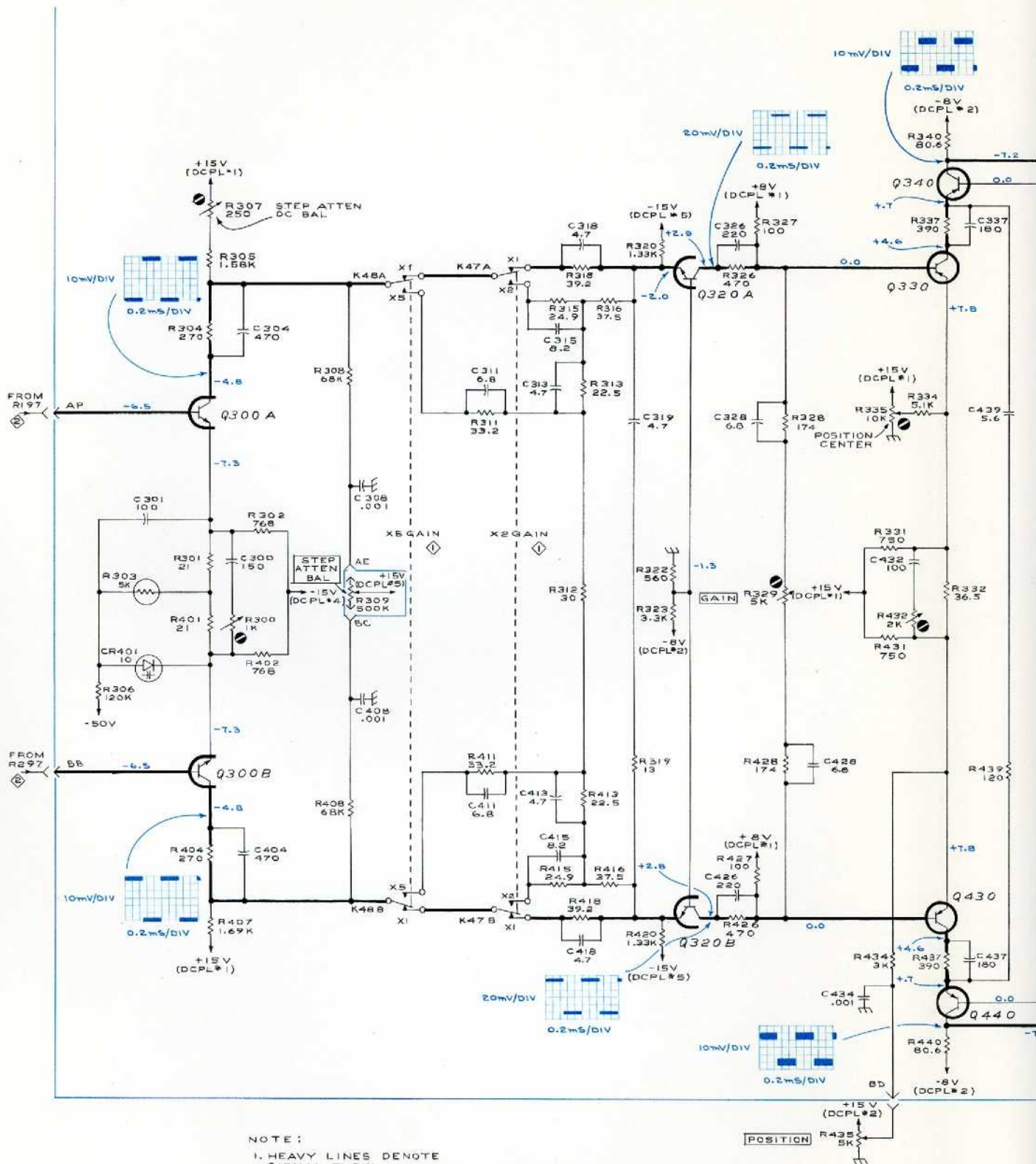

NOTE:
 1. HEAVY LINES DENOTE SIGNAL FLOW
 2. SEE PARTS LIST FOR SEMICONDUCTOR TYPES

VOLTAGE & WAVEFORM CONDITIONS GIVEN ON DIAGRAM

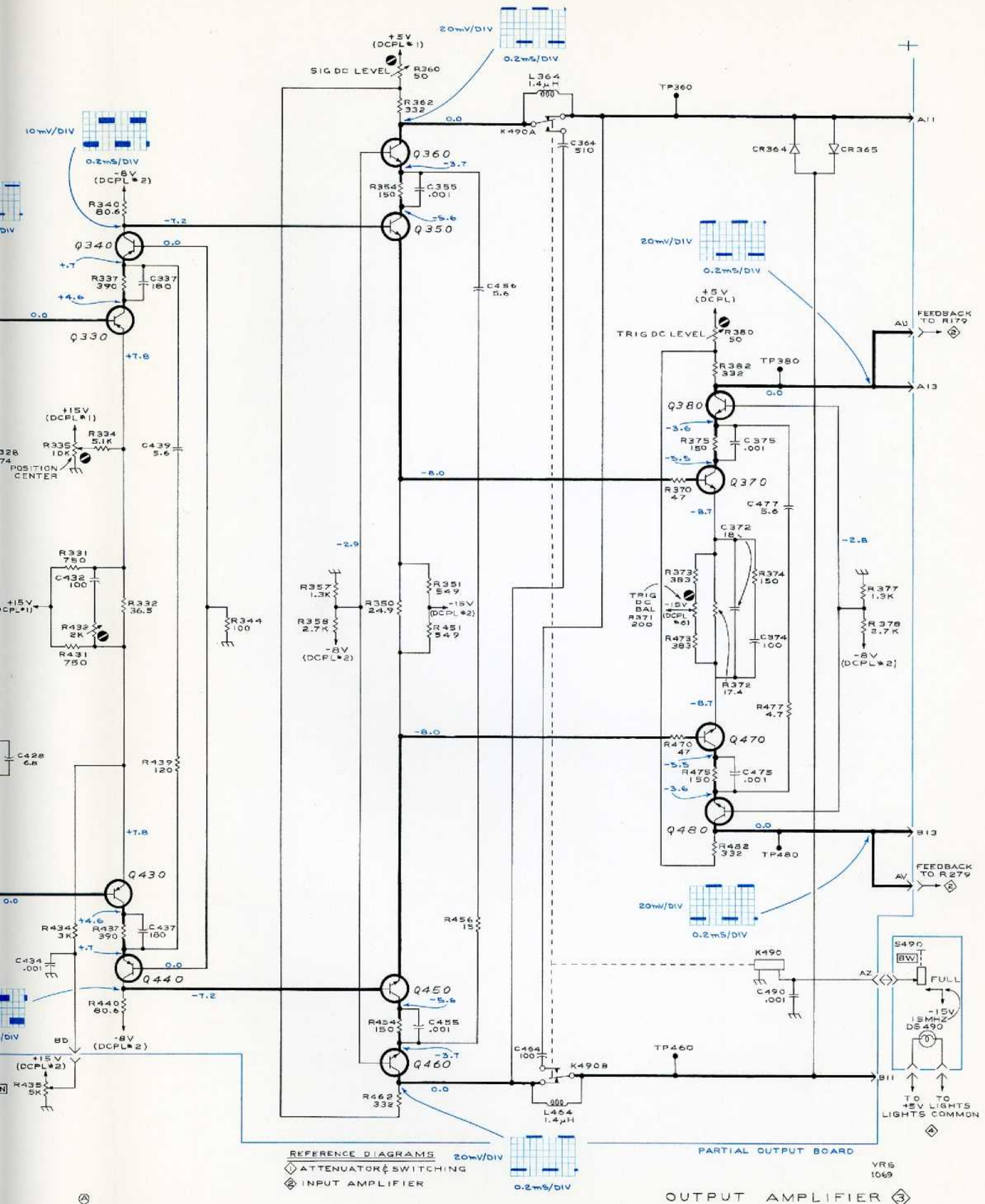

OUTPUT AMPLIFIER 3

VR5
1069

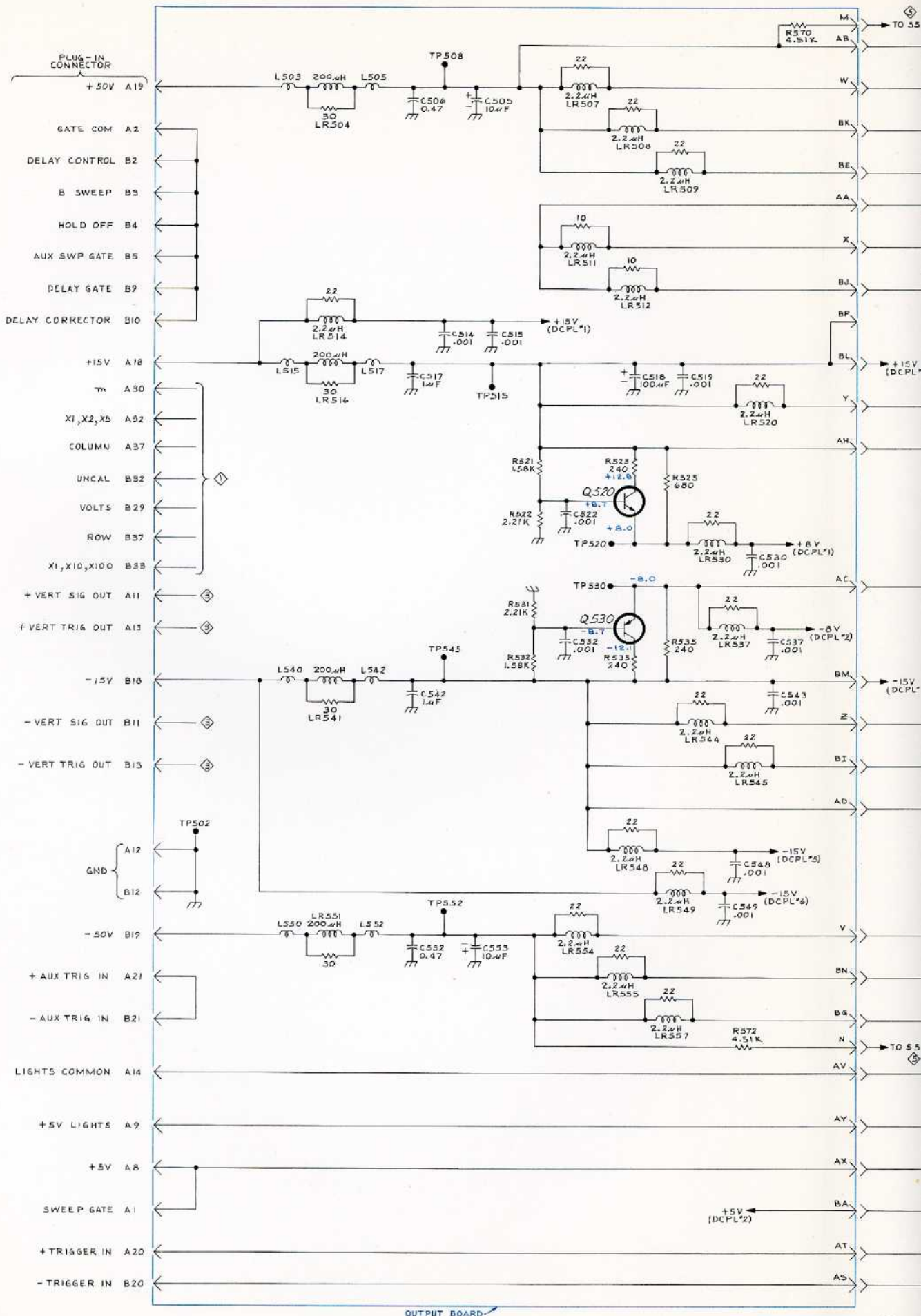

TYPE 7A13

OUTPUT BOARD

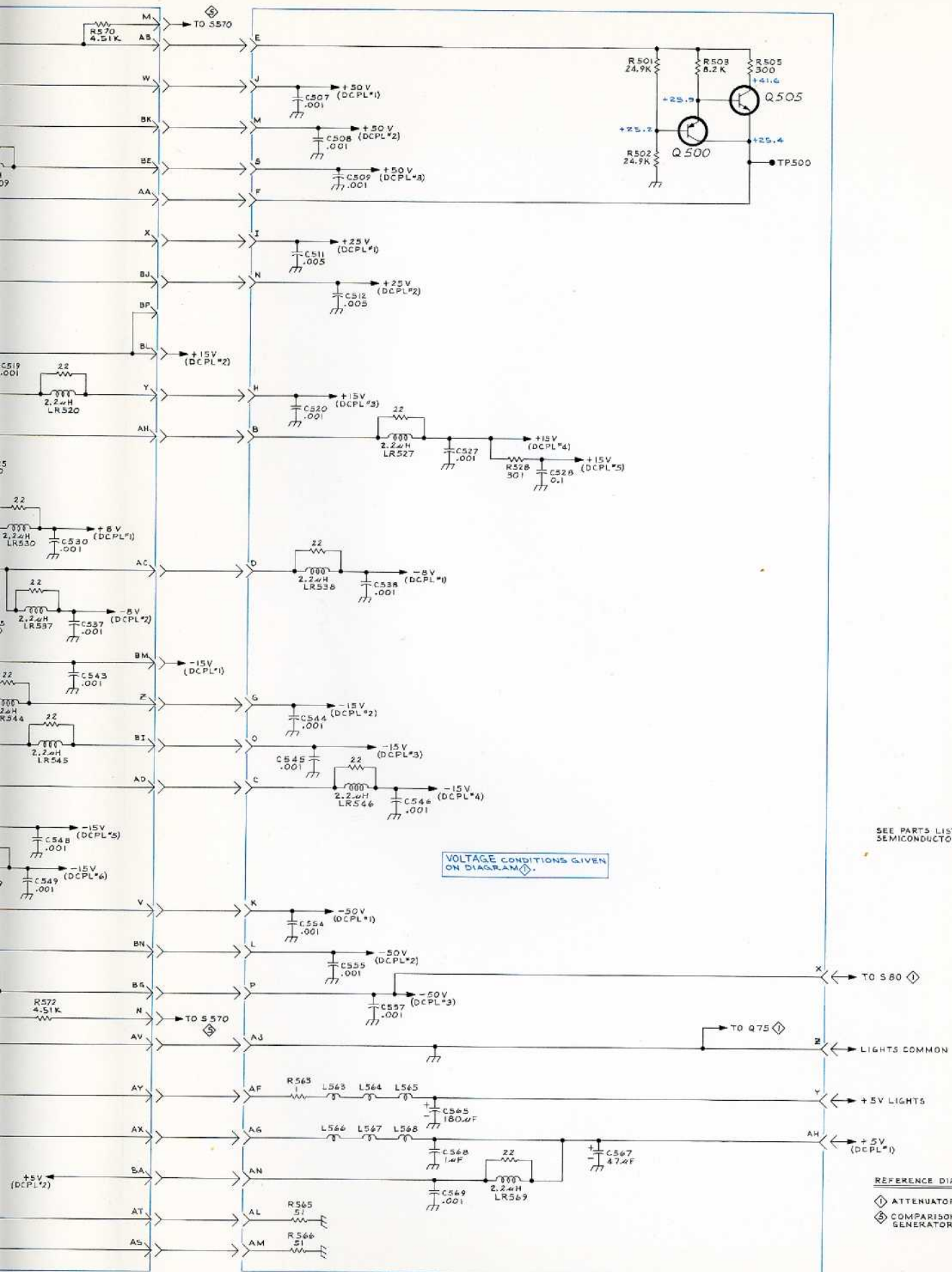

VOLTAGE CONDITIONS GIVEN ON DIAGRAM.

SEE PARTS LIST FOR SEMICONDUCTOR TYPES

- REFERENCE DIAGRAM
- ◇ ATTENUATOR & SWITCHING
 - ⊠ COMPARISON VOLTAGE GENERATOR

(A)

INPUT BOARD

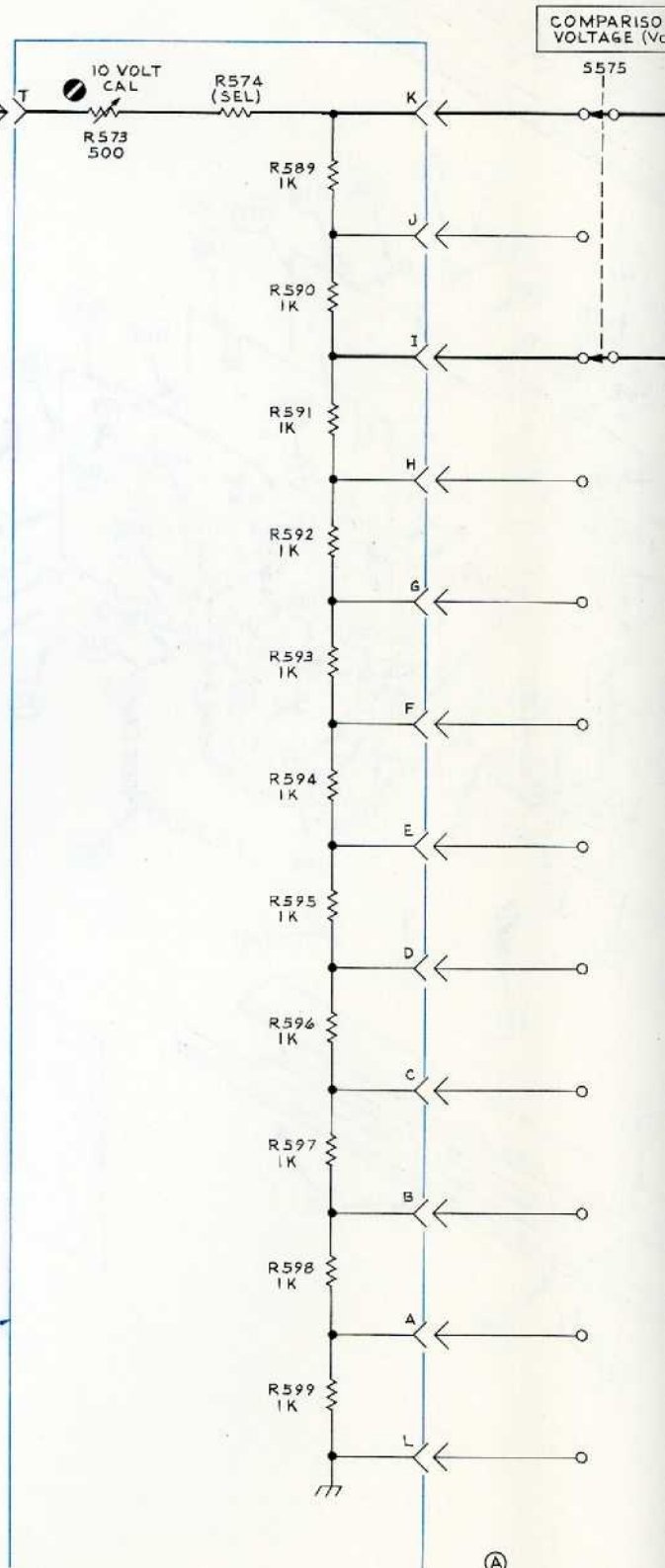
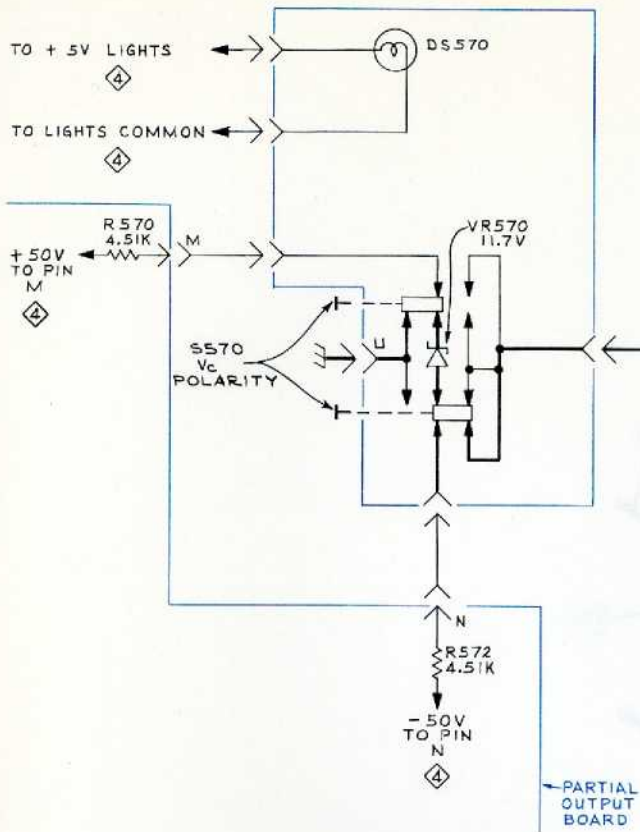

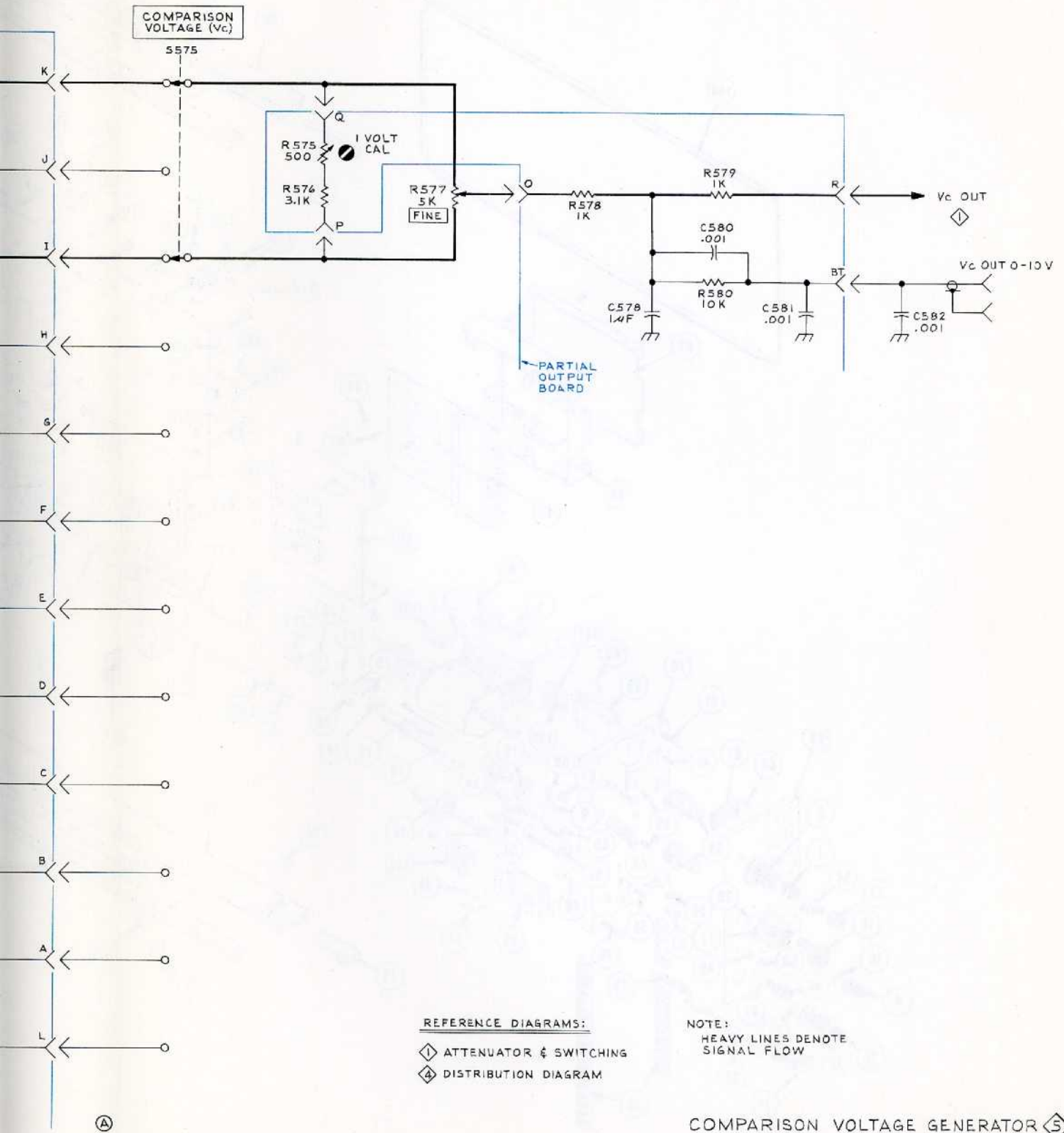

REFERENCE DIAGRAMS:

- ① ATTENUATOR & SWITCHING
- ② DISTRIBUTION DIAGRAM

NOTE:
HEAVY LINES DENOTE
SIGNAL FLOW

+

FIGURE 1 EXPLODED

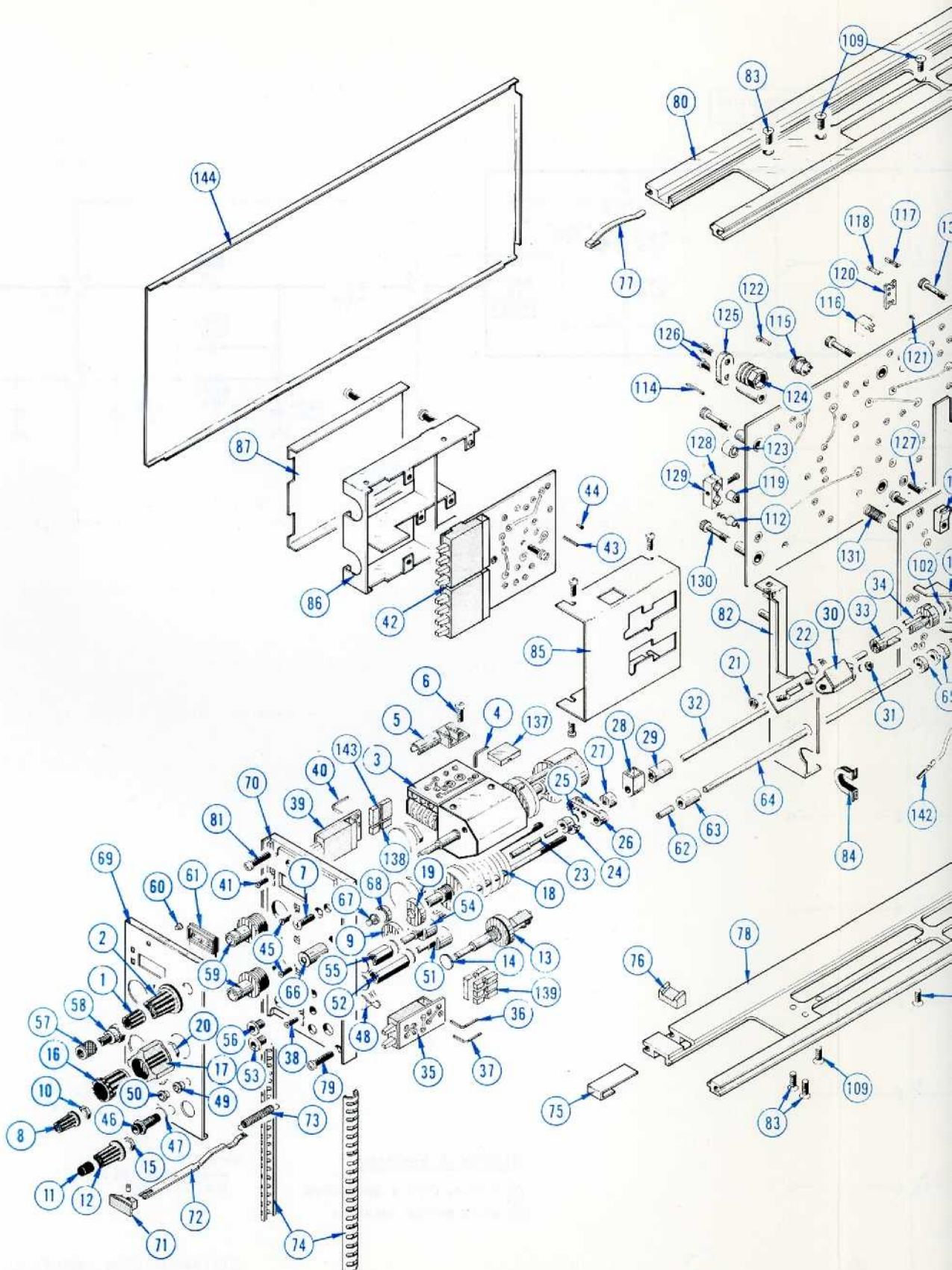

TYPE 7A13 DIFFERENTIAL COMPARATOR

FIGURE 1 EXPLODED

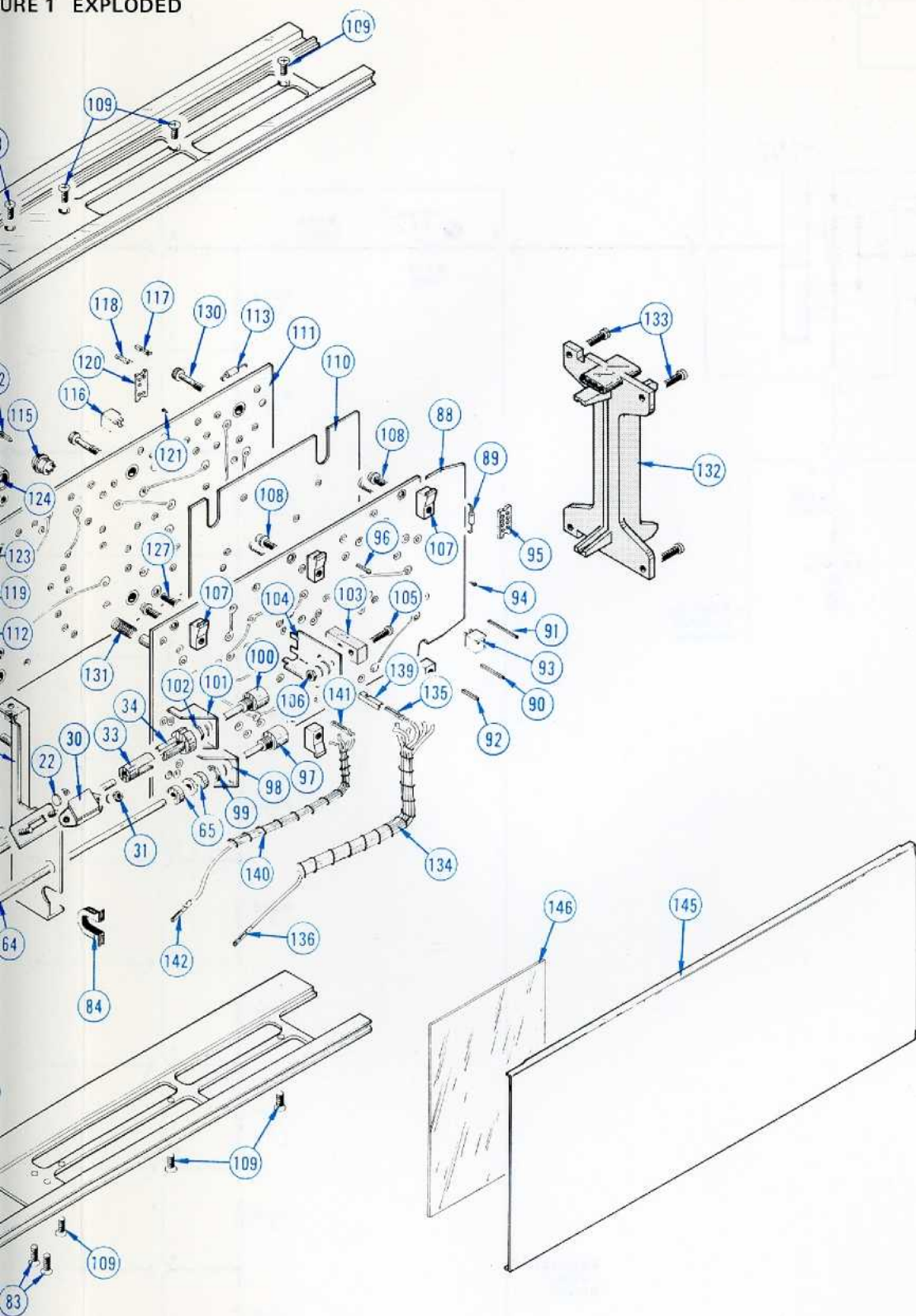

FIGURE AND INDEX NUMBERS

Items in this section are referenced by figure and index numbers to the illustrations which appear either on the back of the diagrams or on pullout pages immediately following the diagrams of the instruction manual.

INDENTATION SYSTEM

This mechanical parts list is indented to indicate item relationships. Following is an example of the indentation system used in the Description column.

Assembly and/or Component
 Detail Part of Assembly and/or Component
 mounting hardware for Detail Part
 Parts of Detail Part
 mounting hardware for Parts of Detail Part
 mounting hardware for Assembly and/or Component

Mounting hardware always appears in the same indentation as the item it mounts, while the detail parts are indented to the right. Indented items are part of, and included with, the next higher indentation.

Mounting hardware must be purchased separately, unless otherwise specified.

PARTS ORDERING INFORMATION

Replacement parts are available from or through your local Tektronix, Inc. Field Office or representative.

Changes to Tektronix instruments are sometimes made to accommodate improved components as they become available, and to give you the benefit of the latest circuit improvements developed in our engineering department. It is therefore important, when ordering parts, to include the following information in your order: Part number, instrument type or number, serial or model number, and modification number if applicable.

If a part you have ordered has been replaced with a new or improved part, your local Tektronix, Inc. Field Office or representative will contact you concerning any change in part number.

Change information, if any, is located at the rear of this manual.

ABBREVIATIONS AND SYMBOLS

For an explanation of the abbreviations and symbols used in this section, please refer to the page immediately preceding the Electrical Parts List in this instruction manual.

INDEX OF MECHANICAL PARTS ILLUSTRATION

Title	Location (reverse side of)
Figure 1 Exploded	Comparison Voltage Generator Diagram

SECTION 8

MECHANICAL PARTS LIST

FIGURE 1 EXPLODED

Fig. & No. Index	Tektronix Part No.	Serial/Model No. Eff	No. Disc	Q					Description	
				t	y	1	2	3		4
1-1	366-1023-00			1						1 KNOB, gray—FINE
	- - - - -			-						knob includes:
	213-0153-00			1						SETSCREW, 5-40 x 0.125 inch, HSS
-2	366-1170-00			1						1 KNOB, gray—COMPARISON VOLTAGE
	- - - - -			-						knob includes:
	213-0153-00			1						SETSCREW, 5-40 x 0.125 inch, HSS
-3	670-1045-00			1						1 ASSEMBLY, circuit board—COMPARISON VOLTAGE (Vc)
	- - - - -			-						assembly includes:
	388-1142-00			1						BOARD, circuit
-4	131-0589-00			5						5 TERMINAL, pin, 0.50 inch long
-5	200-1034-00			1						1 COVER, lamp
	- - - - -			-						mounting hardware: (not included w/cover)
-6	211-0097-00			2						2 SCREW, 4-40 x 5/16 inch, PHS
	- - - - -			-						mounting hardware: (not included w/assembly)
-7	211-0538-00			2						2 SCREW, 6-32 x 5/16 inch, 100° csk, FHS
-8	366-1170-00			1						1 KNOB, gray—VAR BAL
	- - - - -			-						knob includes:
	213-0153-00			1						SETSCREW, 5-40 x 0.125 inch, HSS
	- - - - -			1						RESISTOR, variable (not shown)
	- - - - -			-						mounting hardware: (not included w/resistor)
-9	361-0143-00			1						1 SPACER, ring
-10	210-0583-00			1						1 NUT, hex., 1/4-32 x 5/16 inch
-11	366-1059-00			1						1 PUSHBUTTON, gray—Vc REF-IDENT
-12	366-1077-00			1						1 KNOB, gray—POSITION
	- - - - -			-						knob includes:
	213-0020-00			1						SETSCREW, 6-32 x 1/8 inch, HSS
-13	- - - - -			1						1 RESISTOR, variable
	- - - - -			-						mounting hardware: (not included w/resistor)
-14	210-0046-00			1						1 WASHER, lock, internal, 0.261 ID x 0.400 inch OD
-15	210-0583-00			1						1 NUT, hex., 1/4-32 x 5/16 inch
-16	366-1082-00			1						1 KNOB, gray—VARIABLE CAL
	- - - - -			-						knob includes:
	213-0153-00			1						SETSCREW, 5-40 x 0.125 inch, HSS
-17	366-1123-00			1						1 KNOB, gray—VOLTS/DIV
	- - - - -			-						knob includes:
	213-0153-00			1						SETSCREW, 5-40 x 0.125 inch, HSS
-18	260-1033-00			1						1 SWITCH, unwired—VOLTS/DIV
	- - - - -			-						mounting hardware: (not included w/ switch)
-19	210-1084-00			1						1 WASHER, key
-20	210-0590-00			1						1 NUT, hex., 3/8-32 x 7/16 inch
-21	210-0405-00			4						4 NUT, hex., 2-56 x 3/16 inch
-22	210-0001-00			4						4 WASHER, lock, internal, #2

FIGURE 1 EXPLODED (cont)

Fig. & Index No.	Tektronix Part No.	Serial/Model Eff	No. Disc	Q					Description
				t	1	2	3	4	
1-23	384-0701-00			1					EXTENSION SHAFT
-24	105-0077-00			1					STOP, rotary switch
	- - - - -			-					stop includes:
	213-0048-00			1					SETSCREW, 4-40 x 1/8 inch, HSS
-25	354-0330-00			2					RING, retaining
-26	105-0078-00			1					STOP, rotary switch
-27	343-0178-00			1					COLLAR, shaft
	- - - - -			-					collar includes:
	213-0048-00			1					SETSCREW, 4-40 x 1/8 inch, HSS
-28	376-0058-00			1					COUPLING, slide switch
-29	376-0039-00			1					COUPLING
	- - - - -			-					coupling includes:
	213-0075-00			2					SETSCREW, 4-40 x 3/32 inch, HSS
-30	260-0816-00			1					SWITCH, slide
	- - - - -			-					mounting hardware: (not included w/switch)
	210-0053-00			2					WASHER, lock, split, #2
-31	210-0405-00			2					NUT, hex., 2-56 x 3/16 inch
-32	384-0487-00			1					SHAFT, extension, plastic
-33	376-0073-00			1					COUPLING HALF, shaft
	- - - - -			-					coupling half includes:
	213-0048-00			1					SETSCREW, 4-40 x 1/8 inch, HSS
-34	376-0072-00			1					COUPLING HALF, shaft
	- - - - -			-					coupling half includes:
	213-0048-00			1					SETSCREW, 4-40 x 1/8 inch, HSS
-35	670-1073-00			1					ASSEMBLY, circuit board—BANDWIDTH
	- - - - -			-					assembly includes:
-36	131-0589-00			3					TERMINAL, pin, 0.50 inch long
-37	131-0590-00			5					TERMINAL, pin, 0.71 inch long
	380-0153-00			1					HOUSING, light
	- - - - -			-					mounting hardware: (not included w/housing)
	213-0181-00			1					SCREW, thread forming, #2 x 0.375 inch, PHS
	- - - - -			-					mounting hardware: (not included w/assembly)
-38	211-0156-00			1					SCREW, 1-72 x 1/4 inch, 82° csk, FHS
-39	670-1042-00			1					ASSEMBLY, circuit board—VC POLARITY
	- - - - -			-					assembly includes:
-40	131-0589-00			6					TERMINAL, pin, 0.50 inch long
	380-0153-00			1					HOUSING, light
	- - - - -			-					mounting hardware: (not included w/housing)
	213-0181-00			1					SCREW, thread forming, #2 x 0.375 inch, PHS
	- - - - -			-					mounting hardware: (not included w/assembly)
-41	211-0156-00			1					SCREW, 1-72 x 1/4 inch, 82° csk, FHS
-42	670-1043-00			1					ASSEMBLY, circuit board—ATTENUATOR
	- - - - -			-					assembly includes:
-43	131-0608-00			8					TERMINAL, pin, 0.364 inch long
-44	136-0252-01			38					SOCKET, pin connector
	380-0155-00			2					HOUSING, light
	- - - - -			-					mounting hardware for each: (not included w/housing)
	213-0181-00			1					SCREW, thread forming, #2 x 0.375 inch, PHS
	- - - - -			-					mounting hardware: (not included w/assembly)
-45	211-0156-00			4					SCREW, 1-71 x 1/4 inch, 82° csk, FHS

FIGURE 1 EXPLODED (cont)

Fig. & Index No.	Tektronix Part No.	Serial/Model Eff	No. Disc	Q					Description	
				t	y	1	2	3		4
1-46	136-0187-00			1						SOCKET, 1 pin, black
				-						mounting hardware: (not included w/socket)
-47	210-0940-00			1						WASHER, flat, 1/4 ID x 1/8 inch OD
-48	210-0223-00			1						LUG, solder, 1/4 ID x 7/16 inch OD, SE
	210-0583-00			1						NUT, hex., 1/4-32 x 5/16
-49	358-0378-00			1						BUSHING, sleeve, plastic
-50	358-0301-02			2						BUSHING, sleeve, plastic, 0.250 inch diameter
-51				1						RESISTOR, variable
				-						mounting hardware: (not included w/resistor)
	210-0046-00			2						WASHER, lock, internal, 0.261 ID x 0.400 inch OD
-52	129-0213-00			1						POST, hex., 1.156 inches long
-53	358-0377-00			1						BUSHING
-54				1						RESISTOR, variable
				-						mounting hardware: (not included w/resistor)
	210-0046-00			2						WASHER, lock, internal, 0.261 ID x 0.400 inch OD
-55	210-0471-00			1						NUT, hex., 1/4-32 x 5/16 x 1 1/12 inch long
-56	358-0377-00			1						BUSHING
-57	200-0103-00			1						CAP, binding post
-58	355-0131-00			1						STUD, binding post
-59	131-0679-00			2						CONNECTOR, receptacle, BNC w/hardware
-60	378-0613-00			1						LENS, indicator light
-61	378-0621-00			1						LENS HOLDER ASSEMBLY
-62	384-0488-00			1						SHAFT, extension
-63	376-0029-00			1						COUPLING
				-						coupling includes:
	213-0075-00			2						SETSCREW, 4-40 x 3/32 inch, HSS
-64	384-0700-00			1						EXTENSION SHAFT, plastic
-65	376-0051-00			1						COUPLING, flexible
				-						coupling includes:
	354-0251-00			2						RING, coupling
	376-0049-00			1						COUPLING, plastic
	213-0048-00			4						SETSCREW, 4-40 x 1/8 inch, HSS
-66	352-0084-01			1						HOLDER, neon
-67	378-0541-00			1						LENS, neon
-68	200-0609-00			1						CAP, lamp holder, plastic
-69	333-1095-00			1						PANEL, front
-70	386-1447-03			1						SUBPANEL, front
-71	366-1058-02			1						KNOB, latch
				-						mounting hardware: (not included w/knob)
	214-1095-00			1						PIN, spring, split
-72	105-0076-00			1						RELEASE BAR, latch
-73	214-1280-00			1						SPRING, helical compression
-74	348-0235-00			2						SHIELDING GASKET
-75	214-1054-00			1						SPRING, flat, latch detent
-76	105-0075-00			1						BODY, latch, plastic
-77	214-1061-00			1						SPRING, flat, sliding ground
-78	426-0499-01			1						FRAME SECTION, bottom
				-						mounting hardware: (not included w/frame section)
-79	213-0192-00			2						SCREW, thread forming, 6-32 x 1/2 inch, Fil HS

FIGURE 1 EXPLODED (cont)

Fig. & Index No.	Tektronix Part No.	Serial/Model Eff	No. Disc	Q					Description
				y	1	2	3	4	
1-80	426-0505-01			1					FRAME SECTION, top
	- - - - -			-					mounting hardware: (not included w/frame section)
-81	213-0192-00			2					SCREW, thread forming, 6-32 x 1/2 inch, Fil HS
-82	407-0493-00			1					BRACKET, support
	- - - - -			-					mounting hardware: (not included w/bracket)
	210-0586-00			3					NUT, keps, 4-40 x 1/4 inch
-83	211-0101-00			3					SCREW, 4-40 x 1/4 inch, 100° csk, FHS
-84	348-0171-00			1					GROMMET, plastic, U shaped
-85	337-1040-00			1					SHIELD, electrical, bottom
	- - - - -			-					mounting hardware: (not included w/shield)
	213-0055-01			4					SCREW, thread forming, 2-32 x 3/16 inch, PHS
-86	337-1042-00			1					SHIELD ASSEMBLY, electrical
	- - - - -			-					mounting hardware: (not included w/shield assembly)
	213-0055-01			4					SCREW, thread forming, 2-32 x 3/16 inch, PHS
	210-1008-00	XB010128		4					WASHER, flat, 0.090 ID x 0.188 inch OD
	211-0008-00			2					SCREW, 4-40 x 1/4 inch, PHS
-87	337-1041-00			1					SHIELD, electrical, top
	- - - - -			-					mounting hardware: (not included w/shield)
	213-0088-00			2					SCREW, thread forming, #4 x 1/4 inch, PHS
-88	670-1044-00			1					ASSEMBLY, circuit board—OUTPUT
	- - - - -			-					assembly includes:
	388-1141-00			1					BOARD, circuit
-89	131-0566-00			2					LINK, terminal
-90	131-0589-00			43					TERMINAL, pin, 0.50 inch long
-91	131-0590-00			27					TERMINAL, pin, 0.71 inch long
-92	131-0608-00			2					TERMINAL, pin, 0.375 inch long
-93	136-0220-00			3					SOCKET, transistor, 3 pin, square
-94	136-0252-01			48					SOCKET, pin connector
-95	136-0337-00			3					SOCKET, relay, 8 pin
-96	214-0579-00			13					PIN, test point
-97	- - - - -			1					RESISTOR, variable
	- - - - -			-					mounting hardware: (not included w/resistor)
-98	407-0581-00			1					BRACKET, component
	210-0046-00			1					WASHER, lock, internal, 0.261 ID x 0.400 inch OD
-99	210-0583-00			1					NUT, hex., 1/4-32 x 5/16 inch
-100	- - - - -			1					RESISTOR, variable
	- - - - -			-					mounting hardware: (not included w/resistor)
-101	407-0580-00			1					BRACKET, component
	210-0046-00			1					WASHER, lock, internal, 0.261 ID x 0.400 inch OD
-102	210-0583-00			1					NUT, hex., 1/4-32 x 5/16 inch

FIGURE 1 EXPLODED (cont)

Fig. & Index No.	Tektronix Part No.	Serial/Model Eff	No. Disc	Q t y	Description					
					1	2	3	4	5	
1-103	260-0760-00			1	SWITCH, sensitive snap action					
	- - - - -			-	mounting hardware: (not included w/switch)					
-104	407-0498-00			1	BRACKET, switch					
-105	211-0034-00			2	SCREW, 2-56 x 1/2 inch, RHS					
	210-0938-00			2	WASHER, flat, #2					
	210-0001-00			2	WASHER, lock, internal, #2					
-106	210-0405-00			2	NUT, hex., 2-56 x 3/16 inch					
-107	220-0547-01			6	NUT, block					
	- - - - -			-	mounting hardware for each: (not included w/nut)					
-108	211-0116-00			1	SCREW, sems, 4-40 x 5/16 inch, PHB					
	- - - - -			-	mounting hardware: (not included w/assembly)					
-109	211-0101-00			6	SCREW, 4-40 x 1/4 inch, 100° csk, FHS					
-110	388-1195-00			1	CIRCUIT BOARD, RF shield					
-111	670-1046-00			1	ASSEMBLY, circuit board—INPUT					
	- - - - -			-	assembly includes:					
	388-1143-00			1	BOARD, circuit					
-112	131-0183-00			2	CONNECTOR, terminal feed-thru					
	358-0136-00			2	BUSHING, plastic					
-113	131-0566-00			4	LINK, terminal					
-114	131-0589-00			15	TERMINAL, pin, 0.50 inch long					
-115	136-0183-00			3	SOCKET, transistor, 3 pin					
-116	136-0220-00			10	SOCKET, transistor, 3 pin, square					
-117	136-0252-01			72	SOCKET, pin connector					
-118	136-0263-01			27	SOCKET, pin terminal					
-119	136-0323-00			2	SOCKET, transistor, 4 pin, plastic					
-120	136-0336-00			2	SOCKET, relay, 5 pin					
-121	136-0352-00			4	SOCKET, connector pin					
-122	214-0579-00			1	PIN, test point					
-123	214-0781-00			2	INSULATOR, plastic					
-124	214-1121-00			1	HEAT SINK, transistor					
-125	352-0044-00			1	HOLDER, plastic					
	- - - - -			-	mounting hardware: (not included w/holder)					
-126	211-0007-00			2	SCREW, 4-40 x 3/16 inch, PHS					
	385-0149-00			1	POST, plastic					
-127	211-0097-00			1	SCREW, 4-40 x 3/16 inch, PHS					
-128	200-0945-00			1	COVER, half transistor					
-129	200-0945-01			1	COVER, half transistor, threaded					
	- - - - -			-	mounting hardware: (not included w/cover)					
	211-0062-00			1	SCREW, 2-56 x 5/16 inch, RHS					
-130	211-0155-00			6	SCREW, 4-40 x 0.081 inch, PHS					
	- - - - -			-	mounting hardware: (not included w/assembly)					
-131	214-1140-00			6	SPRING, helical compression					
-132	386-1402-00			1	PANEL, rear					
	- - - - -			-	mounting hardware: (not included w/panel)					
-133	213-0192-00			4	SCREW, thread forming, 6-32 x 1/2 inch, Fil HS					

FIGURE 1 EXPLODED (cont)

Fig. & Index No.	Tektronix Part No.	Serial/Model Eff	No. Disc	Q					Description	
				t	y	1	2	3		4
1-134	179-1430-00			1						WIRING HARNESS, main
	- - - - -			-						wiring harness includes:
-135	131-0621-00			40						CONNECTOR, terminal, straight
-136	131-0707-00			13						CONNECTOR, terminal, straight
-137	352-0163-00			2						HOLDER, terminal connector, 5 wire
-138	352-0169-00			1						HOLDER, terminal connector, 2 wire
-139	352-0171-00			9						HOLDER, terminal connector, 1 wire
-140	179-1431-00			1						WIRING HARNESS, readout
	- - - - -			-						wiring harness includes:
-141	131-0621-00			20						CONNECTOR, terminal, straight
-142	131-0707-00			5						CONNECTOR, terminal, straight
-143	352-0162-00			1						HOLDER, terminal connector, 4 wire
-144	337-1160-00			1						SHIELD, electrical, left
-145	337-1163-00			1						SHIELD, electrical, right
	- - - - -			-						shield includes:
-146	337-1167-00			1						SHIELD, electrical, plastic

STANDARD ACCESSORIES

070-0978-00	2	MANUAL, instruction (not shown)
-------------	---	---------------------------------

MANUAL CHANGE INFORMATION

At Tektronix, we continually strive to keep up with latest electronic developments by adding circuit and component improvements to our instruments as soon as they are developed and tested.

Sometimes, due to printing and shipping requirements, we can't get these changes immediately into printed manuals. Hence, your manual may contain new change information on following pages.

A single change may affect several sections. Sections of the manual are often printed at different times, so some of the information on the change pages may already be in your manual. Since the change information sheets are carried in the manual until ALL changes are permanently entered, some duplication may occur. If no such change pages appear in this section, your manual is correct as printed.

TYPE 7A13

ELECTRICAL PARTS LIST AND SCHEMATIC CORRECTIONS

CHANGE TO:

Q40	151-0254-00	Silicon	NPS	TO-98D16P4		
R41	321-0223-00	2.05 k Ω	1/8 W	Prec		1%
R42	321-0223-00	2.05 k Ω	1/8 W	Prec		1%
R49	321-0299-00	12.7 k Ω	1/8 W	Prec		1%

M16,018/1269