

**TEKTRONIX®**

**7D10**

**DIGITAL EVENTS  
DELAY**

**WITH OPTIONS**

**INSTRUCTION MANUAL**

Tektronix, Inc.  
P.O. Box 500  
Beaverton, Oregon 97077

Serial Number \_\_\_\_\_



## WARRANTY

This Tektronix product is warranted against defective materials and workmanship, under normal use, for a period of one year from date of initial shipment. Tektronix will repair or replace, at its option, those products determined to be defective within the warranty period and returned, freight prepaid, to a Tektronix Service Center. There is no implied warranty for fitness of purpose.

Please direct all requests for service or replacement parts to the nearest Tektronix Service Center or Field Office; include the type or part number of the product and its serial number.

Copyright © 1978 by Tektronix, Inc. All rights reserved.  
Contents of this publication may not be reproduced in any form without the permission of Tektronix, Inc.

Products of Tektronix, Inc. and its subsidiaries are covered by U.S. and foreign patents and/or pending patents.

TEKTRONIX, TEK, SCOPE-MOBILE, TELEEQUIPMENT,  
and  are registered trademarks of Tektronix, Inc.

Printed in U.S.A. Specification and price change privileges are reserved.

# TABLE OF CONTENTS

PAGE	PAGE
LIST OF ILLUSTRATIONS . . . . .	ii
LIST OF TABLES . . . . .	ii
SAFETY SUMMARY . . . . .	iii
<b>SECTION 1 GENERAL INFORMATION</b>	
INTRODUCTION . . . . .	1-1
INSTRUMENT REPACKAGING . . . . .	1-1
SPECIFICATION . . . . .	1-2
STANDARD ACCESSORIES . . . . .	1-6
<b>SECTION 2 OPERATING INSTRUCTIONS</b>	
PRELIMINARY INFORMATION . . . . .	2-1
Installation . . . . .	2-1
CONTROLS, CONNECTORS, AND INDICATORS . . . . .	2-1
BASIC BLOCK DIAGRAM . . . . .	2-1
FUNCTIONAL CHECK . . . . .	2-1
Test Equipment Required . . . . .	2-1
Preliminary Set Up . . . . .	2-5
Trigger Functions . . . . .	2-5
Events Count Functions . . . . .	2-6
B Sweep Delay Mode Functions . . . . .	2-6
DETAILED OPERATING INFORMATION . . . . .	2-7
Events Readout Display . . . . .	2-7
Signal Connection . . . . .	2-7
Trigger Controls . . . . .	2-8
Triggered Light . . . . .	2-8
Trigger Coupling . . . . .	2-8
Trigger Source . . . . .	2-8
Trigger Slope/Level . . . . .	2-8
Events Start Trigger . . . . .	2-9
Delay Events . . . . .	2-9
Delay Modes . . . . .	2-9
OUTPUT SIGNALS . . . . .	2-9
Front-Panel Output Signals . . . . .	2-9
Output Signals to Mainframe . . . . .	2-10
APPLICATIONS . . . . .	2-10
Logic State Identification . . . . .	2-11
Transient Identification . . . . .	2-12
Delay By Words . . . . .	2-13
Delay By Events . . . . .	2-13
Time Interval Measurements . . . . .	2-14
<b>SECTION 3 THEORY OF OPERATION</b>	
BLOCK DIAGRAM . . . . .	3-1
EVENTS TRIGGER . . . . .	3-1
OUTPUTS PROCESSING AND EVENTS TRIGGER . . . . .	3-1
DELAYING COUNTER AND DISPLAY GENERATOR . . . . .	3-1
READOUT ENCODING . . . . .	3-1
DETAILED CIRCUIT OPERATION . . . . .	3-2
EVENTS TRIGGER . . . . .	3-2
OUTPUTS PROCESSING AND EVENTS START TRIGGER . . . . .	3-6
DELAYING COUNTER AND DISPLAY GENERATOR . . . . .	3-10
READOUT ENCODING . . . . .	3-13
POWER DISTRIBUTION AND MAINFRAME CONNECTOR . . . . .	3-14
INTRODUCTION TO THE READOUT SYSTEM . . . . .	3-15
<b>SECTION 4 MAINTENANCE</b>	
PREVENTIVE MAINTENANCE . . . . .	4-1
CLEANING . . . . .	4-1
VISUAL INSPECTION . . . . .	4-1
LUBRICATION . . . . .	4-1
SEMICONDUCTOR CHECKS . . . . .	4-1
TROUBLESHOOTING . . . . .	4-2
TROUBLESHOOTING EQUIPMENT . . . . .	4-2
TROUBLESHOOTING TECHNIQUES . . . . .	4-2
CORRECTIVE MAINTENANCE . . . . .	4-4
OBTAINING REPLACEMENT PARTS . . . . .	4-4
SOLDERING TECHNIQUES . . . . .	4-4
COMPONENT REMOVAL AND REPLACEMENT . . . . .	4-5
ADJUSTMENT AFTER REPAIR . . . . .	4-6
<b>SECTION 5 PERFORMANCE CHECK AND ADJUSTMENT</b>	
PRELIMINARY INFORMATION . . . . .	5-1
TEST EQUIPMENT REQUIRED . . . . .	5-1
INDEX TO PERFORMANCE CHECK AND ADJUSTMENT PROCEDURE . . . . .	5-4
PRELIMINARY PROCEDURE . . . . .	5-4
A. TRIGGERING . . . . .	5-5
B. EVENTS COUNT . . . . .	5-9
C. OUTPUT SIGNALS . . . . .	5-13
<b>SECTION 6 REPLACEABLE ELECTRICAL PARTS</b>	
<b>SECTION 7 INSTRUMENT OPTIONS</b>	
<b>SECTION 8 DIAGRAMS AND CIRCUIT BOARD ILLUSTRATIONS</b>	
<b>SECTION 9 REPLACEABLE MECHANICAL PARTS CHANGE INFORMATION</b>	

## WARNING

THE REMAINING PORTION OF THIS TABLE OF CONTENTS LISTS THE SERVICING INSTRUCTIONS. THESE SERVICING INSTRUCTIONS ARE FOR USE BY QUALIFIED PERSONNEL ONLY. TO AVOID ELECTRICAL SHOCK, DO NOT PERFORM ANY SERVICING OTHER THAN THAT CALLED OUT IN THE OPERATING INSTRUCTIONS UNLESS QUALIFIED TO DO SO.

# LIST OF ILLUSTRATIONS

FIGURE NO.	PAGE	FIGURE NO.	PAGE
Frontis-piece	7D10 Features . . . . . iv	3-3	Trig'd Lamp Multi input and output waveforms with trigger signal applied . . . . 3-6
1-1	Dimensional Drawing. . . . . 1-5	3-4	Detailed block diagram of Outputs Processing and Events Start Trigger circuit. . . . . 3-7
2-1	Location and function of front-panel controls, indicators, and connectors . . . . 2-2	3-5	7D10 outputs timing diagram . . . . . 3-8
2-2	7D10 basic block diagram . . . . . 2-4	3-6	7D10 Reset function timing diagram. . . . 3-9
2-3	Display showing time relationship of (A) input signal at front panel to (B) Delay Interval, and (C) Delayed Trigger outputs. . . . . 2-10	3-7	Detailed block diagram of Delaying Counter and Display Generator circuit. . . 3-11
2-4	Display showing time relationship of (A) Delay Interval Pedestal and (B) input signal . . . . . 2-10	3-8	Delaying Counter and outputs timing diagram . . . . . 3-13
2-5	Equipment set up and data display for determining the logic state of a 4-bit binary word . . . . . 2-11	3-9	Detailed block diagram of Readout Encoding circuit . . . . . 3-14
2-6	Equipment set up and display for finding a transient and determining its location on a data train . . . . . 2-12	4-1	Orientation of multi-connector holders . . . 4-6
2-7	Equipment set up and data display window that has been positioned after a selected binary word has occurred 25 times . . . . . 2-13	5-1	Simulated waveforms for checking Events Count . . . . . 5-12
2-8	Equipment set up and data display window that has been positioned after 10,500 clock pulses have occurred . . . . 2-14	5-2	Simulated waveforms for checking Delay Interval and Delayed Trigger coincidence . . . . . 5-15
2-9	Equipment set up and display for time interval measurements from start of sweep or between any two points on a displayed data train . . . . . 2-15		
3-1	Detailed block diagram of Events Trigger circuit. . . . . 3-3	8-1	Semiconductor lead configurations.
3-2	Trigger current path for positive-slope triggering. . . . . 3-4	8-2	A1—Source switch.
		8-3	A2—Coupling switch.
		8-4	A3—Trigger circuit board.
		8-5	A4—Interface circuit board.
		8-6	A7—Logic circuit board.
		8-7	A4—Partial Interface circuit board.
		8-8	Trigger circuit board adjustment locations.
		8-9	Logic circuit board adjustment locations.
		8-10	Source switch adjustment locations.
		8-11	Interface circuit board adjustment locations.

The illustrations in Section 8 are located near their associated diagrams on the foldout pages.

# LIST OF TABLES

TABLE NO.	PAGE	TABLE NO.	PAGE
1-1	Shipping Carton Test Strength . . . . . 1-1	5-4	Low-Frequency External Trigger Sensitivity Checks . . . . . 5-8
1-2	Electrical Characteristics. . . . . 1-2	5-5	Medium-Frequency External Trigger Sensitivity Checks . . . . . 5-8
1-3	Environmental Characteristics . . . . . 1-4	5-6	Front-Panel Delayed Trigger Output Check . . . . . 5-14
1-4	Physical Characteristics. . . . . 1-4		
5-1	Test Equipment . . . . . 5-2		
5-2	Low-Frequency Internal Trigger Sensitivity Checks . . . . . 5-7		
5-3	Medium-Frequency Internal Trigger Sensitivity Checks . . . . . 5-7		

# SAFETY SUMMARY

The following safety information is provided to ensure safe operation of this instrument. WARNING information is intended to protect the operator; CAUTION information is intended to protect the instrument. The following are general safety precautions that must be observed during all phases of operation and maintenance.

## WARNING

### Ground the Instrument

*To reduce electrical-shock hazard, the mainframe (oscilloscope) chassis must be properly grounded. Refer to the mainframe manual for grounding information.*

### Do Not Operate in Explosive Atmosphere

*Do not operate this instrument in an area where flammable gases or fumes are present. Such operation could cause an explosion.*

### Avoid Live Circuits

*Electrical-shock hazards are present in this instrument. The protective instrument covers must not be removed by operating personnel. Component replacement and internal adjustments must be referred to qualified service personnel.*

### Do Not Service or Adjust Alone

*Do not service or make internal adjustments to this instrument unless another person, capable of giving first aid and resuscitation, is present.*

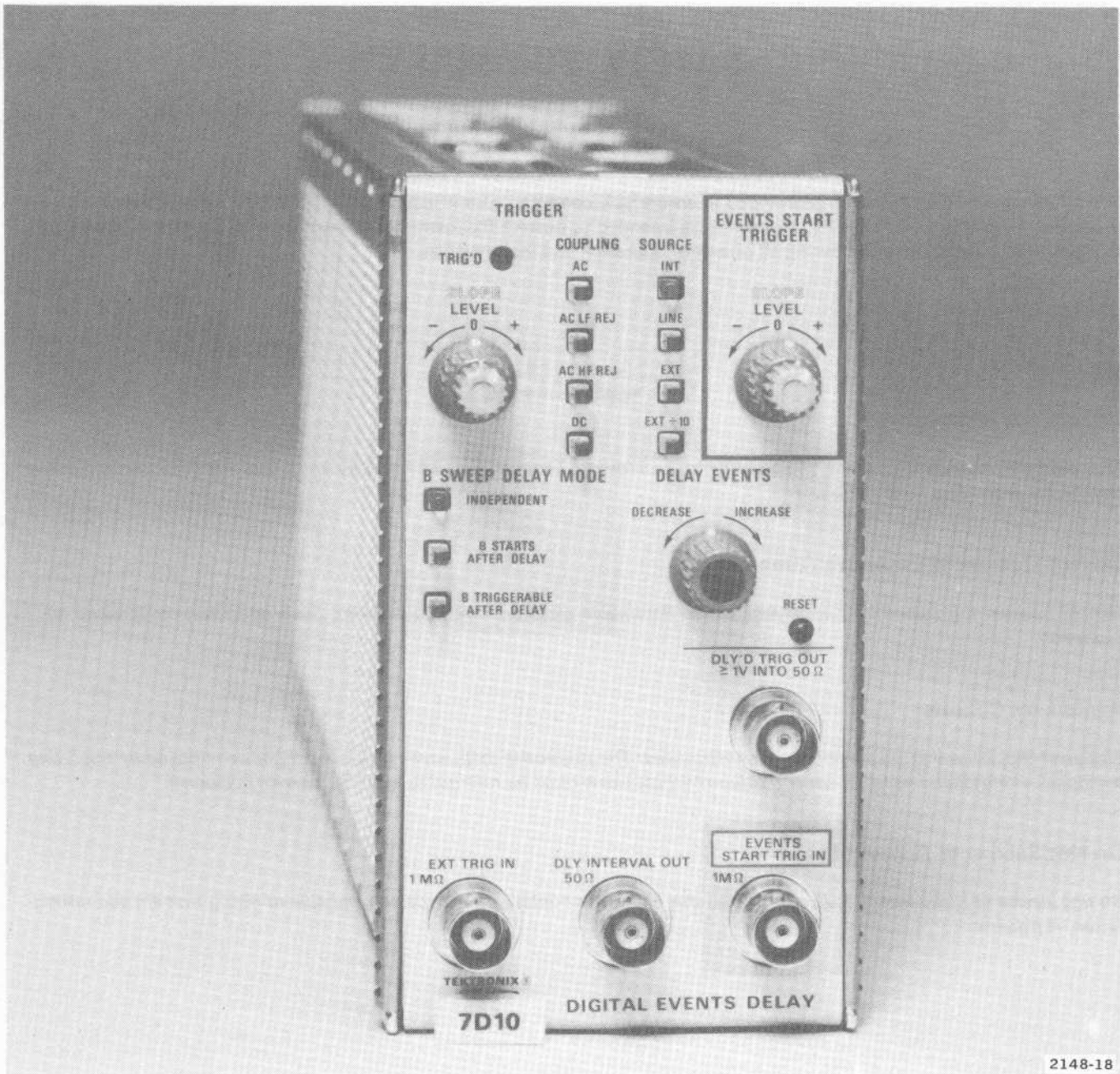

## FEATURES

The 7D10 provides delay by events in a plug-in unit for readout-equipped 7000-series oscilloscope mainframes. The operator can, with a single front-panel control, select any desired delay from one to  $10^7$  events. The 7D10 uses the mainframe readout system to count the selected integral number of events on the crt. When the number of input events reaches the preset count, the 7D10 will output a trigger pulse which can be used to trigger a logic analyzer, oscilloscope sweep, or other equipment. Because the 7D10 creates the delay by counting a number of pulses rather than by analog timing of an interval, jitter is not a problem even when viewing pulses toward the end of a long train.

The 7D10 complements the 7D01 Logic Analyzer. The logic analyzer memory window is easily delayed from the trigger by a selected count using the 7D10. This facilitates bit error detection in pulse trains that are significantly longer than the capacity of the logic analyzer memory.

The 7D10 can be used for selecting a certain time frame for jitter-free analysis of data in mechanically based systems such as disc-file memories. It is also useful for making measurements under complex timing conditions.

# GENERAL INFORMATION

## INTRODUCTION

The Operator's Manual contains information necessary to effectively operate the 7D10 Digital Events Delay unit and is divided into three sections: Section 1 provides packaging for shipment information, specifications, and a list of standard accessories. Section 2 contains operating information. Information concerning available options for the 7D10 Digital Events Delay unit is in section 3.

The Instruction Manual contains nine sections. Operating information is covered in the first two sections; servicing information is covered in the remaining seven sections. Schematic diagrams are located at the rear of the manual and can be unfolded for reference while reading other parts of the manual. The reference designators and symbols used on the schematic diagrams are defined on the first page of the Diagrams and Circuit Board Illustrations section. Abbreviations used in the manuals, except in the parts list and schematic diagrams, comply with the American National Standards Institute Y1.1-1972 publication. The parts list is a computer printout and uses computer-supplied abbreviations.

## INSTRUMENT REPACKAGING

If this instrument is to be shipped for long distances by commercial transportation, it is recommended that the instrument be packaged in the original manner for maximum protection. The carton and packaging material in which your instrument was shipped should be saved and used for this purpose.

Also, if this instrument is to be shipped to a Tektronix Service Center for service or repair, attach a tag to the instrument showing the following: Owner of the instrument (with address), the name of an individual at your firm that can be contacted, complete instrument type and serial number, and a description of the service required.

If the original packaging is unfit for use or not available, package the instrument as follows:

1. Obtain a carton of corrugated cardboard having inside dimensions of no less than six inches more than the instrument dimensions; this will allow for cushioning. Refer to Table 1-1 for carton test strength requirements.
2. Surround the instrument with polyethylene sheeting to protect the finish of the instrument.
3. Cushion the instrument on all sides by tightly packing dunnage or urethane foam between the carton and the instrument, allowing three inches on all sides.
4. Seal the carton with shipping tape or with an industrial stapler.
5. Mark the address of the Tektronix Service Center and your return address on the carton in one or more locations.

**TABLE 1-1**  
**Shipping Carton Test Strength**

Gross Weight (lb)	Carton Test Strength (lb)
0-10	200
10-30	275
30-120	375
120-140	500
140-160	600

## SPECIFICATION

The electrical specifications listed in Table 1-2 apply when the following conditions are met: (1) The instrument must have been adjusted at an ambient temperature between +20° and +30° C, (2) the instrument must be fully installed in a calibrated mainframe, and (3) the instrument must have been operating for at least 20 minutes.

**TABLE 1-2**  
**Electrical Characteristics**

Characteristic	Performance Requirement
<b>TRIGGERING</b>	
<b>Internal Trigger Sensitivity<sup>1</sup></b>	
Coupling	
AC	0.3 div of deflection, minimum, 30 Hz to 10 MHz; increasing to 1.0 div at 50 MHz.
AC LF REJ	0.3 div of deflection, minimum, 30 kHz to 10 MHz; increasing to 1.0 div at 50 MHz. Will not trigger on sine waves of 3 div or less below 120 Hz.
AC HF REJ	0.3 div of deflection, minimum, 30 Hz to 50 kHz.
DC	0.3 div of deflection, minimum, dc to 10 MHz; increasing to 1.0 div at 50 MHz.
<b>External Trigger Sensitivity</b>	
Coupling	
AC	150 mV, minimum, 30 Hz to 10 MHz; increasing to 500 mV at 50 MHz.
AC LF REJ	150 mV, minimum, 150 kHz to 10 MHz; increasing to 500 mV at 50 MHz.
AC HF REJ	150 mV, minimum, 30 Hz to 50 kHz.
DC	150 mV, minimum, dc to 10 MHz; increasing to 500 mV at 50 MHz.
<b>External Trigger Input</b>	
Maximum Input Voltage	250 V (dc + peak ac), 500 V p-p ac at 1 kHz or less.
Input Resistance	Approximately 1 MΩ.
Input Capacitance	Approximately 20 pF.
Input RC Product	One MΩ X 20 pF within 2%.
Level Control Range	At least +1.75 V to -1.75 V in EXT; at least +17.5 V to -17.5 V in EXT ÷ 10.

<sup>1</sup> Triggering frequency range is also affected by the bandwidth limits of the mainframe and vertical plug-in unit used.



TABLE 1-2 (CONT.)  
Electrical Characteristics

Characteristic	Performance Requirement
<b>EVENTS DELAY</b>	
Range	One to $10^7$ events.
Increment	One event.
Insertion Delay	35 ns within 5 ns.
Recycle Time	500 ns or less.
Maximum Events Frequency	At least 50 MHz.
Minimum Event Width	10 ns.
Events Start Triggering	
Source	External only.
Coupling	Dc.
Maximum Input Voltage	150 V (dc + peak ac).
Sensitivity	100 mV, minimum, 30 Hz to 2 MHz; increasing to 250 mV, 2 MHz to 20 MHz; increasing to 500 mV, 20 MHz to 50 MHz.
Input Resistance	Approximately 1 M $\Omega$ .
Input Capacitance	Approximately 20 pF.
Level Control Range	At least +3 V to -3 V.
<b>OUTPUT SIGNALS</b>	
Delayed Trigger	
Waveshape	Positive-going rectangular pulse.
Amplitude	
Into Open Circuit	At least 2 V.
Into 50 Ohms	At least 1 V.
Rise Time (With 50 Ohm Load)	2 ns or less.
Fall Time (With 50 Ohm Load)	5 ns or less.
Pulse Width	200 to 250 ns.

**TABLE 1-2 (CONT.)  
Electrical Characteristics**

Characteristic	Performance Requirement
<b>OUTPUT SIGNALS (CONT.)</b>	
Delay Interval Waveshape	Positive-going rectangular pulse.
Amplitude	
Into Open Circuit	At least 2 V.
Into 50 Ohms	At least 1 V.
Rise and Fall Times (With 50 Ohm Load)	5 ns or less.
Accuracy	Delay Interval pulse width is equal to the generated Events Delay within 30 ns.
Relative Timing of Delayed Trigger and Delay Interval Output Signals	Leading edge of Delayed Trigger pulse is coincident with falling edge of Delay Interval pulse within 2 ns.

**TABLE 1-3  
Environmental Characteristics**

Characteristic	Performance Requirement
Temperature	
Operating	0° to +40° C.
Non-operating	-40° to +75° C.
Altitude	
Operating	To 15,000 feet.
Non-operating	To 50,000 feet.
Transportation	Qualified under National Safe Transit Committee Test Procedure 1A, Category II.

**TABLE 1-4  
Physical Characteristics**

Characteristic	Description
Finish	Anodized aluminum front panel.
Weight	1.00 Kg (2.20 lbs).
Dimensions	See Figure 1-1, Dimensional Drawing.

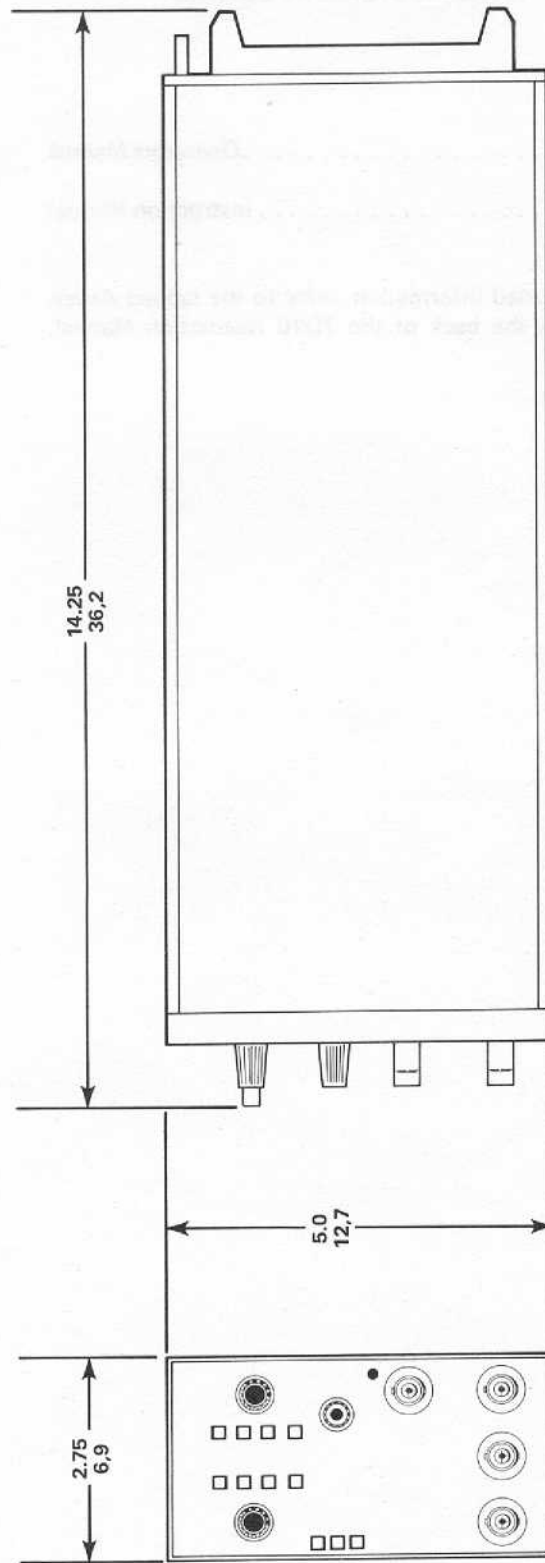

NOTE: DIMENSIONS ARE GIVEN WITH TOP FIGURE IN INCHES AND BOTTOM IN CENTIMETERS.

Figure 1-1. Dimensional Drawing.

## STANDARD ACCESSORIES

1 each . . . . . Operators Manual

1 each . . . . . Instruction Manual

For more detailed information, refer to the tabbed Accessories page in the back of the 7D10 Instruction Manual.

# OPERATING INSTRUCTIONS

## PRELIMINARY INFORMATION

### Installation

The 7D10 is designed to operate in any plug-in compartment of Tektronix 7000-series mainframes. However, certain modes of operation require the 7D10 to be installed in a specific compartment. The unit must be operated in a horizontal compartment to trigger from a signal applied to a vertical amplifier unit. For example, the 7D10 must be operated in the A Horizontal compartment to control the delay mode of a time-base unit in the B Horizontal compartment, or in a vertical compartment to view the Delay Interval Pedestal without the use of external cables.

To install the 7D10 into a plug-in compartment, push the unit in until it is seated flush against the front panel of the mainframe. To remove, pull the release latch to disengage the 7D10. Continue to pull the release latch to remove the unit from the mainframe.

## CONTROLS, CONNECTORS, AND INDICATORS

The major controls, connectors, and indicators for operation of the 7D10 are located on the front panel of the unit. One control, located inside the unit, for an auxiliary function is described in Detailed Operating Information. The front-panel controls, connectors, and indicators are located and described in Figure 2-1.

## BASIC BLOCK DIAGRAM

The following discussion provides an aid to understanding the overall concept of the 7D10. Figure 2-2 shows a basic block diagram of the 7D10. Each block represents a major circuit within the instrument. The number enclosed within a diamond on each block refers to the schematic diagram of that circuit in the 7D10 Instruction Manual.

The EVENTS DELAY control sets up the desired number of events to be counted in the Events Counter. The number of delay events is encoded by the Readout Encoding circuit, which provides readout data to the mainframe in order to display the number of delay events on the crt.

The Events Start Trigger starts the delay interval and allows the Events Trigger circuit output to be counted by the Events Counter. When the selected number of events has been counted, the Outputs Processing circuit ends the delay interval and outputs the DLY'D TRIG OUT signal.

<sup>1</sup> Requires TM 500-series power module.

## FUNCTIONAL CHECK

The following procedure may be used as a check of basic instrument operation. The procedure can be used for incoming inspection to verify proper operation, and can also be used by the operator for instrument familiarization. Only instrument functions, and not measurement quantities or specifications, are checked in these procedures. Therefore, a minimum amount of test equipment is required. If performing the Functional Check procedure reveals improper performance or instrument malfunction, first check the operation of associated equipment; then refer to qualified service personnel for repair or adjustment of the instrument.

### Test Equipment Required

The following test equipment is used to perform the Functional Check procedure. Other test equipment, which meets these requirements, may be substituted. When other equipment is substituted, the control settings or set-up may need to be altered.

#### 1. Indicator Mainframe

Description: Any Tektronix 7000-series oscilloscope equipped with a readout system and able to accommodate four plug-in units.

Type Used: TEKTRONIX 7904 Oscilloscope.

#### 2. Time-Base Plug-In Unit

Description: Sweep rates, 20 milliseconds/division to magnified or delayed-sweep rate of 20 nanoseconds/division; accuracy, within 5%.

Type Used: TEKTRONIX 7B80 Time Base.

#### 3. Dual-Trace Wide-Band Vertical Amplifier Unit

Description: Bandwidth (combined with indicator mainframe), dc to 150 megahertz; deflection factor, variable from 50 millivolts to 5 volts/division; accuracy, within 3%.

Type Used: TEKTRONIX 7A26 Dual-Trace Amplifier.

#### 4. Time-Mark Generator

Description: Marker outputs, 1 second to 10 microseconds; trigger output, 1 millisecond; marker accuracy, within 0.1%; marker amplitude, 0.5 volt into 50 ohms; trigger amplitude, 0.5 volt into 50 ohms.

Type Used: TEKTRONIX TG 501 Time-Mark Generator.<sup>1</sup>

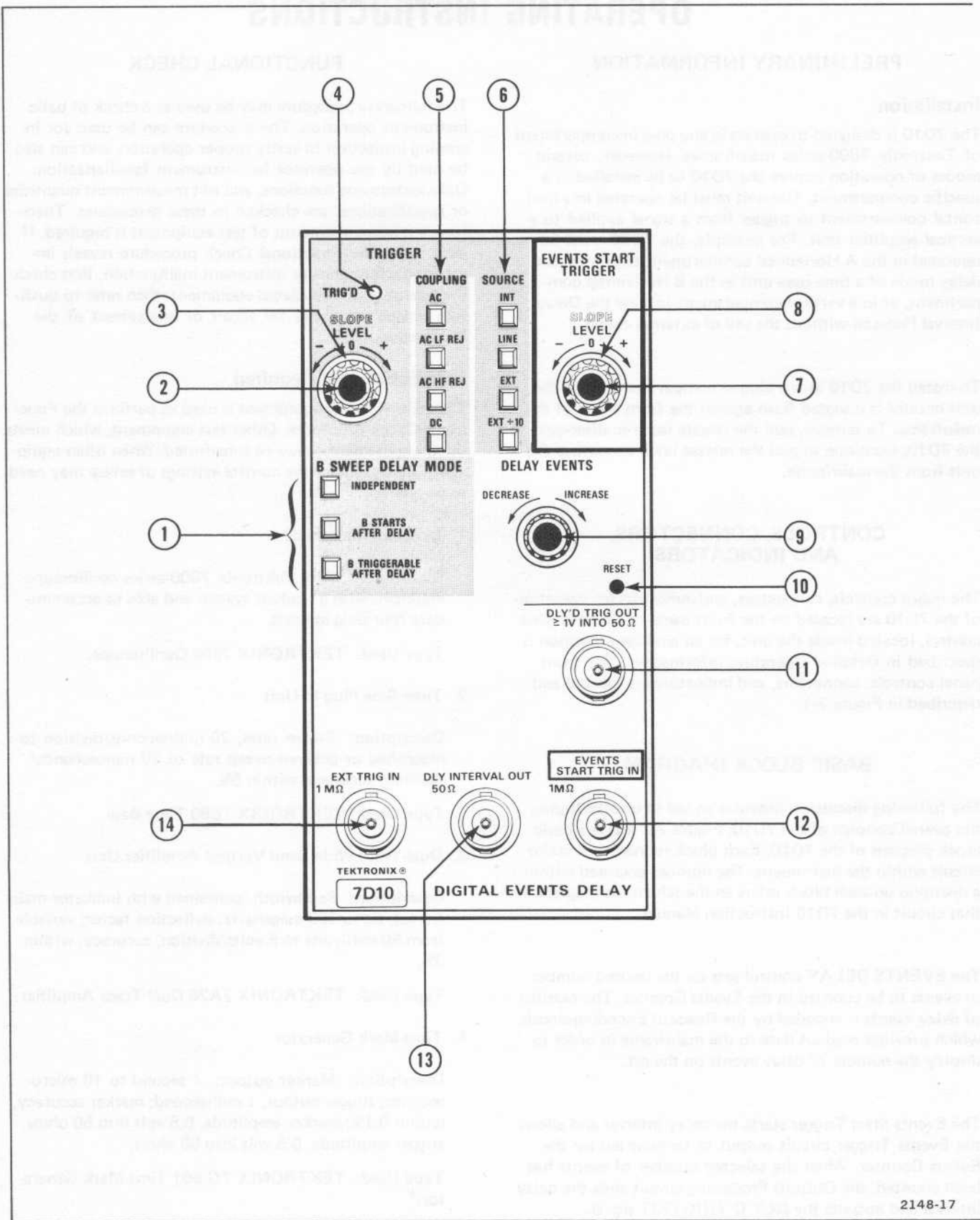

2148-17

Figure 2-1. Location and function of front-panel controls, indicators, and connectors.

- ① **B SWEEP DELAY MODE Switches**—Self-cancelling pushbutton switches that select the operating mode of the B sweep (time-base) unit for independent or delayed sweep operation.
- ② **TRIGGER SLOPE Switch**—Selects the slope of the trigger signal on which the delay is initiated.
- ③ **TRIGGER LEVEL Control**—Selects the amplitude point at which the delay is initiated.
- ④ **TRIG'D Indicator**—Lamp that lights when a trigger is being produced.
- ⑤ **COUPLING Switches**—Self-cancelling pushbutton switches that select the following coupling methods for the trigger signal: AC (capacitive coupling), AC LF REJ (capacitive coupling, low frequency rejected), AC HF REJ (capacitive coupling, high frequency rejected), and DC (direct coupling).
- ⑥ **SOURCE Switches**—Self-cancelling pushbutton switches that select the following trigger signal sources: INT (internal from associated vertical unit with 7D10 installed in horizontal compartment), LINE (internal from power source), EXT (external from EXT TRIG IN connector), and EXT ÷ 10 (10X input signal attenuation).
- ⑦ **EVENTS START TRIGGER SLOPE Switch**—Selects slope of trigger signal from which the Events Start is initiated.
- ⑧ **EVENTS START TRIGGER LEVEL Control**—Selects the amplitude point on the trigger signal from which the Events Start is initiated.
- ⑨ **DELAY EVENTS Control**—Spring return to zero (center) control that selects the number of events counted. Direction of rotation increases or decreases the number of events counted.
- ⑩ **RESET Switch**—Pushbutton switch that resets the number of events counted to 0000001.
- ⑪ **DLY'D TRIG OUT Connector**—BNC connector that provides a delayed trigger output signal.
- ⑫ **EVENTS START TRIG IN Connector**—BNC connector that provides an input for the events start trigger signal.
- ⑬ **DLY INTERVAL OUT Connector**—BNC connector that provides a delay interval output signal.
- ⑭ **EXT TRIG IN Connector**—BNC connector that provides an external input for the trigger signal.

Figure 2-1. Location and function of front-panel controls, indicators, and connectors (continued).

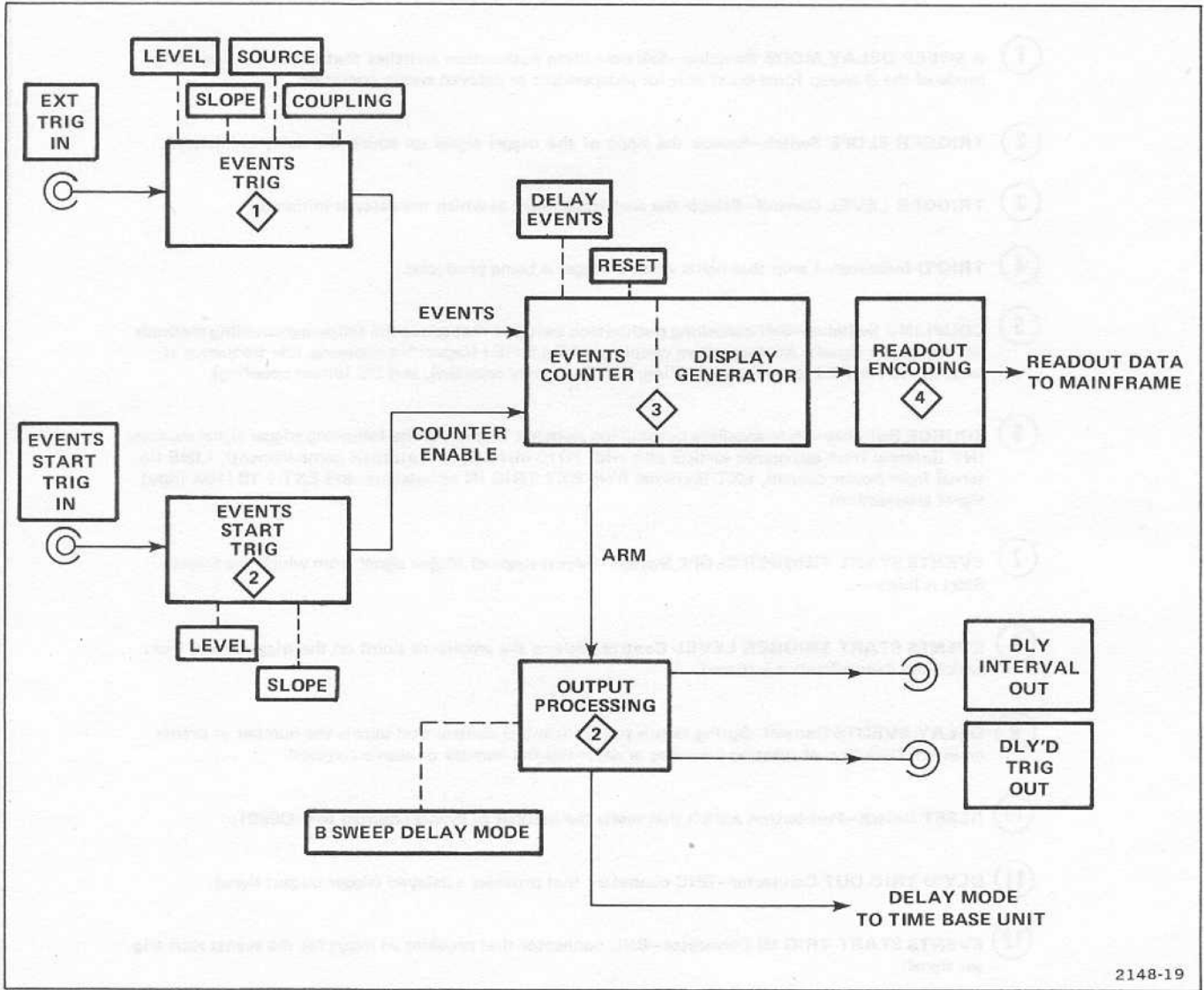

2148-19

Figure 2-2. 7D10 basic block diagram.



5. 10X Passive Probe

Description: Compatible with amplifier unit.

Type Used: TEKTRONIX P6053B 10X Probe.

6. Termination

Description: Impedance, 50 ohms; accuracy, within 2%; connectors, BNC.

Type Used: Tektronix part 011-0049-01.

7. T Connector

Description: Connectors, BNC.

Type Used: Tektronix part 103-0030-00.

8. Cable (3 required)

Description: Impedance, 50 ohms; type, RG-58/U; length, 18 inches; connectors, BNC.

Type Used: Tektronix part 012-0076-00.

**Preliminary Set Up**

1. Install a vertical amplifier unit in a vertical compartment and a time-base unit in the B Horizontal compartment of the indicator mainframe. Install the 7D10 in the A Horizontal compartment (see Installation).

2. Set the 7D10 controls as follows:

```

TRIGGER
  SLOPE . . . . .+
  LEVEL . . . . .Centered
  COUPLING . . . .AC
  SOURCE . . . . .INT
EVENTS START
TRIGGER
  SLOPE . . . . .-
  LEVEL . . . . .Centered
B SWEEP
DELAY MODE . . . .INDEPENDENT
    
```

3. Turn indicator mainframe power ON and allow at least 5 minutes for warm up.

**Trigger Functions**

1. Perform the Preliminary Set Up procedure.

2. Attach the T connector to the mainframe calibrator output.

3. Connect the calibrator output signal to the vertical amplifier unit input and to the 7D10 EVENTS START TRIG IN connector.

4. Connect the DLY'D TRIG OUT connector to the time-base unit external trigger input.

5. Set the mainframe calibrator for a 1-kilohertz, 4-volt output.

6. Set the time-base unit triggering for auto mode and external source at a sweep rate of 0.5 millisecond/division.

7. Set the amplifier unit deflection factor for 2 volts/division.

8. Set the indicator mainframe vertical mode to display the amplifier unit input signal and use the vertical signal as the trigger source for the 7D10.

9. Set the 7D10 TRIGGER LEVEL control to light the TRIG'D indicator.

10. Set the EVENTS START TRIGGER LEVEL control approximately midway between fully clockwise and the 0 position.

11. Set the time-base unit triggering for a stable display.

12. Turn the EVENTS START TRIGGER LEVEL control throughout its range and notice that a stable display can be obtained between the 0 and fully clockwise positions.

13. Set the 7D10 TRIGGER SLOPE switch to the + and then to the - position and notice that the display starts on the selected slope of the input signal.

14. Connect the mainframe calibrator signal to the 7D10 EXT TRIG IN connector. (Use a T connector attached to the EVENTS START TRIG IN connector).

## Operating Instructions—7D10

15. Set the 7D10 SOURCE switch to EXT.
  16. Set the EVENTS START TRIGGER LEVEL control approximately midway between fully clockwise and the 0 position.
  17. If necessary, set the 7D10 TRIGGER LEVEL and time-base unit triggering for a stable display.
  18. Turn the EVENTS START TRIGGER LEVEL control throughout its range and notice that a stable display can be obtained between the 0 and fully clockwise positions.
  19. Set the 7D10 TRIGGER SLOPE switch to the + and then to the – position and notice that the display starts on the selected slope of the input signal.
  20. Disconnect the mainframe calibrator signal from the amplifier input.
  21. Set the 7D10 TRIGGER SOURCE switch to LINE.
  22. Set the time-base unit sweep rate for 5 milliseconds/division and the amplifier unit deflection factor for 2 volts/division.
  23. Connect the 10X probe to the amplifier unit input and the probe tip to a line-voltage source.
  24. Set the time-base triggering for a stable display.
  25. Turn the EVENTS START TRIGGER LEVEL control throughout its range and notice that a stable display can be obtained between the 0 and fully clockwise positions.
  26. Set the 7D10 TRIGGER SLOPE switch to the + and then to the – position and notice that the display starts on the selected slope of the input signal.
  27. Disconnect the interconnecting cables.
2. Connect the time-mark generator marker output through the T connector and the 50-ohm termination to the vertical amplifier unit input.
  3. Set the time-mark generator for a 0.1-millisecond marker output.
  4. Connect the time-mark generator marker output from the T connector to the 7D10 EXT TRIG IN connector.
  5. Connect the time-mark generator trigger out to EVENTS START TRIG IN connector.
  6. Connect the 7D10 DLY'D TRIG OUT connector to the time-base unit external trigger input.
  7. Set the indicator mainframe vertical mode to alternately display the amplifier unit and the 7D10.
  8. Set the time-base unit sweep rate for 0.1 millisecond/division and the amplifier unit deflection factor for 0.5 volt/division.
  9. Set the 7D10 TRIGGER LEVEL control to light the TRIG'D indicator.
  10. Set the EVENTS START TRIGGER control and the time-base unit triggering level for a stable time-marker display.
  11. Turn the DELAY EVENTS control clockwise to obtain an events count readout of 0000002. Notice that a dual-trace display of positive-going, 0.1-millisecond duration delay-interval pedestals, and 0.1-millisecond time-markers, appear on the crt.
  12. Turn the DELAY EVENTS control clockwise and notice that the duration of the delay-interval pedestals increase one marker at a time as indicated by the events count readout.
  13. Disconnect the interconnecting cables.

## Events Count Functions

1. Install the 7D10 in a vertical compartment of the indicator mainframe and press the RESET button. Notice that an events count readout of 0000001 appears at the upper left side of the graticule vertical center line.

## B Sweep Delay Mode Functions

1. Perform the Preliminary Set Up procedure.
2. Connect the time-mark generator marker output to the vertical amplifier input and the generator trigger output to the EVENTS START TRIG IN connector.
3. Set the 7D10 B SWEEP DELAY MODE switch to the B STARTS AFTER DELAY position.

4. Set the time-mark generator for a 10-millisecond marker output.
5. Set the time-base unit for a 10-milliseconds/division sweep rate.
6. Press the RESET button.
7. Set the 7D10 TRIGGER LEVEL and EVENTS START TRIGGER LEVEL controls for a flickering time-mark display.
8. Turn the DELAY EVENTS control clockwise until the events count readout on the crt indicates 0000100 and notice that a displayed sweep occurs once each second, i.e., after each 100 markers (10 milliseconds/marker).
9. Turn the DELAY EVENTS control to increase and decrease the events count readout. Notice that a displayed sweep appears after the selected number of time markers have occurred (indicated by the events count readout).
10. Set the B SWEEP DELAY MODE switch to the B TRIGGERABLE AFTER DELAY position.
11. Set the time-base unit triggering for normal mode, ac coupling, and internal source.
12. Set the 7D10 TRIGGER LEVEL to light the TRIG'D indicator.
13. Set the time-base unit triggering level to light the triggered indicator on the negative-going slope of the input signal.
14. Set the EVENTS START TRIGGER LEVEL control for a time-marker display.
15. Turn the time-base unit triggering level and notice that the sweep can be triggered anywhere on the negative-going slope of the first displayed time-marker at the start of the sweep.

## DETAILED OPERATING INFORMATION

### Events Readout Display

The events readout display is presented on the mainframe crt, along with information encoded by the other plug-in units. The number of events being counted is presented in a seven to eight digit display.

The 7D10 readout display appears on the crt in a location corresponding to the plug-in compartment used. It is not necessary to select the 7D10 with the mainframe Vertical or Horizontal Mode switches to view the digital display.

### Signal Connection

In general, probes offer the most convenient means of connecting signals to the 7D10 external trigger inputs. Tektronix probes are shielded to prevent pickup of electrostatic interference. A 10X attenuation probe offers a high input impedance and allows the circuit under test to perform very close to normal operating conditions. Also, a 10X probe attenuates the input signal ten times.

Tektronix probes are designed to monitor the signal source with minimum circuit loading. The use of a probe will, however, limit the maximum trigger frequency range. To obtain maximum trigger bandwidth when using probes, select a probe capable of compensating the input capacitance; observe the grounding considerations given in the probe manual. The probe-to-connector adapters and the bayonet-ground tip provide the best frequency response.

In high-frequency applications, requiring maximum overall bandwidth, use a coaxial cable terminated at both ends in the characteristic impedance of the cable. To maintain the high-frequency characteristics of the applied signal, use high-quality low-loss cable. Resistive coaxial attenuators can be used to minimize reflection if the applied signal has suitable amplitude.

High-level, low-frequency signals can be connected directly to the external trigger inputs with short, unshielded leads. When this method is used, establish a common ground between the 7D10 and the associated equipment. The common ground provided by the line cords is usually inadequate. If interference is excessive with unshielded leads, use a coaxial cable or probe.

A signal can also be routed to the 7D10 through an amplifier unit via the internal trigger circuitry of the mainframe (7D10 installed in a horizontal compartment). This method of signal connection minimizes circuit loading, especially when triggering a time-base unit in parallel with the 7D10.

### NOTE

*Only external signals can be used with the Events Start Trigger.*

## Trigger Controls

The input signal may have a wide variety of shapes and amplitudes, many of which are unsuitable as delay-initiating triggers. For this reason, these signals are first applied to a trigger circuit where they are converted to pulses of uniform amplitude and shape. This makes it possible to start the delay with a pulse that has a constant size, eliminating variations of the delay circuit operation caused by changing input signals. The TRIGGER controls provide a means to select the signal source, filter unwanted frequencies, and start the delay at any voltage level on either slope of the waveform.

## Triggered Light

The TRIG'D light provides a convenient indication of the Trigger circuit condition. If the TRIGGER controls are correctly set and an adequate signal is applied, the TRIG'D light is on. If the TRIG'D light is off, no delay interval is started. The cause might be an incorrectly set TRIGGER control, low signal amplitude, or a signal repetition rate outside the usable frequency range. This feature can be used as a general indication of correct triggering when there is no display on the crt. The Delay Interval Pedestal and Z-Axis Blanking displays also aid in obtaining correct TRIGGER control settings. See the discussion of these features under Output Signals to Mainframe for further information.

## Trigger Coupling

The TRIGGER pushbuttons located below the COUPLING title select the method by which the input signal is connected to the Trigger circuit. Each position permits selection or rejection of various frequency components of the signal used to trigger the count.

**AC.** In this position of the COUPLING switch, the dc component of the input signal is blocked. Signals with low-frequency components below about 30 hertz are attenuated. In general, AC COUPLING can be used for most applications. However, if the signal contains unwanted frequency components or if the delay is to be triggered at a low repetition rate or dc level, one of the other switch positions will provide better results.

The triggering point in the AC position depends upon the average voltage level of the input signal. If the input signal occurs randomly, the average voltage level will vary, causing the triggering point to vary also. This shift of the triggering point may be enough so it is impossible to maintain a stable count; in such cases, use DC coupling.

**AC LF REJ.** In this position, dc is rejected and low-frequency input signals below about 30 kilohertz are attenuated. Therefore, the count is triggered only by the higher-frequency components of the input signal. The AC

LF REJ position is particularly useful for providing stable triggering if the signal contains line-frequency components.

**AC HF REJ.** This COUPLING switch position passes all low-frequency signals between about 30 hertz and 50 kilohertz. Dc is rejected and signals above 50 kilohertz are attenuated. This position is useful to trigger the count from the low-frequency components of a complex waveform.

**DC.** The DC position can be used to provide stable triggering from low-frequency or low-repetition-rate signals which would be attenuated in other modes. It can also be used to trigger the count when the input signal reaches a dc level selected by the setting of the SLOPE/LEVEL control. When triggering from the internal source, the setting of the vertical unit position control(s) affects the dc triggering point.

## Trigger Source

The TRIGGER pushbuttons located below the SOURCE title select the source of the signal connected to the Trigger circuit.

**INT.** In this position, the input signal is derived from the associated vertical unit. Therefore, the 7D10 must be installed in a horizontal compartment to use the internal source. Further selection of the internal signal may be provided by the vertical unit and mainframe; see the instruction manuals for these instruments for further information.

**LINE.** In this SOURCE switch position, a sample of the power-line voltage from the mainframe is connected to the Trigger circuit. Line triggering is useful when the input signal is time related (multiple or submultiple) to the line frequency. It is also useful for providing stable triggering from a line-frequency component in a complex waveform.

**EXT.** A signal connected to the EXT TRIG IN connector can be used to trigger the count in the EXT position of the SOURCE switch. An external signal can be used to provide a trigger when the internal signal amplitude is too low.

**EXT ÷ 10.** Operation in this position is the same as described for EXT, except the external signal is attenuated 10 times. Attenuation of high-amplitude signals is desirable to extend the range of the LEVEL control.

## Trigger Slope/Level

The TRIGGER SLOPE/LEVEL controls determine the slope and voltage level of the input signal where the Trigger circuit responds. Generally, the best point on a waveform for triggering the count is where the slope is steep, and

therefore usually free of noise. Assuming a sine-wave input waveform, the steepest slope occurs at the zero-crossing point. This is the point selected for triggering when the LEVEL control is set to 0 (center). A more positive or negative point on the waveform is selected as the LEVEL control is rotated clockwise or counterclockwise respectively from 0 (toward + or – symbols on panel).

Before setting the TRIGGER LEVEL, the desired SLOPE, MODE, COUPLING, and SOURCE should be selected. Then, adjust the LEVEL control so the count is triggered from the desired point.

### Events Start Trigger

The Events Start Trigger is used to start the delay interval.

The EVENTS START TRIG IN connector provides the input for the events-start signal. The EVENTS START TRIGGER SLOPE and LEVEL controls select the amplitude point and slope on the input signal where the delay interval is triggered.

### Delay Events

The DELAY EVENTS control selects the number of events counted. The integer number of events selected is displayed on the crt readout.

This control is a spring-return-to-center control that increases or decreases the number of events counted before a delayed pulse will occur. The direction of rotation determines whether the count is increased or decreased. The rate at which the count increments is determined by the magnitude of rotation. After either extreme of the range is reached, the next count starts from the other end of the range. For example, if the events counted is increased above 10000000, the count will go to 0000001. Conversely, if the delay time is decreased past 0000001, the count will go to 10000000.

### Delay Modes

The B SWEEP DELAY MODE switch permits the 7D10, under specific conditions, to select the delay mode of a compatible time-base unit. To use this feature, the 7D10 is installed in the A Horizontal compartment and the time-base in the B Horizontal compartment of a four-plug-in mainframe. With this arrangement, the time-base unit can be controlled through the mainframe interface. Some dual time-base units are not compatible with this feature; see the time-base unit instruction manual for further information.

**INDEPENDENT.** The 7D10 and the time-base unit operate independently.

**B STARTS AFTER DELAY.** The time-base unit produces a sweep immediately following the selected delay interval. This provides the same mode of operation as triggering the time-base unit with the delayed trigger output.

**B TRIGGERABLE AFTER DELAY.** The time-base unit produces a sweep after the first trigger pulse is received following the selected delay interval. This mode of operation provides a stable display of a signal having time jitter. Precision time measurements cannot be made in this mode because the actual delay time is only partially dependent on the delay interval of the 7D10.

Sweep delay can also be used to select a portion of a complex signal for display. A sweep is delayed by triggering the sweep from the Delayed Trigger output of the 7D10, rather than from the signal to be displayed. Several methods of coupling the Delayed Trigger to the sweep are possible, depending on the application.

### NOTE

*The logic levels provided to the 7D10 from the mainframe are designed to control a time-base unit delaying sweep. For this reason, the 7D10 might become locked out (no output) when the setting of either the B-Sweep unit Time/Division switch or the B SWEEP DELAY MODE switch is changed. If this occurs, a delayed sweep will not be produced. To reset the 7D10, set the B SWEEP DELAY MODE switch first to INDEPENDENT, then select the desired delay mode.*

**Internal Trigger.** The sweep produced by a time-base unit in a horizontal compartment can be internally triggered from a 7D10 in a vertical compartment. To use this sweep delay mode, the 7D10 must be selected by the mainframe trigger source switch. Delaying a time-base sweep from the internal source can be used with the units installed in either a three- or four-plug-in mainframe.

**External Trigger Source.** A sweep can be delayed by external triggering from the DLY'D TRIG OUT connector. This method can be used with any triggered sweep.

## OUTPUT SIGNALS

### Front-Panel Output Signals

The Delay Interval and Delayed Trigger outputs are available at the front-panel DLY INTERVAL OUT and DLY'D TRIG OUT connectors respectively. These outputs can be used to control other equipment during or immediately following the delay interval. To maintain the rise- and fall-time characteristics of these signals, connection to other equipment should be made with 50-ohm coaxial cable; the output of the cable should be terminated in 50 ohms.

## Operating Instructions—7D10

**DLY INTERVAL OUT.** This output is a positive-going, rectangular waveform coincident with the generated delay interval. The DLY INTERVAL OUT signal duration is within 30 nanoseconds of actual delay, usually 10 nanoseconds.

**DLY'D TRIG OUT.** This signal is generated as a positive-going rectangular pulse coincident with the end of the delay interval.

The front-panel output signals are shown in Figure 2-3, along with the input signal. The input signal, Figure 2-3A, is comprised of 10-microsecond time markers. The resultant Delay Interval and Delayed Trigger outputs are shown in Figure 2-3B and 2-3C, respectively.

### Output Signals to Mainframe

Signal outputs are provided to the mainframe via the interface connector. The following discussion describes these signals and the operating conditions necessary for their use.

**DELAY-INTERVAL PEDESTAL.** This output provides an on-screen display of the approximate delay interval. To view the pedestal display, the 7D10 must be installed in a vertical plug-in compartment and be selected by the mainframe Vertical Mode switch. The position of this display is fixed near the vertical center of the graticule area. The Delay-Interval Pedestal display is shown in Figure 2-4A. The input signal, shown in Figure 2-4B, is comprised of 10-microsecond time markers.

**DELAYED TRIGGER.** The Delayed Trigger output provides an internal Delayed Trigger source for a time-base unit. A time-base unit can be triggered from the Delay Trigger when the 7D10 is in a vertical compartment. To use this output, the 7D10 must be selected by the appropriate trigger source switch (mainframe).

**Z-AXIS BLANKING.** Z-axis blanking provides an on-screen display of the approximate delay interval. This is accomplished by blanking out the crt display during the delay interval. Z-axis blanking can be obtained with the 7D10 installed in any plug-in compartment. The Z-axis blanking display is selected by a slide switch located inside the unit (see Fig. 8-5, Section 8).

### NOTE

*At faster sweep rates (100 ns/div or faster), care must be taken when interpreting crt display because relative propagation delays through the 7D10 and vertical amplifier plug-ins are not the same. This appears as a relative time shift between delay interval pedestal or Z-axis blanking generated by the 7D10 and the signal(s) viewed through a vertical amplifier on the crt. Changing the TRIG SOURCE between INT and EXT  $\div$  10 will vary this apparent time shift due to differences in propagation delays of the signal path.*

## APPLICATIONS

The 7D10 counts arbitrary events and delivers an output when a preselected number of events is reached. By counting events rather than delaying by a fixed time, trigger jitter and drift caused by mechanical fluctuations in disc memories or servo control systems is eliminated.

Delay by events provides a convenient method for triggering a time base, after a preselected number of clock pulses, to look at a particular word in a data train without tedious counting. Only two signals are required to operate the 7D10. The events to be counted (clock, line, or mechanical switch pulses) are fed to the EXT TRIG IN connector, and the control (frame or sector) pulse is fed to the EVENTS START TRIG IN connector to tell the 7D10 when to start counting.

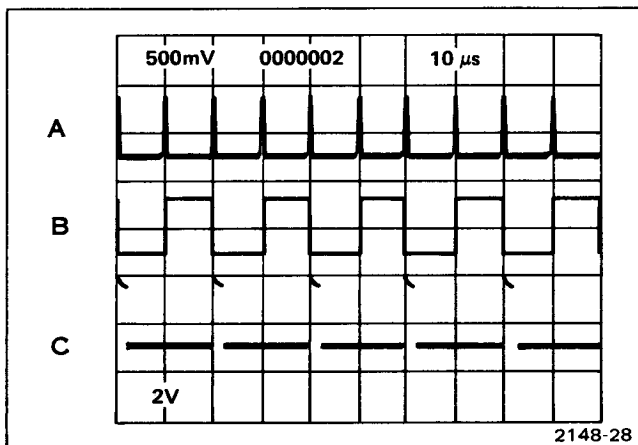

Figure 2-3. Display showing time relationship of (A) input signal at front panel to (B) Delay Interval, and (C) Delayed Trigger outputs.

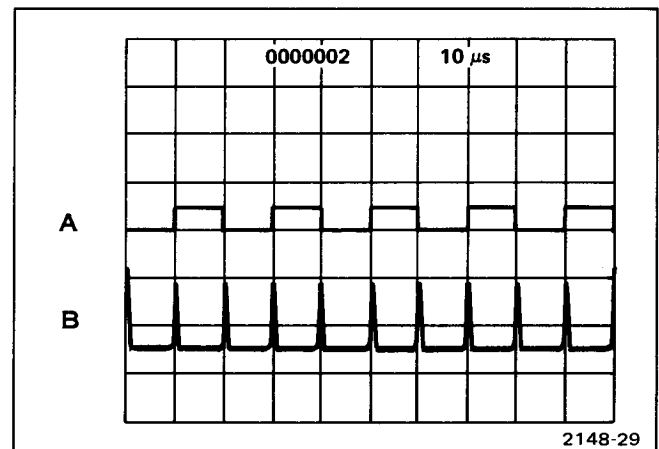

Figure 2-4. Display showing time relationship of (A) Delay Interval Pedestal and (B) input signal.

The 7D10 can be used with companion vertical amplifier and time-base units in a three- or four-hole mainframe to identify transients or incorrect logic state locations on a word or bit that occurs anywhere from 1 event to 10 million events from the start of a data train. Time interval measurements between events can be made with delaying and delayed time base units.

The 7D10 can also be used with a logic analyzer (e.g., TEKTRONIX 7D01 Logic Analyzer) to preselect a binary word or event and examine the data train either before, after, or on both sides of the first to the 10 millionth time that such word or event occurs.

The following procedures describe some specific measurement applications for the 7D10. Contact your local Tektronix Field Office or representative for assistance on applications that are not described in this manual.

### Logic State Identification

The following procedure describes a method for displaying a binary word on a data train in order to determine its logic state:

1. Connect the equipment as shown in Figure 2-5A.
2. Set the mainframe to trigger the time-base unit from the left vertical-amplifier unit and display the time-base unit and both vertical amplifier units in the chopped mode.
3. Set both amplifier units to display channel 1 and 2 in the chopped mode.
4. Set the 7D10 controls as follows:

```

TRIGGER
  COUPLING . . . .AC
  SOURCE. . . . .EXT
  SLOPE . . . . .+
EVENTS START
  TRIGGER
  SLOPE . . . . .+
B SWEEP
  DELAY MODE. . . .B STARTS AFTER
                    DELAY
    
```

5. Set the EVENTS START TRIGGER LEVEL control for a stable display.

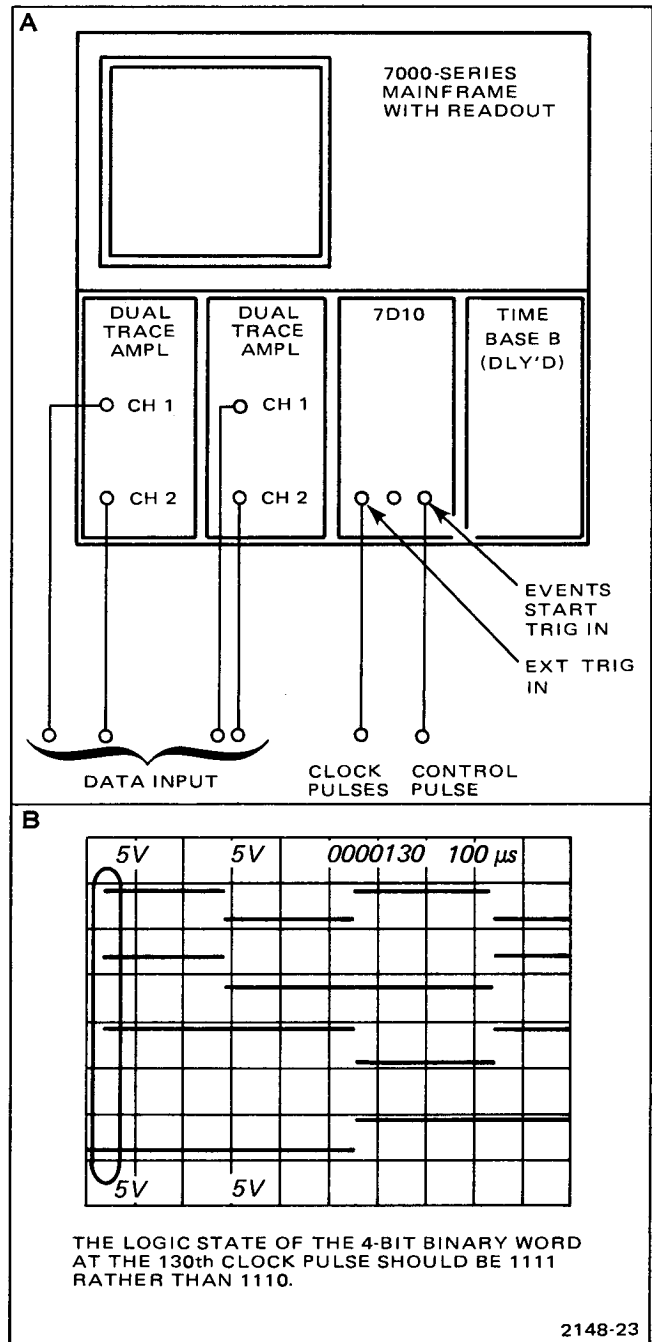

Figure 2-5. Equipment set up and data display for determining the logic state of a 4-bit binary word.

6. Turn the DELAY EVENTS control for the location of the binary word to be examined as indicated by the events count readout.

7. Determine the logic state of the displayed binary word at the left edge of the display (see example in Fig. 2-5B).

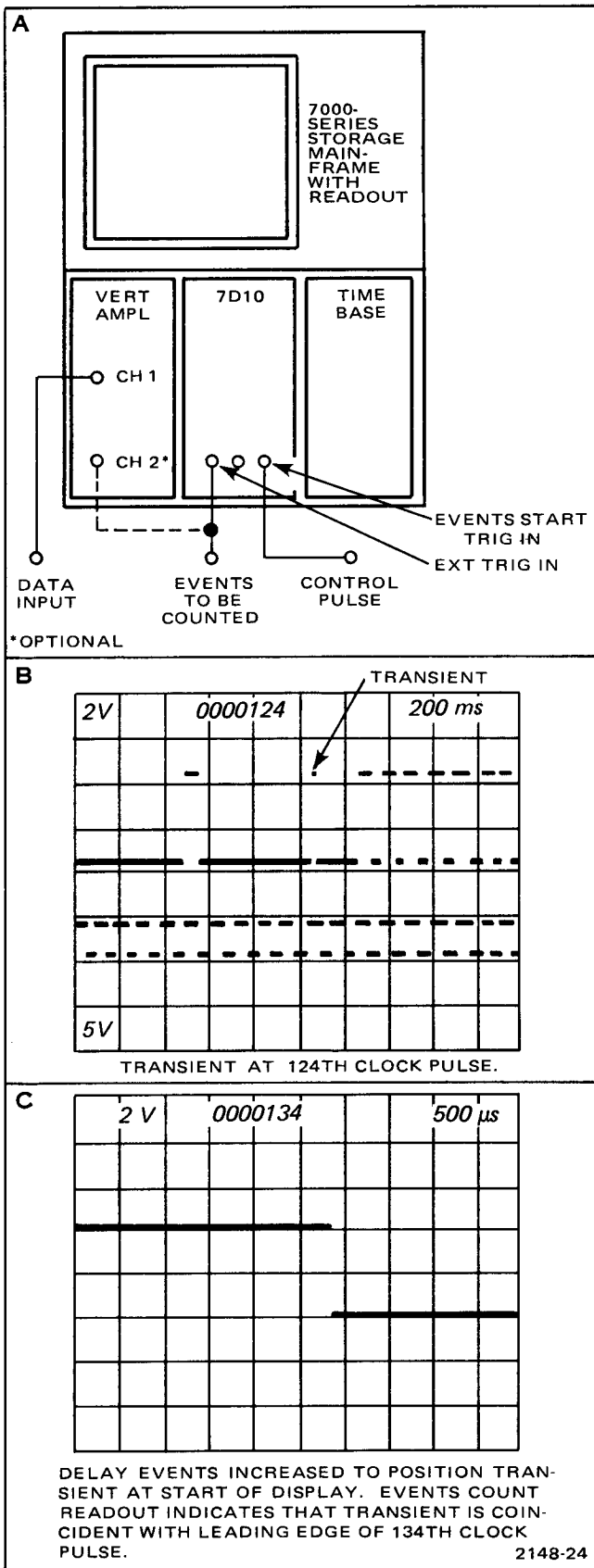

Figure 2-6. Equipment set up and display for finding a transient and determining its location on a data train.

### Transient Identification

The following procedure describes a method for locating and examining a transient caused by a timing problem:

1. Connect the equipment as shown in Figure 2-6A.
2. Set the mainframe to trigger the time-base unit from the vertical-amplifier unit and to display the time-base unit and the amplifier unit.
3. Set the time-base unit triggering for normal mode, ac coupling, internal source, and + slope.
4. Set the 7D10 controls as follows:
  - TRIGGER
  - COUPLING . . . .AC
  - SOURCE . . . .EXT
  - SLOPE . . . . .+
  - EVENTS START
  - TRIGGER
  - SLOPE . . . . .+
  - B SWEEP
  - DELAY MODE . . . .INDEPENDENT
5. Set the 7D10 TRIGGER LEVEL control to light the TRIG'D indicator.
6. Set the EVENTS START TRIGGER LEVEL control for a stable display.
7. Turn the DELAY EVENTS control clockwise (INCREASE) to view the data train, bit-by-bit, until the transient is located (see example in Fig. 2-6B).
8. Turn the DELAY EVENTS control to position the transient at the left edge of the display. The events count readout now indicates at which clock pulse the transient occurred.
9. Set the mainframe for storage mode and increase the time-base unit sweep rate to expand the display.
10. Set the time-base unit triggering for single sweep.
11. Press the time-base unit single-sweep reset button to provide the desired single sweep stored display (see example in Fig. 2-6C).



### Delay By Words

The following procedure utilizes a 7D10 with a logic analyzer and word recognizer (e.g., TEKTRONIX 7D01 Logic Analyzer) to select a binary word and position the data display window anywhere from the first to the 10 millionth time that such word occurs.

1. Connect the equipment as shown in Figure 2-7A.
2. Set the 7D10 controls as follows:
  - TRIGGER
  - COUPLING . . . .AC
  - SOURCE . . . .EXT
  - SLOPE . . . . .+
  - EVENTS START
  - TRIGGER
  - SLOPE . . . . .+
  - B SWEEP
  - DELAY MODE . . .INDEPENDENT
3. Set the logic analyzer for asynchronous operation with the word recognizer as the trigger source.
4. Set the word recognizer for the desired binary word code.
5. Connect the data input to the logic analyzer.
6. Set the mainframe to display the right vertical compartment.
7. Set the 7D10 TRIGGER LEVEL control to light the TRIG'D indicator.
8. Set the EVENTS START TRIGGER LEVEL control for a stable display.
9. Set the DELAY EVENTS control to indicate, on the events count readout, the desired number of times that the preselected binary word is to occur before the 7D10 initiates a data display. For example, if the DELAY EVENTS control is set for an events count readout of 0000025, the word recognizer and 7D10 will initiate a display of the data before, after, or on both sides of the 25th time that the preselected binary word occurs in the data train (see example in Fig. 2-7B).

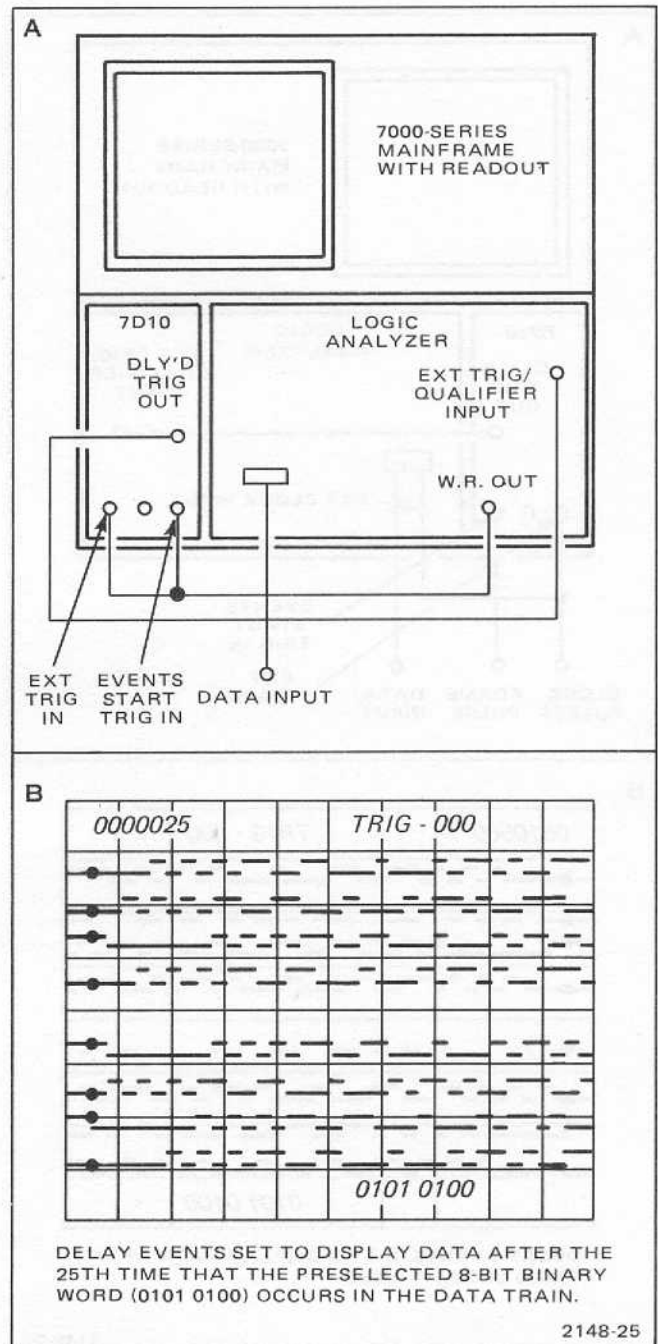

Figure 2-7. Equipment set up and data display window that has been positioned after a selected binary word has occurred 25 times.

### Delay By Events

The following procedure utilizes a 7D10 with a logic analyzer (e.g., TEKTRONIX 7D01 Logic Analyzer) to effectively position the data display window to virtually anywhere along a data train:

1. Connect the equipment as shown in Figure 2-8A.

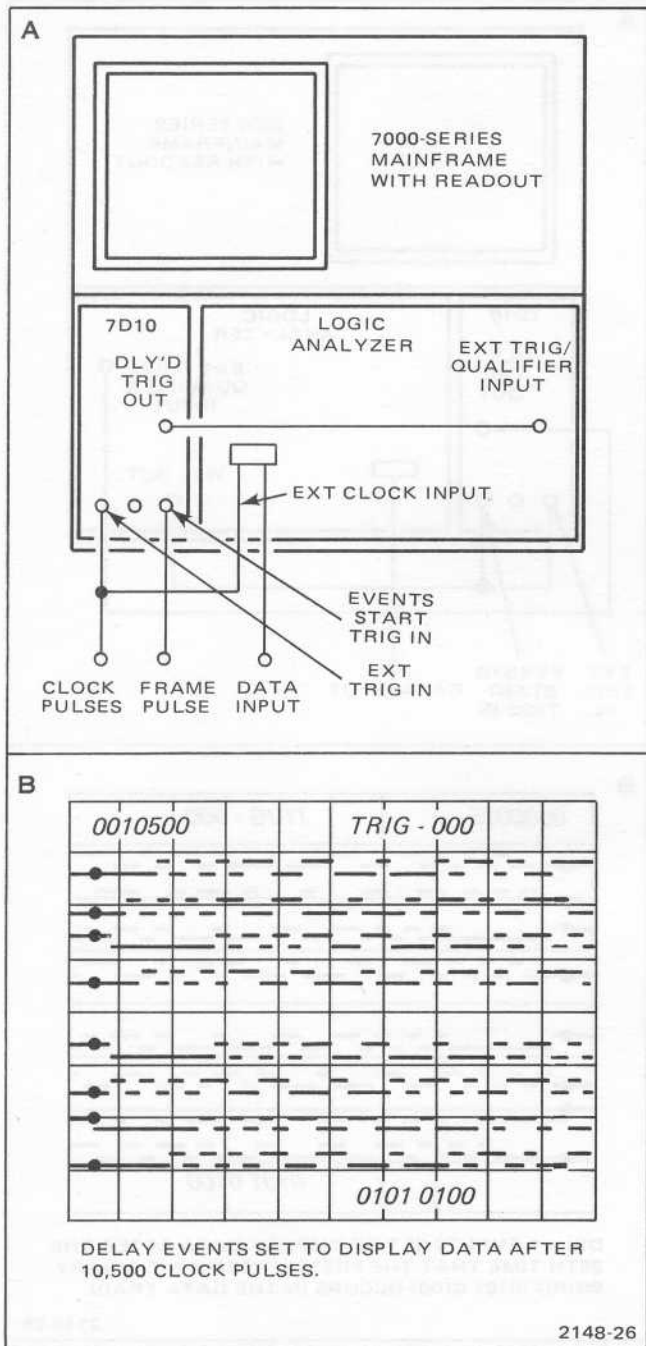

Figure 2-8. Equipment set up and data display window that has been positioned after 10,500 clock pulses have occurred.

2. Set the 7D10 controls as follows:

TRIGGER  
 COUPLING . . . .AC  
 SOURCE . . . .EXT  
 SLOPE . . . . .+  
 LEVEL . . . . .0

EVENTS START  
 TRIGGER  
 SLOPE . . . . .+

3. Set the logic analyzer to the external clock mode and trigger from the external trigger/qualifier input.
4. Set the mainframe to display the right vertical compartment.
5. Set the EVENTS START TRIGGER LEVEL control for a stable display.
6. Set the DELAY EVENTS control to indicate the desired number of clock pulses, on the events count readout, that the logic analyzer bit-storage window is to be shifted down the data train. For example, if the DELAY EVENTS control is set for an events count readout of 0010500, the logic analyzer and 7D10 will initiate a display of the data before, after, or on both sides of the 10,500th clock pulse (see example in Fig. 2-8B).

**Time Interval Measurements**

The following procedure describes a method for measuring time intervals either from the display trigger (start of sweep) or between any two points on a displayed data train:

1. Connect the equipment as shown in Figure 2-9A.
2. Set the mainframe to display the left vertical-amplifier unit and both time-base units in the chopped mode.
3. Set the 7D10 controls as follows:

TRIGGER  
 COUPLING . . . .AC  
 SOURCE . . . .EXT  
 SLOPE . . . . .+  
 EVENTS START  
 TRIGGER  
 SLOPE . . . . .+

4. Set the EVENTS START TRIGGER LEVEL and time-base A triggering level controls for a stable display.
5. Turn the DELAY EVENTS control to display the desired events to be measured.

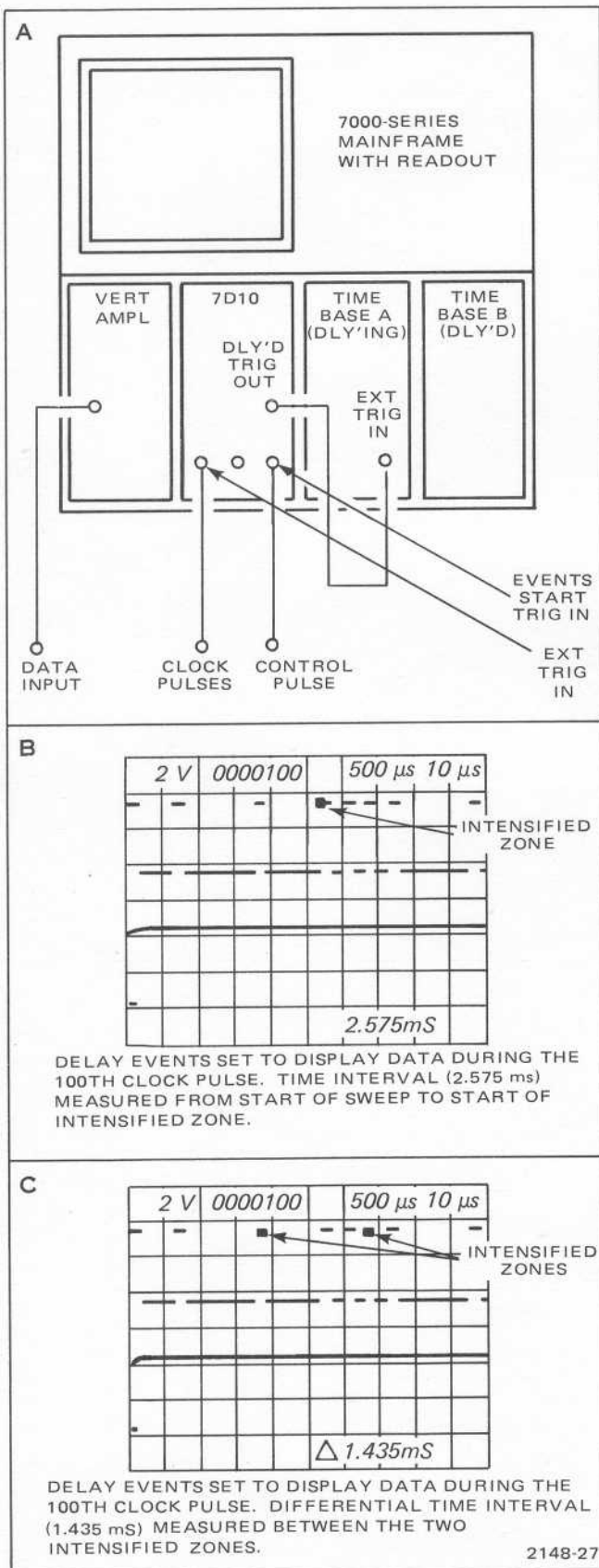

6. Set time-base A to the delaying mode.

7. Set the time-base A delay time to position the start of the intensified zone to the desired point on the display (see example in Fig. 2-9B). The readout in the bottom right side of the display indicates the time interval from the display trigger (start of sweep) to the start of the intensified zone. (Refer to the delaying time-base unit operator's manual for detailed operating instructions.)

8. For differential time-interval measurements, set time-base A to the differential-time mode.

9. Set the time-base A delay time and differential time to position the start of the two intensified zones at the beginning and end of the time-interval to be measured (see example in Fig. 2-9C). The readout in the bottom right side of the display indicates the time between the start of the two intensified zones. (Refer to the delaying time-base unit operator's manual for detailed operating instructions.)

Figure 2-9. Equipment set up and display for time interval measurements from start of sweep or between any two points on a displayed data train.

## **WARNING**

THE FOLLOWING SERVICING INSTRUCTIONS ARE FOR USE BY QUALIFIED PERSONNEL ONLY. TO AVOID PERSONAL INJURY, DO NOT PERFORM ANY SERVICING OTHER THAN THAT CONTAINED IN OPERATING INSTRUCTIONS UNLESS YOU ARE QUALIFIED TO DO SO.

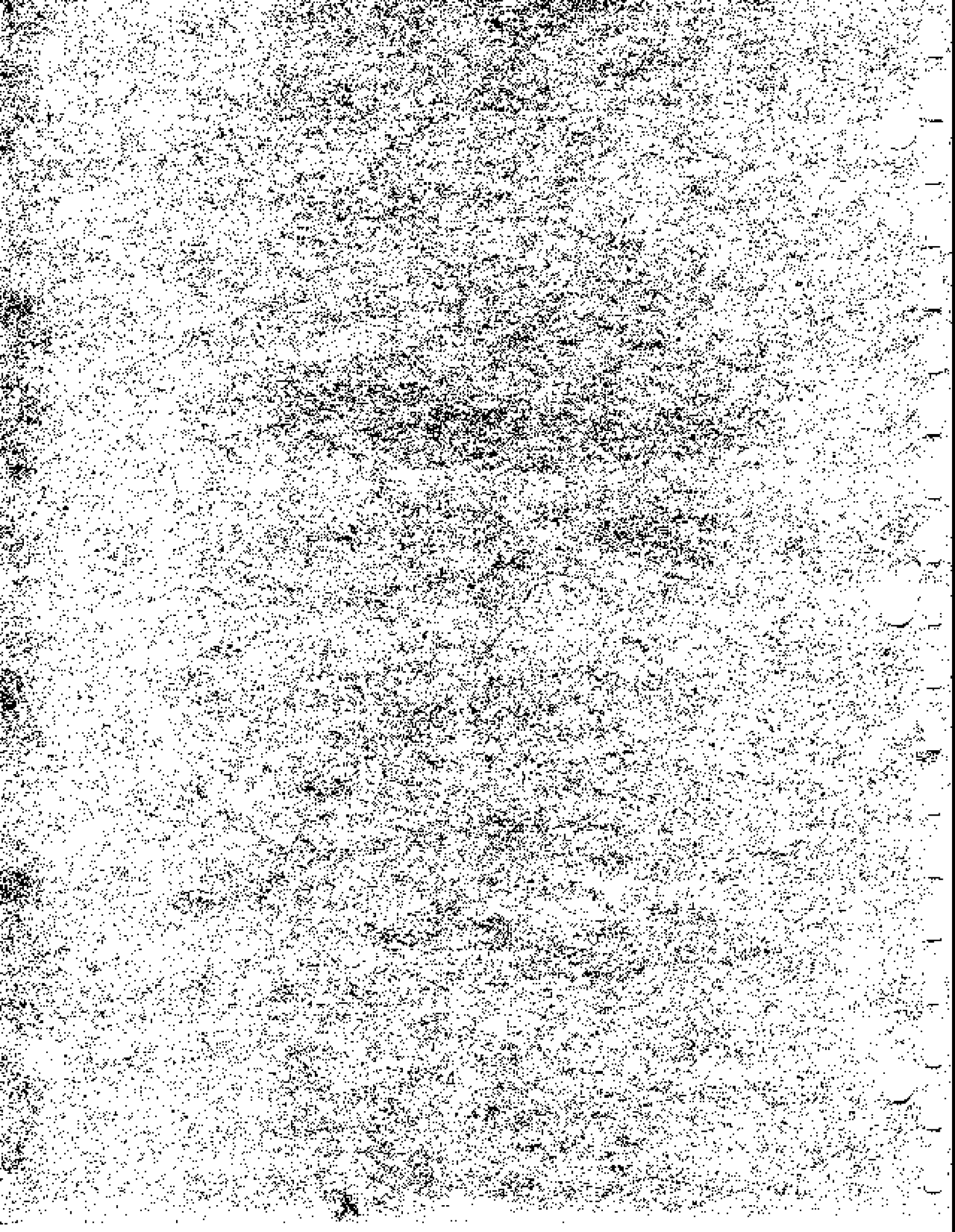

## THEORY OF OPERATION

This section provides a general, block diagram description of the 7D10. This is followed by the theory of operation which is keyed to the schematic diagrams of the circuits described. If more information is desired on commonly-used circuits, refer to standard electronics textbooks.

Following the Detailed Circuit Operation is a brief description of the readout system used in Tektronix 7000-series oscilloscope mainframes. If more information is required on the readout system, refer to the instruction manual for the oscilloscope.

### BLOCK DIAGRAM

The block diagram is divided into the following five main circuits: Events Trigger, Outputs Processing and Events Start Trigger, Delaying Counter and Display Generator, and Readout Encoding. A basic block diagram is provided in Section 2, Operating Instructions.

#### EVENTS TRIGGER

The Events Trigger circuit provides the actual count signal, derived from the signal selected by the SOURCE and COUPLING switches.

#### OUTPUTS PROCESSING AND EVENTS START TRIGGER

The Outputs Processing and Events Start Trigger circuit performs several internal and reset functions in addition to providing the various outputs of the 7D10. The circuit provides B sweep delay, Z-axis intensification during the delay interval, the delay interval pedestal, and the delayed trigger output. This circuit also contains the Events Start Trigger, which allows counting of trigger events.

#### DELAYING COUNTER AND DISPLAY GENERATOR

The Delaying Counter and Display Generator circuit provides the circuitry for setting up the delay by events count. The delay is set up as the nines complement of the delay count in the Reversible Counter by the DELAY EVENTS Control and is counted by the Delaying Counter. The Delaying Counter counts events to 10,000,000. When the preset delay count is completed (the count signal to the Delaying Counter comes from the Events Count Source Gate on Diagram 2), the Nine Arm Gate activates the Output Release Gate on Diagram 2. This simultaneously ends the DLY INTERVAL OUT and activates the DLY'D TRIGGER OUT.

#### READOUT ENCODING

The delay events setting is encoded by the Readout Encoding circuit. This circuit provides necessary information to the readout system in the associated oscilloscope mainframe to allow the delay events count to be displayed on the crt.

## DETAILED CIRCUIT OPERATION

The following discussions are referenced to the schematic diagrams in the diagram section of this manual. Each main topic heading is followed by the number of the schematic to which it applies.

### EVENTS TRIGGER

The EVENTS TRIGGER circuit consists of two main sections, the Trigger Preamplifier and the Trigger Generator. A detailed block diagram of this circuit is shown in Figure 3-1.

#### Trigger Preamplifier

The Trigger Preamplifier serves to select trigger source and coupling for the Trigger Generator. This circuit may be considered as consisting of the following four elements: Trigger Source Switching, U60; External Trigger Preamp or external input amplifier, Q32-Q37-Q41; Balanced-to-Single-Ended Converter, Q71-Q75-Q78; and Trigger Coupling Q82-Q84-Q86.

**TRIGGER SOURCE SWITCHING.** U60 receives internal trigger inputs at pins 2 and 15 and external trigger signals at pin 7. Integrated circuit U60 determines which input signal is selected by means of a digital signal (voltage level) at pin 4. A LO on pin 4 activates pins 2 and 15 for internal triggering, while a HI on pin 4 switches U60 to activate pins 7 and 10 for external triggering.

To further examine U60, assume that pin 4 is low, activating pins 2 and 15 for internal triggering. This input is a relatively high impedance, differential configuration. Pin 15 receives the positive-going trigger signal and pin 2 is the negative-going input. The inputs are biased at the center of their dynamic range, and signal limiting in the trigger pick-off circuitry (in the mainframe) ensures that the inputs will not be driven into cutoff or saturation. R55 and R57 terminate the internal trigger signal from the mainframe. The analog current source for internal triggering is through pins 1 and 16.

The switch output current appears at pins 12 and 13. A positive-going signal at pin 15 will cause an increase of current into pin 13 and out through pin 15, R66, and R69. Simultaneously, the negative-going signal at pin 2 causes a decrease of current into pin 12 and out through pin 1, R68, and R69. The net result is that the total current through pins 12 and 13 and through R69 remains constant.

**EXTERNAL TRIGGER PREAMP.** This circuit includes Q32, Q37, and Q41. The SOURCE switch (S5) at the input selects internal, external, or line signals for triggering. The external trigger signal may be attenuated to one-tenth amplitude by selecting EXT ÷ 10. Resistors R6 and R7 (paralleled by R30) form a 10:1 attenuator.

The input impedance for the trigger input is one megohm, consisting primarily of R12 and R30. This resistor pair also causes a 2X attenuation of the input signal as seen at the gate of Q32A and B. Adjustable capacitor C24 serves to compensate the input stage and C10 compensates the 10X attenuator.

CR27 and CR28 protect Q32 from excessive input signals by conducting to clamp the gate if the signal at the input connector exceeds approximately plus or minus 2.5 volts. The signal at the source of Q32 is coupled through emitter follower Q37 to the base of Q41. Transistor Q41 is another emitter follower, which drives U60. The signal at pin 7 of U60 is terminated in approximately 50 ohms by R46 to preserve the high-frequency characteristics.

R49 sets the dc level at pin 10 of U60, which is the negative side of the external-trigger differential input. This serves to match the dc balance of the external trigger input of U60 to that of the internal trigger input.

**BALANCED-TO-SINGLE-ENDED CONVERTER.** Q71, Q75, and Q78 convert the balanced (push-pull) output of U60 to a single-ended signal at the emitter of Q75.

The trigger signal through U60 causes a decrease of current into pin 12 from R77 and R78 and an increase of current into pin 13 from R71. This would normally cause the voltage at pin 12 to swing in a positive direction, while pin 13 goes in a negative direction. However, the current through R77 and R78 actually increases due to the feedback via R79 and R78, causing the voltage at pin 12 to swing negatively along with pin 13. Transistor Q78 is connected as a diode, and is enclosed in the same heat-sink with Q71 to provide good dc stability.

**TRIGGER COUPLING.** When DC coupling is selected by the front-panel COUPLING switch, Q86 and Q84 are turned on by the +15-volt supply through S95 and resistors to their bases. The triggering signal is then coupled through R80 and Q86-Q84 to the base of Q100.

Only Q84 is turned on when AC coupling is selected. The triggering signal then passes through Q84 and C87 to the base of Q100. For AC LF REJ coupling, Q84 is turned off and the triggering signal is differentiated by C88 and R89 to attenuate low-frequency signals.

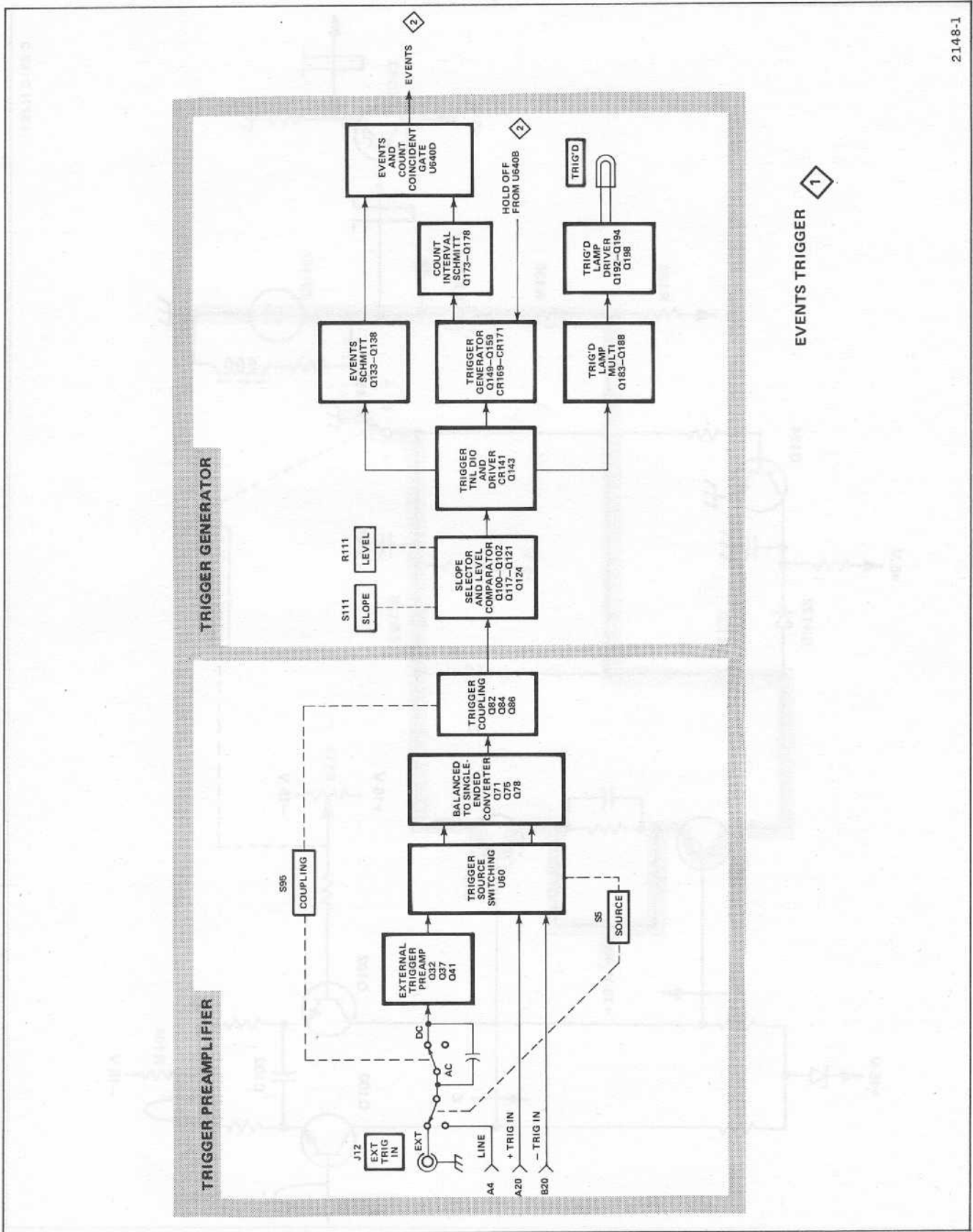
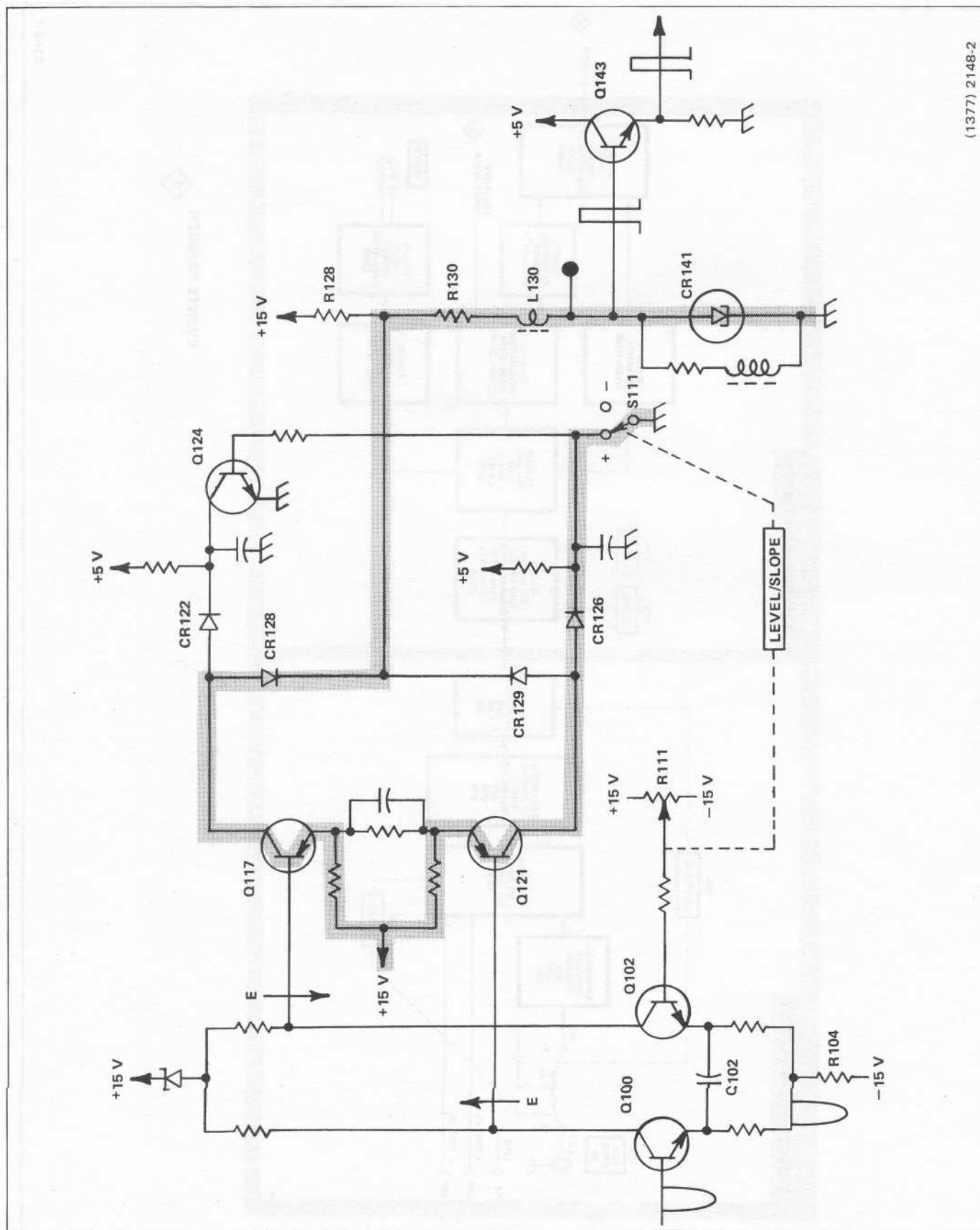

Figure 3-1. Detailed block diagram of Events Trigger circuit.





(1377) 2148-2

Figure 3-2. Trigger current path for positive-slope triggering.

For AC HF REJ coupling, both Q84 and Q82 are turned on. The high-frequency components are coupled through Q82 and C83 to ground, while the desired triggering component is coupled through Q84 and C87 (as in AC coupling).

### Trigger Generator

The Trigger Generator consists of the Slope Selector and Level Comparator, Trigger Tunnel Diode and Driver, TRIG'D Lamp Multi (multivibrator), TRIG'D Lamp Driver, Trigger Generator, Events Schmitt, and Events and Count Coincident Gate.

**SLOPE SELECTOR AND LEVEL COMPARATOR.** This stage comprises Q100, Q102, Q117, Q121, and Q124. Transistors Q100 and Q102 are connected as a differential comparator. The reference voltage for the comparator is selected by the setting of LEVEL control R111. The internal DC Balance adjustment, R77, sets the level at the base of Q100 so that the Delaying Counter is triggered at the zero-volt point of the incoming trigger when the LEVEL control is set to the center of the positive or negative slope region. The LEVEL control varies the voltage on the base of Q102 to select the point on the trigger signal where triggering occurs.

R104 establishes the emitter current for Q100 and Q102. Prior to the arrival of a trigger signal, with the LEVEL control set to the center of the positive or negative slope, Q100 and Q102 are passing equal currents.

Assume that a positive-going signal is applied to the EXT TRIG IN connector and that the LEVEL/SLOPE control is set to zero on the positive slope.

The signal at the EXT TRIG IN connector is inverted by the Trigger Preamplifier to appear at the base of Q100 as a negative-going signal. This will cause a decrease of current through Q100, and because of the common emitter source, R104, the current through Q102 will increase. The decreased collector current of Q100 biases Q121 in a reverse direction, while Q117 becomes more forward biased due to the increased current through Q102.

With the SLOPE switch (S2) in the + position, the cathode of CR126 is grounded, forward biasing CR126, which reverse biases CR129. At the same time, the base of Q124 is at ground and Q124 is off. This causes CR122 to be reverse biased and CR128 is forward biased through Q117. An increased current is applied through Q117 and CR128 to the Trigger Tunnel Diode and Driver stage (see Fig. 3-2).

When the SLOPE switch is set to the - position, Q124 and CR122 are forward biased and CR128 is reverse biased. CR126 is reverse biased and CR129 is forward biased so that current flows through Q121 and CR129 to the Trigger Tunnel Diode and Driver stage.

**TRIGGER TUNNEL DIODE AND DRIVER.** The Trigger Tunnel Diode and Driver stage shapes the output of the comparator to provide a trigger pulse with a fast leading edge.

Tunnel diode CR141 is quiescently biased so that it is in its low-voltage state. Increased trigger current from Q117 and CR128 or Q121 and CR129 through R130, L130, and CR141 causes CR141 to switch to its high-voltage state. The resulting fast-rise positive step is coupled through emitter-follower Q143 and C145-C166-C182 to the next stages.

**TRIG'D LAMP MULTI.** The Trig'd Lamp Multi stage includes Q183 and Q188. When no trigger is applied, Q183 is off and C185 is charged to a positive level (at the collector of Q183) determined by R184, R190, and R191. The base of Q192 is more positive than the base of Q194, so Q194 is conducting.

When a trigger is applied, Q183 and Q188 operate as an emitter-coupled monostable multivibrator. Q183 is momentarily turned on by the positive transition coupled through C182. The collector of Q183 drops and C185 discharges through R185, turning off Q188. This holds Q183 on for a period determined by the charging time-constant of C185. If the trigger signal has a repetition rate of 20 hertz or greater, Q183 stays on (see Fig. 3-3). With Q183 on, Q192 is also conducting and Q194 is off.

**TRIG'D LAMP DRIVER.** During the time that Q183 is on, the increased drop across R184 forward biases Q192. This turns on Q198, which drives the TRIG'D lamp, DS197.

**TRIGGER GENERATOR.** The Trigger Generator includes Q149, Q159, CR169, and CR171. The function of this circuit is to supply a fast-rise trigger signal to the Count Interval Schmitt. For normal triggering, this signal is developed after receipt of a fast-rise transition from the Trigger Tunnel Diode and Driver stage, except during Holdoff.

For the following discussion of operation, assume that a trigger signal is applied to the EXT TRIG IN connector.

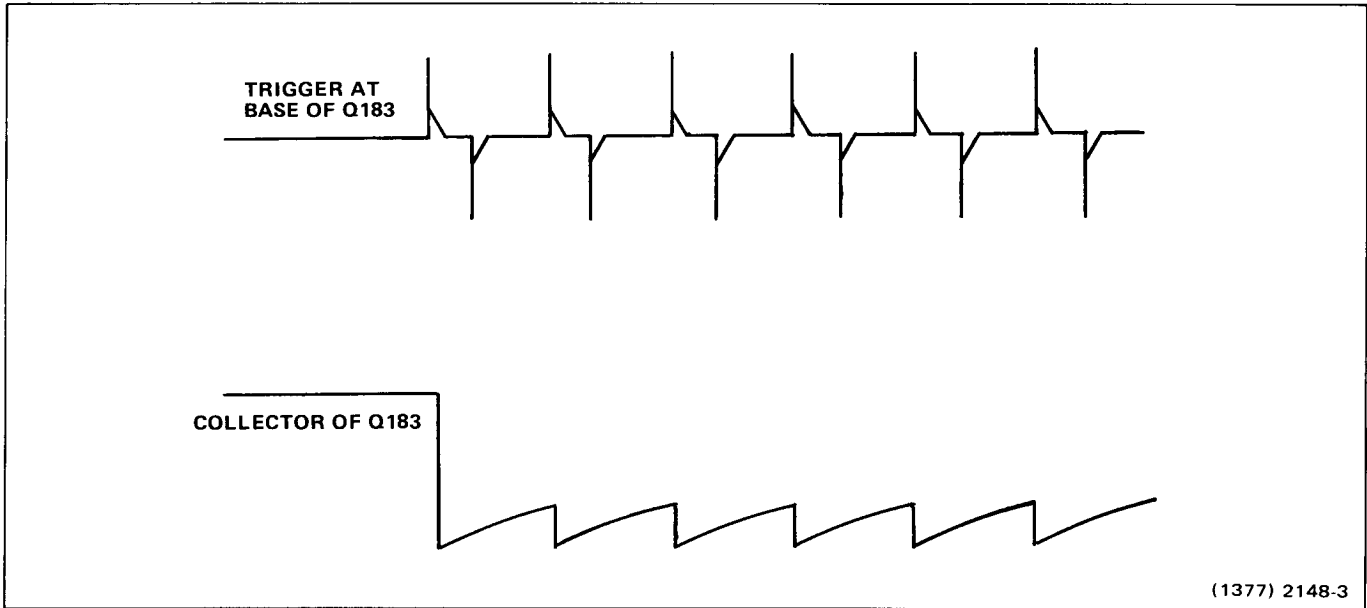

Figure 3-3. Trig'd Lamp Multi input and output waveforms with trigger signal applied.

The positive-going transition at the emitter of Q143 is coupled through C182, causing the TRIG'D lamp, DS197 to be energized as previously described.

CR169 and CR171 are both in their high states until the Holdoff signal switches them to the low state. The Holdoff signal is a positive pulse which forward biases both Q149 and Q159. When these transistors are forward biased, they divert current from CR171 and CR169, which causes the tunnel diodes to switch to their low states.

The next trigger after Holdoff appears as a positive transition at C145 and C166. The positive transition coupled through R166 and R168 causes CR169 to switch to its high state. This higher level, through R170, brings CR171 up to near its switching current. The positive transition is also coupled through C145, R145, a 3.5 nanosecond delay line, and R154 to CR171. The short delay ensures that CR169 has had time to switch to its high state in order to arm CR171 before the arrival of the positive transition at CR171. This prevents extraneous noise from prematurely activating CR171. The positive transition then switches CR171 to its high state.

**EVENTS AND COUNT COINCIDENT GATE.** The signal output of CR141 is used for events counting. The output of CR141 is coupled through a level shifting Schmitt trigger, Q133 and Q138, to an input of U640D. To ensure that events are counted only when Holdoff is not present, the output of CR171 is also coupled to an input of U640D

through the Count Interval Schmitt, Q173 and Q178. Therefore, U640D is enabled, during the absence of Holdoff, to output the events count pulses to Q512, the Events Count Source Gate.

### OUTPUTS PROCESSING AND EVENTS START TRIGGER 2

The Outputs Processing and Events Start Trigger circuits contain the various reset and output circuits of the 7D10, and the Events Start Trigger circuit. A detailed block diagram of this circuit is shown in Figure 3-4.

#### Events Count Source Gate

The Events Count Source Gate comprises Q512, Q514, and Q518. The Events signal from U640D in the Events Trigger circuit is routed through Q512 and Q518 to the Delaying Counter and Display Generator circuit and to the Output Release Gate stage.

#### Output Release Gate

Q525 is armed by the Delaying Counter and Display Generator circuit at one count less than overflow. The following pulse, which is accepted as the end of count, is now synchronously gated through the Output Release Gate, Q525. The output of Q525 is a pulse applied to the clock inputs of U543A and U543B causing them to change state (Q output goes to its HI state). U543A is the Delayed Trigger Flip-Flop and U543B is the Delay Gate Flip-Flop.



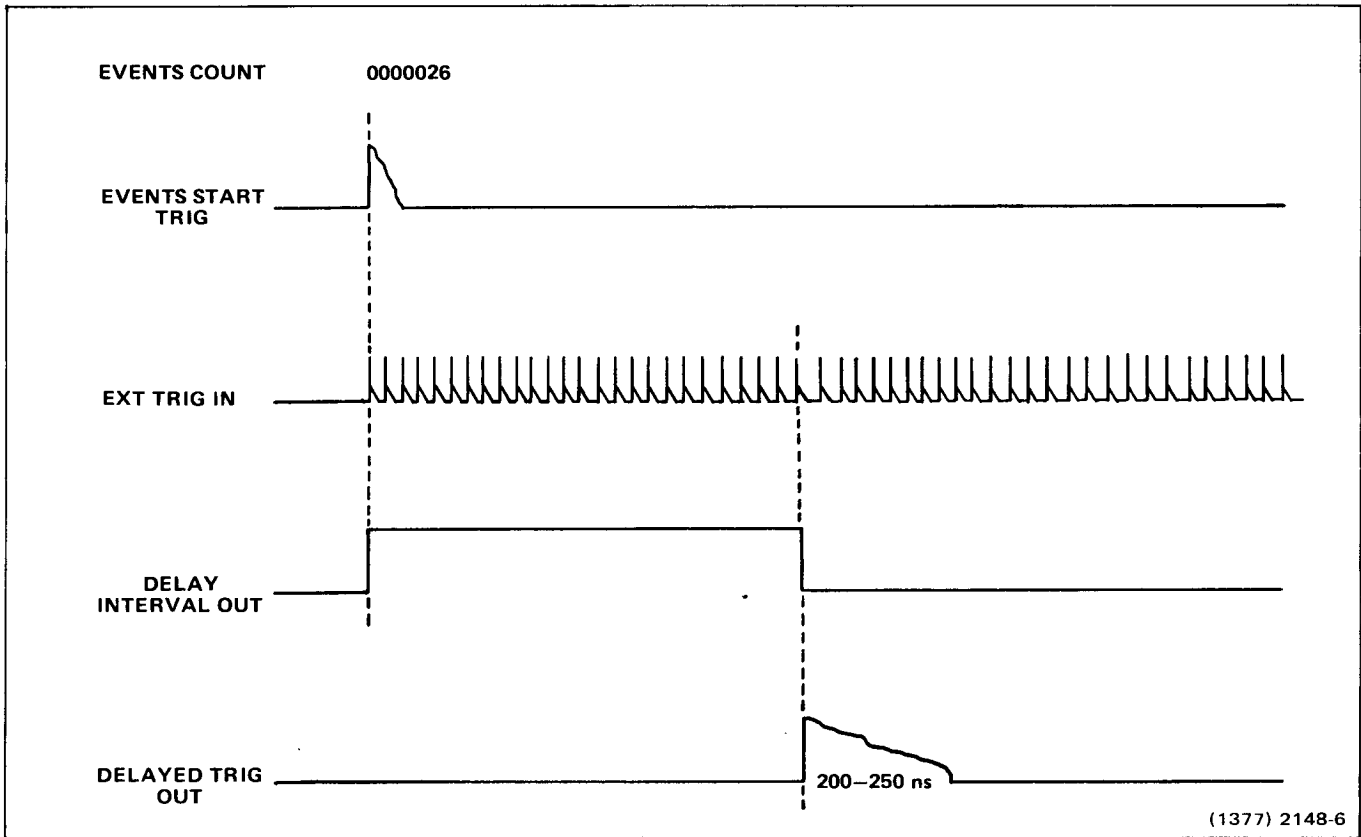

Figure 3-5. 7D10 outputs timing diagram.

### Delayed Trigger Flip-Flop

The change of state of U543A causes several functions to happen. The negative transition at pin 6 of U543A causes a multivibrator, composed of Q562 and Q565 to output the DLY'D TRIG OUT signal through the 50-ohm matching amplifier Q568. This delayed trigger pulse is timed to stay in the HI state for approximately 200-250 nanoseconds (see Fig. 3-5). This same output signal from U543A is coupled through T579 to provide a fast push-pull trigger signal to interface connector pins A13 (+) and B13 (-). This is compatible with plug-in units that accept the trigger signal from the vertical compartment.

Coincident with the delayed trigger output, the delay interval output is returned to a LO state (see Fig. 3-5). This happens when U543A changes state, causing Q648 and Q653 to stop conducting. Q648 and Q653 conduct during the delay interval to indicate that a delay is in process. A delay interval signal is also provided to the mainframe Z-axis via interface connector pin A17. During the delay interval, Q662 conducts to provide optional Z-axis de-intensification (if selected by S669). At the end of the delay interval, the display intensity returns to its normal level; this effectively creates an "intensified after delay" display. This same signal, present on interface connector pin A11, provides a

vertical deflection signal during the delay interval when the 7D10 is used in a vertical plug-in compartment of the associated mainframe.

When U543A changes state at the end of the delay interval, its output at pin 5 is routed through U586B and U586A. The output of U586A causes multivibrators U589A, U589B, and U598A to change state (see Fig. 3-6) and begin their prescribed timing periods. The timing of each multivibrator is determined by its respective external resistor and capacitor components.

When U589A changes state (for 400 nanoseconds), the LO output at pin 4 activates trigger Holdoff through U640A and U640B to prevent another trigger pulse from being accepted while the 7D10 circuits are being reset. The HI output on pin 13 is coupled back through U586D to clear U543A.

During the approximately 300-nanosecond timing interval of U589B (see Fig. 3-6), the LO output at pin 12 provides the Reload command to the Delaying Counter (U800 through U812).

As U598A (timed for 330 nanoseconds) returns to its normal state, the positive transition on pin 4 causes U598B to change state briefly (45 to 65 nanoseconds). The output at pin 12 of U598B becomes the Initializer pulse through Q518 to pin 8 of U800.

When the RESET button is pressed, Q595 conducts to provide a positive-going pulse, which is coupled into pin 6 of U586B. This performs the same reset functions as described above for the change of state of U543A.

### Delayed Gate Flip-Flop

During the delay interval, pin 9 of U543B is LO, so Q546 is not conducting and the B time-base unit is locked out by a HI Delay Gate current level to interface connector pin B9. At the end of the delay interval, U543B changes state causing Q546 to saturate and divert the current from Q547 to ground. This allows the B time-base unit to start the sweep or, if in the armed mode, allows the B time-base unit to start the sweep after receipt of a trigger. In the INDEPENDENT mode, Q546 is saturated by a voltage applied through R545 to allow the B time-base unit to operate independently of the 7D10.

At the end of the sweep, the time-base unit presents a HI Sweep Lockout pulse to interface connector pin B8. This pulse is coupled through Q532 as a positive voltage on the base of Q538. This positive voltage allows Q538 to conduct, causing a negative-going pulse at its collector, which in turn, clears U543B. This stops the conduction of Q546, which again causes Sweep Lockout.

The B SWEEP DELAY MODE switch, S555, provides one of three voltage levels out on interface connector pin B2. In the INDEPENDENT mode, a ground level is present to allow the B time-base unit to operate independently of the 7D10. In the B STARTS AFTER DELAY mode, +5 volts is presented to the B time-base unit to start the sweep at the end of the delay interval. The B TRIGGERABLE AFTER DELAY mode places a voltage level of about +3.5 volts on interface connector pin B2. This level arms the B time-base unit to start the sweep after receipt of a trigger. C535 and R535 couple a positive-going transient to the base of Q538 whenever S555 is switched from INDEPENDENT to one of the two slaved modes. This ensures that the B time-base unit is locked out initially by forcing U543B to clear.

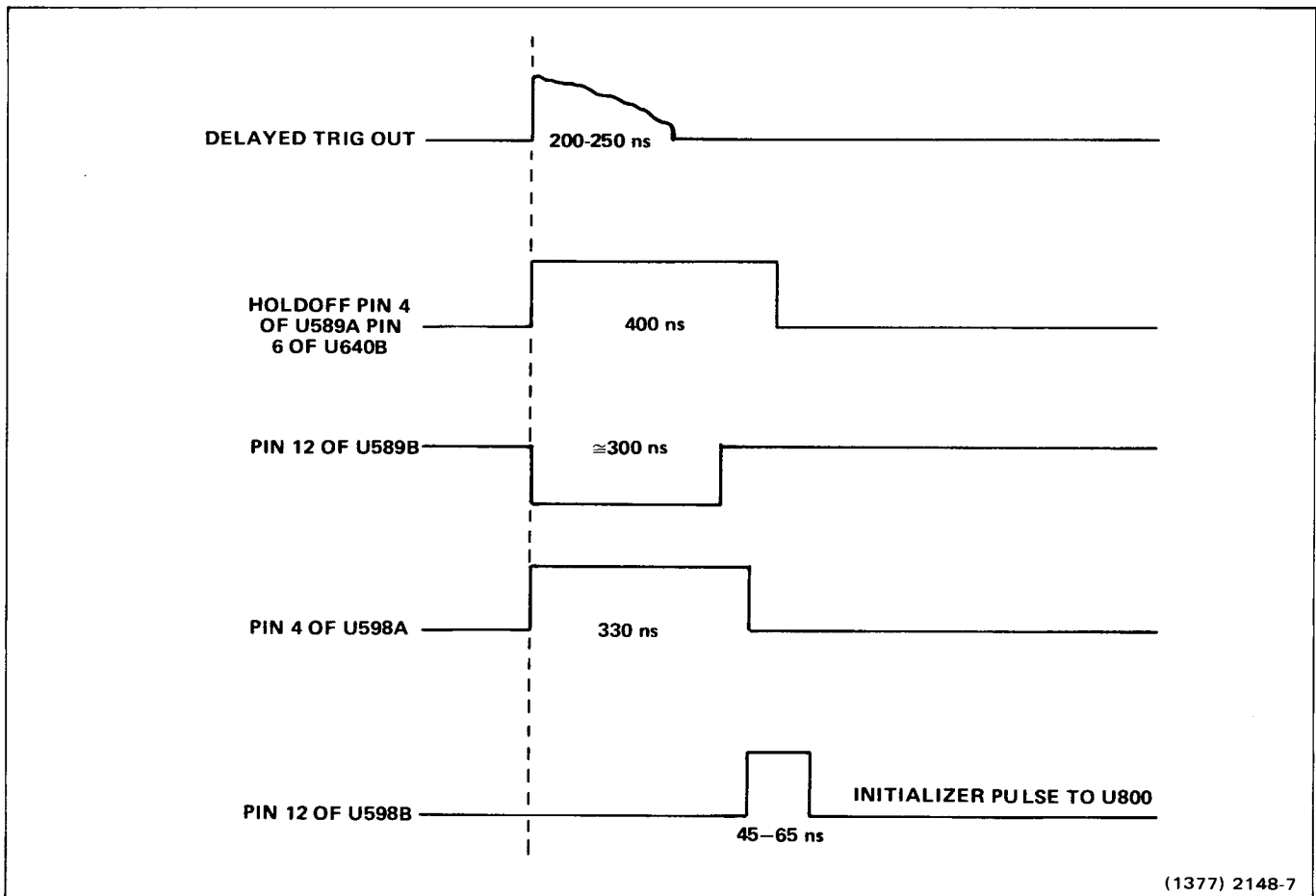

(1377) 2148-7

Figure 3-6. 7D10 Reset function timing diagram.

## NOTE

*The logic levels supplied by the mainframe to the 7D10 are designed to control a delaying sweep time-base unit. For this reason, the 7D10 can become locked out (no output) when the setting of either the B time-base unit Time/- Division switch or the 7D10 B SWEEP DELAY MODE switch setting is changed. If this occurs, a delayed sweep will not be produced. To reset the 7D10, set the B SWEEP DELAY MODE switch first to INDEPENDENT, then select the desired delay mode.*

**Events Start Trigger**

The Events Start Trigger circuit is used to end Holdoff, which then enables the Events Trigger circuit. The input impedance is approximately 1 megohm, determined by R601 and R609. CR605 and CR609 prevent overdriving the input by clamping the input signal should it be excessive. This circuit is a very high-gain amplifier and has a dual-FET input which is connected for a zero temperature coefficient with no offset between the gate and the source of Q610A. The trigger LEVEL is adjustable by R615. It varies the dc voltage at the base of Q620 and compares it with that at the base of Q624.

The SLOPE (+ or -), selected by S615, determines which collector is chosen for the output. In the + position, Q634 is turned off and the collector of Q628 is pulled high through CR632, which reverse biases CR635. This causes the output of Q630 to be routed through CR636 to the base of Q637. In the - position, Q634 is turned on, to pull the collector of Q630 high; thus reverse biasing CR636. The output at the collector of Q628 is presented to the base of Q637 through CR635. Buffer Q637 provides isolation from the following stage.

**HOLDOFF FLIP-FLOP.** U640C and Q640 form a one-shot multivibrator. The input is normally HI, so the active input signal is a negative-going transition. CR638 is a feed-through diode in parallel with a delay circuit comprising U640C, R638, C639, CR639, and R639. The signal at the base of Q640 is a negative-going pulse, the width of which is determined by the delay through U640C, etc.

The output at pin 6 of RS flip-flop U640B-U640A is returned to a HI logic level after each Reset cycle. The negative-going pulse at the collector of Q640 causes the flip-flop to change state so that a LO logic level is presented at pin 6 of U640B. This ends Holdoff to allow the 7D10 Events Trigger circuit to become active.

**DELAYING COUNTER AND DISPLAY GENERATOR**

The Delaying Counter and Display Generator consists of the Voltage-to-Frequency Converter, Up/Down Count Control, Up/Down Clock Steering, Power-On Initializer, Reversible Counter, Counter Buffers, Delaying Counter, Nines Detector, and the Nines Arm Gate. A detailed block diagram of this circuit is shown in Figure 3-7.

**Voltage-to-Frequency Converter**

The Voltage-to-Frequency Converter provides the signal used for incrementing the Reversible Counter, which permits presetting the desired delay events count. The DELAY EVENTS control, R700, is spring loaded to its mechanical and electrical center. Turning it counterclockwise causes the delay count to be decreased; turning it clockwise causes the delay count to be increased. Rotating R700 applies either a positive or negative voltage on its wiper. This condition is sensed by Q718 or Q721 through diodes CR712 or CR715 respectively, and, through a separate path, by Q705. As Q718 and Q712 are turned on, they cause Q724 to conduct. Q724 is a current generator that charges C725. The waveform at C725 is a sawtooth voltage. This waveform is applied to source follower Q733 and, through a zener diode network, to emitter follower Q740. Emitter follower Q740 then drives common-base stage Q743 to output the sawtooth waveform to the inputs of the Up/Down Clock Steering stage, U747A and U747B. Also, the sawtooth is applied to the base of Q738. At the peak of the sawtooth waveform, the emitter of Q738 drives Q730 to conduct, discharging C725. The waveform on C725 having fallen, the feedback path through Q733, Q740, Q743, Q738, and Q730 collapses and C725 is permitted to start charging again. The repetition rate of the sawtooth waveform is determined by the collector current of Q718 and Q721 as set by the magnitude of the rotation of the DELAY EVENTS control, R700. Increased rotation of R700, either clockwise or counterclockwise, is converted into more charging current in C725, thereby increasing the repetition rate. Thus, this stage operates as a Voltage-to-Frequency Converter. In idle condition, Q730 is turned on by current through CR729 to keep C725 from charging. When setting the counter (rotating R700), Q721 turns on Q727 to reverse bias CR729, which prevents Q730 from being turned on except through the feedback path.

The output of Q743, through U749F, resets (Recycle Force) the circuits in the Outputs Processing and Events Start Trigger (diagram 2). This, in turn, provides the Reload signal for U800-U812 to ensure that the Delaying Counter is updated along with the Reversible Counter.

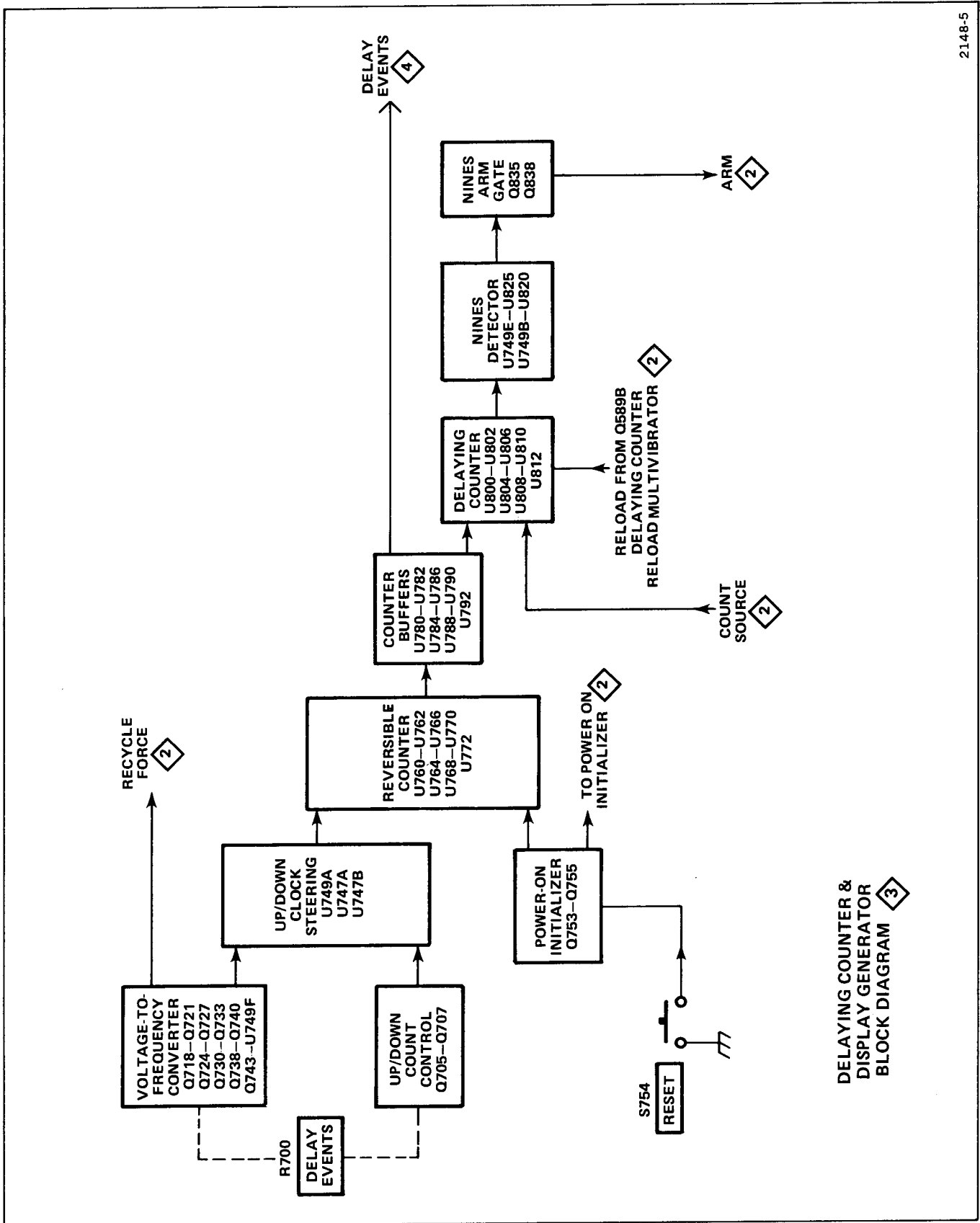

Figure 3-7. Detailed block diagram of Delaying Counter and Display Generator circuit.



### Up/Down Count Control and Clock Steering

The output of Q743 is applied to the inputs of U747A and B to cause the Reversible Counter to count either up or down. The steering is derived from the voltage (positive or negative) present when the DELAY EVENTS control, R700, is turned. This voltage operates the Up/Down Count Control stage (Schmitt trigger circuit) formed by Q705 and Q707 to cause the count signal to be gated through either U747A for counting up, or through U747B for counting down.

### Reversible Counter and Nines Complement Review

The nines complement of a number can be defined as the value that must be added to the number in order to yield nine. For example, the nines complement of 7 is 2 because 2 must be added to 7 to obtain 9. When a count is loaded into the Reversible Counter, it is set up as the nines complement in BCD (binary coded decimal) form. To illustrate, the Reversible Counter BCD inputs are preloaded to the minimum delay count (0000001) when the RESET button is pressed. The BCD inputs (pins 15, 1, 10, and 9) of U760 are set to encode, upon receipt of a Preset or load command at pin 11, the number eight, which is the nines complement of the number one. The BCD inputs to U762 through U772 are set to encode the number nine, the complement of which is zero. The Readout Encoding circuit inverts this BCD information (the 9999998 in the Reversible Counter) so the number displayed on the crt after power-on initialization or RESET is the minimum delay, or an events count of 0000001. All values of delay-event counts, as well, are entered into the Reversible Counter by the DELAY EVENTS control as previously described.

When DELAY EVENTS control R700 is turned, the output of U747 allows what will be interpreted as the nines complement of the desired delay events count to be set up in the Reversible Counter, U760 through U772. The BCD inputs to the counter are set to load the nines complement of the minimum count (0000001) when the RESET button is pressed. U760 resets to BCD eight and U762 through U772 are reset to BCD nines. The BCD outputs of the Reversible Counter are routed through the Counter Buffers, U780 through U792, to the Readout Encoding circuit and to the Delaying Counter.

### Delaying Counter

The Delaying Counter, U800 through U812, is used for arming Q525 in the Outputs Processing circuit by turning off Q838 (see Fig. 3-8). The network between the outputs of the Delaying Counter and the base of Q835, composed of U820, U749B, U825, U749E, CR830, and CR832, form a 14-input, positive AND gate. The output of this Nines Detector will go HI only when these 14 inputs are HI. This

occurs when the  $Q_A$  and  $Q_D$  outputs of the Delaying Counters are all at a HI logic level (BCD nines), enabling the Nines Detector circuit to turn on Q835. Transistors Q835 and Q838 compose the Nines Arm Gate. Q838 is turned off when Q835 conducts.

The nines complement of the delay events count from the Counter Buffers is applied to the BCD inputs of the Delaying Counters. During each reset cycle, a Reload signal, applied to pin 1 of each Delaying Counter IC, allows the BCD inputs to be loaded into the Delaying Counter; the Delaying Counter is advanced toward overflow by the delay events Count Source signal applied to pin 8 of U800. When the minimum count is loaded into the Reversible and Delaying Counters, as occurs when the RESET button is pressed, it is the complement (9999998) of the displayed 0000001 that is loaded. Keeping in mind that Q525 is armed when the Delaying Counter is at 9999999 and that Q525 conducts when the Delaying Counter overflows, it is apparent that even though the display indicates a delay count of one, two counts are required for Q525 to effect an output. Therefore, an initializing pulse is applied to pin 8 of U800 at the end of each reset cycle to provide a plus one advancing count to the Delaying Counter. It must be remembered that the Nines Detector arms Q525 when all the Delaying Counter outputs are binary-coded nines. The actual output of the 7D10 will occur on the next delay events Count Source pulse.

### Power-On Initializer

The Power-On Initializer, composed of Q753 and Q755, provides a negative-going pulse to load the Reversible Counter for minimum delay and also for initially resetting the Output Processing circuits. This is accomplished, when power is applied, by the charging time-constant of R751 and C751. Capacitor C751 charges to approximately one volt, causing Q753 to conduct. The conduction of Q753, applied to the gate of SCR Q755, causes Q755 to conduct. This negative transition at the collector of Q753 is coupled through C755 to apply a preload pulse to pin 11 of the Reversible Counter IC's, U760 through U772. The SCR remains in the conduction mode until power to the instrument is removed.

### Reset

The front-panel RESET button will effect a reload of the Reversible Counter to display the minimum count in a fashion similar to the Power-On Initializer. When the RESET button is pressed, the grounding of the junction of R756-R757 generates a negative-going transition which is applied to the Reversible Counter and to the Outputs Processing circuits.

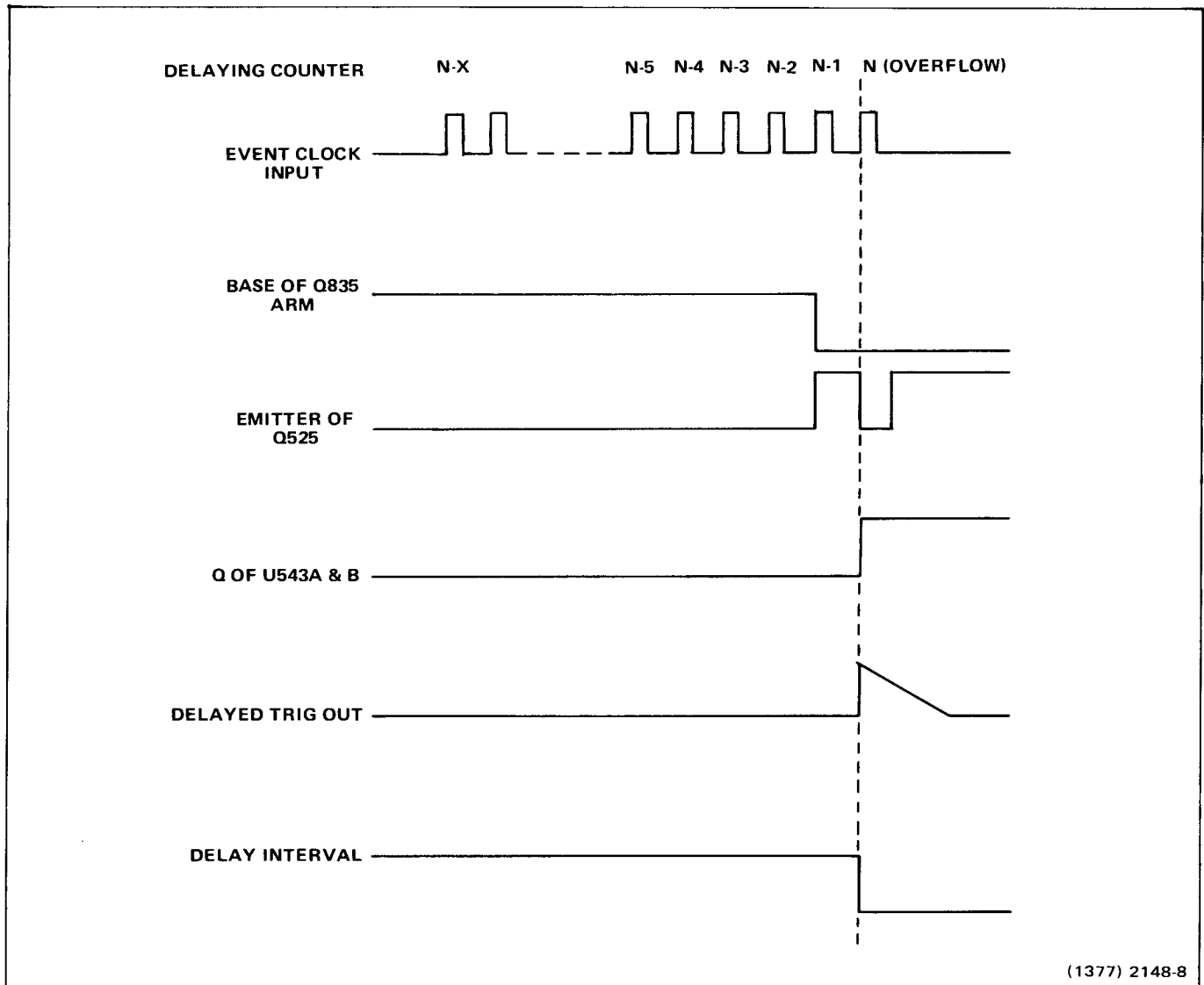

Figure 3-8. Delaying Counter and outputs timing diagram.

## READOUT ENCODING 4

The Readout Encoding circuit provides the necessary data to encode the Readout System (located in the mainframe) to display the 7D10 readout. The Readout Encoding circuit contains the Time-Slot Converters, BCD Multiplexers, Readout Encoder, and Leading 1 Inserter stages. A detailed block diagram of this circuit is shown in Figure 3-9.

### Time-Slot Converters and BCD Multiplexers

The outputs of U902-U906-U910-U914-U918-U922-U926 are the complement, or inverse, of their respective inputs from the Delaying Counter and Display Generator (diagram 3). The outputs of U902 through U926 are enabled, one at a time, as their respective negative-going time-slot pulses cut off the Time-Slot Converter FET's connected to their in-

puts. For example, when time-slot 2 is active, it stops the conduction of Q924, which raises its inputs to U926 to a HI logic level through R924. This, in turn, allows U926 to output the complement of the information from U792.

### Readout Encoder

The outputs of the BCD Multiplexers are routed through diodes CR930-CR932-CR934-CR936 where they derive current levels through resistors R960-R961-R962-R963. These currents, through diodes CR960-CR961-CR962-CR963, add together to form a current level through Q968, R965, and CR965. This current level is routed to the base of U974E, which provides the output to the interface connector that will cause the appropriate number to be displayed on the crt. Subsequent numbers are displayed during their respective time-slots in the same manner.

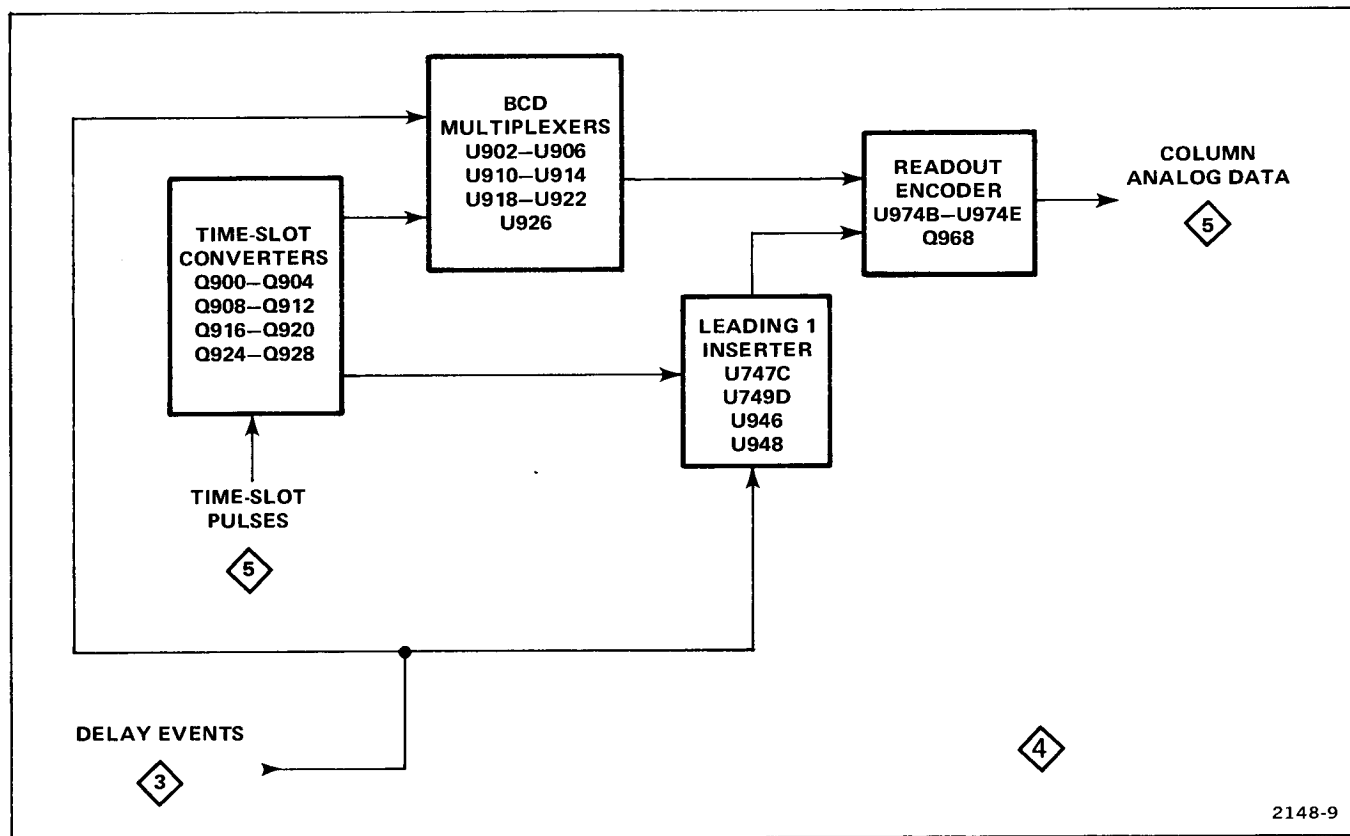

Figure 3-9. Detailed block diagram of Readout Encoding circuit.

### Leading 1 Inserter

In order that an eighth digit may be displayed when inputs to U902-U926 are coded to display 9's (the outputs of U902-U926 are inverted; therefore, the actual displays are the complements, or zeros), these inputs are all routed to U946 and U948. When all these inputs are at a HI logic level and time-slot 1 is active, the output of U948 goes LO and, through CR953, will allow a 1 to be displayed. This is equal to a maximum count of 10,000,000 events.

When no leading 1 is to be displayed, the inputs of U747C are at a HI logic level which allows its LO logic level output to provide a current path through CR955 and CR954. This permits a current corresponding to a "skip" command to flow through Q968. Since the current through Q968 is "mirrored" through U947E, the mainframe Readout System skips time-slot 1 and nothing is displayed.

### POWER DISTRIBUTION AND MAINFRAME CONNECTOR 5

Diagram 5 shows the mainframe to plug-in interface connector and the power distribution for the 7D10. Decoupled +15 volts, -15 volts, +5 volts, and -5 volts are routed to the various circuits. In addition to these voltages, a regulated, decoupled +4.9 volts is provided by the DC Inverter stage described below.

### DC Inverter

This is a +15-volt to +4.9-volt inverter of the switching regulator type. Q1025 and Q1028 form a differential comparator that compares a reference voltage of approximately +4.9 volts against the unfiltered output of the regulator at C1038.

R1034 introduces a small amount of positive feedback and hysteresis into the circuit by causing the +4.9-volt reference at the base of Q1028 to vary slightly. If the regulator output voltage is low (below +4.9 volts), Q1025 is turned off and Q1028 conducts. This turns on Q1036 and Q1038, causing them to saturate. The current through these two transistors flows through T1038, which stores energy in the form of a magnetic field. The current through T1038 flows out of the regulator and into the load to increase the output voltage.

When Q1038 turns on, its collector voltage approaches +15 volts which causes the +4.9-volt reference at the base of Q1028 to rise several hundred millivolts through R1034.

When the output voltage of the regulator rises sufficiently to equal this new reference voltage, Q1028 turns off and Q1025 turns on. This causes Q1036 and Q1038 to stop conduction.

Because of the inductance of T1038, the current flow through it tries to remain constant. This causes the collector of Q1038 and the base of Q1034 to seek a voltage, negative enough with respect to the converter output, to maintain this current flow. When the voltage at the base of Q1034 drops to approximately  $-0.7$  volts, the base-collector junction of Q1034 forward biases and operates in an inverted mode (emitter and collector reversed). When Q1034 saturates (in the inverted mode), the voltage at the tap of T1038 is maintained at a voltage of approximately  $-0.1$  to  $-0.2$  volts. The majority of the current flow through T1038 is now absorbed through Q1034.

The current through T1038 starts to decay through the load and C1038. When Q1038 turned off, the voltage at its collector dropped to approximately  $-0.7$  volts. This causes the  $+4.9$ -volt reference to drop by several hundred millivolts through R1034.

When the output voltage of the regulator falls to a value approaching this new reference voltage, Q1028 turns on and Q1025 turns off and the cycle repeats.

The duty cycle during which Q1038 supplies current is approximately the ratio of the output voltage to the input voltage ( $4.9/15$ ).

L1020 and C1020 provide filtering so that the mainframe  $+15$ -volt supply sees a more constant current load instead of the low duty cycle, relatively high current waveform of Q1038. L1039 and C1039 provide filtering for the ripple which is inherent in this form of regulator. Fuse F1020 protects the regulator from short circuits and overloads.

By providing a tap on T1038, Q1038 and Q1036 can reach saturation simultaneously during the conduction cycle. By operating Q1034 in the inverted mode, it appears as a very low-voltage-drop diode between the emitter and collector terminals during the non-operative portion of the cycle. The result is a very high overall operating efficiency of approximately ninety percent.

## INTRODUCTION TO THE READOUT SYSTEM

### Introduction

The following discussion is provided to acquaint the 7D10 user with the Readout System employed in Tektronix 7000-series oscilloscope mainframes. Since the Mainframe Readout System provides the readout for the 7D10, it is necessary to relate the function of the 7D10 to the Readout System to gain a better understanding of the 7D10 operation. A detailed circuit description of the 7000-series Readout System is given in the oscilloscope instruction manual.

### The Readout System

The Readout System in the 7000-series mainframe provides alpha-numeric display of information encoded by plug-in units. This display is presented on the crt and is written by the crt beam on a time-shared basis with the analog waveform display.

The Readout System produces a pulse train consisting of ten negative-going pulses called time-slots. These pulses represent a possible character in a readout word, and each is assigned a time-slot number corresponding to its position in the word. Each time-slot pulse is directed to one of ten output lines, labeled TS-1 through TS-10 (time-slots one through ten), which are connected to the vertical and horizontal plug-in compartments. Two output lines, Row and Column Analog Data, are connected from each channel (two channels per plug-in compartment) back to the Readout System.

Data is encoded on these output lines either by connecting resistors between them and the time-slot input lines or by generating equivalent currents. The resultant output is a sequence of analog current levels on the Row and Column Analog Data output lines. The row and column current levels are decoded by the Readout System to address a character matrix during each time-slot, thus selecting a character to be displayed or a special instruction to be followed.

# MAINTENANCE

This section of the manual contains information for performing preventive maintenance, troubleshooting, and corrective maintenance.

## PREVENTIVE MAINTENANCE

Preventive maintenance consists of cleaning, visual inspection, lubrication, etc. Preventive maintenance performed on a regular basis may prevent instrument breakdown and will improve the reliability of the instrument. The severity of the environment to which the instrument is subjected determines the frequency of maintenance. A convenient time to perform preventive maintenance is preceding adjustment of the instrument.

### CLEANING

The instrument should be cleaned as often as operating conditions require. Accumulation of dirt on components acts as an insulating blanket and prevents efficient heat dissipation which can cause overheating and component breakdown.

#### CAUTION

*Avoid the use of chemical cleaning agents which might damage the plastics used in this instrument. In particular, avoid chemicals that contain benzene, toluene, xylene, acetone, or similar solvents.*

#### Exterior

Loose dust accumulated on the front panel can be removed with a soft cloth or small brush. Dirt that remains can be removed with a soft cloth dampened in a mild detergent and water solution. Abrasive cleaners should not be used.

#### Interior

Dust in the interior of the instrument should be removed occasionally due to its electrical conductivity under high-humidity conditions. The best way to clean the interior is to blow off the accumulated dust with dry, low-pressure air.

Remove any dirt which remains with a soft brush or a cloth dampened with a mild detergent and water solution. A

cotton-tipped applicator is useful for cleaning in narrow spaces.

### VISUAL INSPECTION

The instrument should be inspected occasionally for such defects as broken connections, improperly seated semiconductors, damaged circuit boards, and heat-damaged parts.

The corrective procedure for most visible defects is obvious; however, particular care must be taken if heat-damaged components are found. Overheating usually indicates other trouble in the instrument; therefore, correcting the cause of overheating is important to prevent recurrence of the damage.

### LUBRICATION

Generally, there are no components in the instrument that will require lubrication during the life of the instrument.

### SEMICONDUCTOR CHECKS

Periodic checks of semiconductors in the instrument are not recommended. The best check of semiconductor performance is actual operation in the instrument. More details on checking semiconductor operation are given under troubleshooting.

## TROUBLESHOOTING

The following information is provided to help troubleshoot the instrument. Information contained in other sections of this manual should be used along with the following information to aid in locating a defective component. An understanding of the circuit operation is very helpful in locating troubles, particularly where integrated circuits are used.

### TROUBLESHOOTING EQUIPMENT

The following equipment, in addition to that listed in section 5, Performance Check and Adjustment, is useful for troubleshooting the 7D10 Digital Events Delay unit.

#### Transistor Tester

Description: Dynamic-type tester.

Purpose: Test semiconductors.

Recommended Tektronix types: 576 Curve Tracer, 577/177 Curve Tracer system, 7CT1N Curve Tracer unit and a 7000-series oscilloscope system, or a 5CT1N Curve Tracer unit and a 5000-series oscilloscope.

#### Multimeter

Description: Voltmeter, 10-megohm input impedance and a range from 0 to at least 50 volts dc; accuracy, within 0.1%. Ohmmeter, 0 to 20 megohms. Test probes should be insulated to prevent accidental shorting.

Purpose: Check voltage and resistance.

#### Test Oscilloscope

Description: Frequency response, dc to 100 megahertz minimum, vertical deflection factor, 5 millivolts to 5 volts/division. A 10X, 10-megohm voltage probe should be used to reduce circuit loading.

Purpose: Check operating waveforms.

#### Plug-In Extender

Description: Two types of extenders are available.

1. Flexible Plug-In Extender. Tektronix Part 067-0616-00.
2. Rigid Plug-In Extender. Tektronix Part 067-0589-00.

Purpose: Allows plug-in operation outside the mainframe.

### TROUBLESHOOTING TECHNIQUES

#### Troubleshooting Procedure

This troubleshooting procedure is arranged to check the simple trouble possibilities before proceeding with extensive troubleshooting. The first few checks ensure proper connection, operation, and adjustment. If the trouble is not located by these checks, the remaining steps aid in locating the defective component. When the defective component is located, it should be replaced using the replacement procedure given under Corrective Maintenance.

**1. CHECK CONTROL SETTINGS.** Incorrect control settings can indicate a trouble that does not exist. If there is any question about the function or operation of any control, see section 2, Operating Instructions.

**2. CHECK ASSOCIATED EQUIPMENT.** Before proceeding with troubleshooting, check that the equipment used with this instrument is operating correctly. Check that the signal is properly connected and that interconnecting cables are not defective. Also check the power source. If the trouble persists, the 7D10 is probably at fault.

**3. VISUAL CHECK.** Visually check that portion of the instrument in which the trouble is located. Many troubles can be located by visible indications such as unsoldered connections, broken wires, damaged circuit boards, damaged components, etc.

**4. CHECK INSTRUMENT ADJUSTMENT.** Check the electrical adjustment of the 7D10, or the affected circuit if the trouble appears in one circuit. The apparent trouble may only be a result of misadjustment. Complete adjustment instructions are given in section 5, Performance Check and Adjustment.

**5. ISOLATE TROUBLE TO A CIRCUIT.** To isolate trouble to a circuit, note the trouble symptom. The symptom often identifies the circuit in which the trouble is located. When trouble symptoms appear in more than one

circuit, check the affected circuits by taking voltage and waveform readings. Also check for the correct output signals at the front-panel connector with a test oscilloscope. Incorrect operation of all circuits often indicates trouble in the power supply. Check for correct voltages of the individual supplies. A defective component elsewhere in the instrument can appear as a power-supply trouble and may also affect the operation of other circuits.

**6. CHECK INDIVIDUAL COMPONENTS.** The following procedures describe methods of checking individual components. Two-lead components that are soldered in place are best checked by first disconnecting one end. This isolates the measurement from the effects of surrounding circuitry.

**CAUTION**

*To avoid component damage, disconnect the power source before removing or replacing semiconductors.*

**Transistors.** A good check of transistor operation is actual performance under operating conditions. A transistor can be effectively checked by substituting a new component, or one that has been checked previously. However, be sure that circuit conditions are not such that a replacement transistor might also be damaged. If substitute transistors are not available, use a dynamic tester. Static-type testers are not recommended, since they do not check operation under simulated operating conditions.

**Integrated Circuits.** Integrated circuits can be checked with a voltmeter, test oscilloscope, or by direct substitution. A good understanding of circuit operation is desirable when troubleshooting circuits using integrated circuits. Use care when checking voltages and waveforms around the integrated circuits so that adjacent leads are not shorted together. A convenient means of clipping a test probe to the 14- and 16-pin integrated circuits is with an integrated circuit test clip. This device also serves as an extraction tool. The lead configuration for the semiconductors used in this instrument are shown on the pullout page in the front of the diagrams section.

**Diodes.** A diode can be checked for an open or shorted condition by measuring the resistance between terminals with an ohmmeter scale having a low internal source current, such as the R X 1k scale. The resistance should be very high in one direction and very low when the meter leads are reversed.

**CAUTION**

*Do not use the ohmmeter on a scale that has high internal current. High currents may damage the diode under test.*

The cathode end of each glass-encased diode is indicated by a stripe, a series of stripes, or a dot. The cathode and anode ends of metal-encased diodes are identified by the diode symbol marked on the case.

**Resistors.** Check resistors with an ohmmeter. See the Replaceable Electrical Parts list for the tolerance of the resistors used in the 7D10. Resistors normally do not need to be replaced unless the measured value varies widely from that specified.

**Inductors.** Check for open inductors by checking continuity with an ohmmeter. Shorted or partially shorted inductors can usually be found by checking the waveform response when high-frequency signals are passed through the circuit. Partial shorting often reduces high-frequency response (roll off).

**Capacitors.** A leaky or shorted capacitor can usually be detected by checking resistance with an ohmmeter on the highest scale. Do not exceed the voltage rating of the capacitor. The resistance reading should be high after initial charge of the capacitor. An open capacitor can best be detected with a capacitance meter or by checking if the capacitor passes ac signals.

**Fuses.** Check for open fuses by checking continuity with an ohmmeter.

**7. REPAIR AND READJUST.** If any defective parts are located, follow the replacement procedures given in Corrective Maintenance. Be sure to check the performance of any circuit that has been repaired or had any electrical components replaced.

## CORRECTIVE MAINTENANCE

Corrective maintenance consists of component replacement and instrument repair. Special techniques required to replace components in this instrument are given here.

### OBTAINING REPLACEMENT PARTS

All electrical and mechanical part replacements can be obtained through your Tektronix Field Office or representative. However, many of the standard electronic components can be obtained locally in less time than is required to order them from Tektronix, Inc. Before purchasing or ordering replacement parts, check the parts list for value, tolerance, rating, and description.

#### NOTE

*When selecting replacement parts, remember that the physical size and shape of a component may affect its performance in the instrument, particularly at high frequencies. All parts should be direct replacements unless you know that a different component will not adversely affect instrument performance.*

Some parts are manufactured or selected by Tektronix, Inc. to satisfy particular requirements, or are manufactured for Tektronix, Inc. to our specifications. Most of the mechanical parts used in this instrument have been manufactured by Tektronix, Inc. To determine the manufacturer of parts, refer to parts list, Cross Index Mfg. Code Number to Manufacturer.

When ordering replacement parts from Tektronix, Inc., include the following information:

1. Instrument type.
2. Instrument serial number.
3. A description of the part (if electrical, include circuit number).
4. Tektronix part number.

### SOLDERING TECHNIQUES

#### WARNING

*To avoid electric shock, disconnect the instrument from the power source before soldering.*

The reliability and accuracy of this instrument can be maintained only if proper soldering techniques are used when repairing or replacing parts. General soldering techniques, which apply to maintenance of any precision electronic equipment, should be used when working on this instrument. Use only 60/40 rosin-core, electronic-grade solder. The choice of soldering iron is determined by the repair to be made. When soldering on circuit boards or small wiring, use only a 15-watt, pencil-type soldering iron. A higher wattage soldering iron can cause the etched circuit wiring to separate from the board base material and melt the insulation from small wiring. Always keep the soldering-iron tip properly tinned to ensure the best heat transfer to the solder joint. Apply only enough heat to remove the component or to make a good solder joint. To protect heat-sensitive components, hold the component lead with a pair of long-nose pliers between the component body and the solder joint. Use a solder-removing wick to remove excess solder from connections or to clean circuit board pads.

#### CAUTION

*All the circuit boards in this instrument are multi-layer boards with a conductive path(s) laminated between the top and bottom board layers. All soldering on these boards should be done with extreme care to prevent breaking the connections to the center conductor(s); only experienced maintenance personnel should attempt repair of these boards.*

The following technique should be used to replace a component on a circuit board. Most components can be replaced without removing the board(s) from the instrument.

1. Touch the soldering iron to the lead at the solder connection. Never place the iron directly on the board, as this may damage the board.
2. Melt a small amount of solder onto the component lead connection. This replaces the flux, which may have been removed during instrument cleaning, and facilitates removal of the component.
3. Grip the component lead with a pair of long-nose pliers. When the solder begins to flow, gently pull the component lead from the board. If unable to separate the lead from the board, try removing the other end of the component.



**NOTE**

*Some components are difficult to remove from the circuit board due to a bend placed in each lead during machine insertion of the component. The purpose of the bent leads is to hold the component in position during a flow-solder manufacturing process which solders all components at once. To make removal of machine inserted components easier, straighten the leads of the component on the back of the circuit board using a small screwdriver or pliers while heating the soldered connection.*

4. Bend the leads of the replacement component to fit the holes in the circuit board. If the component is replaced while the board is mounted in the instrument, cut the leads so they will just protrude through the board. Insert the leads into the holes in the board so that the component is firmly seated against the board, or as originally positioned.
5. Touch the iron to the connection and apply enough solder to make a firm solder joint.
6. Cut off any excess lead protruding through the board (if not clipped in step 4).
7. Clean the area around the solder connection with a flux-removing solvent. Be careful not to remove information printed on the circuit board.

**COMPONENT REMOVAL AND REPLACEMENT****WARNING**

*To avoid electric shock, disconnect the instrument from the power source before replacing components.*

The exploded-view drawing associated with the Replaceable Mechanical Parts list may be helpful in the removal or disassembly of individual components or subassemblies. Component locations and circuit board locations are shown in section 8, Diagrams and Circuit Board Illustrations.

**Circuit Boards**

If a circuit board is damaged beyond repair, replace the entire board assembly. Part numbers are given in the Replaceable Electrical Parts list for completely wired boards.

**Semiconductors**

Semiconductors should not be replaced unless actually defective. If removed from their sockets during routine maintenance, return them to their original sockets. Unnecessary replacement of semiconductors may affect the adjustment of this instrument. When semiconductors are replaced, check the operation of the part of the instrument which may be affected.

**WARNING**

*To avoid electric shock, always disconnect the instrument from the power source before replacing components.*

Replacement devices should be of the original type or a direct replacement. The lead configurations of the semiconductors used in this instrument are shown in section 8, Diagrams and Circuit Board Illustrations. When replacing semiconductors, check the manufacturer's basing diagram for correct basing. Semiconductors which have heat radiators use silicone grease to increase heat transfer. Replace the silicone grease when replacing these semiconductors.

**WARNING**

*Handle silicone grease with care. Avoid getting silicone grease in your eyes. Wash hands thoroughly after use.*

An extracting tool should be used to remove the 14- and 16-pin integrated circuits to prevent damage to the pins. This tool is available from Tektronix, Inc. Order Tektronix Part 003-0619-00. If an extracting tool is not available when removing one of these integrated circuits, pull slowly and evenly on both ends of the device. Try to avoid having one end of the integrated circuit disengage from the socket before the other, as the pins may be damaged.

**Interconnecting Pins**

Two methods of interconnection are used to connect the circuit boards with other boards and components. When the interconnection is made with a coaxial cable, a special end-lead connector plugs into a socket on the board. When the interconnection is made with a wire lead, an end-lead connector is used which mates with an interconnecting pin soldered into the board. The following information provides the removal and replacement procedures for the various types of interconnecting methods.

**COAXIAL-TYPE END-LEAD CONNECTORS.** Replacement of the coaxial-type end-lead connectors requires special tools and techniques; only experienced maintenance personnel should attempt to remove and replace these connectors. We recommend that the cable be replaced as a unit. For cable part numbers, see the Replaceable Mechanical Parts list. An alternative solution is to refer the replacement of the defective connector to your local Tektronix Field Office or representative.

**END-LEAD PIN CONNECTORS.** The pin connectors used to connect the wires to the interconnecting pins are clamped to the ends of the associated leads. To remove and replace damaged end-lead pin connectors, remove the old pin connector from the end of the lead and clamp the replacement connector to the lead.

Some of the pin connectors are grouped together in a plastic holder; the overall result is that these connectors are removed and installed as a multi-pin connector. The multi-pin connector holders are keyed with two triangles, one on the holder and one on the circuit board. When a connection is made perpendicular to a circuit board surface, the orientation of the triangle on the end-lead multi-pin connector holder is determined by the placement of the multi-pin connector index (see Fig. 4-1).

**CIRCUIT-BOARD PINS.** A circuit-board pin replacement kit including the necessary tools, instructions, and replacement pins is available from Tektronix, Inc. Order Tektronix Part 040-0542-00. Replacement of circuit-board pins on multi-layer boards is not recommended; refer such repairs to your local Tektronix Field Office or representative.

### TRIG'D Indicator

The TRIG'D light is mounted on the sub-panel using a plastic sleeve. Unsolder the lead wires and pull the bulb out of the sleeve from the rear of the sub-panel.

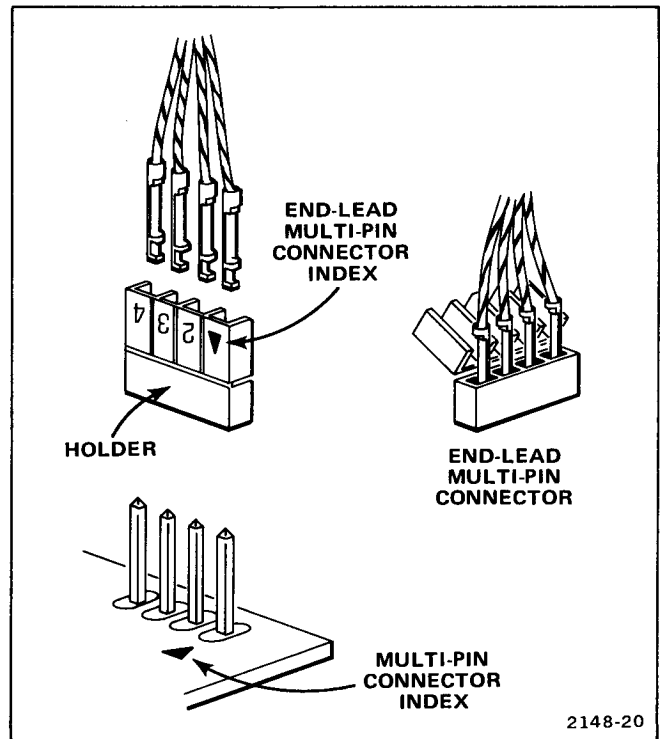

Figure 4-1. Orientation of multi-connector holders.

### ADJUSTMENT AFTER REPAIR

After any electrical component has been replaced, the adjustment of that particular circuit should be checked, as well as other closely related circuits. See section 5, Performance Check and Adjustment, for complete adjustment procedure.

# PERFORMANCE CHECK AND ADJUSTMENT

This section contains information necessary to perform a complete instrument performance check and adjustment. Limits given in the procedure are adjustment guides and should not be interpreted as performance requirements unless preceded by a check mark (✓). Where possible, instrument performance is checked before an adjustment is made.

## PRELIMINARY INFORMATION

### Adjustment Interval

To maintain instrument accuracy, check the performance of the 7D10 every 1000 hours of operation, or every 6 months if used infrequently. Before complete adjustment, thoroughly clean and inspect this instrument as outlined in section 4, Maintenance.

### Tektronix Field Service

Tektronix Field Service Centers and the Factory Service Center provide instrument repair and adjustment services. Contact your Tektronix Field Office or representative for further information.

### Using This Procedure

The Performance Check and Adjustment procedure can be used either for complete adjustment or as a check of instrument performance. Completion of each step in the procedure ensures that the instrument is correctly adjusted and operating within specified limits. Refer to the following discussion for instructions on a complete or partial check and adjustment.

**INDEX.** An index precedes the procedure to aid in locating Performance Check and Adjustment steps.

**PERFORMANCE CHECK.** Instrument performance can be checked by performing the complete Performance Check and Adjustment procedure and omitting only the ADJUST parts of the steps. A check mark (✓) preceding a CHECK indicates that the limit given is a performance requirement specified under Specification in section 1, General Information.

**ADJUSTMENT.** Completion of each step in the Performance Check and Adjustment procedure ensures that the instrument is correctly adjusted and performing within specified limits. Where possible, instrument performance is checked before an adjustment is made. For best overall performance when performing the complete adjustment procedure, make each adjustment to the exact setting indicated.

**PARTIAL PROCEDURES.** The following procedure is written to completely check and adjust the instrument to the Specification in section 1, General Information. If the applications for which the instrument is used do not require the full available performance, the procedure and the required equipment list can be shortened accordingly.

A partial performance check and adjustment may be desirable after replacing components, or to touch up the adjustment of a portion of the instrument. To check or adjust only part of the instrument, refer to the Equipment Required list which precedes that portion of the procedure to be performed. To avoid unnecessary adjustment of other parts, adjust only if the tolerance given in each CHECK is not met.

## TEST EQUIPMENT REQUIRED

The test equipment listed in Table 5-1 is required for a complete performance check and adjustment of this instrument. The specifications given in Table 5-1 for test equipment are the minimum required to meet the Specification in section 1. Detailed operating instructions for test equipment are omitted in this procedure. Refer to the test equipment instruction manual if more information is needed.

### Special Fixtures

Special fixtures are used only where they facilitate instrument adjustment. These fixtures are available from Tektronix, Inc. Order by part number from Tektronix Field Offices or representatives.

### Test Equipment Alternatives

The test equipment listed in the Examples of Applicable Test Equipment column, Table 5-1, is required to check and adjust this instrument. The Performance Check and Adjustment procedure is based on the first item of equipment given as an example. If other equipment is substituted, control settings or setups may need to be altered. If the exact item of equipment given as an example is not available, refer to the Minimum Specifications column to determine if other equipment may be substituted. Then check the Purpose column. If you determine that your measurement requirements will not be affected, the item and corresponding step(s) can be deleted.

**TABLE 5-1**  
**Test Equipment**

Description	Minimum Specifications	Purpose	Examples of Applicable Test Equipment
1. Indicator mainframe	Equipped with a readout system; must be capable of accommodating four plug-in units for complete procedure as written.	Used throughout procedure to provide readout display. Also used with amplifier and time-base units as a test-oscilloscope system.	a. TEKTRONIX 7904 Oscilloscope. b. TEKTRONIX 7704A Oscilloscope System. c. Any other Tektronix 7000-series oscilloscope equipped with a readout system. Must accommodate four plug-in units.
2. Time-base unit	Sweep rates, 20 milliseconds/division to magnified or delayed-sweep rate of 20 nanoseconds/division; accuracy, within 5%.	Used throughout procedure to provide sweep for the indicator mainframe.	a. TEKTRONIX 7B80 Time Base. b. TEKTRONIX 7B50A Time Base.
3. Dual-trace wide-band vertical amplifier unit	Bandwidth (combined with indicator mainframe), dc to 150 megahertz, deflection factor, variable from 50 millivolts to 5 volts/division; accuracy, within 3%.	Used throughout procedure to provide internal trigger input to 7D10, and for vertical input to indicator mainframe for test oscilloscope use.	a. TEKTRONIX 7A26 Dual-Trace Amplifier. b. TEKTRONIX 7A18 Dual-Trace Amplifier.
4. Low-frequency signal generator	Sine-wave output; frequency range, 30 hertz to 150 kilohertz, output amplitude variable from 50 millivolts to 3.5 volts peak-to-peak.	Triggering checks and adjustments.	a. TEKTRONIX FG 501 Function Generator. <sup>1</sup> b. General Radio 1310B Oscillator.
5. Medium-frequency signal generator	Sine-wave output; frequency range, 50 kilohertz and 0.9 to 50 megahertz; output amplitude, variable from 50 millivolts to one volt peak-to-peak into 50 ohms.	Triggering checks and adjustments. Recycle time checks. Front-panel delay interval output check.	a. TEKTRONIX SG 503 Leveled Sine Wave Generator. <sup>1</sup>
6. Time-mark generator	Marker outputs, 1 second to 10 microseconds; trigger output, 1 millisecond; marker accuracy, within 0.1%; marker amplitude, 0.5 volt into 50 ohms; trigger amplitude, 0.5 volt into 50 ohms.	Used throughout procedure to provide accurate time reference.	a. TEKTRONIX TG 501 Time-Mark Generator. <sup>1</sup> b. TEKTRONIX 2901 Time-Mark Generator.
7. Square-wave generator	Negative-going output: Amplitude, 15 volts into 50 ohms; repetition rate, 1 kilohertz; risetime, less than 12 nanoseconds. Positive-going output: Amplitude, 500 millivolts into 50 ohms; repetition rate, 1 megahertz; risetime, 1 nanosecond or less.	External trigger input compensation. Recycle timing adjustment.	a. TEKTRONIX PG 506 Calibration Generator. b. TEKTRONIX Type 284 Pulse Generator for positive-going output only.

<sup>1</sup> Requires TM 500-Series Power Module.

**TABLE 5-1 (CONT.)  
Test Equipment**

Description	Minimum Specifications	Purpose	Examples of Applicable Test Equipment
8. 10X Probe	Compatible with amplifier unit used.	Used throughout procedure to make measurements within the 7D10.	a. TEKTRONIX P6053B Probe.
9. Flexible plug-in extender	Flexible extender for 7000-series plug-in units.	Used throughout procedure to gain access to adjustments and test points.	a. Tektronix Part 067-0616-00.
10. 10X Attenuator	Impedance, 50 ohms; attenuation, 10X; connectors, BNC.	External trigger input compensation.	a. Tektronix Part 011-0059-01.
11. 50-Ohm Termination (two required)	Impedance, 50 ohms; accuracy, within 2%; connectors, BNC.	External trigger input compensation.	a. Tektronix Part 011-0049-01.
12. Input RC normalizer	Time constant, one megohm X 20 picofarads; attenuation, 2X; connectors, BNC.	External trigger input compensation.	a. Tektronix Part 067-0538-00.
13. T Connector	Connectors, BNC.	Used throughout procedure to simultaneously connect signals to two inputs.	a. Tektronix Part 103-0030-00.
14. 50-Ohm BNC cable (three required)	Impedance, 50 ohms; type, RG-58/U; length, 18 inches; connectors, BNC.	Used throughout procedure for signal interconnection.	a. Tektronix Part 012-0076-00.
15. Three-inch screwdriver	Three-inch shaft; 3/32-inch bit.	Used to adjust variable resistors.	a. Xcelite R-3323.
16. Low-capacitance screwdriver	1-1/2-inch shaft.	Used to adjust variable capacitors.	a. Tektronix Part 003-0000-00.

**INDEX TO PERFORMANCE CHECK AND ADJUSTMENT PROCEDURE**

	PAGE
A. TRIGGERING . . . . .	5-5
1. Adjust Trigger DC Balance (R77) . . . . .	5-5
2. Adjust External Trigger DC Balance (R49) . . . . .	5-6
✓ 3. Adjust External Trigger Input Compensation (C10 and C24) . . . . .	5-6
✓ 4. Adjust Internal Trigger Sensitivity, DC Coupled (R151) . . . . .	5-6
✓ 5. Check External Trigger Sensitivity . . . . .	5-7
✓ 6. Check Trigger Level Control Range . . . . .	5-8
✓ 7. Check Line Source Trigger . . . . .	5-8
B. EVENTS COUNT . . . . .	5-9
1. Check Events Count Readout . . . . .	5-9
✓ 2. Check Events Start Trigger Sensitivity . . . . .	5-9
✓ 3. Check Events Start Trigger Level Range . . . . .	5-10
✓ 4. Adjust Recycle Timing (C589) . . . . .	5-10
✓ 5. Check Maximum Recycle Time . . . . .	5-11
6. Adjust Arming TD Bias (R161) . . . . .	5-11
✓ 7. Check Events Count . . . . .	5-11
C. OUTPUT SIGNALS . . . . .	5-13
✓ 1. Check Front-Panel Delay Interval Output . . . . .	5-13
✓ 2. Check Delay Interval Outputs to Mainframe . . . . .	5-14
✓ 3. Check Front-Panel Delayed Trigger Output . . . . .	5-14
✓ 4. Check Delayed Trigger and Delay Interval Coincidence . . . . .	5-15
5. Check B Sweep Delay Mode Operation . . . . .	5-15

**PRELIMINARY PROCEDURE**

**NOTE**

*The performance of this instrument can be checked at any ambient temperature from 0° to +50° C unless otherwise stated. Adjustments must be performed at an ambient temperature from +20° to +30° C for specified accuracies.*

1. Remove both side covers from the 7D10. Set the internal Z-Axis Blanking switch S669 to the Non-Intensified (forward) position. See the Adjustment Locations pullout pages for the switch location.

2. Install the 7D10 in the indicator mainframe according to the Set-Up instructions preceding the procedure to be performed.

**NOTE**

*Titles for external controls and connectors of this instrument are capitalized in this procedure (e.g., DELAY EVENTS). Internal switches and adjustments are initial capitalized only (e.g., Delay Time Mode).*

## A. TRIGGERING

## Equipment Required

- |  |                                 |
|--|---------------------------------|
| 1. Indicator mainframe                           | 8. 10X attenuator               |
| 2. Dual-trace, wide-band vertical amplifier unit | 9. 50-ohm termination           |
| 3. Time-base unit                                | 10. Input RC normalizer         |
| 4. Low-frequency signal generator                | 11. Three-inch screwdriver      |
| 5. 10X probe                                     | 12. Low-capacitance screwdriver |
| 6. Flexible plug-in extender                     |                                 |
| 7. Square-wave generator                         |                                 |

BEFORE YOU BEGIN, see

**ADJUSTMENT LOCATIONS**in the **Diagrams and Circuit Board Illustrations** section.

## Set-Up

In the indicator mainframe, install the vertical amplifier unit in either vertical compartment and a time-base unit in the B horizontal compartment. Place the 7D10 on the plug-in extender, and plug the extender into the A horizontal compartment. Set the 7D10 controls as follows:

```

TRIGGER
SLOPE . . . . .+
LEVEL . . . . .0
COUPLING . . . .AC
SOURCE . . . . .INT
EVENTS START
TRIGGER
SLOPE . . . . .-
LEVEL . . . . .0
B SWEEP
DELAY MODE . . . .INDEPENDENT

```

## A1. ADJUST TRIGGER DC BALANCE (R77)

- a. Set the indicator mainframe to display the time-base and the amplifier units.
- b. Set the amplifier unit for dual-trace operation in the alternate mode with the trigger source from channel 1.
- c. Set the time-base unit for a free-running sweep rate at 10 microseconds/division.

d. Connect the low-frequency signal generator to channel 1 of the amplifier unit and to the 7D10 EXT TRIG IN connector.

e. Set the signal generator and channel 1 of the amplifier unit for a 0.5-division display of a 50-kilohertz signal, vertically centered on the graticule. Do not change the vertical position of the display for the remainder of step A1.

f. Set the indicator mainframe trigger source for vertical mode.

g. Connect a 10X probe to channel 2 of the amplifier unit. Set the channel 2 deflection factor for 20 millivolts/division (200 millivolts/division at probe tip) and dc input coupling.

h. Connect the probe tip to TP 130 on the Trigger board.

i. Set the TRIGGER LEVEL control for a TP 130 waveform with approximately equal positive and negative half cycles (50% duty cycle).

j. Set the 7D10 TRIGGER SLOPE switch to -. If necessary, compromise the setting of the 7D10 TRIGGER LEVEL control for a TP 130 waveform with

## Performance Check and Adjustment—7D10

approximately equal positive and negative half cycles in the + and – positions of the TRIGGER SLOPE switch. Do not change the setting of the TRIGGER LEVEL control for the remainder of step A1.

### NOTE

*When the conditions given in part (j) are met, the dot on the TRIGGER LEVEL knob should be aligned with the 0 on the front panel. If not, loosen the setscrew and reposition the knob.*

k. Set the 7D10 COUPLING switch to DC.

l. Check the waveform at TP 130 for approximately equal positive and negative half cycles.

m. ADJUST—R77 (Trigger DC Balance) for a TP 130 waveform with approximately equal positive and negative half cycles.

### A2. ADJUST EXTERNAL TRIGGER DC BALANCE (R49)

a. Set the 7D10 SOURCE switch to EXT.

b. Check the waveform at TP 130 for approximately equal positive and negative half cycles.

c. ADJUST—R49 (External Trigger DC Balance) for a display with approximately equal positive and negative half cycles.

d. Disconnect all test equipment. Leave the 10X probe connected to channel 2 of the amplifier unit.

### ✓ A3. ADJUST EXTERNAL TRIGGER INPUT COMPENSATION (C10 and C24)

a. Connect the probe tip to TP 41. Set the amplifier unit channel 2 deflection factor for 10 millivolts/division (100 millivolts/division at probe tip) and trigger source for mode.

b. Set the amplifier unit channel 1 deflection factor for 0.1 volt/division and connect the high-amplitude output of the square-wave generator to channel 1 through a 10X attenuator and RC normalizer.

c. Set the time-base unit for auto, internal triggering at a sweep rate of 500 microseconds/division.

d. Set the square-wave generator for a 5-division display (0.5 volt) at a 1-kilohertz repetition rate.

e. Disconnect the square-wave generator from the amplifier unit and connect it to the 7D10 EXT TRIG IN connector through the 10X attenuator, 50-ohm termination, and RC normalizer.

f. Set the indicator mainframe to display channel 2.

✓ g. CHECK—Displayed square wave for a flat top and an optimum square front corner.

h. ADJUST—C24 (External Trigger Input Compensation) for optimum square front corner.

i. Set the 7D10 SOURCE switch to EXT ÷ 10.

j. Remove the 10X attenuator from the signal connection to the 7D10 EXT TRIG IN connector.

✓ k. CHECK—Displayed square wave for a flat top and an optimum square front corner. Disregard the spike on the leading edge of the displayed square wave.

l. ADJUST—C10 (on TRIGGER SOURCE switch) for an optimum square corner on the displayed square wave. Disregard the spike on the leading edge of the displayed square wave.

m. Disconnect all test equipment.

### ✓ A4. ADJUST INTERNAL TRIGGER SENSITIVITY, DC COUPLED (R151)

a. Set the 7D10 SOURCE switch to INT.

b. Connect the low-frequency signal generator to the amplifier unit input. Set the indicator mainframe to display the amplifier unit.

✓ Performance Requirement check; see introductory information.



- c. Connect the DLY'D TRIG OUT connector to the time-base unit external trigger input.
- d. Connect a 4-volt, 1-kilohertz calibrator signal from the indicator mainframe to the EVENTS START TRIG IN connector.
- e. Set the time-base unit for p-p auto, external triggering at a sweep rate of 10 milliseconds/division.
- f. Set the amplifier unit deflection factor and the signal generator for a 0.3-division display at 30 hertz. (A 0.3-division display amplitude can easily be obtained by setting the display for 3 divisions and increasing the deflection factor ten times.)
- g. Set the indicator mainframe to select the amplifier unit as the internal trigger source for the 7D10.
- h. Set the 7D10 TRIGGER LEVEL control to light the TRIG'D indicator. Set the EVENTS START TRIGGER LEVEL CONTROL for a stable display.

k. Disconnect the low-frequency signal generator and connect the medium-frequency signal generator to the amplifier unit.

- ✓ l. CHECK—For a stable display for each condition in Table 5-3 at the + and then the – TRIGGER SLOPE switch positions. Reset the TRIGGER LEVEL control as necessary to light the TRIG'D indicator and obtain a stable display. Set the time-base unit sweep rate for optimum viewing of the display.

**TABLE 5-3**  
Medium-Frequency Internal Trigger Sensitivity Checks

7D10 COUPLING	Generator Frequency	Display Amplitude
AC	10 megahertz	0.3 division
AC LF REJ	10 megahertz	0.3 division
DC	10 megahertz	0.3 division
AC	50 megahertz	1.0 division
AC LF REJ	50 megahertz	1.0 division
DC	50 megahertz	1.0 division

- ✓ i. CHECK—For a stable display in the + and – positions of the 7D10 TRIGGER SLOPE switch (it might be necessary to reset the 7D10 TRIGGER LEVEL control for a stable display).
- ✓ j. CHECK—Display stability for each condition in Table 5-2 at the + and then the – position of the 7D10 TRIGGER SLOPE switch. It might be necessary to reset the 7D10 TRIGGER LEVEL control to obtain a stable display after changing the coupling or 7D10 TRIGGER SLOPE switch setting. Set the time-base unit sweep rate for optimum viewing of the display.

m. ADJUST—If necessary, adjust R151 (Sweep Start TD Bias), for a stable display of the 50-megahertz signal.

n. Disconnect all test equipment (leave DLY'D TRIG OUT connected to the time-base unit for the next step).

✓ **A5. CHECK EXTERNAL TRIGGER SENSITIVITY**

- a. Set the 7D10 SOURCE switch to EXT.
- b. Connect the low-frequency signal generator to the amplifier unit input and to the 7D10 EXT TRIG IN connector.
- c. Set the time-base unit for a 10 milliseconds/division sweep rate.
- d. Set the amplifier unit for a calibrated deflection factor of 50 millivolts/division.
- e. Set the signal generator for a 3-division display (150 millivolts) at 30 hertz.

**TABLE 5-2**  
Low-Frequency Internal Trigger Sensitivity Checks

7D10 COUPLING	Generator Frequency	Display Amplitude	Stable Display
AC	30 hertz	0.3 division	yes
AC HF REJ	30 hertz	0.3 division	yes
DC	30 hertz	0.3 division	yes
AC LF REJ	120 hertz	3 division	no
AC LF REJ	30 kilohertz	0.3 division	yes
AC HF REJ	50 kilohertz	0.3 division	yes

✓ **Performance Requirement check; see introductory information.**

**Performance Check and Adjustment—7D10**

- f. Set the 7D10 TRIGGER LEVEL control to light the TRIG'D indicator. Set the EVENTS START TRIGGER LEVEL control for a stable display.
- ✓ g. CHECK—Stable display can be obtained with the TRIGGER SLOPE control set to the + and then the – position (resetting the TRIGGER LEVEL control might be required).
- ✓ h. CHECK—For a stable display for each condition in Table 5-4 at the + and then the – position of the TRIGGER SLOPE switch. It might be necessary to reset the 7D10 TRIGGER LEVEL control to obtain a stable display. Set the time-base unit sweep rate for optimum viewing of the display.

**TABLE 5-4**

**Low-Frequency External Trigger Sensitivity Checks**

7D10 COUPLING	Generator Frequency	Sine-Wave Amplitude
AC	30 hertz	150 millivolts
AC HF REJ	30 hertz	150 millivolts
DC	30 hertz	150 millivolts
AC LF REJ	150 kilohertz	150 millivolts
AC HF REJ	50 kilohertz	150 millivolts

- i. Disconnect the low-frequency signal generator. Connect the medium-frequency signal generator to the amplifier unit input and to the EXT TRIG IN connector.
- ✓ j. CHECK—For a stable display for each condition in Table 5-5 at the + and then the – TRIGGER SLOPE switch positions. Reset the 7D10 TRIGGER LEVEL control as necessary for a stable display. Set the time-base unit sweep rate for optimum viewing of the display.
- k. Disconnect the medium-frequency signal generator. Retain the connection between the 7D10 and the time-base unit for the next step.

✓ **A6. CHECK TRIGGER LEVEL CONTROL RANGE**

- a. Set the 7D10 COUPLING switch to AC.
- b. Set the amplifier unit for a calibrated deflection factor of 0.5 volt/division and the time-base unit for a sweep rate of 10 microseconds/division.

- c. Connect the low-frequency signal generator to the EXT TRIG IN connector and to the amplifier unit input.

- d. Set the signal generator for a 7-division display (3.5 volts, peak-to-peak) at 50 kilohertz.

- ✓ e. CHECK—Turn the 7D10 TRIGGER LEVEL control throughout its range and check that the delay can be triggered at any point on the positive-going slope of the waveform. Set the 7D10 TRIGGER SLOPE switch to – and repeat this check for the negative-going slope of the waveform (TRIGGER LEVEL range, at least +1.75 volts to –1.75 volts).

- f. Disconnect all test equipment. Retain the connection between the 7D10 and the time-base unit for the next step.

✓ **A7. CHECK LINE SOURCE TRIGGER**

- a. Set the 7D10 SOURCE switch to LINE.
- b. Set the time-base unit for a sweep rate of 5 milliseconds/division and the amplifier unit for a deflection factor of 5 or 10 volts/division.
- c. Connect a 10X probe to the amplifier unit input. Connect the probe tip to a line-voltage source.
- ✓ d. CHECK—Set the 7D10 TRIGGER LEVEL control to light the TRIG'D indicator and check for a stable display.
- e. Disconnect the 10X probe.

**TABLE 5-5**

**Medium-Frequency External Trigger Sensitivity Checks**

7D10 COUPLING	Generator Frequency	Sine-Wave Amplitude
AC	10 megahertz	150 millivolts
AC LF REJ	10 megahertz	150 millivolts
DC	10 megahertz	150 millivolts
DC	50 megahertz	500 millivolts
AC LF REJ	50 megahertz	500 millivolts
AC	50 megahertz	500 millivolts

✓ **Performance Requirement check; see introductory information.**

## B. EVENTS COUNT

### Equipment Required

- |   |                                      |
|---|--------------------------------------|
| 1. Indicator mainframe                          | 7. Low-capacitance screwdriver       |
| 2. Dual-trace wide-band vertical amplifier unit | 8. Three-inch screwdriver            |
| 3. Time-base unit                               | 9. Medium-frequency signal generator |
| 4. Flexible plug-in extender                    | 10. Low-frequency signal generator   |
| 5. Square-wave generator                        |                                      |
| 6. 10X probe                                    |                                      |

BEFORE YOU BEGIN, see **ADJUSTMENT LOCATIONS** in the Diagrams and Circuit Board Illustrations section.

### Set-Up

In the indicator mainframe, install the dual-trace vertical amplifier unit in either vertical compartment and a time-base unit in the B horizontal compartment. Place the 7D10 on the plug-in extender and plug the extender into the remaining vertical compartment. Set the 7D10 controls as follows:

```

TRIGGER
  SLOPE . . . . .+
  LEVEL . . . . .0
  COUPLING . . . .AC
  SOURCE . . . . .EXT
EVENTS START
TRIGGER
  SLOPE . . . . .-
  LEVEL . . . . .0
B SWEEP
DELAY MODE . . . .INDEPENDENT
    
```

### B1. CHECK EVENTS COUNT READOUT

- a. Press the 7D10 RESET button.
- b. Check for an events count readout of 0000001 in the upper left portion of the crt.
- c. Check that the events count readout increases when the DELAY EVENTS control is turned clockwise and decreases when turned counterclockwise.

### ✓ B2. CHECK EVENTS START TRIGGER SENSITIVITY

- a. Set the indicator mainframe to display the amplifier and time-base units.
- b. Set the amplifier unit for dual-trace operation in the chopped mode.
- c. Connect a 10X probe to channel 1 of the amplifier unit. Check the probe compensation. Set channel 1 for a deflection factor of 50 millivolts/division (500 millivolts/division at probe tip).
- d. Connect the probe tip to TP 638.
- e. Connect the medium-frequency signal generator to the EVENTS START TRIG IN connector and to channel 2 of the amplifier unit.
- f. Set the signal generator for a 100-millivolt output at 2 megahertz.
- g. Set the time-base unit for auto, internal triggering at a 500 nanoseconds/division sweep rate.

- ✓ h. CHECK—That a display of the trigger-circuit output can be obtained with the EVENTS START TRIGGER LEVEL control set at or near zero (midrange) in both positions of the EVENTS START TRIGGER SLOPE switch.

✓Performance Requirement check; see introductory information.

## Performance Check and Adjustment--7D10

### NOTE

*When the conditions given in part (h) are met, the dot on the EVENTS START TRIGGER LEVEL knob should be aligned with the 0 on the front panel. If not, loosen the setscrew and reposition the knob.*

- i. Disconnect the medium-frequency signal generator and connect the low-frequency signal generator to the EVENTS START TRIG IN connector and to channel 2 of the amplifier unit.
  - j. Set the low-frequency signal generator for a 100-millivolt output at 30 hertz. Set the time-base unit for a 10 milliseconds/division sweep rate.
  - ✓ k. CHECK—That a display of the trigger-circuit output can be obtained with the EVENTS START TRIGGER LEVEL control set at or near zero (midrange) in both positions of the EVENTS START TRIGGER SLOPE switch.
- ✓ **B3. CHECK EVENTS START TRIGGER LEVEL RANGE**
- a. Set the low-frequency generator for a 6-volt output at 50 kilohertz.
  - b. Set the amplifier unit to select channel 1 as the trigger source for the time-base unit.
  - c. Set the time-base unit for a 5 microseconds/division sweep rate and – slope triggering.
  - d. Set the EVENTS START TRIGGER SLOPE switch to +.
  - ✓ e. CHECK—Rotate the EVENTS START TRIGGER LEVEL control throughout its range and check that a stable display can be obtained at any point on the positive-going slope of the sine wave. Set the EVENTS START TRIGGER SLOPE switch to – and repeat this check for the negative-going slope of the sine wave (EVENTS START TRIGGER LEVEL range, at least +3 volts to –3 volts).
  - f. Disconnect all test equipment. Leave the 10X probe connected to channel 1 of the amplifier unit.
- ✓ **B4. ADJUST RECYCLE TIMING (C589)**
- a. Set the EVENTS START TRIGGER SLOPE switch to +.
  - b. Set the time-base unit for auto, internal triggering at a 1 millisecond/division sweep rate.
  - c. Connect the fast-rise, positive-transition output of the square-wave generator to channel 2 of the amplifier unit. Set the amplifier unit channel 2 deflection factor for 100 millivolts/division with dc input coupling.
  - d. Set the square-wave generator for a 5-division display (500 millivolts) of a fast-rise square wave at a 1 megahertz repetition rate.
  - e. Disconnect the generator from channel 2 of the amplifier unit and connect it to the 7D10 EXT TRIG IN and EVENTS START TRIG IN connectors.
  - f. Set the amplifier unit to display channel 1. Set the channel 1 deflection factor for 200 millivolts/division (2 volts/division at probe tip).
  - g. Set the time-base unit to trigger on the negative slope of the input signal at a sweep rate of 100 nanoseconds/division.
  - h. Set the 7D10 TRIGGER LEVEL control to light the TRIG'D indicator.
  - i. Connect the probe tip to pin 4 of U589 on the Interface circuit board.
  - j. Set the EVENTS START TRIGGER LEVEL control to obtain a square-wave display.
  - ✓ k. CHECK—Negative portion of displayed square wave for 4 divisions (400 nanoseconds) between the 50% amplitude points on the falling and rising portion.
  - l. ADJUST—C589 (Recycle Timing) for a 4-division (400 nanoseconds) negative portion of the displayed square wave measured between the 50% amplitude points.

✓Performance Requirement check; see introductory information.

m. Move probe to pin 4 of U598.

✓ n. CHECK—Negative portion of displayed square wave for 3.1 to 3.2 divisions (310 to 320 nanoseconds) between the 50% amplitude points on the falling and rising portion.

o. ADJUST—C598 (Recycle Timing) for a 3.1 to 3.2 division (310 to 320 nanoseconds) negative portion of the displayed square wave measured between the 50% amplitude points.

p. Disconnect all test equipment.

✓ **B5. CHECK MAXIMUM RECYCLE TIME**

a. Install the 7D10 in a vertical compartment and set the amplifier unit for single-channel operation.

b. Set the indicator mainframe for a dual-trace vertical display in the alternate mode, with the 7D10 selected as the internal trigger source for the time-base unit.

c. Connect the medium-frequency signal generator to the 7D10 EXT TRIG IN connector, EVENTS START TRIG IN connector, and to the amplifier unit.

d. Set the signal generator for a 500-millivolt output at 1.6 megahertz.

e. Set the time-base unit for a 0.5 microsecond/division sweep rate.

f. Set the DELAY EVENTS control for an events count readout of 0000001 by pressing the RESET button.

g. Set the 7D10 TRIGGER SLOPE switch to + and the TRIGGER LEVEL control to light the TRIG'D indicator.

h. Set the EVENTS START TRIGGER SLOPE switch to + and the EVENTS START TRIGGER LEVEL control to obtain 1 count for each cycle of the signal generator waveform (indicated by a Pedestal Display of 1 pulse per cycle of sine wave).

i. Increase the generator frequency until 1 count is obtained for each 2 cycles of the sine wave. Reset the 7D10 TRIGGER LEVEL control while increasing the generator frequency to reach the highest possible frequency before the 1 count for each 2 cycles of sine wave is obtained.

✓ j. CHECK—Output frequency of the generator for at least 2 megahertz (indicates recycle time of 500 nanoseconds or less).

**B6. ADJUST ARMING TD BIAS (R161)**

a. Decrease the frequency of the signal generator to obtain 1 count per cycle of sine wave.

b. ADJUST—R161 (Arming TD Bias) counterclockwise until the trace becomes unstable, then clockwise for a stable display.

c. Disconnect all test equipment.

✓ **B7. CHECK EVENTS COUNT**

a. Connect the marker output of the time-mark generator to the amplifier unit and to the EXT TRIG IN connector.

b. Connect the trigger output of the time-mark generator to the EVENTS START TRIG IN connector.

c. Set the time-mark generator for a 0.1-millisecond marker output.

d. Set the time-base unit for auto, internal triggering at a 0.1 millisecond/division sweep rate.

e. Set the DELAY EVENTS control for an events count readout of 0000002.

f. Set the TRIGGER LEVEL control to light the TRIG'D indicator.

g. Set the EVENTS START TRIGGER LEVEL control for a stable display.

✓ **Performance Requirement check; see introductory information.**

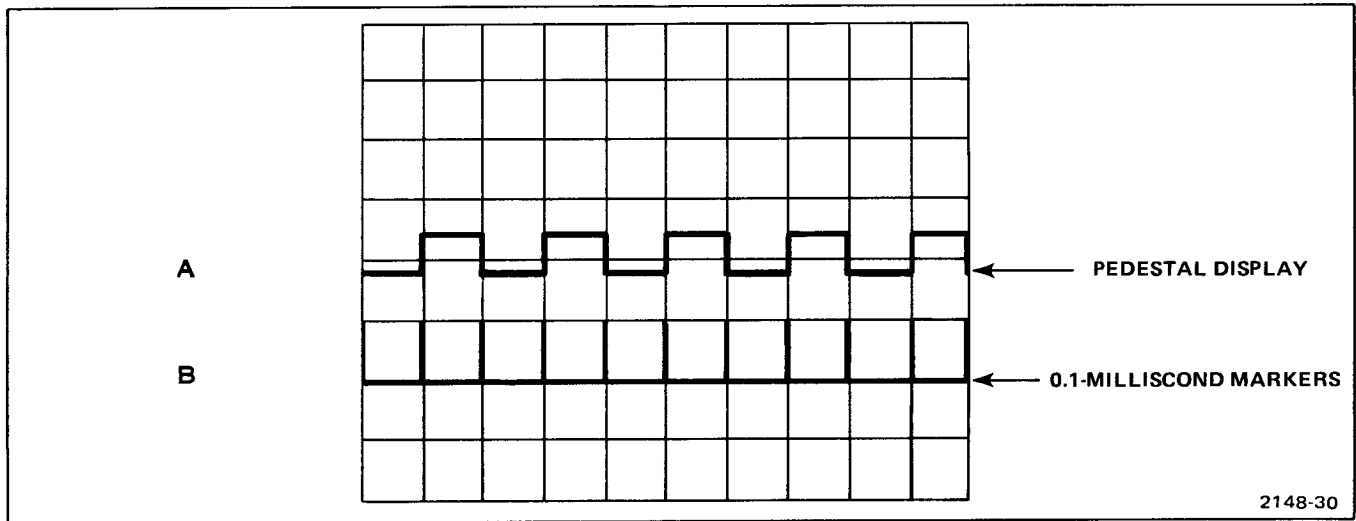

Figure 5-1. Simulated waveforms for checking Events Count.

✓ h. CHECK—That the positive portions of the Pedestal Display (near the vertical center of the crt viewing area) is coincident with the displayed markers as shown in Figure 5-1.

i. Turn the DELAY EVENTS control clockwise to slowly increase the events count readout in 1 count increments.

✓ j. CHECK—That the width of the first positive portion of the Pedestal Display increases by 1 marker increments corresponding to the events count readout.

k. Disconnect the test equipment.

✓Performance Requirement check; see introductory information.

## C. OUTPUT SIGNALS

## Equipment Required

- |   |  |
|---|--|
| 1. Indicator mainframe                          | 5. 50-ohm BNC cable (two required; must be equal length) |
| 2. Dual-trace wide-band vertical amplifier unit | 6. 50-ohm BNC termination (two required)                 |
| 3. Time-base unit                               | 7. Medium-frequency signal generator                     |
| 4. Time-mark generator                          |  |

BEFORE YOU BEGIN, see

**ADJUSTMENT LOCATIONS**in the **Diagrams and Circuit Board Illustrations** section.

## Set-Up

In the indicator mainframe, install the 7D10 and wide-band vertical amplifier unit in the vertical plug-in compartments. Install the time-base unit in the B horizontal plug-in compartment. Set the 7D10 controls as follows:

```

TRIGGER
SLOPE . . . . .+
LEVEL . . . . .0
COUPLING . . . .AC
SOURCE . . . . .EXT
EVENTS START
TRIGGER
SLOPE . . . . .-
LEVEL . . . . .0
B SWEEP
DELAY MODE . . . .INDEPENDENT
  
```

✓ **C1. CHECK FRONT-PANEL DELAY INTERVAL OUTPUT**

- Connect the trigger output of the time-mark generator to the 7D10 EXT TRIG IN connector and the marker output to the EVENTS START TRIG IN connector.
- Set the time-mark generator for a 50-nanosecond marker and 50-nanosecond trigger output.
- Connect the DLY INTERVAL OUT connector to the amplifier unit input.
- Set the amplifier unit for a calibrated deflection factor of 0.5 volt/division.

e. Set the indicator mainframe to select the amplifier unit for display and as the internal trigger source for the time-base unit.

f. Set the time-base unit for auto, internal, positive-slope triggering at a sweep rate of 20 nanoseconds/division.

g. Set the 7D10 TRIGGER LEVEL control to light the TRIG'D indicator.

h. Set the time-base unit trigger level and 7D10 EVENT START TRIGGER LEVEL controls to obtain a stable display.

✓ i. CHECK—Displayed pulse amplitude for at least 2 divisions (delay interval pulse amplitude is at least 1 volt into 50-ohm load).

j. Set the DELAY EVENTS control for an events count readout of 0000002.

k. Set the time-base unit for a sweep rate of 200 nanoseconds/division.

l. Set the EVENTS START TRIGGER LEVEL control to obtain a pulse display.

✓ m. CHECK—Displayed waveform for 5 divisions between the 50% amplitude points on the rising and falling portion (DLY INTERVAL OUT signal equal to generated events delay within 30 nanoseconds; 1 microsecond within 30 nanoseconds).

✓ **Performance Requirement check; see introductory information.**

**Performance Check and Adjustment—7D10**

- n. Set the amplifier unit deflection factor to obtain a display amplitude of 5 or 6 divisions.
- o. Set the time-base unit to start the sweep prior to the rising portion of the waveform at a sweep rate of 2 nano-seconds/division.
- ✓ p. CHECK—Displayed waveform for 2.5 divisions or less between the 10% and 90% amplitude points (rise time into 50 ohms, 5 nanoseconds or less).
- q. Set the time-base unit to start the sweep prior to the falling portion of the waveform.
- ✓ r. CHECK—Displayed waveform for 2.5 divisions or less between the 90% and 10% amplitude points (fall time into 50 ohms, 5 nanoseconds or less).

✓ **C2. CHECK DELAY INTERVAL OUTPUTS TO MAIN-FRAME**

- a. Set the indicator mainframe for a dual-trace vertical display in the chopped mode.
- b. Set the time-mark generator for 1-millisecond markers.
- c. Set the time-base unit for auto, internal triggering at a 0.5 millisecond/division sweep rate.
- ✓ d. CHECK—For a Pedestal Display (fixed near the center of the crt viewing area) and the DLY INTERVAL OUT waveform.
- e. Set S669 (Z-Axis Blanking) to the Intensified (rear) position (see Adjustment Locations pullout page).
- f. Check that the DELAY EVENTS control is set for an events count readout of 0000002.
- ✓ g. CHECK—That the crt display is blanked out during the delay interval (blanking occurs during the positive portion of the displayed waveforms).
- h. Disconnect all cables.
- i. Set S669 (Z-Axis Blanking) to the Non-Intensified (forward) position.

✓ **C3. CHECK FRONT-PANEL DELAYED TRIGGER OUTPUT**

- a. Connect the marker output of the time-mark generator to the 7D10 EXT TRIG IN connector.
- b. Connect the medium-frequency signal generator to the EVENTS START TRIG IN connector.
- c. Connect the DLY'D TRIG OUT connector to the amplifier unit input.
- d. Set the time-mark generator for 1-microsecond markers.
- e. Set the medium-frequency signal generator for a 10-megahertz, 5-volt output.
- f. Set the time-base unit for a 1 microsecond/division sweep rate.
- g. Set the indicator mainframe to select the 7D10 as the internal trigger source for the time-base unit.
- h. Set the 7D10 TRIGGER LEVEL to light the TRIG'D indicator and the EVENTS START TRIGGER LEVEL for a stable display.
- i. Push the RESET button and check for 1 pulse/division.
- ✓ j. CHECK—Display for 1 pulse per 1 through 10 divisions as the event count readout is increased incrementally in decade steps according to Table 5-6.
- k. Disconnect the test equipment.

**TABLE 5-6**  
**Front-Panel Delayed Trigger Output Check**

Events Count Readout	Time Base Unit Sweep Rate	Display
0000001 through 0000010	1 $\mu$ s/div	1 pulse/1-10 div
0000011 through 0000100	10 $\mu$ s/div	1 pulse/1-10 div
0000101 through 0001000	100 $\mu$ s/div	1 pulse/1-10 div
0001001 through 0010000	1 ms/div	1 pulse/1-10 div
0010001 through 0100000	10 ms/div	1 pulse/1-10 div
0100001 through 1000000	0.1 s/div	1 pulse/1-10 div
1000001 through 10000000	1 s/div	1 pulse/1-10 div

✓ **Performance Requirement check; see introductory information.**



✓ **C4. CHECK DELAYED TRIGGER AND DELAY INTERVAL COINCIDENCE**

- a. Connect the time-mark generator marker output to the 7D10 EXT TRIG IN connector and the trigger output to the EVENTS START TRIG IN connector.
- b. Set the DELAY EVENTS control for an events count readout of 0000001.
- c. Connect the DLY'D TRIG OUT connector to channel 1 of the amplifier unit and the DLY INTERVAL OUT connector to channel 2 with two equal-length 50-ohm BNC cables.
- d. Set the indicator mainframe to select the amplifier unit as the internal trigger source.
- e. Set the amplifier unit for chopped operation. Select the Delay-Interval channel as the internal trigger source. Set the deflection factors for 6-division displays. Vertically center both waveforms.
- f. Set the time-base unit to trigger on the falling portion of the Delay Interval waveform at a magnified sweep rate of 2 nanoseconds/division (use a basic sweep rate of 20 nanoseconds/division, magnified 10 times with X10 magnifier or delayed sweep to obtain 2 nanoseconds/division).

- g. CHECK—Display for not more than 1 division between the rising portion of the Delayed Trigger waveform and the falling portion of the Delay Interval waveform, as measured at the 50% amplitude points (rising edge of Delayed Trigger waveform is coincident with the falling edge of the Delay Interval waveform within 2 nanoseconds). See Figure 5-2.
- h. Disconnect the test equipment.

✓ **C5. CHECK B SWEEP DELAY MODE OPERATION**

- a. Install the 7D10 in the A horizontal compartment of the indicator mainframe.
- b. Connect the marker output of the time-mark generator, through the BNC T connector, to the amplifier unit input.
- c. Connect the time-marker output from the BNC T connector to the 7D10 EXT TRIG IN connector.
- d. Connect the time-mark generator trigger output to the EVENTS START TRIG IN connector.
- e. Set the time-mark generator for 1-microsecond markers.

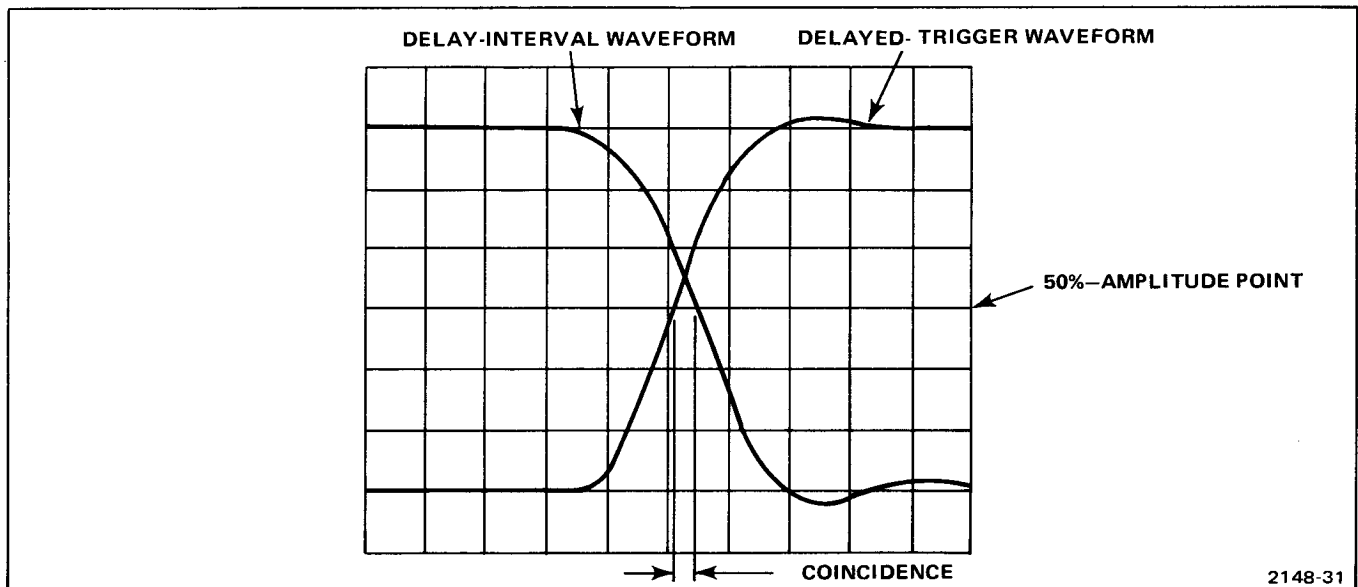

Figure 5-2. Simulated waveforms for checking Delay Interval and Delayed Trigger Coincidence.

## Performance Check and Adjustment—7D10

f. Set the amplifier unit to display the time markers (single-channel operation). Select the displayed channel as the internal trigger source for the time-base unit.

g. Set the DELAY EVENTS control for an events count readout of 0000500.

h. Set the B SWEEP DELAY MODE switch to B STARTS AFTER DELAY.

i. CHECK—That the displayed markers dim, (if necessary, set the 7D10 TRIGGER LEVEL and EVENTS START TRIGGER LEVEL controls for a stable display). Turn the time-base unit trigger level throughout its range and check the marker display for no change.

j. Set the 7D10 B SWEEP DELAY MODE switch to B TRIGGERABLE AFTER DELAY.

k. CHECK—That the displayed markers dim. Turn the time-base unit trigger slope throughout its range and check that the sweep can be triggered on the positive-going slope of the displayed markers.

l. Disconnect all test equipment and remove the plug-in units from the indicator mainframe.

This completes the Performance Check and Adjustment procedure for the 7D10.

---

√Performance Requirement check; see introductory information.

# REPLACEABLE ELECTRICAL PARTS

## PARTS ORDERING INFORMATION

Replacement parts are available from or through your local Tektronix, Inc. Field Office or representative.

Changes to Tektronix instruments are sometimes made to accommodate improved components as they become available, and to give you the benefit of the latest circuit improvements developed in our engineering department. It is therefore important, when ordering parts, to include the following information in your order: Part number, instrument type or number, serial number, and modification number if applicable.

If a part you have ordered has been replaced with a new or improved part, your local Tektronix, Inc. Field Office or representative will contact you concerning any change in part number.

Change information, if any, is located at the rear of this manual.

## SPECIAL NOTES AND SYMBOLS

X000 Part first added at this serial number  
00X Part removed after this serial number

## ITEM NAME

In the Parts List, an Item Name is separated from the description by a colon (:). Because of space limitations, an Item Name may sometimes appear as incomplete. For further Item Name identification, the U.S. Federal Cataloging Handbook H6-1 can be utilized where possible.

## ABBREVIATIONS

ACTR	ACTUATOR	PLSTC	PLASTIC
ASSY	ASSEMBLY	QTZ	QUARTZ
CAP	CAPACITOR	RECP	RECEPTACLE
CER	CERAMIC	RES	RESISTOR
CKT	CIRCUIT	RF	RADIO FREQUENCY
COMP	COMPOSITION	SEL	SELECTED
CONN	CONNECTOR	SEMICOND	SEMICONDUCTOR
ELCTLT	ELECTROLYTIC	SENS	SENSITIVE
ELEC	ELECTRICAL	VAR	VARIABLE
INCAND	INCANDESCENT	WW	WIREWOUND
LED	LIGHT EMITTING DIODE	XFMR	TRANSFORMER
NONWIR	NON WIREWOUND	XTAL	CRYSTAL

# Replaceable Electrical Parts—7D10

## CROSS INDEX—MFR. CODE NUMBER TO MANUFACTURER

Mfr. Code	Manufacturer	Address	City, State, Zip
00853	SANGAMO ELECTRIC CO., S. CAROLINA DIV.	P O BOX 128	PICKENS, SC 29671
01121	ALLEN-BRADLEY COMPANY	1201 2ND STREET SOUTH	MILWAUKEE, WI 53204
01295	TEXAS INSTRUMENTS, INC., SEMICONDUCTOR GROUP	P O BOX 5012, 13500 N CENTRAL EXPRESSWAY	DALLAS, TX 75222
02735	RCA CORPORATION, SOLID STATE DIVISION	ROUTE 202	SOMERVILLE, NY 08876
03508	GENERAL ELECTRIC COMPANY, SEMI-CONDUCTOR PRODUCTS DEPARTMENT	ELECTRONICS PARK	SYRACUSE, NY 13201
03877	TRANSITRON ELECTRONIC CORPORATION	168 ALBION STREET	WAKEFIELD, MA 01880
04222	AVX CERAMICS., DIVISION OF AVX CORP.	P O BOX 867, 19TH AVE. SOUTH	MURTLE BEACH, SC 29577
04713	MOTOROLA, INC., SEMICONDUCTOR PROD. DIV.	5005 E MCDOWELL RD, PO BOX 20923	PHOENIX, AZ 85036
07263	FAIRCHILD SEMICONDUCTOR, A DIV. OF FAIRCHILD CAMERA AND INSTRUMENT CORP.	464 ELLIS STREET	MOUNTAIN VIEW, CA 94042
07910	TELEDYNE SEMICONDUCTOR	12515 CHADRON AVE.	HAWTHORNE, CA 90250
08806	GENERAL ELECTRIC CO., MINIATURE LAMP PRODUCTS DEPARTMENT	NELA PARK	CLEVELAND, OH 44112
12637	FLEET PRODUCTS COMPANY, INC.	1920 E POMONA STREET	SANTA ANA, CA 92705
18324	SIGNETICS CORP.	811 E. ARQUES	SUNNYVALE, CA 94086
28480	HEWLETT-PACKARD CO., CORPORATE HQ.	1501 PAGE MILL RD.	PALO ALTO, CA 94304
56289	SPRAGUE ELECTRIC CO.		NORTH ADAMS, MA 01247
71400	BUSSMAN MFG., DIVISION OF MCGRAW EDISON CO.	2536 W. UNIVERSITY ST.	ST. LOUIS, MO 63107
71590	CENTRALAB ELECTRONICS, DIV. OF GLOBE-UNION, INC.	5757 N. GREEN BAY AVE.	MILWAUKEE, WI 53201
72982	ERIE TECHNOLOGICAL PRODUCTS, INC.	644 W. 12TH ST.	ERIE, PA 16512
75042	TRW ELECTRONIC COMPONENTS, IRC FIXED RESISTORS, PHILADELPHIA DIVISION	401 N. BROAD ST.	PHILADELPHIA, PA 19108
78488	STACKPOLE CARBON CO.		ST. MARYS, PA 15857
79727	CONTINENTAL-WIRT ELECTRONICS CORP.		WARMINSTER, PA 18974
80009	TEKTRONIX, INC.	P. O. BOX 500	BEAVERTON, OR 97005
80740	BECKMAN INSTRUMENTS, INC.	2500 HARBOR BLVD.	FULLERTON, CA 92634
81073	GRAYHILL, INC.	561 HILLGROVE AVE.	LA GRANGE, IL 60525
81483	INTERNATIONAL RECTIFIER CORP.	9220 SUNSET BLVD.	LOS ANGELES, CA 90069
86684	RCA CORP., ELECTRONIC COMPONENTS	415 S. 5TH ST.	HARRISON, NJ 07029
90201	MALLORY CAPACITOR CO., DIV. OF P. R. MALLORY CO., INC.	3029 E. WASHINGTON ST.	INDIANAPOLIS, IN 46206
91637	DALE ELECTRONICS, INC.	P. O. BOX 609	COLUMBUS, NB 68601

Replaceable Electrical Parts—7D10

Ckt No.	Tektronix Part No.	Serial/Model No. Eff	Dscont	Name & Description	Mfr Code	Mfr Part Number
A1	670-1221-02			CKT CARD ASSY:SOURCE SWITCH	80009	670-1221-02
A2	670-1222-02			CKT CARD ASSY:COUPLING SWITCH	80009	670-1222-02
A3	670-2156-00			CKT CARD ASSY:TRIGGER	80009	670-2156-00
A4	670-2150-03	B010100	B019999	CKT BOARD ASSY:INTERFACE	80009	670-2150-03
A4	670-2150-05	B020000		CKT BOARD ASSY:INTERFACE	80009	670-2150-05
A7	670-2151-03			CKT BOARD ASSY:LOGIC	80009	670-2151-03
A8	670-2148-00			CKT CARD ASSY:B SWEEP DELAY MODE SWITCH	80009	670-2148-00
C2	283-0239-00			CAP.,FXD,CER DI:0.022UF,10%,50V	72982	813N075WR5223K
C6	281-0661-00			CAP.,FXD,CER DI:0.8PF,+/-0.1PF,500V	72982	301-000COK0808B
C10	281-0123-00			CAP.,VAR,CER DI:5-25PF,100V	72982	518-000A5-25
C13	281-0632-00			CAP.,FXD,CER DI:35PF,1%,500V	72982	308-000COG0350F
C21	283-0080-00			CAP.,FXD,CER DI:0.022UF,+80-20%,25V	56289	19C611
C24	281-0122-00			CAP.,VAR,CER DI:2.5-9PF,100V	72982	518-000A2.5-9
C32	283-0000-00			CAP.,FXD,CER DI:0.001UF,+100-0%,500V	72982	831-516E102P
C38	283-0000-00			CAP.,FXD,CER DI:0.001UF,+100-0%,500V	72982	831-516E102P
C39	281-0613-00			CAP.,FXD,CER DI:10PF,+/-1PF,200V	72982	374-001COG0100F
C41	290-0523-00			CAP.,FXD,ELCTLT:2.2UF,20%,20V	56289	196D225X0025HA1
C52	283-0178-00			CAP.,FXD,CER DI:0.1UF,+80-20%,100V	72982	8131N145 E 104Z
C62	281-0511-00			CAP.,FXD,CER DI:22PF,+/-2.2PF,500V	72982	301-000COG0220K
C67	281-0511-00			CAP.,FXD,CER DI:22PF,+/-2.2PF,500V	72982	301-000COG0220K
C75	283-0080-00			CAP.,FXD,CER DI:0.022UF,+80-20%,25V	56289	19C611
C82	283-0080-00			CAP.,FXD,CER DI:0.022UF,+80-20%,25V	56289	19C611
C83	283-0169-00			CAP.,FXD,CER DI:0.022UF,10%,200V	72982	8131N225X5R223K
C84	283-0080-00			CAP.,FXD,CER DI:0.022UF,+80-20%,25V	56289	19C611
C86	283-0080-00			CAP.,FXD,CER DI:0.022UF,+80-20%,25V	56289	19C611
C87	283-0194-00			CAP.,FXD,CER DI:4.7UF,20%,50V	72982	8151N080651475M
C88	283-0051-00			CAP.,FXD,CER DI:0.0033UF,5%,100V	72982	8131N145 A 332J
C92	315-0101-00			RES.,FXD,CMPNSN:100 OHM,5%,0.25W	01121	CB1015
C96	283-0068-00			CAP.,FXD,CER DI:0.01UF,+100-0%,500V	56289	19C241
C102	283-0633-00			CAP.,FXD,MICA D:77PF,1%,100V	00853	D151E770F0
C106	283-0212-00			CAP.,FXD,CER DI:2UF,20%,50V	72982	8141N064Z25U0205M
C119	281-0516-00			CAP.,FXD,CER DI:39PF,+/-3.9PF,500V	72982	301-000U2J0390K
C122	283-0080-00			CAP.,FXD,CER DI:0.022UF,+80-20%,25V	56289	19C611
C126	283-0080-00			CAP.,FXD,CER DI:0.022UF,+80-20%,25V	56289	19C611
C137	290-0523-00			CAP.,FXD,ELCTLT:2.2UF,20%,20V	56289	196D225X0025HA1
C145	281-0513-00			CAP.,FXD,CER DI:27PF,+/-5.4PF,500V	72982	301-000P2G0270M
C150	290-0246-00			CAP.,FXD,ELCTLT:3.3UF,10%,15V	56289	162D335X9015CD2
C160	290-0136-00			CAP.,FXD,ELCTLT:2.2UF,20%,20V	56289	162D225X0020CD2
C162	281-0613-00			CAP.,FXD,CER DI:10PF,+/-1PF,200V	72982	374-001COG0100F
C166	281-0513-00			CAP.,FXD,CER DI:27PF,+/-5.4PF,500V	72982	301-000P2G0270M
C174	281-0651-00			CAP.,FXD,CER DI:47PF,5%,200V	72982	374-001T2H0470J
C177	290-0523-00			CAP.,FXD,ELCTLT:2.2UF,20%,20V	56289	196D225X0025HA1
C179	283-0178-00			CAP.,FXD,CER DI:0.1UF,+80-20%,100V	72982	8131N145 E 104Z
C179	283-0178-00			CAP.,FXD,CER DI:0.1UF,+80-20%,100V	72982	8131N145 E 104Z
C182	281-0518-00			CAP.,FXD,CER DI:47PF,+/-9.4PF,500V	72982	301-000U2J0470M
C185	290-0187-00			CAP.,FXD,ELCTLT:4.7UF,20%,35V	56289	150D475X0035B2
C188	290-0267-00			CAP.,FXD,ELCTLT:1UF,20%,35V	56289	162D105X0035CD2
C510	290-0530-00			CAP.,FXD,ELCTLT:68UF,20%,6V	90201	TDC686M006NLF
C517	283-0178-00			CAP.,FXD,CER DI:0.1UF,+80-20%,100V	72982	8131N145 E 104Z
C524	283-0178-00			CAP.,FXD,CER DI:0.1UF,+80-20%,100V	72982	8131N145 E 104Z
C528	290-0523-00			CAP.,FXD,ELCTLT:2.2UF,20%,20V	56289	196D225X0025HA1
C534	281-0523-00			CAP.,FXD,CER DI:100PF,+/-20PF,500V	72982	301-000U2M0101M
C535	283-0067-00			CAP.,FXD,CER DI:0.001UF,10%,200V	72982	835-515B102K

# Replaceable Electrical Parts—7D10

Ckt No.	Tektronix Part No.	Serial/Model No. Eff	Dscont	Name & Description	Mfr Code	Mfr Part Number
C560	281-0650-00			CAP.,FXD,CER DI:18PF,10%,200V	72982	374-001COH0180K
C563	281-0638-00			CAP.,FXD,CER DI:240PF,5%,500V	72982	301000Z5D241J
C568	283-0178-00			CAP.,FXD,CER DI:0.1UF,+80-20%,100V	72982	8131N145 E 104Z
C569	281-0540-00			CAP.,FXD,CER DI:51PF,5%,500V	72982	301-000U2J0510J
C581	281-0525-00			CAP.,FXD,CER DI:470PF,+/-94PF,500V	04222	7001-1364
C586	281-0525-00			CAP.,FXD,CER DI:470PF,+/-94PF,500V	04222	7001-1364
C589	281-0123-00			CAP.,VAR,CER DI:5-25PF,100V	72982	518-000A5-25
C591	283-0635-00			CAP.,FXD,MICA D:51PF,1%,100V	00853	D151E510F0
C596	281-0580-00			CAP.,FXD,CER DI:470PF,10%,500V	04222	7001-1374
C598	281-0123-00			CAP.,VAR,CER DI:5-25PF,100V	72982	518-000A5-25
C601	281-0523-00			CAP.,FXD,CER DI:100PF,+/-20PF,500V	72982	301-000U2M0101M
C604	290-0523-00			CAP.,FXD,ELCTLT:2.2UF,20%,20V	56289	196D225X0025HA1
C607	290-0523-00			CAP.,FXD,ELCTLT:2.2UF,20%,20V	56289	196D225X0025HA1
C610	283-0178-00			CAP.,FXD,CER DI:0.1UF,+80-20%,100V	72982	8131N145 E 104Z
C622	283-0178-00			CAP.,FXD,CER DI:0.1UF,+80-20%,100V	72982	8131N145 E 104Z
C626	290-0523-00			CAP.,FXD,ELCTLT:2.2UF,20%,20V	56289	196D225X0025HA1
C627	281-0592-00			CAP.,FXD,CER DI:4.7PF,+/-0.5PF,500V	72982	301-023COH0479D
C639	281-0651-00			CAP.,FXD,CER DI:47PF,5%,200V	72982	374-001T2H0470J
C656	281-0540-00			CAP.,FXD,CER DI:51PF,5%,500V	72982	301-000U2J0510J
C668	281-0504-00			CAP.,FXD,CER DI:10PF,+/-1PF,500V	72982	301-055C0G0100F
C725	285-0862-00			CAP.,FXD,PLSTC:0.001,10%,100V	56289	410P10291
C736	281-0589-00			CAP.,FXD,CER DI:170PF,5%,500V	72982	301000Z5D171J
C751	290-0526-00			CAP.,FXD,ELCTLT:6.8UF,20%,6V	90201	TDC685M006EL
C755	283-0067-00			CAP.,FXD,CER DI:0.001UF,10%,200V	72982	835-515B102K
C838	283-0076-00			CAP.,FXD,CER DI:27PF,10%,500V	56289	40C287A2
C968	281-0543-00			CAP.,FXD,CER DI:270PF,10%,500V	72982	301055X5P271K
C1001	283-0178-00			CAP.,FXD,CER DI:0.1UF,+80-20%,100V	72982	8131N145 E 104Z
C1002	290-0527-00			CAP.,FXD,ELCTLT:15UF,20%,20V	90201	TDC156M020FL
C1004	283-0178-00			CAP.,FXD,CER DI:0.1UF,+80-20%,100V	72982	8131N145 E 104Z
C1005	290-0527-00			CAP.,FXD,ELCTLT:15UF,20%,20V	90201	TDC156M020FL
C1007	283-0178-00			CAP.,FXD,CER DI:0.1UF,+80-20%,100V	72982	8131N145 E 104Z
C1008	290-0530-00			CAP.,FXD,ELCTLT:68UF,20%,6V	90201	TDC686M006NLF
C1009	283-0239-00			CAP.,FXD,CER DI:0.022UF,10%,50V	72982	813N075WR5223K
C1011	290-0535-00			CAP.,FXD,ELCTLT:33UF,20%,10V	56289	196D336X0010KA1
C1015	290-0535-00			CAP.,FXD,ELCTLT:33UF,20%,10V	56289	196D336X0010KA1
C1018	283-0178-00			CAP.,FXD,CER DI:0.1UF,+80-20%,100V	72982	8131N145 E 104Z
C1019	283-0178-00			CAP.,FXD,CER DI:0.1UF,+80-20%,100V	72982	8131N145 E 104Z
C1020	290-0519-00			CAP.,FXD,ELCTLT:100UF,20%,20V	56289	196D107X0020MA3
C1021	283-0178-00			CAP.,FXD,CER DI:0.1UF,+80-20%,100V	72982	8131N145 E 104Z
C1033	290-0523-00			CAP.,FXD,ELCTLT:2.2UF,20%,20V	56289	196D225X0025HA1
C1038	290-0531-00			CAP.,FXD,ELCTLT:100UF,20%,10V	90201	TDC107M010WLC
C1039	290-0530-00			CAP.,FXD,ELCTLT:68UF,20%,6V	90201	TDC686M006NLF
C1066	290-0532-00			CAP.,FXD,ELCTLT:150UF,20%,6V	90201	TDC157M006CL
C1067	283-0178-00			CAP.,FXD,CER DI:0.1UF,+80-20%,100V	72982	8131N145 E 104Z
C1067	283-0178-00			CAP.,FXD,CER DI:0.1UF,+80-20%,100V	72982	8131N145 E 104Z
C1069	283-0080-00			CAP.,FXD,CER DI:0.022UF,+80-20%,25V	56289	19C611
C1072	283-0178-00			CAP.,FXD,CER DI:0.1UF,+80-20%,100V	72982	8131N145 E 104Z
C1074	283-0178-00			CAP.,FXD,CER DI:0.1UF,+80-20%,100V	72982	8131N145 E 104Z
C1076	283-0178-00			CAP.,FXD,CER DI:0.1UF,+80-20%,100V	72982	8131N145 E 104Z
CR21	152-0141-02			SEMICONV DEVICE:SILICON,30V,150MA	07910	1N4152

## Replaceable Electrical Parts—7D10

Ckt No.	Tektronix Part No.	Serial/Model No. Eff	Dscnt	Name & Description	Mfr Code	Mfr Part Number
CR27	152-0141-02			SEMICON D DEVICE:SILICON,30V,150MA	07910	1N4152
CR28	152-0141-02			SEMICON D DEVICE:SILICON,30V,150MA	07910	1N4152
CR122	152-0141-02			SEMICON D DEVICE:SILICON,30V,150MA	07910	1N4152
CR126	152-0141-02			SEMICON D DEVICE:SILICON,30V,150MA	07910	1N4152
CR128	152-0141-02			SEMICON D DEVICE:SILICON,30V,150MA	07910	1N4152
CR141	152-0140-01			SEMICON D DEVICE:TUNNEL,8PF,10MA	03508	SMTD905
CR153	152-0141-02			SEMICON D DEVICE:SILICON,30V,150MA	07910	1N4152
CR169	152-0140-01			SEMICON D DEVICE:TUNNEL,8PF,10MA	03508	SMTD905
CR171	152-0140-01			SEMICON D DEVICE:TUNNEL,8PF,10MA	03508	SMTD905
CR184	152-0141-02			SEMICON D DEVICE:SILICON,30V,150MA	07910	1N4152
CR521	152-0141-02			SEMICON D DEVICE:SILICON,30V,150MA	07910	1N4152
CR525	152-0141-02			SEMICON D DEVICE:SILICON,30V,150MA	07910	1N4152
CR526	152-0141-02			SEMICON D DEVICE:SILICON,30V,150MA	07910	1N4152
CR532	152-0141-02			SEMICON D DEVICE:SILICON,30V,150MA	07910	1N4152
CR563	152-0141-02			SEMICON D DEVICE:SILICON,30V,150MA	07910	1N4152
CR570	152-0141-02			SEMICON D DEVICE:SILICON,30V,150MA	07910	1N4152
CR571	152-0141-02			SEMICON D DEVICE:SILICON,30V,150MA	07910	1N4152
CR586	152-0141-02			SEMICON D DEVICE:SILICON,30V,150MA	07910	1N4152
CR605	152-0141-02			SEMICON D DEVICE:SILICON,30V,150MA	07910	1N4152
CR609	152-0141-02			SEMICON D DEVICE:SILICON,30V,150MA	07910	1N4152
CR632	152-0141-02			SEMICON D DEVICE:SILICON,30V,150MA	07910	1N4152
CR633	152-0141-02			SEMICON D DEVICE:SILICON,30V,150MA	07910	1N4152
CR635	152-0141-02			SEMICON D DEVICE:SILICON,30V,150MA	07910	1N4152
CR636	152-0141-02			SEMICON D DEVICE:SILICON,30V,150MA	07910	1N4152
CR638	152-0153-00			SEMICON D DEVICE:SILICON,15V,50MA	07263	FD7003
CR639	152-0153-00			SEMICON D DEVICE:SILICON,15V,50MA	07263	FD7003
CR643	152-0153-00			SEMICON D DEVICE:SILICON,15V,50MA	07263	FD7003
CR644	152-0153-00			SEMICON D DEVICE:SILICON,15V,50MA	07263	FD7003
CR645	152-0153-00			SEMICON D DEVICE:SILICON,15V,50MA	07263	FD7003
CR647	152-0153-00			SEMICON D DEVICE:SILICON,15V,50MA	07263	FD7003
CR655	152-0141-02			SEMICON D DEVICE:SILICON,30V,150MA	07910	1N4152
CR656	152-0141-02			SEMICON D DEVICE:SILICON,30V,150MA	07910	1N4152
CR661	152-0153-00			SEMICON D DEVICE:SILICON,15V,50MA	07263	FD7003
CR712	152-0141-02			SEMICON D DEVICE:SILICON,30V,150MA	07910	1N4152
CR715	152-0141-02			SEMICON D DEVICE:SILICON,30V,150MA	07910	1N4152
CR718	152-0008-00			SEMICON D DEVICE:GERMANIUM,75V,60MA	03877	T-12G
CR729	152-0141-02			SEMICON D DEVICE:SILICON,30V,150MA	07910	1N4152
CR735	152-0141-02			SEMICON D DEVICE:SILICON,30V,150MA	07910	1N4152
CR798	152-0322-00			SEMICON D DEVICE:SILICON,15V,HOT CARRIER	28480	5082-2672
CR830	152-0141-02			SEMICON D DEVICE:SILICON,30V,150MA	07910	1N4152
CR832	152-0141-02			SEMICON D DEVICE:SILICON,30V,150MA	07910	1N4152
CR834	152-0141-02			SEMICON D DEVICE:SILICON,30V,150MA	07910	1N4152
CR930	152-0141-02			SEMICON D DEVICE:SILICON,30V,150MA	07910	1N4152
CR932	152-0141-02			SEMICON D DEVICE:SILICON,30V,150MA	07910	1N4152
CR934	152-0141-02			SEMICON D DEVICE:SILICON,30V,150MA	07910	1N4152
CR936	152-0141-02			SEMICON D DEVICE:SILICON,30V,150MA	07910	1N4152
CR953	152-0141-02			SEMICON D DEVICE:SILICON,30V,150MA	07910	1N4152
CR954	152-0141-02			SEMICON D DEVICE:SILICON,30V,150MA	07910	1N4152
CR955	152-0141-02			SEMICON D DEVICE:SILICON,30V,150MA	07910	1N4152
CR960	152-0141-02			SEMICON D DEVICE:SILICON,30V,150MA	07910	1N4152
CR961	152-0141-02			SEMICON D DEVICE:SILICON,30V,150MA	07910	1N4152

# Replaceable Electrical Parts—7D10

Ckt No.	Tektronix Part No.	Serial/Model No. Eff	Dscont	Name & Description	Mfr Code	Mfr Part Number
CR962	152-0141-02			SEMICON D DEVICE:SILICON,30V,150MA	07910	1N4152
CR963	152-0141-02			SEMICON D DEVICE:SILICON,30V,150MA	07910	1N4152
CR965	152-0141-02			SEMICON D DEVICE:SILICON,30V,150MA	07910	1N4152
CR967	152-0141-02			SEMICON D DEVICE:SILICON,30V,150MA	07910	1N4152
CR974	152-0141-02			SEMICON D DEVICE:SILICON,30V,150MA	07910	1N4152
CR975	152-0141-02			SEMICON D DEVICE:SILICON,30V,150MA	07910	1N4152
CR976	152-0141-02			SEMICON D DEVICE:SILICON,30V,150MA	07910	1N4152
CR977	152-0141-02			SEMICON D DEVICE:SILICON,30V,150MA	07910	1N4152
CR978	152-0141-02			SEMICON D DEVICE:SILICON,30V,150MA	07910	1N4152
CR979	152-0141-02			SEMICON D DEVICE:SILICON,30V,150MA	07910	1N4152
CR980	152-0141-02			SEMICON D DEVICE:SILICON,30V,150MA	07910	1N4152
CR981	152-0141-02			SEMICON D DEVICE:SILICON,30V,150MA	07910	1N4152
CR1066	152-0066-00			SEMICON D DEVICE:SILICON,400V,750MA	80009	152-0066-00
DS197	150-0048-01			LAMP, INCAND:5V,0.06A,SEL	08806	683AS15
F1020	159-0022-00			FUSE,CARTRIDGE:3AG,1A,250V,FAST-BLOW	71400	AGC 1
L106	276-0507-00			SHIELDING BEAD,:0.6UH	78488	57-0180-7D 500B
L130	276-0507-00			SHIELDING BEAD,:0.6UH	78488	57-0180-7D 500B
L141	108-0420-00			COIL,RF:60NH	80009	108-0420-00
L175	276-0532-00			SHIELDING BEAD,:	78488	57-1634
L569	276-0507-00			SHIELDING BEAD,:0.6UH	78488	57-0180-7D 500B
L574	276-0525-00			CORE,FERRITE:0.196 ID X 0.437"OD	01121	T037C351A
L968	276-0507-00			SHIELDING BEAD,:0.6UH	78488	57-0180-7D 500B
L1020	120-0638-00			XFMR,TOROID:15 TURNS,BIFILAR	80009	120-0638-00
L1039	120-0638-00			XFMR,TOROID:15 TURNS,BIFILAR	80009	120-0638-00
L1658	276-0525-00			CORE,FERRITE:0.196 ID X 0.437"OD	01121	T037C351A
LR1001	108-0537-00			COIL,RF:200UH	80009	108-0537-00
LR1004	108-0537-00			COIL,RF:200UH	80009	108-0537-00
LR1007	108-0537-00			COIL,RF:200UH	80009	108-0537-00
Q32	151-1011-00			TRANSISTOR:SILICON,JFE,N-CHANNEL,DUAL	80009	151-1011-00
Q37	151-0221-00			TRANSISTOR:SILICON,PNP	80009	151-0221-00
Q41	151-0367-00			TRANSISTOR:SILICON,NPN,SEL FROM 3571TP	80009	151-0367-00
Q71	151-0221-00			TRANSISTOR:SILICON,PNP	80009	151-0221-00
Q75	151-0367-00			TRANSISTOR:SILICON,NPN,SEL FROM 3571TP	80009	151-0367-00
Q78	151-0221-00			TRANSISTOR:SILICON,PNP	80009	151-0221-00
Q82	151-0198-00			TRANSISTOR:SILICON,NPN,SEL FROM MPS918	80009	151-0198-00
Q84	151-0302-00			TRANSISTOR:SILICON,NPN	04713	2N2222A
Q86	151-0302-00			TRANSISTOR:SILICON,NPN	04713	2N2222A
Q100	151-0367-00			TRANSISTOR:SILICON,NPN,SEL FROM 3571TP	80009	151-0367-00
Q102	151-0367-00			TRANSISTOR:SILICON,NPN,SEL FROM 3571TP	80009	151-0367-00
Q117	151-0221-00			TRANSISTOR:SILICON,PNP	80009	151-0221-00
Q121	151-0221-00			TRANSISTOR:SILICON,PNP	80009	151-0221-00
Q124	151-0223-00			TRANSISTOR:SILICON,NPN	80009	151-0223-00
Q133	151-0282-00			TRANSISTOR:SILICON,NPN	02735	2N5179
Q138	151-0367-00			TRANSISTOR:SILICON,NPN,SEL FROM 3571TP	80009	151-0367-00
Q143	151-0367-00			TRANSISTOR:SILICON,NPN,SEL FROM 3571TP	80009	151-0367-00
Q149	151-0223-00			TRANSISTOR:SILICON,NPN	80009	151-0223-00
Q159	151-0223-00			TRANSISTOR:SILICON,NPN	80009	151-0223-00
Q173	151-0212-00			TRANSISTOR:SILICON,NPN	80009	151-0212-00
Q178	151-0212-00			TRANSISTOR:SILICON,NPN	80009	151-0212-00



## Replaceable Electrical Parts—7D10

Ckt No.	Tektronix Part No.	Serial/Model No. Eff	Dscont	Name & Description	Mfr Code	Mfr Part Number
Q183	151-0223-00			TRANSISTOR:SILICON,NPN	80009	151-0223-00
Q188	151-0223-00			TRANSISTOR:SILICON,NPN	80009	151-0223-00
Q192	151-0220-00			TRANSISTOR:SILICON,PNP	80009	151-0220-00
Q194	151-0220-00			TRANSISTOR:SILICON,PNP	80009	151-0220-00
Q198	151-0192-00			TRANSISTOR:SILICON,NPN,SEL FROM MPS6521	80009	151-0192-00
Q512	151-0135-00			TRANSISTOR:GERMANIUM,PNP	04713	2N2635
Q514	151-0221-00			TRANSISTOR:SILICON,PNP	80009	151-0221-00
Q518	151-0424-00			TRANSISTOR:SILICON,NPN	07263	2N5769
Q525	151-0221-00			TRANSISTOR:SILICON,PNP	80009	151-0221-00
Q532	151-0220-00			TRANSISTOR:SILICON,PNP	80009	151-0220-00
Q538	151-0223-00			TRANSISTOR:SILICON,NPN	80009	151-0223-00
Q546	151-0223-00			TRANSISTOR:SILICON,NPN	80009	151-0223-00
Q547	151-0220-00			TRANSISTOR:SILICON,PNP	80009	151-0220-00
Q562	151-0259-00			TRANSISTOR:SILICON,NPN	80009	151-0259-00
Q565	151-0259-00			TRANSISTOR:SILICON,NPN	80009	151-0259-00
Q568	151-0271-00			TRANSISTOR:SILICON,PNP	80009	151-0271-00
Q588	151-0188-00			TRANSISTOR:SILICON,PNP	01295	2N3906
Q595	151-0188-00			TRANSISTOR:SILICON,PNP	01295	2N3906
Q610	151-1011-00			TRANSISTOR:SILICON,JFE,N-CHANNEL,DUAL	80009	151-1011-00
Q620	151-0220-00			TRANSISTOR:SILICON,PNP	80009	151-0220-00
Q624	151-0325-00			TRANSISTOR:SILICON,PNP,SEL FROM 2N4258	80009	151-0325-00
Q628	151-0333-00			TRANSISTOR:SILICON,NPN,SEL FROM MPS918	80009	151-0333-00
Q630	151-0333-00			TRANSISTOR:SILICON,NPN,SEL FROM MPS918	80009	151-0333-00
Q634	151-0220-00			TRANSISTOR:SILICON,PNP	80009	151-0220-00
Q637	151-0221-00			TRANSISTOR:SILICON,PNP	80009	151-0221-00
Q640	151-0325-00			TRANSISTOR:SILICON,PNP,SEL FROM 2N4258	80009	151-0325-00
Q645	151-0221-00			TRANSISTOR:SILICON,PNP	80009	151-0221-00
Q648	151-0221-00			TRANSISTOR:SILICON,PNP	80009	151-0221-00
Q653	151-0212-00			TRANSISTOR:SILICON,NPN	80009	151-0212-00
Q662	151-0221-00			TRANSISTOR:SILICON,PNP	80009	151-0221-00
Q705	151-0192-00			TRANSISTOR:SILICON,NPN,SEL FROM MPS6521	80009	151-0192-00
Q707	151-0192-00			TRANSISTOR:SILICON,NPN,SEL FROM MPS6521	80009	151-0192-00
Q718	151-0192-00			TRANSISTOR:SILICON,NPN,SEL FROM MPS6521	80009	151-0192-00
Q724	151-0220-00			TRANSISTOR:SILICON,PNP	80009	151-0220-00
Q727	151-0192-00			TRANSISTOR:SILICON,NPN,SEL FROM MPS6521	80009	151-0192-00
Q730	151-0223-00			TRANSISTOR:SILICON,NPN	80009	151-0223-00
Q733	151-1006-00			TRANSISTOR:SILICON,JFE,N-CHANNEL	80009	151-1006-00
Q738	151-0223-00			TRANSISTOR:SILICON,NPN	80009	151-0223-00
Q740	151-0192-00			TRANSISTOR:SILICON,NPN,SEL FROM MPS6521	80009	151-0192-00
Q743	151-0192-00			TRANSISTOR:SILICON,NPN,SEL FROM MPS6521	80009	151-0192-00
Q753	151-0192-00			TRANSISTOR:SILICON,NPN,SEL FROM MPS6521	80009	151-0192-00
Q755	151-0503-00			TRANSISTOR:SCR,30V,0.8A	04713	2N5060
Q821	151-0216-00			TRANSISTOR:SILICON,PNP	04713	MPS6523
Q835	151-0367-00			TRANSISTOR:SILICON,NPN,SEL FROM 3571TP	80009	151-0367-00
Q838	151-0367-00			TRANSISTOR:SILICON,NPN,SEL FROM 3571TP	80009	151-0367-00
Q900	151-1022-00			TRANSISTOR:SILICON,JFE,SEL FROM 2N4392	80009	151-1022-00
Q904	151-1022-00			TRANSISTOR:SILICON,JFE,SEL FROM 2N4392	80009	151-1022-00
Q908	151-1022-00			TRANSISTOR:SILICON,JFE,SEL FROM 2N4392	80009	151-1022-00
Q912	151-1022-00			TRANSISTOR:SILICON,JFE,SEL FROM 2N4392	80009	151-1022-00
Q916	151-1022-00			TRANSISTOR:SILICON,JFE,SEL FROM 2N4392	80009	151-1022-00
Q920	151-1022-00			TRANSISTOR:SILICON,JFE,SEL FROM 2N4392	80009	151-1022-00
Q924	151-1022-00			TRANSISTOR:SILICON,JFE,SEL FROM 2N4392	80009	151-1022-00
Q928	151-1022-00			TRANSISTOR:SILICON,JFE,SEL FROM 2N4392	80009	151-1022-00

# Replaceable Electrical Parts—7D10

Ckt No.	Tektronix Part No.	Serial/Model No. Eff	Dscont	Name & Description	Mfr Code	Mfr Part Number
Q968	151-0220-00			TRANSISTOR:SILICON,PNP	80009	151-0220-00
Q1025	151-0192-00			TRANSISTOR:SILICON,NPN,SEL FROM MPS6521	80009	151-0192-00
Q1028	151-0192-00			TRANSISTOR:SILICON,NPN,SEL FROM MPS6521	80009	151-0192-00
Q1034	151-0335-00			TRANSISTOR:SILICON,PNP	80009	151-0335-00
Q1036	151-0235-00			TRANSISTOR:SILICON,PNP	80009	151-0235-00
Q1038	151-0335-00			TRANSISTOR:SILICON,PNP	80009	151-0335-00
R1	315-0472-00			RES.,FXD,CMPSN:4.7K OHM,5%,0.25W	01121	CB4725
R2	315-0101-00			RES.,FXD,CMPSN:100 OHM,5%,0.25W	01121	CB1015
R4	315-0470-00			RES.,FXD,CMPSN:47 OHM,5%,0.25W	01121	CB4705
R6	321-0448-00			RES.,FXD,FILM:453K OHM,1%,0.125W	91637	MFF1816G45302F
R7	321-0361-00			RES.,FXD,FILM:56.2K OHM,1%,0.125W	91637	MFF1816G56201F
R9	315-0470-00			RES.,FXD,CMPSN:47 OHM,5%,0.25W	01121	CB4705
R12	321-0452-00			RES.,FXD,FILM:499K OHM,1%,0.125W	91637	MFF1816G49902F
R13	315-0510-00			RES.,FXD,CMPSN:51 OHM,5%,0.25W	01121	CB5105
R21	315-0392-00			RES.,FXD,CMPSN:3.9K OHM,5%,0.25W	01121	CB3925
R22	315-0183-00			RES.,FXD,CMPSN:18K OHM,5%,0.25W	01121	CB1835
R24	315-0221-00			RES.,FXD,CMPSN:220 OHM,5%,0.25W	01121	CB2215
R26	315-0562-00			RES.,FXD,CMPSN:5.6K OHM,5%,0.25W	01121	CB5625
R27	315-0202-00			RES.,FXD,CMPSN:2K OHM,5%,0.25W	01121	CB2025
R28	315-0682-00			RES.,FXD,CMPSN:6.8K OHM,5%,0.25W	01121	CB6825
R30	321-0452-00			RES.,FXD,FILM:499K OHM,1%,0.125W	91637	MFF1816G49902F
R32	315-0101-00			RES.,FXD,CMPSN:100 OHM,5%,0.25W	01121	CB1015
R35	315-0511-00			RES.,FXD,CMPSN:510 OHM,5%,0.25W	01121	CB5115
R37	315-0102-00			RES.,FXD,CMPSN:1K OHM,5%,0.25W	01121	CB1025
R38	315-0202-00			RES.,FXD,CMPSN:2K OHM,5%,0.25W	01121	CB2025
R41	315-0510-00			RES.,FXD,CMPSN:51 OHM,5%,0.25W	01121	CB5105
R42	315-0751-00			RES.,FXD,CMPSN:750 OHM,5%,0.25W	01121	CB7515
R44	315-0820-00			RES.,FXD,CMPSN:82 OHM,5%,0.25W	01121	CB8205
R46	315-0510-00			RES.,FXD,CMPSN:51 OHM,5%,0.25W	01121	CB5105
R48	321-0199-00			RES.,FXD,FILM:1.15K OHM,1%,0.125W	91637	MFF1816G11500F
R49	311-0634-00			RES.,VAR,NONWIR:500 OHM,10%,0.50W	80740	62-55-3
R50	321-0239-00			RES.,FXD,FILM:3.01K OHM,1%,0.125W	91637	MFF1816G30100F
R52	315-0510-00			RES.,FXD,CMPSN:51 OHM,5%,0.25W	01121	CB5105
R55	321-0072-00			RES.,FXD,FILM:54.9 OHM,1%,0.125W	91637	MFF1816G5490F
R57	321-0072-00			RES.,FXD,FILM:54.9 OHM,1%,0.125W	91637	MFF1816G5490F
R60	322-0212-00			RES.,FXD,FILM:1.58K OHM,1%,0.25W	75042	CEBT0-1581F
R61	321-0113-00			RES.,FXD,FILM:147 OHM,1%,0.125W	91637	MFF1816G147ROF
R63	321-0113-00			RES.,FXD,FILM:147 OHM,1%,0.125W	91637	MFF1816G147ROF
R64	322-0210-00			RES.,FXD,FILM:1.5K OHM,1%,0.25W	75042	CEBT0-1501F
R66	321-0113-00			RES.,FXD,FILM:147 OHM,1%,0.125W	91637	MFF1816G147ROF
R68	321-0113-00			RES.,FXD,FILM:147 OHM,1%,0.125W	91637	MFF1816G147ROF
R69	322-0210-00			RES.,FXD,FILM:1.5K OHM,1%,0.25W	75042	CEBT0-1501F
R71	322-0175-00			RES.,FXD,FILM:649 OHM,1%,0.25W	75042	CEBT0-6490F
R73	322-0239-00			RES.,FXD,FILM:3.01K OHM,1%,0.25W	75042	CEBT0-3011F
R75	315-0101-00			RES.,FXD,CMPSN:100 OHM,5%,0.25W	01121	CB1015
R76	323-0197-00			RES.,FXD,FILM:1.1K OHM,1%,0.50W	75042	CECT0-1101F
R77	311-0622-00			RES.,VAR,NONWIR:100 OHM,10%,0.50W	80740	62-53-5
R78	322-0172-00			RES.,FXD,FILM:604 OHM,1%,0.25W	75042	CEBT0-6040F
R79	321-0211-00			RES.,FXD,FILM:1.54K OHM,1%,0.125W	91637	MFF1816G15400F
R80	315-0680-00			RES.,FXD,CMPSN:68 OHM,5%,0.25W	01121	CB6805
R82	315-0103-00			RES.,FXD,CMPSN:10K OHM,5%,0.25W	01121	CB1035
R84	315-0303-00			RES.,FXD,CMPSN:30K OHM,5%,0.25W	01121	CB3035

Replaceable Electrical Parts—7D10

Ckt No.	Tektronix Part No.	Serial/Model No. Eff Dscont	Name & Description	Mfr Code	Mfr Part Number
R86	315-0303-00		RES.,FXD,CMPSN:30K OHM,5%,0.25W	01121	CB3035
R89	315-0222-00		RES.,FXD,CMPSN:2.2K OHM,5%,0.25W	01121	CB2225
R96	315-0101-00		RES.,FXD,CMPSN:100 OHM,5%,0.25W	01121	CB1015
R101	315-0150-00		RES.,FXD,CMPSN:15 OHM,5%,0.25W	01121	CB1505
R103	315-0150-00		RES.,FXD,CMPSN:15 OHM,5%,0.25W	01121	CB1505
R104	315-0162-00		RES.,FXD,CMPSN:1.6K OHM,5%,0.25W	01121	CB1625
R107	SELECTED				
R108	315-0222-00		RES.,FXD,CMPSN:2.2K OHM,5%,0.25W	01121	CB2225
R109	315-0123-00		RES.,FXD,CMPSN:12K OHM,5%,0.25W	01121	CB1235
R111	311-1192-00		RES.,VAR, NONWIR:10K OHM,20%,1W	12637	381-CM39695
R113	315-0101-00		RES.,FXD,CMPSN:100 OHM,5%,0.25W	01121	CB1015
R115	315-0101-00		RES.,FXD,CMPSN:100 OHM,5%,0.25W	01121	CB1015
R118	321-0193-00		RES.,FXD,FILM:1K OHM,1%,0.125W	91637	MPF1816G10000F
R119	315-0300-00		RES.,FXD,CMPSN:30 OHM,5%,0.25W	01121	CB3005
R120	321-0193-00		RES.,FXD,FILM:1K OHM,1%,0.125W	91637	MPF1816G10000F
R122	315-0622-00		RES.,FXD,CMPSN:6.2K OHM,5%,0.25W	01121	CB6225
R124	315-0302-00		RES.,FXD,CMPSN:3K OHM,5%,0.25W	01121	CB3025
R126	315-0622-00		RES.,FXD,CMPSN:6.2K OHM,5%,0.25W	01121	CB6225
R128	315-0242-00		RES.,FXD,CMPSN:2.4K OHM,5%,0.25W	01121	CB2425
R130	315-0101-00		RES.,FXD,CMPSN:100 OHM,5%,0.25W	01121	CB1015
R132	315-0270-00		RES.,FXD,CMPSN:27 OHM,5%,0.25W	01121	CB2705
R133	315-0221-00		RES.,FXD,CMPSN:220 OHM,5%,0.25W	01121	CB2215
R134	315-0121-00		RES.,FXD,CMPSN:120 OHM,5%,0.25W	01121	CB1215
R135	315-0300-00		RES.,FXD,CMPSN:30 OHM,5%,0.25W	01121	CB3005
R137	315-0150-00		RES.,FXD,CMPSN:15 OHM,5%,0.25W	01121	CB1505
R138	315-0241-00		RES.,FXD,CMPSN:240 OHM,5%,0.25W	01121	CB2415
R139	323-0192-00		RES.,FXD,FILM:976 OHM,1%,0.50W	75042	CECT0-9760F
R140	315-0242-00		RES.,FXD,CMPSN:2.4K OHM,5%,0.25W	01121	CB2425
R141	315-0360-00		RES.,FXD,CMPSN:36 OHM,5%,0.25W	01121	CB3605
R143	315-0331-00		RES.,FXD,CMPSN:330 OHM,5%,0.25W	01121	CB3315
R145	315-0470-00		RES.,FXD,CMPSN:47 OHM,5%,0.25W	01121	CB4705
R147	315-0471-00		RES.,FXD,CMPSN:470 OHM,5%,0.25W	01121	CB4715
R148	315-0202-00		RES.,FXD,CMPSN:2K OHM,5%,0.25W	01121	CB2025
R150	315-0101-00		RES.,FXD,CMPSN:100 OHM,5%,0.25W	01121	CB1015
R151	311-0635-00		RES.,VAR, NONWIR:1K OHM,10%,0.50W	80740	62-56-3
R152	315-0162-00		RES.,FXD,CMPSN:1.6K OHM,5%,0.25W	01121	CB1625
R154	315-0470-00		RES.,FXD,CMPSN:47 OHM,5%,0.25W	01121	CB4705
R156	315-0471-00		RES.,FXD,CMPSN:470 OHM,5%,0.25W	01121	CB4715
R157	315-0202-00		RES.,FXD,CMPSN:2K OHM,5%,0.25W	01121	CB2025
R160	315-0201-00		RES.,FXD,CMPSN:200 OHM,5%,0.25W	01121	CB2015
R161	311-0634-00		RES.,VAR, NONWIR:500 OHM,10%,0.50W	80740	62-55-3
R162	315-0821-00		RES.,FXD,CMPSN:820 OHM,5%,0.25W	01121	CB8215
R164	315-0391-00		RES.,FXD,CMPSN:390 OHM,5%,0.25W	01121	CB3915
R166	315-0470-00		RES.,FXD,CMPSN:47 OHM,5%,0.25W	01121	CB4705
R168	315-0470-00		RES.,FXD,CMPSN:47 OHM,5%,0.25W	01121	CB4705
R170	315-0101-00		RES.,FXD,CMPSN:100 OHM,5%,0.25W	01121	CB1015
R172	315-0270-00		RES.,FXD,CMPSN:27 OHM,5%,0.25W	01121	CB2705
R173	315-0221-00		RES.,FXD,CMPSN:220 OHM,5%,0.25W	01121	CB2215
R174	315-0121-00		RES.,FXD,CMPSN:120 OHM,5%,0.25W	01121	CB1215
R175	315-0300-00		RES.,FXD,CMPSN:30 OHM,5%,0.25W	01121	CB3005
R177	315-0150-00		RES.,FXD,CMPSN:15 OHM,5%,0.25W	01121	CB1505
R178	315-0301-00		RES.,FXD,CMPSN:300 OHM,5%,0.25W	01121	CB3015
R179	323-0192-00		RES.,FXD,FILM:976 OHM,1%,0.50W	75042	CECT0-9760F

# Replaceable Electrical Parts—7D10

Ckt No.	Tektronix Part No.	Serial/Model No. Eff	Dscont	Name & Description	Mfr Code	Mfr Part Number
R181	315-0202-00			RES.,FXD,CMPSN:2K OHM,5%,0.25W	01121	CB2025
R182	315-0301-00			RES.,FXD,CMPSN:300 OHM,5%,0.25W	01121	CB3015
R184	315-0303-00			RES.,FXD,CMPSN:30K OHM,5%,0.25W	01121	CB3035
R185	315-0183-00			RES.,FXD,CMPSN:18K OHM,5%,0.25W	01121	CB1835
R186	315-0131-00			RES.,FXD,CMPSN:130 OHM,5%,0.25W	01121	CB1315
R188	315-0101-00			RES.,FXD,CMPSN:100 OHM,5%,0.25W	01121	CB1015
R189	315-0152-00			RES.,FXD,CMPSN:1.5K OHM,5%,0.25W	01121	CB1525
R190	315-0154-00			RES.,FXD,CMPSN:150K OHM,5%,0.25W	01121	CB1545
R191	315-0223-00			RES.,FXD,CMPSN:22K OHM,5%,0.25W	01121	CB2235
R193	315-0332-00			RES.,FXD,CMPSN:3.3K OHM,5%,0.25W	01121	CB3325
R195	315-0223-00			RES.,FXD,CMPSN:22K OHM,5%,0.25W	01121	CB2235
R196	315-0912-00			RES.,FXD,CMPSN:9.1K OHM,5%,0.25W	01121	CB9125
R197	315-0151-00			RES.,FXD,CMPSN:150 OHM,5%,0.25W	01121	CB1515
R198	315-0270-00			RES.,FXD,CMPSN:27 OHM,5%,0.25W	01121	CB2705
R510	315-0100-00			RES.,FXD,CMPSN:10 OHM,5%,0.25W	01121	CB1005
R511	315-0470-00			RES.,FXD,CMPSN:47 OHM,5%,0.25W	01121	CB4705
R516	315-0151-00			RES.,FXD,CMPSN:150 OHM,5%,0.25W	01121	CB1515
R517	315-0102-00			RES.,FXD,CMPSN:1K OHM,5%,0.25W	01121	CB1025
R519	315-0101-00			RES.,FXD,CMPSN:100 OHM,5%,0.25W	01121	CB1015
R521	315-0101-00			RES.,FXD,CMPSN:100 OHM,5%,0.25W	01121	CB1015
R522	315-0152-00			RES.,FXD,CMPSN:1.5K OHM,5%,0.25W	01121	CB1525
R524	315-0270-00			RES.,FXD,CMPSN:27 OHM,5%,0.25W	01121	CB2705
R525	301-0471-00			RES.,FXD,CMPSN:470 OHM,5%,0.50W	01121	EB4715
R527	315-0153-00			RES.,FXD,CMPSN:15K OHM,5%,0.25W	01121	CB1535
R528	315-0151-00			RES.,FXD,CMPSN:150 OHM,5%,0.25W	01121	CB1515
R529	315-0151-00			RES.,FXD,CMPSN:150 OHM,5%,0.25W	01121	CB1515
R531	315-0512-00			RES.,FXD,CMPSN:5.1K OHM,5%,0.25W	01121	CB5125
R532	315-0153-00			RES.,FXD,CMPSN:15K OHM,5%,0.25W	01121	CB1535
R534	315-0621-00			RES.,FXD,CMPSN:620 OHM,5%,0.25W	01121	CB6215
R535	315-0102-00			RES.,FXD,CMPSN:1K OHM,5%,0.25W	01121	CB1025
R537	315-0182-00			RES.,FXD,CMPSN:1.8K OHM,5%,0.25W	01121	CB1825
R538	315-0152-00			RES.,FXD,CMPSN:1.5K OHM,5%,0.25W	01121	CB1525
R541	315-0160-00			RES.,FXD,CMPSN:16 OHM,5%,0.25W	01121	CB1605
R542	315-0471-00			RES.,FXD,CMPSN:470 OHM,5%,0.25W	01121	CB4715
R543	315-0102-00			RES.,FXD,CMPSN:1K OHM,5%,0.25W	01121	CB1025
R545	315-0102-00			RES.,FXD,CMPSN:1K OHM,5%,0.25W	01121	CB1025
R547	315-0620-00			RES.,FXD,CMPSN:62 OHM,5%,0.25W	01121	CB6205
R548	315-0242-00			RES.,FXD,CMPSN:2.4K OHM,5%,0.25W	01121	CB2425
R549	315-0822-00			RES.,FXD,CMPSN:8.2K OHM,5%,0.25W	01121	CB8225
R555	315-0820-00			RES.,FXD,CMPSN:82 OHM,5%,0.25W	01121	CB8205
R556	315-0201-00			RES.,FXD,CMPSN:200 OHM,5%,0.25W	01121	CB2015
R560	315-0301-00			RES.,FXD,CMPSN:300 OHM,5%,0.25W	01121	CB3015
R562	315-0221-00			RES.,FXD,CMPSN:220 OHM,5%,0.25W	01121	CB2215
R563	315-0103-00			RES.,FXD,CMPSN:10K OHM,5%,0.25W	01121	CB1035
R565	321-0104-00			RES.,FXD,FILM:118 OHM,1%,0.125W	91637	MFF1816G118ROF
R566	323-0192-00			RES.,FXD,FILM:976 OHM,1%,0.50W	75042	CECT0-9760F
R568	321-0014-00			RES.,FXD,FILM:13.7 OHM,1%,0.125W	91637	MFF1816G13R70F
R571	315-0150-00			RES.,FXD,CMPSN:15 OHM,5%,0.25W	01121	CB1505
R572	321-0069-00			RES.,FXD,FILM:51.1 OHM,1%,0.125W	91637	MFF1816G51R10F
R577	321-0139-00			RES.,FXD,FILM:274 OHM,1%,0.125W	91637	MFF1816G274ROF
R578	321-0110-00			RES.,FXD,FILM:137 OHM,1%,0.125W	91637	MFF1816G137ROF
R581	315-0221-00			RES.,FXD,CMPSN:220 OHM,5%,0.25W	01121	CB2215
R586	315-0102-00			RES.,FXD,CMPSN:1K OHM,5%,0.25W	01121	CB1025

## Replaceable Electrical Parts—7D10

Ckt No.	Tektronix Part No.	Serial/Model No. Eff	Dscont	Name & Description	Mfr Code	Mfr Part Number
R587	315-0103-00			RES.,FXD,CMPSN:10K OHM,5%,0.25W	01121	CB1035
R589	321-0335-00			RES.,FXD,FILM:30.1K OHM,1%,0.125W	91637	MFF1816G30101F
R591	321-0281-00			RES.,FXD,FILM:8.25K OHM,1%,0.125W	91637	MFF1816G82500F
R593	315-0221-00			RES.,FXD,CMPSN:220 OHM,5%,0.25W	01121	CB2215
R596	315-0103-00			RES.,FXD,CMPSN:10K OHM,5%,0.25W	01121	CB1035
R598	321-0329-00			RES.,FXD,FILM:26.1K OHM,1%,0.125W	91637	MFF1816G26101F
R599	315-0512-00			RES.,FXD,CMPSN:5.1K OHM,5%,0.25W	01121	CB5125
R601	315-0913-00			RES.,FXD,CMPSN:91K OHM,5%,0.25W	01121	CB9135
R602	315-0101-00			RES.,FXD,CMPSN:100 OHM,5%,0.25W	01121	CB1015
R604	315-0512-00			RES.,FXD,CMPSN:5.1K OHM,5%,0.25W	01121	CB5125
R605	315-0512-00			RES.,FXD,CMPSN:5.1K OHM,5%,0.25W	01121	CB5125
R607	315-0512-00			RES.,FXD,CMPSN:5.1K OHM,5%,0.25W	01121	CB5125
R609	315-0915-00			RES.,FXD,CMPSN:9.1M OHM,5%,0.25W	01121	CB9155
R610	315-0101-00			RES.,FXD,CMPSN:100 OHM,5%,0.25W	01121	CB1015
R612	315-0511-00			RES.,FXD,CMPSN:510 OHM,5%,0.25W	01121	CB5115
R615	311-1192-00			RES.,VAR,NONWIR:10K OHM,20%,1W	12637	381-CM39695
R617	315-0272-00			RES.,FXD,CMPSN:2.7K OHM,5%,0.25W	01121	CB2725
R618	315-0132-00			RES.,FXD,CMPSN:1.3K OHM,5%,0.25W	01121	CB1325
R619	315-0103-00			RES.,FXD,CMPSN:10K OHM,5%,0.25W	01121	CB1035
R620	315-0331-00			RES.,FXD,CMPSN:330 OHM,5%,0.25W	01121	CB3315
R622	315-0101-00			RES.,FXD,CMPSN:100 OHM,5%,0.25W	01121	CB1015
R623	315-0392-00			RES.,FXD,CMPSN:3.9K OHM,5%,0.25W	01121	CB3925
R624	315-0331-00			RES.,FXD,CMPSN:330 OHM,5%,0.25W	01121	CB3315
R627	315-0472-00			RES.,FXD,CMPSN:4.7K OHM,5%,0.25W	01121	CB4725
R629	321-0177-00			RES.,FXD,FILM:681 OHM,1%,0.125W	91637	MFF1816G681R0F
R630	315-0472-00			RES.,FXD,CMPSN:4.7K OHM,5%,0.25W	01121	CB4725
R632	315-0222-00			RES.,FXD,CMPSN:2.2K OHM,5%,0.25W	01121	CB2225
R633	315-0183-00			RES.,FXD,CMPSN:18K OHM,5%,0.25W	01121	CB1835
R635	315-0471-00			RES.,FXD,CMPSN:470 OHM,5%,0.25W	01121	CB4715
R636	315-0361-00			RES.,FXD,CMPSN:360 OHM,5%,0.25W	01121	CB3615
R637	315-0331-00			RES.,FXD,CMPSN:330 OHM,5%,0.25W	01121	CB3315
R638	315-0331-00			RES.,FXD,CMPSN:330 OHM,5%,0.25W	01121	CB3315
R639	315-0682-00			RES.,FXD,CMPSN:6.8K OHM,5%,0.25W	01121	CB6825
R640	315-0681-00			RES.,FXD,CMPSN:680 OHM,5%,0.25W	01121	CB6815
R645	315-0102-00			RES.,FXD,CMPSN:1K OHM,5%,0.25W	01121	CB1025
R647	301-0102-00			RES.,FXD,CMPSN:1K OHM,5%,0.50W	01121	EB1025
R649	315-0181-00			RES.,FXD,CMPSN:180 OHM,5%,0.25W	01121	CB1815
R650	315-0271-00			RES.,FXD,CMPSN:270 OHM,5%,0.25W	01121	CB2715
R651	315-0301-00			RES.,FXD,CMPSN:300 OHM,5%,0.25W	01121	CB3015
R654	315-0101-00			RES.,FXD,CMPSN:100 OHM,5%,0.25W	01121	CB1015
R656	321-0066-00			RES.,FXD,FILM:47.5 OHM,1%,0.125W	91637	MFF1816G47R50F
R661	301-0122-00			RES.,FXD,CMPSN:1.2K OHM,5%,0.50W	01121	EB1225
R663	315-0181-00			RES.,FXD,CMPSN:180 OHM,5%,0.25W	01121	CB1815
R664	315-0271-00			RES.,FXD,CMPSN:270 OHM,5%,0.25W	01121	CB2715
R666	315-0101-00			RES.,FXD,CMPSN:100 OHM,5%,0.25W	01121	CB1015
R668	315-0821-00			RES.,FXD,CMPSN:820 OHM,5%,0.25W	01121	CB8215
R669	315-0102-00			RES.,FXD,CMPSN:1K OHM,5%,0.25W	01121	CB1025
R671	315-0222-00			RES.,FXD,CMPSN:2.2K OHM,5%,0.25W	01121	CB2225
R672	315-0510-00			RES.,FXD,CMPSN:51 OHM,5%,0.25W	01121	CB5105
R700	311-0959-00			RES.,VAR,WW:10K OHM,5%,1.5W	71590	BA165-007
R702	315-0103-00			RES.,FXD,CMPSN:10K OHM,5%,0.25W	01121	CB1035
R704	321-0402-00			RES.,FXD,FILM:150K OHM,1%,0.125W	91637	MFF1816G15002F
R706	315-0302-00			RES.,FXD,CMPSN:3K OHM,5%,0.25W	01121	CB3025

# Replaceable Electrical Parts—7D10

Ckt No.	Tektronix Part No.	Serial/Model No. Eff	Dscont	Name & Description	Mfr Code	Mfr Part Number
R708	315-0272-00			RES., FXD, CMPSN: 2.7K OHM, 5%, 0.25W	01121	CB2725
R709	321-0322-00			RES., FXD, FILM: 22.1K OHM, 1%, 0.125W	91637	MFF1816G22101F
R711	315-0102-00			RES., FXD, CMPSN: 1K OHM, 5%, 0.25W	01121	CB1025
R712	321-0352-00			RES., FXD, FILM: 45.3K OHM, 1%, 0.125W	91637	MFF1816G45301F
R713	321-0235-00			RES., FXD, FILM: 2.74K OHM, 1%, 0.125W	91637	MFF1816G27400F
R715	321-0235-00			RES., FXD, FILM: 2.74K OHM, 1%, 0.125W	91637	MFF1816G27400F
R716	321-0352-00			RES., FXD, FILM: 45.3K OHM, 1%, 0.125W	91637	MFF1816G45301F
R718	315-0241-00			RES., FXD, CMPSN: 240 OHM, 5%, 0.25W	01121	CB2415
R720	321-0260-00			RES., FXD, FILM: 4.99K OHM, 1%, 0.125W	91637	MFF1816G49900F
R721	315-0272-00			RES., FXD, CMPSN: 2.7K OHM, 5%, 0.25W	01121	CB2725
R723	315-0104-00			RES., FXD, CMPSN: 100K OHM, 5%, 0.25W	01121	CB1045
R725	315-0122-00			RES., FXD, CMPSN: 1.2K OHM, 5%, 0.25W	01121	CB1225
R727	315-0153-00			RES., FXD, CMPSN: 15K OHM, 5%, 0.25W	01121	CB1535
R729	315-0102-00			RES., FXD, CMPSN: 1K OHM, 5%, 0.25W	01121	CB1025
R734	315-0682-00			RES., FXD, CMPSN: 6.8K OHM, 5%, 0.25W	01121	CB6825
R735	315-0153-00			RES., FXD, CMPSN: 15K OHM, 5%, 0.25W	01121	CB1535
R737	315-0101-00			RES., FXD, CMPSN: 100 OHM, 5%, 0.25W	01121	CB1015
R741	315-0202-00			RES., FXD, CMPSN: 2K OHM, 5%, 0.25W	01121	CB2025
R744	315-0152-00			RES., FXD, CMPSN: 1.5K OHM, 5%, 0.25W	01121	CB1525
R751	315-0304-00			RES., FXD, CMPSN: 300K OHM, 5%, 0.25W	01121	CB3045
R752	315-0222-00			RES., FXD, CMPSN: 2.2K OHM, 5%, 0.25W	01121	CB2225
R753	315-0431-00			RES., FXD, CMPSN: 430 OHM, 5%, 0.25W	01121	CB4315
R754	315-0221-00			RES., FXD, CMPSN: 220 OHM, 5%, 0.25W	01121	CB2215
R756	315-0472-00			RES., FXD, CMPSN: 4.7K OHM, 5%, 0.25W	01121	CB4725
R757	315-0103-00			RES., FXD, CMPSN: 10K OHM, 5%, 0.25W	01121	CB1035
R798	315-0101-00			RES., FXD, CMPSN: 100 OHM, 5%, 0.25W	01121	CB1015
R833	315-0431-00			RES., FXD, CMPSN: 430 OHM, 5%, 0.25W	01121	CB4315
R836	315-0300-00			RES., FXD, CMPSN: 30 OHM, 5%, 0.25W	01121	CB3005
R837	315-0331-00			RES., FXD, CMPSN: 330 OHM, 5%, 0.25W	01121	CB3315
R838	315-0181-00			RES., FXD, CMPSN: 180 OHM, 5%, 0.25W	01121	CB1815
R900	315-0302-00			RES., FXD, CMPSN: 3K OHM, 5%, 0.25W	01121	CB3025
R904	315-0302-00			RES., FXD, CMPSN: 3K OHM, 5%, 0.25W	01121	CB3025
R908	315-0302-00			RES., FXD, CMPSN: 3K OHM, 5%, 0.25W	01121	CB3025
R912	315-0302-00			RES., FXD, CMPSN: 3K OHM, 5%, 0.25W	01121	CB3025
R916	315-0302-00			RES., FXD, CMPSN: 3K OHM, 5%, 0.25W	01121	CB3025
R920	315-0302-00			RES., FXD, CMPSN: 3K OHM, 5%, 0.25W	01121	CB3025
R924	315-0302-00			RES., FXD, CMPSN: 3K OHM, 5%, 0.25W	01121	CB3025
R928	315-0302-00			RES., FXD, CMPSN: 3K OHM, 5%, 0.25W	01121	CB3025
R930	315-0272-00			RES., FXD, CMPSN: 2.7K OHM, 5%, 0.25W	01121	CB2725
R932	315-0272-00			RES., FXD, CMPSN: 2.7K OHM, 5%, 0.25W	01121	CB2725
R934	315-0272-00			RES., FXD, CMPSN: 2.7K OHM, 5%, 0.25W	01121	CB2725
R936	315-0272-00			RES., FXD, CMPSN: 2.7K OHM, 5%, 0.25W	01121	CB2725
R960	321-0398-00			RES., FXD, FILM: 137K OHM, 1%, 0.125W	91637	MFF1816G13702F
R961	321-0369-00			RES., FXD, FILM: 68.1K OHM, 1%, 0.125W	91637	MFF1816G68101F
R962	321-0690-00			RES., FXD, FILM: 34K OHM, 1%, 0.125W	91637	MFF1816G34001D
R963	321-0673-00			RES., FXD, FILM: 17K OHM, 0.5%, 0.125W	91637	MFF1816D17001D
R965	321-0604-00			RES., FXD, FILM: 30K OHM, 0.25%, 0.125W	91637	MFF1816D30001C
R969	321-1289-03			RES., FXD, FILM: 10.1K OHM, 0.25%, 0.125W	91637	MFF1816D10101C
R974	321-0289-07			RES., FXD, FILM: 10K OHM, 0.1%, 0.125W	91637	MFF1816C10001B
R984	315-0101-00			RES., FXD, CMPSN: 100 OHM, 5%, 0.25W	01121	CB1015
R1009	315-0150-00			RES., FXD, CMPSN: 15 OHM, 5%, 0.25W	01121	CB1505
R1011	307-0106-00			RES., FXD, CMPSN: 4.7 OHM, 5%, 0.25W	01121	CB47G5

## Replaceable Electrical Parts—7D10

Ckt No.	Tektronix Part No.	Serial/Model No. Eff	Dscont	Name & Description	Mfr Code	Mfr Part Number
R1015	307-0106-00			RES.,FXD,CMPNSN:4.7 OHM,5%,0.25W	01121	CB47G5
R1024	315-0561-00			RES.,FXD,CMPNSN:560 OHM,5%,0.25W	01121	CB5615
R1026	315-0122-00			RES.,FXD,CMPNSN:1.2K OHM,5%,0.25W	01121	CB1225
R1028	315-0681-00			RES.,FXD,CMPNSN:680 OHM,5%,0.25W	01121	CB6815
R1030	315-0303-00			RES.,FXD,CMPNSN:30K OHM,5%,0.25W	01121	CB3035
R1031	315-0471-00			RES.,FXD,CMPNSN:470 OHM,5%,0.25W	01121	CB4715
R1033	315-0101-00			RES.,FXD,CMPNSN:100 OHM,5%,0.25W	01121	CB1015
R1034	315-0223-00			RES.,FXD,CMPNSN:22K OHM,5%,0.25W	01121	CB2235
R1036	315-0270-00			RES.,FXD,CMPNSN:27 OHM,5%,0.25W	01121	CB2705
R1069	315-0511-00			RES.,FXD,CMPNSN:510 OHM,5%,0.25W	01121	CB5115
R1074	315-0270-00			RES.,FXD,CMPNSN:27 OHM,5%,0.25W	01121	CB2705
S5 <sup>1</sup>	-----			PUSH BUTTON:TRIGGER SOURCE		
S95 <sup>2</sup>	-----			PUSH BUTTON:TRIGGER COUPLING		
S111 <sup>3</sup>	311-1192-00			RES.,VAR,NONWIR:10K OHM,20%,1W	12637	381-CM39695
S555	-----			PUSH BUTTON:B SWEEP DELAY MODE SWITCH		
S615	311-1192-00			RES.,VAR,NONWIR:10K OHM,20%,1W	12637	381-CM39695
S669	260-0723-00			SWITCH,SLIDE:DPDT,0.5A,125VAC	79727	GF126-0028
S754	260-0735-00			SWITCH,PUSH:SPST	81073	39-1
T579	120-0444-00			XFMR,TOROID:5 TURNS,BIFILAR	80009	120-0444-00
T1038	120-0784-00			TRANSFORMER,PLS:POT CORE,SW REGULATOR	80009	120-0784-00
U60	155-0022-00			MICROCIRCUIT,DI:A AND B LOGIC ML CHAN SW	80009	155-0022-00
U543	156-0118-00			MICROCIRCUIT,DI:J-K MASTER-SLAVE FLIP-FLOP	01295	SN74S112N
U586	156-0043-00			MICROCIRCUIT,DI:QUAD 2-INPUT POS NOR GATE	80009	156-0043-00
U589	156-0172-00			MICROCIRCUIT,DI:DUAL RETRIG MONOSTABLE MV	80009	156-0172-00
U598	156-0172-00			MICROCIRCUIT,DI:DUAL RETRIG MONOSTABLE MV	80009	156-0172-00
U640	156-0180-00			MICROCIRCUIT,DI:QUAD 2-INPUT NAND GATE	01295	SN74S00N
U747	156-0030-00			MICROCIRCUIT,DI:QUAD 2-INPUT POS NAND GATE	01295	SN7400N
U749	156-0058-00			MICROCIRCUIT,DI:HEX.INVERTER	01295	SN7404N
U760	156-0245-00			MICROCIRCUIT,DI:DECADE CNTR W/UP DOWN CLK	01295	SN74L192N
U762	156-0245-00			MICROCIRCUIT,DI:DECADE CNTR W/UP DOWN CLK	01295	SN74L192N
U764	156-0245-00			MICROCIRCUIT,DI:DECADE CNTR W/UP DOWN CLK	01295	SN74L192N
U766	156-0245-00			MICROCIRCUIT,DI:DECADE CNTR W/UP DOWN CLK	01295	SN74L192N
U768	156-0245-00			MICROCIRCUIT,DI:DECADE CNTR W/UP DOWN CLK	01295	SN74L192N
U770	156-0245-00			MICROCIRCUIT,DI:DECADE CNTR W/UP DOWN CLK	01295	SN74L192N
U772	156-0245-00			MICROCIRCUIT,DI:DECADE CNTR W/UP DOWN CLK	01295	SN74L192N
U780	156-0129-00			MICROCIRCUIT,DI:QUAD 2-INPUT GATE	01295	SN7408N
U782	156-0129-00			MICROCIRCUIT,DI:QUAD 2-INPUT GATE	01295	SN7408N
U784	156-0129-00			MICROCIRCUIT,DI:QUAD 2-INPUT GATE	01295	SN7408N
U786	156-0129-00			MICROCIRCUIT,DI:QUAD 2-INPUT GATE	01295	SN7408N
U788	156-0129-00			MICROCIRCUIT,DI:QUAD 2-INPUT GATE	01295	SN7408N
U790	156-0129-00			MICROCIRCUIT,DI:QUAD 2-INPUT GATE	01295	SN7408N
U792	156-0129-00			MICROCIRCUIT,DI:QUAD 2-INPUT GATE	01295	SN7408N
U800	156-0097-00			MICROCIRCUIT,DI:DIV BY 2 AND 5 RIPPLE CNTR	18324	M8290A
U802	156-0097-00			MICROCIRCUIT,DI:DIV BY 2 AND 5 RIPPLE CNTR	18324	M8290A
U804	156-0091-00			MICROCIRCUIT,DI:DIV BY 2 AND 5 RIPPLE CNTR	18324	N8292A
U806	156-0091-00			MICROCIRCUIT,DI:DIV BY 2 AND 5 RIPPLE CNTR	18324	N8292A
U808	156-0091-00			MICROCIRCUIT,DI:DIV BY 2 AND 5 RIPPLE CNTR	18324	N8292A
U810	156-0091-00			MICROCIRCUIT,DI:DIV BY 2 AND 5 RIPPLE CNTR	18324	N8292A
U812	156-0091-00			MICROCIRCUIT,DI:DIV BY 2 AND 5 RIPPLE CNTR	18324	N8292A
U820	156-0035-00			MICROCIRCUIT,DI:SGL 8-INPUT POS NAND GATE	80009	156-0035-00
U825	156-0035-00			MICROCIRCUIT,DI:SGL 8-INPUT POS NAND GATE	80009	156-0035-00

<sup>1</sup>Replaceable under 670-1221-XX A1 ckt board only.

<sup>2</sup>Replaceable under 670-1222-XX A2 ckt board only.

<sup>3</sup>Replaceable under 670-2148-XX A8 ckt board only.

# Replaceable Electrical Parts—7D10

Ckt No.	Tektronix Part No.	Serial/Model No. Eff	Dscont	Name & Description	Mfr Code	Mfr Part Number
U902	156-0057-00			MICROCIRCUIT,DI:QUAD 2-INPUT NAND GATE	07263	7401PC
U906	156-0057-00			MICROCIRCUIT,DI:QUAD 2-INPUT NAND GATE	07263	7401PC
U910	156-0057-00			MICROCIRCUIT,DI:QUAD 2-INPUT NAND GATE	07263	7401PC
U914	156-0057-00			MICROCIRCUIT,DI:QUAD 2-INPUT NAND GATE	07263	7401PC
U918	156-0057-00			MICROCIRCUIT,DI:QUAD 2-INPUT NAND GATE	07263	7401PC
U922	156-0057-00			MICROCIRCUIT,DI:QUAD 2-INPUT NAND GATE	07263	7401PC
U926	156-0057-00			MICROCIRCUIT,DI:QUAD 2-INPUT NAND GATE	07263	7401PC
U946	156-0035-00			MICROCIRCUIT,DI:SGL 8-INPUT POS NAND GATE	80009	156-0035-00
U948	156-0035-00			MICROCIRCUIT,DI:SGL 8-INPUT POS NAND GATE	80009	156-0035-00
U974	156-0259-00			MICROCIRCUIT,LI:5 TRANSISTOR ARRAY	86684	CA3083
VR114	152-0226-00			SEMICONV DEVICE:ZENER,0.4W,5.1V,5%	81483	69-6584
VR626	152-0127-00			SEMICONV DEVICE:ZENER,0.4W,7.5V,5%	04713	1N755A
VR734	152-0279-00			SEMICONV DEVICE:ZENER,0.4W,5.1V,5%	07910	CD332305



# INSTRUMENT OPTIONS

No options were available for this instrument at the time of this printing.

Information on any subsequent options may be found in the CHANGE INFORMATION section in the back of this manual.



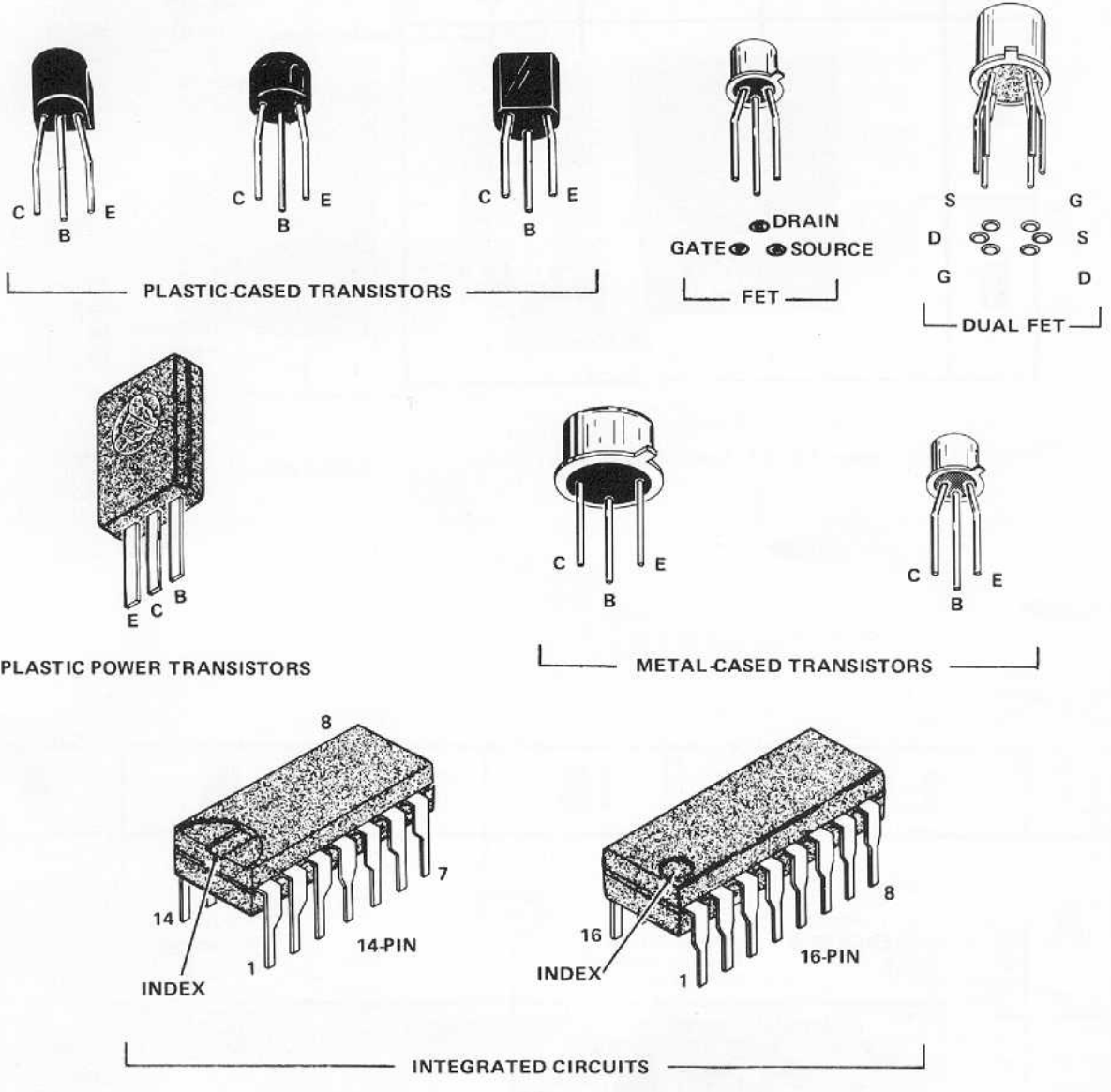

(1377)2148-30

Figure 8-1. Semiconductor lead configurations.

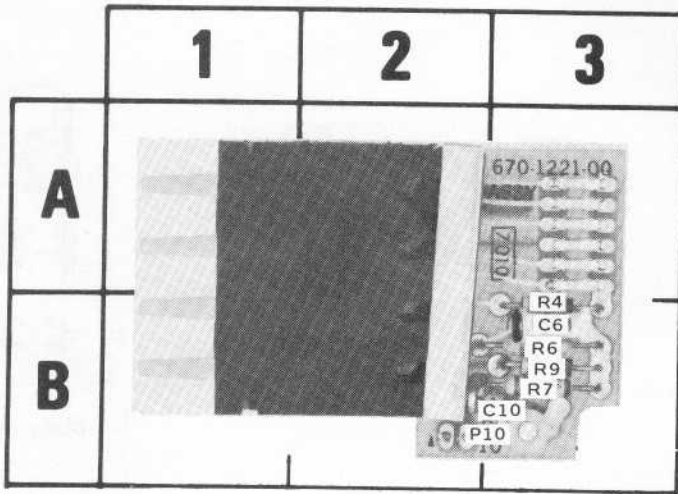

2148-31

GRID LOCATOR FOR FIGS 8-2 & 8-3.

CKT NO	GRID LOC
C6	3B
C10	3B
C96	1A
P10	2B
R4	3A
R6	3B
R7	3B
R9	3B
R92	1A
R96	1A

Figure 8-2. A1—Source switch.

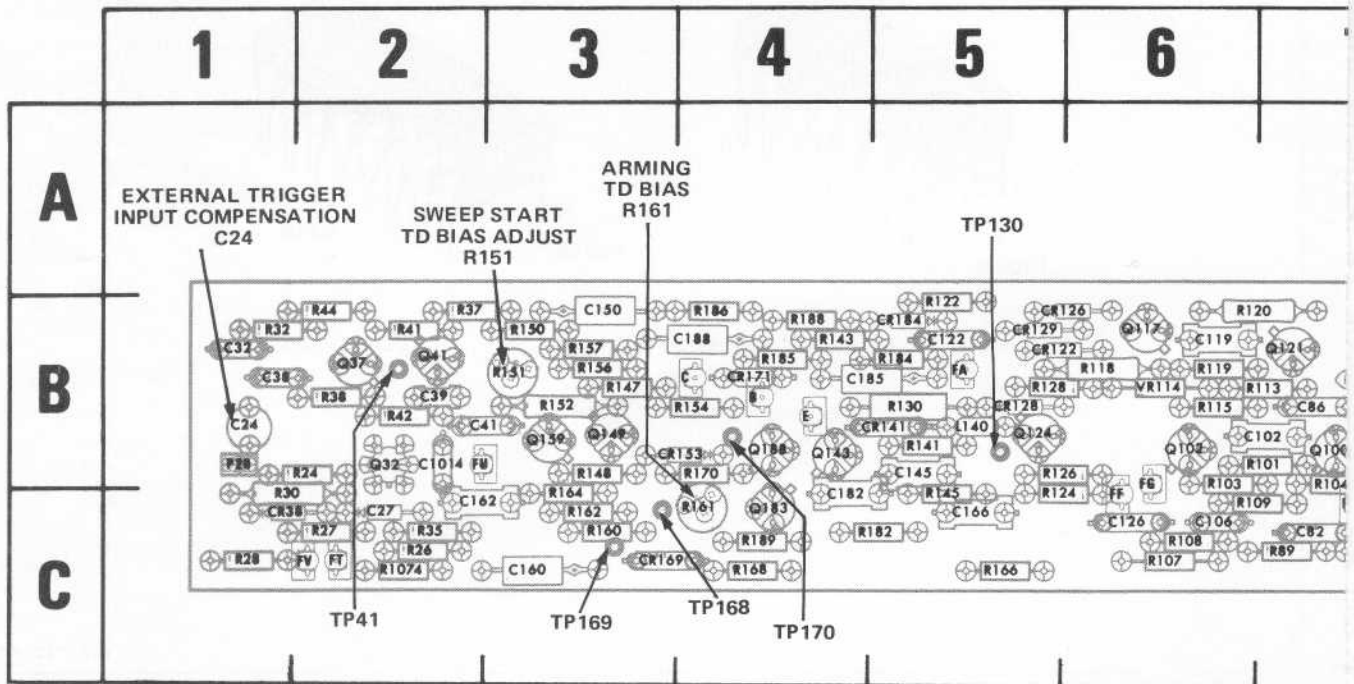
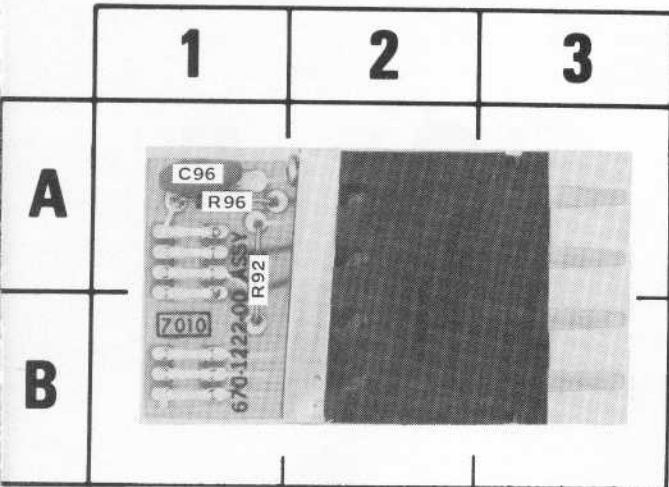
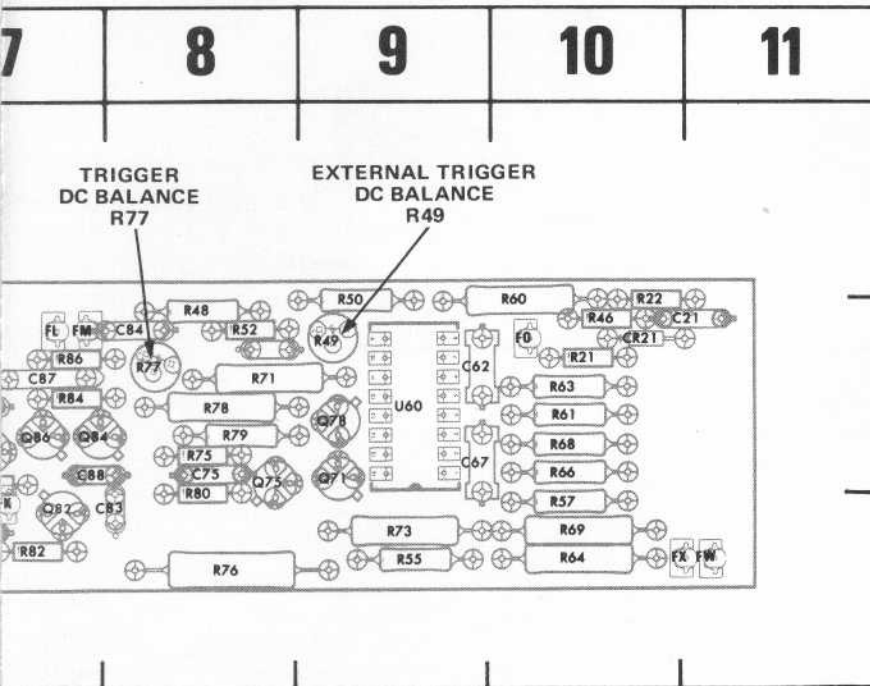

Figure 8-4. A3—Trigger circuit board



2148-32

Figure 8-3. A2—Coupling switch.



(1377)2148-33

GRID LOCATI

CKT NO	GRID LOC	CKT NO	GRID LOC	CKT NO	GRID LOC
C24	1B	C182	4C	Q71	9B
C27	2C	C185	5B	Q75	8B
C32	1B	C188	4B	Q78	9B
C38	1B	C1014	2B	Q82	7C
C39	2B			Q84	7B
C41	2B	CR21	10B	Q86	7B
C62	9B	CR38	1C	Q100	7B
C67	9B	CR122	5B	Q102	6B
C75	8B	CR126	5B	Q117	6B
C82	7C	CR128	5B	Q121	7B
C83	8C	CR129	5B	Q124	5B
C84	8B	CR141	5B	Q143	4B
C86	7B	CR153	4B	Q149	3B
C87	7B	CR169	3C	Q159	3B
C88	7B	CR171	4B	Q183	4C
C102	7B	CR184	5B	Q188	4B
C106	6C			R21	10B
C119	6B	L140	5B	R22	10B
C122	5B			R24	2B
C126	6C	P20	1B	R26	2C
C145	5B			R27	2C
C150	3B	Q21	11B	R28	1C
C160	3C	Q32	2B	R30	1C
C162	2C	Q37	2B	R32	1B
C166	5C	Q41	2B	R35	2C

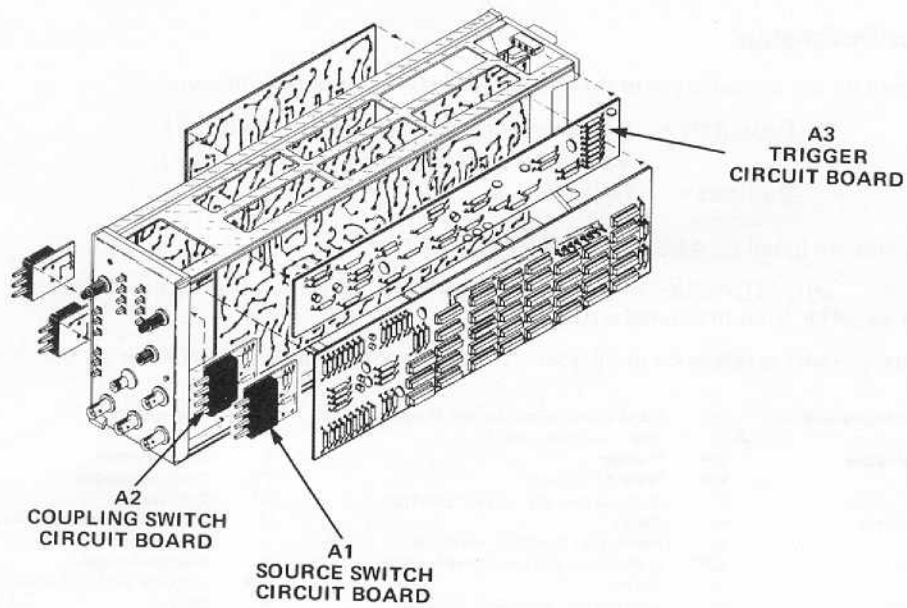

GRID LOCATOR FOR FIG 8-4.

CKT NO	GRID LOC	CKT NO	GRID LOC	CKT NO	GRID LOC	CKT NO	GRID LOC
071	9B	R37	2B	R79	8B	R147	3B
075	8B	R38	2B	R80	8B	R148	3B
078	9B	R41	2B	R82	7C	R150	3B
082	7C	R42	2B	R84	7B	R151	3B
084	7B	R44	2B	R86	7B	R152	3B
086	7B	R46	10B	R89	7C	R154	4B
100	7B	R48	8B	R101	7D	R156	3B
102	6B	R49	9B	R103	6B	R157	3B
117	6B	R50	9B	R104	3C	R160	3C
121	7B	R52	8B	R107	6C	R161	4C
124	5B	R55	9C	R108	6C	R162	3C
143	4B	R57	10C	R109	6C	R166	5C
149	3B	R60	10B	R113	7B	R168	4C
159	3B	R61	10B	R115	6B	R170	4B
183	4C	R63	10B	R118	6B	R182	5C
188	4B	R64	10C	R119	6B	R184	5B
21	10B	R66	10B	R120	6B	R185	4B
22	10B	R68	10B	R122	5B	R186	4B
24	2B	R69	10C	R124	5C	R188	4B
26	2C	R71	8B	R126	5B	R189	4C
27	2C	R73	9C	R128	5B	R1074	2C
28	1C	R75	8B	R130	5B		
30	1C	R76	8C	R141	5B	U60	9B
32	1B	R77	8B	R143	4B		
35	2C	R78	8B	R145	5C	VR114	6B



Digitally signed by  
<http://www.aa4df.com>

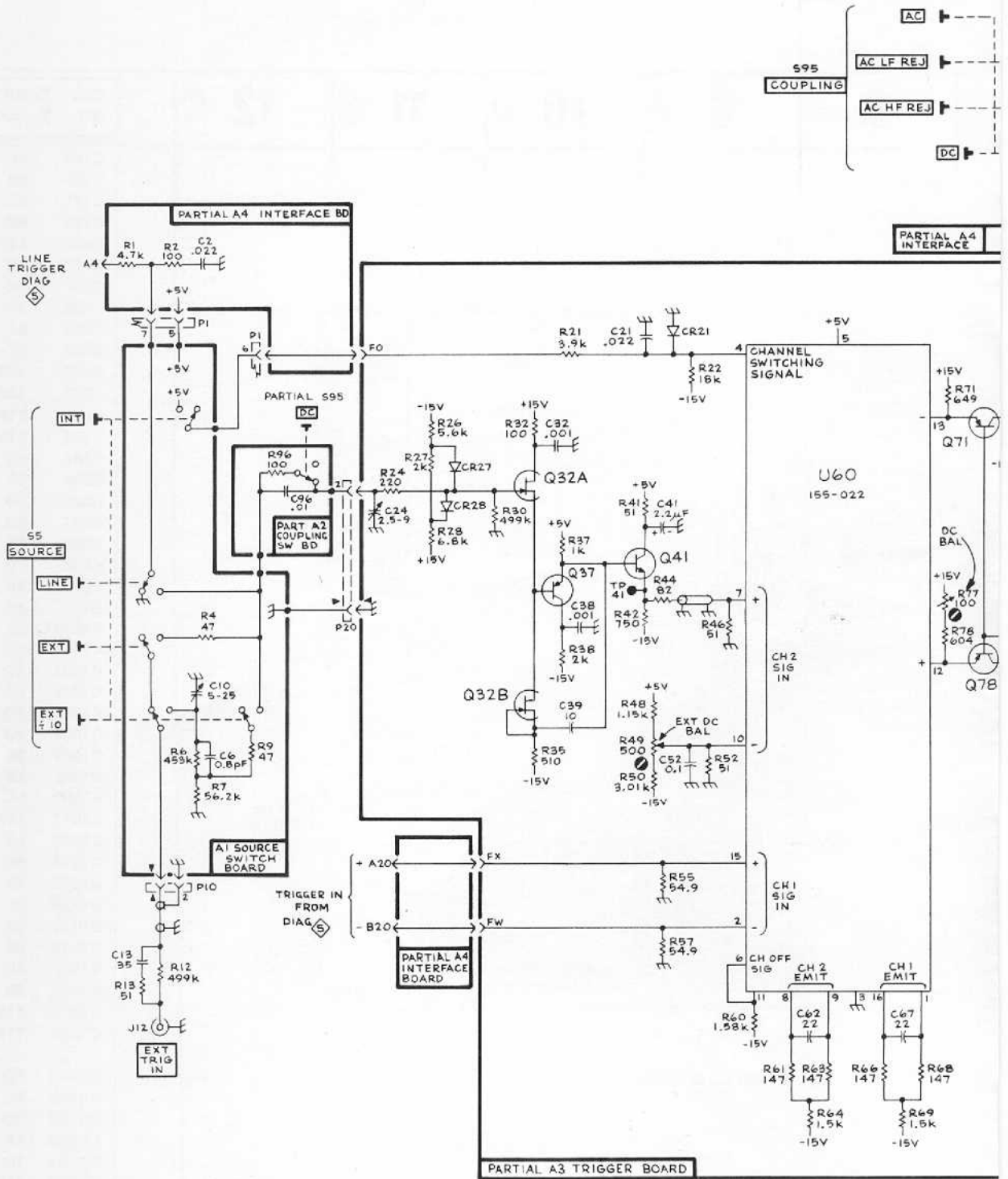

NOTE: ALL VOLTAGES ARE DECOUPLED;  
SEE Ⓢ FOR DETAILS.

SEE PARTS LIST FOR  
SEMICONDUCTOR TYPES.

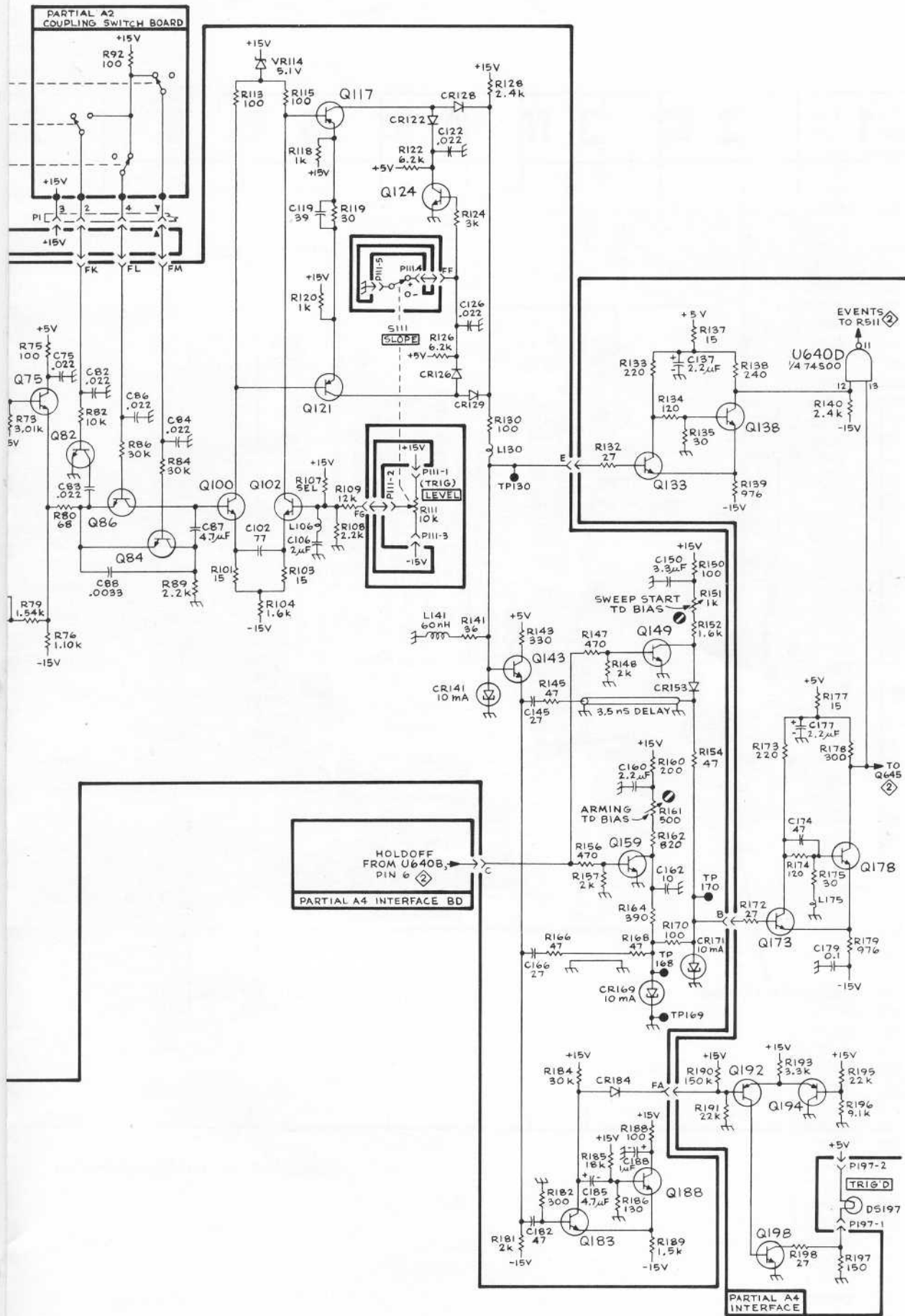

EVENTS TRIGGER 1





GRID LOCATOR FOR FIG 8-5.

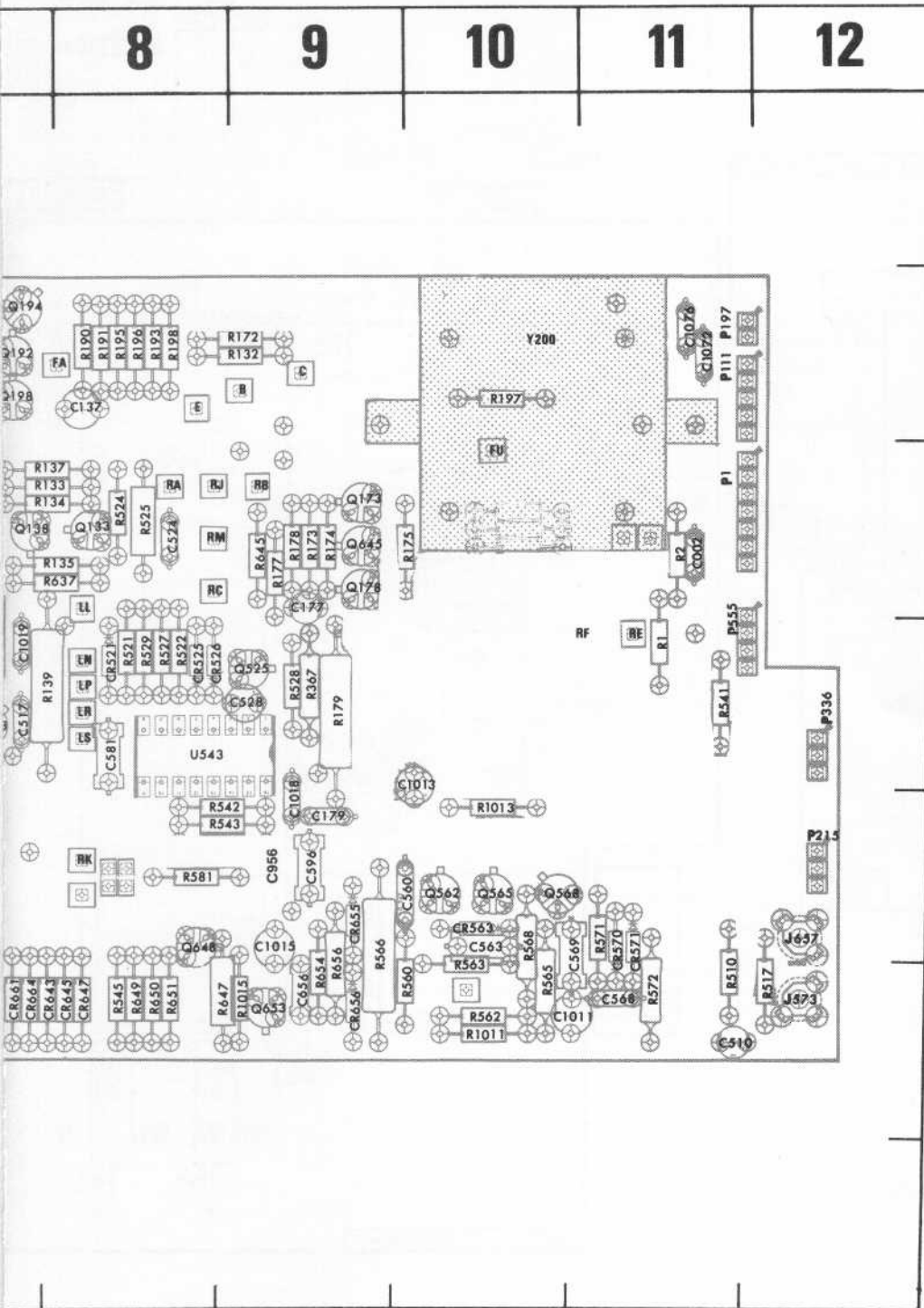

(1377)2148-34

CKT NO	GRID COORD	CKT NO	GRID COORD	CKT NO	GRID COORD
C108	9E	CR976	4C	Q1025	3C
C137	8B	CR977	4C	Q1034	3C
C177	9C	CR978	4C	Q1036	3D
C179	9E	CR979	5C	Q1038	3D
C510	11F	CR980	5C		
C517	7D	CR981	5C	R1	11D
C524	8C			R2	11C
C528	2D	F1020	2C	R132	9B
C534	5F			R133	7C
C535	6E	J573	12F	R134	7C
C560	10E	J657	12E	R135	8C
C563	10E			R137	7C
C568	11F	L1020	3E	R138	7C
C569	11E	L1039	3B	R139	7D
C581	8D			R140	7C
C586	5E	LR1001	2D	R172	9B
C589	5D	LR1004	2D	R173	9C
C591	5D	LR1007	2D	R174	9C
C596	9E			R175	10C
C598	5D	P1	11C	R177	9C
C656	9F	P111	11B	R178	9C
C668	4F	P197	11B	R179	9D
C956††	9E	P215	12E	R190	8B
C968	6C	P336	12D	R191	8B
C1001	2D	P555	11D	R193	8B
C1002	2D			R195	8B
C1004	2D	Q133	8C	R196	8B
C1005	2D	Q138	7C	R197	10E
C1007	2E	Q173	9C	R198	8B
C1008	2E	Q178	9C	R510	11E
C1009	5C	Q192	7B	R511	7D
C1011	11F	Q194	7B	R516	7D
C1015	9E	Q198	7B	R517	12E
C1018	9E	Q512	7D	R519	7E
C1019	7D	Q514	7D	R521	8D
C1020	3E	Q518	7D	R522	8D
C1021	3E	Q525	9D	R524	8C
C1033	3E	Q532	6E	R525	8C
C1038	3C	Q538	6F	R527	8D
C1039	3B	Q546	6F	R528	9D
C1072	11B	Q547	6F	R529	8D
C1076	11B	Q562	10E	R531	5E
		Q565	10E	R532	5F
		Q568	10E	R534	5F
CR521	8D	Q588	5D	R535	6F
CR525	8D	Q595	5E	R537	6F
CR526	8D	Q640	7C	R538	6F
CR532	5F	Q645	9C	R541	11D
CR563	10E	Q648	8E	R542	8E
CR570	11E	Q653	9F	R543	8E
CR571	11E	Q662	4E	R545	8F
CR586	5E	Q900	4C	R547	6F
CR638	7C	Q904	4C	R548	6F
CR739	6C	Q908	4C	R549	6F
CR643	7F	Q912	4C	R560	10E
CR645	8F	Q916	4C	R562	10E
CR647	8F	Q920	4C	R565	10E
CR655	9E	Q924	5C	R566	9E
CR656	9F	Q928	5C	R568	10E
CR967	5D	Q968	5C	R571	11E
CR974	4C	Q1028	3D	R572	11E
CR975	4C				

FIG 8-5.

CKT NO	GRID COORD	CKT NO	GRID COORD
Q1025	3C	R577	4E
Q1034	3D	R578	4E
Q1036	3D	R581	8E
Q1038	3D	R586	5E
		R587	5E
R1	11D	R593	5E
R2	11C	R596	5E
R132	9B	R599	6C
R133	7C	R637	8C
R134	7C	R638	6C
R135	8C	R639	7C
R137	7C	R640	7C
R138	7C	R645	9C
R139	7D	R647	9F
R140	7C	R649	8F
R172	9B	R650	8F
R173	9C	R651	8F
R174	9C	R654	9F
R175	10C	R656	9F
R177	9C	R661	5F
R178	9C	R663	5F
R179	9D	R664	5F
R190	8B	R666	5F
R191	8B	R668	4F
R193	8B	R669	4F
R195	8B	R671	4F
R196	8B	R672	4F
R197	10B	R900	4D
R198	8B	R904	4D
R510	11F	R908	4D
R511	7D	R912	4D
R516	7D	R916	4D
R517	12F	R920	4D
R519	7E	R924	5D
R521	8D	R928	5D
R522	8D	R929†*	
R524	8C	R984††	6B
R525	8C	R969	6C
R527	8D	R974	6C
R528	9D	R1009	6C
R529	8D	R1011	10F
R531	5F	R1015	9F
R532	5F	R1024	3C
R534	5F	R1026	3C
R535	6F	R1028	3E
R537	6F	R1030	3D
R538	6F	R1031	3D
R541	11D	R1033	3D
R542	8E	R1034	3C
R543	8E	R1036	3E
R545	8F	R1041	9B
R547	6F		
R548	6F	T579	4E
R549	6F	T1038	3C
R560	10F		
R562	10F	U543	8D
R565	10F	U586	6E
R566	9E	U589	6D
R568	10E	U598	6D
R571	11E	U640	7D
R572	11F	U984	4B
		U974	6B

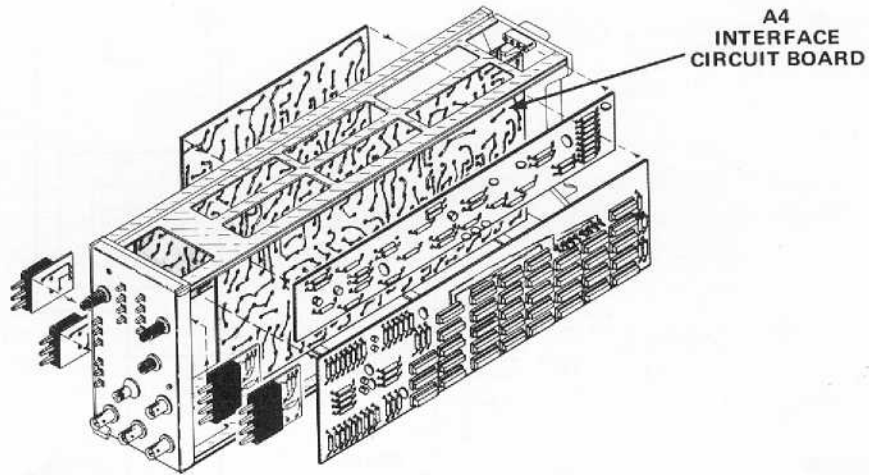

\*See Parts List for serial number ranges.

† LOCATED ON BACK ON BOARD

††RELOCATED TO FRONT OF BOARD AT SN B030000 & UP.

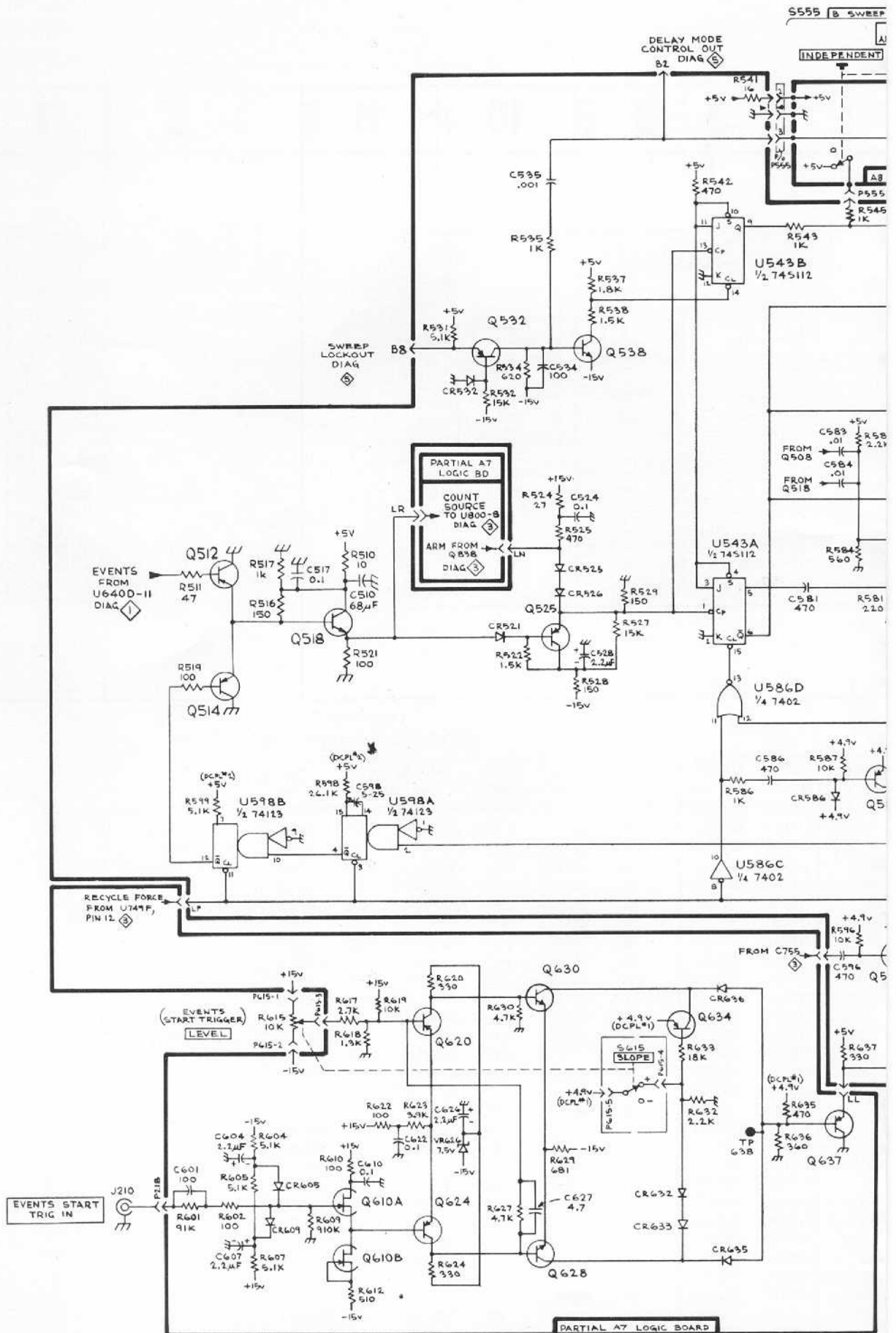

DELAY MODE  
 A STARTS AFTER DELAY  
 B TRIGGERABLE AFTER DELAY

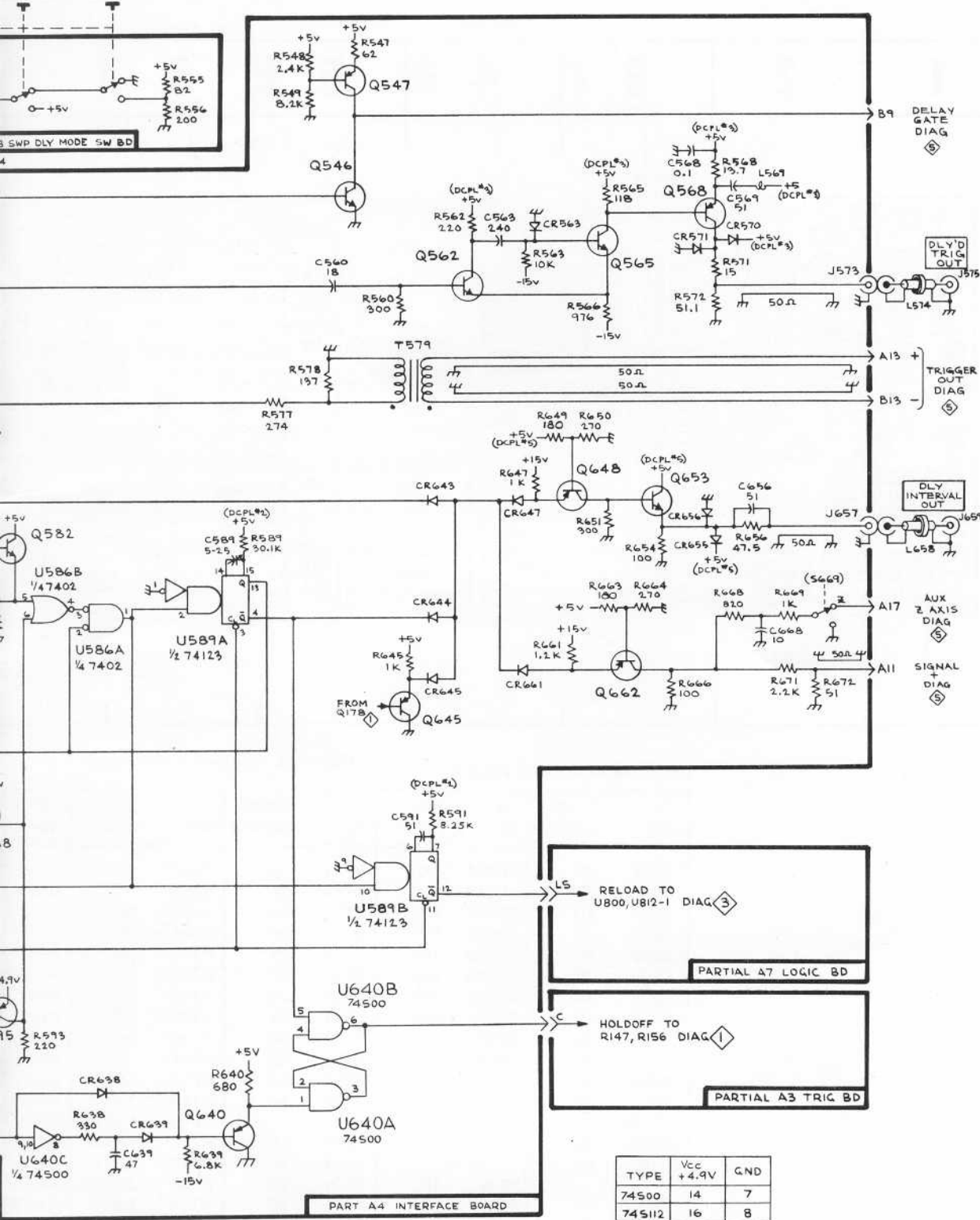

TYPE	Vcc	GND
74500	14	7
745112	16	8
74123	16	8

NOTE: ALL VOLTAGES ARE DECOUPLED, SEE ⑤ FOR DETAILS.  
 SEE PARTS LIST FOR SEMICONDUCTOR TYPES.

OUTPUTS PROCESSING & EVENTS START TRIGGER

OUTPUTS PROCESSING & EVENTS START TRIGGER

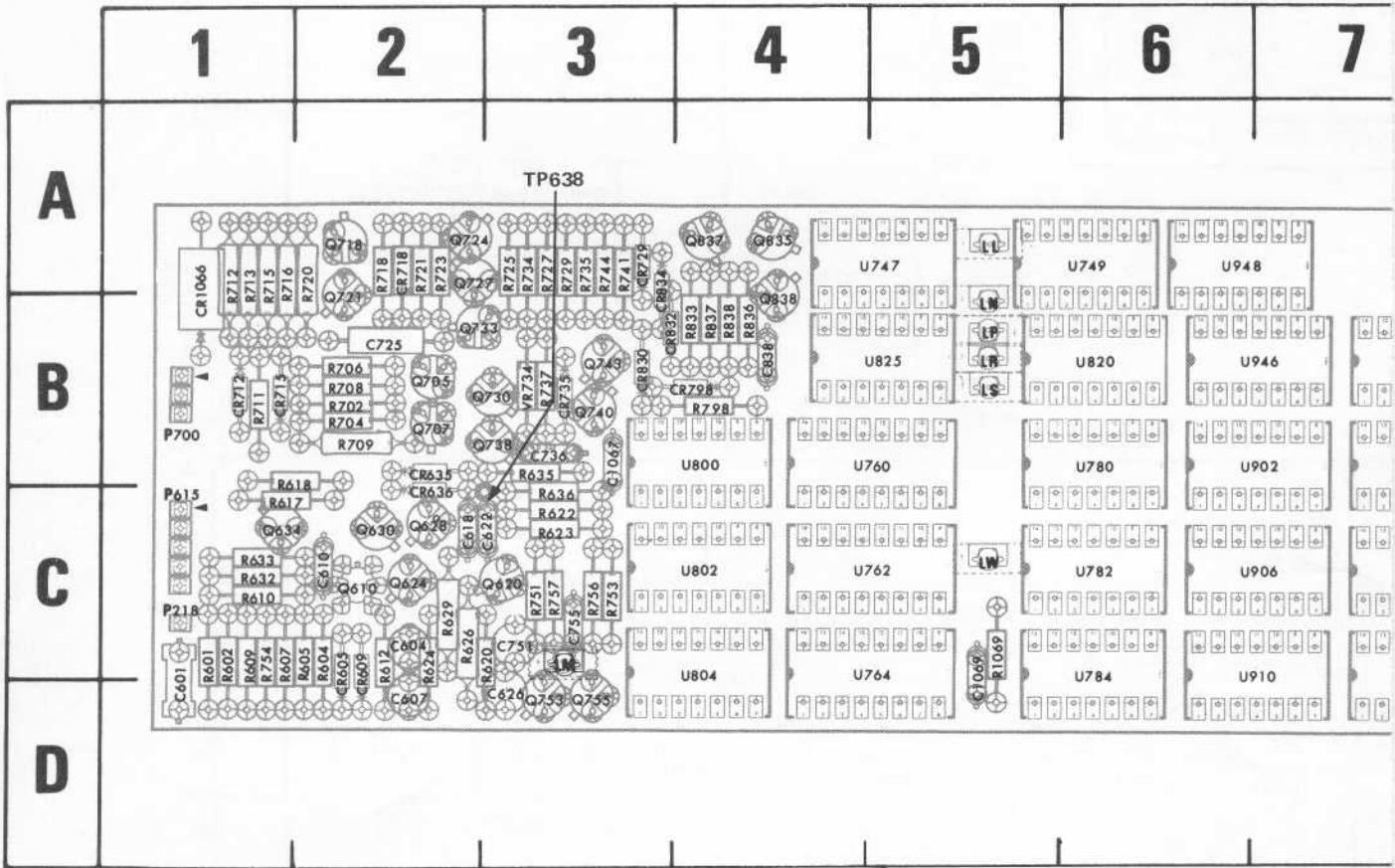
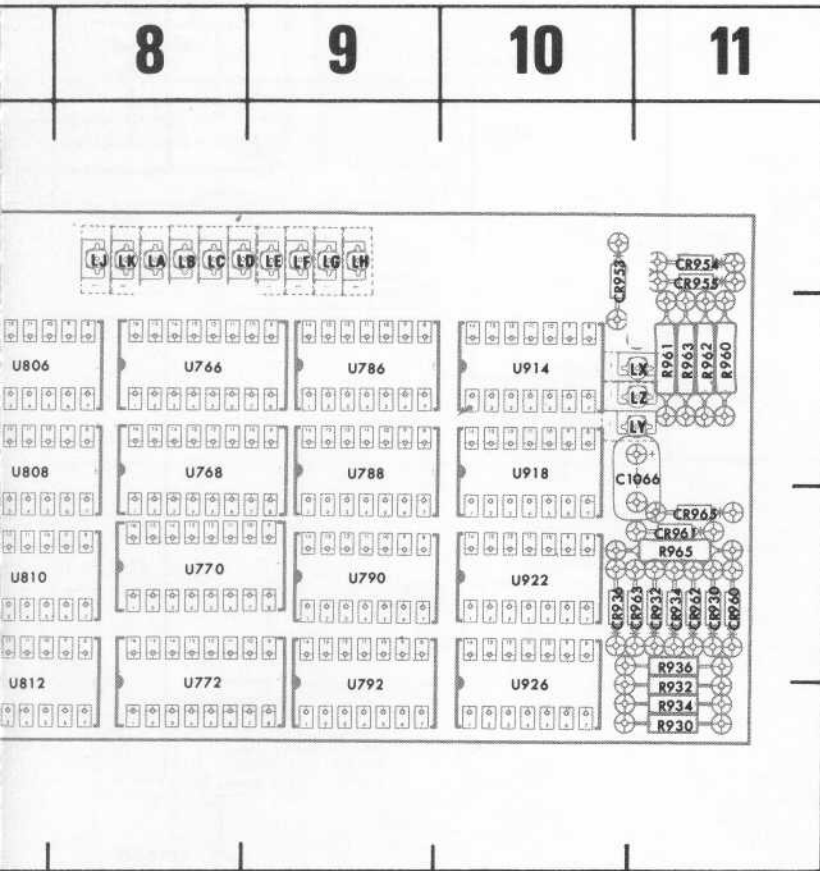

Figure 8-6. A7—Logic circuit board.

GRID LOCATOR FOR FIG 8-6.

CKT NO	GRID COORD	CKT NO	GRID COORD	CKT NO	GRID COORD	CKT NO	GRID COORD	CKT NO
C601	1C	CR834	3A	Q721	2B	R632	1C	R754
C604	2C	CR930	11C	Q724	2A	R633	1C	R756
C607	2D	CR932	11C	Q727	2A	R635	3B	R757
C610	2C	CR934	11C	Q730	3B	R636	3C	R798
C618	2C	CR936	10C	Q733	2B	R702	2B	R833
C622	3C	CR953	10A	Q738	3B	R704	2B	R836
C626	3D	CR954	11A	Q740	3B	R706	2B	R837
C725	2B	CR955	11A	Q743	3B	R708	2B	R838
C736	3B	CR960	11C	Q753	3D	R709	2B	R932
C751	3C	CR961	11C	Q755	3D	R711	1B	R934
C755	3C	CR962	11C	Q835	4A	R712	1A	R936
C838	4B	CR963	11C	Q838	4B	R713	1A	R960
C1066	11B	CR965	11C			R715	1A	R961
C1067	3B	CR1066	1A	R601	1C	R716	1A	R962
C1069	5C			R602	1C	R718	2A	R963
		P218	1C	R604	2C	R720	2A	R965
		P615	1C	R605	2C	R721	2A	R1069
		P700	1B	R607	1C	R723	2A	
				R609	1C	R725	3A	TP638
CR605	2C			R610	1C	R727	3A	
CR609	2C			R612	2C	R729	3A	U747
CR635	2B			R617	1C	R734	3A	U749
CR636	2C	Q610	2C	R618	1B	R735	3A	U760
CR712	1B	Q620	3C	R620	3C	R737	3B	U762
CR715	2B	Q624	2C	R622	3C	R741	3A	U764
CR718	2B	Q628	2C	R623	3C	R744	3A	U766
CR729	3A	Q630	2C	R624	2C	R751	3C	U768
CR735	3B	Q634	1C	R629	2C	R753	3C	U770
CR798	4B	Q705	2B					
CR830	3B	Q707	2B					
CR832	3B	Q718	2A					



(1377)2148-35

GRID COORD	CKT NO	GRID COORD
1C	U772	8C
3C	U780	6B
3C	U782	6C
4B	U784	6C
4B	U786	9B
4B	U788	9B
4B	U790	9C
4B	U792	9C
11D	U800	4B
11D	U802	4C
11C	U804	4C
11B	U806	7B
11B	U808	7B
11B	U810	7C
11B	U812	7C
11C	U820	
5C	U825	5B
	U902	6B
3C	U906	6C
	U910	6C
5A	U914	10B
6A	U918	10B
5B	U922	10C
5C	U926	10D
5C	U946	6B
	U948	6A
8B		
8B		
8C	VR734	3B

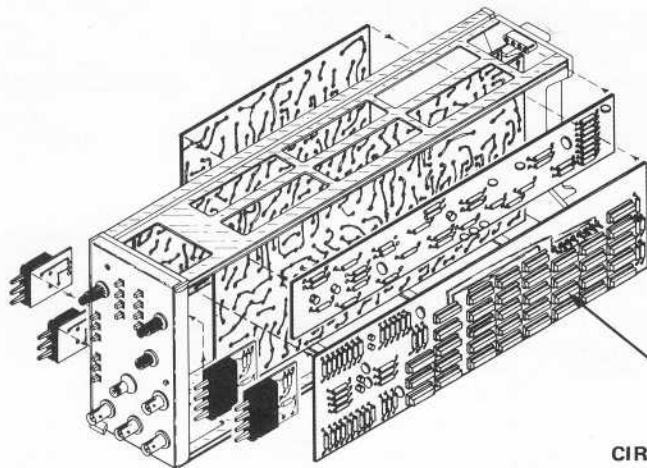

A7  
LOGIC  
CIRCUIT BOARD



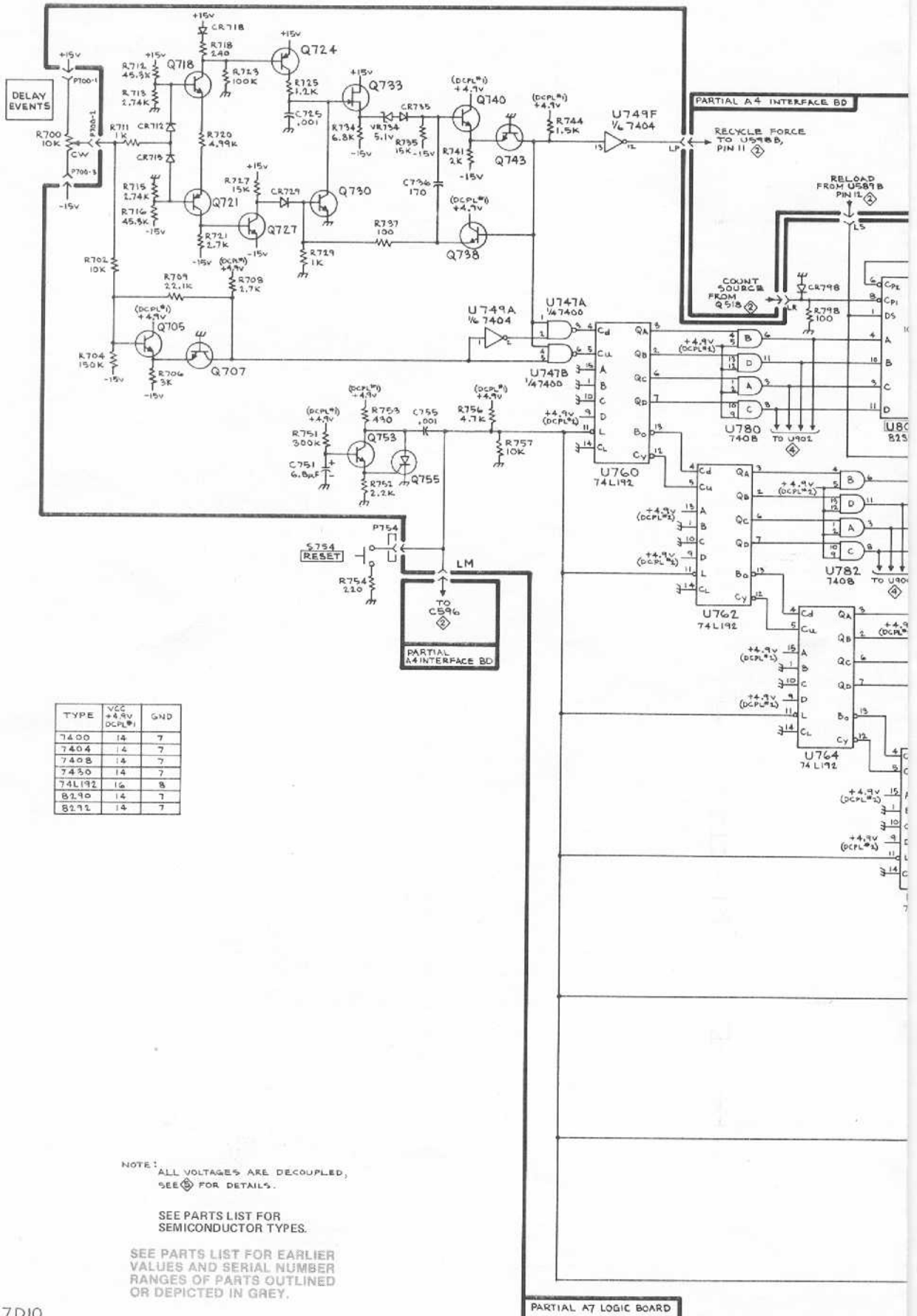

7D10

2148-4  
REV B, MA



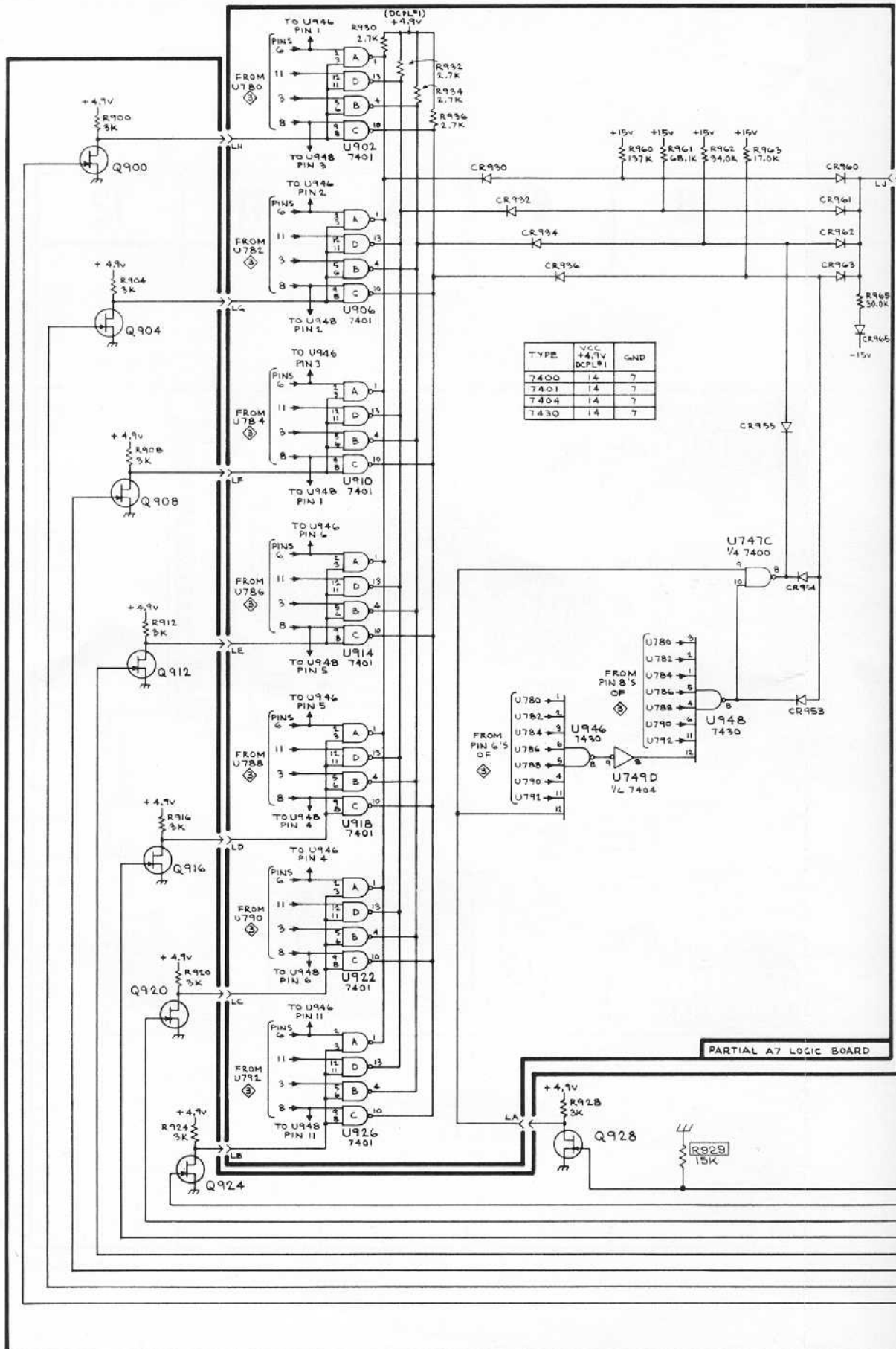

7D10

SEE PARTS LIST FOR SEMICONDUCTOR TYPES.

NOTE: ALL VOLTAGES ARE DECOUPLED, SEE  $\text{Ⓢ}$  FOR DETAILS.

2148-44  
REV A JUL 1977

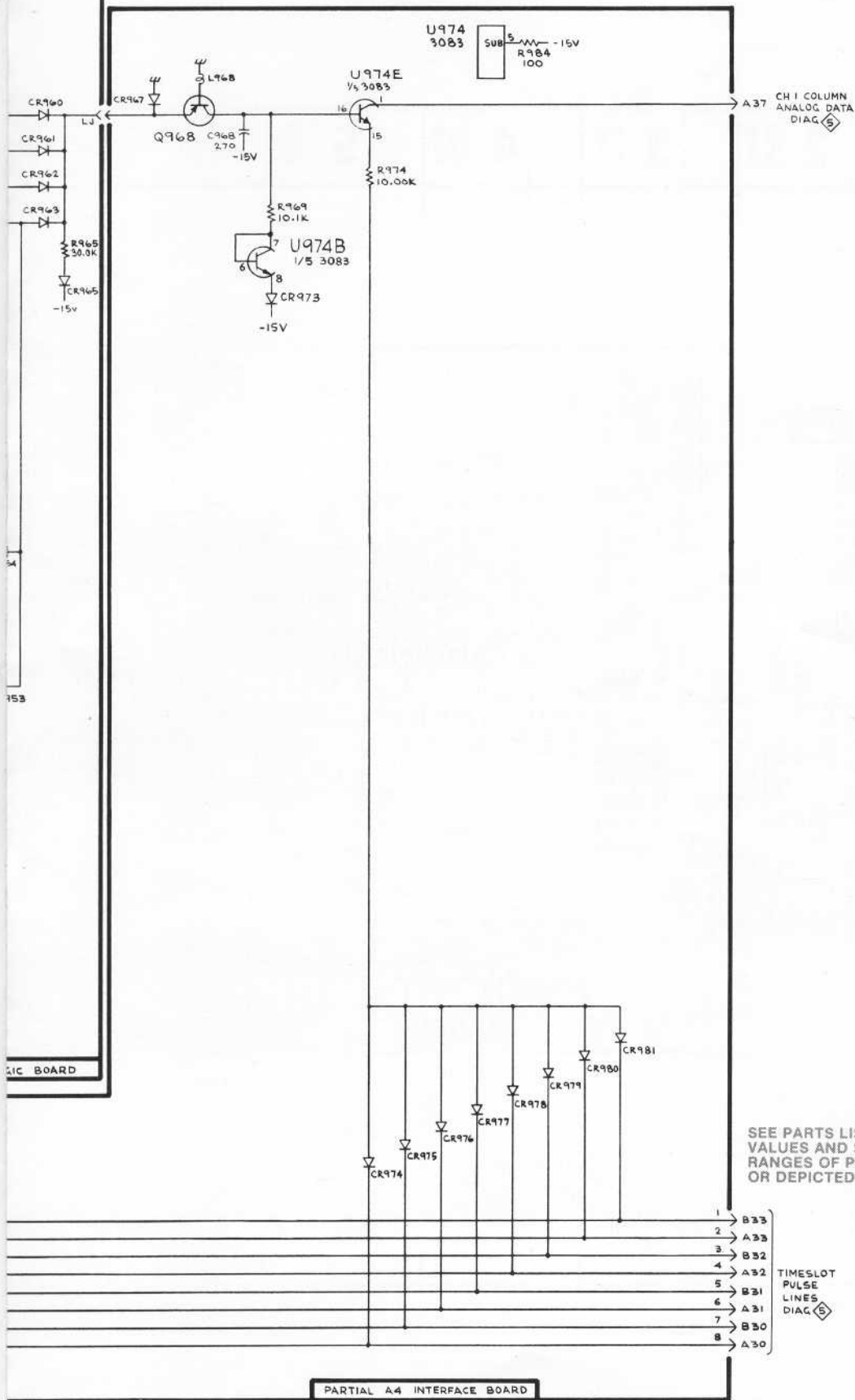

SEE PARTS LIST FOR EARLIER VALUES AND SERIAL NUMBER RANGES OF PARTS OUTLINED OR DEPICTED IN GREY.

- 1 → B33
  - 2 → A33
  - 3 → B32
  - 4 → A32
  - 5 → B31
  - 6 → A31
  - 7 → B30
  - 8 → A30
- TIMESLOT PULSE LINES DIAG

PARTIAL A4 INTERFACE BOARD

READOUT ENCODING 4

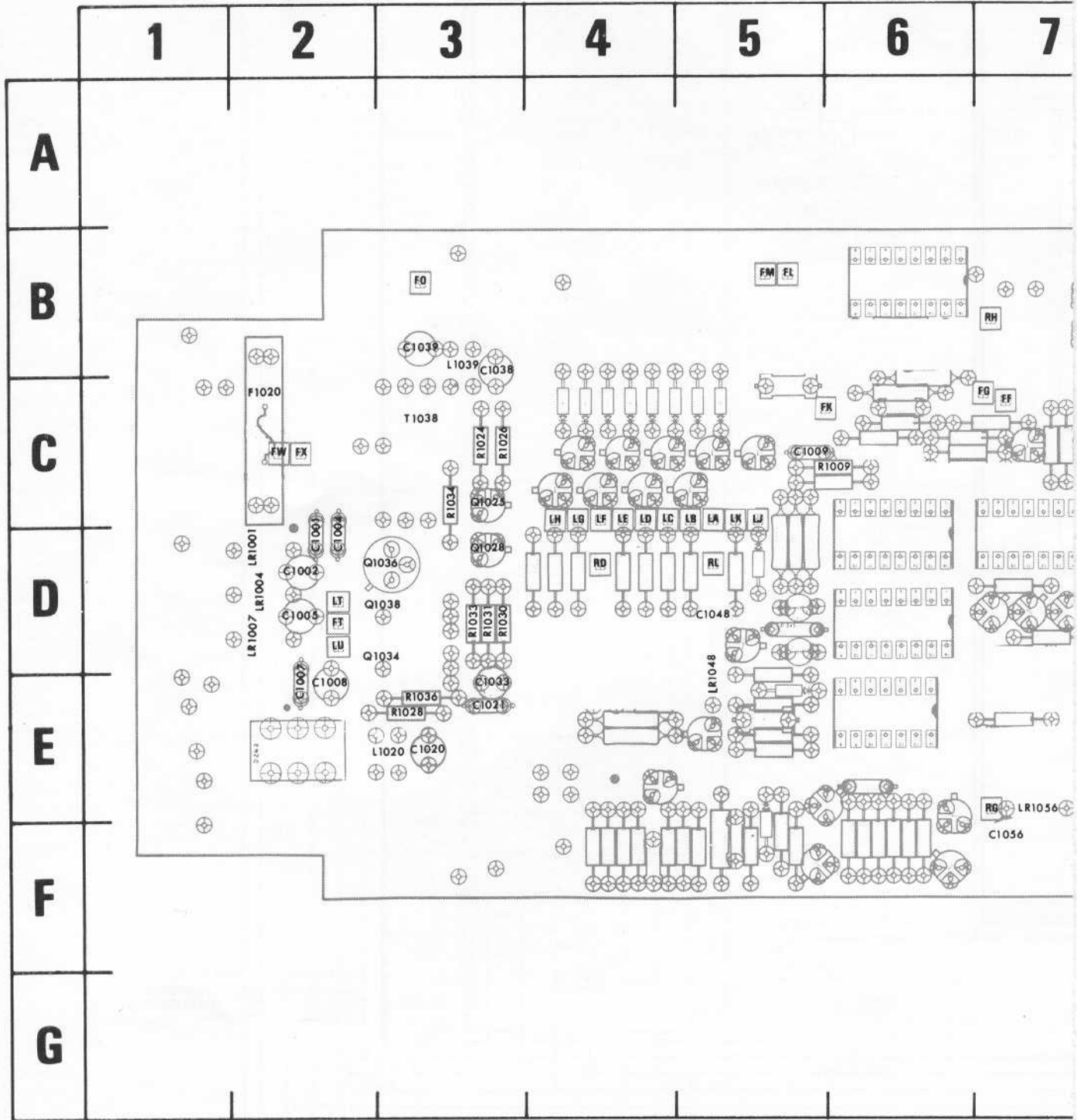
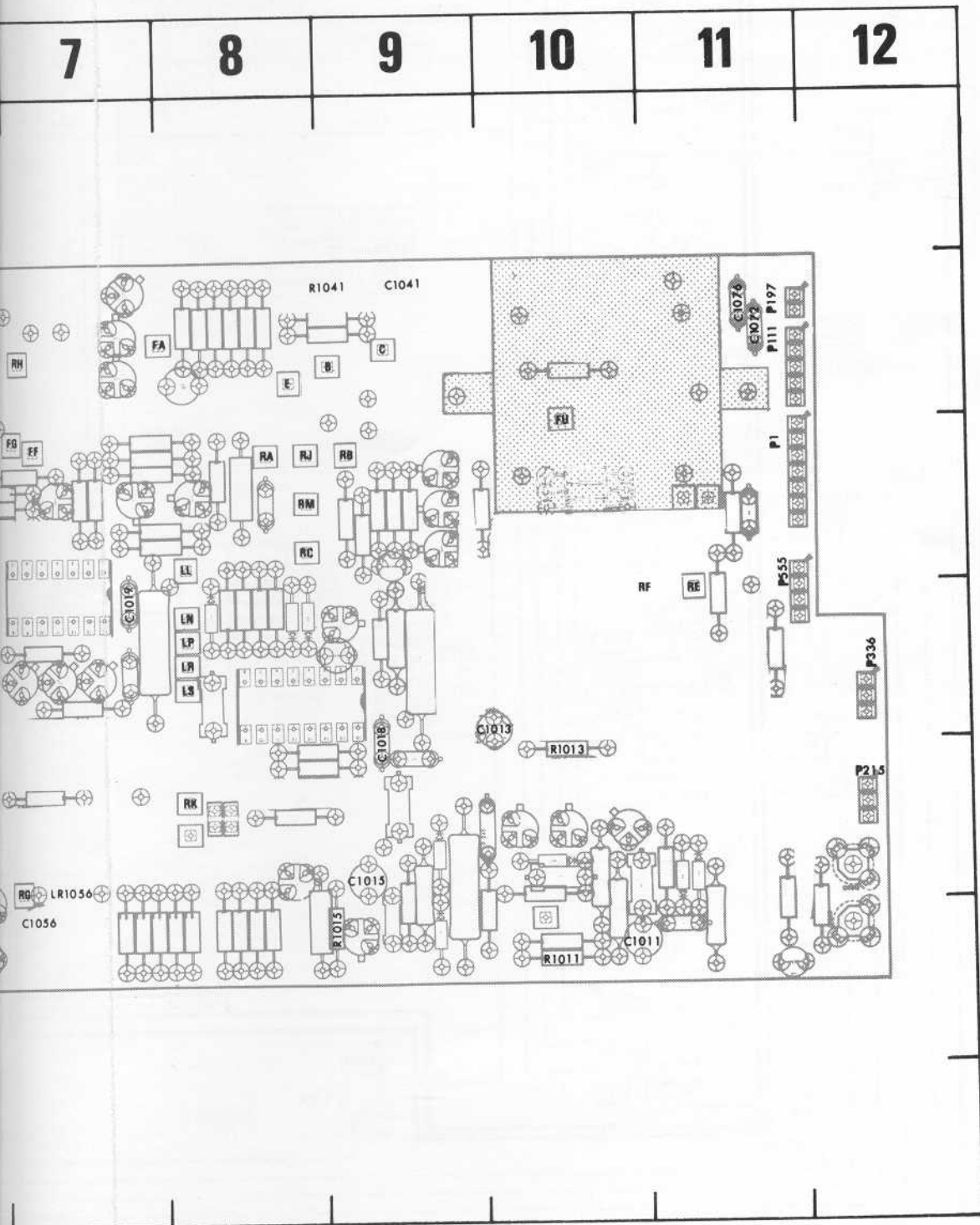

Figure 8-7. A4—Partial Interface circuit



CKT NO	GRID LOC	C N
C1001	2D	C
C1002	2D	C
C1004	2D	C
C1005	2D	C
C1007	2E	C
C1008	2E	C
C1009	5C	
C1011	11F	F
C1013	10D	
C1015	9E	L
C1019	7D	L
C1020	3E	
C1023	3E	L
C1033	3E	L
C1038	3C	L

(1377)2148-36

Interface circuit board.

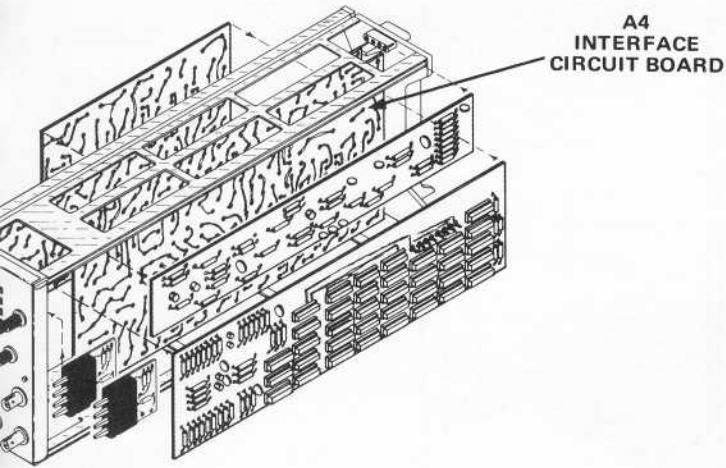

GRID LOCATOR FOR FIG 8-7.

CKT NO	GRID LOC	CKT NO	GRID LOC	CKT NO	GRID LOC
039	3B	LR1048	5E	R1009	6C
041	9B	LR1056	7E	R1011	10F
048	5D			R1013	10E
056	7F	P1	11C	R1015	9F
072	11B	P111	11B	R1024	3C
076	11B	P197	11B	R1026	3C
		P215	12E	R1028	3E
020	2C	P336	12D	R1030	3D
		P555	11D	R1031	3D
020	3E			R1033	3D
039	3B	Q1028	3D	R1034	3C
		Q1025	3C	R1036	3E
1001	2D	Q1034	3D	R1041	9B
1004	2D	Q1036	3D		
1007	2D	Q1038	3D	T1038	3C

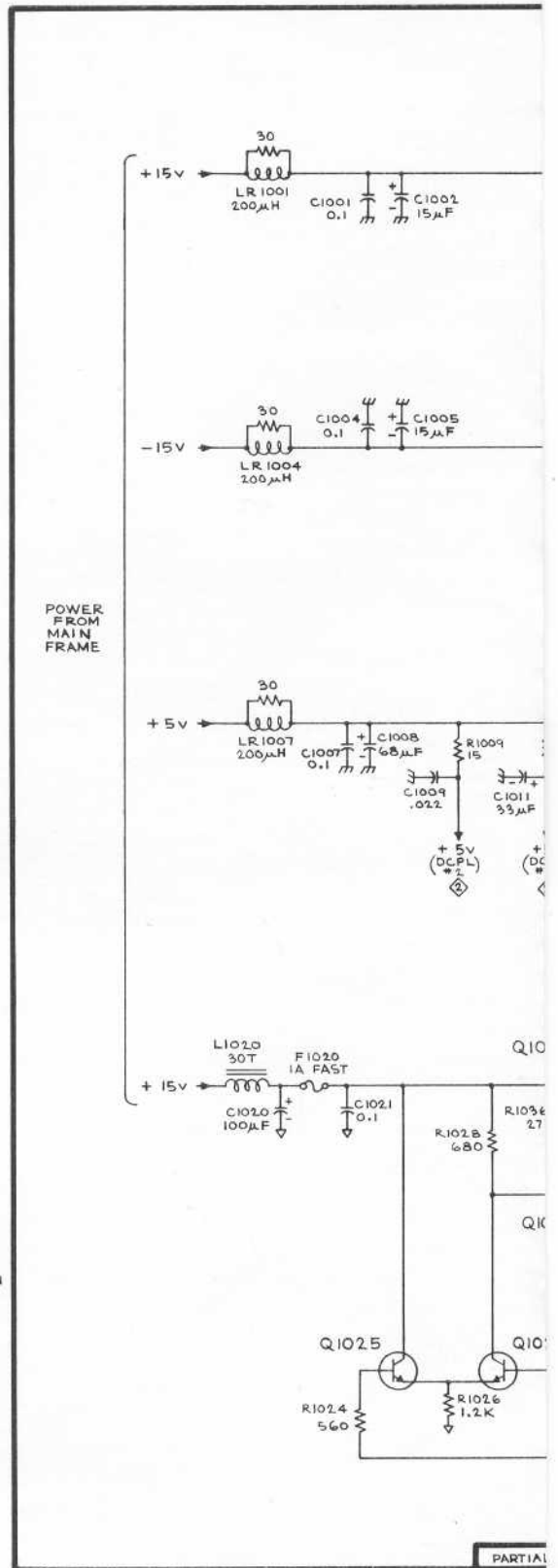
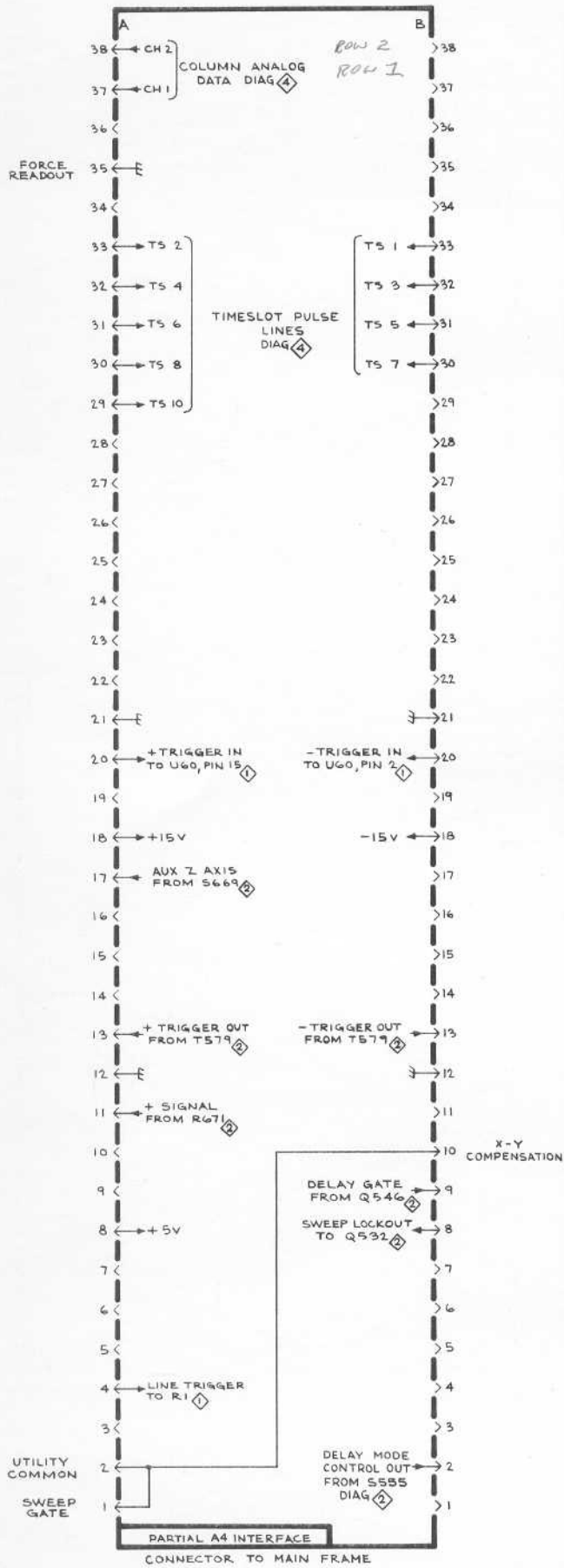



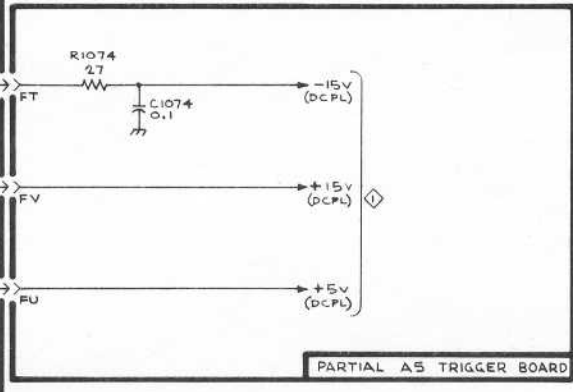
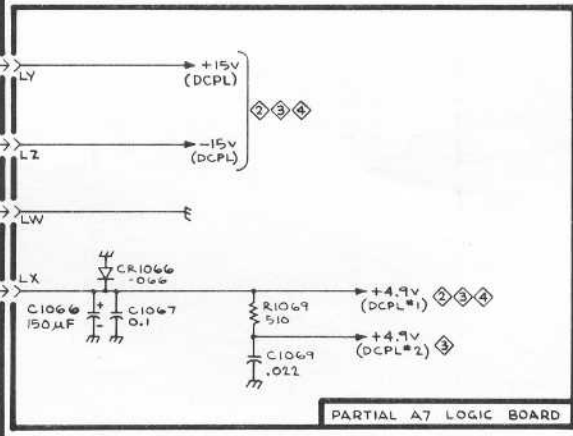
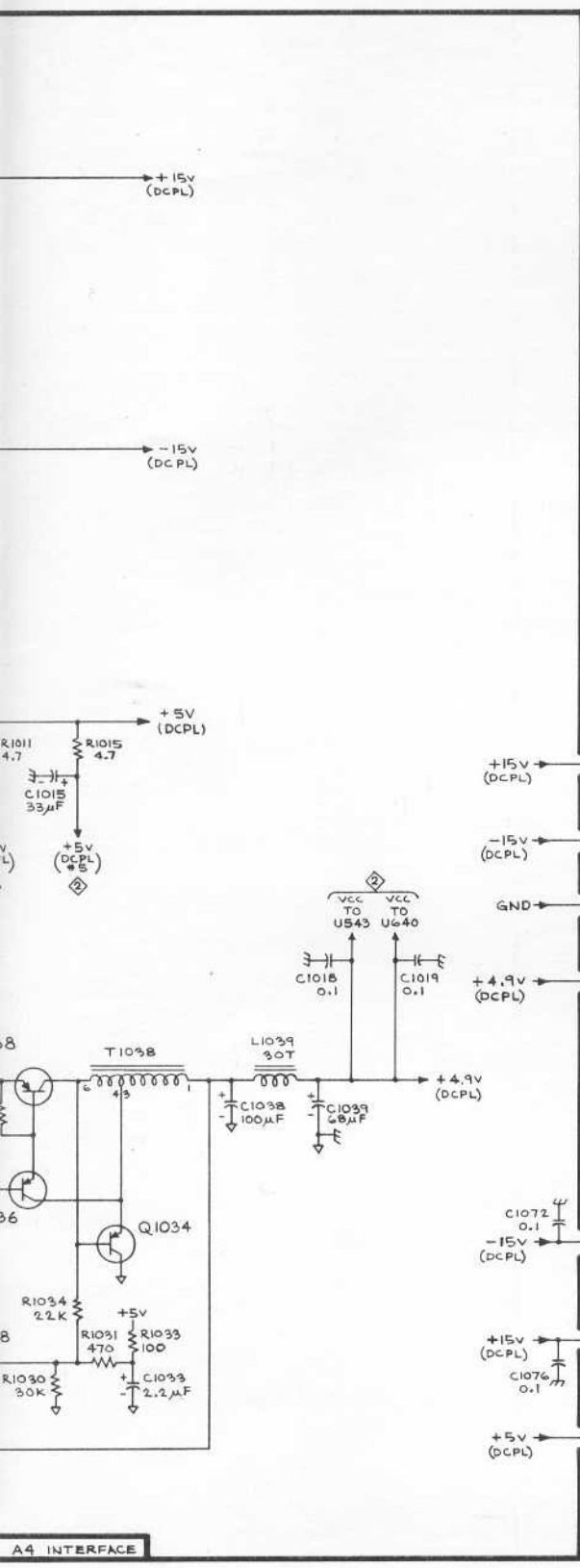

SEE PARTS LIST FOR SEMICONDUCTOR TYPES.



EXTERNAL TRIGGER  
INPUT COMPENSATION  
C24

SWEEP START  
TD BIAS ADJUST  
R151

ARMING  
TD BIAS  
R161

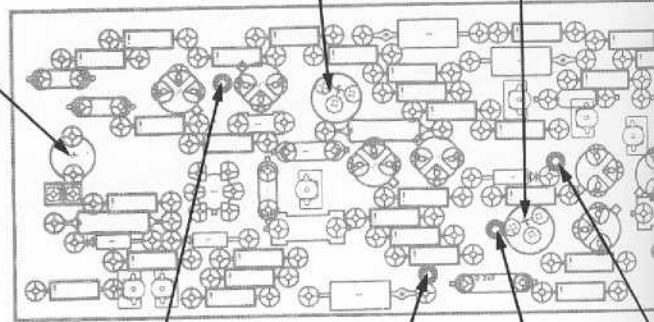

TP41

TP169

TP168

A3  
TRIGGER  
CIRCUIT BOARD

A7  
LOGIC  
CIRCUIT BOARD

TP638

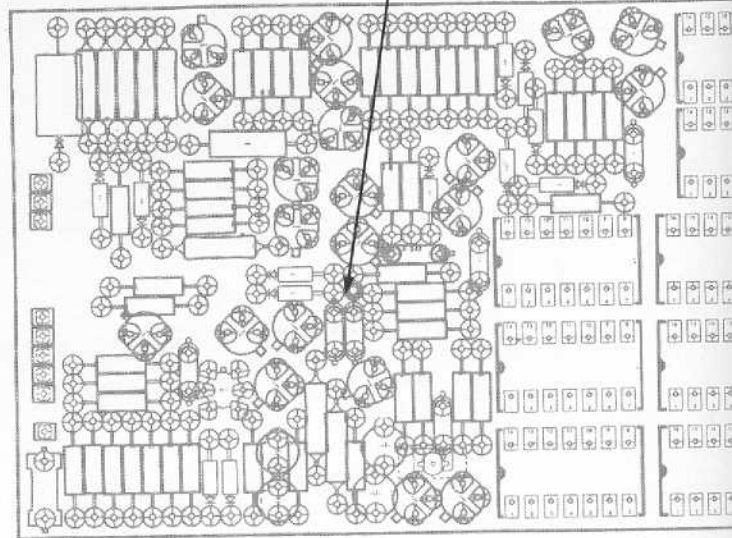

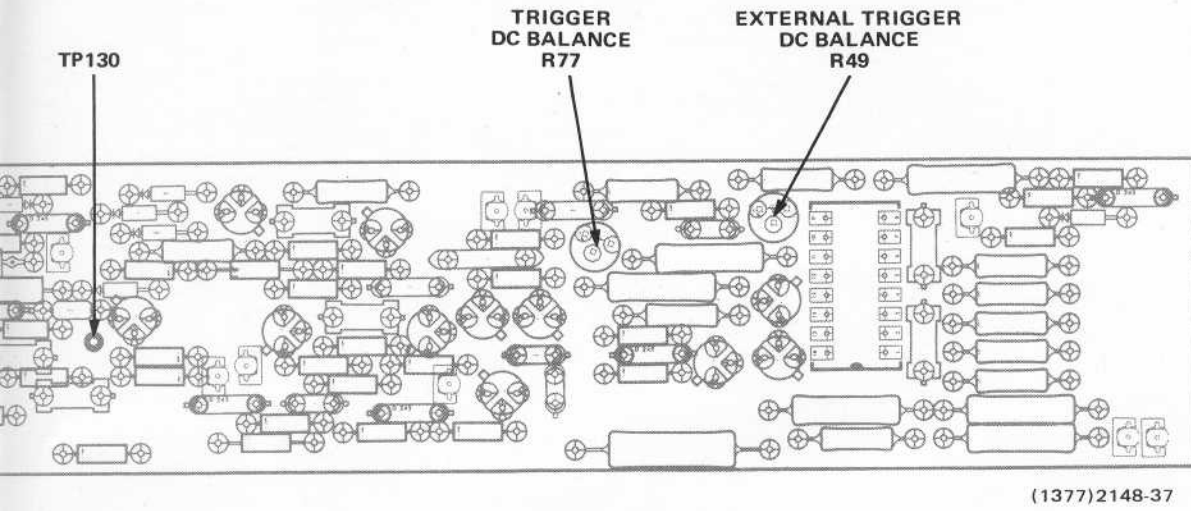

Figure 8-8. Trigger circuit board adjustment locations.

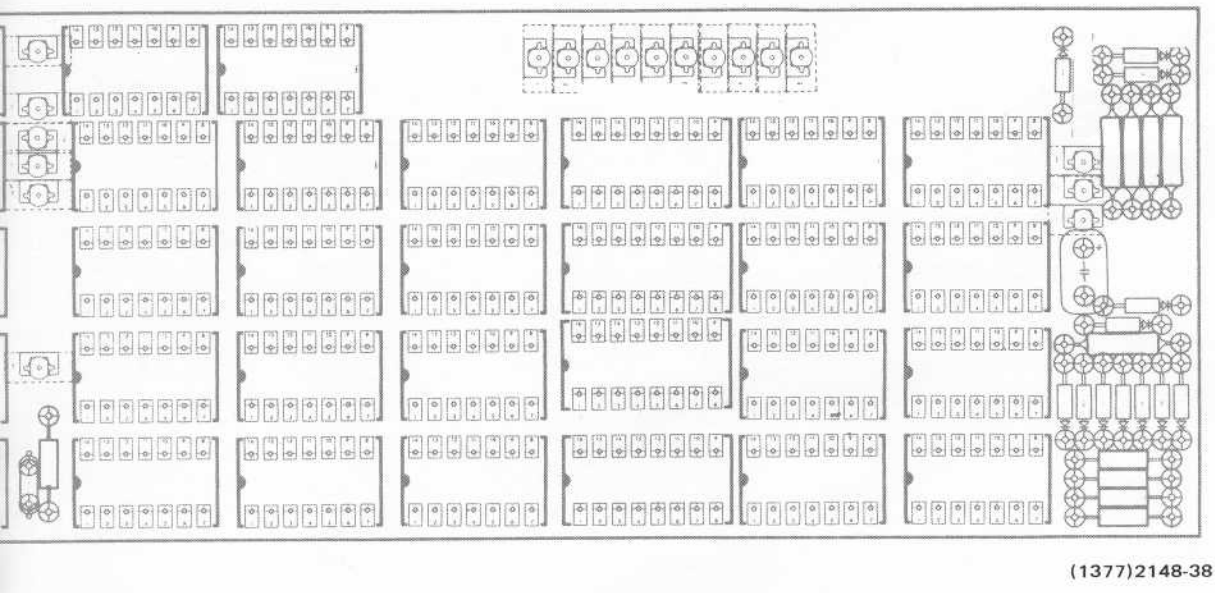
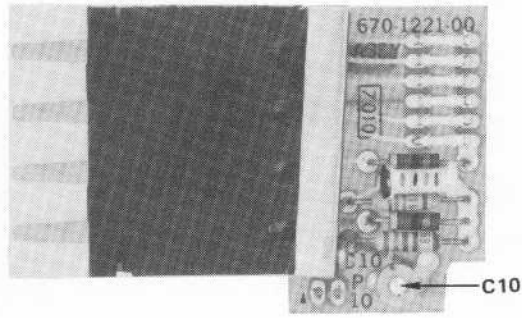

Figure 8-9. Logic circuit board adjustment locations.

ADJUSTMENT LOCATIONS



2148-39

Figure 8-10. Source switch adjustment locations.

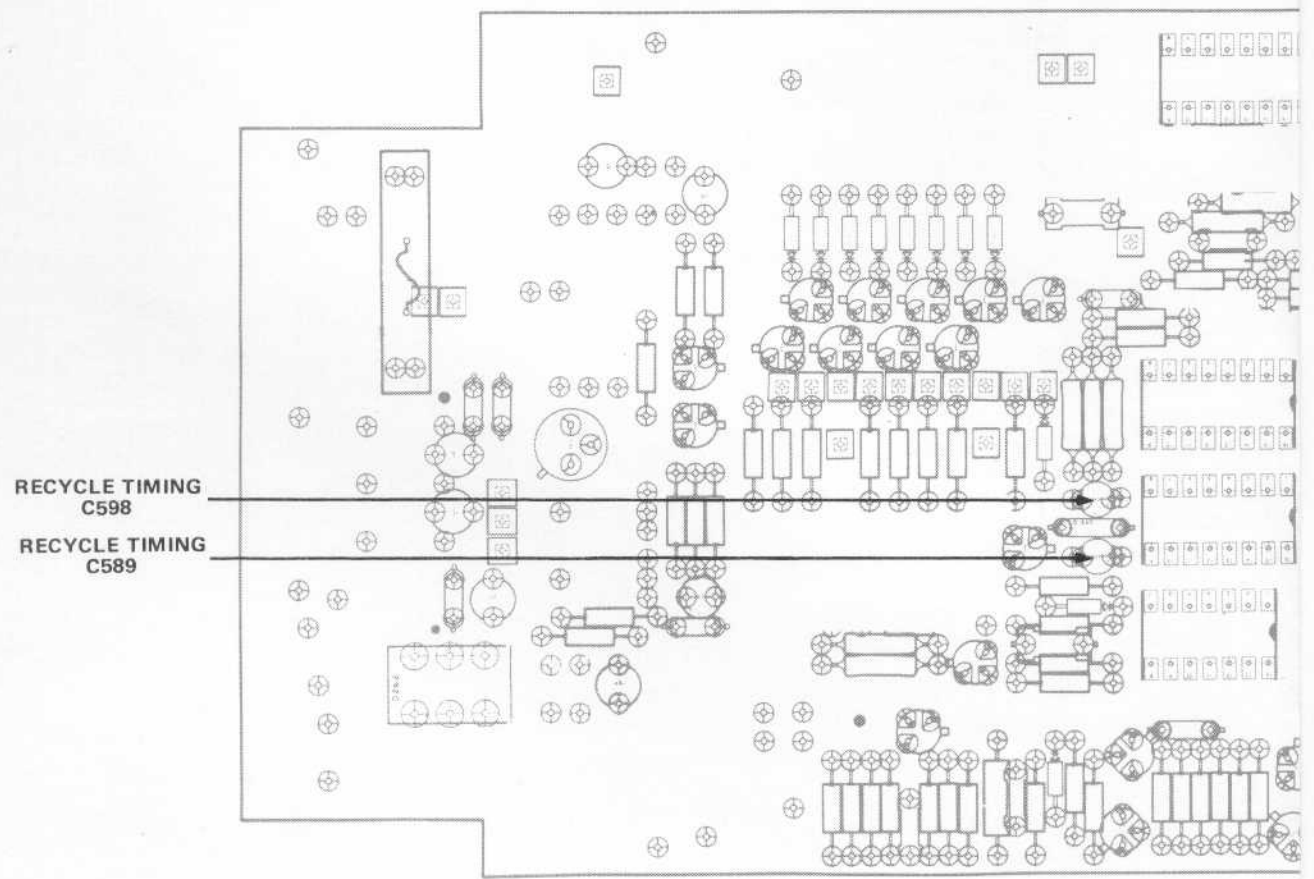
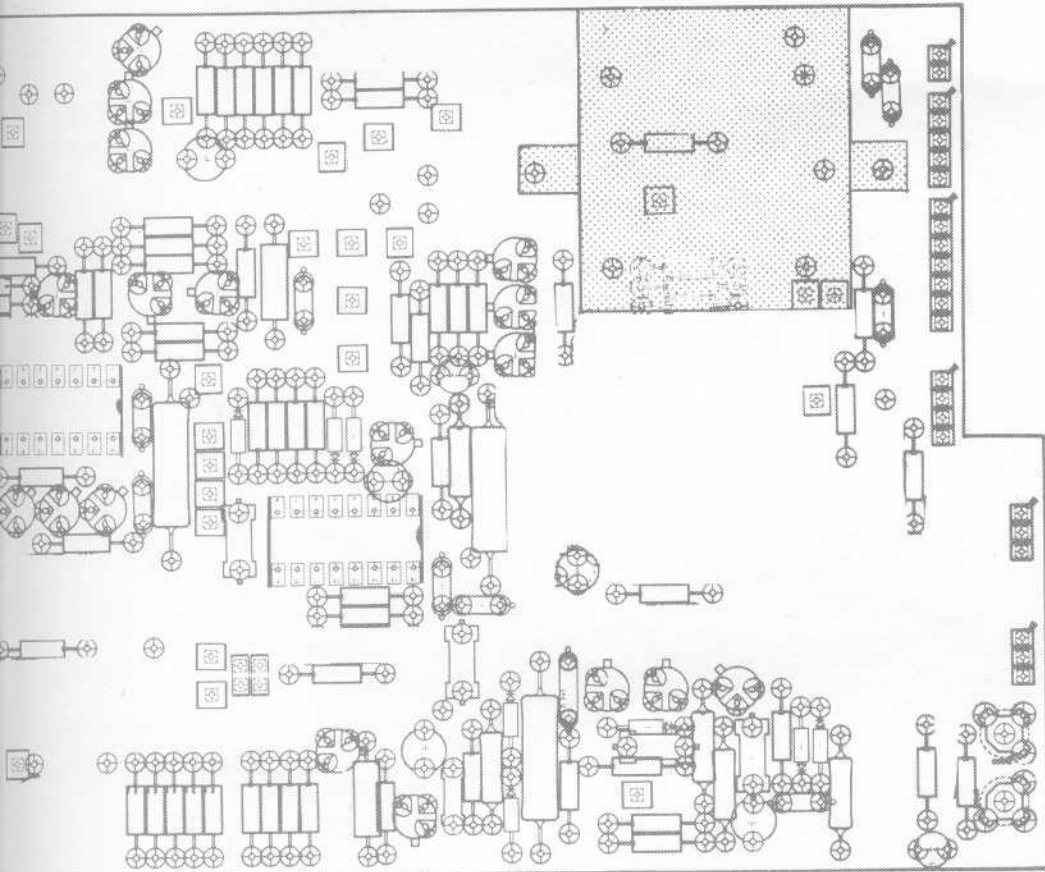
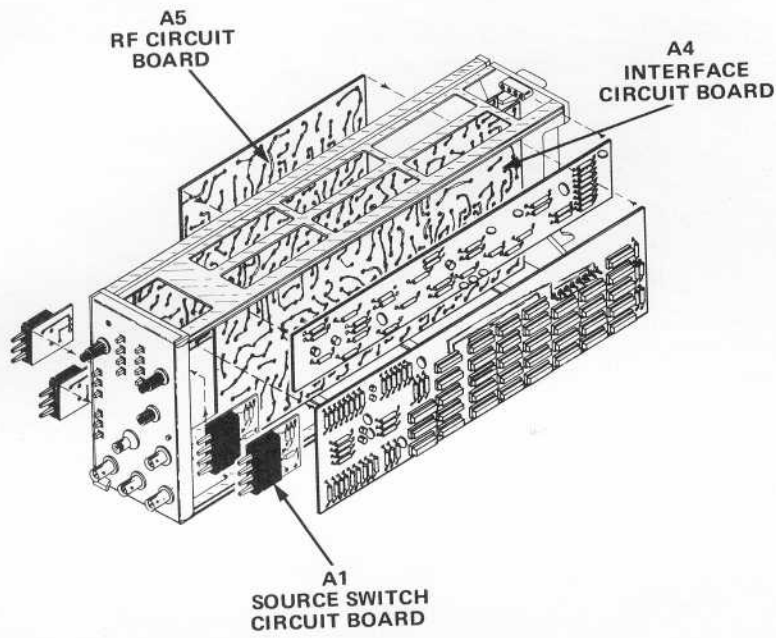

Figure 8-11. Interface circuit



it board adjustment locations.

(1377)2148-40

©

ADJUSTMENT LOCATIONS

# REPLACEABLE MECHANICAL PARTS

## PARTS ORDERING INFORMATION

Replacement parts are available from or through your local Tektronix, Inc. Field Office or representative.

Changes to Tektronix instruments are sometimes made to accommodate improved components as they become available, and to give you the benefit of the latest circuit improvements developed in our engineering department. It is therefore important, when ordering parts, to include the following information in your order: Part number, instrument type or number, serial number, and modification number if applicable.

If a part you have ordered has been replaced with a new or improved part, your local Tektronix, Inc. Field Office or representative will contact you concerning any change in part number.

Change information, if any, is located at the rear of this manual.

## SPECIAL NOTES AND SYMBOLS

X000 Part first added at this serial number  
00X Part removed after this serial number

## FIGURE AND INDEX NUMBERS

Items in this section are referenced by figure and index numbers to the illustrations.

## INDENTATION SYSTEM

This mechanical parts list is indented to indicate item relationships. Following is an example of the indentation system used in the description column.

```

1 2 3 4 5           Name & Description
Assembly and/or Component
Attaching parts for Assembly and/or Component
  ---*---
Detail Part of Assembly and/or Component
Attaching parts for Detail Part
  ---*---
Parts of Detail Part
Attaching parts for Parts of Detail Part
  ---*---

```

Attaching Parts always appear in the same indentation as the item it mounts, while the detail parts are indented to the right. Indented items are part of, and included with, the next higher indentation. The separation symbol ---\*--- indicates the end of attaching parts.

**Attaching parts must be purchased separately, unless otherwise specified.**

## ITEM NAME

In the Parts List, an Item Name is separated from the description by a colon (:). Because of space limitations, an Item Name may sometimes appear as incomplete. For further Item Name identification, the U.S. Federal Cataloging Handbook H6-1 can be utilized where possible.

## ABBREVIATIONS

"	INCH	ELCTRN	ELECTRON	IN	INCH	SE	SINGLE END
#	NUMBER SIZE	ELEC	ELECTRICAL	INCAND	INCANDESCENT	SECT	SECTION
ACTR	ACTUATOR	ELCTLT	ELECTROLYTIC	INSUL	INSULATOR	SEMICON	SEMICONDUCTOR
ADPTR	ADAPTER	ELEM	ELEMENT	INTL	INTERNAL	SHLD	SHIELD
ALIGN	ALIGNMENT	EPL	ELECTRICAL PARTS LIST	LPHLDR	LAMPHOLDER	SHLDR	SHOULDERED
AL	ALUMINUM	EQPT	EQUIPMENT	MACH	MACHINE	SKT	SOCKET
ASSEM	ASSEMBLED	EXT	EXTERNAL	MECH	MECHANICAL	SL	SLIDE
ASSY	ASSEMBLY	FIL	FILLISTER HEAD	MTG	MOUNTING	SLFLKG	SELF-LOCKING
ATTEN	ATTENUATOR	FLEX	FLEXIBLE	NIP	NIPPLE	SLVG	SLEEVING
AWG	AMERICAN WIRE GAGE	FLH	FLAT HEAD	NON WIRE	NOT WIRE WOUND	SPR	SPRING
BD	BOARD	FLTR	FILTER	OBD	ORDER BY DESCRIPTION	SO	SQUARE
BRKT	BRACKET	FR	FRAME or FRONT	OD	OUTSIDE DIAMETER	SST	STAINLESS STEEL
BRS	BRASS	FSTNR	FASTENER	OVH	OVAL HEAD	STL	STEEL
BRZ	BRONZE	FT	FOOT	PH BRZ	PHOSPHOR BRONZE	SW	SWITCH
BSHG	BUSHING	FXD	FIXED	PL	PLAIN or PLATE	T	TUBE
CAB	CABINET	GSKT	GASKET	PLSTC	PLASTIC	TERM	TERMINAL
CAP	CAPACITOR	HDL	HANDLE	PN	PART NUMBER	THD	THREAD
CER	CERAMIC	HEX	HEXAGON	PNH	PAN HEAD	THK	THICK
CHAS	CHASSIS	HEX HD	HEXAGONAL HEAD	PWR	POWER	TNSN	TENSION
CKT	CIRCUIT	HEX SOC	HEXAGONAL SOCKET	RCPT	RECEPTACLE	TPG	TAPPING
COMP	COMPOSITION	HLCPS	HELICAL COMPRESSION	RES	RESISTOR	TRH	TRUSS HEAD
CONN	CONNECTOR	HLEXT	HELICAL EXTENSION	RGD	RIGID	V	VOLTAGE
COV	COVER	HV	HIGH VOLTAGE	RLF	RELIEF	VAR	VARIABLE
CPLG	COUPLING	IC	INTEGRATED CIRCUIT	RTNR	RETAINER	W/	WITH
CRT	CATHODE RAY TUBE	ID	INSIDE DIAMETER	SCH	SOCKET HEAD	WSHR	WASHER
DEG	DEGREE	IDNT	IDENTIFICATION	SCOPE	OSCILLOSCOPE	XFMR	TRANSFORMER
DWR	DRAWER	IMPLR	IMPELLER	SCR	SCREW	XSTR	TRANSISTOR

# Replaceable Mechanical Parts—7D10

## CROSS INDEX—MFR. CODE NUMBER TO MANUFACTURER

Mfr. Code	Manufacturer	Address	City, State, Zip
00779	AMP, Inc.	P. O. Box 3608	Harrisburg, PA 17105
01295	Texas Instruments, Inc., Components Group	P. O. Box 5012	Dallas, TX 75222
08261	Spectra-Strip Corp.	7100 Lampson Ave.	Garden Grove, CA 92642
13257	Esna, Ltd.	10 Esna Park Dr.	Markham, Ontario, Canada
22526	Berg Electronics, Inc.	Youk Expressway	New Cumberland, PA 17070
23499	Gavitt Wire and Cable, Division of Amerace Esna Corp.	455 N. Quince St.	Escondido, CA 92025
24931	Specialty Connector Co., Inc.	3560 Madison Ave.	Indianapolis, IN 46227
71159	Bristol Socket Screw, Div. of American Chain and Cable Co., Inc.	P. O. Box 2244	Waterbury, CT 06720
73743	Fischer Special Mfg. Co.	446 Morgan St.	Cincinnati, OH 45206
74445	Holo-Krome Co.	31 Brook St. West	Hartford, CT 06110
76854	Oak Industries, Inc., Switch Div.	S. Main St.	Crystal Lake, IL 60014
77250	Pheoll Manufacturing Co., Division of Allied Products Corp.	5700 W. Roosevelt Rd.	Chicago, IL 60650
78189	Illinois Tool Works, Inc. Shakeproof Division	St. Charles Road	Elgin, IL 60126
79136	Walges, Kohinoor, Inc.	47-16 Austel Place	Long Island City, NY 11101
80009	Tektronix, Inc.	P. O. Box 500	Beaverton, OR 97005
83385	Central Screw Co.	2530 Crescent Dr.	Broadview, IL 60153
87308	N. L. Industries, Inc., Southern Screw Div.	P. O. Box 1360	Statesville, NC 28677

Replaceable Mechanical Parts—7D10

Fig. & Index No.	Tektronix Part No.	Serial/Model No. Eff Dscont	Qty	1	2	3	4	5	Name & Description	Mfr Code	Mfr Part Number
1-1	337-1064-04		2						SHIELD,ELEC:RIGHT SIDE	80009	337-1064-00
-2	366-1391-00		2						KNOB:GRAY	80009	366-1391-00
									. EACH KNOBS INCLUDE:		
	213-0239-00		1						. SETSCREW:3-48 X 0.062 INCH,HEX SOC STL	71159	OBD
-3	366-1077-00		2						KNOB:GRAY	80009	366-1077-00
									. EACH KNOB INCLUDES:		
	213-0153-00		1						. SETSCREW:5-40 X 0.125 INCH,HEX SOC STL	74445	OBD
-4	366-0494-00	B010100 B010119	1						KNOB:GRAY	80009	366-0494-00
	366-0494-04	B010120	1						KNOB:GRAY	80009	366-0494-04
	213-0153-00		1						. SETSCREW:5-40 X 0.125 INCH,HEX SOC STL	74445	OBD
-5	366-1058-71		1						KNOB:LATCH,MARKED 7D10	80009	366-1058-71
									(ATTACHING PARTS)		
-6	214-1095-00		1						PIN,SPG,SPLIT:0.094 OD X 0.187 INCH LONG	13257	52-022-094-0187
									- - - * - - -		
-7	105-0076-00		1						REL BAR,LATCH:PLUG-IN UNIT	80009	105-0076-00
-8	214-1280-00		1						SPRING,HLCPS:0.14 OD X 1.126"L,0.16"DIA W	80009	214-1280-00
-9	333-1595-02		1						PANEL,FRONT:	80009	333-1595-02
-10	200-0935-00		1						BASE,LAMPHOLDER:0.29 OD X 0.19 CASE	80009	200-0935-00
-11	352-0157-00		1						LAMPHOLDER:WHITE PLASTIC	80009	352-0157-00
-12	378-0602-00		1						LENS,LIGHT:GREEN	80009	378-0602-00
-13	-----		1						RESISTOR,VAR:(SEE R111,S111 EPL)		
									(ATTACHING PARTS)		
-14	210-0583-00		1						NUT,PLAIN,HEX.:0.25-32 X 0.312 INCH,BRS	73743	2X20224-402
									- - - * - - -		
-15	-----		1						CKT CARD ASSY:B SWP DLY MODE SW(SEE A8 EPL)		
									(ATTACHINC PARTS)		
-16	211-0156-00		2						SCREW,MACHINE:1-72 X 0.25",82 DEG,FLH STL	77250	OBD
									- - - * - - -		
-17	-----		1						CKT CARD ASSY:COUPLING SWITCH(SEE A2 EPL)		
									(ATTACHING PARTS)		
-18	211-0156-00		2						SCREW,MACHINE:1-72 X 0.25",82 DEG,FLH STL	77250	OBD
									- - - * - - -		
-19	-----		1						CKT CARD ASSY:SOURCE SWITCH(SEE A1 EPL)		
									(ATTACHING PARTS)		
-20	211-0156-00		2						SCREW,MACHINE:1-72 X 0.25",82 DEG,FLH STL	77250	OBD
									- - - * - - -		
									. CKT CARD INCLUDES:		
-21	131-0608-00		2						. CONTACT,ELEC:0.365 INCH LONG	22526	47357
-22	-----		1						RESISTOR,VAR:(SEE R615,S615 EPL)		
									(ATTACHING PARTS)		
-23	210-0583-00		1						NUT,PLAIN,HEX.:0.25-32 X 0.312 INCH,BRS	73743	2X20224-402
									- - - * - - -		
-24	-----		1						RESISTOR,VAR:(SEE R700 EPL)		
									(ATTACHING PARTS)		
-25	376-0014-00		1						CPLG,SHAFT,FLEX:SST WIRE	76854	22675-001
-26	210-0583-00		1						NUT,PLAIN,HEX.:0.25-32 X 0.312 INCH,BRS	73743	2X20224-402
									- - - * - - -		
-27	386-2173-00		1						SPRT,KNOB ASSY:	80009	386-2173-00
									(ATTACHING PARTS)		
-28	211-0109-00		2						SCREW,MACHINE:4-40 X 0.875"100 DEG,FLH STL	83385	OBD
									- - - * - - -		
-29	200-1339-00		1						COVER,HOUSING:VARIABLE RESISTOR	80009	200-1339-00
-30	214-1702-00		1						SPR,HLCL,TRSN:0.215 INCH OD	80009	214-1702-00
-31	358-0465-00		1						SPACER,SLEEVE:0.13 ID X 0.155 OD X 0.18"L	80009	358-0465-00
-32	384-1130-00		1						EXTENSION SHAFT:	80009	384-1130-00
									(ATTACHING PARTS)		
-33	354-0350-00		1						RING,RETAINING:0.073"FREE ID X 0.015",STL	79136	5133-9MD
									- - - * - - -		
-34	380-0273-00		1						HOUSING,SHAFT:	80009	380-0273-00
-35	-----		1						SWITCH,PUSH:SPST(SEE S614 EPL)		
-36	131-0955-00		4						CONNECTOR,RCPT,:BNC,FEMALE,W/HARDWARE	05091	31-279
-37	210-0255-00		3						TERMINAL,LUG:0.391" ID INT TOOTH	80009	210-0255-00
-38	348-0235-00		2						SHLD GSKT,ELEC:4.734 INCH LONG	80009	348-0235-00



# Replaceable Mechanical Parts—7D10

Fig. & Index No.	Tektronix Part No.	Serial/Model No. Eff Dscont	Qty	1 2 3 4 5	Name & Description	Mfr Code	Mfr Part Number
1-39	386-1447-66		1		SUBPANEL,FRONT: (ATTACHING PARTS)	80009	386-1447-66
-40	213-0192-00		4		SCR,TPG,THD FOR:6-32 X 0.50 INCH,PNH STL - - - * - - -	87308	OBD
-41	214-1054-00		1		SPRING,DETENT:LATCH	80009	214-1054-00
-42	105-0075-00		1		PAWL:0.475 X 0.21 X 0.184 INCH,PLSTC	80009	105-0075-00
-43	214-1061-00		1		SPRING,GROUND:FLAT	80009	214-1061-00
-44	-----		1		CKT CARD ASSY:LOGIC(SEE A7 EPL) (ATTACHING PARTS)		
-45	211-0155-00		3		SCREW,EXT,RLV B:4-40 X 0.375 INCH,SST - - - * - - -	80009	211-0155-00
	-----		-		. CKT CARD ASSY INCLUDES:		
-46	136-0269-02		27		. SOCKET,PLUG-IN:14 CONTACT,LOW CLEARANCE	01295	C931402
-47	136-0260-02		7		. SOCKET,PLUG-IN:16 CONTACT,LOW CLEARANCE	01295	C931602
-48	131-0608-00		10		. CONTACT,ELEC:0.365 INCH LONG	22526	47357
-49	136-0263-04		20		. CONTACT,ELEC:FOR 0.025 INCH SQUARE PIN	22526	75377-001
-50	214-0579-00		1		. TERM.,TEST PT:0.40 INCH LONG	80009	214-0579-00
-51	136-0252-04		69		. CONTACT,ELEC:0.188 INCH LONG	22526	75060
-52	361-0238-00		3		. SPACER,SLEEVE:0.25 OD X 0.34 INCH LONG	80009	361-0238-00
-53	-----		1		CKT CARD ASSY:TRIGGER(SEE A3 EPL) (ATTACHING PARTS)		
-54	211-0155-00		3		. SCREW,EXT,RLV B:4-40 X 0.375 INCH,SST - - - * - - -	80009	211-0155-00
	-----		-		. CKT CARD ASSY INCLUDES:		
-55	136-0263-03		15		. CONTACT,ELEC:FOR 0.025 INCH SQUARE PIN	00779	86250-2
-56	361-0238-00		3		. SPACER,SLEEVE:0.25 OD X 0.34 INCH LONG	80009	361-0238-00
-57	352-0238-00		4		. HOLDER,COAXIAL:GROUNDING,FOR 0.125" DIA	80009	352-0238-00
-58	136-0260-02		1		. SOCKET,PLUG-IN:16 CONTACT,LOW CLEARANCE	01295	C931602
-59	136-0252-04		60		. CONTACT,ELEC:0.188 INCH LONG	22526	75060
-60	131-0608-00		2		. CONTACT,ELEC:0.365 INCH LONG	22526	47357
-61	214-0579-00		5		. TERM.,TEST PT:0.40 INCH LONG	80009	214-0579-00
-62	200-0945-01		1		. COVER,HALF XSTR:FOR DUAL TO-18 CS,2-56 THD (ATTACHING PARTS)	80009	200-0945-01
-63	211-0062-00		1		. SCREW,MACHINE:2-56 X 0.312 INCH,RDH STL - - - * - - -	83385	OBD
-64	200-0945-00		1		. COVER,HALF XSTR:FOR DUAL TO-18 CASE	80009	200-0945-00
-65	352-0228-00		3		. HOLDER,CABLE:FOR 0.125"DIA CABLE,PLASTIC	80009	352-0228-00
-66	352-0213-00		7		. HOLDER,CABLE:FOR 0.16 X 0.08"CABLE,PLASTIC	80009	352-0213-00
-67	-----		1		CKT CARD ASSY:INTERFACE(SEE A4 EPL) (ATTACHING PARTS)		
-68	211-0116-00		6		SCR,ASSEM WSHR:4-40 X 0.312 INCH,PNH BRS - - - * - - -	83385	OBD
	-----		-		. CKT CARD INCLUDES:		
-69	131-1003-00		2		. CONNECTOR BODY,:CKT BD MT,3 PRONG	80009	131-1003-00
-70	351-0186-00		6		. GUIDE-POST,LOCK:0.84 INCH LONG	80009	351-0186-00
-71	131-0608-00		18		. CONTACT,ELEC:0.365 INCH LONG	22526	47357
-72	136-0269-02		2		. SOCKET,PLUG-IN:14 CONTACT,LOW CLEARANCE	01295	C931402
-73	136-0260-02		4		. SOCKET,PLUG-IN:16 CONTACT,LOW CLEARANCE	01295	C931602
-74	-----		2		. TRANSISTOR:SILICON,PNP(SEE Q1034,Q1038 EPL) (ATTACHING PARTS)		
-75	211-0012-00		2		. SCREW,MACHINE:4-40 X 0.375 INCH,PNH STL	83385	OBD
-76	210-1122-00		2		. WASHER,LOCK:0.228 ID X 0.375 INCH OD,STL - - - * - - -	78189	4704-04-02
	-----		1		. SWITCH,SLIDE:DPDT,0.5A,125V(SEE S669 EPL)		
-78	136-0252-04		164		. CONTACT,ELEC:0.188 INCH LONG	22526	75060
-79	344-0154-00		2		. CLIP,ELECTRICAL:FOR 0.25 INCH DIA FUSE	80009	344-0154-00
-80	131-0592-00		35		. CONTACT,ELEC:0.885 INCH LONG	22526	47353
-81	386-1559-00		3		. SPACER,CKT CARD:PLASTIC	80009	386-1559-00
-82	351-0213-00		2		. GUIDE-POST,LOCK:0.285 INCH LONG	80009	351-0213-00
-83	386-1402-00		1		PANEL,REAR: (ATTACHING PARTS)	80009	386-1402-00
-84	213-0192-00		4		SCR,TPG,THD FOR:6-32 X 0.50 INCH,PNH STL	87308	OBD
-85	361-0326-00		1		SPACER,SLEEVE:0.18 ID X 0.25 OD X 0.10"L - - - * - - -	80009	361-0326-00

## Replaceable Mechanical Parts—7D10

Fig. & Index No.	Tektronix Part No.	Serial/Model No.		Qty	1 2 3 4 5	Name & Description	Mfr	
		Eff	Dscont				Code	Mfr Part Number
1-86	220-0547-00			6		NUT,BLOCK:0.38 X 0.25 X0.282 INCH OA (ATTACHING PARTS FOR EACH)	80009	220-0547-00
-87	211-0105-00			1		SCREW,MACHINE:4-40 X 0.188"100 DEG,FLH STL - - - * - - -	83385	OBD
-88	426-0505-11			1		FR SECT,PLUG-IN:TOP	80009	426-0505-11
-89	426-0499-11			1		FR SECT,PLUG IN:BOTTOM	80009	426-0499-11
	198-3282-00			1		WIRE KIT,ELEC:	80009	198-3282-00
-90	131-0707-00			30		. CONTACT,ELEC:0.48"L,22-26 AWG WIRE	22526	47439
-91	175-0825-00			FT		. WIRE,ELECTRICAL:2 WIRE RIBBON	08261	TEK-175-0825-00
-92	175-0826-00			FT		. WIRE,ELECTRICAL:3 WIRE RIBBON	08261	TEK-175-0826-00
-93	175-0827-00			FT		. WIRE,ELECTRICAL:4 WIRE RIBBON	08261	TEK-175-0827-00
-94	175-0828-00			FT		. WIRE,ELECTRICAL:5 WIRE RIBBON	23499	TEK-175-0828-00
-95	175-0830-00			FT		. WIRE,ELECTRICAL:7 WIRE RIBBON	08261	TEK-175-0830-00
-96	210-0775-00			2		. EYELET,METALLIC:0.126 OD X 0.23 INCH L,BRS	80009	210-0775-00
-97	210-0774-00			2		. EYELET,METALLIC:0.152 OD X 0.245 INCH L,BRS	80009	210-0774-00
-98	352-0171-00			2		. CONN BODY,PL,EL:1 WIRE BLACK	80009	352-0171-00
-99	352-0169-01			1		. CONN BODY,PL,EL:2 WIRE BROWN	80009	352-0169-01
	352-0169-03			1		. CONN BODY,PL,EL:2 WIRE ORANGE	80009	352-0169-03
-100	352-0161-01			1		. CONN BODY,PL,EL:3 WIRE BROWN	80009	352-0161-01
-101	352-0162-04			1		. CONN BODY,PL,EL:4 WIRE YELLOW	80009	352-0162-04
-102	352-0163-02			2		. CONN BODY,PL,EL:5 WIRE RED	80009	352-0163-02
-103	352-0165-03			1		. CONN BODY,PL,EL:7 WIRE ORANGE	80009	352-0165-03

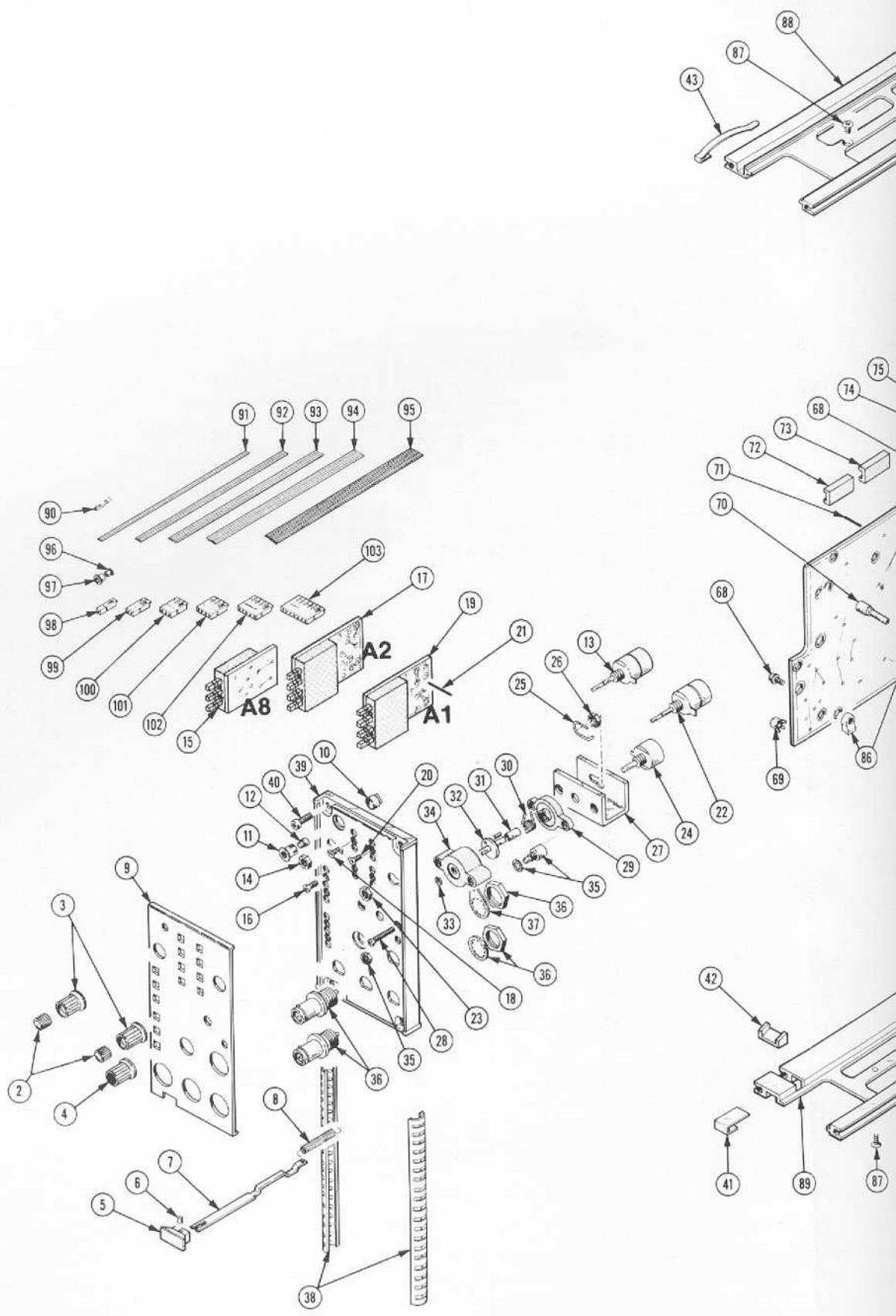

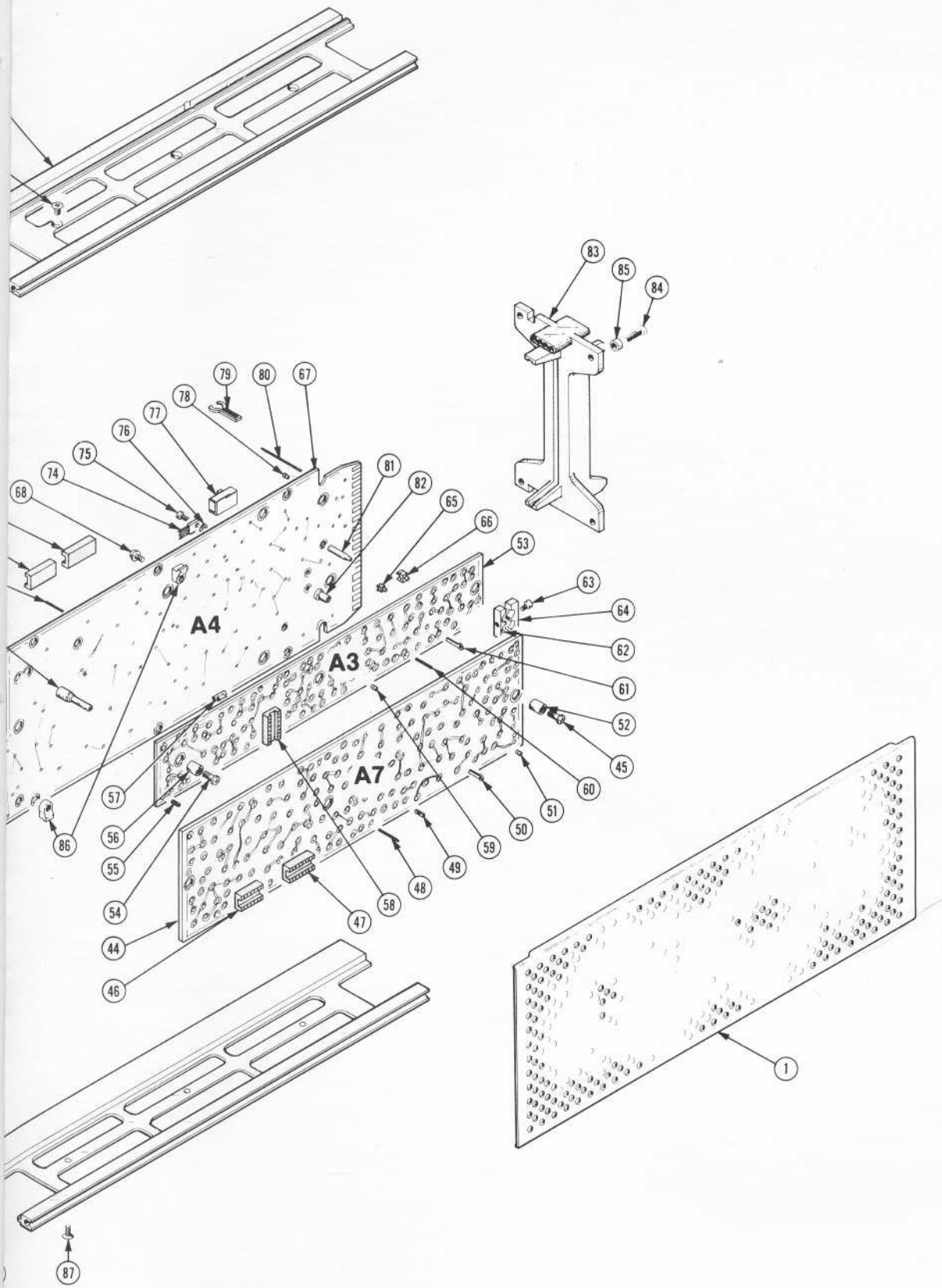

7D10 DIGITAL ADVANCE DELAY

Fig. & Index No.	Tektronix Part No.	Serial/Model No. Eff	Dscont	Qty	1	2	3	4	5	Name & Description	Mfr Code	Mfr Part Number
	070-2147-00			1						MANUAL, TECH: OPERATORS	80009	070-2147-00
	070-2148-00			1						MANUAL, TECH: INSTRUCTION	80009	070-2148-00

## **MANUAL CHANGE INFORMATION**

At Tektronix, we continually strive to keep up with latest electronic developments by adding circuit and component improvements to our instruments as soon as they are developed and tested.

Sometimes, due to printing and shipping requirements, we can't get these changes immediately into printed manuals. Hence, your manual may contain new change information on following pages.

A single change may affect several sections. Since the change information sheets are carried in the manual until all changes are permanently entered, some duplication may occur. If no such change pages appear following this page, your manual is correct as printed.

## **SERVICE NOTE**

Because of the universal parts procurement problem, some electrical parts in your instrument may be different from those described in the Replaceable Electrical Parts List. The parts used will in no way alter or compromise the performance or reliability of this instrument. They are installed when necessary to ensure prompt delivery to the customer. Order replacement parts from the Replaceable Electrical Parts List.

# CALIBRATION TEST EQUIPMENT REPLACEMENT

## Calibration Test Equipment Chart

This chart compares TM 500 product performance to that of older Tektronix equipment. Only those characteristics where significant specification differences occur, are listed. In some cases the new instrument may not be a total functional replacement. Additional support instrumentation may be needed or a change in calibration procedure may be necessary.

Comparison of Main Characteristics

DM 501 replaces 7D13		
PG 501 replaces 107 108	PG 501 - Risetime less than 3.5 ns into 50 $\Omega$ . PG 501 - 5 V output pulse; 3.5 ns Risetime	107 - Risetime less than 3.0 ns into 50 $\Omega$ . 108 - 10 V output pulse 1 ns Risetime
PG 502 replaces 107 108 111	PG 502 - 5 V output PG 502 - Risetime less than 1 ns; 10 ns Pretrigger pulse delay	108 - 10 V output 111 - Risetime 0.5 ns; 30 to 250 ns Pretrigger pulse delay
PG 508 replaces 114 115 2101	Performance of replacement equipment is the same or better than equipment being replaced.	
PG 506 replaces 106 067-0502-01	PG 506 - Positive-going trigger output signal at least 1 V; High Amplitude output, 60 V. PG 506 - Does not have chopped feature.	106 - Positive and Negative-going trigger output signal, 50 ns and 1 V; High Amplitude output, 100 V. 0502-01 - Comparator output can be alternately chopped to a reference voltage.
SG 503 replaces 190, 190A, 190B 191 067-0532-01	SG 503 - Amplitude range 5 mV to 5.5 V p-p. SG 503 - Frequency range 250 kHz to 250 MHz.	190B - Amplitude range 40 mV to 10 V p-p. 0532-01 - Frequency range 65 MHz to 500 MHz.
SG 504 replaces 067-0532-01 067-0650-00	SG 504 - Frequency range 245 MHz to 1050 MHz.	0532-01 - Frequency range 65 MHz to 500 MHz.
TG 501 replaces 180, 180A 181 184 2901	TG 501 - Trigger output-slaved to marker output from 5 sec through 100 ns. One time-mark can be generated at a time. TG 501 - Trigger output-slaved to market output from 5 sec through 100 ns. One time-mark can be generated at a time. TG 501 - Trigger output-slaved to marker output from 5 sec through 100 ns. One time-mark can be generated at a time.	180A - Trigger pulses 1, 10, 100 Hz; 1, 10, and 100 kHz. Multiple time-marks can be generated simultaneously. 181 - Multiple time-marks 184 - Separate trigger pulses of 1 and 0.1 sec; 10, 1, and 0.1 ms; 10 and 1 $\mu$ s. 2901 - Separate trigger pulses, from 5 sec to 0.1 $\mu$ s. Multiple time-marks can be generated simultaneously.

NOTE: All TM 500 generator outputs are short-proof. All TM 500 plug-in instruments require TM 500-Series Power Module.



**TEKTRONIX®**

committed to  
technical excellence

# MANUAL CHANGE INFORMATION

PRODUCT 7D10  
070-2148-00

CHANGE REFERENCE C1/978  
DATE 9-14-78

CHANGE:

DESCRIPTION

## TEXT CORRECTIONS

SECTION 5 PERFORMANCE CHECK AND ADJUSTMENT

Page 5-13 Step C1, parts (a) and (b)

CHANGE TO READ:

- a. Connect the marker output to the EXT TRIG IN connector and set the time-mark generator for 1  $\mu$ s markers.
- b. Connect a 500 millivolt, four-megahertz signal from the medium-frequency signal generator to the EVENTS START TRIG IN connector.

Page 5-16 Step C5, part (j)

CHANGE TO READ:

- j. Set the 7D10 B SWEEP DELAY MODE switch back to INDEPENDENT and then switch to B TRIGGERABLE AFTER DELAY.





**TEKTRONIX®**  
 committed to  
 technical excellence

# MANUAL CHANGE INFORMATION

PRODUCT 7D10  
070-2148-00

CHANGE REFERENCE M32361  
 DATE 9-12-77

CHANGE:	DESCRIPTION
---------	-------------

EFF SN B030000

ELECTRICAL PARTS LIST AND SCHEMATIC CHANGES

CHANGE TO:

A4            670-2150-06            CKT BOARD ASSY:INTERFACE

ADD:

R929            315-0153-00            RES.,FXD,CMPSN:15K OHM,5%,0.25W

R929 is added from the gate of Q928 to ground; located on the INTERFACE circuit board and shown on diagram 4.



**TEKTRONIX®**  
committed to  
technical excellence

# MANUAL CHANGE INFORMATION

PRODUCT 7D10  
070-2148-00

CHANGE REFERENCE M34668  
DATE 12-20-78

CHANGE:	DESCRIPTION
---------	-------------

EFF SN B040720

ELECTRICAL PARTS LIST CHANGES

CHANGE TO:

- |      |             |  |
|------|-------------|--|
| A4   | 670-2150-08 | CKT BOARD ASSY:INTERFACE                             |
| A7   | 670-2151-05 | CKT BOARD ASSY:LOGIC                                 |
| Q512 | 151-0221-00 | TRANSISTOR:SILICON,PNP,2N5771                        |
| U800 | 156-0482-00 | MICROCIRCUIT,DI:PRESETTABLE DECASE COUNTER,82S90,TTL |