

**MANUAL MERCHANT**  
PO BOX 927792  
SAN DIEGO CA 92192-7792  
TEL (858) 642-0785 • FAX (858) 642-0885

# INSTRUCTION MANUAL

Serial Number \_\_\_\_\_

*S/B COMM. SHOP*

**7S12**

**TDR/SAMPLER**

S/N B020000-up

MANUAL MERCHANT  
PO BOX 22700  
SAN DIEGO CA 92122  
TEL (602) 642-0788 • FAX (602) 642-0888

## WARRANTY

All Tektronix instruments are warranted against defective materials and workmanship for one year.

Any questions with respect to the warranty, mentioned above, should be taken up with your Tektronix Field Engineer or representative.

All requests for repairs and replacement parts should be directed to the Tektronix Field Office or representative in your area. This procedure will assure you the fastest possible service. Please include the instrument Type (or Part Number) and Serial or Model Number with all requests for parts or service.

Specifications and price change privileges reserved.

Copyright © 1971 by Tektronix, Inc., Beaverton, Oregon. Printed in the United States of America. All rights reserved. Contents of this publication may not be reproduced in any form without permission of the copyright owner.

U.S.A. and foreign Tektronix products covered by U.S. and foreign patents and/or patents pending.

# TABLE OF CONTENTS

<b>SECTION 1</b>	<b>CHARACTERISTICS</b>	<b>Page</b>	<b>SECTION 4</b>	<b>MAINTENANCE (cont)</b>	
	Description	1-1		Readout Symbol Adjustment	
	Electrical Characteristics	1-1		(> and <)	4-2
	Physical Characteristics	1-5		Repackaging for Shipment	4-3
	Environmental Characteristics	1-5			
<b>SECTION 2</b>	<b>OPERATING INSTRUCTIONS</b>		<b>SECTION 5</b>	<b>PERFORMANCE CHECK/ADJUST- MENT</b>	
	General Information	2-1		Introduction	5-1
	Installation	2-1		Equipment Required	5-1
	Controls and Connectors	2-1		Performance Check and Adjustment	
	First Time Operation	2-5		Record and Index	5-2
	Voltage Reflection Coefficient	2-7		7S12 Checks	5-3
	Impedance Scale Overlays	2-8		S-6, S-52 and 7S12 System Checks	5-5
	Time or Distance Measurements	2-8		S-5, S-54 and 7S12 System Checks	5-7
	High Resolution	2-11		Adjustment Procedure	5-9
	Single Sweep Operation	2-11			
	PRESET Calibration	2-12	<b>SECTION 6</b>	<b>ELECTRICAL PARTS LIST</b>	
	Application Connections	2-13			
<b>SECTION 3</b>	<b>CIRCUIT DESCRIPTION</b>		<b>SECTION 7</b>	<b>DIAGRAMS AND CIRCUIT BOARD ILLUSTRATIONS</b>	
	Introduction	3-1		Symbols and Reference Designators	
	Vertical Circuits Block Diagram	3-1		Schematic Diagrams and Component Board Locations	
	Horizontal Circuits Block Diagram	3-4	<b>SECTION 8</b>	<b>MECHANICAL PARTS LIST</b>	
	Circuit Description	3-10		Mechanical Parts List	
<b>SECTION 4</b>	<b>MAINTENANCE</b>			Mechanical Parts List Illustration	
	Introduction	4-1		Accessories	
	Lubrication	4-1			
	Troubleshooting	4-1			
	Tape Dial Removal	4-2			
	Tape Dial Installation	4-2			
	Tape Dial Alignment	4-2			



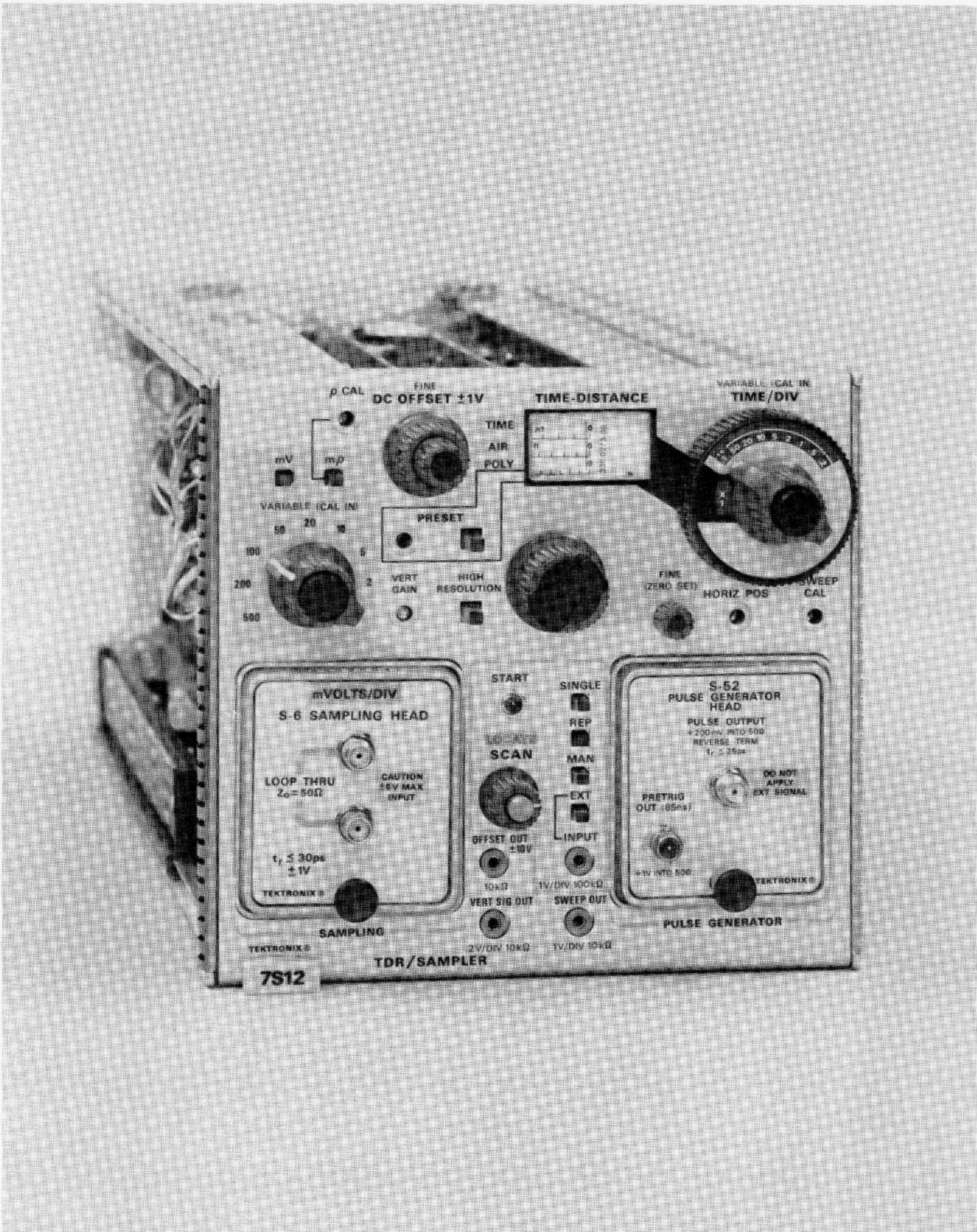

Fig. 1-1. 7S12 TDR/Sampler unit.



# SECTION 1

## CHARACTERISTICS

### Description

The 7S12 is a dual-purpose plug-in unit for measurement of recurring fast-rise signals or for time-domain reflectometry. It occupies two compartments (one vertical input and one horizontal input) of a Tektronix 7000-series oscilloscope.

The 7S12 has two compartments for plug-in heads. The left-hand compartment (labeled SAMPLING on the 7S12 front panel) accepts Tektronix S-series Sampling Heads. The type of sampling head selected determines the vertical input characteristics of the 7S12. The right-hand compartment (labeled PULSE GENERATOR) accepts S-series pulse generators, trigger recognizers or trigger count-down heads.

The 7S12 has the following features: The vertical deflection factors, i.e., millivolts/div and millirho/div, are from 2 to 500 in a 1-2-5 sequence. The time/div is cali-

brated from 20 ps/div to 1  $\mu$ s/div in a 1-2-5 sequence. The DC OFFSET control offsets the display in a  $\pm 1$  V range. The HI RESOLUTION switch reduces the waveform noise and jitter by signal averaging with a corresponding reduction of sweep rate. The LOCATE switch increases the time/div and intensifies a portion of the display to locate the time window relative to the total waveform. Front panel outputs include OFFSET OUT ( $\pm 10$  V range), VERTICAL SIGNAL OUT and SWEEP OUT. Modes of sweep operation include SINGLE sweep, REPetitive sweep, MANual scan and EXTernal sweep IN.

The TIME-DISTANCE scale is calibrated for round-trip time measurements of 0 to 10  $\mu$ s and one-way distance measurements up to 4900 feet (1500 meters) air dielectric or 3200 feet (975 meters) polyethylene dielectric. The POLY scale may be calibrated for transmission lines which have a velocity of propagation equal to or greater than that of polyethylene. The Time-Distance scale may be ordered with distance calibrated in metric units.

### SECTION 1

#### ELECTRICAL CHARACTERISTICS

Characteristic	Performance Requirement	Supplemental Information
Deflection Factor		
Accuracy	Within 3%	
Range		2 units/div to 500 units/div in a 1-2-5 sequence. Units/div are labeled on the sampling head.
Units/Div VARIABLE Range		Provides continuous coverage from 1 to 770 units/div (mV or $m\rho$ )
$\rho$ CAL Range		Allows calibrated reflection coefficient ( $\rho$ ) with pulse generators supplying from 200 mV to 1 V pulse amplitude.
DC OFFSET Range	Offsets display at least +1 V to -1 V.	
OFFSET OUT		
Range		At least +10 V to -10 V. OFFSET OUT = 10X (DC OFFSET) within 2%
Source Resistance		10 k $\Omega$ within 1%

Characteristics—7S12

Characteristic	Performance Requirement	Supplemental Information
VERTical SIGNAL OUT Amplitude		200 mV/div of signal display within 2%  VARIABLE control must be in CAL position.
Source Resistance		10 k $\Omega$ within .5%
SWEEP OUT Amplitude		1 V/div of horizontal deflection within 2%
Range		0 V to greater than 10 V
Source Resistance		10 k $\Omega$ within 1%
TIME/DIV Accuracy	Within 3%	
Range		20 ps/div to 1 $\mu$ s/div in a 1-2-5 sequence
Time/Div VARIABLE Range		Provides continuous coverage to at least 8 ps/div.
Display Modes SINGLE Sweep		Each sweep is initiated by pushing and releasing the START button.
REPetitive Sweep		Normal resolution: sweep rate is continuously variable from at least 1 sweep in 20 ms to less than 1 sweep in 5 s.  HI RESOLUTION: sweep rate is continuously variable from at least 1 sweep in 200 ms to less than 1 sweep in 50 s.
MANual Sweep		Any portion of the display may be observed by manual operation of the SCAN control.
EXTernal Input Deflection Factor		1 V/div within 5% to at least 15 V/div
Input Resistance		100 k $\Omega$ within 10%
Maximum Input Voltage		150 V (DC + peak AC)
FINE (ZERO SET) Range		Moves an unmagnified waveform at least .9 div.

**ELECTRICAL CHARACTERISTICS  
SYSTEM PERFORMANCE WITH S-6 AND S-52**

Characteristic	Performance Requirement	Supplemental Information						
Risetime	35 ps or less for the incident step, 45 ps or less for the displayed reflection from a short-circuited 1 ns test line							
Pulse Amplitude	At least +200 mV into 50 Ω							
Input Impedance		Nominal 50 Ω						
Jitter	Less than 10 ps (without signal averaging)							
Aberrations	Not more than +7%, -7%, total of 10% P-P within the first 1.8 ns of the step edge with the reference level at 1.8 ns from the step edge; not more than +2%, -2%, total of 4% P-P after 2.5 ns from the step edge with the reference level at 0.3 μs from the step edge.							
TIME-DISTANCE Scale		Time scale indicates round-trip time. Distance scales (AIR and POLY dielectrics) indicate one-way distance. The usable TIME-DISTANCE ranges for TDR measurements are limited by the S-52 pulse duration.						
Accuracy	TIME scale within 1% of full scale.	Distance scales are calibrated for the nominal velocity of propagation of the AIR and POLY dielectrics.						
TIME Range		<b>TIME-DISTANCE Multiplier</b>						
		<table border="1" style="width: 100%; border-collapse: collapse;"> <tr> <td style="width: 33%; text-align: center;">X.1</td> <td style="width: 33%; text-align: center;">X1</td> <td style="width: 33%; text-align: center;">X10</td> </tr> <tr> <td style="text-align: center;">.1 μs</td> <td style="text-align: center;">1 μs</td> <td style="text-align: center;">10 μs</td> </tr> </table>	X.1	X1	X10	.1 μs	1 μs	10 μs
		X.1	X1	X10				
.1 μs	1 μs	10 μs						
Maximum of about 150 ns one-way cable delay.								
AIR Dielectric Distance Range		<table border="1" style="width: 100%; border-collapse: collapse;"> <tr> <td style="width: 33%;">49 feet</td> <td style="width: 33%;">490 feet</td> <td style="width: 33%;">4900 feet</td> </tr> <tr> <td>15 meters</td> <td>150 meters</td> <td>1500 meters</td> </tr> </table>	49 feet	490 feet	4900 feet	15 meters	150 meters	1500 meters
		49 feet	490 feet	4900 feet				
15 meters	150 meters	1500 meters						
Maximum of about 150 feet (46 meters) cable length.								
POLY Dielectric Distance Range		<table border="1" style="width: 100%; border-collapse: collapse;"> <tr> <td style="width: 33%;">32 feet</td> <td style="width: 33%;">320 feet</td> <td style="width: 33%;">3200 feet</td> </tr> <tr> <td>9.75 meters</td> <td>97.5 meters</td> <td>975 meters</td> </tr> </table>	32 feet	320 feet	3200 feet	9.75 meters	97.5 meters	975 meters
		32 feet	320 feet	3200 feet				
		9.75 meters	97.5 meters	975 meters				
Maximum of about 100 feet (30 meters) cable length.								



Characteristics—7S12

Characteristic	Performance Requirement	Supplemental Information
PRESET		Permits the calibration of the POLY scale for dielectrics having a velocity of propagation between those of polyethylene and air.

**ELECTRICAL CHARACTERISTICS  
SYSTEM PERFORMANCE WITH S-5 AND S-54**

Characteristic	Performance Requirement	Supplemental Information						
Risetime	1.5 ns or less for the displayed reflection from a short-circuited test line							
Pulse Amplitude	At least +400 mV into 50 Ω							
Input Impedance		Nominal 50 Ω						
Jitter	Less than 20 ps (without signal averaging)							
Aberrations	Not more than +4%, -6%, total of 10% P-P within the first 17 ns of the step: not more than +1.5%, -1.5%, total of 3% after 17 ns.							
TIME-DISTANCE Scale		Time scale indicates round-trip time. Distance scales (AIR and POLY dielectrics) indicate one-way distance. TDR events out to 20 μs (round-trip time) may be viewed. This corresponds to 9800 feet (3000 meters) in AIR dielectric and to 6400 feet (1950 meters) in POLY dielectric. This distance is the sum of the displayed time window (10 μs maximum) and the TIME scale readout (10 μs maximum).						
Accuracy	TIME scale within 1% of full scale.	Distance scales are calibrated for the nominal velocity of propagation of the AIR and POLY dielectrics.						
TIME Range		TIME-DISTANCE Multiplier						
		<table border="1" style="width: 100%; border-collapse: collapse;"> <tr> <td style="width: 33%; text-align: center;">X.1</td> <td style="width: 33%; text-align: center;">X1</td> <td style="width: 33%; text-align: center;">X10</td> </tr> <tr> <td style="text-align: center;">.1 μs</td> <td style="text-align: center;">1 μs</td> <td style="text-align: center;">10 μs</td> </tr> </table>	X.1	X1	X10	.1 μs	1 μs	10 μs
		X.1	X1	X10				
.1 μs	1 μs	10 μs						
An additional time range may be viewed.								

Characteristic	Performance Requirement	Supplemental Information		
AIR Dielectric Distance Range		49 feet	490 feet	4900 feet
		15 meters	150 meters	1500 meters
		An additional distance range may be viewed (in terms of time).		
POLY Dielectric Distance Range		32 feet	320 feet	3200 feet
		97.5 meters	975 meters	975 meters
		An additional distance range may be viewed (in terms of time).		
PRESET		Permits the calibration of the POLY scale for dielectrics having a velocity of propagation between those of polyethylene and air.		

**PHYSICAL CHARACTERISTICS**

Characteristic	Performance Requirement
Finish	Anodized aluminum front panel
Weight	
Net	4.7 lb
Domestic Shipping	7.2 lb
Export Packed	11.7 lb
Dimensions	
Length (excluding knobs)	13.383 in
Width	5.464 in
Height	4.988 in

**ENVIRONMENTAL CHARACTERISTICS**

Characteristic	Performance Requirement
Temperature	
Operating	0°C to +50°C
Non-operating	-40°C to +65°C

**ENVIRONMENTAL CHARACTERISTICS (cont)**

Characteristic	Performance Requirement
Altitude	
Operating	To 15,000 feet
Non-operating	To 50,000 feet
Vibration	
Operating	0.025 in P-P displacement at 55 Hz
Shock	
Operating	To 20 g's, 1/2 sine, 11 ms duration
Humidity	
Non-operating and Operating	5 cycles (120 hours) to 95% relative humidity referenced to MIL-E-16400F (Paragraph 4.5.9 through 4.5.9.5.1, Class 4)
Transportation	Qualifies under National Safe Transit Committee test procedure 1A, Category II





# SECTION 2

## OPERATING INSTRUCTIONS

### General Information

This section of the manual provides the basic information required for operation of the 7S12 TDR/Sampler including installation, front panel information, and First Time operation instructions.

The 7S12 is a combined horizontal and vertical, double width sampling unit for use in any 7000-series Oscilloscope. The 7S12 accepts two plug-in heads, a sampling head and a generator head, which determine the characteristics of the TDR system. If a trigger recognizer head such as the S-53 is used in the 7S12 generator head compartment, general purpose sampling can be accomplished using the S-53 to trigger the 7S12 sweep.

### INSTALLATION

The 7S12 can be powered by any Tektronix 7000-series Oscilloscope. Since the 7S12 is a combined horizontal and vertical unit, it must be installed in the center two compartments of a 7000-series Oscilloscope containing 4 compartments, or into the right two compartments of a 7000-series Oscilloscope containing 3 compartments. A vertical unit such as a 7S11 can be installed in the left compartment of either Oscilloscope for dual-trace operation. Then J641 (a fixed shoe connector) provides a strobe connection to the 7S11.

Three methods of installation are shown in Fig. 2-1. Part A shows the 7S12 installed in the center two compartments of a 7504 Oscilloscope. The 7S11 and sampling heads are shown for TDR and dual-trace use. Part B shows the 7S12 installed with the 7S11, 7M11, and sampling heads for General Purpose Sampling and dual-trace use. Part C shows the 7S12 installed with the 7S11 and sampling heads in the 7403N (or 7503) 3-compartment Oscilloscope for TDR and dual-trace use. For General Purpose sampling, use the 7M11 outside the Oscilloscope, and the sampling heads as shown for installation B.

### Installing the 7S12 in the Oscilloscope

Insert the 7S12 into a vertical and a horizontal compartment of a 7000-series Oscilloscope (See Fig. 2-1). Slide the 7S12 completely into the two compartments. The 7S12 will lock into place with a spring loaded latch knob.

To install a head into one of the two 7S12 compartments, insert the head into the compartment with the latch knob free to move until completely in the 7S12. Then push the latch to lock the head in place. To remove, pull the latch knob away from the panel, then pull the unit from the 7S12.

### Mating

The 7S12 vertical output amplifier gain must be matched to the oscilloscope deflection factor for accurate gain measurements. The VERT GAIN control, a screwdriver adjustment on the front panel, adjusts the vertical output amplifier gain of the 7S12. Adjustment of this VERT GAIN control using the Oscilloscope Calibrator as a signal source is shown under First Time Operation in this section of the manual.

The 7S12 horizontal gain must be matched to the horizontal deflection factor of the oscilloscope. Horizontal gain is set by the SWEEP CAL adjustment located on the 7S12 front panel. The adjustment is made for full rotation of the SCAN control for 10 divisions with the MAN button pushed in. The HORIZ POS adjustment is used to position the spot on the CRT. The HORIZ POS control is also located on the front panel. The adjustment method is discussed in First Time Operation.

### CONTROLS AND CONNECTORS

A brief description of the function and operation of the controls and connectors of the 7S12 follows. Fig. 2-2 shows the 7S12 front panel with a sampling head and a pulse generator installed.

#### Vertical Section

DC OFFSET  $\pm 1$  V      Positions the display vertically by applying an internal offset voltage

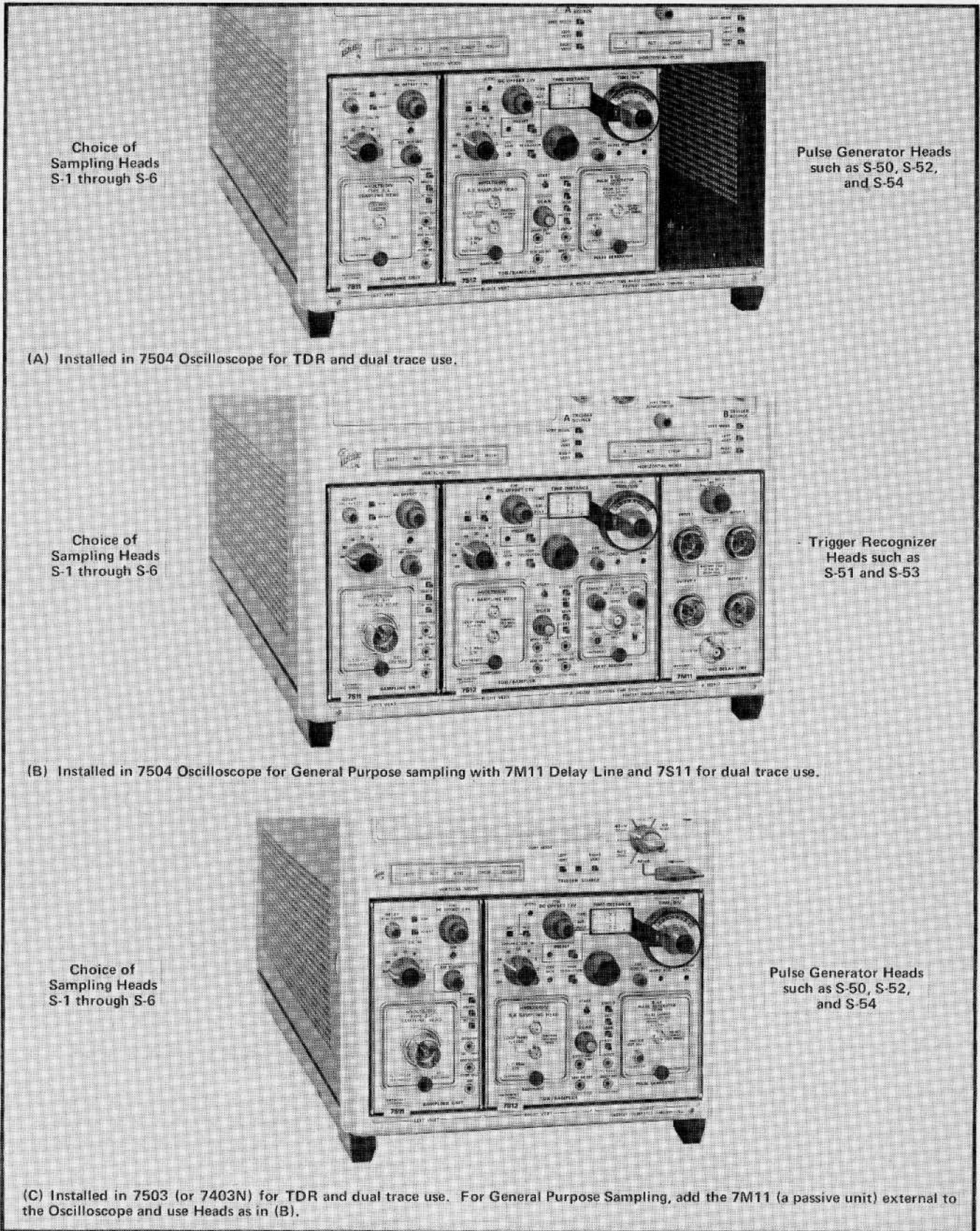

Fig. 2-1. 7S12 Installation Information.

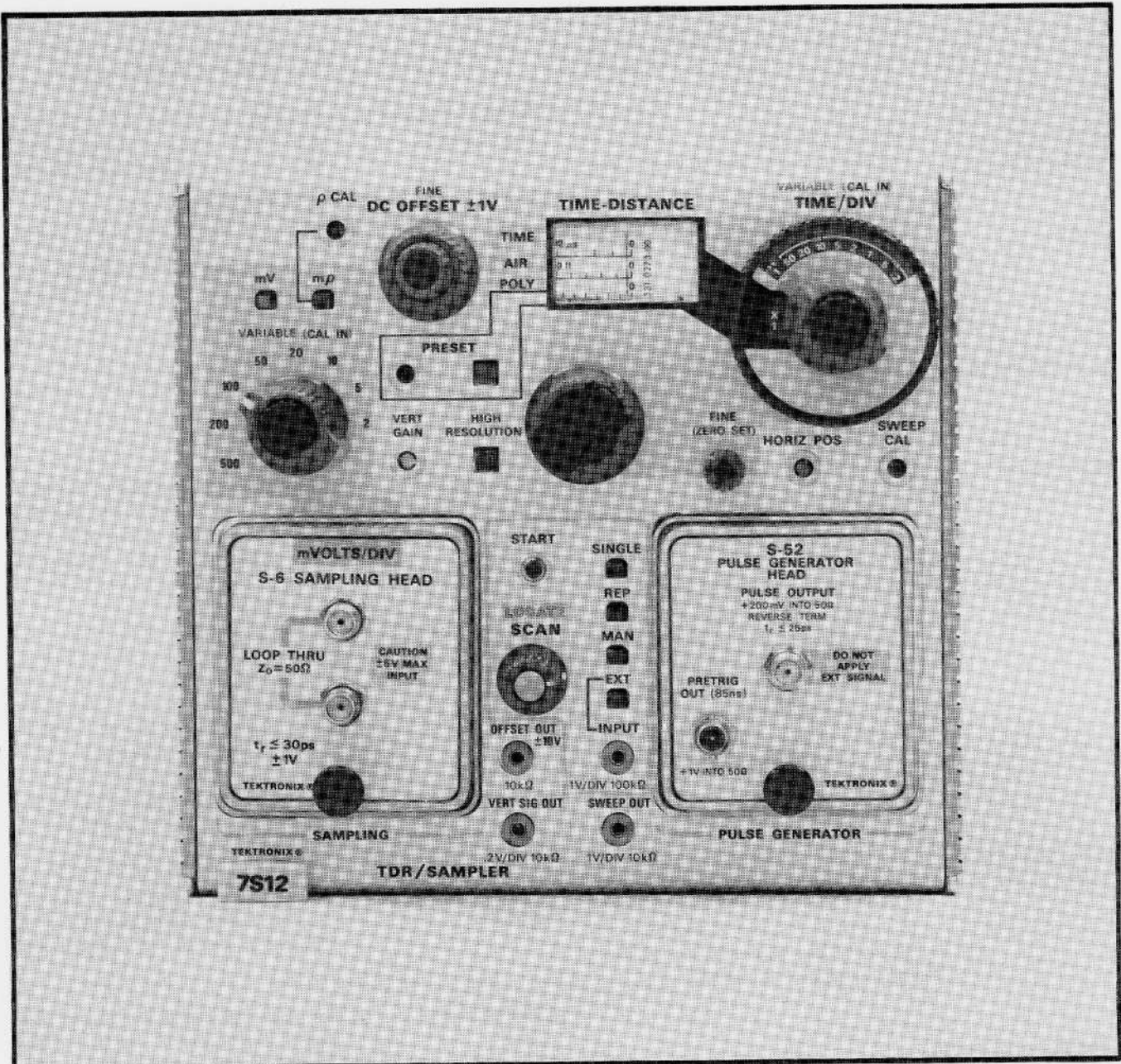

Fig. 2-2. 7S12 front panel.

of up to  $\pm 1$  volt to the sampling head. The input signal zero reference (related to the CRT) is the DC offset voltage instead of ground. This control permits all portions of a  $\pm 1$  volt input signal to be positioned through the CRT graticule area vertically even at a deflection factor of 2 units per division.

FINE

Provides fine control of the DC Offset function. Control is con-

centric with the DC OFFSET  $\pm 1$  V control.

Units/Div

Selects calibrated deflection factors from 500 units/div to 2 units/div in a 1, 2, 5 sequence. The actual deflection factor is determined by the sampling head used and the "mV", "mP" switch.

VARIABLE (CAL IN)

Provides uncalibrated, continuously variable deflection factor



## Operating Instructions—7S12

	from less than 0.65 to at least 2.5 times the calibrated setting. Concentric with the Units/Div switch.		at a point on the displayed sweep corresponding to the setting of the TIME/POSITION control.
mV and m $\rho$ pushbuttons	Permit selecting either mV/Div or m $\rho$ /Div as the basic unit of vertical measurement.	PRESET Switch and Control	Provides a means of calibrating the POLY scale to accommodate the dielectric constants between Poly and air.
$\rho$ CAL	Screwdriver adjustment permits calibrating the display for use with pulse amplitudes between 200 mV and 1 V.	TIME/DIV Switch	A 9 position switch used in conjunction with the 3 position Multiplier switch. The 27 combinations of TIME/DIV and Multiplier switches provide 15 different calibrated TIME/DIV settings, from 20 ps/div to 1 $\mu$ s/div, in a 1, 2, 5 sequence.
HIGH RESOLUTION	Reduces the displayed noise by approximately 10 times and slows the display rate by 10 times.		
VERT GAIN	Screwdriver adjustment permits calibration of the vertical output amplifier gain to match the oscilloscope CRT deflection factor.	VARIABLE (CAL IN) Control	Provides continuously variable, uncalibrated time/div by reducing the time/division. Concentric with the Multiplier and TIME/DIV controls.
OFFSET OUT $\pm 10$ V 10 k $\Omega$	Miniature connector provides an output voltage proportional to the internal DC offset voltage. Unless otherwise specified on the sampling head front-panel, the open circuit voltage at this connector is ten times the internal DC Offset voltage as set by the DC OFFSET control. The output resistance is 10 k $\Omega$ .	TIME/DISTANCE Multiplier	Provides a X10, X1, X.1 range multiplier for the TIME-DISTANCE tape dial. Switches Time/Distance ranges. Concentric with the TIME/DIV and VARIABLE (CAL IN) controls.
VERT SIG OUT .2 V/DIV 10 k $\Omega$	Miniature connector providing a real-time reproduction of the sampling display. Permits a non-sampling type oscilloscope to monitor the facsimile signal. Output resistance is 10 k $\Omega$ .	HORIZ POS Control	Screwdriver adjustment for setting the horizontal position of the display.
		SWEEP CAL Control	Screwdriver adjustment that sets the horizontal gain to match the deflection factor of the oscilloscope.
		SWEEP OUT Jack	Pin jack providing an output voltage proportional to the horizontal display amplitude. Provides 1 V for each division of display with an output resistance of 10 k $\Omega$ .
<b>Horizontal Section</b>			
TIME/DISTANCE Control	Crank-handle drive positions the display over the full TIME/DISTANCE range selected by the Multiplier switch.	Variable SCAN Control	Provides an internal voltage for adjusting the scan rate in the REP mode and SINGLE mode. Provides the manual scan voltage in MAN mode and can be used to calibrate the horizontal gain. In the EXT mode this control serves as a variable attenuator.
FINE Control	The FINE control provides a 10% position range with a 10 turn potentiometer for calibration of initial step.		
LOCATE Switch	Provides a display of the location of the position control setting on a display equal to twice the normal position range. The width of a brightened portion approximates the TIME/DIV setting and starts	REP Pushbutton	Provides repetitive scanning of the display. The scan rate is adjusted using the variable SCAN control.

SINGLE Pushbutton	Provides single scan display for photographic use. Scan rate is adjusted using the variable SCAN control.
START Pushbutton	Starts the single scan display after the SINGLE pushbutton is pushed.
MAN Pushbutton	Provides manual operation of the scan function using the variable SCAN control.
EXT INPUT Pushbutton	Allows scanning the display using an external signal. In this mode of operation, the variable SCAN control serves as a variable gain control.
EXT INPUT Jack	Pin jack provides the input facility for externally scanning the display. Requires 1 V for each division of display into an input resistance of 100 k $\Omega$ .
Correction Memory Switch	The three position switch is located near the top rear edge of the Horizontal card inside the 7S12. The Correction Memory circuit provides automatic base line correction for pulse generator heads and trigger heads.
On (front position)	This switch position is used when automatic base line correction is desired for trigger heads installed in the Pulse Generator compartment for DC stabilized sampler applications.
Normal (center position)	This is the normal operating switch position. The Correction Memory circuit provides automatic base line correction only for pulse generator heads installed in the Pulse Generator compartment.
Off (rear position)	This switch position disables the Correction Memory circuit. This position is also used when a sampling head gate balance control is being adjusted.

### FIRST TIME OPERATION

#### General Information

This First Time Operation procedure shows the basic operation of the 7S12 controls for TDR operation using the S-52 Pulse Generator Head and the S-6 Sampling Head. Additional operating information follows the First Time Operation procedure.

#### Procedure

1. Insert the 7S12 TDR/Sampler into the center two compartments of the 7504 Oscilloscope. Any Tektronix 7000-series Oscilloscope may be substituted for the 7504. (See the installation information in this section.)
2. Install the S-52 in the 7S12 Pulse Generator compartment.
3. Install the S-6 in the 7S12 Sampling compartment.
4. Set the controls as follows:

#### 7504 Indicator Oscilloscope

A Intensity	CCW
B Intensity	CCW
Vertical Mode	Right
Horizontal Mode	A

#### 7S12 with S-6 and S-52

(Two center compartments, the right vertical and the A horizontal compartments)

TIME-DISTANCE dial	0
Multiplier	X10
TIME/DIV	1 $\mu$ s
VARIABLE	CAL IN
FINE (ZERO SET)	Fully clockwise
REP	pushed in
SCAN	Midrange
LOCATE	pushed in
mV	pushed in
mV/Div	100
DC OFFSET (& FINE)	Midrange

5. Turn the Oscilloscope Power on. After about 5 minutes warmup time, advance the A Intensity until a free running trace is observed. Center the trace on the CRT with the 7S12 DC OFFSET control.

#### Adjust VERT GAIN

6. Install a SMA 1 ns coaxial cable (supplied with the S-52) with a 50  $\Omega$  termination connector to the S-6 Loop Thru (upper) connector. Install a SMA (3 mm) to BNC adapter on the Loop Thru (lower) connector. Use a BNC cable to connect the 0.4 V (into 50  $\Omega$ ) Calibrator Output signal to the adapter installed on the S-6 Loop Thru (lower) connector.

7. Use a small screwdriver to adjust the VERT GAIN (on the 7S12 front panel) for a square wave display of 4 divisions. Note that the sweep is free running and its repetition rate is determined by the setting of the SCAN control. Remove the BNC cable and the BNC to SMA (3 mm) adapter.

### Adjust SWEEP CAL & HORIZ POS

8. Push the MAN button and turn the SCAN control fully counterclockwise. A spot should be observed at the left edge of the graticule. If not, use a small screwdriver to adjust the HORIZ POS control (located on the 7S12 front panel) to position the spot at the left edge of the graticule. Rotate the SCAN control to its fully clockwise position. The spot should have moved exactly ten divisions to the right of its previous position. Use a small screwdriver to adjust the SWEEP CAL control (located on the 7S12 front panel) for ten divisions of movement when the SCAN control is turned from one extreme to the other. Readjust the HORIZ POS as necessary in this adjustment. Push the REP pushbutton and set the SCAN control to its approximate midposition.

9. Use 50  $\Omega$  semi-rigid cable (u-shaped, supplied with the 7S12) to connect the S-52 Pulse Output signal to the Loop Thru (lower) connector on the S-6. The upper Loop Thru connector is connected to a 1 ns semi-rigid coaxial cable in part 6.

#### NOTE

*Connectors at both ends of the coaxial cable should be firmly connected to mating connectors or accessories. Tighten slightly more than finger tight using a 5/16 inch wrench. A good connection is necessary to minimize reflections at the junctions of connectors.*

10. Observe the S-52 waveform shown in Fig. 2-3A. The positive pulse in the center of the screen is used in the S-52 to automatically reset the tunnel diode bias for the next pulser trigger from the 7S12. The S-52 output pulse is not visible on the screen due to the additional 7S12 trigger delay with X10 Multiplier.

Change the 7S12 Multiplier setting to X1 and observe the S-52 output pulse shown in Fig. 2-3B. The width of the pulse top will determine the maximum time (round trip time) of the reflection from the leading edge that can be observed with X1. Fig. 2-3C shows the leading edge of the pulse on the X.1 position of the Multiplier. Use the lowest Multiplier range setting to observe a reflection.

### Observing Risetime

11. To observe the leading edge of the S-52 Output Pulse, set the TIME-DISTANCE Multiplier to X.1, and the TIME/DIV to a sweep rate desired up to 20 ps; Use the Time-Distance knob to position the leading edge of the pulse to the center of the graticule. Use the 20 ps sweep rate for risetime display (Incident risetime) and

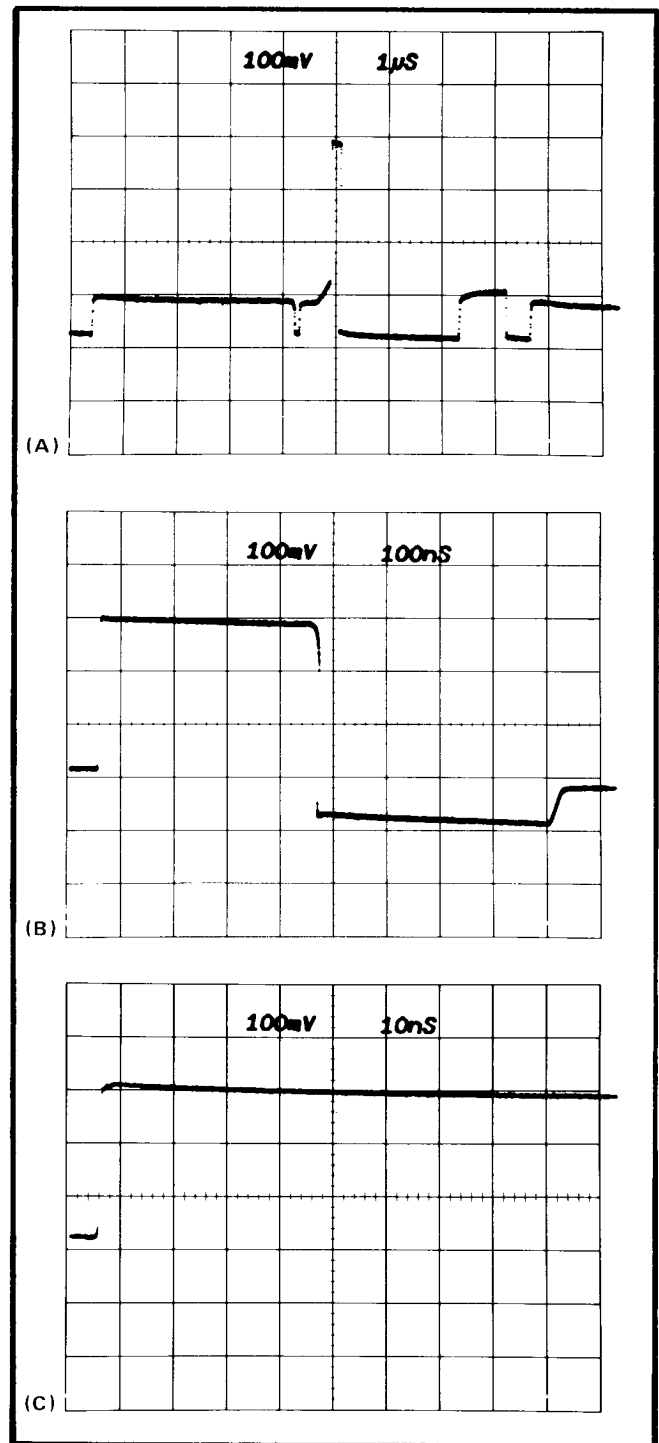

Fig. 2-3. First Time Operation showing Multiplier setting (A) X10, (B) X1 and (C) X.1.

use the mV/Div VARIABLE knob to set the leading edge for 5 divisions on the graticule. See Fig. 2-4. Note that the 5-division points on the display are about one  $T_r$  time from reference point 1 for 0% level and about one  $T_r$  time from reference point 2 for the 100% level.



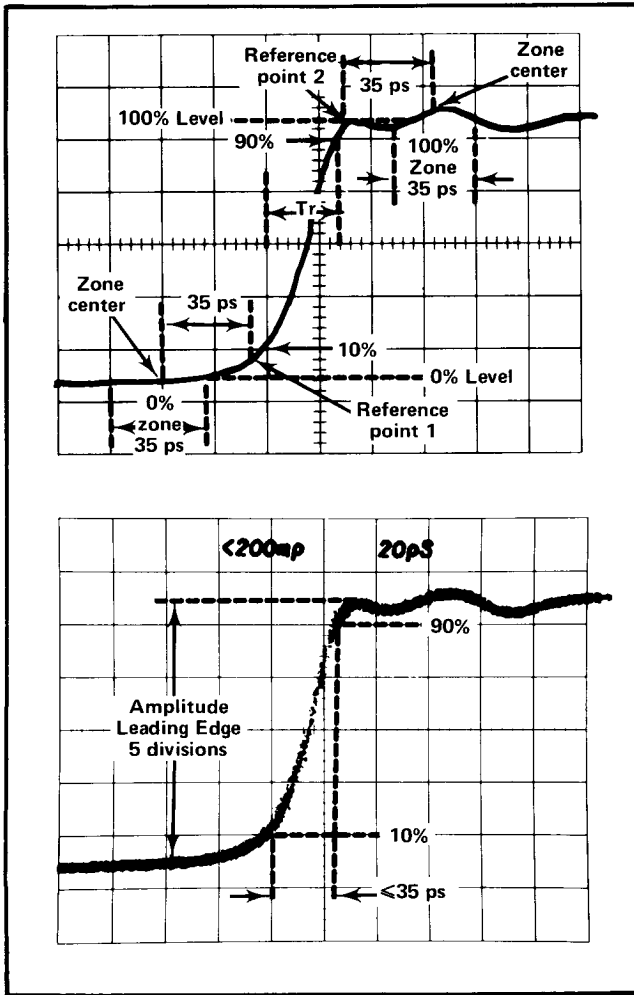

Fig. 2-4. Risetime measurement ( $T_r$ ) information (upper) and typical risetime display (lower). Note that Reference point 1 and 2 are selected at the corners where the rate of change of the slope is maximum (where the radius of curvature is least).

12. To observe the reflected edge (Reflected risetime) of the S-52 Output Pulse, remove the  $50 \Omega$  termination from the end of the 1 ns semi-rigid coaxial cable connected to the S-6 Loop Thru (upper) connector, and connect a short-circuit termination to the cable.

Change the Time-Distance knob to move the Pulse leading edge to the left and off the CRT until the reflected edge display is centered on the CRT. See the typical waveform in Fig. 2-5. The Reflected risetime is measured in the same way as the Incident risetime.

**FINE (ZERO SET)**

Turn the FINE (ZERO SET) control and note that the control will change the horizontal position of the display. This control can be used as a fine position control, or can be used by the operator as a zero set for the TIME-DISTANCE dial. Since the reflected edge

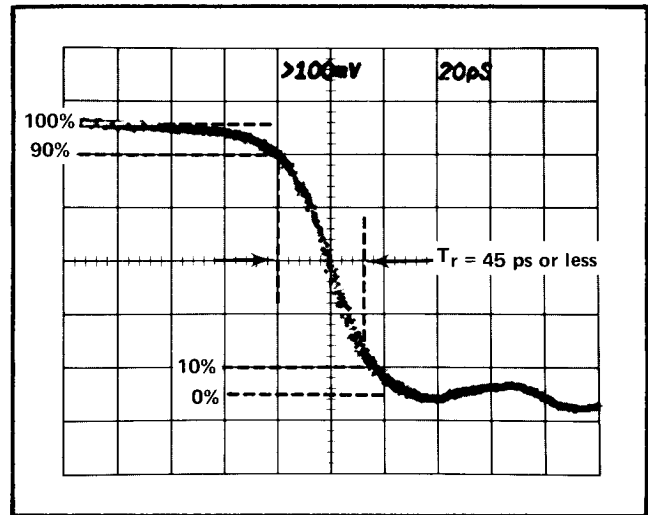

Fig. 2-5. Reflected risetime display.

represents the end of the 1 ns line where the test line will be attached, adjust the FINE control so the reflected edge of the pulse is displayed at the center of the screen (or a reference point selected by the operator) with the TIME-DISTANCE dial set to zero.

13. Change the TIME/DIV to .1, and change the Time-Distance knob to position the reflected pulse to the graticule centerline. See the typical waveform in Fig. 2-6A.

14. The negative reflection is caused from the short circuit termination. This reflection therefore has a voltage reflection coefficient of about  $-1\rho$  or  $-1000 \text{ m}\rho$ .

15. Remove the short circuit termination. Change the DC OFFSET control to position the display to show the positive reflection due to the open line. This reflection as shown in Fig. 2-6B has a voltage reflection coefficient of about  $+1\rho$  or  $+1000 \text{ m}\rho$ .

**CAL Adjustment**

16. Terminate the 1 ns semi-rigid coaxial line with a  $50 \Omega$  termination. Change the TIME/DIV to .2 ns, and change the Time-Distance knob to position the leading edge of the pulse to the center of the graticule. Push the  $\text{m}\rho$  button in, and set the  $\text{m}\rho/\text{Div}$  to 200.

17. With a small screwdriver, adjust the  $\rho$  CAL control for a 5 division displayed step amplitude.

**Voltage Reflection Coefficient**

As shown in Fig. 2-6, the reflection coefficient  $\rho$  (rho) is taken from the top of the incident pulse from

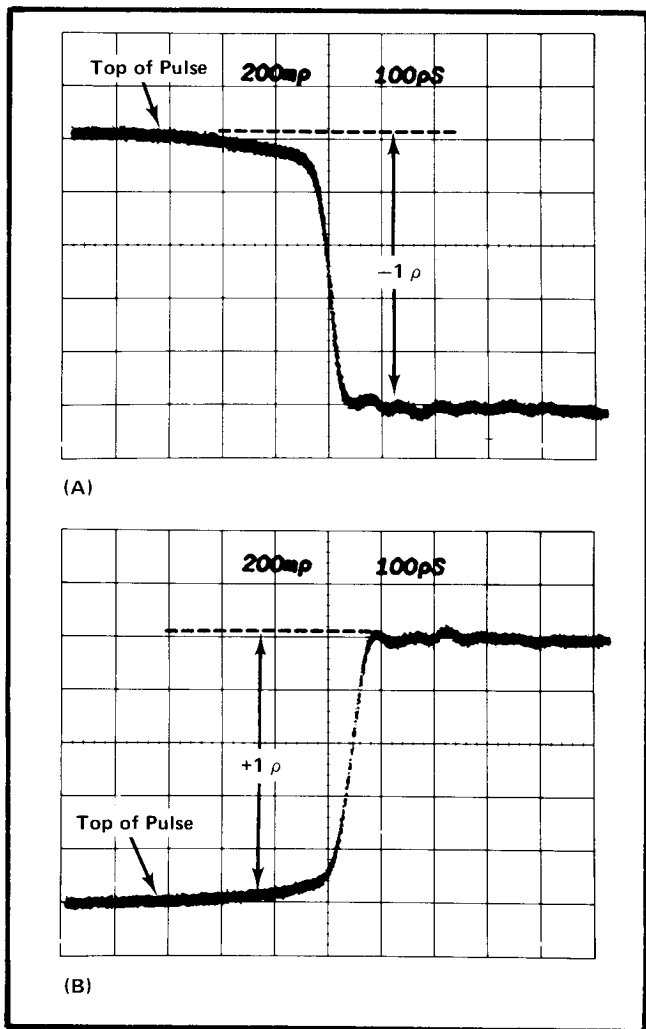

Fig. 2-6. Display of a short circuit terminated line (A) and unterminated line (B).

the pulse generator. A positive reflection (referenced from the top of the incident pulse) indicates an impedance greater than the impedance of the line. A negative reflection indicates an impedance less than the impedance of the line. With a known  $\rho$ , resulting from a resistive load, the resistance of the load can be found by the following formula:

$$R_L = Z_0 \left( \frac{1 + \rho}{1 - \rho} \right)$$

### Impedance Scale Overlays

For each  $mp$  amplitude discontinuity displayed on the CRT, the indicated impedance  $R_L$  can be calculated by the above formula. Impedance Scale Overlays are available for the CRT face showing direct reading of the Impedance at each graticule setting for 6 different  $mp/Div$  settings. Three overlays are required to cover 5, 10, 20, 50, 100 and 200  $mp/Div$  settings. Two sizes of three overlays each are included in the 7S12 accessories.

To use the Impedance Scale Overlays, select the overlay for the  $mp/Div$  setting you are using, and install it in position over the graticule on the Oscilloscope; read the impedance values under the proper  $mp/Div$  scale listing for the amplitude of the reflection. Note that the graticule center is used as the  $50 \Omega$  reference line.

In addition to impedance values, the overlays include a POLY distance scale in cm using the 100 ps/Div time. For further information, read the Time or Distance Measurement Procedures later in this section.

## TIME OR DISTANCE MEASUREMENTS

### General Information

The TIME-DISTANCE dial setting can be considered to be a delay in time before the operation of the display time (except in LOCATE). The display time has 3 multipliers or ranges, which also multiply the TIME-DISTANCE dial reading. The display time includes a TIME/DIV (magnification of 1 to 500 times), and a TIME/DIV VARIABLE control which provides a variable uncalibrated time by reducing the time per division.

When the LOCATE button is depressed to release (out position), the displayed time is twice the time (magnification of 0.5) labeled at the CCW position of the TIME/DIV switch. Then the TIME/DIV switch controls the length of the bright portion of the display to show the position on the display relative to the pulse edge. The Oscilloscope readout of the Time/Div will show the correct reading when the LOCATE button is depressed (in position).

### Time/Div

Fig. 2-7 shows the TIME/DIV settings for the Multiplier settings. The Multiplier changes the scale factor of the TIME-DISTANCE dial readings. The TIME-DISTANCE dial readings are not generally used when in LOCATE. The LOCATE position display is intensified by the Display Window time as controlled by the TIME/DIV and the TIME/DIV VARIABLE controls. The Display Window time becomes the normal display time when the LOCATE button is depressed.

Fig. 2-8 shows the Display Window time for two settings of the TIME/DIV control and three settings of the TIME-DISTANCE dial.

With the TIME/DIV setting CCW ( $.1 \mu s/Div$ ), shown in Fig. 2-8A, the TIME-DISTANCE dial is set for a Multiplier of X1. Note that a delay from zero time to  $1 \mu s$  dial setting, with the additional time of the Display window results in a total of  $2 \mu s$  from the zero time. Accordingly, the duration of the Pulse Output from the Pulse Generator head must be at least  $2 \mu s$ . Use of the Multiplier of X1 with the S-52 is

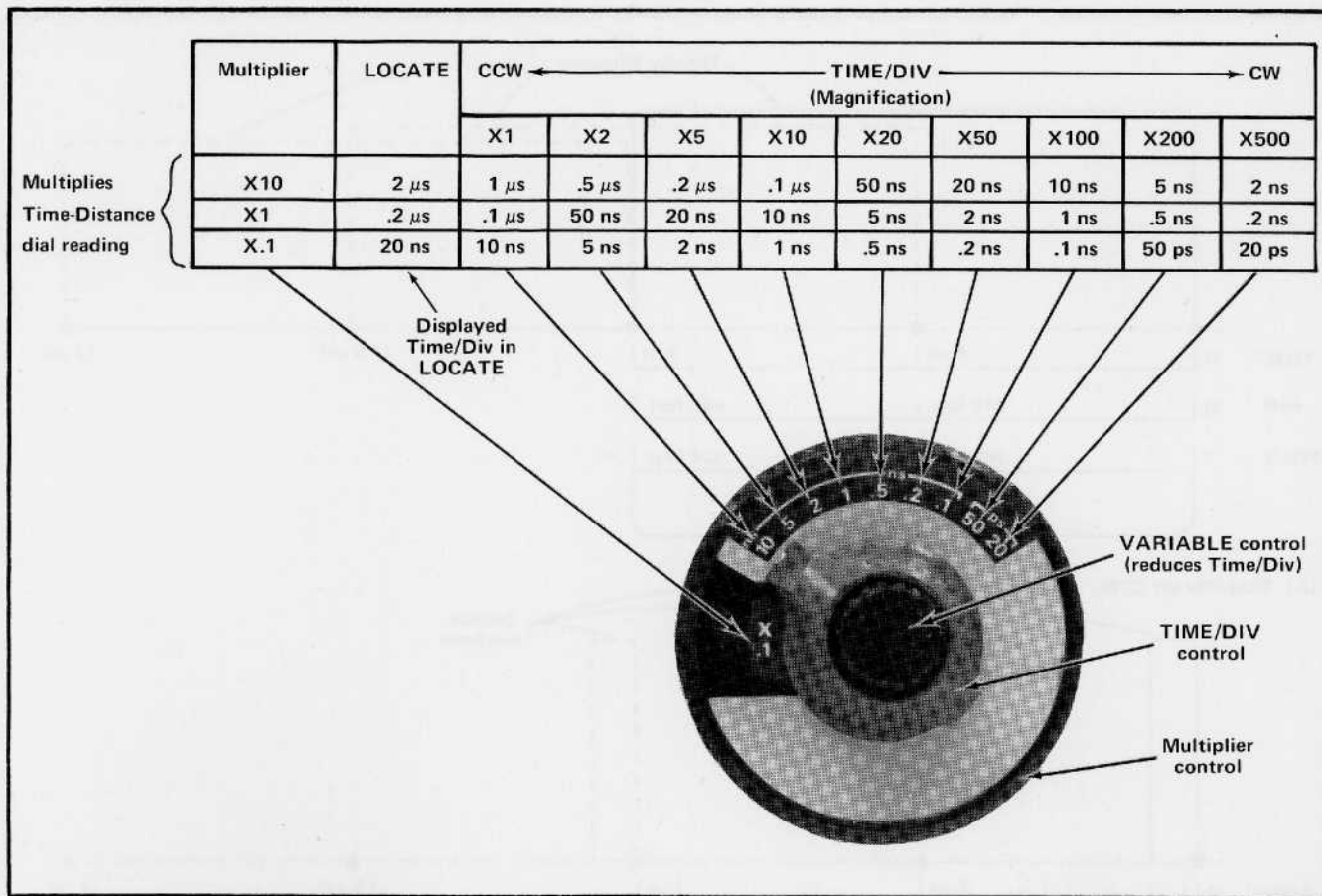

Fig. 2-7. Time/Div control information.

limited due to the short duration S-52 output pulse, shown in Fig. 2-3B. Also, use of the X10 Multiplier is restricted due to the 7S12 pulser trigger delay and the S-52 short pulse. Using the Multiplier of X10 with a pulse generator head with a long pulse duration (for example S-54 with a pulse duration of 25 μs) the total time of about 20 μs is available.

As the TIME/DIV is changed toward the CW positions, the Display Window time is less and the total time from zero is less, as shown in Fig. 2-8B.

**Time or Distance Measurement Procedures**

Procedures for Time or Distance measurements can be shown in three general methods:

- (A) On the screen, where measurement points are located a short distance apart.
- (B) Between two points on the TIME-DISTANCE dial.
- (C) From dial zero, on the TIME-DISTANCE dial.

(A) On the Screen. The distance between two measurement points or discontinuities on the screen may be deter-

mined more readily than from the TIME-DISTANCE dial. Measure the time separation on the CRT screen, note the horizontal calibration (TIME/DIV) and use Table 2-1 to determine the distance separation. This table is an aid in making measurements for short distances, where the TIME-DISTANCE dial's resolution is limited. The column "Separ-

TABLE 2-1

**On Screen Time vs. Distance (Separation)**

Time is for round trip, and Distance is for one way, in inches or cm/div.

TIME/DIV	Separation in AIR	Separation in POLY	Separation in PRESET (Spans AIR to POLY)
20 ps/Div	.12 inch/Div .3 cm/Div	.08 inch/Div .2 cm/Div	
50 ps/Div	.3 inch/Div .75 cm/Div	.2 inch/Div .5 cm/Div	
100 ps/Div	.6 inch/Div 1.5 cm/Div	.4 inch/Div 1 cm/Div	

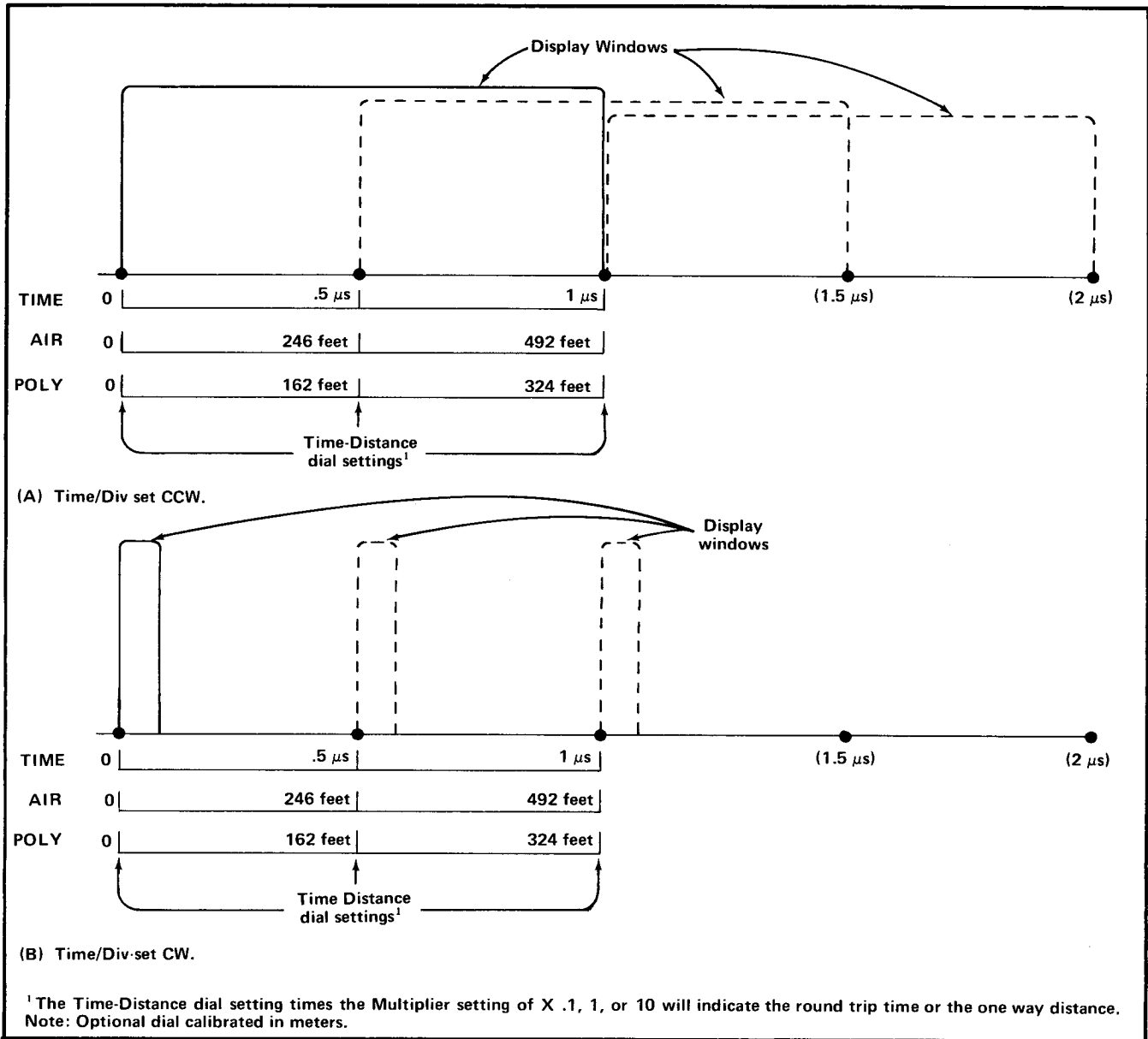

Fig. 2-8. Effect of the Time/Div setting in relation to the three settings of Time-Distance dial. The time or distance represented in the time windows shown is determined by the Multiplier setting.

ation in PRESET (Spans AIR to POLY)'' can be filled in or noted by the operator. The PRESET distances will be determined by the setting of the PRESET control (a screwdriver adjustment on the front panel) when the PRESET button is pushed in. The adjustment is set by the operator for cable propagation velocities between air and Poly.

(B) Two dial points. This method uses the net dial reading to determine the distance between the two points or discontinuities. Observe one of the two discontinuities and note its reference point on the screen (or set the FINE control to position the discontinuity to the center or reference point on the CRT). Record the Time-Distance dial

setting (TIME, POLY, or PRESET POLY). Change the Time-Distance knob to position the other discontinuity to the same reference point on the CRT. Record the TIME-DISTANCE setting. Subtract one recorded reading from the other, to determine the net dial reading. The net dial reading, times the Multiplier setting, will result in the round trip time or one way distance between the two discontinuities.

(C) From dial zero. In order to make measurements directly from the TIME-DISTANCE dial, the zero point must be determined. The FINE (ZERO SET) control is useful for a fine positioning control, and to set the dial zero.

For example, use the S-52 and S-6 with a Multiplier setting of X.1. Set the TIME-DISTANCE dial to 0, the TIME/DIV to 2 ns, and the FINE control fully clockwise. Use the open or short circuit termination at the end of the 1 ns line connected at the S-6 Loop Thru (upper) connector, to display the zero point or reference on the CRT. Then, use the FINE control to position this reference point to the left side of the graticule. Check other TIME/DIV settings especially at 20 ps/Div. The TIME-DISTANCE dial reading time 0.1 will then be the round trip time or one way distance from the reference point. The same procedure applies with the X1 Multiplier (limited by the S-52 Output pulse duration). When using the S-54 Pulse Generator head, the risetime is less; however, the same procedure applies, but on all Multiplier settings.

**NOTE**

*The 1 ns semi-rigid coaxial line (Tektronix Part No. 015-1023-00) should be used when making time or distance measurements because S-6 and S-52 waveform discontinuities are in the first 2.0 ns. The junction of the transmission line and the sampling head connector is found by partially disconnecting the line under test from the sampling head connector to produce an inductive discontinuity (see Fig. 2-9) at the junction. Adjust the FINE control to place the discontinuity, a bump, at a convenient reference point for the measurement and then fully reconnect the transmission line.*

**High Resolution**

Smoothing is always switched into the circuit in the 5 and 2 positions of the units/Div switch. High resolution, a separate pushbutton switch on the front panel, can be selected whenever smoothing of the display is required. The displayed noise is reduced by about 10 times, and the scan

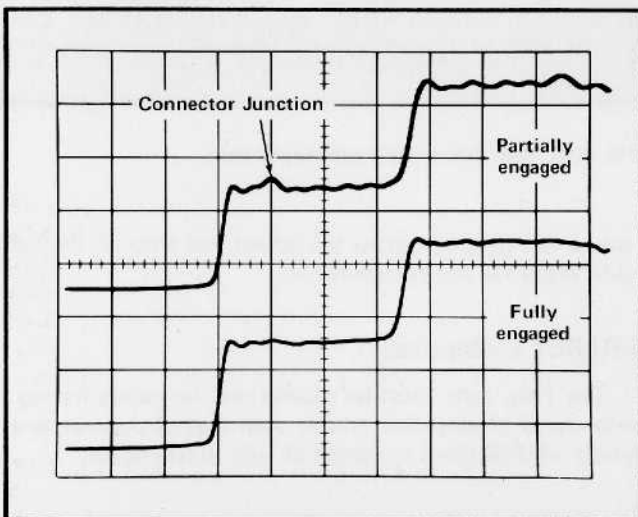

Fig. 2-9. TEST LINE connector junction location obtained by partially engaging the line to the connector.

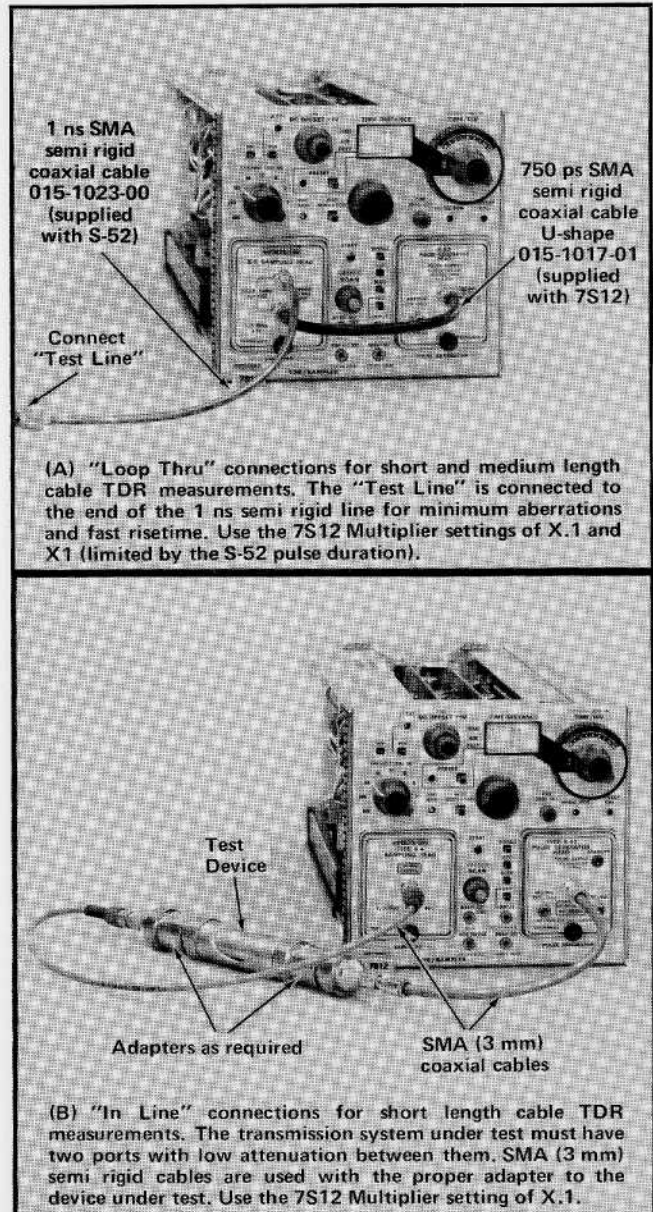

Fig. 2-10. Application connections for "Loop Thru", and "In Line" TDR.

rate is reduced about 10 times. A further reduction in the scan rate may be necessary (by changing the SCAN control) to avoid oversmoothing the display.

**Single Sweep Operation**

The SINGLE and START front panel controls are used in the single sweep operation for recorders.

Before recording, set the controls for the desired display in the normal repetitive mode. Set the desired scan rate for the recorder. Connect the recorder to the 7S12, using the VERT SIG OUT and the SWEEP OUT as required by the recorder.





Fig. 2-11. Application connections (A) for TDR of medium and long cables and (B) for testing triggerable devices.

When single sweep recording is desired either with a camera or with another type recorder, push the SINGLE button. The CRT spot will move off to the right of the screen. Push the START button and hold it depressed, which will move the spot to the left side of the screen ready for single sweep, and the blanking will be turned on. During this time, activate the recorder controls as necessary, or open the camera shutter. Then release the START button, and the

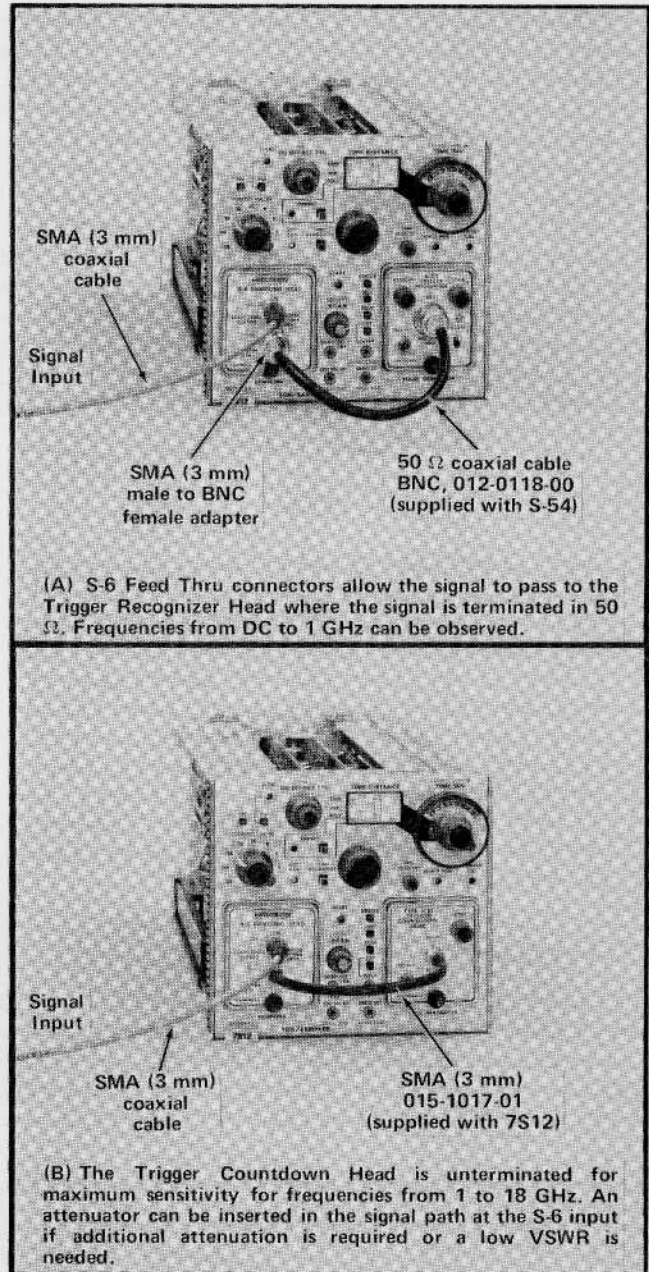

Fig. 2-12. High Frequency Signal Application.

sweep will progress across the screen and stop on the right side, ready for another operation.

### PRESET Calibration

The Poly scale must be recalibrated for cables having a velocity of propagation greater than that of polyethylene, which is 0.659 times the speed of light in free space.

The following procedure recalibrates the Poly scale when the PRESET switch is pushed in.

1. Push in the PRESET switch.
2. Place the UNITS/DIV switch to 500.
3. Install a KNOWN length of the type of unterminated cable that is to be measured on the end of the 1 ns semi-rigid coaxial line.
4. Place the TIME-DISTANCE scale at zero.
5. Produce an inductive discontinuity at the cable connector by partially disengaging the cable connector from the 1 ns coaxial line connector. Adjust the FINE control to position the discontinuity (a bump on the displayed waveform) at a convenient reference line and then fully engage the connector. See Fig. 2-9 which illustrates this discontinuity.
6. Place the TIME-DISTANCE scale at the KNOWN length readout of the POLY-PRESET scale.

7. Adjust the PRESET calibration control, at the left of the PRESET switch, so that the reflected pulse is positioned at the reference graticule line.

## APPLICATION CONNECTIONS

Figures 2-10 through 2-13 show some general applications for the 7S12 and other instruments. Normal interconnections are shown with the accessories supplied with the instruments. Where dual-trace is required, a plug-in unit such as a 7S11 with an appropriate sampling head can be used, installed in the left vertical compartment of the 7000-series Oscilloscope next to the 7S12. Choice of Heads for the 7S12 Sampling and Pulse Generator compartments provides further flexibility of the general applications shown.

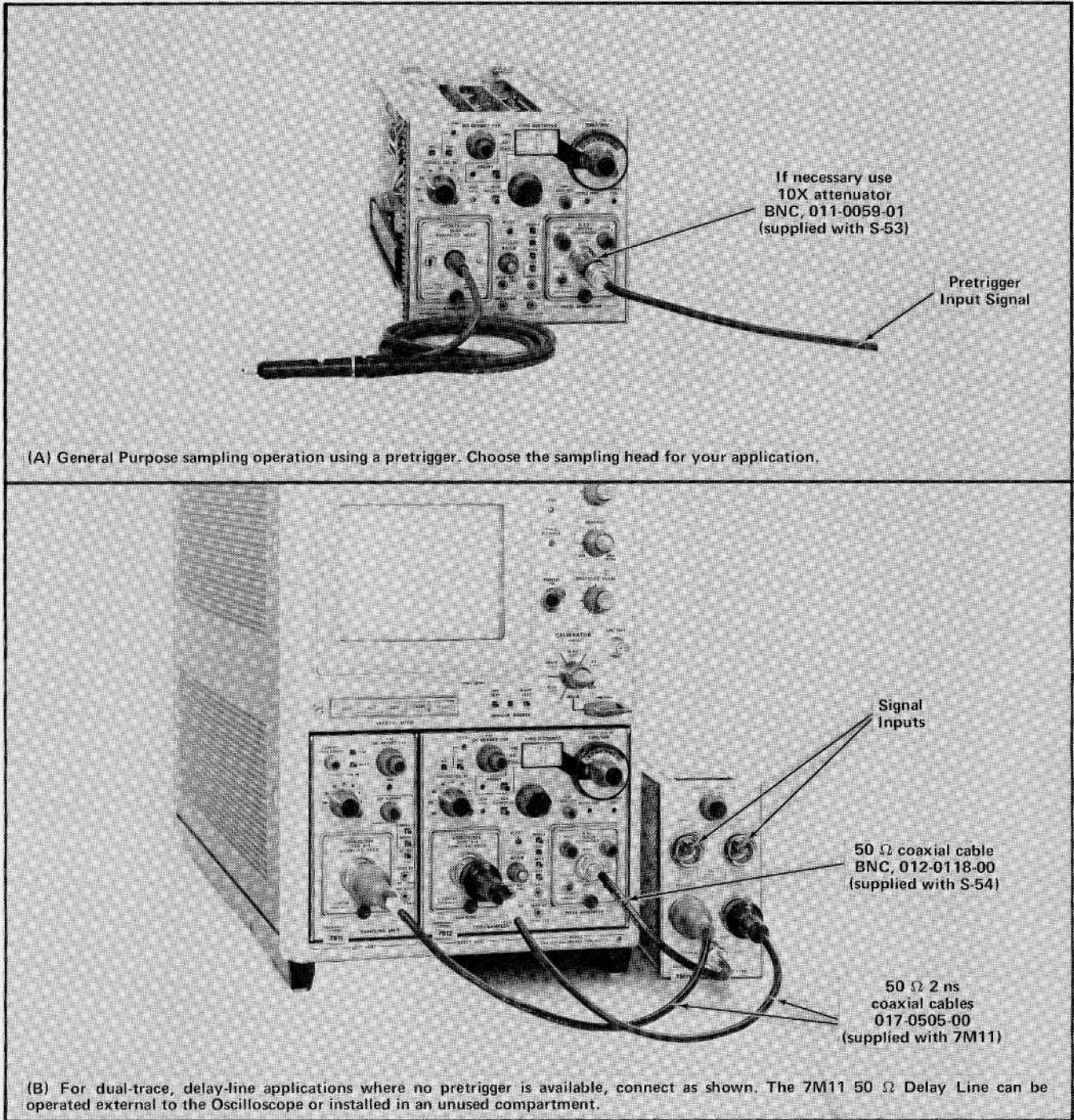

Fig. 2-13. General Purpose sampling.



# SECTION 3

## CIRCUIT DESCRIPTION

### Introduction

This section of the manual contains a block diagram description and circuit description of the 7S12 TDR Sampling Unit. The block diagram description explains the purpose and interrelationship of the 7S12 circuits. The circuit description explains the function of each individual circuit.

Circuits of the 7S12 can be broadly classified into two groups: Vertical Circuits and Horizontal Circuits. The vertical circuits provide sampling of the signal to be observed and supply the appropriate voltage levels to the oscilloscope vertical deflection system. The horizontal circuits provide a movable equivalent-time sweep for measuring time or distance.

### VERTICAL CIRCUITS BLOCK DIAGRAM

#### Sampling Heads

The block diagram of Fig. 3-1 shows the 7S12 Vertical Circuits. Since the 7S12 requires a sampling head, Fig. 3-1 includes a simplified block diagram of a typical sampling head.

Signals applied to the sampling head input appear at the input of the sampling bridge. The bridge is normally shut off by reverse bias applied to the sampling bridge diodes. The sampling bridge is turned on for short intervals of time by strobe pulses from the Avalanche and Snap Off circuits. These circuits are controlled by drive pulses from the 7S12.

When the sampling bridge diodes conduct, a sample input signal is taken. If the input signal amplitude differs from that which occurred during the previous strobe interval, a signal appears at the sampling bridge output (otherwise, no signal appears.) The signal amplitude at the bridge output is dependent upon the difference between the bridge input and output levels during the strobe interval.

The sampling bridge output signal is called the error signal. A small storage capacitance at the sampling head Pre-amplifier input time-stretches the error signal. In this way, the vertical amplifiers can amplify error signals having a moderate rate of rise. After amplification by the sampling

head Pre-amplifier the error signal is applied to the Post Amplifier in the 7S12.

For more detailed information about sampling heads, consult the instruction manual for your sampling head. The publication, "Sampling Oscilloscope Circuits", (available through your Tektronix Field Office) contains an extensive discussion of subjects such as sampling efficiency, forward attenuation, feedback attenuation, loop gain and DC offset.

#### Pulse Amplifier Chain

The Post Amplifier, AC Amplifier, and Memory (together with the Pre-amplifier in the Sampling Head), supply the gain needed to provide the approximate 1.23 volt per division Memory output. The Forward Attenuator maintains the correct amplifier gain for the deflection factor selected.

The AC Amplifier output is coupled to the Memory input only at strobe time, when the Memory Gate is opened by the memory gating pulse. Each time the Memory Gate is turned on, the error signal (if any) corrects the Memory output voltage to reflect the latest sampled value of signal at the sampling head input.

Memory output will change in correct proportion to the change in input signal if the forward loop gain is unity. With the UNITS/DIV switch set at 2 or 5, additional capacitance is connected between the input and output of the Memory circuit. Selecting HIGH RESOLUTION adds still more capacitance. Increasing the value of the Memory feedback capacitor reduces the gain of the Memory, and therefore reduces loop gain below unity. The display of random high-frequency noise is reduced by this reduction in loop gain.

If loop gain is less than unity, the displayed risetime of the input signal will be increased unless adequate dot density is maintained. See the Smoothing discussion in the Operating section of this manual.

#### Feedback Attenuator

The Feedback Attenuation must be correct if the deflection factor calibration is to be correct. The Feedback Attenuation determines the volts per division output of the Memory.

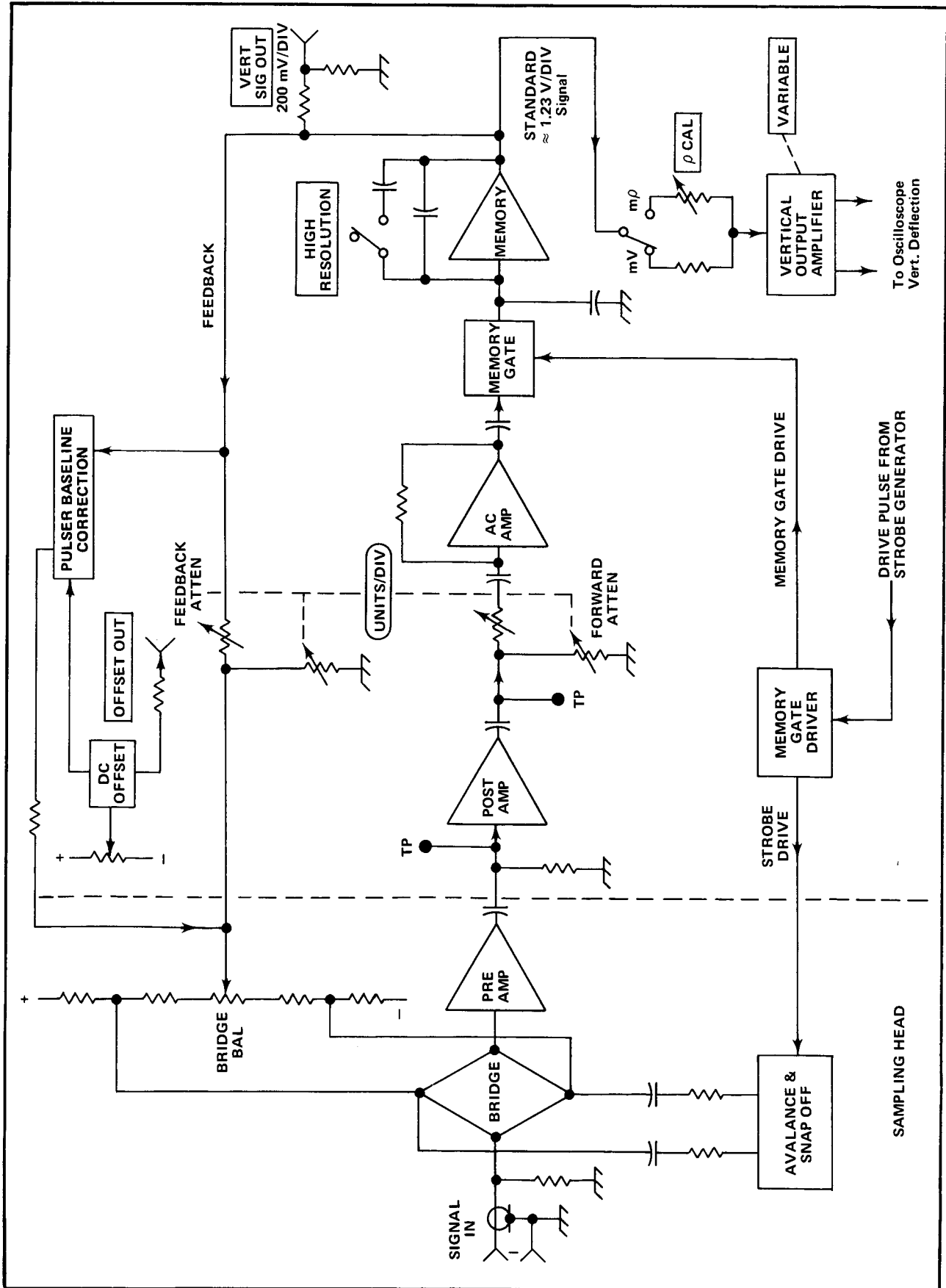

Fig. 3-1. Vertical Block Diagram.

An error signal will appear at the sampling head output if the Memory output voltage does not represent the input signal amplitude at the last strobe interval. When the Memory output voltage represents the last strobed value of sampling head input signal, the attenuator must provide a voltage to the bridge output that equals the sampling head input signal. The amount of Feedback Attenuation required is therefore dependent upon the deflection factor selected.

In order to maintain unity gain when the deflection factor is changed, the UNITS/DIV switch controls both the Forward and Feedback Attenuators. As more sensitive settings of the UNITS/DIV switch are selected, the Forward Attenuation is reduced and the Feedback Attenuation is increased by the same factor, thereby maintaining loop gain at unity.

### DC Offset

The DC Offset circuit provides a DC voltage (−1 volt to +1 volt) that is added to the Feedback voltage from the Feedback Attenuator. This permits the display of small voltage changes superimposed on relatively large DC levels.

The amount of offset voltage can be determined by measuring the voltage at the front panel OFFSET OUT jack. This is explained in the 7S12 Operating Instructions.

### Vertical Output Amplifier

With the mV-m $\rho$  switch in the mV position, the approximate 1.23 volt/div output of the Memory is more than is required at the input of the Vertical Output Amplifiers to produce the correct vertical deflection on the CRT. The Memory output voltage is reduced by voltage division approximately 240 mV/division.

Since the reference pulse amplitude is dependent on pulse generator output amplitude (and most pulse generator heads are limited to about 200 mV output), the selection of m $\rho$  increases the vertical sensitivity to about twice normal. Sensitivity is increased by applying a greater percentage of the Memory output (see  $\rho$  CAL adjustment in Fig. 3-1) to the input of the Vertical Output Amplifiers.

The front panel VARIABLE control changes the gain of the Vertical Output Amplifiers. This control provides a means of increasing or decreasing vertical sensitivity from the calibrated value.

The output of the Vertical Output Amplifier is fed to the vertical deflection circuits of the oscilloscope.

### Pulser Baseline Correction Circuit

The Pulser Baseline Correction circuit (see Fig. 3-2) sets the displayed pre-pulse baseline to zero for any termination

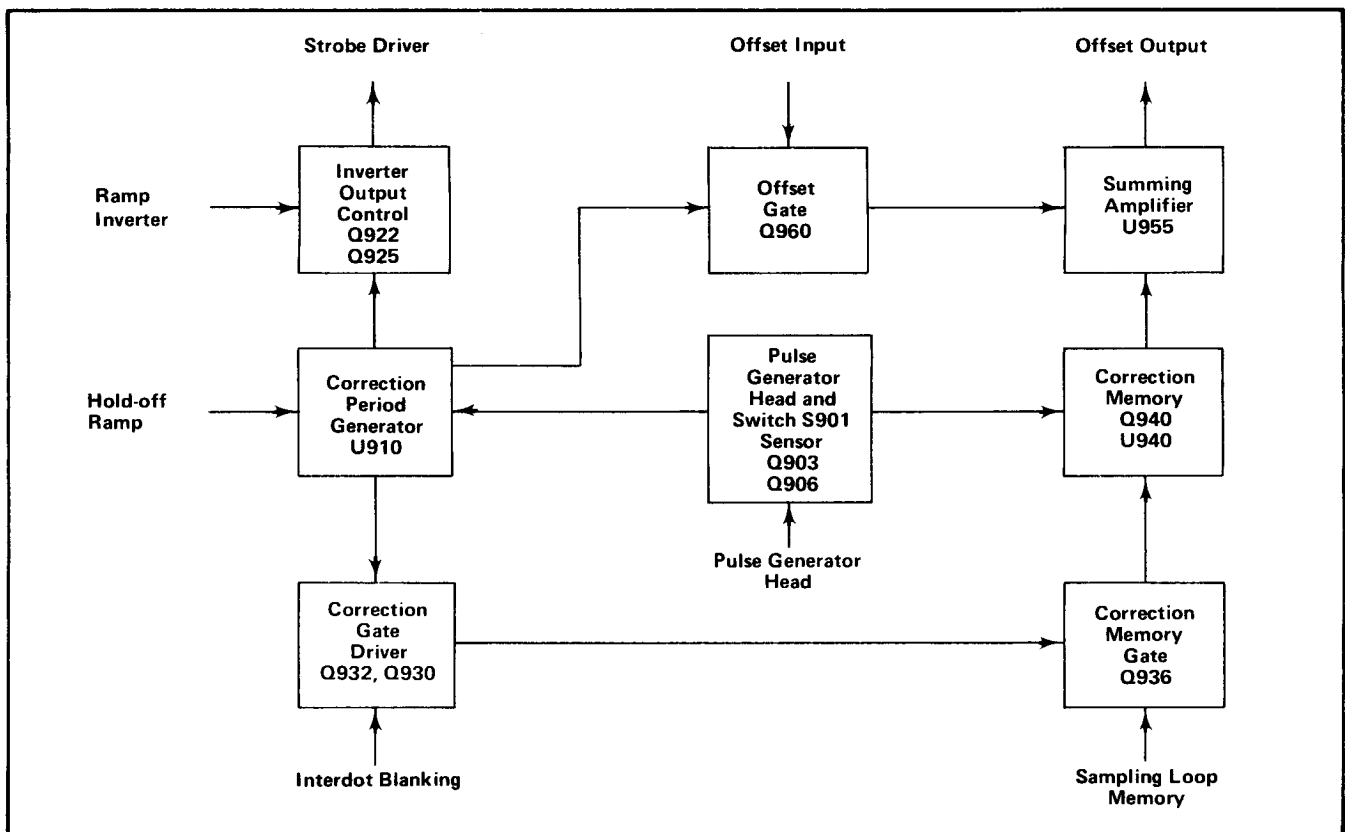

Fig. 3-2. Pulser Baseline Correction circuit block diagram.

## Circuit Description—7S12

that may be attached to the coaxial line on the Sampling Head input. The Pulser Baseline Correction circuit recognizes if an S-52 or an S-54 Pulse Generator Head is installed in the Pulse Generator compartment of the 7S12 with switch S901 in the Normal (center) position. The Pulser Baseline Correction circuit does not operate when Trigger Countdown or Trigger Heads are installed in the Pulse Generator compartment, unless switch S901 is set at the On (forward) position.

The Correction Period Generator compares a DC level and the Slow Scan Hold-off Ramp (see Fig. 3-3). This comparison occurs at the end of each sweep of the trace. The signal from the Correction Period Generator drives the Offset Gate and the Correction Gate Driver. The Correction Gate Driver gates the interdot blanking signals which turn on the Correction Memory Gate. Vertical Sampling Loop Memory signals through the gate drive the Correction Memory. The Correction Memory signal is applied to the

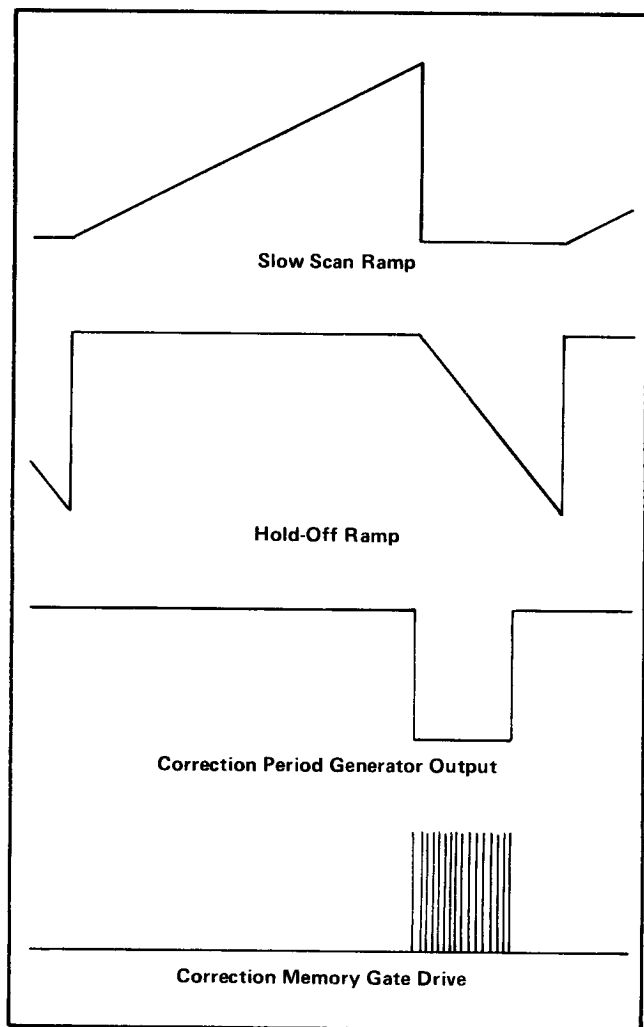

Fig. 3-3. Pulser Baseline Correction circuit waveforms showing signal events relative to the slow scan ramp.

Summing Amplifier, which also receives the manually controlled DC offset voltage from the Offset Gate. The Summing Amplifier output is the corrected offset voltage to the Sampling Head.

The Pulse Generator Head Sensor enables the Pulser Baseline Correction circuit when switch S901 is in the on position, or when an S-52 or an S-54 Pulse Generator Head is installed and switch S901 is in the Normal position.

## HORIZONTAL CIRCUITS BLOCK DIAGRAM

### Trigger and Trigger Holdoff

The pretrigger pulse from the S-52 or S-54 Pulse Generator is coupled to the 7S12 Trigger Circuit (See Fig. 3-4A). If the 7S12 Trigger Holdoff times has elapsed, the pretrigger pulse causes the Trigger Circuit to start the rundown of the Fast Ramp circuit. Setting the Multiplier switch to the X10 position (the slowest sweep) adds capacitance to the trigger hold-off circuit to increase hold-off time.

### Fast Ramp

The slope (rate of change) of the Fast Ramp output depends upon which of the three fast ramp timing capacitors is selected (see Fig. 3-4A and C). This selection is made by the TIME/DISTANCE Multiplier switch. The Fast Ramp output is used by the Pulser Comparator and the Strobe Comparator.

### Pulser Comparator and Pulser Driver

The Pulser Comparator (Fig. 3-4A and 3-4B) determines the delay between the pulse generator pretrigger and TD (tunnel diode) output pulse. The delay circuit in the pulse generator is disabled when the pulse generator is used in the 7S12. The 7S12 Pulser Comparator provides a separate trigger for each of the three 7S12 ranges.

The three pulser delay (Pulse Registration) adjustments R590, R592 and R594 normally are set so that the pulse generator output pulse will be displayed 0.5 division from the left edge of the graticule (with the TIME/DISTANCE and FINE delay cranked out and the slowest available TIME/DIV setting selected).

When the Fast Ramp output reaches the level set by the Pulser Delay adjustment, the Pulser Driver receives an input from the Pulser Comparator. The output of the Pulser Driver is fed to the Pulse Generator, causing the Pulse Generator to produce an output pulse.

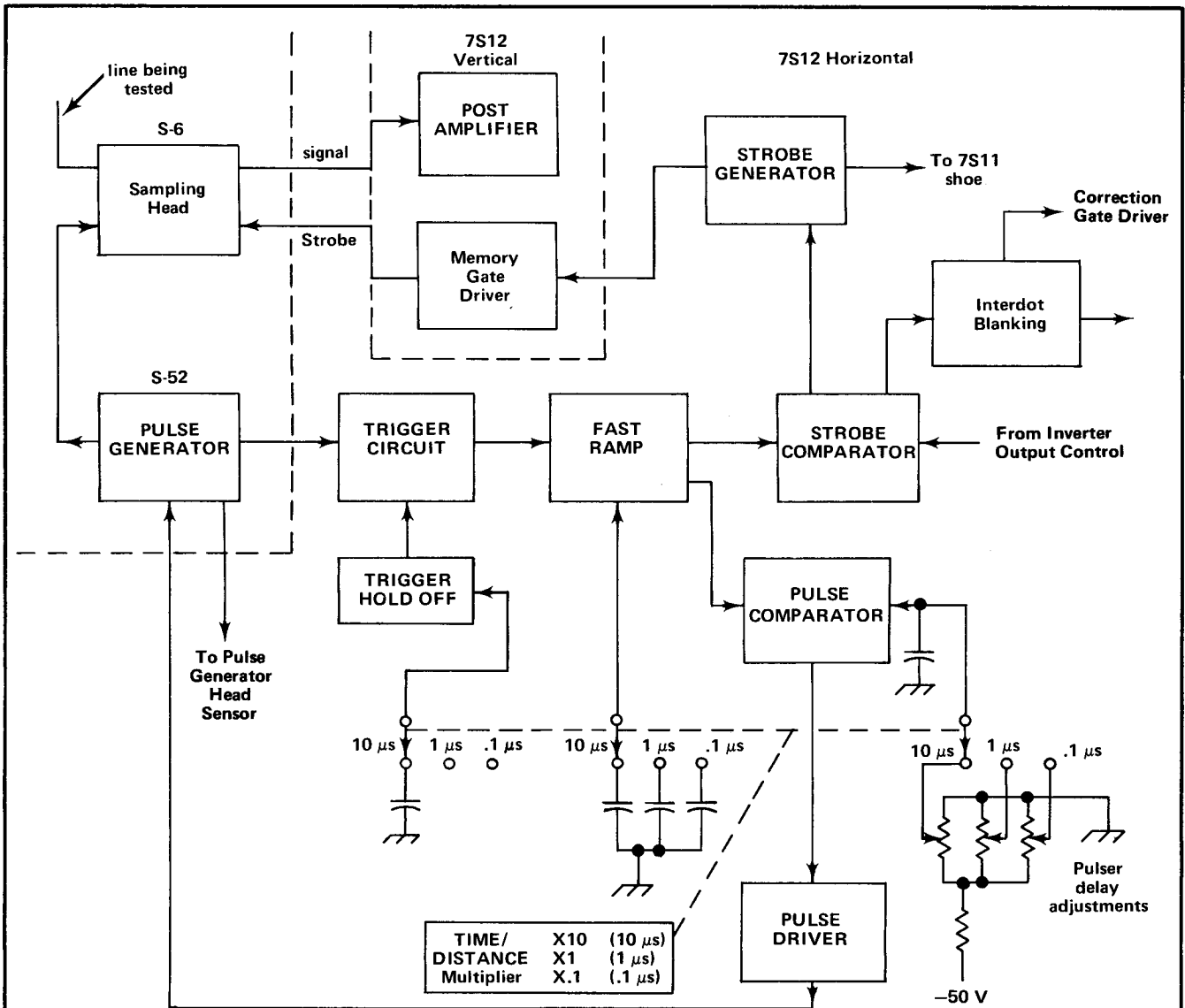

(a) Partial Horizontal Circuit block diagram

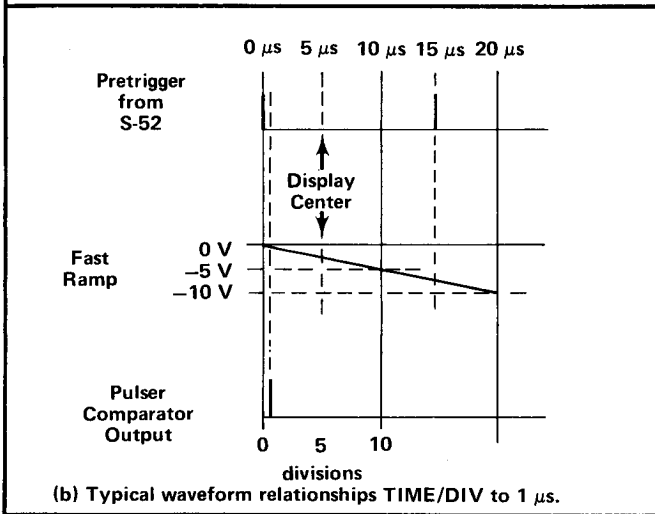

(b) Typical waveform relationships TIME/DIV to 1 μs.

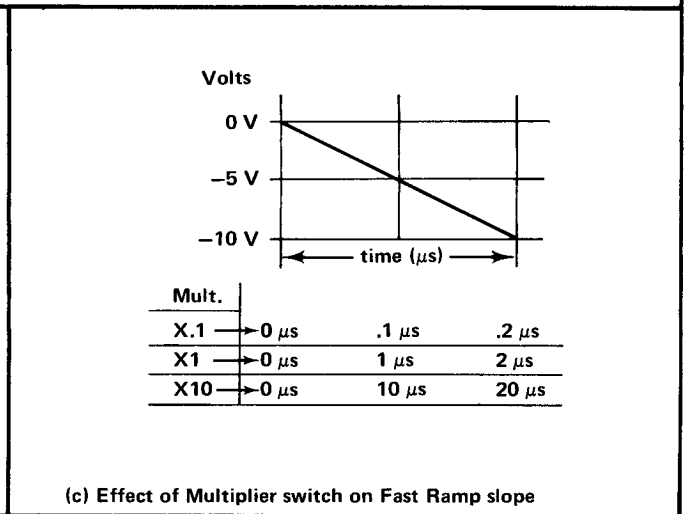

(c) Effect of Multiplier switch on Fast Ramp slope

Fig. 3-4. Partial Horizontal circuit block diagram and Fast Ramp voltage versus time waveforms.

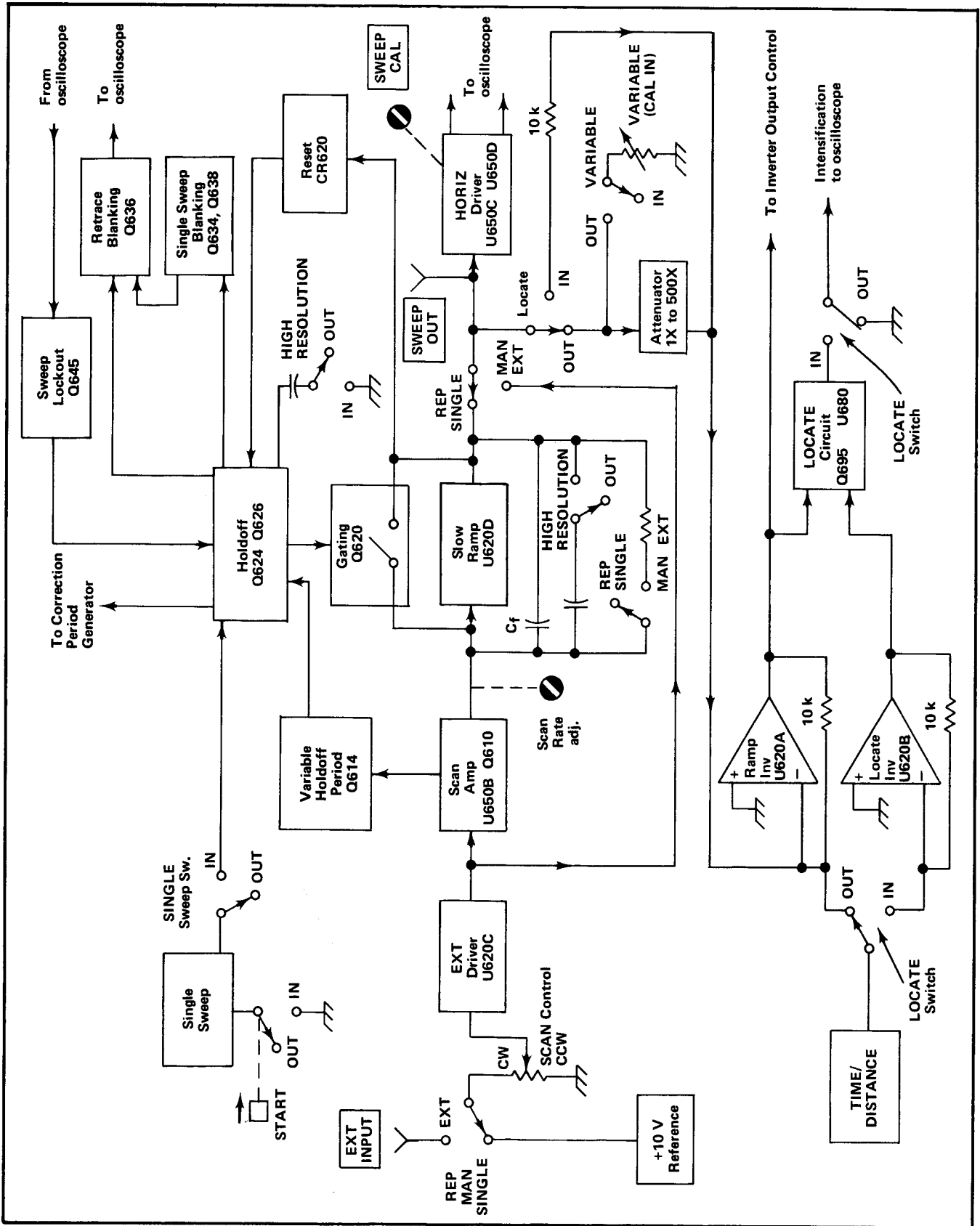

Fig. 3-5. Block diagram of Slow Ramp and associated circuits.

## Associated Equipment and Circuits

When using the 7S12 for TDR, the Pulse Generator output pulse and the reflection of this pulse from discontinuities along the test line are the Sampling Head input signals. The Sampling Head output is fed to the Post Amplifier (vertical input) of the 7S12. The Strobe Comparator, Strobe Generator, and Interdot Blanking blocks shown in Fig. 3-4 are discussed later, under the heading of Strobe Comparator and Strobe Generator.

## +10 V Reference and External Driver

The +10 V Reference supplies a stable source of DC voltage (see Fig. 3-5). The +10 V output is applied across the SCAN control except when EXT is selected. With EXT selected, the voltage applied to the front panel EXT INPUT connector is applied to the SCAN control. The voltage at the movable contact of the SCAN control is applied to the input of the External Driver.

With MAN or EXT SCAN selected, the output of the External Driver is applied directly to the Horizontal Driver. With manual (MAN) scan selected, rotating the SCAN control from fully CCW to fully CW causes the spot to move 10 divisions, provided that the Horizontal Driver gain (SWEEP CAL) is properly adjusted. When EXT SCAN is selected, the SCAN control attenuates the signal applied to the EXT INPUT connector. The External Driver prevents the Horizontal Driver from loading the external signal source. With REP or SINGLE SCAN selected, the output of the External Driver applied to the input of the Scan Amplifier is utilized.

## Scan Amplifier

The Scan Amplifier serves as a constant current source for the integrating circuit that produces the slow ramp. Maximum current is supplied when the SCAN control is fully CW. An internal calibration adjustment is provided to adjust the minimum value of current (SCAN Control fully CCW) delivered to capacitor  $C_f$ .

## Slow Ramp Generator

The output of the Slow Ramp Generator is a positive-going ramp having an amplitude of approximately 11 volts. This voltage must be 10 volts in order to produce 10 divisions of horizontal deflection. Other considerations make it desirable that the output amplitude of the Slow Ramp Generator be more than 10 volts. It should be understood that timing accuracy is not affected by the Slow Ramp output amplitude; only trace length is affected. Fig. 3-6 shows that with the SCAN control fully CW (solid line), about 20 ms is required to develop a 10 V Slow Ramp output. The affect on Slow Ramp slope of turning the SCAN control slightly CCW is illustrated by the dotted lines of Fig. 3-6. The time required to produce a 10 volt Slow Ramp output is dependent upon the SCAN control setting.

In Fig. 3-5 the output of the Slow Ramp Generator is shown applied to the Reset Circuit, Horizontal Driver, Attenuator network and SWEEP OUT connector.

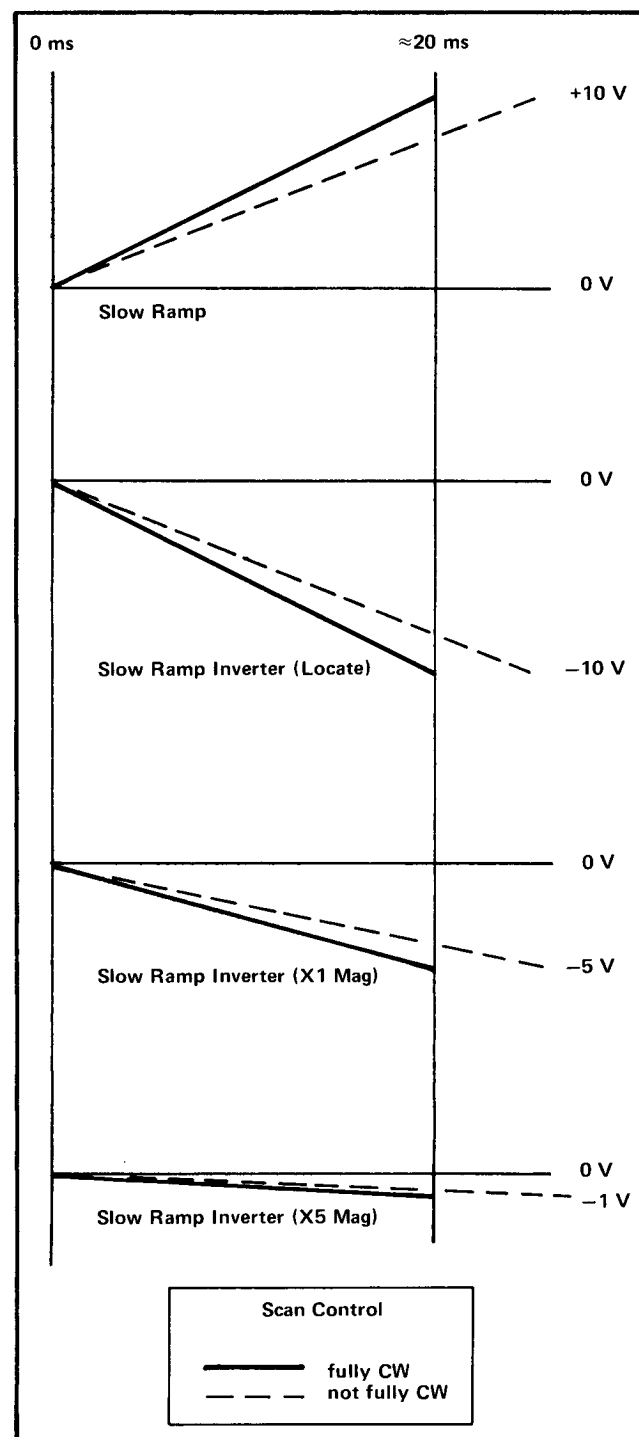

Fig. 3-6. Slow Ramp and Slow Ramp Inverter outputs (TIME/DISTANCE control fully CW to 0  $\mu$ s).

### Reset and Hold-Off Circuits

The Reset Circuit ends the Slow Ramp Generator runup, and the Hold-off circuit provides sufficient hold-off time for recovery of the Slow Ramp Generator. When the Slow Ramp Generator output voltage reaches a value somewhat more than +10 volts, the Reset Circuit initiates (through the Hold-Off and Gating Circuits) the discharge of feedback capacitor  $C_f$ . An RC network in the Hold-Off Circuit ensures that sufficient time is provided for complete recovery of the horizontal and vertical circuits before another ramp runup is permitted.

### Horizontal Driver

The single-ended output of the Slow Ramp Generator is converted to a push-pull output by the Horizontal Driver. The approximate 0 V to +10 V output of the Slow Ramp Generator appears at the input of the Horizontal Driver as a positive-going ramp running from -5 V to +5 V. This level shift results from an offset network at the Horizontal Driver input. One of the Horizontal Driver outputs runs from -5 volts to +5 volts while the other output is running from +5 volts to -5 volts.

If the Slow Ramp Generator output is 0 volts when the sampling bridge is strobed on, the sample taken is displayed at the sweep start (left edge of the CRT graticule). If the Slow Ramp Generator output is +10 volts at the time of sampling, the sample is displayed at the end of the sweep (10 divisions to the right of sweep start). The horizontal position of the displayed sample is, therefore, directly proportional to the output voltage of the Slow Ramp Generator.

### Attenuator and Slow Ramp Inverter

The 10 volt output of the Slow Ramp Generator is also fed to an attenuator network at the input of the Slow Ramp Inverter. The Attenuator input offers 20 k $\Omega$  impedance to the output of the Slow Ramp Generator.

If the LOCATE pushbutton is pushed, the Attenuator is bypassed. With the Attenuator bypassed, the 10 volt positive-going output of the Slow Ramp Generator appears at the Slow Ramp Inverter output as a 10 volt negative-going ramp (see Fig. 3-6).

With the LOCATE pushbutton in the "out" position the maximum input signal to the Slow Ramp Inverter is only one-half the attenuator by-passed value. The 10 volt positive-going output of the Slow Ramp Generator appears at the Slow Ramp Inverter output as a 5 volt negative-going ramp, provided the VARIABLE (CAL IN) control is pushed in and the TIME/DIV control is fully counterclockwise. As the TIME/DIV control is rotated from its fully counter-

clockwise position to its fully clockwise position, attenuation of the 5 V ramp increases from 1X to 500X in a 1, 2, 5 sequence. Output of the Slow Ramp Inverter is inversely proportional to the attenuation (5 volts/Attenuation).

### Strobe Comparator and Strobe Generator

The negative-going output ramp of the Slow Ramp Inverter is applied to one input of the Strobe Comparator (Fig. 3-4A). The negative-going output of the Fast Ramp is applied to the other Strobe Comparator input. When the Fast Ramp runs down to the level of the Slow Ramp Inverter output, the Strobe Comparator produces an output. The Strobe Comparator output results in the Strobe Generator delivering a strobe pulse to the Bridge Circuit in the Sampling Head, and a sample of the vertical input signal is taken. The Strobe Generator also provides a strobe pulse to turn on the sampling bridge in an adjacent 7S11 Sampling Unit (if used).

At the time the Strobe Comparator causes the Strobe Generator to deliver strobe pulses, the Strobe Comparator also causes an interdot blanking pulse to be produced.

The attenuation of the Slow Ramp Inverter input signal determines the magnification of the Fast Ramp (See Fig. 3-7A). With the TIME/DIV control set to the slowest rate available, at the selected Multiplier setting, magnification is X1. At X1 magnification the 5 volt output of the Slow Ramp Inverter results in slewing along a 5 volt section of the Fast Ramp while the CRT beam is slowly moving horizontally through ten divisions. The equivalent time of the display is therefore equal to the time required for the Fast Ramp output voltage to change 5 volts. At X5 magnification (See Fig. 3-7B) slewing along a 1 volt portion of the Fast Ramp occurs, and the equivalent time of the display is equal to the time required for the Fast Ramp output voltage to change 1 volt.

### Time/Distance Circuit

The Time/Distance circuit provides a means of delaying the displayed portion of the sweep (relative to the pretrigger from the pulse generator).

Comparison of Fig. 3-7A and Fig. 3-7C shows that turning the TIME/DISTANCE control from fully CW (0  $\mu$ s) to fully CCW (1  $\mu$ s), shifts the starting level of the Slow Ramp Inverter output from 0 volts to -5 volts. Fig. 3-7C shows that reflected signals occurring during the interval from 1  $\mu$ s to 2  $\mu$ s after the pulse generator pretrigger pulse are displayed.

With the TIME/DIV control set to the 20 ns position (X5 Mag) as shown in Fig. 3-7D, the display window is



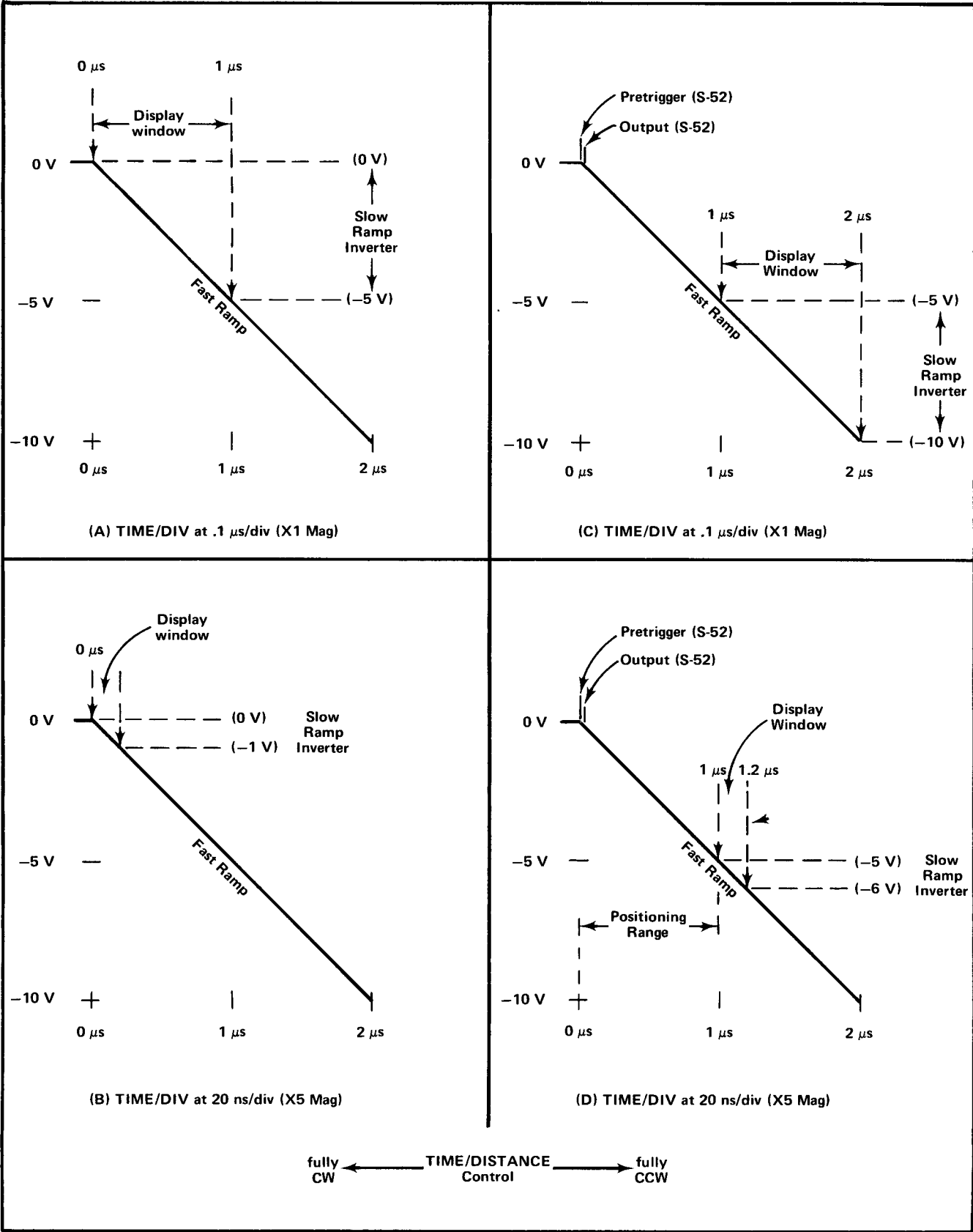

Fig. 3-7. Effect of TIME/DIV and TIME/DISTANCE controls on the display window. (TIME/DISTANCE Multiplier at X1).

## Circuit Description—7S12

narrowed. The output of the Slow Ramp Inverter now runs from  $-5$  volts to  $-6$  volts and signals received from  $1 \mu\text{s}$  to  $1.2 \mu\text{s}$  after the start of the Fast Ramp are displayed. Therefore, the time range displayed is dependent upon the range of voltage at the Slow Ramp Inverter output and the slope of the Fast Ramp.

### Locate Inverter

The Locate Inverter is only used (see Fig. 3-5) when the LOCATE pushbutton is at its "in" position. This inverter takes the DC voltage supplied by the Time Distance Circuit and inverts it. The DC output voltage (0 volts to  $-5$  volts) of the Locate Inverter depends upon the setting of the TIME/DISTANCE control.

The output of the Locate Inverter serves as one of the inputs to an integrated circuit used in the Locate Circuit.

### Locate Circuit

During LOCATE operation the output of the Slow Ramp Inverter runs from 0 volts to about  $-10$  volts. Since the Slow Ramp Inverter output determines the portion of the Fast Ramp along which slewing occurs (see Fig. 3-7), during LOCATE operation, slewing along the entire 10 volt fast ramp occurs. The time interval displayed across the 10 horizontal divisions on the CRT is therefore, the time from pretrigger (Fig. 3-7A through D) until  $2 \mu\text{s}$  after pretrigger.

During LOCATE operation, however, the normal display window portion of the display is brighter than the rest of the display. Under the conditions shown in Fig. 3-7D, during normal display operation, the time interval from  $1 \mu\text{s}$  to  $1.2 \mu\text{s}$  after pretrigger time is displayed across the ten horizontal CRT divisions. When the LOCATE pushbutton is in, the entire interval from pretrigger until  $2 \mu\text{s}$  later is displayed across the CRT. The portion of the display between the 5th and 6th horizontal division on the CRT graticule ( $1 \mu\text{s}$  to  $1.2 \mu\text{s}$  after pretrigger) is brighter than the remaining portion of the trace.

The block diagram of Fig. 3-5 shows the circuit changes that occur during LOCATE operation. The approximate 10 volt output of the Slow Ramp supplies current to the Slow Ramp Inverter through a  $10 \text{ k}\Omega$  input resistor, and a negative-going 10 volt ramp therefore appears at the Slow Ramp Inverter output (see Fig. 3-6).

During LOCATE operation, the output of the TIME/DISTANCE circuit is switched to the input of the Locate Inverter. A DC voltage of 0 volts to  $-5$  volts, depending upon the setting of the TIME/DISTANCE control, appears at the output of the Locate Inverter.

Another change is that the intensity of the CRT display is controlled by the output of the Locate Circuit. Functioning of the Locate Circuit is represented in Fig. 3-8.

The Locate Circuit consists of an IC (integrated circuit) and several external components. The IC portion of the Locate Circuit is shown within the dotted lines on Fig. 3-8. The IC consists of two differential amplifiers, one to start intensification and the other to end it.

Pin 12 of the IC is the output of the "Start" differential amplifier. Pin 7 is the output of the "Stop" differential amplifier. With current through pin 12 or pin 7, the intensity of the CRT trace is normal but with no current through pins 12 and 7 of the IC, the trace is dimmed.

The 0 to  $-10$  volt output ramp of the Slow Ramp Inverter is applied to pins 5 and 10 of the IC. The voltage at pin 11 is determined by the setting of the TIME/DISTANCE control. The voltage at pin 8 is equal to that at pin 11 plus an offset voltage that is determined by the value of the Locate resistor selected by the TIME/DIV switch.

Intensification starts when the voltage at pin 10 drops below that at pin 11. Intensification stops when the voltage at pin 5 drops below that at pin 8.

## CIRCUIT DESCRIPTION

The following circuit description follows the sequence of the schematic diagrams at the back of this manual.

### Post Amplifier Attenuators 1

The **Post Amplifier** is a two-stage non-inverting operational amplifier with AC-coupled complementary emitter followers between the second stage and the output. The input impedance is  $90.9 \Omega$ , which properly terminates the coaxial cable feed from the sampling head. Output impedance is very low to provide signal current to the relatively low input impedance of the Forward Attenuator. Total AC gain is approximately 12, producing a 2.4 volt output signal for a 0.2 volt input signal. DC gain is essentially unity, and feedback keeps the amplifier within its proper dynamic range.

Q123 and Q128 are the amplifier transistors, and Q133 and Q136 are the output emitter followers. Q133 ensures low output impedance for positive output signals, and Q136 ensures low output impedance for negative output signals. Each emitter follower has a resistor in the collector for parasitic oscillation suppression. C134 permits the output emitter to be at different DC voltages and ensures that the emitter of the non-driving transistor follows the output voltage.

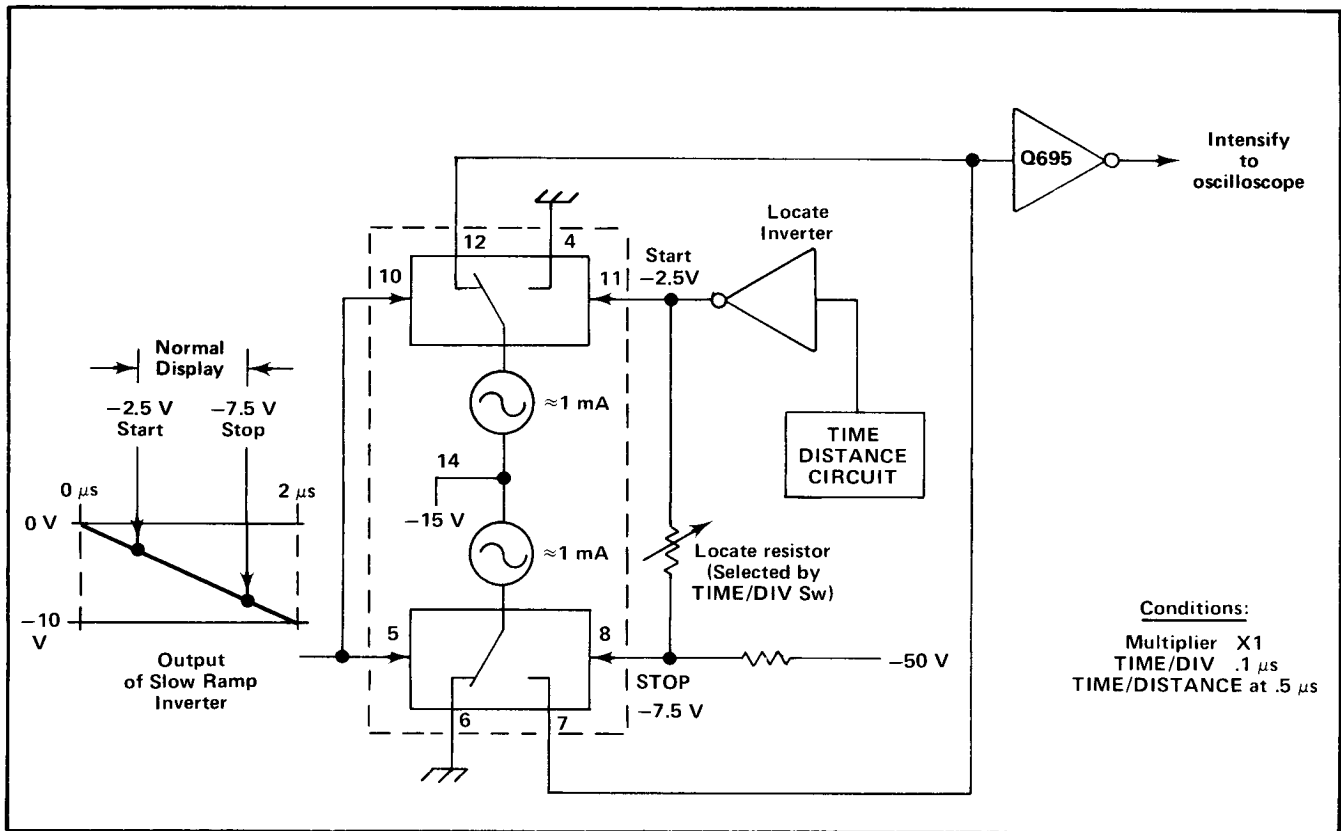

Fig. 3-8. Simplified functional diagram of the Locate Circuit.

Output of the Post Amplifier is AC coupled to the Forward Attenuator (part of the Units/Div switch).

**The Forward Attenuator** is made up of resistors R145A through R145H. The input resistance to the AC Amplifier is changed by the Forward Attenuator from 1 k $\Omega$  to 249 k $\Omega$  in eight steps. Seven of the eight resistors are always in parallel connection to ground, while the eighth is in series with the signal to the AC Amplifier input. Signal pulse amplitude across the Forward Attenuator does not change appreciably when the Units/Div switch position is changed, because the Post Amplifier output is a low impedance driving source. Attenuation occurs because of a changing current drive into the low impedance of the operational AC Amplifier.

**The Feedback Attenuator** is also controlled by the Units/Div control. Rotating the Units/Div control places one of the eight Feedback Attenuator resistors in series with the Memory circuit output signal. The other seven resistors are paralleled and connected from the sampling head side of the series resistor to ground.

The Feedback Attenuator and the DC Offset outputs are connected together within the sampling head, where they

are combined and applied to the sampling bridge output terminals.

**The DC Offset Circuit** is a single transistor emitter follower that converts the fairly high resistance of the DC OFFSET control to a fairly low resistance at the emitter of Q163. Q163 emitter voltage follows the voltage picked off by the movable arm of the DC OFFSET control, offset by -0.6 volt. Q163 drives a resistive load consisting of R163 output resistance, and R962 in the Pulser Baseline Correction circuit, R165, and the Feedback Attenuator. The DC offset voltage at the emitter of Q163 is not affected by the Units/Div switch setting.

## Memory 2

The Memory diagram includes the AC Amplifier, the Memory Gate, and the Memory Amplifier.

**The AC Amplifier** is an inverting operational amplifier with AC coupled complementary emitter followers at the output. Q204 is the voltage amplifier, Q208 emitter follower adds current gain to Q204 collector signal, and Q212-Q214 provide the very low output resistance.

## Circuit Description—7S12

The amplifier input is AC coupled by C201 to permit the amplifier DC operating voltages to be independent of the changes made in input resistance by the Units/Div switch. Q204 base is the summing input terminal of the operational amplifier. The AC Amplifier gain is controlled by the ratio of feedback resistor R209 to the value of the series element of R145 in the Forward Attenuator.

The output signal is coupled to the Memory Gate by Q212, Q214 and R219-C219. Resistor R219 limits the signal output current, ensuring that C219 does not receive a significant charge for output signals of high pulse amplitude.

Diodes CR201 and CR206 provide protection when transistors are removed from their sockets. CR201 conducts if Q208 is removed, and CR206 conducts if Q204 is removed. Parasitic suppressing resistors include R206, R207, R211, R213 and R214.

**The Memory Gate** is a special pulse-driven diode gate that ensures a very high input resistance to the Memory except for about 0.15 to 0.20  $\mu$ s at the time of each sample. During the conduction time, the Memory Gate is a low impedance that allows the AC amplifier to introduce a charge into the Memory.

The circuits shown on the Memory schematic diagram are shown, in block diagram form, in Fig. 3-9. The Memory Gate is represented by a resistor, a coil and a relay switch.

The resistor is the parallel value of the four biasing resistors which ensure that the four gating diodes are normally not conducting. This equivalent circuit shows that the Memory input is zero volts when there is no error signal at sample time.

Looking from the Memory Gate output toward its input, the four gating diodes are normally reverse biased by the voltage of Zener diode VR221. Two of the gating diodes provide very high reverse biased leakage resistance, although they don't turn off very fast. The other two diodes turn off fast at the end of the gating pulse, although they don't provide high resistance when reverse biased. VR221 voltage is balanced to ground by R224 and R226 so CR236 cathode rests at +2.5 volts and CR238 anode rests at -2.5 volts. Capacitor C221 ensures that the AC Amplifier output signal drives both sides of the memory gate diodes.

The gate diodes are forward biased into conduction by T230 at the time of each sample, due to the drive pulse from the Memory Gate Driver. T230 is a toroidal transformer specially wound to balance capacitive and inductive coupling to the two secondary windings. The winding with only one end connected provides the capacitive balance. The magnetic toroid core provides the inductive balance. Thus, the drive pulse is converted to identical drive signals to ensure that the output junction of the four diodes accurately divides the 5 volts of VR221-C221. This places the junction of CR237-CR239 at ground when no error signal is applied from the AC Amplifier. The functions of the two limiting diodes CR224-CR226 and the Memory Gate are covered somewhat later in this discussion of the

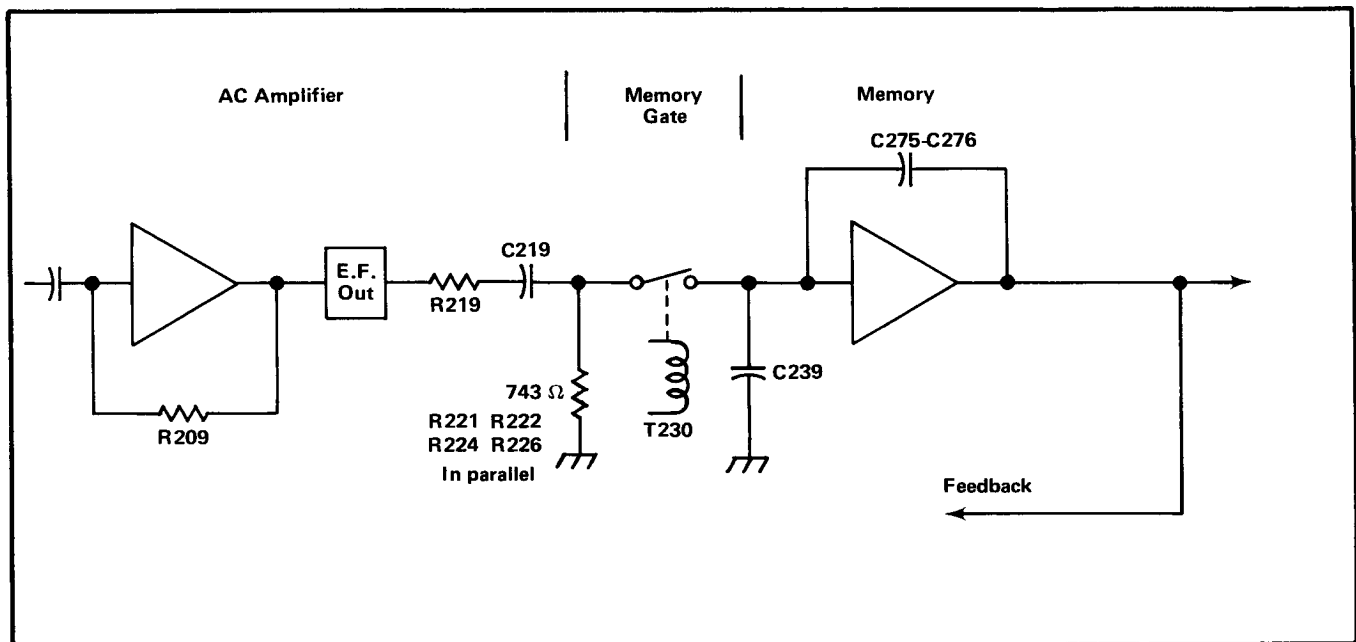

Fig. 3-9. Block diagram representation of circuits shown on the Memory schematic diagram.

Memory circuit. Resistors R229 and R231, and diode CR232 are shunt damping loads to T230 which minimize self-inductance ringing when the memory gate drive pulse ends.

**The Memory Amplifier** is an integrating operational amplifier with a special low leakage (high DC resistance) input circuit. The input and feedback components are capacitors, making the AC input impedance very low. The internal high gain ensures a very low output resistance; so that as long as there is no change at the input, the output DC voltage remains stable. The input low leakage circuit has no DC connection to ground, except during the time the Memory Gate conducts.

The Memory amplifier is specially decoupled from the power supplies because the output stage (Q262 and Q266) can require a current pulse as great as 30 mA for a 20 volt output change at sample time. The decoupling networks are R261-C261 and R267-C267. Inductor L268 in the VERT SIG OUT and feedback lead presents a high impedance to the Memory output for high frequency (fast change) signals. The inductor ensures that the output amplifier does not have to provide high current to the output load. L268 slows the output signal response, but at a time when the CRT is blanked.

A dual FET (Q242) is the input stage. It is a long-tailed differential amplifier providing a high gain. With no signal applied to the gate of Q242A, the current through each section of the dual FET is about 1 mA. If the input signal drives the gate of Q242A positive, the current through Q242A increases while current through Q242B decreases the same amount. The increase in current through Q242A results in an increase in the drop across diode-connected Q252A. The increased drop across Q252A increases the forward bias of transistor Q252B, causing current through Q252B to increase the same amount as the current through the series combination of Q252A and Q242A. While the current through Q242B has decreased, the current through Q252B has increased by the same amount. The base current of Q256 is therefore reduced by an amount equal to the decrease in current through Q242B, plus the increase in current through Q252B. Transistor Q252 effectively causes doubling of the change in Q256 base current resulting from a given change at the input of Q242A.

Any voltage change at the left Q242 gate lead is amplified and applied to inverting amplifier Q256. Q256 collector circuit applies proper bias to both bases of output complementary emitter follower pair Q262-Q266, and restores the DC level negatively so a zero input signal (at the left side of Q242) is also a zero output signal. Q256 collector and Q262-Q266 output lead operate linearly through the range of +12 to -12 volts.

Because of the high open-loop gain, the Memory Amplifier does not have the fast risetime of preceding amplifiers. The AC Amplifier output pulse duration is shorter than the Memory Amplifier risetime. C239 at Q242 input gate lead accepts some of the charge from the AC Amplifier, stores it until the Memory amplifier can respond, and then loses the charge again due to feedback current.

A cycle of operation at sample time takes the following sequence:

a. The Memory Gate drive pulse arrives at essentially the same time the Sampling Bridge is strobed into conduction. The CRT is blanked during this time. Propagation delay through the three AC coupled amplifiers is quite short. (The fact that the Memory amplifier input is always at zero volts prevents any false changes in C275-C276 charge. Therefore, there is no change in the Memory amplifier output voltage during the time the Memory Gate conducts ahead of the arrival of the AC Amplifier output signal).

b. The AC Amplifier applies a pulse signal through R219-C219 and the Memory Gate to the Memory amplifier input. C239 accepts some of the charge until the amplifier begins to respond, driving an equal and opposite current back to the input through feedback capacitors C275 and C276.

c. Since the AC Amplifier output signal is applied to the Memory amplifier "virtual signal ground" input, C219 receives about 10% of the total error signal charge before the Memory Gate stops conducting. Thus, as the AC Amplifier output returns to its quiescent voltage, the output side of C219 overshoots. Capacitor C219 discharges well in advance of the next error signal.

If the 7S12 is displaying a single transition step over the full graticule with the display starting at the lower left and ending at the upper right, the error signal is very large during retrace. Such large error signals apply a significant charge to C219. In this case, the overshoot at the end of the error signal pulse is large enough to cause one side of the Memory Gate to conduct and remove some of the intended charge in the feedback capacitors. Two normally non-conducting clamp diodes prevent such undesired removal of memory charge. Diodes CR224 and CR226 help to discharge C219 if it receives too great a charge during the Memory Gate conduction time, thus preventing false amplitude displays. These two diodes do not conduct at any other time.

d. As the Memory Gate drive pulse ends, C239 charge is removed by the Memory amplifier feedback. This causes the Memory output voltage to continue changing toward

## Circuit Description—7S12

proper amplitude for a short period of time after the Memory Gate stops conducting. As soon as C239 is returned to normal, the output voltage remains fixed until the next sample.

The actual resting voltage at the gate of Q242A may not be precisely zero, but it is within a few millivolts of zero. Any deviation from zero can be due to several things: slight differences in conduction of the Memory Gating diodes; slight differences in resistance of the four Memory Gate biasing resistors; some small error signal being generated at each sample time even when the sampling head input signal is zero. The gate voltage of Q242B is adjustable to provide correction in spite of variation of these errors between instruments. The Memory Balance adjustment (R245) provides an adjustable voltage to the gate of Q242B.

Capacitor C275 is used to set Memory Gain to approximately unity. Additional capacitance is added to the feedback circuit when 2 mV, 5 mV, or HIGH RESOLUTION is selected. The additional capacitance provided reduces the memory gain but results in a less noisy display.

Memory output voltage limits of about +12 and -12 volts are set by two diodes in parallel with the feedback capacitors. The diodes, CR272 and CR274, are reverse biased by 12 volts each. If the output tries to go more positive than about +12 volts, CR274 conducts reducing the amplifier gain to much less than 1. If the output tries to go more negative than about -12 volts, CR272 conducts, reducing the amplifier gain to much less than 1. The clamping diodes prevent the amplifier transistors from saturating at the time of an overdrive signal, and thus ensure fast transition away from the clamped voltage at the next sample.

CR242 conducts only when Q242 is removed from the socket while the power is on, thus keeping -50 volts off the source leads when Q242 is plugged in. Temperature compensation of the amplifier is accomplished effectively by the source-coupled FET input amplifier and CR257 and CR259. Transistor Q252 is an active load for Q242. This active load causes the signal current to the base of Q256 to be about twice the signal current out of the drain of Q242B. Transistor Q252 also serves to speed up the circuit response time. The two identical halves of Q242 compensate each other so their total current does not change with temperature change. CR257 and CR259 have junction-drop temperature coefficients similar to Q262 and Q266 base-emitter junctions, and thus stabilize the output circuit.

The Memory amplifier drives the front panel vertical output jack through a resistive attenuator. The jack is labeled VERT SIG OUT, 0.2 V/DIV, 10 k $\Omega$ .

## Gate Generator and Vertical Output 3

**Gate Generator.** The sampling drive pulse from the Strobe Comparator is slewed in time from the initial sweep triggering of the Fast Ramp, and can be further delayed using the TIME/DISTANCE control. The Memory Gate Driver circuit provides the proper time-positioning of the Memory Gate pulse so that the error signals are gated at the correct time.

The Memory Gate Driver is preceded by a blocking oscillator (Q370 and associated components) which standardizes the risetime and amplitude of the strobe pulse. Until the positive sampling drive pulse occurs, Q370 is cut off and its collector is at +15 volts. The arriving pulse causes the transistor to start conduction as a normal amplifier, but the regenerative feedback from T370 via CR370 quickly drives Q370 into saturation. As the current through T370 reaches a steady value, the counter-EMF generated in the secondary is stopped by the reverse-biasing of CR370. Q370 remains in saturation until it is cut off when the sampling drive pulse ends.

The Memory Gate Driver circuit consists of a low-current amplifier (Q382) and a monostable multivibrator (Q386-Q394). At quiescence, the base voltage of Q382 (determined by the Delay Cal adjust R380) is between +11 and +15 volts. The current through Q382 is about 1 mA, which is insufficient to forward-bias Q386. Diode CR385 holds the base of Q386 at -15.6 volts to ensure that the Memory Gate Driver output does not change as the Delay Cal setting is changed. Q394 is reverse-biased by the current through R391, R390 (Memory Gate Width adjustment), CR392 and R392, and its base voltage is clamped at +0.6 volt by CR394. The collector voltage of Q394 rests at -14.5 volts.

When the blocking oscillator fires, the negative-going transition at Q370 collector appears as a fast negative-going signal at the base of Q382. The ramp voltage drops to a level (determined by the Delay Cal setting) sufficient to forward-bias CR374 and shortly thereafter, Q382 is driven to conduct harder. The additional current required by the emitter of Q382 is furnished by C381, and the collector of Q382 rises far enough to forward-bias Q386. When Q386 conducts its collector voltage drops, the negative change is coupled by C390 to reverse-bias CR392, which turns on Q394. R394 applies a steady 50 mA current to the Memory Gate transformer primary (T230) for about 180 nanoseconds. The positive-going change at the collector of Q394 is coupled back to the base of Q386 as positive feedback, holding Q386 in conduction.

The negative-going transition at the collector of Q386 is also coupled via C387 and C377 to the base of Q382, holding that transistor in hard conduction. The Strobe for



the sampling head is taken from the junction of C387 and C377.

The regeneration from C377 to Q382 does not last as long as that holding Q386 in conduction, but since the base voltage of Q386 cannot go more positive than about -14.4 volts, Q382's collector voltage does not change. The position of the Memory Gate Width control adjusts the charge rate of C390, and therefore the conduction time of Q394. The conduction time and gate duration vary directly with the resistance of R390.

As C390 charges toward +15 volts, CR392 again conducts and turns Q394 off, ending the Memory Gate pulse and the drive to the base of Q386. However, Q386 was in saturation, so it does not stop conducting immediately. The collector voltage of Q386 rises positive about 350 ns after the transistor is turned on. This RC rise is slow and does not couple much energy through either C387 or C390.

**Vertical Output Amplifier.** The Memory output is applied to the input of the Vertical Output Amplifier through one of two attenuators. The voltage divider consisting of R304 and R302 in series is used when mV is selected at the front panel. With  $\rho$ /DIV selected, the series combination of R305 and R303 is used. Resistor R305 is the front panel screwdriver adjustment labeled  $\rho$  CAL, which permits proper  $\rho$ /DIV calibration.

The Vertical Output Amplifier consists of a two-stage push-pull balanced circuit. The first stage includes the VARIABLE gain control (R320) and the Position Balance adjustment (R325) in the common emitter circuit of Q314 and Q334. The Position Balance adjustment changes the

current through each side of the push-pull circuit for a center-screen output voltage. Gain of the stage is controlled by the VARIABLE control. Maximum gain occurs with minimum resistance between the two emitters. The Variable Balance adjustment (R335) sets the level on the base of Q334 so that no current flows between emitters under no-signal conditions. This ensures that there is no ground reference shift of the trace when the VARIABLE control is turned.

The second stage of the Vertical Output Amplifier includes the VERT GAIN adjustment (R345), which varies the emitter degeneration of Q344 and Q354. The push-pull outputs are applied to the oscilloscope vertical amplifier.

**Real Time Trigger.** The Real Time Trigger amplifier (Q362 and Q366) is a balanced circuit with push-pull input from the first stage of the Vertical Output Amplifier. Positive and negative trigger signals are applied to the timing unit through the oscilloscope interface. Signal amplitude at the trigger output is about one-half of that at the output of the Vertical Amplifier.

#### Vertical Readout Logic

The readout logic in the 7S12 provides the necessary time-slot current to operate the Scale Factor readout on the indicator oscilloscope. Currents supplied from the 7S12 controls the display of appropriate symbols. The circuit used to determine row and column current is basically as shown in Fig. 3-10.

Table 3-1 lists functions performed on symbols displayed with various values of column and row current. Consult your 7000 series oscilloscope manual for additional information about Scale Factor Readout.

**Table 3-1**  
**Signal Currents for Readout Logic Symbols**

Time Slot	Function or Character Selected	Row Current (B37)	Column Current (A37)
1 (B33)	Add one zero	.2 mA	.1 mA
	Add two zeros	.2 mA	.2 mA
	Reduce prefix	.2 mA	.3 mA
	Reduce prefix and add one zero	.2 mA	.4 mA
	Identify	.2 mA	$\geq 1$ mA
3 (B32)	>	.1 mA	$\geq 1.0$ mA (R428)
	<	.1 mA	0.2 mA (R427)
4 (A32)	1	0.0 mA	0.2 mA (R421)
	2	0.0 mA	0.3 mA (R421 and R422)
	5	0.0 mA	0.6 mA (R421 and R423)
8 (A30)	m	0.3 mA	0.1 mA
9 (B29)	V	0.4 mA	0.2 mA
10 (A29)	$\rho$	0.3 mA	0.4 mA

## Circuit Description—7S12

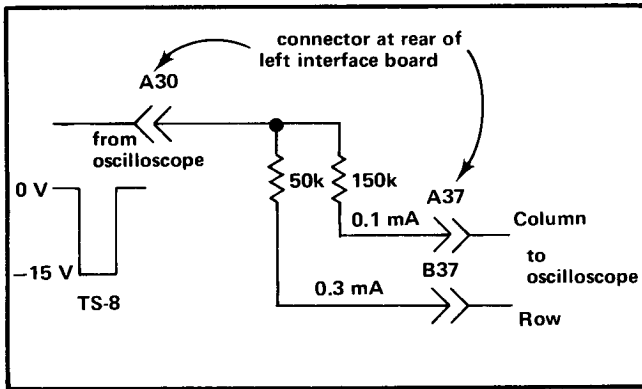

Fig. 3-10. Basic readout logic circuit.

### Time Slot 1

As shown in Table 3-1, the Vertical Readout Logic of the 7S12 can send the following instructions to the readout oscilloscope: add one zero, add two zeros, reduce prefix, reduce prefix and add one zero, and display IDENTIFY.

With the UNITS/DIV switch set to 10, 20, or 50 the 0.1 mA column current through R424 and the 0.2 mA row current through R431 instruct the readout oscilloscope to display a zero following the 1, 2, or 5 selected during time slot 4. Switching the UNITS/DIV to 100, 200, or 500 results in adding two zeros.

Transistor Q416 permits control of the readout by a probe and sampling head combination (i.e. P6052 probe and a Type S-5 Sampling Head) having this capability. Switching the probe to the 10X position results in a 0.1 mA current through Q416. This 0.1 mA of column current is added to any current through R424 or R425. With 500 mV/Div selected and the probe attenuation switch to 10X, a 0.3 mA current results. This 0.3 mA column current selects "reduce prefix" (equivalent to adding three zeros) and 5 V/Div is displayed.

If the probe is switched to "IDENTIFY", current through Q416 is about 1 mA. This 1 mA plus any current through R424 or R425 results in a column current  $\geq 1$  mA, and IDENTIFY is displayed on the oscilloscope.

The circuitry consisting of Q402, Q406, Q408, and Q412 together with associated components is provided for future use.

### Time Slot 3

When the VARIABLE (CAL IN) knob is in the out position (uncalibrated) the symbol for less than ( $<$ ) will be

displayed, provided that the VARIABLE control (R320) is CCW from its approximate midposition. A 0.2 mA column current through R427, and the switch contact closed when the control is out (S320), results in the selection of the symbol less than ( $<$ ). When the VARIABLE control is rotated CW past its approximate midposition, switch S146A closes. The approximate 1 mA current through R428 plus 0.2 mA current through R427 provide a column current of more than 1 mA. This column current together with the row current of 0.1 mA through R435 results in the selection of the symbol for greater than ( $>$ ).

### Time Slot 4

Depending upon the position of the UNITS/DIV switch (S146) the numeral 1, 2, or 5 is selected for display during time slot 4. Row current is not required and no path for row current exists. When the numeral "1" is required a 0.2 mA column current is provided through R421. Column current required to select a "2" is provided through R421 and R422. A "5" is selected by the column current through R421 and R423.

### Time Slot 8

The symbol for milli (m) is displayed during time slot 8. This symbol is selected by the 0.1 mA column current through R413 and the 0.3 mA row current through R437.

### Time Slot 9

The symbol for volts (V) can be displayed during time slot 9. With a sampling head intended for measuring voltage, pin F of J120 is grounded. This provides a base voltage on Q418 that permits a 0.2 mA column current through R419. Since the row current through R439 is 0.4 mA, the symbol for volts is displayed.

### Time Slot 10

If the mV-m $\rho$  switch (S304) is in the m $\rho$  position no column current can flow during time slot 9. When m $\rho$  is selected Q417 turns on, causing Q418 to shut off. With Q418 off, no column current can flow during time slot 9 and no symbols will be displayed during this period. The symbol for rho ( $\rho$ ), however, will be displayed during time slot 10. The rho symbol is selected by the 0.4 mA column current through R429 and the 0.3 mA row current through R433.

## Trigger, Fast Ramp, Pulser Driver, and Strobe Driver 5

**Introduction.** An input trigger from an S-series pulse generator or trigger recognizer is fed to the base of Q508 (see Fig. 3-10 and schematic diagram 5). This results in the turn-on of Q504. A positive pulse appears at the collector of Q504 while it is turned on.

The leading edge of the positive-going pulse at the collector of Q504 turns on Q518, which pulls up on the base of Q520. With Q520 shut off, the 5 mA timing current through Q522 results in producing a negative-going fast ramp across timing capacitor C520 and C535.

The duration of the positive pulse at Q504 collector provides adequate time for the Fast Ramp to complete its run. When the positive pulse ends, the Fast Ramp is reset to zero to await the next trigger pulse.

**Trigger Circuit and Trigger Holdoff.** Time designated 1 through 5 are shown for the table and waveforms of Fig.

3-11. Reference to this information will aid in understanding the sequence of events in the Trigger and Trigger Hold-off Circuits. Transistor Q508 conducts at all times, but has two conducting levels. In the table portion of Fig. 3-11, the low current state (about 0.33 mA) is indicated using small letters "on" and heavy current conduction by capital letters "ON".

Prior to the arrival of the trigger pulse from the S-series head (time 1), the state of transistors in the Trigger and Trigger Hold-off circuits is shown in the table portion of Fig. 3-11. Looking down the column headed (1) shows that

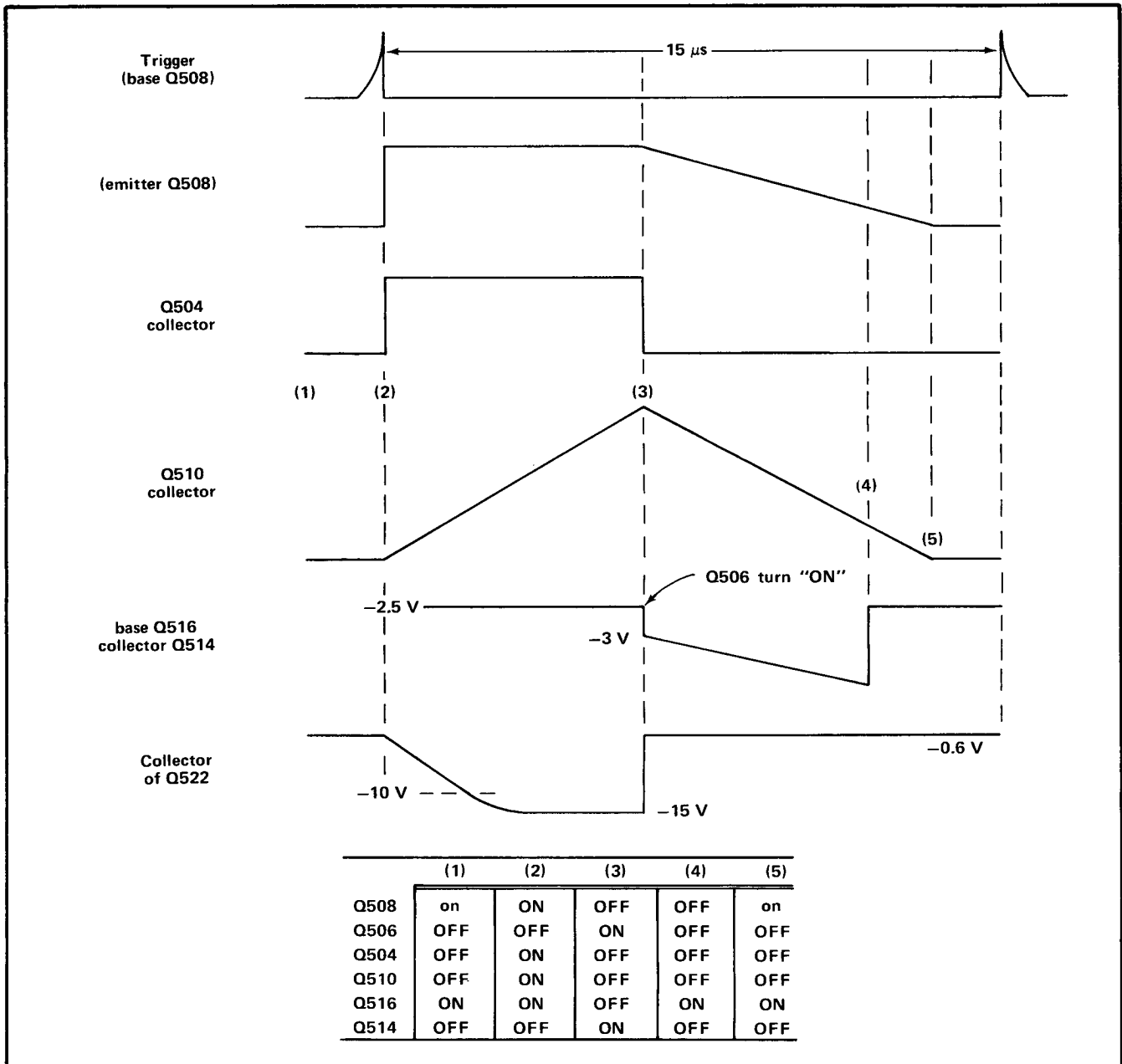

Fig. 3-11. Transistor signal waveforms and conduction levels table for the Trigger Circuit and the Trigger Holdoff.

## Circuit Description—7S12

Q508 is “on”, Q516 is “ON”, and the remaining transistors (Q504, Q506, Q510, and Q514) are “OFF”.

Current through Q508, before the trigger arrives, is about 0.33 mA and its emitter voltage is  $-0.6$  volt. This 0.33 mA current also flows through R507 and R504, but insufficient forward bias voltage is provided by the drop across R504 to turn on Q504.

When a trigger is applied to the base of Q508 (time 2 on Fig. 3-11) current through Q508 increases due to the presence of capacitor C508.

The 0.33 mA current through R508 plus the current due to C508 provide sufficient forward bias to turn on Q504. Capacitor C507 speeds up the turn-on of Q504. When Q504 starts conducting, regenerative feedback through C503 causes a rapid increase in current through Q508, and thereby further reduces the turn-on time of Q504. The current of Q504 through R501 and R503 pulls the base of Q508 positive, maintaining the heavy conduction of Q508. Transistor Q504 must be kept turned on long enough to permit the fast ramp to complete its negative-going run.

The additional current through Q508 produced by the input trigger signal and the regenerative feedback of Q504 causes C508 voltage to rapidly rise from  $-0.6$  volt to  $+0.6$  volt. When this voltage reaches approximately  $+0.6$  volt, transistor Q510 is turned on, and it takes over the job of C508 in providing current needed to keep Q504 turned on. Transistor Q504 remains on until its forward bias is shorted by conduction of Q506.

Transistor Q516 emitter current flows through R514. Prior to arrival of the input trigger and the turn-on of Q510 which follows, the collector of Q510 is held at about  $-15.6$  volts by current through CR510 and R510. Diode CR512 protects Q514 from this high reverse bias voltage. Conduction of Q510 causes the voltage at its collector to rise at a rate dependent on the value of hold-off capacitor C511. When the voltage at the collector of Q510 reaches about  $-3$  V (time 3), turn-on forward bias is applied to the base of Q514 through CR512. Saturation current through Q514 results in a drop in voltage at Q514 collector and Q516 base. Transistor Q516 is switched off, Q506 turns on, and Q504 shuts off ending the positive pulse at Q504 collector and resulting in resetting of the fast ramp to zero.

The turn-off of Q504 causes the loss of forward bias to Q508 and Q508 shuts off. Capacitor C508 starts discharging from  $+0.6$  volt toward  $-0.6$  volt. The start of this discharge causes Q510 to shut off and results in hold-off capacitor C511 starting its discharge toward  $-15$  volts.

The collector and emitter of still-saturated Q514 follow the decreasing voltage on the base of Q514. Although Q514 emitter current is decreasing, Q514 collector current is increasing. This results in a decrease in the base current of Q514. When the voltage on the hold-off capacitor decreases to where Q514 base current is unable to maintain saturation current through Q514 ( $\approx -14$  V, Time 4), Q514 collector voltage rises. This causes Q516 to switch on and Q514 to switch off. The turn-on of Q516 shuts off Q506.

Capacitors C508 and C511 continue recovery toward their initial voltage of about  $-0.6$  volt and  $-15.6$  volts respectively during the interval between (4) and (5). When C508 reaches  $-0.6$  volt, Q508 again conducts (time 5) and all transistors are back at initial (time 1) conditions.

The circuit can be triggered during the interval between (4) and (5), provided the trigger signal amplitude is sufficient to forward bias Q508. Triggering is not possible, however, prior to the shut-off of Q506 at time (4). Additional capacitance is added to the hold-off when the Multiplier switch is set to the X10 position (C512). This is necessary to provide adequate time for the run of the fast ramp. The increase in hold-off time reduces the maximum triggering rate.

**Fast Ramp.** In order that the displayed equivalent-time sweep will accurately represent the selected TIME/DIV setting, the rate of change of the Fast Ramp must be correct.

Transistors Q518, Q520, and Q522 are considered to be part of the Fast Ramp circuit. The ramp slope depends on the value of timing current and timing capacitance.

With the Multiplier switch set at X.1 position, a timing capacitance of about 100 pF is provided by stray circuit capacitance plus that of variable capacitor C535, and fixed capacitor C520.

The  $-15$  volts on the base of Q522 together with the  $-50$  volt supply provide approximately 35 volts across emitter resistors R524 and R525. Resistor R525 is a calibration adjustment used to set the timing capacitor current to about 5 mA.

Before arrival of a trigger signal, the top of the timing capacitor is held at a potential of  $-0.6$  volt by conduction of Q520. The trigger signal results in a positive pulse at the collector of Q504 which turns on Q518. When Q518 conducts, Q520 is shut off and the timing current causes the voltage at the timing capacitor to run down from  $-0.6$  volt toward the  $-15$  volt potential on the base of Q522.

Since the timing current remains constant for more than 10 volts of this run, and only 10 volts of this ramp is needed, the circuit provides the required linear ramp of the proper slope and amplitude.

The timing capacitor is returned to its initial  $-0.6$  volt level when the positive pulse at the collector of Q504 ends. The timing capacitor is quickly discharged through Q520, and Q520 carries the 5 mA timing current until the next trigger occurs.

**Strobe Driver Comparator.** Transistors Q538, Q540, and Q542 are part of the Strobe Driver Comparator. The function of this comparator is to supply outputs to the Interdot Blanking and Strobe Driver circuits. The Strobe Driver Comparator will deliver an output when the Fast Ramp runs down to the level of the Slow Ramp Inverter output.

The Fast Ramp starts its negative run from a starting potential of about  $-0.6$  volt. Therefore, just prior to the start of the fast ramp, the potential at the base of Q538 is  $-0.6$  volt. Since the output of the Slow Ramp Inverter runs negative from a starting level of about  $-1.5$  volts, the base of Q540 will be at least 1.5 volts negative. Transistor Q538 will be conducting and Q540 shut off until the fast ramp output is more negative than the Slow Ramp Inverter output.

When Q538 shuts off a signal is delivered through Q542 to the interdot blanking circuit. Simultaneously the turning on of Q540 provides a signal to the Strobe Generator.

**Interdot Blanking.** Prior to the start of the fast ramp, Q538 is carrying a current of about 3 mA and Q540 is shut off. Approximately 1 mA of this current is Q542 base current and 2 mA is Q542 collector current. The voltage at the collector of Q542 and the left side of C543 is near zero while the right side of C543 is held at  $-0.6$  volt by conduction of Q930 base in the Pulser Baseline Correction circuit. Conduction through Q930 and R545 is about 0.5 mA.

When the Fast Ramp voltage at Q538 base runs below Q540 base voltage, Q538 shuts off. The collector of Q542 (also the left side of C543) attempts to go to +15 volts. Both sides of C543 jump positive 1.2 volts before conduction of Q546 emitter clamps the right side of C543 at +0.6 volt. The turn-on of Q546 produces a positive-going interdot blanking pulse at Q546 collector.

The duration of Q546 conduction, and therefore the blanking pulse duration, is dependent on the time required

for the voltage at the left side of C543 to rise from +1.2 volts to +5.6 volts. The capacitor charging current is dependent on the difference in potential across R543 and is  $(15 \text{ volts} - 1.2 \text{ volts}/7.5 \text{ k}\Omega)$  about 2 mA initially. About 0.5 mA of this current is through R545 and the remainder is Q546 emitter current. When the left side of C543 reaches +5.6 volts, CR543 conducts. Conduction of CR543 switches off Q546 emitter current, and Q546 stops conducting, ending the interdot blanking pulse. The duration of this pulse is about 3  $\mu$ s. When the Fast Ramp resets to its  $-0.6$  volt level, Q538 again conducts, Q540 is shut off, and the comparator awaits the next rundown of the Fast Ramp.

**Strobe Driver.** Transistors Q552, Q556, Q566, and Q568 are part of the Strobe Driver. Before Q540 of the Strobe Driver Comparator turns on, Q552 current is about .25 mA, and Q556, Q566, and Q568 are non-conducting.

The voltage divider consisting of R560, R562, and R564 provides about +5 volts for the base of Q566 and Q568, and approximately +10 volts for the base of Q552. Since the emitter of Q552 is near +11 volts, diode CR554 is reverse biased.

When Strobe Driver Comparator transistor Q540 switches on, transistor Q552 current increases. The additional Q552 current is supplied initially by C554. After C554 discharges slightly, diode CR554 is forward biased and provides the path for current requirements in excess of the approximately .25 mA flowing through R554.

Transistors Q552 and Q556 form a regenerative circuit. When current through Q552 increases, its collector is pulled up. This positive-going signal is coupled through C552 to the base of Q556. Conduction of Q556 turns on Q552 harder, which turns on Q556 harder.

Transistor Q556 is rapidly turned on hard by a short duration positive-going pulse. This results in a large short duration current pulse through Q566 and Q568, and a positive pulse is developed at the collector of these transistors. The output of Q566 is applied to the Memory Gate Driver. The output of Q568 is available for use by an adjacent 7S11 (if used).

**Pulser Driver Comparator.** Operation of the Pulser Driver Comparator is essentially the same as that of the Strobe Driver Comparator. High beta transistors are used in both of these comparators to minimize the effect of comparator base current change on Fast Ramp linearity. Diodes in the emitter circuits prevent exceeding the base-emitter reverse voltage limitations of the transistors.

## Circuit Description—7S12

The output of the Fast Ramp is applied to the base of Q532 and a negative DC voltage is applied to the base of Q534. For further information on this refer to Fig. 3-4 and the discussion earlier in this section, under the heading of Pulser Driver Comparator and Pulser Driver.

Prior to rundown of the Fast Ramp, Q532 is conducting and Q534 is cut off. When the output voltage of the Fast Ramp goes below that on the base of Q534, transistor Q532 shuts off and Q534 conducts. The conduction of Q534 provides an input to the Pulser Driver circuit.

**Pulser Driver.** Transistors Q576, Q574, and Q580 are used in the Pulser Driver. Before Q534 conducts, transistor Q576 current is about 0.33 mA and Q574 and Q580 are shut off. This 0.33 mA current through R580 does not provide enough forward bias to cause conduction of Q574.

When Q534 conducts, this current turns Q576 on hard. Transistor Q576 current increases, which causes the drop across R580 to increase. Transistor Q574 conducts and couples a large-amplitude signal through C575 to the base of Q580. Since R575 and C575 form a short RC time, transistor Q580 is rapidly turned on, and then off. This results in a fast-rise positive-going spike at the collector of Q580. This output serves as a drive signal to the snap-off diode in the pulse generator head.

## Slow Ramp and Horizontal Driver

**+10 Volt Reference and External Driver.** The +10 volt reference uses the "A" section of U650. This IC contains four separate operational amplifiers. Refer to Fig. 3-5 and diagram 6 during the following discussion.

Input current to U650A is provided by Q682. The current is dependent on the voltage supplied by the regulated -15 volt and -50 volt supplies of the oscilloscope. This current is about 2 mA and results in an output from U650A of approximately +10 volts.

The output of the +10 Volt Reference is applied to the Scan Control, except when EXT INPUT mode is selected. With EXT INPUT selected, the signal fed to the Ext Input connector (J601) is applied across the Scan control. The voltage at the movable contact of the Scan control is applied as input to External Driver U620A. Diodes VR604 and CR604 prevent application of excessive positive voltage to the input of U620A, and diode CR606 prevents excessive negative voltage. The output from pin 9 of U620A is always applied to the input of the Scan Amplifier, and is applied to the input of the Horizontal Driver when Ext Input or Manual (MAN) mode is selected. The Scan Amplifier is utilized during the repetitive (REP)

and single sweep (SINGLE) modes of operation but serves no useful function when Ext Input or Manual mode is selected.

**Horizontal Driver.** The Horizontal Driver consists of U650C, U650D, Q650, and associated components. Two front-panel screwdriver adjustments (SWEEP CAL and HORIZ POS) are located at the output of the push-pull Horizontal Driver. During the EXT INPUT or MAN modes of operation, the output of the External Amplifier is applied directly to the input of the Horizontal Driver (pin 13 of U650C) via transistor Q640. The bias normally applied to Q640 causes this transistor to act as a closed switch. With MAN selected and the SCAN control set to midposition, about +5 volts appear at the input and output of U620A. Since Q640 normally acts as a closed switch +5 volts also appear at the source of Q640. Offset current through R644 results in the voltage level being shifted 5 volts negative at the input (pin 13) of U650C.

Rotating the SCAN control from fully CCW to fully CW results in the voltage at the input of U650C changing from -5 volts to +5 volts. This same change (from -5 volts to +5 volts) also appears at the output (pin 15) of U650C. The output of the other half of the push-pull stage (collector of Q650) is inverted. The output of the Horizontal Driver supplies horizontal deflection voltage to the oscilloscope CRT.

Two other sources of input for the Horizontal Driver are available: an input signal may be applied through pin 1 of P18 (connects to pin 12 of fixed shoe J641) or the output of the Slow Ramp Generator can be used. The source of the signal at pin 12 of the shoe (J641) can be an auxiliary device located in the oscilloscope compartment to the left of the 7S12. When an input signal is applied via the fixed shoe, a disabling voltage is also delivered to the gate of Q640. This voltage is applied from pin 10 of the shoe to pin 2 of P18, and thence to pin P of J3. The disabling voltage opens Q640 and prevents the drain voltage of Q640 from appearing at the Horizontal Driver input (pin 13 of U650).

It should be noted that any voltage appearing at the source of Q640, whether delivered through Q640 or from the fixed shoe (J641), appears at the Horizontal Driver input, SWEEP OUT connector J640, and at pin 14 of J3.

**Slow Ramp Generator.** When REP or SINGLE mode is selected (schematic 6 shows REP selected) the output of the Slow Ramp Generator supplies the input to pin 13 of U650C. Runup of the Slow Ramp Generator is now possible, since shorting resistor R621 is removed.

The time required for the Slow Ramp Generator to run up from approximately 0 volts to about +11 volts is



dependent on input current delivered to pin 14 of U620B. With the SCAN control fully CW, about +10 volts is applied to pin 11 of U620A. The +10 volt output of U620A is applied to the Scan Amplifier input, and approximately -10 volts appear at the collector of Q610. This provides maximum input current to (pin 14 of U620B) the Slow Ramp Generator, and the maximum rate of rise in output voltage results. As the SCAN control is turned CCW, the rate of rise decreases and a longer time is required for the approximate 11 volt runup. A calibration adjustment (Scan Rate R618) is provided to ensure that input current does not decrease to zero as the SCAN control is rotated toward its fully CCW position. With the SCAN fully CCW a small current is provided to the input circuit of the Slow Ramp Generator through R617. The value of this current is adjusted using R618 to supply circuit leakage currents plus enough charging current for C620 to meet minimum scan rate specifications.

#### Hold-off, Reset, Blanking, and Sweep Lockout.

Transistor Q636 is used for retrace blanking, and Q624, Q626, and Q620 for hold-off and reset of the Slow Ramp Generator. While the Slow Ramp Generator output is running up, Q620 and Q626 are off and Q624 and Q636 are on. Capacitor C624 is rapidly charged by emitter-base current of Q624 as the capacitor voltage follows the base of Q624. When the output voltage of the Slow Ramp Generator exceeds C624 voltage, the capacitor voltage follows the rising output of the Slow Ramp Generator due to conduction of CR620. When the Slow Ramp Generator output reaches about +11 volts, the charge on capacitor C624 is approximately +10 volts.

With a base voltage of +10 volts, Q624 current is reduced to a value that is insufficient to keep Q626 shut off. When Q626 starts conducting the multivibrator switches; Q624 is turned off and Q626 is turned on.

The turn-on of Q626 pulls the base of Q636 positive, and the turn-off of Q636 causes retrace blanking. The turn-on of Q626 also pulls the gate of Q620 up. Conduction of Q620 shorts out the Slow Ramp Generator feedback capacitor (C620) and ends the runup of the Slow Ramp Generator.

Since the Slow Ramp Generator output voltage has returned to zero, hold-off capacitor C624 is no longer charging through diode CR620. Capacitor C624 now discharges toward -50 volts through R628, but is prevented from going below zero volts by diode CR631. When the hold-off capacitor voltage reaches approximately +5 volts, the hold-off multivibrator again switches. Transistor Q624 is turned on, Q620 and Q626 are turned off. Retrace blanking ends with Q636 turn-on and another run-up of the Slow Ramp Generator begins.

With High Resolution selected, the hold-off time is increased by paralleling hold-off capacitor C624 with C628.

As previously mentioned, if a negative disabling voltage is applied through R638 by an auxiliary device, Q640 opens. This negative voltage also disables retrace blanking. Normally, retrace blanking occurs when Q626 turns on and pulls the base of Q636 positive. The negative voltage applied through the network consisting of R638, R637, and diode CR637 prevents conduction of Q626 from turning off Q636. Q614 is driven by the Scan Amplifier. Q614 drives Q624 to provide a variable hold-off period. The hold-off period is increased when the display period is increased.



Sweep Lockout Q645 holds off the Slow Ramp Generator signal to Q624 base when the storage oscilloscope has a stored display.

Single Sweep Blanking, Q634 and Q638, is turned on by U620D when the slow ramp exceeds 10 V. Q638 emitter signal provides a sharp edged pulse to Retrace Blanking Q636 when the Slow Ramp Generator is running at a slow display rate.

#### Time/Distance, Locate, and Slow Ramp Inverter

Since these circuits were discussed earlier in this section (Theory of Operation) no explanation will be given here.

#### Timing Switches and Horizontal Readout Logic

The components and switches shown on the lower half of schematic  provide the column and row currents required for Auto Scale Factor Readout on the CRT. Since selection of symbols was discussed for schematic  (VERTICAL READOUT LOGIC), refer to the discussion of schematic  if the functioning of Horizontal Readout is not understood.

The TIME/DISTANCE switch (S530B) and TIME/DIV switch (S530A) are cam-type switches operated by front panel controls. Contact numbers of the switches are shown, and the switch position at which contacts are closed is indicated by dots on schematic diagram . For example, contact 1 of switch S530B is closed when the multiplier indicates X10, contact 2 at X1, and contact 3 at the X.1 position.

Contacts 9 through 16 of the TIME/DIV switch (S530A) determine attenuation of the Slow Ramp, and therefore the apparent magnification of the Fast Ramp. Contacts 17 through 21 of the TIME/DIV switch select the proper locate resistor for the intensification circuit.

### Vertical Power Distribution and Decoupling

This diagram shows that +50 V, +15 V, +5 V, -15 V and -50 V is delivered to the Left Interface Board of the 7S12 from the oscilloscope. These voltages enter the 7S12 via the A and B sides of the Vertical Output Connector at the rear of the plug-in.

Since -12.2 V is required at both sampling head compartments, a regulated source of this voltage is provided in the 7S12. The "A" side of comparator Q824 is provided with a reference voltage by the -15 volt supply and R821 and R822. The series resistance of Q826 is controlled by output at the collector of the "B" section of the comparator so that -12.2 V is maintained across the load. The -12.2 volts is delivered to the sampling head in the vertical side of the 7S12 via pin A of J120, and to the sampling head in the horizontal side via pin A of J520.

### Pulser Baseline Correction Circuit

The Slow Scan Hold-off ramp from the Hold-off Reset circuit is applied to the minus input of the Correction Period Generator U910. The beginning edge (fast rise component) of the hold-off period is coupled through C914 to switch the U910 output to -12 V. The U910 plus input is biased to the voltage at the junction of R910 and R911. The correction period ends when the negative going Hold-off ramp from Q624 base causes U910 output to switch to +12 V. The U910 negative output level biases Q930 in the Correction Gate Driver so that interdot blanking signals from Q546 through the Correction Gate Driver, Q930 and Q932, drive the Correction Memory Gate.

The Correction Memory Gate Q936 couples the Vertical Sampling Loop Memory signal to the Correction Memory. The Correction Memory is an operational integrator composed of differential comparator Q940 and operational

amplifier U940 with feedback capacitors C952 and C953. The second gate of Q940 receives the Memory Balance voltage from R945. The Correction Memory is disabled when Q954 is turned on by the Pulse Generator Head and Switch S901 Position Sensor circuit.

The Summing Amplifier minus input receives the correction signal from U940 output. The plus input receives the DC offset voltage, which is controlled at the front panel, via the Offset Gate. The Offset Gate disables the DC offset voltage during the Correction Memory period. The DC offset voltage and the Correction Memory voltage are summed during the display period. The Summing Amplifier output is the corrected offset voltage that is applied to the Sampling Head.

The Pulse Generator Head and Switch S901 Position Sensor is composed of Q903 and Q906. The Pulse Generator Head inhibit voltage at J520 pin 5 is applied to Q903 base. With switch S901 in the Normal position, a low positive level from the Pulse Generator Head turns off Q903, Q906 and Q954 and the Pulser Baseline Correction circuit is enabled. Switch S901 in the Off position forward biases Q903 to turn the Pulser Baseline Correction circuit off. Switch S901 in the On position disables Q903, Q906 and Q954. The Pulser Baseline Correction circuit is also disabled by Q914 when an external chart recorder is installed in the left-hand vertical compartment of the oscilloscope.

Q922 in the Inverter Output Control forces all sampling strobes to occur before the Pulser is triggered by the Pulser Comparator. Thus, during the correction memory period all Pulser Baseline correction samples are taken on the arming level of the Pulser. This occurs when Q922 is turned on by the Correction Period Generator. When Q922 is turned off and Q925 is turned on by the Correction Period Generator, Q925 gates the Slow Scan ramp to the Strobe Driver comparator.

# SECTION 4

## MAINTENANCE

### Introduction

This section of the manual contains maintenance information for use in preventive maintenance, corrective maintenance or troubleshooting of these instruments.

Preventive maintenance consists of cleaning, visual inspection, lubrication, etc. Regular preventive maintenance may prevent instrument breakdown and improves instrument reliability. Perform preventive maintenance as often as necessary.

The instrument covers protect against dust in the interior. Leave panels in place except when working on the instrument.

### CAUTION

*Avoid the use of chemical cleaning agents which might damage the plastics used in these instruments. Avoid chemicals which contain benzene, toluene, xylene, acetone or similar solvents.*

**Exterior.** Remove loose dust on the outside of the instruments with a soft cloth or small paint brush. Use the paint brush to dislodge dirt on and around the front. Remove the remaining dirt with a soft cloth dampened in a mild detergent and water solution. Do not use abrasive cleaners.

**Interior.** Keep the interior of the instrument free of dust, since a heavy dust layer combined with high-humidity conditions can cause failure. Clean the interior by blowing off the accumulated dust with dry, low-pressure air. Remove any remaining dirt with a soft paint brush or a cloth dampened with a mild detergent and water solution. Use a cotton-tipped applicator to clean circuit boards.

### Lubrication

Proper lubrication increases the reliability of potentiometers, switches and other moving parts. Do not use too much lubrication. A lubrication kit containing the necessary lubricants and instructions is available from Tektronix, Inc. Order Tektronix Part No. 003-0342-01.

### Troubleshooting

To perform troubleshooting, the 7S12 must be connected to the oscilloscope by two Flexible Plug-in Extenders (Tektronix Part No. 067-0572-01). A Sampling Head and a Pulse Generator Head must be installed. A coaxial cable must be connected from the Pulse Generator Head output connector to the Sampling Head input connector. The two plug-in cards may be removed from the top of the 7S12 and separated by removing the screws that hold them together. Either card may be mounted on a Plug-in Extender (Tektronix Part No. 018-0064-00 for instruments SN B010100 to B010144) to gain access to the circuit. The following instructions are intended to aid in troubleshooting the more complex circuits; therefore, not all circuits are discussed.

**Horizontal Circuits.** If the trace is not visible, check the +10 V Supply, External Driver, Scan Amplifier and Slow Ramp circuit. Push the MAN Scan switch and measure the voltage at the SWEEP OUT jack with an oscilloscope. The voltage varies from 0 to 10 V DC when the Scan control is turned from the fully counterclockwise position to the fully clockwise position.

Check the Hold-off and Reset circuit. Turn the SCAN control fully clockwise and push the REP switch. Check for a 0 to 10 V Slow Ramp at the SWEEP OUT jack. Push the SINGLE sweep switch and check that the dot is at the right side of the CRT. This checks that the Slow Ramp runs up. Push the START switch and check for a sweep of the trace. This checks the Reset circuit.

Check the Horizontal Driver. Observe the waveform at TP (test point) 650 and 658 for equal amplitude ramps (one is inverted) of about 9 V.

**Vertical Circuits.** If there is no signal at the VERT SIG OUT jack, and the Memory Gate Drive signal is correct at TP394, make the following set up and checks. Set the 7S12 mV/DIV switch at 2 mV and the DC OFFSET control fully clockwise. Check the Post Amplifier input TP121, its output TP139 and the AC Amplifier output TP218 for an error signal in the form of a trace with spikes which reduce to zero and then invert when the DC OFFSET control is turned to its fully counterclockwise position. The Memory voltage changes from +12 V to -12 V when the DC OFFSET control is turned throughout its range.

## Maintenance—7S12

If the correct signal appears at the VERT SIG OUT jack, but not on the CRT, observe the waveform at TP314, TP344, and TP354. If correct signals exist at these points, the trouble is probably in the oscilloscope.

### Tape Dial Removal

1. Turn off the oscilloscope power.
2. Turn the tape dial (using the TIME-DISTANCE control) to  $.50 \mu\text{s}$ .
3. Using a sharp instrument (small screwdriver, etc.), remove both retaining rings from the posts. See Fig. 4-1.
4. Lift the flat washers and retaining plate from the posts.
5. Carefully lift the tape and sleeve bearings (spools) from the two posts.
6. Unroll and remove the tape from each sleeve bearing. If the tape is to be re-used, avoid kinking it.

### Tape Dial Installation

1. Install the new tape on the sleeve bearings. Take care not to kink the tape.
2. Be sure that  $.50 \mu\text{s}$  is visible when the face of the tape is observed. This ensures that the amount of tape on each sleeve bearing is roughly equal, making installation easier.
3. Slide the tape and sleeve bearings over the posts, making sure that the serrated side is down. Take care not to scrape the tape face on the 7S12 frame. When the tape is installed, the hairline should be on or near  $.50 \mu\text{s}$ .
4. Re-install the retaining plate, flat washers, and retaining rings on the assembly.

### Tape Dial Alignment

1. Turn the TIME-DISTANCE control clockwise until resistance is encountered.
2. Using an  $.050$  Allen wrench, loosen the setscrew shown in Fig. 4-1.

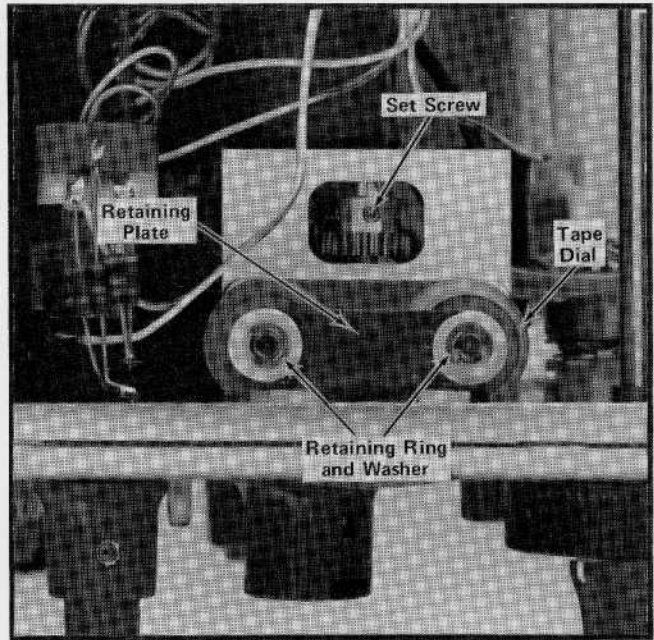

Fig. 4-1. Component locations for tape dial replacement or adjustment.

3. Place the TIME-DISTANCE tape dial zero at the hairline.
4. Tighten the setscrew and check the adjustment. When the TIME-DISTANCE control is turned fully clockwise, the hairline should be at zero on the tape dial.

### Readout Symbol Adjustment (> & <)

Since the mV (or m $\rho$ ) VARIABLE knob changes the deflection amplitude to greater than or less than the calibrated position, a switch on the shaft changes the symbol on the CRT of the oscilloscope containing a readout. A check and adjustment of this switch in relation to the rotation of the VARIABLE control follows.

1. Obtain a step display, including the Readout on the CRT.
2. Record the amplitude of the display with the VARIABLE control in the CAL IN position.
3. Press the VARIABLE control to release to the out (uncalibrated) position. Adjust the VARIABLE control for the same amplitude as recorded in part 2. If the control is at the point where the readout symbols change, no adjustment is necessary. If the symbols do not change at this point, do the remaining adjustment steps.

4. Use a .050 Allen wrench to loosen the setscrew; see Fig. 4-2.

5. With the setscrew loose, the switch activator containing the setscrew is free to move along the shaft and rotate. (Be sure the VARIABLE control is set as in part 3.) Move the Switch Activator toward the front of the instrument until the end of the flat shaft touches the switch rotor; then move the assembly back about 1/32 inch to relieve the strain on the switch rotor.

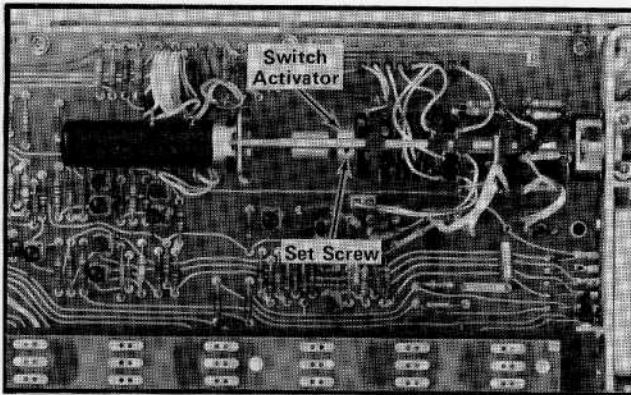

Fig. 4-2. Readout adjustment location, instrument left side.

6. Rotate the Switch Activator (rotates the switch) to a point where the Readout symbols ( $\triangleright$  &  $\triangleleft$ ) change. Then tighten the setscrew with the Allen wrench.

### Repackaging for Shipment

If the Tektronix instrument is to be shipped to a Tektronix Service Center for service or repair, attach a tag showing: owner (with address) and the name of an individual at your firm that can be contacted, complete instrument serial number and a description of the service required.

Save and re-use the package in which your instrument was shipped. If the original packaging is unfit for use or not available, repackage the instrument as follows:

Surround the instrument with polyethylene sheeting to protect the finish of the instrument. Obtain a carton of corrugated cardboard of the correct carton strength and having inside dimensions of no less than six inches more than the instrument dimensions. Cushion the instrument by tightly packing three inches of dunnage or urethane foam between carton and instrument, on all sides. Seal carton with shipping tape or industrial stapler.

The carton test strength for your instrument is 200 pounds.

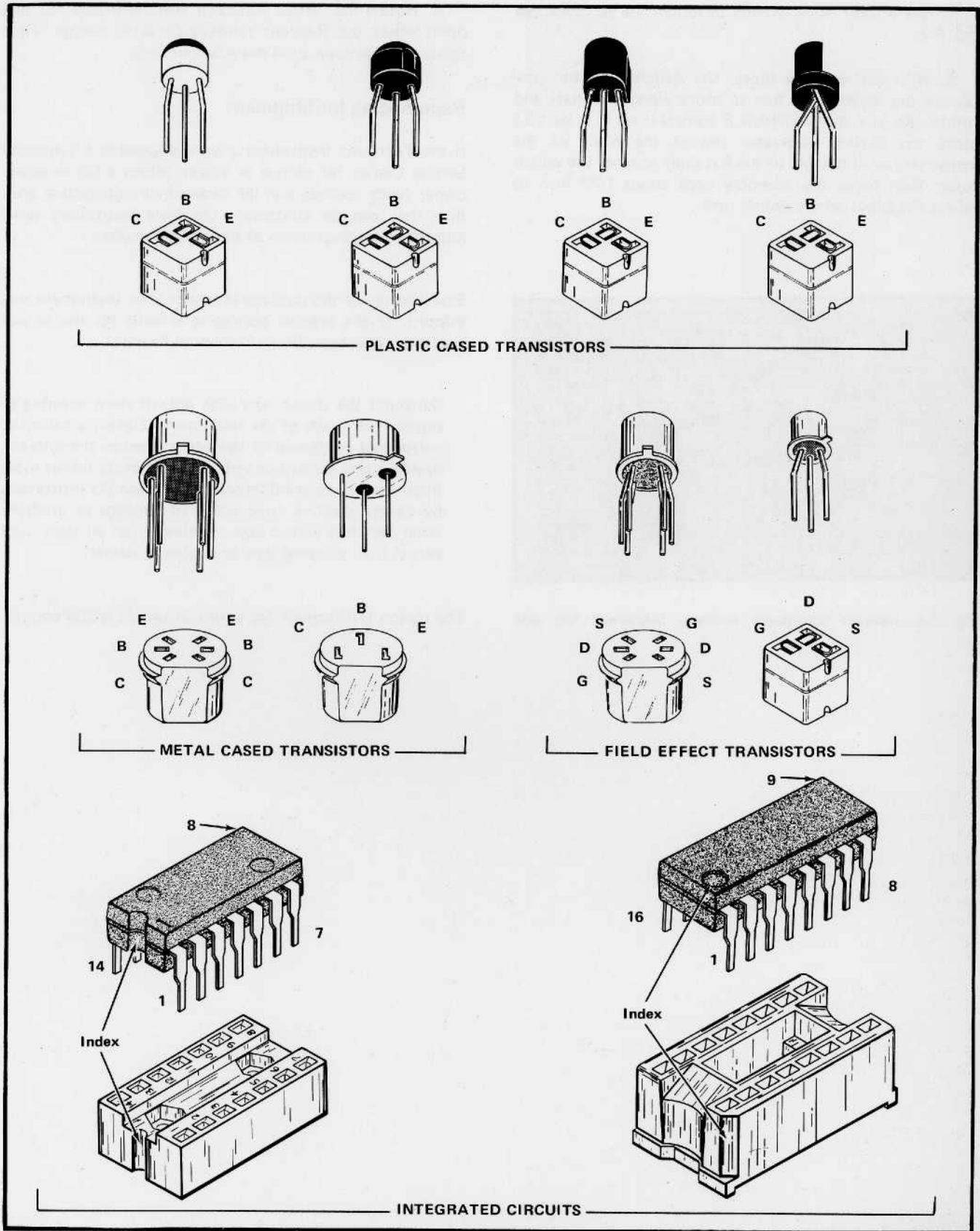

Fig. 4-3. Lead configuration of transistors and integrated circuits.

# SECTION 5

## PERFORMANCE CHECK / ADJUSTMENT

### Introduction

This section of the manual contains the Performance Check and the Adjustment Procedure for the 7S12 TDR Sampling Unit. The Performance Check verifies that the instrument meets the Section 1 Specifications. The Adjustment Procedure restores the performance of the instrument to the Section 1 Specifications.

The 7S12 TDR Sampling Unit controls are indicated in CAPITAL letters and the test equipment controls are indicated in initial Capitals.

#### NOTE

*All waveforms shown in this procedure were taken with a Tektronix Oscilloscope Camera System. Limits, tolerances and waveforms in this procedure are given as calibration guides and should not be interpreted as instrument specifications, except as specified in Section 1.*

### Equipment Required

The following test equipment and accessories, or equivalent, are required for the complete performance check and adjustment of the 7S12 TDR Sampling Unit. Specifications given are the minimum necessary for accurate checks and adjustments; therefore, some of the recommended equipment may have specifications that exceed those given. All test equipment is assumed to be correctly calibrated and operating within the given specifications. If equipment is substituted, it must meet or exceed the specifications of the recommended equipment.

Special Tektronix Calibration fixtures are used in this procedure only where they facilitate the checks and adjustments. The special calibration fixtures are available from Tektronix, Inc. Order by part number through your local Tektronix Field Office or representative.

### Test Equipment

1. Oscilloscope. Tektronix 7503 or other 7000-series oscilloscope in which the 7S12 is used.

2. Vertical Amplifier. Tektronix 7A16 Amplifier with a P6012 (Tektronix Part No. 010-0203-00) or other 10X probe.

3. Delay Line. Tektronix 7M11 50  $\Omega$  Delay Line which has a 75 ns signal delay.

4. Calibrator. 50  $\Omega$  Amplitude Calibrator, Tektronix Calibration Fixture 067-0508-00. The signal amplitude requirements are 12 mV and multiples through 600 mV, within 0.25%.

5. Time-Mark Generator. The marker requirements are 1  $\mu$ s with submultiples through 2 ns periods, within 0.3%. The trigger output requirement is 10  $\mu$ s period triggers or the trigger output is slaved to the marker output. Tektronix TG 501 Time-Mark Generator recommended. (If a TG 501 is used, a TM 500-series power module is required.)

6. Sampling Head and Pulse Generator. Tektronix Type S-5 Sampling Head and S-54 Pulse Generator Head or Type S-6 Sampling Head and S-52 Pulse Generator Head, or both pairs.

7. Trigger Recognizer. Tektronix S-53 Trigger Recognizer.

8. Normalizer Head. Tektronix Calibration Fixture 067-0572-01. This item is not required if the 7S12 is limited to one or two sampling heads.

9. Flexible Plug-in Extension. Tektronix Part No. 067-0616-00.

10. Cable. 50  $\Omega$ , approximately 8-inch length of coaxial cable with BNC connectors. Tektronix Part No. 012-0118-00. It is supplied with and is required only for the S-54 Pulse Generator Head.

11. Cable. 50  $\Omega$  coaxial cable, 42-inch length with BNC connectors. Tektronix Part No. 012-0057-01. Two required.

12. Cable. 50  $\Omega$  coaxial cable, 5 ns signal delay, Type RG213/U with GR connectors. Tektronix Part No. 017-0502-00.

## Performance Check and Adjustment —7S12

13. Cable. 50  $\Omega$  coaxial cable, 10-inch length with a BSM female and a BNC male connector. Tektronix Part No. 012-0128-00.

14. Coaxial Line. 50  $\Omega$ , 1 ns signal delay with 3-mm male connectors. Tektronix Part No. 015-1023-00. It is supplied with, and is required only for the S-52 Pulse Generator Head.

15. Coaxial Line. 50  $\Omega$ , 750 ps signal delay, U-shape with 3-mm male connectors. Tektronix Part No. 015-1017-01. It is supplied with the 7S12.

16. Adapter. GR to BNC female connector. Tektronix Part No. 017-0063-00.

17. Adapter. 3-mm female to female connector. Tektronix Part No. 015-1012-00. It is supplied with and is required only for the Type S-6 Sampling Head.

18. Adapter. BNC female to 3-mm male. Tektronix Part No. 015-1018-00.

19. Adapter. GR to 3-mm male. Tektronix Part No. 015-1007-00. It is supplied with and required only for the Type S-6 Sampling Head.

20. Adapter. BNC "T" female to male to female connector. Tektronix Part No. 103-0030-00. It is supplied with and is required only for the S-54 Pulse Generator Head.

21. Termination. 50  $\Omega$  feedthrough with BNC connectors. Tektronix Part No. 011-0049-01. It is supplied with and is required only for the Type S-5 Sampling Head.

22. Termination. Short-circuit with GR connector. Tektronix Part No. 017-0087-00.

23. Termination. 50  $\Omega$  with 3-mm male connector. Tektronix Part No. 015-1022-00. It is supplied with and is required only for the Type S-6 Sampling Head.

24. Termination. 50  $\Omega$  with GR connector. Tektronix Part No. 017-0081-00.

25. Termination. Short-circuit with 3-mm female connector. Tektronix Part No. 015-1021-00. It is supplied with the 7S12.

## PERFORMANCE CHECK AND ADJUSTMENT RECORD AND INDEX

The following abridged procedure may be used as a guide by the experienced technician for checking the performance of the 7S12. The abridged procedure may be used as a maintenance record (the procedure may be reproduced without special permission of Tektronix, Inc.). The step numbers and titles are identical to those in the complete procedure.

7S12, Serial No. \_\_\_\_\_

Calibration Date \_\_\_\_\_

Calibrated By \_\_\_\_\_

Checked By \_\_\_\_\_

### 7S12 Checks

1. Preliminary Procedure	Page 5-3
2. Check Vertical Deflection Factors	Page 5-4
3. Check TIME/DIV Accuracy	Page 5-4
4. Check TIME-DISTANCE Dial Accuracy	Page 5-4
5. Check DC OFFSET Range	Page 5-5

### S-6, S-52 and 7S12 System Checks

1. Check Pulse Amplitude	Page 5-5
2. Check Pulse Jitter	Page 5-6
3. Check Pulse Aberrations	Page 5-6
4. Check Pulse Risetime	Page 5-6

### S-5, S-54 and 7S12 System Checks

1. Check Pulse Amplitude	Page 5-7
2. Check Pulse Jitter	Page 5-8
3. Check Pulse Aberrations	Page 5-8
4. Check Pulse Risetime	Page 5-8

### Adjustment Procedure

1. Preliminary Procedure	Page 5-9
2. Adjust Memory Gate Width Control R390 and Memory Gain Control C275 Using Normalizer Head	Page 5-9



2. (Alternate) Adjust Memory Gate Width Control R390 and Memory Gain Control C275 Using Sampling Head	Page 5-9
3. Adjust Memory Balance Control R245, Variable Balance Control R335 and Vertical Position Balance Control R325	Page 5-11
4. Adjust Delay Calibrate Control R380	Page 5-11
5. Adjust VERT GAIN Control	Page 5-12
6. Adjust HORIZ POS and SWEEP CAL Controls	Page 5-13
7. Adjust Timing Controls R525 and C535	Page 5-13
8. Adjust TIME-DISTANCE Calibration Control R668	Page 5-13
9. Adjust Pulse Position Controls R590, R592 and R594	Page 5-14
10. Adjust Scan Rate Control R618	Page 5-14
11. Adjust LOCATE Calibration Control R677	Page 5-14
12. Adjust Correction Memory Control R945	Page 5-15

h. Set the 7S12 controls:

mV	on
mV/DIV	100
PRESET	off
HI RESOLUTION	off
REP	on
SCAN	fully clockwise
DC OFFSET	center trace
TIME-DISTANCE Multiplier	X10
TIME/DIV	1 $\mu$ s
TIME-DISTANCE Dial	0

i. Push the MAN switch after obtaining the trace.

j. Check that the dot range of movement is from graticule vertical line 0 (left edge) to graticule vertical line 10 (right edge) when the SCAN control is turned from the fully counterclockwise position to the fully clockwise position. Adjust the HORIZ POS and SWEEP CAL (screw-driver adjust) controls as necessary to obtain this performance. The SWEEP CAL control sets the distance the dot moves. The HORIZ POS control positions the range of dot movement of the graticule. See Fig. 5-1 for this display.

k. Push the 7S12 REP switch and turn the SCAN control fully clockwise.

l. Connect a GR coaxial cable from the 50  $\Omega$  Amplitude Calibrator Output connector to the Sampling Head lower input connector with a GR to 3-mm male adapter.

m. Set the 50  $\Omega$  Amplitude Calibrator signal amplitude at .6 V and the DC-Square wave switch at Square wave.

## 7S12 CHECKS

### 1. Preliminary Procedure

- a. Install the 7S12 in the two right-hand compartments of a 7503 Oscilloscope.
- b. Install an S-6 Sampling Head in the 7S12 Sampling (left) compartment and an S-53 Trigger Recognizer in the Pulse Generator (right) compartment.
- c. Switch the power on to the oscilloscope, the time-mark generator and the 50  $\Omega$  Amplitude Calibrator.
- d. Connect a 3-mm male 50  $\Omega$  termination to the upper input connector to the S-6 Sampling Head.
- e. Connect a BNC coaxial cable from the 50  $\Omega$  Amplitude Calibrator Trigger Output connector to the Trigger Recognizer Input connector.
- f. Turn the Trigger Recognizer Stability and Level controls fully clockwise.
- g. Push the Oscilloscope Right Vertical Mode switch and the Right Vert Trigger Source switch.

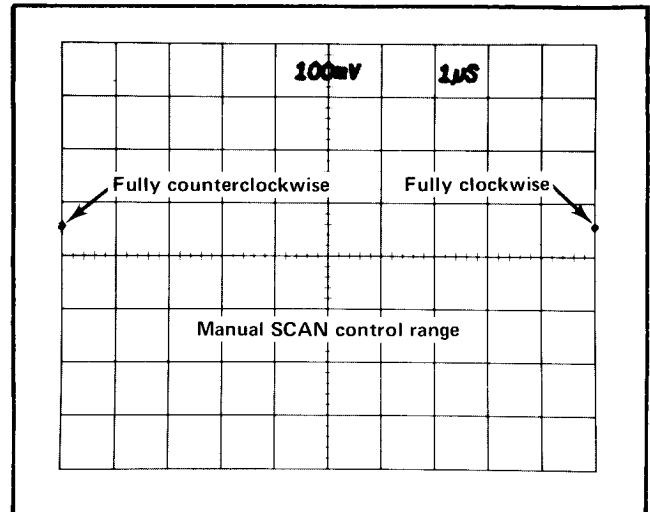

Fig. 5-1. The correct dot range of movement for Manual SCAN control operation.

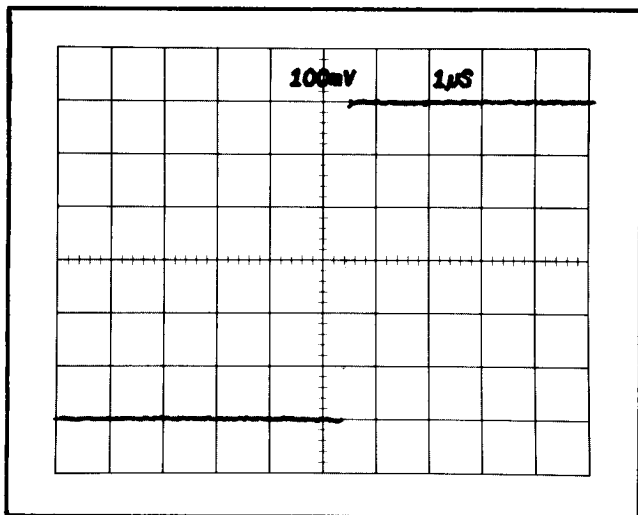

Fig. 5-2. VERT GAIN control adjustment. Only a portion of the square wave input signal is displayed.

n. Check that the pulse step amplitude is a 6 div (600 mV) step. Adjust the VERT GAIN (screwdriver adjust) control for a 6 div step if necessary. See Fig. 5-2 for this waveform.

### 2. Check Vertical Deflection Factors

a. CHECK that the deflection factors are within 3% for the control settings given in Table 5-1.

TABLE 5-1

mV/DIV	Signal Amplitude volts	Step Amplitude/div	Tolerance/div
500	.6	1.2	.07
200	.6	3	.18
100	.6	6	.18
50	.3	6	.18
20	.12	6	.18
10	.06	6	.18
5	.03	6	.18
2	.012	6	.18

b. Remove the coaxial cable and adapter from the Sampling Head input connector and the 50 Ω Amplitude Calibrator Output connector, and the coaxial cable from the 50 Ω Amplitude Calibrator.

### 3. Check TIME/DIV Accuracy

a. Connect the BNC coaxial cable from the Trigger Recognizer Input connector to the time-mark generator trigger output connector.

b. Connect a BNC coaxial cable from the time-mark generator marker output connector to the sampling head lower input connector with a BNC female to 3-mm male adapter.

c. Set the time-mark generator for 1 μs time marks and a 1 μs trigger.

d. Set the 7S12 controls:

mV/DIV	500
TIME-DISTANCE Multiplier	X10
TIME/DIV	1 μs
DC OFFSET	display trace

e. CHECK that the TIME/DIV accuracy is within 3% (0.24 div) for all ranges according to Table 5-2. Perform all measurements from graticule line 1 to graticule line 9 (8 div range). See Fig. 5-3 which shows the 1 μs/div measurement. The check should be made at each end of the TIME-DISTANCE scale.

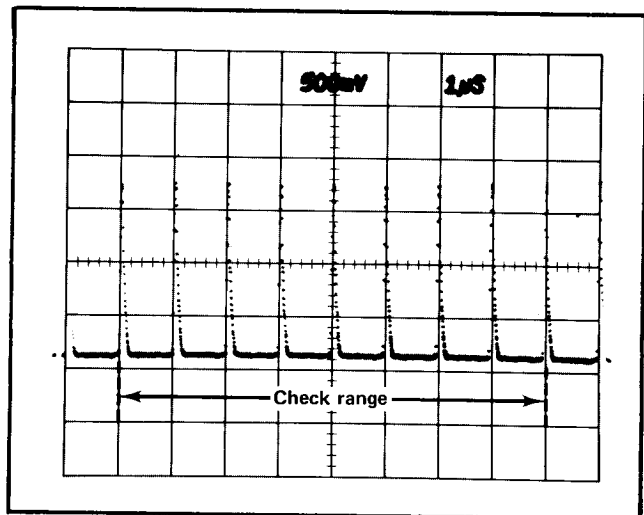

Fig. 5-3. Correct TIME/DIV check range. One μs period markers are shown.

### 4. Check TIME-DISTANCE Dial Accuracy

a. Set the time-mark generator for 1 μs time marks.

b. Set the 7S12 controls:

mV/DIV	200
TIME-DISTANCE Multiplier	X10
TIME/DIV	20 ns
TIME-DISTANCE Dial	0
DC OFFSET	display trace

c. Adjust the FINE control to place a marker on graticule line 5. See Fig. 5-4 for this waveform.

d. Turn the TIME-DISTANCE control and count the markers that pass graticule line 5. Place the tenth marker from graticule line 5 at line 5.

e. CHECK that the TIME-DISTANCE Dial is at  $1.00 \mu\text{s}$  within  $0.1 \mu\text{s}$ .

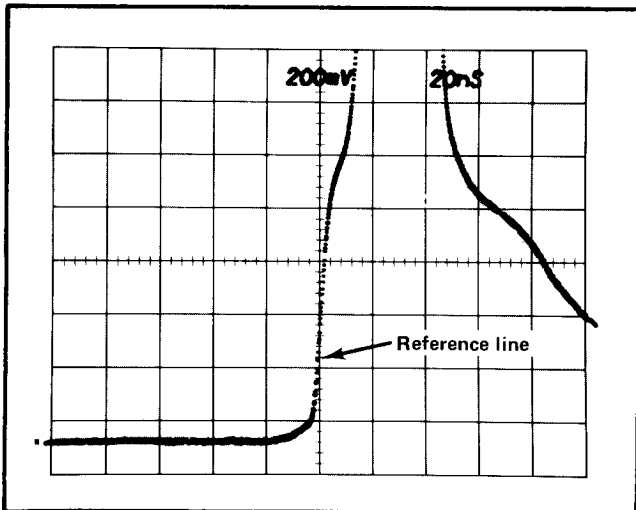

Fig. 5-4. TIME-DISTANCE Dial accuracy check. A  $1 \mu\text{s}$  period marker is shown.

## 5. Check DC OFFSET Range

a. Remove the coaxial cable and adapter from the Sampling Head and the Time Mark Generator. Retain the trigger coaxial cable.

b. Set the Sampler mV/Div switch at 500.

c. Turn the DC OFFSET and FINE controls from the fully clockwise position to the fully counterclockwise position.

d. CHECK that the trace moves from at least 2 div ( $-1 \text{ V}$ ) above the graticule center to at least 2 div ( $+1 \text{ V}$ ) below the graticule center.

e. Remove the coaxial cable from the Time Mark Generator to the Trigger Recognizer.

TABLE 5-2

TIME/DIV	TIME-DISTANCE Multiplier	Marker Selector Input Signal	Marks/Div
$1 \mu\text{s}$	X10	$1 \mu\text{s}$	1
$.5 \mu\text{s}$	X10	$.5 \mu\text{s}$	1
$.2 \mu\text{s}$	X10	$.1 \mu\text{s}$	2
$.1 \mu\text{s}$	X10	$.1 \mu\text{s}$	1
50 ns	X10	50 ns	1
20 ns	X10	10 ns	2
10 ns	X10	10 ns	1
5 ns	X10	5 ns	1
2 ns	X10	2 ns	1
$.1 \mu\text{s}$	X1	$.1 \mu\text{s}$	1
50 ns	X1	50 ns	1
20 ns	X1	10 ns	2
10 ns	X1	10 ns	1
5 ns	X1	5 ns	1
2 ns	X1	2 ns	1
1 ns	X1	2 ns	.5
10 ns	X.1	10 ns	1
5 ns	X.1	5 ns	1
2 ns	X.1	2 ns	1
1 ns	X.1	2 ns	.5

## S-6, S-52 and 7S12 SYSTEM CHECKS

### 1. Check Pulse Amplitude

a. Install an S-6 Sampling Head in the Sampling (left) compartment and an S-52 Pulse Generator Head in the Pulse Generator (right) compartment of the 7S12 TDR/SAMPLER.

b. Connect a 3-mm U-shaped coaxial cable (Tektronix Part No. 015-1017-01) from the S-52 Pulse Output connector to the lower Sampling Head input connector.

c. Connect a  $50 \Omega$  3-mm male termination (Tektronix Part No. 015-1022-00) to the upper Sampling Head input connector.

d. Set the 7S12 controls:

TIME-DISTANCE Multiplier	X1
TIME/DIV	10 ns
mV	on
mV/DIV	100
DC OFFSET	display pulse
TIME-DISTANCE Dial	0
FINE (ZERO SET)	fully clockwise

e. CHECK that the pulse amplitude is at least 200 mV (2 div). This waveform is similar to Fig. 5-2.

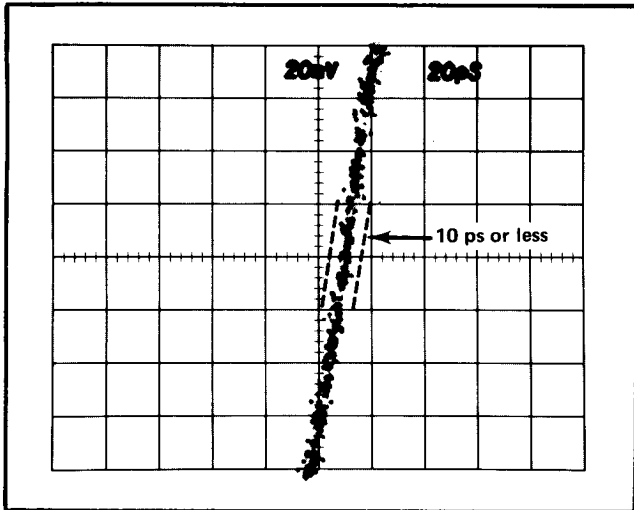

Fig. 5-5. Pulse jitter measurement of the S-6, S-52 and 7S12 system.

## 2. Check Pulse Jitter

a. Set the 7S12 controls:

mV/DIV	20
TIME-DISTANCE Multiplier	X.1
TIME/DIV	20 ps
DC OFFSET	display pulse edge
TIME-DISTANCE Dial	display pulse edge

b. CHECK that the pulse jitter is not greater than 10 ps (.5 div). Use only 90% of the trace width for this check. See Fig. 5-5 for this waveform.

## 3. Check Pulse Aberrations

a. Remove the 50  $\Omega$  termination from the Sampling Head upper connector and install a 3-mm, 1 ns, 50  $\Omega$  coaxial line (Tektronix Part No. 015-1023-00) with the 50  $\Omega$  termination attached. Use a 3-mm female to female adapter (Tektronix Part No. 015-1012-00) to connect the 50  $\Omega$  termination to the coaxial line.

b. Set the 7S12 controls:

TIME/DIV	.5 ns
TIME-DISTANCE Dial	0
FINE (ZERO SET)	display pulse step
DC OFFSET	display pulse top
mp	on
mp/DIV	200
$\rho$ CAL (screwdriver adjust)	5 div pulse

c. Set the mp/DIV switch at 50 and place the pulse step near the left edge of the graticule.

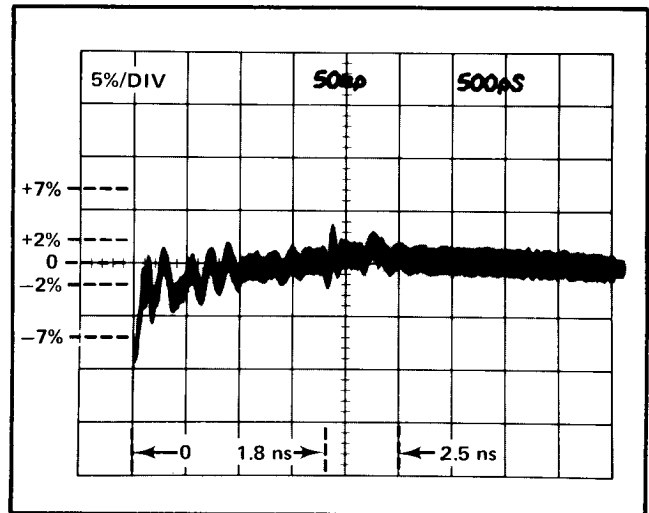

Fig. 5-6. Pulse aberrations of the S-6, S-52 and 7S12 system.

d. CHECK that the aberrations are within +7%, -7%, total of 10% P-P within 1.8 ns of the step edge with the reference level at 1.8 ns from the step edge.

e. Set the Time-Distance Multiplier at X1, the Time/Div switch at 50 ns and turn the Time-Distance and Fine (Zero Set) controls fully clockwise.

f. Place the top of the pulse on the graticule center-line. Use the portion of the pulse that is 300 ns (6 div) from the start of the pulse for the reference level.

g. Set the Time-Distance Multiplier at X.1 and the Time/Div switch at 500 ps. Adjust the Time-Distance control to position the point which is 2.5 ns from the start of the pulse at the graticule center. See Fig. 5-6.

h. CHECK that the aberrations are within +2%, -2%, total of 4% P-P after 2.5 ns of the pulse edge. See Fig. 5-6.

## 4. Check Pulse Risetime

a. Remove the 50  $\Omega$  termination with the adapter and install a 3-mm female short-circuit termination on the end of the coaxial line.

b. Set the 7S12 controls:

mV	on
mV/DIV	100
TIME/DIV	20 ps
TIME-DISTANCE Dial	display incident pulse

c. Adjust the mV/DIV VARIABLE control so that the 0% and the 100% levels of the incident pulse are 5 div

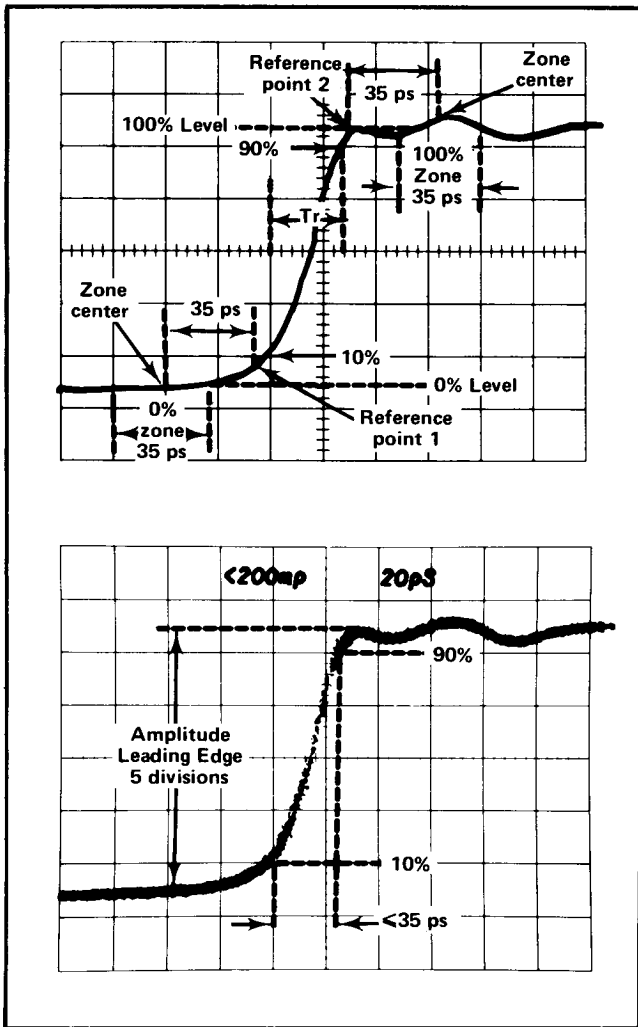

Fig. 5-7. Incident pulse risetime of the S-6, S-52 and 7S12 system.

apart. Use the following procedure to locate the 0% (100% is in parenthesis) level for the incident or reflected pulse. This procedure is necessary whenever a level is not clearly defined.

1. Find the knee reference point at the start (end) of the step where the rate of change of the slope is maximum (the radius of curvature is least). See Fig. 5-7 for this waveform.
2. At a distance of one risetime before (after) the knee reference point in step 1, place the center of a zone which is one risetime in width. The S-6, S-52 and 7S12 system risetime is 35 ps.
3. Determine the average level of the waveform within the zone and use it for the 0% (100%) reference level.
- d. CHECK that the incident pulse risetime from the 10% level to the 90% level is 35 ps or less.

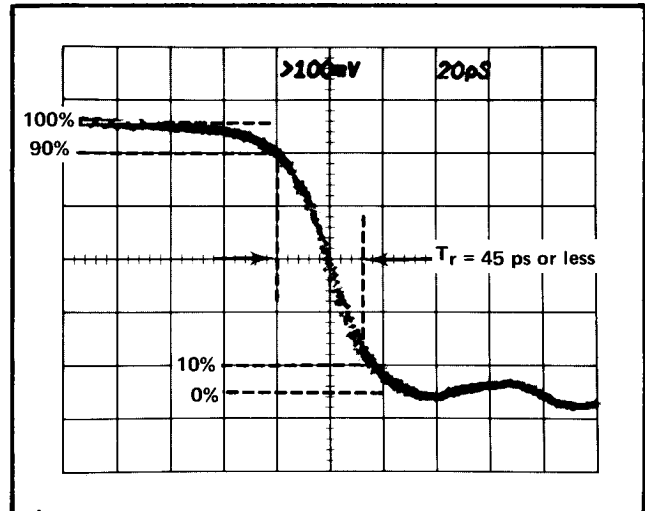

Fig. 5-8. Reflected pulse risetime of the S-6, S-52, and 7S12 system.

e. Display the reflected pulse and adjust the mV/DIV VARIABLE control so that the 100% level and the 0% level are 5 div apart. Use the step c procedure to establish the two levels. The 100% level is the start (top) and the 0% level is the end (bottom) of the pulse. The system reflected pulse risetime (actually a falltime) of 45 ps is to be used for the zone widths to establish the 0% and 100% levels.

f. CHECK that the reflected pulse risetime from the 90% level to the 10% level is 45 ps or less. See Fig. 5-8 for this waveform.

g. Set the mV/DIV VARIABLE at CAL IN.

### S-5, S-54 and 7S12 SYSTEM CHECKS

#### 1. Check Pulse Amplitude

a. Install an S-5 Sampling Head in the Sampling (left) compartment and an S-54 Pulse Generator Head in the Pulse Generator (right) compartment of the 7S12 TDR/SAMPLER.

b. Connect an 8-inch BNC coaxial cable from the Pulse Generator Head Pulse Output connector to the Sampling Head input connector which has a BNC 50 Ω through-line termination attached.

c. Set the 7S12 controls:

mV	on
mV/DIV	100
mV/DIV VARIABLE	CAL IN
TIME-DISTANCE Multiplier	X10
TIME/DIV	.1 μs
TIME-DISTANCE Dial	0
FINE (ZERO SET)	fully clockwise
DC OFFSET	display step

## Performance Check and Adjustment –7S12

d. CHECK that the pulse step is at least 400 mV (4 div). This waveform is similar to Fig. 5-2.

### 2. Check Pulse Jitter

a. Set the 7S12 controls:

$m\rho$	on
$\rho$ CAL (screwdriver adjust)	fully clockwise
$m\rho$ /DIV	10
$m\rho$ /DIV VARIABLE	fully clockwise
TIME-DISTANCE Multiplier	X.1
TIME/DIV	20 ps
DC OFFSET	display pulse edge
TIME-DISTANCE Dial	display pulse edge

b. CHECK that the pulse jitter is not greater than 20 ps (1 div). Use only 90% of the trace width for this check. See Fig. 5-5 for a similar waveform.

### 3. Check Pulse Aberrations

a. Remove the 50  $\Omega$  through-line termination and connect a BNC "T" connector to the Sampling Head input connector.

b. Connect the 8-inch BNC coaxial cable from the Pulse Generator Head Pulse Output connector to the "T" connector.

c. Connect about 3 feet of BNC coaxial cable to the "T" connector and terminate the coaxial cable with a GR 50  $\Omega$  termination and a GR to BNC female adapter.

d. Set the 7S12 controls:

$m\rho$	on
$m\rho$ /DIV VARIABLE	CAL IN
$m\rho$ /DIV	200
TIME-DISTANCE Multiplier	X10
TIME/DIV	5 ns
DC OFFSET	display step
TIME-DISTANCE Dial	display step
$\rho$ CAL (screwdriver adjust)	5 div step

e. Set the  $m\rho$ /DIV switch at 20 and place the step near the left edge of the graticule. See Fig. 5-9 for this waveform.

f. CHECK that the aberrations do not exceed +4% (+2 div) or -6% (-3 div) within the first 17 ns (3.4 div) of the step and not more than +1.5% (+.75 div) or -1.5% (-.75 div) thereafter.

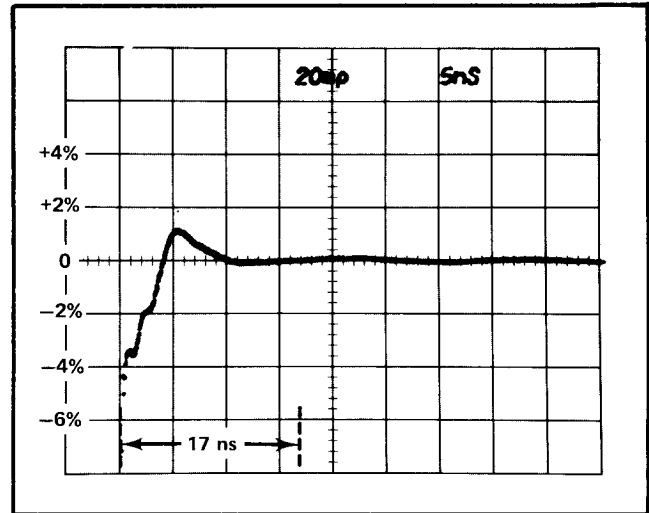

Fig. 5-9. Pulse aberrations of the S-5, S-54 and 7S12 system.

### 4. Check Pulse Risetime

a. Set the 7S12 controls:

mV	on
mV/DIV	100
TIME-DISTANCE Multiplier	X1
TIME/DIV	1 ns
DC OFFSET	display step
TIME-DISTANCE Dial	display step

b. ADJUST the mV/DIV VARIABLE control so that the 0% and the 100% levels are 5 div apart. The 0% level is the well defined base of the pulse. The 100% level must be established in the manner described in step 4c of the S-6, S-52 and 7S12 System check, since the top of the pulse is not well defined. The risetime to be used in the procedure is 1.5 ns. See Fig. 5-10 for the waveform.

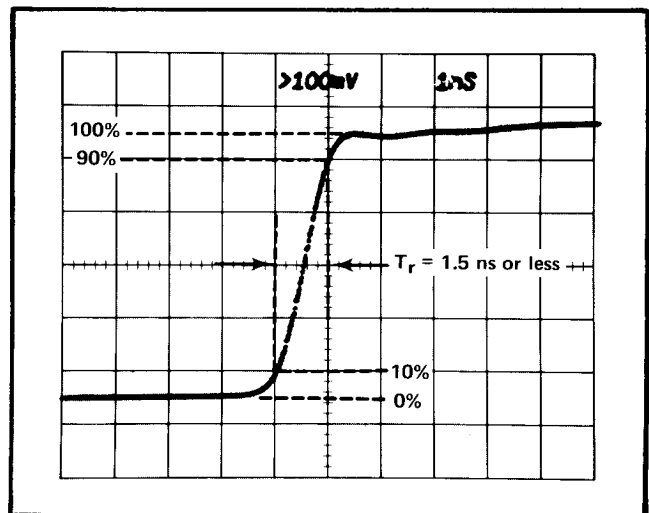

Fig. 5-10. Incident pulse risetime of the S-5, S-54 and 7S12 system.

c. CHECK that the incident pulse risetime from the 10% level to the 90% level is 1.5 ns or less.

This completes the Performance Check.

## ADJUSTMENT PROCEDURE

### 1. Preliminary Procedure

a. Install two Flexible Plug-in Extenders (Tektronix Calibration Fixture 067-0616-00) in the 7503 Oscilloscope. Place one in the Right Vert compartment and the other in the Horiz compartment.

b. Connect the 7S12 to the extenders. Do not cross the cables.

### 2. Adjust Memory Gate Width Control R390 and Memory Gain Control C275 Using Normalizer Head

#### NOTE

*If a Normalizer Head is not available, use Step 2 (Alternate).*

a. Install a 7A16 Amplifier in the Left Vert compartment of the oscilloscope.

b. Install a Normalizer Head (Tektronix Calibration Fixture 067-0572-01) in the 7S12 Sampling compartment and an S-52 Pulse Generator Head in the Pulse Generator compartment.

c. Switch the power on to the oscilloscope, the time-mark generator, and to the 50  $\Omega$  Amplitude Calibrator. Allow a 5-minute warm up.

d. Set the Normalizer Head Units switch at Volts and the Units/Div Multiplier switch at X1.

e. Push the oscilloscope Right Vertical Mode switch and the Right Vert Trigger Source switch.

f. Set the 7S12 controls:

mV	on
mV/DIV VARIABLE	CAL IN
mV/DIV	100

REP	on
TIME-DISTANCE Multiplier	X10
TIME/DIV	1 $\mu$ s
DC OFFSET	display waveform

g. ADJUST the Memory Gate Width control R390 to obtain maximum separation of the two traces. See Fig. 5-11 for the control location and Fig. 5-12 for a typical waveform.

h. Set the 7A16 controls:

Input	AC
Polarity	+Up
Bandwidth	20 MHz
Volts/Div	20 mV

i. Push the oscilloscope Left Vertical Mode switch.

j. Connect a 10X probe from the 7A16 Input connector to the 7S12 VERT SIG OUT jack.

k. ADJUST the Memory Gain control C275 to obtain 1 V (5 div) separation of the two traces. See Fig. 5-11 for the control location.

### 2. (Alternate) Adjust Memory Gate Width Control R390 and Memory Gain Control C275 Using Sampling Head

#### NOTE

*This is an alternate procedure which may be used if a Normalizer Head is not available. The 7S12 Memory Gain is adjusted to compensate for the gain of the Sampling Head used and may not be properly adjusted for other Sampling Heads.*

a. Install an S-6 Sampling Head in the Sampling compartment and an S-52 Pulse Generator Head in the Pulse Generator compartment of the 7S12.

b. Switch the power on to the oscilloscope, the time-mark generator, and to the 50  $\Omega$  Amplitude Calibrator. Allow a 5-minute warm up.

c. Connect a 3-mm U-shaped coaxial line (Tektronix Part No. 015-1017-01) from the Pulse Generator Head Pulse Output connector to the Sampling Head lower input connector.

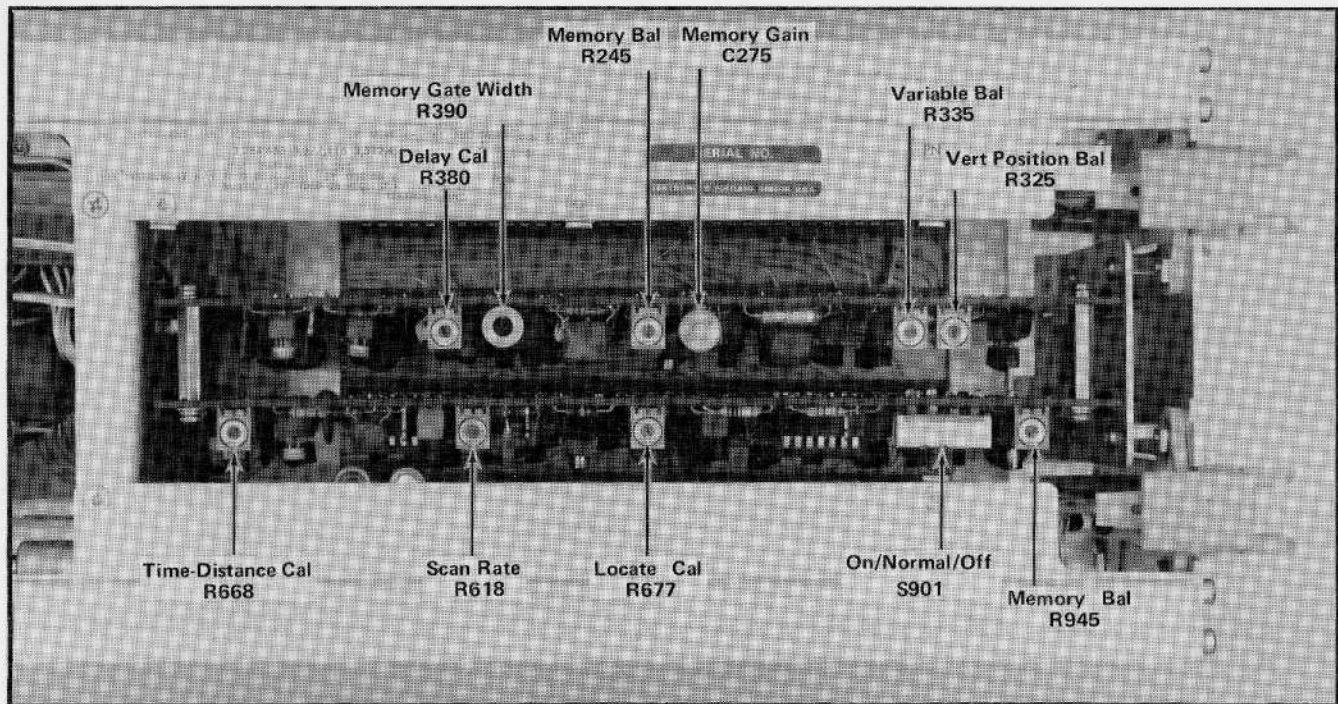

Fig. 5-11. Control locations on the Vertical and Horizontal cards.

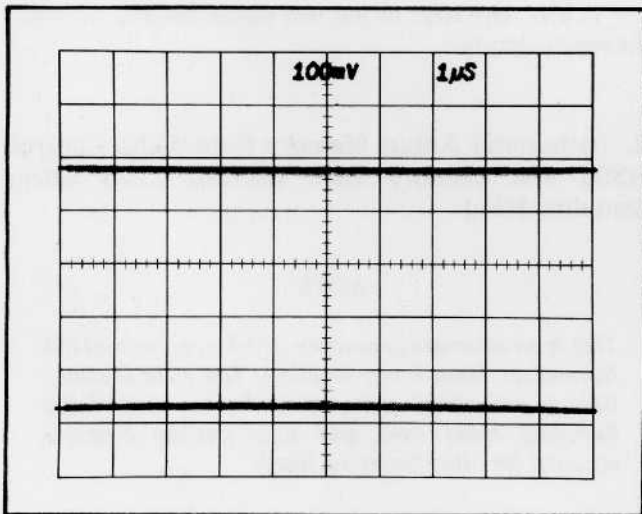

Fig. 5-12. Waveform for Memory Gate Width control R390 adjustment using a Normalizer Head.

d. Connect a 3-mm male 50  $\Omega$  termination to the Sampling Head upper input connector.

e. Push the oscilloscope Right Vertical Mode switch and the Right Vert Trigger Source switch.

f. Set the 7S12 controls:

mV	on
mV/DIV VARIABLE	CAL IN
mV/DIV	100
REP	on
TIME-DISTANCE Multiplier	X1
TIME/DIV	.1 $\mu$ s
TIME-DISTANCE Dial	0
FINE (ZERO SET)	fully clockwise
DC OFFSET	display pulse
SCAN	fully clockwise

Note: If the step is off screen, adjust Pulse Position control R592 to display the step. See Fig. 5-15 for the control location.

g. Adjust the 7S12 mV/DIV VARIABLE control for a 5 div step.

h. ADJUST the Memory Gate Width control R390 to raise the first dot above the step 0% level to its MAXIMUM amplitude. It may overshoot the 100% level. See Fig. 5-11 for the control location and Fig. 5-13 for a similar waveform.

i. ADJUST the Memory Gain control C275 to place the first dot above the 0% level at the 90% level (4.5 div above



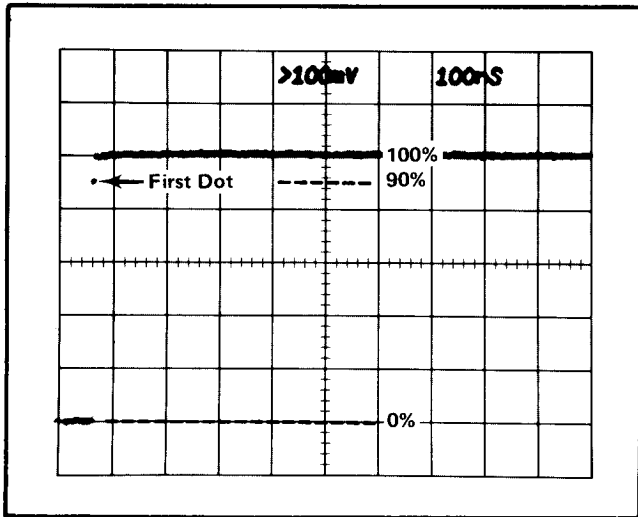

Fig. 5-13. Waveform for Memory Gate Width control R390 and Memory Gain control C275 adjustments using a Sampling Head.

the 0% level). See Fig. 5-11 for the control location and Fig. 5-13 for the waveform.

j. Set the mV/DIV VARIABLE at the CAL IN position.

k. Remove the coaxial line from the Sampling Head input connector to the Pulse Generator Head Pulse Output connector.

### 3. Adjust Memory Balance Control R245, Variable Balance Control R335 and Vertical Position Balance Control R325 (For this Step Set 5901 to Off)

a. Remove the Normalizer Head and install an S-6 Sampling Head with a 50 Ω termination on the upper input connector in the 7S12 Sampling compartment. Set the mV/DIV switch at 100.

b. Push the oscilloscope Left Vertical Mode switch and connect a 10X probe to the 7A16 Amplifier Input.

c. Set the Amplifier Volts/Div switch at 10 mV and push the ground switch.

d. Set the Amplifier trace at graticule center (zero reference) and then push the DC switch.

e. Connect the probe tip to the OFFSET OUT jack and adjust the DC OFFSET control for 0 V (trace at graticule center). The DC OFFSET control must not be touched during the remainder of this step.

f. Connect the probe tip to the VERT SIG OUT jack.

g. ADJUST the Memory Balance control R245 to set the VERT SIG OUT at 0 V. See Fig. 5-11 for the control location.

h. Push the oscilloscope Right Vertical Mode switch.

i. ADJUST the Variable Balance control R335 for no trace shift when the mV/DIV VARIABLE control is rotated throughout its range.

j. Set the mV/DIV VARIABLE control at the CAL IN position.

k. ADJUST the Vertical Position Balance control R325 to place the trace at graticule center.

### 4. Adjust Delay Calibrate Control R380

a. Remove the Pulse Generator Head and install an S-53 Trigger Recognizer.

b. Connect a 10-inch (or as short as possible) length of 50 Ω coaxial cable having a BSM female connector and a BNC male connector (Tektronix Part No. 012-0128-00) from the S-53 Trigger Recognizer Trig Out connector to the 7M11 50 Ω Delay Line Input 1 connector with a GR to BNC female adapter.

c. Connect a 5-ns, GR coaxial cable from the Delay Line Output 1 connector to the Sampling Head lower input connector with a GR to 3-mm male adapter.

d. Set the Trigger Recognizer Stability control fully clockwise and the Level control at mid-range to obtain a trace.

e. Set the 7S12 controls:

mV/DIV	500
TIME-DISTANCE Multiplier	X.1
TIME/DIV	5 ns
TIME-DISTANCE Dial	0
FINE	fully clockwise
DC OFFSET	display pulse

f. ADJUST R380 to place the 10% to 20% level of the leading edge of the pulse at graticule center (25 ns from

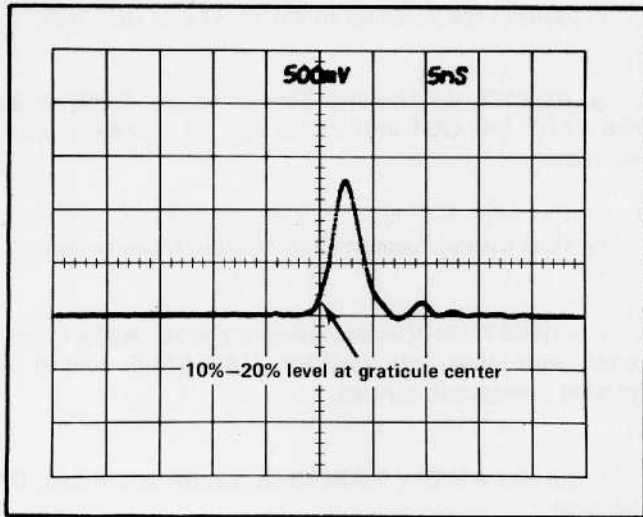

Fig. 5-14. Delay Calibrate control R380 adjustment waveform.

graticule line 0). See Fig. 5-11 for the control location and Fig. 5-14 for the waveform.

g. Remove the coaxial cable from between the Trigger Recognizer Trig Out connector and the Delay Line Input 1 connector, and the coaxial cable from the Delay Line Output 1 connector.

### 5. Adjust VERT GAIN Control

a. Connect a GR coaxial cable from the Sampling Head lower input connector with a GR to 3-mm male adapter to the 50 Ω Amplitude Calibrator Output connector.

b. Connect a BNC coaxial cable from the Trigger Recognizer Input connector to the 50 Ω Amplitude Calibrator Trigger Output connector.

c. Set the 50 Ω Amplitude Calibrator DC-Square wave switch at Square wave and the Volts switch at .3 V.

d. Set the Trigger Recognizer Stability control fully counterclockwise. Set the Trigger Recognizer Level control fully clockwise. Set the Slope switch to +. Adjust the Trigger Recognizer Level control counterclockwise until the trigger signal appears.

e. Set the 7S12 controls:

mV/DIV	50
TIME-DISTANCE Multiplier	X10
TIME/DIV	1 μs
TIME-DISTANCE Dial	0
FINE (ZERO SET)	fully clockwise
DC OFFSET	display step

Note: If the step is off the screen release the locate button.

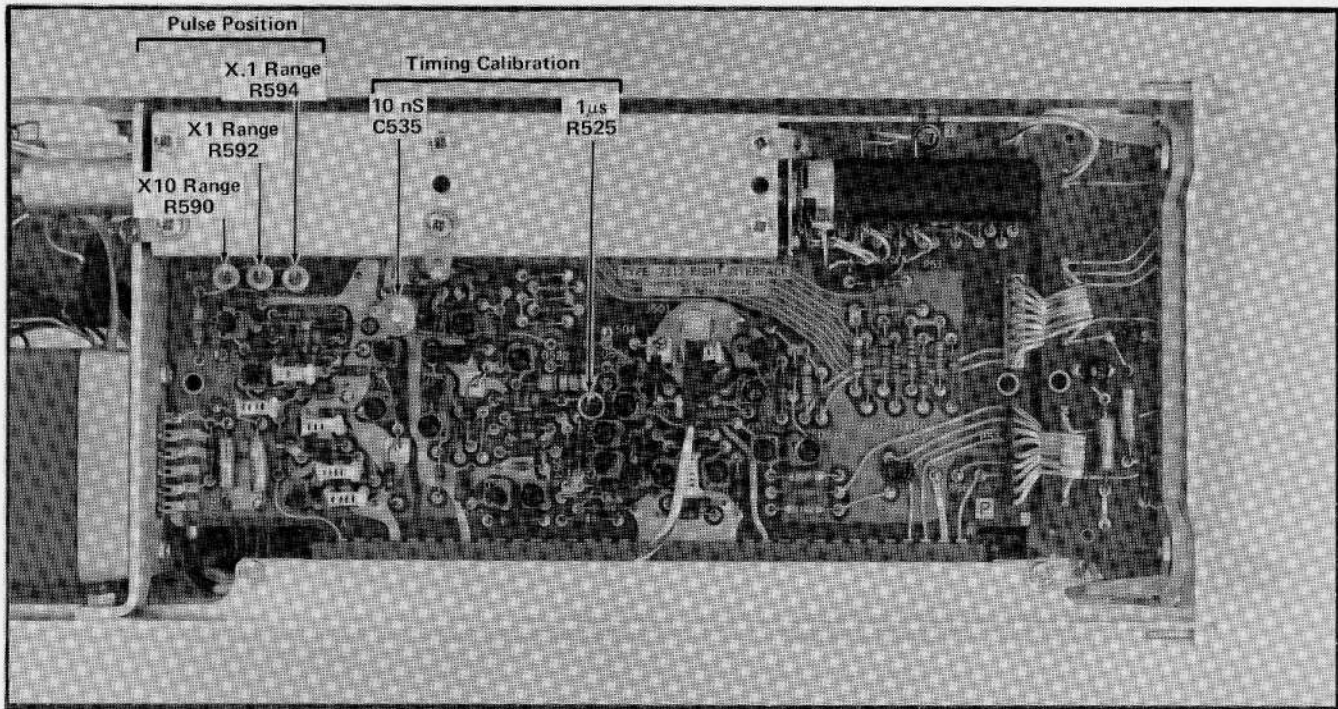

Fig. 5-15. Control locations on the Right Interface card.

f. ADJUST the VERT GAIN control (front panel) for a 6 div step (.3 V). See Fig. 5-2 for a similar waveform.

g. Remove the coaxial cable and adapter from the Sampling Head Input and the calibrator.

### 6. Adjust HORIZ POS and SWEEP CAL Controls

a. Position the free running trace on the screen and set the trace intensity at a low level.

b. Push the 7S12 MAN switch.

c. ADJUST the HORIZ POS and SWEEP CAL controls so that the dot moves from graticule line zero (left edge) to graticule line ten (right edge) when the SCAN control is turned from the fully counterclockwise position to the fully clockwise position. The SWEEP CAL controls the dot range of movement and the HORIZ POS positions the range on the screen. See Fig. 5-1 for this display.

d. Push the REP switch and disconnect the cable from the 50 Ω Amplitude Calibrator Trigger Out connector.

### 7. Adjust Time Controls R525 and C535

a. Connect a BNC coaxial cable from the Trigger Recognizer Input to the time-mark generator trigger output connector.

b. Connect a BNC coaxial cable from the sampling head input with a 3-mm male to BNC female adapter to the time-mark generator marker output connector.

c. Set the time-mark generator for 1 μs time-marks and a 1 μs trigger.

d. Set the 7S12 controls:

mV/DIV	500
TIME-DISTANCE	.50 μs
TIME-DISTANCE Multiplier	X10
TIME/DIV	1 μs

e. Adjust Timing control R525 for one marker per division. Use the FINE control to place the markers at the graticule lines and use graticule lines one through nine for this adjustment. See Fig. 5-15 for the control location and Fig. 5-3 for this waveform.

f. Set the TIME-DISTANCE Multiplier at X.1 and the TIME/DIV at 10 ns.

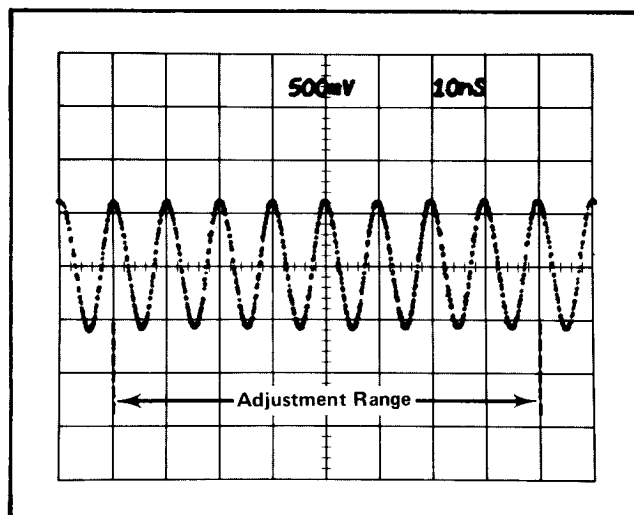

Fig. 5-16. Correct 10 ns/div adjustment waveform.

g. Set the time-mark generator for 10 ns time-marks.

h. ADJUST Timing control C535 for one cycle to sine wave per division from graticule line 1 to graticule line 9. See Fig. 5-15 for the control location and Fig. 5-16 for this waveform.

### 8. Adjust TIME-DISTANCE Calibration Control R668

a. Set the time-mark generator for 1 μs time-marks.

b. Set the 7S12 controls:

mV/DIV	200
TIME-DISTANCE Multiplier	X10
TIME/DIV	20 ns
TIME-DISTANCE	0

c. Turn the Trigger Recognizer controls fully clockwise.

d. Adjust the FINE (ZERO SET) control to place a marker at graticule line 5.

e. Turn the TIME-DISTANCE control to 1.00 μs and count the markers that pass graticule line 5.

f. ADJUST the TIME-DISTANCE Calibration control R668 so that the tenth marker from graticule line 5 is placed on graticule line 5. See Fig. 5-11 for the control location and Fig. 5-4 for the waveform.

**9. Adjust Pulse Position Controls R594, R592 and R590**

a. Remove the cables, the adapter and the Trigger Recognizer.

b. Install an S-52 Pulse Generator Head in the 7S12 Pulse Generator compartment and connect a 3-mm U-shaped coaxial line (Tektronix Part No. 015-1017-01) from the Pulse Generator to the Sampling Head lower input.

c. Set the 7S12 controls:

mV/DIV	100
TIME-DISTANCE Multiplier	X.1
TIME/DIV	1 ns
TIME-DISTANCE	0
FINE (ZERO SET)	fully clockwise

d. ADJUST the Pulse Position control R594 to place the pulse at graticule line 5. See Fig. 5-15 for the three controls location and Fig. 5-17 for this waveform.

e. Set the TIME-DISTANCE Multiplier switch at X1.

f. ADJUST the Pulse Position control R592 to place the pulse at graticule line 5.

**NOTE**

*Omit the remainder of this step if only the S-52 Pulse Generator Head is used in the 7S12. Complete the remainder of this step if the S-54 Pulse Generator Head is also used in the 7S12.*

g. Remove the S-52 with the U-shaped coaxial cable from the 7S12.

h. Install an S-54 Pulse Generator Head in the 7S12 Pulse Generator compartment.

i. Connect a BNC coaxial cable (Tektronix Part No. 012-0118-00) from the S-54 Pulse Output connector to the S-6 lower LOOP THRU input connector with a BNC female to 3 mm male adapter.

j. Set the TIME-DISTANCE Multiplier switch at X10.

k. ADJUST the Pulse Position control R590 to place the pulse at graticule line 5.

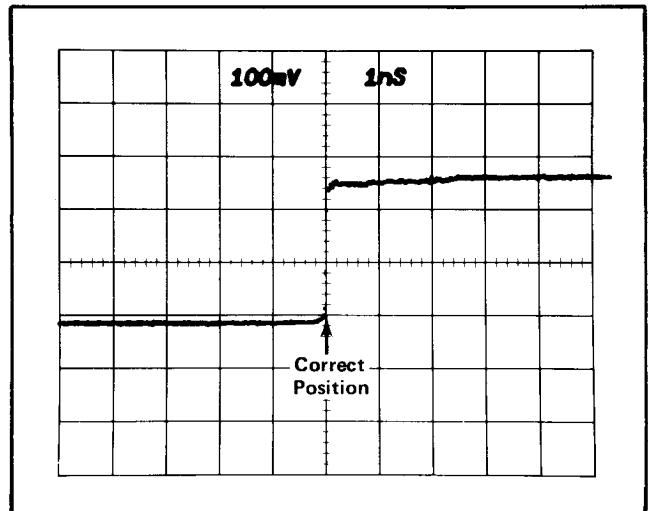

Fig. 5-17. Correct pulse start position adjustment waveform.

**10. Adjust Scan Rate Control R618**

a. Push the 7S12 HIGH RESOLUTION switch and turn the SCAN control fully counterclockwise.

b. ADJUST the Scan Rate control R618 for one sweep in 50 or more seconds (5 s/div). Use a watch sweep-second hand to measure the time. See Fig. 5-10 for the control location.

c. Switch to normal resolution and turn the SCAN control fully clockwise.

**11. Adjust LOCATE Calibration Control R677**

a. Set the 7S12 controls as follows:

TIME-DISTANCE Multiplier	X.1
TIME/DIV	.2 ns

b. Position the step edge at graticule center with the TIME-DISTANCE control.

c. Push to release the LOCATE switch.

d. ADJUST the LOCATE Calibration control R677 to center the bright portion of the trace on the step edge. See Fig. 5-11 for the control location.

e. Push the LOCATE switch in.

**12. Adjust Correction Memory Control R945**

a. Disconnect the coaxial cable from the Pulse Generator Head to the Sampling Head.

b. Connect a 3 mm female short circuit termination to the coaxial line on the S-6 upper LOOP THRU connector.

c. ADJUST the Correction Memory control R945 for

no trace shift when Correction Memory switch S901 is switched from the Off (rear) position to its Normal (center) position. See Fig. 5-11 for the control and switch location.

d. Set the Correction Memory switch at its Normal (center) position.

This completes the Adjustment Procedure.



# REPLACEABLE ELECTRICAL PARTS

## PARTS ORDERING INFORMATION

Replacement parts are available from or through your local Tektronix, Inc. Field Office or representative.

Changes to Tektronix instruments are sometimes made to accommodate improved components as they become available, and to give you the benefit of the latest circuit improvements developed in our engineering department. It is therefore important, when ordering parts, to include the following information in your order: Part number, instrument type or number, serial number, and modification number if applicable.

If a part you have ordered has been replaced with a new or improved part, your local Tektronix, Inc. Field Office or representative will contact you concerning any change in part number.

Change information, if any, is located at the rear of this manual.

## SPECIAL NOTES AND SYMBOLS

X000 Part first added at this serial number  
00X Part removed after this serial number

## ITEM NAME

In the Parts List, an Item Name is separated from the description by a colon (:). Because of space limitations, an Item Name may sometimes appear as incomplete. For further Item Name identification, the U.S. Federal Cataloging Handbook H6-1 can be utilized where possible.

## ABBREVIATIONS

ACTR	ACTUATOR	PLSTC	PLASTIC
ASSY	ASSEMBLY	QTZ	QUARTZ
CAP	CAPACITOR	RECP	RECEPTACLE
CER	CERAMIC	RES	RESISTOR
CKT	CIRCUIT	RF	RADIO FREQUENCY
COMP	COMPOSITION	SEL	SELECTED
CONN	CONNECTOR	SEMICOND	SEMICONDUCTOR
ELCTLT	ELECTROLYTIC	SENS	SENSITIVE
ELEC	ELECTRICAL	VAR	VARIABLE
INCAND	INCANDESCENT	WW	WIREWOUND
LED	LIGHT EMITTING DIODE	XFMR	TRANSFORMER
NONWIR	NON WIREWOUND	XTAL	CRYSTAL

CROSS INDEX—MFR. CODE NUMBER TO MANUFACTURER

Mfr. Code	Manufacturer	Address	City, State, Zip
000AL	CINCH MANUFACTURING COMPANY	1501 MORSE AVENUE	ELK GROVE, IL 60007
00853	SANGAMO ELECTRIC CO., S. CAROLINA DIV.	P O BOX 128	PICKENS, SC 29671
01121	ALLEN-BRADLEY COMPANY	1201 2ND STREET SOUTH	MILWAUKEE, WI 53204
01295	TEXAS INSTRUMENTS, INC., SEMICONDUCTOR GROUP	P O BOX 5012, 13500 N CENTRAL EXPRESSWAY	DALLAS, TX 75222
04222	AVX CERAMICS, DIVISION OF AVX CORP.	P O BOX 867, 19TH AVE. SOUTH	MURTL BEACH, SC 29577
04713	MOTOROLA, INC., SEMICONDUCTOR PROD. DIV.	5005 E MCDOWELL RD, PO BOX 20923	PHOENIX, AZ 85036
05574	VIKING INDUSTRIES, INC.	21001 NORDHOFF STREET	CHATSWORTH, CA 91311
07263	FAIRCHILD SEMICONDUCTOR, A DIV. OF FAIRCHILD CAMERA AND INSTRUMENT CORP.	464 ELLIS STREET	MOUNTAIN VIEW, CA 94042
07910	TELEDYNE SEMICONDUCTOR	12515 CHADRON AVE.	HAWTHORNE, CA 90250
08806	GENERAL ELECTRIC CO., MINIATURE LAMP PRODUCTS DEPARTMENT	NELA PARK	CLEVELAND, OH 44112
11237	CTS KEENE, INC.	3230 RIVERSIDE AVE.	PASO ROBLES, CA 93446
12697	CLAROSTAT MFG. CO., INC.	LOWER WASHINGTON STREET	DOVER, NH 03820
28480	HEWLETT-PACKARD CO., CORPORATE HQ.	1501 PAGE MILL RD.	PALO ALTO, CA 94304
32997	BOURNS, INC., TRIMPOT PRODUCTS DIV.	1200 COLUMBIA AVE.	RIVERSIDE, CA 92507
51642	CENTRE ENGINEERING INC.	2820 E COLLEGE AVENUE	STATE COLLEGE, PA 16801
56289	SPRAGUE ELECTRIC CO.		NORTH ADAMS, MA 01247
72982	ERIE TECHNOLOGICAL PRODUCTS, INC.	644 W. 12TH ST.	ERIE, PA 16512
73138	BECKMAN INSTRUMENTS, INC., HELIPOT DIV.	2500 HARBOR BLVD.	FULLERTON, CA 92634
75042	TRW ELECTRONIC COMPONENTS, IRC FIXED RESISTORS, PHILADELPHIA DIVISION	401 N. BROAD ST.	PHILADELPHIA, PA 19108
79727	C-W INDUSTRIES	550 DAVISVILLE RD., P O BOX 96	WARMINISTER, PA 18974
80009	TEKTRONIX, INC.	P O BOX 500	BEAVERTON, OR 97077
80294	BOURNS, INC., INSTRUMENT DIV.	6135 MAGNOLIA AVE.	RIVERSIDE, CA 92506
81073	GRAYHILL, INC.	561 HILLGROVE AVE., PO BOX 373	LA GRANGE, IL 60525
86684	RCA CORP., ELECTRONIC COMPONENTS DIV.	415 S. 5TH STREET	HARRISON, NJ 07029
91637	DALE ELECTRONICS, INC.	P. O. BOX 609	COLUMBUS, NE 68601
98291	SEAELECTRO CORP.	225 HOYT	MAMARONECK, NY 10544



Ckt No.	Tektronix Part No.	Serial/Model No. Eff	Dscont	Name & Description	Mfr Code	Mfr Part Number
A1	670-1312-01	B020150	B089999	CKT BOARD ASSY:LEFT INTERFACE	80009	670-1312-01
A1	670-1312-02	B090000	B099999	CKT BOARD ASSY:LEFT INTERFACE	80009	670-1312-02
A1	670-1312-03	B100000	B119999	CKT BOARD ASSY:LEFT INTERFACE	80009	670-1312-03
A1	670-1312-04	B120000		CKT BOARD ASSY:LEFT INTERFACE	80009	670-1312-04
A2	670-1315-01			CKT BOARD ASSY:VERTICAL	80009	670-1315-01
A3	670-1311-01	B020150	B029999	CKT BOARD ASSY:RIGHT INTERFACE	80009	670-1311-01
A3	670-1311-02	B030000	B049999	CKT BOARD ASSY:RIGHT INTERFACE	80009	670-1311-02
A3	670-1311-03	B050000	B089999	CKT BOARD ASSY:RIGHT INTERFACE	80009	670-1311-03
A3	670-1311-04	B090000	B099999	CKT BOARD ASSY:RIGHT INTERFACE	80009	670-1311-04
A3	670-1311-05	B100000	B100473	CKT BOARD ASSY:RIGHT INTERFACE	80009	670-1311-05
A3	670-1311-06	B100474	B110539	CKT BOARD ASSY:RIGHT INTERFACE	80009	670-1311-06
A3	670-1311-07	B110540	B119999	CKT BOARD ASSY:RIGHT INTERFACE	80009	670-1311-07
A3	670-1311-08	B120000		CKT BOARD ASSY:RIGHT INTERFACE	80009	670-1311-08
A4	670-1314-01	B020150	B039999	CKT BOARD ASSY:HORIZONTAL	80009	670-1314-01
A4	670-1314-02	B040000	B079999	CKT BOARD ASSY:HORIZONTAL	80009	670-1314-02
A4	670-1314-03	B080000	B089999	CKT BOARD ASSY:HORIZONTAL	80009	670-1314-03
A4	670-1314-04	B090000	B099999	CKT BOARD ASSY:HORIZONTAL	80009	670-1314-04
A4	670-1314-05	B100000		CKT BOARD ASSY:HORIZONTAL	80009	670-1314-05
A5	670-1309-01			CKT BOARD ASSY:CABLE	80009	670-1309-01
A6	670-1310-02	B020150	B029999	CKT BOARD ASSY:FLOATING CONNECTOR	80009	670-1310-02
A6	670-1310-01	B030000	B059999	CKT BOARD ASSY:FLOATING CONNECTOR	80009	670-1310-01
A6	670-1310-03	B060000		CKT BOARD ASSY:FLOATING CONNECTOR	80009	670-1310-03
A7	670-1317-00			CKT BOARD ASSY:RHO CAL SWITCH	80009	670-1317-00
A8	670-1313-00			CKT BOARD ASSY:HIGH RESOLUTION/PRESET SWITCH	80009	670-1313-00
A9	670-1316-00			CKT BOARD ASSY:SCAN MODE SWITCH	80009	670-1316-00
C127	283-0051-00			CAP.,FXD,CER DI:0.0033UF,5%,100V	72982	8131N145 A 332J
C134	283-0059-00			CAP.,FXD,CER DI:1UF,+80-20%,25V	72982	8141N037Z5U0105Z
C139	283-0078-00			CAP.,FXD,CER DI:0.001UF,20%,500V	56289	20C114A8
C149	283-0103-00			CAP.,FXD,CER DI:180PF,5%,500V	56289	40C638
C160	283-0026-00			CAP.,FXD,CER DI:0.2UF,+80-20%,25V	56289	274C3
C166	283-0078-00			CAP.,FXD,CER DI:0.001UF,20%,500V	56289	20C114A8
C201	283-0059-00			CAP.,FXD,CER DI:1UF,+80-20%,25V	72982	8141N037Z5U0105Z
C216	283-0059-00			CAP.,FXD,CER DI:1UF,+80-20%,25V	72982	8141N037Z5U0105Z
C219	281-0623-00			CAP.,FXD,CER DI:650PF,5%,500V	04222	7001-1362
C221	283-0059-00			CAP.,FXD,CER DI:1UF,+80-20%,25V	72982	8141N037Z5U0105Z
C234	283-0059-00			CAP.,FXD,CER DI:1UF,+80-20%,25V	72982	8141N037Z5U0105Z
C239	283-0110-00			CAP.,FXD,CER DI:0.005UF,+80-20%,150V	56289	19C242B
C245	283-0059-00			CAP.,FXD,CER DI:1UF,+80-20%,25V	72982	8141N037Z5U0105Z
C256	281-0579-00			CAP.,FXD,CER DI:21PF,5%,500V	72982	301-050C0G0210J
C261	283-0059-00			CAP.,FXD,CER DI:1UF,+80-20%,25V	72982	8141N037Z5U0105Z
C267	283-0059-00			CAP.,FXD,CER DI:1UF,+80-20%,25V	72982	8141N037Z5U0105Z
C270	283-0103-00			CAP.,FXD,CER DI:180PF,5%,500V	56289	40C638
C271	283-0088-00			CAP.,FXD,CER DI:1100PF,5%,500V	56289	20C285
C272	283-0026-00			CAP.,FXD,CER DI:0.2UF,+80-20%,25V	56289	274C3
C273	283-0051-00			CAP.,FXD,CER DI:0.0033UF,5%,100V	72982	8131N145 A 332J
C274	283-0026-00			CAP.,FXD,CER DI:0.2UF,+80-20%,25V	56289	274C3
C275	281-0097-00			CAP.,VAR,CER DI:9-35PF,200V	72982	538-006-D9-35
C276	283-0615-00			CAP.,FXD,MICA D:33PF,5%,500V	00853	D155E330J0
C341	281-0523-00			CAP.,FXD,CER DI:100PF,+/-20PF,500V	72982	301-000U2M0101M
C371	281-0580-00			CAP.,FXD,CER DI:470PF,10%,500V	04222	7001-1374
C374	281-0512-00			CAP.,FXD,CER DI:27PF,+/-2.7PF,500V	72982	308-000C0G0270K
C377	281-0518-00			CAP.,FXD,CER DI:47PF,+/-9.4PF,500V	72982	301-000U2J0470M
C378	281-0580-00			CAP.,FXD,CER DI:470PF,10%,500V	04222	7001-1374

Replaceable Electrical Parts—7S12

Ckt No.	Tektronix Part No.	Serial/Model No. Eff	Dscont	Name & Description	Mfr Code	Mfr Part Number
C381	281-0580-00			CAP.,FXD,CER DI:470PF,10%,500V	04222	7001-1374
C387	283-0103-00			CAP.,FXD,CER DI:180PF,5%,500V	56289	40C638
C388	283-0059-00			CAP.,FXD,CER DI:1UF,+80-20%,25V	72982	8141N037Z5U0105Z
C390	281-0512-00			CAP.,FXD,CER DI:27PF,+/-2.7PF,500V	72982	308-000COG0270K
C401	283-0059-00			CAP.,FXD,CER DI:1UF,+80-20%,25V	72982	8141N037Z5U0105Z
C501	281-0523-00			CAP.,FXD,CER DI:100PF,+/-20PF,500V	72982	301-000U2M0101M
C503	283-0159-00			CAP.,FXD,CER DI:18PF,5%,50V	72982	8111B065COG0180J
C505	283-0072-01			CAP.,FXD,CER DI:0.01UF,+80-20%,200V	51642	S-300-200Z5V103M
C507	283-0159-00	B010100	B129999	CAP.,FXD,CER DI:18PF,5%,50V	72982	8111B065COG0180J
C507	283-0168-00	B130000		CAP.,FXD,CER DI:12PF,5%,100V	72982	8111-100COG0120J
C508	283-0065-00			CAP.,FXD,CER DI:0.001UF,5%,100V	72982	805-505B102J
C509	283-0054-00	B020150	B089999X	CAP.,FXD,CER DI:150PF,(NOM VALUE),SEL	72982	855-535U2J151J
C511	283-0116-00			CAP.,FXD,CER DI:820PF,5%,500V	72982	801-547B821J
C512	283-0142-00			CAP.,FXD,CER DI:0.0027UF,5%,200V	72982	875-551B272J
C520	283-0639-00			CAP.,FXD,MICA D:56PF,1%,100V	00853	D151E560F0
C524	283-0072-01			CAP.,FXD,CER DI:0.01UF,+80-20%,200V	51642	S-300-200Z5V103M
C525	295-0141-00			CAP.,MATCHED:0.0099UF	80009	295-0141-00
C526				900PF		
C534	283-0111-00			CAP.,FXD,CER DI:0.1UF,20%,50V	72982	8121-N088Z5U104M
C535	281-0092-00			CAP.,VAR,CER DI:9-35PF,200V	72982	538-011 D9-35
C540	283-0111-00	B010100	B129999	CAP.,FXD,CER DI:0.1UF,20%,50V	72982	8121-N088Z5U104M
C540	283-0010-00	B130000		CAP.,FXD,CER DI:0.05UF,+100-20%,50V	56289	273C20
C543	283-0065-00			CAP.,FXD,CER DI:0.001UF,5%,100V	72982	805-505B102J
C546	283-0032-00	XB120000		CAP.,FXD,CER DI:470PF,5%,500V	72982	831-500Z5D471J
C547	283-0028-00	B020150	B089999X	CAP.,FXD,CER DI:0.0022UF,20%,50V	56289	19C606
C552	283-0159-00	B010100	B100473	CAP.,FXD,CER DI:18PF,5%,50V	72982	8111B065COG0180J
C552	283-0175-00	B100474		CAP.,FXD,CER DI:10PF,5%,200V	72982	8101-200COG0100J
C554	283-0114-00			CAP.,FXD,CER DI:0.0015UF,5%,200V	72982	805-509B152J
C564	281-0525-00			CAP.,FXD,CER DI:470PF,+/-94PF,500V	04222	7001-1364
C574	281-0501-00			CAP.,FXD,CER DI:4.7PF,+/-1PF,500V	72982	301-000S2H0479F
C575	281-0523-00			CAP.,FXD,CER DI:100PF,+/-20PF,500V	72982	301-000U2M0101M
C576	281-0523-00			CAP.,FXD,CER DI:100PF,+/-20PF,500V	72982	301-000U2M0101M
C578	281-0504-00	B020150	B110539X	CAP.,FXD,CER DI:10PF,+/-1PF,500V	72982	301-055COG0100F
C582	281-0605-00			CAP.,FXD,CER DI:200PF,10%,500V	04222	7001-1375
C586	283-0072-01			CAP.,FXD,CER DI:0.01UF,+80-20%,200V	51642	S-300-200Z5V103M
C592	283-0078-00			CAP.,FXD,CER DI:0.001UF,20%,500V	56289	20C114A8
C604	283-0078-00			CAP.,FXD,CER DI:0.001UF,20%,500V	56289	20C114A8
C608	283-0111-00			CAP.,FXD,CER DI:0.1UF,20%,50V	72982	8121-N088Z5U104M
C613	283-0111-00			CAP.,FXD,CER DI:0.1UF,20%,50V	72982	8121-N088Z5U104M
C620	290-0267-00			CAP.,FXD,ELCTLT:1UF,20%,35V	56289	162D105X0035CD2
C621	290-0301-00			CAP.,FXD,ELCTLT:10UF,10%,20V	56289	150D106X9020B2
C624	283-0004-00	B020150	B099999	CAP.,FXD,CER DI:0.02UF,+80-20%,150V	72982	855-558-Z5V0203Z
C624	283-0208-00	B100000		CAP.,FXD,CER DI:0.22UF,10%,200V	72982	8151N230 C 224K
C628	283-0059-00			CAP.,FXD,CER DI:1UF,+80-20%,25V	72982	8141N037Z5U0105Z
C651	283-0059-00			CAP.,FXD,CER DI:1UF,+80-20%,25V	72982	8141N037Z5U0105Z
C652	283-0078-00			CAP.,FXD,CER DI:0.001UF,20%,500V	56289	20C114A8
C657	283-0078-00			CAP.,FXD,CER DI:0.001UF,20%,500V	56289	20C114A8
C673	283-0111-00			CAP.,FXD,CER DI:0.1UF,20%,50V	72982	8121-N088Z5U104M
C678	283-0111-00			CAP.,FXD,CER DI:0.1UF,20%,50V	72982	8121-N088Z5U104M
C680	283-0111-00			CAP.,FXD,CER DI:0.1UF,20%,50V	72982	8121-N088Z5U104M
C681	283-0111-00			CAP.,FXD,CER DI:0.1UF,20%,50V	72982	8121-N088Z5U104M
C685	283-0003-00			CAP.,FXD,CER DI:0.01UF,+80-20%,150V	72982	855-558Z5U-103Z
C686	283-0111-00	B020150	B129999	CAP.,FXD,CER DI:0.1UF,20%,50V	72982	8121-N088Z5U104M

Ckt No.	Tektronix Part No.	Serial/Model No. Eff	Dscont	Name & Description	Mfr Code	Mfr Part Number
C686	283-0212-00	B130000		CAP.,FXD,CER DI:2UF,20%,50V	72982	8141N064Z5U205M
C692	283-0067-00	XB090000		CAP.,FXD,CER DI:0.001UF,10%,200V	72982	835-515B102K
C801	283-0004-00			CAP.,FXD,CER DI:0.02UF,+80-20%,150V	72982	855-558-Z5V0203Z
C802	283-0059-00			CAP.,FXD,CER DI:1UF,+80-20%,25V	72982	8141N037Z5U0105Z
C803	290-0134-00			CAP.,FXD,ELCTLT:22UF,20%,15V	56289	150D226X0015B2
C804	290-0134-00			CAP.,FXD,ELCTLT:22UF,20%,15V	56289	150D226X0015B2
C805	283-0059-00			CAP.,FXD,CER DI:1UF,+80-20%,25V	72982	8141N037Z5U0105Z
C806	283-0059-00			CAP.,FXD,CER DI:1UF,+80-20%,25V	72982	8141N037Z5U0105Z
C807	290-0134-00			CAP.,FXD,ELCTLT:22UF,20%,15V	56289	150D226X0015B2
C808	290-0134-00			CAP.,FXD,ELCTLT:22UF,20%,15V	56289	150D226X0015B2
C809	283-0059-00			CAP.,FXD,CER DI:1UF,+80-20%,25V	72982	8141N037Z5U0105Z
C810	283-0026-00			CAP.,FXD,CER DI:0.2UF,+80-20%,25V	56289	274C3
C821	283-0059-00			CAP.,FXD,CER DI:1UF,+80-20%,25V	72982	8141N037Z5U0105Z
C829	283-0059-00			CAP.,FXD,CER DI:1UF,+80-20%,25V	72982	8141N037Z5U0105Z
C830	290-0134-00			CAP.,FXD,ELCTLT:22UF,20%,15V	56289	150D226X0015B2
C831	290-0134-00			CAP.,FXD,ELCTLT:22UF,20%,15V	56289	150D226X0015B2
C832	283-0010-00	XB040000		CAP.,FXD,CER DI:0.05UF,+100-20%,50V	56289	273C20
C834	290-0327-00			CAP.,FXD,ELCTLT:0.56UF,20%,100V	56289	150D564X0100A2
C835	290-0134-00			CAP.,FXD,ELCTLT:22UF,20%,15V	56289	150D226X0015B2
C836	290-0134-00			CAP.,FXD,ELCTLT:22UF,20%,15V	56289	150D226X0015B2
C839	290-0327-00			CAP.,FXD,ELCTLT:0.56UF,20%,100V	56289	150D564X0100A2
C850	290-0135-00			CAP.,FXD,ELCTLT:15UF,20%,20V	56289	150D156X0020B2
C852	290-0135-00			CAP.,FXD,ELCTLT:15UF,20%,20V	56289	150D156X0020B2
C864	290-0134-00			CAP.,FXD,ELCTLT:22UF,20%,15V	56289	150D226X0015B2
C865	283-0065-00	XB090000		CAP.,FXD,CER DI:0.001UF,5%,100V	72982	805-505P102J
C866	290-0134-00			CAP.,FXD,ELCTLT:22UF,20%,15V	56289	150D226X0015B2
C870	290-0135-00			CAP.,FXD,ELCTLT:15UF,20%,20V	56289	150D156X0020B2
C872	290-0135-00			CAP.,FXD,ELCTLT:15UF,20%,20V	56289	150D156X0020B2
C914	283-0150-00			CAP.,FXD,CER DI:650PF,5%,200V	72982	835-515P651J
C930	283-0116-00			CAP.,FXD,CER DI:820PF,5%,500V	72982	801-547R821J
C936	281-0504-00			CAP.,FXD,CER DI:10PF,+/-1PF,500V	72982	301-055C0G0100F
C952	283-0078-00			CAP.,FXD,CER DI:0.001UF,20%,500V	56289	20C114A8
C953	283-0004-00			CAP.,FXD,CER DI:0.02UF,+80-20%,150V	72982	855-558-Z5V0203Z
CR128	152-0141-02			SEMICONV DEVICE:SILICON,30V,150MA	07910	1N4152
CR201	152-0141-02			SEMICONV DEVICE:SILICON,30V,150MA	07910	1N4152
CR206	152-0141-02			SEMICONV DEVICE:SILICON,30V,150MA	07910	1N4152
CR224	152-0141-02			SEMICONV DEVICE:SILICON,30V,150MA	07910	1N4152
CR226	152-0141-02			SEMICONV DEVICE:SILICON,30V,150MA	07910	1N4152
CR232	152-0141-02			SEMICONV DEVICE:SILICON,30V,150MA	07910	1N4152
CR236	152-0141-02			SEMICONV DEVICE:SILICON,30V,150MA	07910	1N4152
CR237	152-0323-00			SEMICONV DEVICE:SILICON,35V,100MA	80009	152-0323-00
CR238	152-0141-02			SEMICONV DEVICE:SILICON,30V,150MA	07910	1N4152
CR239	152-0323-00			SEMICONV DEVICE:SILICON,35V,100MA	80009	152-0323-00
CR242	152-0141-02			SEMICONV DEVICE:SILICON,30V,150MA	07910	1N4152
CR257	152-0141-02			SEMICONV DEVICE:SILICON,30V,150MA	07910	1N4152
CR259	152-0141-02			SEMICONV DEVICE:SILICON,30V,150MA	07910	1N4152
CR272	152-0323-00			SEMICONV DEVICE:SILICON,35V,100MA	80009	152-0323-00
CR274	152-0323-00			SEMICONV DEVICE:SILICON,35V,100MA	80009	152-0323-00
CR314	152-0141-02			SEMICONV DEVICE:SILICON,30V,150MA	07910	1N4152
CR370	152-0141-02			SEMICONV DEVICE:SILICON,30V,150MA	07910	1N4152
CR374	152-0141-02			SEMICONV DEVICE:SILICON,30V,150MA	07910	1N4152
CR378	152-0141-02			SEMICONV DEVICE:SILICON,30V,150MA	07910	1N4152
CR385	152-0141-02			SEMICONV DEVICE:SILICON,30V,150MA	07910	1N4152

Replaceable Electrical Parts—7S12

Ckt No.	Tektronix Part No.	Serial/Model No. Eff	Dscont	Name & Description	Mfr Code	Mfr Part Number
CR392	152-0141-02			SEMICON D DEVICE:SILICON,30V,150MA	07910	1N4152
CR394	152-0141-02			SEMICON D DEVICE:SILICON,30V,150MA	07910	1N4152
CR406	152-0141-02			SEMICON D DEVICE:SILICON,30V,150MA	07910	1N4152
CR418	152-0141-02			SEMICON D DEVICE:SILICON,30V,150MA	07910	1N4152
CR422	152-0141-02			SEMICON D DEVICE:SILICON,30V,150MA	07910	1N4152
CR423	152-0141-02			SEMICON D DEVICE:SILICON,30V,150MA	07910	1N4152
CR424	152-0141-02			SEMICON D DEVICE:SILICON,30V,150MA	07910	1N4152
CR425	152-0141-02			SEMICON D DEVICE:SILICON,30V,150MA	07910	1N4152
CR429	152-0141-02			SEMICON D DEVICE:SILICON,30V,150MA	07910	1N4152
CR505	152-0141-02			SEMICON D DEVICE:SILICON,30V,150MA	07910	1N4152
CR510	152-0141-02			SEMICON D DEVICE:SILICON,30V,150MA	07910	1N4152
CR512	152-0141-02			SEMICON D DEVICE:SILICON,30V,150MA	07910	1N4152
CR518	152-0322-00	B020150	B099999X	SEMICON D DEVICE:SILICON,15V,HOT CARRIER	28480	5082-2672
CR519	152-0322-00	B020150	B099999X	SEMICON D DEVICE:SILICON,15V,HOT CARRIER	28480	5082-2672
CR520	152-0141-02	XB090000		SEMICON D DEVICE:SILICON,30V,150MA	07910	1N4152
CR532	152-0141-02			SEMICON D DEVICE:SILICON,30V,150MA	07910	1N4152
CR534	152-0141-02			SEMICON D DEVICE:SILICON,30V,150MA	07910	1N4152
CR538	152-0153-00	B020150	B079999	SEMICON D DEVICE:SILICON,15V,50MA	80009	152-0153-00
CR538	152-0153-01	B080000	B110539	SEMICON D DEVICE:SILICON,15V,100MA	80009	152-0153-01
CR538	152-0322-00	B110540		SEMICON D DEVICE:SILICON,15V,HOT CARRIER	28480	5082-2672
CR539	152-0153-00	B020150	B079999	SEMICON D DEVICE:SILICON,15V,50MA	80009	152-0153-00
CR539	152-0153-01	B080000	B110539	SEMICON D DEVICE:SILICON,15V,100MA	80009	152-0153-01
CR539	152-0322-00	B110540		SEMICON D DEVICE:SILICON,15V,HOT CARRIER	28480	5082-2672
CR540	152-0141-02	XB090000		SEMICON D DEVICE:SILICON,30V,150MA	07910	1N4152
CR543	152-0141-02			SEMICON D DEVICE:SILICON,30V,150MA	07910	1N4152
CR554	152-0141-02			SEMICON D DEVICE:SILICON,30V,150MA	07910	1N4152
CR576	152-0141-02			SEMICON D DEVICE:SILICON,30V,150MA	07910	1N4152
CR604	152-0141-02			SEMICON D DEVICE:SILICON,30V,150MA	07910	1N4152
CR606	152-0141-02			SEMICON D DEVICE:SILICON,30V,150MA	07910	1N4152
CR610	152-0141-02			SEMICON D DEVICE:SILICON,30V,150MA	07910	1N4152
CR619	152-0141-02			SEMICON D DEVICE:SILICON,30V,150MA	07910	1N4152
CR620	152-0141-02			SEMICON D DEVICE:SILICON,30V,150MA	07910	1N4152
CR623	152-0141-02			SEMICON D DEVICE:SILICON,30V,150MA	07910	1N4152
CR628	152-0141-02			SEMICON D DEVICE:SILICON,30V,150MA	07910	1N4152
CR629	152-0141-02			SEMICON D DEVICE:SILICON,30V,150MA	07910	1N4152
CR631	152-0141-02			SEMICON D DEVICE:SILICON,30V,150MA	07910	1N4152
CR632	152-0141-02			SEMICON D DEVICE:SILICON,30V,150MA	07910	1N4152
CR637	152-0141-02			SEMICON D DEVICE:SILICON,30V,150MA	07910	1N4152
CR639	152-0141-02			SEMICON D DEVICE:SILICON,30V,150MA	07910	1N4152
CR640	152-0141-02	XB080000		SEMICON D DEVICE:SILICON,30V,150MA	07910	1N4152
CR681	152-0141-02			SEMICON D DEVICE:SILICON,30V,150MA	07910	1N4152
CR686	152-0141-02			SEMICON D DEVICE:SILICON,30V,150MA	07910	1N4152
CR687	152-0141-02	B020150	B099999X	SEMICON D DEVICE:SILICON,30V,150MA	07910	1N4152
CR689	152-0233-00	XB090000		SEMICON D DEVICE:SILICON,85V,100MA	80009	152-0233-00
CR692	152-0141-02	XB100000		SEMICON D DEVICE:SILICON,30V,150MA	07910	1N4152
CR769	152-0141-02			SEMICON D DEVICE:SILICON,30V,150MA	07910	1N4152
CR771	152-0141-02			SEMICON D DEVICE:SILICON,30V,150MA	07910	1N4152
CR772	152-0141-02			SEMICON D DEVICE:SILICON,30V,150MA	07910	1N4152
CR773	152-0141-02			SEMICON D DEVICE:SILICON,30V,150MA	07910	1N4152
CR775	152-0141-02			SEMICON D DEVICE:SILICON,30V,150MA	07910	1N4152
CR824	152-0141-02			SEMICON D DEVICE:SILICON,30V,150MA	07910	1N4152
CR825	152-0141-02			SEMICON D DEVICE:SILICON,30V,150MA	07910	1N4152
CR901	152-0141-02			SEMICON D DEVICE:SILICON,30V,150MA	07910	1N4152

Ckt No.	Tektronix Part No.	Serial/Model No. Eff	Dscont	Name & Description	Mfr Code	Mfr Part Number
CR902	152-0141-02			SEMICON D DEVICE:SILICON,30V,150MA	07910	1N4152
CR903	152-0141-02			SEMICON D DEVICE:SILICON,30V,150MA	07910	1N4152
CR907	152-0141-02			SEMICON D DEVICE:SILICON,30V,150MA	07910	1N4152
CR916	152-0141-02			SEMICON D DEVICE:SILICON,30V,150MA	07910	1N4152
CR921	152-0141-02			SEMICON D DEVICE:SILICON,30V,150MA	07910	1N4152
CR925	152-0141-02			SEMICON D DEVICE:SILICON,30V,150MA	07910	1N4152
CR926	152-0141-02			SEMICON D DEVICE:SILICON,30V,150MA	07910	1N4152
CR932	152-0141-02			SEMICON D DEVICE:SILICON,30V,150MA	07910	1N4152
CR936	152-0141-02			SEMICON D DEVICE:SILICON,30V,150MA	07910	1N4152
DS304	150-0048-01			LAMP, INCAND:5V,0.06A,SEL	08806	683AS15
DS630	150-0102-01			LAMP, INCAND:5V,0.06A	80009	150-0102-01
DS632	150-0102-01			LAMP, INCAND:5V,0.06A	80009	150-0102-01
DS640	150-0048-01			LAMP, INCAND:5V,0.06A,SEL	08806	683AS15
J1	131-0990-00			CONNECTOR, RCPT, :	05574	2VH36/1AV3
J2	131-0990-00			CONNECTOR, RCPT, :	05574	2VH36/1AV3
J3	131-0990-00			CONNECTOR, RCPT, :	05574	2VH36/1AV3
J4	131-0990-00			CONNECTOR, RCPT, :	05574	2VH36/1AV3
J101	131-0410-00			CONNECTOR, RCPT:	000AL	OBD
J120	131-0581-00			CONNECTOR, RCPT, :12 FEMALE CONTACTS	05574	2VK6D2/1-2
J166	131-0779-00			JACK, TIP:FOR 0.08 INCH DIA TEST POINT	98291	016-8010-8
J269	131-0779-00			JACK, TIP:FOR 0.08 INCH DIA TEST POINT	98291	016-8010-8
J500	131-0410-00			CONNECTOR, RCPT:	000AL	OBD
J501	131-0391-00			CONNECTOR, RCPT, :50 OHM, COAX, SNAP-ON MALE	98291	51-051-0049
J520	131-0581-00			CONNECTOR, RCPT, :12 FEMALE CONTACTS	05574	2VK6D2/1-2
J601	131-0779-00			JACK, TIP:FOR 0.08 INCH DIA TEST POINT	98291	016-8010-8
J640	131-0779-00			JACK, TIP:FOR 0.08 INCH DIA TEST POINT	98291	016-8010-8
L268	120-0402-00			XFMR, TOROID:3 TURNS SINGLE	80009	120-0402-00
L427	108-0440-00	XB090000		COIL, RF:8UH, TOROIDAL INDUCTOR	80009	108-0440-00
L437	108-0440-00	XB090000		COIL, RF:8UH, TOROIDAL INDUCTOR	80009	108-0440-00
L693	120-0382-00	XB090000		XFMR, TOROID:14 TURNS, SINGLE	80009	120-0382-00
L803	120-0382-00			XFMR, TOROID:14 TURNS, SINGLE	80009	120-0382-00
L804	120-0382-00			XFMR, TOROID:14 TURNS, SINGLE	80009	120-0382-00
L807	120-0382-00			XFMR, TOROID:14 TURNS, SINGLE	80009	120-0382-00
L808	120-0382-00			XFMR, TOROID:14 TURNS, SINGLE	80009	120-0382-00
L829	120-0382-00			XFMR, TOROID:14 TURNS, SINGLE	80009	120-0382-00
L831	120-0382-00			XFMR, TOROID:14 TURNS, SINGLE	80009	120-0382-00
L835	120-0382-00			XFMR, TOROID:14 TURNS, SINGLE	80009	120-0382-00
L837	120-0382-00			XFMR, TOROID:14 TURNS, SINGLE	80009	120-0382-00
L839	120-0382-00			XFMR, TOROID:14 TURNS, SINGLE	80009	120-0382-00
L850	120-0382-00			XFMR, TOROID:14 TURNS, SINGLE	80009	120-0382-00
L852	120-0382-00			XFMR, TOROID:14 TURNS, SINGLE	80009	120-0382-00
L854	108-0440-00	XB090000		COIL, RF:8UH, TOROIDAL INDUCTOR	80009	108-0440-00
L856	108-0440-00	XB090000		COIL, RF:8UH, TOROIDAL INDUCTOR	80009	108-0440-00
L862	120-0382-00			XFMR, TOROID:14 TURNS, SINGLE	80009	120-0382-00
L870	120-0382-00			XFMR, TOROID:14 TURNS, SINGLE	80009	120-0382-00
L872	120-0382-00			XFMR, TOROID:14 TURNS, SINGLE	80009	120-0382-00
P501	131-0375-00			CONNECTOR, PLUG, :RIGHT ANGLE	98291	051-028-0079-220
Q123	151-0192-00			TRANSISTOR:SILICON,NPN,SEL FROM MPS6521	80009	151-0192-00
Q128	151-0188-00			TRANSISTOR:SILICON,PNP	01295	2N3906
Q133	151-0190-01			TRANSISTOR:SILICON,NPN	80009	151-0190-01
Q136	151-0188-00			TRANSISTOR:SILICON,PNP	01295	2N3906
Q163	151-0190-01			TRANSISTOR:SILICON,NPN	80009	151-0190-01

**Replaceable Electrical Parts—7S12**

Ckt No.	Tektronix Part No.	Serial/Model No. Eff	Dscont	Name & Description	Mfr Code	Mfr Part Number
Q204	151-0190-01			TRANSISTOR:SILICON,NPN	80009	151-0190-01
Q208	151-0190-01			TRANSISTOR:SILICON,NPN	80009	151-0190-01
Q212	151-0190-01			TRANSISTOR:SILICON,NPN	80009	151-0190-01
Q214	151-0188-00			TRANSISTOR:SILICON,PNP	01295	2N3906
Q242	151-1007-00			TRANSISTOR:SILICON,FET,N-CHANNEL	80009	151-1007-00
Q252	151-0261-00			TRANSISTOR:SILICON,PNP,DUAL	80009	151-0261-00
Q256	151-0188-00			TRANSISTOR:SILICON,PNP	01295	2N3906
Q262	151-0190-01			TRANSISTOR:SILICON,NPN	80009	151-0190-01
Q266	151-0188-00			TRANSISTOR:SILICON,PNP	01295	2N3906
Q314	151-0192-00			TRANSISTOR:SILICON,NPN,SEL FROM MPS6521	80009	151-0192-00
Q334	151-0192-00			TRANSISTOR:SILICON,NPN,SEL FROM MPS6521	80009	151-0192-00
Q344	151-0216-00			TRANSISTOR:SILICON,PNP	04713	SPS8803
Q354	151-0216-00			TRANSISTOR:SILICON,PNP	04713	SPS8803
Q362	151-0216-00			TRANSISTOR:SILICON,PNP	04713	SPS8803
Q366	151-0216-00			TRANSISTOR:SILICON,PNP	04713	SPS8803
Q370	151-0225-00			TRANSISTOR:SILICON,NPN	01295	TIS62A
Q382	151-0188-00			TRANSISTOR:SILICON,PNP	01295	2N3906
Q386	151-0190-01			TRANSISTOR:SILICON,NPN	80009	151-0190-01
Q394	151-0188-00			TRANSISTOR:SILICON,PNP	01295	2N3906
Q402	151-0188-00			TRANSISTOR:SILICON,PNP	01295	2N3906
Q406	151-0190-01			TRANSISTOR:SILICON,NPN	80009	151-0190-01
Q408	151-0188-00			TRANSISTOR:SILICON,PNP	01295	2N3906
Q412	151-0188-00			TRANSISTOR:SILICON,PNP	01295	2N3906
Q416	151-0254-00			TRANSISTOR:SILICON,NPN	80009	151-0254-00
Q417	151-0190-01			TRANSISTOR:SILICON,NPN	80009	151-0190-01
Q418	151-0190-01			TRANSISTOR:SILICON,NPN	80009	151-0190-01
Q504	151-0188-00			TRANSISTOR:SILICON,PNP	01295	2N3906
Q506	151-0190-01			TRANSISTOR:SILICON,NPN	80009	151-0190-01
Q508	151-0225-00			TRANSISTOR:SILICON,NPN	01295	TIS62A
Q510	151-0188-00			TRANSISTOR:SILICON,PNP	01295	2N3906
Q514	151-0190-01			TRANSISTOR:SILICON,NPN	80009	151-0190-01
Q516	151-0190-01			TRANSISTOR:SILICON,NPN	80009	151-0190-01
Q518	151-0221-00	B020150	B099999	TRANSISTOR:SILICON,PNP	80009	151-0221-00
Q518	151-0325-00	B100000		TRANSISTOR:SILICON,PNP,SEL FROM 2N4258	80009	151-0325-00
Q520	151-0221-00	B020150	B099999	TRANSISTOR:SILICON,PNP	80009	151-0221-00
Q520	151-0325-00	B100000		TRANSISTOR:SILICON,PNP,SEL FROM 2N4258	80009	151-0325-00
Q522	151-0225-00	B020150	B099999	TRANSISTOR:SILICON,NPN	01295	TIS62A
Q522	151-0441-00	B100000		TRANSISTOR:SILICON,NPN	80009	151-0441-00
Q532	151-0192-00			TRANSISTOR:SILICON,NPN,SEL FROM MPS6521	80009	151-0192-00
Q534	151-0192-00			TRANSISTOR:SILICON,NPN,SEL FROM MPS6521	80009	151-0192-00
Q538	151-0192-00			TRANSISTOR:SILICON,NPN,SEL FROM MPS6521	80009	151-0192-00
Q540	151-0192-00			TRANSISTOR:SILICON,NPN,SEL FROM MPS6521	80009	151-0192-00
Q542	151-0190-01			TRANSISTOR:SILICON,NPN	80009	151-0190-01
Q546	151-0188-00	B020150	B089999	TRANSISTOR:SILICON,PNP	01295	2N3906
Q546	151-0301-00	B090000		TRANSISTOR:SILICON,PNP	04713	2N2907A
Q552	151-0271-00			TRANSISTOR:SILICON,PNP	80009	151-0271-00
Q556	151-0269-00	B020150	B079999	TRANSISTOR:SILICON,NPN,SEL FROM SE3005	80009	151-0269-00
Q556	151-0441-01	B080000		TRANSISTOR:SILICON,NPN	80009	151-0441-01
Q566	151-0220-00	B020150	B099999	TRANSISTOR:SILICON,PNP	80009	151-0220-00
Q566	151-0325-00	B100000		TRANSISTOR:SILICON,PNP,SEL FROM 2N4258	80009	151-0325-00
Q568	151-0220-00	B020150	B099999	TRANSISTOR:SILICON,PNP	80009	151-0220-00
Q568	151-0325-00	B100000		TRANSISTOR:SILICON,PNP,SEL FROM 2N4258	80009	151-0325-00
Q574	151-0190-01			TRANSISTOR:SILICON,NPN	80009	151-0190-01

Ckt No.	Tektronix Part No.	Serial/Model No. Eff	Dscont	Name & Description	Mfr Code	Mfr Part Number
Q576	151-0188-00			TRANSISTOR:SILICON,PNP	01295	2N3906
Q580	151-0188-00			TRANSISTOR:SILICON,PNP	01295	2N3906
Q610	151-0164-00			TRANSISTOR:SILICON,PNP	80009	151-0164-00
Q614	151-0190-01			TRANSISTOR:SILICON,NPN	80009	151-0190-01
Q620	151-1021-00			TRANSISTOR:SILICON,JFE	80009	151-1021-00
Q624	151-0219-00			TRANSISTOR:SILICON,PNP	80009	151-0219-00
Q626	151-0220-00			TRANSISTOR:SILICON,PNP	80009	151-0220-00
Q634	151-0188-00			TRANSISTOR:SILICON,PNP	01295	2N3906
Q636	151-0188-00			TRANSISTOR:SILICON,PNP	01295	2N3906
Q638	151-0190-01			TRANSISTOR:SILICON,NPN	80009	151-0190-01
Q640	151-1025-00			TRANSISTOR:SILICON,JFE,N-CHANNEL	80009	151-1025-00
Q645	151-0188-00			TRANSISTOR:SILICON,PNP	01295	2N3906
Q646	151-0302-00	XB080000		TRANSISTOR:SILICON,NPN	04713	2N2222A
Q650	151-0164-00			TRANSISTOR:SILICON,PNP	80009	151-0164-00
Q660	151-0224-00			TRANSISTOR:SILICON,NPN	07263	2N3904
Q661	151-0188-00			TRANSISTOR:SILICON,PNP	01295	2N3906
Q662	151-0188-00			TRANSISTOR:SILICON,PNP	01295	2N3906
Q680	151-0164-00			TRANSISTOR:SILICON,PNP	80009	151-0164-00
Q682	151-0224-00			TRANSISTOR:SILICON,NPN	07263	2N3904
Q686	151-0164-00			TRANSISTOR:SILICON,PNP	80009	151-0164-00
Q690	151-0190-01			TRANSISTOR:SILICON,NPN	80009	151-0190-01
Q692	151-0190-00	XB090000		TRANSISTOR:SILICON,NPN	80009	151-0190-00
Q694	151-0301-00	XB100000		TRANSISTOR:SILICON,PNP	04713	2N2907A
Q695	151-0188-00			TRANSISTOR:SILICON,PNP	01295	2N3906
Q824A,B	151-0261-00			TRANSISTOR:SILICON,PNP,DUAL	80009	151-0261-00
Q826	151-0134-00			TRANSISTOR:SILICON,PNP	80009	151-0134-00
Q850	151-0188-00	XB060000		TRANSISTOR:SILICON,PNP	01295	2N3906
Q903	151-0190-01			TRANSISTOR:SILICON,NPN	80009	151-0190-01
Q906	151-0188-00			TRANSISTOR:SILICON,PNP	01295	2N3906
Q914	151-0190-01			TRANSISTOR:SILICON,NPN	80009	151-0190-01
Q925	151-1025-00			TRANSISTOR:SILICON,JFE,N-CHANNEL	80009	151-1025-00
Q930	151-0188-00			TRANSISTOR:SILICON,PNP	01295	2N3906
Q932	151-0188-00			TRANSISTOR:SILICON,PNP	01295	2N3906
Q936	151-1021-00			TRANSISTOR:SILICON,JFE	80009	151-1021-00
Q940A,B	151-1007-00			TRANSISTOR:SILICON,FET,N-CHANNEL	80009	151-1007-00
Q954	151-1025-00			TRANSISTOR:SILICON,JFE,N-CHANNEL	80009	151-1025-00
Q960	151-1025-00			TRANSISTOR:SILICON,JFE,N-CHANNEL	80009	151-1025-00
R101	317-0510-00			RES.,FXD,CMPSN:51 OHM,5%,0.125W	01121	BB5105
R121	321-0093-00			RES.,FXD,FILM:90.9 OHM,1%,0.125W	91637	MFF1816G9090F
R123	315-0183-00			RES.,FXD,CMPSN:18K OHM,5%,0.25W	01121	CB1835
R125	315-0752-00			RES.,FXD,CMPSN:7.5K OHM,5%,0.25W	01121	CB7525
R127	321-0154-00			RES.,FXD,FILM:392 OHM,1%,0.125W	91637	MFF1816G392R0F
R129	315-0512-00			RES.,FXD,CMPSN:5.1K OHM,5%,0.25W	01121	CB5125
R130	315-0101-00			RES.,FXD,CMPSN:100 OHM,5%,0.25W	01121	CB1015
R133	315-0101-00			RES.,FXD,CMPSN:100 OHM,5%,0.25W	01121	CB1015
R134	315-0153-00			RES.,FXD,CMPSN:15K OHM,5%,0.25W	01121	CB1535
R135	315-0153-00			RES.,FXD,CMPSN:15K OHM,5%,0.25W	01121	CB1535
R136	315-0101-00			RES.,FXD,CMPSN:100 OHM,5%,0.25W	01121	CB1015
R137	315-0101-00			RES.,FXD,CMPSN:100 OHM,5%,0.25W	01121	CB1015
R138	321-0263-00			RES.,FXD,FILM:5.36K OHM,1%,0.125W	91637	MFF1816G53600F
R145A	321-0193-00			RES.,FXD,FILM:1K OHM,1%,0.125W	91637	MFF1816G10000F
R145B	321-0231-00			RES.,FXD,FILM:2.49K OHM,1%,0.125W	91637	MFF1816G24900F

Replaceable Electrical Parts—7S12

Ckt No.	Tektronix Part No.	Serial/Model No. Eff	Dscont	Name & Description	Mfr Code	Mfr Part Number
R145C	321-0260-00			RES.,FXD,FILM:4.99K OHM,1%,0.125W	91637	MFF1816G49900F
R145D	321-0289-00			RES.,FXD,FILM:10K OHM,1%,0.125W	91637	MFF1816G10001F
R145E	321-0327-00			RES.,FXD,FILM:24.9K OHM,1%,0.125W	91637	MFF1816G24901F
R145F	321-0356-00			RES.,FXD,FILM:49.9K OHM,1%,0.125W	91637	MFF1816G49901F
R145G	321-0385-00			RES.,FXD,FILM:100K OHM,1%,0.125W	91637	MFF1816G10002F
R145H	321-0423-00			RES.,FXD,FILM:249K OHM,1%,0.125W	91637	MFF1816G24902F
R147A	321-0314-01			RES.,FXD,FILM:18.2K OHM,0.5%,0.125W	91637	MFF1816G18201D
R147B	321-0905-01			RES.,FXD,FILM:121.4K OHM,0.5%,0.125W	91637	MFF1816G12142D
R147C	321-0898-01			RES.,FXD,FILM:466K OHM,0.5%,0.125W	91637	MFF1816G46602D
R147D	321-0899-01			RES.,FXD,FILM:233.2K OHM,0.5%,0.125W	91637	MFF1816G23322D
R147E	321-1391-01			RES.,FXD,FILM:117K OHM,0.5%,0.125W	91637	MFF1816G11702D
R147F	321-0904-01			RES.,FXD,FILM:46.6K OHM,0.5%,0.125W	91637	MFF1816G46601D
R147G	321-0903-01			RES.,FXD,FILM:23.32K OHM,0.5%,0.125W	91637	MFF1816G23321D
R147H	321-1295-01			RES.,FXD,FILM:11.7K OHM,0.5%,0.125W	91637	MFF1816G11701D
R147I	321-0902-01			RES.,FXD,FILM:4.66K OHM,0.5%,0.125W	91637	MFF1816G46600D
R149	321-0225-01			RES.,FXD,FILM:2.15K OHM,0.5%,0.125W	91637	MFF1816G21500D
R151A,B	311-0965-00			RES.,VAR,NONWIR:2 X 10K OHM,10W	80009	311-0965-00
R153	315-0303-00			RES.,FXD,CMPSN:30K OHM,5%,0.25W	01121	CB3035
R154	315-0303-00			RES.,FXD,CMPSN:30K OHM,5%,0.25W	01121	CB3035
R156	315-0471-00			RES.,FXD,CMPSN:470 OHM,5%,0.25W	01121	CB4715
R158	315-0621-00			RES.,FXD,CMPSN:620 OHM,5%,0.25W	01121	CB6215
R162	315-0101-00			RES.,FXD,CMPSN:100 OHM,5%,0.25W	01121	CB1015
R163	301-0123-00			RES.,FXD,CMPSN:12K OHM,5%,0.50W	01121	EB1235
R166	321-0289-00			RES.,FXD,FILM:10K OHM,1%,0.125W	91637	MFF1816G10001F
R202	321-0420-00			RES.,FXD,FILM:232K OHM,1%,0.125W	91637	MFF1816G23202F
R204	315-0183-00			RES.,FXD,CMPSN:18K OHM,5%,0.25W	01121	CB1835
R206	315-0122-00			RES.,FXD,CMPSN:1.2K OHM,5%,0.25W	01121	CB1225
R207	315-0101-00			RES.,FXD,CMPSN:100 OHM,5%,0.25W	01121	CB1015
R208	315-0752-00			RES.,FXD,CMPSN:7.5K OHM,5%,0.25W	01121	CB7525
R209	321-0335-00			RES.,FXD,FILM:30.1K OHM,1%,0.125W	91637	MFF1816G30101F
R211	315-0101-00			RES.,FXD,CMPSN:100 OHM,5%,0.25W	01121	CB1015
R212	315-0220-00			RES.,FXD,CMPSN:22 OHM,5%,0.25W	01121	CB2205
R213	315-0101-00			RES.,FXD,CMPSN:100 OHM,5%,0.25W	01121	CB1015
R214	315-0220-00			RES.,FXD,CMPSN:22 OHM,5%,0.25W	01121	CB2205
R216	315-0752-00			RES.,FXD,CMPSN:7.5K OHM,5%,0.25W	01121	CB7525
R218	315-0752-00			RES.,FXD,CMPSN:7.5K OHM,5%,0.25W	01121	CB7525
R219	315-0101-00			RES.,FXD,CMPSN:100 OHM,5%,0.25W	01121	CB1015
R221	321-0245-00			RES.,FXD,FILM:3.48K OHM,1%,0.125W	91637	MFF1816G34800F
R222	321-0245-00			RES.,FXD,FILM:3.48K OHM,1%,0.125W	91637	MFF1816G34800F
R224	321-0231-00			RES.,FXD,FILM:2.49K OHM,1%,0.125W	91637	MFF1816G24900F
R226	321-0231-00			RES.,FXD,FILM:2.49K OHM,1%,0.125W	91637	MFF1816G24900F
R229	315-0102-00			RES.,FXD,CMPSN:1K OHM,5%,0.25W	01121	CB1025
R231	315-0102-00			RES.,FXD,CMPSN:1K OHM,5%,0.25W	01121	CB1025
R234	315-0100-00			RES.,FXD,CMPSN:10 OHM,5%,0.25W	01121	CB1005
R239	315-0510-00			RES.,FXD,CMPSN:51 OHM,5%,0.25W	01121	CB5105
R242	321-0328-00			RES.,FXD,FILM:25.5K OHM,1%,0.125W	91637	MFF1816G25501F
R244	321-0254-00			RES.,FXD,FILM:4.32K OHM,1%,0.125W	91637	MFF1816G43200F
R245	311-1280-00			RES.,VAR,NONWIR:1K OHM,10%,0.50W	32997	3329W-L58-102
R246	321-0254-00			RES.,FXD,FILM:4.32K OHM,1%,0.125W	91637	MFF1816G43200F
R248	315-0475-00			RES.,FXD,CMPSN:4.7M OHM,5%,0.25W	01121	CB4755
R253	315-0101-00			RES.,FXD,CMPSN:100 OHM,5%,0.25W	01121	CB1015
R257	315-0241-00			RES.,FXD,CMPSN:240 OHM,5%,0.25W	01121	CB2415
R258	315-0241-00			RES.,FXD,CMPSN:240 OHM,5%,0.25W	01121	CB2415



Ckt No.	Tektronix Part No.	Serial/Model No. Eff	Dscont	Name & Description	Mfr Code	Mfr Part Number
R259	315-0243-00			RES.,FXD,CMPSN:24K OHM,5%,0.25W	01121	CB2435
R261	315-0101-00			RES.,FXD,CMPSN:100 OHM,5%,0.25W	01121	CB1015
R264	315-0101-00			RES.,FXD,CMPSN:100 OHM,5%,0.25W	01121	CB1015
R266	315-0101-00			RES.,FXD,CMPSN:100 OHM,5%,0.25W	01121	CB1015
R267	315-0101-00			RES.,FXD,CMPSN:100 OHM,5%,0.25W	01121	CB1015
R268	321-0900-03			RES.,FXD,FILM:61.5K OHM,0.25W,0.125W	91637	MFF1816D61501C
R269	321-0901-03			RES.,FXD,FILM:11.94K OHM,0.25%,0.125W	91637	MFF1816D11941C
R271	321-0360-00			RES.,FXD,FILM:54.9K OHM,1%,0.125W	91637	MFF1816G54901F
R272	315-0331-00			RES.,FXD,CMPSN:330 OHM,5%,0.25W	01121	CB3315
R274	315-0331-00			RES.,FXD,CMPSN:330 OHM,5%,0.25W	01121	CB3315
R275	321-0360-00			RES.,FXD,FILM:54.9K OHM,1%,0.125W	91637	MFF1816G54901F
R302	321-0270-00			RES.,FXD,FILM:6.34K OHM,1%,0.125W	91637	MFF1816G63400F
R303	315-0103-00			RES.,FXD,CMPSN:10K OHM,5%,0.25W	01121	CB1035
R304	321-0328-00			RES.,FXD,FILM:25.5K OHM,1%,0.125W	91637	MFF1816G25501F
R305	311-0329-00			RES.,VAR,NONWIR:50K OHM,20%,0.50W	01121	W7356
R308	315-0472-00			RES.,FXD,CMPSN:4.7K OHM,5%,0.25W	01121	CB4725
R311	321-0193-00			RES.,FXD,FILM:1K OHM,1%,0.125W	91637	MFF1816G10000F
R312	321-0232-00			RES.,FXD,FILM:2.55K OHM,1%,0.125W	91637	MFF1816G25500F
R313	315-0512-00			RES.,FXD,CMPSN:5.1K OHM,5%,0.25W	01121	CB5125
R314	321-0205-00			RES.,FXD,FILM:1.33K OHM,1%,0.125W	91637	MFF1816G13300F
R315	315-0102-00			RES.,FXD,CMPSN:1K OHM,5%,0.25W	01121	CB1025
R317	321-0335-00			RES.,FXD,FILM:30.1K OHM,1%,0.125W	91637	MFF1816G30101F
R320 <sup>1</sup>	311-1147-01			RES.,VAR,NONWIR:15K OHM,10%,0.25W	80009	311-1147-01
R321	321-0269-00			RES.,FXD,FILM:6.19K OHM,1%,0.125W	91637	MFF1816G61900F
R322	321-0193-00			RES.,FXD,FILM:1K OHM,1%,0.125W	91637	MFF1816G10000F
R325	311-1282-00			RES.,VAR,NONWIR:5K OHM,10%,0.50W	32997	3329W-L58-502
R326	321-0193-00			RES.,FXD,FILM:1K OHM,1%,0.125W	91637	MFF1816G10000F
R332	315-0684-00			RES.,FXD,CMPSN:680K OHM,5%,0.25W	01121	CB6845
R333	315-0512-00			RES.,FXD,CMPSN:5.1K OHM,5%,0.25W	01121	CB5125
R334	321-0205-00			RES.,FXD,FILM:1.33K OHM,1%,0.125W	91637	MFF1816G13300F
R335	311-1287-00			RES.,VAR,NONWIR:1000 OHM,+/-10%,0.5W	32997	3329W-L58-104
R336	315-0105-00			RES.,FXD,CMPSN:1M OHM,5%,0.25W	01121	CB1055
R337	321-0335-00			RES.,FXD,FILM:30.1K OHM,1%,0.125W	91637	MFF1816G30101F
R343	321-0238-00			RES.,FXD,FILM:2.94K OHM,1%,0.125W	91637	MFF1816G29400F
R344	321-0108-00			RES.,FXD,FILM:130 OHM,1%,0.125W	91637	MFF1816G130R0F
R345	311-0169-00			RES.,VAR,NONWIR:100 OHM,20%,0.50W	01121	W-7564B
R346	321-0209-00			RES.,FXD,FILM:1.47K OHM,1%,0.125W	91637	MFF1816G14700F
R353	321-0238-00			RES.,FXD,FILM:2.94K OHM,1%,0.125W	91637	MFF1816G29400F
R356	321-0209-00			RES.,FXD,FILM:1.47K OHM,1%,0.125W	91637	MFF1816G14700F
R362	321-0222-00			RES.,FXD,FILM:2K OHM,1%,0.125W	91637	MFF1816G20000F
R363	321-0251-00			RES.,FXD,FILM:4.02K OHM,1%,0.125W	91637	MFF1816G40200F
R365	321-0251-00			RES.,FXD,FILM:4.02K OHM,1%,0.125W	91637	MFF1816G40200F
R366	321-0222-00			RES.,FXD,FILM:2K OHM,1%,0.125W	91637	MFF1816G20000F
R368	321-0155-00			RES.,FXD,FILM:402 OHM,1%,0.125W	91637	MFF1816G402R0F
R370	315-0510-00			RES.,FXD,CMPSN:51 OHM,5%,0.25W	01121	CB5105
R371	315-0102-00			RES.,FXD,CMPSN:1K OHM,5%,0.25W	01121	CB1025
R374	315-0122-00			RES.,FXD,CMPSN:1.2K OHM,5%,0.25W	01121	CB1225
R377	315-0222-00			RES.,FXD,CMPSN:2.2K OHM,5%,0.25W	01121	CB2225
R378	315-0204-00			RES.,FXD,CMPSN:200K OHM,5%,0.25W	01121	CB2045
R380	311-1282-00			RES.,VAR,NONWIR:5K OHM,10%,0.50W	32997	3329W-L58-502
R381	315-0513-00			RES.,FXD,CMPSN:51K OHM,5%,0.25W	01121	CB5135
R382	315-0101-00			RES.,FXD,CMPSN:100 OHM,5%,0.25W	01121	CB1015
R383	315-0243-00			RES.,FXD,CMPSN:24K OHM,5%,0.25W	01121	CB2435

<sup>1</sup>Furnished as a unit with S320.

Replaceable Electrical Parts—7S12

Ckt No.	Tektronix Part No.	Serial/Model No. Eff	Dscont	Name & Description	Mfr Code	Mfr Part Number
R384	315-0511-00			RES., FXD, CMPSN:510 OHM, 5%, 0.25W	01121	CB5115
R386	315-0183-00			RES., FXD, CMPSN:18K OHM, 5%, 0.25W	01121	CB1835
R387	315-0472-00			RES., FXD, CMPSN:4.7K OHM, 5%, 0.25W	01121	CB4725
R390	311-1283-00			RES., VAR, NONWIR:10K OHM, 10%, 0.50W	32997	3329W-L58-103
R391	315-0272-00			RES., FXD, CMPSN:2.7K OHM, 5%, 0.25W	01121	CB2725
R392	315-0223-00			RES., FXD, CMPSN:22K OHM, 5%, 0.25W	01121	CB2235
R394	315-0331-00			RES., FXD, CMPSN:330 OHM, 5%, 0.25W	01121	CB3315
R395	315-0432-00			RES., FXD, CMPSN:4.3K OHM, 5%, 0.25W	01121	CB4325
R401	315-0683-00			RES., FXD, CMPSN:68K OHM, 5%, 0.25W	01121	CB6835
R402	315-0104-00			RES., FXD, CMPSN:100K OHM, 5%, 0.25W	01121	CB1045
R403	315-0474-00			RES., FXD, CMPSN:470K OHM, 5%, 0.25W	01121	CB4745
R404	315-0105-00			RES., FXD, CMPSN:1M OHM, 5%, 0.25W	01121	CB1055
R405	315-0154-00			RES., FXD, CMPSN:150K OHM, 5%, 0.25W	01121	CB1545
R406	321-0399-00			RES., FXD, FILM:140K OHM, 1%, 0.125W	91637	MFF1816G14002F
R408	321-0373-00			RES., FXD, FILM:75K OHM, 1%, 0.125W	91637	MFF1816G75001F
R409	315-0105-00			RES., FXD, CMPSN:1M OHM, 5%, 0.25W	01121	CB1055
R410	315-0563-00			RES., FXD, CMPSN:56K OHM, 5%, 0.25W	01121	CB5635
R411	315-0564-00			RES., FXD, CMPSN:560K OHM, 5%, 0.25W	01121	CB5645
R412	321-0402-00			RES., FXD, FILM:150K OHM, 1%, 0.125W	91637	MFF1816G15002F
R413	321-0402-00			RES., FXD, FILM:150K OHM, 1%, 0.125W	91637	MFF1816G15002F
R415	321-0223-00			RES., FXD, FILM:2.05K OHM, 1%, 0.125W	91637	MFF1816G20500F
R416	321-0299-00			RES., FXD, FILM:12.7K OHM, 1%, 0.125W	91637	MFF1816G12701F
R417	321-0346-00			RES., FXD, FILM:39.2K OHM, 1%, 0.125W	91637	MFF1816G39201F
R418	321-0346-00			RES., FXD, FILM:39.2K OHM, 1%, 0.125W	91637	MFF1816G39201F
R419	321-0335-00			RES., FXD, FILM:30.1K OHM, 1%, 0.125W	91637	MFF1816G30101F
R421	321-0373-00			RES., FXD, FILM:75K OHM, 1%, 0.125W	91637	MFF1816G75001F
R422	321-0402-00			RES., FXD, FILM:150K OHM, 1%, 0.125W	91637	MFF1816G15002F
R423	321-0344-00			RES., FXD, FILM:37.4K OHM, 1%, 0.125W	91637	MFF1816G37401F
R424	321-0373-00			RES., FXD, FILM:75K OHM, 1%, 0.125W	91637	MFF1816G75001F
R425	321-0402-00			RES., FXD, FILM:150K OHM, 1%, 0.125W	91637	MFF1816G15002F
R427	321-0373-00			RES., FXD, FILM:75K OHM, 1%, 0.125W	91637	MFF1816G75001F
R428	321-0304-00			RES., FXD, FILM:14.3K OHM, 1%, 0.125W	91637	MFF1816G14301F
R429	321-0343-00			RES., FXD, FILM:36.5K OHM, 1%, 0.125W	91637	MFF1816G36501F
R431	321-0373-00			RES., FXD, FILM:75K OHM, 1%, 0.125W	91637	MFF1816G75001F
R433	321-0356-00			RES., FXD, FILM:49.9K OHM, 1%, 0.125W	91637	MFF1816G49901F
R435	321-0402-00			RES., FXD, FILM:150K OHM, 1%, 0.125W	91637	MFF1816G15002F
R437	321-0356-00			RES., FXD, FILM:49.9K OHM, 1%, 0.125W	91637	MFF1816G49901F
R439	321-0344-00			RES., FXD, FILM:37.4K OHM, 1%, 0.125W	91637	MFF1816G37401F
R501	316-0222-00			RES., FXD, CMPSN:2.2K OHM, 10%, 0.25W	01121	CB2221
R503	315-0103-00			RES., FXD, CMPSN:10K OHM, 5%, 0.25W	01121	CB1035
R504	315-0102-00			RES., FXD, CMPSN:1K OHM, 5%, 0.25W	01121	CB1025
R505	315-0100-00			RES., FXD, CMPSN:10 OHM, 5%, 0.25W	01121	CB1005
R506	316-0222-00			RES., FXD, CMPSN:2.2K OHM, 10%, 0.25W	01121	CB2221
R507	321-0232-00	B020150	B089999	RES., FXD, FILM:2.55K OHM, 1%, 0.125W	91637	MFF1816G25500F
R507	321-0265-00	B090000		RES., FXD, FILM:5.62K OHM, 1%, 0.125W	91637	MFF1816G56200F
R508	315-0154-00			RES., FXD, CMPSN:150K OHM, 5%, 0.25W	01121	CB1545
R510	321-0291-00	B020150	B089999	RES., FXD, FILM:10.5K OHM, 1%, 0.125W	91637	MFF1816G10501F
R510	321-0352-00	B090000		RES., FXD, FILM:45.3K OHM, 1%, 0.125W	91637	MFF1816G45301F
R512	316-0103-00			RES., FXD, CMPSN:10K OHM, 10%, 0.25W	01121	CB1031
R514	321-0302-00			RES., FXD, FILM:13.7K OHM, 1%, 0.125W	91637	MFF1816G13701F
R515	321-0333-00			RES., FXD, FILM:28.7K OHM, 1%, 0.125W	91637	MFF1816G28701F
R516	321-0293-00			RES., FXD, FILM:11K OHM, 1%, 0.125W	91637	MFF1816G11001F
R517	315-0124-00	XB090000	B119999	RES., FXD, CMPSN:120K OHM, 5%, 0.25W	01121	CB1245

Replaceable Electrical Parts—7S12

Ckt No.	Tektronix Part No.	Serial/Model No. Eff	Dscont	Name & Description	Mfr Code	Mfr Part Number
R517	315-0473-00	B120000		RES., FXD, CMPSN:47K OHM, 5%, 0.25W	01121	CB4735
R518	315-0622-00			RES., FXD, CMPSN:6.2K OHM, 5%, 0.25W	01121	CB6225
R520	315-0273-00	B020150	B099999	RES., FXD, CMPSN:27K OHM, 5%, 0.25W	01121	CB2735
R520	315-0393-00	B100000		RES., FXD, CMPSN:39K OHM, 5%, 0.25W	01121	CB3935
R521	315-0103-00			RES., FXD, CMPSN:10K OHM, 5%, 0.25W	01121	CB1035
R522	315-0101-00			RES., FXD, CMPSN:100 OHM, 5%, 0.25W	01121	CB1015
R523	315-0101-00			RES., FXD, CMPSN:100 OHM, 5%, 0.25W	01121	CB1015
R524	322-0268-00			RES., FXD, FILM:6.04K OHM, 1%, 0.25W	75042	CEBT0-6041F
R525	311-0609-00			RES., VAR, NONWIR:2K OHM, 10%, 0.50W	73138	82-26-0
R526	315-0510-00			RES., FXD, CMPSN:51 OHM, 5%, 0.25W	01121	CB5105
R527	315-0510-00	XB100000		RES., FXD, CMPSN:51 OHM, 5%, 0.25W	01121	CB5105
R531	315-0101-00	XB100000		RES., FXD, CMPSN:100 OHM, 5%, 0.25W	01121	CB1015
R532	301-0163-00			RES., FXD, CMPSN:16K OHM, 5%, 0.50W	01121	EB1635
R534	315-0561-00			RES., FXD, CMPSN:560 OHM, 5%, 0.25W	01121	CB5615
R536	315-0101-00			RES., FXD, CMPSN:100 OHM, 5%, 0.25W	01121	CB1015
R537	315-0103-00			RES., FXD, CMPSN:10K OHM, 5%, 0.25W	01121	CB1035
R538	315-0101-00	XB100000		RES., FXD, CMPSN:100 OHM, 5%, 0.25W	01121	CB1015
R539	301-0163-00			RES., FXD, CMPSN:16K OHM, 5%, 0.50W	01121	EB1635
R540	315-0101-00			RES., FXD, CMPSN:100 OHM, 5%, 0.25W	01121	CB1015
R543	315-0752-00	B020150	B049999	RES., FXD, CMPSN:7.5K OHM, 5%, 0.25W	01121	CB7525
R543	315-0512-00	B050000		RES., FXD, CMPSN:5.1K OHM, 5%, 0.25W	01121	CB5125
R545	315-0303-00			RES., FXD, CMPSN:30K OHM, 5%, 0.25W	01121	CB3035
R546	315-0471-00	B020150	B089999	RES., FXD, CMPSN:470 OHM, 5%, 0.25W	01121	CB4715
R546	315-0821-00	B090000	B099999	RES., FXD, CMPSN:820 OHM, 5%, 0.25W	01121	CB8215
R546	315-0182-00	B100000	B119999	RES., FXD, CMPSN:1.8K OHM, 5%, 0.25W	01121	CB1825
R546	315-0821-00	B120000		RES., FXD, CMPSN:820 OHM, 5%, 0.25W	01121	CB8215
R552	315-0103-00	B020150	B099999	RES., FXD, CMPSN:10K OHM, 5%, 0.25W	01121	CB1035
R552	315-0512-00	B100000		RES., FXD, CMPSN:5.1K OHM, 5%, 0.25W	01121	CB5125
R554	315-0154-00			RES., FXD, CMPSN:150K OHM, 5%, 0.25W	01121	CB1545
R556	315-0622-00			RES., FXD, CMPSN:6.2K OHM, 5%, 0.25W	01121	CB6225
R557	315-0103-00			RES., FXD, CMPSN:10K OHM, 5%, 0.25W	01121	CB1035
R560	315-0102-00			RES., FXD, CMPSN:1K OHM, 5%, 0.25W	01121	CB1025
R562	315-0102-00			RES., FXD, CMPSN:1K OHM, 5%, 0.25W	01121	CB1025
R563	315-0103-00	XB100000		RES., FXD, CMPSN:10K OHM, 5%, 0.25W	01121	CB1035
R564	315-0102-00			RES., FXD, CMPSN:1K OHM, 5%, 0.25W	01121	CB1025
R565	315-0200-00			RES., FXD, CMPSN:20 OHM, 5%, 0.25W	01121	CB2005
R566	315-0511-00			RES., FXD, CMPSN:510 OHM, 5%, 0.25W	01121	CB5115
R567	315-0200-00			RES., FXD, CMPSN:20 OHM, 5%, 0.25W	01121	CB2005
R568	315-0511-00			RES., FXD, CMPSN:510 OHM, 5%, 0.25W	01121	CB5115
R572	315-0103-00			RES., FXD, CMPSN:10K OHM, 5%, 0.25W	01121	CB1035
R574	315-0103-00			RES., FXD, CMPSN:10K OHM, 5%, 0.25W	01121	CB1035
R575	315-0103-00			RES., FXD, CMPSN:10K OHM, 5%, 0.25W	01121	CB1035
R576	315-0154-00			RES., FXD, CMPSN:150K OHM, 5%, 0.25W	01121	CB1545
R578	315-0103-00			RES., FXD, CMPSN:10K OHM, 5%, 0.25W	01121	CB1035
R580	315-0102-00			RES., FXD, CMPSN:1K OHM, 5%, 0.25W	01121	CB1025
R582	315-0101-00			RES., FXD, CMPSN:100 OHM, 5%, 0.25W	01121	CB1015
R584	315-0222-00			RES., FXD, CMPSN:2.2K OHM, 5%, 0.25W	01121	CB2225
R586	315-0101-00			RES., FXD, CMPSN:100 OHM, 5%, 0.25W	01121	CB1015
R590	311-0607-00			RES., VAR, NONWIR:10K OHM, 10%, 0.50W	73138	82P-59-4-103K
R592	311-0607-00			RES., VAR, NONWIR:10K OHM, 10%, 0.50W	73138	82P-59-4-103K
R594	311-0607-00			RES., VAR, NONWIR:10K OHM, 10%, 0.50W	73138	82P-59-4-103K
R596	321-0193-00	B020150	B099999	RES., FXD, FILM:1K OHM, 1%, 0.125W	91637	MFF1816G10000F
R596	321-0164-00	B100000		RES., FXD, FILM:499 OHM, 1%, 0.125W	91637	MFF1816G499R0F

Replaceable Electrical Parts—7S12

Ckt No.	Tektronix Part No.	Serial/Model No. Eff	Dscont	Name & Description	Mfr Code	Mfr Part Number
R597	321-0357-00			RES.,FXD,FILM:51.1K OHM,1%,0.125W	91637	MFF1816G51101F
R601 <sup>1</sup>	311-1159-00			RES.,VAR, NONWIR:100K OHM,20%,0.25W	12697	381S-CM40208
R603	321-0289-00			RES.,FXD,FILM:10K OHM,1%,0.125W	91637	MFF1816G10001F
R604	315-0102-00			RES.,FXD,CMPSN:1K OHM,5%,0.25W	01121	CB1025
R606	315-0513-00			RES.,FXD,CMPSN:51K OHM,5%,0.25W	01121	CB5135
R608	321-0356-00			RES.,FXD,FILM:49.9K OHM,1%,0.125W	91637	MFF1816G49901F
R610	321-0289-00			RES.,FXD,FILM:10K OHM,1%,0.125W	91637	MFF1816G10001F
R611	321-0289-00			RES.,FXD,FILM:10K OHM,1%,0.125W	91637	MFF1816G10001F
R612	316-0102-00	XB040000		RES.,FXD,CMPSN:1K OHM,10%,0.25W	01121	CB1021
R613	301-0243-00			RES.,FXD,CMPSN:24K OHM,5%,0.50W	01121	EB2435
R614	315-0104-00			RES.,FXD,CMPSN:100K OHM,5%,0.25W	01121	CB1045
R615	321-0306-00			RES.,FXD,FILM:15K OHM,1%,0.125W	91637	MFF1816G15001F
R617	316-0475-00			RES.,FXD,CMPSN:4.7M OHM,10%,0.25W	01121	CB4751
R618	311-1285-00			RES.,VAR, NONWIR:25K OHM,+/-10%,0.5W	32997	3329W-L58-253
R619	315-0433-00			RES.,FXD,CMPSN:43K OHM,5%,0.25W	01121	CB4335
R620	315-0564-00			RES.,FXD,CMPSN:560K OHM,5%,0.25W	01121	CB5645
R621	315-0221-00			RES.,FXD,CMPSN:220 OHM,5%,0.25W	01121	CB2215
R623	321-0318-00			RES.,FXD,FILM:20K OHM,1%,0.125W	91637	MFF1816G20001F
R625	321-0262-00			RES.,FXD,FILM:5.23K OHM,1%,0.125W	91637	MFF1816G52300F
R626	321-0306-00			RES.,FXD,FILM:15K OHM,1%,0.125W	91637	MFF1816G15001F
R629	315-0333-00			RES.,FXD,CMPSN:33K OHM,5%,0.25W	01121	CB3335
R630	321-0289-00			RES.,FXD,FILM:10K OHM,1%,0.125W	91637	MFF1816G10001F
R631	315-0752-00			RES.,FXD,CMPSN:7.5K OHM,5%,0.25W	01121	CB7525
R632	315-0752-00			RES.,FXD,CMPSN:7.5K OHM,5%,0.25W	01121	CB7525
R633	315-0512-00			RES.,FXD,CMPSN:5.1K OHM,5%,0.25W	01121	CB5125
R634	315-0103-00			RES.,FXD,CMPSN:10K OHM,5%,0.25W	01121	CB1035
R635	315-0433-00			RES.,FXD,CMPSN:43K OHM,5%,0.25W	01121	CB4335
R636	315-0752-00			RES.,FXD,CMPSN:7.5K OHM,5%,0.25W	01121	CB7525
R637	315-0433-00			RES.,FXD,CMPSN:43K OHM,5%,0.25W	01121	CB4335
R638	315-0753-00			RES.,FXD,CMPSN:75K OHM,5%,0.25W	01121	CB7535
R639	315-0303-00			RES.,FXD,CMPSN:30K OHM,5%,0.25W	01121	CB3035
R640	315-0564-00			RES.,FXD,CMPSN:560K OHM,5%,0.25W	01121	CB5645
R641	321-0289-00			RES.,FXD,FILM:10K OHM,1%,0.125W	91637	MFF1816G10001F
R642	315-0303-00			RES.,FXD,CMPSN:30K OHM,5%,0.25W	01121	CB3035
R643	321-0288-00			RES.,FXD,FILM:9.76K OHM,1%,0.125W	91637	MFF1816G97600F
R644	321-0384-00			RES.,FXD,FILM:97.6K OHM,1%,0.125W	91637	MFF1816G97601F
R645	315-0203-00			RES.,FXD,CMPSN:20K OHM,5%,0.25W	01121	CB2035
R646	321-0289-00			RES.,FXD,FILM:10K OHM,1%,0.125W	91637	MFF1816G10001F
R647	315-0102-00	B020150	B079999X	RES.,FXD,CMPSN:1K OHM,5%,0.25W	01121	CB1025
R648	321-0288-00			RES.,FXD,FILM:9.76K OHM,1%,0.125W	91637	MFF1816G97600F
R649	315-0202-00	XB080000		RES.,FXD,CMPSN:2K OHM,5%,0.25W	01121	CB2025
R650	301-0123-00			RES.,FXD,CMPSN:12K OHM,5%,0.50W	01121	EB1235
R651	321-0231-00	XB080000		RES.,FXD,FILM:2.49K OHM,1%,0.125W	91637	MFF1816G24900F
R652	315-0101-00			RES.,FXD,CMPSN:100 OHM,5%,0.25W	01121	CB1015
R653	321-0213-00			RES.,FXD,FILM:1.62K OHM,1%,0.125W	91637	MFF1816G16200F
R654	321-0261-00			RES.,FXD,FILM:5.11K OHM,1%,0.125W	91637	MFF1816G51100F
R655	321-0289-00			RES.,FXD,FILM:10K OHM,1%,0.125W	91637	MFF1816G10001F
R656	316-0102-00	XB040000		RES.,FXD,CMPSN:1K OHM,10%,0.25W	01121	CB1021
R657	315-0101-00			RES.,FXD,CMPSN:100 OHM,5%,0.25W	01121	CB1015
R658	301-0113-00			RES.,FXD,CMPSN:11K OHM,5%,0.50W	01121	EB1135
R659	321-0213-00			RES.,FXD,FILM:1.62K OHM,1%,0.125W	91637	MFF1816G16200F
R660	311-0387-00			RES.,VAR, NONWIR:5K OHM,20%	01121	W7565A
R661	321-0231-00	XB080000		RES.,FXD,FILM:2.49K OHM,1%,0.125W	91637	MFF1816G24900F

<sup>1</sup>Furnished as a unit with S650.

Ckt No.	Tektronix Part No.	Serial/Model No. Eff	Dscont	Name & Description	Mfr Code	Mfr Part Number
R662	315-0511-00			RES.,FXD,CMPSN:510 OHM,5%,0.25W	01121	CB5115
R663	316-0102-00	XB040000		RES.,FXD,CMPSN:1K OHM,10%,0.25W	01121	CB1021
R664	315-0223-00			RES.,FXD,CMPSN:22K OHM,5%,0.25W	01121	CB2235
R665	311-0487-00			RES.,VAR,NONWIR:30K OHM,10%,0.50W	11237	300SF-41337
R666	316-0102-00	XB040000		RES.,FXD,CMPSN:1K OHM,10%,0.25W	01121	CB1021
R667	321-0261-00			RES.,FXD,FILM:5.11K OHM,1%,0.125W	91637	MFF1816G51100F
R668	311-1283-00			RES.,VAR,NONWIR:10K OHM,10%,0.50W	32997	3329W-L58-103
R669	321-0367-00			RES.,FXD,FILM:64.9K OHM,1%,0.125W	91637	MFF1816G64901F
R670	311-0329-00			RES.,VAR,NONWIR:50K OHM,20%,0.50W	01121	W7356
R671	321-0261-00			RES.,FXD,FILM:5.11K OHM,1%,0.125W	91637	MFF1816G51100F
R672	315-0512-00			RES.,FXD,CMPSN:5.1K OHM,5%,0.25W	01121	CB5125
R673	315-0105-00			RES.,FXD,CMPSN:1M OHM,5%,0.25W	01121	CB1055
R674	311-0342-00			RES.,VAR,WW:50K OHM,3%	80294	3500S-110-503
R675	311-0838-00			RES.,VAR,WW:10K OHM,5%,1W	80294	3707-425-103
R676	321-0433-00	B020150	B099999	RES.,FXD,FILM:316K OHM,1%,0.125W	91637	MFF1816G31602F
R676	321-0447-00	B100000		RES.,FXD,FILM:442K OHM,1%,0.125W	91637	MFF1816G44202F
R677	311-1285-00	B020150	B099999	RES.,VAR,NONWIR:25K OHM,+/-10%,0.5W	32997	3329W-L58-253
R677	311-1286-00	B100000	B129999	RES.,VAR,NONWIR:50K OHM,10%,0.5W	32997	3329W-L58-503
R677	311-1288-00	B130000		RES.,VAR,NONWIR:200K OHM,10%,0.50W	32997	3329W-L58-204
R678	315-0102-00			RES.,FXD,CMPSN:1K OHM,5%,0.25W	01121	CB1025
R679	321-0289-00			RES.,FXD,FILM:10K OHM,1%,0.125W	91637	MFF1816G10001F
R680	315-0243-00			RES.,FXD,CMPSN:24K OHM,5%,0.25W	01121	CB2435
R681	315-0101-00			RES.,FXD,CMPSN:100 OHM,5%,0.25W	01121	CB1015
R682	321-0435-00	B020150	B099999	RES.,FXD,FILM:332K OHM,1%,0.125W	91637	MFF1816G33202F
R682	321-0452-00	B100000		RES.,FXD,FILM:499K OHM,1%,0.125W	91637	MFF1816G49902F
R683	315-0102-00			RES.,FXD,CMPSN:1K OHM,5%,0.25W	01121	CB1025
R684	321-0312-00			RES.,FXD,FILM:17.4K OHM,1%,0.125W	91637	MFF1816G17401F
R685	321-0289-00			RES.,FXD,FILM:10K OHM,1%,0.125W	91637	MFF1816G10001F
R686	315-0163-00			RES.,FXD,CMPSN:16K OHM,5%,0.25W	01121	CB1635
R687	315-0183-00			RES.,FXD,CMPSN:18K OHM,5%,0.25W	01121	CB1835
R688	315-0153-00	B020150	B099999	RES.,FXD,CMPSN:15K OHM,5%,0.25W	01121	CB1535
R688	315-0752-00	B100000		RES.,FXD,CMPSN:7.5K OHM,5%,0.25W	01121	CB7525
R689	316-0222-00	B020150	B089999X	RES.,FXD,CMPSN:2.2K OHM,10%,0.25W	01121	CB2221
R690	321-0351-00			RES.,FXD,FILM:44.2K OHM,1%,0.125W	91637	MFF1816G44201F
R691	315-0512-00	B020150	B099999	RES.,FXD,CMPSN:5.1K OHM,5%,0.25W	01121	CB5125
R691	315-0102-00	B100000	B119999	RES.,FXD,CMPSN:1K OHM,5%,0.25W	01121	CB1025
R691	315-0431-00	B120000		RES.,FXD,CMPSN:430 OHM,5%,0.25W	01121	CB4315
R692	315-0513-00	XB090000	B099999	RES.,FXD,CMPSN:51K OHM,5%,0.25W	01121	CB5135
R692	315-0203-00	B100000		RES.,FXD,CMPSN:20K OHM,5%,0.25W	01121	CB2035
R693	315-0153-00	XB100000		RES.,FXD,CMPSN:15K OHM,5%,0.25W	01121	CB1535
R694	315-0303-00			RES.,FXD,CMPSN:30K OHM,5%,0.25W	01121	CB3035
R695	315-0104-00			RES.,FXD,CMPSN:100K OHM,5%,0.25W	01121	CB1045
R696	315-0104-00			RES.,FXD,CMPSN:100K OHM,5%,0.25W	01121	CB1045
R697	315-0202-00	B020150	B099999	RES.,FXD,CMPSN:2K OHM,5%,0.25W	01121	CB2025
R697	315-0432-00	B100000		RES.,FXD,CMPSN:4.3K OHM,5%,0.25W	01121	CB4325
R698	315-0104-00			RES.,FXD,CMPSN:100K OHM,5%,0.25W	01121	CB1045
R699	315-0104-00			RES.,FXD,CMPSN:100K OHM,5%,0.25W	01121	CB1045
R702	315-0102-00	XB100000		RES.,FXD,CMPSN:1K OHM,5%,0.25W	01121	CB1025
R710 <sup>1</sup>	311-1122-01			RES.,VAR,NONWIR:5K OHM,10%,0.5W	80009	311-1122-01
R712	315-0242-00			RES.,FXD,CMPSN:2.4K OHM,5%,0.25W	01121	CB2425
R716	321-0313-00			RES.,FXD,FILM:17.8K OHM,1%,0.125W	91637	MFF1816G17801F
R717	321-0226-00			RES.,FXD,FILM:2.21K OHM,1%,0.125W	91637	MFF1816G22100F
R720	321-0317-00			RES.,FXD,FILM:19.6K OHM,1%,0.125W	91637	MFF1816G19601F

<sup>1</sup>Furnished as a unit with S531.

# Replaceable Electrical Parts—7S12

Ckt No.	Tektronix Part No.	Serial/Model No. Eff	Dscont	Name & Description	Mfr Code	Mfr Part Number
R721	321-0829-02			RES.,FXD,FILM:202 OHM,0.5%,0.125W	91637	MFF1816D202ROD
R723	321-0318-00			RES.,FXD,FILM:20K OHM,1%,0.125W	91637	MFF1816G20001F
R725	321-0347-00			RES.,FXD,FILM:40.2K OHM,1%,0.125W	91637	MFF1816G40201F
R726	321-0347-00			RES.,FXD,FILM:40.2K OHM,1%,0.125W	91637	MFF1816G40201F
R727	321-0385-00			RES.,FXD,FILM:100K OHM,1%,0.125W	91637	MFF1816G10002F
R729	321-0327-00			RES.,FXD,FILM:24.9K OHM,1%,0.125W	91637	MFF1816G24901F
R740	315-0101-00	B020150	B099999	RES.,FXD,CMPSN:100 OHM,5%,0.25W	01121	CB1015
R740	315-0241-00	B100000		RES.,FXD,CMPSN:240 OHM,5%,0.25W	01121	CB2415
R741	315-0151-00	B020150	B099999	RES.,FXD,CMPSN:150 OHM,5%,0.25W	01121	CB1515
R741	315-0241-00	B010000		RES.,FXD,CMPSN:240 OHM,5%,0.25W	01121	CB2415
R743	315-0241-00			RES.,FXD,CMPSN:240 OHM,5%,0.25W	01121	CB2415
R744	315-0511-00			RES.,FXD,CMPSN:510 OHM,5%,0.25W	01121	CB5115
R746	315-0152-00			RES.,FXD,CMPSN:1.5K OHM,5%,0.25W	01121	CB1525
R747	315-0242-00			RES.,FXD,CMPSN:2.4K OHM,5%,0.25W	01121	CB2425
R761	321-0335-00			RES.,FXD,FILM:30.1K OHM,1%,0.125W	91637	MFF1816G30101F
R765	321-0356-00			RES.,FXD,FILM:49.9K OHM,1%,0.125W	91637	MFF1816G49901F
R767	315-0753-00			RES.,FXD,CMPSN:75K OHM,5%,0.25W	01121	CB7535
R768	315-0154-00			RES.,FXD,CMPSN:150K OHM,5%,0.25W	01121	CB1545
R769	315-0154-00			RES.,FXD,CMPSN:150K OHM,5%,0.25W	01121	CB1545
R770	315-0154-00			RES.,FXD,CMPSN:150K OHM,5%,0.25W	01121	CB1545
R771	315-0753-00			RES.,FXD,CMPSN:75K OHM,5%,0.25W	01121	CB7535
R772	321-0344-00			RES.,FXD,FILM:37.4K OHM,1%,0.125W	91637	MFF1816G37401F
R773	315-0154-00			RES.,FXD,CMPSN:150K OHM,5%,0.25W	01121	CB1545
R778	321-0344-00			RES.,FXD,FILM:37.4K OHM,1%,0.125W	91637	MFF1816G37401F
R781	315-0154-00			RES.,FXD,CMPSN:150K OHM,5%,0.25W	01121	CB1545
R783	315-0753-00			RES.,FXD,CMPSN:75K OHM,5%,0.25W	01121	CB7535
R785	315-0753-00			RES.,FXD,CMPSN:75K OHM,5%,0.25W	01121	CB7535
R786	315-0154-00			RES.,FXD,CMPSN:150K OHM,5%,0.25W	01121	CB1545
R787	315-0753-00			RES.,FXD,CMPSN:75K OHM,5%,0.25W	01121	CB7535
R801	315-0101-00			RES.,FXD,CMPSN:100 OHM,5%,0.25W	01121	CB1015
R802	315-0101-00			RES.,FXD,CMPSN:100 OHM,5%,0.25W	01121	CB1015
R805	315-0101-00			RES.,FXD,CMPSN:100 OHM,5%,0.25W	01121	CB1015
R806	315-0101-00			RES.,FXD,CMPSN:100 OHM,5%,0.25W	01121	CB1015
R809	315-0101-00			RES.,FXD,CMPSN:100 OHM,5%,0.25W	01121	CB1015
R810	315-0101-00			RES.,FXD,CMPSN:100 OHM,5%,0.25W	01121	CB1015
R821	321-0632-00			RES.,FXD,FILM:9.41K OHM,0.5%,0.125W	91637	MFF1816D94100C
R822	321-0601-00			RES.,FXD,FILM:2.141K OHM,0.25%,0.125W	91637	MFF1816D21410C
R824	321-0236-00			RES.,FXD,FILM:2.8K OHM,1%,0.125W	91637	MFF1816G28000F
R826	321-0315-00			RES.,FXD,FILM:18.7K OHM,1%,0.125W	91637	MFF1816G18701F
R827	315-0180-00			RES.,FXD,CMPSN:18 OHM,5%,0.25W	01121	CB1805
R829	315-0512-00			RES.,FXD,CMPSN:5.1K OHM,5%,0.25W	01121	CB5125
R834	315-0101-00			RES.,FXD,CMPSN:100 OHM,5%,0.25W	01121	CB1015
R839	315-0101-00			RES.,FXD,CMPSN:100 OHM,5%,0.25W	01121	CB1015
R851	315-0472-00			RES.,FXD,CMPSN:4.7K OHM,5%,0.25W	01121	CB4725
R853	316-0393-00	XB060000		RES.,FXD,CMPSN:39K OHM,10%,0.25W	01121	CB3931
R901	315-0103-00			RES.,FXD,CMPSN:10K OHM,5%,0.25W	01121	CB1035
R903	315-0104-00			RES.,FXD,CMPSN:100K OHM,5%,0.25W	01121	CB1045
R906	315-0103-00			RES.,FXD,CMPSN:10K OHM,5%,0.25W	01121	CB1035
R907	315-0303-00			RES.,FXD,CMPSN:30K OHM,5%,0.25W	01121	CB3035
R910	315-0273-00			RES.,FXD,CMPSN:27K OHM,5%,0.25W	01121	CB2735
R911	315-0303-00			RES.,FXD,CMPSN:30K OHM,5%,0.25W	01121	CB3035
R913	315-0335-00			RES.,FXD,CMPSN:3.3M OHM,5%,0.25W	01121	CB3355
R914	315-0304-00			RES.,FXD,CMPSN:300K OHM,5%,0.25W	01121	CB3045

Ckt No.	Tektronix Part No.	Serial/Model No. Eff	Dscont	Name & Description	Mfr Code	Mfr Part Number
R916	315-0104-00			RES., FXD, CMPSN:100K OHM, 5%, 0.25W	01121	CB1045
R920	315-0510-00			RES., FXD, CMPSN:51 OHM, 5%, 0.25W	01121	CB5105
R921	315-0562-00			RES., FXD, CMPSN:5.6K OHM, 5%, 0.25W	01121	CB5625
R922	315-0511-00			RES., FXD, CMPSN:510 OHM, 5%, 0.25W	01121	CB5115
R923	315-0510-00			RES., FXD, CMPSN:51 OHM, 5%, 0.25W	01121	CB5105
R925	315-0105-00			RES., FXD, CMPSN:1M OHM, 5%, 0.25W	01121	CB1055
R926	315-0104-00			RES., FXD, CMPSN:100K OHM, 5%, 0.25W	01121	CB1045
R929	315-0103-00			RES., FXD, CMPSN:10K OHM, 5%, 0.25W	01121	CB1035
R933	315-0103-00			RES., FXD, CMPSN:10K OHM, 5%, 0.25W	01121	CB1035
R934	315-0102-00			RES., FXD, CMPSN:1K OHM, 5%, 0.25W	01121	CB1025
R935	315-0224-00			RES., FXD, CMPSN:220K OHM, 5%, 0.25W	01121	CB2245
R937	315-0303-00			RES., FXD, CMPSN:30K OHM, 5%, 0.25W	01121	CB3035
R940	315-0513-00			RES., FXD, CMPSN:51K OHM, 5%, 0.25W	01121	CB5135
R941	315-0513-00			RES., FXD, CMPSN:51K OHM, 5%, 0.25W	01121	CB5135
R945	311-1280-00			RES., VAR, NONWIR:1K OHM, 10%, 0.50W	32997	3329W-L58-102
R946	315-0153-00			RES., FXD, CMPSN:15K OHM, 5%, 0.25W	01121	CB1535
R947	315-0151-00			RES., FXD, CMPSN:150 OHM, 5%, 0.25W	01121	CB1515
R950	315-0151-00			RES., FXD, CMPSN:150 OHM, 5%, 0.25W	01121	CB1515
R951	315-0153-00			RES., FXD, CMPSN:15K OHM, 5%, 0.25W	01121	CB1535
R952	315-0183-00			RES., FXD, CMPSN:18K OHM, 5%, 0.25W	01121	CB1835
R954	315-0105-00			RES., FXD, CMPSN:1M OHM, 5%, 0.25W	01121	CB1055
R955	321-0289-00			RES., FXD, FILM:10K OHM, 1%, 0.125W	91637	MFF1816G10001F
R956	321-0316-00			RES., FXD, FILM:19.1K OHM, 1%, 0.125W	91637	MFF1816G19101F
R957	321-0289-00			RES., FXD, FILM:10K OHM, 1%, 0.125W	91637	MFF1816G10001F
R960	321-0385-00			RES., FXD, FILM:100K OHM, 1%, 0.125W	91637	MFF1816G10002F
R962	321-0356-00			RES., FXD, FILM:49.9K OHM, 1%, 0.125W	91637	MFF1816G49901F
R963	315-0105-00			RES., FXD, CMPSN:1M OHM, 5%, 0.25W	01121	CB1055
R965	321-0385-00			RES., FXD, FILM:100K OHM, 1%, 0.125W	91637	MFF1816G10002F
S146	262-0927-00			SWITCH, ROTARY:	80009	262-0927-00
S146	260-1218-00	B020150	B029999	SWITCH, ROTARY:	80009	260-1218-00
S146	260-1218-01	B030000		SWITCH, ROTARY:	80009	260-1218-01
S146A <sup>1</sup>						
S304 <sup>2</sup>	670-1317-00			SW, PUSH BUTTON:	80009	670-1317-00
S320 <sup>3</sup>						
S530A, B <sup>2</sup>	670-1311-02	B020150	B029999	SW, PUSH BUTTON:	80009	670-1311-02
S530A, B <sup>2</sup>	670-1311-01	B030000		SW, PUSH BUTTON:	80009	670-1311-01
S531 <sup>4</sup>						
S625	260-0735-00			SWITCH, PUSH:SPST	81073	39-1
S630 <sup>5</sup>	670-1313-00			SW, PUSH BUTTON:	80009	670-1313-00
S640	670-1316-00			SW, PUSH BUTTON:	80009	670-1316-00
S650 <sup>6</sup>						
S670 <sup>7</sup>	670-1313-00			SW, PUSH BUTTON:	80009	670-1313-00
S901	260-0984-00			SWITCH, SLIDE:DP 3 POSN, 0.5A, 125VAC-DC	79727	G-128SPC/7140
T230	120-0547-00			XFMR, TOROID: (4) 15 TURN WINDINGS	80009	120-0547-00
T370	120-0546-00			XFMR, TOROID: 4 TURNS BIFILAR	80009	120-0546-00
U620	155-0035-00			MICROCIRCUIT, LI:QUAD OPERATIONAL AMPL	80009	155-0035-00
U650	155-0035-00			MICROCIRCUIT, LI:QUAD OPERATIONAL AMPL	80009	155-0035-00
U680	156-0095-00			MICROCIRCUIT, LI:VOLTAGE COMPARATOR	86684	CA3051
U910	156-0067-00			MICROCIRCUIT, LI:OPERATIONAL AMPLIFIER	80009	156-0067-00

<sup>1</sup>Furnished as a unit with S146.

<sup>2</sup>See Mechanical Parts List for replacement parts.

<sup>3</sup>Furnished as a unit with R320.

<sup>4</sup>Furnished as a unit with R710.

<sup>5</sup>See Mechanical Parts List for replacement parts. Furnished as a unit with S670.

<sup>6</sup>Furnished as a unit with R601.

<sup>7</sup>Furnished as a unit with S630.

## Replaceable Electrical Parts—7S12

Ckt No.	Tektronix Part No.	Serial/Model No. Eff	Dscont	Name & Description	Mfr Code	Mfr Part Number
U940	156-0067-00			MICROCIRCUIT,LI:OPERATIONAL AMPLIFIER	80009	156-0067-00
U955	156-0067-00			MICROCIRCUIT,LI:OPERATIONAL AMPLIFIER	80009	156-0067-00
VR221	152-0279-00			SEMICOND DEVICE:ZENER,0.4W,5.1V,5%	80009	152-0279-00
VR272	152-0168-00			SEMICOND DEVICE:ZENER,0.4W,12V,5%	04713	1N963B
VR274	152-0168-00			SEMICOND DEVICE:ZENER,0.4W,12V,5%	04713	1N963B
VR604	152-0055-00			SEMICOND DEVICE:ZENER,0.4W,11V,5%	04713	1N962B
VR619	152-0055-00			SEMICOND DEVICE:ZENER,0.4W,11V,5%	04713	1N962B



# SECTION 7

## DIAGRAMS AND CIRCUIT BOARD ILLUSTRATIONS

### Symbols and Reference Designators

Electrical components shown on the diagrams are in the following units unless noted otherwise:

Capacitors = Values one or greater are in picofarads (pF).  
 Values less than one are in microfarads ( $\mu$ F).  
 Resistors = Ohms ( $\Omega$ )

Symbols used on the diagrams are based on USA Standard Y32.2-1967.

Logic symbology is based on MIL-STD-806B in terms of positive logic. Logic symbols depict the logic function performed and may differ from the manufacturer's data.

The following special symbols are used on the diagrams:

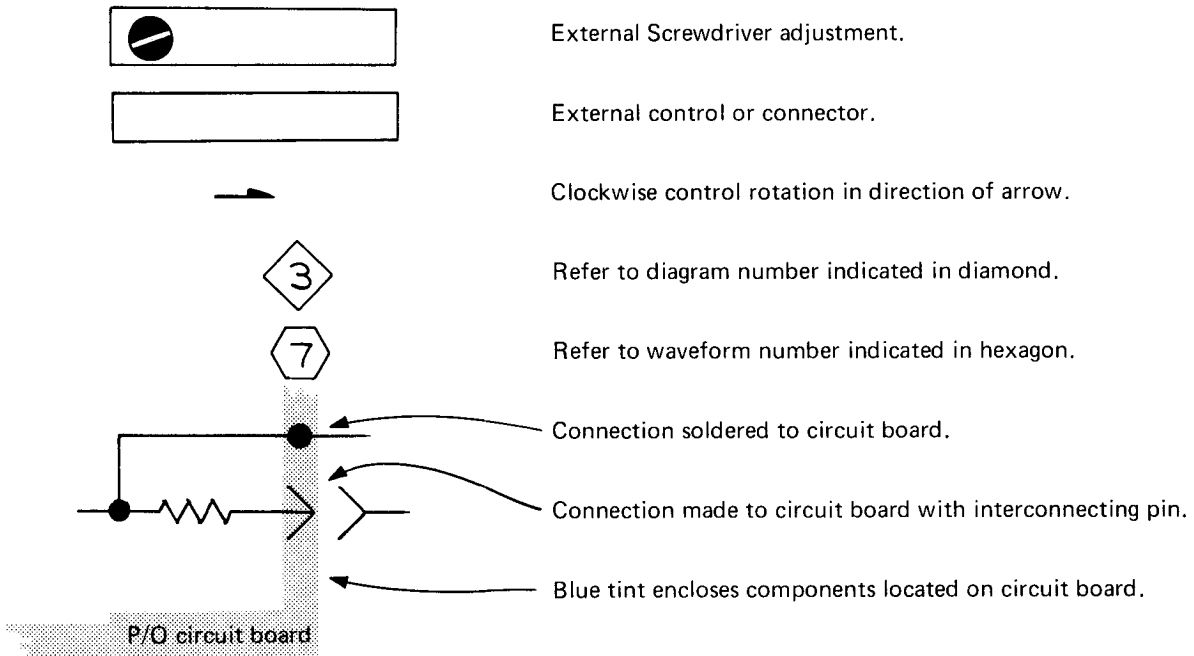

The following prefix letters are used as reference designators to identify components or assemblies on the diagrams.

A	Assembly, separable or repairable (circuit board, etc.)	LR	Inductor/resistor combination
AT	Attenuator, fixed or variable	M	Meter
B	Motor	Q	Transistor or silicon-controlled rectifier
BT	Battery	P	Connector, movable portion
C	Capacitor, fixed or variable	R	Resistor, fixed or variable
CR	Diode, signal or rectifier	RT	Thermistor
DL	Delay line	S	Switch
DS	Indicating device (lamp)	T	Transformer
F	Fuse	TP	Test point
FL	Filter	U	Assembly, inseparable or non-repairable (integrated circuit, etc.)
H	Heat dissipating device (heat sink, heat radiator, etc.)	V	Electron tube
HR	Heater	VR	Voltage regulator (zener diode, etc.)
J	Connector, stationary portion	Y	Crystal
K	Relay		
L	Inductor, fixed or variable		

## TROUBLESHOOTING CONDITIONS

Power the 7S12 (with S-52 and S-6 Heads installed) from a 7000-series Oscilloscope by two flexible extenders (Tektronix Part No. 067-0616-00 Calibration Fixture). Use a card extender (Tektronix Part No. 018-0064-00) when necessary for access to the Vertical or the Horizontal plug-in circuit cards.

### Control settings for the 7S12:

Time Distance dial	0
Multiplier	X1
Time/Div	10 ns
Variable	Cal In
Fine (Zero Set)	Fully Clockwise
Rep	Pushed in
Scan	Midrange
Locate	Pushed in
mV	Pushed in
mV/Div	100
DC Offset (& Fine)	Midrange
S901	Normal (center)

The troubleshooting waveforms, shown with some schematic diagrams, were obtained with a 7504 Oscilloscope with 7B50 Time Base, 7S16 Amplifier (in 20 MHz Bandwidth Mode), and P6053, 10X probe (the CRT readout includes probe attenuation).

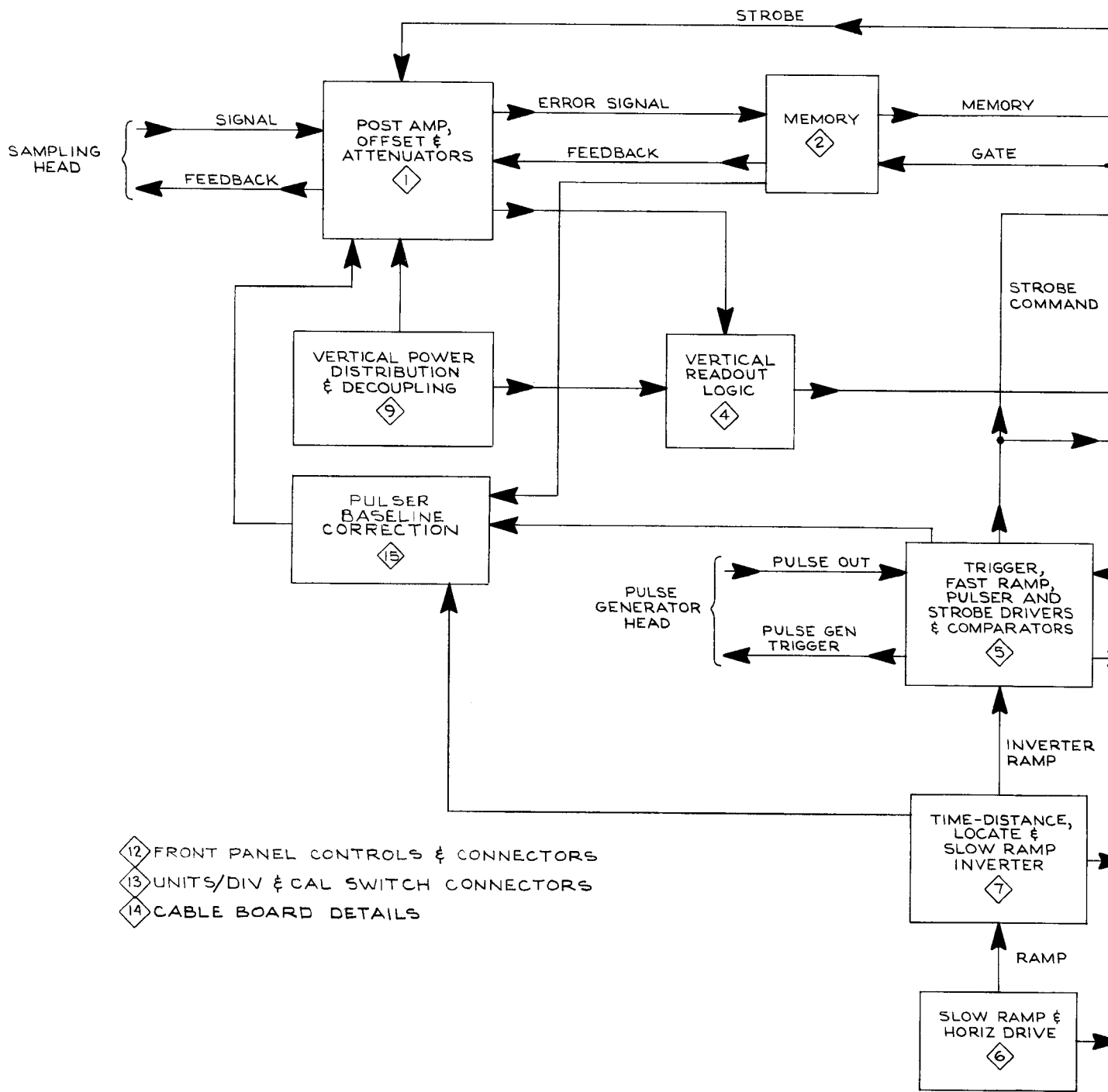

7S12 SAMPLING PLUG-IN

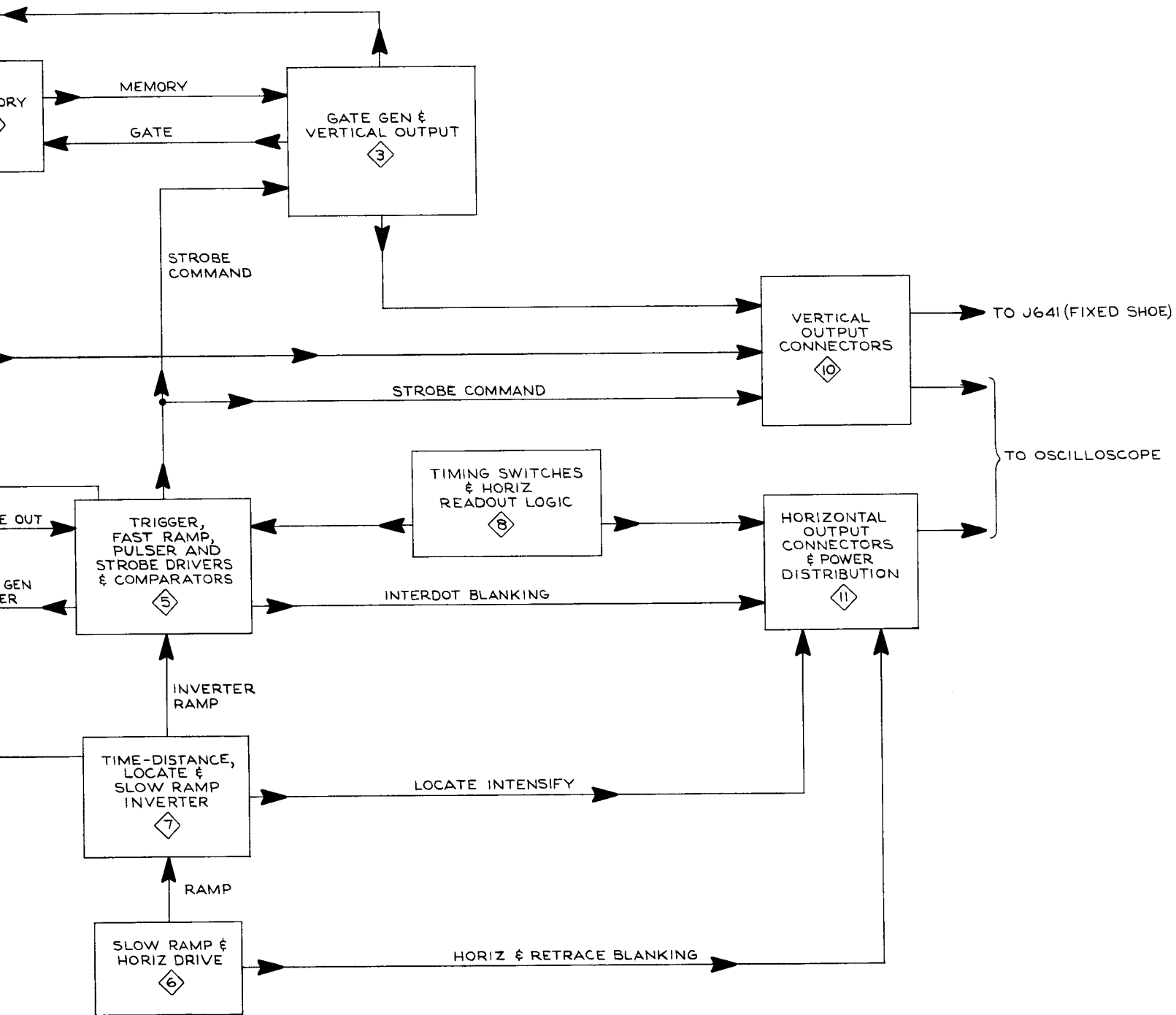

A



- P32** Red 9 pin conn  
 1 Brn on wht  
 2 Red on wht  
 3 Orn on wht  
 4 Yel on wht  
 5 Grn on wht  
 6 Blu on wht  
 7 Vio on wht  
 8 Gry on wht  
 9 Blk on wht

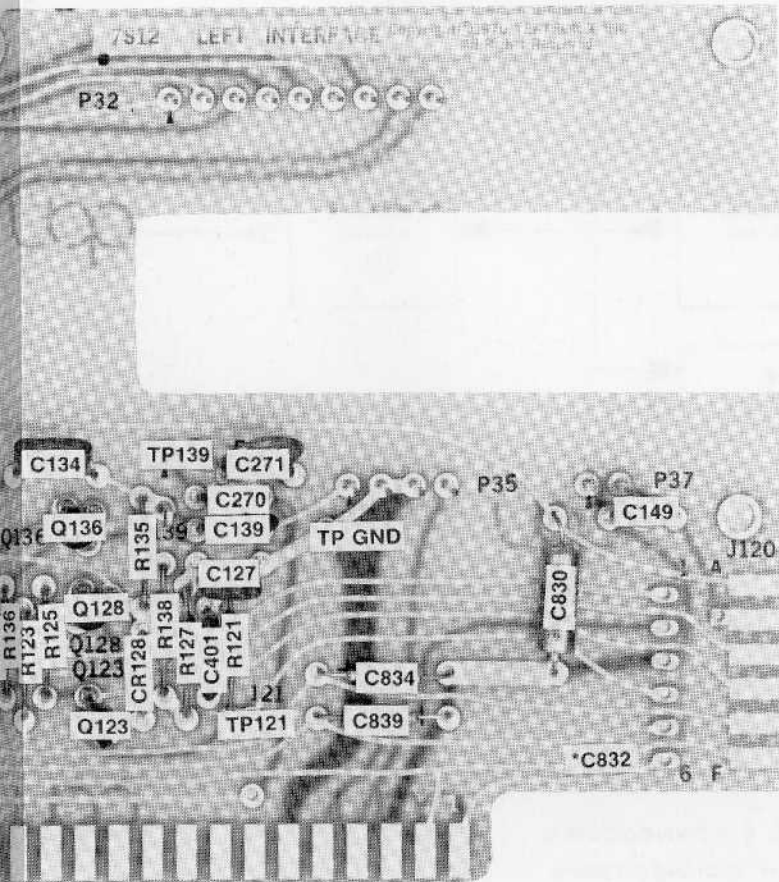

- P35** Grn 4 pin conn  
 1 Blk on wht (50 Ω Coax)  
 2 Shield of P1  
 3 Shield of P4  
 4 Brn on wht (50 Ω Coax)

- P37** Vio 2 pin conn  
 1 Shield of P2  
 2 Red on wht (50 Ω Coax)

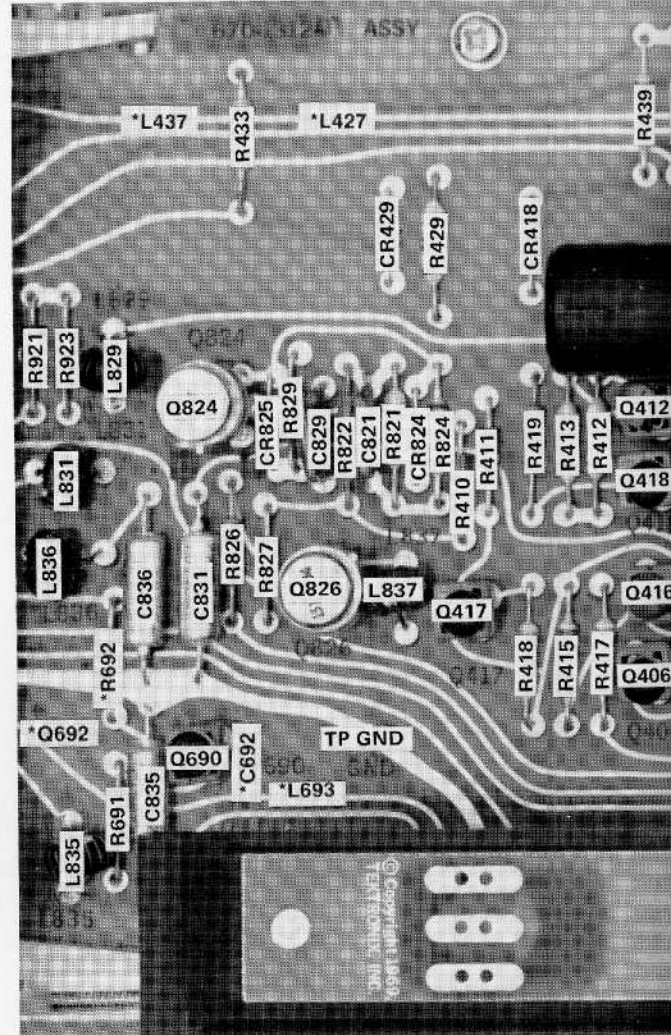

- P31** Brn 7 pin conn  
 1 Brn on wht  
 2 Red on wht  
 3 Orn on wht  
 4 Yel on wht  
 5 Grn on wht  
 6 Blu on wht  
 7 Vio on wht

- P32** Red 9 pin conn  
 1 Brn on wht  
 2 Red on wht  
 3 Orn on wht  
 4 Yel on wht  
 5 Grn on wht  
 6 Blu on wht  
 7 Vio on wht  
 8 Gry on wht  
 9 Blk on wht

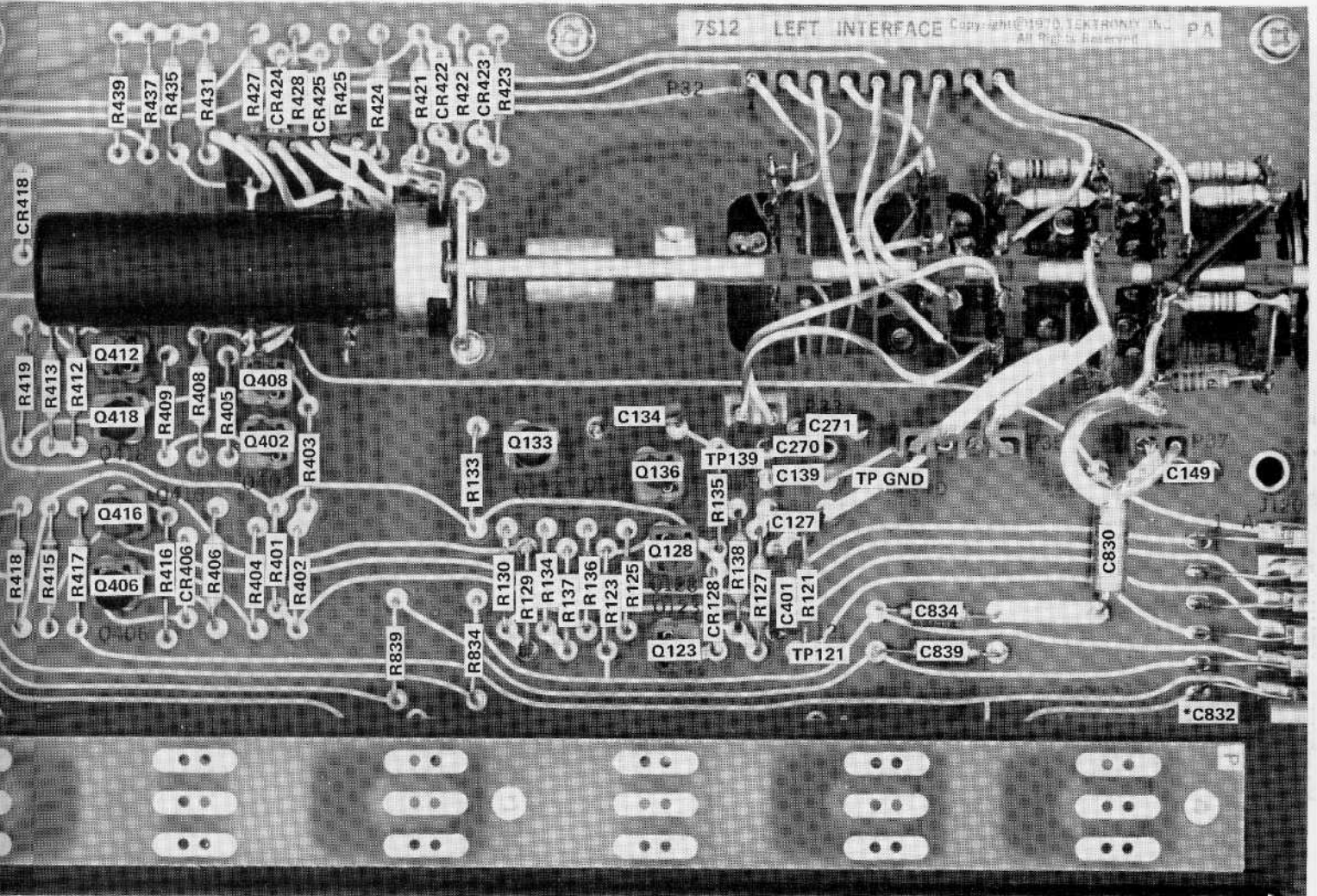

- P33** Orn 2 pin conn  
 1 Brn on wht  
 2 Red on wht

- P35** Grn 4 pin conn  
 1 Blk on wht (50 Ω Coax)  
 2 Shield of P1  
 3 Shield of P4  
 4 Brn on wht (50 Ω Coax)

- P37** Vio 2 pin conn  
 1 Shield of P2  
 2 Red on wht (50 Ω Coax)

\*See Parts List for serial number ranges.

Fig. 7-1b. Assembly A-1, Left Interface board (below SN B10000).

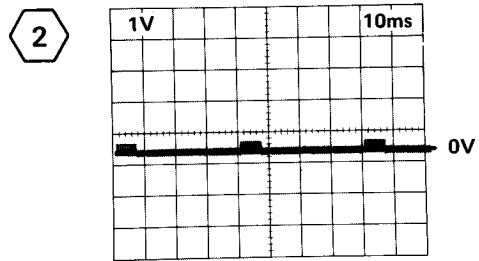
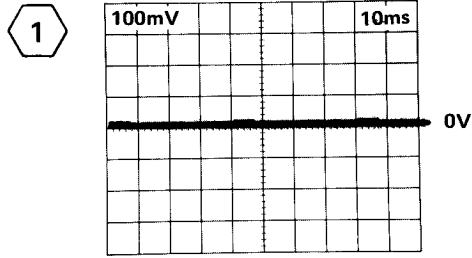

Test oscilloscope triggered internally. For other conditions see page 7-2.

F  
F  
(OF



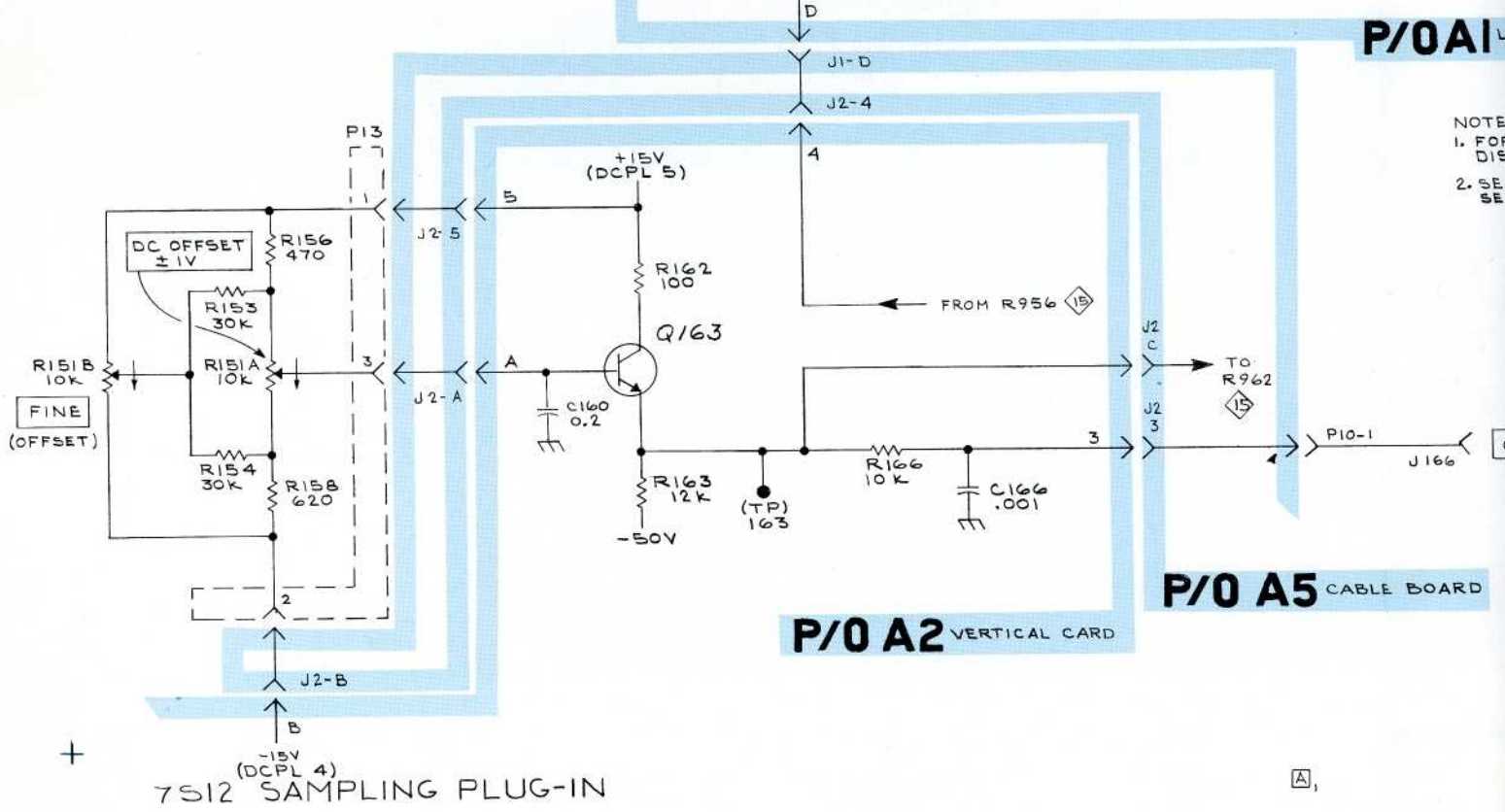
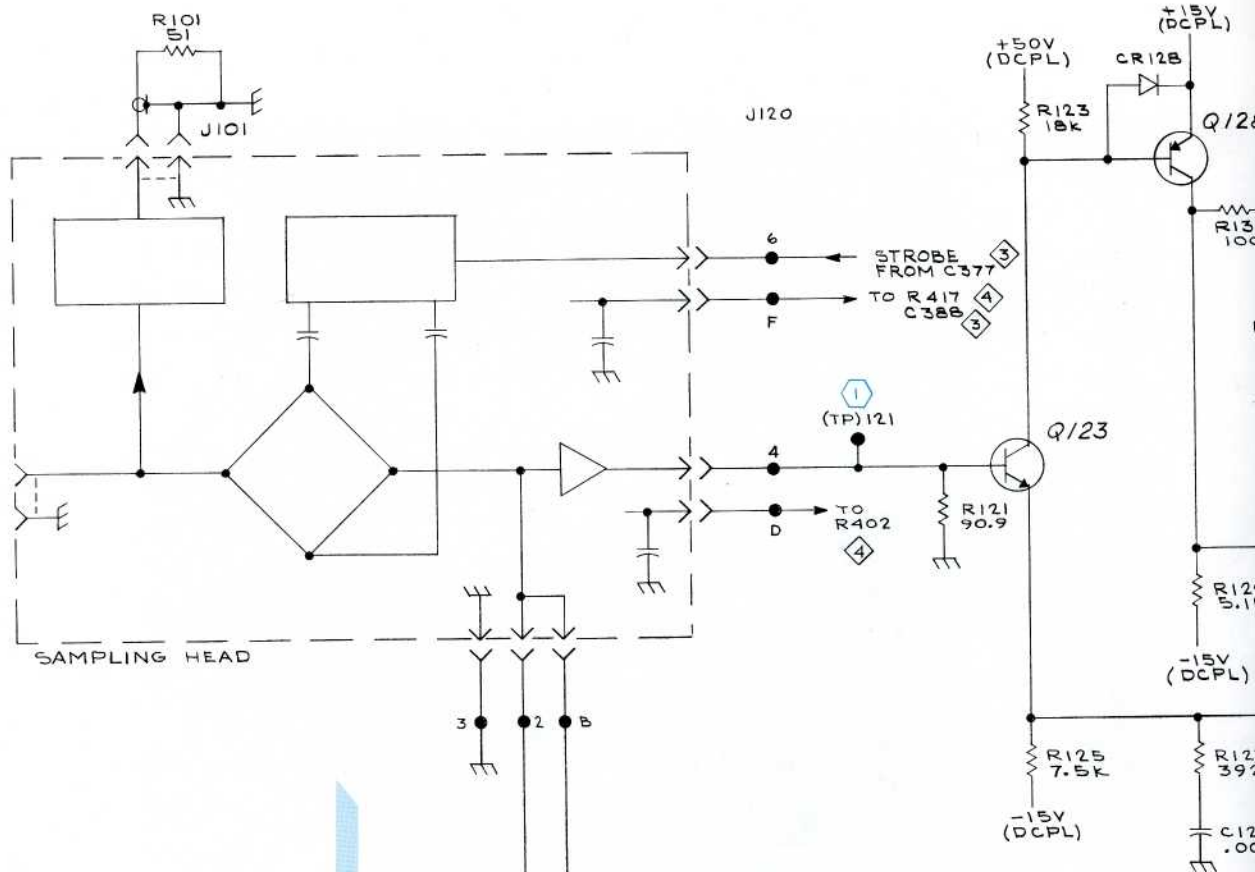

NOTE  
1. FOR DIS  
2. SEE SE

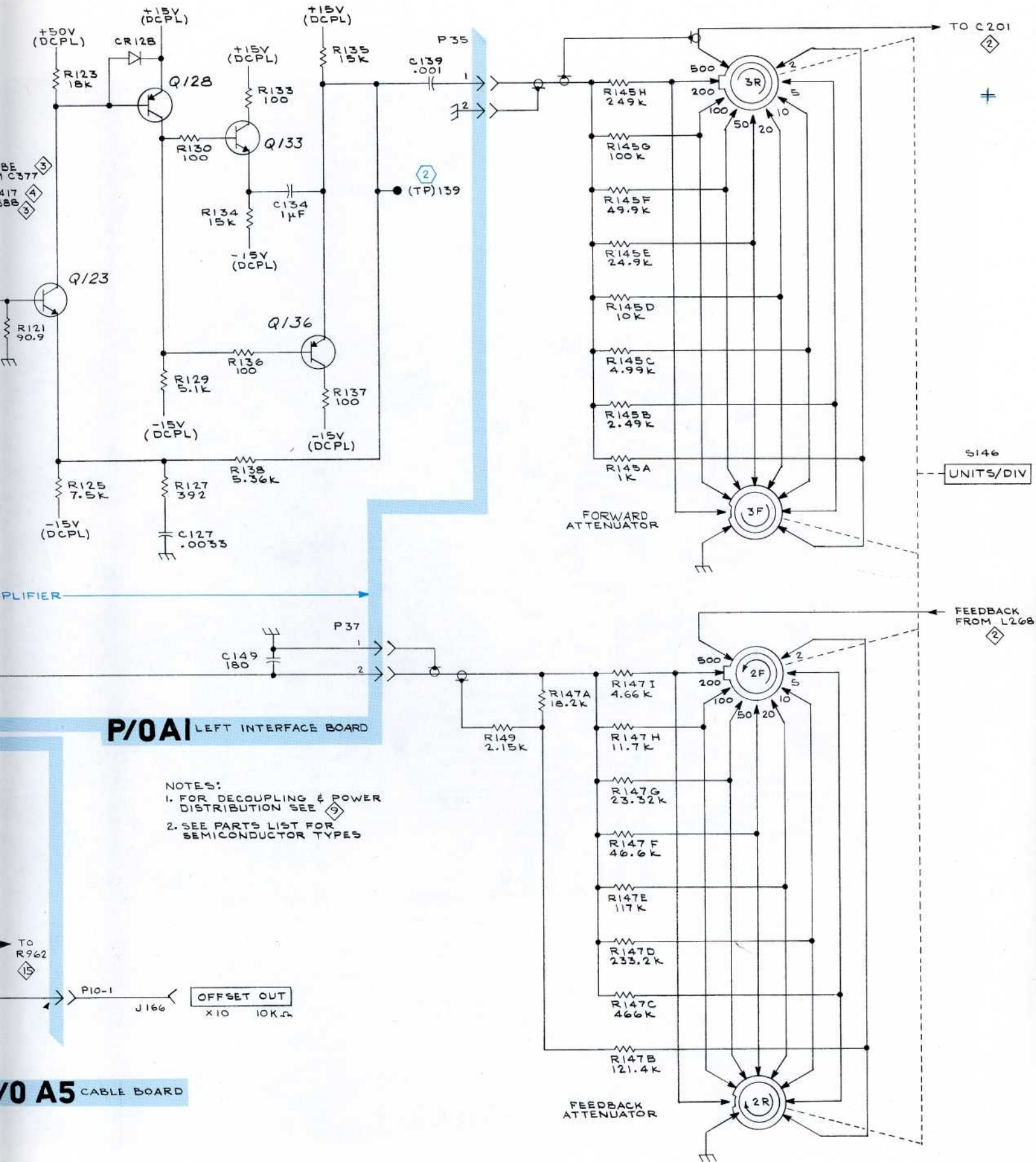

**P/OAI** LEFT INTERFACE BOARD

- NOTES:  
 1. FOR DECOUPLING & POWER DISTRIBUTION SEE [9]  
 2. SEE PARTS LIST FOR SEMICONDUCTOR TYPES

OFFSET OUT  
 X10 10KΩ

**P/O A5** CABLE BOARD





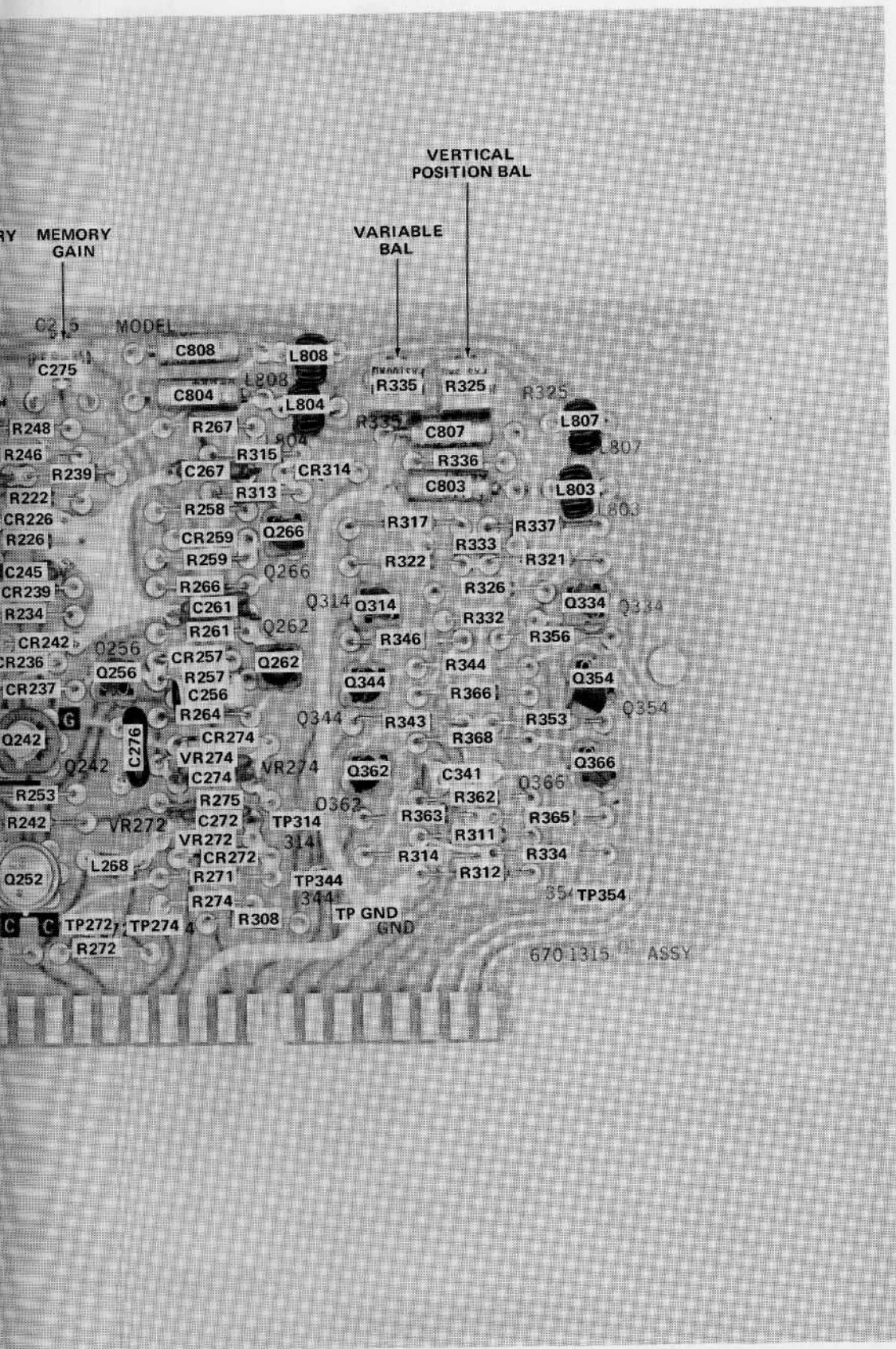

VERTICAL  
POSITION BAL

VARIABLE  
BAL

RY MEMORY  
GAIN

MODEL

670 1315 ASSY

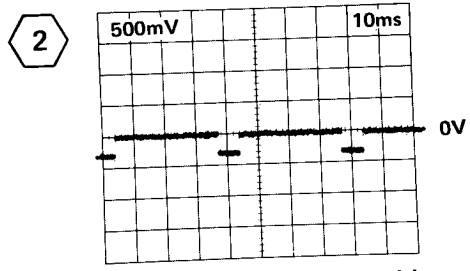
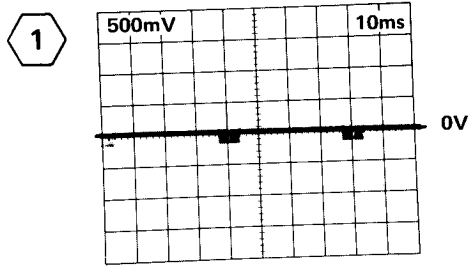

This waveform is affected by DC OFFSET control.

Test oscilloscope triggered internally. For other conditions see page 7-2.



- NOTES:  
 1. FOR DECOUPLING & POWER DISTRIBUTION SEE  $\diamond$   
 2. SEE PARTS LIST FOR SEMICONDUCTOR TYPES

**P/O A2** VERTICAL CARD

(TP) 274

AC AMPLIFIER

MEMORY GATE

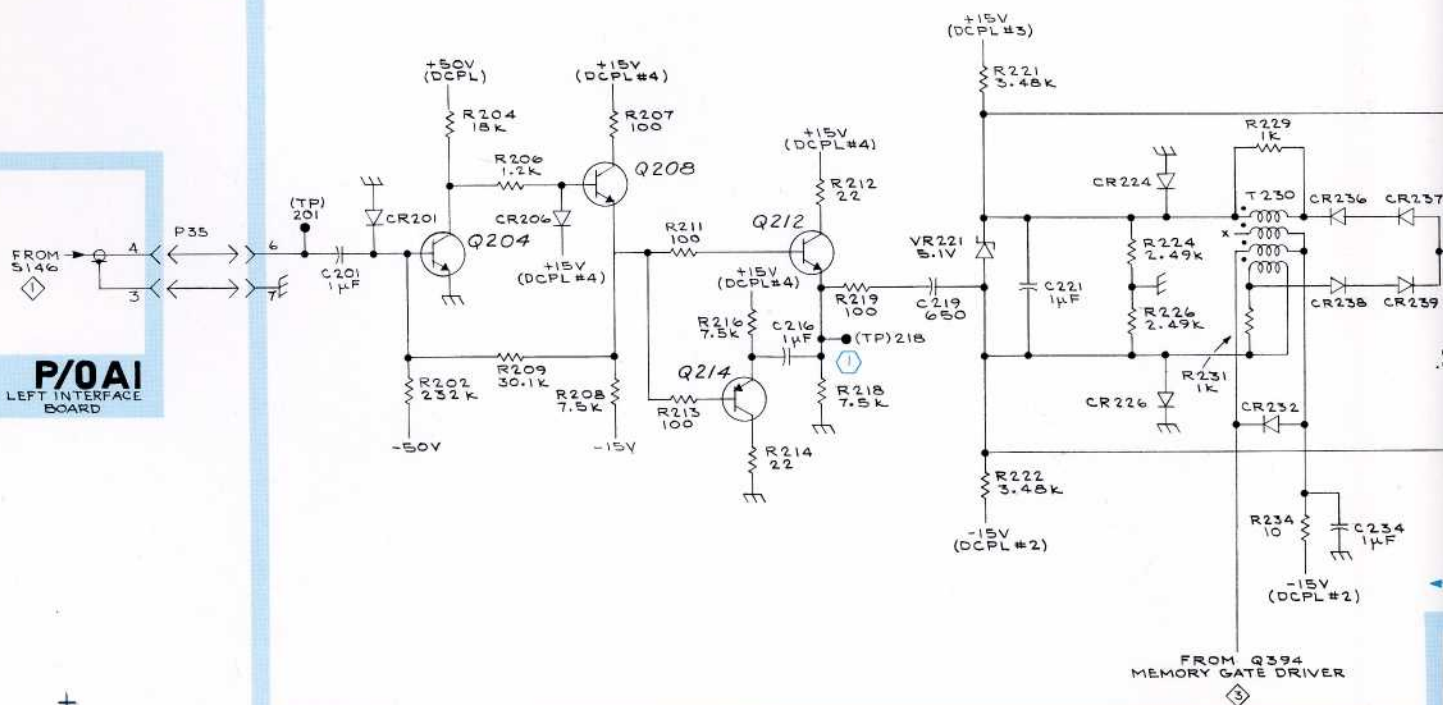

**P/O A1**  
LEFT INTERFACE BOARD

**P/O A1** LEFT INTERFACE BOARD

**P/O A5** CABLE BOARD

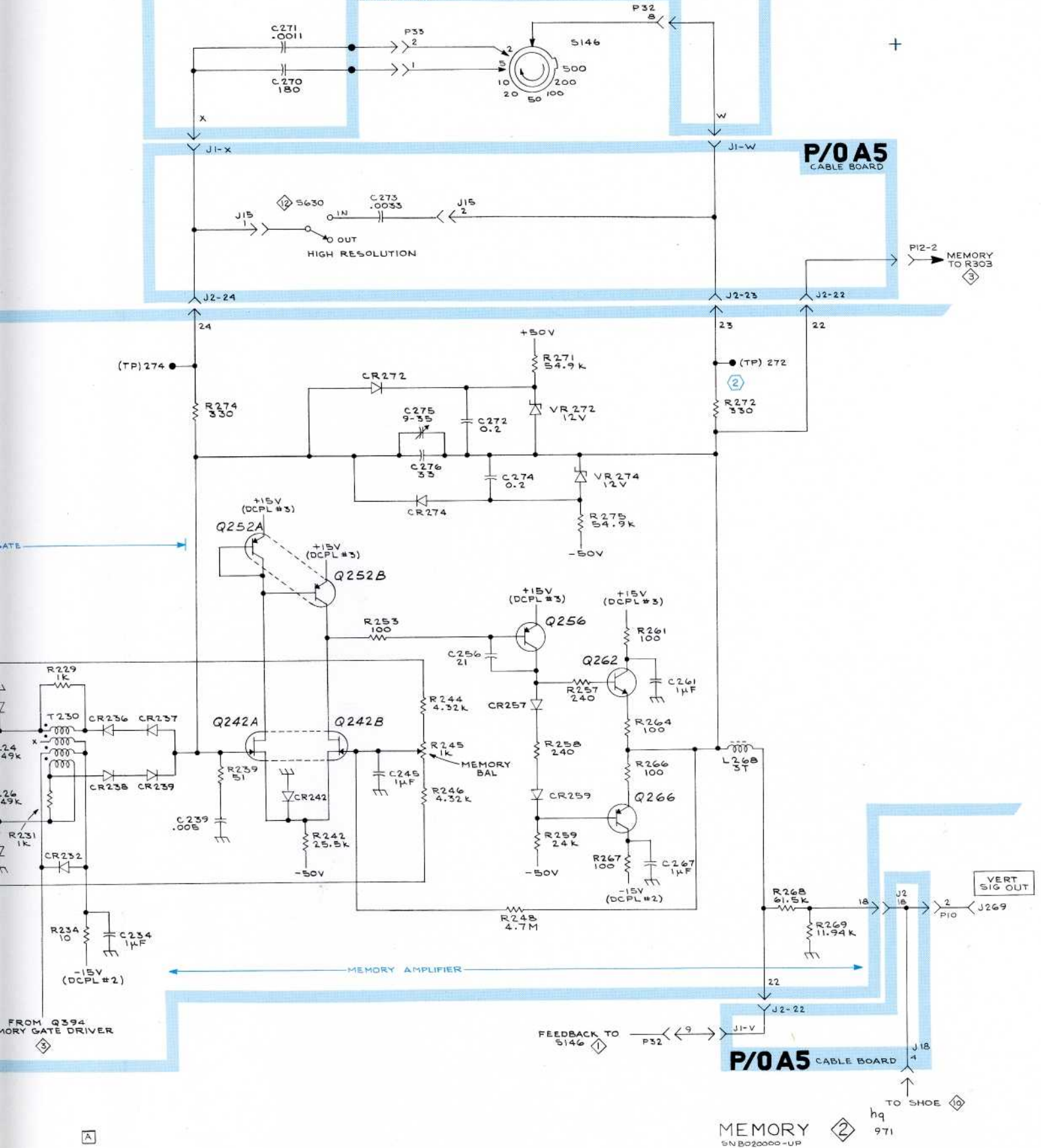

MEMORY  
SNB020000-UP

A

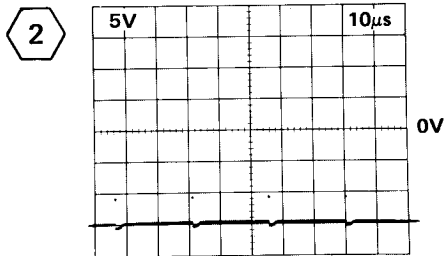
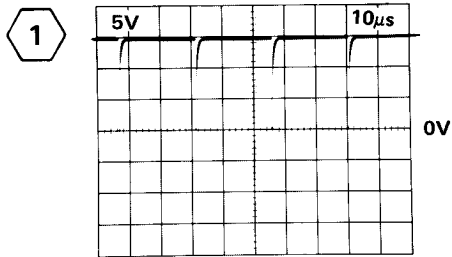

Test oscilloscope triggered from Right Interface board  
TP 504 signal. For other conditions see page 7-2.



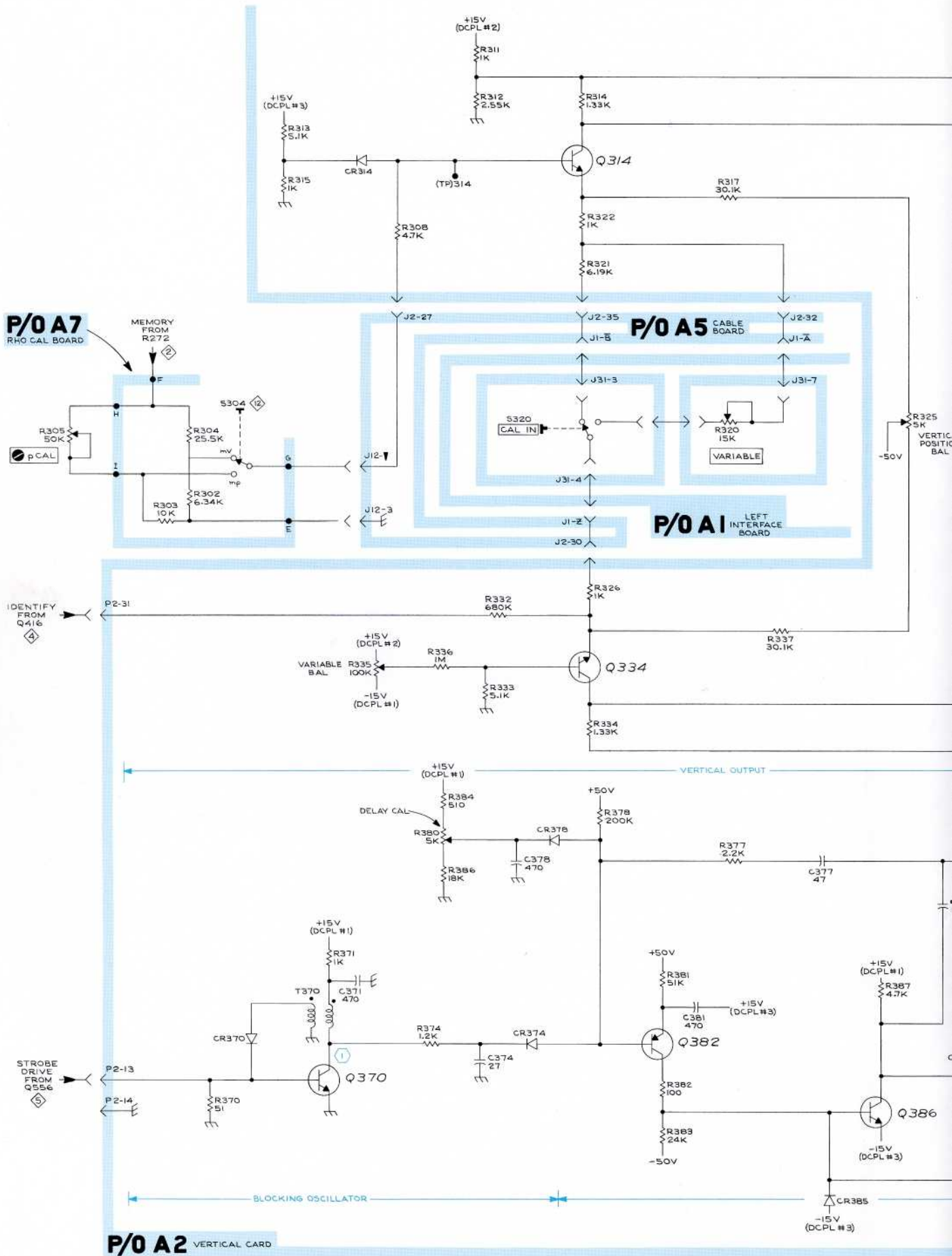

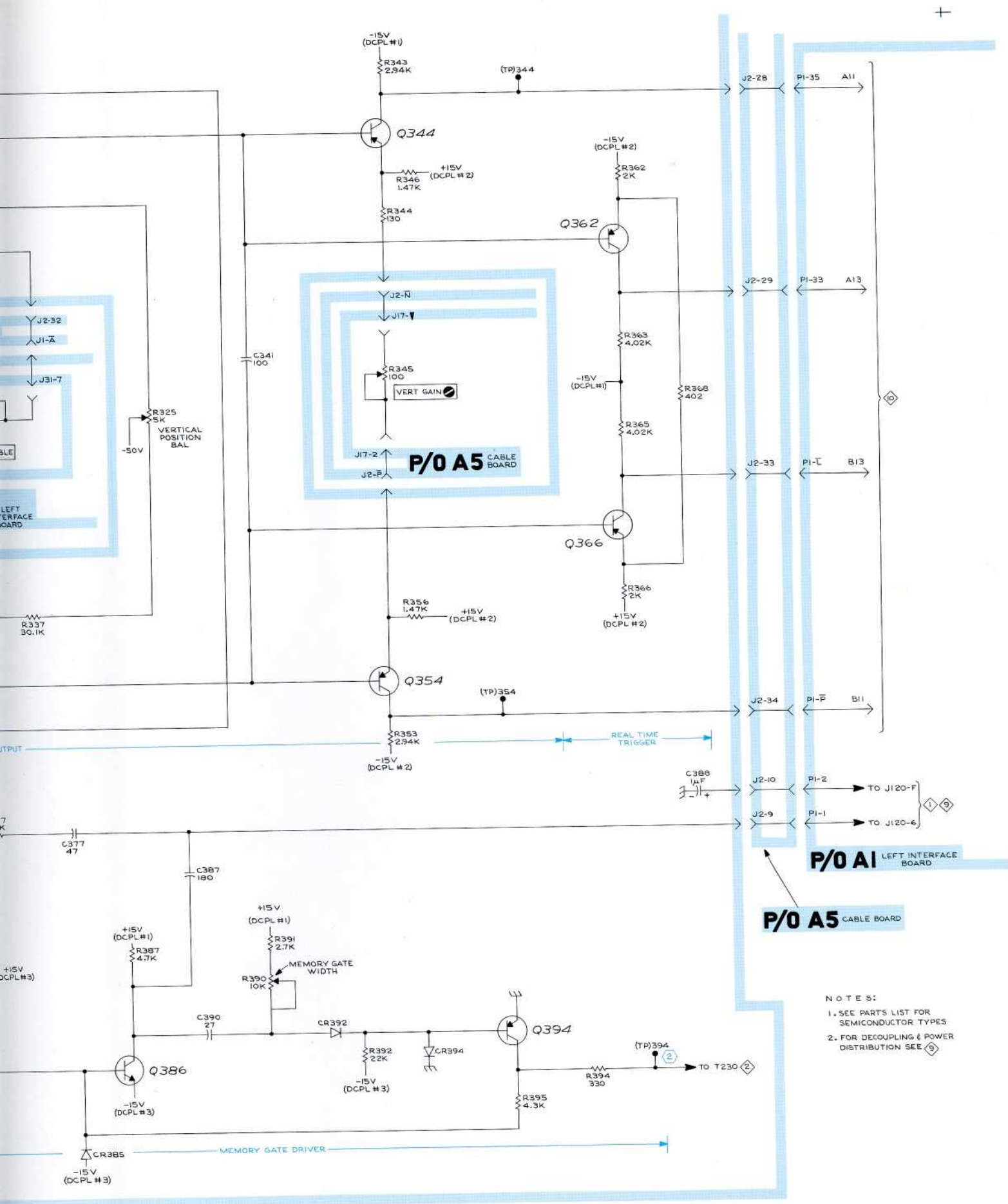

- NOTES:
1. SEE PARTS LIST FOR SEMICONDUCTOR TYPES
  2. FOR DECOUPLING & POWER DISTRIBUTION SEE ⑨

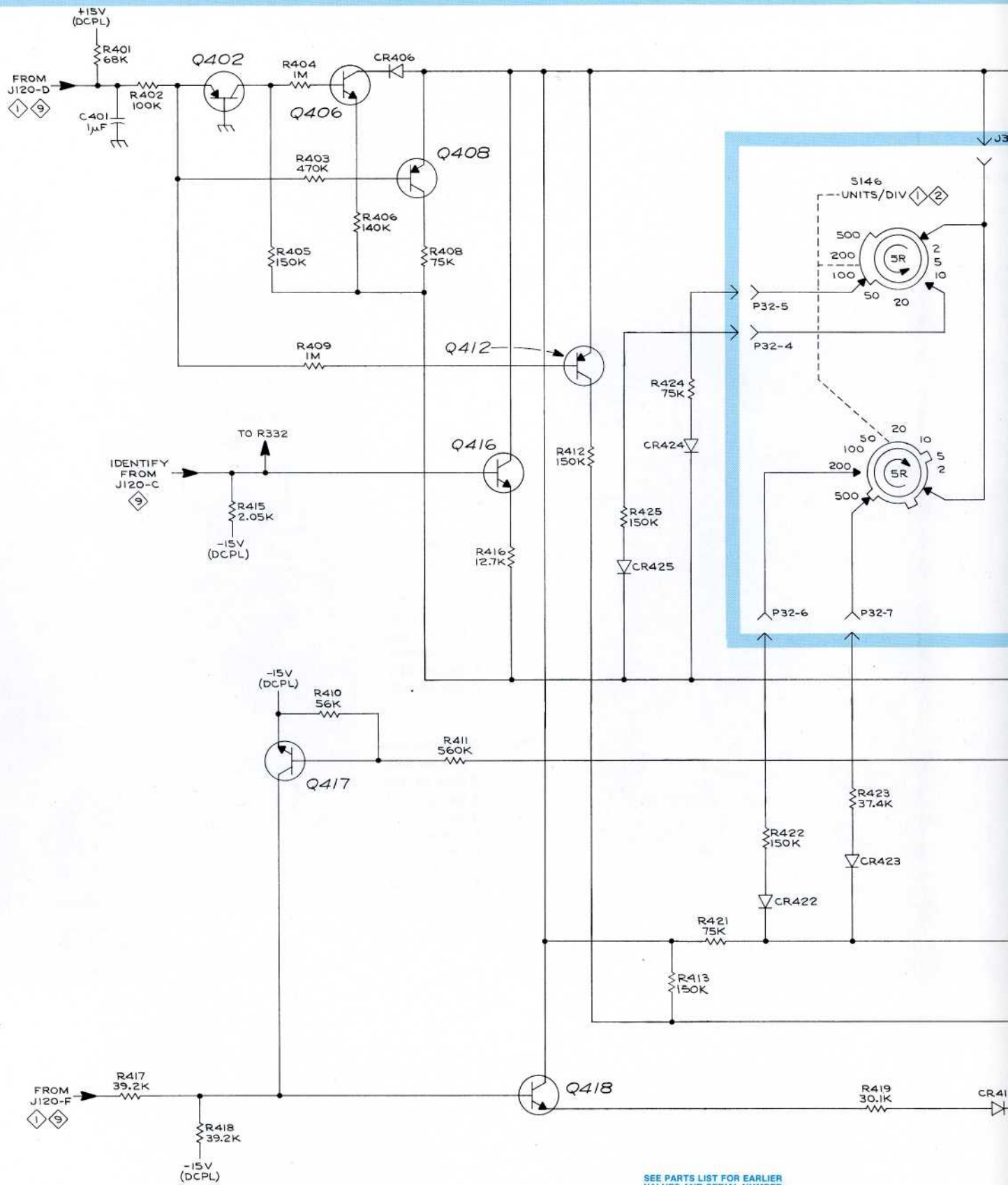

**P/O AI** LEFT INTERFACE BOARD

7512 SAMPLING PLUG-IN

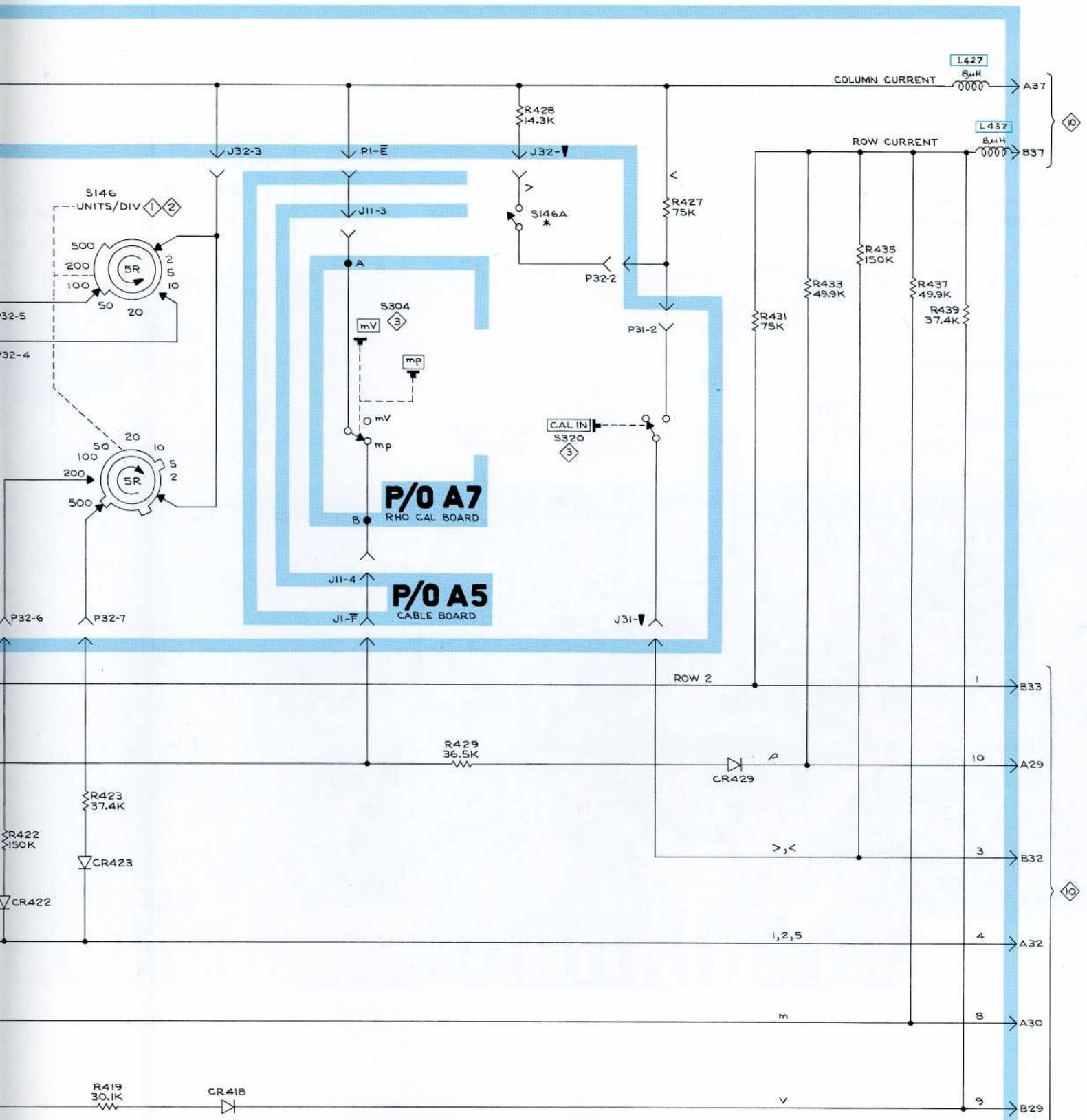

- NOTES:
1. SEE PARTS LIST FOR SEMICONDUCTOR TYPES
  2. FOR DECOUPLING & POWER DISTRIBUTION SEE ⑨
  3. \*CONCENTRIC WITH UNITS/DIV, S146 GANGED WITH VARIABLE, R320



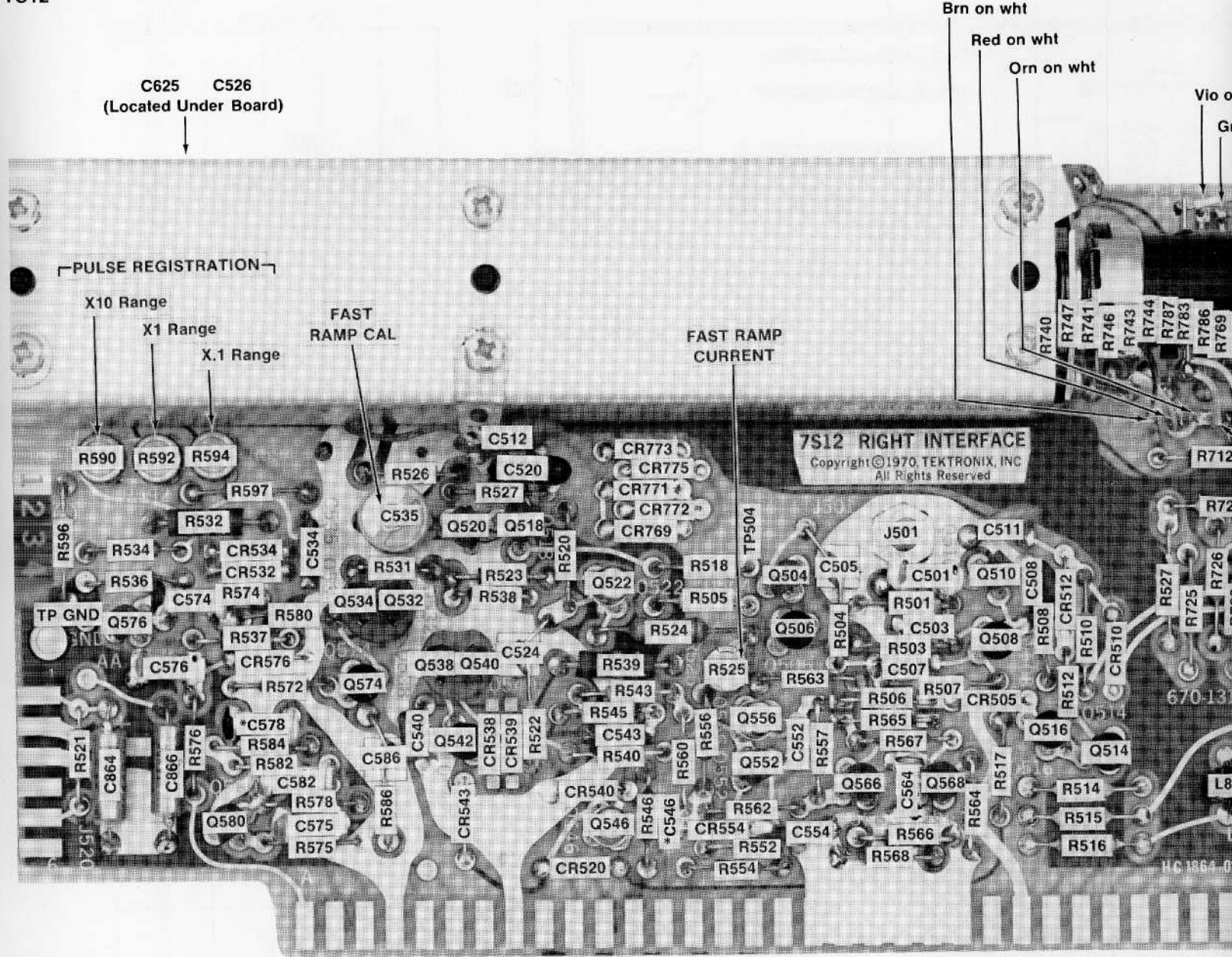

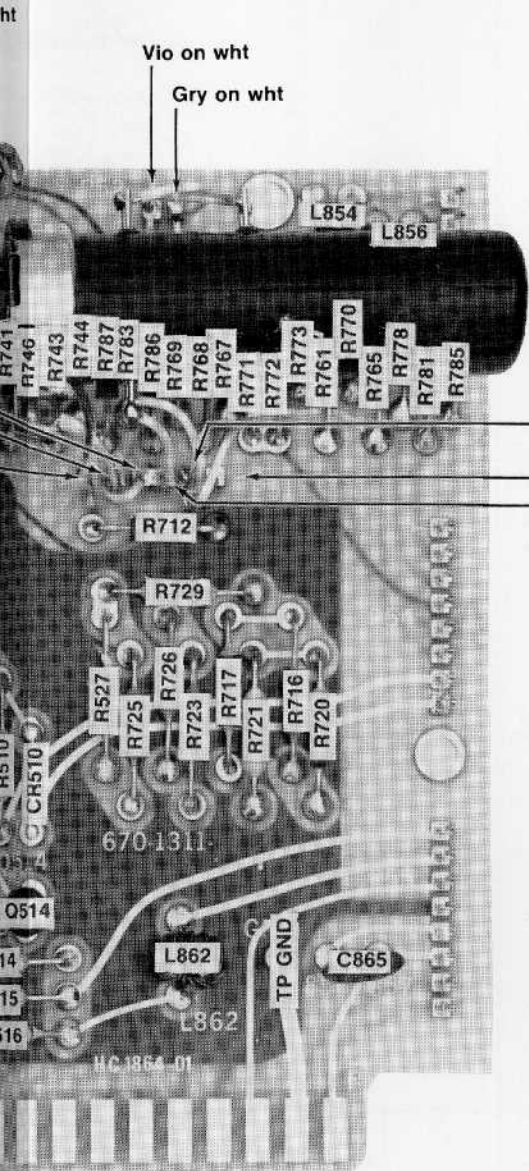

P53 Orn 2 pin conn  
1 Brn on wht  
2 Red on wht

Grn on wht  
Blu on wht  
Yel on wht

P54 Yel 8 pin conn  
1 Brn on wht  
2 Red on wht  
3 Orn on wht  
4 Yel on wht  
5 Grn on wht  
6 Blu on wht  
7 Vio on wht  
8 Gry on wht

P55 Grn 8 pin conn  
1 Brn on wht  
2 Red on wht  
3 Orn on wht  
4 Yel on wht  
5 Grn on wht  
6 Blu on wht  
7 Vio on wht  
8 Gry on wht

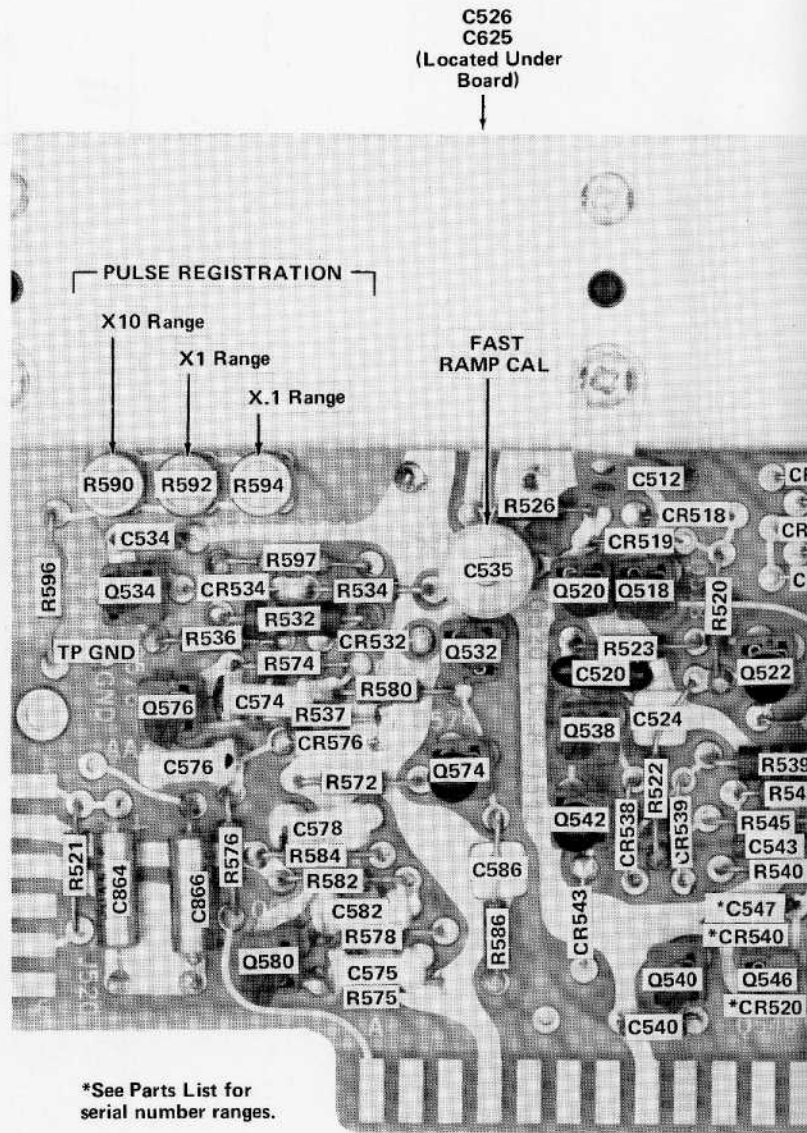

\*See Parts List for  
serial number ranges.

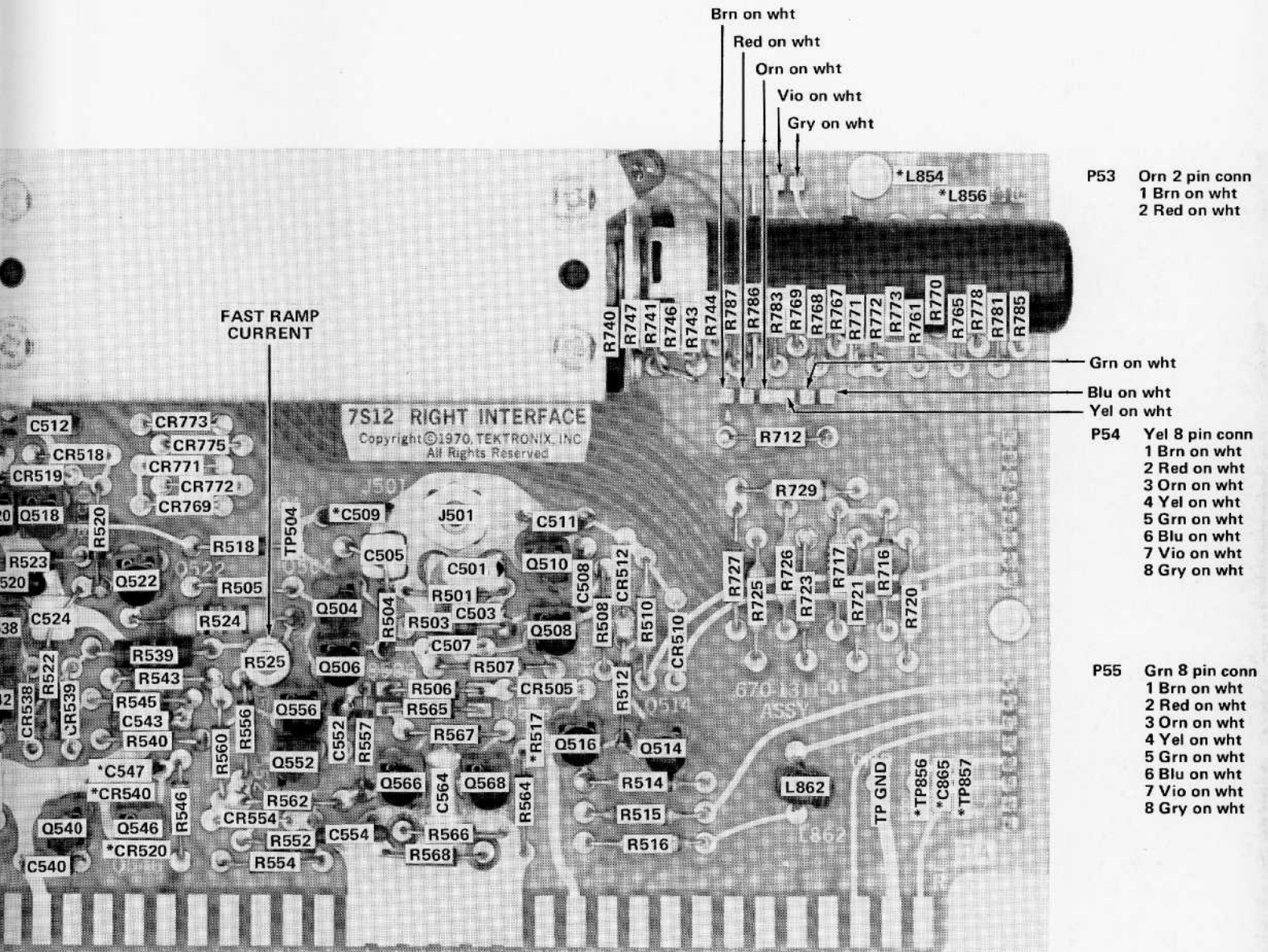
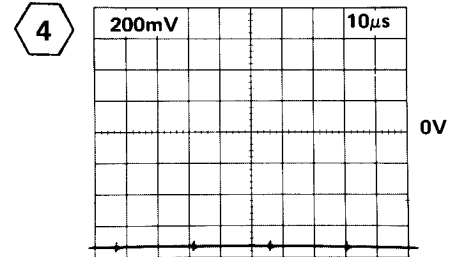
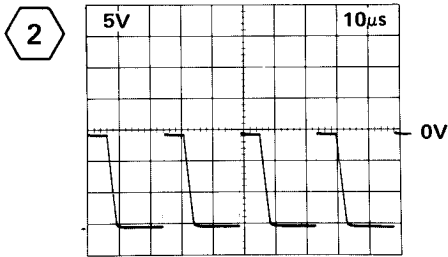
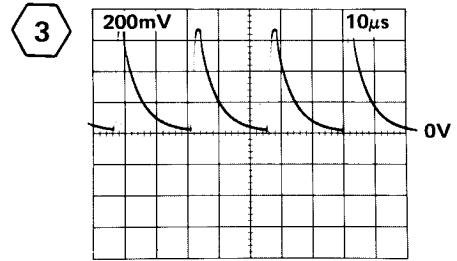
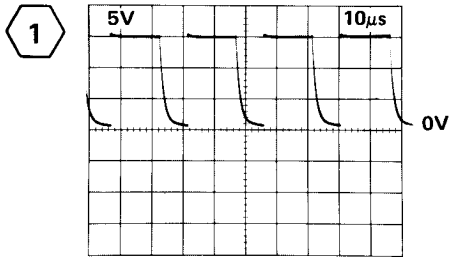
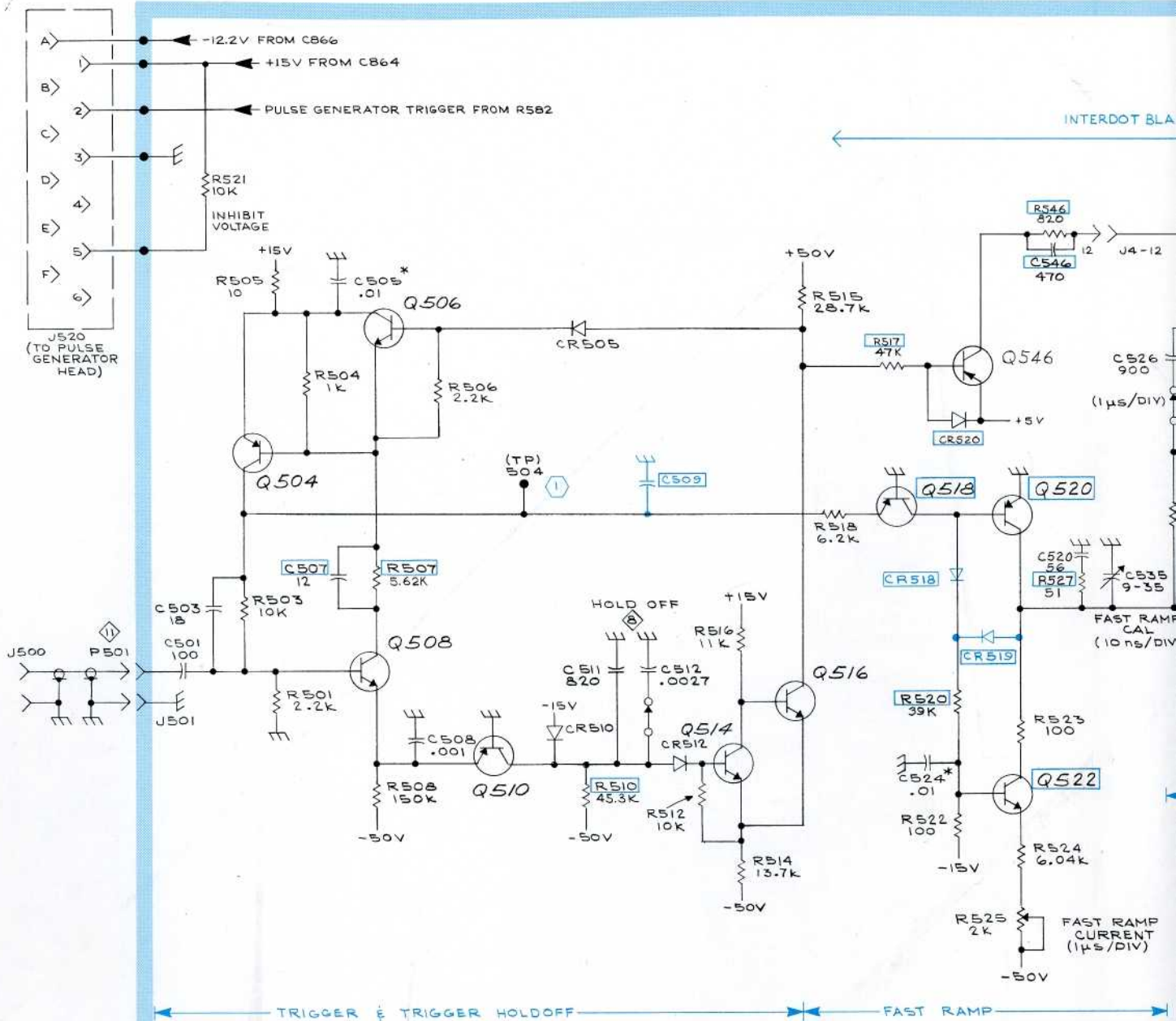

Fig. 7-3b. Assembly A-3, Right Interface (below SN B10000).



Test oscilloscope triggered from Right Interface board  
TP 504 signal. For other conditions see page 7-2.





**P/O A3** RIGHT INTERFACE BOARD

NOTES:

1. \* DENOTES LEADLESS CAPACITOR
2. FOR POWER DISTRIBUTION & DECOUPLING SEE DIAGRAM
3. SEE PARTS LIST FOR SEMICONDUCTOR TYPES



SEE PARTS LIST FOR EARLIER VALUES AND SERIAL NUMBER RANGES OF PARTS OUTLINED OR DEPICTED IN BLUE.

+

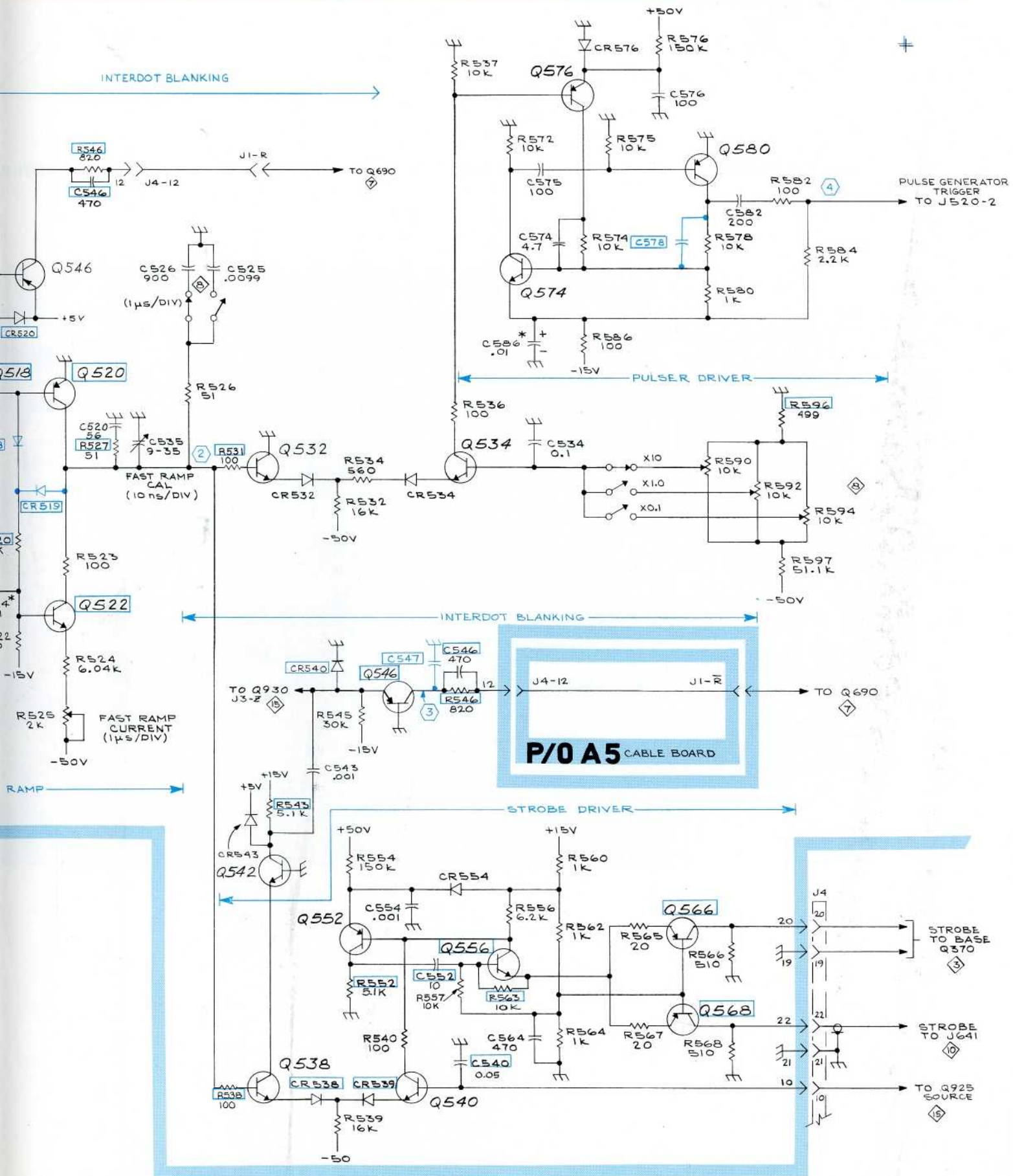

TRIGGER, FAST RAMP, PULSER, STROBE DRIVERS & COMPARATORS

hq  
573



3N B010000-UP

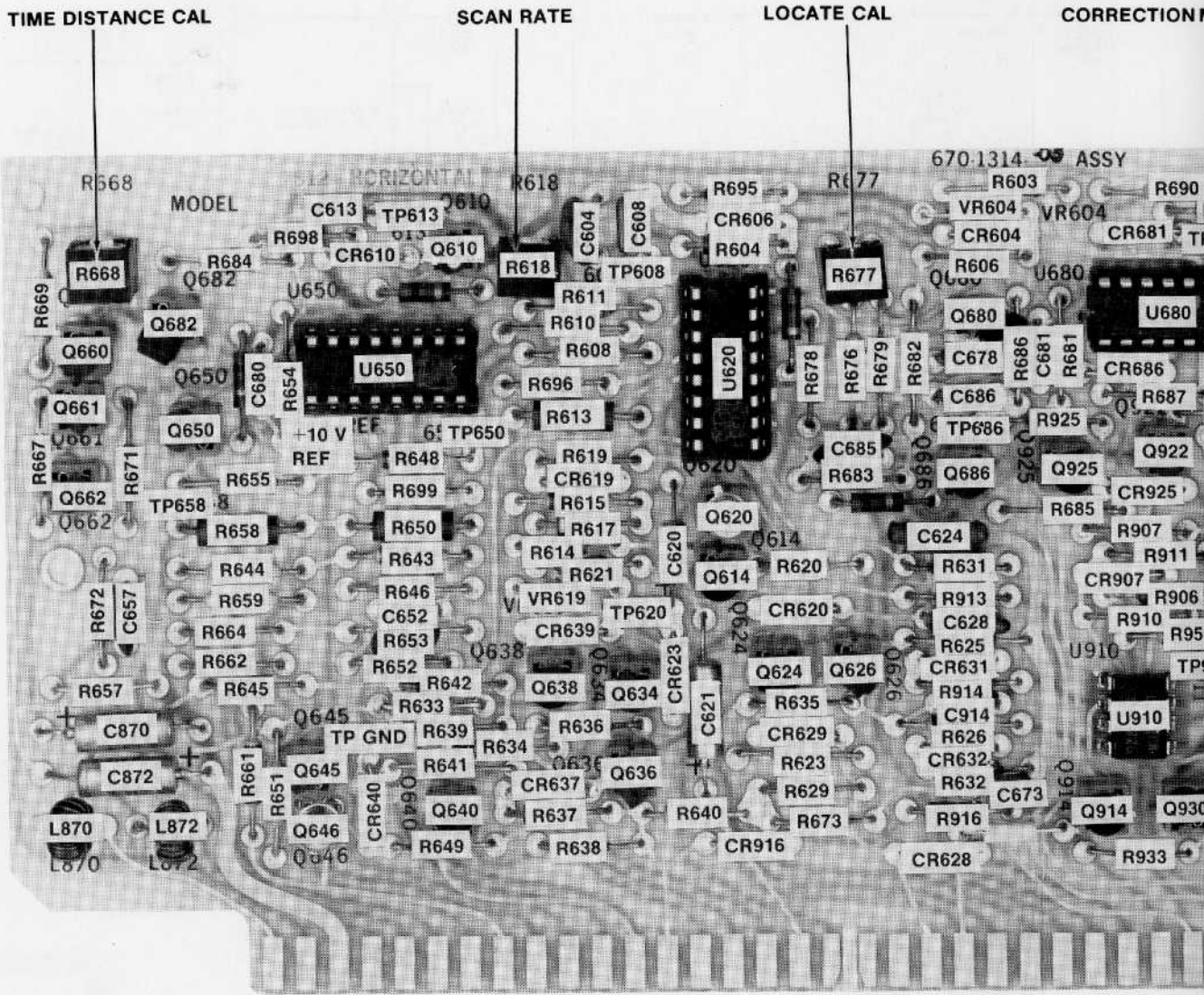
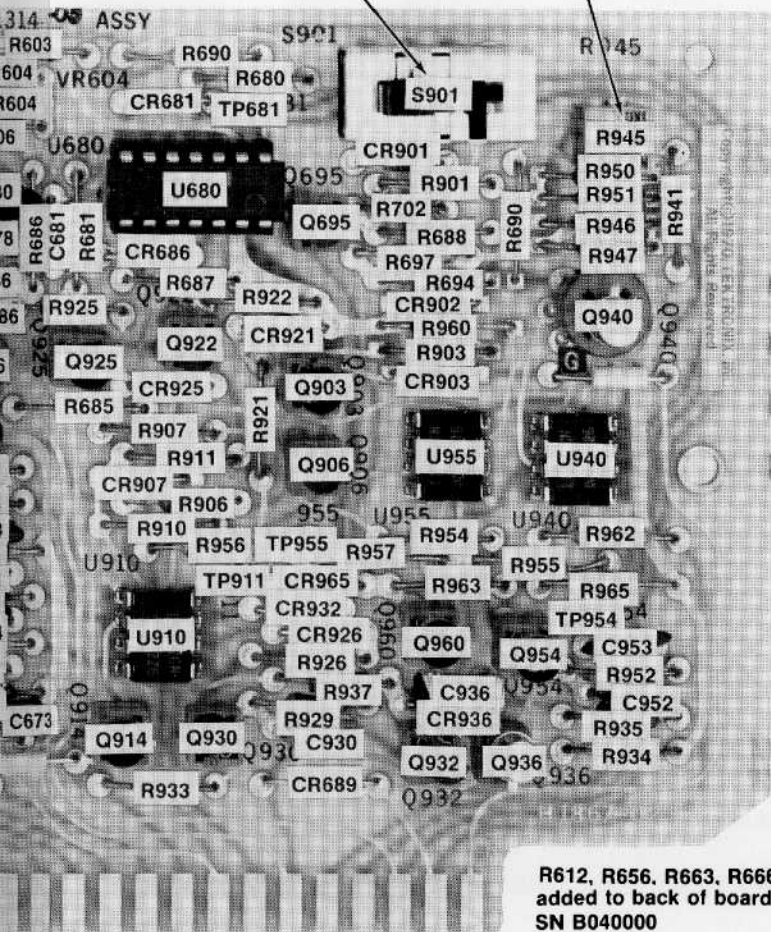

Fig. 7-4a. Assembly A-4, Horizontal Card (SN B10000 & up).



CORRECTION MEMORY CONTROL

MEMORY BAL



R612, R656, R663, R666  
added to back of board  
SN B040000

TIME-DISTANCE CAL

SCAN RA

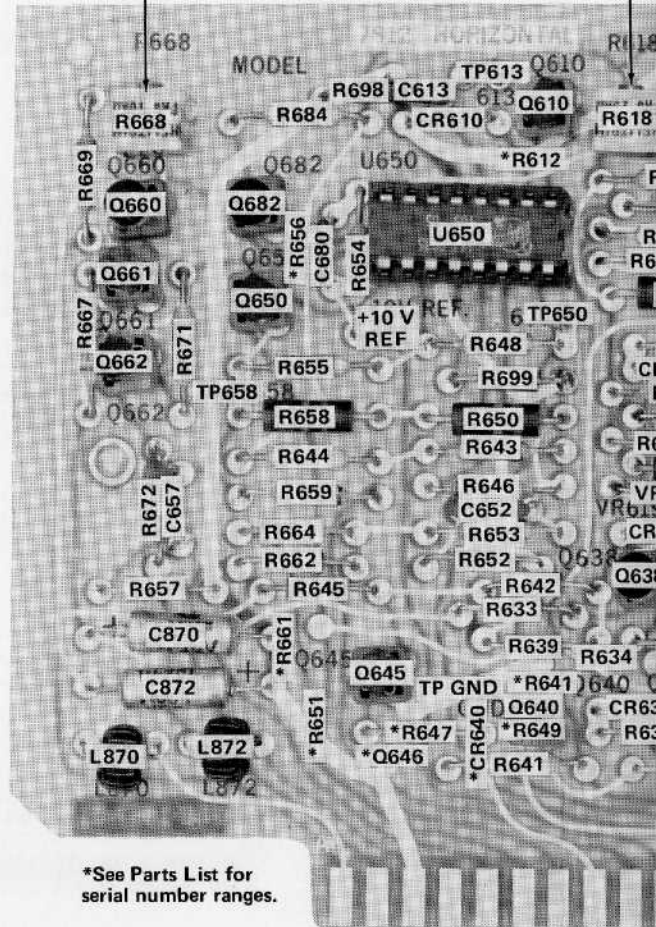

\*See Parts List for  
serial number ranges.

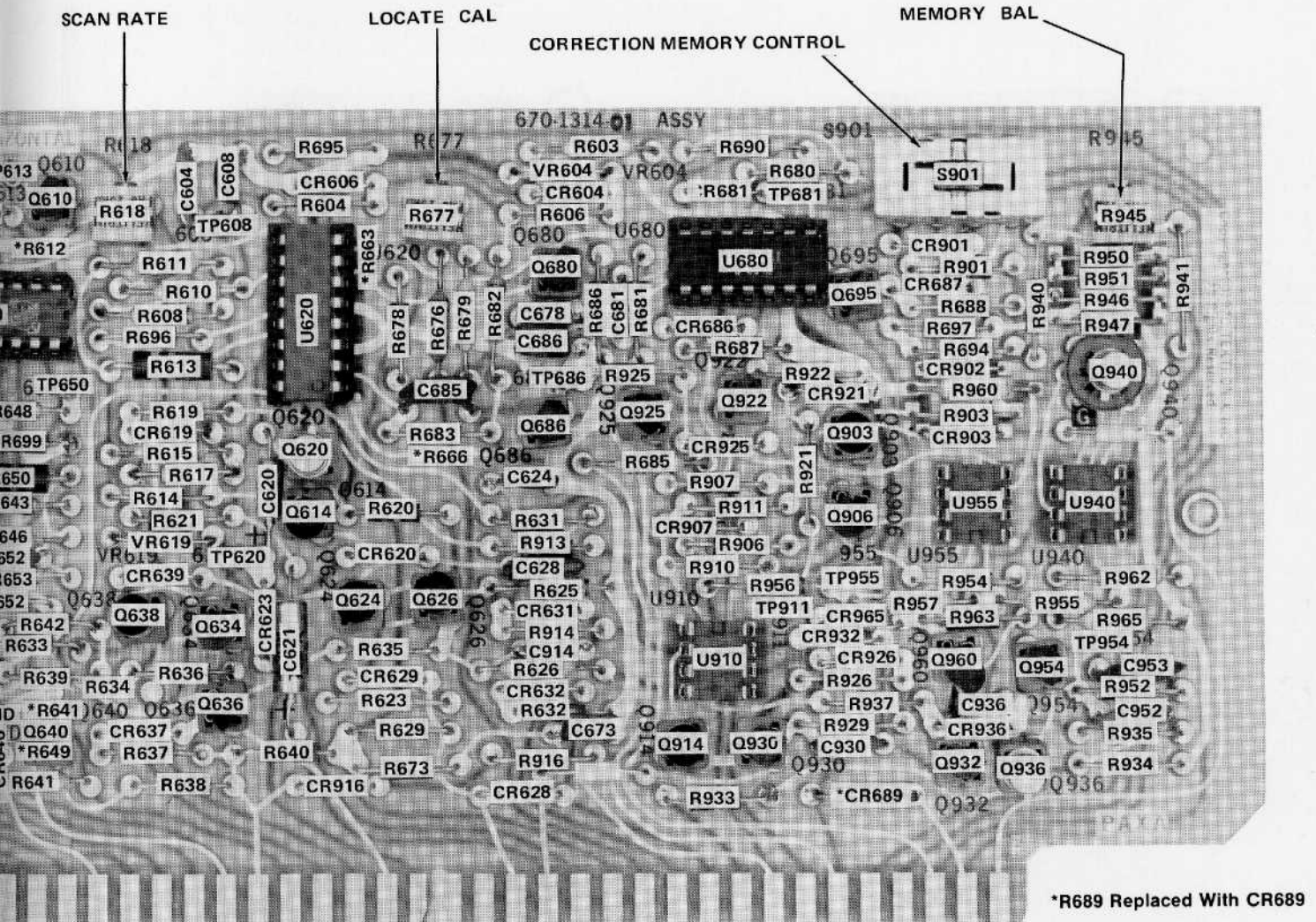
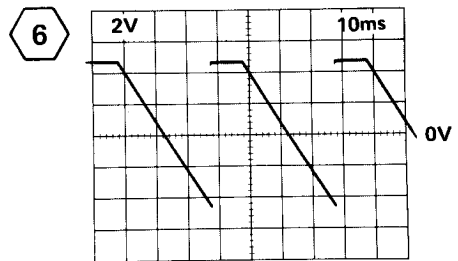
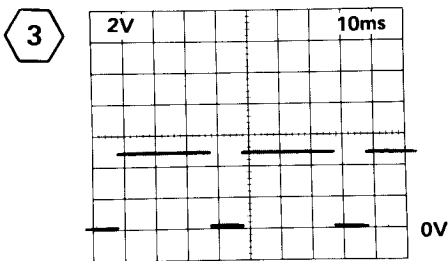
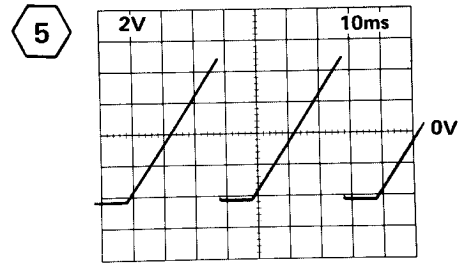
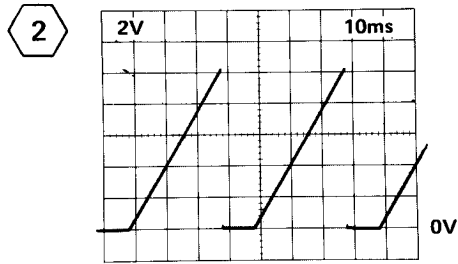
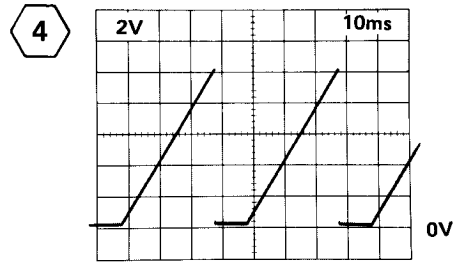
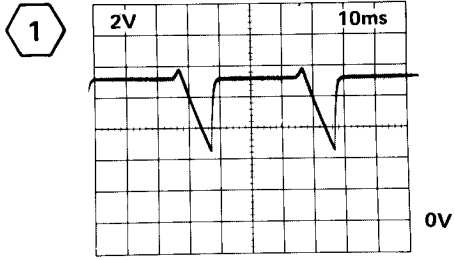

Fig. 7-4b. Assembly A-4, Horizontal Card (below SN B10000).

Rev. D, AUG. 1974

R612, R656, R663, R666  
 added to back of board  
 SN B040000



Test oscilloscope triggered from SWEEP OUT signal.  
For other conditions see page 7-2.

**← WAVEFORMS**

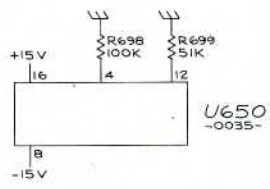
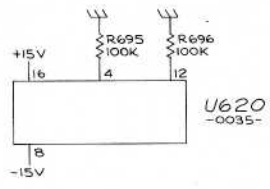

**P/O A5 CABLE BOARD**

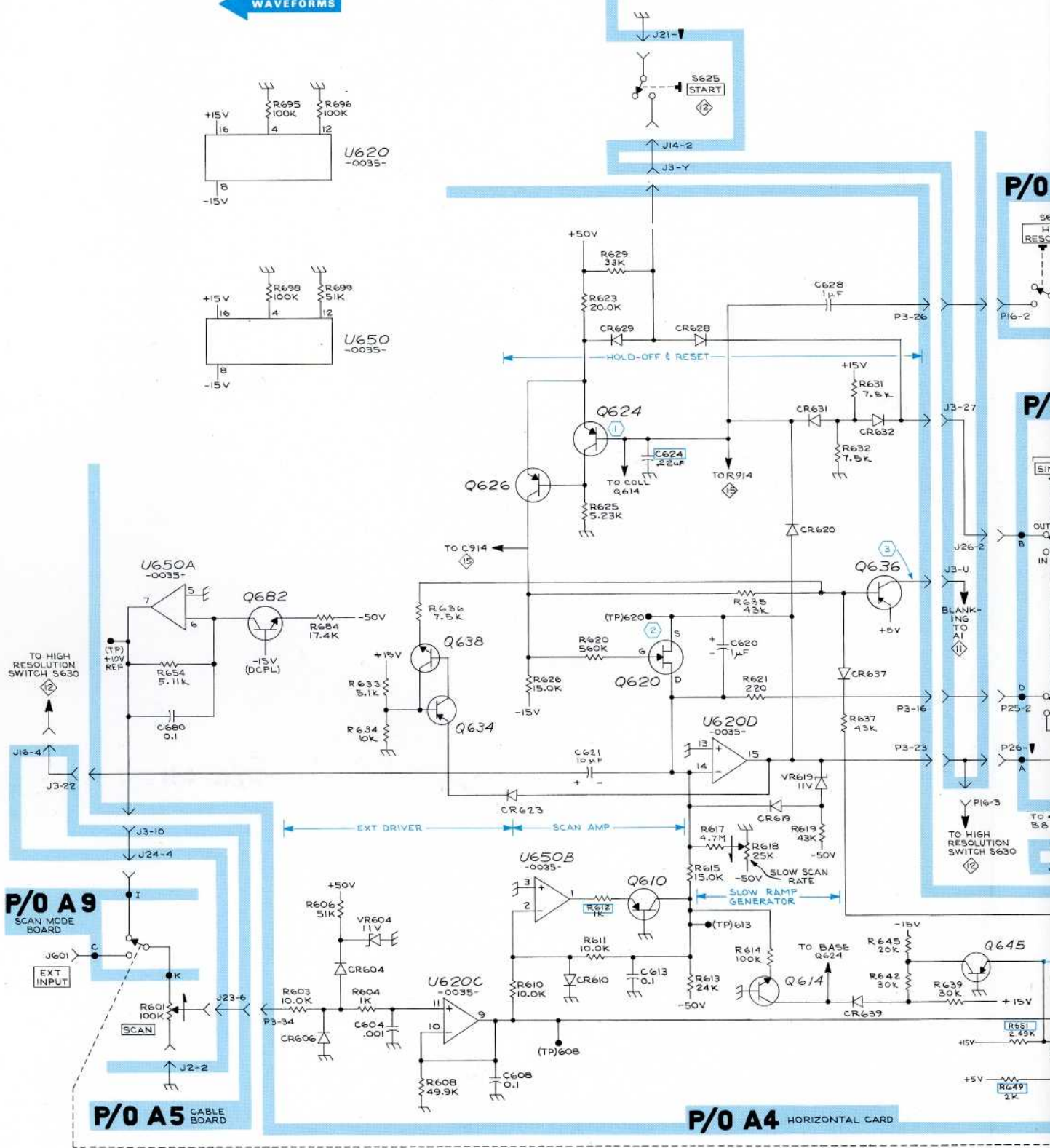

**P/O A9**  
SCAN MODE BOARD

**P/O A5** CABLE BOARD

**P/O A4** HORIZONTAL CARD



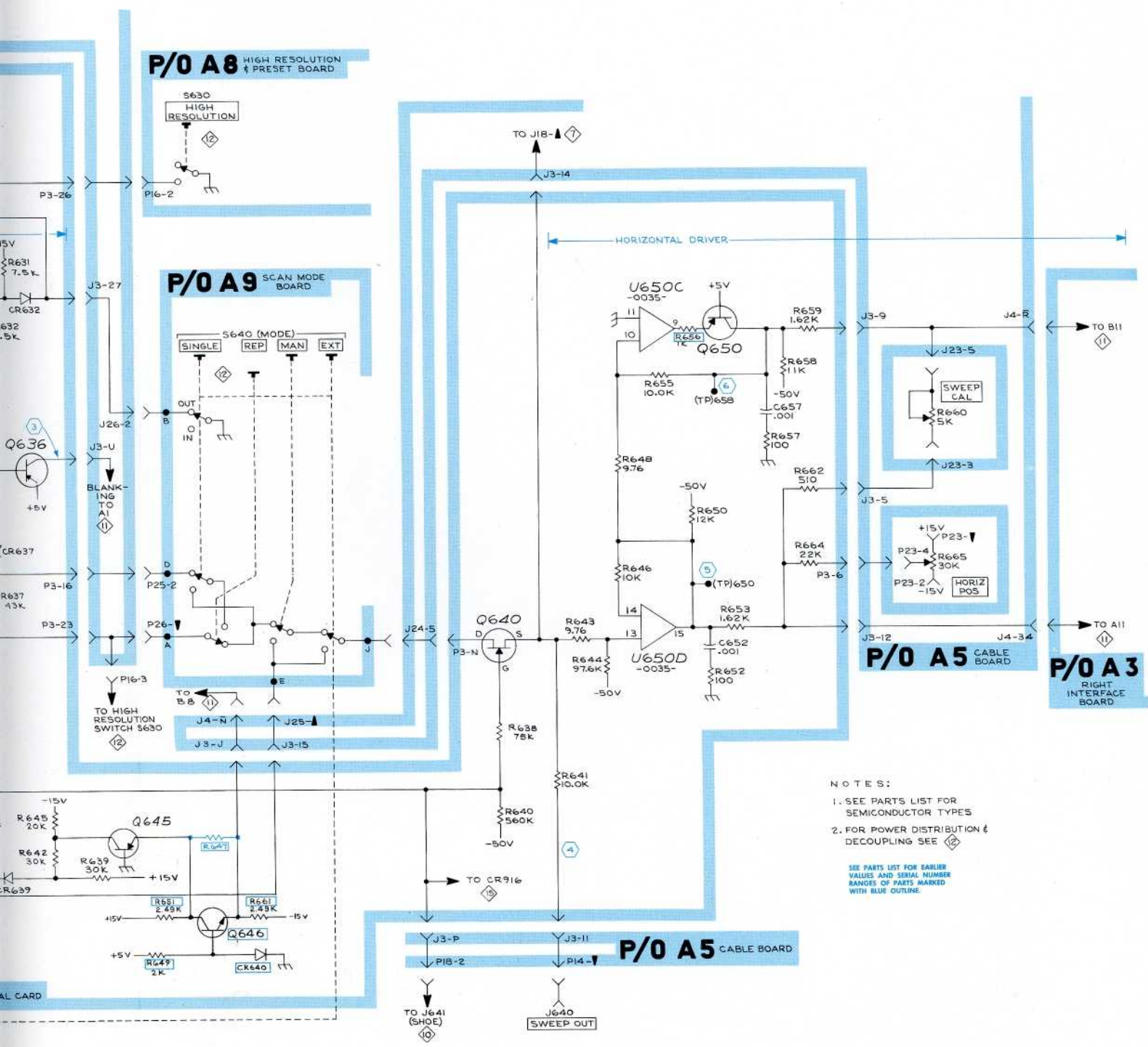

- NOTES:
1. SEE PARTS LIST FOR SEMICONDUCTOR TYPES
  2. FOR POWER DISTRIBUTION & DECOUPLING SEE [6]

SEE PARTS LIST FOR EARLIER VALUES AND SERIAL NUMBER RANGES OF PARTS MARKED WITH BLUE OUTLINE.



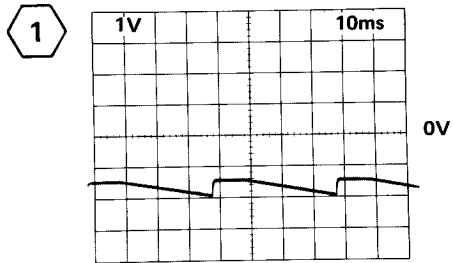

**Test oscilloscope triggered from SWEEP OUT signal.  
For other conditions see page 7-2.**

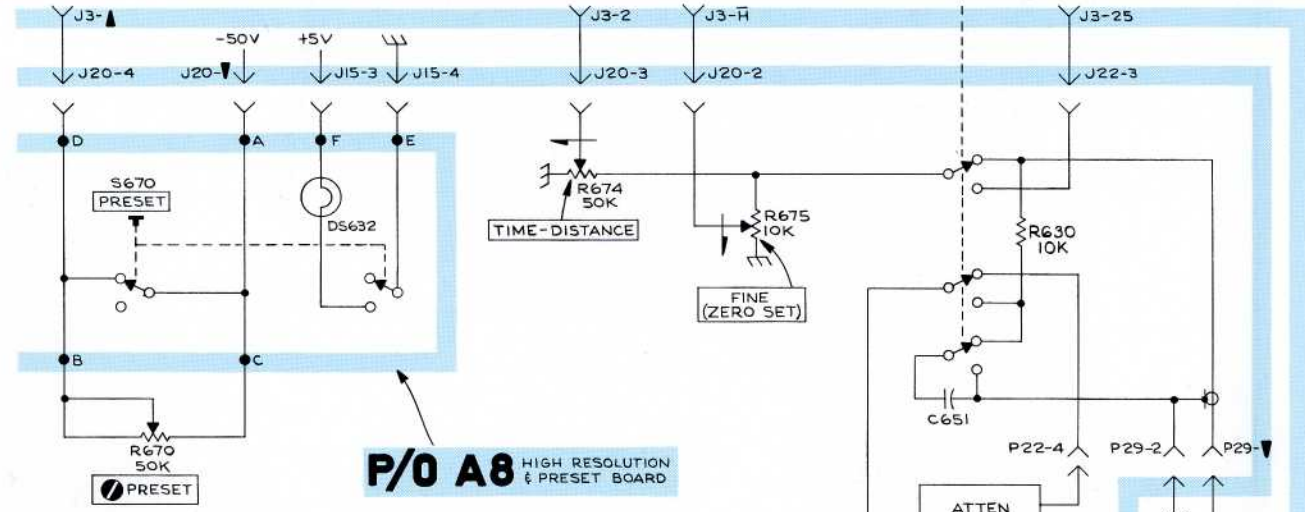
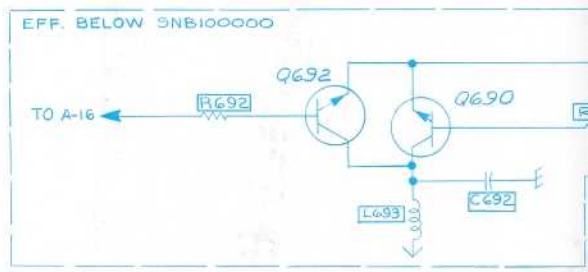
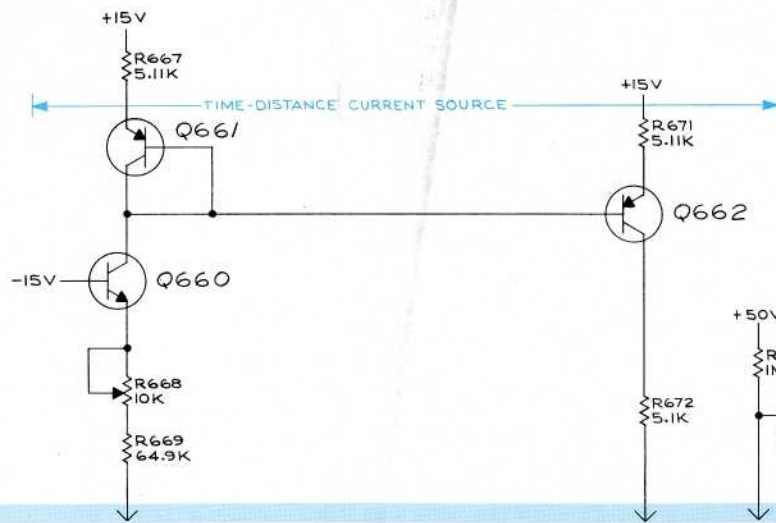

← WAVEFORM

- NOTES:
1. SEE PARTS LIST FOR SEMICONDUCTOR TYPES
  2. POWER DISTRIBUTION & DECOUPLING SEE (1)

SEE PARTS LIST FOR EARLIER VALUES AND SERIAL NUMBER RANGES OF PARTS OUTLINED OR DEPICTED IN BLUE.

**P/O A5** CABLE BOARD

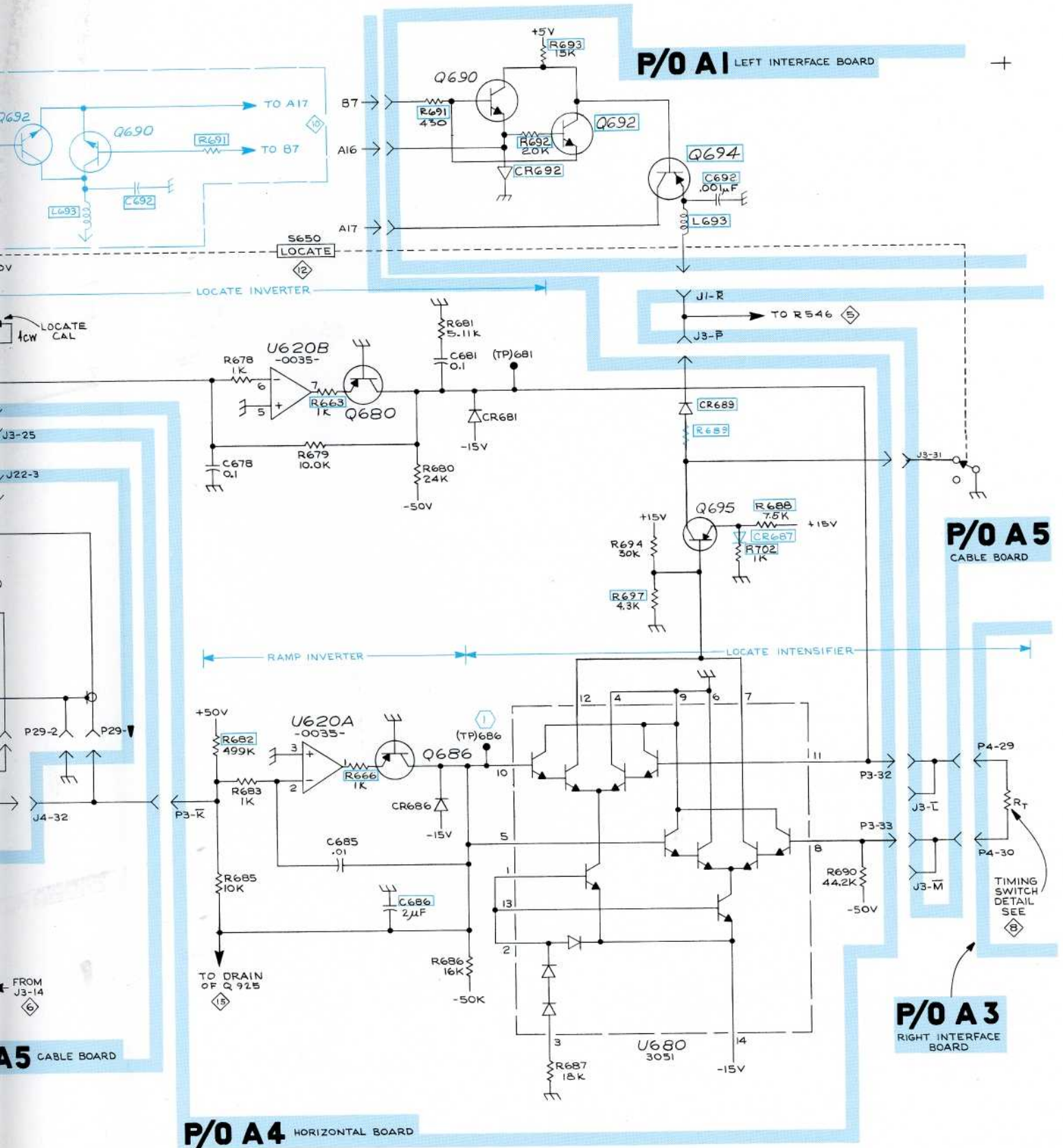

**P/O A1 LEFT INTERFACE BOARD**

**P/O A2 CABLE BOARD**

**P/O A3 RIGHT INTERFACE BOARD**

**P/O A4 HORIZONTAL BOARD**

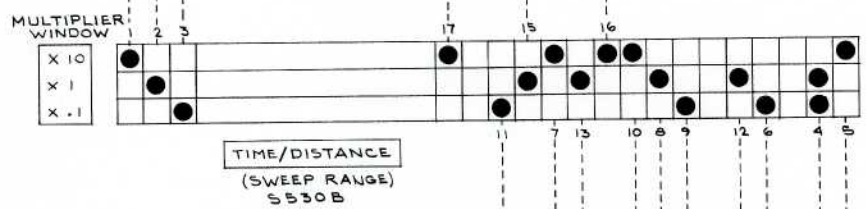
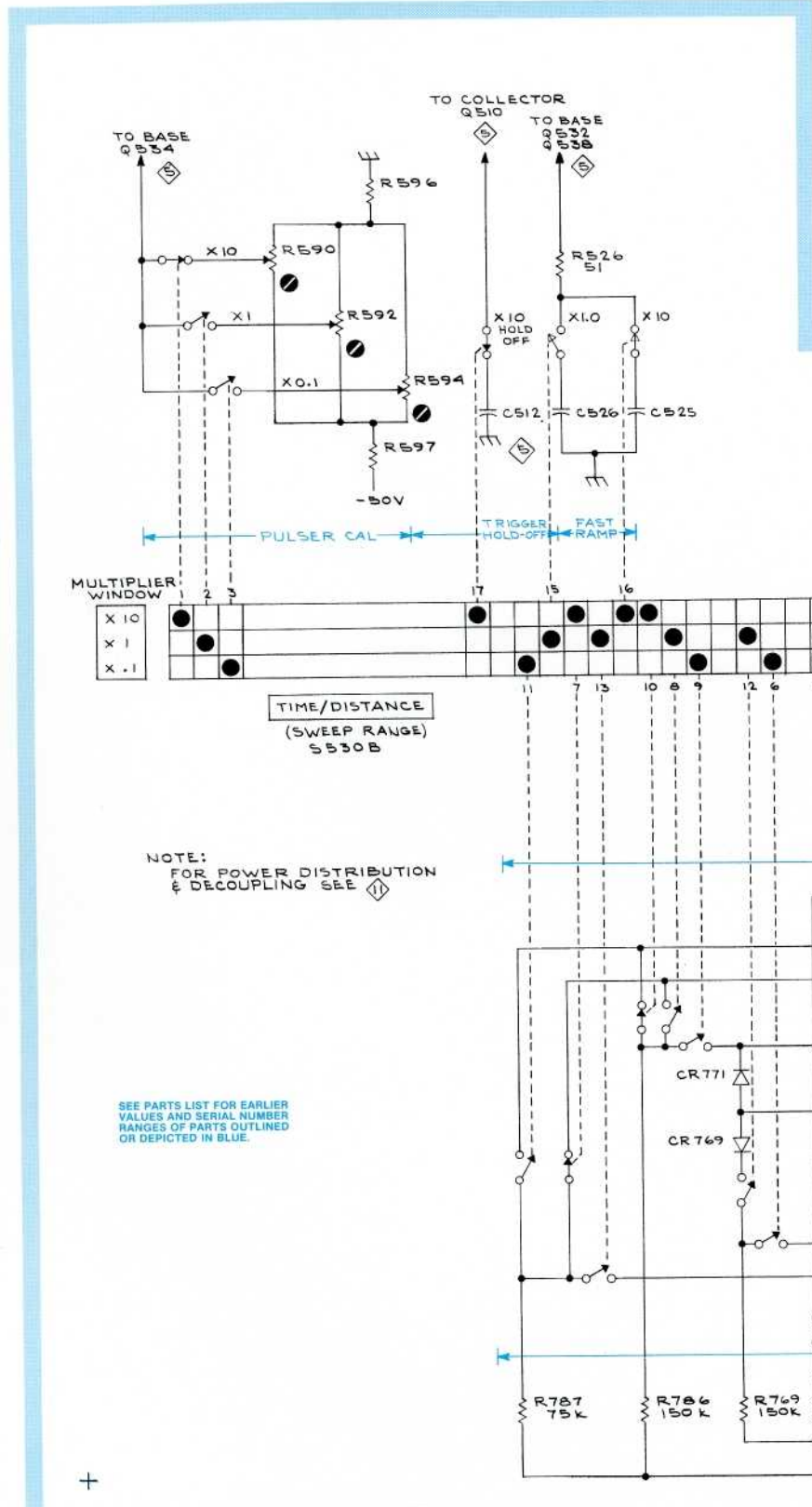

NOTE:  
FOR POWER DISTRIBUTION  
& DECOUPLING SEE  $\diamond$

SEE PARTS LIST FOR EARLIER  
VALUES AND SERIAL NUMBER  
RANGES OF PARTS OUTLINED  
OR DEPICTED IN BLUE.

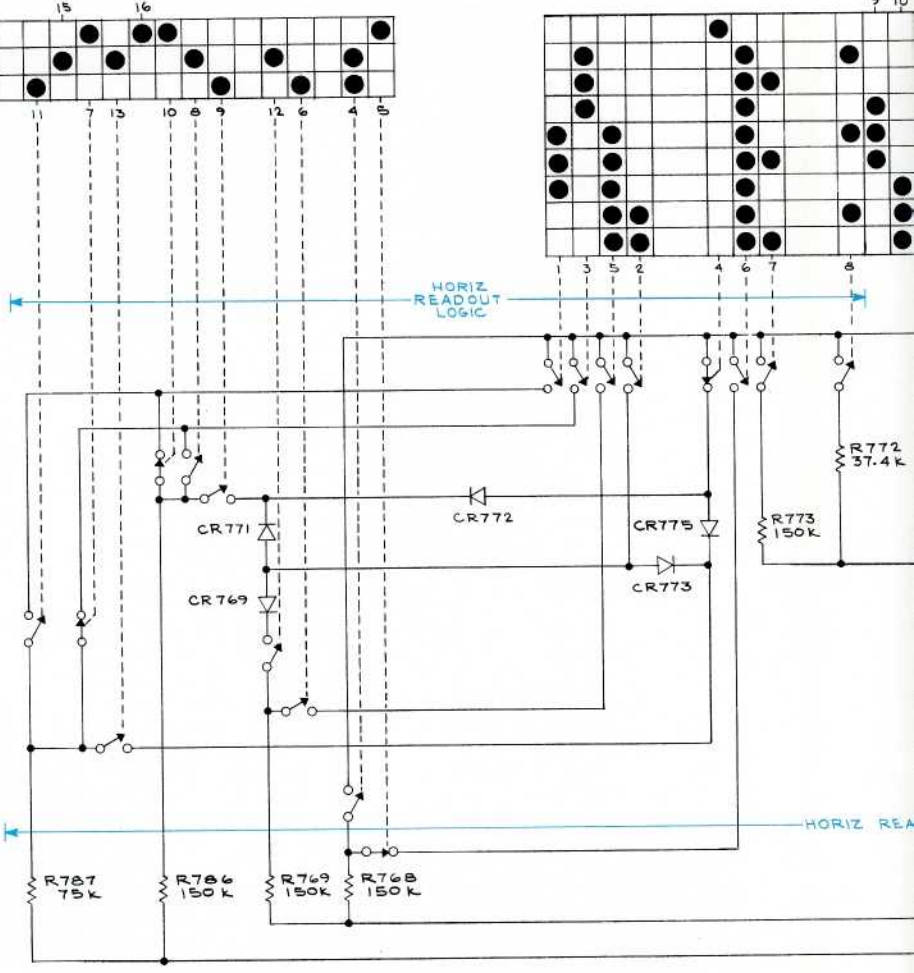
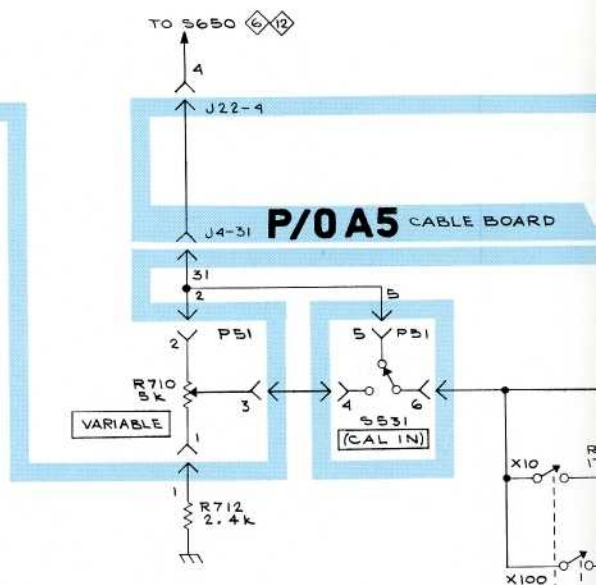

**P/O A3** RIGHT INTERFACE BOARD

7S12 SAMPLING UNIT



# P/O A4 HORIZONTAL CARD

# P/O A5 CABLE BOARD

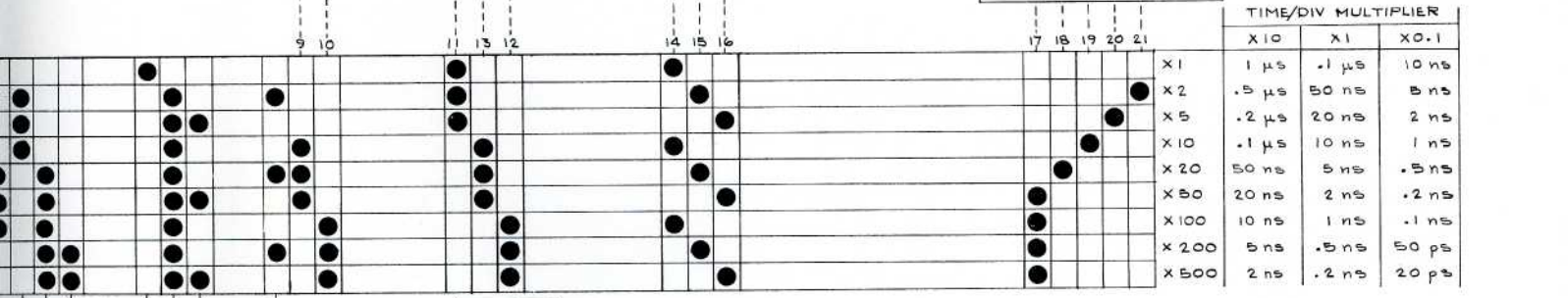
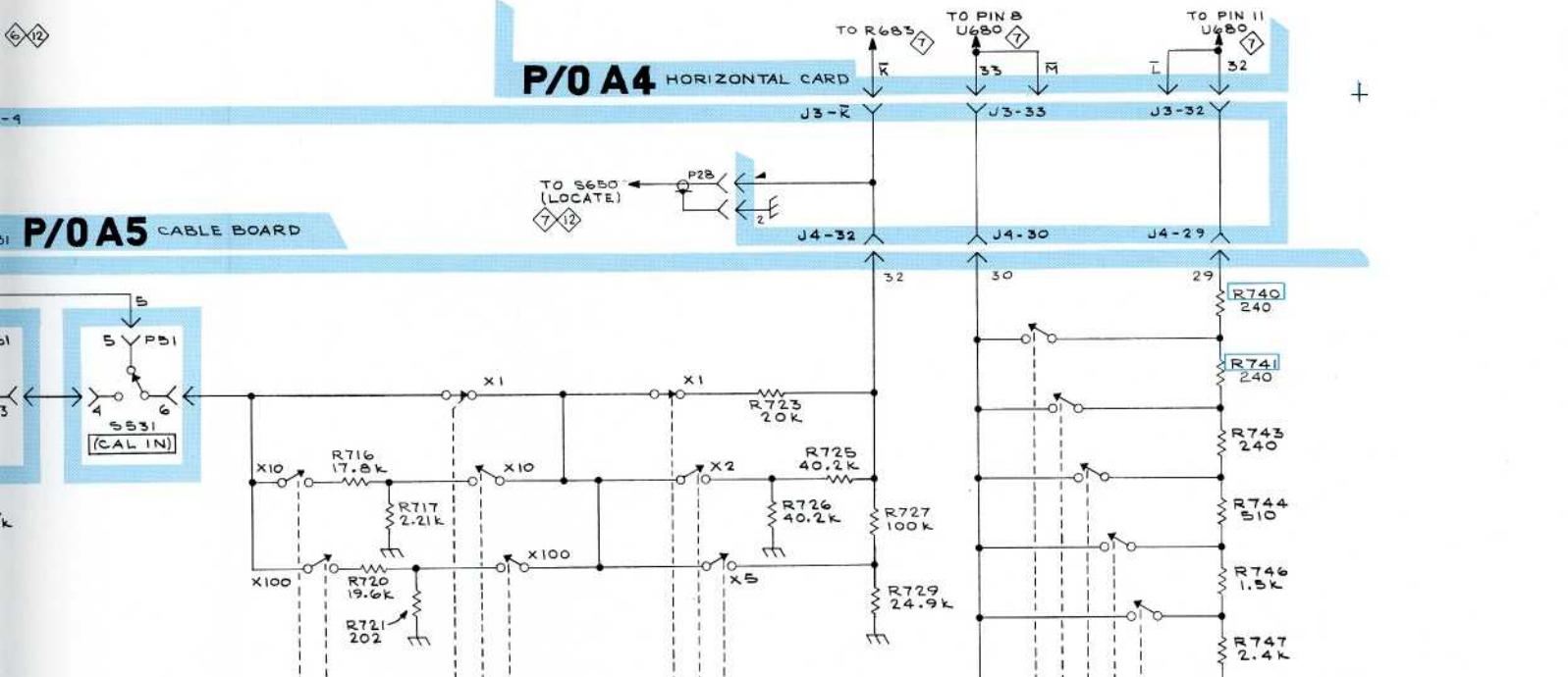

	X10	X1	X0.1
X1	1 $\mu$ s	.1 $\mu$ s	10 ns
X2	.5 $\mu$ s	50 ns	5 ns
X5	.2 $\mu$ s	20 ns	2 ns
X10	.1 $\mu$ s	10 ns	1 ns
X20	50 ns	5 ns	.5 ns
X50	20 ns	2 ns	.2 ns
X100	10 ns	1 ns	.1 ns
X200	5 ns	.5 ns	50 ps
X500	2 ns	.2 ns	20 ps

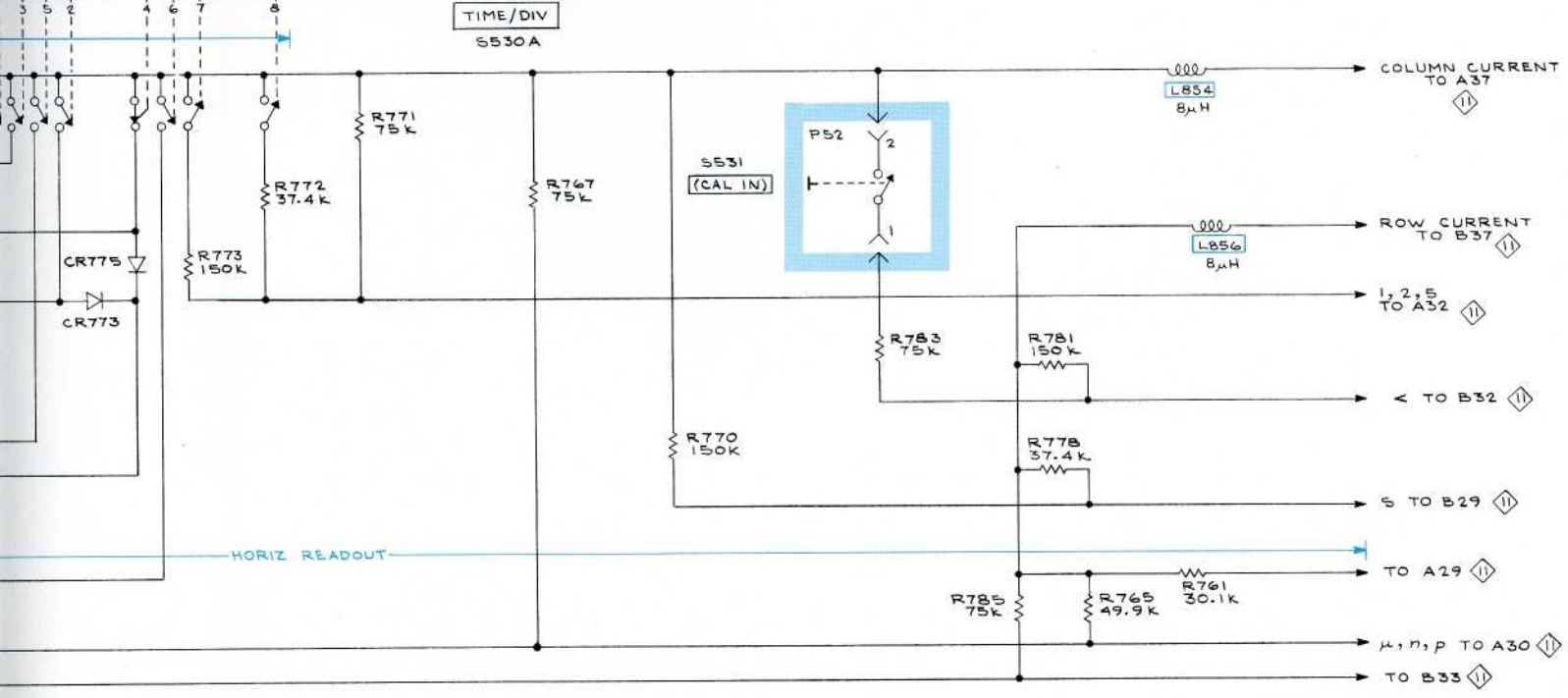

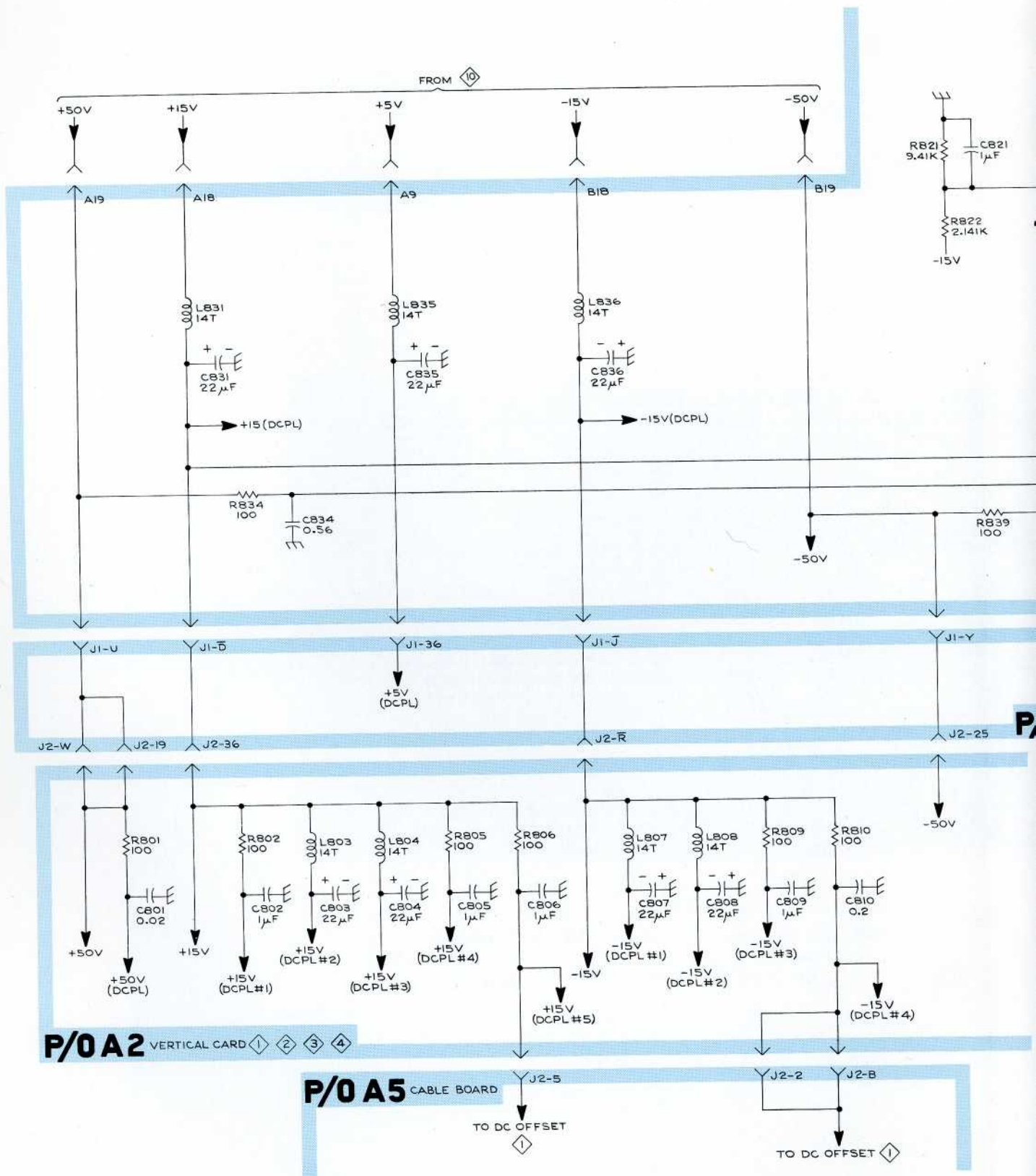

7S12 SAMPLING PLUG-IN

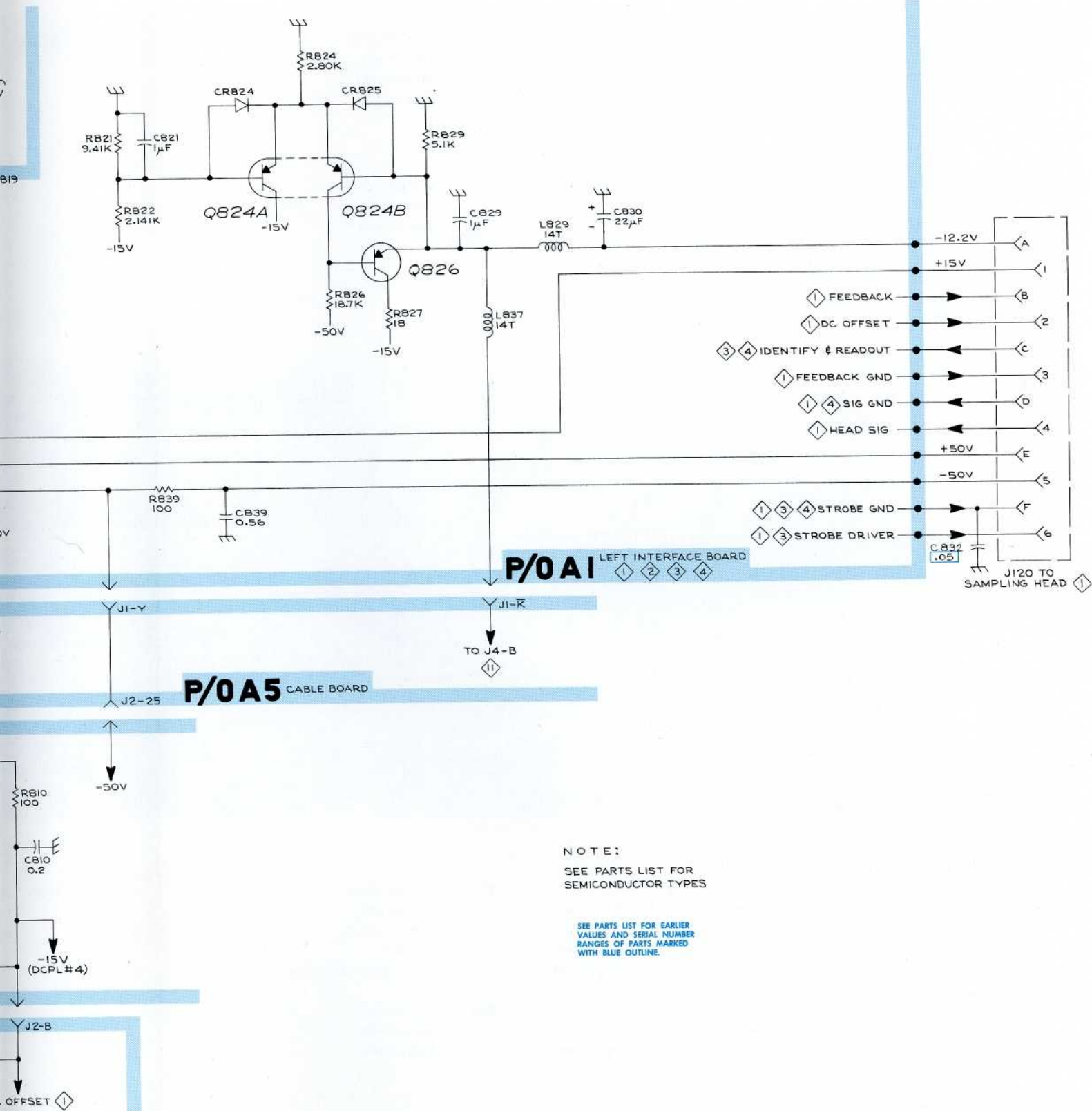

B



P10	Blk 2 pin conn 1 Brn on wht 2 Red on wht	P11	Brn 4 pin conn 1 Brn on wht 2 Red on wht 3 Orn on wht 4 Yel on wht	P12	Red 3 pin conn 1 Brn on wht 2 Red on wht 3 Orn on wht	P13	Orn 3 pin conn 1 Brn on wht 2 Red on wht 3 Orn on wht
P14	Yel 2 pin conn 1 Brn on wht 2 Red on wht	P15	Grn 4 pin conn 1 Brn on wht 2 Red on wht 3 Orn on wht 4 Yel on wht	P16	Blu 4 pin conn 1 Brn on wht 2 Red on wht 3 Orn on wht 4 Yel on wht	P17	Vio 2 pin conn 1 Brn on wht 2 Red on wht

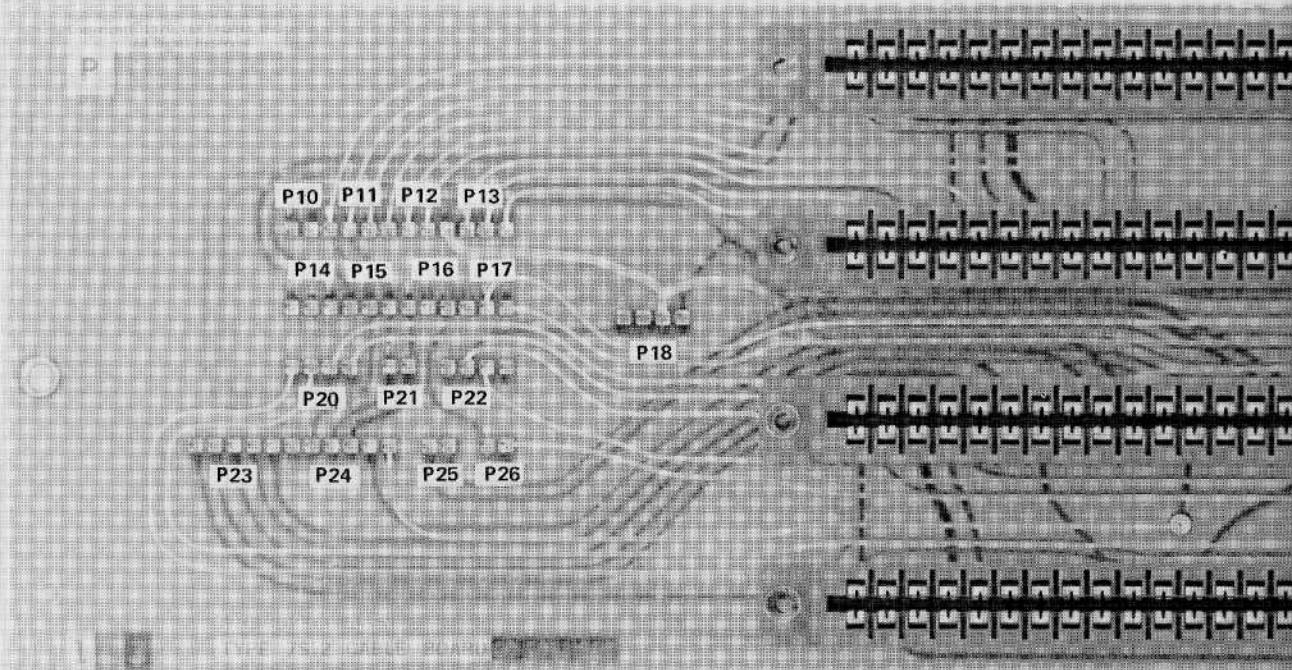

P20	Blk 4 pin conn 1 Brn on wht 2 Red on wht 3 Orn on wht 4 Yel on wht	P21	Brn 2 pin conn 1 Brn on wht 2 Red on wht	P22	Red 4 pin conn 1 Brn on wht 2 Red on wht 3 Orn on wht 4 Yel on wht	P18	Gry 4 pin conn 1 Brn on wht 2 Red on wht 3 Shield 4 Vio on wht (50 Ω Coax)
P23	Orn 6 pin conn 1 Brn on wht 2 Red on wht 3 Orn on wht 4 Yel on wht 5 Grn on wht 6 Blu on wht	P24	Yel 5 pin conn 1 Brn on wht 2 Red on wht 3 Orn on wht 4 Yel on wht 5 Grn on wht	P25	Grn 2 pin conn 1 Brn on wht 2 Red on wht	P26	Blu 2 pin conn 1 Brn on wht 2 Red on wht

Fig. 7-5. Assembly A-5, Cable Board.



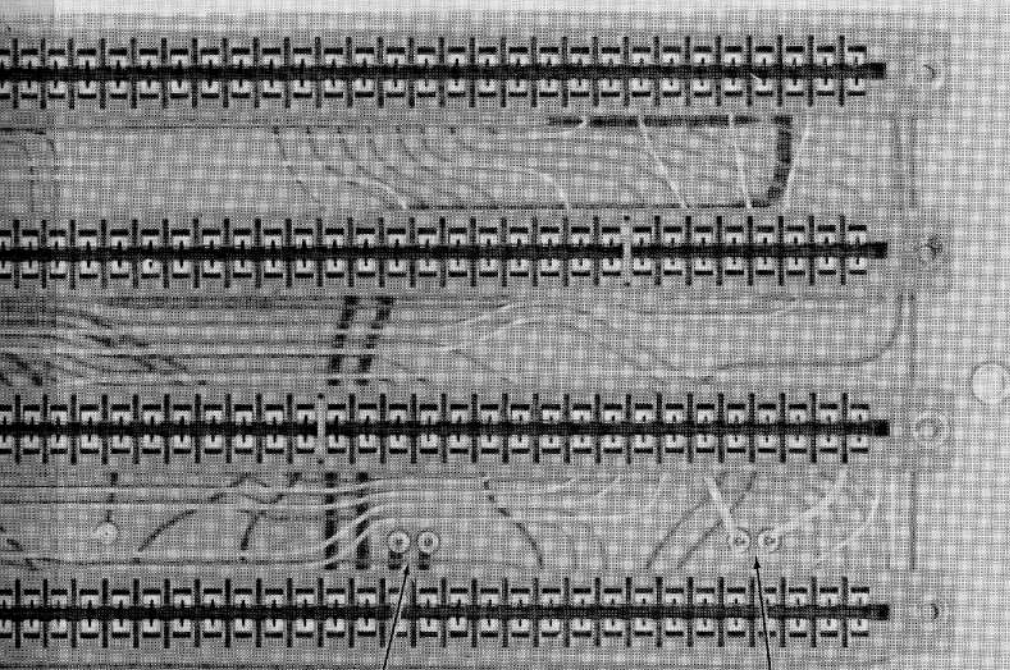

P27 Gry 2 pin conn  
1 Shield  
2 Grn on wht (50 Ω Coax)

P28 Wht 2 pin conn  
1 Blu on wht (50 Ω Coax)  
2 Shield

(FIXED SHOE)  
J 641

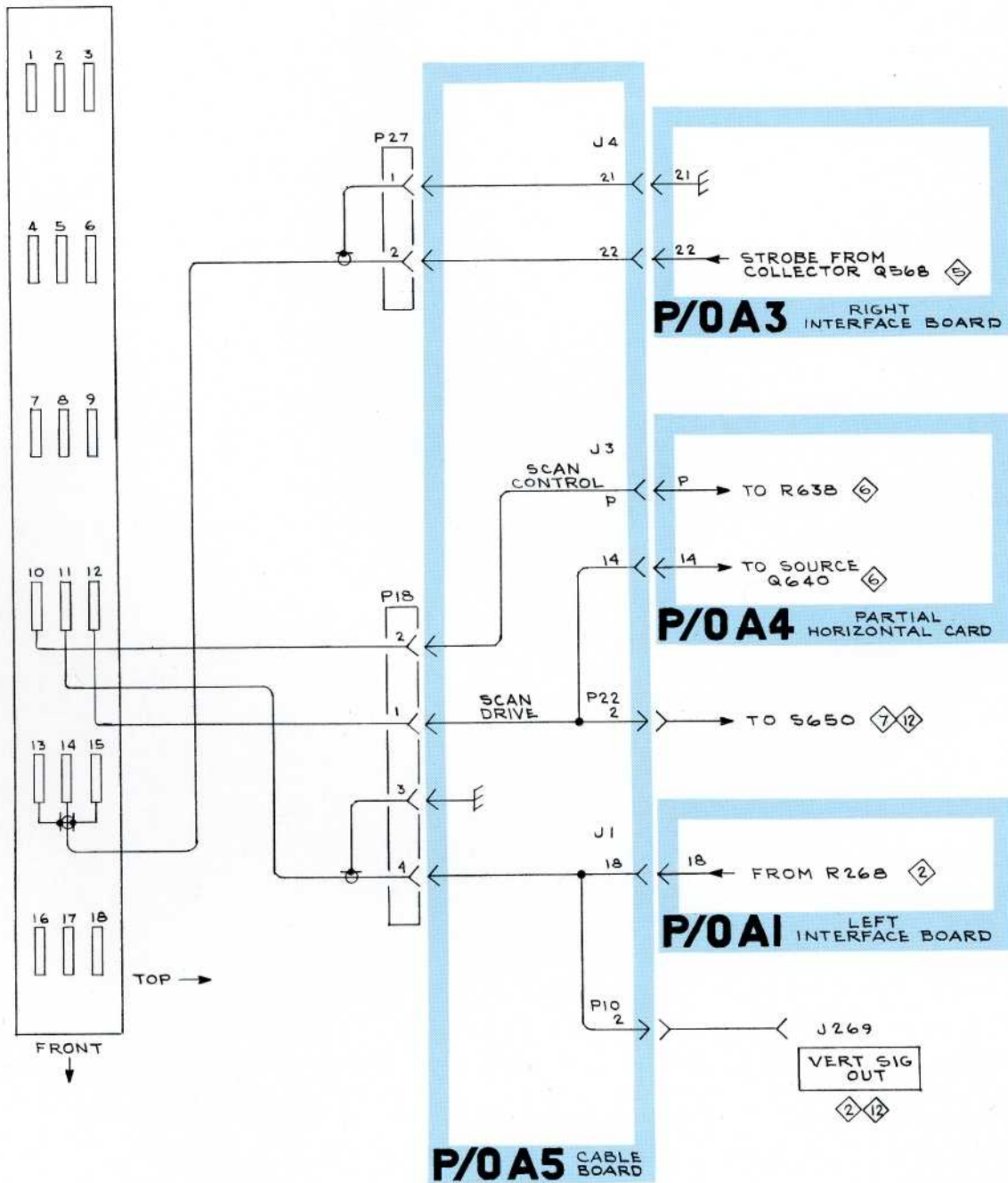

+

7S12 SAMPLING PLUG-IN

B

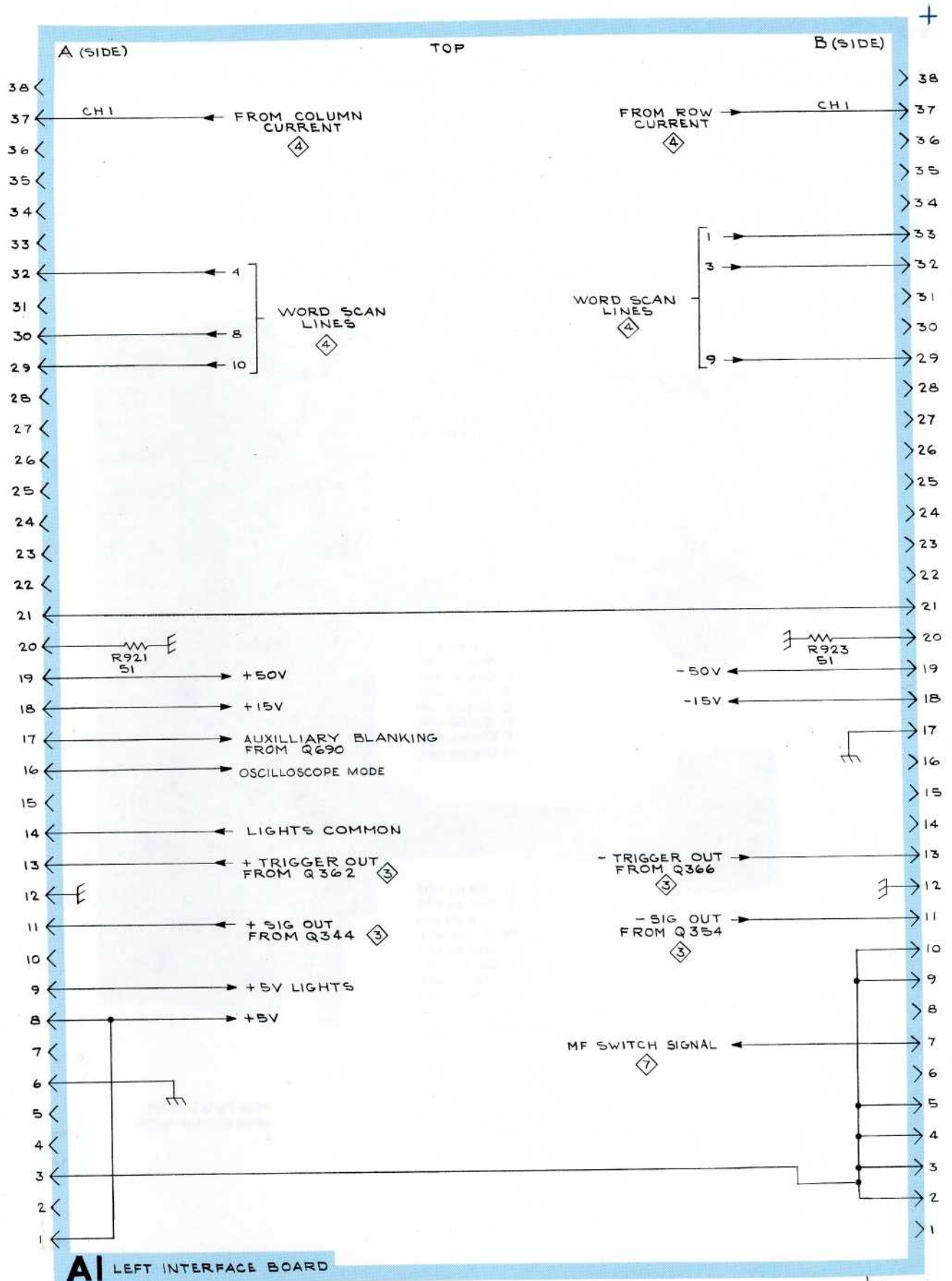

**A** LEFT INTERFACE BOARD

**B** VERTICAL OUTPUT CONNECTORS

10

hq  
971  
REV. APR. 1974

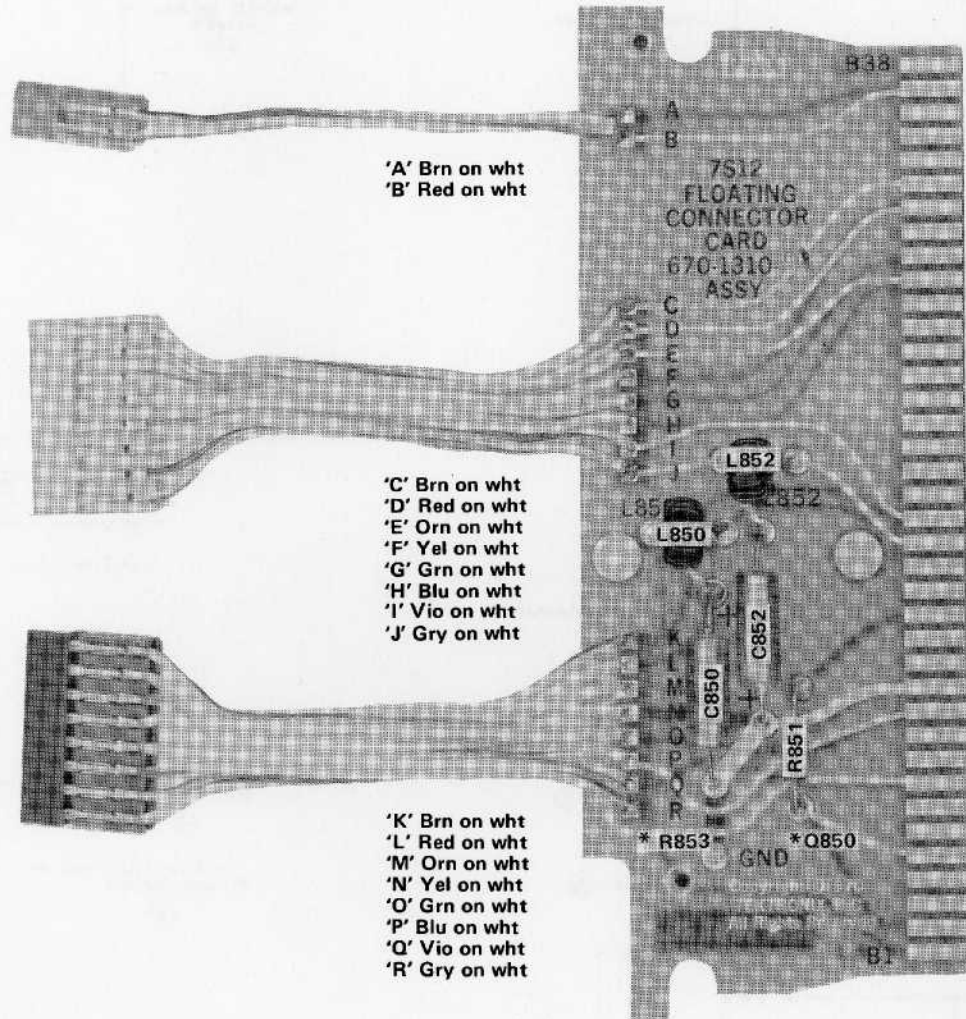

'A' Brn on wht  
'B' Red on wht

'C' Brn on wht  
'D' Red on wht  
'E' Orn on wht  
'F' Yel on wht  
'G' Grn on wht  
'H' Blu on wht  
'I' Vio on wht  
'J' Gry on wht

'K' Brn on wht  
'L' Red on wht  
'M' Orn on wht  
'N' Yel on wht  
'O' Grn on wht  
'P' Blu on wht  
'Q' Vio on wht  
'R' Gry on wht

\*See Parts List for serial number ranges.

Fig. 7-6. Assembly A-6, Floating Connecting Board.



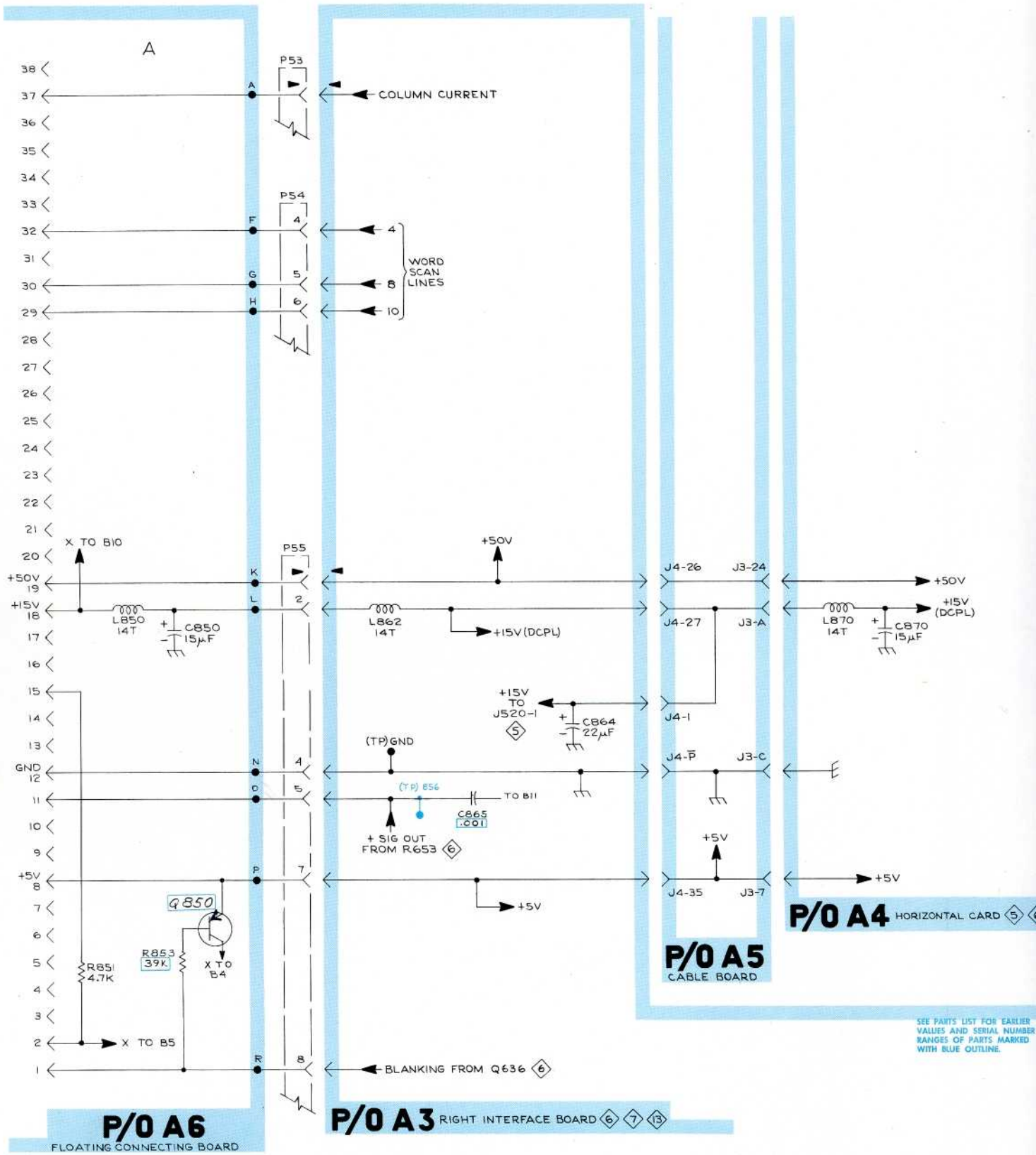

SEE PARTS LIST FOR EARLIER VALUES AND SERIAL NUMBER RANGES OF PARTS MARKED WITH BLUE OUTLINE.

+

7S12 SAMPLING PLUG-IN

©

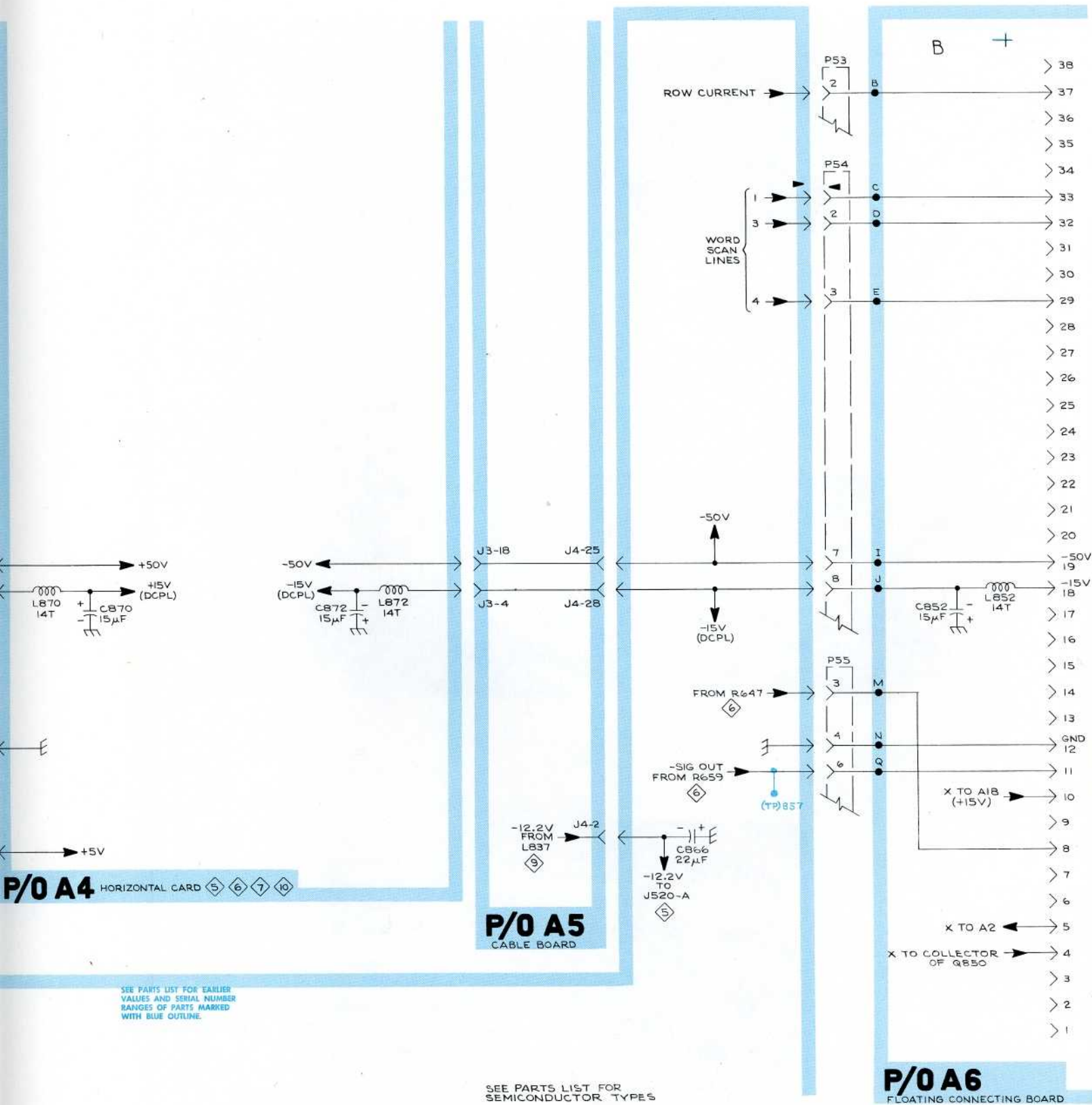

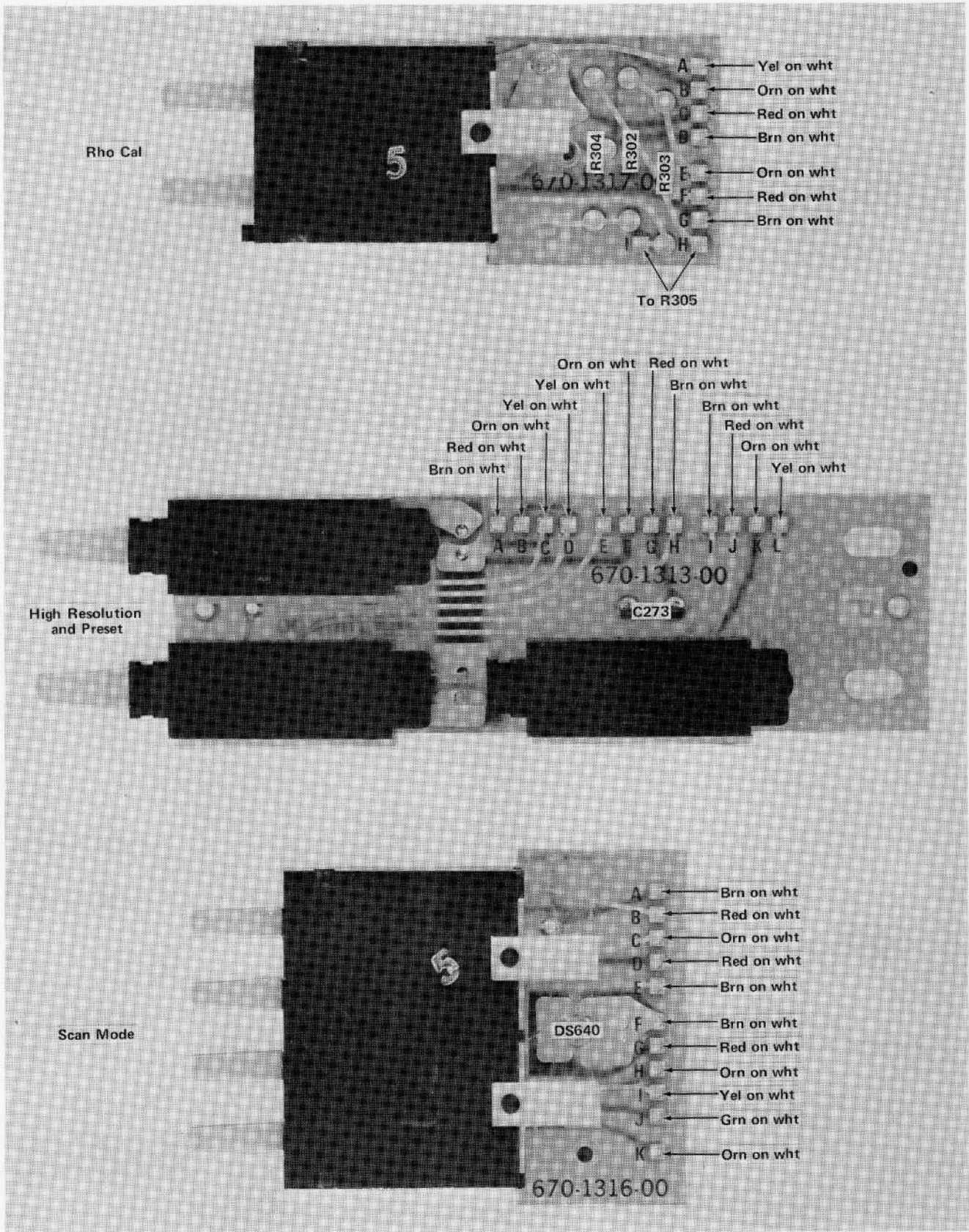
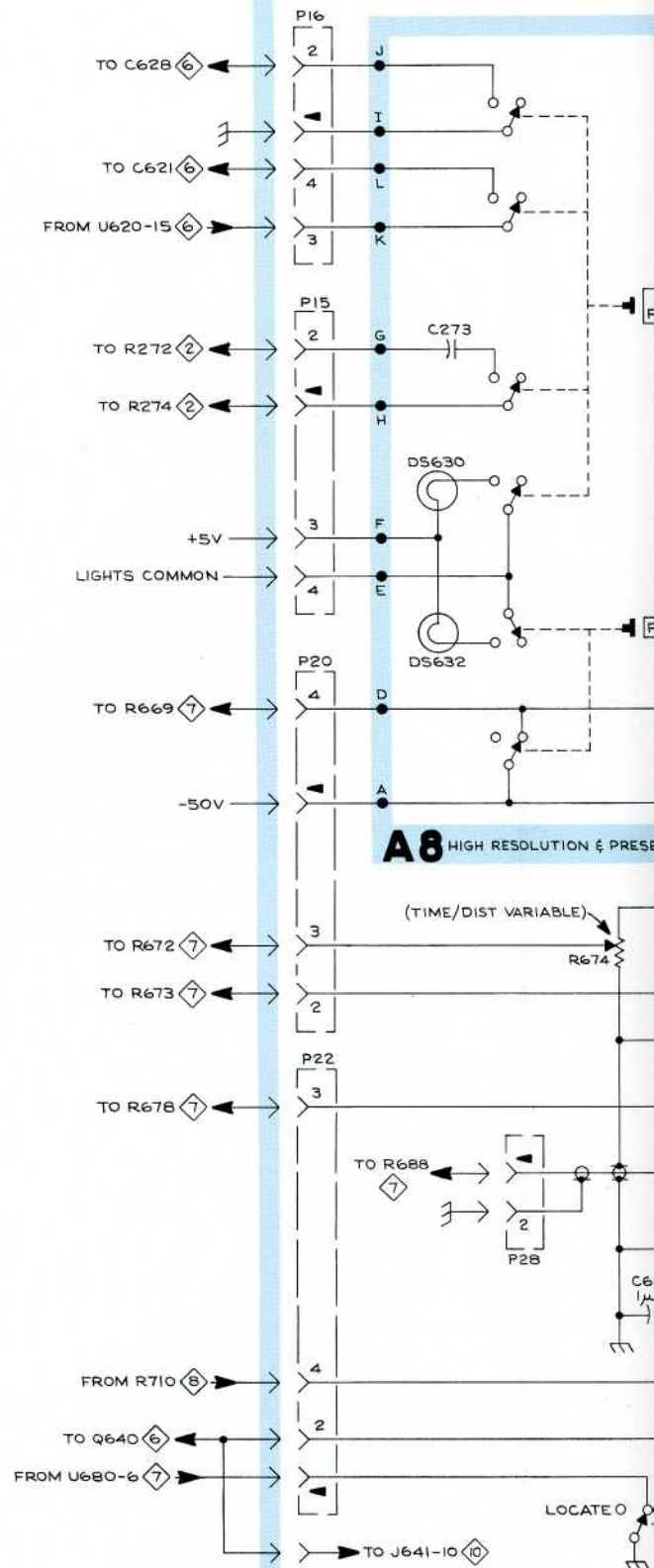
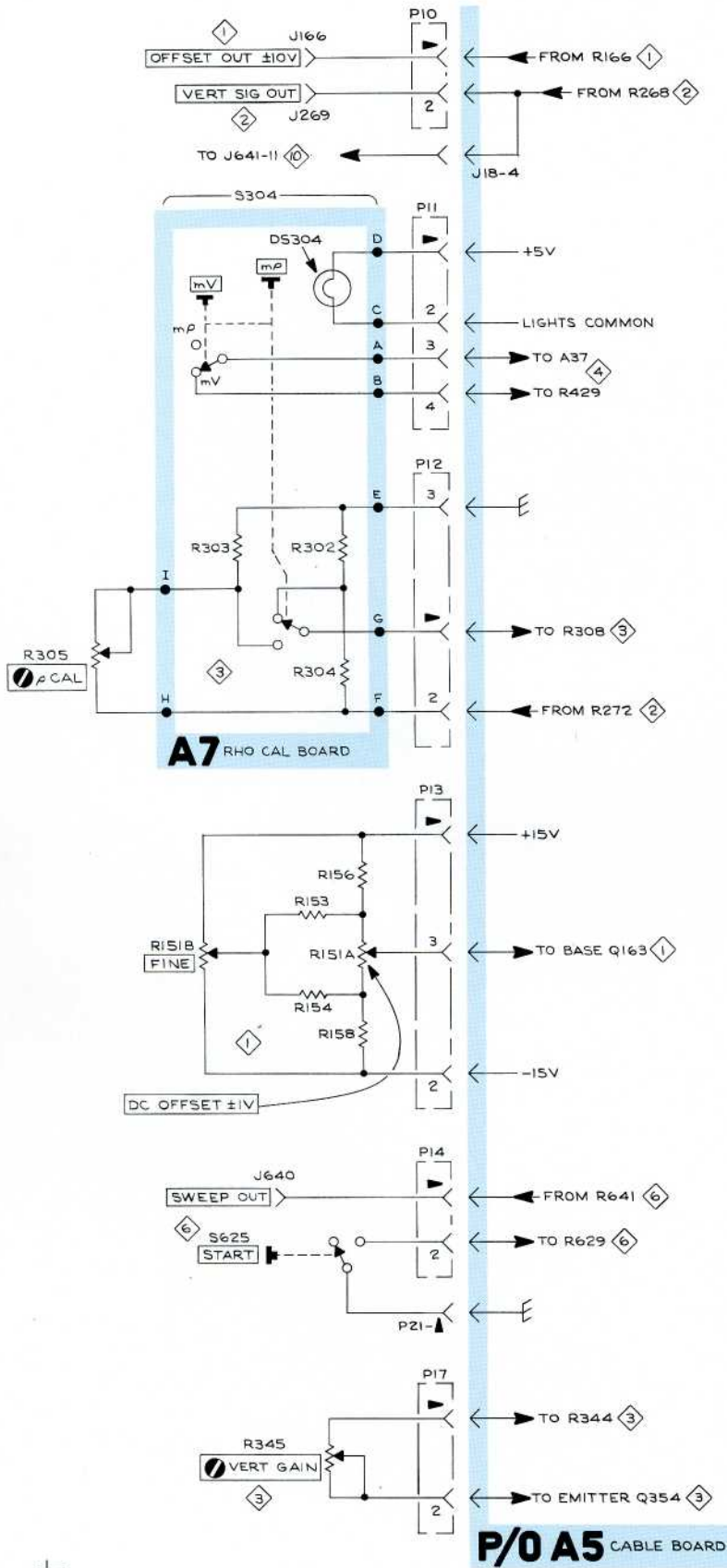
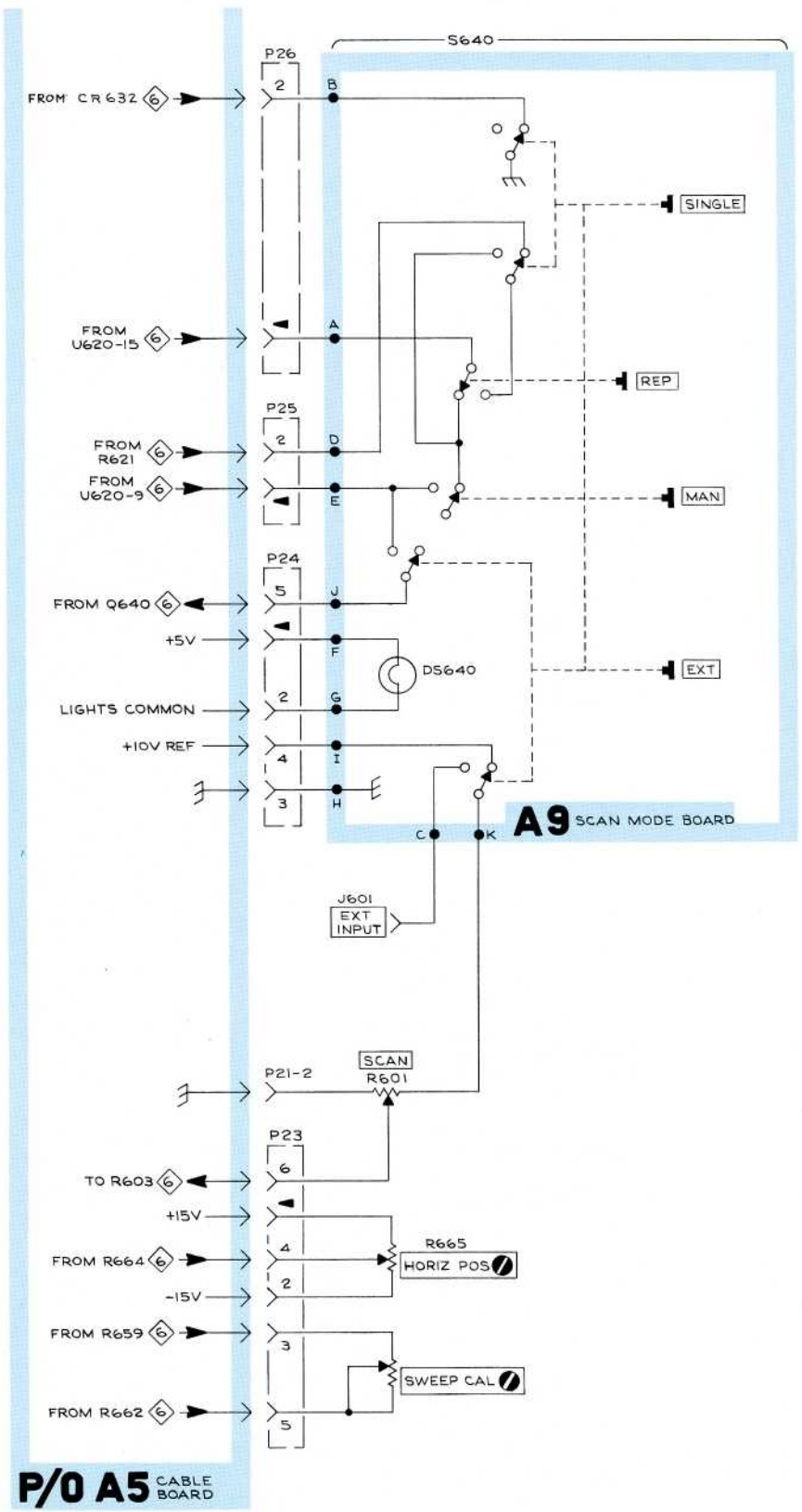
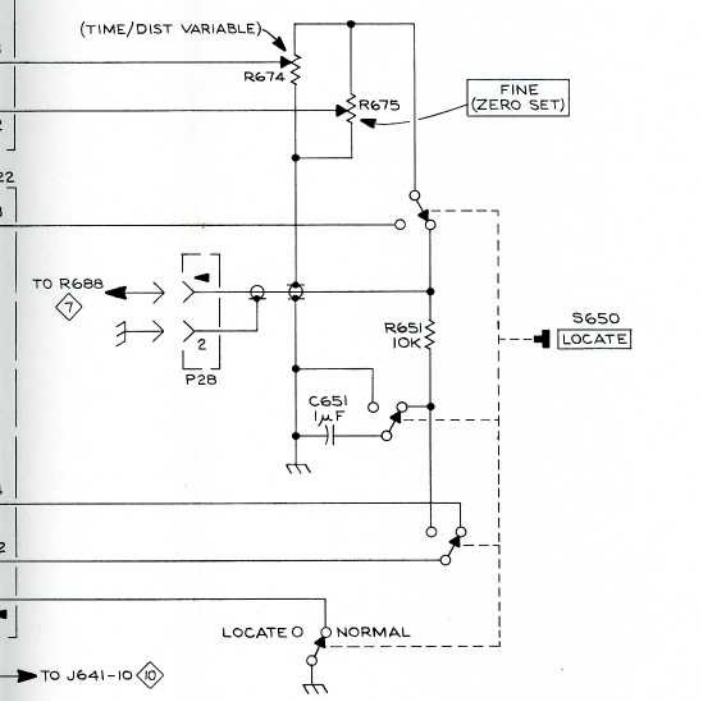
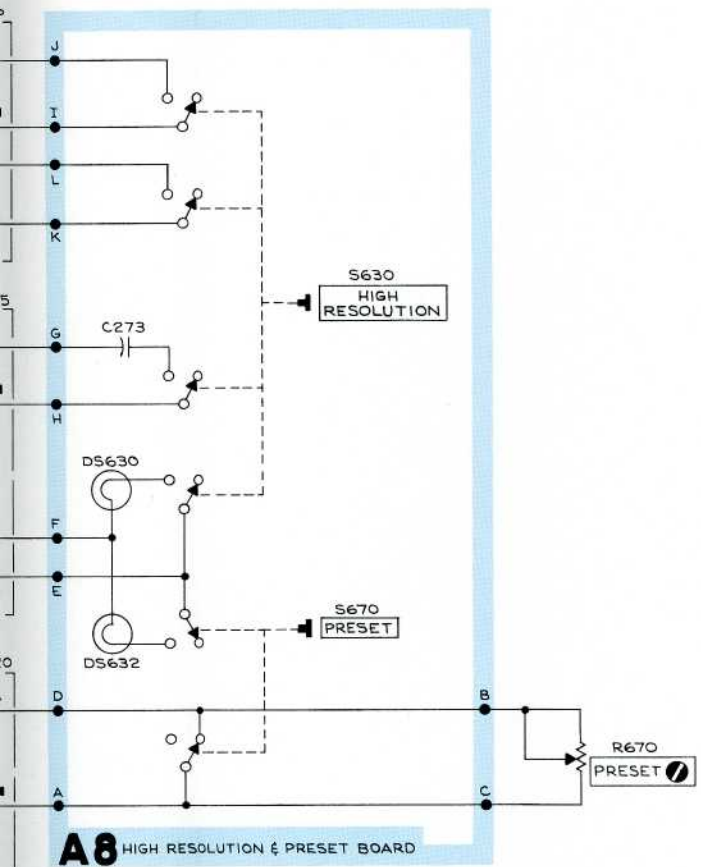

Fig. 7-7. Assemblies A-7, A-8, and A-9.







A

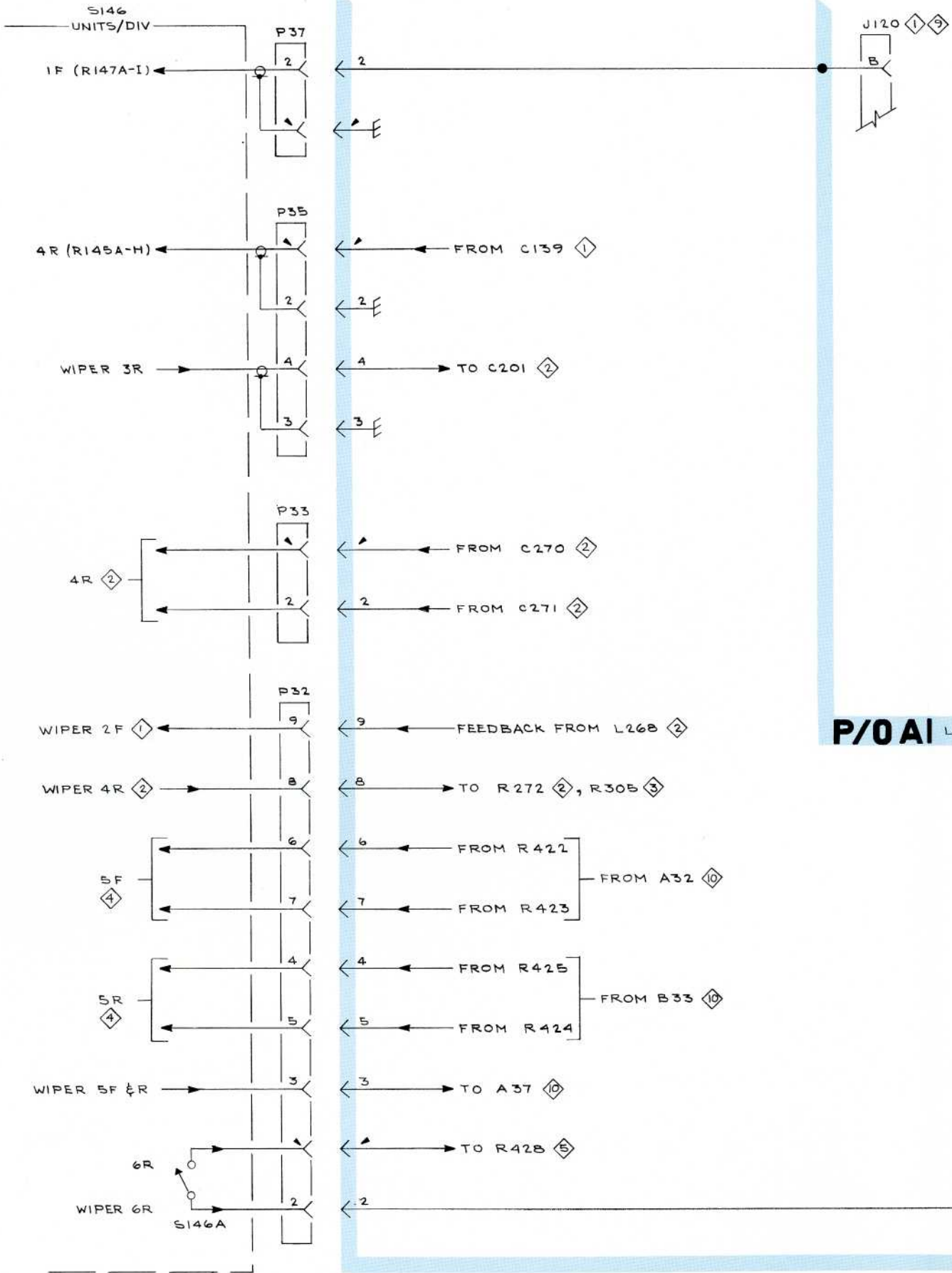

**P/O AI** LEFT INT

+  
7512 SAMPLING UNIT

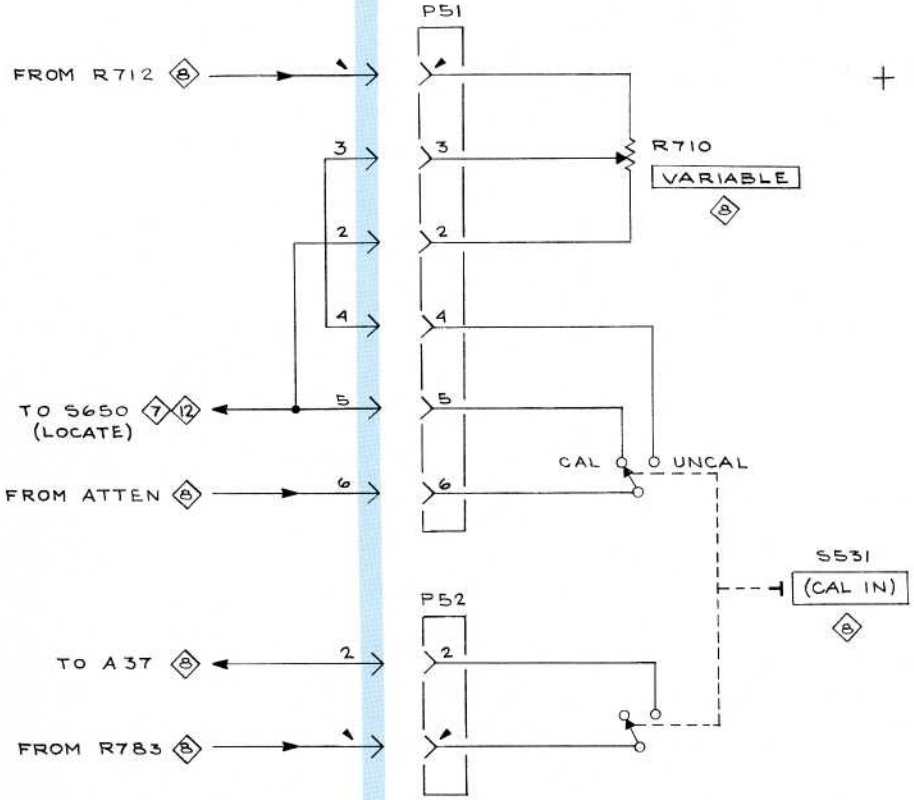
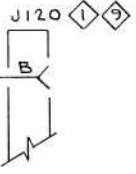

**P/O A3** RIGHT INTERFACE BOARD

**P/O A1** LEFT INTERFACE BOARD

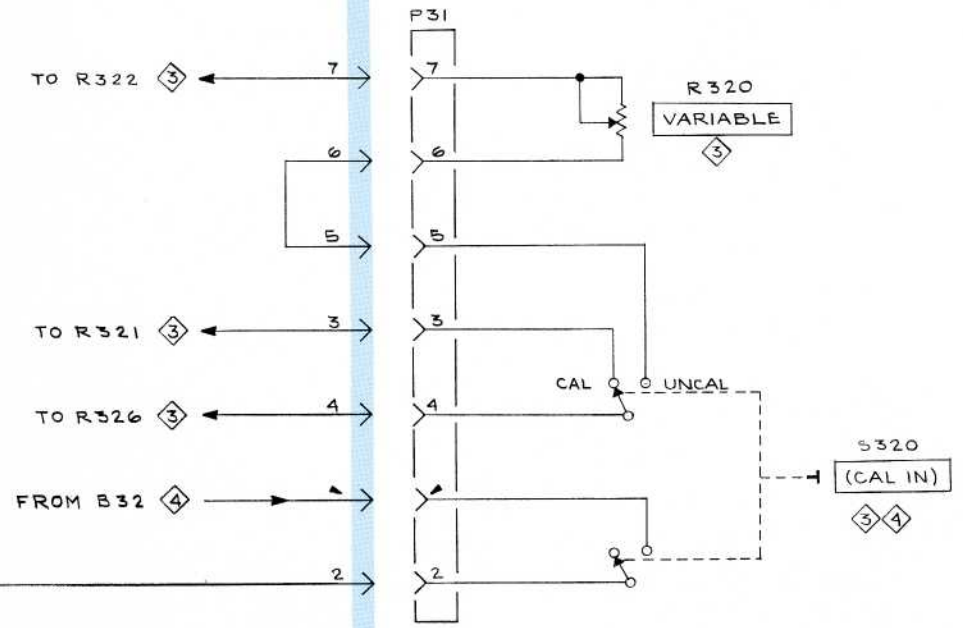

hq  
971

A

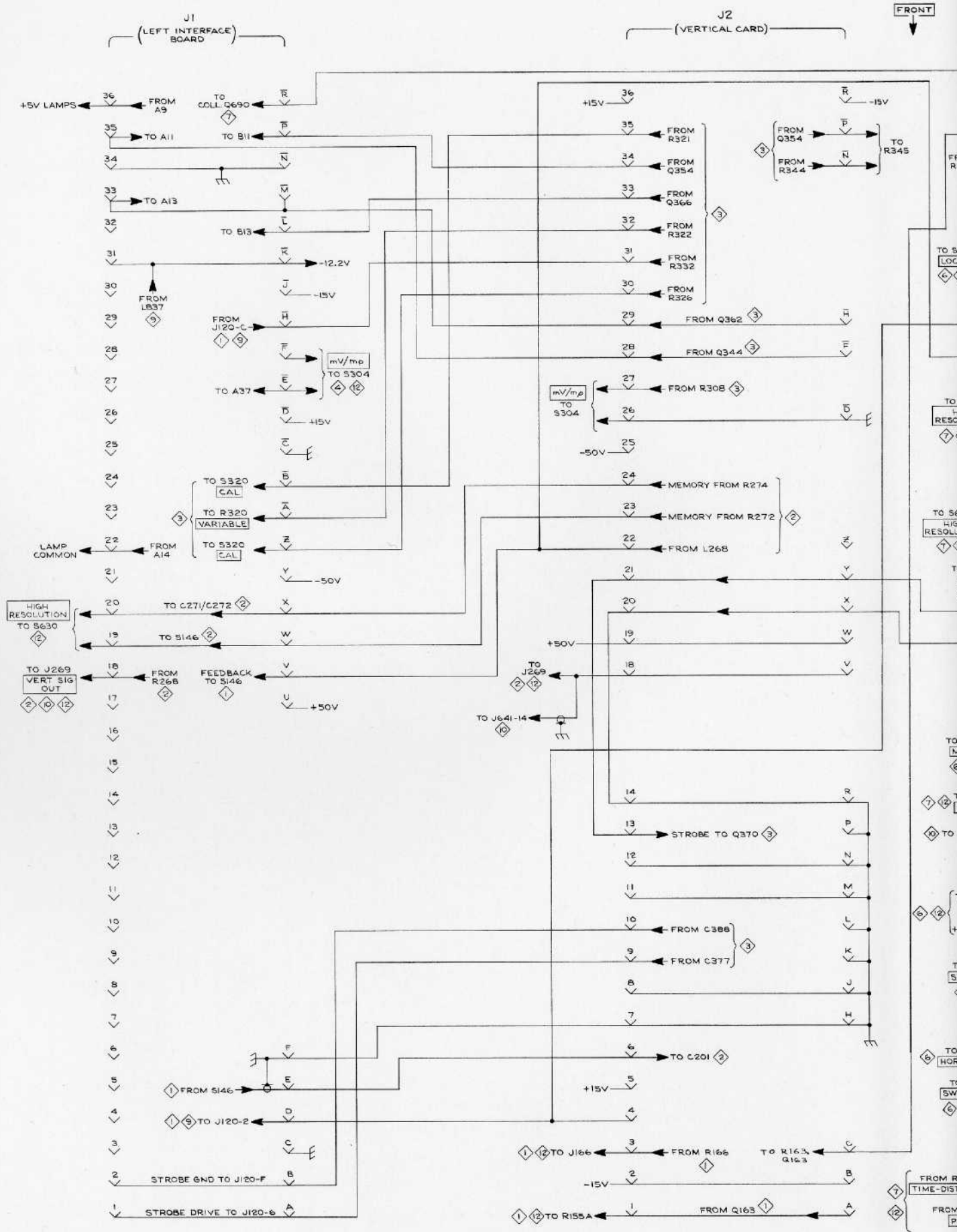

NOTE:  
TOP VIEW OF BOARD



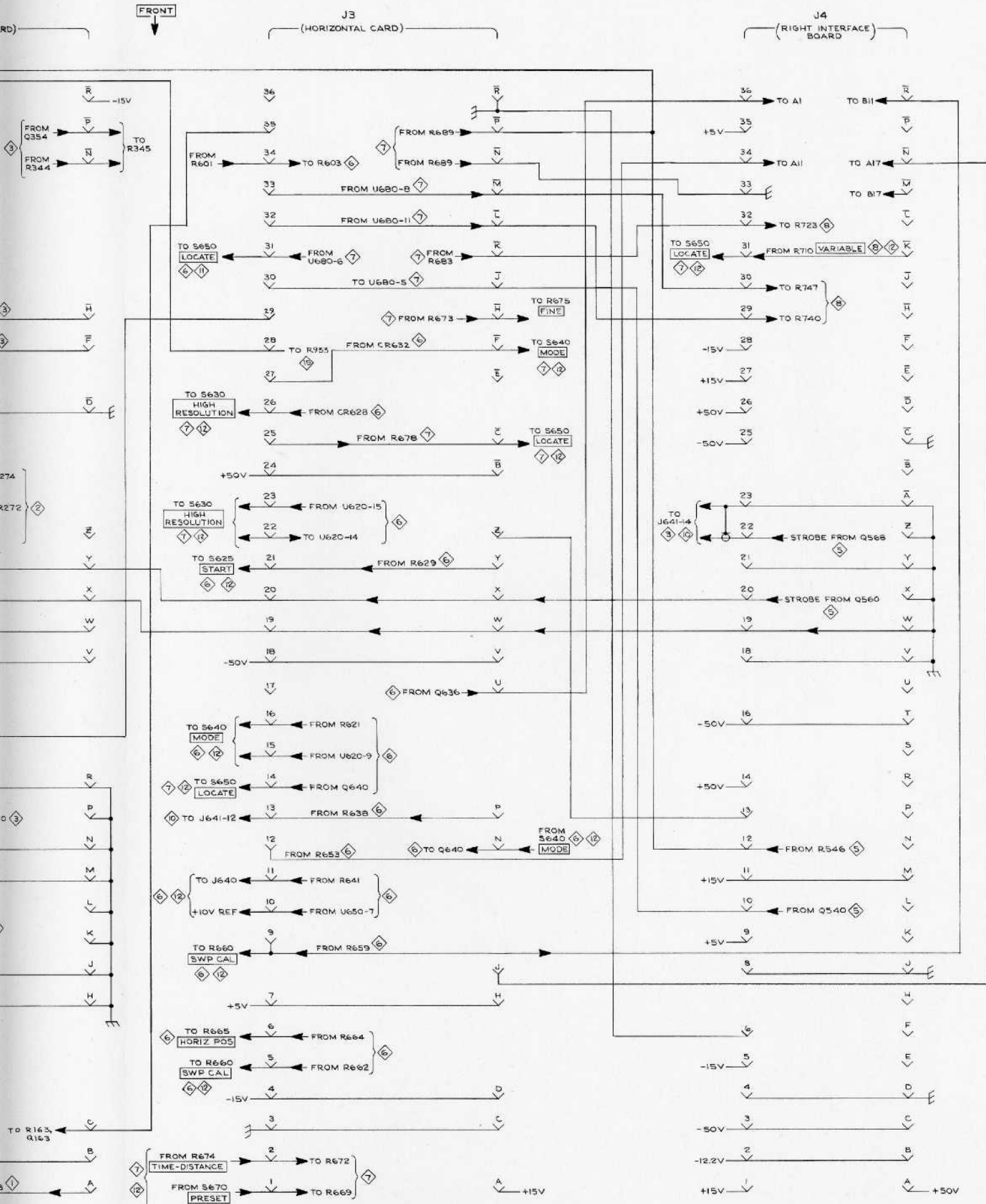



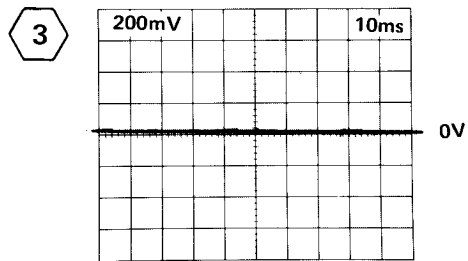
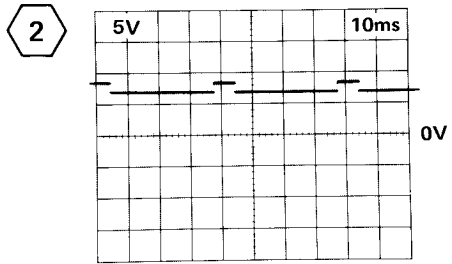
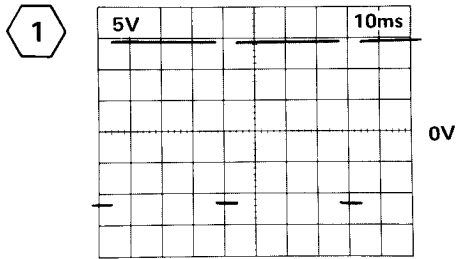

Test oscilloscope triggered from SWEEP OUT signal. For other conditions see page 7-2.

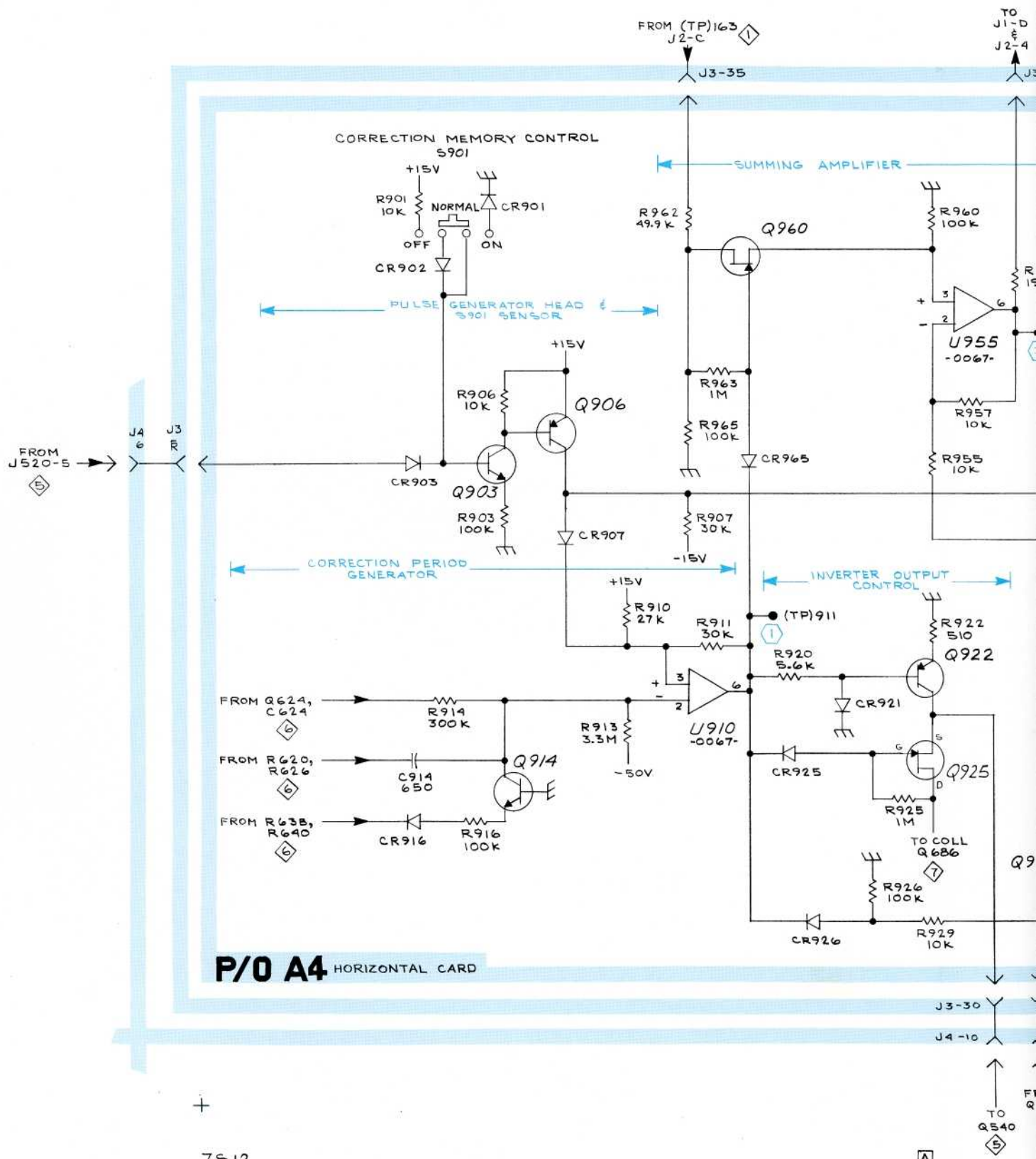

+

7512

A

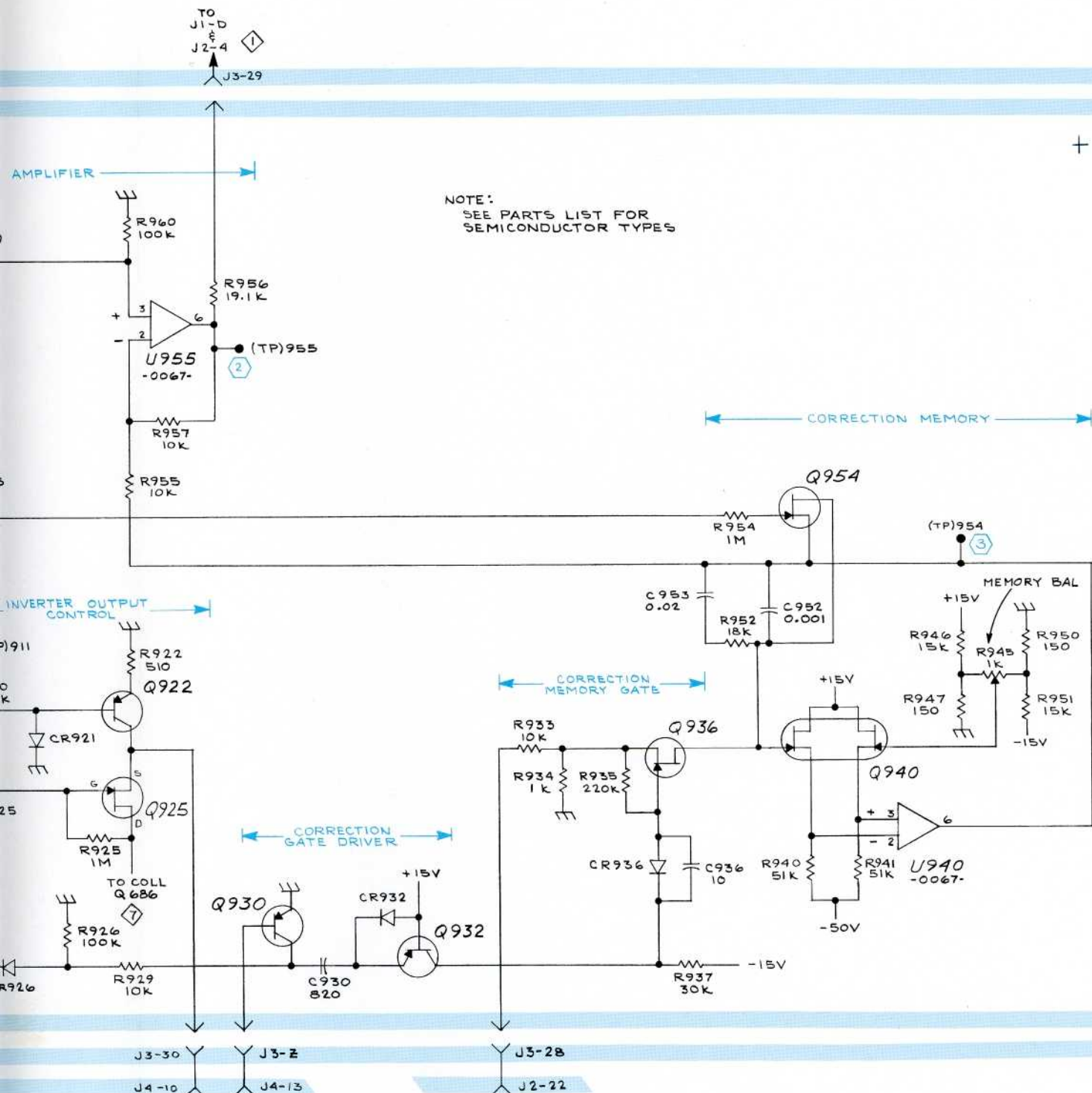

NOTE:  
SEE PARTS LIST FOR  
SEMICONDUCTOR TYPES

PULSER BASELINE CORRECTION

SNB020000-UP

hq  
971

15

# REPLACEABLE MECHANICAL PARTS

## PARTS ORDERING INFORMATION

Replacement parts are available from or through your local Tektronix, Inc. Field Office or representative.

Changes to Tektronix instruments are sometimes made to accommodate improved components as they become available, and to give you the benefit of the latest circuit improvements developed in our engineering department. It is therefore important, when ordering parts, to include the following information in your order: Part number, instrument type or number, serial number, and modification number if applicable.

If a part you have ordered has been replaced with a new or improved part, your local Tektronix, Inc. Field Office or representative will contact you concerning any change in part number.

Change information, if any, is located at the rear of this manual.

## SPECIAL NOTES AND SYMBOLS

X000 Part first added at this serial number  
00X Part removed after this serial number

## FIGURE AND INDEX NUMBERS

Items in this section are referenced by figure and index numbers to the illustrations.

## INDENTATION SYSTEM

This mechanical parts list is indented to indicate item relationships. Following is an example of the indentation system used in the description column.

```

1 2 3 4 5           Name & Description
Assembly and/or Component
Attaching parts for Assembly and/or Component
    --- * ---
Detail Part of Assembly and/or Component
Attaching parts for Detail Part
    --- * ---
Parts of Detail Part
Attaching parts for Parts of Detail Part
    --- * ---

```

Attaching Parts always appear in the same indentation as the item it mounts, while the detail parts are indented to the right. Indented items are part of, and included with, the next higher indentation. The separation symbol --- \* --- indicates the end of attaching parts.

**Attaching parts must be purchased separately, unless otherwise specified.**

## ITEM NAME

In the Parts List, an Item Name is separated from the description by a colon (:). Because of space limitations, an Item Name may sometimes appear as incomplete. For further Item Name identification, the U.S. Federal Cataloging Handbook H6-1 can be utilized where possible.

## ABBREVIATIONS

#	INCH	ELCTRN	ELECTRON	IN	INCH	SE	SINGLE END
ACTR	NUMBER SIZE	ELEC	ELECTRICAL	INCAND	INCANDESCENT	SECT	SECTION
ADPTR	ACTUATOR	ELCTLT	ELECTROLYTIC	INSUL	INSULATOR	SEMICOND	SEMICONDUCTOR
ALIGN	ADAPTER	ELEM	ELEMENT	INTL	INTERNAL	SHLD	SHIELD
AL	ALIGNMENT	EPL	ELECTRICAL PARTS LIST	LPHLDR	LAMPHOLDER	SHLDR	SHOULDERED
ASSEM	ALUMINUM	EQPT	EQUIPMENT	MACH	MACHINE	SKT	SOCKET
ASSY	ASSEMBLED	EXT	EXTERNAL	MECH	MECHANICAL	SL	SLIDE
ATTEN	ASSEMBLY	FIL	FILLISTER HEAD	MTG	MOUNTING	SLFLKG	SELF-LOCKING
AWG	ATTENUATOR	FLEX	FLEXIBLE	NIP	NIPPLE	SLVG	SLEEVING
BD	AMERICAN WIRE GAGE	FLH	FLAT HEAD	NON WIRE	NOT WIRE WOUND	SPR	SPRING
BRKT	BOARD	FLTR	FILTER	OBD	ORDER BY DESCRIPTION	SQ	SQUARE
BRS	BRACKET	FR	FRAME or FRONT	OD	OUTSIDE DIAMETER	SST	STAINLESS STEEL
BRZ	BRASS	FSTNR	FASTENER	OVH	OVAL HEAD	STL	STEEL
BSHG	BRONZE	FT	FOOT	PH BRZ	PHOSPHOR BRONZE	SW	SWITCH
CAB	BUSHING	FXD	FIXED	PL	PLAIN or PLATE	T	TUBE
CAP	CABINET	GSKT	GASKET	PLSTC	PLASTIC	TERM	TERMINAL
CER	CAPACITOR	HDL	HANDLE	PN	PART NUMBER	THD	THREAD
CHAS	CERAMIC	HEX	HEXAGON	PNH	PAN HEAD	THK	THICK
CKT	CHASSIS	HEX HD	HEXAGONAL HEAD	PWR	POWER	TNSN	TENSION
COMP	CIRCUIT	HEX SOC	HEXAGONAL SOCKET	RCPT	RECEPTACLE	TPG	TAPPING
CONN	COMPOSITION	HLCPS	HELICAL COMPRESSION	RES	RESISTOR	TRH	TRUSS HEAD
COV	CONNECTOR	HLEXT	HELICAL EXTENSION	RGD	RIGID	V	VOLTAGE
CPLG	COVER	HV	HIGH VOLTAGE	RLF	RELIEF	VAR	VARIABLE
CRT	COUPLING	IC	INTEGRATED CIRCUIT	RTNR	RETAINER	W/	WITH
DEG	CATHODE RAY TUBE	ID	INSIDE DIAMETER	SCH	SOCKET HEAD	WSHR	WASHER
DWR	DEGREE	IDNT	IDENTIFICATION	SCOPE	OSCILLOSCOPE	XFMR	TRANSFORMER
	DRAWER	IMPLR	IMPELLER	SCR	SCREW	XSTR	TRANSISTOR

CROSS INDEX—MFR. CODE NUMBER TO MANUFACTURER

Mfr. Code	Manufacturer	Address	City, State, Zip
0000L	MATSUHITA ELECTRIC	200 PARK AVENUE, 54TH FLOOR	NEW YORK, NY 10017
01295	TEXAS INSTRUMENTS, INC., SEMICONDUCTOR GROUP	P O BOX 5012, 13500 N CENTRAL EXPRESSWAY	DALLAS, TX 75222
05574	VIKING INDUSTRIES, INC.	21001 NORDHOFF STREET	CHATSWORTH, CA 91311
08261	SPECTRA-STRIP CORP.	7100 LAMPSON AVE.	GARDEN GROVE, CA 92642
12327	FREEWAY CORPORATION	9301 ALLEN DRIVE	CLEVELAND, OH 44125
13257	AMERACE, LTD.	10 ESNA PARK DRIVE	MARKHAM, ONTARIO, CANADA
16179	OMNI SPECTRA, INC.	24600 HALLWOOD CT.	FARMINGTON, MI 48024
22526	BERG ELECTRONICS, INC.	YOUK EXPRESSWAY	NEW CUMBERLAND, PA 17070
23499	GAVITT WIRE AND CABLE, DIVISION OF RSC INDUSTRIES, INC.	455 N. QUINCE ST.	ESCONDIDO, CA 92025
28499	CHEMELEC PRODUCTS, INC.	6 SPRINGDALE RD.	CHERRY HILL, NJ 08003
70276	ALLEN MFG. CO.	P. O. DRAWER 570	HARTFORD, CT 06101
71468	ITT CANNON ELECTRIC	666 E. DYER RD.	SANTA ANA, CA 92702
71590	CENTRALAB ELECTRONICS, DIV. OF GLOBE-UNION, INC.	P O BOX 858	FORT DODGE, IA 50501
71785	TRW, CINCH CONNECTORS	1501 MORSE AVENUE	ELK GROVE VILLAGE, IL 60007
73743	FISCHER SPECIAL MFG. CO.	446 MORGAN ST.	CINCINNATI, OH 45206
74445	HOLO-KROME CO.	31 BROOK ST. WEST	HARTFORD, CT 06110
77250	PHEOLL MANUFACTURING CO., DIVISION OF ALLIED PRODUCTS CORP.	5700 W. ROOSEVELT RD.	CHICAGO, IL 60650
78189	ILLINOIS TOOL WORKS, INC. SHAKEPROOF DIVISION	ST. CHARLES ROAD	ELGIN, IL 60120
79136	WALDES, KOHINOOR, INC.	47-16 AUSTEL PLACE	LONG ISLAND CITY, NY 11101
79727	C-W INDUSTRIES	550 DAVISVILLE RD., P O BOX 96	WARMINISTER, PA 18974
79807	WROUGHT WASHER MFG. CO.	2100 S. O BAY ST.	MILWAUKEE, WI 53207
80009	TEKTRONIX, INC.	P. O. BOX 500	BEAVERTON, OR 97077
81073	GRAYHILL, INC.	561 HILLGROVE AVE., PO BOX 373	LA GRANGE, IL 60525
83385	CENTRAL SCREW CO.	2530 CRESCENT DR.	BROADVIEW, IL 60153
83501	GAVITT WIRE AND CABLE, DIVISION OF RSC INDUSTRIES, INC.	CENTRAL ST.	BROOKFIELD, MA 01506
87308	N. L. INDUSTRIES, INC., SOUTHERN SCREW DIV.	P. O. BOX 1360	STATESVILLE, NC 28677
90484	ITT, SURPRENANT DIV.	172 STERLING STREET	CLINTON, MA 01510
97464	INDUSTRIAL RETAINING RING CO.	57 CORDIER ST.	IRVINGTON, NJ 07111
98291	SEALECTRO CORP.	225 HOYT	MAMARONECK, NY 10544

Fig. & Index No.	Tektronix Part No.	Serial/Model No.		Qty	1 2 3 4 5	Name & Description	Mfr Code	Mfr Part Number
		Eff	Dscont					
1-1	366-1064-00			1		KNOB:GRAY	80009	366-1064-00
	213-0153-00			1		. SETSCREW:5-40 X 0.125 INCH,HEX SOC STL	74445	OBD
-2	366-1148-01			1		KNOB:GRAY	80009	366-1148-01
	213-0153-00			2		. SETSCREW:5-40 X 0.125 INCH,HEX SOC STL	74445	OBD
-3	366-1168-00			2		KNOB:BLACK CAP AND RED BODY	80009	366-1168-00
	213-0153-00			1		. SETSCREW:5-40 X 0.125 INCH,HEX SOC STL	74445	OBD
-4	366-1057-00			1		KNOB:GRAY	80009	366-1057-00
	213-0153-00			2		. SETSCREW:5-40 X 0.125 INCH,HEX SOC STL	74445	OBD
-5	366-0402-00			1		KNOB:GRAY	80009	366-0402-00
	213-0153-00			2		. SETSCREW:5-40 X 0.125 INCH,HEX SOC STL	74445	OBD
-6	366-1258-00			1		KNOB:GRAY	80009	366-1258-00
	213-0153-00			2		. SETSCREW:5-40 X 0.125 INCH,HEX SOC STL	74445	OBD
-7	200-1011-03			1		CAP,KNOB:	80009	200-1011-03
	366-1284-00			1		KNOB ASSY:	80009	366-1284-00
-8	331-0277-00			1		. SCALE,DIAL IND:TIME/DIV	80009	331-0277-00
-9	366-1150-00			1		KNOB:GRAY	80009	366-1150-00
	213-0153-00			2		. SETSCREW:5-40 X 0.125 INCH,HEX SOC STL	74445	OBD
-10	366-1059-01			1		PUSH BUTTON:GRAY	80009	366-1059-01
-11	366-1215-00			1		KNOB:GRAY	80009	366-1215-00
	213-0153-00			1		. SETSCREW:5-40 X 0.125 INCH,HEX SOC STL	74445	OBD
-12	366-1173-00	B010100	B039999	1		KNOB:GRAY	80009	366-1173-00
	366-1173-02	B040000		1		KNOB:GRAY	80009	366-1173-02
	213-0140-00			1		. SETSCREW:2-56 X 0.94 INCH,HEX SOC STL	70276	OBD
-13	366-1058-19			1		KNOB:LATCH	80009	366-1058-19
						(ATTACHING PARTS)		
-14	214-1095-00			1		PIN,SPG,SPLIT:0.094 OD X 0.187 INCH LONG	13257	52-022-094-0187
-15	358-0414-00			1		BUSHING,SLEEVE:0.25 OD X 0.21 INCH LONG	80009	358-0414-00
-16	105-0076-00			1		REL BAR,LATCH:PLUG-IN UNIT	80009	105-0076-00
-17	214-1280-00			1		SPRING,HLCPS:0.14 OD X 1.126"L,0.16"DIA W	80009	214-1280-00
-18	214-1054-00			1		SPRING,DETENT:LATCH	80009	214-1054-00
-19	105-0075-00			1		PAWL:0.475 X 0.21 X 0.184 INCH,PLSTC	80009	105-0075-00
						- - - * - - -		
-20	358-0378-00			5		BUSHING,SLEEVE:PRESS MOUNT	80009	358-0378-00
-21	333-1378-00			1		PANEL,FRONT:	80009	333-1378-00
-22	348-0235-00			2		SHLD GSKT,ELEC:4.734 INCH LONG	80009	348-0235-00
-23	260-0735-00			1		SWITCH,PUSH:SPST	81073	39-1
-24	386-1858-01			1		SUBPANEL,FRONT:	80009	386-1858-01
						(ATTACHING PARTS)		
-25	213-0192-00			8		SCR,TPG,THD FOR:6-32 X 0.50 INCH,PNH STL	87308	OBD
						- - - * - - -		
-26	200-0895-00			1		BEZEL,SMPLG HD:PLASTIC	80009	200-0895-00
						(ATTACHING PARTS)		
-27	210-0586-00			4		NUT,PLAIN,EXT W:4-40 X 0.25 INCH,STL	78189	OBD
-28	343-0153-00			4		CLAMP,RIM,CLENC:0.375 X 0.358INCH	80009	343-0153-00
						- - - * - - -		
-29	200-0895-00			1		BEZEL,SMPLG HD:PLASTIC	80009	200-0895-00
						(ATTACHING PARTS)		
-30	210-0586-00			2		NUT,PLAIN,EXT W:4-40 X 0.25 INCH,STL	78189	OBD
-31	343-0153-00			2		CLAMP,RIM,CLENC:0.375 X 0.358INCH	80009	343-0153-00
						- - - * - - -		
-32	-----			2		RESISTOR,VAR:(SEE R660,R665 EPL)		
						(ATTACHING PARTS FOR EACH)		
-33	358-0409-00			1		BSHG,MACH.THD:0.25-32 X 0.159 ID X 0.24	80009	358-0409-00
-34	220-0510-00			1		NUT,PLAIN,HEX.:0.25-32 X 0.312 INCH	80009	220-0510-00
-35	210-0046-00			2		WASHER,LOCK:INTL,0.26 ID X 0.40" OD,STL	78189	1214-05-00-0541C
						- - - * - - -		
-36	343-0293-00			1		BRACKET,ANGLE:	80009	343-0293-00
-37	131-0779-00			4		JACK,TIP:FOR 0.08 INCH DIA TEST POINT	98291	016-8010-8
						(ATTACHING PARTS)		
-38	352-0216-00			2		HOLDER,TIP,JACK:	80009	352-0216-00
-39	213-0078-00			2		SCR,TPG,THG CTG:4-24 X 0.375 FLH,100 DEG STL	83385	OBD
						- - - * - - -		



Replaceable Mechanical Parts—7S12

Fig. & Index No.	Tektronix Part No.	Serial/Model No. Eff Dscont	Qty	1 2 3 4 5	Name & Description	Mfr Code	Mfr Part Number
1-40	-----		1		CKT CARD ASSY:SCAN MODE(SEE A9 EPL) (ATTACHING PARTS)		
-41	211-0156-00		2		SCREW,MACHINE:1-72 X 0.25",82 DEG,FLH STL - - - * - - -	77250	OBD
-42	-----		1		RESISTOR,VAR:(SEE R601 EPL) (ATTACHING PARTS)		
-43	210-0583-00		1		NUT,PLAIN,HEX.:0.25-32 X 0.312 INCH,BRS	73743	2X20224-402
	210-0940-00		1		WASHER,FLAT:0.25 ID X 0.375 INCH OD,STL	79807	OBD
-44	210-0046-00		1		WASHER,LOCK:INTL,0.26 ID X 0.40" OD,STL - - - * - - -	78189	1214-05-00-0541C
	331-0275-00		1		DIAL ASSY,TAPE:	80009	331-0275-00
-45	354-0163-00		2		. RING,RETAINING:TRUAR,CAD PLATE	79136	5133-12MD
-46	210-0803-00		2		. WASHER,FLAT:0.15 ID X 0.375 INCH OD,STL	12327	OBD
-47	386-1299-00		1		. PLATE,RETAINING:DIAL TAPE	80009	386-1299-00
-48	331-0273-00		1		. DIAL TAPE:	80009	331-0273-00
-49	401-0042-00		2		. BEARING,CAM SW:0.255 ID X 0.50" OD,NYLON	80009	401-0042-00
-50	129-0288-00		2		. POST,ELEC-MECH:	80009	129-0288-00
-51	210-1043-00		2		. WASHER,NONMETAL:0.254 ID X 0.685" OD,TEFLON	80009	210-1043-00
-52	331-0189-00		1		. LENS,TAPE DIAL:MOLD ACRYLIC (ATTACHING PARTS)	80009	331-0189-00
-53	211-0105-00		2		. SCREW,MACHINE:4-40 X 0.188"100 DEG,FLH STL - - - * - - -	83385	OBD
-54	407-0861-00		1		. BRACKET,ANGLE:	80009	407-0861-00
-55	-----		1		. RESISTOR,VAR:(SEE R674 EPL) (ATTACHING PARTS)		
-56	210-0413-00		1		. NUT,PLAIN,HEX.:0.375-32 X 0.50 INCH,STL	73743	3145-402
-57	210-0012-00		1		. WASHER,LOCK:INTL,0.375 ID X 0.50" OD STL - - - * - - -	78189	1220-02-00-0541C
-58	407-0843-00		1		. BRKT,COMPONENT:	80009	407-0843-00
-59	214-1634-00		1		. SPRING,FLAT: (ATTACHING PARTS)	80009	214-1634-00
-60	211-0503-00		1		. SCREW,MACHINE:6-32 X 0.188 INCH,PNH STL - - - * - - -	83385	OBD
-61	214-0953-00		1		. GEAR,SPUR:0.825 LONG THRU HUB	80009	214-0953-00
	213-0075-00		4		. . SETSCREW:4-40 X 0.094 INCH,HEX SOC STL	70276	OBD
-62	384-1040-00		1		. EXTENSION SHAFT:1.335 L X 0.25 OD SST	80009	384-1040-00
-63	401-0105-00		1		. GEAR,SPUR:21 TEETH,BRS	80009	401-0105-00
	213-0075-00		1		. . SETSCREW:4-40 X 0.094 INCH,HEX SOC STL	70276	OBD
-64	384-1039-00		1		. EXTENSION SHAFT:1.54 L X 0.186 OD,SST	80009	384-1039-00
-65	166-0024-00		1		. SPACER,SLEEVE:0.133 ID X 0.125 INCH L,BRS	71590	P1646XS
-66	401-0106-00		1		. GEAR,SPUR:30 TEETH,BRS	80009	401-0106-00
	213-0075-00		1		. . SETSCREW:4-40 X 0.094 INCH,HEX SOC STL	70276	OBD
-67	210-0917-00		1		. WASHER,NONMETAL:0.191 ID X 0.625 INCH OD (ATTACHING PART FOR DIAL ASSY)	28499	OBD
-68	211-0538-00		2		SCREW,MACHINE:6-32 X 0.312"100 DEG,FLH STL - - - * - - -	83385	OBD
-69	-----		1		CKT CARD ASSY:RHO CAL SWITCH(SEE A7 EPL) (ATTACHING PARTS FOR CKT CD ASSY)		
-70	211-0156-00		1		SCREW,MACHINE:1-72 X 0.25",82 DEG,FLH STL - - - * - - -	77250	OBD
-71	-----		1		CKT CD ASSY:HIGH RESOL.,PRESET SW(SEE A8 EPL) (ATTACHING PARTS FOR CKT CD)		
-72	211-0116-00		2		SCR,ASSEM WSHR:4-40 X 0.312 INCH,PNH BRS - - - * - - -	83385	OBD
-73	-----		1		RESISTOR,VAR:(SEE R151 EPL)		
-74	210-0465-00		1		. NUT,PLAIN,HEX.:0.25-32 X 0.375 INCH BRS (ATTACHING PARTS)	73743	3095-402
-75	210-0583-00		1		NUT,PLAIN,HEX.:0.25-32 X 0.312 INCH,BRS	73743	2X20224-402
-76	210-0940-00		1		WASHER,FLAT:0.25 ID X 0.375 INCH OD,STL	79807	OBD
-77	210-0046-00		1		WASHER,LOCK:INTL,0.26 ID X 0.40" OD,STL - - - * - - -	78189	1214-05-00-0541C
-78	-----		1		RESISTOR,VAR:(SEE R345 EPL)		

Fig. & Index No.	Tektronix Part No.	Serial/Model No. Eff Dscont	Qty	1 2 3 4 5	Name & Description	Mfr Code	Mfr Part Number
1-79	-----		2		RESISTOR,VAR:(SEE R305,R670 EPL) (ATTACHING PARTS FOR EACH)		
-80	358-0409-00		1		BSHG,MACH.THD:0.25-32 X 0.159 ID X 0.24	80009	358-0409-00
-81	129-0252-00		1		SPACER,POST:	80009	129-0252-00
-82	210-0583-00		1		NUT,PLAIN,HEX.:0.25-32 X 0.312 INCH,BRS - - - * - - -	73743	2X20224-402
-83	361-0366-00		1		SPACER,SWITCH:1.075 X 1.10 INCHES	80009	361-0366-00
-84	-----		1		RESISTOR,VAR:(SER R675 EPL) (ATTACHING PARTS)		
-85	358-0422-00		1		BSHG,MACH.THD:0.25-32 X 0.187" LONG BRS	80009	358-0422-00
-86	129-0252-00 210-0583-00		1		SPACER,POST:0.45 LONG X 0.312 HEX	80009	129-0252-00
			1		NUT,PLAIN,HEX.:0.25-32 X 0.312 INCH,BRS - - - * - - -	73743	2X20224-402
-87	337-1238-00	B020000 B029999	1		SHIELD,ELEC:LEFT SIDE	80009	337-1238-00
	337-1238-01	B030000	1		SHIELD,ELEC:LEFT SIDE	80009	337-1238-01
-88	337-1064-00	B020000 B029999	1		SHLD,SIDE,ELEC:RIGHT AND LEFT SIDE	80009	337-1064-00
	337-1064-04	B030000	1		SHIELD,ELEC:RIGHT SIDE	80009	337-1064-00
-89	426-0680-00		1		FR SECT,PLUG-IN:LOWER RIGHT	80009	426-0680-00
-90	386-1856-00		2		SPRT,CKT BD CON: (ATTACHING PARTS FOR EACH)	80009	386-1856-00
-91	213-0192-00		2		SCR,TPG,THD FOR:6-32 X 0.50 INCH,PNH STL - - - * - - -	87308	OBD
-92	426-0689-00		1		FR SECT,PL-IN:LOWER LEFT	80009	426-0689-00
-93	388-1473-00		1		CKT CARD ASSY: (ATTACHING PARTS FOR CKT CD)	80009	388-1473-00
-94	211-0112-00		3		SCREW,MACHINE:4-40 X 0.375"100DEG,FLH STL	83385	OBD
-95	210-0001-00		3		WASHER,LOCK:INTL,0.092 ID X 0.18"OD,STL	78189	1202-00-00-0541C
-96	210-0405-00		3		NUT,PLAIN,HEX.:2-56 X 0.188 INCH,BRS - - - * - - -	73743	2X12157-402
-97	204-0410-00		1		BODY,ELEC CONN: (ATTACHING PARTS)	80009	204-0410-00
-98	211-0038-00		3		SCREW,MACHINE:4-40 X 0.312"100 DEG,FLH STL	83385	OBD
-99	210-0586-00		3		NUT,PLAIN,EXT W:4-40 X 0.25 INCH,STL - - - * - - -	78189	OBD
-100	-----		1		CKT CARD ASSY:CABLE(SEE A5 EPL)		
-101	131-0608-00		58		. CONTACT,ELEC:0.365 INCH LONG	22526	47357
	131-0589-00		6		. CONTACT,ELEC:0.46 INCH LONG	22526	47350
-102	131-0990-00		4		. CONNECTOR,RCPT:72 CONTACT	05574	2VH36/1AV3
-103	214-0702-00		1		. KEY,CONN PLZN:T SHAPED MOLD ACETAL (ATTACHING PARTS FOR CKT CD)	80009	214-0702-00
-104	211-0008-00		4		SCREW,MACHINE:4-40 X 0.25 INCH,PNH STL - - - * - - -	83385	OBD
-105	426-0678-00		1		FR SECT,PL-IN:UPPER RIGHT	80009	426-0678-00
-106	220-0547-01		4		NUT,BLOCK:0.38 X 0.25 X 0.282"OA (ATTACHING PARTS FOR EACH)	80009	220-0547-01
-107	211-0105-00		1		SCREW,MACHINE:4-40 X 0.188"100 DEG,FLH STL - - - * - - -	83385	OBD
-108	426-0679-00		1		FR SECT,PL-IN:UPPER LEFT	80009	426-0679-00
-109	214-1061-00		1		SPRING,GROUND:FLAT	80009	214-1061-00
-110	262-0927-00		1		SW,ROT,WIRED:	80009	262-0927-00
	260-1218-00	B020000 B029999	1		. SWITCH,ROTARY:	80009	260-1218-00
	260-1218-01	B030000	1		. SWITCH,ROTARY:	80009	260-1218-01
-111	386-1951-00		1		. . SUPPORT,SWITCH:	80009	386-1951-00
-112	-----		1		. RESISTOR,VAR:(SEE R320 EPL) (ATTACHING PARTS)		
-113	210-0583-00		1		. NUT,PLAIN,HEX.:0.25-32 X 0.312 INCH,BRS	73743	2X20224-402
-114	210-0046-00		1		. WASHER,LOCK:INTL,0.26 ID X 0.40" OD,STL - - - * - - -	78189	1214-05-00-0541C
-115	214-1205-00		1		. ACTUATOR,SW:	80009	214-1205-00
-116	131-0621-00		11		. CONTACT,ELEC:0.577"L,22-26 AWG WIRE	22526	46231
	131-0622-00		3		. CONTACT,ELEC:0.577"L,28-32 AWG WIRE	22526	46241
-117	131-0707-00		7		. CONTACT,ELEC:0.48"L,22-26 AWG WIRE	22526	47439
	131-0792-00		3		. CONTACT,ELEC:0.577"L,18-20 AWG WIRE	22526	46221

Replaceable Mechanical Parts—7S12

Fig. & Index No.	Tektronix Part No.	Serial/Model No. Eff	Dscont	Qty	1	2	3	4	5	Name & Description	Mfr Code	Mfr Part Number
1-118	352-0165-01			1	.	CONN	BODY,PL,EL:7	WIRE	BROWN		80009	352-0165-01
-119	352-0198-03			1	.	CONN	BODY,PL,EL:2	WIRE	ORANGE		80009	352-0198-03
	352-0198-07			1	.	CONN	BODY,PL,EL:2	WIRE	PURPLE		80009	352-0198-07
-120	352-0200-05			1	.	CONN	BODY,PL,EL:4	WIRE	GREEN		80009	352-0200-05
-121	352-0205-02			1	.	CONN	BODY,PL,EL:9	WIRE	RED		80009	352-0205-02
										(ATTACHING PARTS FOR SWITCH)		
-122	210-0413-00			1	NUT,PLAIN,HEX.:0.375-32 X 0.50 INCH,STL						73743	3145-402
-123	210-0012-00			1	WASHER,LOCK:INTL,0.375 ID X 0.50" OD STL						78189	1220-02-00-0541C
										- - - * - - -		
-124	376-0007-00			2	CPLG,SHAFT,RIGI:						80009	376-0007-00
	-----			-	. EACH COUPLING INCLUDES:							
	213-0005-00			2	SETSCREW:8-32 X 1.25 INCH,HEX SOC STL						74445	OBD
-125	358-0029-00			2	BSHG,MACH.THD:HEX,0.375-32 X 0.438"LONG						80009	358-0029-00
										(ATTACHING PARTS FOR EACH)		
-126	210-0413-00			1	NUT,PLAIN,HEX.:0.375-32 X 0.50 INCH,STL						73743	3145-402
-127	210-0012-00			1	WASHER,LOCK:INTL,0.375 ID X 0.50" OD STL						78189	1220-02-00-0541C
										- - - * - - -		
-128	131-0581-00			2	CONNECTOR,RCPT:						05574	2VK602/1-2
-129	351-0132-00			2	GUIDE,CLIP:PLASTIC						80009	351-0132-00
										(ATTACHING PARTS FOR EACH)		
-130	213-0082-00			2	SCR,TPG,THD CTG:4-40 X 0.50 INCH,PNH STL						80009	213-0082-00
										- - - * - - -		
-131	407-0842-00			1	BRACKET,COMPT:						80009	407-0842-00
										(ATTACHING PARTS)		
-132	211-0038-00			2	SCREW,MACHINE:4-40 X 0.312"100 DEG,FLH STL						83385	OBD
-133	211-0101-00			2	SCREW,MACHINE:4-40 X 0.25" 100 DEG,FLH STL						83385	OBD
-134	210-0586-00			4	NUT,PLAIN,EXT W:4-40 X 0.25 INCH,STL						78189	OBD
										- - - * - - -		
-135	-----			1	CKT CARD ASSY:LEFT INTERFACE(SEE A1 EPL)							
-136	131-0589-00			17	. CONTACT,ELEC:0.46 INCH LONG						22526	47350
	131-0608-00			7	. CONTACT,ELEC:0.365 INCH LONG						22526	47357
-137	136-0183-00			1	. SOCKET,PLUG-IN:3 PIN,ROUND						80009	136-0183-00
-138	136-0220-00			12	. SOCKET,PLUG-IN:3 PIN,SQUARE						71785	133-23-11-034
-139	136-0235-00			1	. SOCKET,PLUG-IN:6 CONTACT,ROUND						71785	133-96-12-062
-140	131-0566-00			1	. LINK,TERM.CONNE:0.086 DIA X 2.375 INCH L						0000L	ERD-18TO
-141	214-0579-00			4	. TERM.,TEST PT:0.40 INCH LONG						80009	214-0579-00
	136-0252-04	XB100000		3	. CONTACT,ELEC:0.188 INCH LONG						22526	75060
										(ATTACHING PARTS FOR CKT CD)		
-142	211-0116-00			3	SCR,ASSEM WSHR:4-40 X 0.312 INCH,PNH BRS						83385	OBD
-143	-----			1	CKT CARD ASSY:RIGHT INTERFACE(SEE A3 EPL)							
										- - - * - - -		
-144	214-0579-00	B010100	B089999	5	. TERM.,TEST PT:0.40 INCH LONG						80009	214-0579-00
	214-0579-00	B090000		3	. TERM.,TEST PT:0.40 INCH LONG						80009	214-0579-00
-145	131-0604-00			38	. CONTACT,ELEC:0.025 SQ X 0.365 INCH LONG						80009	131-0604-00
-146	131-0608-00			19	. CONTACT,ELEC:0.365 INCH LONG						22526	47357
-147	131-0391-00			1	. CONNECTOR,RCPT,:50 OHM,COAX,SNAP-ON MALE						98291	51-051-0049
-148	136-0220-00			22	. SOCKET,PLUG-IN:3 PIN,SQUARE						71785	133-23-11-034
	136-0252-04	B010100	B099999	12	. CONTACT,ELEC:0.188 INCH LONG						22526	75060
	136-0235-00	B100000		2	. SOCKET,PLUG-IN:6 CONTACT,ROUND						71785	133-96-12-062
	200-0687-01	XB100000		2	. COV,TRANSISTOR:0.438 DIA X 0.47 INCH H						80009	200-0687-01
	105-0265-00			1	. ACTR ASSY,CAM S:						80009	105-0265-00
-149	200-1157-00			1	. COVER,CAM SW:						80009	200-1157-00
										(ATTACHING PARTS)		
-150	211-0097-00			6	. SCREW,MACHINE:4-40 X 0.312 INCH,PNH STL						83385	OBD
-151	210-0201-00			3	. TERMINAL,LUG:SE #4						78189	2104-04-00-2520N
-152	210-0004-00			3	. WASHER,LOCK:INTL,0.12 ID X 0.26"OD,STL						78189	1204-00-00-0541C
-153	210-0406-00			6	. NUT,PLAIN,HEX.:4-40 X 0.188 INCH,BRS						73743	2X12161-402
										- - - * - - -		
-154	401-0081-01			2	. BEARING,CAM SW:WITH THREADED INSERTS						80009	401-0081-01
										(ATTACHING PARTS FOR EACH)		
-155	210-0406-00			2	. NUT,PLAIN,HEX.:4-40 X 0.188 INCH,BRS						73743	2X12161-402
										- - - * - - -		

Replaceable Mechanical Parts—7S12

Fig. & Index No.	Tektronix Part No.	Serial/Model No. Eff Dscont	Qty	1	2	3	4	5	Name & Description	Mfr Code	Mfr Part Number
1-156	214-1139-02 <sup>1</sup>		1	.	.	.	.	.	SPRING,FLAT:GREEN COLORED	80009	214-1139-02
	214-1139-03 <sup>1</sup>		1	.	.	.	.	.	SPRING,FLAT:RED COLORED	80009	214-1139-03
-157	214-1127-00		4	.	.	.	.	.	ROLLER,DETENT:0.125 DIA X 0.125 INCH L	80009	214-1127-00
-158	401-0104-01		1	.	.	.	.	.	BEARING,CAM SW: (ATTACHING PARTS)	80009	401-0104-01
	210-0406-00		2	.	.	.	.	.	NUT,PLAIN,HEX.:4-40 X 0.188 INCH,BRS - - - * - - - -	73743	2X12161-402
-159	105-0205-00		1	.	.	.	.	.	ACTUATOR,CAM SW:FRONT	80009	105-0205-00
-160	105-0207-00		1	.	.	.	.	.	ACTUATOR,CAM SW:REAR	80009	105-0207-00
-161	-----		1	.	.	.	.	.	RESISTOR,VAR:(SEE R710 EPL) (ATTACHING PARTS)		
-162	210-0583-00		1	.	.	.	.	.	NUT,PLAIN,HEX.:0.25-32 X 0.312 INCH,BRS	73743	2X20224-402
	210-0046-00		1	.	.	.	.	.	WASHER,LOCK:INTL,0.26 ID X 0.40" OD,STL	78189	1214-05-00-0541C
	210-0905-00		1	.	.	.	.	.	WASHER,FLAT:0.256 ID X 0.438 INCH OD,BRS - - - * - - - -	83385	OBD
-163	386-1792-00		1	.	.	.	.	.	PLATE,VAR RES M:1.136 X 0.875 INCH OA (ATTACHING PARTS)	80009	386-1792-00
-164	211-0022-00		2	.	.	.	.	.	SCREW,MACHINE:2-56 X 0.188 INCH,PNH STL	83385	OBD
-165	210-0001-00		1	.	.	.	.	.	WASHER,LOCK:INTL,0.092 ID X 0.18"OD,STL	78189	1202-00-00-0541C
-166	210-0259-00		1	.	.	.	.	.	TERMINAL,LUG:0.099"ID INT TOOTH,SE - - - * - - - -	80009	210-0259-00
-167	384-1032-00		1	.	.	.	.	.	SHAFT,CAM SW:6.812 L X 0.156 OD	80009	384-1032-00
-168	384-1027-00		1	.	.	.	.	.	EXTENSION SHAFT:9.52 L X 0.081 OD SST (ATTACHING PARTS)	80009	384-1027-00
	376-0039-00		1	.	.	.	.	.	ADPT,SHAFT,CPLG:0.128 AND 0.082"DIA SHAFT	80009	376-0039-00
	213-0075-00		2	.	.	.	.	.	SETSCREW:4-40 X 0.094 INCH,HEX SOC STL	70276	OBD
-169	354-0391-00		1	.	.	.	.	.	RING,RETAINING:0.395"FREE ID X 0.025" STL - - - * - - - -	97464	3100-43-CD
									(ATTACHING PARTS FOR CAM SW)		
-170	211-0116-00		4	.	.	.	.	.	SCR,ASSEM WSHR:4-40 X 0.312 INCH,PNH BRS - - - * - - - -	83385	OBD
									(ATTACHING PARTS FOR CKT CD)		
-171	211-0116-00		1	.	.	.	.	.	SCR,ASSEM WSHR:4-40 X 0.312 INCH,PNH BRS	83385	OBD
-172	211-0001-00		2	.	.	.	.	.	SCREW,MACHINE:2-56 X 0.25 INCH,PNH STL	83385	OBD
-173	210-0001-00		1	.	.	.	.	.	WASHER,LOCK:INTL,0.092 ID X 0.18 OD,STL	78189	1202-00-00-0541C
-174	210-0259-00		1	.	.	.	.	.	TERMINAL,LUG:0.099"ID INT TOOTH,SE - - - * - - - -	80009	210-0259-00
-175	384-1028-00		1	.	.	.	.	.	SHAFT,CAM SW:EXT,3.15 L X 0.248 OD	80009	384-1028-00
-176	-----		1	.	.	.	.	.	CKT CARD ASSY:FLOATING CONNECTOR(SEE A6 EPL)		
	136-0252-04	XB060000	3	.	.	.	.	.	CONTACT,ELEC:0.188 INCH LONG	22526	75060
-177	175-0825-00		FT	.	.	.	.	.	WIRE,ELECTRICAL:2 WIRE RIBBON	08261	TEK-175-0825-00
-178	175-0831-00		FT	.	.	.	.	.	WIRE,ELECTRICAL:8 WIRE RIBBON	08261	TEK-175-0831-00
-179	131-0707-00		18	.	.	.	.	.	CONTACT,ELEC:0.48"L,22-26 AWG WIRE	22526	47439
-180	352-0169-03		1	.	.	.	.	.	CONN BODY,PL,EL:2 WIRE ORANGE	80009	352-0169-03
-181	352-0166-04		1	.	.	.	.	.	CONN BODY,PL,EL:8 WIRE YELLOW	80009	352-0166-04
-182	352-0167-05	B020000 B029999	1	.	.	.	.	.	CONN BODY,PL,EL:9 WIRE GREEN	80009	352-0167-05
	352-0166-06	B030000	1	.	.	.	.	.	CONN BODY,PL,EL:8 WIRE BLUE	80009	352-0166-06
-183	-----		1	.	.	.	.	.	CKT CARD ASSY:HORIZONTAL(SEE A4 EPL)		
-184	136-0260-00	B020000 B020149	2	.	.	.	.	.	SOCKET,PLUG-IN:16 CONTACT,RECT SHAPE	71785	133-51-92-008
	136-0260-02	B020150	2	.	.	.	.	.	SOCKET,PLUG-IN:16 CONTACT,LOW CLEARANCE	01295	C931602
-185	136-0252-04	B080000	27	.	.	.	.	.	CONTACT,ELEC:0.188 INCH LONG	22526	75060
-186	136-0269-02		1	.	.	.	.	.	SOCKET,PLUG-IN:14 CONTACT,LOW CLEARANCE	01295	C931402
-187	136-0220-00		28	.	.	.	.	.	SOCKET,PLUG-IN:3 PIN,SQUARE	71785	133-23-11-034
-188	214-0579-00		9	.	.	.	.	.	TERM.,TEST PT:0.40 INCH LONG	80009	214-0579-00
-189	131-0566-00		2	.	.	.	.	.	LINK,TERM.CONNE:0.086 DIA X 2.375 INCH L	0000L	ERD-18TO
-190	136-0235-00		1	.	.	.	.	.	SOCKET,PLUG-IN:6 CONTACT,ROUND	71785	133-96-12-062
-191	260-0984-00		1	.	.	.	.	.	SWITCH,SLIDE:DP 3 POSN,0.5A,125VAC-DC (ATTACHING PARTS FOR CKT CARD)	79727	G-128SPC/7140
-192	211-0116-00		2	.	.	.	.	.	SCR,ASSEM WSHR:4-40 X 0.312 INCH,PNH BRS	83385	OBD
-193	361-0095-00		2	.	.	.	.	.	SPACER,POST:0.828 INCH LONG X 0.312 HEX BRS - - - * - - - -	80009	361-0095-00
-194	-----		1	.	.	.	.	.	CKT CARD ASSY:VERTICAL(SEE A2 EPL)		
-195	136-0220-00		18	.	.	.	.	.	SOCKET,PLUG-IN:3 PIN,SQUARE	71785	133-23-11-034

<sup>1</sup>Replace only with part bearing the same color as the original part in your instrument.

Replaceable Mechanical Parts—7S12

Fig. & Index No.	Tektronix Part No.	Serial/Model No. Eff Dscont	Qty	1 2 3 4 5	Name & Description	Mfr Code	Mfr Part Number
1-196	136-0235-00		2		. SOCKET, PLUG-IN: 6 CONTACT, ROUND	71785	133-96-12-062
-197	214-0579-00		11		. TERM., TEST PT: 0.40 INCH LONG (ATTACHING PARTS FOR CKT CD)	80009	214-0579-00
-198	211-0116-00		2		SCR, ASSEM WSHR: 4-40 X 0.312 INCH, PNH BRS - - - * - - -	83385	OBD
-199	384-1070-00		1		EXTENSION SHAFT: 3.2 L X 0.25 OD	80009	384-1070-00
-200	351-0087-02		4		GUIDE, CKT BD: 3.675 INCH LONG, PLASTIC	80009	351-0087-02
-201	407-0841-00		1		BRACKET, GUIDE: (ATTACHING PARTS)	80009	407-0841-00
-202	211-0008-00		8		SCREW, MACHINE: 4-40 X 0.25 INCH, PNH STL	83385	OBD
-203	129-0098-00		4		POST, ELEC-MECH: 0.250 HEX. X 0.406 INCH L, BRS - - - * - - -	80009	129-0098-00
-204	386-1855-00		1		PANEL, REAR: (ATTACHING PARTS)	80009	386-1855-00
-205	213-0192-00		8		SCR, TPG, THD FOR: 6-32 X 0.50 INCH, PNH STL - - - * - - -	87308	OBD
-206	351-0217-00		1		GUIDE, CKT BOARD: PLASTIC (ATTACHING PARTS)	80009	351-0217-00
-207	211-0507-00		4		SCREW, MACHINE: 6-32 X 0.312 INCH, PNH STL	83385	OBD
-208	220-0556-00		4		NUT, SLEEVE: 6-32 X 0.252 OD X 0.015" L BRS - - - * - - -	80009	220-0556-00
-209	351-0217-00		1		GUIDE, CKT CARD: PLASTIC (ATTACHING PARTS)	80009	351-0217-00
-210	211-0507-00		4		SCREW, MACHINE: 6-32 X 0.312 INCH, PNH STL	83385	OBD
-211	220-0557-00		4		NUT, SLEEVE: 6-32 X 0.204 OD X 0.118 L BRS - - - * - - -	80009	220-0557-00
-212	351-0284-00		1		SLIDE, GUIDE: (ATTACHING PARTS)	80009	351-0284-00
-213	213-0192-00		2		SCR, TPG, THD FOR: 6-32 X 0.50 INCH, PNH STL - - - * - - -	87308	OBD
-214	131-0410-00		2		CONNECTOR, RCPT: (ATTACHING PARTS)	71468	DM53741-5001
	343-0190-00		1		RTNR, CONNECTOR:	80009	343-0190-00
-215	354-0331-00		1		RING, RETAINING: - - - * - - -	79136	5131 X-21MD
-216	179-1635-00		1		WIRING HARNESS: FIXED SHOE	80009	179-1635-00
-217	131-0621-00		2		. CONTACT, ELEC: 0.577" L, 22-26 AWG WIRE	22526	46231
	131-0622-00		2		. CONTACT, ELEC: 0.577" L, 28-32 AWG WIRE	22526	46241
-218	131-0707-00		1		. CONTACT, ELEC: 0.48" L, 22-26 AWG WIRE	22526	47439
	131-0708-00		1		. CONTACT, ELEC: 0.48" L, 28-32 AWG WIRE	22526	47437
	131-0792-00		2		. CONTACT, ELEC: 0.577" L, 18-20 AWG WIRE	22526	46221
	131-0842-00		1		. TERMINAL, LUG:	80009	131-0842-00
-219	352-0162-08		1		. CONN BODY, PL, EL: 4 WIRE GRAY	80009	351-0162-08
-220	352-0198-08		1		. CONN BODY, PL, EL: 2 WIRE GRAY	80009	351-0198-08
	352-0198-09		1		. CONN BODY, PL, EL: 2 WIRE WHITE	80009	351-0198-09
-221	175-0825-00		FT		WIRE, ELECTRICAL: 2 WIRE RIBBON	08261	TEK-175-0825-00
-222	175-0826-00		FT		WIRE, ELECTRICAL: 3 WIRE RIBBON	08261	TEK-175-0826-00
-223	175-0827-00		FT		WIRE, ELECTRICAL: 4 WIRE RIBBON	08261	TEK-175-0827-00
-224	175-0828-00		FT		WIRE, ELECTRICAL: 5 WIRE RIBBON	23499	TEK-175-0828-00
-225	175-0829-00		FT		WIRE, ELECTRICAL: 6 WIRE RIBBON	83501	TEK-175-0829-00
-226	131-0375-00		1		CONNECTOR, PLUG, : RIGHT ANGLE	98291	51-028-0079
-227	131-0707-00		49		CONTACT, ELEC: 0.48" L, 22-26 AWG WIRE	22526	47439
-228	352-0161-02		1		CONN BODY, PL, EL: 3 WIRE RED	80009	352-0161-02
-229	352-0162-00		1		CONN BODY, PL, EL: 4 WIRE BLACK	80009	352-0162-00
	352-0162-01		1		CONN BODY, PL, EL: 4 WIRE BROWN	80009	352-0162-01
	352-0162-02		1		CONN BODY, PL, EL: 4 WIRE RED	80009	352-0162-02
	352-0162-05		1		CONN BODY, PL, EL: 4 WIRE GREEN	80009	352-0162-05
	352-0162-06		1		CONN BODY, PL, EL: 4 WIRE BLUE	80009	352-0162-06

Fig. & Index No.	Tektronix Part No.	Serial/Model No.		Qty						Name & Description	Mfr Code	Mfr Part Number
		Eff	Dscont		1	2	3	4	5			
1-230	352-0163-04			1						CONN BODY, PL, EL: 5 WIRE YELLOW	80009	352-0163-04
-231	352-0164-03			1						CONN BODY, PL, EL: 6 WIRE ORANGE	80009	352-0164-03
-232	352-0169-00			1						CONN BODY, PL, EL: 2 WIRE BLACK	80009	352-0169-00
	352-0169-01			1						CONN BODY, PL, EL: 2 WIRE BROWN	80009	352-0169-01
	352-0169-04			1						CONN BODY, PL, EL: 2 WIRE YELLOW	80009	352-0169-04
	352-0169-05			1						CONN BODY, PL, EL: 2 WIRE, GREEN	80009	352-0169-05
	352-0169-07			2						CONN BODY, PL, EL: 2 WIRE PURPLE	80009	352-0169-07
-233	175-1020-00	B010100	B120714	1						CABLE, RF: 50 OHM COAX	90484	DAB70JAAAWHITE
	175-1768-00	B120715		1						CABLE ASSY, RF: 1-50 OHM COAX, 7.0 L	80009	175-1768-00







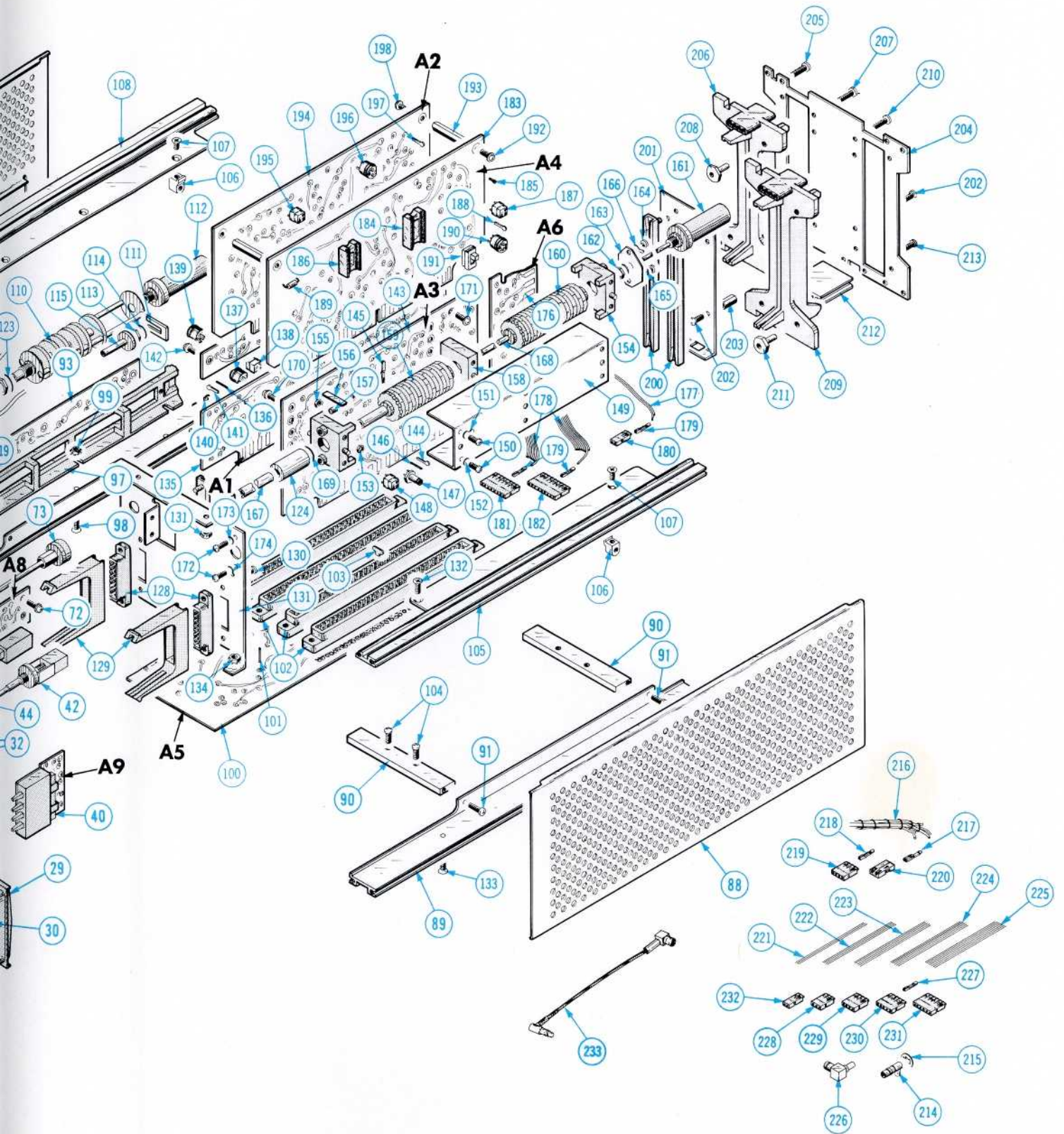

7S12 TDR SAMPLING UNIT (SN B020000-up)

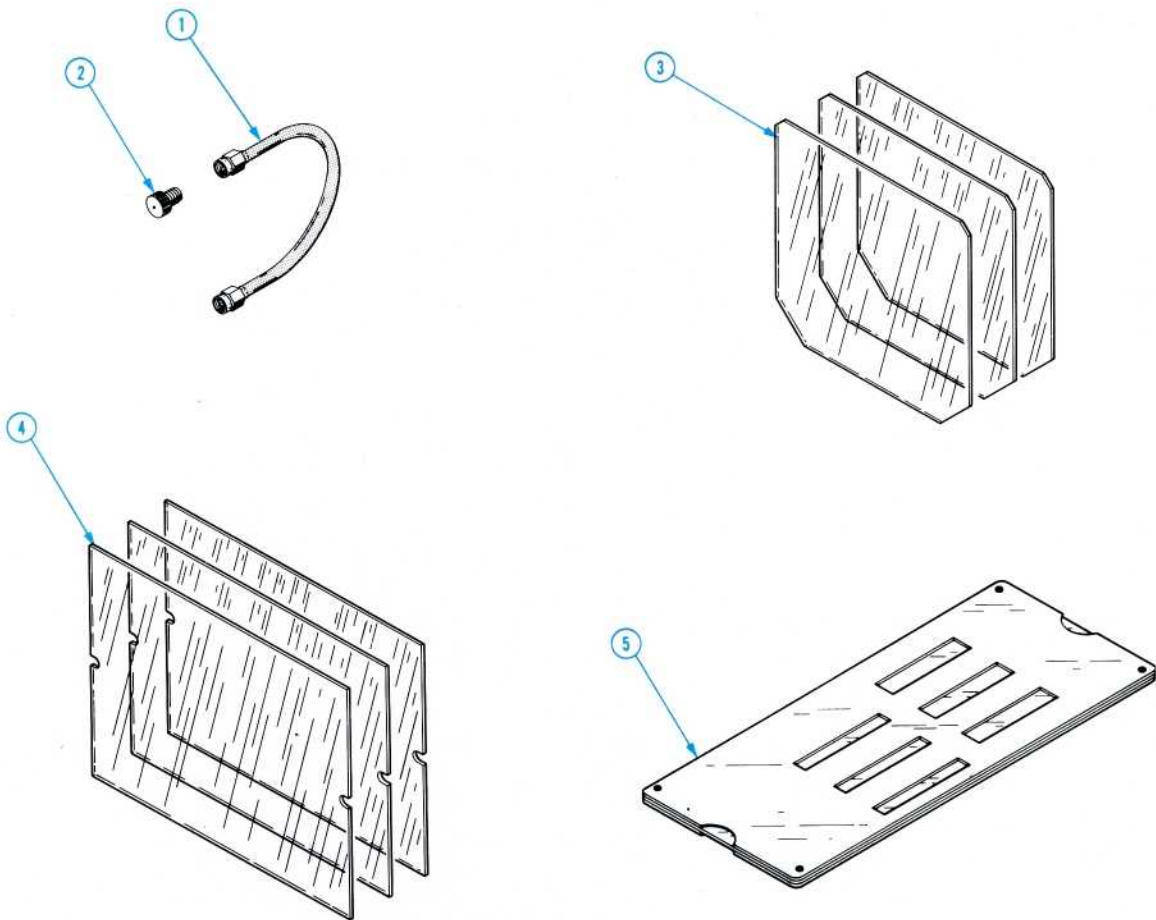

Fig. & Index No.	Tektronix Part No.	Serial/Model No.		Qty						Name & Description	Mfr Code	Mfr Part Number	
		Eff	Dscont		1	2	3	4	5				
-1	015-1017-01			1						1	DELAY LINE,ELEC:50 OHM,3.75NS	80009	015-1017-01
-2	015-1021-00			1						1	TERM,COAX:SHORT CIRCUIT	16179	20140J
-3	331-0296-00			1						1	OVERLAY,SET:CRT SCALE OVERLAY SET(3)	80009	331-0296-00
-4	331-0297-00			1						1	OVERLAY,SET:CRT SCALE OVERLAY SET(3)	80009	331-0297-00
	003-0700-01			1						1	RULE,SLIDE:TDR,W/MANUAL	80009	003-0700-01
-5	003-0700-00			1						1	. RULE,SLIDE:TIME DOMAIN REFLECTOMETER	80009	003-0700-00
	062-1538-00			1						1	. DATA SHEET:003-0700-00	80009	062-1538-00
	070-1277-00			1						1	MANUAL,TECH:INSTRUCTION	80009	070-1277-00

## **MANUAL CHANGE INFORMATION**

At Tektronix, we continually strive to keep up with latest electronic developments by adding circuit and component improvements to our instruments as soon as they are developed and tested.

Sometimes, due to printing and shipping requirements, we can't get these changes immediately into printed manuals. Hence, your manual may contain new change information on following pages.

A single change may affect several sections. Since the change information sheets are carried in the manual until all changes are permanently entered, some duplication may occur. If no such change pages appear following this page, your manual is correct as printed.

## **SERVICE NOTE**

Because of the universal parts procurement problem, some electrical parts in your instrument may be different from those described in the Replaceable Electrical Parts List. The parts used will in no way alter or compromise the performance or reliability of this instrument. They are installed when necessary to ensure prompt delivery to the customer. Order replacement parts from the Replaceable Electrical Parts List.

# CALIBRATION TEST EQUIPMENT REPLACEMENT

## Calibration Test Equipment Chart

This chart compares TM 500 product performance to that of older Tektronix equipment. Only those characteristics where significant specification differences occur, are listed. In some cases the new instrument may not be a total functional replacement. Additional support instrumentation may be needed or a change in calibration procedure may be necessary.

### Comparison of Main Characteristics

DM 501 replaces 7D13		
PG 501 replaces 107	PG 501 - Risetime less than 3.5 ns into 50 $\Omega$ .	107 - Risetime less than 3.0 ns into 50 $\Omega$ .
108	PG 501 - 5 V output pulse; 3.5 ns Risetime.	108 - 10 V output pulse; 1 ns Risetime.
111	PG 501 - Risetime less than 3.5 ns; 8 ns Pretrigger pulse delay.	111 - Risetime 0.5 ns; 30 to 250 ns Pretrigger Pulse delay.
114	PG 501 - $\pm 5$ V output.	114 - $\pm 10$ V output. Short proof output.
115	PG 501 - Does not have Paired, Burst, Gated, or Delayed pulse mode; $\pm 5$ V dc Offset. Has $\pm 5$ V output.	115 - Paired, Burst, Gated, and Delayed pulse mode; $\pm 10$ V output. Short-proof output.
PG 502 replaces 107		
108	PG 502 - 5 V output	108 - 10 V output.
111	PG 502 - Risetime less than 1 ns; 10 ns Pretrigger pulse delay.	111 - Risetime 0.5 ns; 30 to 250 ns Pretrigger pulse delay.
114	PG 502 - $\pm 5$ V output	114 - $\pm 10$ V output. Short proof output.
115	PG 502 - Does not have Paired, Burst, Gated, Delayed & Undelayed pulse mode; Has $\pm 5$ V output.	115 - Paired, Burst, Gated, Delayed & Undelayed pulse mode; $\pm 10$ V output. Short-proof output.
2101	PG 502 - Does not have Paired or Delayed pulse. Has $\pm 5$ V output.	2101 - Paired and Delayed pulse; 10 V output.
PG 506 replaces 106	PG 506 - Positive-going trigger output signal at least 1 V; High Amplitude output, 60 V.	106 - Positive and Negative-going trigger output signal, 50 ns and 1 V; High Amplitude output, 100 V.
067-0502-01	PG 506 - Does not have chopped feature.	0502-01 - Comparator output can be alternately chopped to a reference voltage.
SG 503 replaces 190, 190A, 190B, 191, 067-0532-01	SG 503 - Amplitude range 5 mV to 5.5 V p-p. SG 503 - Frequency range 250 kHz to 250 MHz. SG 503 - Frequency range 250 kHz to 250 MHz.	190B - Amplitude range 40 mV to 10 V p-p. 191 - Frequency range 350 kHz to 100 MHz. 0532-01 - Frequency range 65 MHz to 500 MHz.
TG 501 replaces 180, 180A	TG 501 - Marker outputs, 5 sec to 1 ns. Sinewave available at 5, 2, and 1 ns. Trigger output - slaved to marker output from 5 sec through 100 ns. One time-mark can be generated at a time.	180A - Marker outputs, 5 sec to 1 $\mu$ s. Sinewave available at 20, 10, and 2 ns. Trigger pulses 1, 10, 100 Hz; 1, 10, and 100 kHz. Multiple time-marks can be generated simultaneously.
181	TG 501 - Marker outputs, 5 sec to 1 ns. Sinewave available at 5, 2, and 1 ns.	181 - Marker outputs, 1, 10, 100, 1000, and 10,000 $\mu$ s, plus 10 ns sinewave.
184	TG 501 - Marker outputs, 5 sec to 1 ns. Sinewave available at 5, 2, and 1 ns. Trigger output - slaved to marker output from 5 sec through 100 ns. One time-mark can be generated at a time.	184 - Marker outputs, 5 sec to 2 ns. Sinewave available at 50, 20, 10, 5, and 2 ns. Separate trigger pulses of 1 and .1 sec; 10, 1, and .1 ms; 10 and 1 $\mu$ s. Marker amplifier provides positive or negative time marks of 25 V min. Marker intervals of 1 and .1 sec; 10, 1, and .1 ms; 10 and 1 $\mu$ s.
2901	TG 501 - Marker outputs, 5 sec to 1 ns. Sinewave available at 5, 2, and 1 ns. Trigger output - slaved to marker output from 5 sec through 100 ns. One time-mark can be generated at a time.	2901 - Marker outputs, 5 sec to 0.1 $\mu$ s. Sinewave available to 50, 10, and 5 ns. Separate trigger pulses, from 5 sec to 0.1 $\mu$ s. Multiple time-marks can be generated simultaneously.

**NOTE: All TM 500 generator outputs are short-proof. All TM 500 plug-in instruments require TM 500-Series Power Module.**