

TEKTRONIX®

**7A26
DUAL TRACE
AMPLIFIER**

INSTRUCTION MANUAL

Tektronix, Inc.
P.O. Box 500
Beaverton, Oregon 97005

Serial Number _____



WARRANTY

All TEKTRONIX instruments are warranted against defective materials and workmanship for one year. Any questions with respect to the warranty should be taken up with your TEKTRONIX Field Engineer or representative.

All requests for repairs and replacement parts should be directed to the TEKTRONIX Field Office or representative in your area. This will assure you the fastest possible service. Please include the instrument Type Number or Part Number and Serial Number with all requests for parts or service.

Specifications and price change privileges reserved.

Copyright © 1972, new material copyright 1975, by Tektronix, Inc., Beaverton, Oregon. Printed in the United States of America. All rights reserved. Contents of this publication may not be reproduced in any form without permission of Tektronix, Inc.

U.S.A. and foreign TEKTRONIX products covered by U.S. and foreign patents and/or patents pending.

TEKTRONIX is a registered trademark of Tektronix, Inc.

TABLE OF CONTENTS

	Page
SECTION 1	OPERATING INSTRUCTIONS
	7A26 Features 1-1
	Installation 1-1
	General Operating Information 1-1
	7A26 Front-panel Controls and Connectors 1-2
	Basic Applications 1-4
SECTION 2	SPECIFICATION
	Introduction 2-1
	Electrical Characteristics 2-1
	Environmental Characteristics 2-2
	Physical Characteristics 2-2
SECTION 3	THEORY OF OPERATION
	Introduction 3-1
	Block Diagram 3-1
	Detailed Circuit Description 3-1
SECTION 4	MAINTENANCE
	Introduction 4-1
	Preventive Maintenance 4-1
	Troubleshooting 4-1
	Corrective Maintenance 4-3
	Troubleshooting Chart 4-5
	Repackaging for Shipment 4-8
SECTION 5	CALIBRATION
	Introduction 5-1
	Performance Check 5-1
	Test Equipment Required 5-1
	Calibration Procedure 5-3
	Index To Calibration Procedure 5-3
SECTION 6	ELECTRICAL PARTS LIST
	Parts Ordering Information
	Abbreviations and Symbols
SECTION 7	DIAGRAMS AND CIRCUIT BOARD ILLUSTRATIONS
	Symbols and Reference Designators
SECTION 8	MECHANICAL PARTS LIST
	Mechanical Parts List Information
	Index of Mechanical Parts Illustrations
	Mechanical Parts List

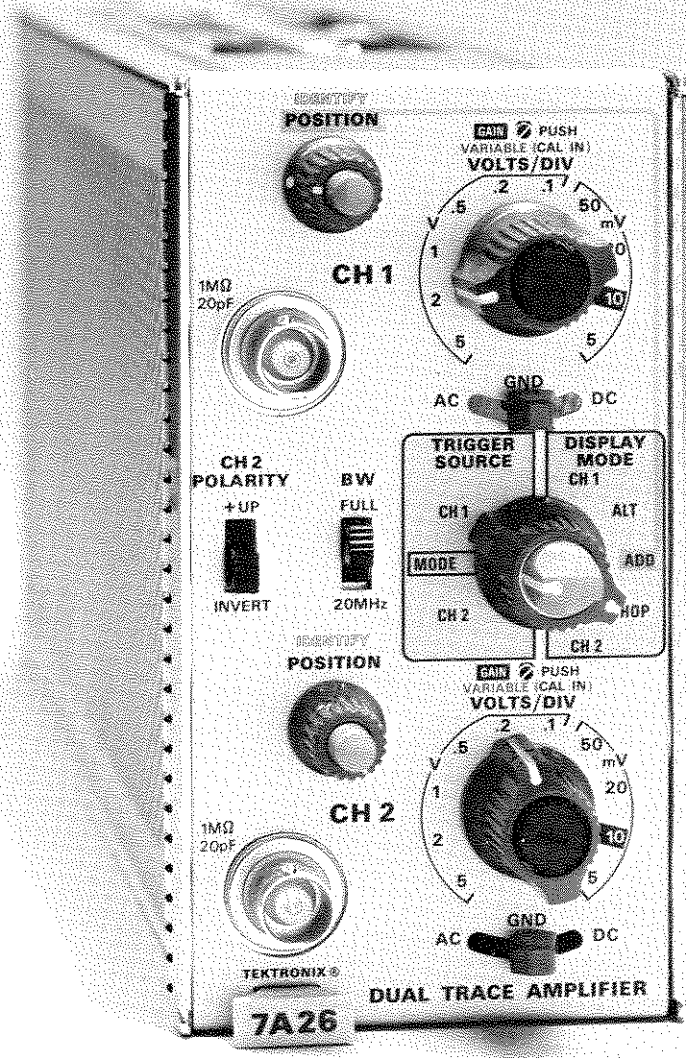

Fig. 1-1. 7A26 Dual Trace Amplifier.

OPERATING INSTRUCTIONS

7A26 Features

The 7A26 Dual Trace Amplifier plug-in unit is designed for use with TEKTRONIX 7000-Series Oscilloscopes. The 7A26 is a dual-channel wide-bandwidth amplifier. Internal gain and compensation circuits are automatically switched to correspond to the setting of the VOLTS/DIV switch. Channel 2 can be inverted for differential measurements.

PRELIMINARY INFORMATION

Installation

The 7A26 is calibrated and ready for use as received. It can be installed in any compartment of TEKTRONIX 7000-series oscilloscopes, but is intended for principal use in vertical plug-in compartments. To install, align the upper and lower rails of the 7A26 with the oscilloscope tracks and fully insert it. The front will be flush with the front of the oscilloscope when the 7A26 is fully inserted, and the latch at the bottom-left corner of the 7A26 will be in place against the front panel. See Fig. 1-2.

To remove the 7A26, pull on the latch (which is inscribed with the unit identification "7A26") and the 7A26 will unlatch. Continue pulling on the latch to slide the 7A26 out of the oscilloscope.

GENERAL OPERATING INFORMATION

Introduction

For single-trace operation, either of the two identical amplifier channels can be used independently by setting the DISPLAY MODE and TRIGGER SOURCE switches to CH 1 or CH 2 and connecting the signal to be observed to the appropriate input. In the discussions to follow, single-trace operations using CH 1 only apply equally to CH 2 only.

Signal Connections

In general, probes offer the most convenient means of connecting a signal to the input of the 7A26. A 10X attenuation probe offers a high input impedance and allows the circuit under test to perform very close to normal operating conditions.

Any TEKTRONIX probe, with a readout coding ring can be used with TEKTRONIX 7A-series amplifier units equipped with readout. The readout coding ring on the probe connects to a circuit in the amplifier unit which automatically corrects the readout displayed on the CRT to the actual deflection factor at the tip of the probe being

used. For probes to be used with amplifier units with or without readout, see the Tektronix, Inc. catalog.

Vertical Gain Check and Adjustment

To check the gain of either channel, set the VOLTS/DIV switch to 10 mV and connect 40 millivolts, 1 kilohertz signal from the oscilloscope calibrator to the input connector of the channel being checked. The vertical deflection should be exactly four divisions. If not, adjust the front-panel GAIN for exactly four divisions of deflection. The GAIN adjustment is engaged by pressing in the GAIN control knob and turning the knob with a narrow-blade screwdriver (see Fig. 1-3 Front Panel Controls and Connectors). Turn the knob clockwise, then counter-clockwise, until the GAIN control is engaged. When the GAIN control is engaged, the vertical deflection will change as the knob is turned. Turn the GAIN control knob with the screwdriver until the deflection is set to exactly four divisions, then remove the screwdriver.

Input Coupling

The Channel 1 and Channel 2 coupling (AC-GND-DC) switches allow a choice of input coupling methods. The type of display desired and the applied signal will determine the coupling to use.

The DC coupling position must be used to display the DC component of the signal. It must also be used to display AC signals below about 30 hertz (ten hertz with a 10X probe) and square waves with low-frequency components as these signals are attenuated in the AC position.

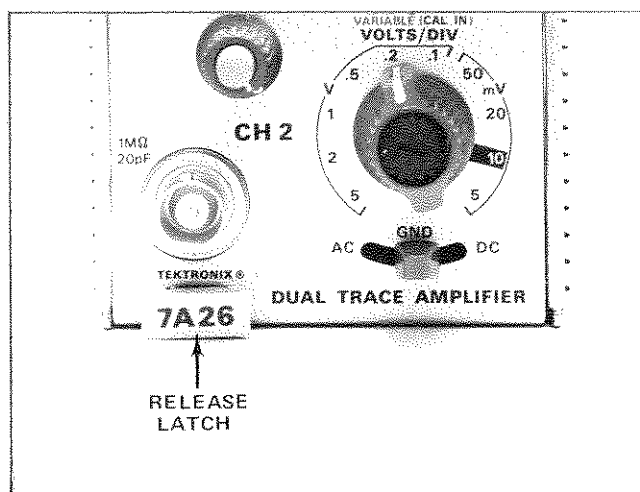

Fig. 1-2. Release latch.

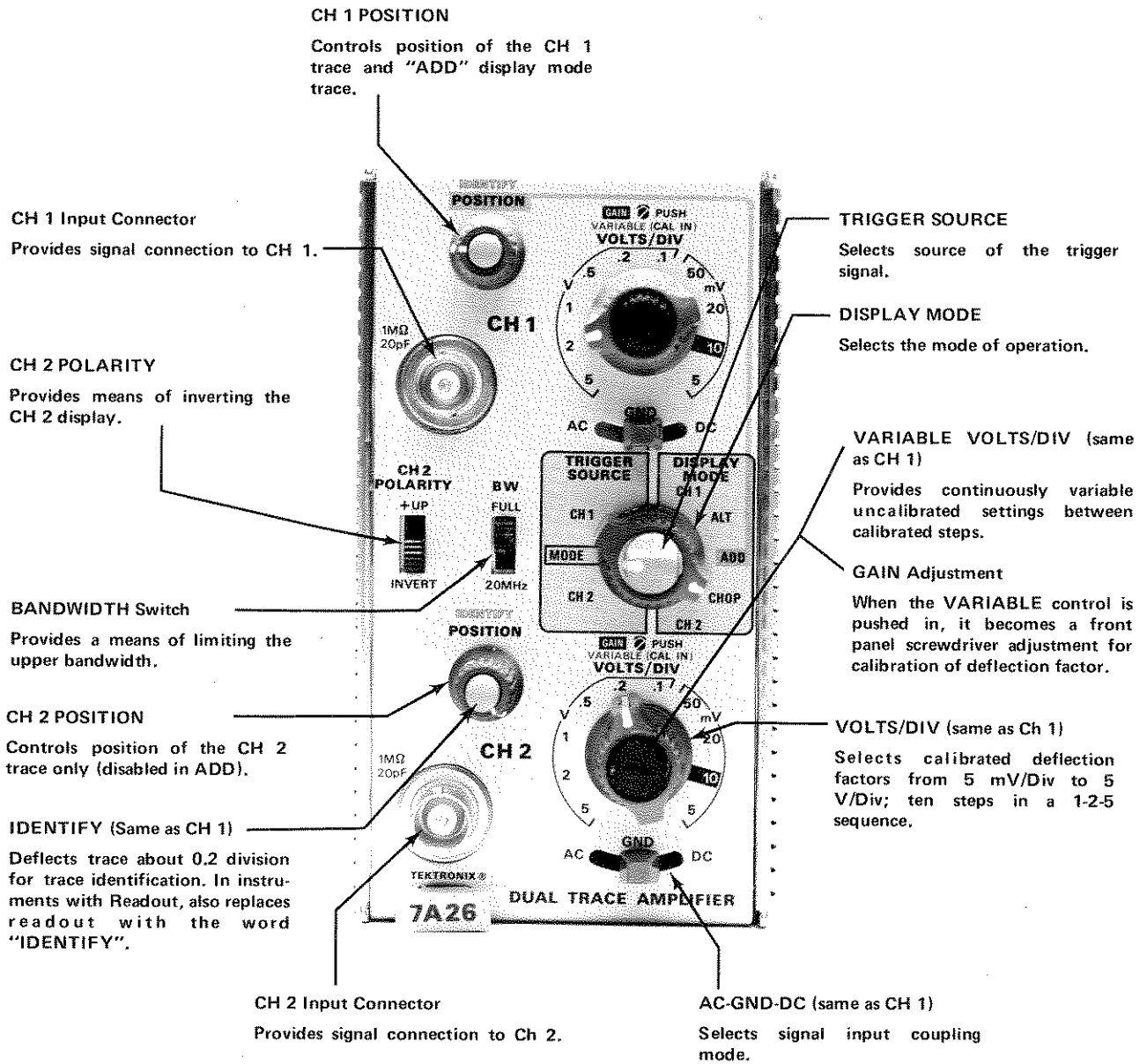

Fig. 1-3. 7A26 front-panel controls and connectors.

In the AC coupling position, the DC component of the signal is blocked by a capacitor in the input circuit. The AC coupling position provides the best display of signals with a DC component much larger than the AC components. The precharge feature should be used with large DC inputs. To use this feature, first set the coupling to GND. Connect the probe to the circuit and wait about two seconds for the coupling capacitor to charge. Then set the coupling to AC.

The GND position provides a ground reference at the input of the amplifier without externally grounding the input connectors. However, the signals connected to the inputs are not grounded, and the same DC load is presented to the signal source.

VOLTS/DIV and VARIABLE Controls

The amount of vertical deflection produced by a signal is determined by the signal amplitude, the attenuation factor of the probe, the setting of the VOLTS/DIV switch, and the setting of the VARIABLE control. Calibration deflection factors indicated by the settings of the VOLTS/DIV switch apply only when the VARIABLE control is in the calibrated (CAL IN) position.

The VARIABLE control provides variable, uncalibrated settings between the calibrated steps of the VOLTS/DIV switch. With the VARIABLE control fully counter-clockwise and the VOLTS/DIV set to 5 volts/division the uncalibrated vertical deflection factor is extended to at least 12.5 volts/division. By applying a calibrated voltage source to the input connector, any specific deflection factor can be set within the range of the VARIABLE control.

CH 2 POLARITY Switch

The CH 2 POLARITY switch may be used to invert the displayed waveform of the signal applied to the CH 2 input. This is particularly useful in added operation of the 7A26 when differential measurements are to be made. The CH 2 POLARITY switch has two positions, +UP and INVERT. In the +UP position, the displayed waveform will have the same polarity as the applied signal and a positive DC voltage will move the CRT trace up. In the INVERT position, a positive-going waveform at the CH 2 input will be displayed on the CRT in inverted form and a positive DC voltage will move the trace down.

DISPLAY MODE Switch

For single-trace operation, apply the signal either to the CH 1 input or the CH 2 input and set the DISPLAY MODE switch to the corresponding position: CH 1 or CH 2.

To display a signal in one channel independently when a signal is also applied to the other channel, simply select the desired channel by setting the DISPLAY MODE switch to the appropriate CH 1 or CH 2 position.

Alternate Mode. The ALT position of the DISPLAY MODE switch produces a display which alternates between channel 1 and channel 2 with each sweep on the CRT. Although the ALT mode can be used at all sweep rates, the CHOP mode provides a more satisfactory display at sweep rates below about 0.5 millisecond/division. At slow sweep rates alternate mode switching becomes visually perceptible.

Add Mode. The ADD position of the DISPLAY MODE switch can be used to display the sum or difference of two signals, for common-mode rejection to remove an undesired signal. The overall deflection factor in the ADD mode with both VOLTS/DIV switches set to the same position is the deflection factor indicated by either VOLTS/DIV switch. However, if the CH 1 and CH 2 VOLTS/DIV switches are set to different deflection factors, the resultant amplitude is difficult to determine from the CRT display. In this case, the voltage amplitude of the resultant display can be determined accurately only if the amplitude of the signal applied to one channel is known. In the ADD mode, positioning of the trace is controlled by the channel 1 POSITION control only.

Chop Mode. The CHOP position of the DISPLAY MODE switch produces a display which is electronically switched between channels at approximately a 500 kilohertz rate (controlled by mainframe). In general the CHOP mode provides the best display at sweep rates slower than about 0.5 millisecond/division or whenever dual-trace, non-repetitive phenomena is to be displayed.

TRIGGER SOURCE Switch

CH 1. The CH 1 position of the TRIGGER SOURCE switch provides a trigger signal obtained from the signal applied to the CH 1 input connector. This provides a stable display of the signal applied to the CH 1 input connector.

CH 2. The CH 2 position of the TRIGGER SOURCE switch provides a trigger signal obtained from the signal applied to the CH 2 input connector. This provides a stable display of the signal applied to the CH 2 input connector.

MODE. In this position of the TRIGGER SOURCE switch, the trigger signal for the time-base unit is dependent on the setting of the DISPLAY MODE switch. The trigger

source for each position of the DISPLAY MODE switch is as follows:

MODE	TRIGGER SIGNAL SOURCE
CH 1	Channel 1
CH 2	Channel 2
ADD	Algebraic sum of channel 1 and channel 2
CHOP	Algebraic sum of channel 1 and channel 2
ALT	Alternates between channel 1 and channel 2

Trace Identification

When the IDENTIFY button is pressed, the trace is deflected about 0.2 division to identify the 7A26 trace. This feature is particularly useful when multiple traces are displayed. When the IDENTIFY button is pressed on instruments with readout, the deflection factor readout is replaced with the word "IDENTIFY".

BW Switch

Provides a means of limiting the upper bandwidth. FULL: Allows the 7A26 to operate at full bandwidth. 20 MHz: Reduces the upper bandwidth of the 7A26 to about 20 megahertz.

BASIC APPLICATIONS

General

The following information describes the procedures and techniques for making basic measurements with a 7A26 and the associated TEKTRONIX oscilloscope and time-base. These applications are not described in detail since each application must be adapted to the requirements of the individual measurements. This instrument can also be used for many applications not described in this manual. Contact your local TEKTRONIX Field Office or representative for assistance in making specific measurements with this instrument.

Peak-to-Peak Voltage Measurements (AC)

To make peak-to-peak voltage measurements, use the following procedure:

1. Apply the signal to either input connector.
2. Set the DISPLAY MODE and TRIGGER SOURCE switches to display the channel used.
3. Set the coupling switch to AC.

NOTE

For low-frequency signals below about 30 hertz use the DC position to prevent attenuation of the signal.

4. Set the VOLTS/DIV switch to display about five divisions of the waveform vertically.

5. Set the time-base Triggering controls for a stable display. Set the time-base unit to a sweep rate which displays several cycles of the waveform.

6. Turn the 7A26 POSITION control so the lower portion of the waveform coincides with one of the graticule lines below the center horizontal line, and the top of the waveform is within the viewing area. With the time-base Position control, move the display so one of the upper peaks lies near the center vertical line (see Fig. 1-4).

7. Measure the divisions of vertical deflection peak-to-peak. Check that the VARIABLE (VOLTS/DIV) control is in the CAL IN position.

NOTE

This technique can also be used to make measurements between two points on the waveform, rather than peak to peak.

8. Multiply the deflection measured in step 7 by the VOLTS/DIV switch setting. Include the attenuation factor of the probe if used.

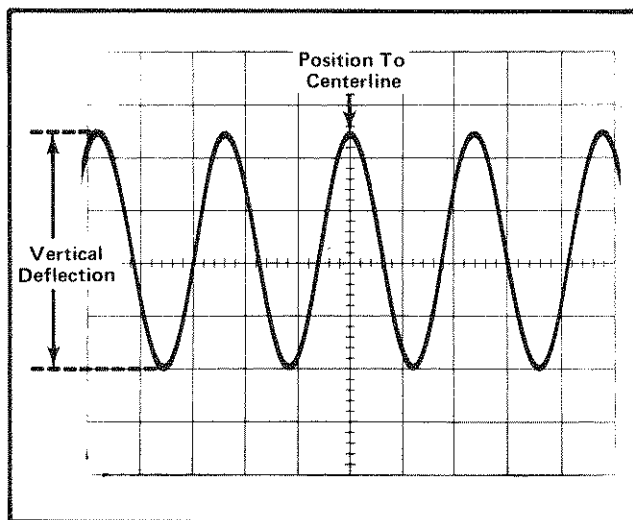

Fig. 1-4. Measuring the peak-to-peak voltage of a waveform.

EXAMPLE: Assume that the peak to peak vertical deflection is 4.5 divisions (see Fig. 1-4) using a 10X attenuator probe, and the VOLTS/DIV switch is set to 1 V.

$$\text{Volts Peak to Peak} = \text{vertical deflection (divisions)} \times \text{VOLTS/DIV setting} \times \text{probe attenuation factor}$$

Substituting the given values:

$$\text{Volts Peak-to-Peak} = 4.5 \times 1 \times 10$$

The peak-to-peak voltage is 45 volts.

Instantaneous Voltage Measurements (DC)

To measure the DC level at a given point on a waveform, proceed as follows:

1. Connect the signal to either input connector.
2. Set the DISPLAY MODE and TRIGGER SOURCE switches to display the channel used.
3. Set the VOLTS/DIV switch to display about five divisions of the waveform.
4. Set the coupling switch to GND and position the trace to the bottom graticule line or other reference line. If the voltage is negative with respect to ground, position the trace to the top graticule line. Do not move the POSITION control after this reference line has been established.

NOTE

To measure a voltage level with respect to a voltage other than ground, make the following changes to step 4. Set the coupling switch to DC and apply the reference voltage to the input connector. Then position the trace to the reference line.

5. Set the coupling switch to DC. The ground reference line can be checked at any time by switching to the GND position.

6. Set the time-base Triggering controls for a stable display. Set the time-base sweep rate for an optimum display of the waveform.

7. Measure the distance in divisions between the reference line and the point on the waveform at which the DC level is to be measured. For example, in Fig. 1-5 the measurement is between the reference line and point A.

8. Establish the polarity of the waveform. With the CH 2 POLARITY switch in the +UP position, any point above the reference line is positive.

9. Multiply the distance measured in step 7 by the VOLTS/DIV setting. Include the attenuation factor of the probe, if used.

EXAMPLE: Assume the vertical distance measured is 3.6 divisions (see Fig. 1-5) and the waveform is above the reference line using a 10X probe with a VOLTS/DIV setting of 0.5 V.

Using the formula:

$$\text{Instantaneous Voltage} = \text{vertical distance (divisions)} \times \text{polarity} \times \text{VOLTS/DIV setting} \times \text{probe attenuation factor}$$

Substituting the given values:

$$\text{Instantaneous Voltage} = 3.6 \times +1 \times 0.5 \text{ V} \times 10$$

The instantaneous voltage is 18 volts.

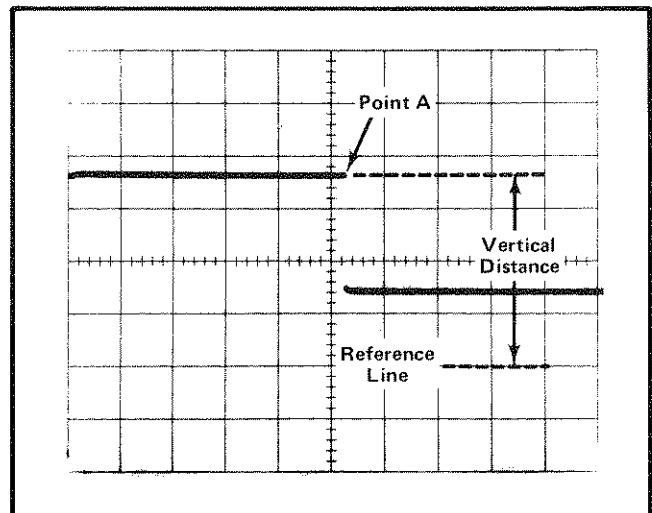

Fig. 1-5. Measuring instantaneous voltage with respect to some reference.

Comparison Measurements

In some applications it may be desirable to establish arbitrary units of measurement other than those indicated by the VOLTS/DIV switch. This is particularly useful when comparing unknown signals to a reference amplitude. One use for the comparison-measurement technique is to facilitate calibration of equipment where the desired amplitude does not produce an exact number of divisions of deflection. The adjustment will be easier and more accurate if arbitrary units of measurement are established so that the correct adjustment is indicated by an exact number of divisions of deflection. The following procedure describes how to establish arbitrary units of measure for comparison measurements.

To establish an arbitrary vertical deflection factor based upon a specific reference amplitude, proceed as follows:

1. Connect the reference signal to the input connector. Set the time-base unit sweep rate to display several cycles of the signal.

2. Set the VOLTS/DIV switch and the VARIABLE control to produce a display which is an exact number of vertical divisions in amplitude. Do not change the VARIABLE control after obtaining the desired deflection.

3. To establish an arbitrary vertical deflection factor so the amplitude of an unknown signal can be measured accurately at any setting of the VOLTS/DIV switch, the amplitude of the reference signal must be known. If it is not known, it can be measured before the VARIABLE VOLTS/DIV control is set in step 2.

4. Divide the amplitude of the reference signal (volts) by the product of the vertical deflection (divisions) established in step 2 and the setting of the VOLTS/DIV switch. This is the vertical conversion factor.

$$\text{Vertical Conversion Factor} = \frac{\text{reference signal amplitude (volts)}}{\text{vertical deflection (divisions)} \times \text{VOLTS/DIV switch setting}}$$

5. To measure the amplitude of an unknown signal, disconnect the reference signal and connect the unknown signal to the input connector. Set the VOLTS/DIV switch to a setting that provides sufficient vertical deflection to make an accurate measurement. Do not readjust the VARIABLE control.

6. Measure the vertical deflection in divisions and calculate the amplitude of the unknown signal using the following formula.

$$\text{Signal Amplitude} = \text{VOLTS/DIV setting} \times \text{vertical conversion factor} \times \text{vertical deflection (divisions)}$$

EXAMPLE: Assume a reference signal amplitude of 30 volts, a VOLTS/DIV setting of 5 V and the VARIABLE control adjusted to provide a vertical deflection of four divisions. Substituting these values in the vertical conversion factor formula (step 4):

$$\text{Vertical Conversion Factor} = \frac{30 \text{ V}}{4 \times 5 \text{ V}} = 1.5$$

Then with a VOLTS/DIV setting of 2 V, the peak-to-peak amplitude of an unknown signal which produces a vertical deflection of five divisions can be determined by using the signal amplitude formula (step 6):

$$\text{Signal Amplitude} = 2 \text{ V} \times 1.5 \times 5 = 15 \text{ volts}$$

Dual-Trace Phase Difference Measurements

Phase comparison between two signals of the same frequency can be made using the dual-trace feature of the 7A26. This method of phase difference measurement can be used up to the frequency limit of the oscilloscope system. To make the comparison, use the following procedure:

1. Set the CH 1 and CH 2 coupling switches to the same position, depending on the type of coupling desired.

2. Set the DISPLAY MODE to ALT or CHOP. In general, CHOP is more suitable for low frequencies and ALT is more suitable for high frequencies. Set the TRIGGER SOURCE to CH 1.

3. Connect the reference signal to the CH 1 input and the comparison signal to the CH 2 input. Use coaxial cables or probes which have similar time delay characteristics to connect the signals to the input connectors.

4. If the signals are of opposite polarity, set the CH 2 POLARITY switch to invert the channel 2 display. (Signals may be of opposite polarity due to 180° phase difference; if so, take this into account in the final calculation.)

5. Set the VOLTS/DIV switches and the VARIABLE controls of the two channels so the displays are equal and about five divisions in amplitude.

6. Set the time-base unit to a sweep rate which displays about one cycle of the waveforms. Set the Triggering controls for a stable display.

7. Center the waveforms on the graticule with the 7A26 POSITION controls.

8. Adjust the time-base Variable Time/Div control until one cycle of the reference signal occupies exactly eight horizontal divisions between the second and tenth vertical lines of the graticule (see Fig. 1-6). Each division of the graticule represents 45° of the cycle ($360^\circ \div 8 \text{ divisions} = 45^\circ/\text{division}$). The sweep rate can now be stated in terms of degrees as $45^\circ/\text{division}$.

9. Measure the horizontal difference between corresponding points on the waveform.

10. Multiply the measured distance (in divisions) by $45^\circ/\text{division}$ to obtain the exact amount of phase difference.

EXAMPLE: Assume a horizontal difference of 0.3 division with a sweep rate of $45^\circ/\text{division}$ as shown in Fig. 1-6.

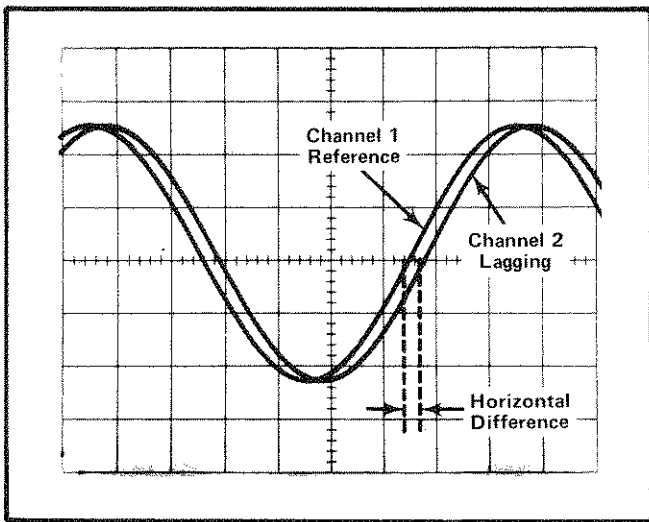

Fig. 1-6. Measuring phase difference between two signals.

Using the formula:

$$\text{Phase Difference} = \frac{\text{horizontal difference}}{\text{(divisions)}} \times \text{sweep rate} \text{ (degrees/division)}$$

Substituting the given values:

$$\text{Phase Difference} = 0.3 \times 45^\circ$$

The phase difference is 13.5° .

High Resolution Phase Measurements

More accurate dual-trace phase measurements can be made by increasing the sweep rate (without changing the Variable Time/Div control). One of the easiest ways to increase the sweep rate is with the time-base Magnifier switch. Set the Magnifier to X10 and determine the magnified sweep rate by dividing the sweep rate obtained previously by the amount of sweep magnification.

EXAMPLE: If the sweep rate is increased 10 times by the Magnifier, the magnified sweep rate is $45^\circ/\text{division} \div 10 = 4.5^\circ/\text{division}$. Fig. 1-7 shows the same signals as used in Fig. 1-6 but with the Magnifier set to X10. With a horizontal difference of 3 divisions, the phase difference is:

$$\text{Phase Difference} = \frac{\text{horizontal difference}}{\text{(divisions)}} \times \text{magnified sweep rate} \text{ (degrees/division)}$$

Substituting the given values:

$$\text{Phase Difference} = 3 \times 4.5^\circ$$

The phase difference is 13.5° .

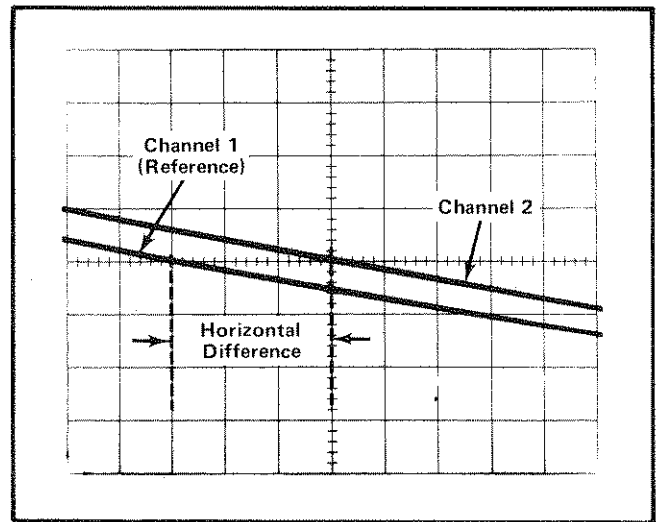

Fig. 1-7. High resolution phase measurement using time-base magnifier.

Common Mode Rejection

The ADD feature of the 7A26 can be used to display signals which contain undesirable components. These undesirable components can be eliminated through common-mode rejection. The procedure is as follows:

1. Set the DISPLAY MODE switch to ALT or CHOP and the TRIGGER SOURCE switch to MODE.

2. Connect the signal containing both the desired and undesired information to the CH 1 input connector.

3. Connect a signal similar to the unwanted portion of the CH 1 signal to the CH 2 input connector. For example, in Fig. 1-8 a line-frequency signal is connected to Channel 2 to cancel out the line-frequency component of the Channel 1 signal.

4. Set both coupling switches to the same setting, DC or AC, depending on the applied signal.

5. Set the VOLTS/DIV switches so the signals are about equal in amplitude.

6. Set the DISPLAY MODE switch to ADD. Set the CH 2 POLARITY switch to INVERT so the common-mode signals are of opposite polarity.

7. Adjust the Channel 2 VOLTS/DIV switch and VARIABLE control for maximum cancellation of the common-mode signal. The signal which remains should be only the desired portion of the channel 1 signal.

EXAMPLE: An example of this mode of operation is shown in Fig. 1-8. The signal applied to Channel 1 contains unwanted line frequency components (Fig. 1-8A). A corresponding line frequency signal is connected to Channel 2 (Fig. 1-8B). Fig. 1-8C shows the desired portion of the signal as displayed when common-mode rejection is used.

The above procedure can also be used for examining a signal superimposed on some DC level when DC coupling is used. A DC voltage of the proper polarity applied to Channel 2 can be used to cancel out the DC portion of the signal applied to Channel 1.

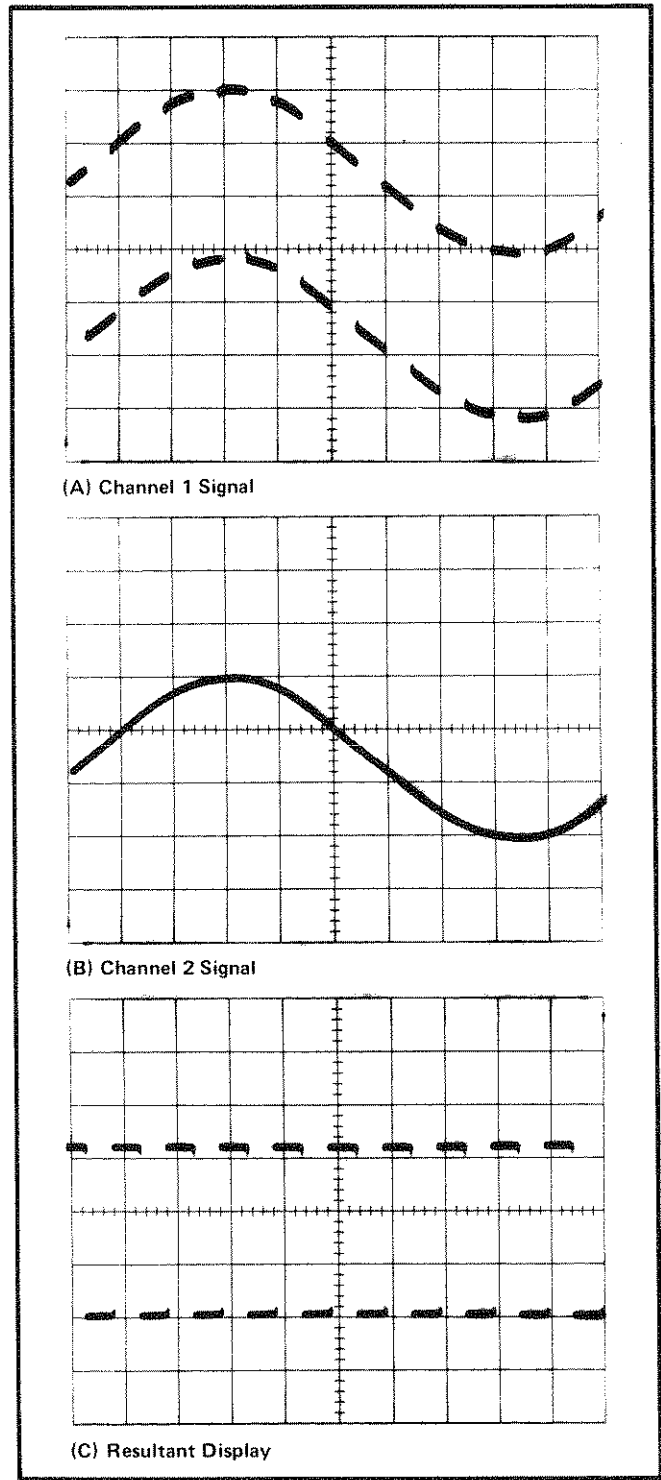

Fig. 1-8. Using the ADD mode for common-mode rejection. (A) Channel 1 signal contains desired information along with line-frequency component. (B) Channel 2 contains line frequency only. (C) Resultant CRT display using common-mode rejection.

SPECIFICATION

Introduction

The following electrical characteristics are valid over the stated environmental range for instruments calibrated at an ambient temperature of +20°C to +30°C, and after a five-minute warmup unless otherwise noted.

TABLE 2-1

Electrical

Characteristic	Performance Requirement	Supplemental Information
Deflection Factor		
Calibrated Range	5 mV/Div to 5 V/Div; ten steps in a 1,2,5 sequence.	Aberrations; 5 mV and 10 mV. +4.0%, -4.0%, total not to exceed 6% P-P; 20 mV to 5 V, not to exceed 8%.
Deflection Factor Accuracy	Within 2% with GAIN adjusted at 10 mV/Div.	
Uncalibrated (VARIABLE)		Continuously variable between calibrated steps; extends deflection factor to at least 12.5 volts per division.
GAIN Range		
BW FULL/20 MHz Gain Match	20 MHz gain within 1% full gain.	Permits adjustment of deflection factor for calibrated operation with all 7000-series oscilloscopes.
Frequency Response		
Upper Bandwidth	Depends upon oscilloscope used.	See the oscilloscope mainframe specifications or the current Tektronix, Inc. catalog.
Lower Bandwidth (AC coupled)	10 hertz or less.	
20 MHz Bandwidth		20 MHz, ± 3 MHz.
Risetime		21 ns maximum.
Maximum Input Voltage		
DC Coupled		250 volts, (DC + Peak AC); AC component 500 volts peak-to-peak maximum, one kilohertz or less.
AC Coupled		500 volts, (DC + Peak AC); AC component 500 volts peak-to-peak maximum, one kilohertz or less.
Channel Isolation		50:1 display ratio up to 200 megahertz.
Input R and C		
Resistance		One megohm within 2%.
Capacitance		Approximately 20 picofarads.
Overdrive Recovery Time		0.1 ms or less to recover to within one division after removal of overdrive signal of up to +75 divisions or -75 divisions regardless of overdrive signal duration.

TABLE 2-1 (cont)

Characteristic	Performance Requirement	Supplemental Information
Delay Time Difference Between Channels		200 picoseconds or less.
Common Mode Rejection Ratio	At least 10:1, DC to 50 MHz.	
Display Modes	Channel 1 only.	
	Dual-trace, alternate between channels.	
	Added algebraically.	
	Dual-trace chopped between channels.	
	Channel 2 trace only.	
Trigger Source Selection	Channel 1 only.	
	Follows DISPLAY MODE selection.	
	Channel 2 only.	

TABLE 2-2

Environmental Characteristic

	Refer to the specification for the associated mainframe.
--	--

TABLE 2-3

Physical

	Size	Fits all 7000-series plug-in compartments.
	Weight	2 Pounds 9 Ounces (1.2 kilograms).

THEORY OF OPERATION

Introduction

This section of the manual contains a description of the circuitry used in the 7A26 amplifier. The 7A26 description begins with a discussion of the instrument using the block diagram shown in the Diagrams section. Then, each circuit is described in detail using the block diagram to show the interconnections between stages in each major circuit and the relationship of the front-panel controls to the individual stages.

Complete schematics of each circuit are given in the Diagrams section. Refer to these schematics throughout the following circuit description for electrical values and relationship.

BLOCK DIAGRAM

The Channel 1 Amplifier circuit provides gain setting, variable gain control, and trace positioning. The Channel 2 Amplifier provides signal polarity inversion in addition to gain setting, variable gain control, and trace positioning.

The signal to be displayed on the CRT is applied to the CH 1 or CH 2 INPUT connector. The signal passes through the input coupling switch, where the appropriate coupling is selected, to the attenuators. The VOLTS/DIV switch selects the correct amount of attenuation and the signal is passed to the Input Source Follower.

When the VOLTS/DIV switch is set to the 5 mV and 10 mV positions, the signal connected to the INPUT connector is passed through the attenuators without attenuation. When the VOLTS/DIV switch is set in the 5 mV position, the 2X Gain Amplifier operates at full gain. In all other positions of the VOLTS/DIV switch, the 2X Gain Amplifier's gain is reduced by two. Internal gain and balance adjustments are included in the 2X Amplifier.

Overall GAIN and VARIABLE gain is adjusted in the Gain Amplifier. Variable Balance and high frequency adjustments are also controlled in the Gain Amplifier. The output of the Gain Amplifier is connected to the Positioning circuitry where the POSITION and IDENTIFY functions are controlled. Channel 2 is identical to Channel 1, with the exception of the polarity inversion function in Channel 2.

The Display and Trigger Channel switch amplifiers provide differential signal outputs for the signal and trigger lines, from each channel, to a common display and trigger output. These stages also contain a bandwidth limiter that limits the upper frequency response to 20 megahertz.

The output of the Display and Trigger Channel switch Amplifier is connected to the oscilloscope mainframe via the interface connector.

Readout encoding circuitry used in the 7A26 is standard to the 7000-series.

DETAILED CIRCUIT DESCRIPTION

NOTE

The CH 1 and CH 2 amplifier circuits are identical with the exception of the CH 2 GAIN stage U2450, which includes a POLARITY inverting circuit. Only CH 1 is described in detail throughout this discussion.

AC-GND-DC Switch

Input signals connected to the INPUT connectors can be AC-coupled, DC-coupled, or internally disconnected. S100A is a cam-type switch; a contact-closure chart showing the operation is given on the schematic diagrams. When the AC-GND-DC switch is in the DC position, the INPUT signal is connected directly to the attenuators. In the AC position, the INPUT signal passes through capacitor C10. The capacitor prevents the DC component of the signal from passing to the amplifier. The GND position opens the signal path and connects the input circuit of the amplifier to ground. This provides a ground reference without the need to disconnect the applied signal from the INPUT connector. Resistor R102, connected across the AC-GND-DC switch, allows C10 to be pre-charged in the GND position.

Input Attenuator

The effective overall deflection factor of the 7A26 is determined by the setting of the VOLTS/DIV switch, S100B. The basic deflection factor is 5 millivolts per division of CRT deflection. To increase the basic deflection

factor to the values indicated on the front panel, precision attenuators are switched into the circuit. S100B is a cam-type switch and the dots on the contact-closure chart (see Diagram 1) indicate when the associated contacts are in the position shown (open or closed). In the 5 mV/Div and 10 mV/Div positions, the attenuators are not used; the input signal is connected directly to the Input Source Follower. The 10 mV/Div position decreases the gain of the 2X Gain Amplifier. For switch positions above 10 mV/Div, the attenuators are switched into the circuit singly or stacked to produce the deflection factor indicated on the front panel. These hybrid attenuators are frequency-compensated voltage dividers. For DC and low-frequency signals, the attenuators act as resistance dividers; at high frequencies the attenuator acts as a capacitive divider.

In addition to providing constant attenuation at all frequencies within the bandwidth of the instrument, the input attenuators are designed to maintain the same input RC characteristics (one megohm X 20 pF). Each attenuator contains an adjustable series capacitor to provide correct attenuation at high frequencies, and an adjustable shunt capacitor to provide correct input capacitance.

Input Source Follower

Below SN B080000. Q150A and Q140 form a cascode amplifier with Q150B providing constant current. R132 limits the current drive to the gate of Q150A. Dual-diode CR130 provides circuit protection by limiting the voltage swing at the gate of Q150A to about ± 9 volts. R134, C130, and the capacitance of R130 provide low frequency compensation. Input capacitance for the 5 mV and 10 mV positions is set by C134. The output of the 2X Gain Amplifier (U1350) is from the source of Q150A and high frequencies from the collector of Q140. R160 is used to balance the input to the 2X Gain Amplifier between the 5 mV and 10 mV positions.

SN B080000-Up. Q150A is a source follower with Q150B providing a constant current. R132 limits the current drive to the gate of Q150A. Dual-diode CR130 provides circuit protection by limiting the voltage swing at the gate of Q150A to about ± 10 volts. C130, C134, and the capacitance of R130 provides low frequency compensation. Input capacitance for the 5 mV and 10 mV positions is set by C130. The output of the 2X Gain Amplifier (U1350) is from the source of Q150A. C134 and R134 form a negative resistance network for Q150A.

2X Gain Amplifier

T1301 is a balun transformer which provides differential drive to U1350 at high frequencies. U1350 is a paraphase type amplifier with dual differential output capabilities.

In the 5 mV position, full drive is provided from pins 5 and 9 of U1350 to the U1450 load resistors R1401 and

R1403. In all other attenuator positions the signal path drive current through the load resistors is divided in half. The other half is diverted through pins 6 and 8 of U1350 and is dissipated in dummy load resistors R1343 and R1341.

CR1319 and R1319 maintain proper collector voltage while switching between the 5 mV and 10 mV positions. C1331, R1331, C1332 and R1332 are thermal compensations. C1334 and RT1334 provide high-frequency temperature compensation. R1336, C1336, C1345, L1345 and R1345 are high-frequency adjustments.

Fixed length inductors and capacitors are part of the Amplifier etched circuit board and provide T-coil peaking at the input of U1350.

Gain Amplifier

U1450 is a variable-gain cascode amplifier which sets the overall channel gain. The GAIN (R1423A) and VARIABLE (R1423B) controls determine the ratio of base currents through pins 11 and 12 of U1450. The base-current ratio determines the shared collector output levels between pins 5, 6 and 8, 9.

R1436 provides adjustable low frequency compensation. Fixed components R1434, C1434, C1436, R1431, and C1431 are thermal compensations. R1435 and C1435 are adjustable high frequency compensations. U1450 Input T-coil peaking inductors and capacitors are part of the etched circuit board. DC balance over the variable range is adjusted by R1353.

Position Circuit

Positioning current is added to the signal current of U1450 output from the current sources Q1470 and Q1490. R1465 controls the voltage at the bases of the current sources, which in turn determines the amount of positioning current added. R1467, R1466, and CR1465 provide trace shift current for the IDENTITY function.

Display Channel Switch Amplifier

The third cascode amplifier, U1550 is used for controlling the channel 1 display modes. When the DISPLAY CH 1 ON Level at pin 12 is HI, the channel 1 signal passes through the transistor pair with outputs at pins 5 and 9 to the level shifters. At the same time the DISPLAY CH 1 OFF Level at pin 11 is LO, turning off the second transistor pair collectors, pins 6 and 8. When pin 12 is HI, channel 1 is displayed and when pin 11 is HI channel 1 is not displayed. Pins 11 and 12 are always in opposite states, the levels being selected by the DISPLAY MODE switch S30A. The signal is routed through T-coiled bases of U1550 to the trigger amplifier switch, U1750, which is also T-coiled. C1531 and R1531 are high frequency adjustments.

Trigger Channel Switch Amplifier

U1750 is a cascode amplifier used as the trigger switch, and operates similarly to the Display Channel Switch Amplifier, U1550. The TRIGGER SOURCE switch, S30B determines the base levels on pins 11 and 12 of U1750 for trigger selection.

Display and Trigger Common Base Level Shifters

The Display Out Common Base Level Shifters, Q820, Q840, Q860, and Q880 are used to return the DC signal level to zero volts at the plug-in interface for display output. Bandwidth selection is obtained by controlling base currents with the BW switch, S32. Q820 and Q840 are shifters at FULL BANDWIDTH and Q860, Q880 are used at 20 megahertz. The level shifters also serve as a current summing point for CH 1 and CH 2 selection.

The pi filter is used in the collectors of Q860 and Q880. The pi filter is isolated from the output by CR860 and CR880 when the BW switch is in FULL.

The Trigger Output Common Base Level Shifters Q920, Q940, Q960, and Q980 operation is similar to the Display Output Shifters just discussed.

Channel 2 Gain-Polarity Amplifier

CH 2 operation is the same as CH 1. For circuit number reference the prefix number for CH 1 is 1 and CH 2 is 2. For instance, U2350 functions in CH 2 the same as does U1350 in CH 1. In CH 2 a Polarity feature is included in the second cascode amplifier U2450. S22A allows base drives to be reversed to U2450. Polarity Gain R2411, matches the gain in both polarity positions.

Translator

A schematic of the Translator circuit is shown on Diagram 4 in the Diagrams section. The translator, Q1050 and Q1070, increase the CHOP and ALT control logic DC levels from the mainframe to a usable level in the 7A26. CR1060 and CR1062 keep Q1050 and Q1070 from going into saturation.

Readout Encoding

The Readout Encoding circuit consists of switching resistors and probe sensing stage Q620. This circuit encodes the Channel 1 and 2, Row and Column output lines for readout of deflection factor, uncalibrated deflection factor (VARIABLE) information, and signal inversion (Channel 2

only). Data is encoded on these output lines by switching resistors between them and the time-slot input lines, or by adding current through Q620.

R647-CR647 are switched between time-slot three (TS-3) and Column output line when the CAL IN switch is in the uncal position. This results in the symbol > (greater than) being displayed preceding the deflection factor readout. R648 (Channel 2 only) is switched between TS-2 and the Column output line when the CH 2 POLARITY switch is in the INVERT position. This results in the symbol ↓ (inverted) being displayed preceding the deflection factor readout.

Switching resistors are used to indicate the setting of the VOLTS/DIV switch to the mainframe readout system. The dots on the contact-closure chart (see Diagram Section) indicate when the associated contacts on the VOLTS/DIV cam switch are closed. R633, R634, and R635 select the number 1, 2, or 5 depending on the combination that is switched in. R368 and R642 select the m (milli) prefix in the 5 mV through 0.5 V (500 mV) positions of the VOLTS/DIV switch. R639 and R643 select the V (volts) symbol in all ranges. R630, R631, and the output of the probe sensing stage (Q620) select the decimal point (number of zeroes), again depending on the resistor combination switched in by the VOLTS/DIV switch.

Probe sensing stage Q620 identifies the attenuation factor of the probe connected to the input connector by sensing the amount of current flowing from the current sink through the probe coding resistance. The output of this circuit corrects the mainframe readout system to include the probe attenuation factor. The third contact of the input connector provides the input to the probe sensing stage from the probe coding resistance (coded probes only; see Operating Instructions). The third contact is also used for the IDENTIFY input. The coding resistor forms a voltage divider with R621 through CR621 to the -15 V supply. The resultant voltage sets the bias on Q620 and determines, along with emitter resistor R622, the collector current. When the -15 volt time-slot pulse is applied to Interface Connector B33, Q620 is interrogated and its collector current is added to the column current output through Interface Connector A37.

With a 1X probe (or no probe) connected to the input connector, Q620 is turned off. The deflection factor readout is determined by the VOLTS/DIV switch position. With a 10X probe connected, the bias on Q620 will allow 100 microamperes of collector current to flow. This increases the deflection factor readout by a factor of 10.

Theory of Operation—7A26

The IDENTIFY button (S1465 on Diagram 2 or S2465 on Diagram 3) does two things when pressed:

1. It causes the trace representing the appropriate channel of the 7A26 to move about 0.3 division (see the front panel controls and connectors, Fig. 1-3).

2. It forward biases CR621 and Q620 to result in a sufficient amount of collector current which, when added to the column current output, replaces the deflection factor readout with the word "IDENTIFY".

These two actions aid in identifying the 7A26 trace when multiple traces are displayed. When the IDENTIFY button is released, the deflection factor readout and trace position are restored.

CR1465 in CH 1, and CR2465 in CH 2 isolate readout circuitry from the position circuitry. For further information on the operation of the readout system, see the oscilloscope instruction manual.

MAINTENANCE

Introduction

This section of the manual contains maintenance information for use in preventive maintenance, corrective maintenance, and troubleshooting of the 7A26.

Further maintenance information relating to general maintenance can be found in the instruction manuals for the 7000-series oscilloscopes.

PREVENTIVE MAINTENANCE

General

Preventive maintenance, consisting of cleaning, visual inspection, etc., performed on a regular basis, will improve the reliability of this instrument. Periodic checks of the semiconductor devices used in the unit are not recommended as a preventive maintenance measure.

Cleaning

CAUTION

Avoid the use of chemical cleaning agents which might damage the plastics used in this instrument. Special care should be taken when cleaning the Polyphenylene Oxide attenuator boards. Do not apply any solvent containing ketones, esters or halogenated hydrocarbons. To clean, use only water soluble detergents, ethyl, methyl or isopropyl alcohol.

Front Panel. Loose dust may be removed with a soft cloth or a dry brush. Water and mild detergent may be used; however, abrasive cleaners should not be used.

Interior. Cleaning the interior of the unit should precede calibration, since the cleaning process could alter the settings of the calibration adjustments. Use low-velocity compressed air to blow off the accumulated dust. Hardened dirt can be removed with a soft dry brush, cotton-tipped swab, or cloth dampened with a mild detergent and water solution.

Lubrication

Use a cleaning-type lubricant on shaft bushings, interconnecting plug contacts, and switch contacts. Lubricate switch detents with a heavier grease. A lubrication kit

containing the necessary lubricating materials and instructions is available through any TEKTRONIX Field Office. Order TEKTRONIX Part Number 003-0342-01.

TROUBLESHOOTING

General

The following is provided to augment information contained in other sections of this manual when troubleshooting the 7A26. The schematic diagrams, circuit description, and calibration sections should be used to full advantage. The theory of operation section gives detailed information on circuit behavior and output requirements.

Troubleshooting Aids

Diagrams. Circuit diagrams are given on foldout pages in Section 7. The circuit number and electrical value of each component in this instrument are shown on the diagrams.

Circuit Boards. The circuit boards used in the 7A26 are outlined on the schematic diagrams, and photographs of the boards are shown on the backs of the schematic diagrams. Each board-mounted electrical component is identified on the photograph by its circuit number.

Component and Wiring Color Code. Colored stripes or dots on resistors and capacitors signify electrical values, tolerances, etc., according to the EIA standard color code. Components not color coded usually have the value printed on the body.

The insulated wires used for interconnection in the 7A26 are color coded to facilitate tracing wires from one point to another in the unit.

Semiconductor Lead Configuration. The lead configurations of the semiconductor devices used in this instrument are shown on the foldout following the schematic diagrams.

Troubleshooting Equipment

The following equipment is useful for troubleshooting the 7A26.

1. Semiconductor Tester—Some means of testing the transistors, diodes, and FET's used in this instrument is helpful. A transistor-curve tracer such as the TEKTRONIX Type 576 will give the most complete information.

2. DC Voltmeter and Ohmmeter—A voltmeter is required for checking voltages within the circuits, and an ohmmeter for checking resistors and diodes.

3. Test Oscilloscope—A test oscilloscope is required to view waveforms at different points in the circuit. A TEKTRONIX 7000-series mainframe equipped with a readout system, 7D13 Digital Multimeter unit, 7B-series Time-Base unit, and a 7A-series amplifier unit with a 10X probe will meet the needs of both items 2 and 3.

4. Plug-in Extender—A fixture that permits operation of the unit outside of the plug-in compartment for better accessibility during troubleshooting. Order TEKTRONIX Part Number 067-0589-00.

Troubleshooting Procedure

This troubleshooting procedure is arranged in an order which checks the simple trouble possibilities before proceeding with extensive troubleshooting.

1. **Check Control Settings.** An incorrect setting of the 7A26 controls can indicate a trouble that does not exist. If there is any question about the correct function or operation of a control or front-panel connector, see the Operating Instructions section.

2. **Check Associated Equipment.** Before proceeding with troubleshooting of the 7A26 check that the equipment used with this instrument is operating correctly. If possible, substitute an amplifier unit known to be operating correctly into the indicator unit and see if the problem persists. Check that the input signals are properly connected and that the interconnecting cables are not defective.

3. **Visual Check.** Visually check the portion of the instrument in which the trouble is suspected. Many troubles can be located by visual indications, such as unsoldered connections, broken wires, damaged circuit boards, damaged components, etc.

4. **Check Instrument Performance.** Check the calibration of the unit or the affected circuit, by performing Performance Check of Section 5. The apparent trouble may only be a result of mis-adjustment, and may be corrected by calibration. Complete calibration instructions are given in Section 5.

5. **Check Voltages.** Often the defective component or stage can be located by checking the voltage in the circuit.

6. **Check Individual Components.** The following methods are provided for checking the individual components. Components which are soldered in place are best checked by disconnecting one end to isolate the measurement from the effects of surrounding circuitry.

NOTE

To locate intermittent or temperature sensitive components mounted on the attenuator board, Quik Freeze (Miller Stephenson, MS-240, TEKTRONIX Part Number 006-0173-01) is recommended. Dry ice or dichlorodi-fluorremethane (Freon 12, Dupont or Can-O-Gas) may also be used. Other types of circuit coolant may damage the polyphenylene oxide boards.

A. **TRANSISTORS.** The best check of transistor operation is actual performance under operating conditions. If a transistor is suspected of being defective, it can best be checked by substituting a component known to be good; however, be sure that circuit conditions are not such that a replacement might also be damaged. If substitute transistors are not available, use a dynamic tester (such as TEKTRONIX Type 576). Static-type testers may be used, but since they do not check operation under simulated operating conditions, some defects may go unnoticed. Be sure the power is off before attempting to remove or replace any transistor.

B. **DIODES.** A diode can be checked for an open or for a short circuit by measuring the resistance between terminals with an ohmmeter set to the R X 1k scale. The diode resistance should be very high in one direction and very low when the meter leads are reversed. Do not check tunnel diodes or back diodes with an ohmmeter.

CAUTION

Do not use an ohmmeter scale that has a high internal current. High currents may damage the diodes.

C. **RESISTORS.** Check resistors with an ohmmeter. Resistor tolerance is given in the Electrical Parts List. Resistors normally do not need to be replaced unless the measured value varies widely from the specified value.

D. **CAPACITORS.** A leaky or shorted capacitor can be detected by checking resistance with an ohmmeter on the highest scale. Use an ohmmeter which will not exceed the voltage rating of the capacitor. The resistance reading should be high after initial charge of the capacitor. An open capacitor can best be detected with a capacitance meter, or by checking whether the capacitor passes AC signals.

7. Repair and Readjust the Circuit. Special techniques required to replace components in this unit are given under Component Replacement. Be sure to check the performance of any circuit that has been repaired or that has had any electrical components replaced. Recalibration of the affected circuit may be necessary.

CORRECTIVE MAINTENANCE

General

Corrective maintenance consists of component replacement and instrument repair. Special techniques required to replace components in this instrument are given here.

Obtaining Replacement Parts

Standard Parts. All electrical and mechanical part replacements for the 7A26 can be obtained through your local TEKTRONIX Field Office or representative. However, many of the electronic components can be obtained locally in less time than is required to order them from Tektronix, Inc. Before purchasing or ordering replacement parts, check the parts list for value, tolerance, rating and description.

NOTE

When selecting replacement parts, it is important to remember that the physical size and shape of a component may affect the performance of the instrument, particularly at high frequencies. All replacement parts should be direct replacements unless it is known that a different component will not adversely affect instrument performance.

Special Parts. In addition to the standard electronic components, some special parts are used in the 7A26. These parts are manufactured or selected by Tektronix, Inc. in accordance with our specifications. Most of the mechanical parts used in this instrument have been manufactured by Tektronix, Inc. Order all special parts directly from your local TEKTRONIX Field Office or representative.

Ordering Parts. When ordering replacement parts from Tektronix, Inc., include the following information:

1. Instrument Type.
2. Instrument Serial Number.
3. A description of the part (if electrical, include circuit number).
4. TEKTRONIX Part Number.

Soldering Techniques

WARNING

Disconnect the instrument from the power source before soldering.

Attenuator Circuit Board. The Attenuator Circuit Boards are made from polyphenylene oxide because of its excellent electrical characteristics. Use more than normal care when cleaning or soldering this material. The following rules should be observed when removing or replacing parts:

1. Use a low-wattage soldering iron (not over 15 watts).
2. Do not apply more heat, or apply heat for a longer time, than is absolutely necessary.
3. Use some form of vacuum solder remover when removing multi-lead devices.
4. Do not apply any solvent containing ketones, esters or halogenated hydrocarbons.
5. To clean, use only water-soluble detergents, ethyl, methyl or isopropyl alcohol.

Circuit Boards (except Attenuator board). The components mounted on the circuit boards in the amplifier can be replaced using normal circuit board soldering techniques. Keep the following points in mind when soldering on the circuit boards:

1. Use a pencil-type soldering iron with a (wattage) rating from 15 to 50 watts.
2. Apply heat from the soldering iron to the junction between the component and the circuit board.
3. Heat-shunt the lead to the component by means of a pair of long-nose pliers.
4. Avoid excessive heating of the junction with the circuit board, as this could separate the circuit board wiring from the base material.
5. Use electronic grade 60-40 tin lead solder.

6. Clip off any excess lead length extending beyond the circuit board. Clean off any residual flux with a flux-removing solvent.

Metal Terminals. When soldering metal terminals (potentiometers, etc.) use 60-40 tin-lead solder and a 15 to 50 watt soldering iron. Observe the following precautions when soldering metal terminals:

1. Apply only enough heat to make the solder flow freely.
2. Apply only enough solder to form a solid connection. Excess solder may impair the function of the part.
3. If a wire extends beyond the solder joint, clip off the excess.
4. Clean the flux from the solder joint with a flux-removing solvent.

Component Replacement

WARNING

Disconnect the equipment from the power source before replacing components.

Semiconductor Replacement. Transistors should not be replaced unless actually defective. If removed from their sockets during routine maintenance, return them to their original sockets. Unnecessary replacement of transistors may effect the calibration of this instrument. When transistors are replaced, check the performance of the part of the instrument which may be affected.

Replacement semiconductors should be of the original type or a direct replacement. The pullout following the schematic diagram section shows the lead configurations of the semiconductors used in this instrument. If the replacement semiconductor is not of the original type, check the manufacturer's basing diagram for proper basing.

Circuit Board Removal

In general, the circuit boards used in the 7A26 need never be removed unless they must be replaced. Electrical connections to the boards are made by soldered connections. If it is necessary to replace a circuit board assembly, use the following procedures.

A. READOUT CIRCUIT BOARD REMOVAL

1. Disconnect the wires connected to the outside of the board.
2. Remove the screws holding the board to the mounting surface.
3. Disconnect the wires connected to the inside of the board.
4. Remove the board from the unit.
5. To replace the board, reverse the order of removal.

B. ATTENUATOR CIRCUIT BOARD REMOVAL

1. Remove the readout board for either channel as outlined in the previous procedure.
2. Disconnect the inductor, capacitor, power connector, and ground strap connected to the rear of the board.
3. Loosen the front set screw on the VARIABLE control shaft coupling (use a 0.050-inch hex-key wrench).
4. Remove the red VARIABLE control knob and glass rod from the control shaft.
5. Remove the knobs for either channel using a 1/16-inch hex-key wrench.
6. Remove the nut holding the positioning control using a 5/16-inch wrench.
7. Remove the attenuator shields.
8. Disconnect the wires and resistor from the INPUT BNC connector.
9. Remove the INPUT BNC connector.
10. Remove the attenuator board with cam switch from the instrument.
11. Replace by reversing the Removal Procedure.

C. AMPLIFIER CIRCUIT BOARD REMOVAL

1. Remove the plastic plug-in guide from the rear of the instrument.

2. Disconnect the wires connected to the amplifier board from the CH 1 and CH 2 readout board and all front panel controls, with the exception of the TRIGGER SOURCE/DISPLAY MODE switch.

3. Loosen the hex-socket screw in the coupling of both the VARIABLE control shafts using a 0.050-inch hex-key wrench. Pull both the VARIABLE knobs and shafts from the front of the instrument.

4. Loosen the hex-socket screws in both the TRIGGER SOURCE and DISPLAY MODE knobs. Remove knobs.

5. Disconnect the inductors, capacitors, power connectors, and ground straps from the front of the board.

6. Remove the screws and nuts securing the board to the chassis or other mounting surface.

7. Remove the board from the instrument.

8. To replace, reverse the order of removal.

Switch Replacement

Several types of switches are used in the 7A26. The slide and micro switches should be replaced as a unit if damaged. The following special maintenance information is provided for the cam-type switches.

CAUTION

Repair of cam-type switches should be undertaken only by experienced maintenance personnel. Switch alignment and spring tension of the contacts must be carefully maintained for proper operation of the switch. For assistance in maintenance of cam-type switches, contact your local TEKTRONIX Field Office or representative.

A. CAM-TYPE SWITCHES

A cam-type switch consists of a rotating cam, which is turned by the front-panel knobs, and a set of contacts mounted on an adjacent circuit board. These switch contacts are actuated by lobes on the cam. The VOLTS/DIV and AC-GND-DC (coupling) cam-type switches can be disassembled for inspection, cleaning, repair, or replacement as follows:

1. Remove the Readout board and the Attenuator board/switch assembly as described previously. The front switch section on the Attenuator board is the AC-GND-DC switch and the rear switch section is the VOLTS/DIV switch. The switches are now open for inspection or cleaning.

2. To completely remove the switch from the board, remove the two screws and four hexagonal posts which hold the cam-type switch to the circuit board.

3. To remove the cam from the front support block, remove the retaining ring from the shaft on the front of the switch and slide the cam out of the support block. Be careful not to lose the small detent roller.

4. To replace defective switch contacts, follow the instructions given in the switch repair kit.

5. To re-install the switch assembly, reverse the above procedure.

Troubleshooting Chart

The Troubleshooting Chart contained in Fig. 4-1 can be used without disassembling the equipment. It will indicate the circuit or circuits most likely to contain the source of the trouble being investigated.

To Use the chart, start at the top, working down and to the right. If a check provides a "yes" answer, proceed down along the solid line. If the answer to a check is "no", follow the broken line to the right. Exceptions to the direction of flow are indicated by arrows where they occur. Directions and questions are contained in rectangles. Probable trouble areas are indicated in triangles.

When checking the probable trouble area, associated leads, switches and other components should not be ignored. A transistor might be inoperative because of a defective resistor in series with it.

The chart is designed on the basis of single defects. Multiple problems may disrupt the logic, but it should still be effective in determining the problems, one at a time.

Recalibration After Repair

After any electrical component has been replaced, the calibration of that particular circuit should be checked, as well as the calibration of other closely related circuits. Refer to Section 5 for these procedures.

TROUBLESHOOTING CHART

EQUIPMENT SETUP

7A26

POSITION
 CH 1, CH 2 VOLTS/DIV 50 mV
 VARIABLE Cal In
 DISPLAY MODE¹ CH 1
 CH 2 POLARITY +UP
 BW FULL
 CH 1, CH 2 Input
 Switches GND
 TRIGGER SOURCE MODE

Time Base Triggering Auto, AC, INT
 Time/Div 1 ms

Oscilloscope Intensity and Focus adjusted for sharp trace.

7A26 installed in Oscilloscope; check 7A26 set-up; after 1 minute, horizontal trace is visible. Readout display appears in upper crt area for both Amplifier and Time Base.

Check Oscilloscope or Time Base.

Yes

Trace moves in response to Front Panel IDENTIFY button.

Trace moves in response to POSITION control.

Check Interconnecting plug, Output Amplifier, Power Supply.

Yes

Check Identify circuit.

Yes

Can trace be positioned off-screen top and bottom with POSITION control.

Check Power Supply; Output Amplifier.

Yes

Set trace to crt center, using POSITION control. Trace moves about 0.3 division in response to stop-to-stop rotation of VARIABLE control.

Check Input Amplifier, and Step Attenuator Balance circuits.

Yes

Rotate VOLTS/DIV switch to each position; trace remains visible on screen; Readout display changes to correspond with indicated VOLTS/DIV.

Trace remains visible on screen.

Check Attenuator circuit.

Yes

Check 7A26 Readout Encoding circuit.

Note: Time base is set to 20 ms/DIV; trace alternates on CRT display.

1484-16

Fig. 4-1. Troubleshooting chart.

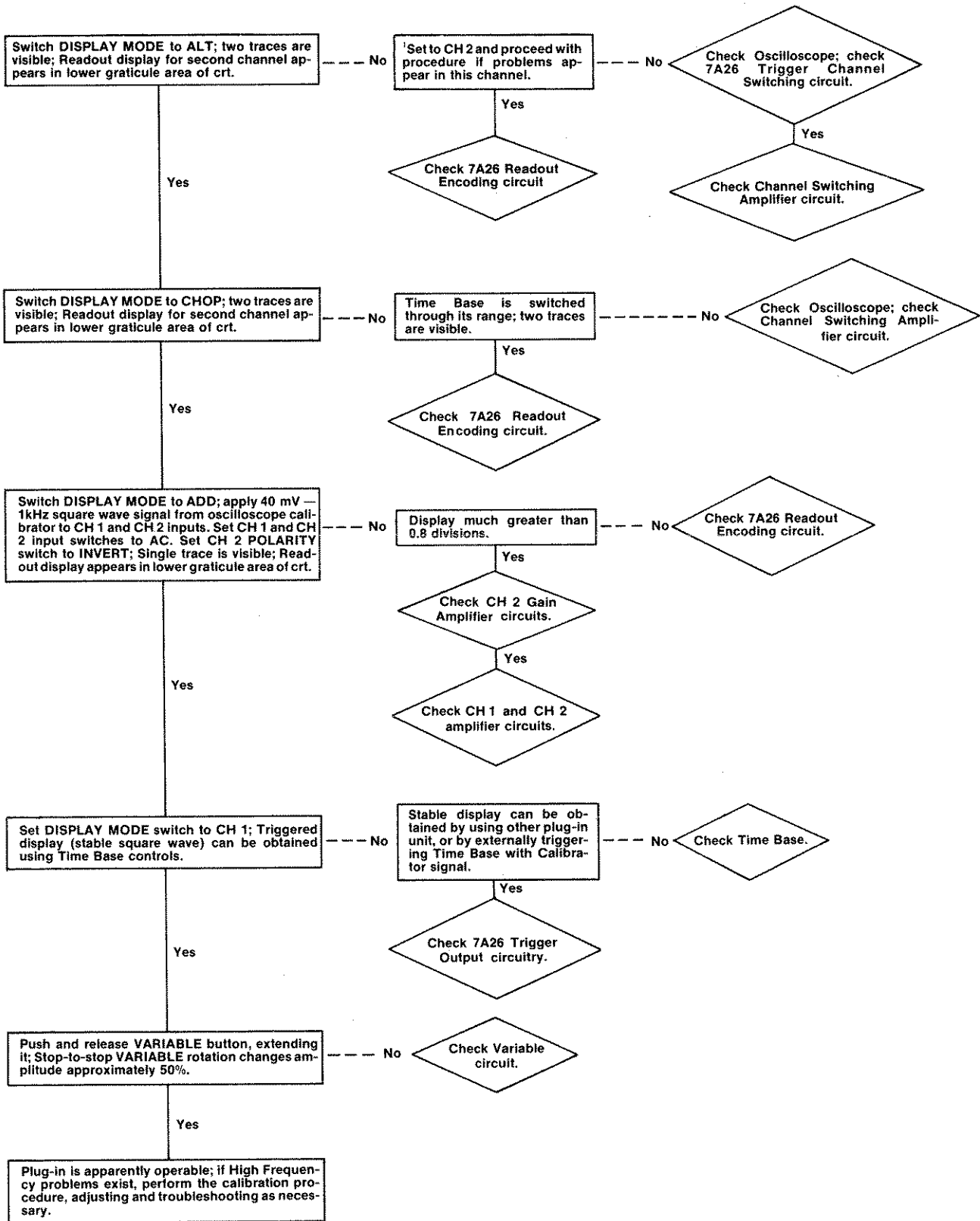

Fig. 4-1 (cont).

1484-17

REPACKAGING FOR SHIPMENT

If the Tektronix instrument is to be shipped to a Tektronix Service Center for service or repair, attach a tag showing: owner (with address) and the name of an individual at your firm that can be contacted, complete instrument serial number and a description of the service required.

Save and re-use the package in which your instrument was shipped. If the original packaging is unfit for use or not available, repackage the instrument as follows:

Surround the instrument with polyethylene sheeting to protect the finish of the instrument. Obtain a carton of corrugated cardboard of the correct carton strength and having inside dimensions of no less than six inches more than the instrument dimensions. Cushion the instrument by tightly packing three inches of dunnage or urethane foam between carton and instrument, on all sides. Seal carton with shipping tape or industrial stapler.

The carton test strength for your instrument is 200 pounds.

CALIBRATION

Introduction

To assure instrument accuracy, check the calibration of the 7A26 every 1000 hours of operation, or every six months if used infrequently. Before complete calibration, thoroughly clean and inspect this instrument as outlined in the Maintenance section.

TEKTRONIX Field Service

Tektronix, Inc., provides complete instrument repair and recalibration service at local Field Service Centers and the Factory Service Center. Contact your local field office or representative for further information.

Performance Check

The performance of this instrument can be checked by performing only the ✓ CHECK steps. Performing the steps marked with a ✓ indicate that the instrument is checked against the tolerances listed as a Performance Requirement (see Specification section).

Limits and tolerances given in other check steps are calibration guides and should not be interpreted as instrument specifications. Operator front-panel adjustments are adjusted as part of the Performance Check procedure.

Calibration

To verify proper calibration of the 7A26 and to prevent unnecessary re-calibration of the entire instrument, perform the Adjust— portion of a step only if the tolerance given in the Check— part of the step is not met.

For best overall instrument performance when performing a complete calibration procedure, make each adjustment to the exact setting even if the Check— is within allowable tolerance.

TEST EQUIPMENT REQUIRED

General

The following test equipment and accessories, or its equivalent, is required for complete calibration of the 7A26. Specifications given for the test equipment are the minimum necessary for accurate calibration. Therefore, the specifications of any test equipment used must meet or exceed the listed specifications. All test equipment is assumed to be correctly calibrated and operating within the listed specifications. Detailed operating instructions for the test equipment are not given in this procedure. Refer to the instruction manual for the test equipment if more information is needed.

Special Calibration Fixtures

Special TEKTRONIX calibration fixtures are used in this procedure only where they facilitate instrument calibration. These special calibration fixtures are available from Tektronix, Inc. Order by part number through your local TEKTRONIX Field Office or representative.

Calibration Equipment Alternatives

All of the listed test equipment is required to completely check and adjust this instrument. The Calibration procedure is based on the first item of equipment given as an example of applicable equipment. When other equipment is substituted, control settings or the calibration setup may need to be altered slightly to meet the requirements of the substitute equipment. If the exact item of test equipment given as an example in the Test Equipment list is not available, first check the Specifications column carefully to see if any other equipment is available which might suffice. Then check the Usage column to see what this item of test equipment is used for. If used for a check or adjustment which is of little or no importance to your measurement requirements, the item and corresponding step(s) can be deleted.

Signal Connections

Detailed signal-connection information is not given in this procedure except when critical for the particular test. Use a BNC T connector to simultaneously connect a signal to two inputs. Refer to the test equipment instruction manuals for other signal-connection information.

TEST EQUIPMENT

Description	Minimum Specifications	Usage	Examples of Applicable Test Equipment
1. Calibration oscilloscope.	7000-Series oscilloscope mainframe. 7900-Series required to check 7A26 maximum bandwidth.	Used throughout procedure to provide display.	TEKTRONIX 7904 Oscilloscope. Any TEKTRONIX 7000-Series oscilloscopes. Check Specifications for bandwidth.
2. Time Base Unit.	7B-Series time-base unit. Sweep speed to 2 ns/division.	Used throughout procedure to provide horizontal sweep.	TEKTRONIX 7B70 Time Base or equivalent.
3. Standard amplitude calibrator.	Amplitude accuracy, within 0.25%; signal amplitude, 20 mV to 20 V; frequency, 1 kHz square-wave.	Gain calibration.	TEKTRONIX Type PG 506 Calibration Generator. ¹
4. Square-wave generator.	Output capabilities: 12 V into 50 Ω with a risetime of at least 12 ns and a frequency of approximately 1 kHz; 500 mV into 50 Ω with a risetime of at least 1 ns to 100 kHz.	Input compensation and low frequency compensation.	TEKTRONIX Type PG 506 Calibration Generator. ¹
5. Pulse Generator.	Risetime of at least 70 ps, step amplitude of 200 mV into 50 Ω .	High frequency compensation.	TEKTRONIX Type 284 Pulse Generator.
6. High-frequency constant-amplitude signal generator.	Upper frequency range, 225 MHz; reference frequency, approximately 3 MHz; constant amplitude accuracy, within 2% of reference frequency; amplitude range, 0.5 V to 4 V peak-to-peak.	Bandwidth check.	TEKTRONIX Type SG 503 Signal Generator. ¹
7. Medium-frequency constant-amplitude sine-wave generator.	Frequency, variable from 50 to 75 megahertz; reference frequency, 50 kilohertz; output amplitude variable from 5 millivolts to 50 millivolts into 50 ohms; output amplitude constant within 3% at 50 kilohertz and 50 to 75 megahertz.	Common mode rejection.	TEKTRONIX Type SG 503 Signal Generator. ¹
8. Plug-in Extender	Provides access to 7A26 adjustments.	Used for aberrations check.	TEKTRONIX Calibration Fixture 067-0589-00.
Accessories			
1. BNC cable	Connectors, BNC; length, 42 inches.	Used throughout procedure.	TEKTRONIX Part Number 012-0057-01.
2. GR cable	Connectors, GR; impedance, 50 Ω ; length, approximately 20 inches.	High frequency compensation.	TEKTRONIX Part Number 017-0515-00.
3. 5X attenuator	Connectors, GR; impedance, 50 Ω .	High frequency compensation.	TEKTRONIX Part Number 017-0079-00.
4. 10X attenuator	Connectors, GR; impedance, 50 Ω .	Used throughout procedure.	TEKTRONIX Part Number 017-0078-00.
5. RC normalizer	Time constant, 1 M Ω X 20 pF; connectors, BNC; attenuation, 2X.	Input compensation.	TEKTRONIX Part Number 067-0538-00.
6. Termination (through line)	Impedance, 50 Ω ; connectors, GR to BNC male.	Used throughout procedure.	TEKTRONIX Part Number 017-0083-00.
7. Dual-input cable	Connectors, BNC; matched signal transfer to each input.	Common mode rejection.	TEKTRONIX Calibration Fixture 067-0525-00.
Adjustment tools			
1. Screwdriver	Three-inch shaft, 3/32-inch bit.	Used for potentiometer adjustments.	Xcelite R-3323.
2. Low-capacitance screwdriver	1 1/2-inch shaft.	Used for variable capacitor adjustments.	TEKTRONIX Part Number 003-0000-00.
3. Tuning tool	Handle with inserts.	Used for capacitance and attenuator adjustments.	TEKTRONIX Part Numbers 003-0307-00, 003-0334-00, and 003-0497-00.

¹ Requires TM 500-Series Power Module.

CALIBRATION PROCEDURE

CH 1 and CH 2

General

The following procedure is arranged so the 7A26 can be calibrated with the least interaction of adjustments and reconnection of equipment. The control settings and test equipment setups throughout this procedure continue from the preceding steps unless otherwise noted.

POSITION	Midrange
VOLTS/DIV	10 mV
AC-GND-DC	DC

NOTE

Control titles which are printed on the front panel of the 7A26 are capitalized (e.g., POSITION). Internal adjustments and associated equipment controls are initially capitalized only (e.g., oscilloscope Vertical Mode).

Preliminary Procedure for Calibration

1. Remove the oscilloscope left side cover and side panel of plug-in.
2. Insert the 7A26 in the calibration oscilloscope Left Vertical compartment.
3. Insert the time-base unit into the calibration oscilloscope Horizontal compartment.
4. Turn oscilloscope on and allow 20 minutes warm-up before proceeding.

NOTE

This instrument should be calibrated at an ambient temperature of +20°C to +30°C for best overall accuracy. The performance of the instrument can be checked at any temperature within the 0°C to +50°C range.

Preliminary Control Settings

Set the calibration oscilloscope and time-base unit for a sharp, well-defined trace. Set the 7A26 controls as follows:

7A26

DISPLAY MODE	CH 1
TRIGGER SOURCE	MODE
CH 2 POLARITY	+UP
BW	FULL

INDEX TO CALIBRATION PROCEDURE

1. Check/Adjust Channel 1 and 2 2X BAL and DC Balance (R160, R1353), (R1423A, R2423A). Check CH 2 POLARITY switch, and BW switch balance. Page 5-4
- ✓ 2. Check/Adjust Channel 1 and 2 GAIN (R1317, R2317). Page 5-4
Check/Adjust Polarity Gain (R2410).
- ✓ 3. Check Channel 1 and 2 Deflection Factor Accuracy. Page 5-5
- ✓ 4. Check Channel 1 and 2 VARIABLE (VOLTS/DIV) Range. Page 5-6
- ✓ 5. Check Channel 1 and 2 Trace IDENTIFY. Page 5-6
6. Check/Adjust Channel 1 and 2 Attenuator Compensation, (C134, C106, C107, C110, C111, C114, C115, C118, C119). Page 5-6
7. Check/Adjust Channel 1 and 2 Low-Frequency Compensation (R1436, R2436). Page 5-6
8. Check/Adjust Channel 1 and 2 High-Frequency Compensation (C2336, R2336, C2435, R2435, C2531, R2531, C2345, R2345), (C1336, R1336, C1435, R1435, C1531, R1531, C1345, R1345). Page 5-7
- ✓ 9. Check Common-Mode Rejection Ratio. Page 5-7
- ✓ 10. Check Alternate Operation. Page 5-7

Calibration—7A26

- √11. Check Chopped Operation. Page 5-7
- √12. Check TRIGGER SOURCE Operation. Page 5-8
- √13. Check Channel 1 and 2 Bandwidth. Page 5-8

Location of Adjustments

The locations of the 7A26 adjustments are shown in Fig. 7-7 on the fold-out page following the schematic diagrams.

1. Check/Adjust Channel 1 and 2 DC Balance

- a. Position the trace to the center horizontal line with the CH 1 POSITION control.
- b. ADJUST—Channel 1 2X BAL adjustment R160 for minimum vertical trace shift as the CH 1 VOLTS/DIV control is moved between the 5 mV and 10 mV positions. The trace should not move more than 0.5 division vertically.
- c. Set the CH 1 VOLTS/DIV control to 5 mV.
- d. Push and release the CH 1 VARIABLE (VOLTS/DIV) control to its outward position.
- e. CHECK—Turn the VARIABLE control from fully counterclockwise to fully clockwise. Trace should not move more than 0.5 division vertically.
- f. ADJUST—Channel 1 DC Balance, R1353, for minimum trace shift as the CH 1 VARIABLE control is rotated from fully counterclockwise to fully clockwise.
- g. Set the CH 1 VARIABLE control to the CAL IN position.
- h. Set the DISPLAY MODE switch to CH 2.
- i. Position the trace to the center horizontal line with the CH 2 POSITION control.
- j. ADJUST—Channel 2 2X BAL adjustment R160 for minimum vertical trace shift as the CH 2 VOLTS/DIV control is moved between the 5 mV and 10 mV positions. The trace should not move more than 0.5 division vertically.
- k. Set the CH 2 VOLTS/DIV control at 5 mV.
- l. CHECK—While switching from +UP to INVERT, trace should not move more than 0.5 division vertically.
- m. ADJUST—Channel 2 DC Balance, R2353, for minimum trace shift while switching CH 2 POLARITY from +UP to INVERT.
- n. Set the CH 2 POLARITY switch to +UP.
- o. CHECK—Shift the BW switch between FULL and 20 MHz. The trace should not move more than 0.5 division vertically.
- p. Set the BW switch to FULL.

√2. Check/Adjust Channel 1 and 2 GAIN

- a. Connect the standard amplitude calibrator to the CH 2 input connector with a BNC cable.
- b. Set the standard amplitude calibrator for 20 millivolt square-wave output.
- c. Position the display to the center of the graticule with the CH 2 POSITION control.
- d. CHECK—CRT display for exactly four divisions in amplitude.

e. ADJUST—CH 2 GAIN adjustment (front panel) for exactly four divisions of deflection. To adjust, press in the GAIN knob with a screwdriver and turn until the GAIN control is engaged.

f. Set the CH 2 AC-GND-DC switch to AC.

g. CHECK—Shift the CH 2 POLARITY switch between +UP and INVERT. The trace amplitude should not change more than 0.05 division.

h. ADJUST—Polarity Gain R2411 for minimum gain change while shifting the CH 2 POLARITY switch between +UP and INVERT. Recheck CH 2 GAIN because of interaction between step e and h.

i. Set the CH 2 AC-GND-DC switch to DC.

j. Set the CH 2 VOLTS/DIV switch to 10 mV.

k. Set the standard amplitude calibrator for 50-millivolt square-wave output.

l. CHECK—CRT display for exactly five divisions in amplitude.

m. ADJUST—Channel 2 2X GAIN R2317 for exactly five divisions in amplitude.

n. Disconnect the standard amplitude calibrator from the CH 2 input connector and connect it to the CH 1 input connector.

o. Set the DISPLAY MODE switch to CH 1.

p. Set the standard amplitude calibrator for 20-millivolt square-wave output.

q. Position the display to the center of the graticule with the CH 1 POSITION control.

r. CHECK—CRT display for exactly four divisions in amplitude.

s. ADJUST—CH 1 GAIN adjustment (front panel) for exactly four divisions of deflection. To adjust, press in the

GAIN knob with a screwdriver and turn until the GAIN control is engaged.

t. Set the CH 1 VOLTS/DIV switch to 10 mV.

u. Set the standard amplitude calibrator for 50-millivolt square-wave output.

v. CHECK—CRT display for exactly five divisions in amplitude.

w. ADJUST—Channel 1 2X GAIN R1317 for exactly five divisions in amplitude.

√3. Check Channel 1 and 2 Deflection Factor Accuracy

a. CHECK—Using the CH 1 VOLTS/DIV and standard amplitude calibrator settings given in Table 5-1, check vertical deflection within 2% in each position of the CH 1 VOLTS/DIV switch.

b. Disconnect the standard amplitude calibrator from the CH 1 input connector and connect it to the CH 2 input connector.

c. Set the DISPLAY MODE switch to CH 2.

d. Repeat part a of this step for channel 2.

TABLE 5-1

Vertical Deflection Accuracy

VOLTS/DIV Switch Setting	Standard Amplitude Calibrator Output	Vertical Deflection in Divisions	Maximum Error for ±2% Accuracy (divisions)
5 mV	20 mV	4	±.08
10 mV	50 mV	5	Set in step 2
20 mV	0.1 V	5	±0.1
50 mV	0.2 V	4	±.08
.1 V	0.5 V	5	±0.1
.2 V	1 V	5	±0.1
.5 V	2 V	4	±.08
1 V	5 V	5	±0.1
2 V	10 V	5	±0.1
5 V	20 V	4	±.08

4. Check Channel 1 and 2 VARIABLE (VOLTS/DIV) Range

- a. Set the Channel 1 and 2 VOLTS/DIV switches to 10 mV and the standard amplitude calibrator for a 50-millivolt output.
- b. Press and release the CH 2 VARIABLE control to its outward position.
- c. CHECK—With the CH 2 VARIABLE control fully counterclockwise, check for two divisions or less of deflection. Change POLARITY switch to INVERT and check for two divisions or less. Return to the +UP position.
- d. Return the CH 2 VARIABLE control to the CAL IN position.
- e. Disconnect the standard amplitude calibrator from the CH 2 input connector and connect it to the CH 1 input connector.
- f. Set the DISPLAY MODE switch to CH 1.
- g. Repeat parts b, c, and d of this step for channel 1.
- h. Disconnect all test equipment.

5. Check Channel 1 and 2 Trace IDENTIFY

- a. Center the CRT display vertically with the CH 1 POSITION control.
- b. CHECK—Press the IDENTIFY button and check that the trace moves upward.
- c. Set the DISPLAY MODE switch to CH 2 and repeat parts a and b of this step for Channel 2.

6. Check/Adjust Channel 1 and 2 Low-Frequency Compensation

- a. Connect the Square-wave Generator to the 7A26 CH 1 input through a 10X 50 Ω attenuator and a 50 Ω terminator.
- b. Set the Square-wave Generator to obtain approximately six vertical divisions of a 1 kHz square wave.
- c. ADJUST—R1436, LF compensation control, for best flat top (minimum tilt).

- d. Disconnect the Square-wave Generator from CH 1 and connect to the CH 2 input connector.
- e. Set the DISPLAY MODE switch to CH 2.
- f. ADJUST—R2436, LF compensation control, for best flat top (minimum tilt).
- g. Disconnect all test equipment.

7. Check/Adjust Channel 1 and 2 Attenuator Compensation

- a. Connect the Square-wave Generator high-amplitude output to the CH 2 input connector through a 10X 50 Ω attenuator, 50 Ω termination, and a 20 pF RC Normalizer.
- b. Set the CH 1 and CH 2 VOLTS/DIV switches to 5 mV.
- c. Set the Square-wave Generator to obtain a 1 kHz, six-division display.
- d. ADJUST—And check CH 2 attenuator compensations as given in Table 5-2 for optimum square corner and flat top on the displayed waveform (use tuning tool). Maintain a six-division display for all VOLTS/DIV switch positions, removing the 10X attenuator and the 50 Ω termination when necessary.

TABLE 5-2

Attenuator Compensation

VOLTS/DIV Switch Setting	Adjust for Optimum	
	Square Corner	Flat Top
5 mV	*C130	—
10 mV	Check	Check
20 mV	C106	C107
50 mV	C110	C111
.1 V	C114	C115
.2 V	Check	Check
.5 V	Check	Check
1 V	C118	C119
2 V	Check	Check
5 V	Check	Check

*C134 Below SN B080000

- e. Disconnect the Normalizer from CH 2 and connect to the CH 1 input connector.
- f. Set the DISPLAY MODE switch to CH 1.
- g. Repeat part b of this step for channel 1.
- h. Disconnect the Square-wave Generator from the 7A26 and return the CH 1 and CH 2 VOLTS/DIV switch to 10 mV.

8. Check/Adjust Channel 1 and 2 High-Frequency Compensation

- a. Set the CH 1 and CH 2 VOLTS/DIV switches to 10 mV.
- b. Connect the Pulse Generator to the 7A26 CH 2 input through a 5X 50 Ω attenuator and a 50 Ω terminator.
- c. Set the time-base unit to obtain a triggered display at a rate of approximately 0.2 μ s per division.
- d. Position the top of the waveform to 1 division above center screen. Note the peak to peak amplitude.
- e. CHECK—Aberrations should not exceed +4% or -4% and 6% peak to peak of the pulse amplitude noted in part d.
- f. ADJUST—High-frequency compensations C2336, R2336, C2432, C2435, R2435, C2531, R2531, C2345, and R2345 for best front corner and flat top.
- g. Remove the 7A26 from the Vertical compartment and insert the Plug-in Extender into the same compartment.
- h. Insert the 7A26 into the Plug-in Extender.
- i. Reverse the trigger cable connections from A11 to A13, and B11 to B13 of the Plug-in Extender.
- j. CHECK—Aberrations should not exceed +10% or -10% and 15% peak to peak total of the pulse amplitude.
- k. ADJUST—High-frequency compensation C2721 for minimum aberrations.
- l. Repeat step f.
- m. Remove the Plug-in Extender from the Vertical compartment and insert the 7A26 into the compartment.

- n. Disconnect the Pulse Generator from CH 2 and connect to the CH 1 input through a 5X 50 Ω attenuator and a 50 Ω terminator.

- o. Set the DISPLAY MODE switch to CH 1.
- p. CHECK—Aberrations should not exceed +4% or -4% and 6% peak to peak of the pulse amplitude.
- q. ADJUST—High-frequency compensations C1336, R1336, C1432, C1435, R1435, C1531, R1531, C1345, and R1345 for best front corner flat top.
- r. Remove the 7A26 from the Vertical compartment and insert the Plug-in Extender into the compartment.
- s. Insert the 7A26 into the Plug-in Extender.
- t. CHECK—Aberrations should not exceed +10% or -10%, and 15% peak to peak total of the pulse amplitude.
- u. ADJUST—High-frequency compensation C1721 for minimum aberrations.
- v. Repeat part q.
- w. Remove the Plug-in Extender from the Vertical compartment and insert the 7A26 into the compartment.
- x. ADJUST—C134 for best compromise between 10, 20, and 50 mV positions for first 20 n sec of pulse.
- y. Disconnect all test equipment.
- z. Repeat step 6.

✓ 9. Check Common-Mode Rejection Ratio

- a. Set the CH 1 and CH 2 VOLTS/DIV switches to 5 mV.
- b. Connect the medium-frequency generator to the CH 1 and CH 2 input connectors through the 50 Ω termination and the dual-input cable.
- c. Set the constant-amplitude generator for an eight-division display (40 millivolts) at 50 megahertz.
- d. Change the following control settings:

DISPLAY MODE	ADD
CH 2 POLARITY	INVERT

e. CHECK—CRT display for 0.8 division or less deflection (common-mode rejection ratio 10:1 or better).

f. Disconnect all test equipment.

✓ 10. Check Alternate Operation

a. Set the DISPLAY MODE switch to ALT.

b. Position the traces about two divisions apart.

c. Turn the time-base unit time/division switch through-out its range.

d. CHECK—Trace alternation between channel 1 and 2 at all sweep rates. At faster sweep rates, alternation will not be apparent; instead display appears as two traces on the screen.

✓ 11. Check Chopped Operation

a. Set the DISPLAY MODE switch to CHOP.

b. CHECK—CRT display for two traces.

✓ 12. Check Trigger Source Operation

a. Change the following control settings:

DISPLAY MODE	ALT
TRIGGER SOURCE	CH 1

b. Connect the Indicator oscilloscope cal out connector to the CH 1 input connector.

c. Set the time-base unit for a stable display at a sweep rate of 0.5 millisecond/division.

d. Connect the square-wave generator through a 50 Ω termination to the CH 2 input connector. Set CH 2 to .2 V/div.

e. Set the square-wave generator for a one-division (200 millivolts) one-kilohertz signal.

f. CHECK—CRT display; CH 1 trace is stable and CH 2 trace cannot be triggered.

g. Set the TRIGGER SOURCE switch to CH 2.

h. Adjust the time-base triggering for a stable display.

i. CHECK—CRT display; CH 2 trace is stable and CH 1 trace cannot be triggered.

j. Set the TRIGGER SOURCE switch to MODE.

k. CHECK—CRT display; CH 1 trace and CH 2 trace can both be triggered.

l. Disconnect all test equipment.

✓ 13. Check Channel 1 and 2 Bandwidth

a. Connect the high-frequency constant amplitude signal generator to the 7A26 CH 1 input through a 50 Ω termination.

b. Set the high-frequency constant amplitude signal generator to the reference frequency of 3 MHz and adjust the output amplitude to obtain a 6 division display.

c. Change the frequency of the high-frequency constant amplitude signal generator to the value given in Table 5-3 relative to the individual mainframe.

d. CHECK—That the amplitude of the display is 4.2 divisions or greater.

TABLE 5-3

System Bandwidth

Mainframe	Bandwidth
7900-Series	*200 megahertz
7700-Series	*150 megahertz
7600-Series	*100 megahertz
7500-Series	* 90 megahertz
7400-Series	* 60 megahertz

*See part c of step 13.

e. Disconnect the high-frequency constant signal generator and 50 Ω termination from CH 1 and connect to CH 2 input.

f. Set the DISPLAY MODE switch to CH 2.

g. Repeat parts b, c, and d of this step for CH 2.

h. Disconnect all test equipment.

This completes the calibration for the 7A26.

REPLACEABLE ELECTRICAL PARTS

PARTS ORDERING INFORMATION

Replacement parts are available from or through your local Tektronix, Inc. Field Office or representative.

Changes to Tektronix instruments are sometimes made to accommodate improved components as they become available, and to give you the benefit of the latest circuit improvements developed in our engineering department. It is therefore important, when ordering parts, to include the following information in your order: Part number, instrument type or number, serial number, and modification number if applicable.

If a part you have ordered has been replaced with a new or improved part, your local Tektronix, Inc. Field Office or representative will contact you concerning any change in part number.

Change information, if any, is located at the rear of this manual.

SPECIAL NOTES AND SYMBOLS

X000 Part first added at this serial number
00X Part removed after this serial number

ITEM NAME

In the Parts List, an Item Name is separated from the description by a colon (:). Because of space limitations, an Item Name may sometimes appear as incomplete. For further Item Name identification, the U.S. Federal Cataloging Handbook H6-1 can be utilized where possible.

ABBREVIATIONS

ACTR	ACTUATOR	PLSTC	PLASTIC
ASSY	ASSEMBLY	QTZ	QUARTZ
CAP	CAPACITOR	RECP	RECEPTACLE
CER	CERAMIC	RES	RESISTOR
CKT	CIRCUIT	RF	RADIO FREQUENCY
COMP	COMPOSITION	SEL	SELECTED
CONN	CONNECTOR	SEMICOND	SEMICONDUCTOR
ELCTLT	ELECTROLYTIC	SENS	SENSITIVE
ELEC	ELECTRICAL	VAR	VARIABLE
INCAND	INCANDESCENT	WW	WIREWOUND
LED	LIGHT EMITTING DIODE	XFMR	TRANSFORMER
NONWIR	NON WIREWOUND	XTAL	CRYSTAL

CROSS INDEX—MFR. CODE NUMBER TO MANUFACTURER

Mfr. Code	Manufacturer	Address	City, State, Zip
00853	SANGAMO ELECTRIC CO., S. CAROLINA DIV.	P O BOX 128	PICKENS, SC 29671
01121	ALLEN-BRADLEY COMPANY	1201 2ND STREET SOUTH	MILWAUKEE, WI 53204
04222	AVX CERAMICS, DIVISION OF AVX CORP.	P O BOX 867, 19TH AVE. SOUTH	MURTLE BEACH, SC 29577
04713	MOTOROLA, INC., SEMICONDUCTOR PROD. DIV.	5005 E MCDOWELL RD, PO BOX 20923	PHOENIX, AZ 85036
07263	FAIRCHILD SEMICONDUCTOR, A DIV. OF FAIRCHILD CAMERA AND INSTRUMENT CORP.	464 ELLIS STREET	MOUNTAIN VIEW, CA 94042
07910	TELEDYNE SEMICONDUCTOR	12515 CHADRON AVE.	HAWTHORNE, CA 90250
12697	CLAROSTAT MFG. CO., INC.	LOWER WASHINGTON STREET	DOVER, NH 03820
24931	SPECIALTY CONNECTOR CO., INC.	3560 MADISON AVE.	INDIANAPOLIS, IN 46227
32997	BOURNS, INC., TRIMPOT PRODUCTS DIV.	1200 COLUMBIA AVE.	RIVERSIDE, CA 92507
50157	N. L. INDUSTRIES, INC., ELECTRONICS DEPT.	P. O. BOX 787	MUSKEGON, MI 49445
56289	SPRAGUE ELECTRIC CO.		NORTH ADAMS, MA 01247
72982	ERIE TECHNOLOGICAL PRODUCTS, INC.	644 W. 12TH ST.	ERIE, PA 16512
73899	JFD ELECTRONICS COMPONENTS CORP.	PINETREE ROAD	OXFORD, NC 27565
74970	JOHNSON, E. F., CO.	299 10TH AVE. S. W.	WASECA, MN 56093
75042	TRW ELECTRONIC COMPONENTS, IRC FIXED RESISTORS, PHILADELPHIA DIVISION	401 N. BROAD ST.	PHILADELPHIA, PA 19108
78488	STACKPOLE CARBON CO.		ST. MARYS, PA 15857
79727	C-W INDUSTRIES	550 DAVISVILLE RD., P O BOX 96	WARMINISTER, PA 18974
80009	TEKTRONIX, INC.	P O BOX 500	BEAVERTON, OR 97077
80740	BECKMAN INSTRUMENTS, INC.	2500 HARBOR BLVD.	FULLERTON, CA 92634
90201	MALLORY CAPACITOR CO., DIV. OF P. R. MALLORY AND CO., INC.	3029 E WASHINGTON STREET P O BOX 372	INDIANAPOLIS, IN 46206
91637	DALE ELECTRONICS, INC.	P. O. BOX 609	COLUMBUS, NE 68601

Ckt No.	Tektronix Part No.	Serial/Model No. Eff	Dscont	Name & Description	Mfr Code	Mfr Part Number
A1	670-2324-01	B010100	B059999	CKT CARD ASSY:ATTENUATOR CH1 + CH2	80009	670-2324-01
A1	670-2324-00	B060000	B079999	CKT CARD ASSY:ATTENUATOR CH1 + CH2	80009	670-2324-00
A1	670-2324-03	B080000	B119999	CKT CARD ASSY:ATTENUATOR CH1 + CH2	80009	670-2324-03
A1	670-2324-05	B120000		CKT CARD ASSY:ATTENUATOR CH1 + CH2	80009	670-2324-05
A2	670-2549-00	B010100	B049999	CKT CARD ASSY:AMPLIFIER	80009	670-2549-00
A2	670-2549-01	B050000	B069999	CKT CARD ASSY:AMPLIFIER	80009	670-2549-01
A2	670-2549-02	B070000	B083789	CKT CARD ASSY:AMPLIFIER	80009	670-2549-02
A2	670-2549-03	B083790	B089999	CKT CARD ASSY:AMPLIFIER	80009	670-2549-03
A2	670-2549-04	B090000	B109999	CKT CARD ASSY:AMPLIFIER	80009	670-2549-04
A2	670-2549-05	B110000	B139377	CKT CARD ASSY:AMPLIFIER	80009	670-2549-05
A2	670-2549-06	B139378	B149999	CKT CARD ASSY:AMPLIFIER	80009	670-2549-06
A2	670-2549-07	B150000	B159999	CKT CARD ASSY:AMPLIFIER	80009	670-2549-07
A2	670-2549-08	B160000		CKT CARD ASSY:AMPLIFIER	80009	670-2549-08
A3	670-2310-01	B010100	B059999	CKT CARD ASSY:READOUT CH1 + CH2	80009	670-2310-01
A3	670-2310-00	B060000	B149999	CKT CARD ASSY:READOUT CH1 + CH2	80009	670-2310-00
A3	670-2310-04	B150000		CKT CARD ASSY:READOUT CH1 + CH2	80009	670-2310-04
C10	285-0816-01	B010100	B119999	CAP.,FXD,PLSTC:0.019UF,10%,600V	80009	285-0816-01
C10	285-1132-00	B120000		CAP.,FXD,PLSTC:0.019UF,10%,600V	80009	285-1132-00
C13	283-0000-00			CAP.,FXD,CER DI:0.001UF,+100-0%,500V	72982	831-516E102P
C15	283-0000-00			CAP.,FXD,CER DI:0.001UF,+100-0%,500V	72982	831-516E102P
C106						
C107	307-1010-00			ATTENUATOR,FXD:2X	80009	307-1010-00
C110						
C111	307-1012-00			ATTENUATOR,FXD:5X	80009	307-1012-00
C114						
C115	307-1013-01			ATTENUATOR,FXD:10X	80009	307-1013-01
C117	281-0626-00	B010100	B079999X	CAP.,FXD,CER DI:3.3PF,1%,500V	72982	301-000C0J0339B
C118						
C119	307-1013-01			ATTENUATOR,FXD:10X	80009	307-1013-01
C130	281-0670-00	B010100	B079999	CAP.,FXD,CER DI:1.8PF,+/-0.1PF,500V	72982	374-005C0K0189B
C130	281-0064-00	B080000		CAP.,VAR,PLSTC:0.25-1.5PF,600V	72982	530-002
C132	283-0000-00			CAP.,FXD,CER DI:0.001UF,+100-0%,500V	72982	831-516E102P
C134	281-0064-00			CAP.,VAR,PLSTC:0.25-1.5PF,600V	72982	530-002
C140	281-0615-00	B010100	B079999	CAP.,FXD,CER DI:3.9PF,+/-0.5PF,200V	72982	374-001C0J0399D
C140	290-0536-00	B080000		CAP.,FXD,ELCTLT:10UF,20%,25V	90201	TDC106M025FL
C142	283-0156-00	XB080000		CAP.,FXD,CER DI:1000PF,+100-0%,200V	72982	8111A208E102Z
C150	281-0562-00	B010100	B079999X	CAP.,FXD,CER DI:39PF,10%,500V	72982	301-000U2J0390K
C154	283-0000-00	B010100	B079999X	CAP.,FXD,CER DI:0.001UF,+100-0%,500V	72982	831-516E102P
C156	283-0156-00	XB080000		CAP.,FXD,CER DI:1000PF,+100-0%,200V	72982	8111A208E102Z
C158	290-0536-00			CAP.,FXD,ELCTLT:10UF,20%,25V	90201	TDC106M025FL
C190	281-0600-00	B010100	B079999X	CAP.,FXD,CER DI:35PF,10%,500V	72982	308-000C0G0350K
C621	283-0000-00			CAP.,FXD,CER DI:0.001UF,+100-0%,500V	72982	831-516E102P
C630	283-0000-00			CAP.,FXD,CER DI:0.001UF,+100-0%,500V	72982	831-516E102P
C631	283-0000-00	XB100000		CAP.,FXD,CER DI:0.001UF,+100-0%,500V	72982	831-516E102P
C634	283-0000-00			CAP.,FXD,CER DI:0.001UF,+100-0%,500V	72982	831-516E102P
C635	283-0000-00			CAP.,FXD,CER DI:0.001UF,+100-0%,500V	72982	831-516E102P
C638	283-0000-00			CAP.,FXD,CER DI:0.001UF,+100-0%,500V	72982	831-516E102P
C643	283-0000-00			CAP.,FXD,CER DI:0.001UF,+100-0%,500V	72982	831-516E102P
C647	283-0000-00			CAP.,FXD,CER DI:0.001UF,+100-0%,500V	72982	831-516E102P
C648	283-0003-00			CAP.,FXD,CER DI:0.01UF,+80-20%,150V	72982	855-558Z5U-103Z
C649	283-0000-00			CAP.,FXD,CER DI:0.001UF,+100-0%,500V	72982	831-516E102P
C820	283-0010-00	B010100	B173947	CAP.,FXD,CER DI:0.05UF,+100-20%,50V	56289	273C20
C820	283-0341-00	B173948		CAP.,FXD,CER DI:0.047UF,10%,100V	72982	8131N075W5R224K

Ckt No.	Tektronix Part No.	Serial/Model No. Eff	Dscont	Name & Description	Mfr Code	Mfr Part Number
C840	283-0010-00	B010100	B173947	CAP.,FXD,CER DI:0.05UF,+100-20%,50V	56289	273C20
C840	283-0341-00	B173948		CAP.,FXD,CER DI:0.047UF,10%,100V	72982	8131N075W5R224K
C860	283-0640-00			CAP.,FXD,MICA Z:160PF,1%,100V	00853	D151E161F0
C880	281-0603-00			CAP.,FXD,CER DI:39PF,5%,500V	72982	308-000COG0390J
C920	283-0010-00	B010100	B173947	CAP.,FXD,CER DI:0.05UF,+100-20%,50V	56289	273C20
C920	283-0341-00	B173948		CAP.,FXD,CER DI:0.047UF,10%,100V	72982	8131N075W5R224K
C940	283-0010-00	B010100	B173947	CAP.,FXD,CER DI:0.05UF,+100-20%,50V	56289	273C20
C940	283-0341-00	B173948		CAP.,FXD,CER DI:0.047UF,10%,100V	72982	8131N075W5R224K
C960	283-0640-00			CAP.,FXD,MICA Z:160PF,1%,100V	00853	D151E161F0
C980	281-0603-00			CAP.,FXD,CER DI:39PF,5%,500V	72982	308-000COG0390J
C1012	290-0512-00	B010100	B039999	CAP.,FXD,ELCTLT:22UF,20%,15V	56289	196D226X0015KA1
C1012	290-0536-00	B040000		CAP.,FXD,ELCTLT:10UF,20%,25V	90201	TDC106M025FL
C1014	283-0002-00			CAP.,FXD,CER DI:0.01UF,+80-20%,500V	72982	811-546E103Z
C1018	290-0512-00	B010100	B039999	CAP.,FXD,ELCTLT:22UF,20%,15V	56289	196D226X0015KA1
C1018	290-0536-00	B040000		CAP.,FXD,ELCTLT:10UF,20%,25V	90201	TDC106M025FL
C1022	290-0512-00	B010100	B039999	CAP.,FXD,ELCTLT:22UF,20%,15V	56289	196D226X0015KA1
C1022	290-0536-00	B040000		CAP.,FXD,ELCTLT:10UF,20%,25V	90201	TDC106M025FL
C1024	283-0002-00			CAP.,FXD,CER DI:0.01UF,+80-20%,500V	72982	811-546E103Z
C1028	290-0512-00	B010100	B039999	CAP.,FXD,ELCTLT:22UF,20%,15V	56289	196D226X0015KA1
C1028	290-0536-00	B040000		CAP.,FXD,ELCTLT:10UF,20%,25V	90201	TDC106M025FL
C1032	283-0000-00			CAP.,FXD,CER DI:0.001UF,+100-0%,500V	72982	831-516E102P
C1034	283-0000-00			CAP.,FXD,CER DI:0.001UF,+100-0%,500V	72982	831-516E102P
C1070	281-0589-00	XB070000		CAP.,FXD,CER DI:170PF,5%,500V	72982	301000Z5D171J
C1311	283-0000-00			CAP.,FXD,CER DI:0.001UF,+100-0%,500V	72982	831-516E102P
C1327	283-0000-00			CAP.,FXD,CER DI:0.001UF,+100-0%,500V	72982	831-516E102P
C1329	283-0000-00	B010100	B159999X	CAP.,FXD,CER DI:0.001UF,+100-0%,500V	72982	831-516E102P
C1331	281-0540-00	B010100	B109999	CAP.,FXD,CER DI:51PF,5%,500V	72982	301-000U2J0510J
C1331	281-0549-00	B110000		CAP.,FXD,CER DI:68PF,10%,500V	72982	301-000U2J0680K
C1332	283-0203-00	B010100	B109999	CAP.,FXD,CER DI:0.47UF,(NOM VALUE),SEL	72982	8131N075 E474M
C1332	283-0177-00	B110000	B139377	CAP.,FXD,CER DI:1UF,+80-20%,25V	72982	8131N039 E 105Z
C1332	283-0203-00	B139378		CAP.,FXD,CER DI:0.47UF,20%,50V	72982	8131N075 E474M
C1336	281-0158-00			CAP.,VAR,CER DI:7-45PF,50V	73899	DVJ-5006
C1339	281-0519-00	B010100	B109999	CAP.,FXD,CER DI:47PF,+/-4.7PF,500V	72982	308-000COG0470K
C1339	281-0158-00	B110000		CAP.,VAR,CER DI:7-45PF,50V	73899	DVJ-5006
C1345	281-0186-00	B010100	B099999	CAP.,VAR,PLSTC:1.1-3.5PF,100V	74970	273-0005-005
C1345	281-0218-00	B100000		CAP.,VAR,CER DI:1-5PF,+2-2.5%,100V	72982	273-0005-005
C1431	283-0142-00	B010100	B029999	CAP.,FXD,CER DI:0.0027UF,5%,200V	72982	875-551B272J
C1431	283-0110-00	B030000	B059999	CAP.,FXD,CER DI:0.005UF,+80-20%,150V	56289	19C242B
C1431	283-0100-00	B060000	B109999	CAP.,FXD,CER DI:0.0047UF,10%,200V	56289	273C3
C1431	283-0051-00	B110000	B139377	CAP.,FXD,CER DI:0.0033UF,(NOM VALUE),SEL	72982	8131N145 A 332J
C1431	283-0119-00	B139378		CAP.,FXD,CER DI:2200PF,(NOM VALUE),SEL	72982	855-535B222J
C1432	281-0122-00	XB083790		CAP.,VAR,CER DI:2.5-9PF,100V	72982	518-000A2.5-9
C1433	281-0628-00			CAP.,FXD,CER DI:15PF,5%,500V	72982	301-000COG0150J
C1434	281-0546-00			CAP.,FXD,CER DI:330PF,10%,500V	04222	7001-1380
C1435	281-0158-00			CAP.,VAR,CER DI:7-45PF,50V	73899	DVJ-5006
C1436	283-0010-00	B010100	B109999	CAP.,FXD,CER DI:0.05UF,+100-20%,50V	56289	273C20
C1436	283-0058-00	B110000	B139377	CAP.,FXD,CER DI:0.027UF,(NOM VALUE),SEL	72982	8131N147W5R273K
C1436	283-0268-00	B139378		CAP.,FXD,CER DI:0.015UF,(NOM VALUE),SEL	72982	8131N075W5R153K
C1480	281-0534-00			CAP.,FXD,CER DI:3.3PF,+/-0.25PF,500V	72982	301-000COJ0339C
C1490	283-0000-00			CAP.,FXD,CER DI:0.001UF,+100-0%,500V	72982	831-516E102P
C1531	281-0161-00			CAP.,VAR,CER DI:5-15PF,350V	72982	518-000A5-15
C1533	283-0177-00	B010100	B109999	CAP.,FXD,CER DI:1UF,+80-20%,25V	72982	8131N039 E 105Z
C1533	281-0658-00	B110000		CAP.,FXD,CER DI:6.2PF,+/-0.25PF,500V	72982	301-000COH0629C
C1721	281-0123-00	XB050000		CAP.,VAR,CER DI:5-25PF,100V	72982	518-000A5-25
C2311	283-0000-00			CAP.,FXD,CER DI:0.001UF,+100-0%,500V	72982	831-516E102P
C2327	283-0000-00			CAP.,FXD,CER DI:0.001UF,+100-0%,500V	72982	831-516E102P

Kct No.	Tektronix Part No.	Serial/Model No. Eff	Dscont	Name & Description	Mfr Code	Mfr Part Number
C2329	283-0000-00	B010100	B159999X	CAP.,FXD,CER DI:0.001UF,+100-0%,500V	72982	831-516E102P
C2331	281-0540-00	B010100	B109999	CAP.,FXD,CER DI:51PF,5%,500V	72982	301-000U2J0510J
C2331	281-0549-00	B110000		CAP.,FXD,CER DI:68PF,10%,500V	72982	301-000U2J0680K
C2332	283-0203-00	B010100	B139377	CAP.,FXD,CER DI:0.47UF,20%,50V	72982	8131N075 E474M
C2332	283-0203-00	B139378		CAP.,FXD,CER DI:0.47UF,(NOM VALUE),SEL	72982	8131N075 E474M
C2336	281-0158-00			CAP.,VAR,CER DI:7-45PF,50V	73899	DVJ-5006
C2339	281-0519-00	B010100	B109999	CAP.,FXD,CER DI:47PF,+/-4.7PF,500V	72982	308-000C0G0470K
C2339	281-0158-00	B110000		CAP.,VAR,CER DI:7-45PF,50V	73899	DVJ-5006
C2345	281-0186-00	B010100	B099999	CAP.,VAR,PLSTC:1.1-3.5PF,100V	74970	273-0005-005
C2345	281-0218-00	B100000		CAP.,VAR,CER DI:1-5PF,+2-2.5%,100V	72982	273-0005-005
C2423	283-0000-00			CAP.,FXD,CER DI:0.001UF,+100-0%,500V	72982	831-516E102P
C2431	283-0142-00	B010100	B029999	CAP.,FXD,CER DI:0.0027UF,5%,200V	72982	875-551B272J
C2431	283-0110-00	B030000	B059999	CAP.,FXD,CER DI:0.005UF,+80-20%,150V	56289	19C242B
C2431	283-0100-00	B060000	B109999	CAP.,FXD,CER DI:0.0047UF,10%,200V	56289	273C3
C2431	283-0051-00	B110000	B139377	CAP.,FXD,CER DI:0.0033UF,(NOM VALUE),SEL	72982	8131N145 A 332J
C2431	283-0119-00	B139378		CAP.,FXD,CER DI:2200PF,(NOM VALUE),SEL	72982	855-535B222J
C2432	281-0122-00	XB083790		CAP.,VAR,CER DI:2.5-9PF,100V	72982	518-000A2.5-9
C2433	281-0628-00			CAP.,FXD,CER DI:15PF,5%,500V	72982	301-000C0G0150J
C2434	281-0546-00			CAP.,FXD,CER DI:330PF,10%,500V	04222	7001-1380
C2435	281-0158-00			CAP.,VAR,CER DI:7-45PF,50V	73899	DVJ-5006
C2436	283-0010-00	B010100	B109999	CAP.,FXD,CER DI:0.05UF,+100-20%,50V	56289	273C20
C2436	283-0058-00	B110000	B139377	CAP.,FXD,CER DI:0.027UF,(NOM VALUE),SEL	72982	8131N147W5R273K
C2436	283-0268-00	B139378		CAP.,FXD,CER DI:0.015UF,(NOM VALUE),SEL	72982	8131N075W5R153K
C2480	281-0659-00			CAP.,FXD,CER DI:4.3PF,+/-0.25PF,500V	72982	301-000C0H0439C
C2531	281-0161-00			CAP.,VAR,CER DI:5-15PF,350V	72982	518-000A5-15
C2533	283-0177-00	B010100	B139377X	CAP.,FXD,CER DI:1UF,+80-20%,25V	72982	8131N039 E 105Z
C2720	281-0627-00	XB020000		CAP.,FXD,CER DI:1PF,+/-0.25PF,500V	72982	301-000C0K0109C
C2721	281-0123-00	XB050000		CAP.,VAR,CER DI:5-25PF,100V	72982	518-000A5-25
CR130	152-0321-00			SEMICOND DEVICE:SILICON,35V,100MA	07263	FSA1480
CR621	152-0141-02			SEMICOND DEVICE:SILICON,30V,150MA	07910	1N4152
CR631	152-0141-02	B010100	B099999X	SEMICOND DEVICE:SILICON,30V,150MA	07910	1N4152
CR647	152-0141-02			SEMICOND DEVICE:SILICON,30V,150MA	07910	1N4152
CR860	152-0141-02			SEMICOND DEVICE:SILICON,30V,150MA	07910	1N4152
CR880	152-0141-02			SEMICOND DEVICE:SILICON,30V,150MA	07910	1N4152
CR960	152-0141-02			SEMICOND DEVICE:SILICON,30V,150MA	07910	1N4152
CR980	152-0141-02			SEMICOND DEVICE:SILICON,30V,150MA	07910	1N4152
CR1050	152-0141-02			SEMICOND DEVICE:SILICON,30V,150MA	07910	1N4152
CR1052	152-0141-02			SEMICOND DEVICE:SILICON,30V,150MA	07910	1N4152
CR1056	152-0141-02	XB070000		SEMICOND DEVICE:SILICON,30V,150MA	07910	1N4152
CR1058	152-0141-02			SEMICOND DEVICE:SILICON,30V,150MA	07910	1N4152
CR1060	152-0141-02	B010100	B069999X	SEMICOND DEVICE:SILICON,30V,150MA	07910	1N4152
CR1062	152-0141-02	B010100	B069999X	SEMICOND DEVICE:SILICON,30V,150MA	07910	1N4152
CR1301	152-0141-02	XB090000		SEMICOND DEVICE:SILICON,30V,150MA	07910	1N4152
CR1319	152-0141-02			SEMICOND DEVICE:SILICON,30V,150MA	07910	1N4152
CR1465	152-0141-02			SEMICOND DEVICE:SILICON,30V,150MA	07910	1N4152
CR2301	152-0141-02	XB090000		SEMICOND DEVICE:SILICON,30V,150MA	07910	1N4152
CR2319	152-0141-02			SEMICOND DEVICE:SILICON,30V,150MA	07910	1N4152
CR2465	152-0141-02			SEMICOND DEVICE:SILICON,30V,150MA	07910	1N4152
CR2476	152-0141-02			SEMICOND DEVICE:SILICON,30V,150MA	07910	1N4152
CR2496	152-0141-02			SEMICOND DEVICE:SILICON,30V,150MA	07910	1N4152
J10	131-0679-00			CONNECTOR,RCPT,:BNC W/HARDWARE	24931	28JR168-1

Electrical Parts List—7A26

Ckt No.	Tektronix Part No.	Serial/Model No. Eff	Dscont	Name & Description	Mfr Code	Mfr Part Number
L118	108-0557-00	B010100	B079999X	COIL,RF:35NH	80009	108-0557-00
L806	108-0420-00	B010100	B159999X	COIL,RF:60NH	80009	108-0420-00
L808	108-0420-00	B010100	B159999X	COIL,RF:60NH	80009	108-0420-00
L860	108-0311-00			COIL,RF:0.18UH	80009	108-0311-00
L861	276-0507-00	XB160000		SHIELDING BEAD,:0.6UH	78488	57-0180-7D 500B
L880	108-0311-00			COIL,RF:0.18UH	80009	108-0311-00
L881	276-0507-00	XB160000		SHIELDING BEAD,:0.6UH	78488	57-0180-7D 500B
L960	108-0311-00			COIL,RF:0.18UH	80009	108-0311-00
L980	108-0311-00			COIL,RF:0.18UH	80009	108-0311-00
LL070	276-0507-00	XB110000		SHIELDING BEAD,:0.6UH	78488	57-0180-7D 500B
LL345	108-0420-00			COIL,RF:60NH	80009	108-0420-00
L2345	108-0420-00			COIL,RF:60NH	80009	108-0420-00
LR107	108-0744-00	B010100	B079999X	COIL,RF:81NH(WOUND ON A 75 OHM RESISTOR)	80009	108-0744-00
LR111	108-0745-00	B010100	B079999X	COIL,RF:110NH(WOUND ON A 130 OHM RESISTOR)	80009	108-0745-00
LR701 ¹	108-0407-00	XB083790		COIL,RF:37NH(WOUND ON A 51 OHM RESISTOR)	80009	108-0407-00
LR703 ¹	108-0407-00	XB083790		COIL,RF:37NH(WOUND ON A 51 OHM RESISTOR)	80009	108-0407-00
LR1010	108-0184-00			COIL,RF:3.2UH(WOUND ON A 10 OHM RESISTOR)	80009	108-0184-00
LR1014	108-0184-00			COIL,RF:3.2UH(WOUND ON A 10 OHM RESISTOR)	80009	108-0184-00
LR1020	108-0184-00			COIL,RF:3.2UH(WOUND ON A 10 OHM RESISTOR)	80009	108-0184-00
LR1024	108-0184-00			COIL,RF:3.2UH(WOUND ON A 10 OHM RESISTOR)	80009	108-0184-00
Q140	151-0367-00	B010100	B079999X	TRANSISTOR:SILICON,NPN,SEL FROM 3571TP	80009	151-0367-00
Q150A,B	151-1032-00			TRANSISTOR:SILICON,FET,DUAL	80009	151-1032-00
Q620	151-0254-00			TRANSISTOR:SILICON,NPN	80009	151-0254-00
Q820	153-0606-00	B010100	B109999	TRANSISTOR:SILICON,PNP,MATCHED	80009	153-0606-00
Q840						
Q860						
Q880						
Q820	153-0644-00	B110000		TRANSISTOR:SILICON,PNP,MATCHED	80009	153-0644-00
Q840						
Q860	153-0644-00	B110000		TRANSISTOR:SILICON,PNP,MATCHED	80009	153-0644-00
Q880						
Q920						
Q940						
Q960						
Q980						
Q1050						
Q1050	151-0347-00	B070000	B109999	TRANSISTOR:SILICON,NPN	80009	151-0347-00
Q1050	151-0302-00	B110000		TRANSISTOR:SILICON,NPN	04713	2N2222A
Q1070	151-0341-00	B010100	B069999	TRANSISTOR:SILICON,NPN	07263	S040065
Q1070	151-0347-00	B070000	B109999	TRANSISTOR:SILICON,NPN	80009	151-0347-00
Q1070	151-0302-00	B110000		TRANSISTOR:SILICON,NPN	04713	2N2222A
Q1470	151-0341-00			TRANSISTOR:SILICON,NPN	07263	S040065
Q1490	151-0341-00			TRANSISTOR:SILICON,NPN	07263	S040065
Q2470	151-0341-00			TRANSISTOR:SILICON,NPN	07263	S040065
Q2490	151-0341-00			TRANSISTOR:SILICON,NPN	07263	S040065
R10	315-0560-00			RES.,FXD,CMPSN:56 OHM,5%,0.25W	01121	CB5605
R13	316-0101-00			RES.,FXD,CMPSN:100 OHM,10%,0.25W	01121	CB1011
R102	317-0105-00			RES.,FXD,CMPSN:1M OHM,5%,0.125W	01121	BB1055
R104	315-0560-00			RES.,FXD,CMPSN:56 OHM,5%,0.25W	01121	CB5605
R106	317-0330-00	XB080000		RES.,FXD,CMPSN:33 OHM,5%,0.125W	01121	BB3305
R110	317-0470-00	XB080000		RES.,FXD,CMPSN:47 OHM,5%,0.125W	01121	BB4705
R114	317-0220-00	XB080000		RES.,FXD,CMPSN:22 OHM,5%,0.125W	01121	BB2205

¹Test selected as needed.

Ckt No.	Tektronix Part No.	Serial/Model No. Eff	Dscont	Name & Description	Mfr Code	Mfr Part Number
R115	315-0430-00	B010100	B079999	RES.,FXD,CMPSN:43 OHM,5%,0.25W	01121	CB4305
R115	315-0560-00	B080000		RES.,FXD,CMPSN:56 OHM,5%,0.25W	01121	CB5605
R118	315-0360-00	B010100	B079999	RES.,FXD,CMPSN:36 OHM,5%,0.25W	01121	CB3605
R118	315-0750-00	B080000		RES.,FXD,CMPSN:75 OHM,5%,0.25W	01121	CB7505
R119	317-0360-00	XB080000		RES.,FXD,CMPSN:36 OHM,5%,0.125W	01121	BB3605
R130	321-0481-00			RES.,FXD,FILM:1M OHM,1%,0.125W	91637	MFF1816G10003F
R132	316-0474-00			RES.,FXD,CMPSN:470K OHM,10%,0.25W	01121	CB4741
R133 ¹						
R134	315-0751-00	B010100	B079999	RES.,FXD,CMPSN:750 OHM,5%,0.25W	01121	CB7515
R134	315-0471-00	B080000		RES.,FXD,CMPSN:470 OHM,5%,0.25W	01121	CB4715
R140	315-0621-00	B010100	B079999	RES.,FXD,CMPSN:620 OHM,5%,0.25W	01121	CB6215
R140	315-0201-00	B080000		RES.,FXD,CMPSN:200 OHM,5%,0.25W	01121	CB2015
R142	315-0132-00	B010100	B079999	RES.,FXD,CMPSN:1.3K OHM,5%,0.25W	01121	CB1325
R142	315-0621-00	B080000		RES.,FXD,CMPSN:620 OHM,5%,0.25W	01121	CB6215
R144	315-0221-00	B010100	B079999X	RES.,FXD,CMPSN:220 OHM,5%,0.25W	01121	CB2215
R145	315-0560-00	B010100	B079999X	RES.,FXD,CMPSN:56 OHM,5%,0.25W	01121	CB5605
R150	315-0200-00			RES.,FXD,CMPSN:20 OHM,5%,0.25W	01121	CB2005
R151	315-0560-00	B010100	B079999X	RES.,FXD,CMPSN:56 OHM,5%,0.25W	01121	CB5605
R152	315-0200-00			RES.,FXD,CMPSN:20 OHM,5%,0.25W	01121	CB2005
R154	316-0105-00	B010100	B079999X	RES.,FXD,CMPSN:1M OHM,10%,0.25W	01121	CB1051
R156	315-0201-00			RES.,FXD,CMPSN:200 OHM,5%,0.25W	01121	CB2015
R158	315-0621-00			RES.,FXD,CMPSN:620 OHM,5%,0.25W	01121	CB6215
R160	311-1268-00			RES.,VAR,NONWIR:10K OHM,10%,0.50W	32997	3329P-L58-103
R162	315-0200-00			RES.,FXD,CMPSN:20 OHM,5%,0.25W	01121	CB2005
R164	315-0562-00	B010100	B019999	RES.,FXD,CMPSN:5.6K OHM,5%,0.25W	01121	CB5625
R164	315-0472-00	B110000		RES.,FXD,CMPSN:4.7K OHM,5%,0.25W	01121	CB4725
R621	321-0223-00			RES.,FXD,FILM:2.05K OHM,1%,0.125W	91637	MFF1816G20500F
R622	321-0299-00			RES.,FXD,FILM:12.7K OHM,1%,0.125W	91637	MFF1816G12701F
R630	315-0154-00			RES.,FXD,CMPSN:150K OHM,5%,0.25W	01121	CB1545
R631	315-0753-00			RES.,FXD,CMPSN:75K OHM,5%,0.25W	01121	CB7535
R633	315-0753-00			RES.,FXD,CMPSN:75K OHM,5%,0.25W	01121	CB7535
R634	315-0154-00			RES.,FXD,CMPSN:150K OHM,5%,0.25W	01121	CB1545
R635	321-0344-00			RES.,FXD,FILM:37.4K OHM,1%,0.125W	91637	MFF1816G37401F
R637	315-0471-00	XB150000		RES.,FXD,CMPSN:470 OHM,5%,0.25W	01121	CB4715
R638	315-0154-00			RES.,FXD,CMPSN:150K OHM,5%,0.25W	01121	CB1545
R639	315-0753-00			RES.,FXD,CMPSN:75K OHM,5%,0.25W	01121	CB7535
R640	315-0753-00			RES.,FXD,CMPSN:75K OHM,5%,0.25W	01121	CB7535
R642	315-0513-00			RES.,FXD,CMPSN:51K OHM,5%,0.25W	01121	CB5135
R643	321-0344-00			RES.,FXD,FILM:37.4K OHM,1%,0.125W	91637	MFF1816G37401F
R645	315-0154-00			RES.,FXD,CMPSN:150K OHM,5%,0.25W	01121	CB1545
R646	315-0154-00			RES.,FXD,CMPSN:150K OHM,5%,0.25W	01121	CB1545
R647	315-0133-00			RES.,FXD,CMPSN:13K OHM,5%,0.25W	01121	CB1335
R648	315-0154-00			RES.,FXD,CMPSN:150K OHM,5%,0.25W	01121	CB1545
R802	315-0560-00			RES.,FXD,CMPSN:56 OHM,5%,0.25W	01121	CB5605
R804	315-0560-00	B010100	B159999X	RES.,FXD,CMPSN:56 OHM,5%,0.25W	01121	CB5605
R804	315-0560-00	XB170000		RES.,FXD,CMPSN:56 OHM,5%,0.25W	01121	CB5605
R806	323-0094-00			RES.,FXD,FILM:93.1 OHM,1%,0.50W	75042	CECT0-93R10F
R808	323-0094-00			RES.,FXD,FILM:93.1 OHM,1%,0.50W	75042	CECT0-93R10F
R810	315-0111-00			RES.,FXD,CMPSN:110 OHM,5%,0.25W	01121	CB1115
R811	315-0111-00			RES.,FXD,CMPSN:110 OHM,5%,0.25W	01121	CB1115
R812	315-0560-00	B010100	B159999X	RES.,FXD,CMPSN:56 OHM,5%,0.25W	01121	CB5605
R812	315-0560-00	XB170000		RES.,FXD,CMPSN:56 OHM,5%,0.25W	01121	CB5605
R814	315-0560-00			RES.,FXD,CMPSN:56 OHM,5%,0.25W	01121	CB5605
R820	315-0221-00			RES.,FXD,CMPSN:220 OHM,5%,0.25W	01121	CB2215
R822	321-0222-00			RES.,FXD,FILM:2K OHM,1%,0.125W	91637	MFF1816G20000F

¹Selected and added if necessary.

Electrical Parts List—7A26

Ckt No.	Tektronix Part No.	Serial/Model No. Eff	Dscont	Name & Description	Mfr Code	Mfr Part Number
R824	321-0146-00			RES.,FXD,FILM:324 OHM,1%,0.125W	91637	MFF1816G324ROF
R828	315-0271-00			RES.,FXD,CMPSN:270 OHM,5%,0.25W	01121	CB2715
R829	321-0157-00			RES.,FXD,FILM:422 OHM,1%,0.125W	91637	MFF1816G422ROF
R830	315-0271-00			RES.,FXD,CMPSN:270 OHM,5%,0.25W	01121	CB2715
R832	321-0222-00			RES.,FXD,FILM:2K OHM,1%,0.125W	91637	MFF1816G20000F
R834	321-0146-00			RES.,FXD,FILM:324 OHM,1%,0.125W	91637	MFF1816G324ROF
R840	315-0221-00			RES.,FXD,CMPSN:220 OHM,5%,0.25W	01121	CB2215
R846	315-0121-00			RES.,FXD,CMPSN:120 OHM,5%,0.25W	01121	CB1215
R860	315-0470-00			RES.,FXD,CMPSN:470 OHM,5%,0.25W	01121	CB4705
R880	315-0470-00			RES.,FXD,CMPSN:470 OHM,5%,0.25W	01121	CB4705
R890	323-0193-00			RES.,FXD,FILM:1K OHM,1%,0.50W	75042	CECTO-1001F
R892	323-0193-00			RES.,FXD,FILM:1K OHM,1%,0.50W	75042	CECTO-1001F
R902	315-0111-00			RES.,FXD,CMPSN:110 OHM,5%,0.25W	01121	CB1115
R904	315-0111-00			RES.,FXD,CMPSN:110 OHM,5%,0.25W	01121	CB1115
R906	323-0094-00			RES.,FXD,FILM:93.1 OHM,1%,0.50W	75042	CECTO-93R10F
R908	323-0094-00			RES.,FXD,FILM:93.1 OHM,1%,0.50W	75042	CECTO-93R10F
R912	315-0330-00	B010100	B049999	RES.,FXD,CMPSN:33 OHM,5%,0.25W	01121	CB3305
R912	315-0390-00	B050000		RES.,FXD,CMPSN:39 OHM,5%,0.25W	01121	CB3905
R914	315-0330-00	B010100	B049999	RES.,FXD,CMPSN:33 OHM,5%,0.25W	01121	CB3305
R914	315-0390-00	B050000		RES.,FXD,CMPSN:39 OHM,5%,0.25W	01121	CB3905
R920	315-0221-00			RES.,FXD,CMPSN:220 OHM,5%,0.25W	01121	CB2215
R928	315-0271-00			RES.,FXD,CMPSN:270 OHM,5%,0.25W	01121	CB2715
R930	315-0271-00			RES.,FXD,CMPSN:270 OHM,5%,0.25W	01121	CB2715
R940	315-0221-00			RES.,FXD,CMPSN:220 OHM,5%,0.25W	01121	CB2215
R946	315-0121-00			RES.,FXD,CMPSN:120 OHM,5%,0.25W	01121	CB1215
R960	315-0470-00			RES.,FXD,CMPSN:47 OHM,5%,0.25W	01121	CB4705
R980	315-0470-00			RES.,FXD,CMPSN:470 OHM,5%,0.25W	01121	CB4705
R990	323-0193-00			RES.,FXD,FILM:1K OHM,1%,0.50W	75042	CECTO-1001F
R992	323-0193-00			RES.,FXD,FILM:1K OHM,1%,0.50W	75042	CECTO-1001F
R1010	315-0470-00			RES.,FXD,CMPSN:470 OHM,5%,0.25W	01121	CB4705
R1012	315-0470-00			RES.,FXD,CMPSN:470 OHM,5%,0.25W	01121	CB4705
R1032	315-0330-00	B010100	B159999	RES.,FXD,CMPSN:33 OHM,5%,0.25W	01121	CB3305
R1032	317-0330-00	B160000		RES.,FXD,CMPSN:33 OHM,5%,0.125W	01121	BB3305
R1034	315-0330-00	B010100	B159999	RES.,FXD,CMPSN:33 OHM,5%,0.25W	01121	CB3305
R1034	317-0330-00	B160000		RES.,FXD,CMPSN:33 OHM,5%,0.125W	01121	BB3305
R1050	315-0103-00			RES.,FXD,CMPSN:10K OHM,5%,0.25W	01121	CB1035
R1052	315-0101-00			RES.,FXD,CMPSN:100 OHM,5%,0.25W	01121	CB1015
R1054	315-0751-00	XB070000		RES.,FXD,CMPSN:750 OHM,5%,0.25W	01121	CB7515
R1060	315-0272-00	B010100	B069999	RES.,FXD,CMPSN:2.7K OHM,5%,0.25W	01121	CB2725
R1060	315-0911-00	B070000		RES.,FXD,CMPSN:910 OHM,5%,0.25W	01121	CB9115
R1062	315-0103-00			RES.,FXD,CMPSN:10K OHM,5%,0.25W	01121	CB1035
R1063	315-0751-00	B010100	B069999	RES.,FXD,CMPSN:750 OHM,5%,0.25W	01121	CB7515
R1063	315-0331-00	B070000		RES.,FXD,CMPSN:330 OHM,5%,0.25W	01121	CB3315
R1065	315-0241-00	B010100	B069999	RES.,FXD,CMPSN:240 OHM,5%,0.25W	01121	CB2415
R1065	315-0561-00	B070000		RES.,FXD,CMPSN:560 OHM,5%,0.25W	01121	CB5615
R1070	315-0302-00	B010100	B069999	RES.,FXD,CMPSN:3K OHM,5%,0.25W	01121	CB3025
R1070	315-0102-00	B070000		RES.,FXD,CMPSN:1K OHM,5%,0.25W	01121	CB1025
R1072	315-0623-00	B010100	B069999	RES.,FXD,CMPSN:62K OHM,5%,0.25W	01121	CB6235
R1072	315-0822-00	B070000		RES.,FXD,CMPSN:8.2K OHM,5%,0.25W	01121	CB8225
R1074	315-0751-00	XB070000		RES.,FXD,CMPSN:750 OHM,5%,0.25W	01121	CB7515
R1081	315-0241-00			RES.,FXD,CMPSN:240 OHM,5%,0.25W	01121	CB2415
R1083	315-0621-00			RES.,FXD,CMPSN:620 OHM,5%,0.25W	01121	CB6215
R1085	315-0392-00			RES.,FXD,CMPSN:3.9K OHM,5%,0.25W	01121	CB3925

Ckt No.	Tektronix Part No.	Serial/Model No. Eff	Dscont	Name & Description	Mfr Code	Mfr Part Number
R1311	315-0512-00			RES.,FXD,CMPSN:5.1K OHM,5%,0.25W	01121	CB5125
R1313	315-0512-00			RES.,FXD,CMPSN:5.1K OHM,5%,0.25W	01121	CB5125
R1315	315-0392-00			RES.,FXD,CMPSN:3.9K OHM,5%,0.25W	01121	CB3925
R1317	311-1265-00			RES.,VAR,NONWIR:2K OHM,10%,0.50W	32997	3329P-L58-202
R1319	315-0472-00			RES.,FXD,CMPSN:4.7K OHM,5%,0.25W	01121	CB4725
R1320	323-0177-00			RES.,FXD,FILM:680 OHM,1%,0.50W	91637	MFF1226G681R0F
R1323	323-0177-00			RES.,FXD,FILM:680 OHM,1%,0.50W	91637	MFF1226G681R0F
R1327	316-0822-00			RES.,FXD,CMPSN:8.2K OHM,10%,0.25W	01121	CB8221
R1329	315-0822-00			RES.,FXD,CMPSN:8.2K OHM,5%,0.25W	01121	CB8225
R1331	315-0132-00			RES.,FXD,CMPSN:1.3K OHM,5%,0.25W	01121	CB1325
R1332	315-0242-00	B010100	B109999	RES.,FXD,CMPSN:2.4K OHM,5%,0.25W	01121	CB2425
R1332	315-0102-00	B110000	B139377	RES.,FXD,CMPSN:1K OHM,5%,0.25W	01121	CB1025
R1332	315-0242-00	B139378		RES.,FXD,CMPSN:2.4K OHM,(NOM VALUE),SEL	01121	CB2425
R1334	315-0121-00			RES.,FXD,CMPSN:120 OHM,5%,0.25W	01121	CB1215
R1336	311-0622-00	B010100	B159999	RES.,VAR,NONWIR:100 OHM,10%,0.50W	32997	3326H-G48-101
R1336	311-1259-00	B160000		RES.,VAR,NONWIR:100 OHM,10%,0.50W	32997	3329P-L58-101
R1337	315-0271-00	XB110000		RES.,FXD,CMPSN:270 OHM,(NOM VALUE),SEL	01121	CB2715
R1338	315-0360-00			RES.,FXD,CMPSN:36 OHM,5%,0.25W	01121	CB3605
R1339	315-0360-00			RES.,FXD,CMPSN:36 OHM,5%,0.25W	01121	CB3605
R1340	315-0181-00			RES.,FXD,CMPSN:180 OHM,5%,0.25W	01121	CB1815
R1341	321-0076-00	B010100	B159999	RES.,FXD,FILM:60.4 OHM,1%,0.125W	91637	MFF1816G60R40F
R1341	315-0560-00	B160000		RES.,FXD,CMPSN:56 OHM,5%,0.25W	01121	CB5605
R1343	321-0076-00	B010100	B159999	RES.,FXD,FILM:60.4 OHM,1%,0.125W	91637	MFF1816G60R40F
R1343	315-0560-00	B160000		RES.,FXD,CMPSN:56 OHM,5%,0.25W	01121	CB5605
R1345	311-0978-00	B010100	B159999	RES.,VAR,NONWIR:250 OHM,10%,0.50W	80740	62-67-3
R1345	311-1260-00	B160000		RES.,VAR,NONWIR:250 OHM,10%,0.50W	32997	3329P-L58-251
R1347	323-0140-00			RES.,FXD,FILM:280 OHM,1%,0.50W	75042	CECT0-2800F
R1351	315-0472-00			RES.,FXD,CMPSN:4.7K OHM,5%,0.25W	01121	CB4725
R1353	311-1268-00			RES.,VAR,NONWIR:10K OHM,10%,0.50W	32997	3329P-L58-103
R1401	321-0076-00			RES.,FXD,FILM:60.4 OHM,1%,0.125W	91637	MFF1816G60R40F
R1403	321-0076-00			RES.,FXD,FILM:60.4 OHM,1%,0.125W	91637	MFF1816G60R40F
R1413	315-0272-00			RES.,FXD,CMPSN:2.7K OHM,5%,0.25W	01121	CB2725
R1416	315-0201-00			RES.,FXD,CMPSN:200 OHM,5%,0.25W	01121	CB2015
R1418	315-0152-00			RES.,FXD,CMPSN:1.5K OHM,5%,0.25W	01121	CB1525
R1419	315-0511-00			RES.,FXD,CMPSN:510 OHM,5%,0.25W	01121	CB5115
R1420	323-0198-00	B010100	B019999	RES.,FXD,FILM:1.13K OHM,1%,0.50W	91637	MFF1226G11300F
R1420	323-0197-00	B020000		RES.,FXD,FILM:1.1K OHM,1%,0.50W	75042	CECT0-1101F
R1421	323-0198-00	B010100	B019999	RES.,FXD,FILM:1.13K OHM,1%,0.50W	91637	MFF1226G11300F
R1421	323-0197-00	B020000		RES.,FXD,FILM:1.1K OHM,1%,0.50W	75042	CECT0-1101F
R1422	315-0152-00	B010100	B149999	RES.,FXD,CMPSN:1.5K OHM,5%,0.25W	01121	CB1525
R1422	315-0202-00	B150000		RES.,FXD,CMPSN:2K OHM,5%,0.25W	01121	CB2025
R1423A,B	311-1465-01	B010100	B149999	RES.,VAR,NONWIR:1K OHM X 2.5K OHM,10%,0.50W	80009	311-1465-01
R1423A	311-1854-00	B150000		RES.,VAR,NONWIR:1K OHM,10%,0.50W	01121	14M403
R1423B	311-1853-00	B150000		RES.,VAR,NONWIR:2.5K OHM,10%,0.50W	01121	14M402
R1425	315-0512-00			RES.,FXD,CMPSN:5.1K OHM,5%,0.25W	01121	CB5125
R1430	315-0360-00	XB020000	B109999X	RES.,FXD,CMPSN:36 OHM,5%,0.25W	01121	CB3605
R1431	315-0162-00	B010100	B029999	RES.,FXD,CMPSN:1.6K OHM,5%,0.25W	01121	CB1625
R1431	315-0122-00	B030000	B139377	RES.,FXD,CMPSN:1.2K OHM,(NOM VALUE),SEL	01121	CB1225
R1431	315-0182-00	B139378	B159999	RES.,FXD,CMPSN:1.8K OHM,(NOM VALUE),SEL	01121	CB1825
R1431	311-1267-00	B160000		RES.,VAR,NONWIR:5K OHM,10%,0.50W	32997	3329P-L58-502
R1432	315-0360-00	XB020000	B109999X	RES.,FXD,CMPSN:36 OHM,5%,0.25W	01121	CB3605
R1434	315-0182-00	B010100	B139377	RES.,FXD,CMPSN:1.8K OHM,5%,0.25W	01121	CB1825
R1434	315-0222-00	B139378		RES.,FXD,CMPSN:2.2K OHM,5%,0.25W	01121	CB2225

¹Furnished as a unit with S1423A,B.

Electrical Parts List—7A26

Ckt No.	Tektronix Part No.	Serial/Model No. Eff	Dscont	Name & Description	Mfr Code	Mfr Part Number
R1435	311-0978-00	B010100	B159999	RES.,VAR, NONWIR:250 OHM,10%,0.50W	80740	62-67-3
R1435	311-1260-00	B160000		RES.,VAR, NONWIR:250 OHM,10%,0.50W	32997	3329P-L58-251
R1436	311-1269-00			RES.,VAR, NONWIR:20K OHM,10%,0.50W	32997	3329P-L58-203
R1465 ¹	311-1320-00			RES.,VAR, NONWIR:5K OHM,1W,W/SW	12697	381CM-39700
R1466	315-0273-00			RES.,FXD,CMPSN:27K OHM,5%,0.25W	01121	CB2735
R1467	315-0273-00			RES.,FXD,CMPSN:27K OHM,5%,0.25W	01121	CB2735
R1470	315-0561-00			RES.,FXD,CMPSN:560 OHM,5%,0.25W	01121	CB5615
R1472	315-0183-00			RES.,FXD,CMPSN:18K OHM,5%,0.25W	01121	CB1835
R1474	315-0331-00			RES.,FXD,CMPSN:330 OHM,5%,0.25W	01121	CB3315
R1490	315-0511-00			RES.,FXD,CMPSN:510 OHM,5%,0.25W	01121	CB5115
R1492	315-0183-00			RES.,FXD,CMPSN:18K OHM,5%,0.25W	01121	CB1835
R1494	315-0331-00			RES.,FXD,CMPSN:330 OHM,5%,0.25W	01121	CB3315
R1498	315-0911-00			RES.,FXD,CMPSN:910 OHM,5%,0.25W	01121	CB9115
R1511	315-0202-00	B010100	B069999	RES.,FXD,CMPSN:2K OHM,5%,0.25W	01121	CB2025
R1511	315-0102-00	B070000		RES.,FXD,CMPSN:1K OHM,5%,0.25W	01121	CB1025
R1512	315-0202-00	B010100	B069999	RES.,FXD,CMPSN:2K OHM,5%,0.25W	01121	CB2025
R1512	315-0102-00	B070000		RES.,FXD,CMPSN:1K OHM,5%,0.25W	01121	CB1025
R1514	315-0152-00	B010100	B069999	RES.,FXD,CMPSN:1.5K OHM,5%,0.25W	01121	CB1525
R1514	315-0751-00	B070000		RES.,FXD,CMPSN:750 OHM,5%,0.25W	01121	CB7515
R1516	315-0202-00	B010100	B069999	RES.,FXD,CMPSN:2K OHM,5%,0.25W	01121	CB2025
R1516	315-0102-00	B070000		RES.,FXD,CMPSN:1K OHM,5%,0.25W	01121	CB1025
R1517	315-0202-00	B010100	B069999	RES.,FXD,CMPSN:2K OHM,5%,0.25W	01121	CB2025
R1517	315-0102-00	B070000		RES.,FXD,CMPSN:1K OHM,5%,0.25W	01121	CB1025
R1519	315-0152-00	B010100	B069999	RES.,FXD,CMPSN:1.5K OHM,5%,0.25W	01121	CB1525
R1519	315-0751-00	B070000		RES.,FXD,CMPSN:750 OHM,5%,0.25W	01121	CB7515
R1520	323-0206-00			RES.,FXD,FILM:1.37K OHM,1%,0.50W	75042	CECT0-1371F
R1523	323-0206-00			RES.,FXD,FILM:1.37K OHM,1%,0.50W	75042	CECT0-1371F
R1531	311-0978-00	B010100	B159999	RES.,VAR, NONWIR:250 OHM,10%,0.50W	80740	62-67-3
R1531	311-1260-00	B160000		RES.,VAR, NONWIR:250 OHM,10%,0.50W	32997	3329P-L58-251
R1533	315-0332-00	B010100	B109999	RES.,FXD,CMPSN:3.3K OHM,5%,0.25W	01121	CB3325
R1533	315-0151-00	B110000		RES.,FXD,CMPSN:150 OHM,5%,0.25W	01121	CB1515
R1701	321-0076-00			RES.,FXD,FILM:60.4 OHM,1%,0.125W	91637	MFF1816G60R40F
R1703	321-0076-00			RES.,FXD,FILM:60.4 OHM,1%,0.125W	91637	MFF1816G60R40F
R1705	323-0119-00			RES.,FXD,FILM:169 OHM,1%,0.50W	75042	CECT0-1690F
R1711	315-0202-00			RES.,FXD,CMPSN:2K OHM,5%,0.25W	01121	CB2025
R1712	315-0202-00			RES.,FXD,CMPSN:2K OHM,5%,0.25W	01121	CB2025
R1714	315-0152-00			RES.,FXD,CMPSN:1.5K OHM,5%,0.25W	01121	CB1525
R1716	315-0202-00			RES.,FXD,CMPSN:2K OHM,5%,0.25W	01121	CB2025
R1717	315-0202-00			RES.,FXD,CMPSN:2K OHM,5%,0.25W	01121	CB2025
R1719	315-0152-00			RES.,FXD,CMPSN:1.5K OHM,5%,0.25W	01121	CB1525
R1720	323-0206-00			RES.,FXD,FILM:1.37K OHM,1%,0.50W	75042	CECT0-1371F
R1721	315-0270-00	XB050000	B109999X	RES.,FXD,CMPSN:27 OHM,5%,0.25W	01121	CB2705
R1722	315-0150-00	XB110000		RES.,FXD,CMPSN:15 OHM,5%,0.25W	01121	CB1505
R1723	323-0206-00			RES.,FXD,FILM:1.37K OHM,1%,0.50W	75042	CECT0-1371F
R1724	315-0150-00	XB110000		RES.,FXD,CMPSN:15 OHM,5%,0.25W	01121	CB1505
R2313	315-0512-00			RES.,FXD,CMPSN:5.1K OHM,5%,0.25W	01121	CB5125
R2315	315-0392-00			RES.,FXD,CMPSN:3.9K OHM,5%,0.25W	01121	CB3925
R2317	311-1265-00			RES.,VAR, NONWIR:2K OHM,10%,0.50W	32997	3329P-L58-202
R2319	315-0472-00			RES.,FXD,CMPSN:4.7K OHM,5%,0.25W	01121	CB4725
R2320	323-0177-00			RES.,FXD,FILM:680 OHM,1%,0.50W	91637	MFF1226G681R0F
R2323	323-0177-00			RES.,FXD,FILM:680 OHM,1%,0.50W	91637	MFF1226G681R0F
R2327	315-0822-00			RES.,FXD,CMPSN:8.2K OHM,5%,0.25W	01121	CB8225
R2329	315-0822-00			RES.,FXD,CMPSN:8.2K OHM,5%,0.25W	01121	CB8225

¹Furnished as a unit with S1465.

Ckt No.	Tektronix Part No.	Serial/Model No. Eff	Dscont	Name & Description	Mfr Code	Mfr Part Number
R2331	315-0132-00			RES.,FXD,CMPSN:1.3K OHM,5%,0.25W	01121	CB1325
R2332	315-0202-00	B010100	B109999	RES.,FXD,CMPSN:2K OHM,5%,0.25W	01121	CB2025
R2332	315-0112-00	B110000	B139377	RES.,FXD,CMPSN:1.1K OHM,5%,0.25W	01121	CB1125
R2332	315-0242-00	B139378		RES.,FXD,CMPSN:2.4K OHM,(NOM VALUE),SEL	01121	CB2425
R2334	315-0121-00			RES.,FXD,CMPSN:120 OHM,5%,0.25W	01121	CB1215
R2336	311-0622-00	B010100	B159999	RES.,VAR,NONWIR:100 OHM,10%,0.50W	32997	3326H-G48-101
R2336	311-1259-00	B160000		RES.,VAR,NONWIR:100 OHM,10%,0.50W	32997	3329P-L58-101
R2337	315-0271-00	XB110000		RES.,FXD,CMPSN:270 OHM,(NOM VALUE),SEL	01121	CB2715
R2338	315-0360-00			RES.,FXD,CMPSN:36 OHM,5%,0.25W	01121	CB3605
R2339	315-0360-00			RES.,FXD,CMPSN:36 OHM,5%,0.25W	01121	CB3605
R2340	315-0181-00			RES.,FXD,CMPSN:180 OHM,5%,0.25W	01121	CB1815
R2341	321-0076-00	B010100	B159999	RES.,FXD,FILM:60.4 OHM,1%,0.125W	91637	MFF1816G60R40F
R2341	315-0560-00	B160000		RES.,FXD,CMPSN:56 OHM,5%,0.25W	01121	CB5605
R2343	321-0076-00	B010100	B159999	RES.,FXD,FILM:60.4 OHM,1%,0.125W	91637	MFF1816G6040F
R2343	315-0560-00	B160000		RES.,FXD,CMPSN:56 OHM,5%,0.25W	01121	CB5605
R2345	311-0978-00	B010100	B159999	RES.,VAR,NONWIR:250 OHM,10%,0.50W	80740	62-67-3
R2345	311-1260-00	B160000		RES.,VAR,NONWIR:250 OHM,10%,0.50W	32997	3329P-L58-251
R2347	323-0140-00			RES.,FXD,FILM:280 OHM,1%,0.50W	75042	CECTO-2800F
R2351	315-0472-00			RES.,FXD,CMPSN:4.7K OHM,5%,0.25W	01121	CB4725
R2353	311-1268-00			RES.,VAR,NONWIR:10K OHM,10%,0.50W	32997	3329P-L58-103
R2401	321-0076-00			RES.,FXD,FILM:60.4 OHM,1%,0.125W	91637	MFF1816G60R40F
R2403	321-0076-00			RES.,FXD,FILM:60.4 OHM,1%,0.125W	91637	MFF1816G60R40F
R2410	315-0102-00			RES.,FXD,CMPSN:1K OHM,5%,0.25W	01121	CB1025
R2411	311-0635-00	B010100	B159999	RES.,VAR,NONWIR:1K OHM,10%,0.50W	80740	62-56-3
R2411	311-1263-00	B160000		RES.,VAR,NONWIR:1K OHM,10%,0.50W	32997	3329P-L58-102
R2413	315-0201-00			RES.,FXD,CMPSN:200 OHM,5%,0.25W	01121	CB2015
R2415	315-0162-00	B010100	B029999	RES.,FXD,CMPSN:1.6K OHM,5%,0.25W	01121	CB1625
R2415	315-0162-00	B030000		RES.,FXD,CMPSN:1.6K OHM,(NOM VALUE),SEL	01121	CB1625
R2416	315-0201-00			RES.,FXD,CMPSN:200 OHM,5%,0.25W	01121	CB2015
R2418	315-0152-00			RES.,FXD,CMPSN:1.5K OHM,5%,0.25W	01121	CB1525
R2419	315-0511-00			RES.,FXD,CMPSN:510 OHM,5%,0.25W	01121	CB5115
R2420	323-0198-00	B010100	B019999	RES.,FXD,FILM:1.13K OHM,1%,0.50W	91637	MFF1226G11300F
R2420	323-0197-00	B020000		RES.,FXD,FILM:1.1K OHM,1%,0.50W	75042	CECTO-1101F
R2421	323-0198-00	B010100	B019999	RES.,FXD,FILM:1.13K OHM,1%,0.50W	91637	MFF1226G11300F
R2421	323-0197-00	B020000		RES.,FXD,FILM:1.1K OHM,1%,0.50W	75042	CECTO-1101F
R2422	315-0202-00	B010100	B029999	RES.,FXD,CMPSN:2K OHM,5%,0.25W	01121	CB2025
R2422	315-0182-00	B030000	B149999	RES.,FXD,CMPSN:1.8K OHM,5%,0.25W	01121	CB1825
R2422	315-0202-00	B150000		RES.,FXD,CMPSN:2K OHM,5%,0.25W	01121	CB2025
R2423A,B	311-1465-01	B010100	B149999	RES.,VAR,NONWIR:1K OHM X 2.5K OHM,10%,0.50W	80009	311-1465-01
R2423A	311-1854-00	B150000		RES.,VAR,NONWIR:1K OHM,10%,0.50W	01121	14M403
R2423B	311-1853-00	B150000		RES.,VAR,NONWIR:2.5K OHM,10%,0.50W	01121	14M402
R2425	315-0512-00			RES.,FXD,CMPSN:5.1K OHM,5%,0.25W	01121	CB5125
R2430	315-0360-00	XB020000	B109999X	RES.,FXD,CMPSN:36 OHM,5%,0.25W	01121	CB3605
R2431	315-0162-00	B010100	B029999	RES.,FXD,CMPSN:1.6K OHM,5%,0.25W	01121	CB1625
R2431	315-0122-00	B030000	B139377	RES.,FXD,CMPSN:1.2K OHM,(NOM VALUE),SEL	01121	CB1225
R2431	315-0182-00	B139378	B159999	RES.,FXD,CMPSN:1.8K OHM,(NOM VALUE),SEL	01121	CB1825
R2431	311-1267-00	B160000		RES.,VAR,NONWIR:5K OHM,10%,0.50W	32997	3329P-L58-502
R2432	315-0360-00	XB020000	B109999X	RES.,FXD,CMPSN:36 OHM,5%,0.25W	01121	CB3605
R2434	315-0182-00	B010100	B139377	RES.,FXD,CMPSN:1.8K OHM,5%,0.25W	01121	CB1825
R2434	315-0222-00	B139378		RES.,FXD,CMPSN:2.2K OHM,5%,0.25W	01121	CB2225
R2435	311-0978-00	B010100	B159999	RES.,VAR,NONWIR:250 OHM,10%,0.50W	80740	62-67-3
R2435	311-1260-00	B160000		RES.,VAR,NONWIR:250 OHM,10%,0.50W	32997	3329P-L58-251
R2436	311-1269-00			RES.,VAR,NONWIR:20K OHM,10%,0.50W	32997	3329P-L58-203

¹Furnished as a unit with S2423A,B.

Ckt No.	Tektronix Part No.	Serial/Model No. Eff	Dscont	Name & Description	Mfr Code	Mfr Part Number
R2465 ¹	311-1320-00			RES.,VAR, NONWIR:5K OHM,1W,W/SW	12697	381CM-39700
R2466	315-0273-00			RES.,FXD,CMPSN:27K OHM,5%,0.25W	01121	CB2735
R2467	315-0273-00			RES.,FXD,CMPSN:27K OHM,5%,0.25W	01121	CB2735
R2470	315-0511-00			RES.,FXD,CMPSN:510 OHM,5%,0.25W	01121	CB5115
R2472	315-0183-00			RES.,FXD,CMPSN:18K OHM,5%,0.25W	01121	CB1835
R2474	315-0331-00			RES.,FXD,CMPSN:330 OHM,5%,0.25W	01121	CB3315
R2476	315-0202-00			RES.,FXD,CMPSN:2K OHM,5%,0.25W	01121	CB2025
R2490	315-0561-00			RES.,FXD,CMPSN:560 OHM,5%,0.25W	01121	CB5615
R2492	315-0183-00			RES.,FXD,CMPSN:18K OHM,5%,0.25W	01121	CB1835
R2494	315-0331-00			RES.,FXD,CMPSN:330 OHM,5%,0.25W	01121	CB3315
R2496	315-0202-00			RES.,FXD,CMPSN:2K OHM,5%,0.25W	01121	CB2025
R2498	315-0911-00			RES.,FXD,CMPSN:910 OHM,5%,0.25W	01121	CB9115
R2511	315-0202-00	B010100	B069999	RES.,FXD,CMPSN:2K OHM,5%,0.25W	01121	CB2025
R2511	315-0102-00	B070000		RES.,FXD,CMPSN:1K OHM,5%,0.25W	01121	CB1025
R2512	315-0202-00	B010100	B069999	RES.,FXD,CMPSN:2K OHM,5%,0.25W	01121	CB2025
R2512	315-0102-00	B070000		RES.,FXD,CMPSN:1K OHM,5%,0.25W	01121	CB1025
R2514	315-0152-00	B010100	B069999	RES.,FXD,CMPSN:1.5K OHM,5%,0.25W	01121	CB1525
R2514	315-0751-00	B070000		RES.,FXD,CMPSN:750 OHM,5%,0.25W	01121	CB7515
R2516	315-0202-00	B010100	B069999	RES.,FXD,CMPSN:2K OHM,5%,0.25W	01121	CB2025
R2516	315-0102-00	B070000		RES.,FXD,CMPSN:1K OHM,5%,0.25W	01121	CB1025
R2517	315-0202-00	B010100	B069999	RES.,FXD,CMPSN:2K OHM,5%,0.25W	01121	CB2025
R2517	315-0102-00	B070000		RES.,FXD,CMPSN:1K OHM,5%,0.25W	01121	CB1025
R2519	315-0152-00	B010100	B069999	RES.,FXD,CMPSN:1.5K OHM,5%,0.25W	01121	CB1525
R2519	315-0751-00	B070000		RES.,FXD,CMPSN:750 OHM,5%,0.25W	01121	CB7515
R2520	323-0206-00			RES.,FXD,FILM:1.37K OHM,1%,0.50W	75042	CECTO-1371F
R2523	323-0206-00			RES.,FXD,FILM:1.37K OHM,1%,0.50W	75042	CECTO-1371F
R2531	311-0978-00	B010100	B159999	RES.,VAR, NONWIR:250 OHM,10%,0.50W	80740	62-67-3
R2531	311-1260-00	B160000		RES.,VAR, NONWIR:250 OHM,10%,0.50W	32997	3329P-L58-251
R2533	315-0242-00	B010100	B109999	RES.,FXD,CMPSN:2.4K OHM,5%,0.25W	01121	CB2425
R2533	315-0202-00	B110000	B139377X	RES.,FXD,CMPSN:2K OHM,5%,0.25W	01121	CB2025
R2701	321-0076-00			RES.,FXD,FILM:60.4 OHM,1%,0.125W	91637	MFF1816G60R40F
R2703	321-0076-00			RES.,FXD,FILM:60.4 OHM,1%,0.125W	91637	MFF1816G60R40F
R2705	323-0119-00			RES.,FXD,FILM:169 OHM,1%,0.50W	75042	CECTO-1690F
R2711	315-0202-00			RES.,FXD,CMPSN:2K OHM,5%,0.25W	01121	CB2025
R2712	315-0202-00			RES.,FXD,CMPSN:2K OHM,5%,0.25W	01121	CB2025
R2714	315-0152-00			RES.,FXD,CMPSN:1.5K OHM,5%,0.25W	01121	CB1525
R2716	315-0202-00			RES.,FXD,CMPSN:2K OHM,5%,0.25W	01121	CB2025
R2717	315-0202-00			RES.,FXD,CMPSN:2K OHM,5%,0.25W	01121	CB2025
R2719	315-0152-00			RES.,FXD,CMPSN:1.5K OHM,5%,0.25W	01121	CB1525
R2720	323-0206-00			RES.,FXD,FILM:1.37K OHM,1%,0.50W	75042	CECTO-1371F
R2721	315-0270-00	XB050000	B109999X	RES.,FXD,CMPSN:27 OHM,5%,0.25W	01121	CB2705
R2722	315-0150-00	XB110000		RES.,FXD,CMPSN:15 OHM,5%,0.25W	01121	CB1505
R2723	323-0206-00			RES.,FXD,FILM:1.37K OHM,1%,0.50W	75042	CECTO-1371F
R2724	315-0150-00	XB110000		RES.,FXD,CMPSN:15 OHM,5%,0.25W	01121	CB1505
RT1334	307-0125-00			RES.,THERMAL:500 OHM,10%,25 DEG C	50157	2D1595
RT1433	307-0125-00			RES.,THERMAL:500 OHM,10%,25 DEG C	50157	2D1595
RT2334	307-0125-00			RES.,THERMAL:500 OHM,10%,25 DEG C	50157	2D1595
RT2433	307-0125-00			RES.,THERMAL:500 OHM,10%,25 DEG C	50157	2D1595
S22A,B	260-0816-00			SWITCH,SLIDE:DPDT,0.5A,125VAC	79727	GF-126-0012A
S30A,B	260-1493-00			SWITCH,ROTARY:	80009	260-1493-00
S30A,B	262-0965-00	B010100	B069999	SWITCH,ROTARY:DISPLAY MODE/TRIG SOURCE	80009	262-0965-00
S30A,B	262-0965-01	B070000		SWITCH,ROTARY:DISPLAY MODE/TRIG SOURCE	80009	262-0965-01
S32	260-0816-00			SWITCH,SLIDE:DPDT,0.5A,125VAC	79727	GF-126-0012A

¹Furnished as a unit with S2465.

Ckt No.	Tektronix Part No.	Serial/Model No. Eff	Dscont	Name & Description	Mfr Code	Mfr Part Number
S100A ¹						
S100B ¹						
S100C ¹						
S1423A,B ^{2,6}	311-1465-01	B010100	B149999X	SWITCH,PUSH:VARIABLE(CAL IN)CH 1	80009	311-1465-01
S1465 ³	311-1320-00			RES.,VAR,NONWIR:5K OHM,1W,W/SW	12697	381CM-39700
S2423A,B ^{4,6}	311-1465-01	B010100	B149999X	SWITCH,PUSH:VARIABLE(CAL IN) CH2	80009	311-1465-01
S2465 ⁵	311-1320-00			RES.,VAR,NONWIR:5K OHM,1W,W/SW	12697	381CM-39700
T11	276-0525-00			CORE,FERRITE:0.196 ID X 0.437"OD	01121	T037C351A
T12	276-0525-00			CORE,FERRITE:0.196 ID X 0.437"OD	01121	T037C351A
T1301	120-0286-00			XFMR,TOROID:2 TURNS,BIFILAR	80009	120-0286-00
T1430	120-0286-00	XB110000		XFMR,TOROID:2 TURNS,BIFILAR	80009	120-0286-00
T1520	120-0286-00	XB110000		XFMR,TOROID:2 TURNS,BIFILAR	80009	120-0286-00
T2301	120-0286-00			XFMR,TOROID:2 TURNS,BIFILAR	80009	120-0286-00
T2430	120-0286-00	XB110000		XFMR,TOROID:2 TURNS,BIFILAR	80009	120-0286-00
T2520	120-0286-00	XB110000		XFMR,TOROID:2 TURNS,BIFILAR	80009	120-0286-00
U1350	155-0078-07	B010100	B019999	MICROCIRCUIT,LI:ML,VERT AMPL,SEL	80009	155-0078-07
U1350	155-0078-03	B020000	B139377	MICROCIRCUIT,LI:ML,VERTICAL AMPL,SEL	80009	155-0078-03
U1350	155-0078-10	B139378		MICROCIRCUIT,LI:ML,VERT AMPL,SEL	80009	155-0078-10
U1450	155-0078-07	B010100	B019999	MICROCIRCUIT,LI:ML,VERT AMPL,SEL	80009	155-0078-07
U1450	155-0078-03	B020000	B139377	MICROCIRCUIT,LI:ML,VERTICAL AMPL,SEL	80009	155-0078-03
U1450	155-0078-10	B139378		MICROCIRCUIT,LI:ML,VERT AMPL,SEL	80009	155-0078-10
U1550	155-0078-05	B010100	B019999	MICROCIRCUIT,LI:ML,VERT AMPL,SEL	80009	155-0078-05
U1550	155-0078-01	B020000	B139377	MICROCIRCUIT,LI:ML,VERT AMPL,SEL	80009	155-0078-01
U1550	155-0078-13	B139378		MICROCIRCUIT,LI:ML,VERTICAL AMPL,SEL	80009	155-0078-13
U1750	155-0078-05	B010100	B019999	MICROCIRCUIT,LI:ML,VERT AMPL,SEL	80009	155-0078-05
U1750	155-0078-01	B020000	B139377	MICROCIRCUIT,LI:ML,VERT AMPL,SEL	80009	155-0078-01
U1750	155-0078-13	B139378		MICROCIRCUIT,LI:ML,VERTICAL AMPL,SEL	80009	155-0078-13
U2350	155-0078-07	B010100	B019999	MICROCIRCUIT,LI:ML,VERT AMPL,SEL	80009	155-0078-07
U2350	155-0078-03	B020000	B139377	MICROCIRCUIT,LI:ML,VERTICAL AMPL,SEL	80009	155-0078-03
U2350	155-0078-10	B139378		MICROCIRCUIT,LI:ML,VERT AMPL,SEL	80009	155-0078-10
U2450	155-0078-07	B010100	B019999	MICROCIRCUIT,LI:ML,VERT AMPL,SEL	80009	155-0078-07
U2450	155-0078-03	B020000	B029999	MICROCIRCUIT,LI:ML,VERTICAL AMPL,SEL	80009	155-0078-03
U2450	155-0078-00	B030000	B139377	MICROCIRCUIT,LI:ML,VERT AMPL	80009	155-0078-00
U2450	155-0078-10	B139378		MICROCIRCUIT,LI:ML,VERT AMPL,SEL	80009	155-0078-10
U2550	155-0078-05	B010100	B019999	MICROCIRCUIT,LI:ML,VERT AMPL,SEL	80009	155-0078-05
U2550	155-0078-01	B020000	B139377	MICROCIRCUIT,LI:ML,VERT AMPL,SEL	80009	155-0078-01
U2550	155-0078-13	B139378		MICROCIRCUIT,LI:ML,VERTICAL AMPL,SEL	80009	155-0078-13
U2750	155-0078-05	B010100	B019999	MICROCIRCUIT,LI:ML,VERT AMPL,SEL	80009	155-0078-05
U2750	155-0078-01	B020000	B139377	MICROCIRCUIT,LI:ML,VERT AMPL,SEL	80009	155-0078-01
U2750	155-0078-13	B139378		MICROCIRCUIT,LI:ML,VERTICAL AMPL,SEL	80009	155-0078-13

¹Replaceable under 670-2310-XX only.

²Furnished as a unit with R1423A,B.

³Furnished as a unit with R1465.

⁴Furnished as a unit with R2423A,B.

⁵Furnished as a unit with R2465.

⁶See Mechanical Parts List page 8-5 for replaceable parts.



DIAGRAMS AND CIRCUIT BOARD ILLUSTRATIONS

Symbols and Reference Designators

Electrical components shown on the diagrams are in the following units unless noted otherwise:

- Capacitors = Values one or greater are in picofarads (pF).
Values less than one are in microfarads (μF).
- Resistors = Ohms (Ω).

Graphic symbols and class designation letters are based on ANSI Standard Y32.2-1975.

Logic symbology is based on ANSI Y32.14-1973 in terms of positive logic. Logic symbols depict the logic function performed and may differ from the manufacturer's data.

The overline on a signal name indicates that the signal performs its intended function when it goes to the low state.

Abbreviations are based on ANSI Y1.1-1972.

Other ANSI standards that are used in the preparation of diagrams by Tektronix, Inc. are:

- Y14.15, 1966 Drafting Practices.
- Y14.2, 1973 Line Conventions and Lettering.
- Y10.5, 1968 Letter Symbols for Quantities Used in Electrical Science and Electrical Engineering.

The following prefix letters are used as reference designators to identify components or assemblies on the diagrams.

A	Assembly, separable or repairable (circuit board, etc)	H	Heat dissipating device (heat sink, heat radiator, etc)	S	Switch or contactor
AT	Attenuator, fixed or variable	HR	Heater	T	Transformer
B	Motor	HY	Hybrid circuit	TC	Thermocouple
BT	Battery	J	Connector, stationary portion	TP	Test point
C	Capacitor, fixed or variable	K	Relay	U	Assembly, inseparable or non-repairable (integrated circuit, etc.)
CB	Circuit breaker	L	Inductor, fixed or variable	V	Electron tube
CR	Diode, signal or rectifier	M	Meter	VR	Voltage regulator (zener diode, etc.)
DL	Delay line	P	Connector, movable portion	W	Wirestrap or cable
DS	Indicating device (lamp)	Q	Transistor or silicon-controlled rectifier	Y	Crystal
E	Spark Gap, Ferrite bead	R	Resistor, fixed or variable	Z	Phase shifter
F	Fuse	RT	Thermistor		
FL	Filter				

The following special symbols may appear on the diagrams:

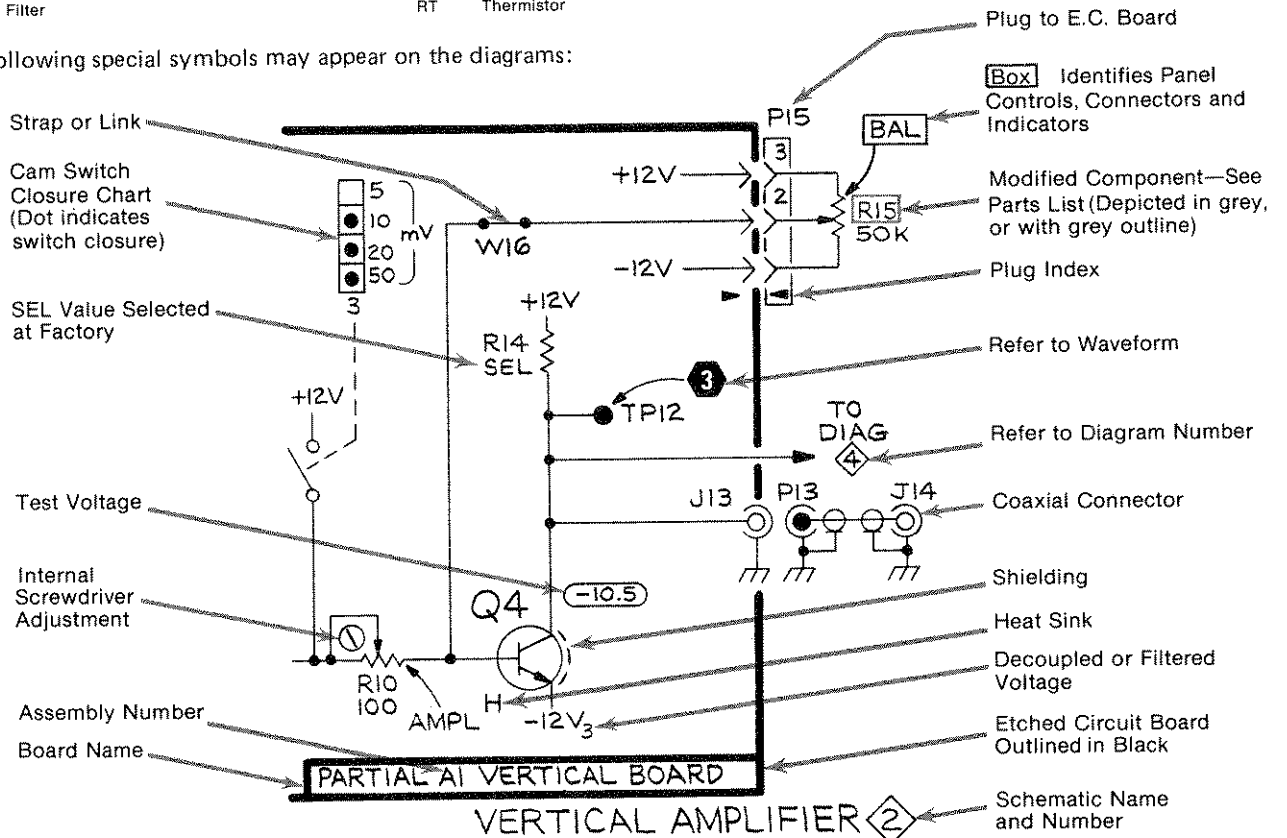





VOLTAGES AND WAVEFORMS

The voltages and waveforms shown on this diagram may be obtained by using the recommended test equipment and test set-ups listed below.

RECOMMENDED TEST EQUIPMENT

ITEM	SPECIFICATIONS	RECOMMENDED TYPE
Oscilloscope system	Deflection factor 10 mV to 2 V/div. Input impedance 10 Megohms Frequency response dc to 25 MHz.	a. Tektronix 7000-series oscilloscope equipped with readout, 7B-series Time-Base 7A16A Amplifier, and a 1X probe. (7A13 Differential Comparator used in place of 7A16A for calibrated offset voltages).
Voltmeter (Non-loading digital multimeter)	Input impedance 10 Megohms Range (full scale) 2 V to 20 V	a. Tektronix DM501 Digital Multimeter, with power module (oscilloscope system must have readout). b. Fairchild Model 7050, or equivalent.
Plug-in extender	Capable of extending the 7A26 from the oscilloscope plug-in compartment	a. Tektronix Part No. 067-0589-00 (rigid) or Tektronix Part No. 067-0616-00 (flexible).

7A26 Control Settings

CH 1 and CH 2 VOLTS/DIV	5 mV
CH 1 and CH 2 Input switches	DC
CH 1 and CH 2 POSITION	center trace on graticule
DISPLAY MODE	CH 1
TRIGGER SOURCE	MODE
CH 2 POLARITY	+ UP

Voltage Conditions

Voltage measurements are taken with no signal applied and the trace centered on the graticule. The voltmeter common is connected to chassis ground. The 7A26 is connected to one of the vertical compartments of the oscilloscope mainframe through the plug-in extender. The 7D13, if used, is inserted into the other vertical compartment.

Waveform Conditions

The 7A26 is connected to one of the vertical compartments of the oscilloscope mainframe through the plug-in extender. The amplifier plug-in, 7A16A or 7A13, is inserted into the other vertical compartment. A 1-kilohertz, 40 millivolt signal is applied to the CH 1 input of the 7A26. The oscilloscope Trigger Source is set to trigger the time-base unit from the 7A26 output.

If the 7A16A Amplifier plug-in is used, the input should be ac coupled.

NOTE

Voltages and waveforms are not absolute and may vary between instruments.

BLOCK DIAGRAM

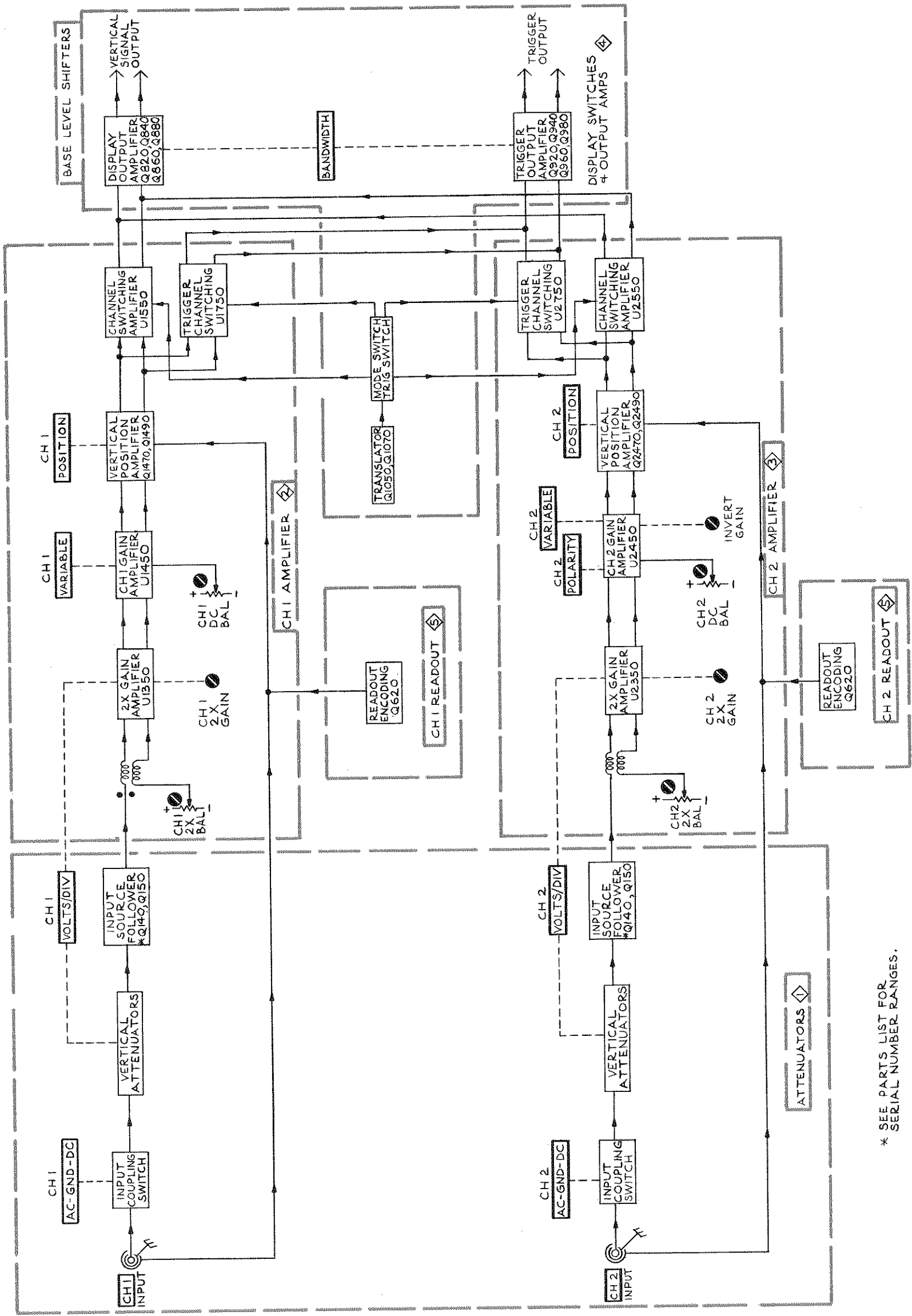

* SEE PARTS LIST FOR SERIAL NUMBER RANGES.

BLOCK DIAGRAM

7A26

REV. E, AUG 1977
1484-15

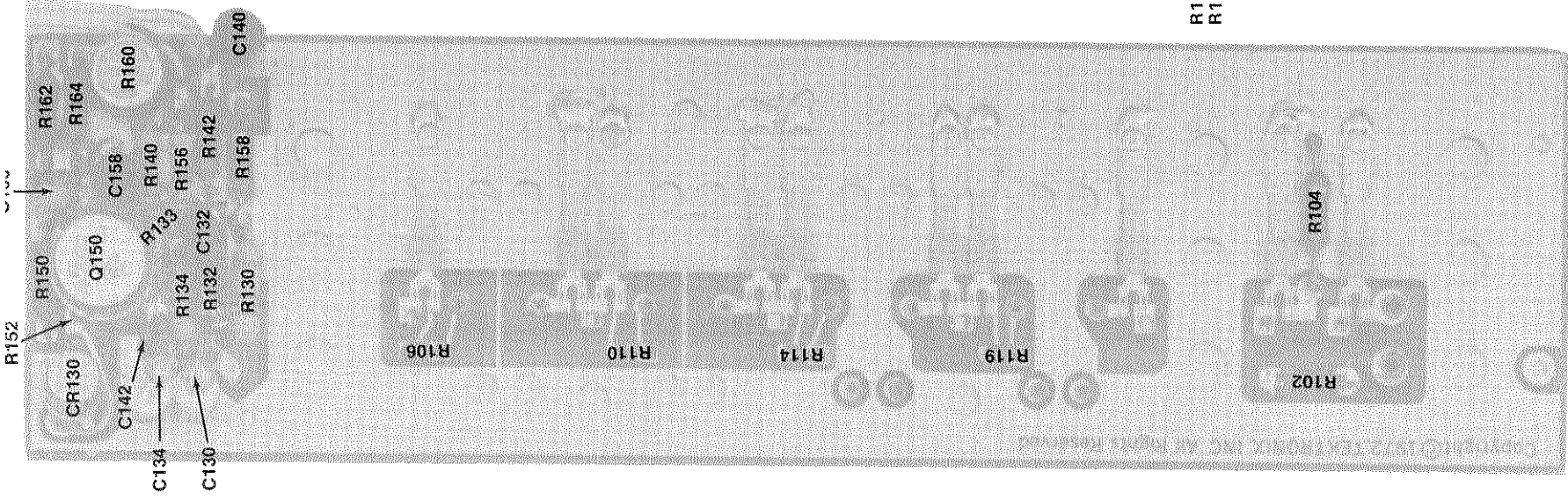

A1 Attenuator Board
(SN B080000-above)

REV. E AUG 1977

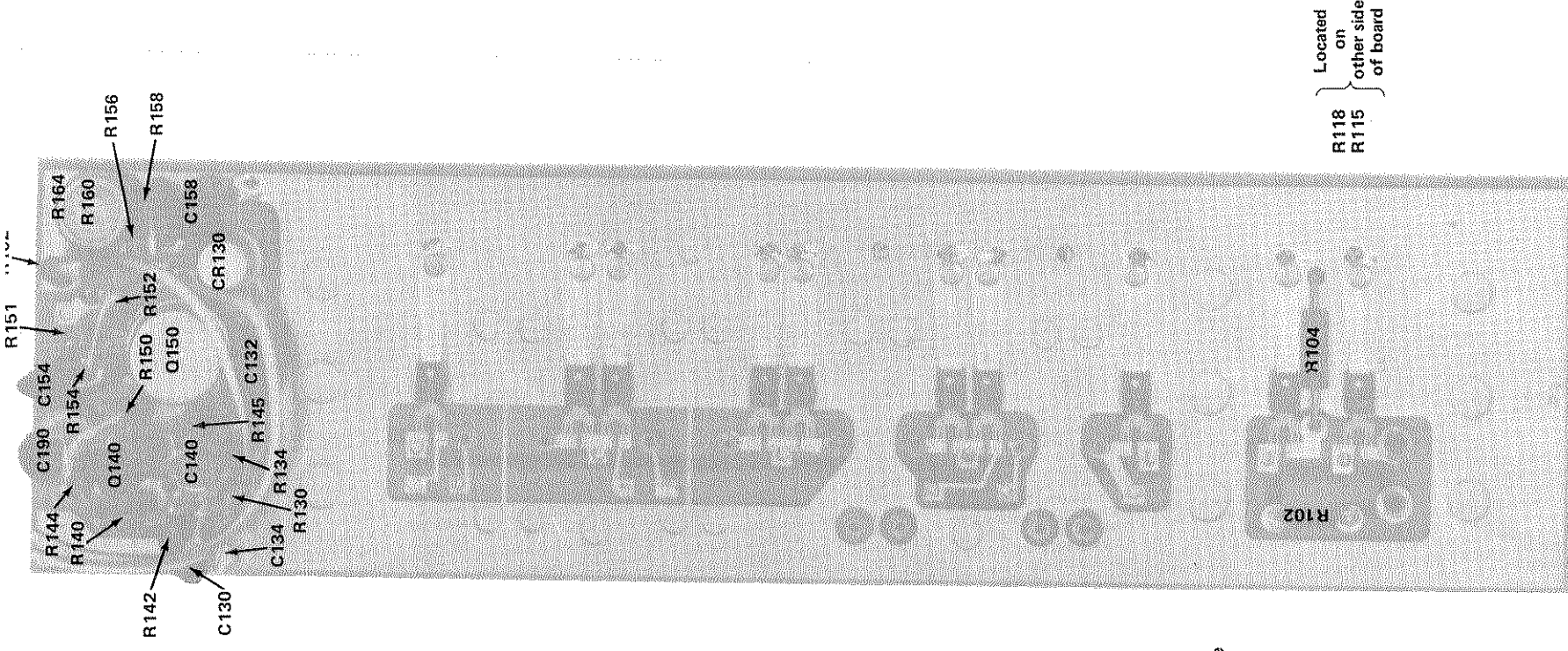

A1 Attenuator Board
(SN B079999-below)

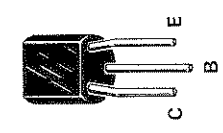
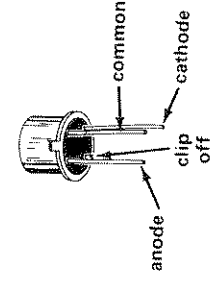
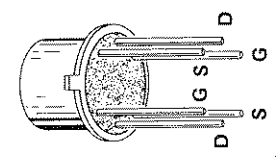
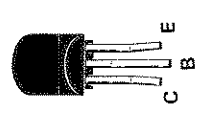
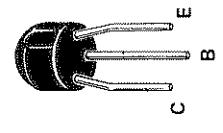
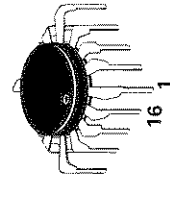
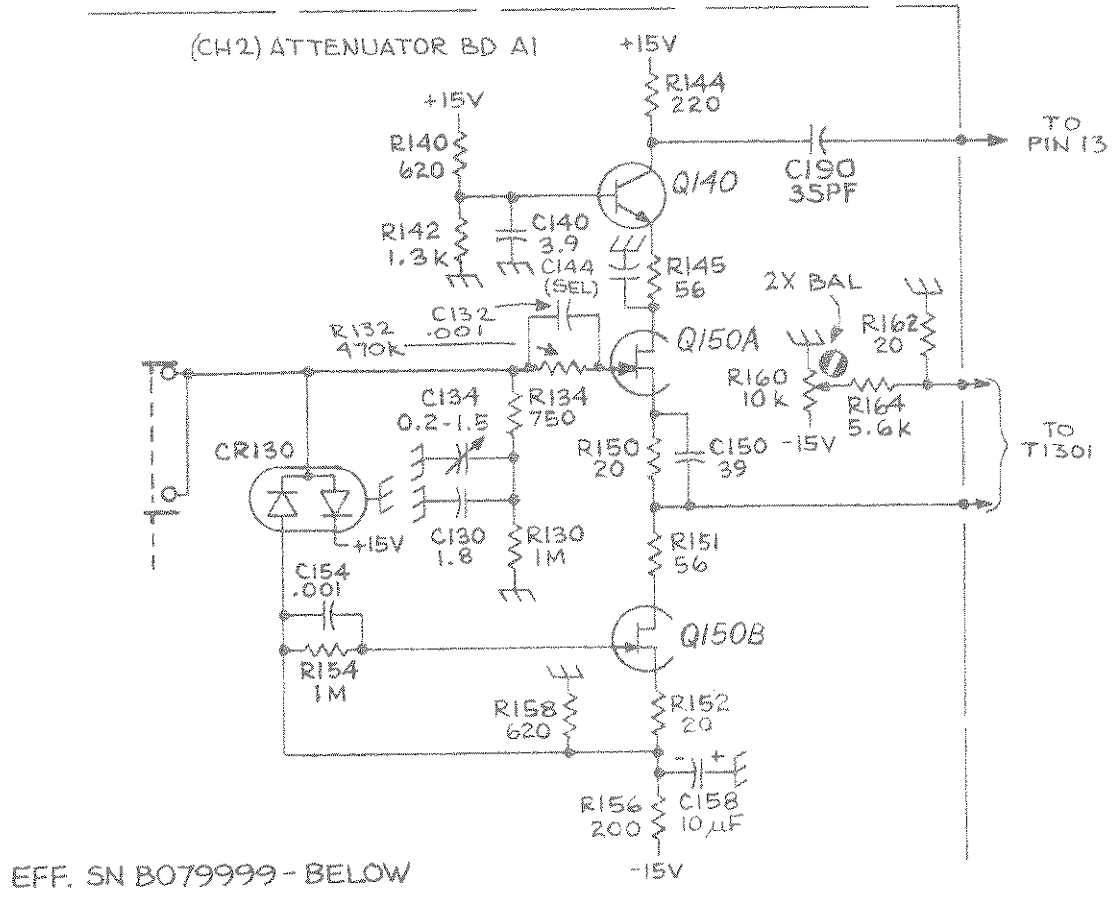
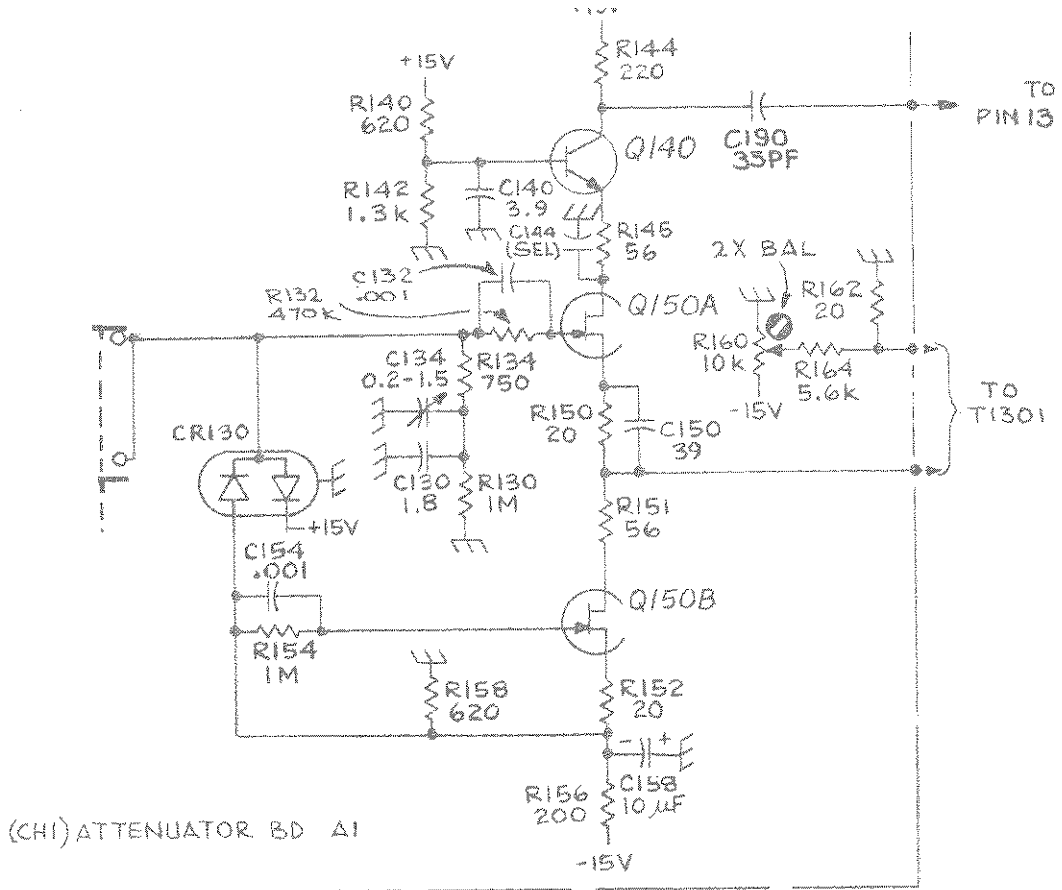
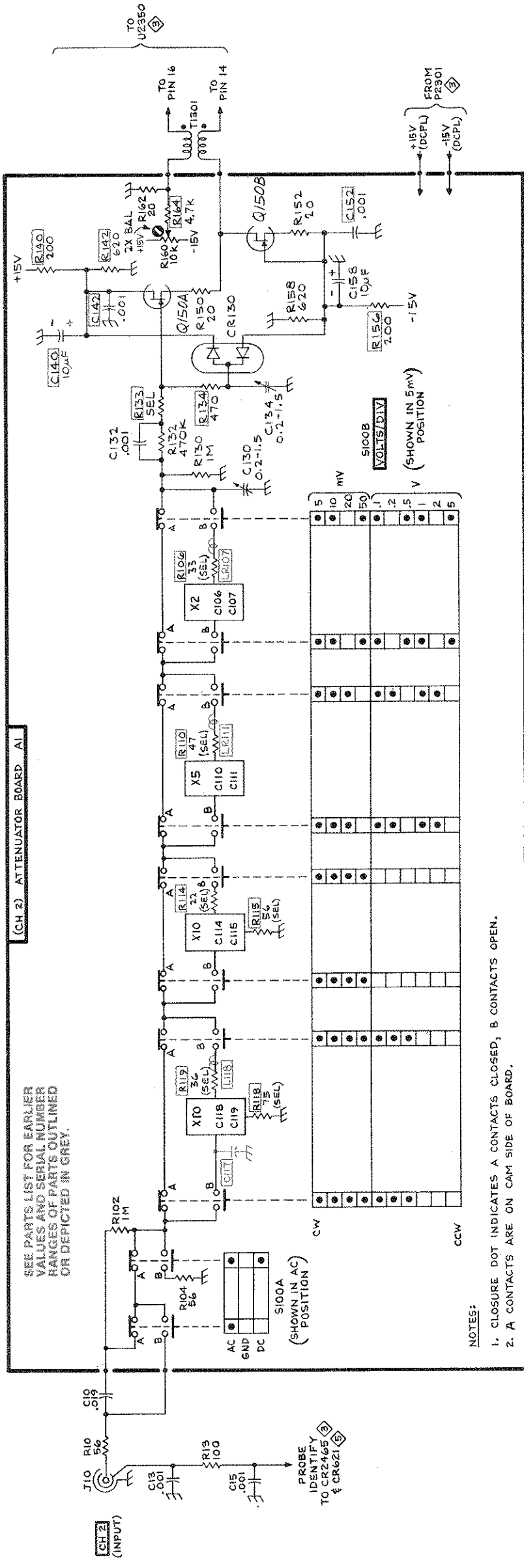
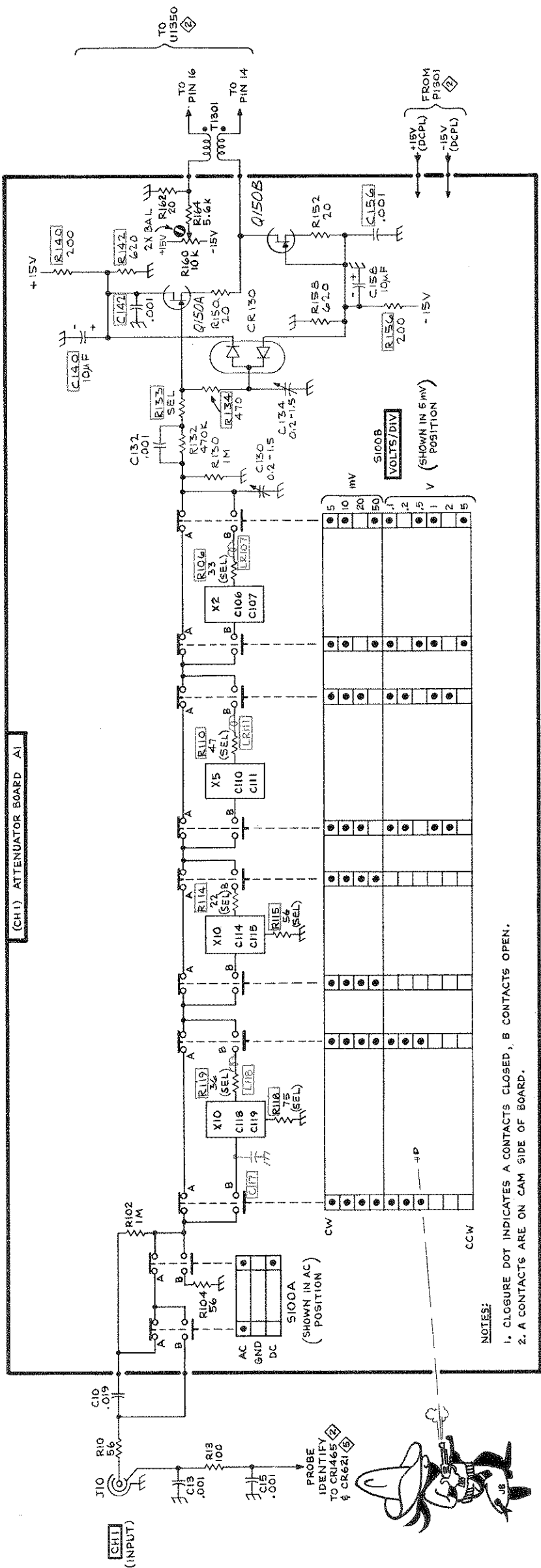

FIG. 7-1. Semiconductor Electrode Configurations.







REV. H AUG 1977
1484-4

CH1 & CH2 ATTENUATORS

7A26

kif
1072

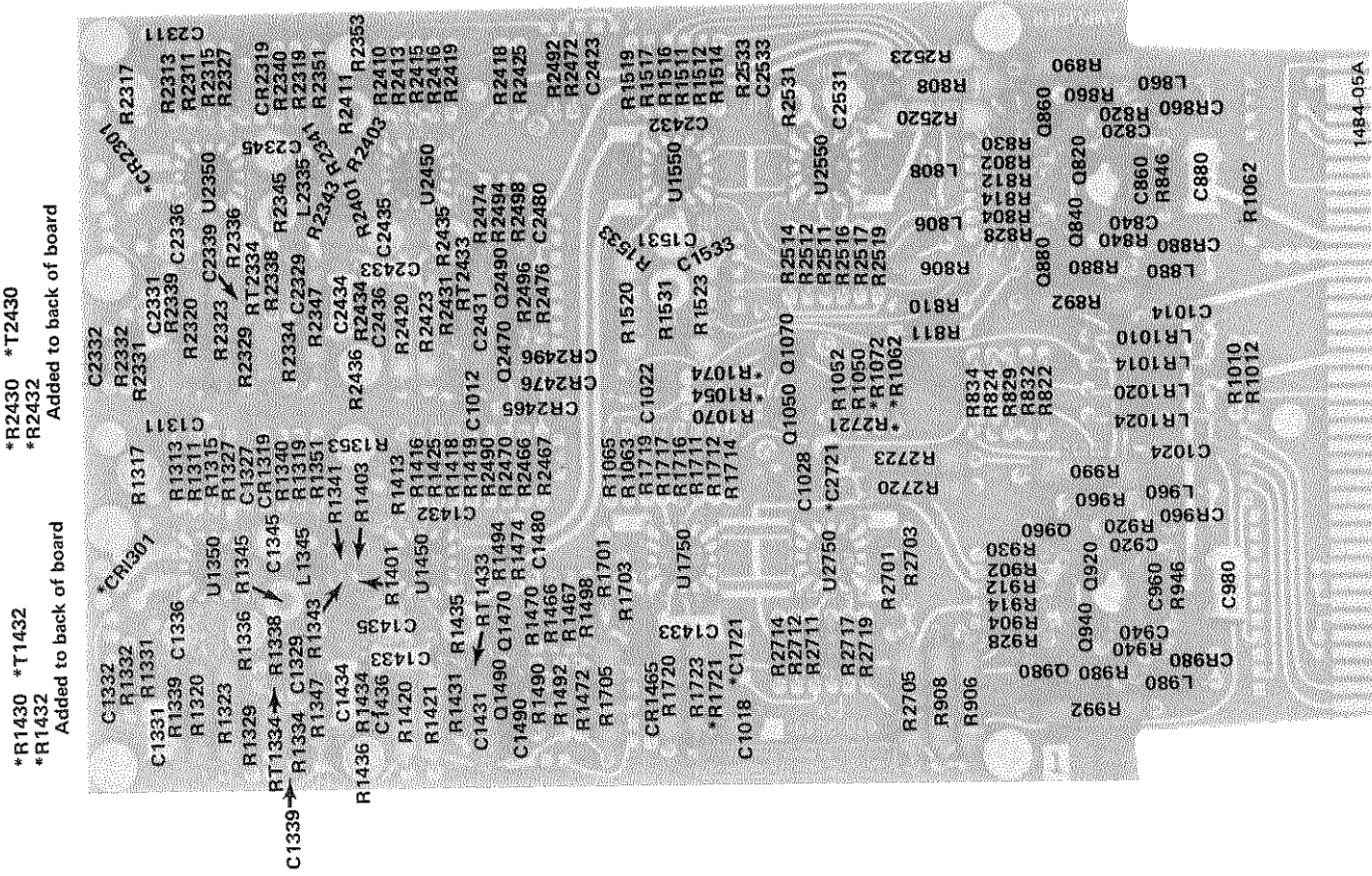

*R1430 *T1432
*R1432
Added to back of board

*R2430 *T2430
*R2432
Added to back of board

*See Parts List for
serial number ranges.

A2 Amplifier Board, SN B159999-below.

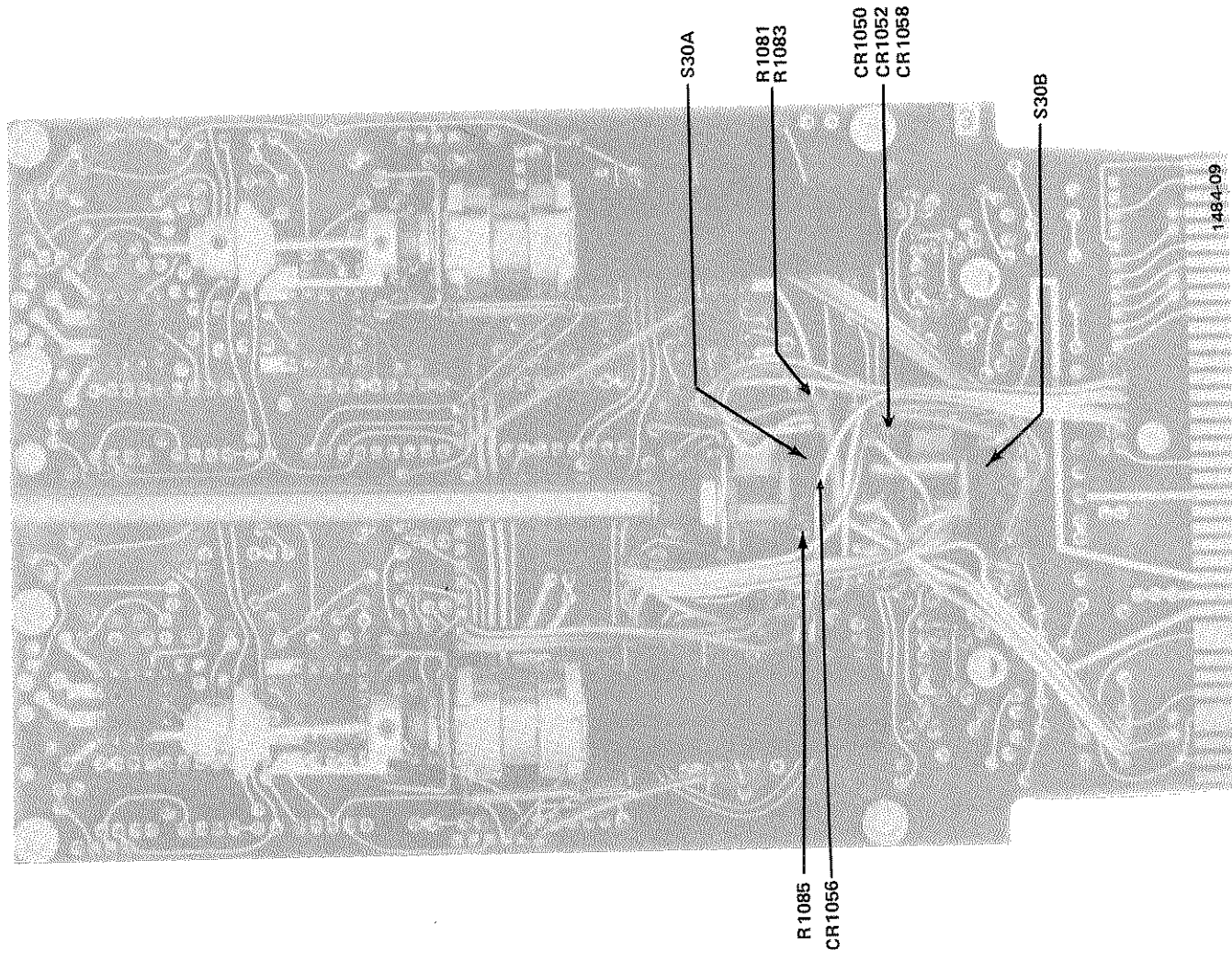

A2 Amplifier Board, Rear View.

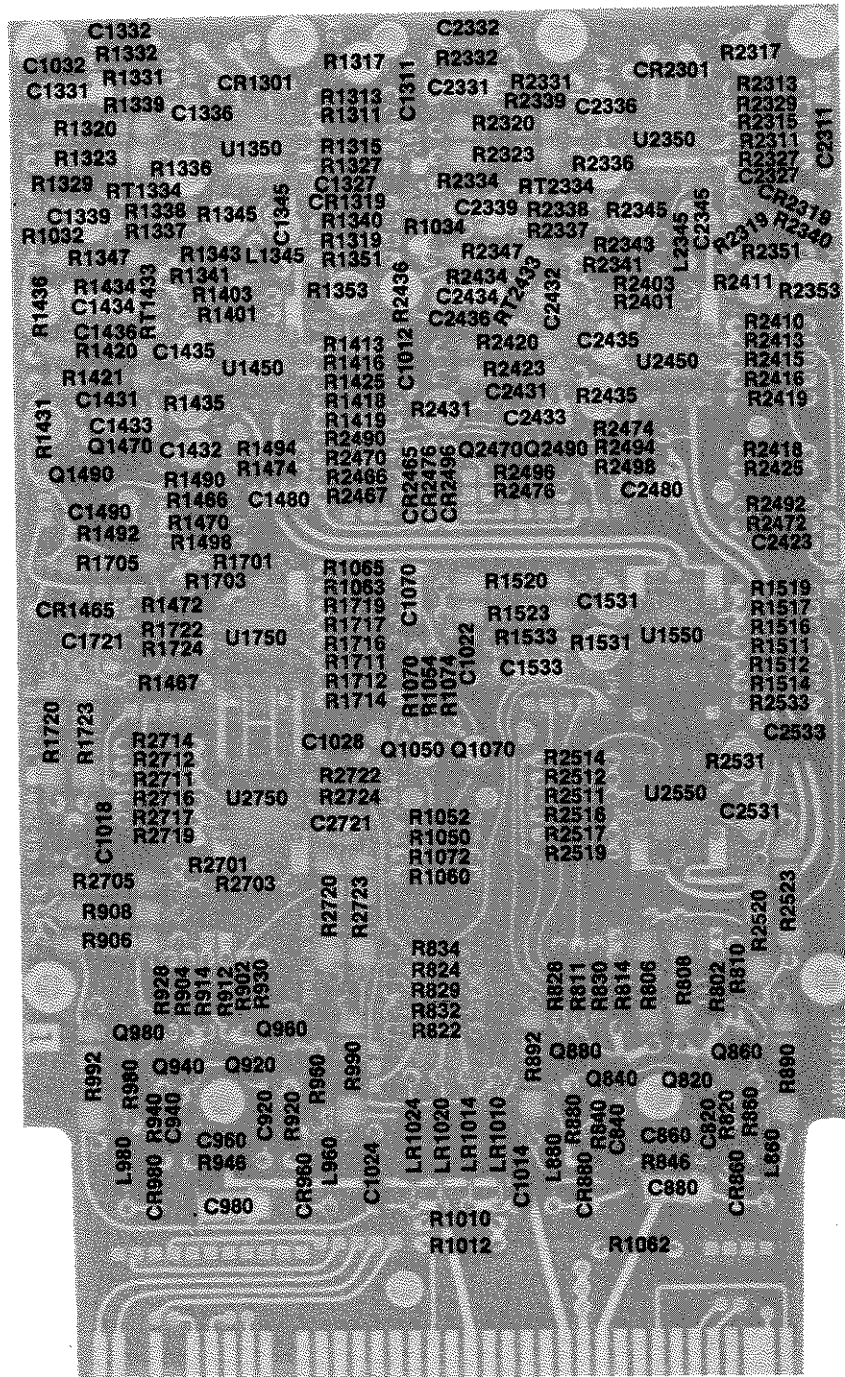

A2 Amplifier Board, SN B160000-above.

1484-18

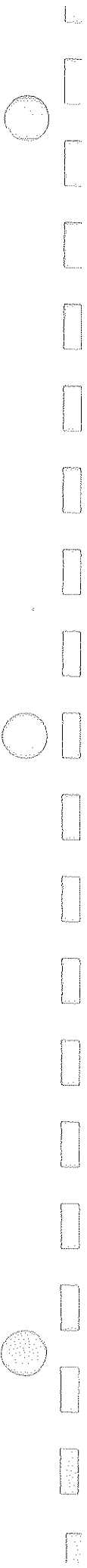

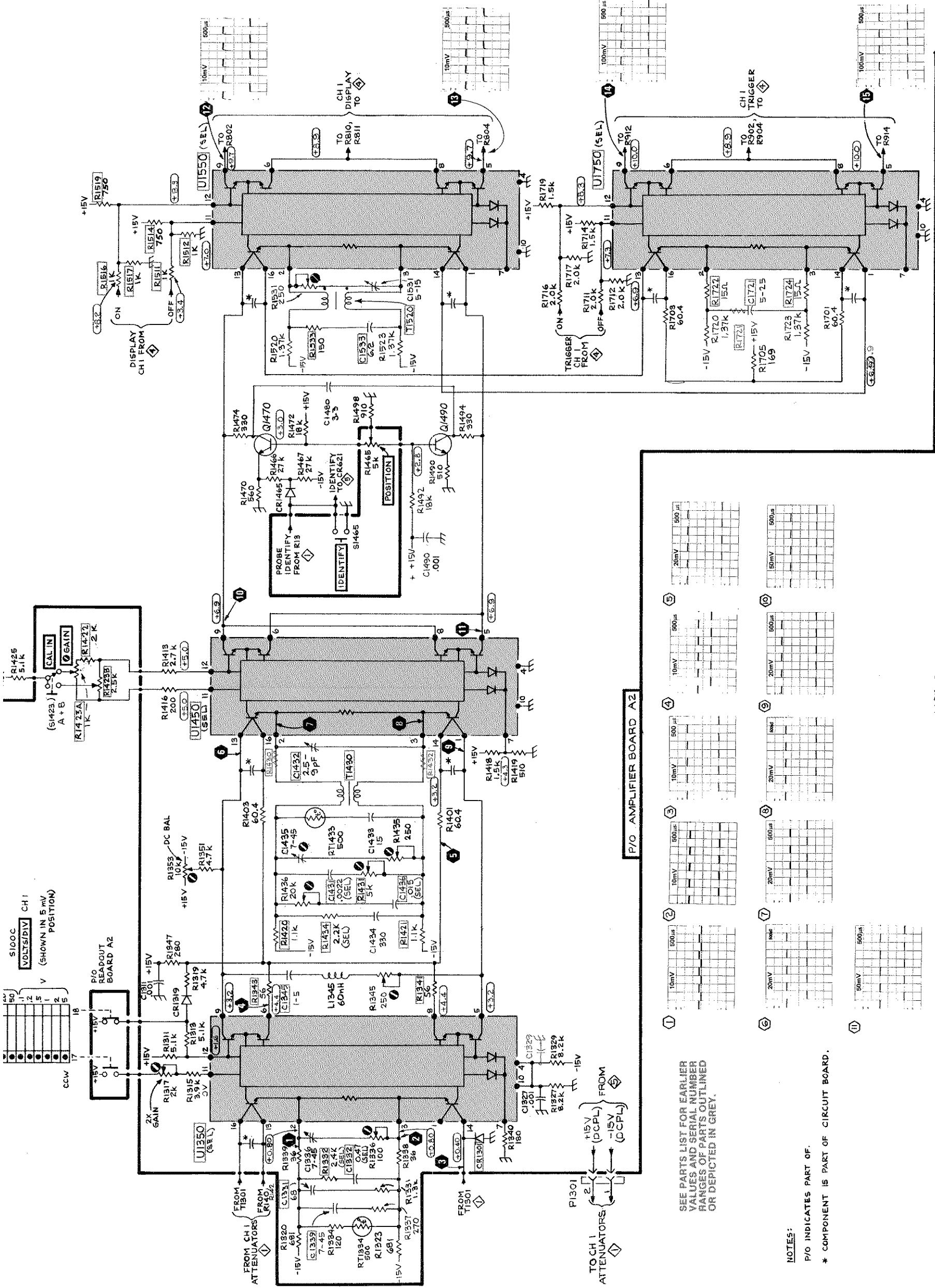

P/O AMPLIFIER BOARD A2

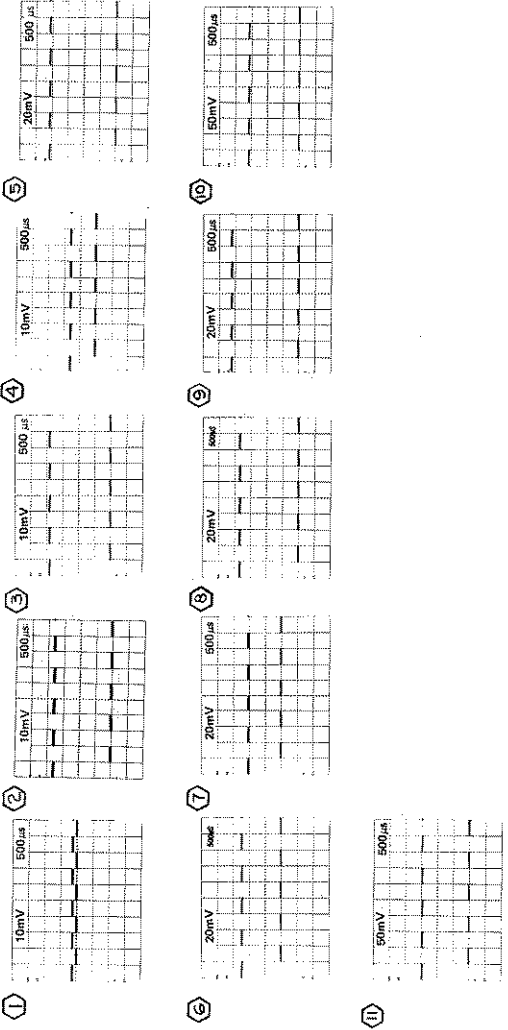

SEE PARTS LIST FOR EARLIER VALUES AND SERIAL NUMBER RANGES OF PARTS OUTLINED OR DEPICTED IN GREY.

NOTES:
 P/O INDICATES PART OF.
 * COMPONENT IS PART OF CIRCUIT BOARD.



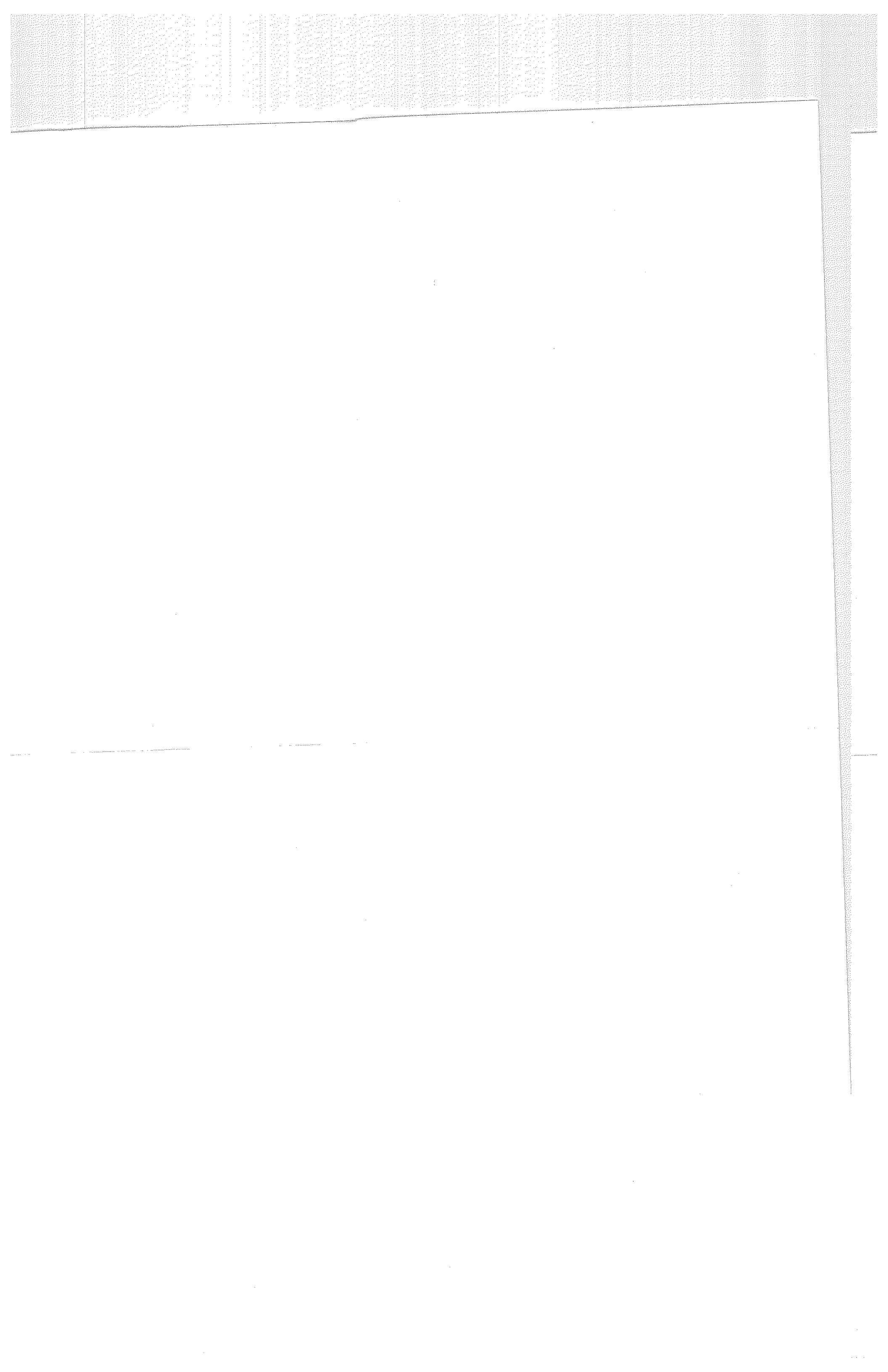

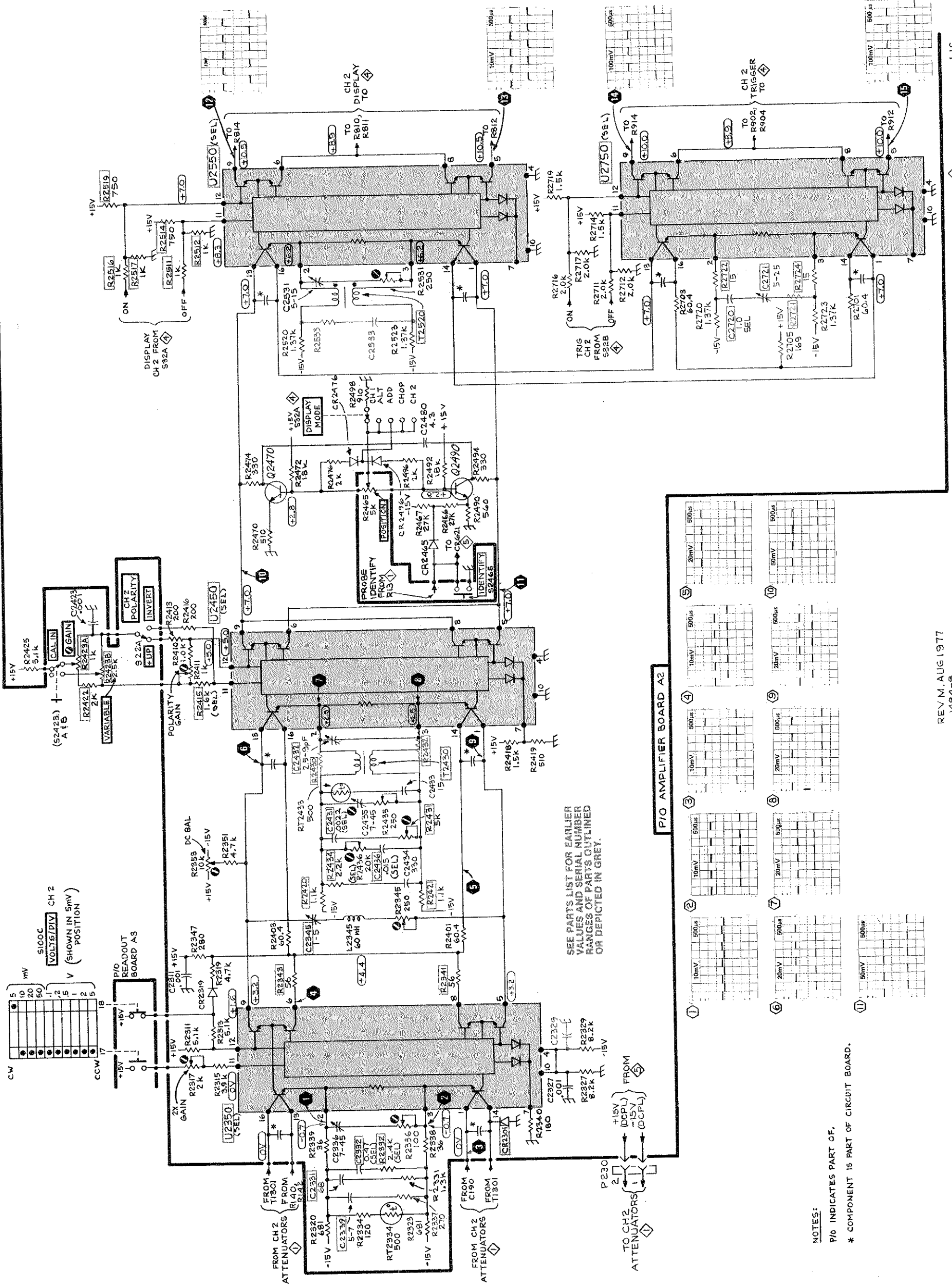

CH 2 AMPLIFIER

K1F 1275

REV. M. AUG 1977
1484-B

7A26

NOTES:
P/O INDICATES PART OF.
* COMPONENT IS PART OF CIRCUIT BOARD.

SEE PARTS LIST FOR EARLIER VALUES AND SERIAL NUMBER RANGES OF PARTS OUTLINED OR DEPICTED IN GREY.

P/O AMPLIFIER BOARD A2



DISPLAY SWITCHING AND OUTPUT

4

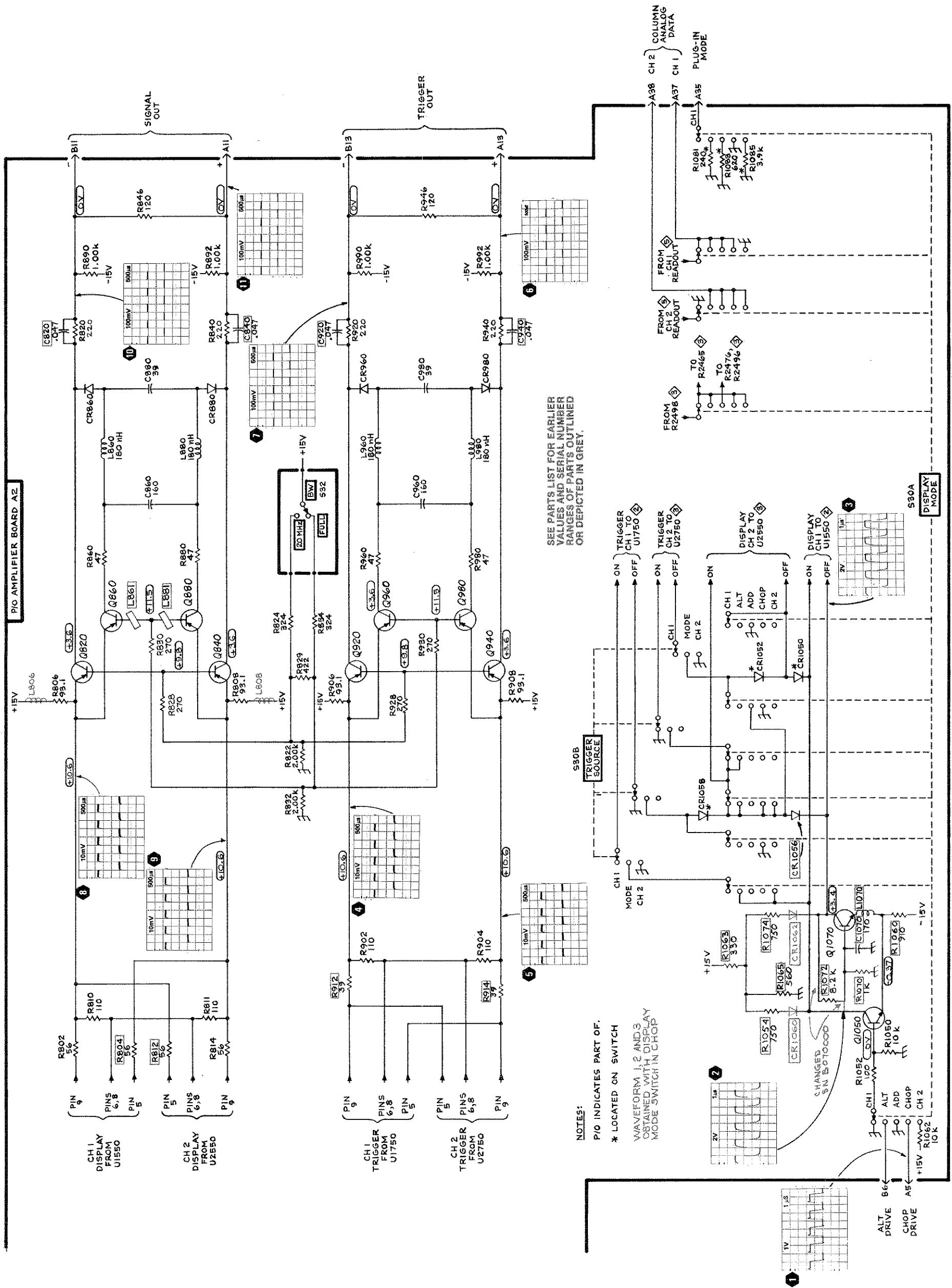

SEE PARTS LIST FOR EARLIER VALUES AND SERIAL NUMBER RANGES OF PARTS OUTLINED OR DEPICTED IN GREY.

NOTES:
 * LOCATED ON SWITCH
 WAVEFORM 1, 2 AND 3 OBTAINED WITH DISPLAY MODE SWITCH IN CHOP

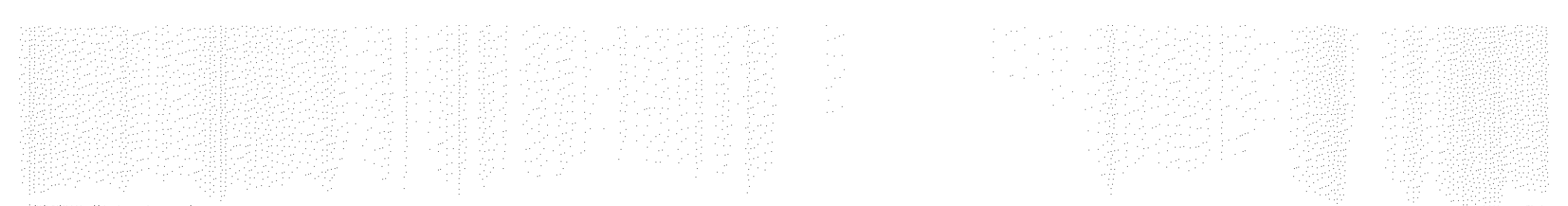

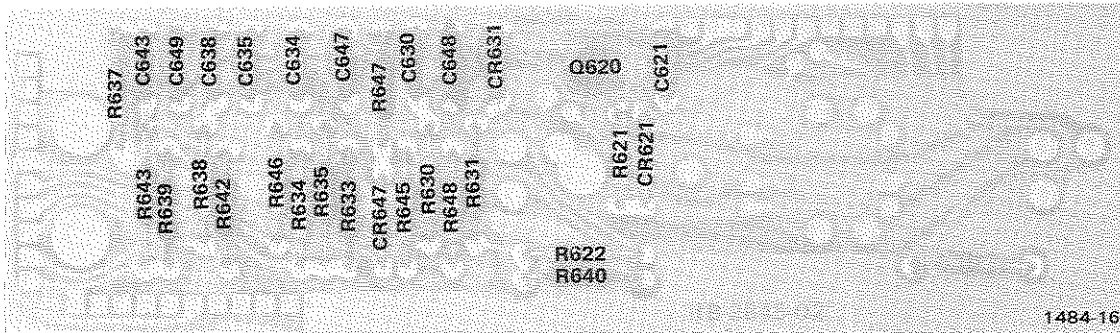
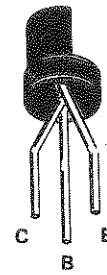

A3 Readout Board SN B150000-up.

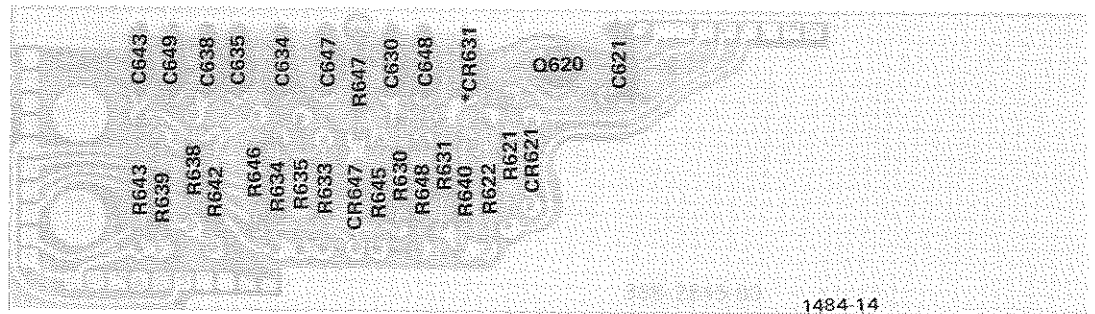

*See Parts List for serial number ranges.

A3 Readout Board SN B149999-below.



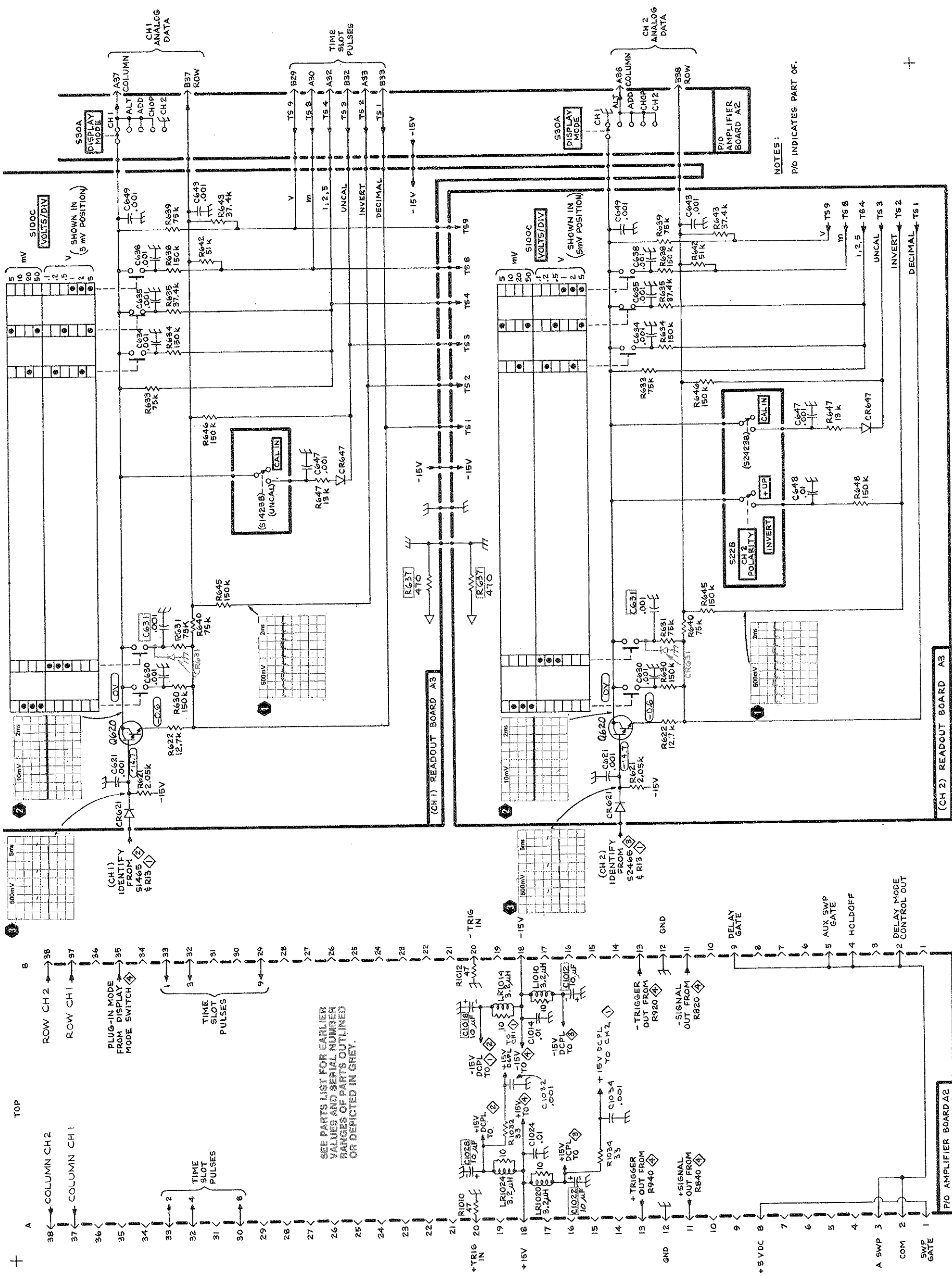

SEE PARTS LIST FOR EARLIER VALUES AND SERIAL NUMBER RANGES OF PARTS OUTLINED OR DEPICTED IN GREY.

NOTES:
PIO INDICATES PART OF.

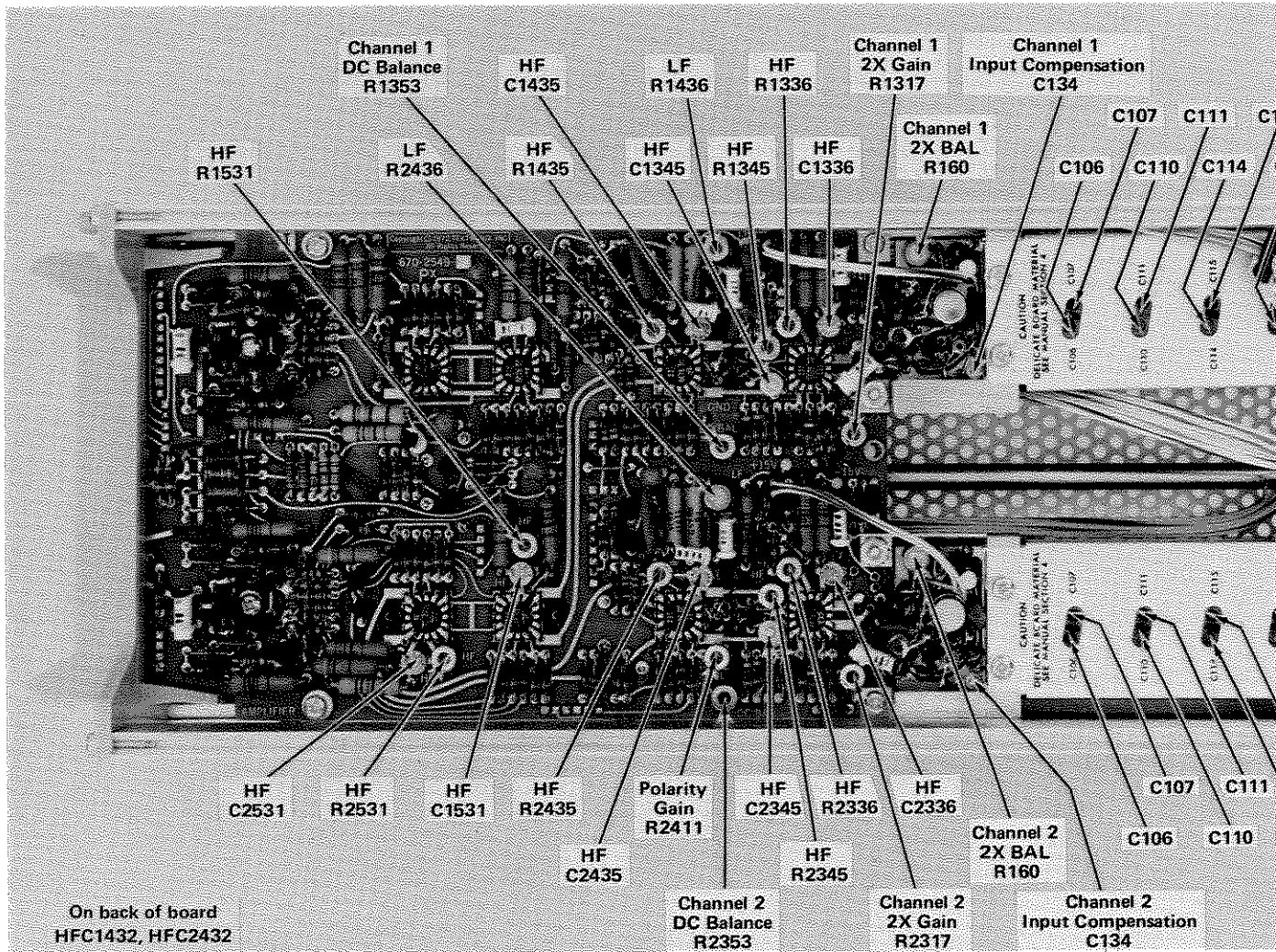

Location of Adjustments SN B159999-below



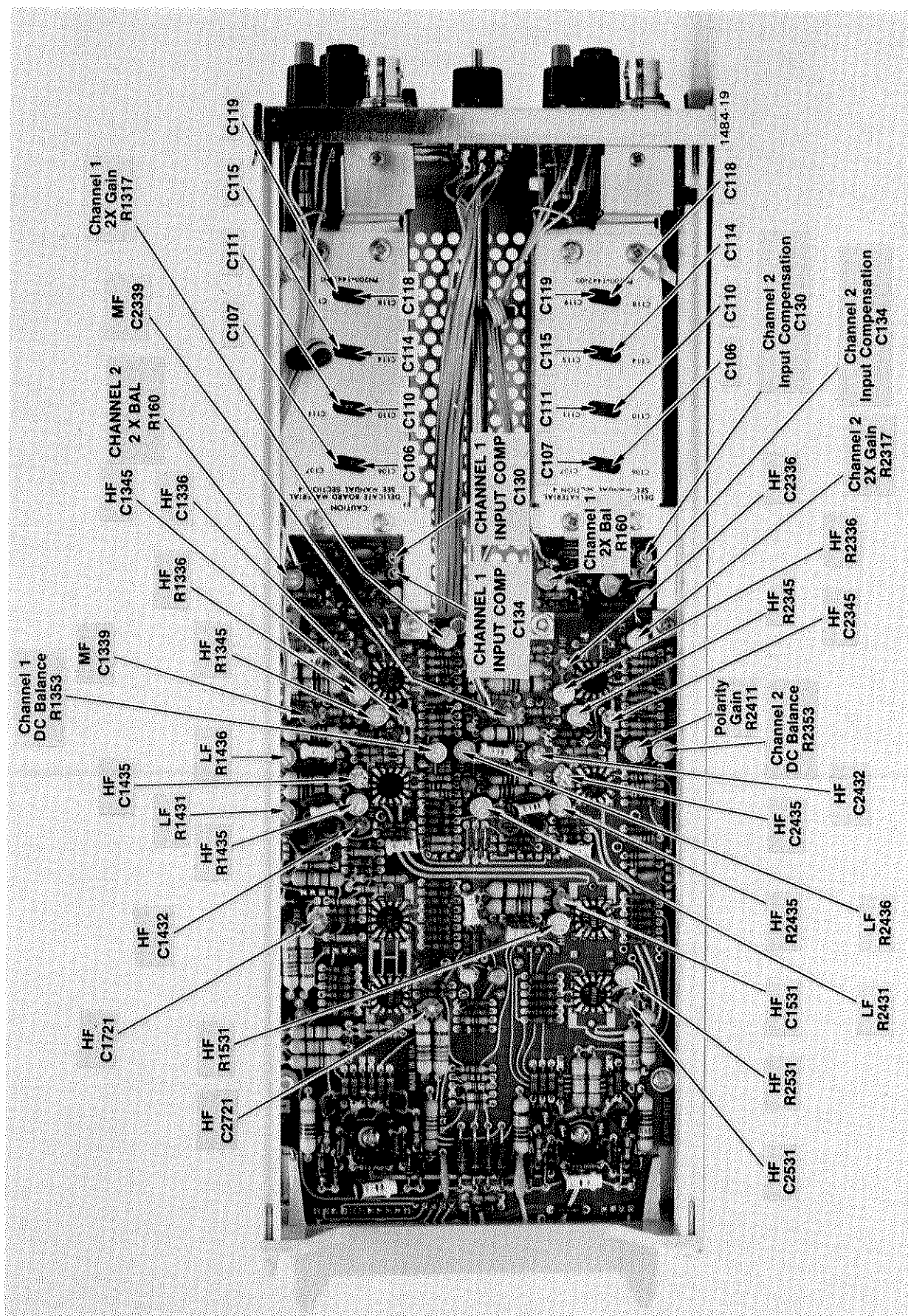

Location of Adjustments SN B160000-above

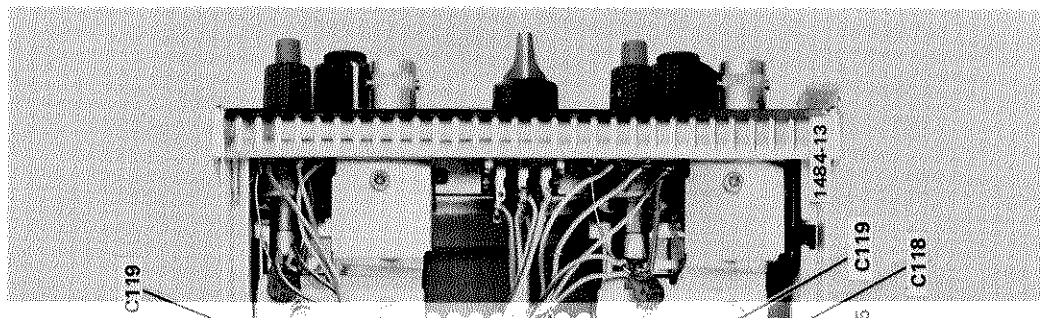

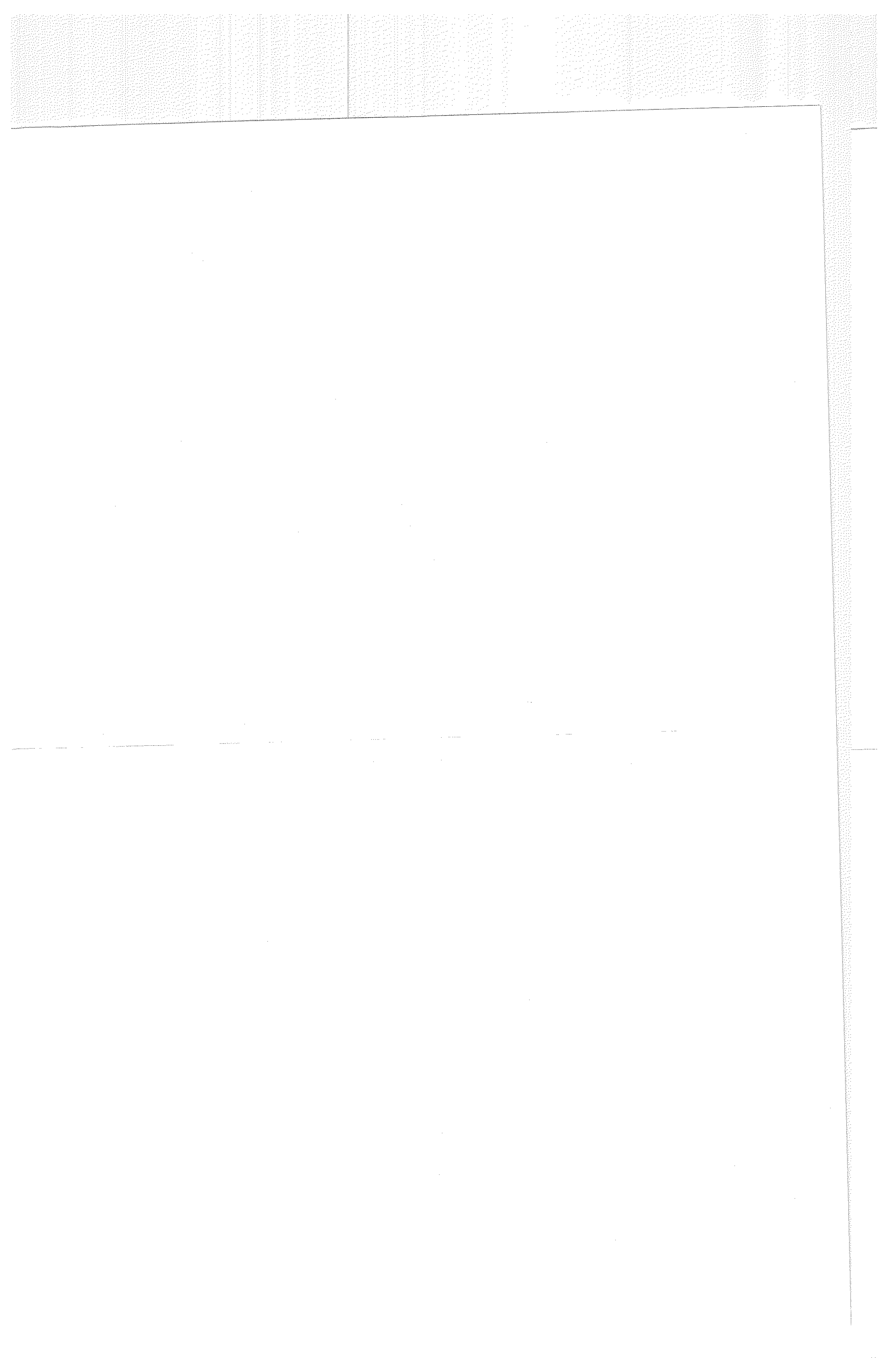

REPLACEABLE MECHANICAL PARTS

PARTS ORDERING INFORMATION

Replacement parts are available from or through your local Tektronix, Inc. Field Office or representative.

Changes to Tektronix instruments are sometimes made to accommodate improved components as they become available, and to give you the benefit of the latest circuit improvements developed in our engineering department. It is therefore important, when ordering parts, to include the following information in your order: Part number, instrument type or number, serial number, and modification number if applicable.

If a part you have ordered has been replaced with a new or improved part, your local Tektronix, Inc. Field Office or representative will contact you concerning any change in part number.

Change information, if any, is located at the rear of this manual.

SPECIAL NOTES AND SYMBOLS

X000 Part first added at this serial number
00X Part removed after this serial number

FIGURE AND INDEX NUMBERS

Items in this section are referenced by figure and index numbers to the illustrations.

INDENTATION SYSTEM

This mechanical parts list is indented to indicate item relationships. Following is an example of the indentation system used in the description column.

```

1 2 3 4 5      Name & Description
Assembly and/or Component
Attaching parts for Assembly and/or Component
    - - - * - - -
Detail Part of Assembly and/or Component
Attaching parts for Detail Part
    - - - * - - -
Parts of Detail Part
Attaching parts for Parts of Detail Part
    - - - * - - -
    
```

Attaching Parts always appear in the same indentation as the item it mounts, while the detail parts are indented to the right. Indented items are part of, and included with, the next higher indentation. The separation symbol - - - * - - - indicates the end of attaching parts.

Attaching parts must be purchased separately, unless otherwise specified.

ITEM NAME

In the Parts List, an Item Name is separated from the description by a colon (:). Because of space limitations, an Item Name may sometimes appear as incomplete. For further Item Name identification, the U.S. Federal Cataloging Handbook H6-1 can be utilized where possible.

ABBREVIATIONS

#	INCH	ELECTRN	ELECTRON	IN	INCH	SE	SINGLE END
ACTR	NUMBER SIZE	ELEC	ELECTRICAL	INCAND	INCANDESCENT	SECT	SECTION
ADPTR	ACTUATOR	ELECTLT	ELECTROLYTIC	INSUL	INSULATOR	SEMICOND	SEMICONDUCTOR
ALIGN	ADAPTER	ELEM	ELEMENT	INTL	INTERNAL	SHLD	SHIELD
AL	ALIGNMENT	EPL	ELECTRICAL PARTS LIST	LPHLDR	LAMPHOLDER	SHLDR	SHOULDERED
ASSEM	ALUMINUM	EOPT	EQUIPMENT	MACH	MACHINE	SKT	SOCKET
ASSY	ASSEMBLED	EXT	EXTERNAL	MECH	MECHANICAL	SL	SLIDE
ATTEN	ASSEMBLY	FIL	FILLISTER HEAD	MTG	MOUNTING	SLFLKG	SELF-LOCKING
AWG	ATTENUATOR	FLEX	FLEXIBLE	NIP	NIPPLE	SLVG	SLEEVING
BD	AMERICAN WIRE GAGE	FLH	FLAT HEAD	NON WIRE	NOT WIRE WOUND	SPR	SPRING
BRKT	BOARD	FLTR	FILTER	OB	ORDER BY DESCRIPTION	SQ	SQUARE
BRS	BRACKET	FR	FRAME or FRONT	OD	OUTSIDE DIAMETER	SST	STAINLESS STEEL
BRZ	BRASS	FSTNR	FASTENER	OVH	OVAL HEAD	STL	STEEL
BSHG	BRONZE	FT	FOOT	PH BRZ	PHOSPHOR BRONZE	SW	SWITCH
CAB	BUSHING	FXD	FIXED	PL	PLAIN or PLATE	T	TUBE
CAP	CABINET	GSKT	GASKET	PLSTC	PLASTIC	TERM	TERMINAL
CER	CAPACITOR	HDL	HANDLE	PN	PART NUMBER	THD	THREAD
CHAS	CERAMIC	HEX	HEXAGON	PNH	PAN HEAD	THK	THICK
CKT	CHASSIS	HEX HD	HEXAGONAL HEAD	PWR	POWER	TNSN	TENSION
COMP	CIRCUIT	HEX SOC	HEXAGONAL SOCKET	RCPT	RECEPTACLE	TPG	TAPPING
CONN	COMPOSITION	HLCPS	HELICAL COMPRESSION	RES	RESISTOR	TRH	TRUSS HEAD
COV	CONNECTOR	HLEXT	HELICAL EXTENSION	RGD	RIGID	V	VOLTAGE
CPLG	COVER	HV	HIGH VOLTAGE	RLF	RELIEF	VAR	VARIABLE
CRT	COUPLING	IC	INTEGRATED CIRCUIT	RTNR	RETAINER	W/	WITH
DEG	CATHODE RAY TUBE	ID	INSIDE DIAMETER	SCH	SOCKET HEAD	WSHR	WASHER
DWR	DEGREE	IDENT	IDENTIFICATION	SCOPE	OSCILLOSCOPE	XFMR	TRANSFORMER
	DRAWER	IMPLR	IMPELLER	SCR	SCREW	XSTR	TRANSISTOR

CROSS INDEX—MFR. CODE NUMBER TO MANUFACTURER

Mfr. Code	Manufacturer	Address	City, State, Zip
00779	AMP, INC.	P O BOX 3608	HARRISBURG, PA 17105
08261	SPECTRA-STRIP CORP.	7100 LAMPSON AVE.	GARDEN GROVE, CA 92642
12360	ALBANY PRODUCTS CO., DIV. OF PNEUMO DYNAMICS CORPORATION	145 WOODWARD AVENUE	SOUTH NORWALK, CT 06586
13257	AMERACE, LTD.	10 ESNA PARK DRIVE	MARKHAM, ONTARIO, CANADA
22526	BERG ELECTRONICS, INC.	YOUK EXPRESSWAY	NEW CUMBERLAND, PA 17070
24931	SPECIALTY CONNECTOR CO., INC.	3560 MADISON AVE.	INDIANAPOLIS, IN 46227
42838	NATIONAL RIVET AND MFG. CO.	1-21 EAST JEFFERSON ST.	WAUPUN, WI 53963
70276	ALLEN MFG. CO.	P. O. DRAWER 570	HARTFORD, CT 06101
70278	ALLIED STEEL AND CONVEYORS, DIV. OF SPARTON CORP.	17333 HEALY	DETROIT, MI 48212
73743	FISCHER SPECIAL MFG. CO.	446 MORGAN ST.	CINCINNATI, OH 45206
74445	HOLO-KROME CO.	31 BROOK ST. WEST	HARTFORD, CT 06110
78189	ILLINOIS TOOL WORKS, INC. SHAKEPROOF DIVISION	ST. CHARLES ROAD	ELGIN, IL 60120
79136	WALDES, KOHINOOR, INC.	47-16 AUSTEL PLACE	LONG ISLAND CITY, NY 11101
79727	C-W INDUSTRIES	550 DAVISVILLE RD., P O BOX 96	WARMINISTER, PA 18974
79807	WROUGHT WASHER MFG. CO.	2100 S. O BAY ST.	MILWAUKEE, WI 53207
80009	TEKTRONIX, INC.	P O BOX 500	BEAVERTON, OR 97077
83385	CENTRAL SCREW CO.	2530 CRESCENT DR.	BROADVIEW, IL 60153
87308	N. L. INDUSTRIES, INC., SOUTHERN SCREW DIV.	P. O. BOX 1360	STATESVILLE, NC 28677
97464	INDUSTRIAL RETAINING RING CO.	57 CORDIER ST.	IRVINGTON, NJ 07111

Fig. & Index No.	Tektronix Part No.	Serial/Model No. Eff	Dscont	Qty	1 2 3 4 5	Name & Description	Mfr Code	Mfr Part Number
1-1	131-0679-00			2		CONNECTOR, RCPT, :BNC W/HARDWARE	24931	28JRI68-1
-2	366-1059-00			1		PUSH BUTTON:GRAY	80009	366-1059-00
-3	366-1077-00			1		KNOB:GRAY	80009	366-1077-00
	213-0153-00			1		. SETSCREW:5-40 X 0.125 INCH,HEX SOC STL	74445	OBD
-4	366-1308-00			1		KNOB:RED	80009	366-1308-00
	213-0153-00			1		. SETSCREW:5-40 X 0.125 INCH,HEX SOC STL	74445	OBD
-5	366-1299-00			1		KNOB:GRAY	80009	366-1299-00
	213-0153-00			2		. SETSCREW:5-40 X 0.125 INCH,HEX SOC STL	74445	OBD
-6	366-1163-00			1		KNOB:LIGHT GRAY	80009	366-1163-00
	213-0153-00			1		. SETSCREW:5-40 X 0.125 INCH,HEX SOC STL	74445	OBD
-7	366-1165-00			1		KNOB:GRAY	80009	366-1165-00
	213-0153-00			2		. SETSCREW:5-40 X 0.125 INCH,HEX SOC STL	74445	OBD
-8	366-1059-00			1		PUSH BUTTON:GRAY	80009	366-1059-00
-9	366-1077-00			1		KNOB:GRAY	80009	366-1077-00
	213-0153-00			1		. SETSCREW:5-40 X 0.125 INCH,HEX SOC STL	74445	OBD
-10	366-1308-00			1		KNOB:RED	80009	366-1308-00
	213-0153-00			1		. SETSCREW:5-40 X 0.125 INCH,HEX SOC STL	74445	OBD
-11	366-1299-00			1		KNOB:GRAY	80009	366-1299-00
	213-0153-00			2		. SETSCREW:5-40 X 0.125 INCH,HEX SOC STL	74445	OBD
-12	366-0215-02			2		KNOB:LEVER SWITCH	80009	366-0215-02
-13	333-1594-00			1		PANEL,FRONT:	80009	333-1594-00
-14	366-1058-45			1		KNOB:LATCH	80009	366-1058-45
						(ATTACHING PARTS)		
-15	214-1095-00			1		PIN,SPG,SPLIT:0.094 OD X 0.187 INCH LONG	13257	52-022-094-0187
-16	105-0076-00			1		REL BAR,LATCH:PLUG-IN UNIT	80009	105-0076-00
						- - - * - - -		
-17	214-1280-00			1		SPRING,HLCPS:0.14 OD X 1.126"L,0.16"DIA W	80009	214-1280-00
-18	348-0235-00			2		SHLD GSKT,ELEC:4.734 INCH LONG	80009	348-0235-00
-19	358-0216-00			1		BUSHING,PLASTIC:0.257 ID X 0.412 INCH OD	80009	358-0216-00
-20	260-0816-00			2		SWITCH,SLIDE:DPDT,0.5A,125VAC	79727	GF-126-0012A
						(ATTACHING PARTS FOR EACH)		
-21	211-0030-00			2		SCREW,MACHINE:2-56 X 0.25"82 DEG,FLH STL	83385	OBD
-22	210-0404-00			2		NUT,PLAIN,SPLIN:2-56 X 0.188 INCH	80009	210-0404-00
						- - - * - - -		
-23	386-1447-54			1		SUBPANEL,FRONT:	80009	386-1447-54
						(ATTACHING PARTS)		
-24	213-0192-00			4		SCR,TPG,THD FOR:6-32 X 0.50 INCH,PNH STL	87308	OBD
						- - - * - - -		
-25	131-1075-00			1		CONTACT,ELEC:	80009	131-1075-00
-26	-----			2		RESISTOR,VAR.:(SEE R1465/S1465 R2465/S2465)		
						(ATTACHING PARTS FOR EACH)		
-27	210-0583-00			1		NUT,PLAIN,HEX.:0.25-32 X 0.312 INCH,BRS	73743	2X20224-402
-28	210-0046-00			1		WASHER,LOCK:INTL,0.26 ID X 0.40" OD,STL	78189	1214-05-00-0541C
						- - - * - - -		
	672-0051-00	B010100	B059999	2		CKT CARD ASSY:ATTENUATOR/READOUT	80009	672-0051-00
	672-0051-01	B060000	B079999	2		CKT CARD ASSY:ATTENUATOR/READOUT	80009	672-0051-01
	672-0051-02	B080000	B119999	2		CKT CARD ASSY:ATTENUATOR/READOUT	80009	672-0051-02
	672-0051-03	B120000	B149999	1		CKT CARD ASSY:ATTENUATOR/READOUT	80009	672-0051-03
	672-0051-04	B150000		1		CKT CARD ASSY:ATTENUATOR/READOUT	80009	672-0051-04
-29	-----			1		. CKT CD ASSY:ATTEN(SEE A1 CH1 AND A3 CH 2 EPL)		
-30	129-0299-00			4		. . POST,ELEC-MECH:HEX,0.333 INCH LONG	80009	129-0299-00
						(ATTACHING PARTS)		
-31	210-0004-00			1		. . WASHER,LOCK:INTL,0.12 ID X 0.26"OD,STL	78189	1204-00-00-0541C
	210-0406-00			1		. . NUT,PLAIN,HEX.:4-40 X 0.188 INCH,BRS	73743	2X12161-402
						- - - * - - -		
-32	131-1030-00			10		. . CAM SWITCH,BOTTOM		OBD
-33	131-1031-00			17		. . CONTACT ASSY,EL:CAM SWITCH,TOP	80009	131-1031-00
-34	210-0779-00			17		. . RIVET,TUBULAR:0.051 OD X 0.115 INCH LONG	42838	RA-29952715
	136-0252-01	B010100	B079999	14		. . CONTACT,ELEC:0.178 INCH LONG	00779	1-332095-2
	136-0252-01	B080000		22		. . CONTACT,ELEC:0.178 INCH LONG	00779	1-332095-2
	136-0333-00			2		. . SOCKET,PIN TERM:0.138 INCH LONG	00779	1-331677-4
-35	337-1406-00			1		. . SHLD,ELECTRICAL:CAM CONTACTS	80009	337-1406-00
-36	131-0707-00			2		. . CONTACT,ELEC:0.48"L,22-26 AWG WIRE	22526	75691-005

Fig. & Index No.	Tektronix Part No.	Serial/Model No. Eff	Dscont	Qty	1	2	3	4	5	Name & Description	Mfr Code	Mfr Part Number
1-37	352-0169-00			1	CONN BODY,PL:EL:2 WIRE BLACK	80009	352-0169-00
-38	175-0825-00			FT	WIRE,ELECTRICAL:2 WIRE RIBBON (ATTACHING PARTS FOR CKT BD)	08261	OBD
-39	211-0001-00			3	SCREW,MACHINE:2-56 X 0.25 INCH,PNH STL	83385	OBD
	210-0053-00			3	WASHER,LOCK:INTL,0.092 ID X 0.175"OD,STL	83385	OBD
-40	210-0405-00			3	NUT,PLAIN,HEX.:2-56 X 0.188 INCH,BRS	73743	2X12157-402
-41	441-1097-00			1	CHAS,ELEC EQPT: (ATTACHING PARTS)	80009	441-1097-00
-42	211-0097-00			2	SCREW,MACHINE:4-40 X 0.312 INCH,PNH STL	83385	OBD
-43	210-0004-00			2	WASHER,LOCK:INTL,0.12 ID X 0.26"OD,STL	78189	1204-00-00-0541C
-44	210-0406-00			2	NUT,PLAIN,HEX.:4-40 X 0.188 INCH,BRS	73743	2X12161-402
-45	131-0963-00			2	CONTACT,ELEC:GROUNDING	80009	131-0963-00
-46	105-0243-00			1	ACTUATOR,SWITCH: (ATTACHING PARTS)	80009	105-0243-00
-47	213-0214-00			1	SCREW,CAP SCH:2-56 X 0.375"HEX HD STL	70278	OBD
-48	131-0907-00			2	CONTACT,ELEC:	80009	131-0907-00
	263-1018-00	XB060000	B070000	1	DRUM ASSY,CAM S:	80009	263-1018-00
	263-1018-01	B080000		1	DRUM ASSY,CAM S:	80009	263-1018-01
-49	354-0391-00	B010100	B059999	2	RING,RETAINING:0.395"FREE ID X 0.025" STL	97464	3100-43-CD
	354-0390-00	B060000		1	RING,RETAINING:0.338 ID X 0.025" THK,STL	79136	5100-37MD
	354-0443-00	B060000		1	RING,RETAINING:0.328 FREE IDX 0.448 OD	97464	200-37
-50	401-0081-02	B010100	B059999	2	BEARING,CAM SW:FRONT	80009	401-0081-02
	401-0180-00	B060000	B079999	2	BEARING,CAM SW:FRONT	80009	401-0180-00
	401-0180-00	B080000		1	BEARING,CAM SW:FRONT	80009	401-0180-00
	401-0180-02	B080000		2	BEARING,CAM SW: (ATTACHING PARTS FOR EACH)	80009	401-0180-02
-51	211-0116-00			2	SCR,ASSEM WSHR:4-40 X 0.312 INCH,PNH BRS	83385	OBD
-52	214-1139-00			-	SPRING,FLAT:GOLD COLORED	80009	214-1139-00
	214-1139-02			-	SPRING,FLAT:GREEN COLORED	80009	214-1139-02
	214-1139-03			-	SPRING,FLAT:RED COLORED	80009	214-1139-03
-53	214-1127-00	B010100	B059999	4	ROLLER,DETENT:0.125 DIA X 0.125 INCH L	80009	214-1127-00
	214-1752-00	B060000		4	ROLLER,DETENT:	80009	214-1752-00
-54	105-0397-00	B010100	B059999	1	DRUM,CAM SWITCH:	80009	105-0397-00
	105-0397-01	B060000		1	DRUM,CAM SWITCH:	80009	105-0397-01
-55	401-0115-00	B010100	B059999	1	BEARING,CAM SW:CENTER	80009	401-0115-00
	401-0178-00	B060000		1	BEARING,CAM SW:CENTER/REAR (ATTACHING PARTS)	80009	401-0178-00
	211-0116-00			2	SCR,ASSEM WSHR:4-40 X 0.312 INCH,PNH BRS	83385	OBD
-56	105-0398-00	B010100	B059999	1	DRUM,CAM SWITCH:	80009	105-0398-00
	105-0398-01	B060000		1	DRUM,CAM SWITCH:	80009	105-0398-01
	384-0880-00	XB060000		1	SHAFT,CAM SW:REAR	80009	384-0880-00
	384-0878-01	XB060000		1	SHAFT,CAM SW:FRONT	80009	384-0878-01
-57	337-1754-00			1	SHIELD,ELEC: (ATTACHING PARTS)	80009	337-1754-00
-58	213-0120-00	B010100	B085114	3	SCR,TPG,THD FOR:2-32 X 0.250 INCH,PNH STL	83385	OBD
	211-0001-00	B085115		12	SCREW,MACHINE:2-56 X 0.25 INCH,PNH STL	83385	OBD
-59	210-0053-00			3	WASHER,LOCK:INTL,0.092 ID X 0.175"OD,STL	83385	OBD
-60	210-1008-00			3	WASHER,FLAT:0.09 ID X 0.188" OD,BRS	12360	OBD
-61	337-1418-01			1	SHIELD,ELEC:CAM SWITCH (ATTACHING PARTS)	80009	337-1418-01
-62	213-0277-00			3	SCR,TPG,THD FOR:2-56 X 0.312 INCH,PNH STL	83385	OBD
	210-0053-00			3	WASHER,LOCK:INTL,0.092 ID X 0.175"OD,STL	83385	OBD
-63	210-1008-00			3	WASHER,FLAT:0.09 ID X 0.188" OD,BRS	12360	OBD
-64	-----			2	CKT CARD ASSY:READOUT(SEE A3 EPL)		
-65	136-0252-04	B010100	B072899	3	SOCKET,PIN TERM:0.188 INCH LONG	22526	75060
	136-0350-00	B072900		1	SOCKET,PLUG-IN:3 PIN,LOW PROFILE	80009	136-0350-00

Fig. & Index No.	Tektronix Part No.	Serial/Model No. Eff	Dscont	Qty	1	2	3	4	5	Name & Description	Mfr Code	Mfr Part Number
1-	-----	XB150000		1	RESISTOR,VAR:(SEE R1423A,R2423A EPL)		
	-----	XB150000		1	RESISTOR,VAR:(SEE R1423B,R2423B EPL)		
	361-0515-00	XB150000		2	SPACER,SWITCH:PLASTIC	80009	361-0515-00
	214-1190-02	XB150000		1	EXTENDER,RETRAC:	80009	214-1190-02
	214-1136-00	XB150000		1	ACTUATOR,SL SW:DUAL DPST	80009	214-1136-00
	351-0180-00	XB150000		1	SLIDE,GUIDE:SWITCH ACTUATOR	80009	351-0180-00
	131-0604-00	XB150000		3	CONTACT,ELEC:0.025 SQ X 0.365 INCH LONG (ATTACHING PARTS FOR CKT BD)	80009	131-0604-00
-66	211-0007-00			1	SCREW,MACHINE:4-40 X 0.188 INCH,PNH STL	83385	OBD
-67	210-0288-00			2	TERMINAL,LUG:0.125 ID X 1.125 INCH LONG (ATTACHING PARTS FOR EACH)	80009	210-0288-00
-68	211-0105-00			1	SCREW,MACHINE:4-40 X 0.188"100 DEG,FLH STL	83385	OBD
	210-0586-00			1	NUT,PLAIN,EXT W:4-40 X 0.25 INCH,STL	78189	OBD
-69	337-1716-00			2	SHIELD,ELEC: (ATTACHING PARTS FOR EACH)	80009	337-1716-00
-70	213-0055-00			1	SCR,TPG,THD FOR:2-32 X 0.188 INCH,PNH STL	83385	OBD
-71	200-1442-00			2	COVER,CHASSIS:ATTENUATOR (ATTACHING PARTS)	80009	200-1442-00
-72	211-0007-00			4	SCREW,MACHINE:4-40 X 0.188 INCH,PNH STL	83385	OBD
-73	210-0994-00			4	WASHER,FLAT:0.125 ID X 0.25" OD,STL	83385	OBD
-74	407-1172-00			2	BRKT,CKT CARD: (ATTACHING PARTS FOR EACH)	80009	407-1172-00
-75	211-0008-00			2	SCREW,MACHINE:4-40 X 0.25 INCH,PNH STL	83385	OBD
-76	210-0586-00			1	NUT,PLAIN,EXT W:4-40 X 0.25 INCH,STL	78189	OBD
-77	384-1194-00			2	SHAFT,EXTENSION:0.125 OD X 7.22 INCH LONG	80009	384-1194-00
	384-1178-00	XB150000		2	EXTENSION SHAFT:0.123 OD X 6.1 INCH LONG	80009	384-1178-00
	384-1388-00	XB150000		2	EXTENSION SHAFT:3.02 L X 0.078 OD,SST	80009	384-1388-00
-78	376-0039-00	B010100	B019999	2	ADPT,SHAFT,CPLG:0.128 AND 0.082"DIA SHAFT	80009	376-0039-00
	376-0152-00	B020000		2	CPLG,SHAFT,RGD:	80009	376-0152-00
	213-0075-00			2	SETSCREW:4-40 X 0.094 INCH,HEX SOC STL	70276	OBD
-79	376-0125-00			2	COUPLER,SWITCH: (ATTACHING PARTS FOR EACH)	80009	376-0125-00
	213-0048-00	B010100	B061339	2	SETSCREW:4-40 X 0.125 INCH,HEX SOC STL	74445	OBD
	213-0022-00	B061340		2	SETSCREW:4-40 X 0.188 INCH,HEX SOC STL	74445	OBD
-80	376-0124-00			2	COUPLER,SWITCH: (ATTACHING PARTS FOR EACH)	80009	376-0124-00
	213-0048-00			4	SETSCREW:4-40 X 0.125 INCH,HEX SOC STL	74445	OBD
	210-0940-00	XB061600	B149999X	2	WASHER,FLAT:0.25 ID X 0.375 INCH OD,STL	79807	OBD
-81	-----	B010100	B149999X	2	RESISTOR,VAR.,(R1422/S1423A R2422/S2423A) (ATTACHING PARTS FOR EACH)		
-82	210-0583-00	B010100	B149999X	2	NUT,PLAIN,HEX.:0.25-32 X 0.312 INCH,BRS	73743	2X20224-402
-83	210-0046-00	B010100	B149999X	2	WASHER,LOCK:INTL,0.26 ID X 0.40" OD,STL	78189	1214-05-00-0541C
-84	129-0080-00	B010100	B149999	2	POST,ELEC-MECH:0.875 INCH LONG	80009	129-0080-00
	129-0554-00	B150000		1	SPACER,POST:0.975" L W/4-40 THD,PLSTC (ATTACHING PARTS FOR EACH)	80009	129-0554-00
	211-0008-00			1	SCREW,MACHINE:4-40 X 0.25 INCH,PNH STL	83385	OBD
	262-0965-00	B010100	B069999	1	SWITCH ASSY,ROT:	80009	262-0965-00
	262-0965-01	B070000		1	SWITCH,WIRED:ROTARY	80009	262-0965-01
	175-0826-00			FT	WIRE,ELECTRICAL:3 WIRE RIBBON	80009	175-0826-00
	175-0827-00			FT	WIRE,ELECTRICAL:4 WIRE RIBBON	08261	OBD
	175-0828-00			FT	WIRE,ELECTRICAL:5 WIRE RIBBON	08261	OBD
-85	260-1493-00			1	SWITCH,ROTARY: (ATTACHING PARTS)	80009	260-1493-00
-86	210-0590-00			1	NUT,PLAIN,HEX.:0.375 X 0.438 INCH,STL	73743	2X28269-402
-87	210-0012-00			1	WASHER,LOCK:INFL,0.375 ID X 0.50" OD STL	78189	1220-02-00-0541C

Mechanical Parts List—/A26

Fig. & Index No.	Tektronix Part No.	Serial/Model No. Eff	Dscont	Qty	1 2 3 4 5	Name & Description	Mfr Code	Mfr Part Number
1-88	-----			1		CKT CARD ASSY:AMPLIFIER(SEE A2 EPL)		
-89	131-0608-00			4		. CONTACT,ELEC:0.365 INCH LONG	22526	47357
-90	136-0252-04	B010100	B072899	162		. SOCKET,PIN TERM:0.188 INCH LONG	22526	75060
	136-0252-04	B072900		120		. SOCKET,PIN TERM:0.188 INCH LONG	22526	75060
	136-0350-00	B072900		14		. SOCKET,PLUG-IN:3 PIN,LOW PROFILE	80009	136-0350-00
-91	214-0579-00			1		. TERM.,TEST PT:0.40 INCH LONG	80009	214-0579-00
-92	407-0553-00	B010100	B149999X	2		. BRKT,CMPNT MTG:	80009	407-0553-00
-93	407-0912-00			1		. BRKT,CMPNT MTG: (ATTACHING PARTS FOR CKT BD)	80009	407-0912-00
-94	211-0008-00			2		SCREW,MACHINE:4-40 X 0.25 INCH,PNH STL - - - * - - -	83385	OBD
-95	386-1402-00			1		PANEL,REAR: (ATTACHING PARTS)	80009	386-1402-00
-96	213-0192-00			4		SCR,TPG,THD FOR:6-32 X 0.50 INCH,PNH STL	87308	OBD
-97	361-0326-00			1		SPACER,SLEEVE:0.18 ID X 0.25 OD X 0.10"L - - - * - - -	80009	361-0326-00
-98	220-0547-01			4		NUT,BLOCK:0.38 X 0.25 X 0.282"OA (ATTACHING PARTS FOR EACH)	80009	220-0547-01
-99	211-0105-00			1		SCREW,MACHINE:4-40 X 0.188"100 DEG,FLH STL - - - * - - -	83385	OBD
-100	105-0075-00			1		PAWL:0.475 X 0.21 X 0.184 INCH,PLSTC	80009	105-0075-00
-101	214-1054-00			1		SPRING,DETENT:LATCH	80009	214-1054-00
-102	214-1061-00			1		SPRING,GROUND:FLAT	80009	214-1061-00
-103	426-0736-00			1		FR SECT,PLUG-IN:TOP	80009	426-0736-00
-104	426-0737-00			1		FR SECT,PLUG-IN:BOTTOM	80009	426-0737-00
-105	337-1064-00			2		SHLD,SIDE,ELEC:RIGHT AND LEFT SIDE	80009	337-1064-00
	175-0825-00			FT		WIRE,ELECTRICAL:2 WIRE RIBBON	08261	OBD
	175-0826-00			FT		WIRE,ELECTRICAL:3 WIRE RIBBON	80009	175-0826-00
	175-0828-00			FT		WIRE,ELECTRICAL:5 WIRE RIBBON	08261	OBD
	175-0829-00			FT		WIRE,ELECTRICAL:6 WIRE RIBBON	08261	OBD
	175-0831-00			FT		WIRE,ELECTRICAL:8 WIRE RIBBON	08261	OBD
	175-0832-00			FT		WIRE,ELECTRICAL:9 WIRE RIBBON	08261	OBD

FIG. 1 EXPLODED

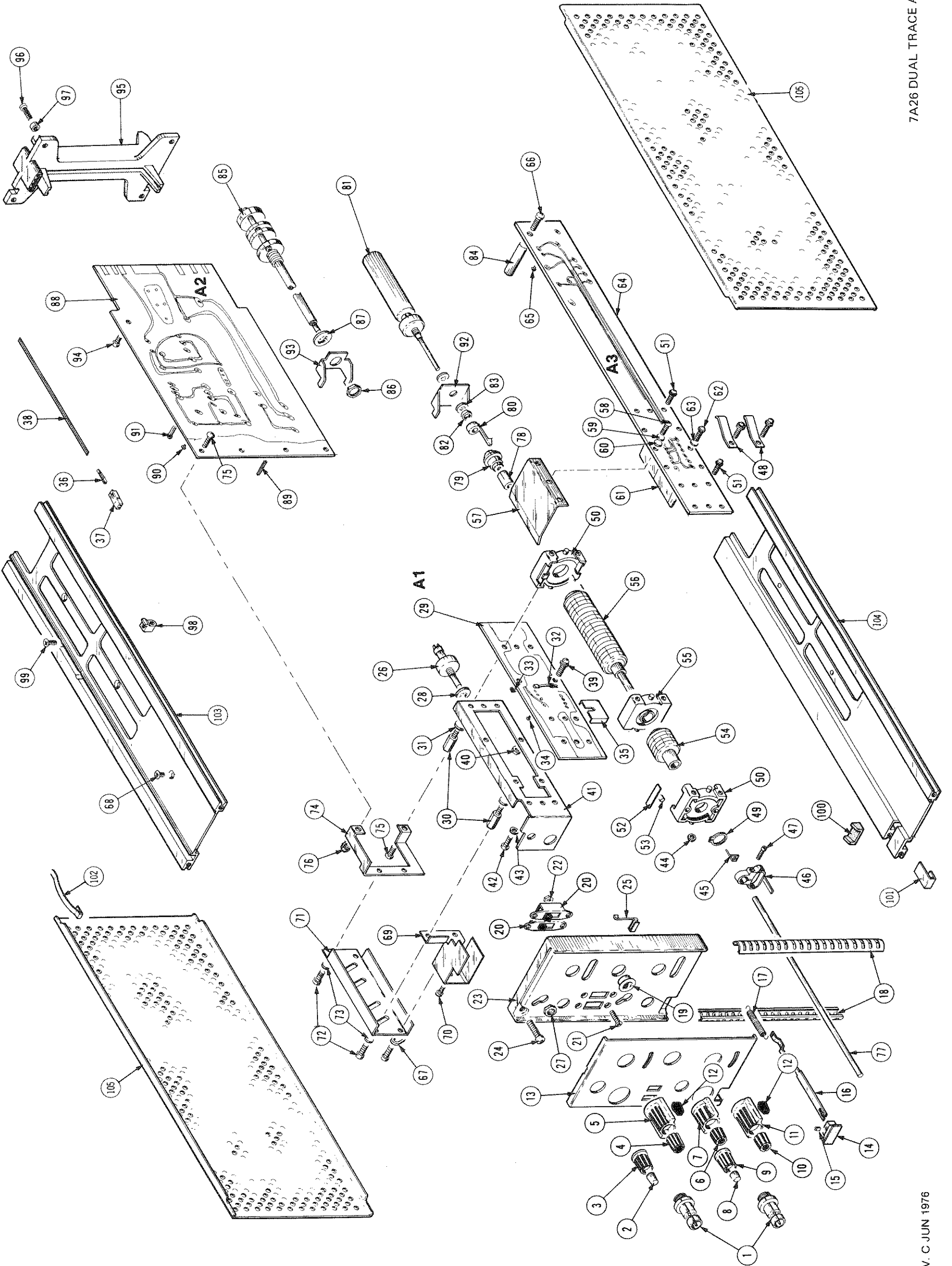

7A26 DUAL TRACE AMPLIFIER

REV. C JUN 1976



Fig. & Index No.	Tektronix Part No.	Serial/Model No. Eff	Dscnt	Qty						Name & Description	Mfr	
					1	2	3	4	5		Code	Mfr Part Number
2-	070-1484-01			1						MANUAL, TECH: INSTRUCTION	80009	070-1484-01

MANUAL CHANGE INFORMATION

At Tektronix, we continually strive to keep up with latest electronic developments by adding circuit and component improvements to our instruments as soon as they are developed and tested.

Sometimes, due to printing and shipping requirements, we can't get these changes immediately into printed manuals. Hence, your manual may contain new change information on following pages.

A single change may affect several sections. Since the change information sheets are carried in the manual until all changes are permanently entered, some duplication may occur. If no such change pages appear following this page, your manual is correct as printed.

SERVICE NOTE

Because of the universal parts procurement problem, some electrical parts in your instrument may be different from those described in the Replaceable Electrical Parts List. The parts used will in no way alter or compromise the performance or reliability of this instrument. They are installed when necessary to ensure prompt delivery to the customer. Order replacement parts from the Replaceable Electrical Parts List.

CALIBRATION TEST EQUIPMENT REPLACEMENT

Calibration Test Equipment Chart

This chart compares TM 500 product performance to that of older Tektronix equipment. Only those characteristics where significant specification differences occur, are listed. In some cases the new instrument may not be a total functional replacement. Additional support instrumentation may be needed or a change in calibration procedure may be necessary.

Comparison of Main Characteristics

DM 501 replaces 7D13		
PG 501 replaces 107	PG 501 - Risetime less than 3.5 ns into 50 Ω .	107 - Risetime less than 3.0 ns into 50 Ω .
108	PG 501 - 5 V output pulse; 3.5 ns Risetime.	108 - 10 V output pulse; 1 ns Risetime.
111	PG 501 - Risetime less than 3.5 ns; 8 ns Pretrigger pulse delay.	111 - Risetime 0.5 ns; 30 to 250 ns Pretrigger Pulse delay.
114	PG 501 - ± 5 V output.	114 - ± 10 V output. Short proof output.
115	PG 501 - Does not have Paired, Burst, Gated, or Delayed pulse mode; ± 5 V dc Offset. Has ± 5 V output.	115 - Paired, Burst, Gated, and Delayed pulse mode; ± 10 V output. Short-proof output.
PG 502 replaces 107		
108	PG 502 - 5 V output	108 - 10 V output.
111	PG 502 - Risetime less than 1 ns; 10 ns Pretrigger pulse delay.	111 - Risetime 0.5 ns; 30 to 250 ns Pretrigger pulse delay.
114	PG 502 - ± 5 V output	114 - ± 10 V output. Short proof output.
115	PG 502 - Does not have Paired, Burst, Gated, Delayed & Undelayed pulse mode; Has ± 5 V output.	115 - Paired, Burst, Gated, Delayed & Undelayed pulse mode; ± 10 V output. Short-proof output.
2101	PG 502 - Does not have Paired or Delayed pulse. Has ± 5 V output.	2101 - Paired and Delayed pulse; 10 V output.
PG 506 replaces 106	PG 506 - Positive-going trigger output signal at least 1 V; High Amplitude output, 60 V.	106 - Positive and Negative-going trigger output signal, 50 ns and 1 V; High Amplitude output, 100 V.
067-0502-01	PG 506 - Does not have chopped feature.	0502-01 - Comparator output can be alternately chopped to a reference voltage.
SG 503 replaces 190, 190A, 190B, 191, 067-0532-01	SG 503 - Amplitude range 5 mV to 5.5 V p-p. SG 503 - Frequency range 250 kHz to 250 MHz. SG 503 - Frequency range 250 kHz to 250 MHz.	190B - Amplitude range 40 mV to 10 V p-p. 191 - Frequency range 350 kHz to 100 MHz. 0532-01 - Frequency range 65 MHz to 500 MHz.
TG 501 replaces 180, 180A	TG 501 - Marker outputs, 5 sec to 1 ns. Sinewave available at 5, 2, and 1 ns. Trigger output - slaved to marker output from 5 sec through 100 ns. One time-mark can be generated at a time.	180A - Marker outputs, 5 sec to 1 μ s. Sinewave available at 20, 10, and 2 ns. Trigger pulses 1, 10, 100 Hz; 1, 10, and 100 kHz. Multiple time-marks can be generated simultaneously.
181	TG 501 - Marker outputs, 5 sec to 1 ns. Sinewave available at 5, 2, and 1 ns.	181 - Marker outputs, 1, 10, 100, 1000, and 10,000 μ s, plus 10 ns sinewave.
184	TG 501 - Marker outputs, 5 sec to 1 ns. Sinewave available at 5, 2, and 1 ns. Trigger output - slaved to marker output from 5 sec through 100 ns. One time-mark can be generated at a time.	184 - Marker outputs, 5 sec to 2 ns. Sinewave available at 50, 20, 10, 5, and 2 ns. Separate trigger pulses of 1 and .1 sec; 10, 1, and .1 ms; 10 and 1 μ s. Marker amplifier provides positive or negative time marks of 25 V min. Marker intervals of 1 and .1 sec; 10, 1, and .1 ms; 10 and 1 μ s.
2901	TG 501 - Marker outputs, 5 sec to 1 ns. Sinewave available at 5, 2, and 1 ns. Trigger output - slaved to marker output from 5 sec through 100 ns. One time-mark can be generated at a time.	2901 - Marker outputs, 5 sec to 0.1 μ s. Sinewave available to 50, 10, and 5 ns. Separate trigger pulses, from 5 sec to 0.1 μ s. Multiple time-marks can be generated simultaneously.

NOTE: All TM 500 generator outputs are short-proof. All TM 500 plug-in instruments require TM 500-Series Power Module.

REV. A, OCT 1975

**TEKTRONIX®**committed to
technical excellence**MANUAL CHANGE INFORMATION**PRODUCT 7A26CHANGE REFERENCE M31483DATE 4-13-78**CHANGE:****DESCRIPTION**

EFF SN B180000 (7A26) 070-1484-01

ELECTRICAL PARTS LIST AND SCHEMATIC CHANGES

CHANGE TO:

A3	670-2310-06	CKT CARD ASSY:READOUT CH1 + CH2
C621	283-0177-00	CAP., FXD, CER DI:1UF,+80-20%,25V
Q620	151-0281-00	TRANSISTOR:SILICON,NPN,DARLINGTON
R621	321-0222-00	RES., FXD, FILM:2K OHM,1%,0.125W

REMOVE:

C630	283-0000-00	CAP., FXD, CER DI:0.001UF,+100-0%,500V
C631	283-0000-00	CAP., FXD, CER DI:0.001UF,+100-0%,500V
C634	283-0000-00	CAP., FXD, CER DI:0.001UF,+100-0%,500V
C635	283-0000-00	CAP., FXD, CER DI:0.001UF,+100-0%,500V
C638	283-0000-00	CAP., FXD, CER DI:0.001UF,+100-0%,500V
C643	283-0000-00	CAP., FXD, CER DI:0.001UF,+100-0%,500V
C647	283-0000-00	CAP., FXD, CER DI:0.001UF,+100-0%,500V
C648	283-0003-00	CAP., FXD, CER DI:0.01UF,+80-20%,150V
C649	283-0000-00	CAP., FXD, CER DI:0.001UF,+100-0%,500V
R637	315-0471-00	RES., FXD, CMPSN:470 OHM,5%,0.25W

ADD:

C49	283-0003-00	CAP., FXD, CER DI:0.01UF,+80-20%,150V
CR630	152-0141-02	SEMICONV DEVICE:SILICON,30V,150MA,1N4152
CR631	152-0141-02	SEMICONV DEVICE:SILICON,30V,150MA,1N4152
CR634	152-0141-02	SEMICONV DEVICE:SILICON,30V,150MA,1N4152
CR635	152-0141-02	SEMICONV DEVICE:SILICON,30V,150MA,1N4152
CR638	152-0141-02	SEMICONV DEVICE:SILICON,30V,150MA,1N4152
CR648	152-0141-02	SEMICONV DEVICE:SILICON,30V,150MA,1N4152
R620	315-0471-00	RES., FXD, CMPSN:470 OHM,5%,0.25W
R629	315-0101-00	RES., FXD, CMPSN:100 OHM,5%,0.25W

SCHEMATIC CHANGES

DIAGRAM 3 CHANNEL 2 AMPLIFIER - Partial

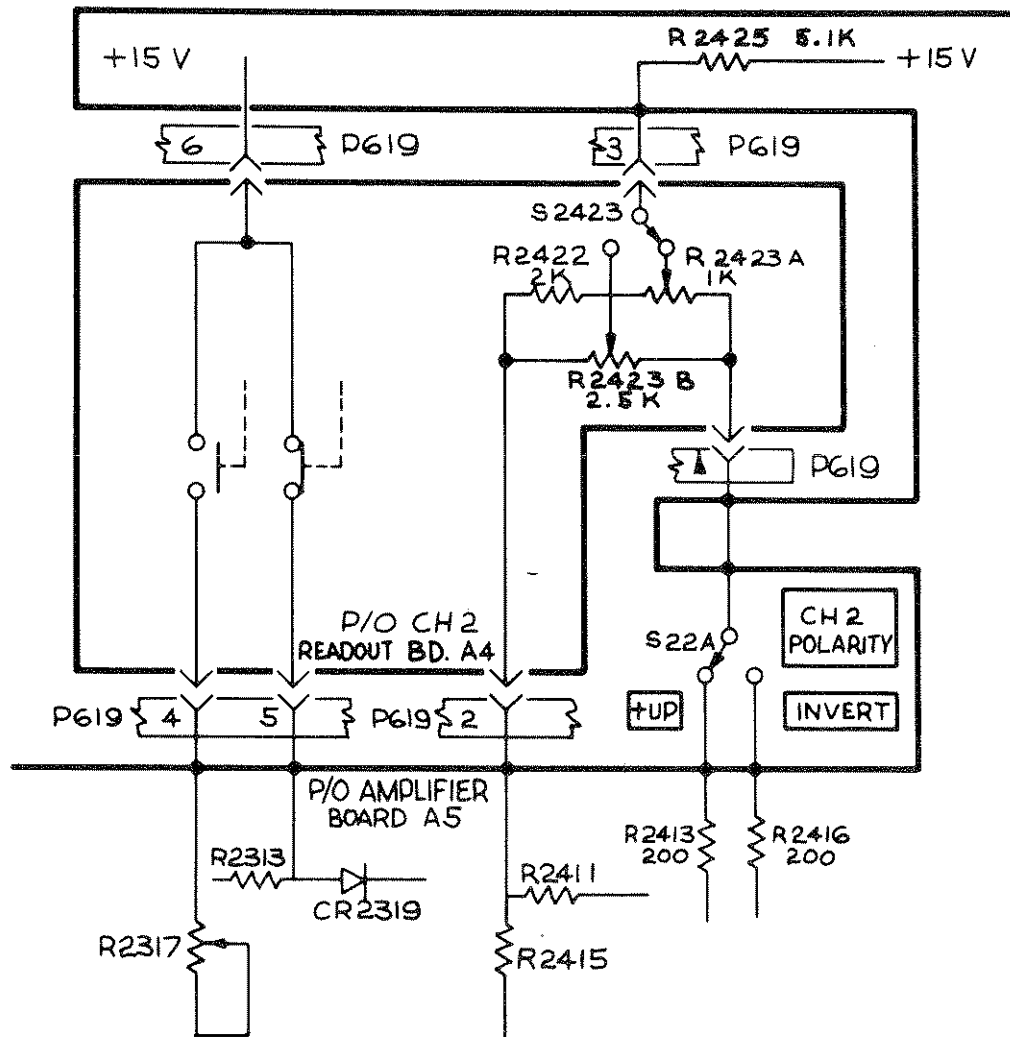

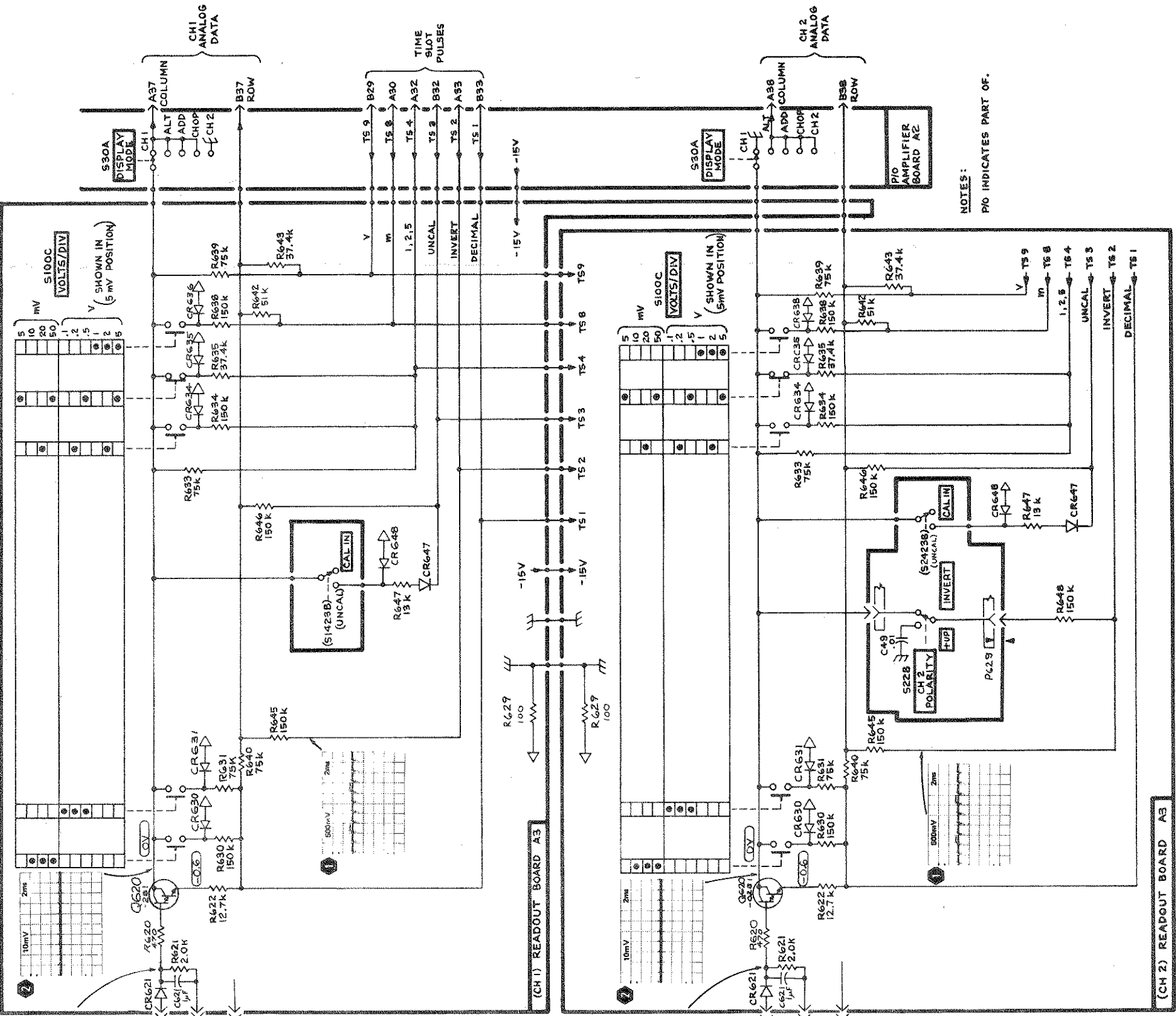

NOTES:
PIO INDICATES PART OF.

