



**ASG 100
Audio Signal Generator
Operator Manual**

070-8152-03

Warning

The servicing instructions are for use by qualified personnel only. To avoid personal injury, do not perform any servicing unless you are qualified to do so. Refer to all safety summaries prior to performing service.



Copyright © Tektronix, Inc., 1991, 1992. All rights reserved. Printed in U.S.A. Tektronix products are covered by U.S. and foreign patents, issued and pending.

Information in this publication supersedes that in all previously published material. Specifications and price change privileges reserved. The following are registered trademarks: TEKTRONIX and TEK.

For further information, contact: Tektronix, Inc., Corporate Offices, P.O. Box 1000, Wilsonville, OR 97070-1000, U.S.A. Phone: (503) 627-7111; TLX: 192825; TWX: (910) 467-8708; Cable: TEKWSGT.

Tektronix' Television Division participates in the Broadcast Professionals Forum (BPFORUM) on the CompuServe® Information Service. Press releases on new products, product-specific newsletters, application information and technical papers are among the types of information uploaded.

Additionally, product specialists from Tektronix will be "on line" to answer questions regarding product applications, operation and maintenance.

Instructions for accessing the information on CompuServe can be found in the current Tektronix Television Products Catalog.

CompuServe access is currently available in the U.S.A., Canada, Europe, Japan, Australia, New Zealand, Argentina, Venezuela, Korea, and Taiwan.

WARRANTY

Tektronix warrants that this product will be free from defects in materials and workmanship for a period of one (1) year from the date of shipment. If any such product proves defective during this warranty period, Tektronix, at its option, either will repair the defective product without charge for parts and labor, or will provide a replacement in exchange for the defective product.

In order to obtain service under this warranty, Customer must notify Tektronix of the defect before the expiration of the warranty period and make suitable arrangements for the performance of service. Customer shall be responsible for packaging and shipping the defective product to the service center designated by Tektronix, with shipping charges prepaid. Tektronix shall pay for the return of the product to Customer if the shipment is to a location within the country in which the Tektronix service center is located. Customer shall be responsible for paying all shipping charges, duties, taxes, and any other charges for products returned to any other locations.

This warranty shall not apply to any defect, failure or damage caused by improper use or improper or inadequate maintenance and care. Tektronix shall not be obligated to furnish service under this warranty a) to repair damage resulting from attempts by personnel other than Tektronix representatives to install, repair or service the product; b) to repair damage resulting from improper use or connection to incompatible equipment; c) to repair any damage or malfunction caused by the use of non-Tektronix supplies; or d) to service a product that has been modified or integrated with other products when the effect of such modification or integration increases the time or difficulty of servicing the product.

THIS WARRANTY IS GIVEN BY TEKTRONIX WITH RESPECT TO THIS PRODUCT IN LIEU OF ANY OTHER WARRANTIES, EXPRESSED OR IMPLIED. TEKTRONIX AND ITS VENDORS DISCLAIM ANY IMPLIED WARRANTIES OF MERCHANTABILITY OR FITNESS FOR A PARTICULAR PURPOSE. TEKTRONIX' RESPONSIBILITY TO REPAIR OR REPLACE DEFECTIVE PRODUCTS IS THE SOLE AND EXCLUSIVE REMEDY PROVIDED TO THE CUSTOMER FOR BREACH OF THIS WARRANTY. TEKTRONIX AND ITS VENDORS WILL NOT BE LIABLE FOR ANY INDIRECT, SPECIAL, INCIDENTAL, OR CONSEQUENTIAL DAMAGES IRRESPECTIVE OF WHETHER TEKTRONIX OR THE VENDOR HAS ADVANCE NOTICE OF THE POSSIBILITY OF SUCH DAMAGES.

TABLE OF CONTENTS

	Page
List of Illustrations	v
List of Tables	vi
Operator's Safety Summary	vii
Operators Safety Summary	
Section 1 Introduction and Specifications	
Introduction	1-1
Automatic Audio Channel Testing	1-1
Sweep Test Signals	1-2
Manual Test Signals	1-2
Line Up	1-2
Manual	1-2
Tone	1-2
Polarity	1-2
Multitone	1-2
Remote Control	1-2
Specifications	1-3
Electrical Characteristics	1-3
Environmental Characteristics	1-7
Mechanical Characteristics	1-7
Power Cord Options	1-8
Section 2 Installation and Setup	
Safety	2-1
Installation	2-1
Insertion Effects	2-1
Install the Power Cord	2-1
Connect to the Audio Path	2-2
Install Remote Control Cable	2-2
Rack Mounting	2-2
Power Up State	2-2
Diagnostics	2-3
Initial Setup	2-3
Setting Up and Editing Test Signals	2-5
Section 3 Operating Instructions	
Features and Capabilities	3-2
Tone Generation	3-2
Manual Sine Tone	3-2
Manual Polarity Tone	3-2
Manual Multitone Test	3-2
Dedicated Line Up Tone	3-2

	Page
Standard Test Sequence Generation	3-2
CCITT O.33 Tests	3-3
“TEK” Tests	3-3
“Sweep” Tests	3-3
Voice Source Identifier	3-3
Encoded Source Identification	3-4
Headphones	3-4
Remote Operation	3-4
Freedom of Operation	3-4
Front Panel Controls	3-5
Functions	3-5
ON LINE	3-5
SILENCE	3-6
VOICE	3-6
RECORD (PRESS SILENCE + VOICE)	3-6
AUTO	3-6
Auto Test Level	3-7
Sweep Test Level	3-7
LINE-UP	3-7
Alternating VOICE and LINE-UP	3-8
MANUAL	3-8
Tone Tests	3-8
Polarity Tests	3-9
Multi-Tone Tests	3-9
Manual Test Level	3-9
Manual Test Frequency	3-9
VOLUME	3-9
MIC. (Microphone)	3-9
IDENTIFICATION	3-10
FREQUENCY	3-10
AMPLITUDE	3-10
Arrow Buttons	3-11
↑(Up Arrow), ↓(Down Arrow)	3-11
←(Left Arrow), ⇒(Right Arrow)	3-11
PAUSE AUTO	3-11
SAVE	3-12
Status Feedback	3-12
Power	3-12
Power-On Diagnostics	3-12
OUTPUT $\geq 775\text{mV(rms)}$	3-13
Display Window	3-13
Headphones	3-13

	Page
Rear Panel Switch and Connectors	3-14
Power Switch	3-14
Audio Signal Connectors	3-14
Remote Connector	3-14
Section 4 Applications	
In the Engineering Van	4-1
At Remote Camera Locations	4-1
In Master Control	4-1
In the Shop	4-1
Multitone Test Signal	4-2
Polarity Signal Checks	4-2
Distortion Analyzer Check Signal	4-2
Polarity Checks	4-3
Appendix A Internal Settings and Setup Editing	
Enabling and Disabling Signal Editing	A-1
Editing Signal Parameters	A-3
Saving Signal Parameters	A-3
External Edit Enable	A-4
Front Panel and Remote Control Enabling	A-5
Setting the Output Impedance	A-5
Appendix B Standard Test Sequences	
CCITT O.33 Test Sequences	B-1
Monophonic Testing	B-1
Stereo Testing	B-1
CCITT O.33	B-7
TEK Test Sequences	B-8
TEK:90 and TEK:91	B-8
TEK:92	B-8
TEK:93	B-8
TEK:94	B-8
TEK:95	B-8
Test Sequence Output Level	B-8
TEK Test Sequence	B-16
TEK Preamble	B-16
Insertion Gain	B-16
Polarity Tone	B-16
Crosstalk	B-17
Total Harmonic Distortion plus Noise	B-17
Noise Floor (Silence)	B-17
Sweep	B-17
TEK Sweep Test	B-17
Appendix C Remote Operation	
Remote Control From a Terminal	C-1
Limited Local Remote Control	C-1

	Page
Installation for Remote Control	C-1
Connect a Properly Configured Communications Cable	C-1
Set DIP Switch to Enable Remote Control	C-4
Set Serial Communication Parameters on the Terminal	C-4
Setting Baud Rate of the ASG 100	C-4
Remote Operation	C-6
Remote Commands	C-6
Command Description	C-10
Help Commands	C-10
Queries	C-11
Unit Identification	C-11
Special Queries	C-12
Restoring Defaults	C-12
Flow Control	C-12
Remote Command Syntax	C-13
auto [[:level]][test_name]	C-13
Aborting an Auto Sequence	C-13
[r l][tone [f:frequency] [l:level]]	C-14
[r l]polr [l:level]	C-15
[r l]mtone<1 2 3 4> [l:level]	C-15
Appendix D Audio/Video Timing	
VM700A Audio/Video Measurement Operating Instructions	D-1
VM700A Signal Hookup	D-1
Audio Video Timing Menu	D-2
VITS200/ASG 100 or ASG 140 Audio/Video Measurement Operating Instructions	D-3
ASG100/ASG140 Instructions	D-3
Checkout	D-3
VITS200 Instructions	D-3
Checkout	D-4
VITS201/ASG100 or ASG 140 Audio/Video Timing Measurement Operating Instructions ...	D-4
Video/Audio Synchronization	D-4
ASG100/ASG 140 Instructions	D-4
Checkout	D-4
VITS201 Instructions	D-4
Checkout	D-5
VITS200, VITS201 and ASG100 Audio/VideoTiming Measurement Circuitry Modifications .	D-6
VITS200 Modification Description	D-6
Board Modifications to Early VITS200 Circuit Boards	D-6
VITS201 Modification Description	D-6
Checkout	D-7
ASG100 Modification Description	D-7
Checkout	D-7

Index

LIST OF ILLUSTRATIONS

Figure	Page
1-1 Typical 1 kHz THD + Noise versus Output Level	1-5
2-1 Back Panel of the ASG 100	2-2
3-1 ASG 100 Menu Map	3-1
3-2 ASG 100 Front Panel controls	3-5
3-3 Manual test signal selection using arrow keys	3-8
3-4 ASG 100 Rear Panel connectors	3-14
4-1 MANUAL polarity signal	4-3
4-2 Lissajous pattern for correct polarity	4-3
4-3 Lissajous pattern for left and right channel reversed polarity	4-4
4-4 Lissajous pattern for left channel reversed polarity	4-4
4-5 Lissajous pattern for right channel reversed polarity	4-5
4-6 Lissajous pattern for unequal gain between right and left channels	4-5
4-7 Lissajous pattern for unequal phase shift between right and left channels	4-6
A-1 Remove side panel door to access DIP switch	A-1
A-2 DIP switch settings for editing	A-2
A-3 Output impedance resistor network	A-6
A-4 Effects of a changing load resistance on the dBm output of the ASG 100	A-7
B-1 TEK polarity signal waveform.	B-16
C-1 Cabling to IBM PC/XT or Compatibles and the VM700A	C-3
C-2 Cabling to IBM AT/386 and Compatibles	C-3
C-3 Setting baud rate during power on	C-5
C-4 Help screen of remote commands	C-11
D-1 Audio Video Timing display	D-2
D-2 Cabling between the VITS200 and the ASG 100/ASG 140	D-3
D-3 Cabling between the VITS201 and the ASG 100/ASG 140	D-5

LIST OF TABLES

Table		Page
1-1	Electrical Characteristics	1-3
1-2	ASG 100 Multitones	1-5
1-3	Environmental Characteristics	1-6
1-4	Physical Characteristics	1-6
1-5	Voltage, Fuse, and Power Cord Data	1-7
2-1	Factory Settings for the ASG 100	2-4
A-1	Dip Switch Functions	A-4
B-1	O.33:00/O.33:00V (Mono) Test Sequence	B-2
B-2	O.33:01/O.33:01V (Stereo) Test Sequence	B-3
B-3	O.33:02/O.33:02V (Medium Band Sound Program) Test Sequence	B-4
B-4	O.33:03/O.33:03V (Narrow Band) Test Sequence	B-5
B-5	O.33:04/O.33:04V (Narrow Band Sound Program With Compandor) Test Sequence	B-6
B-6	O.33:05 (3-Level Alignment Signal for International Sound Program) Test Sequence	B-7
B-7	O.33 Preamble Structure	B-7
B-8	TEK:90/TEK:90V Monophonic Test Sequence	B-9
B-9	TEK:91/TEK:91V Stereo Test Sequence	B-10
B-10	TEK:92/TEK:92V Microphone Level Test Sequence	B-11
B-11	TEK:93/TEK:93V Line Level Test Sequence	B-12
B-12	TEK:94/TEK:94V Transmitter Test Sequence	B-13
B-13	TEK:95/TEK:95V Stereo Test Sequence with Crosstalk	B-15
B-14	Sweep Test Sequence	B-18
C-1	Pin Connections for Remote Connector	C-2
C-2	Serial Communication Parameters	C-4
C-3	List of ASG 100 Commands, Arguments, and Queries	C-7
C-4	Special Queries	C-10
C-5	Control Signals	C-10
C-6	Test Name Arguments to Remote "AUTO" Command	C-14

OPERATOR'S SAFETY SUMMARY

The general safety information in this part of the summary is for both operating and servicing personnel. Specific warnings and cautions will be found throughout the manual where they apply, but may not appear in this summary.

Terms In This Manual



statements identify conditions or practices that could result in damage to the equipment or other property.



statements identify conditions or practices that could result in personal injury or loss of life.

Terms As Marked on Equipment



CAUTION indicates a personal injury hazard not immediately accessible as one reads the marking, or a hazard to property, including the equipment itself. Refer to the manual for information.



DANGER indicates a personal injury hazard immediately accessible as one reads the marking.



Protective ground (earth) terminal.

SAFETY INFORMATION

Use the Proper Power Source. This product is intended to operate from a power source that will not apply more than 250 V rms between the supply conductors or between either supply conductor and ground. A protective-ground connection by way of the grounding conductor in the power cord is essential for safe operation.

Ground the Product. This product is grounded through the grounding conductor of the power cord. To avoid electrical shock, plug the power cord into a properly wired receptacle before connecting to the product input or output terminals. A protective-ground connection by way of the grounding conductor in the power cord is essential for safe operation.

Danger May Arise From Loss of Ground. Upon loss of the protective-ground connection, all accessible conductive parts (including knobs and controls that may appear to be insulating) can render an electric shock.

Use the Proper Fuse. To avoid fire hazard, use only the fuse of correct type, voltage rating, and current rating as specified in the parts list for your product. Refer fuse replacement to qualified service personnel.

Do Not Operate in Explosive Atmospheres. To avoid explosion, do not operate this product in an explosive atmosphere.

Do Not Remove Covers. To avoid personal injury, do not remove the product covers or panels. Do not operate the product without the covers and panels properly installed.

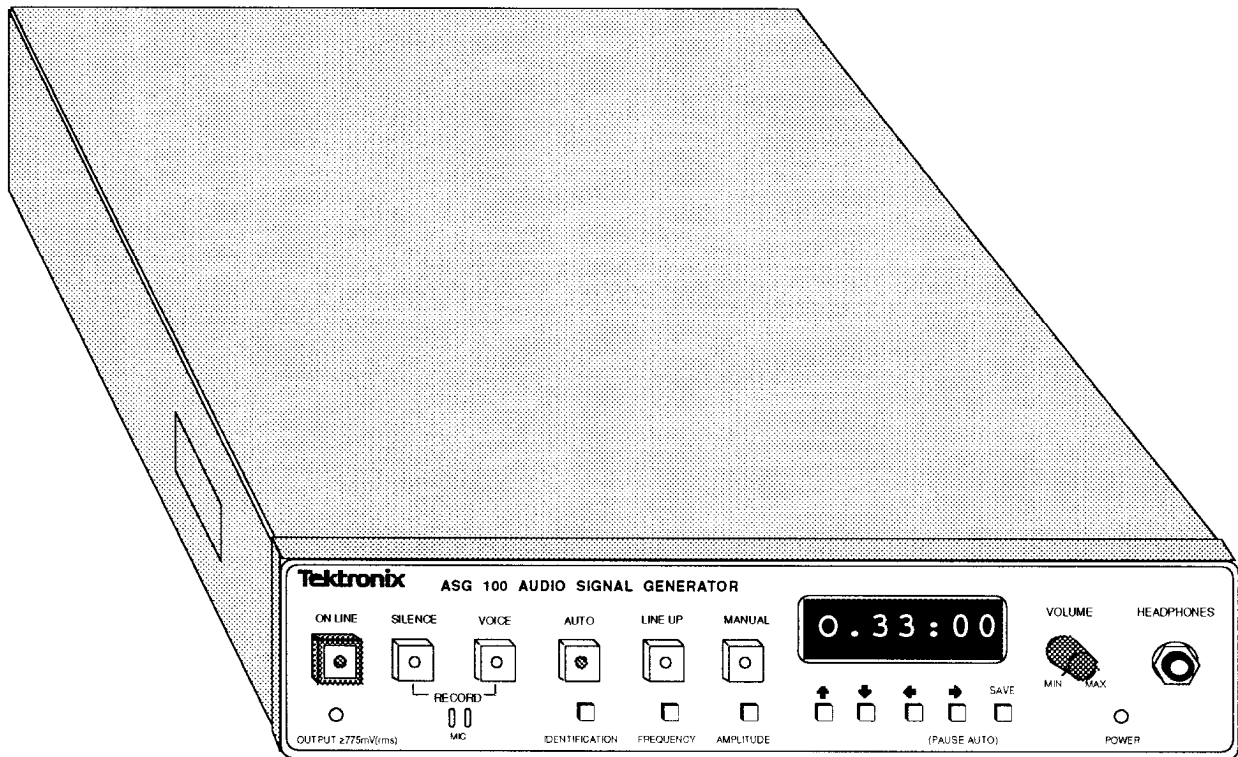

The ASG 100 Audio Signal Generator.

Section 1

INTRODUCTION AND SPECIFICATIONS

INTRODUCTION

The ASG 100 Audio Signal Generator was developed by Tektronix to meet the audio testing requirements of commercial broadcasting. The ASG 100 reduces testing time by transmitting short, predefined audio test sequences that produce precise and easily reproduced results in its AUTO mode. It can also transmit source identification, a voice segment (either continually or as part of the AUTO test) and user defined tones. The user defined tones of LINE UP and MANUAL test signal operation provide the continuous signals needed for adjusting audio levels and manual checking of the left/right audio channels.

AUTOMATIC AUDIO CHANNEL TESTING

Test equipment for sound programming and the sound channels of television programming must be capable of quickly checking the audio signal path to make sure of the circuit's quality. Automatic equipment must be able to rapidly measure the test signal in ways that give repeatable and meaningful test results.

To assist in the repeatability area, standard test signal sequences have been defined. These sequences begin with the necessary components to start the measurement, identify the source of the test signals, and identify the stored automatic test that is to be done. Then the test signal portion of the sequence runs in predefined frequency, level, and timing patterns that permit automated testing of the signal path characteristics.

Each test signal in an automatic test sequence is used to check on the different parameters that are important to signal quality. The tests have defined sequences for both monaural and stereo audio testing, and are based on Recommendation O.33 of the *CCITT Specification For Measuring Equipment, Volume IV, Series O Recommendations-1988*.

When used with a CCITT O.33 compliant receiver, such as the Tektronix VM700A Option 40 or Option 41, the results of the AUTO testing sequence can be documented automatically without the need for human intervention (unless of course, an out-of-tolerance condition is found by the test).

The Tektronix VM700A Option 40 and Option 41 receiving and measuring equipment uses the test signals sent by the companion ASG 100 audio signal generator to measure the following parameters as defined in Recommendation O.33 for monophonic audio paths.

- Insertion Gain
- Frequency Response
- Distortion
- Signal-to-Noise Ratio
- Compondor Linearity
- Expanded Noise

For stereophonic audio paths, additional measurements are done to assure the A/B (left/right) channel parameters of the signal paths are sufficiently matched for proper transmission of the program audio. The added measurements are:

- Interchannel difference in gain and phase
- Interchannel crosstalk and circuit transposition

SWEEP TEST SIGNALS

A sweep test signal is included under the Auto test signals. The sweep level is selectable from -90 to $+24$ dBu, the same amplitude range as the Line Up and Tone signals. The sweep test signal provides a set of frequencies useful for checking the response of audio circuits (see Appendix B, *Standard Test Signals*, for the frequencies).

MANUAL TEST SIGNALS

Line Up

The Line Up test signal is selectable in both frequency and amplitude for use in providing a known line up signal for adjusting levels from various audio sources. This signal may be set for a house standard and then fixed (editing disabled) or it may remain controllable from the front panel. The frequency range is from 10 Hz to 20 kHz and the amplitude range is from -90 dBu to $+24$ dBu. As shipped from the factory (and the default if factory defaults are reloaded), the Line Up signal is 400 Hz at 0.0 dBu.

NOTE

To preserve the Line Up definition, the parameters of the Line Up test signal are not alterable using serial remote control. A new Line Up signal may be defined (amplitude and frequency) from the front panel when the editing feature is enabled.

Manual

Tone

The Tone test signal comes as stereo, left tone, and right tone. The frequency and amplitude are selectable over the same range as the Line Up signal. The factory default for the Tone signals are 440 Hz at 0.0 dBu.

Polarity

Polarity also comes as stereo, left polarity, and right polarity. The polarity test signal is the sum of a fundamental sine wave of 440 Hz and its equal amplitude second harmonic sine wave of 880 Hz. The amplitude of the polarity signal is selectable from -90 dBu to $+24$ dBu with a fixed fundamental frequency of 440 Hz. The factory default for the amplitude is 0.0 dBu.

Multitone

The Multitone signals also come as stereo, and left and right channels. Multitone signals are composed of a selected set of sine wave frequencies. There are presently four sets of multitone signals covering different bandwidths and providing different sine wave components. The multitone signals are used to check for response and harmonic distortion of audio circuits and devices (amplifiers, tape recorders, cables, etc.). The factory default for the amplitude is 0.0 dBu. Note that this amplitude is the RMS value of the combined test signal, not the amplitude of an individual frequency in the signal.

REMOTE CONTROL

There are two types of remote control possible with the ASG 100. The remote control connector on the rear panel of the instrument may be used as contact closure connections for minimal remote operation. Using contact closure remote, an AUTO sequence may be started and front panel editing may be enabled (if it is internally disabled). The second type of remote control uses the remote control connector as an RS-232C serial port, and the majority of the instrument's operation may be controlled via a PC or terminal. Remote Operation is discussed in Appendix C. The Audio/Video Timing signal synchronization feature is also controlled through the remote port. See *Appendix D* for information on the Audio/Video Timing feature.

SPECIFICATIONS

Electrical Characteristics

Table 1-1
Electrical Characteristics

Characteristic	Performance Requirement	Comment
External Power		
Voltage (Nom.)	100 to 240 Vac.	Full range, no selector.
Input Freq Range	47 Hz to 440 Hz.	
Power Consumption	20 W Typical.	
RS-232C Interface		
Baud Rates	1200, 2400, 4800, and 9600 (factory default).	Front panel selection only, no switch settings for baud rate except the factory default of 9600.
Maximum Applied Voltage	25 V (dc + peak ac).	
Signals	RXD (received data), TXD (transmitted data), and GND are used for serial remote control of the ASG 100.	RTS and CTS are not used in the ASG 100. Pins 4, 6, and 9 of the connector are not to be connected to the terminal interconnection cable. Those pins are used for contact closure remote control.
Levels	Compatible with RS-232C.	
Connector	DB-9 DTE (terminal communications device).	Requires a null modem for connection to another DTE device.
Output Signal Frequency		
Range	10 Hz to 20 kHz.	
Multitone	See Table 1-2	
Resolution	1 Hz.	
Accuracy	± 0.1 %.	
Output Signal Amplitude		
Range	-90 dBu to +24 dBu (24.5 μ V to 12.2 V_{rms}) balanced into a load resistance of 10 k Ω or greater with 12 Ω source resistance.	Output is approximately 0.17 dB lower with a 600 Ω load and is 6 dB lower with internal 600 Ω source resistance and a 600 Ω load.
Accuracy	± 0.2 dB at 1 kHz from +24 dBu to -80 dBu into a load resistance of 10 k Ω or greater.	
Resolution	± 0.1 dB.	Multitone signal components are not sent at the specified amplitude; the amplitude specification is for the combined Multitone signal rms value.
Flatness	± 0.2 dB, 10 Hz to 20 kHz* +0.05/-0.2 dB, 10 Hz to 20 kHz (relative to 1 kHz)**	
		Typ. ± 0.1 dB, 10 Hz to 19 kHz* Typ. +0.05/-0.1 dB, 10 Hz to 15 kHz**

* For instruments with serial numbers B0399999 and below

** For instruments with serial numbers B040000 and above

Table 1-1 (cont.)

Characteristic	Performance Requirement	Comment
Total Harmonic Distortion + Noise for outputs ≥ -10 dBu (245 mV _{rms}) (measured over an 80 kHz bandwidth)	< 0.01% (-80 dB), 20 Hz to 18 kHz*; < 0.025% (-72 dB), 18 kHz to 20 kHz*; < 0.015% (-76.5 dB), 10 Hz to 19 kHz**; < 0.056% (-65 dB), >19 kHz to 20 kHz**	< 0.005% at 1 kHz at full output, measured over a 22 KHz bandwidth (see typical curve in Figure 1-1). This typical specification will also hold at +14 dBu and +4 dBu.
Signal-to-Noise, measured over a 22 kHz bandwidth.	> 90 dB at 1 kHz at 0 dBu output level.	$S/N = 20 \log \frac{V_{\text{Manual}}}{V_{\text{Silence}}}$ S/N improves as the output signal increases and decreases as output reduces, proportionally.
XLR Inputs	Balanced.	EMI capacitive load of 0.002 μ F. Looped through to output if ASG 100 is not ON LINE.
XLR Outputs	Balanced.	
Output Impedance	12 Ω , 600 Ω or User-defined; balanced.	
Level Difference Between Channels	≤ 0.2 dB at +14 dBu.	
Phase Difference Between Channels	$\leq 1^\circ$, 10 Hz to 20 kHz.	
Typical Crosstalk + Noise measured over 80 kHz band-width at +24 dBu Generator to Output	≤ -90 dB at 1 kHz and 20 kHz.	Left tone into Right output or Right tone into Left output; generator source resistance 12 Ω and load termination either open or 600 Ω .
Input to Output (loop through; ASG 100 off line)	≤ -110 dB at 1 kHz and 20 kHz with both outputs unterminated. ≤ -115 dB at 1 kHz and ≤ -110 dB at 20 kHz with driven channel terminated into 600 Ω and the inactive channel unterminated. ≤ -120 dB at 1 kHz and 20 kHz with the driven channel unterminated and the inactive channel terminated in 600 Ω . ≤ -120 dB at 1 kHz and 20 kHz with both outputs terminated in 600 Ω .	Left channel input into Right channel output or Right channel input into Left channel output; source resistance 50 Ω . Typ. ≤ -130 dB measured over a 22 kHz bandwidth at 1 kHz.

* For instruments with serial numbers B0399999 and below

** For instruments with serial numbers B040000 and above

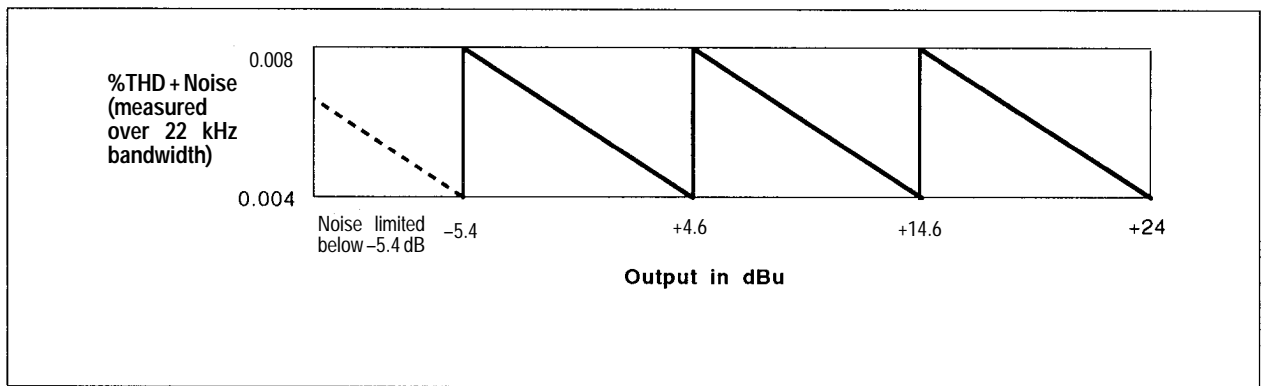

Figure 1-1. Typical 1 kHz THD + Noise versus Output Level.

Table 1-2
ASG 100 Multitones

Multitone 1	Multitone 2	Multitone 3	Multitone 4
59	23	47	23
117	94	141	117
187	141	281	234
246	223	656	750
293	270	1031	867
375	352	2016	1758
422	562	4031	3492
949	879	8019	6984
1184	1113	15000	13992
1512	1395		20015
1887	1758		
2391	2227		
3000	2789		
3785	3516		
4758	4430		
6012	5590		
7570	7043		
9539	8871		
12012	11180		
15000	14074		
	17742		
	19992		

NOTE

The Multitone signals are combined in repetitive blocks. At the end of the block time, all the signals are in phase again for a seamless transition into the next signal block.

ENVIRONMENTAL CHARACTERISTICS

Table 1-3
Environmental Characteristics

Characteristic	Limits
Operating Temp.	0° C to +50° C.
Non-Operating Temp.	-40° C to +65° C.

MECHANICAL CHARACTERISTICS

Table 1-4
Physical Characteristics

Characteristic	Value
Length	18.0 in. (458 mm).
Width	8.1 in. (206 mm).
Height	1.7 in. (43 mm).
Weight	3.25 lb. (1.48 kg).

Table : Certifications and compliances

Category	Standards or description
EC Declaration of Conformity – EMC	<p>Meets intent of Directive 89/336/EEC for Electromagnetic Compatibility. Compliance was demonstrated to the following specifications as listed in the Official Journal of the European Union:</p> <p>EN 50081-1 Emissions: EN 55022 Class B Radiated and Conducted Emissions</p> <p>EN 50082-1 Immunity: IEC 801-2 Electrostatic Discharge Immunity IEC 801-3 RF Electromagnetic Field Immunity IEC 801-4 Electrical Fast Transient/Burst Immunity</p> <p>Must use high quality shielded cables to ensure conformance with EMC regulations.</p>
Australia/New Zealand Declaration of Conformity – EMC	<p>Complies with EMC provision of Radiocommunications Act per the following standard(s):</p> <p>AN/NZS 2064.1/2 Industrial, Scientific, and Medical Equipment: 1992 AN/NZS 3548 Information Technology Equipment: 1995</p>
EMC Compliance	<p>Meets the intent of Directive 89/336/EEC for Electromagnetic Compatibility when it is used with the product(s) stated in the specifications table. Refer to the EMC specification published for the stated products. May not meet the intent of the directive if used with other products.</p>
FCC Compliance	<p>Emissions comply with FCC Code of Federal Regulations 47, Part 15, Subpart B, Class A Limits.</p>
EC Declaration of Conformity – Low Voltage	<p>Compliance was demonstrated to the following specification as listed in the Official Journal of the European Union:</p> <p>Low Voltage Directive 73/23/EEC, amended by 93/69/EEC</p> <p>EN 61010-1:1993 Safety requirements for electrical equipment for measurement control and laboratory use.</p>
U.S. Nationally Recognized Testing Laboratory Listing	<p>UL3111-1 Standard for electrical measuring and test equipment. UL1244 Standard for electrical and electronic measuring and testing equipment.</p>
Canadian Certification	<p>CAN/CSA C22.2 No. 231 CSA safety requirements for electrical and electronic measuring and test equipment.</p>
Additional Compliance	<p>IEC61010-1 Safety requirements for electrical equipment for measurement, control, and laboratory use.</p>
Installation (Overvoltage) Category	<p>Terminals on this product may have different installation (overvoltage) category designations. The installation categories are:</p> <p>CAT III Distribution-level mains (usually permanently connected). Equipment at this level is typically in a fixed industrial location. CAT II Local-level mains (wall sockets). Equipment at this level includes appliances, portable tools, and similar products. Equipment is usually cord-connected. CAT I Secondary (signal level) or battery operated circuits of electronic equipment.</p>
Pollution Degree	<p>A measure of the contaminants that could occur in the environment around and within a product. Typically the internal environment inside a product is considered to be the same as the external. Products should be used only in the environment for which they are rated.</p>

Table : Certifications and compliances (cont.)

Category	Standards or description	
	Pollution Degree 1	No pollution or only dry, nonconductive pollution occurs. Products in this category are generally encapsulated, hermetically sealed, or located in clean rooms.
	Pollution Degree 2	Normally only dry, nonconductive pollution occurs. Occasionally a temporary conductivity that is caused by condensation must be expected. This location is a typical office/home environment. Temporary condensation occurs only when the product is out of service.
	Pollution Degree 3	Conductive pollution, or dry, nonconductive pollution that becomes conductive due to condensation. These are sheltered locations where neither temperature nor humidity is controlled. The area is protected from direct sunshine, rain, or direct wind.
	Pollution Degree 4	Pollution that generates persistent conductivity through conductive dust, rain, or snow. Typical outdoor locations.

POWER CORD OPTIONS

Table 1-5
Voltage, Fuse,^a and Power Cord Data

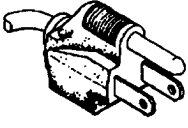
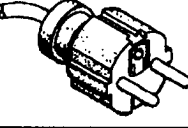
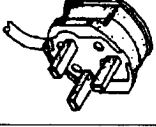
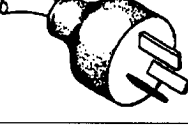
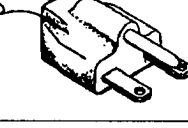
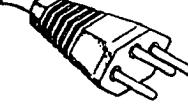
Plug Configuration	Category	Power Cord and Plug Type	Voltage Range	Reference Standards ^b
	U.S. Domestic Standard	U.S. 120 V 15 A	115 V Nominal 90 V to 132 V	ANSI C73.11 NEMA 5-15-P IEC 83 UL 198.6
	Option A1	EURO 240 V 10-16 A	230 V Nominal 180 V to 250 V	CEE(7), II, IV, VII IEC 83 IEC 127
	Option A2	UK ^c 240 V 6 A	230 V Nominal 180 V to 250 V	BS 1363 IEC 83 IEC 127
	Option A3	Australian 240 V 10 A	230 V Nominal 180 V to 250 V	AS C112 IEC 127
	Option A4	North American 240 V 15 A	230 V Nominal 180 V to 250 V	ANSI C73.20 NEMA 6-15-P IEC 83 UL 198.6
	Option A5	Switzerland 220 V 6 A	230 V Nominal 180 V to 250 V	SEV IEC 127

^a All options listed come with a factory-installed fuse for the selected operating voltage range.

^b Reference Standards Abbreviations:

ANSI—American National Standards Institute

AS—Standards Association of Australia

BS—British Standards Institution

CEE—International Commission on Rules for the Approval of Electrical Equipment

IEC—International Electrotechnical Commission

NEMA—National Electrical Manufacturer's Association

SEV—Schweizerischer Elektrotechnischer Verein

UP—Underwriters Laboratories Inc.

^c A 6 Ampere, type C fuse is also installed inside the plug of the Option A2 power cord.

Section 2

INSTALLATION AND SETUP

SAFETY

Before connecting the ASG 100 to a power source, read both this section and the Operator's Safety Summary at the front of this manual.

INSTALLATION

Unlike most audio generators, for which you must break the audio path to connect up the equipment for testing, then break the audio path again and reconnect it when the testing is done, the standard ASG 100 can be installed anywhere in the audio path as a permanent test fixture. Testing can then be done routinely without disturbing the normal transmission audio path.

When not being used for testing, the ASG 100 is off line, and the input ports are connected directly to the corresponding output ports. Your normal outgoing program signal passes right through it to the downstream equipment. When transmitting an AUTO sequence test signal, the ASG 100 temporarily interrupts the program source signal and goes ON LINE to transmit the chosen audio test pattern. After the pattern is sent, the ASG 100 goes off line again and reconnects the input and output ports, restoring the program audio signal. The LINE UP and MANUAL tests can be ON LINE as long you need to perform line up adjustments or manual testing.

Insertion Effects

To protect against electromagnetic interference, the ASG 100 connects the shield (pin 1) of each audio cable to chassis (earth) ground. When the ASG 100 is off line, in the loop-through state, the capacitance to ground from the signal lead for each AUDIO INPUT line causes a small amount of roll off to the looped-through audio signal. The amount of roll off is less than 0.03 dB at 20 kHz with a 600- Ω balanced source and high impedance load. Lower source or load impedances will display even less roll-off effect.

Install the Power Cord

WARNING

To avoid electrical shock, the ground safety lead of the power cord must be properly connected to earth ground.

Connect the detachable three-wire power cord to the power connector on the rear panel of the ASG 100. The back panel of the ASG 100 is shown below in Figure 2-1. Plug the power cord into the outlet for any ac voltage source between 100 and 240 volts. You do not need to make any line voltage selections on the ASG 100 to accommodate different source voltages in the rated operating range. Various power cord options are available to match the various international ac mains. The power cord supplied with the ASG 100 is as ordered from the factory. See Section 1, *Introduction and Specifications*, for the power cord options.

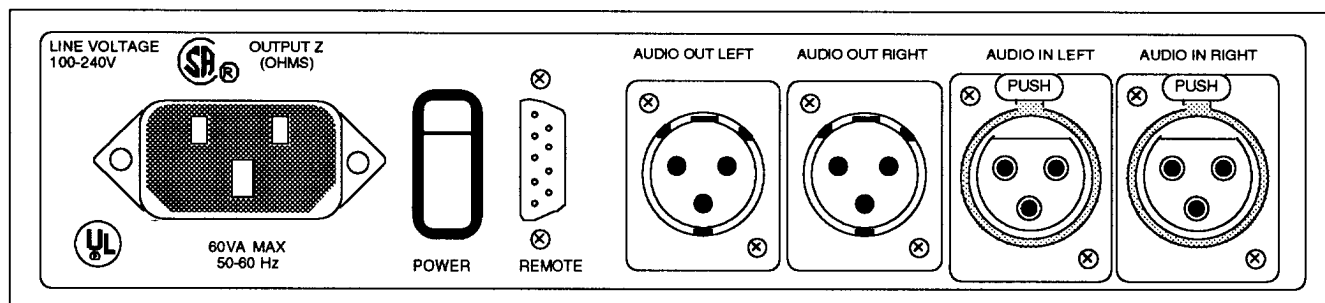

Figure 2-1. Back Panel of the ASG 100.

Connect to the Audio Path

Install the ASG 100 in series at the point in the audio path where you want to initiate the test sequence. Connect cables from the equipment to be tested to the Output ports observing the correct left/right channel placement. If there is equipment in the audio path before the point where the ASG 100 is installed, connect cables from that equipment to Audio In ports.

When powered off, or off-line (the ON-LINE LED not lit), the ASG 100 is in the loop-through state and passes the source signal along the audio path intact.

When on-line, the ASG 100 interrupts the source signal and sends the test sequence you select into the downstream audio equipment.

Install Remote Control Cable

The remote connector is used when controlling the instrument remotely using the commands available via the RS-232C interface. See Appendix C, *Remote Control*, for using the remote commands. The connections and wiring for a remote control cable are also found in Appendix C.

There is also a simple contact-closure type of remote control available via the REMOTE connector. If you want to initiate AUTO test sequences from an operating position using a this type of remote control, connect pins 4 and 9 in the REMOTE port on the ASG 100 to some contact closure, such as a relay on a control panel. When the relay closes and connects pins 4 and 9 together, the ASG 100 goes ON LINE and sends the selected AUTO test sequence. A momentary contact causes the sequence to be sent once and then return to the previously selected operation. Continuous contact will cause the AUTO test sequence to be repeated until the contact is opened. The editing feature, if it is internally disabled, may also be enabled via the remote connector. This feature permits editing of the signal settings without the need to remove the side panel of installed equipment to reset the editing switches (see Appendix A for switch setting information).

Rack Mounting

The ASG 100 Audio Signal Generator is a half-rack wide instrument. For mounting a single ASG 100 signal generator in a standard 19-inch equipment rack, use the full-rack mounting adapter that is only one rack unit high. A dual half-rack mounting adapter permits stacking two ASG 100 generators in a three rack unit high space. There is also a full-width rack adapter for side-by-side installation of two ASG 100 generators in a two rack unit high space. For ordering information on available rack adaptors, refer to the Tektronix Television Products Catalog or contact your local Tektronix Field Office or representative.

Power-Up State

At power up, the normal state of the ASG 100 is OFF LINE (loop-through state) with the AUTO test sequence selected. There are two front-panel setup options: factory default and user selected

default, default meaning the front panel state that is automatically present on power-on. Factory defaults for the selected tests, test levels, and frequencies are restored each time the ASG 100 is turned on if user selected defaults are not enabled. When user selected defaults are enabled, the “saved” setups for the selected auto and manual tests, and the selectable frequencies and test levels are restored. The front-panel defaults in effect at power on depend on the settings of an internal dip switch. One of the switch settings determines whether the factory default settings are recalled or the user programmed settings that have been saved are recalled. Editing and saving of the changes are discussed in the Section 2 and Appendix A of this manual.

When power is lost (either through a power failure or a normal power), the ASG 100 reverts to the off line (loop-through state) state. The ASG 100 remains off line and defaults to AUTO when power is restored. Any LINE UP or MANUAL test that was in progress at power off will have to be reselected and restarted.

Diagnostics

The ASG 100 performs several self tests each time you power it up. If it fails one, the display indicates the failed self test and the other functions are disabled. Refer your instrument to a qualified service person or consult your local Tektronix representative for service information if a diagnostic failure occurs.

INITIAL SETUP

All ASG 100s are shipped with factory settings as listed in Table 2-1.

Initial setup before operation in your system may include changing some or all of the factory settings to settings appropriate for your application. As shipped from the factory, full editing is enabled, and the following functions may be changed:

- Auto test sequence selection (CCITT O.33, TEK, or Sweep)
- Auto-test reference level (for CCITT O.33 and TEK sequences)
- Sweep-test reference level (for Sweep, Sweep Left, and Sweep Right)
- Auto-test four-character identifier (ID)
- Voice identifier (4-seconds of digitally recorded audio)
- Line up frequency and amplitude (local control only)
- Manual Test selection (Tone, Polarity, Multi-tone)
- Tone, Right Tone, or Left Tone
- Tone frequency and amplitude
- Polarity, Left Polarity, or Right Polarity
- Polarity amplitude
- Multi-tone (1, 2, 3, or 4), Left Multi-tone (1, 2, 3, or 4) or Right Multi-tone (1, 2, 3, or 4).
- Multi-tone amplitude
- Source impedance selection (10 Ω from the factory, requires component changes)
- Control enabling/disabling (local and remote disables with internal switch settings)
- Editing capability (internal switch settings)

**Table 2-1
Factory Settings for the ASG 100**

Function	Factory Setting	Comments
AUTO	0.33:01	
TEST LEV CCITT 0.33 and TEK Sequences	0.0 dBu	
SweepLev Sweep, R Sweep, and L Sweep	0.0 dBu	
MANUAL	TONE	
Tone and Polarity Amplitude	0.0 dBu	
Frequency	440 Hz	
Multitone Amplitude	0.0 dBu	
LINE UP		Line Up signal parameters are not editable via remote control. This preserves the Line Up signal definition.
Amplitude	0.0 dBu	
Frequency	400 Hz	
IDENTIFICATION	TEK1	
VOICE IDENTIFIER	Blank	Restoring Factory Defaults does not erase a recorded identifier.
COMMUNICATIONS PARAMETERS		
Baud Rate	9600	Rate are 9600, 4800, 2400, and 1200 baud; selectable at power on.
Parity	None	Parity, Stop Bits, and Data Bits are fixed.
Stop Bits	1	
Data Bits	8	
CONTROL ENABLING		
Front Panel Controls	Enabled	These are switch settings that are not controlled by firmware at power on.
Remote Control	Enabled	
POWER UP DEFAULTS	User Defaults Enabled	These will be the factory defaults until they are edited.
EDITING	Enabled	There are 3 sections of editing enables to permit customization for different levels of operating features accessible to the user.

SETTING UP AND EDITING TEST SIGNALS

The user definable variables vary for the different tests. When editing is enabled, all the definable choices may be accessed for customizing the frequencies and levels of the test signals for your applications. The default test sequence in the AUTO test, the default MANUAL test type, and the encoded IDENTIFICATION may also be defined and saved. The user-defined defaults are recalled at power on.

When editing is disabled, the various test are still selectable, but the frequency and level of the test signals are unalterable from the front panel.

Selective disabling of the editing function permits a fairly wide range of customization choices for front panel editing of and amplitude choices for the test signals. For instance, the Line Up signal frequency and level may be set to the house standard and fixed to prevent accidental editing from the front panel while leaving the user full access to the MANUAL test editing functions. A second option would be to define the level and frequency of the MANUAL TONE tests for specific applications and then disable the editing feature for those test as well. You would then have a dedicated test frequency and level defined for the MANUAL test choices as well as the LINE UP signal.

Editing enabling and disabling are controlled by setting internal switch positions. An access panel must be removed to make the appropriate switch settings. Refer all internal adjustments to a qualified service person. Information on controlling the editing feature is found in Appendix A, *Internal Settings*.

When the contact-closure remote control cable is attached, the editing feature can be temporarily enabled by connecting pins 6 and 9 of the connector together. Make the changes needed, then disconnect the pins. Using RS-232C serial communications remote control, any the test signals and their variable settings may be edited (but not saved as the user defined defaults). See Appendix C, *Remote Operation*, for using the remote commands.

Section 3 OPERATING INSTRUCTIONS

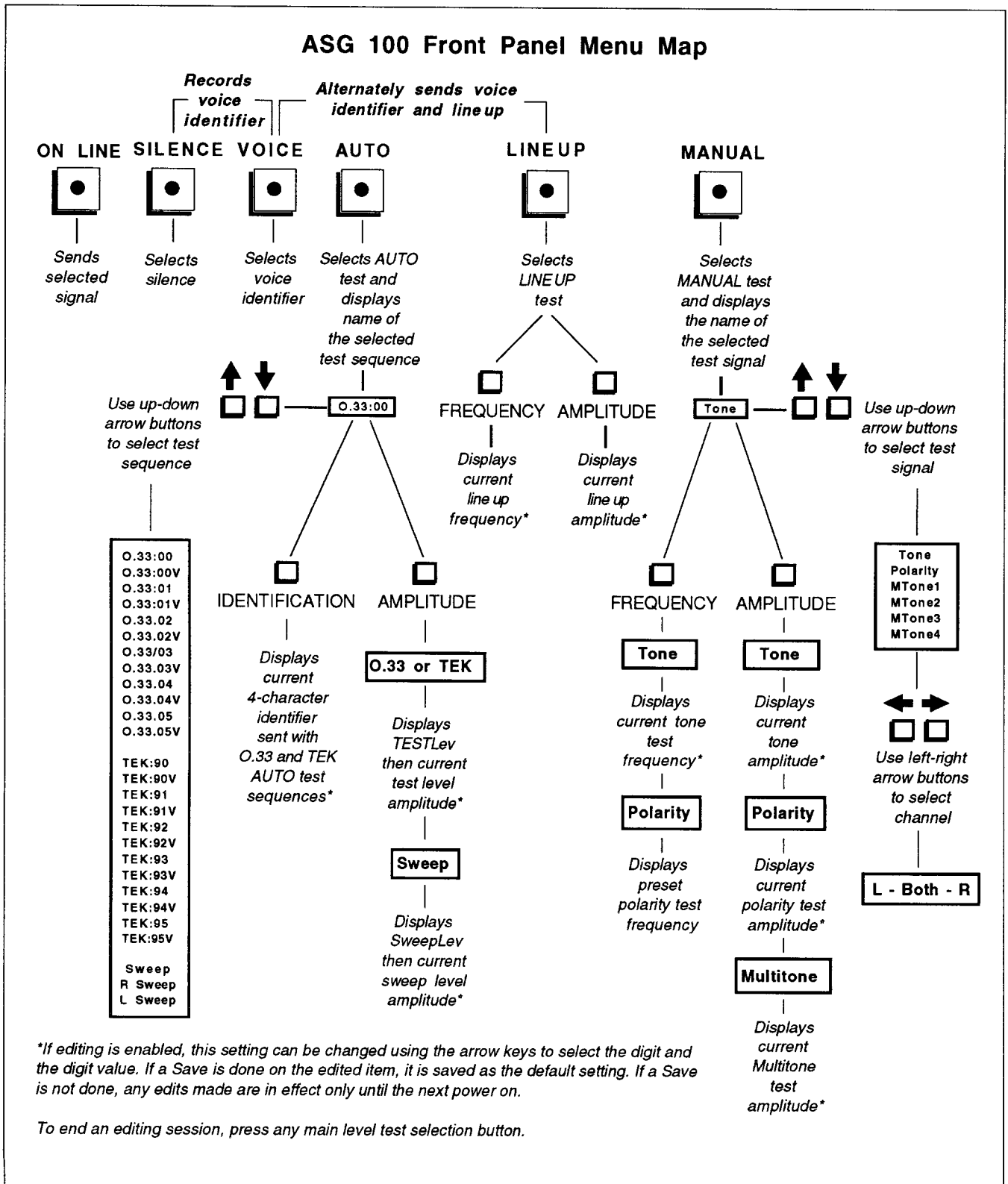

Figure 3-1. ASG 100 Menu Map.

FEATURES AND CAPABILITIES

This text presents an overview of the capabilities of the ASG 100. Complete information on how to use these capabilities is described later in this section of the manual. The menu map shown in Figure 3-1 provides a quick reference for accessing the test signals and setting levels and frequencies.

Tone Generation

The ASG 100 provides all the capabilities of traditional audio generators; it can create tones across the full range of audio frequencies and levels used in broadcasting and transmission. These signals are then monitored with such equipment as the Tektronix VM700A Option 40, Tektronix 760 Stereo Audio Monitor, VU meters, and with distortion analyzers, such as the Tektronix AA5001 to determine the quality of the audio signal path. The variable parameters for the test signals and the selected test signal may be changed either directly from the front panel or remotely via the RS-232C serial port.

Manual Sine Tone

The ASG 100 can generate a tone whose frequency and level can be modified as required for testing an audio circuit. The tone may be applied simultaneously to both channels or to the left or right channel individually. The amplitude and frequency settings for the left channel, right channel, and both channel test signals are the same.

Manual Polarity Tone

The ASG 100 can generate a fixed two-frequency, variable amplitude test tone. This polarity tone may be applied simultaneously to both channels or to left or right channel individually. The amplitude setting is the same for all three polarity test signals.

Manual Multitone Test

The ASG 100 can also generate a selection of multitone test signals. The multitone signals are composed of a set of summed sine wave frequencies and are used in testing a circuit's frequency response and harmonic distortion. These signals also may be applied simultaneously to both channels or to the left or right channel individually. A set amplitude is the same for all the multitone signals.

Dedicated Line-up Tone

The ASG 100 can generate a fixed alignment tone, which you can set from the front panel to match your house line-up level. This gives technicians at the studio confidence that the operator in the field is actually sending the proper level when a line-up is requested. The line-up level and frequency is often set once; then, further editing is disabled to ensure that the line-up signal is not inadvertently changed during operation. The line-up tone frequency and amplitude may be changed only from the front panel when editing of its parameters is enabled. When the line-up signal is asked for remotely, there are no frequency or amplitude arguments available, so the preset line-up signal is the only choice. This preserves the definition of the line-up signal.

Standard Test Sequence Generation

Beyond tone generation, the ASG 100 generates rapid audio test sequences conforming to the CCITT O.33 industry standards. These auto test sequences are recognized by CCITT O.33 compliant receivers, such as the Tektronix VM700A Option 40 or Option 41.

The automatic test sequences complete in about 30 seconds or less. The sequences sent (specified in Appendix B, *Standard Test Sequences*) provide for a full set of measurements. You can initiate the auto test sequences either locally from the front panel or remotely.

From the front panel, selecting AUTO and pressing ON LINE starts the selected auto test sequence. While the ASG 100 is on line for an AUTO test, further button presses (except ON LINE to turn the auto sequence off) are locked out until the test sequence has completed.

There are two methods to start an AUTO test via the REMOTE CONTROL connector found on the rear panel. The first is simply connecting pins 4 and 9 together. This tells the ASG 100 to go ON LINE and initiate the selected AUTO test sequence. A momentary connection sends the test sequence once; holding the connection closed will cause the AUTO test sequence to continually cycle. Remote control of starting the sequence is achieved by connecting pins 4 and 9 to a relay that is controlled either by a manual switch or with commands sent from a computer, such as you might use for controlling the studio equipment.

The second method uses the RS-232C serial port to control the ASG 100 functions remotely using a terminal or PC with terminal emulation software. Sending the command "AUTO" starts the selected auto test sequence. Sending any other command (including just a carriage return) before the test sequence has completed will abort the auto test sequence. All of the test signals, frequency, and level settings (where appropriate) are accessible via remote control in this manner. Remote control operation is discussed in Appendix C, *Remote Operation* of this manual.

CCITT O.33 Tests

The ASG 100 sends test sequences numbered 00, 01, 02, 03, 04, and 05 as defined in CCITT Recommendation O.33. These approximately 30 second test signal sequences are used to measure several monaural and stereo parameters, including insertion gain, interchannel gain and phase inequality, distortion, noise, and compandor tracking. (For detailed test sequence specifications, refer to Appendix B, *Standard Test Sequences*.)

The O.33 tests are internationally standardized and useful for most general purpose line measurement needs.

"TEK" Tests

O.33 specified test sequences do not meet some requirements of the ANSI T1.502-1988 standard— notably the THD+N test (total harmonic distortion + noise), which T1.502 requires be performed at 400 Hz.

Since no predefined test sequence meeting T1.502-1988 requirements exists, Tektronix defined its own, identified on the ASG 100 as "TEK" test 90 and 91. TEK:90 is useful for monaural and TEK:91 for stereo applications. Several other TEK test sequences are available for use in other special testing applications. The TEK test specifications are given in Appendix B, *Standard Test Sequences*, of this manual.

"Sweep" Tests

The sweep tests, Sweep, R Sweep, and L Sweep, provide a set series of frequencies for the purpose of testing a circuit's audio response. The frequencies generated by the Sweep tests are given in Appendix B, *Standard Test Sequences*.

Voice Source Identifier

For many applications, a continuous audible source identification is very useful. For example, when using remotes, audible source identification lets the person at the control panel quickly find the audio line being tested.

The ASG 100 meets this need by letting you record a four-second voice identifier. When you choose the VOICE playback function on line, the voice identifier is continually repeated until another function is chosen or the ASG 100 is taken off line. Restoring factory defaults does not remove a recorded voice identifier.

The voice identifier can be combined with the line up level adjustment signal (Voi + Lnup) so that the two signals alternate. It can also be included in the AUTO test sequences by selecting an AUTO test with a "V" appended to the label.

Encoded Source Identification

The ASG 100 lets you prefix the CCITT 0.33 and TEK test sequences with a user-definable, four-character code that can be used by automated test equipment to identify the ASG 100 unit generating the sequence. The VM700A Option 40 and Option 41 records this code when it logs the test results and includes it in the measurement report, along with a time-stamp. Thus, every auto test report logged by the VM700A shows clearly where the test came from and the time the test was made in the AUTO test sequences.

Headphones

The ASG 100 provides a headphone output with volume control so you can listen to the test signals being generated by the ASG 100. When the ASG 100 is off line, you can use the headphones to monitor the program audio.



It is possible to set levels and adjust the volume so the output through the headphones is excessively loud. For safety, use minimum volume level setting when making level adjustments.

Remote Operation

On the back panel of the ASG 100, to the right of the power switch, is a 9-pin male connector labeled "REMOTE." This DB-9 connector is used to access two types of remote control: contact closing and RS-232C serial communication. Remote control of the ASG 100 is discussed in Appendix C, *Remote Operation*, of this manual.

Freedom of Operation

The user definable states of the ASG 100 may be totally accessible or set to preselected setups that can not be accidentally altered in normal use. As shipped from the factory, the total range of user definable features are available. Once the application needs are determined and programmed, the editing feature may be selectively disabled to prevent accidental changes the frequency and output levels of the test signal. Refer to Appendix A, *Internal Settings*, for information on enabling and disabling the editing function.

FRONT PANEL CONTROLS

The following text details the operation of the front-panel controls and indicators. A front-panel illustration is shown in Figure 3-2 for reference.

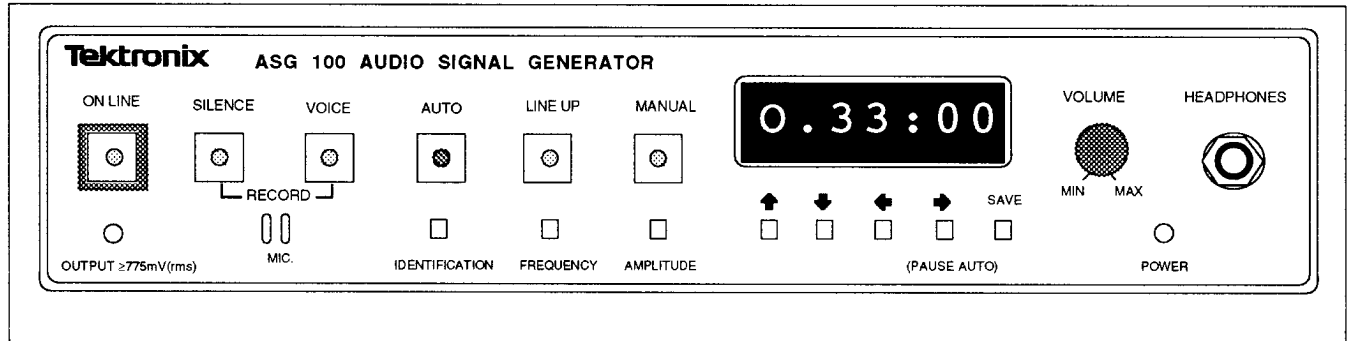

Figure 3-2. ASG 100 Front Panel controls.

FUNCTIONS

The ASG 100 is powered on and off with the power switch to the right of the power receptacle on the back panel.

The ASG 100 functions are enabled from the front panel through the six larger buttons. These “main selection” buttons have LED in the center that indicates the choice is selected. The ON LINE LED is red; the remaining five are green. The smaller buttons are controls that let you display and adjust the values associated with the various test functions.

The test signal functions initiated by the five main selection buttons to the right of the ON-LINE button are mutually exclusive in most cases; enabling one of these five signal functions automatically disables the previously selected function. There are two exceptions to this:

- To initiate a continuously alternating voice ID and line-up tone, press the VOICE and LINE UP buttons simultaneously. (Both LEDs will be on and the display is **Voi + Lnu**.)
- To record four seconds of voice for identification purposes, press the VOICE and SILENCE buttons simultaneously. The recording process is cued with **Record;**, **Ready . . .**, and **Begin;** then a four-second countdown is displayed to time the recording. After that time, the selected function returns.

The ASG 100 outputs the selected signal only when the ON LINE function is enabled. The lighted ON LINE button indicates that the ASG 100 has interrupted the source signal and connected its own output circuit to the downstream audio path.

The ASG 100 sends all signals it generates to the signal ports on the back panel and to the headphones jack on the front panel. When the ASG 100 is not on line, the incoming program audio (if any is applied to the loop-through connectors) may be monitored at the headphone jack.

ON LINE

When the ON LINE function is enabled (indicated by the red LED in the center of the button), the ASG 100 interrupts any source audio signal before it in the audio path, and sends the currently selected test tone or pattern to the audio equipment after it. Selecting any signal choice while on line is permitted. However, when AUTO is selected, that test must be completed before any other

choice (except off line) is permitted. Off line is selected from the front panel by pressing the ON LINE button a second time.

When one of the AUTO mode automatic test sequences is selected, the ASG 100 reverts to off-line status (the red LED turns off) when the selected test sequence is finished and sends a message to that effect over the serial port. Off line reconnects the incoming source audio signal (if any) to the equipment following the ASG 100 in the audio path.

NOTE

The ASG 100 will not go on line when the front panel ON LINE is pressed when the AUTO ID, TEST Lev, or SweepLev is being displayed. You must return to the AUTO Test Selection display or select another test signal to generate.

SILENCE

The SILENCE function makes the ASG 100 generate *no* signal. With SILENCE enabled, any signal shown on the VM700A Option 40 and Option 41 or other monitoring equipment is the noise picked up along the audio path following the ASG 100. The ASG 100 must be ON LINE to send silence, just as for the other functions.

VOICE

The VOICE function continuously replays the 4-second voice identifier the ASG 100 is currently programmed to send. The voice signal level follows the setting of the LINE UP signal amplitude setting.

RECORD (PRESS SILENCE + VOICE)

The RECORD function records 4 seconds of voice input through the built in microphone.

You enable this function by pressing the SILENCE and VOICE buttons simultaneously; there is no remote RECORD command. While the two buttons are held in, the display window shows the prompt **Record:**. When the buttons are released, the display changes to **Ready. . .**, then **Begin**, and a countdown from **4.0** to **0.0**. During the four second countdown, the ASG 100 records any sounds made within several feet of the microphone. When RECORD is started, the front panel controls are disabled until the recording has finished. Upon finishing, the front panel state returns to the state in effect when the recording session was started except ON LINE.

NOTE

If the ASG 100 is ON LINE when a recording session is started, it is switched off line; it remains off line until ON LINE is again selected, either locally or remotely.

AUTO

The AUTO function generates the currently selected automatic predefined test signal sequence, such as CCITT 0.33 and TEK or one of the Sweep signals, when ON LINE.

Auto Test Level

During off line, you may display the test level to which the amplitudes of the tones of the CCITT O.33 and Tek AUTO test sequences are referenced.

For the O.33 and TEK test sequences, the actual output levels in dBm0 of the ASG 100 test signals equals the sum of the test level and the step levels specified in Appendix B, *Standard Test Sequences*. For example, the first step of the O.33 test sequence is specified at -12 dBm0. However, if the test level is set to be $+4.0$ dBu, the actual output level of this signal will be $(-12 + 4) = -8.0$ dBm0. The test level can be set from a minimum of -6 dBu to a maximum of $+14$ dBu. The factory default test level is 0 dBu. This level is one that is usually made uneditable from the front panel so that the known reference for the automatic testing sequences is not easily changed.

Typically, if a TEST Lev change is needed, editing is enabled by a technician to allow an adjustment, then editing is disabled again to lock in the new values for use by operators in the field. For more information on enabling editing, refer to Appendix A, *Internal Settings and Setup Editing*.

NOTE

When monitoring the test signals with test equipment, such as a VM700A Option 40 or Option 41, to get correct readings of insertion gains, be sure the Test Level setting on the VM700A matches the Test Level setting on the ASG 100.

To display the current **TEST Lev** value, from AUTO with an O.33 or TEK AUTO Test selected, press the **AMPLITUDE** button. The **TEST Lev** label is displayed while the button is held in, and the test level setting is displayed when the **AMPLITUDE** button is released. When editing is enabled and you want to change the **TEST Lev** setting, move the blinking cursor to the digit you want to change by pressing the \leftarrow or \rightarrow buttons. Then change the value of the digit by pressing the \downarrow button or \uparrow button. If you wish to make the new setting your default value, you must also press the **SAVE** button after making the edit.

Sweep Test Level

The Sweep sequence test level reference is settable to a different level than the reference level for the CCITT O.33 and TEK tests. It has the same amplitude range as the Line Up and Tone test signals: -90 to $+24$ dBu. When setting the **SweepLev** value, one of the sweep signals (Sweep, R Sweep, or L Sweep) must be the selected AUTO test. Editing is done as above for **TEST Lev** when editing is enabled.

LINE-UP

The **LINE-UP** function generates a single tone at a standard frequency and amplitude. The factory default setting is 400 Hz at 0 dBu.

Once you have pressed the **LINE-UP** button, you can display the frequency or amplitude of the tone by pressing the **FREQUENCY** or **AMPLITUDE** button. For information on adjusting their values (when editing is enabled to allow this), refer to the *FREQUENCY* and *AMPLITUDE* descriptions.

The frequency and amplitude of the **LINE-UP** tone may be programmable from the front panel. If you change the Line-up parameters and want to lock in the new values so they cannot subsequently be changed from the front panel, the editing function can be disabled. Only a qualified technician should make the internal settings needed. For more information, refer to Appendix A, *Internal Settings and Setup Editing*.

Alternating VOICE and LINE-UP

This feature is not indicated on the front panel of the ASG 100. Pressing the VOICE and LINE UP buttons together makes the ASG 100 continuously send the recorded voice pattern alternated with the specified line-up tone when ON LINE. The voice amplitude level follows the level setting of the Line Up signal.

MANUAL

The MANUAL function offers Tone, Polarity, and Multitone signals. Each of these has right and left channel only choices. The factory default option is **Tone**. To choose one of the other options, press either the up-arrow button or down-arrow button until the desired test name appears in the display window. Left and right channel signals are selected using the left-right arrow buttons. The first press of a left or right arrow button selects the left or right channel test signal. If a left or right channel test signal is selected, pressing the opposite arrow returns to stereo test signal. A second press then selects the opposite channel test signal (see Figure 3-3).

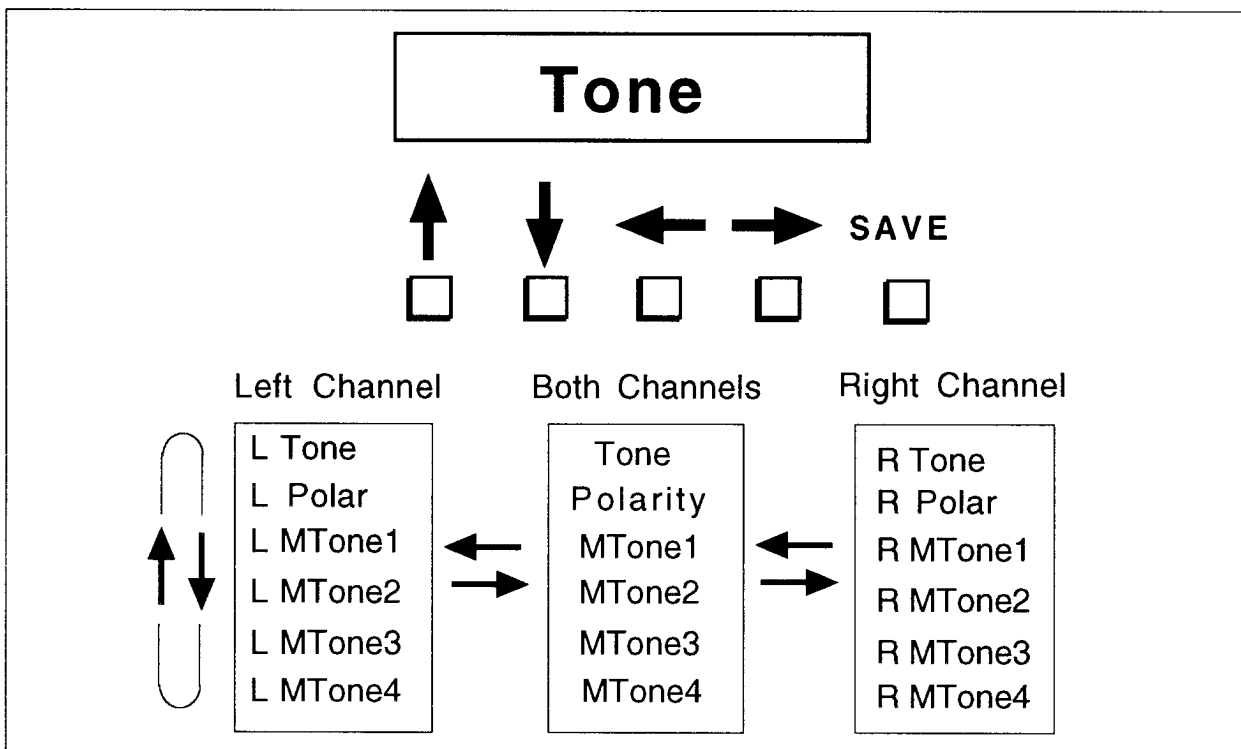

Figure 3-3. Manual test signal selection using arrow keys.

Tone Tests

The Tone functions (**Tone**, **L Tone**, and **R Tone**), generates a single, continuous sine wave tone at a specified frequency and level. If a tone choice, is displayed, you can display the frequency or amplitude of the tone by pressing the FREQUENCY or AMPLITUDE button. If editing is enabled, you can then edit the value using the arrow buttons. For information on enabling editing, refer to Appendix A, *Internal Settings*. For more information on adjusting frequency and amplitude values, refer to the *FREQUENCY* and *AMPLITUDE* descriptions.

Polarity Tests

Most audio systems require signal polarity to be preserved through the distribution system. In stereo systems, polarity is especially important for stereo imaging and for monaural compatibility. If polarity is reversed in one channel of the stereo pair, monaural signals cancel.

The MANUAL Polarity functions (**Polarity**, **L Polar**, and **R Polar**) generate special polarity signals that make it easy to test polarity in the audio path and assure correct wire connections for balanced audio output. This is the same polarity signal included in the TEK automatic test sequence.

Multitone Tests

The Multitone functions, **MTone1**, **MTone2**, **MTone3**, and **MTone4** and their right and left channel choices, **R MTonen** and **L MTonen**, provide signals that are composed of selected sets of sine wave frequencies. These signals are used to check audio circuit frequency response and total harmonic distortion and noise levels in audio circuits. The amplitude of the multitone test signal indicated by the pressing the AMPLITUDE button is defined as the RMS value of the combined signal frequencies, not the peak amplitude of any single frequency in the signal.

Manual Test Level

You can display the amplitude of the manual signals by pressing the AMPLITUDE button when a manual test name is displayed. You can edit the amplitude of any of the manual tests using the arrow buttons when manual test editing is enabled. In normal use, editing of the Manual Test may most often be enabled simply because of the nature of the testing being done when using one of the Manual Test signals. For information on enabling or disabling editing, refer to Appendix A, *Internal Settings*. For more information on adjusting amplitude values, refer to the *AMPLITUDE* control description.

Manual Test Frequency

You can display the frequency of the manual signals by pressing the FREQUENCY button when a manual test name is displayed. The frequency of the polarity signal is preset at the factory to 440 Hz and cannot be changed, and there is no frequency indication for multitone signals. You can edit the frequency of the Tone tests (Tone, R Tone and L Tone) using the arrow buttons when editing is enabled. For information on enabling editing, refer to Appendix A, *Internal Settings*. For more information on adjusting the signal frequency, refer to the *FREQUENCY* control description.

VOLUME

The VOLUME knob controls the level of the audio output through the headphones. It does *not* affect the level of the signal output through the other signal ports. To increase the volume, turn the knob clockwise.

MIC. (Microphone)

When you enable the RECORD function, the microphone picks up 4 seconds of sound made in the vicinity of the ASG 100. Automatic gain control is built into the microphone circuit.

You can then make the ASG 100 replay the recorded sound pattern, either repeatedly with the VOICE function, or at the beginning of one of the standard test signal sequences with the AUTO function.

The AUTO test sequences that include a voice segment in the preamble are identified by a "V" suffix on the sequence name. For example, the TEK mono test sequence that includes a voice segment is displayed as **TEK:90V**.

IDENTIFICATION

The identification code, consisting of 4 alphanumeric characters and various punctuation characters, provides a way to identify the source of the test signals to a remote monitoring device. For example, you could use it to designate the location from which the signal is being generated. This feature is very useful when there may be multiple signal sources arriving at a central control point for testing audio signal paths.

The IDENTIFICATION control is active only when the AUTO function is selected, but off line. It lets you see what the current four-character code that is transmitted as part of the *preamble* is. The preamble is a set of initializing data the ASG 100 prefixes to some of the standard test signal sequences it generates.

To see the current identification code, press the AUTO button, then the IDENTIFICATION button. If editing is enabled, you can change the identification code using the Arrow Buttons. For information on enabling editing, refer to Appendix A, *Internal Settings*. For more information on adjusting values using the arrow buttons, refer to *Arrow Buttons*.

FREQUENCY

The FREQUENCY control displays either the frequency of the LINE-UP signal or the frequency of the MANUAL function signals of Tone and Polarity (there is no single frequency associated with Multitones). To display the signal frequency, press either the LINE-UP button to view the LINE-UP signal frequency, or the MANUAL button to view the Tone or Polarity signal frequency. When viewing a MANUAL signal, use the \uparrow or \downarrow buttons to display the Tone or Polarity functions, then press the FREQUENCY button. All the Tone signals (Tone, R Tone, and L Tone) are set to the same frequency, but the LINE UP signal and the Tone signals are separately settable.

NOTE

The Polarity signal is the sum two equal-amplitude sine waves. One has a fundamental frequency of 440 Hz (the displayed frequency for Polarity) and the other is the second harmonic of that frequency, 880 Hz. The Polarity signal frequency is not editable.

If the internal DIP switches are set to allow editing, you can change the signal frequency of the LINE UP or MANUAL Tone signals using the Arrow Buttons. The frequency of the tone signal may also be changed remotely as an argument to asking for the Tone signal via the serial interface. For information on enabling editing, refer to Appendix A, *Internal Settings*. For more information on adjusting values using the arrow buttons, refer to *Arrow Buttons*.

AMPLITUDE

The AMPLITUDE control displays the amplitude of the tone generated by the LINE UP function, the MANUAL Tone function, the MANUAL Polarity function. To display these amplitudes, press the LINE UP button, or the MANUAL button and the \uparrow or \downarrow buttons to display the Tone or Polarity function, then press the AMPLITUDE button.

As with FREQUENCY (discussed in the preceding subsection), once you display the LINE UP, MANUAL Tone or Polarity amplitude, if editing is enabled, you can change the amplitude using the Arrow Buttons. For information on enabling editing, refer to Appendix A, *Internal Settings*. For more information on adjusting values using the arrow buttons, refer to *Arrow Buttons*.

When the ASG 100 is ON LINE, and you press the \uparrow button to increase the amplitude, if the displayed value is greater than or equal to 0 dBu, the cursor automatically locks onto the least significant digit and increases the level by that increment only. This protects against sudden, unintended jumps in volume.

Arrow Buttons

The Arrow Buttons let you select options and specify values for the AUTO, LINE UP, and MANUAL functions.

For example, the AUTO function offers many standard test signal sequences you can choose. Similarly, the MANUAL function lets you choose a test signal or specify a number of parameters for you can make the ASG 100 generate. The Arrow Buttons let you cycle through the available choices and specify characters or numbers.

↑(Up Arrow), ↓ (Down Arrow)

When the currently selected function offers a set of choices, pressing the ↑ or ↓ button cycles up or down through those choices, displaying them in the display window.

If the currently selected function displays a value that may be edited, such as frequency, test level, or the identification code, a blinking cursor indicates the currently editable character. Pressing the ↑ or ↓ button cycles up or down through the available characters or numerals.

When editing numbers or alpha characters, pressing and immediately releasing the button increments or decrements the value by one number or alpha character. Pressing and holding the button for 1 second initiates automatic incrementing or decrementing, which continues until you release the button. The frequency and level settings have upper and lower limits and cease changing when those limits are reached. The list the character selections for ID are circular and return to the starting point when continuing a change in the same direction.

When making test name selections, the buttons must be pressed and released for each new choice. The list of test names is also circular and returns to the starting point when continuing a change in the same direction.

←(Left Arrow), ⇒(Right Arrow)

The ← and ⇒ buttons are used to select the left or right manual test signal and allow you to select a digit for editing when editing is enabled.

If a value you can edit is displayed, pressing the ← or ⇒ buttons moves a blinking cursor one character to the left or the right. When the cursor is on a character, the character blinks off and on, indicating you can edit it. When editing the alphanumeric encoded IDENTIFICATION, the character to edit must be explicitly selected to be controlled by the ↑ and ↓ buttons. When editing a number value, the selected digit to edit will increment and decrement the total value of the displayed value, not just the digit column selected.

If editing is not enabled, there will be no flashing digit or space in the display.

PAUSE AUTO

During an AUTO test signal sequence, pressing the ⇒ button pauses the sequence at the signal step the ASG 100 is generating at that moment.

For example, suppose you press the ⇒ (PAUSE AUTO) button during the step of the O.33 sequence when the ASG 100 is generating a tone of 80 Hz at -12 dB. The ASG 100 will continue generating that tone, rather than progressing to the next step in the sequence.

Once you have paused the test sequence, you can increment it one step at a time by pressing the ↑ button. You can decrement the sequence by pressing the ↓ button. You can increment to the last test in the sequence or decrement to the first test in a sequence, but you cannot step the test sequence off line.

To resume automatic generation of the rest of the test sequence, press the (PAUSE AUTO) button a second time.

SAVE

If SAVE is pressed when saving is not enabled, the word **Disabled** will be displayed.

If the SAVE function is enabled, pressing the SAVE button stores the function value currently displayed as the default and **Saved** will appear in the display. Once you save a function value, powering on the unit restores that value if user-defined settings are enabled. If user-defined settings are not enabled, the new value saved will be in effect for the time the power is on only. When the power is turned off and back on, the factory defaults will be returned. The normal setting is for user-defined settings to be enabled and recalled on power on.

NOTE

When the factory defaults are restored, all user selected values are written over in the NVRAM, and the user defaults become the same as the factory defaults.

Saving can be done either from the main selection level or at the level of the individual parameter. For example, if the LINE UP function is currently displayed and you press the SAVE button, the frequency and the amplitude parameters currently specified for the line up tone are stored. If the frequency value itself is displayed and you press the SAVE button, only the frequency value is stored.

A selected auto test sequence may be saved as the power-on choice as well as a selected manual test signal. Just select the one you want the start-up setting to be and press SAVE. The ASG 100 powers up each time with the AUTO choice selected, and the selected test will be the one that you saved. When MANUAL is selected, the test name you selected and saved will be the one that appears.

For more information on the enabling edits and saves refer to Appendix A, *Internal Settings*.

STATUS FEEDBACK

Power

When the ASG 100 is powered on, the POWER LED lights up.

Power-On Diagnostics

When you power on the ASG 100, it performs a numbered series of tests of its memories and their interconnections, and then tests the backup battery.

The display window shows the number of each test as the ASG 100 performs it, in the format shown below:

DSP 1/4. . . 2/4. . . 3/4. . . 4/4

The sequence of messages above indicates the ASG 100 is performing the self tests. When it completes the numbered tests, the ASG 100 tests its backup battery. A status message is displayed if the battery is not good.

If the ASG 100 fails one of the numbered self tests, it keeps trying to perform that test and displaying its number. When the ASG 100 indicates a failed self test, you cannot make it perform its other functions. Contact your Tektronix representative for service information.

After repeated iterations, the unit may pass a test it failed initially, and proceed to the next test in the sequence. However, you should still stop using the unit and have it serviced.

OUTPUT $\geq 775\text{mV(rms)}$

The LED above this label blinks when the amplitude of the selected signal is greater than or equal to 0 dBu, as required by the CCITT 0.33 Standard. This is to alert you to the possibility of levels that could overload or damage equipment. Whenever this LED is blinking, the signal level is increased in tenth dBu steps only when you raise the level using the front panel controls. It may be decreased normally.

Display Window

The ASG 100 lets you set a number of parameters affecting the signal it generates. Using the panel controls you can specify the parameter you want to check or modify. The display window shows the current signal pattern for whatever signal parameter you last chose. When you select the RECORD function, the window also displays instructions for inputting a four-second voice pattern.

When you power up the ASG 100, the display window shows the name of the default automatic test sequence, (either the factory default of O.33:01 or a user selected automatic test sequence).

Headphones

The HEADPHONES port outputs whatever signal is currently being output through the external output ports. If the ASG 100 is ON LINE, this is the signal pattern currently selected on the ASG 100. If it is off line, it is the program signal being looped through the ASG 100. The VOLUME knob controls the level of the signal through this port. It has no effect on the signal level through the ASG 100.



It is possible to set levels and adjust the volume so the output through the headphones is excessively loud. For safety, use minimum volume level setting when making level adjustments.

REAR PANEL SWITCH AND CONNECTORS

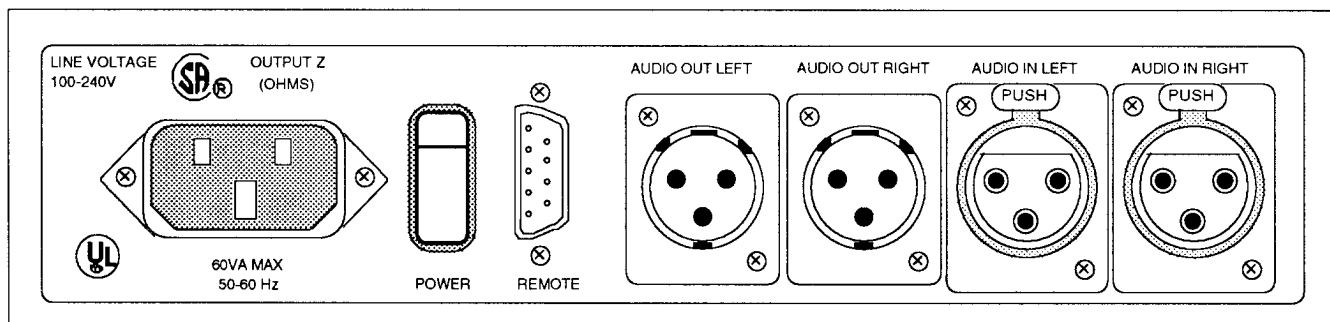

Figure 3-4. ASG 100 Rear Panel connectors.

Power Switch

The ASG 100 power switch is immediately to the right of the power plug receptacle on the rear panel shown in Figure 3-4. In the off position, the top of the switch, which has a red “O” engraved in it, is out. When the ASG 100 is connected to a power source, power it up by pressing the top of the switch. Power it off by pressing the bottom of the switch.

NOTE

When power is turned on, the selections for the settings will be determined by the stored defaults that are recalled. However, the ASG 100 will be off line, and any signal applied will be automatically connected to the output via the loop-through circuitry.

Audio Signal Connectors

The input and output connectors for the AUDIO IN and AUDIO OUT connectors for the left and right channels are loop-through connectors. When the ASG 100 is off line, the signals applied to the input connectors are connected directly to the output connectors via the internal loop-through circuitry of the ASG 100. A small sample of the incoming program signal is fed to the headphones output connector (on the front panel) so the program audio may be monitored.

Remote Connector

This DB-9 connector is used to access two types of remote control. It may be used to connect switching contacts that are used to start the AUTO Test or to override the editing locked feature so new setups may be saved without removing the ASG 100 from a rack installation to reset the internal DIP switches. Its second, and most versatile, purpose is to provide an RS-232C interface for remote control of all the instruments functions. See Appendix C, *Remote Operation*, for using the RS-232C interface to control the operation of the ASG 100 remotely. An additional feature controlled via the remote connector is the Audio/Video Timing measurement signal synchronization. See Appendix D, *Audio/Video Timing*, for information on how this feature is used.

Section 4

APPLICATIONS

IN THE ENGINEERING VAN

Set up an ASG 100 in-line with the output of the Engineering van and send the alternating line-up tone and voice ID. This lets the studio quickly determine the level and source of the remote feed from the van.

Send SILENCE to show the noise on the link.

If troubleshooting is necessary, transmit AUTO test sequences, or transmit various single tones.

AT REMOTE CAMERA LOCATIONS

Place an ASG 100 at each microphone location, and have it send the repeating voice ID to identify each line to the audio operator. Using the headphone output, the remote operators can hear what they are sending without additional equipment.

To document correct link set-up for the producer, transmit an AUTO test sequence. To further verify the identity of the source, program the four-character test sequence ID to include the camera number. Full remote control of the ASG 100 via an RS-232C interface permits a control room operator to ask for the full range of test signal available from the ASG 100.

IN MASTER CONTROL

Install an ASG 100 in the audio rack in line with each outgoing audio feed, and use one of the remote control options of the ASG 100, either contact closure on pins 4 and 9 in the REMOTE connector or full remote control using the RS-232C interface. Connecting pins 4 and 9 initiates the default AUTO test sequence while using the RS-232C interface to send commands to the ASG 100 permits access to the full range of test signals available and control of the test signal parameters.

You can create a program to initiate the AUTO test sequence at specific times or intervals or you can initiate the test signals as needed by the party receiving your feed.

A good strategy for testing audio quality throughout a broadcast network is for the network origination studio to initiate AUTO test sequences during local affiliate insert times. This allows all affiliates to measure their network lines at the same time with their VM700A Option 40 or Option 41 instruments.

IN THE SHOP

To test the performance of recording equipment, record the output of the ASG 100 onto audio and video tape, then measure the output of the tape machines with a VM700A Option 40.

The headphone amplifier is useful for listening to audio circuitry. Monitoring the polarity signal makes it easy to check audio wiring polarity.

When troubleshooting equipment, you can step through the AUTO sequences using the PAUSE function, or you can send tones at levels and frequencies you specify using the MANUAL tone function.

The AUTO test sequences and the measurement report the VM700A Option 40 and Option 41 prints make it easy to keep a log of equipment performance and to verify repairs have been made.

MULTITONE TEST SIGNAL

Most audio tests consist of measuring a sine-wave audio tone, then stepping the frequency and repeating the test. These type of checks for frequency response flatness take some time to complete even when done automatically using one of the ASG 100 AUTO test signals. When the time required to make these tests is a factor, a faster method for obtaining the needed measurements is needed. The time factor comes into play when the available time to perform the measurement is only a few seconds or when you are making circuit adjustments and need immediate feedback to determine the correct settings.

The multitone test signal is composed of a set of sine-wave signals across the audio spectrum. The frequencies are selected to provide predictable circuit responses. Four different multitone signals are available from the ASG 100. See Table 1-2 in Section 1 for a list of the frequencies contained in each set. When coupled with the VM700A Option 40 or Option 41 View Level measurement, the multitone signals provide rapid response curve measurements and continuous, near real-time updates for making circuit adjustments.

When processed by the measurement device, digital filtering can remove the known multitone test sequence frequency components. The remaining frequency components are then analyzed to determine the noise and distortion products produced by stimulating the circuit with the multitone test signal.

POLARITY SIGNAL CHECKS

Distortion Analyzer Check Signal

The ASG 100 polarity signal consists of the sum of a fundamental frequency (440 Hz) with equal amplitude and its second harmonic (880 Hz), with the relative phases chosen to produce the waveform shown in Figure 4-1. Inversion of this signal is easy to recognize with an oscilloscope.

The polarity signal is a good source of a known amount of total harmonic distortion, so you can use it for a quick check of a distortion analyzer. Because the signal is composed of two frequencies, one twice the magnitude of the other, a distortion analyzer will interpret the higher frequency wave as a harmonic of the lower frequency wave. This correspond to a total harmonic distortion of 70.7%. Thus, if the distortion analyzer is calibrated correctly, it should indicate 70.7% when the TEK polarity signal is applied.

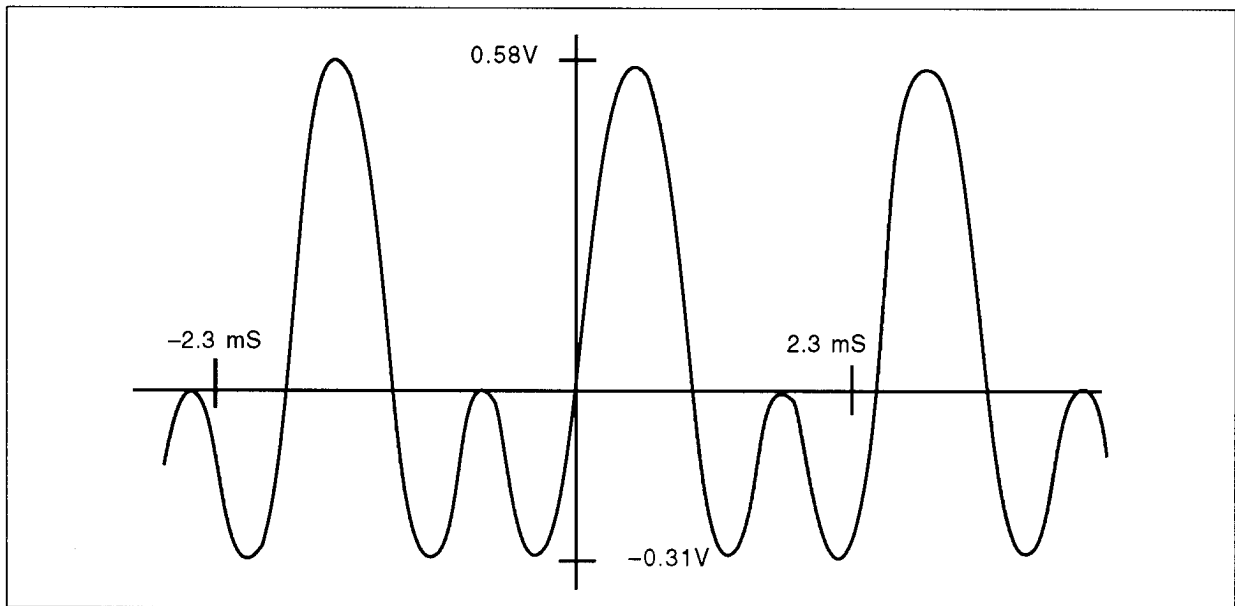

Figure 4-1. MANUAL polarity signal.

Polarity Checks

Using the polarity signal, it is also easy to check for correct audio circuit polarity with a Lissajous pattern stereo monitor, such as the Tektronix 760. In fact, this method provides more information than an oscilloscope, simultaneously showing the status of polarity and phase in both channels.

Figure 4-2 illustrates the Lissajous pattern displayed by a Tektronix 760 stereo monitor for equal left and right channel signals with correct polarity preserved.

Notice that the upper part of the line (above the horizontal axis) is longer than the lower part, which indicates correct polarity. Alignment with the vertical ($L=R$) axis indicates equal amplitudes on left and right channels.

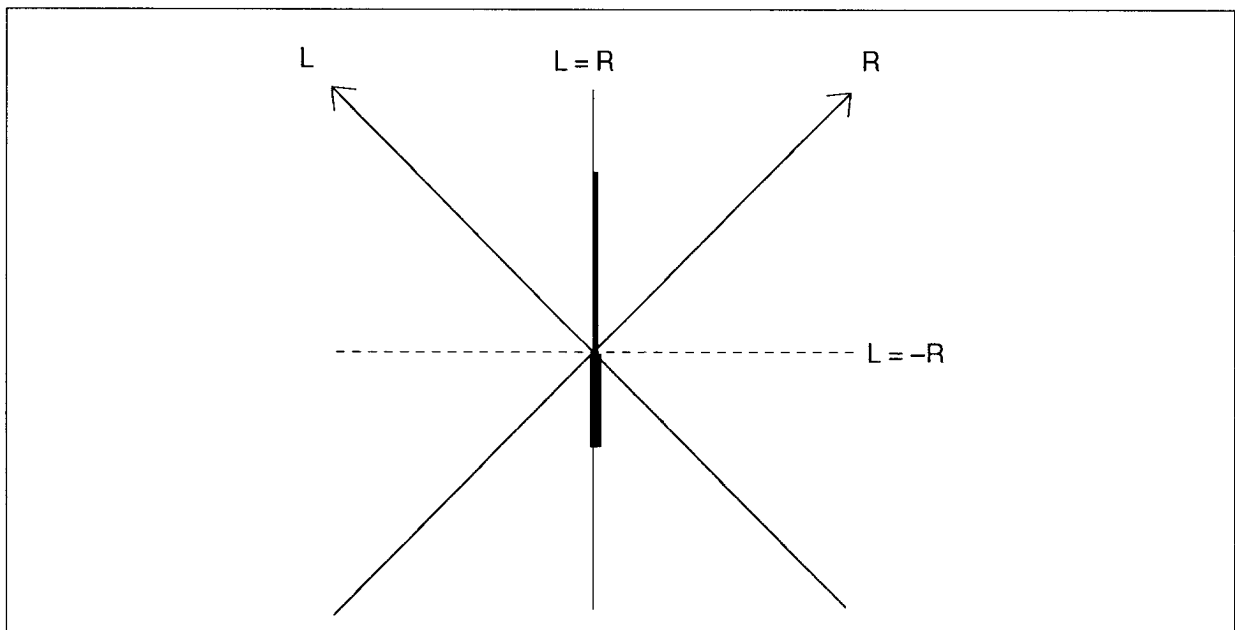

Figure 4-2. Lissajous pattern for correct polarity.

The Lissajous pattern shown in Figure 4-3 indicates reversed polarity on both channels.

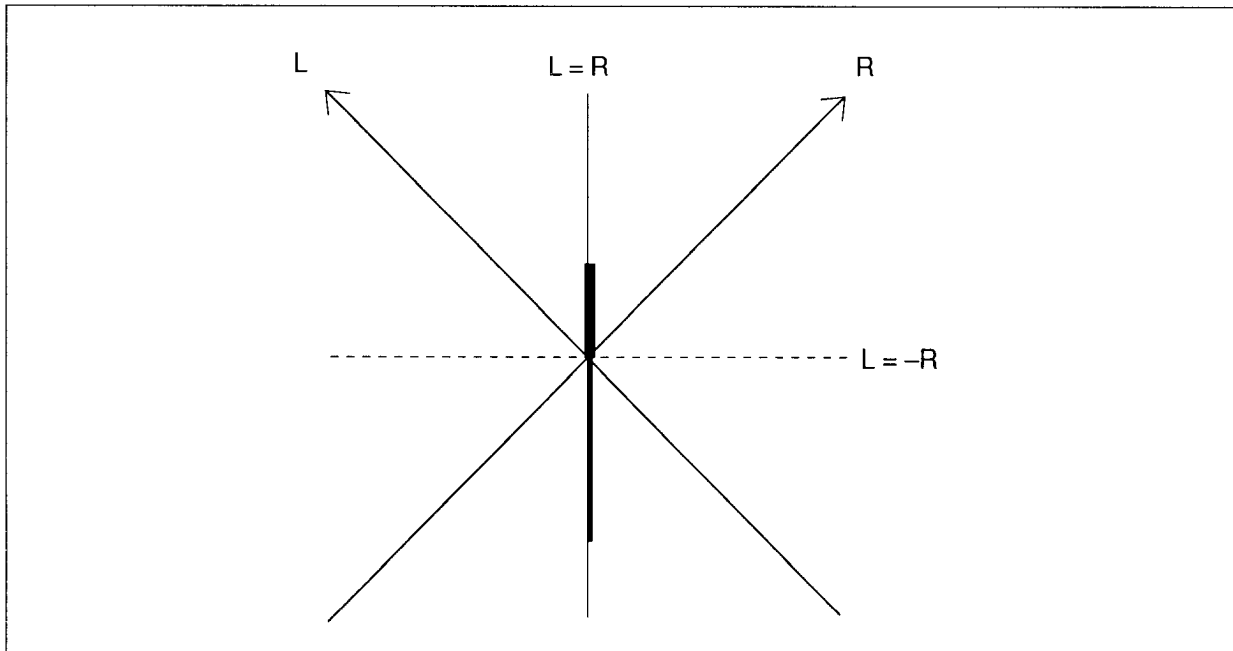

Figure 4-3. Lissajous pattern for left and right channel reversed polarity.

The Lissajous pattern shown in Figure 4-4 below indicates reversed polarity on the *left* channel only.

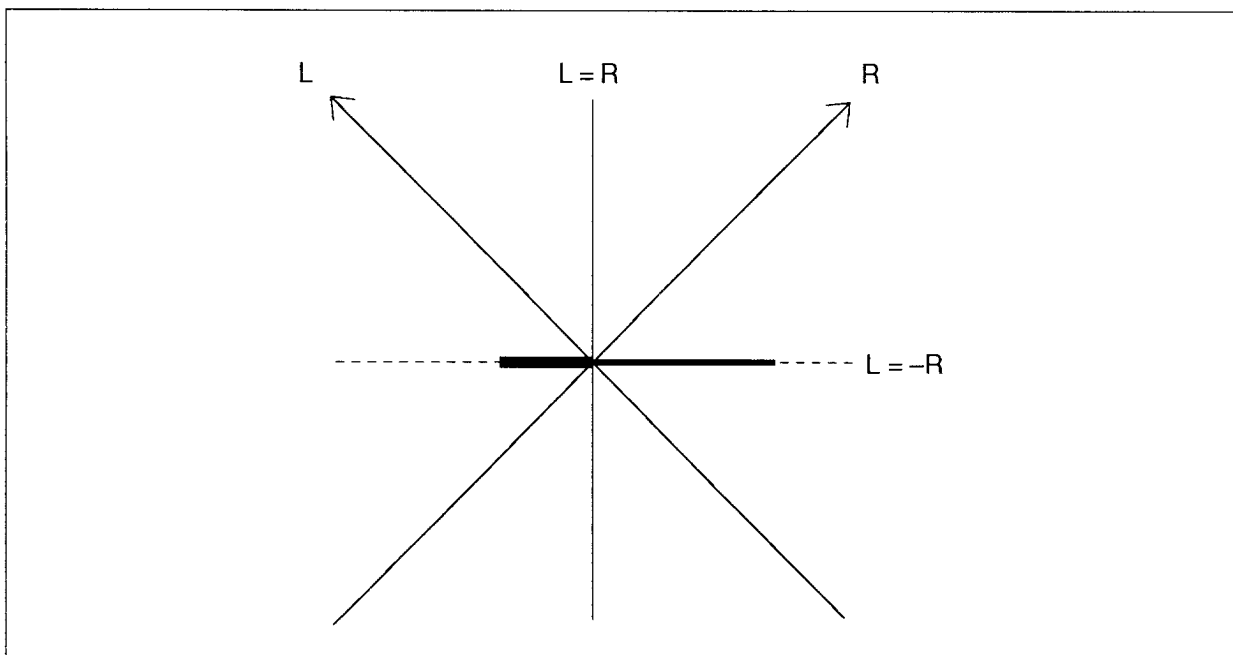

Figure 4-4. Lissajous pattern for left channel reversed polarity.

The horizontal line in Figure 4-4 indicates the signals on the two channels are out of phase ($L = -R$). The shorter part of the line appearing to the left of the origin indicates that the left channel is inverted.

The Lissajous pattern shown in Figure 4-5 below indicates reversed polarity on the *right* channel only.

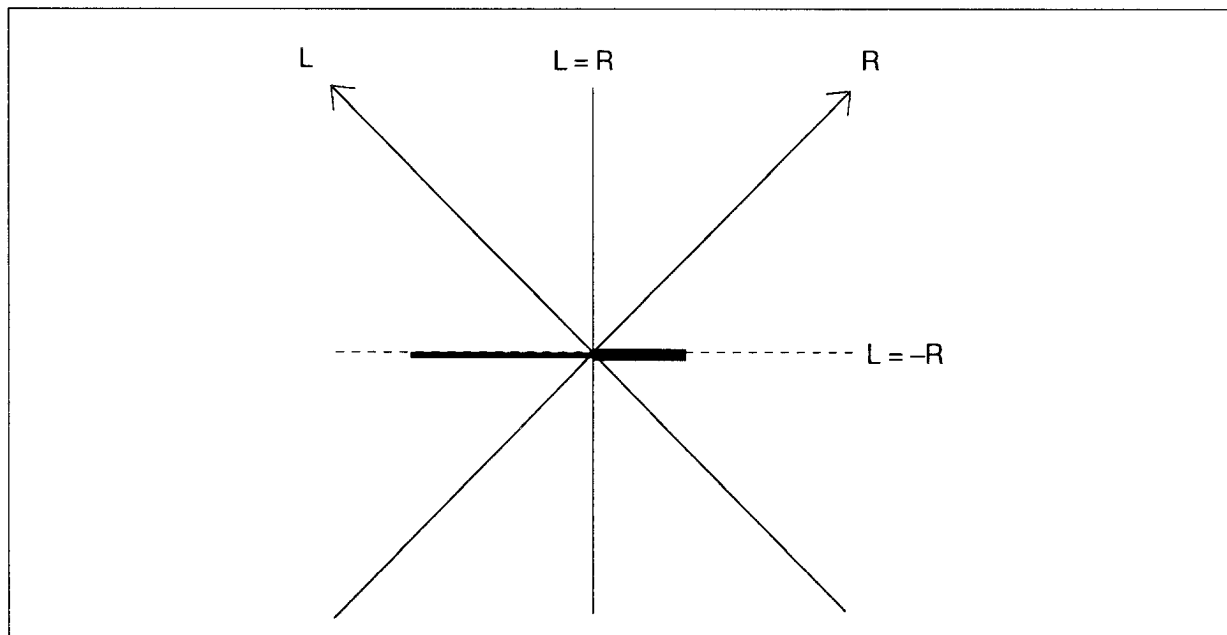

Figure 4-5. Lissajous pattern for right channel reversed polarity.

If the Lissajous pattern appears rotated between the vertical and horizontal axes as shown in Figure 4-6, it indicates unequal gains in the transmission path. An elliptical pattern as shown in Figure 4-7 indicates unequal phase shifts in the two channel signals. Combinations of unequal gain and phase shift plus noise can create many variations of the illustrations used here to show some possibilities.

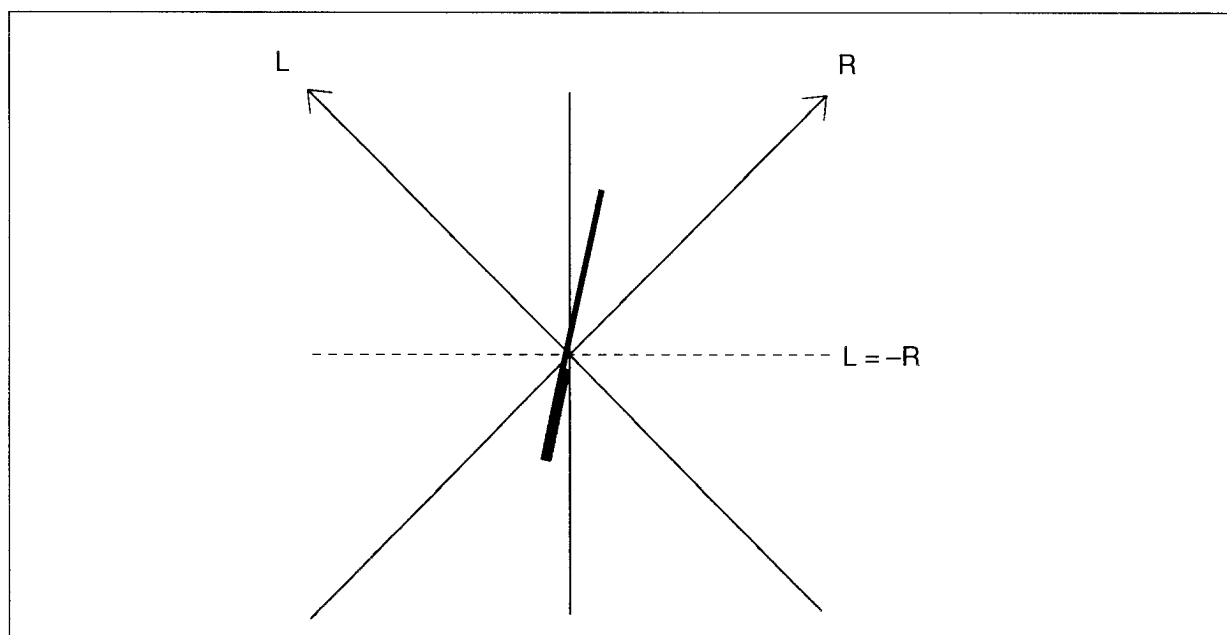

Figure 4-6. Lissajous pattern for unequal gain between right and left channels.

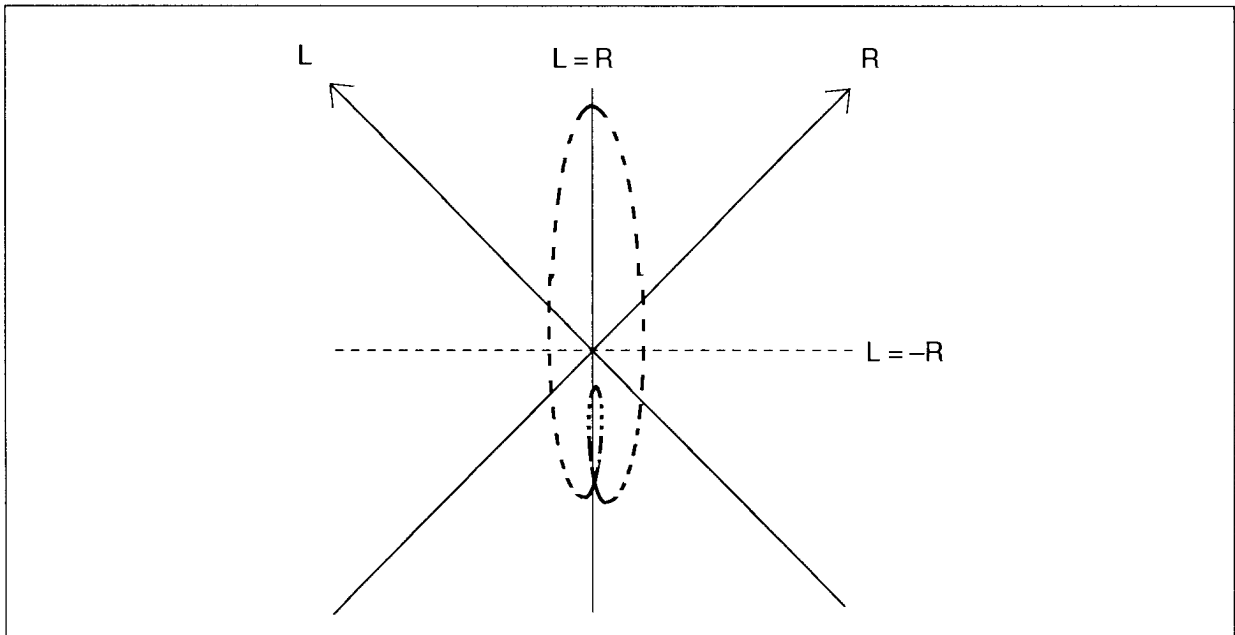

Figure 4-7. Lissajous pattern for unequal phase shift between right and left channels.

Appendix A

INTERNAL SETTINGS AND SETUP EDITING

The ASG 100 allows you to enable and disable editing of various signal features, such as amplitude, frequency and signal identification. Front panel control or remote control or both may also be either enabled or disabled. You can also change the output impedance of the ASG 100. This section describes how to make these changes.

You control signal editing and output impedance through two components found on the circuit board inside the ASG 100:

- The 10-pole DIP switch labeled “S1” on the circuit board. The settings of the first four switches control selectability of the user definable test variables and the default values used when the ASG 100 is powered on.
- The DIP resistor package that sets the output impedance of the ASG 100, located in the socket labeled “R167.” Information on setting the output impedance is found in this section of the manual.

ENABLING AND DISABLING SIGNAL EDITING

On the ASG 100 circuit board is a DIP switch you can set to enable or disable editing of ASG 100 functions, and to select the type of values used as the defaults for user-definable functions.

As you face the ASG 100, on the left side, near the front is a small screw-on door. Removing the side panel reveals the DIP switch, as shown in Figure A-1. The individual switches that affect editing and what each does are shown in Figure A-2.

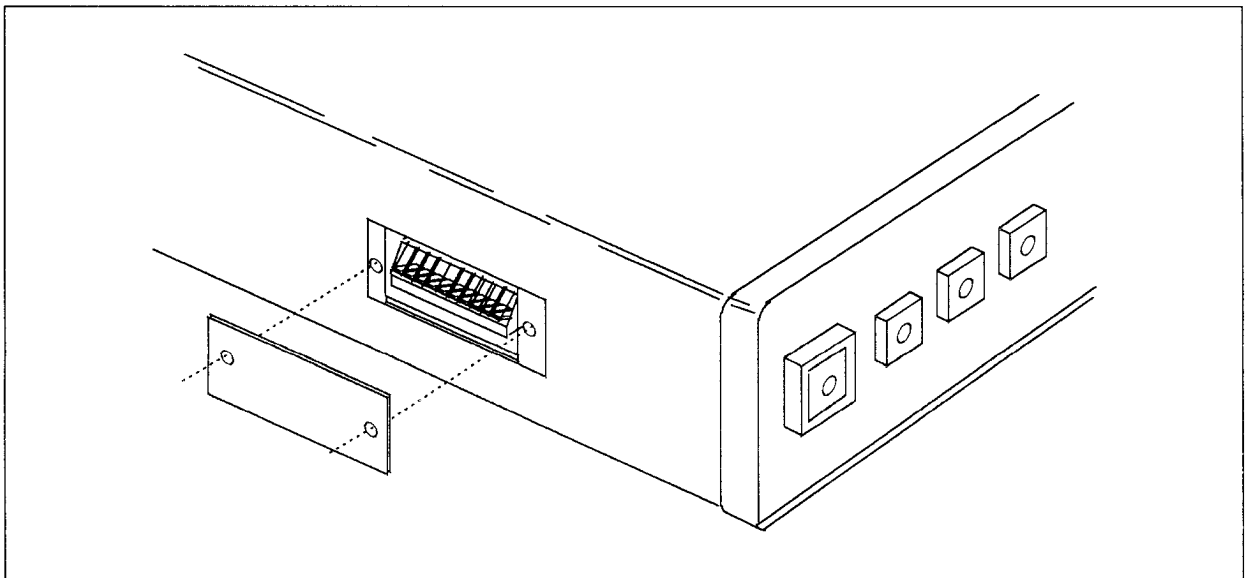

Figure A-1. Remove side panel door to access DIP switch.

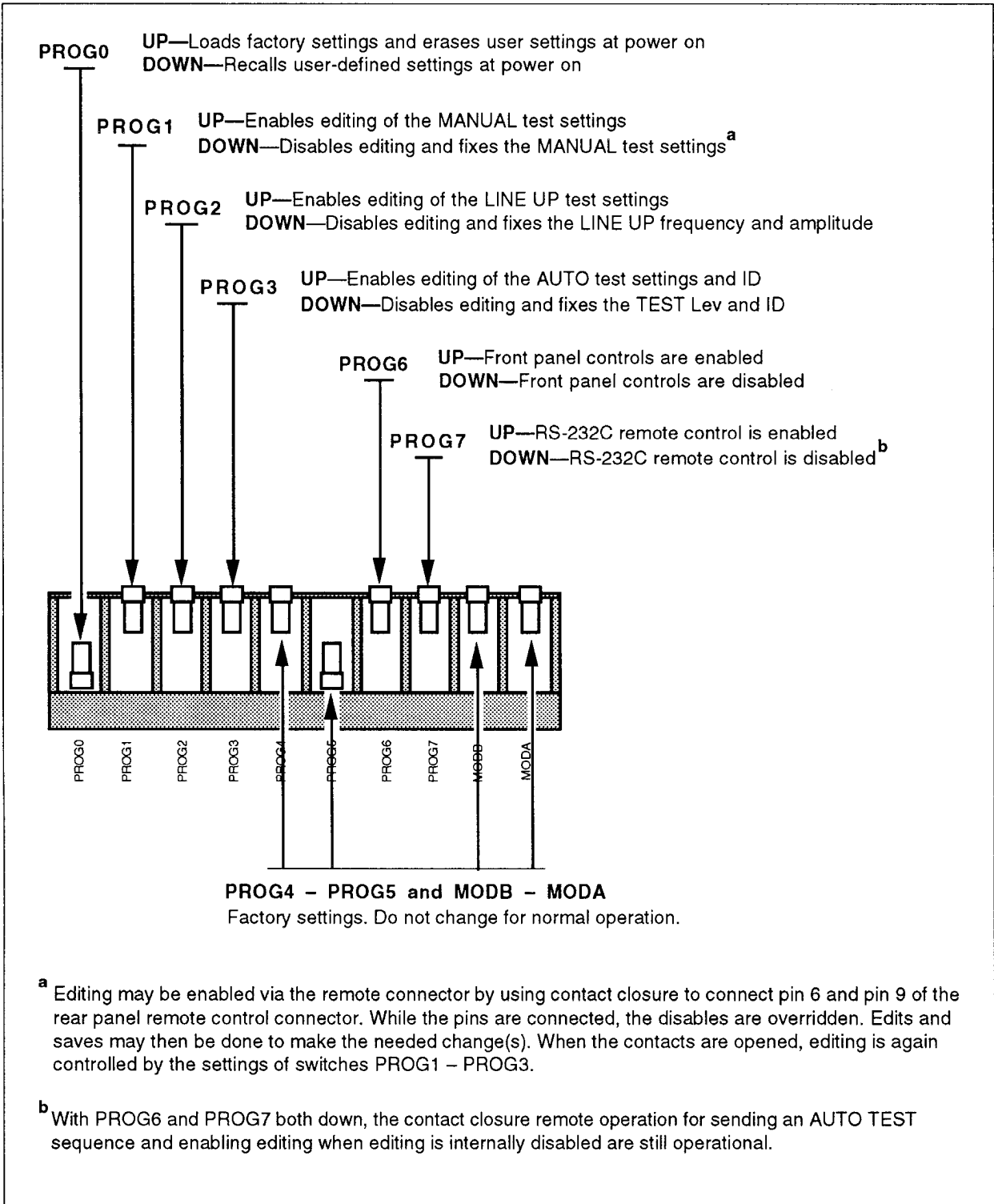

Figure A-2. DIP switch settings for editing.

Editing Signal Parameters

After you enable editing of a signal parameter, you can adjust that parameter value from the front panel. To edit a signal parameter, press the front panel buttons required to display the current value. For example, to edit the frequency of the line-up tone, press the LINE UP button and then the FREQUENCY button.

The digit currently active for editing is indicated by a blinking character, numeral or underscore. To change the active digit, use the \Leftarrow and \Rightarrow buttons. To change the value of the active digit, press either the \Uparrow or \Downarrow button to increment or decrement the value until you get the desired character or number.

Saving Signal Parameters

When you have changed the parameter to the value you want, save it as the default by pressing the SAVE button.

If a top-level function (**Line Up** or one of the **Manual** test signals) is displayed, pressing the button saves as defaults the values of all parameter settings beneath that function (both frequency and amplitude in the case of **Line Up**).

If it is a test signal parameter, such as the frequency, that is displayed, pressing the SAVE button saves only that parameter value as a default; the default values of any other parameters under the function (such as the amplitude) are not updated.

To leave a signal parameter you have been editing, press any of the main-level function buttons: SILENCE, VOICE, AUTO, LINE UP, or MANUAL.

When you finish editing signal parameters and saving the desired default values, ensure the DIP switches are set as follows:

- PROG 0** **Down.** This preserves the saved values as defaults that will be restored whenever the operator powers up the instrument. (Placing DIP switch S-1 in the up position erases all user-defined settings and returns factory settings when the operator powers up the instrument.)
- PROG 1**
- PROG 3** **Down.** This prevents further editing of signal parameters.

NOTE

You may choose to leave all, any, or none of the user-definable frequency and level choices of a testing option editable from the front panel by the technician or engineer using the ASG 100. A normal choice may be to fix the AUTO and LINE UP test to known settings and leave the MANUAL test editable for setting levels and frequencies that may be needed for manual testing. Your application will determine how you decide to customize the test signals and the freedom of operation for the user.

Table A-1 shows the present assignment of all the switches of the DIP switch package, and the factory setting of each switch.

**Table A-1
Dip Switch Functions**

Switch Name	Switch Action		Factory Setting
	Up	Down	
Prog 0	At power up, ASG 100 recalls factory settings for all functions.	At power up, ASG 100 recalls values last saved (with the SAVE button) for user-definable functions. ^a	Down
Prog 1	MANUAL functions can be edited.	MANUAL functions can NOT be edited.	Up
Prog 2	LINE UP function can be edited.	LINE UP function can NOT be edited.	Up
Prog 3	AUTO TEST Level and SOURCE ID can be edited.	AUTO TEST Level and SOURCE ID can NOT be edited.	Up
Prog 4	Normal operating state.	Reserved.	Up
Prog 5	Reserved.	Normal operating state.	Down
Prog 6	Front Panel Controls Enabled.	Front Panel Controls Disabled.	Up
Prog 7	Remote Control Enabled.	Remote Control Disabled.	Up
MOD B	Factory setting required for correct performance. DO NOT CHANGE.		Up
MOD A	Factory setting required for correct performance. DO NOT CHANGE.		Up

^a As shipped from the factory, the factory default settings are stored in the memory reserved for custom settings. This means that when you use the ASG 100 for the first time, the factory defaults will be used, even if DIP switch 1 is in the DOWN (user-defined settings enabled) position.

External Edit Enable

When the editing features are disabled internally, they may be enabled via the rear-panel REMOTE connector. This method of operation permits editing from the front panel when needed without having to remove the installed equipment to access the side panel and internal switches. Editing is enabled by connecting pins 4 and 6 of the Remote connector together. This connection may be made via a jumper, switch, or remote-controlled relay contact.

If activation of the AUTO test sequence using external contact closures is a part of your normal operation, you may also want to add the Remote Edit enable capability. If the need to change a programmed frequency, amplitude, or ID, etc., arises, the feature can be enabled, the edit made by the on-site operator, and then disabled again. When the connection between pin 4 and pin 6 is removed, the settings of internal dip switches again control the state of the editing and saving function for the AUTO, LINE UP, and MANUAL test settings. Note however, that the settings that were edited will now be in effect for the remainder of the test session. If those edits were also SAVED, they will be in effect when the ASG 100 is again turned on.

Front-panel editing may not be enabled via the RS-232C serial commands. However, even with front-panel editing disabled, the remote command arguments for editing still function.

NOTE

There is no remote command for saving an edit to make it a new default, so at the next power on of the ASG 100, the previously "saved" defaults are restored.

FRONT PANEL AND REMOTE CONTROL ENABLING

Depending on your mode of operation, you may choose to disable the control capabilities of the ASG 100. If remote control alone is needed, and you want no local front panel access, you may disable the front panel controls by setting PROG 6, section 7, of S1 to the down position. This effectively prevents any changes from the front panel of the instrument; the front panel is locked out.

The remote control capability of the ASG 100 may be locked out by setting PROG 7, section 8, of S1 to the down position. If access is attempted when the RS-232C serial port is shut off, a message is sent to that effect. The ASG 100 still responds to the control signals it recognizes (control C, control Q, and control S) and sends out the sign on messages, but it will not respond to any commands.

Even if both the front panel and the remote access are disabled, the contact closure operation via the remote connector for sending an auto test sequence and enabling the editing features still work. This state of the controls provides minimal access to making any signal level or auto test type changes, and may be used when those sort of changes to operation are to be restricted.

SETTING THE OUTPUT IMPEDANCE

The factory setting for output impedance is 12 Ω . If your audio system's configuration requires some other impedance level, you can change the resistor network on the ASG 100 circuit board to create the required impedance.

The output impedance of the ASG 100 is controlled by a resistor network located in the socket marked "R167" and labeled "ACTIVE" on the circuit board. This socket is centered in front of the XLR connectors labeled "J11" and "J14" on the circuit board. You can change the factory output impedance of the ASG 100 by changing the resistor package in the ACTIVE socket.

Tektronix manufactures the ASG 100 with a 10 Ω DIP resistor package in the R167 socket. That resistance is added in series with the resistance of the EMI filters creating a default output impedance of 12 Ω (5 Ω per side of each balanced output plus the 0.8 Ω each of the two filters). The resistor package is marked "100G" (meaning 10.0 Ω , $\pm 2\%$).

For your convenience, an alternate resistor package for producing an output impedance 600 Ω is provided. This resistor package comes installed in socket "R168," which is also labeled "SPARE" on the circuit board. The spare resistor package itself is marked "601G" (meaning 600 Ω $\pm 2\%$). To create a 600 Ω output impedance, remove this resistor package from the "SPARE" socket and insert it in the "ACTIVE" socket in place of the 10 Ω resistor package.

In addition, in case you want to create a custom output impedance, the ASG 100 also provides a blank 16 pin header in the socket marked "R173" and labeled "USER" on the circuit board. This socket is adjacent to the "SPARE" socket. To create a custom output impedance, solder your own resistors to this header and insert it in the "ACTIVE" socket in place of the factory-supplied resistor package.

Figure A-3 below shows the resistor network and how the socket is wired.

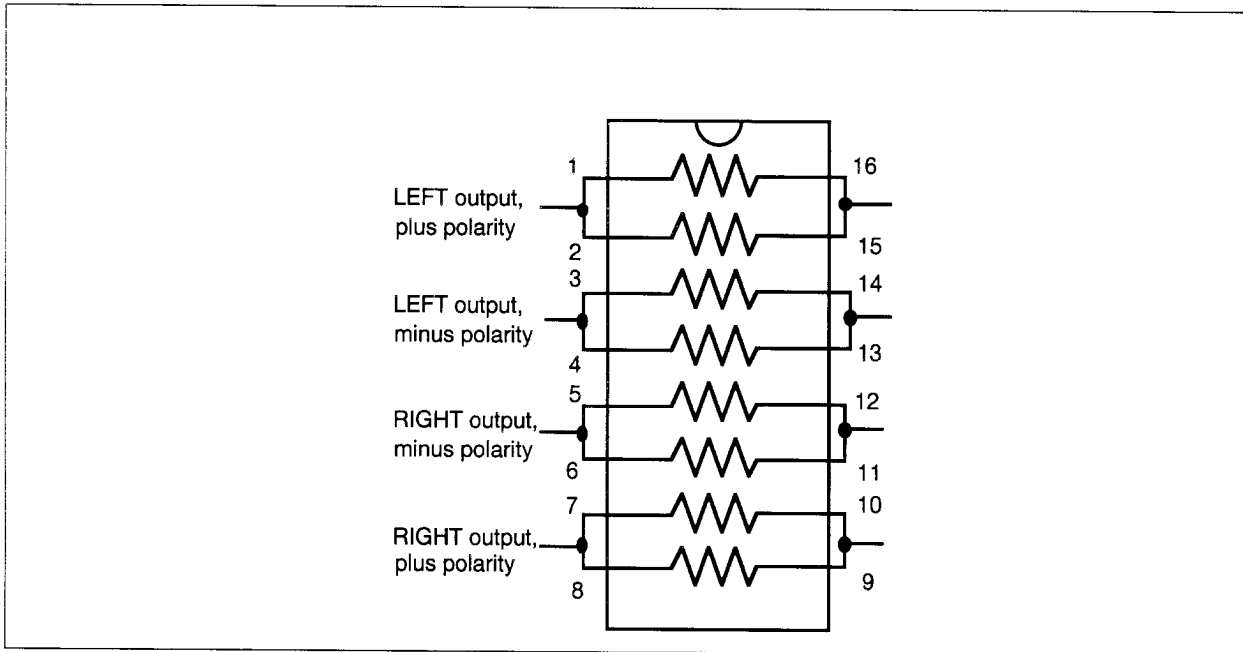

Figure A-3. Output impedance resistor network.

If you make your own resistor network, it must consist of resistors of equal value. As shown in Figure A-3, for each output in the XLR connectors, a pair of resistors are wired together in parallel for power handling purposes.

Use parallel resistors with values equal to the output impedance you want to achieve. The resistor pairs are wired in parallel, so the impedance produced on each output pin is one-half the resistance value of each resistor. However, each output port sums the signals on each of its two signal lines to produce a differential signal. This results in an output impedance equal to the resistance value of the resistors used in the resistor package.

NOTE

The output levels indicated by ASG 100 display are in dBu, not dBm, and do not compensate for changing source or load impedances. The levels displayed by the ASG 100 are correct when used with the 12 Ω source impedance and a high impedance load (>1200 Ω). With a 600 Ω load, the output will be reduced by 0.17 dB (see Figure A-4).

If you change the source impedance to 600 Ω and use the unit in a power-matched system (with 600 Ω loads), the actual output delivered to the load will be 6 dB less than the displayed value.

If you use a custom resistor network to implement some other source impedance, the output levels will be reduced by a different factor, which you must calculate and take into account when reading the displayed values (see Figure A-5)

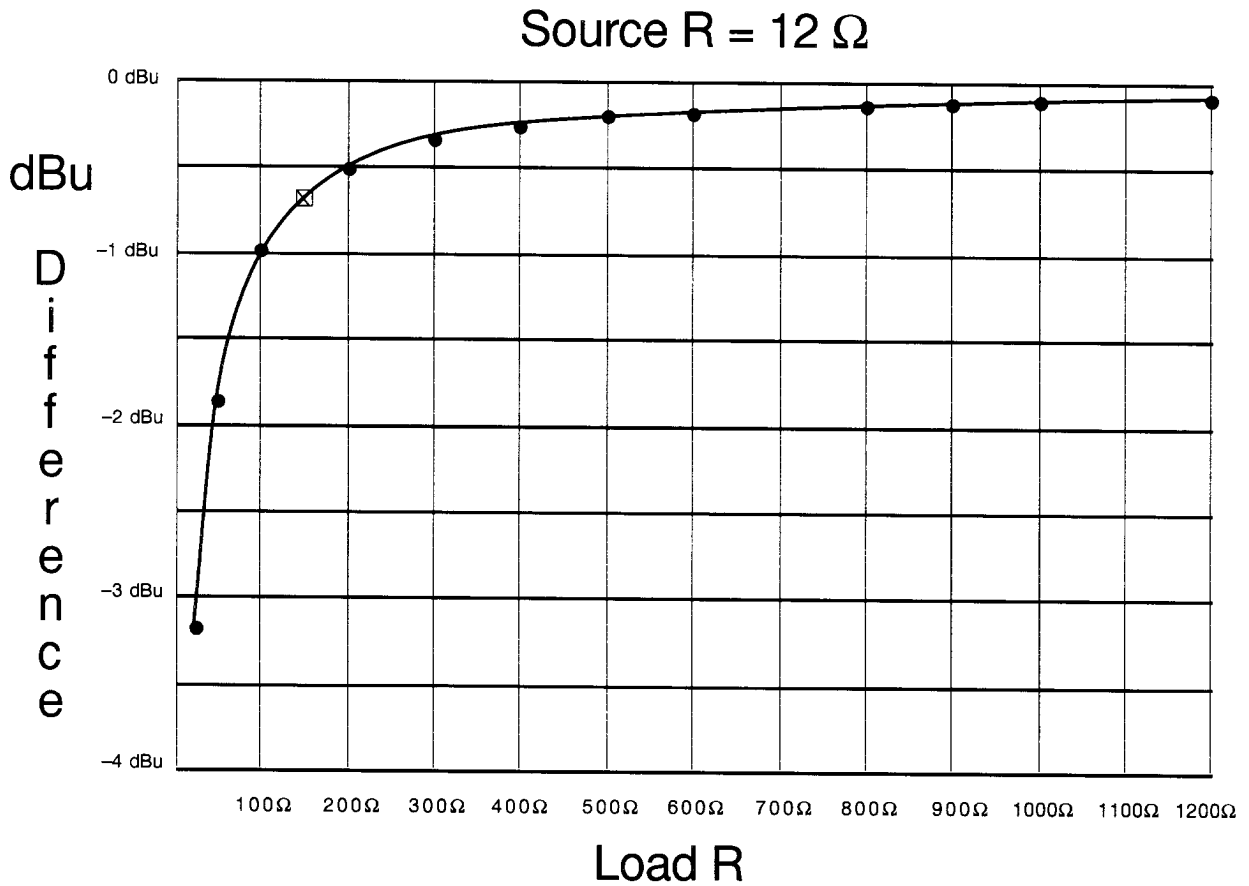

The general formula for calculating the dBu difference when the source resistance is held at 12 Ω and the load resistance varies is:

$$\text{dBu}_{\text{diff}} = 20 \log \left(1 - \frac{12 \Omega}{R_{\text{Load}} + 12 \Omega} \right)$$

Using the above formula it can be seen that the front panel ASG 100 dBu reading approximately corresponds to dBm when driving a 600 Ω load. The difference between actual dBm and the ASG 100 readout is -0.17 dB with a 600 Ω load.

The output amplifiers of the ASG 100 are current limited. The load resistance should not be less than 150 Ω.

Figure A-4. Effects of a changing load resistance on the dBm output of the ASG 100.

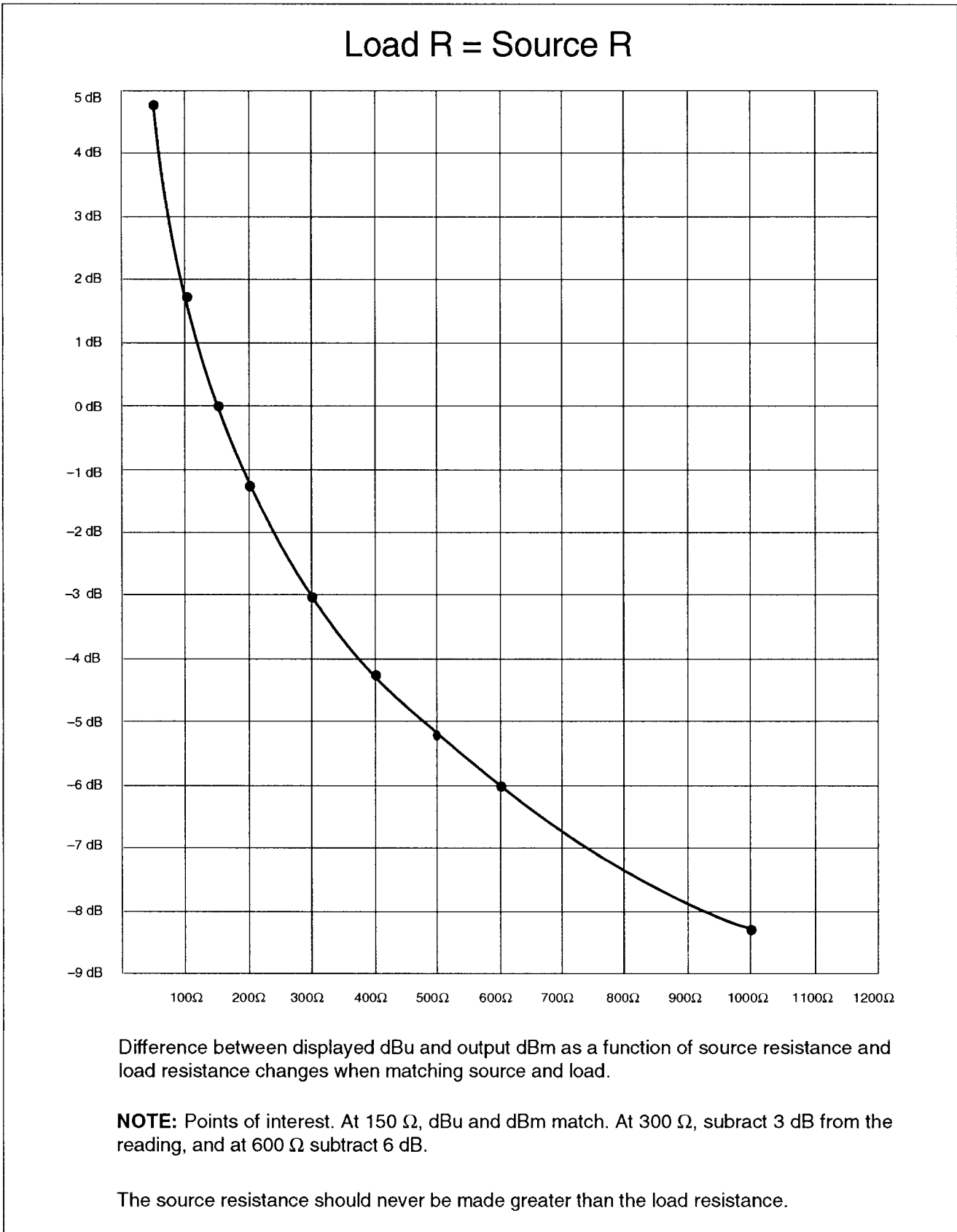

Figure A-5. Effects of matching load and source impedances in the ASG 100.

Appendix B

STANDARD TEST SEQUENCES

CCITT O.33 TEST SEQUENCES

The following text is a brief description of the requirement of the test signals and levels and the measurement equipment for a CCITT O.33 automatic test. Tables B1 through B6 give the test sequences for the CCITT O.33 auto test available with the ASG 100 Audio Signal Generator.

Monophonic Testing

Insertion Gain. For insertion gain, a 1020 Hz signal is sent at the TEST level. The measurement equipment checks the received level of the signal and expresses the result in dB with respect to the transmitted TEST level.

Frequency Response. Frequency response of the audio circuit is checked by sending a set of discrete frequencies from 40 Hz to 15 kHz at a level -12 dB below the TEST level. The measured levels of the received signals are displayed in dB with respect to the received 1020 Hz signal level which is also sent at -12 dB below the TEST level.

Harmonic Distortion. Distortion is checked at two signal frequencies (60 Hz and 1020 Hz) that are sent +9 dB above the TEST level. The test equipment provides an rms indication of the second and third harmonic content of the received test signals expressed in dB with respect to the fundamental level of the test signal. The duration of the +9 dB signal is limited to a single time interval of 1 second each. A 1-second pause between the two test signals used for the harmonic distortion test provides circuit settling time.

Signal-to-Noise Ratio. Signal-to-noise ratio is checked when the sending unit properly terminates the line at the sending end and sends silence. The noise on the terminated line is checked for a period of 8 seconds, and the result is displayed in dB with respect to the received level of the 1020 Hz test signal.

Compressor Linearity. Compressor linearity is checked at a single test frequency that is sent at +6 dB, -6 dB, and +6 dB with respect to the TEST level during three consecutive time intervals. The actual level of the received signal during those test intervals is displayed.

Expanded Noise. Expanded noise testing uses the same time interval and test signal as sent for the 60 Hz distortion test. The measuring equipment filters the signal to remove second and third order harmonics of the 60 Hz frequency, and the remaining noise is measured.

Stereo Testing

The previous testing for monophonic circuitry applies to stereophonic sound channels as well. The added test for stereo check the channel-to-channel matching and crosstalk between the two channels.

Interchannel Gain and Phase. Testing stereo channels for interchannel gain and phase difference must determine the difference in phase and amplitude between the left/right channel signals. These measurements are made at all the frequencies used for the monophonic frequency and distortion tests. The measuring equipment indicates the results of the measurement expressed in dB and phase angle, using channel A as the reference signal channel. This measurement must be done on the channels simultaneously or the results must be verified as equivalent to measuring simultaneously.

Interchannel Crosstalk and Transposition. Interchannel crosstalk and circuit transposition testing uses a signal at 2040 Hz that is -12 dB from the TEST level. Alternate channels are

terminated without a signal being applied. The terminated channel is checked for the level of unwanted signal. The result is expressed in dB with respect to the active channel.

Table B-1
O.33:00/O.33:00V Monophonic Test Sequence

Time Interval	Channel A (left) Sending Unit		Channel B (right) Sending Unit		Program Number: 00
	Seconds	Frequency (Hz)	Level ^a (dBm0)	Frequency (Hz)	Level ^a (dBm0)
1	1650/1850	-12	1650/1850	-12	Start / Source / Program ID
1	1020	0	1020	0	Received Level
1	1020	-12	1020	-12	Frequency Response, Interchannel Gain, and Phase
1	40	-12	40	-12	
1	80	-12	80	-12	
1	200	-12	200	-12	
1	500	-12	500	-12	
1	820	-12	820	-12	
1	1900	-12	1900	-12	
1	3000	-12	3000	-12	
1	5000	-12	5000	-12	
1	6300	-12	6300	-12	
1	9500	-12	9500	-12	
1	11500	-12	11500	-12	
1	13500	-12	13500	-12	
1	15000	-12	15000	-12	
1	1020	+9	1020	+9	
1	-	-	-	-	
1	60	+9	60	+9	
1	820	+6	820	+6	Compandor Test
1	820	-6	820	-6	
1	820	+6	820	+6	
8	-	-	-	-	Signal-to-Noise Ratio

^aRelative to ASG 100 TEST level which can be set from -6 to +14 dBu.

Table B-2
O.33:01/O.33:01V Stereo Test Sequence

Time Interval	Channel A (left) Sending Unit		Channel B (right) Sending Unit		Program Number: 01
Seconds	Frequency (Hz)	Level ^a (dBm0)	Frequency (Hz)	Level ^a (dBm0)	Measuring Function
1	1650/1850	-12	1650/1850	-12	Start / Source / Program ID
1	1020	0	1020	0	Received Level
1	1020	-12	1020	-12	Frequency Response, Interchannel Gain, and Phase
1	40	-12	40	-12	
1	80	-12	80	-12	
1	200	-12	200	-12	
1	500	-12	500	-12	
1	820	-12	820	-12	
1	1900	-12	1900	-12	
1	3000	-12	3000	-12	
1	5000	-12	5000	-12	
1	6300	-12	6300	-12	
1	9500	-12	9500	-12	
1	11500	-12	11500	-12	
1	13500	-12	13500	-12	
1	15000	-12	15000	-12	
1	1020	+9	1020	+9	
1	-	-	-	-	
1	60	+9	60	+9	
1	2040	-12	-	-	Crosstalk and Circuit Transposition
1	-	-	2040	-12	
1	820	+6	820	+6	Compandor Test
1	820	-6	820	-6	
1	820	+6	820	+6	
8	-	-	-	-	Signal-to-Noise Ratio

^aRelative to ASG 100 TEST level which can be set from -6 to +14 dBu.

Table B-3
O.33:02/O.33:02V Medium Band Sound Program Test Sequence

Time Interval	Channel A (left) Sending Unit		Channel B (right) Sending Unit		Program Number: 02
	Seconds	Frequency (Hz)	Level ^a (dBm0)	Frequency (Hz)	Level ^a (dBm0)
1	1650/1850	-12	1650/1850	-12	Start / Source / Program ID
1	1020	0	1020	0	Received Level
1	1020	-12	1020	-12	Frequency Response
1	40	-12	40	-12	
1	80	-12	80	-12	
1	200	-12	200	-12	
1	300	-12	300	-12	
1	500	-12	500	-12	
1	820	-12	820	-12	
1	1400	-12	1400	-12	
1	3000	-12	3000	-12	
1	5000	-12	5000	-12	
1	6300	-12	6300	-12	
1	7400	-12	7400	-12	
1	8020	-12	8020	-12	
1	10000	-12	10000	-12	
1	1020	+9	1020	+9	Total Harmonic Distortion (Waiting Interval)
1	-	-	-	-	
1	60	+9	60	+9	
1	820	+6	820	+6	Compandor Test
1	820	-6	820	-6	
1	820	+6	820	+6	
8	-	-	-	-	Signal-to-Noise Ratio

^aRelative to ASG 100 TEST level which can be set from -6 to +14 dBu.

Table B-4
O.33:03/O.33:03V Narrow Band Test Sequence

Time Interval	Channel A (left) Sending Unit		Channel B (right) Sending Unit		Program Number: 03
	Seconds	Frequency (Hz)	Level ^a (dBm0)	Frequency (Hz)	Level ^a (dBm0)
1	1650/1850	-12	1650/1850	-12	Start / Source / Program ID
1	1020	0	1020	0	Received Level
1	1020	-10	1020	-10	Frequency Response
1	200	-10	200	-10	
1	300	-10	300	-10	
1	400	-10	400	-10	
1	600	-10	600	-10	
1	820	-10	820	-10	
1	1400	-10	1400	-10	
1	1900	-10	1900	-10	
1	2400	-10	2400	-10	
1	2700	-10	2700	-10	
1	2900	-10	2900	-10	
1	3000	-10	3000	-10	
1	3100	-10	3100	-10	
1	3400	-10	3400	-10	
1	1020	+9	1020	+9	
8	-	-	-	-	Signal-to-Noise Ratio

^aRelative to ASG 100 TEST level which can be set from -6 to +14 dBu.

Table B-5
O.33:04/O.33:04V Narrow Band Sound Program With Compandor Test Sequence

Time Interval	Channel A (left) Sending Unit		Channel B (right) Sending Unit		Program Number: 04
	Seconds	Frequency (Hz)	Level ^a (dBm0)	Frequency (Hz)	Level ^a (dBm0)
1	1650/1850	-12	1650/1850	-12	Start / Source / Program ID
1	1020	0	1020	0	Received Level
1	1020	-10	1020	-10	Frequency Response
1	200	-10	200	-10	
1	300	-10	300	-10	
1	400	-10	400	-10	
1	600	-10	600	-10	
1	820	-10	820	-10	
1	1400	-10	1400	-10	
1	1900	-10	1900	-10	
1	2400	-10	2400	-10	
1	2700	-10	2700	-10	
1	2900	-10	2900	-10	
1	3000	-10	3000	-10	
1	3100	-10	3100	-10	
1	3400	-10	3400	-10	
1	1020	+9	1020	+9	Total Harmonic Distortion
1	820	+6	820	+6	Compandor Test
1	820	-6	820	-6	
1	820	+6	820	+6	
8	-	-	-	-	Signal-to-Noise Ratio

^aRelative to ASG 100 TEST level which can be set from -6 to +14 dBu.

Table B-6
O.33:05 3-Level Alignment Signal for International Sound Program Test Sequence

Time Interval	Channel A (left) Sending Unit		Channel B (right) Sending Unit		Program Number: 05
	Seconds	Frequency (Hz)	Level ^a (dBm0)	Frequency (Hz)	Level ^a (dBm0)
1	1650/1850	-12	-	-	Start / Source / Program ID
1	-	-	-	-	Pause
2	1020	-12	1020	-12	Measurement Level (ML)
8	1020	0	1020	0	Alignment Level (AL)
2	1020	0			Permitted Maximum Level (PML)
3	-	-	-	-	Pause
2			1020	0	Permitted Maximum Level (PML)

^aRelative to ASG 100 TEST level which can be set from -6 to +14 dBu.

The "O.33" test sequences comply with the CCITT O.33 recommendation.

CCITT O.33 REQUIREMENTS FOR THE PREAMBLE (START / SOURCE / PROGRAM IDENTIFICATION)

The preamble must contain data that performs the following functions:

- Instructs the receiving unit to start the measurement sequence.
- Identifies the source of the test signals.
- Indicates which of the stored measurement programs is to be used.

The preamble signal must consist of 7 data bits, one even parity bit, and two stop bits. It must be sent by frequency-shift keying with a mark frequency of 1650 Hz and a space frequency of 1850 Hz, at a transmission rate of 110 baud.

The required structure of the preamble signal is shown below in Table B-7.

Table B-7
O.33 Preamble Structure

Char. No.	Character Significance	ISO-7 Character
1	Start of Heading	"SOH" (01 Hexadecimal)
2 - 5	Source ID	Any four alphanumeric characters
6	Special Signaling; Meaning is discretionary.	Any single character
7	Start of Transmission	"STX" (02 Hexadecimal)
8 - 9	Measurement Program ID	ISO-7 characters for a two-digit number, 00 to 99
10	End of Transmission	"ETX" (03 Hexadecimal)

The mark frequency must be transmitted for at least 18 milliseconds (two bits) before the mark bit starting the “SOH” character.

The end of the second stop bit of the “ETX” character defines the start of the measurement sequence.

The preamble signal must be set at 12 dB below whatever the TEST level is defined to be in the ASG 100. You can display the current TEST level (TESTLev) setting by pushing the AMPLITUDE function button while in AUTO mode. If editing is enabled, you can also edit the TEST level. The CCITT O.33 Standard requires the TEST level to be 9 dB below the maximum level permitted at the point where the measurement is made.

TEK TEST SEQUENCES

The TEK Test Sequences allows testing to various standards for audio line measurements not defined in the CCITT O.33 recommendations.

TEK:90 and TEK:91 Test Sequences

TEK:90 and TEK:91 test sequences meet the ANSI TI.502-1988 recommended levels when the test level of the ASG 100 is set to +8 dBu with the ASG 100 output impedance of 10 Ω .

TEK:92 Test Sequence

TEK:92 test sequence is a low-amplitude test used for studio proof microphone level testing. It is used to test for audio circuit response over a frequency range of 50 to 10,000 Hz. When used with the VM700A Option 40 or Option 41, the user must provide a +70 dB preamplifier to raise the ASG 100 signal level to the correct measurement level for the monitoring equipment.

TEK:93 Test Sequence

TEK:93 is a special test sequence used for a studio proof line level test. It tests audio circuit response over a frequency range of 50 to 15,000 Hz.

TEK:94 Test Sequence

TEK:94 is another special test sequence used for transmitter proof testing over a frequency range of 50 to 12,500 Hz.

TEK:95 Test Sequence

TEK:95 Stereo test sequence is similar to the TEK:91 Stereo test sequence, but with a Left and Right Channel Crosstalk test signal added for ANSI Crosstalk measurements.

Test Sequence Output Level

You can display the current TEST level by pressing the AMPLITUDE button with the AUTO test selected (but not on line); and, if editing of function values is enabled, change the test level using the front panel arrow buttons. For complete information, refer to AUTO TESTLev in Section 2, *Operation and Setup*.

Tables B-8 through B-13 specify the steps of the TEK Mono, Stereo, Mic Level, Line Level, and Transmitter automatic test sequences.

**Table B-8
TEK:90/TEK:90V Monophonic Test Sequence**

Time Interval	Channel A (left) Sending Unit		Channel B (right) Sending Unit		Program Number: 90	
	Seconds	Frequency (Hz)	Level ^a (dBm0)	Frequency (Hz)	Level ^a (dBm0)	Measuring Function
1	1650/1850	-12	1650/1850	-12	O.33 Start / Source / Program ID	
1	400	0	400	0	Insertion Gain	
1	400	-8 dB on a peak prog. meter	400	-8 dB on a peak prog. meter	Polarity Tone: Polarity, Crosstalk plus Noise	
250 msec	15000	-8	15000	-8	Sweep: Frequency Response, Interchannel Gain and Phase	
250 msec	13999	-8	13999	-8		
250 msec	12503	-8	12503	-8		
250 msec	11243	-8	11243	-8		
250 msec	9001	-8	9001	-8		
250 msec	7500	-8	7500	-8		
250 msec	6203	-8	6203	-8		
250 msec	3499	-8	3499	-8		
250 msec	953	-8	953	-8		
250 msec	400	-8	400	-8		
500 msec	101	-8	101	-8		
1000 msec	50	-8	50	-8		
1	400	+10	400	+10		Total Harmonic Distortion plus Noise
2	-	-	-	-		Noise Floor (Silence)

^aRelative to ASG 100 TEST level which can be set from -6 to +14 dBu.

Table B-9
TEK:91/TEK:91V Stereo Test Sequence

Time Interval	Channel A (left) Sending Unit		Channel B (right) Sending Unit		Program Number: 91	
	Seconds	Frequency (Hz)	Level ^a (dBm0)	Frequency (Hz)	Level ^a (dBm0)	Measuring Function
1	1650/1850	-12	1650/1850	-12	O.33 Start / Source / Program ID	
1	400	0	400	0	Insertion Gain	
1	400	-8 dB on a peak prog. meter	-	-	Left Polarity Tone: Polarity, Crosstalk plus Noise, Transposition	
1	-	-	400	-8 dB on a peak prog. meter	Right Polarity Tone: Polarity, Crosstalk plus Noise, Transposition	
250 msec	15000	-8	15000	-8	Sweep: Frequency Response, Interchannel Gain and Phase	
250 msec	13999	-8	13999	-8		
250 msec	12503	-8	12503	-8		
250 msec	11243	-8	11243	-8		
250 msec	9001	-8	9001	-8		
250 msec	7500	-8	7500	-8		
250 msec	6203	-8	6203	-8		
250 msec	3499	-8	3499	-8		
250 msec	953	-8	953	-8		
250 msec	400	-8	400	-8		
500 msec	101	-8	101	-8		
1000 msec	50	-8	50	-8		
1	400	+10	400	+10		Total Harmonic Distortion plus Noise
2	-	-	-	-		Noise Floor (Silence)

^aRelative to ASG 100 TEST level which can be set from -6 to +14 dBu.

Table B-10
TEK:92/TEK:92V Microphone Level Test Sequence

Time Interval	Channel A (left) Sending Unit		Channel B (right) Sending Unit		Program Number: 92	
Seconds	Frequency (Hz)	Level ^a (dBm0)	Frequency (Hz)	Level ^a (dBm0)	Measuring Function	
1	FSK	-70	FSK	-70	Start / Source / Program Ident	
1	1000	-70	1000	-70	Insertion Gain	
0.5	Polarity	-70	-	-	Polarity/Channel Transposition	
0.5	-	-	Polarity	-70		
1	55	-70	55	-70	Level/Phase/THD+N	
0.5	100	-70	100	-70		
0.5	200	-70	200	-70		
0.5	1,000	-70	1,000	-70		
0.5	7,500	-70	7,500	-70		
0.5	10,000	-70	10,000	-70		
1	55	-70	-	-		Crosstalk
0.5	100	-70	-	-		
0.5	200	-70	-	-		
0.5	1,000	-70	-	-		
0.5	7,500	-70	-	-		
0.5	10,000	-70	-	-		
1	-	-	55	-70		
0.5	-	-	100	-70		
0.5	-	-	200	-70		
0.5	-	-	1,000	-70		
0.5	-	-	7,500	-70		
0.5	-	-	10,000	-70		
1	55	-60	55	-60	THD+N	
1	1,000	-60	1,000	-60		
1	7,500	-60	7,500	-60		
1	55	-55	55	-55		
1	1,000	-55	1,000	-55		
1	7,500	-55	7,500	-55		
3	-	-	-	-	Signal-to-Noise Ratio	

^aRelative to ASG 100 TEST level which can be set from -6 to +14 dBu.

Table B-11
TEK:93/TEK:93V Line Level Test Sequence

Time Interval	Channel A (left) Sending Unit		Channel B (right) Sending Unit		Program Number: 93	
	Seconds	Frequency (Hz)	Level ^a (dBm0)	Frequency (Hz)	Level ^a (dBm0)	Measuring Function
1	FSK	-12	FSK	-12	Start / Source / Program Ident	
1	1000	0	1000	0	Insertion Gain	
0.5	Polarity	0	-	-	Polarity / Channel Transposition	
0.5	-	-	Polarity	0		
1	55	0	55	0	Level / Phase / THD+N	
0.5	100	0	100	0		
0.5	200	0	200	0		
0.5	400	0	400	0		
0.5	1,000	0	1,000	0		
0.5	3,000	0	3,000	0		
0.5	5,000	0	5,000	0		
0.5	7,500	0	7,500	0		
0.5	10,000	0	10,000	0		
0.5	15,000	0	15,000	0		
1	55	0	-	-		Crosstalk
0.5	100	0	-	-		
0.5	200	0	-	-		
0.5	400	0	-	-		
0.5	1,000	0	-	-		
0.5	3,000	0	-	-		
0.5	5,000	0	-	-		
0.5	7,500	0	-	-		
0.5	10,000	0	-	-		
0.5	15,000	0	-	-		
1	-	-	55	0		
0.5	-	-	100	0		
0.5	-	-	200	0		
0.5	-	-	400	0		
0.5	-	-	1,000	0		
0.5	-	-	3,000	0		

^aRelative to ASG 100 TEST level which can be set from -6 to +14 dBu.

Table B-11 (cont)

Time Interval	Channel A (left) Sending Unit		Channel B (right) Sending Unit		Program Number: 93
Seconds	Frequency (Hz)	Level ^a (dBm0)	Frequency (Hz)	Level ^a (dBm0)	Measuring Function
0.5	–	–	5,000	0	Crosstalk (cont)
0.5	–	–	7,500	0	
0.5	–	–	10,000	0	
0.5	–	–	15,000	0	
1	55	+10	55	+10	THD+N
1	1,000	+10	1,000	+10	
1	7,500	+10	7,500	+10	
1	55	+15	55	+15	
1	1,000	+15	1,000	+15	
1	7,500	+15	7,500	+15	
3	–	–	–	–	Signal-to-Noise Ratio

^aRelative to ASG 100 TEST level which can be set from –6 to +14 dBu.

Table B-12
TEK:94/TEK:94V Transmitter Test Sequence

Time Interval	Channel A (left) Sending Unit		Channel B (right) Sending Unit		Program Number: 94
Seconds	Frequency (Hz)	Level ^a (dBm0)	Frequency (Hz)	Level ^a (dBm0)	Measuring Function
1	FSK	–12	FSK	–12	Start / Source / Program Ident
1	1000	0	1000	0	Insertion Gain
0.5	Polarity	0	–	–	Polarity / Channel Transposition
0.5	–	–	Polarity	0	
1	50	0	50	0	Level / Phase / THD+N
0.5	100	0	100	0	
0.5	400	0	400	0	
0.5	1,000	0	1,000	0	
0.5	2,000	0	2,000	0	
0.5	3,000	0	3,000	0	
0.5	5,000	0	5,000	0	

^aRelative to ASG 100 TEST level which can be set from –6 to +14 dBu.

Table B-12 (cont)

Time Interval	Channel A (left) Sending Unit		Channel B (right) Sending Unit		Program Number: 94
	Seconds	Frequency (Hz)	Level ^a (dBm0)	Frequency (Hz)	Level ^a (dBm0)
0.5	7,500	0	7,500	0	Level / Phase / THD+N (cont)
0.5	10,000	0	10,000	0	
0.5	12,500	0	12,500	0	
1	50	0	–	–	Crosstalk
0.5	100	0	–	–	
0.5	400	0	–	–	
0.5	1,000	0	–	–	
0.5	2,000	0	–	–	
0.5	3,000	0	–	–	
0.5	5,000	0	–	–	
0.5	7,500	0	–	–	
0.5	10,000	0	–	–	
0.5	12,500	0	–	–	
1	–	–	50	0	
0.5	–	–	100	0	
0.5	–	–	400	0	
0.5	–	–	1,000	0	
0.5	–	–	2,000	0	
0.5	–	–	3,000	0	
0.5	–	–	5,000	0	
0.5	–	–	7,500	0	
0.5	–	–	10,000	0	
0.5	–	–	12,500	0	
3	–	–	–	–	Signal-to-Noise Ratio

^aRelative to ASG 100 TEST level which can be set from –6 to +14 dBu.

Table B-13
TEK:95/TEK:95V Stereo Test Sequence with Crosstalk

Time Interval	Channel A (left) Sending Unit		Channel B (right) Sending Unit		Program Number: 95
	Seconds	Frequency (Hz)	Level ^a (dBm0)	Frequency (Hz)	Level ^a (dBm0)
1	1650/1850	-12	1650/1850	-12	O.33 Start / Source / Program ID
1	400	0	400	0	Insertion Gain
1	400	-8 dB on a peak prog. meter	400	-8 dB on a peak prog. meter	Polarity Tone: Polarity
250 msec	15000	-8	15000	-8	Sweep: Frequency Response, Interchannel Gain and Phase
250 msec	13999	-8	13999	-8	
250 msec	12503	-8	12503	-8	
250 msec	11243	-8	11243	-8	
250 msec	9001	-8	9001	-8	
250 msec	7500	-8	7500	-8	
250 msec	6203	-8	6203	-8	
250 msec	3499	-8	3499	-8	
250 msec	953	-8	953	-8	
250 msec	400	-8	400	-8	
500 msec	101	-8	101	-8	
1	50	-8	50	-8	
1	400	+10			
1			400	+10	Right Crosstalk
1	400	+10	400	+10	Total Harmonic Distortion plus Noise
2	-	-	-	-	Noise Floor (Silence)

^aRelative to ASG 100 TEST level which can be set from -6 to +14 dBu.

TEK TEST SEQUENCE DESCRIPTION

TEK Preamble

The TEK preamble conforms to the CCITT O.33 preamble format, described previously in *CCITT O.33 Requirements for the Preamble (Start / Source / Program Identification)*. A special signaling character of "0" is used to indicate the 0 dBm reference level, and a special signaling character of "1" is used to indicate the +8 dBm reference level.

Insertion Gain

This 400 Hz tone at the 0 dBm0 level in TEK:90, TEK:91, and TEK:95 is to be used to check for insertion gain. The tone is 1000 Hz at -70 dBm0 for TEK:92 to be used to check for insertion gain at microphone levels. For the TEK:93 and TEK:94 test, the tone is 1000 Hz, but the level is again 0 dBm0 for use at Line and Transmitter levels.

Polarity Tone

You can use this tone to check simultaneously for reversed polarity on the indicated channel, and for transposition and crosstalk into the other channel. You can measure it at the desired point in the audio path with an oscilloscope, or with analog or digital automatic measurement equipment.

The Polarity signal is the sum of two equal-amplitude sine waves. One has a fundamental frequency of 440 Hz (the displayed frequency for Polarity) and the other is the second harmonic of that frequency, 880 Hz. An example of the waveform generated by this function is shown in Figure B-1.

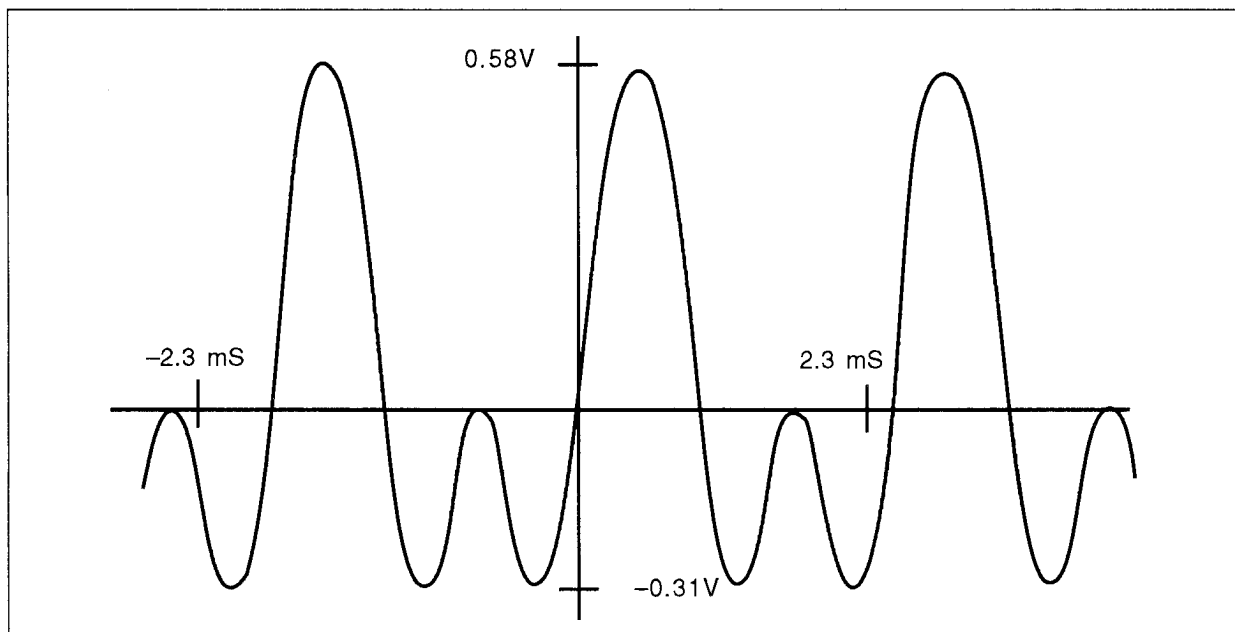

Figure B-1. TEK polarity signal waveform.

Crosstalk

These test levels are sent first on one channel, then the other. The undriven channel is checked to determine the amount of crosstalk between the channels.

Total Harmonic Distortion plus Noise (THD + N)

The test signals are sent at high levels to determine the signal path's harmonic distortion (non-linearity).

Noise Floor (Silence)

Silence is sent for a period of time to be used for checking the noise floor for a signal-to-noise ratio measurement.

Sweep

The frequencies of the sweep signals in the TEK tests satisfy the following conditions:

- Roughly logarithmic above 1 kHz.
- Prime number values.
- Non-multiples of 32 kHz, 44.1 kHz, and 48 kHz sampling rates.

The duration of the sweep signals were chosen to include either enough cycles to allow time for measurement, or to be 150 msec after a 140 msec settling period (conforming to CBC recommendations).

The level of the sweep signal is -8 dBm from the TEST Lev setting.

TEK SWEEP TEST

The TEK Sweep Test frequencies and times are shown in Table B-14.

The amplitude (SweepLev) for the three sweep tests (Sweep, R Sweep, and L Sweep) is separately selectable from the TEST Lev of the other AUTO test sequences. The Sweep level may be set to the same limits as the tone signal, from -90 to $+24$ dBu. With one of the Sweep Tests selected, pressing the AMPLITUDE button displays SweepLev; when the button is released, the current level setting is shown. That is the amplitude at which the sweep signals will be sent. If editing is enabled, the value can be changed using the front panel arrow keys in the same way as the TEST Lev for the other AUTO tests. The value may also be changed remotely using arguments with the AUTO command (see *Remote Operation* in Appendix C of this manual).

Table B-14
Sweep Test Sequence

Time Interval	Channel A (left) Sending Unit	Channel B (right) Sending Unit	Program Name: Sweep
Seconds	Frequency (Hz)	Frequency (Hz)	Measuring Function
1	25	25	Sweep: Frequency Response
1	31	31	
1	40	40	
1	50	50	
1	63	63	
1	80	80	
1	100	100	
1	125	125	
1	160	160	
1	200	200	
1	250	250	
1	315	315	
1	400	400	
1	500	500	
500 msec	630	630	
500 msec	800	800	
500 msec	1000	1000	
500 msec	1250	1250	
500 msec	1600	1600	
500 msec	2000	2000	

Table B-14 (cont)

Time Interval	Channel A (left) Sending Unit	Channel B (right) Sending Unit	Program Name: Sweep
Seconds	Frequency (Hz)	Frequency (Hz)	Measuring Function
500 msec	2500	2500	Sweep: Frequency Response (cont)
500 msec	3150	3150	
500 msec	4000	4000	
500 msec	5000	5000	
500 msec	6300	6300	
500 msec	8000	8000	
500 msec	10000	10000	
500 msec	12500	12500	
500 msec	16000	16000	
500 msec	20000	20000	

Appendix C

REMOTE OPERATION

REMOTE CONTROL FROM A TERMINAL

You can control the ASG 100 from a terminal, a computer running terminal emulation software, or a VM700A Video Measurement Set via the RS-232C serial interface. Remote control via a modem is also possible using the RS-232C serial port of the ASG 100. These operations are:

- AUTO test selection and level setting
- LINE UP test tone
- MANUAL test tone in left, right or both channels plus level and frequency setting
- MANUAL polarity test tone in left, right, or both channels plus level setting
- MANUAL multi-tone test in left, right, or both channels plus level setting
- SILENCE function
- VOICE playback
- VOICE plus LINE UP test tone, alternating
- ID setting and queries
- Queries of test signal settings
- OFFLINE

LIMITED LOCAL REMOTE CONTROL

Limited remote control of the ASG 100 is possible using contact closures on the remote connector. One closure activates the auto sequence, and the other enables front panel editing of a setting when editing is internally disabled. Remote connections for these functions are explained in the following text.

INSTALLATION FOR REMOTE CONTROL

Connect a Properly Configured Communications Cable

On the back panel of the ASG 100, to the right of the power switch, is a 9-pin male connector labeled "REMOTE." This DB-9 connector is used to access two types of remote control. It may be used to connect switching contacts that are used to start the AUTO Test or to override the editing locked feature so new setups may be saved without removing the ASG 100 from a rack installation to reset the internal DIP switches. Its second, and most versatile, purpose is to provide an RS-232C interface for remote control the instrument's signal generation functions.

As an RS-232C serial data port it is configured as a 9-pin (DB-9) DTE (Data Terminal Equipment) connector. You can set up remote control by connecting this serial port to the serial port of a terminal (or terminal-emulating computer) through a properly configured communications cable.

The functions of the pins on the remote connector are shown in Table C-1. On the ASG 100 end, the DTE cable you use must be connected to a 9-pin female connector conforming to this configuration.

Table C-1
Pin Connections for Remote Connector

Pin Number	Signal Name	Signal Description
1	DCD	Data Carrier Detect (not connected)
2	RXD	Received Data (connected)
3	TXD	Transmitted Data (connected)
4	DTR	Contact closure with pin 6 enables editing of function settings. Contact closure with pin 9 starts AUTO test. Do not connect this pin with the remote terminal via the RS-232C interconnection cable.
5	GND	Signal Ground/Common Return (connected)
6	DSR	Contact closure with pin 4 enables editing of function settings. Do not connect this pin to the remote terminal via the RS-232C interconnection cable.
7	RTS	Request to Send (not used in the ASG 100)
8	CTS	Clear to Send (not used in the ASG 100)
9	RI	Contact closure with pin 4 starts AUTO test. Do not connect this pin to the remote terminal via the RS-232C interconnection cable.

On the remote terminal end, the configuration of the cable connector should match that of the terminal's serial port. The cable configurations for communication between the ASG 100 and IBM PCs and compatibles operating as data terminal equipment are shown in Figure C-1 and Figure C-2.

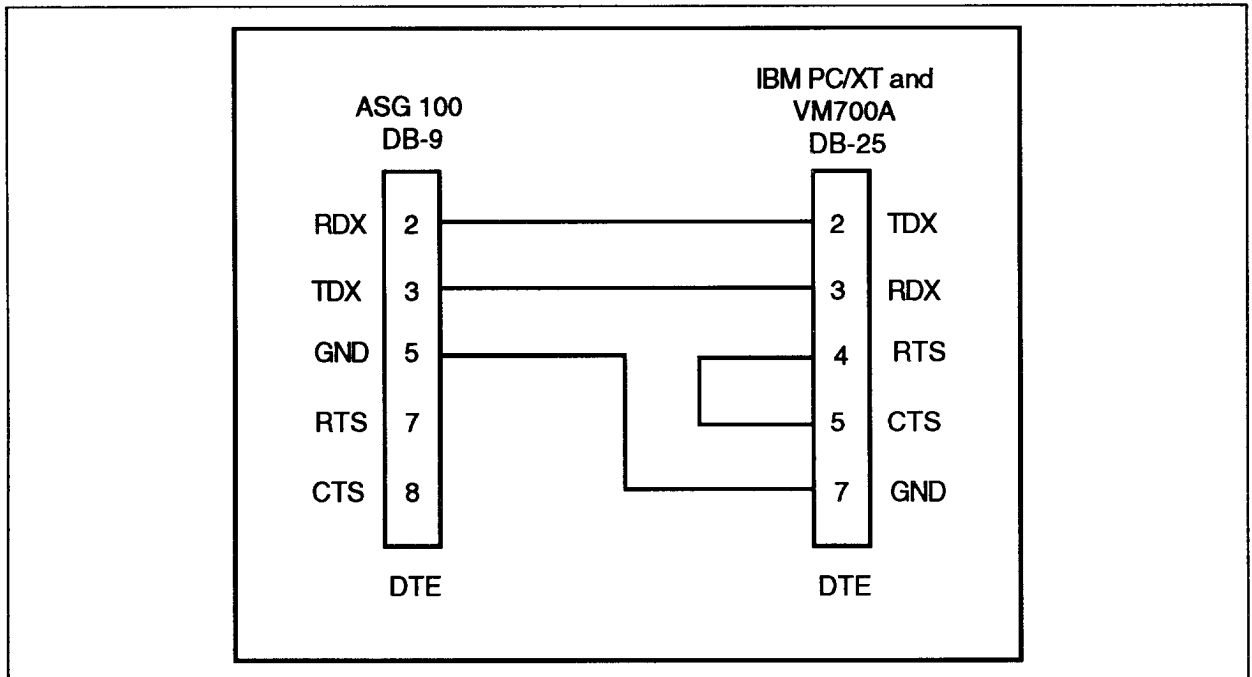

Figure C-1. Cabling to IBM PC/XT or Compatibles and the VM700A.

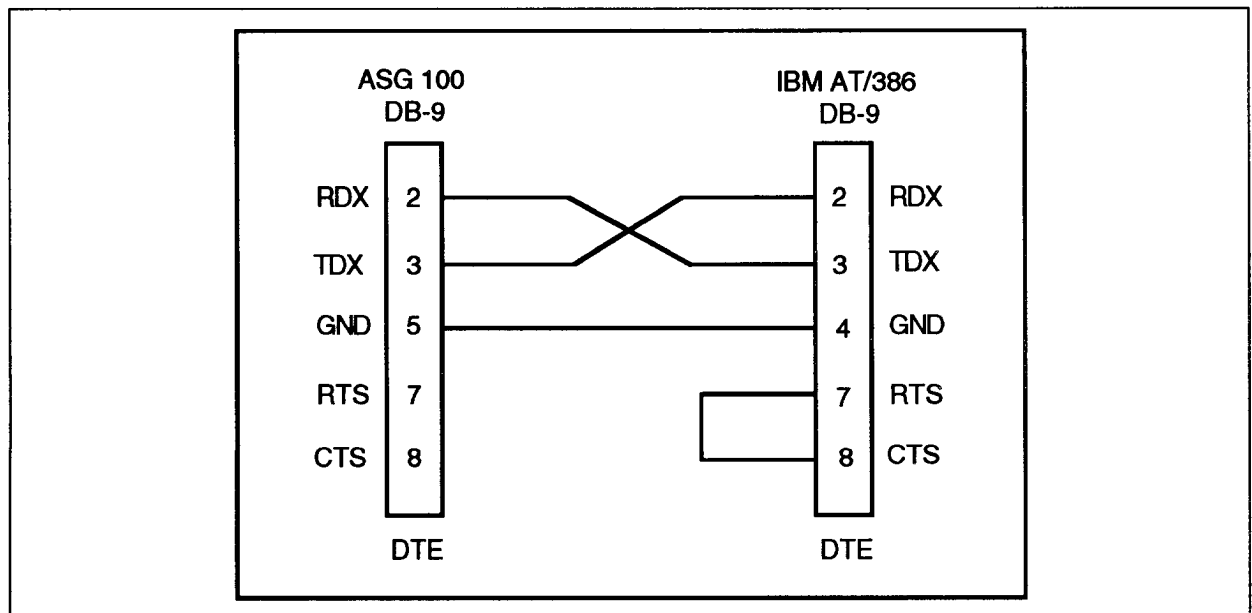

Figure C-2. Cabling to IBM AT/386 and Compatibles.

NOTE

In all configurations pins 4, 6 and 9 on the ASG 100 serial port must not be connected to the serial port on the remote terminal or computer; they are reserved for remotely enabling function editing and initiating the AUTO test. Typically, if you establish remote control through a terminal or computer, you will perform these operations through remote commands, rather than through shorting these pins.

Set DIP Switch to Enable Remote Control

As explained in Appendix A, *Internal Settings*, certain functions are enabled and disabled by the positions of the switches on the 10-switch DIP labeled “S1” on the circuit board. You access this switch through the cover on the left panel of the ASG 100. As with all servicing, refer the internal adjustments to a qualified service person.

Remote operation of the ASG 100 through its remote port is enabled when switch S1, position 8 (labeled “PROG 7” on the circuit board) is in the up position. As shipped from the factory, remote operation is enabled.

Set Serial Communication Parameters on the Terminal

Using the commands appropriate for your terminal or terminal emulator, set the communication parameters to the values shown below in Table C-2.

Table C-2
Serial Communication Parameters

Parameter	Value
Baud Rate	9600 ^a
Data Bits	8
Parity	None
Stop Bits	1

^aBaud rate for the ASG 100 is selectable for 1200, 2400, 4800, or 9600 baud. The factory setting is 9600 baud.

Setting Baud Rate of the ASG 100

The baud rate of the ASG 100 is user settable from the front panel so that lower baud rate modems not capable of the factory default of 9600 baud may be used for remote control. Four choices are available: 1200, 2400, 4800, and 9600 baud. The data bits, parity, and stop bits parameters for the ASG 100 are fixed.

NOTE

If you need to operate the ASG 100 on a baud rate setting other than 9600, PROG0 of S1 must be set to the user defaults position (down) to make the needed baud rate setting. Leave the switch set to user defaults to prevents the baud rate (and the other user selectable front panel settings as well) from being changed to factory defaults in the event of a loss of power to the ASG 100. The factory default baud rate setting of 9600 is restored at power on if PROG0 of S1 is set to the factory default (up) position

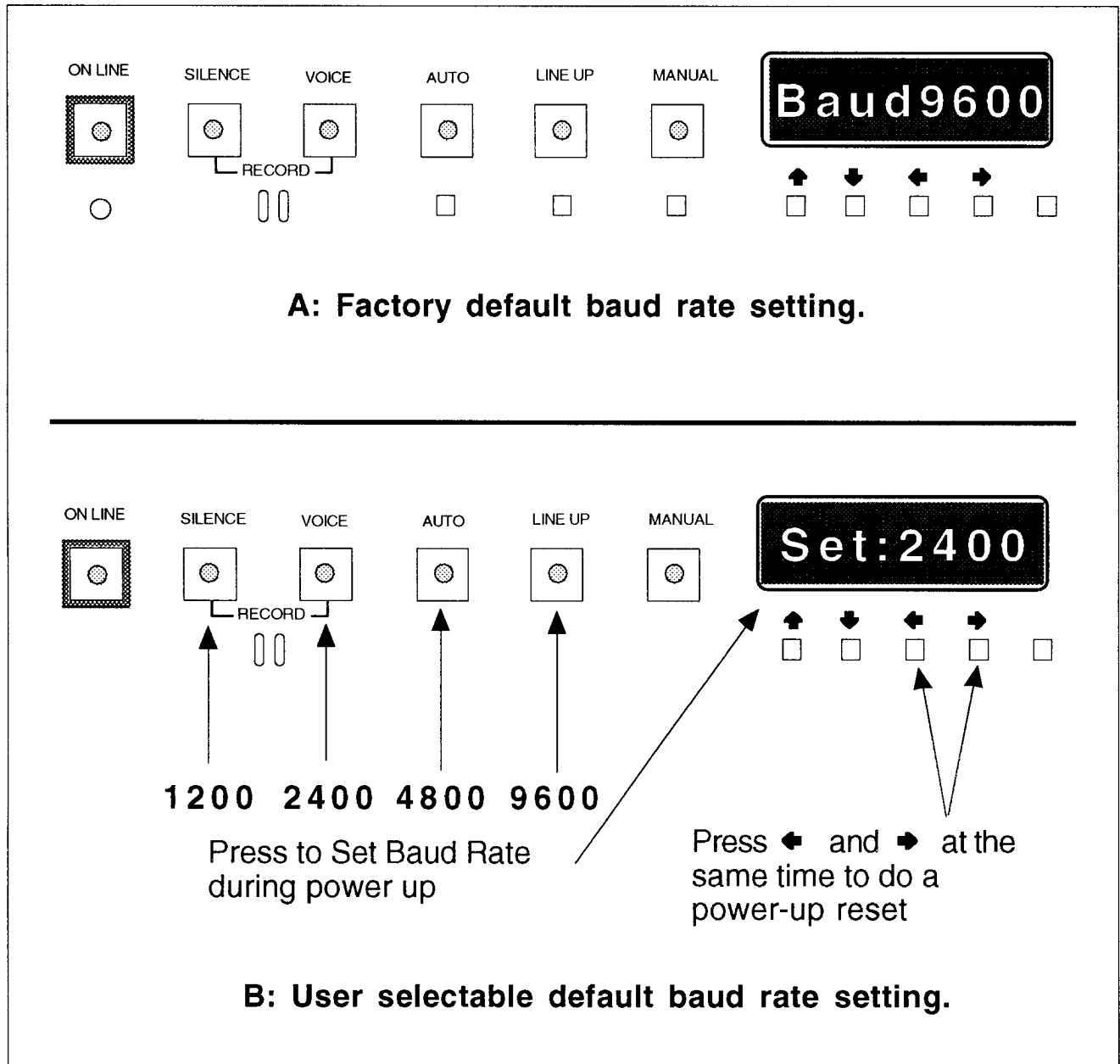

Figure C-3. Setting baud rate during power on.

The baud rate may be set during power up only if PROG0 of S1, the default settings switch (factory defaults up and user defaults down), is set to the user default position (down). At power up, the current baud rate setting (for example, Baud9600) appears in the display window for about 3 seconds. A front panel button that selects baud rate must be pressed to change the setting (see Figure C-3, A) before that message is removed from the display. Setting a new baud rate automatically saves it as the user selectable power-on setting.

When a baud rate selection button is pressed, the message "Set:nnnn" (where nnnn is the new baud rate) will be displayed. Holding a button in keeps the setting associated with that button displayed until it is released. When released, the new baud rate is displayed. If that is not the required setting, immediately pressing another baud rate choice selects the baud rate associated with that front panel button (see Figure C-3, B).

If a another baud rate selection button is not pressed within the 3-second time period after a baud rate setting has been made, the ASG 100 continues with the power-on routine and initialization of the front panel settings.

It is not necessary to turn off the ASG 100 at the rear panel ON/OFF switch to get a power up restart for resetting the baud rate. Pressing the left and right arrow buttons at the same time resets the ASG 100 and restores the enabled defaults (factory or user). This is the same action that occurs when a control C is sent to the ASG 100 via the RS-232C serial port.

Once the ASG 100 baud rate has been set to a different choice, the device communicating with the ASG 100 must also be set to that same baud rate (or be able to auto baud) to communicate with the ASG 100. If the baud rate selected matches the baud rate expected by the device that the ASG 100 is sending to, the remote display will print out the DSP Firmware version number, the DSP diagnostics version number, and the the FP Controller version number. If nothing is seen, either the serial communication path is not connected, or the baud rate is incorrect. If only garbled ascii characters are seen, try another baud rate.

REMOTE OPERATION

Once installation is complete, when you power on the ASG 100 the screen of the remote terminal transcripts the self-test the ASG 100 performs, then displays the following prompt:

```
ASG100\fp>
```

When this prompt is displayed, you can enter the remote commands. Any command that is not understood will cause the error line "Unrecognized command." to appear. Other error messages appear when arguments to the command are not within limits or errors in the syntax of the arguments are found.

The RS-232C interface of the ASG 100 permits only one command per line, and a command line is terminated by a carriage return. If the command sent requires a reply from the ASG 100 or starts an AUTO test sequence (i.e., Sweep which needs about 32 seconds to finish), an appropriate time delay must be permitted before another command is sent. Attempting to batch load a set of commands to the ASG 100 may cause command data to be lost while the ASG 100 is sending its reply. Also, *any* command sent to the ASG 100 while an AUTO test is being executed will terminate the AUTO test.

Remote Commands

There are commands that take arguments to permit the parameters of the command to be altered. The commands also have associated queries to determine the parameters of a test signal. Several of the commands are queries only. There are also three control characters that the ASG 100 recognizes to assist in remote operation of the instrument. A concise list of the commands, arguments, queries, and special control characters is given in Tables C-3, C-4, and C-5 for quick reference. The text following the tables explains the commands in more detail.

Table C-3
List of ASG 100 Commands, Arguments, and Queries

Commands	Argument	Argument	Queries	Responses
auto	l:[level]	[test name]	auto? auto help	<p>Auto with no arguments starts the selected auto test at the current level setting. The level argument sets a new TEST Lev for the O.33 and Tek tests from -6 dBu to +14 dBu. The test name argument selects the test sequence.</p> <p>If the test signal for auto is a Sweep signal, the level argument sets a new SweepLev from -90 dBu to +24 dBu.</p> <p>auto? returns the selected test sequence, the current ID, and the level settings for Test Level and Sweep Level.</p> <p>auto help returns a list of valid arguments for the auto command.</p>
help			help? ?	All forms of this command return a list of ASG 100 commands.
helpoff				Turns off the help replies, error messages, and prompts. Test signal queries are answered.
helpon				Turns the help replies, error messages, and prompts back on.
id "****"			id?	<p>Sets a new 4-character ID. All printable ASCII characters are valid and all four characters must be used. Spaces are valid.</p> <p>The query returns the 4-character ID.</p>
lineup			lineup?	<p>Sends the line up signal to both channels. The frequency and level cannot be changed remotely. If a variable tone signal is needed for a special line up, use the tone test signal.</p> <p>The query returns the present level and frequency for the lineup signal.</p>

Table C-3 (cont)

Commands	Argument	Argument	Queries	Responses
lmtone<1 2 3 4>	l:[<i>level</i>]		lmtone[n]?	Sends the selected multi-tone (1, 2, 3, or 4) to the left channel at the current level. The level argument sets the new signal level from –90 dBu to +24 dBu. The query returns the present level for the multi-tone test signals.
lpolr	l:[<i>level</i>]		lpolr?	Sends the polarity signal to the left channel. The level argument sets the new signal level from –90 dBu to +24 dBu. The query returns the present level for the polarity test signals.
ltone	l:[<i>level</i>]	f:[<i>frequency</i>]	ltone?	Sends the tone signal to the left channel. The level argument sets the new signal level from –90 dBu to +24 dBu. The frequency argument sets a new frequency from 10 Hz to 20 kHz. The query returns the present level for the tone test signals.
mtone<1 2 3 4>	l:[<i>level</i>]		mtone[n]?	Sends the selected multi-tone (1, 2, 3, or 4) to both channel (channels A and B). The level argument sets the new signal level from –90 dBu to +24 dBu. The query returns the present level for the multi-tone test signals.
offline			offline?	Takes the ASG 100 offline and restores the input program (if any) to the downstream equipment. The query replies that there are no variables for offline.
rmtone<1 2 3 4>	l:[<i>level</i>]		rmtone[n]?	Sends the selected multi-tone signal (1, 2, 3, or 4) to the right channel. The level argument sets the new signal level from –90 dBu to +24 dBu. The query returns the present level for the multi-tone test signals.

Table C-3 (cont)

Commands	Argument	Argument	Queries	Responses
rpolar	l:[level]		rpolar?	Sends the polarity signal to the right channel. The level argument sets the new signal level from -90 dBu to +24 dBu. The query returns the present level for the polarity test signals.
rtone	l:[level]	f:[frequency]	rtone?	Sends the tone signal to the right channel. The level argument sets the new signal level from -90 dBu to +24 dBu. The frequency argument sets a new frequency from 10 Hz to 20 kHz. The query returns the present level for the tone test signals.
silence			silence?	Sends silence on the output signal lines. The query replies that there are no variables for the silence command.
tone	l:[level]	f:[frequency]	tone?	Sends the tone signal to both channels. The level argument sets the new signal level from -90 dBu to +24 dBu. The frequency argument sets a new frequency from 10 Hz to 20 kHz. The query returns the present level for the tone test signals.
voi+lu			voi+lu?	Sends the recorded voice id alternately with the line up signal. The query returns the present line up level which is also the voice level.
voice			voice?	Sends the recorded voice id. The query returns the present line up level which is also the voice level.

**Table C-4
Special Queries**

Query	Response
display?	Returns the present display text.
leds?	Returns the LED or LEDs that are on. NOTE: If an auto sequence is on, it is aborted.
version?	Returns the front panel controller firmware version number and date the version was created.

**Table C-5
Control Signals**

Control Signal	Response
control C	Restarts the ASG 100 and restores the default front panel settings (either factory or user selected as determined by the setting PROG 0 of DIP switch S1).
control S	Halts communication from the ASG 100 serial port.
control Q	Restarts communications from the ASG 100 serial port after being halted by a control S.

Command Description

Help Commands

To display a list of the remote test signal commands on the terminal screen, enter:

```
help[cr] or ?
```

Figure C-4 shows the resulting menu.

Sending help with the auto command in the following form:

```
auto help
```

returns a list of the legal arguments that may be used with the auto command (see Table C-5 for test names).

Help mode can be disabled to eliminate the output of the help menu and the normal prompts. The command to disable the help menu is:

```
helpoff[cr]
```

All error messages and prompts are disabled. The ASG 100 still responds to the direct queries for information on frequency or levels when given as shown below, but it will not respond to help, ?, or auto help and does not return error messages on incorrect commands with help turned off.

Help is turned on again using the command:

```
helpon[cr]
```

ASG 100 REMOTE COMMAND MENU

```

offline .....Takes unit offline.
silence .....Sends silence.
voice .....Sends the stored voice sequence.
auto [l:level] [test_name] .....Starts auto sequence.
id "****" .....Assigns identification code.
lineup .....Sends the preset line up tone.
voi+lu .....Alternately sends voice and line up.
[r | l]tone [f:freq] [l:level] .....Sends a tone to respective channel(s).
[r | l]polr [l:level] .....Sends polarity to respective channel(s).
[r | l]mtone<1|2|3|4> [l:level] ....Sends multi-tone to respective channel(s).
Where:
test_name  is an auto sequence argument. Type "auto help" for list.
           Example:      "auto tek:91"    will generate the tek:91 sequence.
freq       is the frequency in Hz.
           Example:      "tone f:440"    sends a tone at 440Hz, default level.
level      is the level in dBu. The level must be entered to the nearest tenth
           of a dBu.
           Example:      "lmtone l:+2.3" sends left channel multi-tone at +2.3dBu.
*          is any ASCII character from " " to "~".

```

Figure C-4. Help screen of remote commands.

Queries

There are several remote queries available. They are associated with the test signal commands. The form of the query is:

```
tone?
```

and the return is the present setting for the Manual Tone frequency and the Manual Tone Level. Similar information is returned when the question mark is used to make a query of one of the other test signal commands. The query associated with the commands of voice, voi+lu, and lineup that have no arguments return the current line-up signal level and frequency.

A query of **Auto?** returns the currently selected test sequence, the 4-character id of the ASG 100 queried, and the Test Level and Sweep Level settings associated with the auto test sequences.

Unit Identification

There is an id command and an id query. The id command sends a four-character identification code to the ASG 100. That identification code will be used in the preamble of the auto tests that make use of the unit identifier. Note: The new id sent via remote control is not saved; if the ASG 100 is reset, the identifier will default to the previously saved id.

The form of the command is:

```
id "****"
```

Any 4-character combination of ASCII figures, letters, or punctuation is permitted. All four characters are needed, but they may be spaces. Note: if you use a space for all four characters, the display will be blank. An error message is generated when an argument syntax error is found if help is on.

The query **id?** returns the 4-character identification code of the ASG 100.

Special Queries

There are two queries that let the remote operator determine the display state of the ASG 100. They are :

`display?` and `leds?`

The `display?` query returns the present display seen on the front panel, and the `leds?` query returns all the front panel indicators that are on.

NOTE

The power-on LED is not firmware controlled, so it is not reported in the return.

Either of these commands may prove useful for determining the state of the ASG 100 without sending a command to cause the state to change. Coupled with the queries regarding the present signal parameters (`tone?`, `lineup?`, etc?), it is possible to determine the state of the ASG 100 front panel and the signal parameters without sending a command that will put it on line or change its state if it is on line.

NOTE

If an auto sequence is in progress, the auto sequence is aborted if any communication is received during the test sequence. This includes asking the ASG 100 what its present state is.

A third special query, `version?`, returns the front panel controller firmware version and the date it was generated. This query is provided because any version related firmware questions that arise may be more easily addressed when the installed version is known.

Restoring Defaults

The remote commands with arguments change the setup from the power-on setup. To restore the power-on state, either the factory defaults or the user selected settings, whichever is enabled, type control C. This restarts the ASG 100 and restores the power-on control settings.

Flow Control

The ASG 100 responds to X ON/X OFF software flow control. When a control S is received for X OFF, the ASG 100 stops sending on its serial port. When a control Q is received for X ON, serial communications is re-enabled. If there is a message pending from the ASG 100, it is sent. The number of messages that are sent after a control Q is received is limited by the memory space available to hold the unsent messages. During the time communication is off, incoming commands are processed, but not echoed.

REMOTE COMMAND SYNTAX

The commands **offline**, **silence**, **voice**, **lineup**, and **voi+lu** take no arguments and perform the requested operation just as from the front panel.

The remote **auto** and remote **tone**, **polarity**, and **mtone** commands allow you to specify optional arguments, as indicated by the bracketed text in Figure C-4 (shown previously). The following text describe the syntax for these remote commands. Type in the commands exactly; do not add extra spaces or other punctuation in front of a command. After the command, use one space before an argument and as a separator when two arguments are used, as in the case of setting both amplitude and frequency for tone. For example:

```
tone f:1000 l:-2.5
```

The order of the arguments does not matter, and the arguments are not case sensitive. The command may be all upper case, all lower case, or mixed. The command line terminator is the carriage return [cr]. The special control characters, control C, control S, and control Q, are received immediately without waiting for a carriage return.

auto [l:level][test_name]

Level is an optional argument. The test level reference for the auto test sequence is specified. If the argument is not used, the auto test level reference remains at the last selected value. The valid arguments are +14 dBu to -6 dBu in whole integer values. For example, 1:5, 1:0, 1:-3, etc.). Error messages are generated if a limit violation is detected in the argument if help is on.

Test_name is also an optional argument. The argument is a text string specifying which automatic test sequence you want to send. If you do not specify a test name, the auto command initiates the test last selected. The level and test name arguments for auto are not order sensitive, and either may be used first.

The text strings to use for the test sequences supplied by Tektronix are listed below in Table C-6. Enter the arguments with punctuation exactly as shown. The command to send the TEK:90 test at 0.0 dBu will look like this: **auto tek:90 l:0** or **AUTO TEK:90 L:0**. A help query of the auto command in the form of **auto help** returns a list of the legal arguments available with the auto command. An error in the test name argument also results in a display of the legal arguments if help is on.

When the sequence is done, the ASG 100 sends the below message followed by a bell:

```
*Auto sequence done.
```

A programmer may choose to watch for the * so that all other commands are held off until the test sequence is done. Another option is to put in a wait state long enough for the test sequence to finish. A wait state would be required if the helpoff command is in effect as the ASG 100 will not return any messages or prompts in this state.

Aborting an Auto Sequence

An auto test sequence is aborted if ANY communication is received after the command is given until the auto test sequence is done. The message "Aborting time sequence, executing new command" is generated. Sending a carriage return only halts the AUTO sequence, and the ASG 100 waits for a second carriage return or a new command to execute before returning the prompt.

Aborting the auto test sequence is a precaution, because the processor of the ASG 100 is also sending the commands needed to generate the test signals in the proper time sequence. Any interruption to handle communications may corrupt the timing of the test sequence.

Table C-6
Test Name Arguments to Remote "AUTO" Command

O.33:00 Test Type	Argument	Tek Test Type	Argument
Mono	O.33:00	Mono	Tek:90
Mono with Voice ID	O.33:00v	Mono with Voice ID	Tek:90v
Stereo	O.33:01	Stereo	Tek:91
Stereo with Voice ID	O.33:01v	Stereo with Voice ID	Tek:91v
Medium Band Sound Program	O.33:02	Microphone	Tek:92
Medium Band Sound Program with Voice ID	O.33:02v	Microphone with Voice ID	Tek:92v
Narrow Band	O.33:03	Line Level	Tek:93
Narrow Band with Voice ID	O.33:03v	Line Level with Voice ID	Tek:93v
Narrow Band Sound Program with Compandor	O.33:04	Transmitter	Tek:94
Narrow Band Sound Program with Compandor with Voice ID	O.33:04v	Transmitter with Voice ID	Tek:94v
3-Level Alignment Signal for International Sound Program without Station Identifier	O.33:05	Stereo with Crosstalk	Tek:95
		Stereo with Crosstalk and Voice ID	Tek:95v
		Sweep	Sweep Sweep r Sweep l

[rl][tone [f:frequency] [l:level]

The **tone** remote command with no arguments makes the ASG 100 send the currently selected MANUAL test tone through the right and left channels at the same time. The **rtone** and **ltone** versions of this command send the MANUAL test tone through the right and left channels, respectively. A query of any of the tone commands in the form of **tone?** returns the current frequency and level setting of the manual tone signals.

The frequency argument specifies a desired frequency for the manual test tone. Enter the initial characters of this argument, **f**, literally, as shown. Specify *frequency* as a positive integer number representing the desired frequency in Hertz. An error in the frequency argument, a number outside the legal range or bad syntax, will result in an error message being generated if help is on.

The level argument specifies a desired amplitude for the manual test tone. Enter the initial characters of this argument, **l**, literally, as shown. Specify *level* as a number representing the amplitude in dBu. You can specify values to tenths of a decibel, for example **5.3**. Do not add extra numbers after the tenths. An error in the argument, specifying a number outside the legal range or incorrect syntax, will result in an error message being generated if help is on.

If you want to specify a negative amplitude, you must prefix the value with a - (minus sign), for example, **-4**. Otherwise the value is assumed to be positive. You can also explicitly specify a positive amplitude with a + (plus sign) prefix, for example, **+6**. A change in the level applies to all the tone signals.

[rll]polr [l:level]

The **polr** remote command with no argument makes the ASG 100 send the polarity tone at the currently selected level through both channels. The **rpolr** and **lpolr** versions of this command send the polarity tone through the right and left channels, respectively. A query of any of the polarity commands in the form of **polr?** returns the fixed frequency of 440 Hz and the current level setting of the manual polarity signals.

The level argument specifies a desired amplitude for the polarity test tone. Enter the initial characters of this argument, **l**, literally, as shown. Specify *level* as a number representing the amplitude in dBu. You can specify values to tenths of a decibel, for example **5.3**. Do not add extra numbers after the tenths. An error in the level argument, specifying a level outside the legal range or incorrect syntax, will result in an error message being generated if help is on.

If you want to specify a negative amplitude, you must prefix the value with a **-** (minus sign), for example, **-4**. Otherwise the value is assumed to be positive. You can also explicitly specify a positive amplitude with a **+** (plus sign) prefix, for example, **+6**. A change in the level applies to all the polarity signals.

There is no frequency argument for polarity. The polarity testing signal is composed of two equal-amplitude sine waves of 440 Hz and 880 Hz, and frequency changes are not permitted. Attempting to send a frequency argument to polarity will result in an error message being generated if help is on.

[rll]mtone<1|2|3|4> [l:level]

The **mtone<1|2|3|4>** remote commands makes the ASG 100 send the selected multi-tone signal at the currently selected amplitude through both channels. The **rmtone <1..4>** and **lmtone <1..4>** versions of this command send the selected test multi-tone through the right and left channels, respectively. The multi-tone signal wanted must be designated. Sending **mtone** alone does not cause a default multi-tone to be sent. A query of any of the multi-tone commands in the form of **mtone1?** returns the current level setting of the manual multi-tone signals.

The level argument specifies a desired amplitude for the multi-tone test signal. Enter the initial characters of this argument, **l**, literally, as shown. Specify *level* as a number representing the amplitude in dBu. A change in the level applies to all the multi-tone signals. An error in the level argument, specifying a level outside the legal range or bad syntax, will result in an error message being generated if help is on.

If you want to specify a negative amplitude, you must prefix the value with a **-** (minus sign), for example, **-4**. Otherwise the value is assumed to be positive. You can also explicitly specify a positive amplitude with a **+** (plus sign) prefix, for example, **+6**.

There is no frequency argument for multi-tone. The test signals are composed of sets of equal-amplitude sine waves at predetermined frequencies, and there is no specific frequency associated with multi-tones. Attempting to send a frequency argument to multi-tone will result in an error message being generated if help is on.

Appendix D

AUDIO/VIDEO TIMING

The Audio/Video Timing feature of the ASG 100/ASG 140 is part of a system that measures the timing difference between audio and video portions of a program that arrive from different transmission paths. Use this feature in conjunction with the VITS200 NTSC and VITS201 PAL insertion generators and VM700A Video Measurement Set. Current production of the ASG 100 and ASG 140 Audio Signal Generators have the circuitry needed to support the Audio/Video timing measurement. Previously manufactured ASG 100 generators can be modified to support the measurement. See your local Tektronix representative for information on ordering any modification kits.

VM700A AUDIO/VIDEO MEASUREMENT OPERATING INSTRUCTIONS

The Audio/Video Timing measurement feature on the generators permits synchronization of the video and audio test signals at the sending end of the program. The VM700A, equipped with Option 40 and the Audio Video Timing measurement, receives both at the receiving end and measures the timing difference to aid in retiming the signals. Figure D-1 shows the VM700A display for the Audio Video Timing measurement with no signals applied. The error message line above the graph provides information regarding the state of the triggers needed to make a timing measurement. The line may say that it is waiting for either or both triggers (audio and video) to arrive, or that one or the other has arrived and it is waiting for the other. Upon receiving both triggers, the VM700A makes the measurement and provides a delay time numerical readout and a graphical display.

VM700A Signal Hookup

The measurement requires both video and audio test signal connections. Use one, two, or all three video input channels. The selected channel on the VM700A is the source for the video part of the measurement, but audio signal selection is not automatic. You must externally switch the correct audio signal when switching between video channels (A, B, or C). The audio part of the timing measurement can come in on either the Left or the Right channel input; the measurement looks at both channels. The first arriving audio signal provides the audio trigger. The video channel providing the video signal for measurement follows the front panel channel selection.

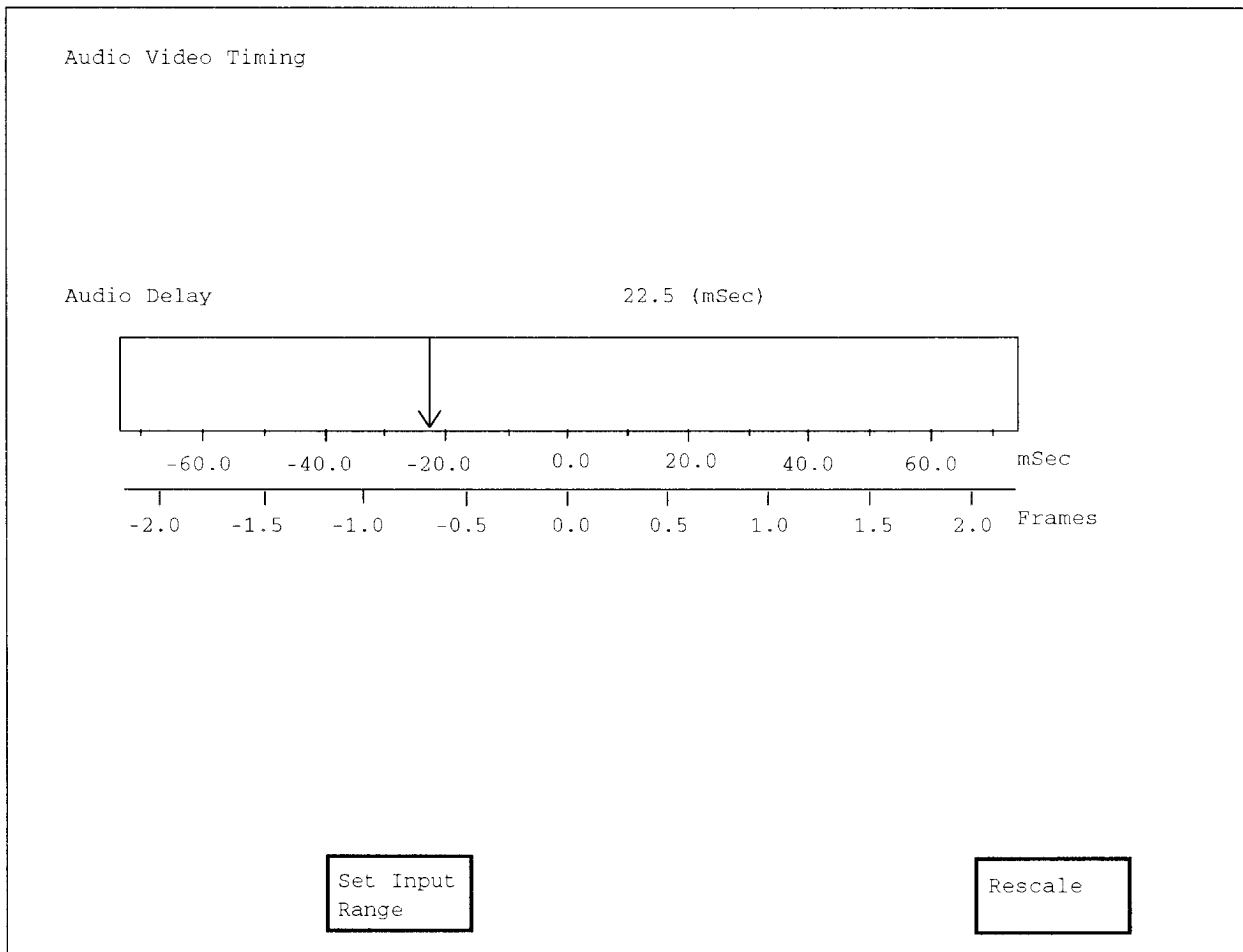

Figure D-1. Audio Video Timing display.

Audio Video Timing Menu

Set Input Range

Set Input Range enables you to select the range window that most closely matches the amplitude range of the input signal.

The VM700A will digitize audio in a 92 dB window within a total input range of 132 dB. The input ranges of the left and right channels may be configured independently with the **Left Range:** or **Right Range:** softkeys.

There are five input range windows:

- range A: -62 to +30 dBu
- range B: -72 to +20 dBu
- range C: -82 to +10 dBu
- range D: -92 to 0 dBu
- range E: -102 to -10 dBu

Rescale

Rescale returns the display scaling to its default values.

VITS200/ASG 100 AND ASG 140 AUDIO/VIDEO MEASUREMENT OPERATING INSTRUCTIONS

The Video/Audio Synchronization feature turns the vertical interval text of the VITS200 generator and the audio output of the ASG 100/ASG 140 on and off at the same instant in time.

ASG100/ASG140 Instructions

- 1 Select manual mode.
- 2 Select 10 kHz frequency.
- 3 Select -10 dB output level.
- 4 Select "ON LINE" or "SIGNAL ON" as appropriate (red LED comes on).

Checkout

Grounding remote connector pin 1 turns off the audio output.

VITS200 Instructions

1. Connect a NTSC video source so that the VITS200 is genlocked.
2. From the front panel, select:
Vertical Characters
VERT CHAR 2 ENABLE
3. Input the message you intend to use.
4. Connect a special cable between the VITS200 remote connector and the ASG 100/ASG 140 remote connector as shown in Figure D-2.

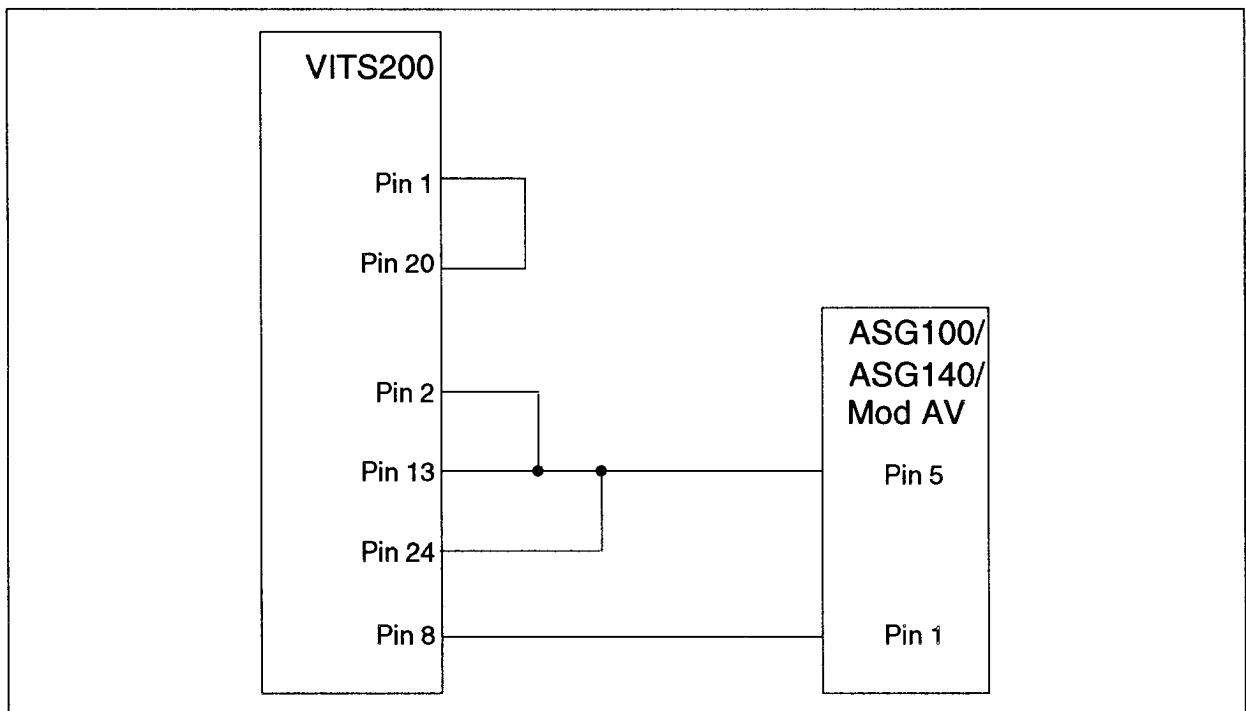

Figure D-2. Cabling between the VITS200 and the ASG 100/ASG 140.

Checkout

When the VITS200 is genlocked, the signal at the remote connector pin 14 of the VITS200 will be a TTL HIGH voltage for 4.5 seconds then LOW for 0.5 seconds. The signal transitions from high to low at line 262 field 3. The signal at remote pin 15 is inverted from pin 14. The ASG 100/ASG 140 audio output is turned ON at this time, but the VITS200 VITS text does not appear until field 1 line 11. This means that the ASG 100/ASG 140 Audio leads the video change by 17.334 ms. The VM700A Audio Video Timing measurement removes the 17.334 ms before presenting the measured time difference.

NOTE

You can select any of the 15 possible messages by changing the selection lines that are grounded (pins 2,3,4,5). The wiring diagram above uses message #2 by grounding pin #2.

VITS201/ASG100 AND ASG 140 AUDIO/VIDEO TIMING MEASUREMENT OPERATING INSTRUCTIONS**Video/Audio Synchronization**

The Audio/Video feature turns the vertical interval text of the VITS201 generator and the audio output of the ASG100/ASG 140 on and off at the same instant in time.

ASG100/ASG 140 Instructions

1. Select manual mode.
2. Select 10 kHz frequency.
3. Select -10 dB output level.
4. Select "ON LINE" or "SIGNAL ON" as appropriate (red LED comes on).

Checkout

Put the ASG 100 or ASG 140 on line with a manual test tone. Use a set of stereo headphones to listen to the outgoing signal. Check that grounding pin 1 of the rear panel remote connector turns off the audio output.

VITS201 Instructions

1. Connect a PAL video source so that the VITS201 is genlocked.
2. Open S11 switch 4 and switch 0.
3. Press function button 6 times until a C appears. Enter some text in the vertical interval like "Electronic Clapboard".

NOTE

Only one character is required.

NOTE

The output signal is HIGH during this function.

4. Close switch 0.
5. Connect a special cable between the VITS201 remote connector and the ASG100 remote connector as shown in Figure D-3.

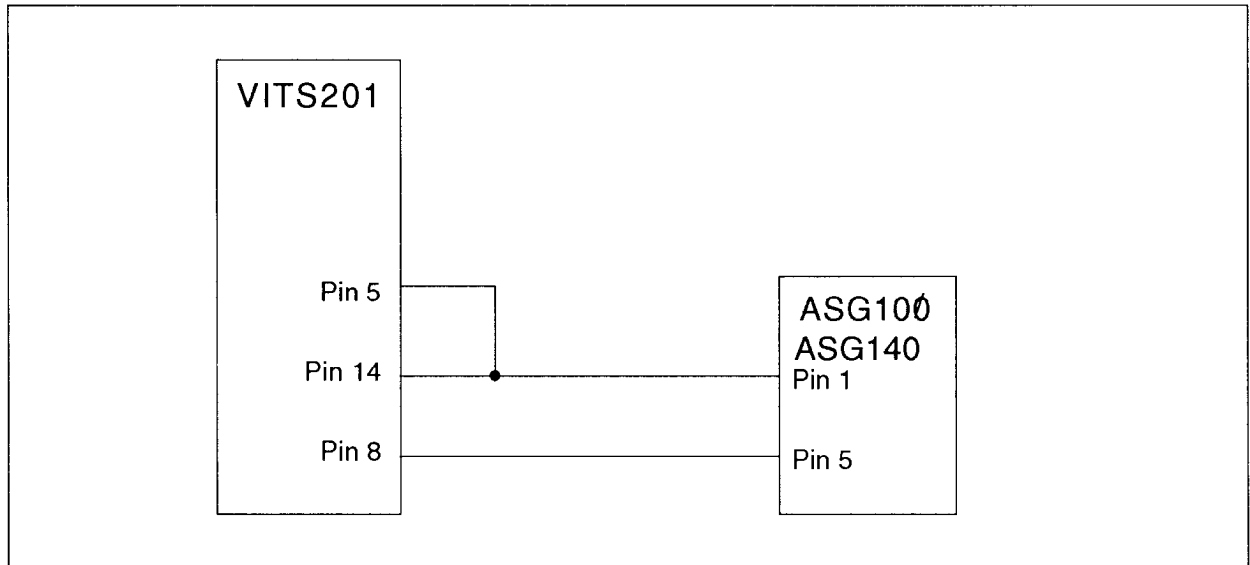

Figure D-3. Cabling between the VITS201 and the ASG 100/ASG 140.

Checkout

When the VITS201 is in the power-up Line Selection mode and is genlocked, the signal at pin 14 of the remote connector will be a TTL low voltage for 4.5 seconds then high for 0.5 seconds. The signal transitions from low to high at line 1 field 1. When the TTL signal is high, the ASG 100/ASG 140 audio output is ON but the VITS201 video text does not become visible until line 10 field 1. This time:

$$(9 \text{ lines} * 64 \mu\text{s} = 576 \mu\text{s})$$

is subtracted out of the VM700A measurement.

VITS200, VITS201 and ASG100 AUDIO/VIDEO TIMING MEASUREMENT CIRCUITRY MODIFICATIONS

Current production instruments have the Audio/Video circuitry incorporated. Make the following changes to existing equipment for the AV Timing Measurement modification. The ASG 140 supports the Audio/Video Timing measurement without modification.

WARNING

Only a qualified service person should attempt any modification to electronic circuitry.

VITS200 Modification Description

This modification, required on early VITS200 instruments only, calls for replacing U32 on the inserter board and U35 on the controller board with new programmed parts. Some rewiring of the control signals routing is also required. Future VITS200 instruments will not require modification. If you require the AV Timing measurement, refer to your VITS200 Operator's Manual or check with your Tektronix representative about the need to modify your existing equipment.

Board Modifications to Early VITS200 Circuit Boards

The MONOCHR line (inserter board U38 pin 9, diagram 4) is an input to the Controller, U32, on pin 67. That signal is wire strapped to pin 4 of PAL U59 that provides two outputs: a buffered output from pin 18 and an inverted output from pin 17. These signals are wire strapped out of the VITS200 on lines REM13 and REM14 on J12 to switch the ASG 100/ASG 140 signal generator on and off in synchronization with the VITS output video signal. Do the wire strapping to make the modification on the bottom side of the circuit board.

Add the following wires:

From	To
U23 pin 67	U59 pin 4
U59 pin 17	J12 pin 15
U59 pin 18	J12 pin 14
U35 pin 14	U35 pin 2

Remove the following components:

C148 0.1 μ F and C147 0.1 μ F.

Lift the pin 4 leg of U35 out of the socket (it remains unconnected).

VITS201 Modification Description

This modification requires replacing U20 on the A1 assembly and adding a wire to route a control signal to the remote connector.

Remove A1U20 160-6539-00 and replace it with the Video Clapboard kernel EPROM **CMP-0028-00** checksum = **3484**.

Add a wire from A1U7 pin 6 (74LS273) to J35 pin 12. The signal will appear on the remote connector at pin 14.

Checkout

When the VITS201 is in the power-up Line Selection mode and it is genlocked, the signal at the remote connector pin 14 will be a TTL low voltage for 4.5 seconds then high for 0.5 seconds. In all other cases, the signal will remain high. The signal transitions from low to high at line 1 field 1.

ASG100 Modification Description

This modification to the ASG100 requires some rewiring to route a control signal into the ASG100 from the remote connector and adding a pull-up resistor to the controlled signal line.

Cut pin 1 of A2U66 (74LS74). Solder a 2.2K resistor (313-1222-00) from pin 1 to pin 4. Connect a wire from A2U66 pin 1 to A2U67 (MAX239) pin 2.

Checkout

Put the ASG 100 on line with a manual test tone. Use a set of stereo headphones to listen to the outgoing signal. Check that grounding pin 1 of the rear panel remote connector turns off the audio output.

INDEX

A

- Aborting an Auto Sequence, C-13
- AMPLITUDE button, B-8
- Amplitude, 3-10
- Applications, 4-1
- arguments, C-13
 - order of, C-13
 - values, C-14
- Arrow Buttons, 3-11
- ASG 100 Remote Commands, C-6
- Audio Path, 2-2
- Audio/Video Timing measurement, D-1
- auto help, C-10
- auto sequence done, C-13
- AUTO, 3-6, C-13
- Auto Test Level, 3-7
- automatic test sequences, 1-1, 3-3
- automatic test, B-1
- Automatic Testing, 1-1

B

- back panel, 2-1
- battery, 3-13
- Baud Rate, C-4
 - setting a new baud rate, C-6

C

- cable configurations, C-2
- Camera Locations, 4-1
- camera number, 4-1
- CCITT O. 33 Tests, 3-3, B-1, B-7, B-8
- commands, C-13
 - display?, C-12
 - helpoff, C-10
 - helpo, C-10
 - leds?, C-12
 - lineup, C-13
 - ltone, C-14
 - offline, C-13
 - rtone, C-14
 - silence, C-13
 - syntax, C-13

- tone, C-14
- version?, C-12
- voice, C-13
- communication parameters, C-4
- Communications Cable, C-1
- Compandor Linearity, B-1
- contact closure, 1-2, 2-2, 4-1, A-5, C-1
- control C, C-12
- control S, C-12
- control Q, C-12
- crosstalk, B-1, B-16

D

- Data Bits, C-4
- data terminal equipment, C-2
- DB-9 connector, C-1
- dBu, 3-7, A-6
- Dedicated Line-up Tone, 3-2
- Default Baud Rate, C-4
- DIP switch, A-1, 3, C-4
- Display Window, 3-13
- display?, C-12
- Down Arrow, 3-11
- DTE (Data Terminal Equipment)
 - connector, C-1
- DTE cable, C-2

E

- editable functions, 2-3
- Editing, 3-11
 - disabling, 2-5
 - enabling, 2-5
 - lock override, C-1
 - Signal Parameters, A-3
 - selective disabling, 2-5
- Electrical Characteristics, 1-3
- Enable Remote Control, C-4
- Encoded Source Identification, 3-4
- Engineering Van, 4-1
- Environmental Characteristics, 1-6
- error messages, C-6
- Expanded Noise, B-1
- External Edit Enable, A-4

F

- factory settings, 2-3
- failed self test, 3-13
- Features and Capabilities, 3-2
- flashing digit, 3-11
- Flow Control, C-12
- Freedom of Operation, 3-4
- Frequency, 3-10
 - argument, C-14
 - Response, B-1
- frequency-shift keying, B-7
- front panel
 - Controls, 3-5
 - enabling, A-5
 - lockout, A-5
- Functions, 3-5

H

- Harmonic Distortion, B-1
- Headphones, 3-4, 3-13
- house line-up level, 3-2

I

- IBM PC, C-2
- id command, C-11
- id?, C-11
- Identification, 3-10
- Initial Setup, 2-3
- Insertion
 - Effects, 2-1
 - Gain, B-1, B-15
 - roll off, 2-1
- Installation, 2-1, C-1
- Interchannel
 - Crosstalk and Transposition, B-1
 - Gain and Phase, B-1

L

- leds?, C-12
- Left Arrow, 3-11
- level argument, C-14
- Line Up, 1-2
 - amplitude range, 1-2
 - frequency range, 1-2

- Line Up signal, 2-5
- LINE-UP, 3-7
- lineup, C-13
- Lissajous pattern, 4-3
- local remote control, C-1
- loop-through, 2-2, 3-14
- ltone, C-14

M

- Manual, 1-2, 3-8, C-14
 - Line Up Tone, 3-2
 - Multitone, 1-2,3-2, 3-9, C-15
 - Polarity, 1-2, 3-8
 - Polarity Tone, 3-2
 - Sine Tone, 3-2
 - Tone, 1-2, 3-8
 - Test Signals, 1-2
- MANUAL test tone, C-14
- mark frequency, B-8
- Master Control, 4-1
- Mechanical Characteristics, 1-6
- menu map, 3-2
- MIC, 3-9
- Monophonic Testing, B-1
- mtone1?, C-15
- mtone<1|2|3|4>, C-15
- multitone, 1-2, 3-9, C-13, C-15
- Multitone test signals, 4-2

N

- Noise Floor (Silence), B-17

O

- Off line, 3-6, C-13
 - command, C-13
- ON LINE, 3-5
- output impedance, A-5
- output resistor network, A-6
- OUTPUT $\geq 775\text{mV(rms)}$, 3-13

P

- Parity, C-4
- PAUSE AUTO, 3-11
- Polarity, 1-2, 4-2, B-16, C-13
 - formula, B-15

- Polarity Tests, 3-9
- Signal Checks, 4-2
- Power Cord Options, 1-7
- Power Cord, 2-1
- Power Switch, 3-14
- power-off state, 2-3
- Power-On Diagnostics, 3-12
- Power-Up State, 2-2
- Preamble, 3-10, B-7, 16
- PROG, C-4
- program signal, 3-14

Q

- Queries, C-11

R

- Rack Mounting, 2-2
- record, 3-5, 3-6, 3-9
- recording equipment, 4-1
- Remote
 - Command Syntax, C-13
 - Connector, 3-14, C-2
 - Control, 2-2
 - enabling, A-5
 - lockout, A-5
 - Control Cable, 2-2
 - Operation, 3-4, C-1, C-6
 - terminal, C-2
 - test signal commands, C-10
- resetting the ASG 100, C-6
- Restoring Defaults, C-6, C-12
- Right Arrow, 3-11
- RS-232C interface, 4-1, C-1
- RS-232C serial port, 1-2, C-1
- rtone, C-14

S

- SAFETY, 2-1
- SAVE, 3-12
- Saving Signal Parameters, A-3
- self tests, 2-3, 3-13, C-6
- self test failure, 3-13
- Serial Communication Parameters, C-4
- serial port, C-1
- Setting the Output Impedance, A-5
- Signal Connectors, 3-14

- signal editing, A-1
- Signal-to-Noise Ratio, B-1
- SILENCE, 3-6, C-13
- Specifications, 1-3
- stereo monitor, 4-3
- Stereo Testing, B-1
- stop bit, B-8, C-4
- Sweep Test Level, 3-7
- Sweep, B-16
- SweepLev, 3-7
- Sweep Tests, 3-3, B-17

T

- tape machines, 4-1
- TEK Preamble, B-16
- TEK Sweep Test, B-17
- TEK Tests, 3-3
- TEK Test
 - 90, B-8
 - 91, B-8
 - 92, B-8
 - 93, B-8
 - 95, B8
 - 95, B-8
- TEK Test Sequence, B-8, B-16
- Terminal, C-1
- Test Frequency, 3-9
- TEST Lev, 3-7, B-8
- test level reference, C-13
- TEST level, 3-9, B-1
- Test Sequence Output Level, B-8
- Test_name, C-13
- text strings, C-13
- time-stamp, 3-4
- tone signals, 1-2, 3-2, C-13
- Tone Tests, 3-8
- Total Harmonic Distortion plus Noise, B-17
- total harmonic distortion, 4-2
- transposition testing, B-1

UVW

- unequal gains, 4-5
- unequal phase shifts, 4-5
- Unit Identification, C-11
- Up Arrow, 3-11

V suffix, 3-10
version?, C-12
Video/Audio Synchronization, D-4
VM700A Option 40, 3-4
voi+lu, C-13
Voice + Line Up, 3-8
voice identification, 3-5
Voice Source Identifier, 3-3
VOICE, 3-6, 3-9, C-13
VOLUME, 3-9, 13

XYZ

X ON/X OFF, C-12