


**TEK** OPERATORS  
MANUAL

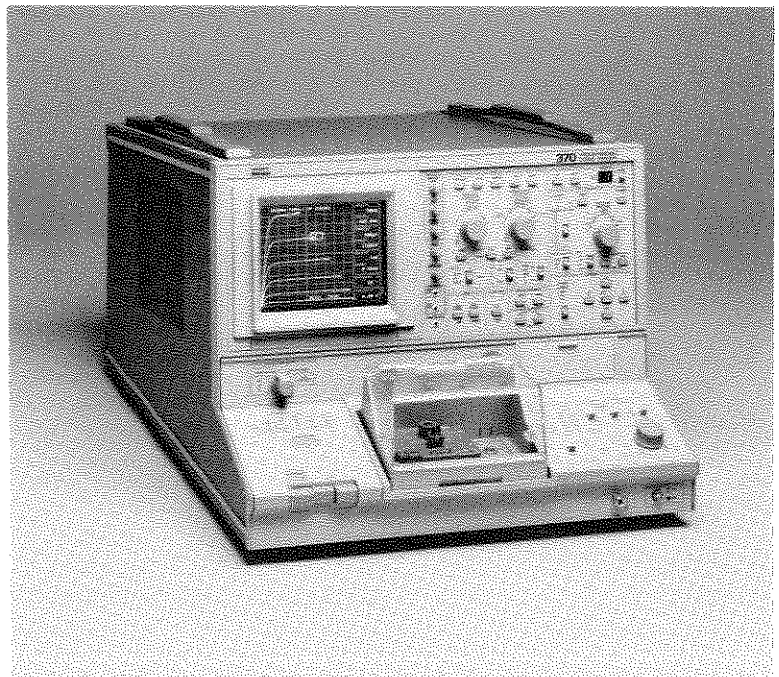
PRODUCT GROUP 48  
070-6064-00

**370**  
**PROGRAMMABLE**  
**CURVE TRACER**

First Printing June 1986  
Reprinted July 1986



Copyright © Tektronix, Inc., 1986. All rights reserved. Tektronix products are covered by U.S. and foreign patents, issued and pending. TEKTRONIX, TEK, SCOPEMOBILE and  are registered trademarks. Printed in U.S.A.



370 Programmable Curve Tracer.



## TABLE OF CONTENTS

	Page
<b>SAFETY SUMMARY</b>	
<b>SECTION 1 GENERAL INFORMATION</b>	
DESCRIPTION .....	1-1
INSTALLATION .....	1-2
Initial Inspection .....	1-2
Power Source Information .....	1-2
Operating Voltage Selection .....	1-2
Power Cord Information .....	1-3
Operating Temperature .....	1-4
Test Adapter and Protective Cover .....	1-5
Rackmounting Information .....	1-5
REPACKING FOR SHIPMENT .....	1-12
SPECIFICATION .....	1-12
Performance Conditions .....	1-12
Electrical Specification .....	1-13
Mechanical Specification .....	1-26
Environmental Specification .....	1-26
Interface Specification .....	1-28
ACCESSORIES .....	1-30
<b>SECTION 2 CONTROLS, INDICATORS AND CONNECTORS</b>	
CRT CONTROLS .....	2-1
(1) INTENSITY Controls .....	2-1
(2) FOCUS .....	2-1
(3) GRAT ILLUM. ....	2-1
(4) POSITION Controls .....	2-1
(5) TRACE ROTATION .....	2-1
MEASUREMENT .....	2-1
(6) REPEAT .....	2-1
(7) SINGLE .....	2-1
BUBBLE MEMORY INDEX .....	2-4
(8) BUBBLE MEMORY INDEX DISPLAY .....	2-4

## TABLE OF CONTENTS (cont)

	Page
DISPLAY MODE .....	2-4
(9) NON STORE .....	2-4
(10) STORE .....	2-4
(11) ENTER .....	2-4
(12) COMPARE .....	2-4
(13) VIEW .....	2-4
SET UP .....	2-4
(14) SAVE .....	2-5
(15) RECALL .....	2-5
DISPLAY .....	2-6
(16) HORIZONTAL .....	2-6
(17) VERTICAL .....	2-6
(18) DISPLAY INVERT .....	2-6
(19) CRT CAL .....	2-7
(20) ACQ MODE .....	2-7
Horiz Envelope .....	2-7
VERT Envelope .....	2-7
NORM .....	2-7
4 Average .....	2-7
32 Average .....	2-7
(21) MAG .....	2-7
VERT x 10 .....	2-7
VERT x 1 .....	2-7
OFF .....	2-7
HORIZ x 1 .....	2-8
HORIZ x 10 .....	2-8
CURSOR .....	2-8
(22) CURSOR Mode .....	2-8
Dot .....	2-8
Cross .....	2-8
Window .....	2-8
(23) Arrow and Fast/Shift .....	2-8
STEP GENERATOR .....	2-10
(24) STEP/OFFSET AMPLITUDE and STEP MULTI.1X .....	2-10
(25) OFFSET .....	2-10
(26) LIMIT .....	2-10
(27) NUMBER OF STEPS .....	2-10
(28) PULSE .....	2-10
(29) POLARITY AND INVERT .....	2-10

## TABLE OF CONTENTS (cont)

	Page
COLLECTOR SUPPLY .....	2-11
(30) MAX PEAK VOLTS HIGH-LOW .....	2-12
(31) MAX PEAK VOLTS .....	2-12
(32) MAX PEAK POWER WATTS .....	2-12
(33) POLARITY .....	2-12
(34) LOOPING COMPENSATION .....	2-13
(35) VARIABLE COLLECTOR .....	2-14
(36) COLLECTOR SUPPLY DISABLED .....	2-14
(37) WARNING .....	2-14
(38) LIMITER .....	2-14
AUX SUPPLY .....	2-14
(39) AUX SUPPLY .....	2-14
CONFIGURATION CONTROLS AND INDICATORS .....	2-14
(40) CONFIGURATION .....	2-14
READOUT DISPLAY .....	2-14
GPIB .....	2-16
(41) USER REQUEST/SRQ .....	2-16
(42) RESET TO LOCAL/REMOTE ADDR .....	2-16
PLOTTER .....	2-17
(43) PLOT/Curve .....	2-17
BUBBLE MEMORY .....	2-17
(44) Bubble Memory .....	2-17
CONNECTORS .....	2-17
(45) Adapter .....	2-17
(46) STEP GEN OUT .....	2-17
(47) EXT BASE EMIT INPUT .....	2-17
(48) AUX OUT .....	2-17
(49) GROUND .....	2-17
LEFT-RIGHT-STANDBY .....	2-18
(50) Left-Right-Standby .....	2-18
POWER .....	2-18
(51) POWER ON-OFF .....	2-18
REAR PANEL .....	2-18
(52) Line Voltage Selector .....	2-18

## TABLE OF CONTENTS (cont)

	Page
(53) GPIB Address .....	2-18
(54) GPIB Interface Connector .....	2-18
(55) Plotter Interface Connector .....	2-18
<b>SECTION 3 OPERATING INSTRUCTIONS</b>	
GENERAL DESCRIPTION OF INSTRUMENT OPERATION .....	3-1
FIRST TIME OPERATION .....	3-1
Power on Diagnostics .....	3-2
CRT and Readout Controls .....	3-4
Positioning Controls .....	3-6
Vertical and Horizontal Sensitivity .....	3-6
Collector Supply .....	3-8
Display Offset and Magnifier .....	3-11
Step Generator .....	3-12
Configuration .....	3-17
Digital Storage and Bubble Memory .....	3-20
ACQ Mode (STORE Mode) .....	3-22
Cursors .....	3-24
Plotter Output .....	3-24
GENERAL OPERATING INFORMATION .....	3-25
CRT .....	3-25
Readout .....	3-25
Intensity .....	3-25
Focus .....	3-25
Positioning .....	3-26
Vertical Measurement and Deflection Factor .....	3-27
Horizontal Measurement and Deflection Factor .....	3-27
Measurements .....	3-28
Display Offset and Magnifier .....	3-28
Collector Supply .....	3-29
Interlock System .....	3-31
Step Generator .....	3-31
Front-Panel Terminals .....	3-33
Collector Supply and Step Generator Output Polarities .....	3-34
Digital Storage and Bubble Memory .....	3-34
Handling a Bubble Memory Cassette .....	3-35
MEASURING EXAMPLES .....	3-36
BIPOLAR TRANSISTORS .....	3-36
FIELD EFFECT TRANSISTORS .....	3-40
SILICON CONTROLLED RECTIFIERS .....	3-42
SIGNAL DIODES AND RECTIFYING DIODES .....	3-44



## TABLE OF CONTENTS (cont)

	Page
ZENER DIODES .....	3-46
<b>SECTION 4 GPIB</b>	
INTRODUCTION TO GPIB .....	4-1
INTRODUCTION .....	4-1
Setting the GPIB ADDRESS switches .....	4-1
Setting the LF OR EOI switch .....	4-1
IEEE-488 FUNCTIONS .....	4-2
Source Handshake (SH1) .....	4-3
Acceptor Handshake (AH1) .....	4-3
Talker (T6) .....	4-3
Listener (L4) .....	4-3
Service Request (SR1) .....	4-3
Remote/Local (RL2) .....	4-3
Parallel Poll (PP0) .....	4-3
Device Clear (DC1) .....	4-3
Device Trigger (DT0) .....	4-3
Controller (C0) .....	4-3
GETTING STARTED .....	4-4
INTRODUCTION .....	4-4
Setting programmable controls .....	4-4
Querying programmable controls .....	4-6
EXERCISE ROUTINES .....	4-7
Listen/Talk .....	4-7
ACQUIRING INSTRUMENT SETTINGS WITH SET? .....	4-8
Learn Settings .....	4-8
RESETTING THE 370 AND INTERFACE MESSAGE .....	4-8
ACQUIRING A WAVEFORM .....	4-9
DEVICE-DEPENDENT MESSAGE STRUCTURE AND EXECUTION .....	4-10
INTRODUCTION .....	4-10
SYNTAX DIAGRAMS .....	4-10
370 INPUT MESSAGES .....	4-11
Message Unit Delimiter (;) .....	4-12
Message Terminator (TERM) .....	4-12
Format Characters .....	4-12
Input Buffering and Execution .....	4-12
Command Format .....	4-12
Header .....	4-12
Header Delimiter (SP) .....	4-12
Argument Delimiter (,) .....	4-12
Argument Format .....	4-12
Numbers .....	4-14
Character Argument .....	4-14

## TABLE OF CONTENTS (cont)

	Page
Link Argument . . . . .	4-14
String Argument . . . . .	4-15
Query Format . . . . .	4-15
Binary Block . . . . .	4-15
370 OUTPUT MESSAGES . . . . .	4-15
Output Message Format . . . . .	4-16
Output Message Execution . . . . .	4-16
370 GPIB COMMANDS . . . . .	4-16
INTRODUCTION . . . . .	4-16
FRONT PANEL CONTROLS . . . . .	4-16
DISPLAY CONTROL COMMAND GROUP . . . . .	4-18
DISPLAY (display mode) command . . . . .	4-18
DISPLAY (display invert) command . . . . .	4-19
DISPLAY (crt calibration) command . . . . .	4-19
DISPLAY (display control) query . . . . .	4-20
ENTER (store display data) command . . . . .	4-20
VERT (vertical current/div) command . . . . .	4-21
VERT (vertical display offset) command . . . . .	4-22
VERT (vertical) query . . . . .	4-23
HORIZ (horizontal volt/div) command . . . . .	4-23
HORIZ (horizontal display offset) command . . . . .	4-24
HORIZ (horizontal) query . . . . .	4-25
ACQUIRE (acquire mode) command . . . . .	4-25
ACQUIRE (acquire mode) query . . . . .	4-26
MAG (MAG mode) command . . . . .	4-26
MAG (MAG mode) query . . . . .	4-27
CURSOR CONTROL COMMAND GROUP . . . . .	4-27
CURSOR (cursor off) command . . . . .	4-27
DOT (dot cursor) command . . . . .	4-27
DOT (dot cursor) query . . . . .	4-28
CROSS (cross-hair cursor) command . . . . .	4-28
CROSS (cross-hair cursor) query . . . . .	4-28
WINDOW (window cursor) command . . . . .	4-29
WINDOW (window cursor) query . . . . .	4-29
COLLECTOR SUPPLY CONTROL . . . . .	4-29
PKVOLT (max peak volts) command . . . . .	4-29
PKVOLT (max peak volts) query . . . . .	4-30
PKPOWER (max peak power watts) command . . . . .	4-30
PKPOWER (max peak power watts) query . . . . .	4-31
CSPOL (collector supply polarity) command . . . . .	4-31
CSPOL (collector supply polarity) query . . . . .	4-32
VCSUPPLY (variable collector supply) command . . . . .	4-33
VCSUPPLY (variable collector supply) query . . . . .	4-33

## TABLE OF CONTENTS (cont)

	Page
HILOWSW (high-low switch status) query . . . . .	4-33
STEP GENERATOR CONTROL COMMAND GROUP . . . . .	4-34
STPGEN (step/offset amplitude) command . . . . .	4-34
STPGEN (number of steps) command . . . . .	4-35
STPGEN (step generator invert) command . . . . .	4-35
STPGEN (step generator multi .1X) command . . . . .	4-35
STPGEN (pulse mode) command . . . . .	4-36
STPGEN (current limit) command . . . . .	4-36
STPGEN (step generator offset) command . . . . .	4-37
STPGEN (step generator) query . . . . .	4-37
CONFIGURATION COMMAND GROUP . . . . .	4-38
CONFIG (terminal mode) command . . . . .	4-38
CONFIG (terminal mode) query . . . . .	4-38
OTHER COMMANDS . . . . .	4-39
MEASURE (measurement mode) command . . . . .	4-39
MEASURE (measurement mode) query . . . . .	4-39
RECALL (recall settings) command . . . . .	4-40
SAVE (store settings) command . . . . .	4-40
PLOT (plot data) command . . . . .	4-40
PSTATUS (plot status) query . . . . .	4-41
AUX (set auxiliary supply) command . . . . .	4-41
AUX query . . . . .	4-41
LRSSW (left-right-standby switch status) query . . . . .	4-42
DISPLAY DATA AND CRT READOUT I/O . . . . .	4-43
WAVEFORM TRANSFER COMMAND GROUP . . . . .	4-43
WFMPRE (waveform preamble) command . . . . .	4-44
X and Y-Axis Scaling . . . . .	4-48
WFMPRE (waveform preamble) query . . . . .	4-48
CURVE (display curve) command . . . . .	4-50
CURVE (display curve) query . . . . .	4-50
WAVFRM (waveform) query . . . . .	4-51
CRT READOUT TRANSFER COMMAND GROUP . . . . .	4-51
READOUT (cursor readout) query . . . . .	4-51
TEXT (display text) command . . . . .	4-52
TEXT (display text) query . . . . .	4-52
SYSTEM COMMANDS AND QUERIES . . . . .	4-53
INTRODUCTION . . . . .	4-53
INSTRUMENT PARAMETER COMMAND GROUP . . . . .	4-53
SET (instrument setting) query . . . . .	4-53
INIT (initialize settings) command . . . . .	4-54
TEST (internal test) query . . . . .	4-55
ID (identify) query . . . . .	4-56

## TABLE OF CONTENTS (cont)

	Page
HELP (list of command headers) query .....	4-56
STATUS AND ERROR REPORTING COMMAND GROUP .....	4-57
RQS (request service) command .....	4-57
RQS (request service) query .....	4-58
Status Byte (response to serial poll) .....	4-58
OPC (operation-complete service request) command .....	4-59
OPC (operation-complete service request) query .....	4-60
EVENT (event information) query .....	4-60
Event codes .....	4-61
COMMAND LIST .....	4-62
OPERATING HINTS .....	4-77
INTRODUCTION .....	4-77
WAVEFORM DATA TRANSFER .....	4-77
ADDING MISCELLANEOUS WAVEFORM PREAMBLE DATA .....	4-79
SAVE, LOAD AND COPY INSTRUMENT SETTINGS .....	4-80
WAVEFORM GRAPHIC DISPLAYS .....	4-82
SAMPLE APPLICATION PROGRAMS .....	4-84
 <b>SECTION 5 OPTIONS</b>	
 <b>APPENDIX A DIAGNOSTIC ROUTINES AND MESSAGES</b>	
Diagonistic Routines .....	A-1
Power-on Diagnostic Routines .....	A-1
System ROM check .....	A-1
System RAM check .....	A-2
Display RAM check .....	A-2
Acquisition RAM check .....	A-2
LED check .....	A-3
Display Quality check .....	A-3
Up/down Control and push button check .....	A-3
User Initiated Diagnostic Routine .....	A-3
GPIB Diagnostic Routine .....	A-6
MESSAGES .....	A-6

## LIST OF ILLUSTRATIONS

Figure No.		Page
1-1	Locations of the Rackmount Latch Release .....	1-6
1-2	Rackmount Hole Spacing .....	1-7
1-3	Rackmounting Length and Clearance .....	1-8
1-4	Rackmounting Hardware .....	1-9
1-5	Mounting Stationary Rackmount Sections .....	1-9
1-6	Cabinet-to-Rackmount Conversion .....	1-11
1-7	18-bit Parallel Interface Connector .....	1-29
2-1	Front-panel controls, indicators and connectors .....	2-2
2-2	Rear-panel controls and connectors .....	2-3
2-3	Text edit display .....	2-9
2-4	CRT readout area .....	2-16
3-1	Basic 370 Block Diagram .....	3-2
3-2	Bubble cassette write-protect key .....	3-5
3-3	Inserting a bubble cassette .....	3-5
3-4	Display of I vs. E for 1 k resistor .....	3-7
3-5	Display of signal diode forward-bias characteristics .....	3-9
3-6	Display of signal diode reverse-bias characteristics .....	3-9
3-7	Adjustment of LOOPING COMPENSATION control .....	3-10
3-8	Display of Zener diode I vs. E characteristic .....	3-11
3-9	(A) IC vs VCE for 10 steps of base current at 5 uA per step. (B) IC vs. VBE for 10 steps of base current at 5 uA per step .....	3-13
3-10	(A) IB vs. VCE, Ib @ 5 uA per division; (B) IB vs. VBE, IB @ 5 uA per division .....	3-14
3-11	IC vs. IB, IB @ 5 uA per division .....	3-15
3-12	Display of FET common-source characteristic curves: ID vs VDS gate voltage at 0.1 volt/step .....	3-16
3-13	(A) CONFIGURATION control set to BASE STEP GEN (NORM),(B) CONFIGURATION control set to EMITTER STEP GEN .....	3-18
3-14	Digitally stored curves .....	3-20
3-15	VIEW curve display .....	3-21
3-16	Text edit mode .....	3-22
3-17	Stored envelope display .....	3-23
3-18	Averaging display .....	3-23
3-19	Different Collector Supply Outputs .....	3-29
3-20	Display Looping .....	3-31
3-21	Step Generator output .....	3-32
3-22	Bipolar Transistor Common-emitter Configuration .....	3-37
3-23	Bipolar Transistor Family of Curves .....	3-37
3-24	Bipolar Transistor Common-base Configuration .....	3-38
3-25	Bipolar Transistor Family of Curves .....	3-39
3-26	Common-source FET Configuration Diagram .....	3-40
3-27	Common-source FET Configuration Family of Curves .....	3-41
3-28	Silicon-controlled Rectifier Configuration Diagram .....	3-42
3-29	Silicon-controlled Rectifier Curve .....	3-43

## LIST OF ILLUSTRATIONS (cont)

Figure No.		Page
3-30	Diode Configuration Diagram .....	3-44
3-31	Diode Curve .....	3-45
3-32	Zener Diode Configuration Diagram .....	3-46
3-33	Zener Diode Curve .....	3-47
4-1	Rear-panel GPIB ADDRESS switches .....	4-2
4-2	Untalk and Unlisten Message Syntax Diagram .....	4-6
4-3	Message Receive Syntax Diagram .....	4-7
4-4	syntax element examples .....	4-11
4-5	Input Message Format .....	4-11
4-6	Command Format Syntax Diagram .....	4-13
4-7	Argument Format .....	4-13
4-8	NR1 Format. NR1 is an integer (no decimal point) .....	4-14
4-9	NR2 Format. NR2 is a floating point number (decimal point required) .....	4-14
4-10	NR3 Format. NR3 is a floating-point number in scientific notation .....	4-14
4-11	Query format .....	4-15
4-12	Binary Block Format Syntax Diagram .....	4-15
4-13	Output Message Format .....	4-16
4-14	DISPLAY Command Syntax Diagram .....	4-18
4-15	DISPLAY (Invert) Command Syntax Diagram .....	4-19
4-16	DISPLAY (Crt Calibration) Command Syntax Diagram .....	4-19
4-17	DISPLAY Query Syntax Diagram .....	4-20
4-18	Display Query Response Syntax Diagram .....	4-20
4-19	ENTER Syntax Diagram .....	4-20
4-20	VERT Command Syntax Diagram .....	4-21
4-21	VERT Command Syntax Diagram .....	4-22
4-23	VERT Query Response Syntax Diagram .....	4-23
4-24	HORIZ Command Syntax Diagram .....	4-23
4-25	HORIZ Command Syntax Diagram .....	4-24
4-26	HORIZ Query Syntax Diagram .....	4-25
4-26	HORIZ Query Syntax Diagram .....	4-25
4-27	HORIZ Query Response .....	4-25
4-28	ACQUIRE Command Syntax Diagram .....	4-25
4-29	ACQUIRE Query Syntax Diagram .....	4-26
4-30	ACQUIRE Query Response .....	4-26
4-31	MAG Command Syntax Diagram .....	4-26
4-32	MAG Query Syntax Diagram .....	4-27
4-33	MAG Query Response .....	4-27
4-34	CURSOR Command Syntax Diagram .....	4-27
4-35	DOT Command Syntax Diagram .....	4-27
4-36	DOT Query Syntax Diagram .....	4-28
4-37	DOT Query Response Syntax Diagram .....	4-28
4-38	CROSS Command Syntax Diagram .....	4-28
4-39	CROSS Query Syntax Diagram .....	4-28
4-40	CROSS Query Response Syntax Diagram .....	4-28

## LIST OF ILLUSTRATIONS (cont)

Figure No.		Page
4-41	WINDOW Command Syntax Diagram . . . . .	4-29
4-42	WINDOW Query Syntax Diagram . . . . .	4-29
4-43	WINDOW Query Response Syntax Diagram . . . . .	4-29
4-44	PKVOLT Command Syntax Diagram . . . . .	4-29
4-45	PKVOLT Query Syntax Diagram . . . . .	4-30
4-46	PKVOLT Query Response . . . . .	4-30
4-47	PKPOWER Command Syntax Diagram . . . . .	4-30
4-48	PKPOWER Query Syntax Diagram . . . . .	4-31
4-49	PKPOWER Query Response . . . . .	4-31
4-50	CSPOL Command Syntax Diagram . . . . .	4-31
4-51	CSPOL Query Syntax Diagram . . . . .	4-32
4-52	CSPOL Query Response Syntax Diagram . . . . .	4-32
4-53	VCSUPPLY Command Syntax Diagram . . . . .	4-33
4-54	VCSUPPLY Query Syntax Diagram . . . . .	4-33
4-55	VCSUPPLY Query Response Syntax Diagram . . . . .	4-33
4-56	HILOWSW Query Syntax Diagram . . . . .	4-33
4-57	HILOWSW Query Response Syntax Diagram . . . . .	4-33
4-58	STPGEN Command Syntax Diagram . . . . .	4-34
4-59	STPGEN Command Syntax Diagram . . . . .	4-35
4-60	STPGEN (invert) Command Syntax Diagram . . . . .	4-35
4-61	STPGEN (multi .1X) Command Syntax Diagram . . . . .	4-35
4-62	STPGEN (pulse) Command Syntax Diagram . . . . .	4-36
4-63	STPGEN (current limit) Command Syntax Diagram . . . . .	4-36
4-64	STPGEN (offset) Command Syntax Diagram . . . . .	4-37
4-65	STPGEN Query Syntax Diagram . . . . .	4-37
4-66	STPGEN Query Response Syntax Diagram . . . . .	4-37
4-67	CONFIG Syntax Diagram . . . . .	4-38
4-68	CONFIG Query Syntax Diagram . . . . .	4-38
4-69	CONFIG Query Response Syntax Diagram . . . . .	4-39
4-70	MEASURE Command Syntax Diagram . . . . .	4-39
4-71	MEASURE Query Syntax Diagram . . . . .	4-39
4-72	MEASURE Query Response Syntax Diagram . . . . .	4-40
4-73	RECALL Command Syntax Diagram . . . . .	4-40
4-74	Save Command Syntax Diagram . . . . .	4-40
4-75	PLOT Command Syntax Diagram . . . . .	4-40
4-76	PSTATUS Query Syntax Diagram . . . . .	4-41
4-77	PSTATUS Query Response Syntax Diagram . . . . .	4-41
4-78	AUX Command Syntax Diagram . . . . .	4-41
4-79	AUX Query Syntax Diagram . . . . .	4-41
4-80	AUX Query Response Syntax Diagram . . . . .	4-42
4-81	LRSSW Query Syntax Diagram . . . . .	4-42
4-82	LRSSW Query Response Syntax Diagram . . . . .	4-42

## LIST OF ILLUSTRATIONS (cont)

Figure No.		Page
4-83	WFMPRE Command Syntax Diagram .....	4-45
4-84	<WFID> Syntax Diagram .....	4-46
4-85	WFMPRE Query Syntax Diagram .....	4-48
4-86	WFMPRE NR.PT Query Response Syntax Diagram .....	4-48
4-87	WFMPRE Query Response Syntax Diagram .....	4-49
4-88	CURVE Command Syntax Diagram .....	4-50
4-89	CURVE Query Syntax Diagram .....	4-50
4-90	CURVE Query Response Syntax Diagram .....	4-50
4-91	WAVFRM Query Syntax Diagram .....	4-51
4-92	Readout Query Syntax Diagram .....	4-51
4-93	READOUT Query Response Syntax Diagram .....	4-51
4-94	TEXT Command Syntax Diagram .....	4-52
4-95	TEXT Query Syntax Diagram .....	4-52
4-96	TEXT Query Response Syntax Diagram .....	4-52
4-97	SET Query Syntax Diagram .....	4-53
4-98	SET query Response Syntax Diagram .....	4-53
4-99	INIT Command Syntax Diagram .....	4-54
4-100	TEST Query Syntax Diagram .....	4-55
4-101	TEST query Response Syntax Diagram .....	4-56
4-102	ID Query Syntax Diagram .....	4-56
4-103	ID Query Response Syntax Diagram .....	4-56
4-104	HELP Query Syntax Diagram .....	4-56
4-105	HELP Query Response Syntax Diagram .....	4-57
4-106	RQS Command Syntax Diagram .....	4-57
4-107	RQS Query Syntax Diagram .....	4-58
4-108	RQS Query Response Syntax Diagram .....	4-58
4-109	OPC Command Syntax Diagram .....	4-59
4-110	OPC Query Syntax Diagram .....	4-60
4-111	OPC Query Response Syntax Diagram .....	4-60
4-112	EVENT Query Syntax Diagram .....	4-60
4-113	EVENT Query Response Syntax Diagram .....	4-60



## LIST OF TABLES

Table No.		Page
1-1	Line Voltage Ranges .....	1-2
1-2	Power-Cord Color Conductor Identification .....	1-3
1-3	Power-Cord and Plug Identification Information .....	1-4
1-4	Electrical Specification .....	1-13
1-5	Mechanical Specification .....	1-26
1-6	Environmental Specification .....	1-26
1-7	Parallel Interface Pin Assignment Table .....	1-28
2-1	Front Panel Controls Settings Not Stored .....	2-5
2-2	Step Generator Polarity .....	2-11
2-3	Max Peak Power vs. Series Resistors .....	2-12
2-4	Collector Supply Polarity Functions .....	2-13
3-1	Default Setup .....	3-3
3-2	Measurements Made by the 370 Display .....	3-29
3-3	Polarities of the Collector Supply and Step Generator Output .....	3-34
4-1	370 IEEE 488 INTERFACE FUNCTIONS .....	4-2
4-2	FRONT-PANEL CONTROL COMMANDS AND QUERIES .....	4-17
4-3	DISPLAY-DATA AND CRT READOUT I/O COMMANDS AND QUERIES .....	4-43
4-4	DEVICE-DEPENDENT COMMANDS AND QUERIES .....	4-53
4-5	Status Byte and Event Code .....	4-61
4-6	FRONT PANEL CONTROLS .....	4-62
4-7	DISPLAY-DATA AND CRT READOUT I/O .....	4-71
4-8	SYSTEM COMMANDS and QUERIES .....	4-75
A-1	Power on System Error Messages .....	A-2
A-2	Front panel control identification .....	A-3
A-3	Messages .....	A-6

## **SAFETY SUMMARY**

---

The Safety Summary is a listing of all safety precautions in the manual. These precautions are gathered here in a single place for convenient review of all precautions, and each also appears at a place in the manual where the reader receives the most benefit from the precaution.

### **TERMS**

#### **IN THIS MANUAL**

**CAUTION** statements identify conditions or practices that could result in damage to the equipment or other property.

**WARNING** statements identify conditions or practices that could result in personal injury or loss of life.

#### **AS MARKED ON EQUIPMENT**

**CAUTION** indicates a personal injury hazard not immediately accessible as one reads the marking, or a hazard to property including the equipment itself.

**DANGER** indicates a personal injury hazard immediately accessible as one reads the marking.

### **SYMBOL**

#### **IN THIS MANUAL**



This symbol indicates where applicable cautionary or other information is to be found.

#### **AS MARKED ON EQUIPMENT**



**DANGER**—High voltage.



Protective ground (earth) terminal.



**ATTENTION**—refer to manual.

**WARNING**

This instrument operates from a single-phase power source, and has a detachable three-wire power cord with a two-pole, three-terminal grounding-type plug. The voltage to ground (earth) from either pole of the power source must not exceed the maximum rated operating voltage (250 volts rms).

Before making connection to the power source, make sure that the instrument is set for the power source voltage, and is equipped with a suitable plug (two-pole, three-terminal, grounding type).

This instrument is safety class 1 equipment (IEC<sup>1</sup> designation). All accessible conductive parts are directly connected through the grounding conductor of the power cord to the grounding contact of the power plug. Therefore, the power plug must only be inserted in a mating receptacle with a grounding contact. Do not defeat the grounding connection. Any interruption of the grounding connection can create an electric shock hazard.

For electric shock protection, connect the instrument to ground before connecting to the instrument input or output terminals.

Prolonged use at the 50w and 220w Power ranges can cause high temperatures that may damage the instrument or the DUT and cause injury if the Protective Cover or DUT are touched. Test time for these power settings should be limited to:

5 min. for 220w range  
9 min. for 50w range

Up to 2000 V may appear at the front-panel collector terminals. To avoid injury or equipment damage, do not remove the protective cover.

If an item to be tested does not fit under the plastic protective cover, external test fixturing may be required. Refer construction of external test fixturing to a qualified serviceman. Refer also to the service manual for information that pertains to external test fixturing.

The 370 weighs more than 75 lbs. To avoid personal injury, use care when lifting the instrument, and where required, seek help in lifting and positioning the instrument in the rack. Once the 370 is installed in a rack, use care that the extended 370 does not tip the rack forward, causing personal injury or instrument damage.

<sup>1</sup>International Electrotechnical Commission.

### 370 Operators

---



CAUTION is used where, if ignored, damage to the instrument or instrument software could result.

To prevent damage to the instrument, always check the settings of the LINE VOLTAGE SELECTOR switches located on the rear panel of the 370 before connecting the instrument to the line-voltage source.

Double-wide test adapters are designed to fit in the left set of adapter connectors. If you try to forcibly install a double-wide test adapter in the right side, you might damage the connector. The connectors are identified by the following numbers:

A1006  
A1007  
A1008  
A1009  
A1010

To prevent equipment damage, do not short the collector and emitter terminals to one another.

# SECTION 1

## GENERAL INFORMATION

---

### DESCRIPTION

The 370 is a high-performance, GPIB-programmable digital-storage curve tracer that provides static and dynamic semiconductor device measurements. This versatile instrument stimulates, measures, and displays the semiconductor characteristics of a variety of two-, three-, and four-terminal devices; including bipolar transistors, field effect transistors, silicon-controlled rectifiers, diodes, thyristors, optoisolators, wafers, integrated circuits, etc. A variety of measurements can be performed using either grounded-emitter or grounded-base configurations.

The collector supply produces ac, rectified ac, or dc voltages ranging from 0 to  $\pm 2000$  volts. This high voltage, combined with a current sensitivity of 100 pA/div, permits extended breakdown measurements on a device under test. A step generator produces voltage or current steps of either polarity for application to the base or emitter terminal. The step generator may also be operated in a pulsed mode to reduce DUT power dissipation.

In addition to conventional curve tracer performance, the 370 includes the following features:

1. Digital storage capability that allows bright and stable display and useful cursor measurements. The 370 can store up to 16 families of characteristic curves in a bubble memory cassette, display them on the crt, and send them for data processing via the GPIB. The bubble memory also provides non-volatile storage for up to 16 complete front-panel setups.
2. Two extended acquisition modes, called Averaging and Envelope. Averaging reduces display noise in high sensitivity ranges. Envelope mode displays the maximum and minimum vertical or horizontal excursion of each curve, which is useful for detecting long-term variations such as thermal drift.
3. GPIB command-controllable front-panel functions. Nearly all are remotely controllable. (Exceptions are those controls intended only for manual operation, such as INTENSITY, FOCUS, COLLECTOR SUPPLY HIGH-LOW control, etc. Also, curve data can be sent to or received from an external controller through the GPIB.
4. The CENTRONICS-compatible plotter interface permits sending displayed curve data and digital on-screen readouts to a digital plotter without an external controller.
5. Other features include an auxiliary voltage supply, cursor measurement readout, and diagnostic routines.

## INSTALLATION

### Initial Inspection

This instrument was thoroughly inspected for mechanical and electrical defects before shipment. It should be free of marks or scratches and meet or exceed all electrical specifications. To confirm this, inspect the instrument for physical damage incurred in transit and test the electrical performance by following the First Time Operation instructions in Section 3, Operating Instructions. For a complete verification of instrument performance, refer a qualified service technician to the performance check section of the service manual. If a discrepancy is found, contact your local Tektronix Field Office or representative.

### Power Source Information

This instrument operates from a power source having a neutral at or near ground (earth) potential. It is not intended for operation from two phases of a multi-phase system, nor across legs of a single-phase, three wire system. This instrument can be operated from either a 115-volt or 230-volt nominal supply source, 48 to 66 Hz. Table 1-1 is a listing of the line voltage ranges, line frequency range, and power consumption.

**TABLE 1-1**  
**Line Voltage Ranges**

Setting of the RANGE switch	Setting of the NOMINAL switch	
	115VAC	230VAC
HIGH	107VAC to 132VAC	214VAC to 250VAC
LOW	90VAC to 110 VAC	180 VAC to 220 VAC
Line frequency range	48 to 66 Hz	
Power consumption		
Max.	400W, 3.5 A at 132V 60Hz	
Typical	120W, 1.3 A at 115 V 50 Hz	

### Operating Voltage Selection and Line Fuse Verification

⚠ The LINE VOLTAGE SELECTOR switches (NOMINAL and RANGE, located on the rear panel) allow selection of the operating line voltage. To select the correct operating line voltage, 1) Disconnect the 370 from the ac power source before changing the operating voltage, 2) Select the nominal ac power-source voltage with the NOMINAL switch, and 3) Select the operating line voltage with the RANGE switch.

**CAUTION**

*To prevent damage to the instrument, always check the settings of the LINE VOLTAGE SELECTOR switches located on the rear panel of the 370 before connecting the instrument to the line-voltage source.*

To verify that the power-input fuse is for the nominal ac source voltage selected, perform the following:

1. Use a small straight-slot screwdriver to pry the cap (with the attached fuse inside) out of fuse holder.
2. Verify proper fuse value:
 

Nominal voltage 230 V	2A slow blow
Nominal voltage 115 V	4A slow blow
3. Install the proper fuse and reinstall the fuse holder cap.

**Power Cord Information**

A power cord with the appropriate plug configuration is supplied with each instrument. The color-coding of the power cord conductors appears in Table 1-2. Also, should you require a power-cord plug other than that supplied, refer to Table 1-3, Power-Cord and Plug Identification.

**TABLE 1-2  
Power-Cord Color Conductor Identification**


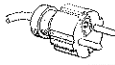




Conductor	Color	Alternate
Ungrounded (Line)	Brown	Black
Grounded (Neutral)	Light Blue	White
Grounded (Protective Ground)	Green/Yellow	Green/Yellow

**WARNING**

*This instrument operates from a single-phase power source, and has a detachable three-wire power cord with a two-pole, three-terminal grounding-type plug. The voltage to ground (earth) from either pole of the power source must not exceed the maximum rated operating voltage (250 volts rms).*

*Before making connection to the power source, make sure that the instrument is set for the power source voltage, and is equipped with a suitable plug (two-pole, three-terminal, grounding type).*

**TABLE 1-3  
Power-Cord and Plug Identification Information**

Plug Configuration	Usage	Nominal Line-Voltage (AC)	Reference Standards	Option #
	North American 120V/15A	120V	<sup>1</sup> ANSI C73.11 <sup>2</sup> NEMA 6-15-P <sup>3</sup> IEC 83	Standard
	Universal Euro 220V/6-16A	220V	<sup>4</sup> CEE (7), II, IV, VII <sup>5</sup> IEC 83	A1
	UK 240V/6-13A	240V	<sup>6</sup> BS 1363 <sup>1</sup> IEC 83	A2
	Australian 240V/6-10A	240V	<sup>6</sup> AS C112	A3
	North American 240V/15A	240V	<sup>1</sup> ANSI C73.20 <sup>2</sup> NEMA 6-15-P <sup>3</sup> IEC 83	A4
	Switzerland 220V/6-10A	220V	<sup>7</sup> SEV	A5

<sup>1</sup>ANSI—American National Standards Institute  
<sup>2</sup>NEMA—National Electrical Manufacturer's Association

<sup>3</sup>IEC—International Electrotechnical Commission  
<sup>4</sup>CEE—International Commission on Rules for the Approval of Electrical Equipment

<sup>5</sup>BS—British Standards Institution  
<sup>6</sup>AS—Standards Association of Australia  
<sup>7</sup>SEV—Schweizerischer Elektrotechnischer Verein

*This instrument is safety class 1 equipment (IEC<sup>3</sup> designation). All accessible conductive parts are directly connected through the grounding conductor of the power cord to the grounding contact of the power plug. Therefore, the power plug must only be inserted in a mating receptacle with a grounding contact. Do not defeat the grounding connection. Any interruption of the grounding connection can create an electric shock hazard.*

*For electric shock protection, connect the instrument to ground before connecting to the instrument input or output terminals.*

#### Operating Temperature

The 370 can be operated where the ambient air temperature is between +10° C and +40° C and can be stored in ambient temperatures from -40° C to +65° C. After storage at temperatures outside the operating limits, allow the chassis temperature to reach the safe operating limits before applying power.

The 370 is cooled by air drawn in through the air filter on the rear panel and blown out through holes in the side panels. For proper instrument cooling, provide adequate clearance on the rear and sides of the instrument to ensure free air flow and dissipation of heat away from the instrument.

<sup>1</sup>International Electrotechnical Commission.



**WARNING**

*Following use of the 370 at high power settings, the device, fixture, or protective cover may be hot enough to cause injury. Avoid touching any of these items until cooled.*

**Test Adapter and Protective Cover**

To use the 370 to display and measure the characteristic curves of most devices, a test adapter and the protective cover must be installed. Four test adapters are provided as standard accessories. Six other test adapters are available as optional accessories. The test adapter is inserted into the adapter connectors provided on the front panel. These connectors allow two devices to be set up at a time.

**WARNING**

*Up to 2000 V may appear at the front-panel collector terminals. To avoid injury or equipment damage, do not remove the protective cover.*

**CAUTION**

*Double-wide test adapters are designed to fit in the left set of adapter connectors. If you try to forcibly install a double-wide test adapter in the right side, you might damage the connector. The connectors are identified by the following numbers:*

A1006  
A1007  
A1008  
A1009  
A1010

**Rackmounting Information**

**Latching.** The 370 incorporates a spring-latch design built into the rackmounting ear. To release, pull the rackmount latch release (see Fig. 1-1). To relatch, push the rackmount latch release until the spring latches engage.

For those applications that require additional rackmounting security, the rackmounting ears of the 370 are drilled for screw fasteners (see Fig. 1-1).

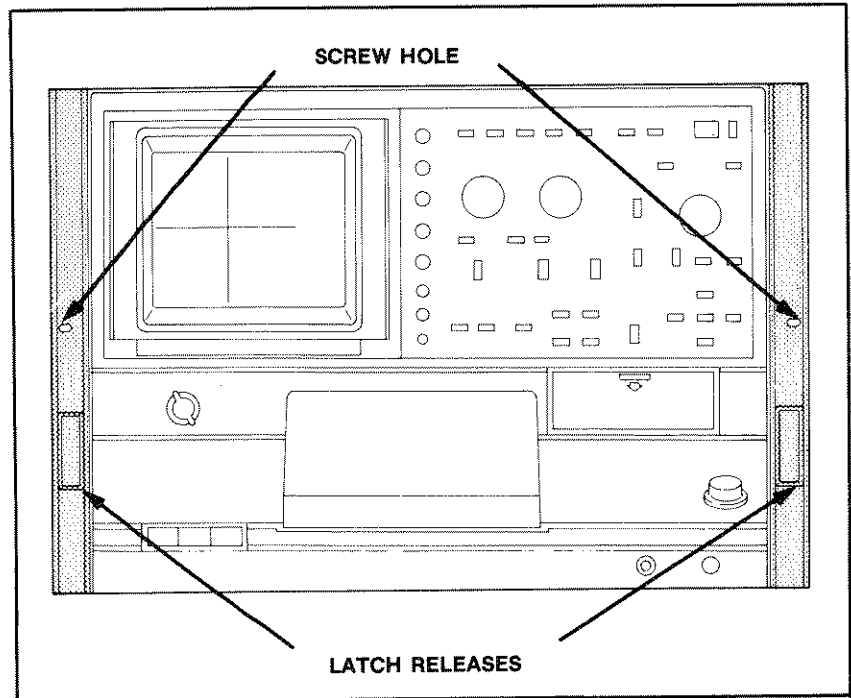


Figure 1-1. Location of the Rackmount Latch Release.

**CAUTION**

*To prevent equipment damage, do not short the collector and emitter terminals to one another.*

**WARNING**

*If an item to be tested does not fit under the plastic protective cover, external test fixturing may be required. Refer construction of external test fixturing to a qualified serviceman. Refer also to the service manual for information that pertains to external test fixturing.*

**Rackmounting.** The 370 fits most commercial consoles and 19-inch racks with rail holes that conform to universal spacing. See Figure 1-2 for hole spacing details. When rackmounting the 370, take note of the following:

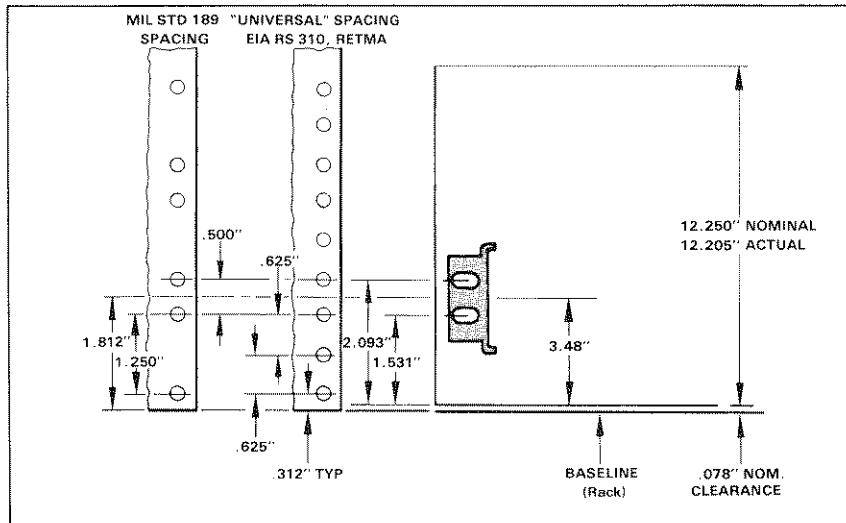


Figure 1-2. Rackmount Hole Spacing.

**WARNING**

*The 370 weighs more than 75 lbs. To avoid personal injury, use care when lifting the instrument, and where required, seek help in lifting and positioning the 370 in to the rack. Once the 370 is installed in a rack, use care that when extended, the 370 does not tip the rack forward, causing personal injury or instrument damage.*

Allow one inch clearance above and below, and on the left and right sides of the 370 for air circulation. Allow at least three inches of clearance between the 370 rear panel and the rack enclosure for adequate cooling air and to provide cable clearance. The depth of the 370 from behind the rack ears to the rear panel is 18.9 inches. The rack depth must be at least 22 inches (see Fig. 1-3) to meet the rear clearance requirement.

### General Information—370

The 370 is 12.25 inches high, a multiple of 1.75 inches (the standard rack spacing). If the 370 is installed in a rack with standard hole spacing, and positioned some multiple of 1.75 inches from the bottom or top, all holes should line up and no drilling should be required.

The slide-out tracks mount easily to the rack front and rear vertical mounting rails if the inside distance between the rails is within 19.8 to 26.5 inches. If the tracks are to be installed in a rack having other dimensions, provide extra support (for example, extensions to the rear mounting brackets) for the rear ends of the slide-out tracks.

The front rack rails must be at least 17 inches apart. The front lip of the stationary-track section mounts in front of the rail. (Use bar nuts behind untapped front rails.) The front lip of the stationary track section must mount in front of the front rail to allow the 370 spring latch to function properly.

The slide-out tracks consist of two assemblies, one for each side of the instrument. Each assembly consists of three sections (see Fig. 1-4). The stationary section of each track attaches to rack rails as shown in Figure 1-5. The chassis section mounts on the instrument and is installed at the factory. The intermediate section fits between the other two sections, allowing the instrument to be fully extended out of the rack.

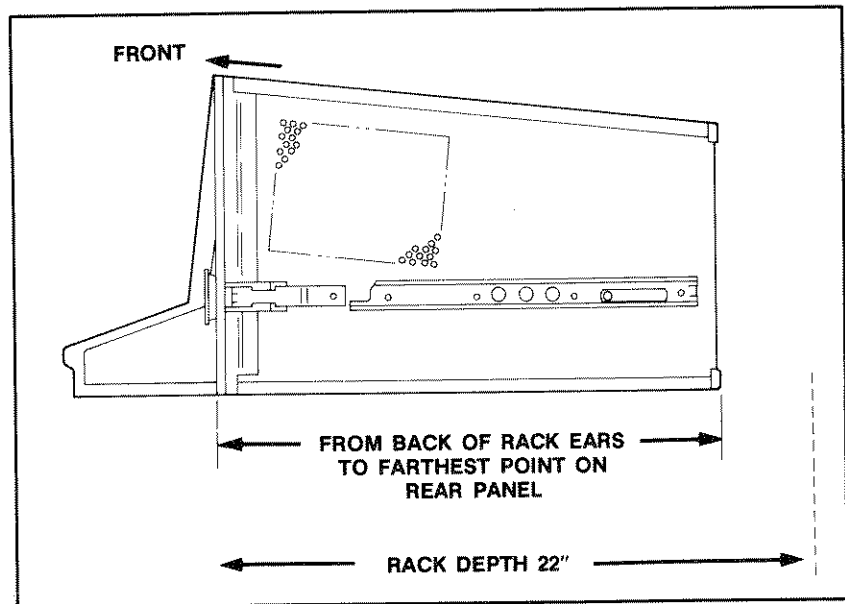


Figure 1-3. Rackmounting Length and Clearance.

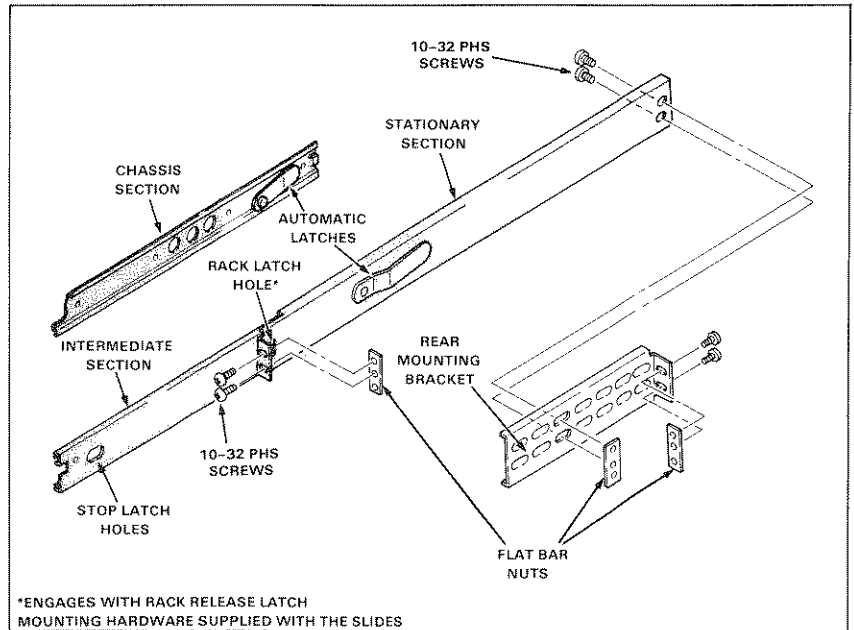


Figure 1-4. Rackmounting Hardware.

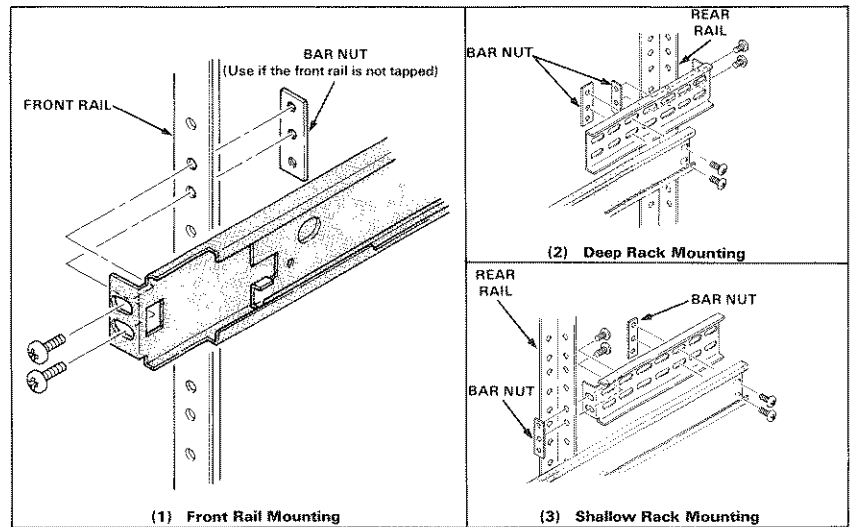


Figure 1-5. Mounting Stationary Rackmount Sections.

## General Information—370

---

The stationary and intermediate sections for both sides are shipped as a matched set and should not be separated. The package includes matched sets for both sides and mounting hardware. To identify the assemblies, note that the automatic latch and intermediate section latch stop holes are located near the top when the matched sets are properly mated to the chassis sections.

1. Select the appropriate holes in the rack rail, using Figure 1-2 as a guide.
2. Mount the stationary-track sections to the front rack rails with truss head screws (and bar nuts, if necessary).
3. Mount the stationary-track sections to the rear rails, using one of the methods depicted in Figure 1-5. Note that the rear mounting bracket can be installed to fit either deep or shallow cabinet racks.
4. After mounting the instrument in the slide-out tracks, adjust for proper width by loosening the front and rear screws and allowing the slides to seek the proper width. Center the instrument, then tighten the screws.
5. Push the instrument into the rack, and check that the automatic spring latch engages the spring latch catch to hold the instrument in place.
6. Extend the instrument out of the rack by pulling the rackmount latch releases on the front panel (see Fig. 1-1) out to disengage the spring latches. Then, pull the instrument out.
7. Once the instrument is out of the rack, press the latch release and push the instrument back into the rack.

**Rackmount to Cabinet Conversion.** To convert the 370 rackmount version to a cabinet model, use the following procedure (see Fig. 1-6):

1. Remove the bracket from each corner of the instrument rear panel.
2. Replace the left and right side panels with cabinet model side panels.
3. Mount a carrying handle assembly on the left and right sides of the top.
4. Fasten a foot at each corner on the bottom of the instrument.

**Cabinet to Rackmount Conversion.** To convert the 370 cabinet model to a rackmount version, use the following procedure (see Fig. 1-6):

1. Remove the bracket from each corner on the rear panel.
2. Replace the side panels with rackmount version side panels.
3. Attach brackets at each corner on the rear panel.

4. Remove both carrying handle assemblies:

- a) Remove the plastic retainer caps that conceal the screws located at each end of the handle.
- b) Remove the screw, spacer and bar nut, then lift off the carrying handle assembly.

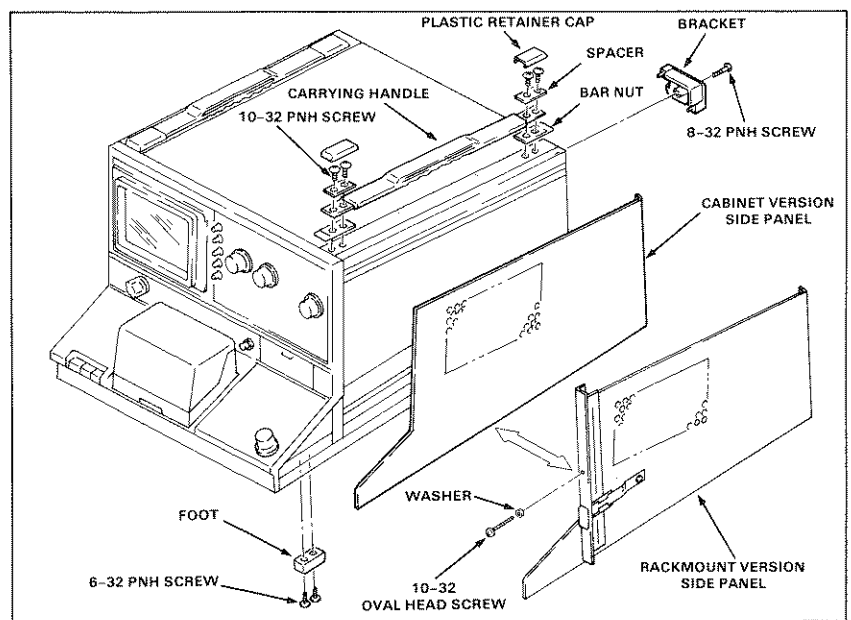


Figure 1-6. Cabinet-to-Rackmount Conversion.

## REPACKING FOR SHIPMENT

If this instrument is to be shipped long distances, we recommend that the instrument be repackaged the same as when it arrived. The cartons and packaging material in which your instrument was shipped should be saved and used for this purpose.

If your instrument is to be shipped to a Tektronix Service Center for service or repair, attach a tag to the instrument showing the following:

Owner of the instrument (with address),  
Name of a person at your firm to contact,  
Instrument type  
Instrument serial number  
Description of the service required.

If the original packaging is unfit for use or not available, package the instrument as follows:

1. Obtain a corrugated cardboard shipping carton with a 375-pound test strength that has inside dimensions at least six inches greater than the instrument dimensions.
2. Surround the instrument with polyethylene sheeting to protect the finish.
3. Cushion the instrument on all sides by tightly packing dunnage or urethane foam between the carton and the instrument, allowing three inches on all sides.
4. Seal the carton with shipping tape or with an industrial stapler.
5. Write the address of the Tektronix Service Center and your return address on the carton in one or more prominent locations.




## SPECIFICATION

### Performance Conditions

The following electrical and environmental characteristics are valid for instruments operated at ambient temperatures from +10° C to +40° C after an initial warmup period of 20 minutes, when previously calibrated with a temperature from +15 to +25° C.



**Table 1-4  
Electrical Specification**

Characteristic	Performance Requirement	Operation Information
<b>COLLECTOR SUPPLY</b>		
Polarity		
+LEAKAGE	Applies positive dc voltage to the collector terminal. Measures emitter current. Sensitivity is increased 1000 times.	
+DC	Applies positive dc voltage to the collector terminal. Measures collector current.	
+ 	Applies positive full-wave rectified sine wave to the collector terminal. Measures collector current.	
AC 	Applies line-frequency sine wave to the collector terminal. Measures collector current.	
- 	Applies negative full-wave rectified sine wave to the collector terminal. Measures collector current.	
-DC	Applies negative dc voltage to the collector terminal. Measures collector current.	
-LEAKAGE	Applies negative dc voltage to the collector terminal. Measures emitter current. Sensitivity is increased 1000 times.	
DC Mode Ripple	2% or less of voltage or 0.1% or less of full-range voltage.	AC p-p open circuit Measurement.
Max Peak Volts		
LOW range	16V, 80V, 400V	
HIGH range	2000V	
Voltage Accuracy	Peak open circuit voltage on all ranges within +10, -0%	at MAX PEAK POWER of 50 WATTS

General Information—370

Table 1-4 (cont)  
Electrical Specification

Characteristic	Performance Requirement				Operation Information
Range	16V	80V	400V	2000V	
Max Peak Current	10A	2A	0.4A	0.05A	
Peak Current, pulsed	20A	4A	0.8A	0.1A	
Minimum Series Resistance (ohms)	0.26	6.4	160	20K	
Maximum Series Resistance (ohms)	800	20K	500K	12.5M	
Series Resistance Available (ohms, $\pm 5\%$ or $\pm 0.1$ ohm)	0.26 160 100K	1.3 800 500K	6.4 4K 2.5M	32 20K 12.5M	
Peak Power Watts					
LOW range (16, 80 and 400V)	220W 0.4W	50W 0.08W	10W	2W	Derived from nominal peak open-circuit collector voltages and nominal series resistance values.
HIGH range (2000 V)	50 W 0.08W	10 W	2 W	0.4 W	
Variable Collector Supply	0 to 100.0%				Uncalibrated variable collector supply amplitude control from 0 to 100% in 0.1% increments.
Resolution % Indicator (5 LEDs)	0.1%				Indicates approximate % of MAX PEAK VOLTS
Safety Interlocks					Applies to all ranges 16, 80, 400, 2000 V). The protective cover must be in place over test terminals and lid shut before voltage can be applied to the collector terminals.
Collector Supply Disabled (LED)					Amber light on indicates interlock is open.

**Table 1-4 (cont)  
Electrical Specification**

Characteristic	Performance Requirement	Operation Information
Warning Indicator		Red light on indicates dangerous voltage maybe applied to collector terminal.
Limiter Indicator		Indicates that internal sensing circuit automatic protection is operating.
Looping compensation		Cancels stray capacitance between collector terminal and ground.

**NOTE**

*The collector supply is limited to a maximum continuous peak current operating time under the following duty cycle and ambient temperature conditions:*

*With the PEAK POWER WATTS at 50 or 220, the following limitations apply:*

*50w: Maximum continuous operating time at rated current (100% duty cycle) into a short circuit is 20 minutes at 25° C ambient, or ten minutes at 40° C ambient.*

*220w: Maximum continuous operating time at rated current (100% duty cycle) into a short circuit is 30 minutes at 25° C ambient, or 90 seconds at 40° C ambient.*

*Alternatively, the duty cycle may be limited to 50% at 25° C ambient or 25% at 40° C ambient. (A normal family of transistor curves will produce a duty cycle effect to 50% or less, even if operated continuously.) Collector Supply over-dissipation temporarily shuts off the power, turns on the amber COLLECTOR SUPPLY VOLTAGE DISABLED indicator, and prints a message on the screen. No damage results when over-dissipation occurs.*

General Information—370

Table 1-4 (cont)  
Electrical Specification

Characteristic	Performance Requirement	Operation Information
<b>STEP GENERATOR</b>		
Accuracy (Current or voltage steps including Offset)		
Incremental	1.5%	
Absolute	Less than 1.5% x total output + 3% x AMPLITUDE setting + 1 mV or 1 nA. (less than 1.5% of total output + 10% of STEP/OFFSET setting + 1 mV or 1 nA with STEP MULTI .1X enabled.)	
Offset Control Range	Variable from - 10 to + 10 times STEP AMPLITUDE.	
Resolution	STEP/OFFSET AMPLITUDE setting X1%.	
Current Mode		
Amplitude Range	50 nA to 200 mA in 1-2-5 sequence of 21 steps.	Selected by STEP/OFFSET AMPLITUDE.
Maximum Current	20 times STEP AMPLITUDE, except 10X STEP AMPLITUDE when control is set to 200 mA.	
Maximum Voltage	At least 10 V.	
Maximum Opposing Offset Current	Ten times STEP AMPLITUDE	
Maximum Opposing Volts	Less than 7 V.	

**Table 1-4 (cont)  
Electrical Specification**

Characteristic	Performance Requirement	Operation Information
Ripple Plus Noise	Less than 0.5% x STEP AMPLITUDE + 1 nA BW:20 MHz.	
Voltage Mode		
Amplitude Switch Range	50 mV to 2 V, in 1-2-5 sequence.	
Maximum Voltage	20 times STEP AMPLITUDE	
Maximum Current	At least 2 A at 10 V or less; 10 mA at 40 V.	
Short Circuit Current Limiting	20 mA, 100 mA, 500 mA, 2 A +50%, -20%	Selected by CURRENT LIMIT switch
Maximum Opposing Offset Volts	10 times STEP AMPLITUDE.	
Maximum Opposing Current	Less than 10 mA	
Ripple Plus Noise	Less than 0.5% x STEP AMPLITUDE + 1 nA BW:20 MHz	
Step Rates	2 x Line frequency (1 x Line frequency in ac collector supply mode). Steps occur at zero collector voltage.	
Pulsed Steps	80 $\mu$ or 300 $\mu$ s wide $\pm$ 10%, at mesial line, with 1 k $\Omega$ load, 1 mA STEP/OFFSET.	
Steps and Offset Polarity	Corresponds to Collector Supply Polarity when STEP GENERATOR POLARITY INVERT disabled. Opposite to Collector Supply Polarity when STEP GENERATOR POLARITY INVERT is selected or CONFIGURATION switch is set to BASE=COMMON. BASE=COMMON configuration disables STEP GENERATOR INVERT.	

**Table 1-4 (cont)  
Electrical Specification**

Characteristic	Performance Requirement	Operation Information
Number of Steps	Ranges from 0 to 10.	
<b>AUX SUPPLY</b>		
Range	From -40 to +40 volts in 20 mV increments.	
Accuracy	Within 50 mV + 1.5% of total output	
Output current	At least 100 mA at ±20 V	
	At least 10 mA at ±40 V	
Ripple plus noise	Less than 50 mV p-p	

**NONSTORE VERTICAL DEFLECTION SYSTEM**

<b>NONSTORE MODE</b>		
Cursor Accuracy	CROSS and WINDOW Within 0.06 division.	
<b>Collector Current</b>		
Range	1 $\mu$ A/div to 2 A/div in 1-2-5 sequence of 20 steps. X10 MAG extends maximum sensitivity to 100 nA/div (1 nA resolution).	
Accuracy	Within 2% of crosshair cursor readout + 0.1 x VERT/DIV settings.	
Maximum displayed noise or ripple	1% or the following, depending on setting of MAX PEAK VOLTS	
	16    80    400    2000	
	1 $\mu$ A    1 $\mu$ A    2 $\mu$ A    5 $\mu$ A p-p	
Emitter Current Range	1 nA/div to 2 mA/div in 1-2-5 sequence of 20 steps. X10 MAG extends maximum sensitivity to 100 pA/div.	Collector Supply Polarity is either +LEAKAGE or -LEAKAGE.

**Table 1-4 (cont)  
Electrical Specification**

Characteristic	Performance Requirement	Operation Information
Accuracy	Within 2% of crosshair cursor readout + 0.1 x VERT/DIV settings, + 1 nA.	
Maximum displayed noise or ripple	1% or the following, depending on setting of MAX PEAK VOLTS:	
	16 80 400 2000	
	1 nA 1 nA 2 nA 5 nA p-p	
Step Generator Display		
Range	1 step/division	
	10 steps/division	with STEP MULTI .1x
	1 step/10 divisions	with VERT x10
Accuracy	Within .3 division	
Display offset	Vertical offset range: $\pm 10$ divisions in half-division steps.	
Display mag X10 accuracy	0.5% of readout + 0.3 div X setting.	
Display invert accuracy	Within 0.1 div X setting.	

**DIGITAL STORAGE VERTICAL ACQUISITION**

A/D converter		
Resolution	10 bits for 10.24 divisions, 100 counts per division.	
max data points	1024	
max sampling rate	line frequency x 1024	
min sampling rate	line frequency x 2	
Collector Current		
Range	1 $\mu$ A/div to 2 A/div in 1-2-5 sequence of 20 steps. X10 MAG extends maximum sensitivity to 100 nA/div (1 nA resolution).	
Accuracy	Within 1.5% of dot cursor readout + 0.3 x VERT/DIV setting.	

**Table 1-4 (cont)  
Electrical Specification**

Characteristic	Performance Requirement	Operation Information
Emitter Current		
Range	1 nA/div to 2 mA/div in a 1-2-5 sequence of 20 steps. X10 MAG extends max sensitivity to 100 pA/div (1 pA resolution).	LEAKAGE mode
Accuracy	Within 1.5% of dot cursor readout + 0.3 x VERT/DIV setting + 1 nA.	
Step Generator Display		
Range	1 step/division	
	1 step/10 divisions	with VERT x10
	10 steps/division	with STEP MULTI .1x
Accuracy	Within 0.3 division	
Display offset	Vertical offset range: ± 10 divisions in half-division steps.	
Accuracy	Within 0.5% of offset readout + 0.01 x VERT/DIV setting.	
Display Mag Accuracy	0.5% of readout + 0.3 x VERT/DIV setting.	
Display Invert Accuracy	Within 0.04 x VERT/DIV and HORIZ/DIV settings.	

**NONSTORE HORIZONTAL DEFLECTION SYSTEM**

Cursor Accuracy	Within 0.06 division	
Collector volts		
Range	50 mV/div to 500 V/div in a 1-2-5 sequence of 21 steps. X10 MAG extends maximum sensitivity to 5 mV/div (50 V resolution).	
Accuracy	Within 2% of crosshair cursor readout + 0.1 x HORIZ/DIV setting.	
Displayed Noise	16    80    400    2000 V 2    10    50    250 mV p-p	



**Table 1-4 (cont)  
Electrical Specification**

<b>Characteristic</b>	<b>Performance Requirement</b>	<b>Operation Information</b>
Base/Emitter Volts		
Range	50 mV/div to 2 V/div in 1-2-5 sequence of 6 steps. X10 MAG extends sensitivity to 5 mV/div (50 $\mu$ V resolution).	
Accuracy	Within 2% of crosshair cursor readout + 0.1 x HORIZ/DIV setting.	
Input Impedance	At least 100 Megohms	
Displayed noise	Less than 10 mV p-p	
Step Generator Display		
Range	1 step/division	
	1 step/10 division with HORIZ x10	
	10 steps/division	with STEP MULTI .1x
Accuracy	Within 0.3 division	
Display offset	Horizontal offset range: $\pm$ 10 divisions in half-division steps.	
Accuracy	0.5% of offset readout + 0.1 x HORIZ/DIV setting.	
Display Mag Accuracy	0.5% of readout + 0.3 x HORIZ/DIV setting.	
Display Invert Accuracy	Within 0.1 x HORIZ/DIV setting.	

**DIGITAL STORAGE HORIZONTAL ACQUISITION**

A/D converter		
Resolution	10 bits for 10.24 divisions. 100 counts per division.	
Max data points	1024	
Max sampling rate	line frequency x 1024	
Min sampling rate	line frequency x 2	

**Table 1-4 (cont)  
Electrical Specification**

Characteristic	Performance Requirement	Operation Information
Collector volts		
Range	50 mV/div to 500 V/div in 1-2-5 sequence of 21 steps. X10 MAG extends maximum sensitivity to 5 mV/div (50 $\mu$ V resolution).	
Accuracy	Within 1.5% of dot cursor readout + 0.03 x HORIZ/DIV setting.	
<b>Base/Emitter Volts</b>		
Range	50 mV/div to 2 V/div in a 1-2-5 sequence of 6 steps. X10 MAG extends maximum sensitivity to 5 mV/div (50 $\mu$ V resolution).	
Accuracy	Within 1.5% of dot cursor readout + 0.03 x HORIZ/DIV setting.	
Step Generator Display		
Range	1 step/division	
	1 step/10 divisions	with HORIZ x10
	10 steps/division	with STEP MULTI .1x
Accuracy	Within 0.3 division	
Display offset	Vertical offset range: $\pm 10$ divisions in half-division steps.	
Accuracy	0.5% of offset + 0.01 x HORIZ/DIV setting.	
Display Mag Accuracy	0.5% of readout + 0.3 x HORIZ/DIV setting.	
Display Invert Accuracy	Within 0.04 X VERT/DIV and 0.04 X HORIZ/DIV setting.	

**Table 1-4 (cont)  
Electrical Specification**

Characteristic	Performance Requirement	Operation Information
<b>ACQUISITION MODES</b>		
NORMAL		
ENVELOPE	Vertical envelope, Horizontal envelope	
AVERAGING	Averages last four or last 32 acquisitions	
<b>CRT AND READOUT</b>		
<b>CRT</b>		
Type	Electrostatic deflection	
Phosphor	P31	
Acceleration Potential	12 kV typical	
Screen Size	7" diagonal Internal graticule and on-screen scale factor readout.	
Total Addressable Points (Graticule Area)	1000 x 1000	
Geometry	1/2 minor division or less of tilt or bowing; 3/4 minor division or less of keystone.	
Resolution	At least 10 lines/div	
Spot Size	Within 0.95 mm at screen center; Elsewhere on screen: Within twice center value.	
Orthogonality	90°, within 0.3°.	
Trace Rotation Range	At least ± 3°.	
<b>READOUT</b>		
	Automatic on-screen display. Over range shown by a flashing display.	

General Information—370

Table 1-4 (cont)  
Electrical Specification

Characteristic	Performance Requirement	Operation Information
Per Vertical Division	100 pA to 2 A.	
Per Horizontal Division	5 mV to 500 V.	
Per Step	5 nA to 200 mA and 5 mV to 2 V	
BETA or gm Per Division	500 x 10 <sup>9</sup> to 400 x 10 <sup>6</sup> for BETA and 50 x 10 <sup>-9S</sup> to 400 S for gm.	
CURSOR	4-digit Horizontal and Vertical values without x10 MAG, 5-digit with MAG.	
OFFSET	4-digit value.	
AUX SUPPLY	-40.00 V to +40.00 V	

TEXT DISPLAY

Text Area		
Alphanumeric Character Font (1)	SP,I,...,A,B,...,0,1—, 9,/,...,a,b,...,y,z,... u is recognized as micro	GPIB-accessible by using TEXT command
Alphanumeric Character Font (2)	A,B,...,Y,Z,(space),m,u, n,p,...,0,1,...,9,-/,*,(,) u is recognized as micro	Accessible by using VERTICAL and HORIZONTAL knobs.
Maximum TEXT Characters	24	
Character Size	Approximately 3 mm height, 2 mm width.	

CONNECTORS

Adapter Connectors		
Collector Collector sense		C, B, and E stands for collector, base, and emitter, respectively.
Maximum output voltage	± 2000	Sense connectors allow Kelvin sensing of voltage for high-current device.
Maximum output Current	± 20 A	

**Table 1-4 (cont)  
Electrical Specification**

Characteristic	Performance Requirement	Operation Information
Base Base Sense Emitter Emitter Sense		
Maximum output voltage $\Delta$	$\pm 40$ V	
Maximum output Current	$\pm 20$ A	
Step Gen Out Connector		
Maximum output voltage $\Delta$	$\pm 40$ V	
Maximum output Current	$\pm 2$ A	
Aux Supply Connector Maximum output voltage and current $\Delta$	$\pm 40$ V @ $\pm 10$ mA, or $\pm 20$ V @ $\pm 100$ mA.	
Ext Base or Emitter Connector		
Maximum output voltage $\Delta$	$\pm 40$ V	
Maximum output	$\pm 2$ A	
Power source		
Line voltage Ranges	115 VAC      230 VAC	
High	107 VAC to 132 VAC      214 VAC to 250 VAC	
Low	90 VAC to 110 VAC      180 VAC to 220 VAC	
Line Frequency Range	48.0 to 66.0 Hz.	
Power Consumption		
Max.	400 W 3.5A at 132 V 60 Hz	
Typical	120 W 1.3 A at 115 V 50 Hz.	

**General Information—370**

**Table 1-5  
Mechanical Specification**

Characteristic		Performance Requirement
Weight	(Std.)	35 kg (77 lbs.)
	(Option 1R)	36 kg (79.2 lbs.)
Height		326 mm (12.8 in) with feet
		310 mm (12.2 in) without feet
Width		429 mm (16.9 in)
Depth		635 mm (25.0 in)

**Table 1-6  
Environmental Specification**

Characteristic		Performance Requirement
Temperature	Non-Operating	-40 to +65° C.
	Operating	+10 to +40° C.
Altitude	Non-Operating	to 50,000 feet
	Operating	to 15,000 feet

Maximum operating temperature decreases 1° C each 1,000 feet above 5,000 feet.

Humidity	Non-operating and operating	Tested non-operating at 60° C and operating to meet MIL-STD-810C method 507. 1 procedure IV, modified as specified in MIL-T-28800B paragraph 4.5.1.1.2. Five cycles (120 hours) at 80% relative humidity.
EMC (Electromagnetic compatibility)	Conducted Emissions	DIN 57871/VDE 0871/6.78 CLASS B

**Table 1-6 (cont)**  
**Environmental Specification**

Characteristic	Performance Requirement
Susceptibility	CS06-MIL-STD-461B PART 5 PLUS ADDITIONAL REQ. CS01-MIL-STD-461B PART 7 CS02-MIL-STD-461B PART 4
Radiated Emissions Susceptibility	DIN 5771/VDE 0871/6.78 CLASS B  RS03-MIL-STD-461B PART 7 LIMIT TO 1 GHZ RS01-MIL-STD-461B PART 4 CHARACTERIZATION ONLY
Electrostatic Discharge	Mainframe—15kV Bubble cassette—5kV Adapter—5kV
Vibration (operating)	Tested to MIL-T-28800B, Section 4.5.5.3.1; 15-minute sweep along each of three major axes at a total displacement of 0.015 inch p-p (2.3G at 55 Hz), with frequency varied from 10 Hz to 55 Hz to 10 Hz. Held 10 minutes at each major resonance, or if no major resonance present, held 10 minutes at 55 Hz.
Shock (nonoperating)	Tested to MIL-T-28800B, Section 4.5.5.4.1; 30 G, half-sine, 11 ms duration, three shocks per axis in each direction for a total of 18 shocks.
Bench Handling	Meets MIL-STD-810C, Method 516.2, Procedure V (MIL-T-28800B, section 4.5.5.4.4).
Packaged Transportation Drop	Meets the limits of the National Safe Transit Association test procedure 1A-B-2; 10 drops of 24 inches.
Package Transportation Vibration	Meets limits of the National Safe Transit Association test procedure 1A-B-1; excursion of 1 inch p-p at 4.63 Hz (1.1G) for 60 minutes.

**General Information—370**

**Interface Specification**

**Table 1-7  
Parallel Interface Pin Assignment Table**

Signal Pin No.	Return Pin No.	Signal	Direction	Description
1	19	STROBE	OUT	An active low strobe qualifies data. Data may be latched on STROBE low or may be clocked on positive transition of STROBE.
2	20	DATA 1	OUT	INPUT DATA LEVELS—A logic one is represented by a high level.
3	21	DATA 2	OUT	
4	22	DATA 3	OUT	
5	23	DATA 4	OUT	
6	24	DATA 5	OUT	
7	25	DATA 6	OUT	
8	26	DATA 7	OUT	
9	27	DATA 8	OUT	
10	28	A CKNLG	IN	A CKNLG—An active low strobe that flags the host that a transaction is completed.
11	29	BUSY	IN	A high-active signal indicates that the plotter is not ready for data.
12	30	PE	IN	Paper Empty—A low signal indicates that the plotter is not paper set.
13	-	SLCT	-	Not used.
14	-	NC	-	Not used.
15	-	NC	-	Not used.
16	-	NC	-	Not used.
17	-	FG	-	370 chassis GND. In the 370, the chassis GND and the logic GND are isolated from each other.
18	-	+5V	OUT	+5V
19-30	-	GND	-	TWISTED-PAIR RETURN signal GND level.
31	-	INIT	OUT	Low for Plotter initialize.



Table 1-7 (cont)  
Parallel Interface Pin Assignment Table

Signal Pin No.	Return Pin No.	Signal	Direction	Description
32	-	FAULT	IN	The 370 aborts data transmission when ERROR signal is low.
33	-	NC	-	Not used.
34	-	NC	-	Not used.
35	-	NC	-	Not used.
36	-	NC	-	Not used.

**Cable.** CENTRONICS 36-pin I/F cable. (see Fig.1-7).

Electrical Specifications

All input/output signals are TTL-compatible.  
(Iol 20 mA)  
(Ioh -10 mA)

**Recorded Data (Bubble Memory).** The Bubble Memory interfaces only with the 370 Programmable Curve Tracer. The Bubble Memory cassette has a capacity of 128K bytes, and can store the data for 16 curves and 16 setups.

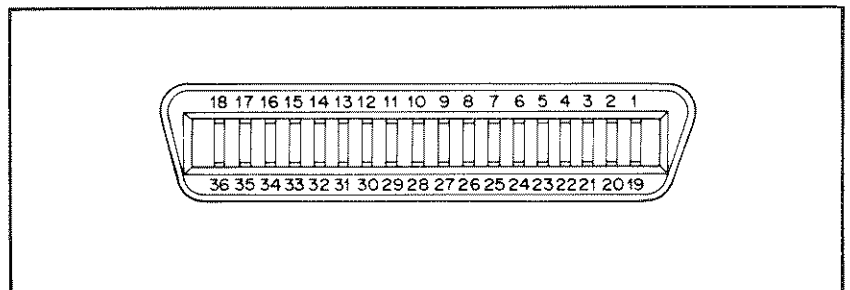


Figure 1-7. 18-bit Parallel Interface Connector.

## General Information—370

**GPIB Interface.** The IEEE-488-1978 (GPIB) standard defines the GPIB interface functions and the allowed subsets of those functions.

Function	Implemented As
Source handshake	SH1
Acceptor Handshake	AH1
Talker	T6
Listener	L4
Service request	SR1
Remote Local	RL2
Parallel poll	PPO
Device clear	DC1
Device trigger	DT0
Controller	CO

## ACCESSORIES

### Standard Accessories

Operators Manual	070-6064-00
Pocket Reference Guide	070-6066-00
Instrument Interface Guide	070-6067-00
FUSE 250V, 2A, medium-blo	159-0260-00
125V, 4A, medium-blo	159-0259-00
Protective Cover	337-3344-00
Bubble Cassette	020-1310-00
Power Cord	161-0066-00

### Text Fixture Adapters

Blank adapter	A1001
In-line adapter	A1002
Axial Lead Adapter	A1005
4 & 6 Lead Transistor Adapter	A1007

### Optional Accessories

TO-3/TO-66 Adapter	A1003
Offset Lead/Power Adapter	A1004
Long-Lead Transistor Adapter	A1006
Long-Lead FET Adapter	A1008
4 and 6-Lead FET Adapter	A1009
IC Adapter	A1010
Service Manual	070-6065-00
Camera Adapter, (C59AP)	016-0244-06
Camera Adapter, C5C op. 01	016-0357-01
Camera Adapter, C4 op. 02	016-0357-01

## SECTION 2

# CONTROLS, INDICATORS AND CONNECTORS

All controls, indicators and connectors required for normal operation of the 370 are located on the front and rear panels of the instrument. In addition, readout of the controls and measurement functions is provided on the crt. Become familiar with all these functions to effectively operate the 370.

Figure 2-1 shows the Front-panel controls, indicators and connectors. Figure 2-4 shows the rear-panel controls and connectors. Refer to these illustrations while using the following.

### CRT CONTROLS

- |                        |   |
|------------------------|---|
| (1) INTENSITY Controls | There are three intensity controls: NON STORE/STORE, VIEW, and READOUT/ CURSOR. The DOT cursor intensity is always proportional to NON STORE/STORE or VIEW intensity. The READOUT/CURSOR intensity control has no effect on DOT CURSOR intensity.   |
| NON STORE/STORE        | controls display brightness in the NON STORE or STORE modes.  |
| VIEW                   | controls display brightness in the VIEW mode.   |
| READOUT/CURSOR         | controls readout, Cross Hair Cursor, and Window display brightness.   |
| (2) FOCUS              | controls display focus.   |
| (3) GRAT ILLUM         | controls internal graticule illumination.   |
| (4) POSITION Controls  | Operator-adjusted screwdriver controls that vertically and horizontally position the display. Adjustable range is at least one division. These adjustments do not affect the acquired curve data accuracy. CRT CAL controls (refer to DISPLAY section) are provided for accurate positioning. |
| (5) TRACE ROTATION     | Operator-adjusted screwdriver control for horizontal trace alignment. Once adjusted, readjustment is not required during normal instrument operation.   |

### MEASUREMENT

The 370 has two measurement modes, REPEAT and SINGLE. These modes determine the step generator output mode.

- (6) REPEAT                    The step generator creates the family of steps repetitively, making a continuous display of a family of characteristic curves. The characteristic curve family is displayed on the crt when the display mode is set to NON STORE, STORE or COMPARE. Stored curves produces a flicker-free display.
  
- (7) SINGLE                    Step Generator produces a single family of steps each time the SINGLE key is pressed. The Collector Supply and the Auxiliary Supply always provide power regardless of the SINGLE function. In the Store or Compare modes, the display is refreshed each time SINGLE is pushed.

### **BUBBLE MEMORY INDEX**

The internal bubble memory system stores characteristics curves and front-panel setups. The Bubble Memory Index display indicates the memory location that identifies where curves or setups are stored in the Bubble Memory. Up to sixteen storage displays and sixteen front panel setups can be stored in a bubble memory cassette.

- (8) Bubble Memory Index display and control                    Indicates the bubble memory location for ENTER/TEXT, VIEW, SAVE and RECALL functions. The BUSY lamp indicates the bubble I/O operation. The control next to the up and down arrows allows selection of the memory location.

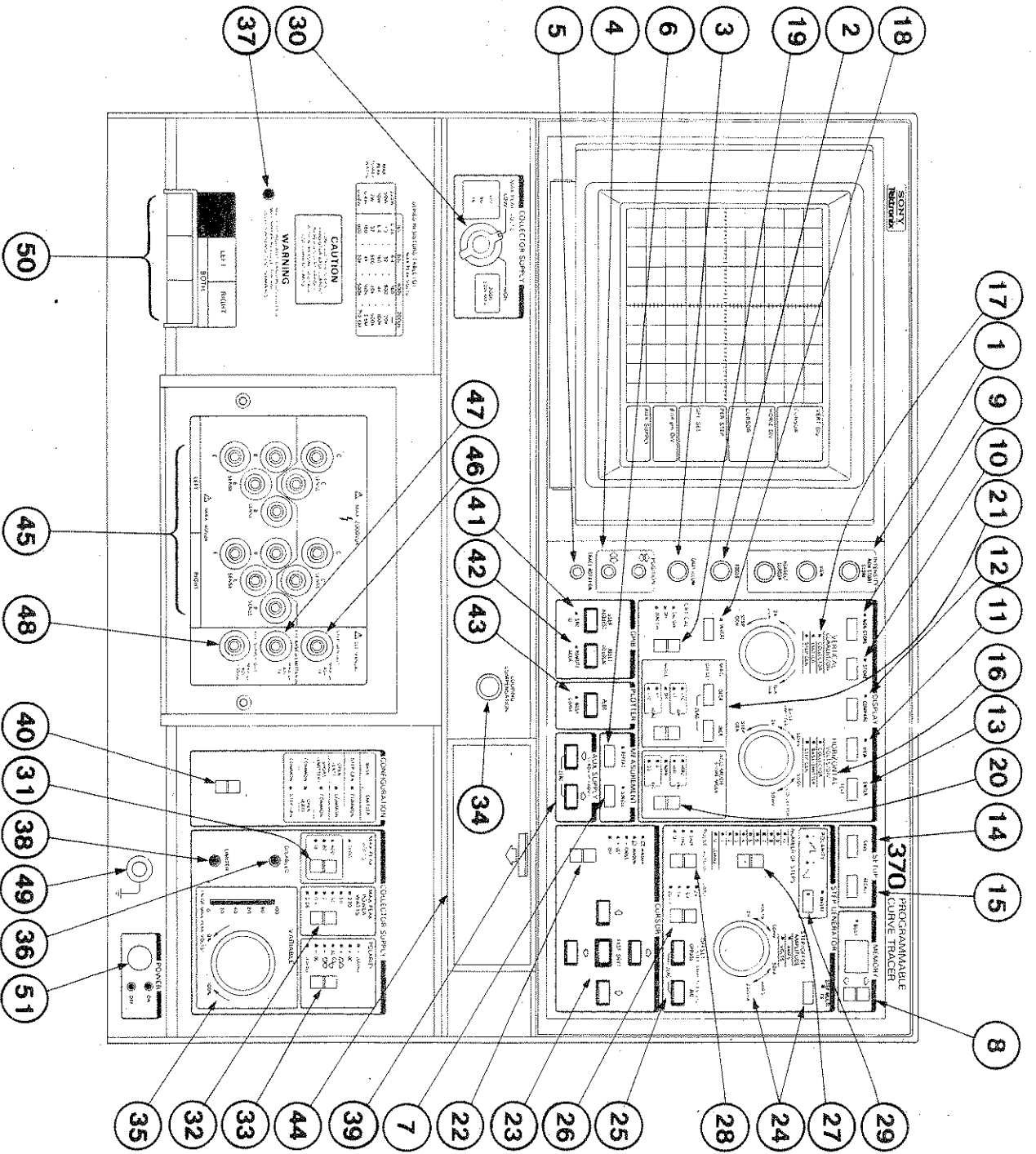


Fig. 2-1. Front panel controls, indicators and connectors.

## DISPLAY MODE

The Display mode controls select one of the following display modes:

NON STORE  
STORE  
COMPARE  
VIEW

The 370 provides only one display mode at a time.

- |                 |   |
|-----------------|---|
| (9) NON STORE   | Provides a real-time analog display of DUT characteristics.   |
| (10) STORE      | Digitally acquired curves are displayed on the crt. ACQ control setting (see DISPLAY description) selects the acquisition mode.   |
| (11) ENTER/TEXT | Stores the currently displayed digital storage curves in the bubble memory cassette. The Bubble Memory Index display indicates the memory location where the current display will be stored. The Enter function is not used with the Non Store and Compare display modes.   |
| (12) COMPARE    | Displays STORE and VIEW curves simultaneously.  |
| (13) VIEW       | Displays the previously entered curves from the bubble memory cassette. Bubble Memory Index display indicates the display curve identification number. CURVE ID number is displayed at the bottom right of the crt and is erased if any setting is changed. If any setting is changed while in View mode, the display mode is changed to Store mode automatically to reflect the setting change result. |

## SETUP

The setup save/recall function allows you to save or recall a group of front panel settings. All of the front panel settings, except those stated in TABLE 2-1, can be stored in or recalled from the bubble memory cassette. The up/down control selects the index number of the Bubble Memory.

- (14) SAVE Front panel setups are saved in the bubble memory cassette when SAVE is pressed. The bubble memory index display indicates the index number of the Bubble Memory location where the setups are stored.
- (15) RECALL Recalls a previously-stored group of 370 front-panel settings. When RECALL is pressed, the 370 is set to the front-panel settings stored in bubble memory, and the display mode is set to the STORE mode. SETUP ID number is displayed at the bottom center of the crt and is erased after any setting is changed.

**TABLE 2-1**  
**Front Panel Controls Settings Not Stored**

LEFT-RIGHT - STANDBY
COLLECTOR SUPPLY HIGH-LOW LOOPING COMPENSATION
DISPLAY MODE NON STORE STORE COMPARE VIEW ENTER/TEXT
SETUP RECALL SAVE
MEMORY Index
CRT CONTROL INTENSITY FOCUS GRATICULE ILLUM POSITION TRACE ROTATION
GPIB USER REQUEST/SRQ ID RESET TO LOCAL/REMOTE ADDR
PLOTTER PLOT/BUSY CURVE

## DISPLAY

- (16) HORIZONTAL Selects horizontal deflection factors (VOLTS/DIV) and horizontal sources (COLLECTOR, BASE/EMITTER or STEP GEN). FULL Clockwise rotation: 1) Selects COLLECTOR voltage source, 2) Turns on the COLLECTOR indicator LED, 3) Displays crt readout for the horizontal deflection factor. In COLLECTOR position, horizontal deflection factor for COLLECTOR voltage can be selected from 50 mV to 500 V in 1-2-5 sequence. Counterclockwise (ccw) rotation from 500V/DIV of COLLECTOR position enters BASE/EMITTER position and the BASE/EMITTER indicator LED turns on. In BASE/EMITTER position, the control selects horizontal deflection factor of either BASE or EMITTER voltage from 50 mV to 2 V in 1-2-5 sequence of 6 steps. Either BASE or EMITTER voltage is determined by the CONFIGURATION mode, as follows:

CONFIGURATION	HORIZONTAL VOLTAGE
BASE: STEP GEN	BASE
BASE: OPEN (EXT)	BASE
BASE: SHORT (EMITTER)	BASE
EMITTER: OPEN (EXT)	EMITTER
EMITTER: STEP GEN	EMITTER

Full counterclockwise rotation selects STEP GEN, which turns on STEP GEN indicator LED, and the horizontal deflection factor and cursor readouts disappear.

- (17) VERTICAL Selects vertical deflection factors and vertical sources (COLLECTOR or STEP GEN). Full ccw rotation of the VERTICAL control displays STEP GEN signal source and turns on STEP GEN LED. When STEP GEN is selected, the VERT/DIV and vertical cursor readouts disappear. When COLLECTOR source signal is selected, deflection factor (CURRENT/DIV) changes in 1-2-5 sequence. When either +LEAKAGE or -LEAKAGE mode is selected for COLLECTOR SUPPLY POLARITY (EMITTER LED turns on), emitter current can be measured and the vertical deflection factor is divided by 1000.
- (18) DISPLAY INVERT Horizontally and vertically inverts NON STORE or STORE curve at graticule center; also lights INVERT LED.



(19) CRT CAL

Provides signals for checking the vertical and horizontal calibration of the origin of the characteristic curve:  
 CAL CHK: Check ten divisions of deflection.  
 OFF: Normal operation mode.  
 ZERO CHK: Calibrate zero divisions of deflection.

(20) ACQ MODE

Determines data acquisition mode for storage display. This setting does not affect NON STORE or VIEW displays. Modes are:

HORIZ Envelope: When HORIZ Envelope is selected, the horizontal min/max envelopes of the waveforms are displayed. The envelope display continuously accumulates until a setting changes.

VERT Envelope: When VERT Envelope is selected, the vertical min/max envelopes of the waveforms are displayed. The envelope display continuously accumulates until a setting changes.

NORM: Conventional digital storage function.

4 Average: Selects 4 times averaging for accurate and precise measurement. This feature provides a filter effect to reduce display noise. The acquisition count is displayed in the upper-right graticule area.

32 Average: Selects 32 times averaging for accurate and precise measurement. This feature provides a filter effect to reduce display noise. The acquisition count is displayed in the upper-right graticule area.

(21) MAG

Horizontally or vertically offsets and magnifies NON STORE and STORE curve displays. MAG function does not affect VIEW curves. INCR or DECR shifts the curves 0.5 division per step when MAG MODE is at x1. Total display offset control range is  $\pm 10$  divisions. Press INCR and DECR to cancel offset.

VERT X10: Vertically magnifies display by ten. INCR and DECR offset functions affect vertical position.

VERT X1: Offset value is added vertically without magnification. INCR and DECR offset functions affect vertical position.

OFF: No offset, no magnification. INCR and DECR offset functions are disabled.

HORIZ X1: Offset value is added horizontally with no magnification. INCR and DECR offset functions affect horizontal position.

HORIZ X10: Horizontally magnifies display by ten. INCR and DECR offset functions affect horizontal position.

## CURSOR

### (22) CURSOR Mode

The 370 provides three cursor modes: DOT, CROSS and WINDOW. The cursor mode up/down control selects cursor mode. Cursor position is set by four arrow keys. Cursor readout is displayed in the cursor readout area discussed under READOUT DISPLAY. Readout resolution is ten bits. When the display mode is COMPARE, cursor readout indicates position of DOT cursor on STORE curve. Differences between DOT, CROSS and WINDOW are described below.

**DOT:** The bright dot moves on the displayed curve and the corresponding vertical and horizontal values are displayed on the crt. If a value exceeds graticule range, the corresponding cursor readout display blinks. DOT does not operate in the NON STORE mode.

**CROSS:** Horizontal and vertical trace (referred to as a cross hair) appear in the graticule area. The vertical and horizontal coordinates of the cross hair intersection point are displayed on the crt. The cross hair is available in all display modes.

**WINDOW:** Displays user-positioned rectangular "target window" to provide a "go/no-go" visual check reference. Operates in all display modes. Either the upper-right corner or the lower-left corner of the window is the reference. Reference coordinate values appear on the crt.

### (23) Arrow and FAST/SHIFT

Four ARROW keys, up (↑), down (↓), right (→) and left (←) are used to move the DOT, CROSS and WINDOW cursors. When the DOT cursor is selected, the cursor-move direction is defined as follows: Selection of the up (↑) or right (→) ARROW keys move the dot to the higher step curve position. Selection of the down (↓) or left (←) ARROW keys move the dot to the lower step curve position.

Pressing both the FAST/SHIFT key and one of the appropriate ARROW keys accelerates cursor movement.

Rapid change of AUX voltage value or STEP GEN OFFSET value is obtained by pressing both the FAST/SHIFT key and appropriate AUX or STEP GEN OFFSET keys.

Pressing both the FAST/SHIFT key and the PLOT/CURVE key causes the 370 to send only curve data to a plotter.

Pressing both the FAST/SHIFT key and the USER REQUEST/SRQ ID key displays the 370 firmware version on crt.

Pressing both the FAST/SHIFT key and the GPIB RESET TO LOCAL key displays selected GPIB address and GPIB termination mode on crt.

Pressing both FAST/SHIFT and ENTER/TEXT enters Text Editing mode, which permits user comments to be displayed on-screen. See Figure 2-2. In TEXT editing mode, 1) Press NON STORE to erase the text line, 2) Rotate the VERTICAL control to select the desired text character, 3) Rotate the HORIZONTAL control to move the text on the screen. Once editing is completed, press FAST/SHIFT and ENTER/TEXT together to exit text editing. Pressing RECALL, STORE, VIEW or COMPARE cancels text editing mode.

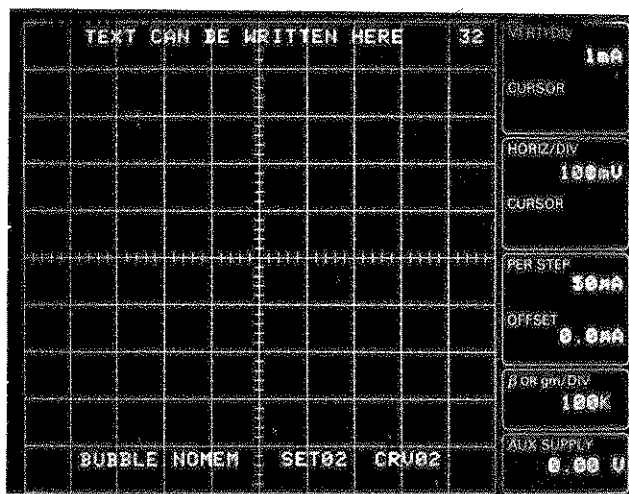


Figure 2-2. Text edit display.

## STEP GENERATOR

- (24) **STEP/OFFSET AMPLITUDE and STEP MULTI .1X** STEP/OFFSET AMPLITUDE control selects step/offset amplitude range and step generator output mode. The step amplitude ranges from 50 nA to 200 mA per step in current output mode and from 50 mV to 2 V per step in voltage output mode in a 1-2-5 sequence. The VOLTS or AMPS LED indicates the selected output mode.
- The STEP MULTI .1X control provides 0.1 times multiplication (division by 10) of the step amplitude setting. The STEP MULTI .1X does not affect the offset amplitude setting.
- (25) **OFFSET** AID and OPPOSE keys control offset value. The offset value ranges from plus 10 to minus 10 times the STEP/OFFSET AMPLITUDE at 1% resolution. The offset value is displayed on the crt.
- AID: The step offset with the same polarity as the polarity setting adds to the step generator output.
- OPPOSE: The step offset with the opposite polarity as the polarity setting subtracts from the step generator output.
- (26) **LIMIT** Selects current limit when the 370 step generator is in voltage output mode. The LED indicates the selected current limit. The voltage limit for current source mode is fixed at seven volts.
- (27) **NUMBER OF STEPS** Selectable between 0 and 10; LED indicates selected number. Number 0 means Step Generator output is DC (constant). When the COLLECTOR SUPPLY POLARITY mode is +LEAKAGE or -LEAKAGE, the actual number of steps is automatically set to 0.
- (28) **PULSE** LONG or SHORT pulse mode is enabled and the step generator supplies either pulsed current or voltage to the base terminal, as selected. Pulse width: 80 uS for SHORT and 300 uS for LONG. Selecting OFF disables Pulse mode. Selecting PULSE mode automatically selects the DC mode of COLLECTOR SUPPLY polarity function.
- (29) **POLARITY and INVERT** POLARITY indicator indicates the step generator output polarity determined by the COLLECTOR SUPPLY POLARITY settings, CONFIGURATION, and the INVERT setting. Pressing INVERT reverses the step generator output polarity. The LED next to the INVERT key indicates if the inverted state is selected. When the configuration control is set to BASE COMMON, pressing INVERT does not effect the actual Step Generator polarity, and the

polarity indicator does not change; only the INVERT indicator changes. Table 2-2 shows the Step Generator Polarity in relation to the Collector Supply Polarity, Configuration mode and INVERT key. For example, if the mode is EMITTER COMMON and the POLARITY is + (full-wave), +DC, or +LEAKAGE, the INVERT key controls the Step Generator Polarity.

**TABLE 2-2**  
**Step Generator Polarity**

		CONFIGURATION mode setting	
		POLARITY	
COLLECTOR SUPPLY Setting	+	BASE COMMON	EMITTER COMMON
	+DC +LEAKAGE	—	+(INVERT OFF) —(INVERT ON)
	— —DC —LEAKAGE	+	—(INVERT OFF) +(INVERT ON)
AC	—	+(INVERT OFF) —(INVERT ON)	

**COLLECTOR SUPPLY**

**WARNING**

*Following use of the 370 at high power settings, the device, fixture, or protective cover may be hot enough to cause injury. Avoid touching any of these items until cooled.*

**WARNING**

*Up to 2000 V may appear at the front-panel collector terminals. To avoid injury or equipment damage, do not remove the protective cover or defeat the protective interlock switch.*

**Controls, Indicators and Connectors—370**

- (30) MAX PEAK VOLTS HIGH-LOW MAX PEAK VOLTS  
 (31) HIGH-LOW MAX PEAK VOLTS  
 (32) MAX PEAK POWER WATTS
- MAX PEAK VOLTS is set by two controls. When the HIGH-LOW control is at 2000V (HIGH), the maximum collector supply peak volts is 2000V, and the LED at the MAX PEAK VOLTS control is lighted. When at LOW, 16, 80 or 400 V maximum peak volts is selectable by using the up/down control. (The LED indicates the selected maximum peak volts.) When the MAX PEAK VOLTS setting is changed, the VARIABLE COLLECTOR SUPPLY output automatically goes to zero.
- The LED indicates the selected MAX PEAK POWER WATTS. This control does not affect the Variable Collector Supply output. When MAX PEAK VOLTS HIGH-LOW is set to the HIGH range (2000V), the available maximum peak power is less than or equal to 50W. The relationship between MAX PEAK POWER and SERIES RESISTORS is shown in Table 2-3.

**TABLE 2-3  
 Max Peak Power vs. Series Resistors**

	16V	80V	400V	2000V
220 W	0.26 OHM	6.4 OHM	160 OHM	—
50	1.3	32	800	20K OHM
10	6.4	160	4K	100K
2	32	800	20K	500K
0.4	160	4K	100K	2.5M
0.08	800	20K	500K	12.5M

(33) POLARITY

- There are seven collector supply polarity modes:
- +LEAKAGE
  - +DC
  - +(full-wave)
  - AC
  - (full-wave)
  - DC
  - LEAKAGE

The LED indicates the selected mode. When the collector supply polarity is changed or switched to or from AC, the variable collector supply output goes to zero. Trace origin is at graticule lower left corner when a plus mode is selected, at graticule center when AC is selected, and at graticule upper right corner when a minus mode is selected.

+LEAKAGE and -LEAKAGE: Vertical sensitivity is increased 1000 times. Vertical amplifier measures emitter current. Collector Supply mode is automatically set for DC voltage output. The step generator furnishes offset to the base terminals with no steps. The number of steps in STEP GENERATOR indicator does not change, but the actual number of steps in the  $\pm$ LEAKAGE mode goes to zero.

+DC and -DC: When +DC or -DC is selected, the collector supply applies a dc voltage equal to the peak value set by the VARIABLE COLLECTOR supply control.

+ (full-wave) and - (full-wave): When either is selected, a full-wave rectified sine wave of + or - polarity, respectively is applied to the collector terminals and either a positive or negative staircase is applied to the base terminals from the step generator.

AC: Selecting ac polarity applies a sinusoidal voltage to the collector terminals. The step generator output is positive-going.

**TABLE 2-4**  
**Collector Supply Polarity Functions**

POLARITY	Vertical Display Source	Collector Supply Output	Number of Steps
+LEAKAGE	EMITTER	+DC	0
+DC	Collector	+DC	as selected
+ (NPN)	Collector	+ rectified sine wave	as selected
AC	Collector	sine wave	as selected
- DC	Collector	- rectified sine wave	as selected
-DC	Collector	-DC	as selected
-LEAKAGE	Emitter	-DC	0

(34) LOOPING COMPENSATION Neutralizes the effects of internal and adapter stray capacitance. Does not compensate for device capacitance.

## Controls, Indicators and Connectors—370

---

- (35) VARIABLE COLLECTOR SUPPLY Allows variable control of collector supply voltage within range set by MAX PEAK VOLTS control. Clockwise (cw) rotation increases the collector supply output voltage, and ccw rotation decreases it. The control has no stops. The VARIABLE COLLECTOR SUPPLY bar graph indicator shows the approximate collector supply output as a percent of MAX PEAK VOLTS.
- (36) COLLECTOR SUPPLY DISABLED Indicates that the collector supply is disabled. Actuation of the safety interlock or a fault condition (such as excessive power consumption) may disable the collector supply output.
- (37) WARNING Red light indicates that the collector supply is enabled and dangerous voltage is applied to the collector terminals.
- (38) LIMITER Indicates that the automatic protection is operating. The protection circuit protects the current-sensing resistors from over-heating.

### AUX SUPPLY

- (39) AUX SUPPLY The auxiliary voltage supply produces up to  $\pm 40$  V at up to 10 mA, or up to  $\pm 20$  V at up to 100 mA. The (1) and (!) keys are used to set the auxiliary supply output voltage. The output voltage is supplied to the AUX SUPPLY OUT connector. The auxiliary voltage setting is displayed on the crt readout area. Simultaneously pushing the two keys sets the auxiliary supply to zero volts.

### CONFIGURATION CONTROLS AND INDICATORS

- (40) CONFIGURATION The CONFIGURATION up/down control selects base and emitter terminal choices. The control also determines the DUT terminal to which the Step Generator is connected. The Collector Supply is connected to the collector terminals in all control positions. COMMON is connected to ground, but through the current-sense resistor in the LEAKAGE MODE. When BASE COMMON is selected, the STEP GENERATOR INVERT key is disabled.

### READOUT DISPLAY

The 370 CRT has an internal printed graticule and characters (VERT/DIV, HORIZ/DIV, etc.) for internal setups.



GRAT ILLUM controls the brightness of the graticule and printed characters. Figure 2-3 illustrates the screen readout areas. The types of readout information are:

- Setup Readout
- Text
- Error Messages
- Curve/Setup ID
- Average Count

**Setup Readout.** The appropriate readouts for VERT/DIV, PER/STEP, OFFSET, AUX, cursor measurement readouts for vertical and horizontal, and the Beta or gm/div readout are displayed on each column.

When the VIEW mode is selected, readout data that was stored in bubble memory are displayed. When the Step Generator source is selected, the VERT/DIV or HORIZ/DIV readout disappears.

**Text.** To identify the stored curves or front-panel settings, the text message can be written on the top of the CRT graticule area.

No more than 24 characters can be written in the text area. The 370 recognizes lower-case "u" as "micro" and displays the Greek letter " $\mu$ " instead.

Text can be stored with the VIEW curve data or the setup data in the Bubble Memory.

**Error Messages.** The error messages (operation error, I/O error, emergency error, etc.) are displayed on this area (14 characters maximum). This error message disappears after any setting change.

**Curve/Setup ID.** The Curve ID in VIEW or COMPARE display mode shows the VIEW memory index number for the VIEW curve currently displayed. The Curve ID does not appear in NON STORE or STORE display mode.

The Setup ID shows the SETUP memory index number for the current setup that is recalled by pressing RECALL. Any setup change erases the Setup ID.

**Average Count.** The number of counts averaged is displayed in this area when the AVG function is selected and operating.

Figure 2-3 is an example of the CRT readout, where the text message is "TEXT CAN BE WRITTEN HERE", the error message is "BUBBLE NOMEN", and the current setup and view data are recalled from index number 2.

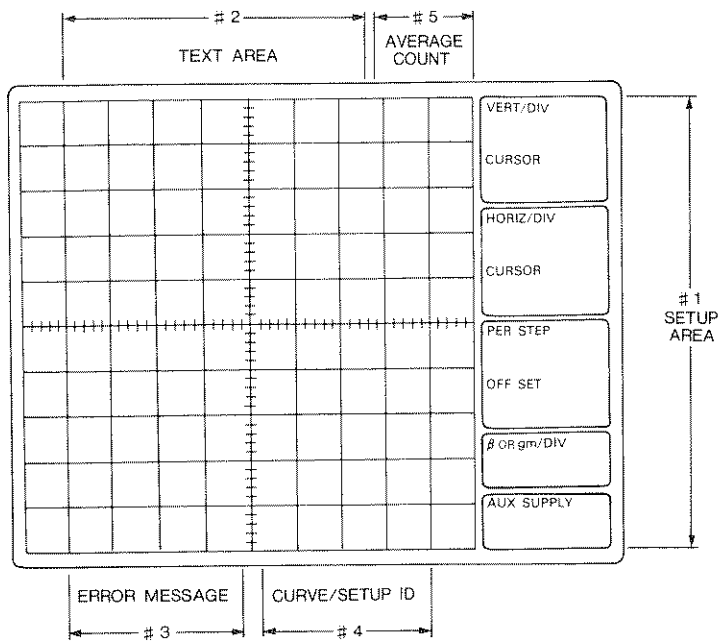


Figure 2-3. CRT readout area.

### GPIB

- (41) USER REQUEST/SRQ ID Sends SRQ over the GPIB to the controller. The LED indicator illuminates until the SRQ is cleared. If FAST/SHIFT is pressed with USER REQUEST/SRQ ID, the instrument firmware version is displayed at the bottom of the crt; for example:

V81.1,F0.02

- (42) RESET TO LOCAL REMOTE ADDR Changes the operating mode of the 370 from remote to local. The instrument is placed in remote operation through the GPIB. When the 370 is under remote control, the REMOTE ADDR LED indicator illuminates. If FAST/SHIFT and RESET TO LOCAL/REMOTE ADDR are pressed simultaneously, the bus address and terminator are displayed at the bottom of the crt screen; for example:

GPIB: LF/EOI,01

## PLOTTER

(43) PLOT/CURVE

When the PLOT/CURVE key is pressed while the display mode is the STORE or VIEW mode and the appropriate plotter is connected to the Plotter Interface, the 370 sends the appropriate HPGL commands to a plotter via the 8-bit parallel plotter interface, and the BUSY indicator turns on. The plotter receives the HPGL command and starts. The BUSY indicator LED turns off and the 370 sends the SRQ status via GPIB after the information is sent. If PLOT/CURVE and FAST/SHIFT are pressed simultaneously, only curves are plotted. Data from CURVE ID, SETUP ID and ERROR MESSAGE are not plotted. If PLOT/CURVE is pressed while sending data to a plotter, nothing occurs. Refer to the Rear Panel discussion for Plotter Interface Connector details.

## BUBBLE MEMORY

(44) Bubble Memory

Provides data storage capability. Sixteen families of curves can be stored or recalled by the ENTER/TEXT, VIEW and COMPARE keys. Sixteen Setups can be stored or recalled by pressing the SAVE or RECALL key. Press eject button to remove cassette.

## CONNECTORS

(45) Adapter  $\Delta$

Allows connection of various test connector adapters.

(46) STEP GEN OUT  $\Delta$

Step Generator signal is available at this terminal.

(47) EXT BASE EMIT  
INPUT  $\Delta$

Allows input of an externally generated signal to either the base terminals or emitter terminals of the DUT as determined by the CONFIGURATION control.

(48) AUX OUT  $\Delta$

Auxiliary Supply Output Terminal.

(49) GROUND

Allows external access to ground reference.

### LEFT-RIGHT-STANDBY

- (50) Left-Right-Standby Selects the device to be tested (left or right). When Left and Right are pressed simultaneously, both devices are selected.

### POWER

- (51) Power Switch Controls instrument power.

### REAR PANEL

- (52) Line Voltage Selector  $\Delta$  Selects either 115 V or 230 V nominal ac power source, either High or Low voltage operation for each line voltage selection.
- (53) GPIB Address  $\Delta$  Selects GPIB address and message terminator.
- (54) GPIB Interface Connector  $\Delta$  Interfaces IEEE-488 Standard Bus Interface Connector.
- (55) Plotter Interface Connector  $\Delta$  Interfaces to a Plotter.

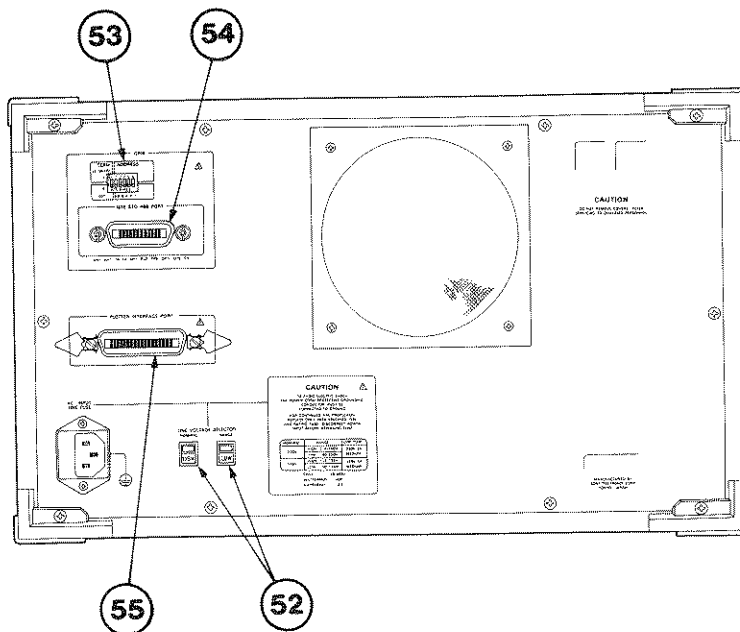


Figure 2-4. Rear-panel controls and connectors.

# SECTION 3

## OPERATING INSTRUCTIONS

---

### GENERAL DESCRIPTION OF INSTRUMENT OPERATION

The 370 is a microprocessor-controlled semiconductor tester that displays and allows measurement of both static and dynamic semiconductor characteristics obtained under simulated operating conditions. The Collector Supply and Step Generator produce voltages and currents that are applied to the device under test. The display amplifiers measure the effects of these applied conditions on the device under test. The result is a family of characteristics curves traced on the crt.

The Collector Supply circuit normally produces a full-wave rectified sine wave that can be either positive- or negative-going. The amplitude of the signal can be varied from 0 to 2000 volts, as determined by the MAX PEAK VOLTS control and the VARIABLE COLLECTOR SUPPLY control. The Collector Supply output is applied to the collector (or equivalent) terminal of the device under test. The Step Generator produces ascending steps of current or voltage at a normal rate of one step per cycle of the Collector Supply. The amount of current or voltage per step is controlled by the AMPLITUDE control and the total number of steps is controlled by the NUMBER OF STEPS control. This Step Generator output can be applied to either the base or the emitter (or equivalent) terminals of the device under test. The display amplifiers are connected to the device under test. These amplifiers measure the effects of the Collector Supply and of the Step Generator on the device under test, amplify the measurements and apply the resulting voltages to the deflection plates of the crt. Display amplifier sensitivity is controlled by the VERTICAL CURRENT/DIV control and the HORIZONTAL VOLTS/DIV control. Figure 3-1 is a block diagram showing the connection of these circuits to the device under test for a typical measurement.

### FIRST TIME OPERATION

When the 370 is received, it is calibrated and should perform within the specification shown in Section 1. The following procedure allows the operator to become familiar with the front panel controls, the function of each, and how each is used in performing semiconductor measurements. This procedure can also be used as a general check of instrument performance. To check instrument operation to the specification in Section 1, refer to the PERFORMANCE CHECK and ADJUSTMENT PROCEDURE (370 Service Manual).

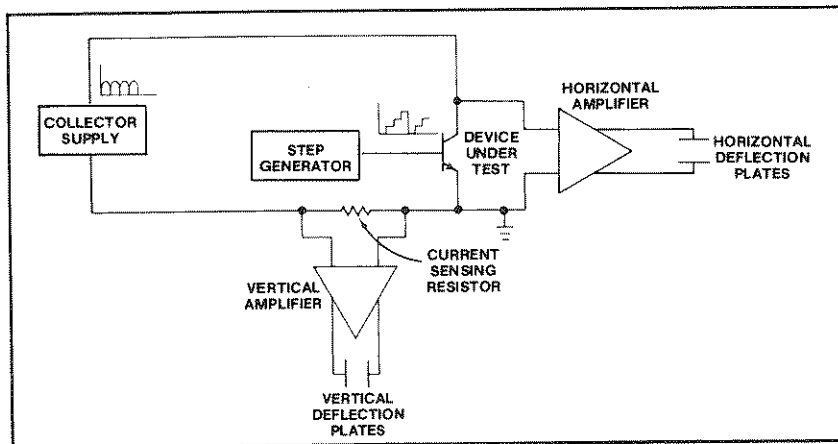


Figure 3-1. Basic 370 Block Diagram.

**NOTE**

*In the following procedure, several figures depict displayed waveforms. When attempting to duplicate the displays while using this procedure, remember that devices differ, and the display depicted herein will likely be different than the one on your 370, using your device-under-test.*

**Power-on Diagnostics**

1. Set the COLLECTOR SUPPLY LOW-HIGH control to LOW. Apply power to the 370. The 370 starts SELFTEST. During SELFTEST, the LED front-panel indicators go through the following sequence:
  - a) The OFF LED of the CURSOR control flashes, and "SELFTEST START" is displayed in the error message area of the crt.
  - b) The . DOT LED indicator, + CROSS LED indicator, the two window reference point indicators of the CURSOR control, and the 0 through 10 indicators of the NUMBER OF STEPS control all flash in succession.
  - c) The 0 through 10 indicators of the NUMBER OF STEPS control flashes in succession more rapidly.

This sequence takes about 10 seconds. If the Power-on Diagnostics detect no error, a "SELFTEST PASS" message is displayed on the error message area of the crt. The 370 then configures to the default setup. Table 3-1 lists the default conditions of the 370.

**TABLE 3-1**  
**Default Setup**

CONTROL	DEFAULT
MEASUREMENT	REPEAT
DISPLAY	
DISPLAY MODE	STORE
HORIZONTAL	COLLECTOR 2 (displayed on the crt READOUT)
ACQ MODE	NORM
MAG	OFF (ZERO OFFSET)
CRT CAL	OFF
INVERT	NOT INVERT (LED OFF)
VERTICAL	COLLECTOR 2A (displayed on the crt READOUT)
BUBBLE MEMORY INDEX	1
STEP GENERATOR	
POLARITY and INVERT	+, NOT INVERTED (LED OFF)
AMPLITUDE	AMPS 50 nA (displayed on the crt READOUT)
STEP MULTI .1X	NOT MULTIPLIED (LED OFF)
OFFSET	ZERO 0.0 nA (displayed on the crt READOUT)
LIMIT	20 mA
PULSE	OFF
NUMBER OF STEPS	5
CURSOR	OFF
PLOTTER	LED OFF
GPIB	USER REQUEST/SRQ LED ON
AUX SUPPLY	ZERO 0.00 V (displayed on the crt READOUT)

**TABLE 3-1 (cont)  
Default Setup**

<b>CONTROL</b>	<b>DEFAULT</b>
<b>COLLECTOR SUPPLY</b>	
MAX PEAK VOLTS	16
MAX PEAK POWER WATTS	0.08
POLARITY	AC
VARIABLE COLLECTOR SUPPLY	0% (LED OFF)
CONFIGURATION	BASE=STEP GEN EMITTER=COMMON

1. The crt controls, LOOPING COMPENSATION control, HIGH-LOW control and LEFT-RIGHT-STANDBY control are not set at power-up. (If powered is applied and LOW-HIGH is at HIGH, the MAX PEAK VOLTS 2000 V indicator illuminates, and all other controls are set to the default condition.)
2. Allow the instrument to warm up for a few minutes. The instrument should operate within specified tolerances after five minutes of operation.
3. Take a new bubble cassette out of its plastic case. If the bubble cassette is write protected, move the write protect key to the write-enable position (see Figure 3-2). Open the 370 bubble cassette door. Insert the bubble to the cassette holder, notched edge first, labeled side facing up (see Figure 3-3) until a click is heard and the eject button returns.
4. Press SAVE to store the default settings in memory location #1. These are used as a starting point for each major step throughout the procedure, so that the reader does not lose his place.

**CRT and Readout Controls**

5. Turn the NON STORE/STORE INTENSITY control clockwise until a spot appears at the lower left corner of the crt graticule. To avoid burning the crt phosphor, adjust the NON STORE/STORE INTENSITY control until the spot is just visible.
6. Turn the READOUT CURSOR INTENSITY control throughout its range. Note that the readout becomes brighter as the control is turned clockwise. Set the control for the desired readout brightness. The initial displayed control settings should be: 2A VERT/DIV, 2 V HORIZ/DIV, 50 nA per step, 0.0 nA OFFSET, 40M B OR gm/DIV, and 0.00 V AUX SUPPLY.
7. Turn the FOCUS control throughout its range. Adjust the FOCUS control for a well-defined spot.



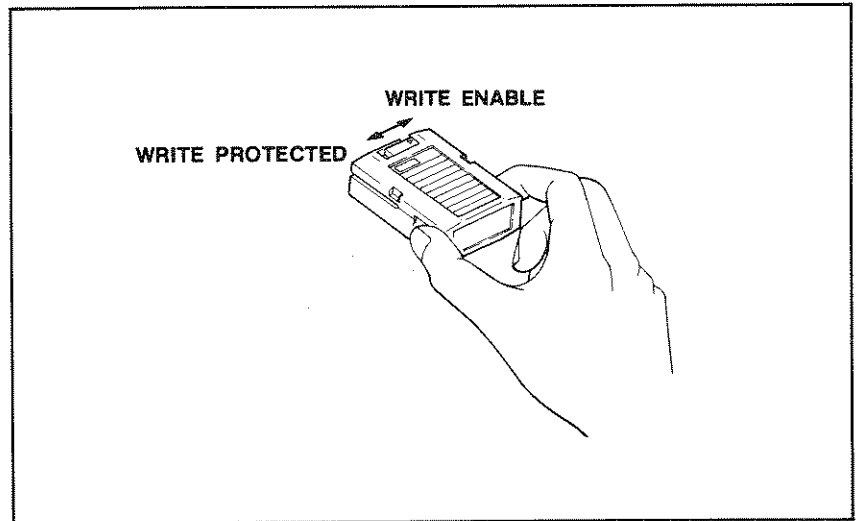


Figure 3-2. Bubble cassette write-protect key.

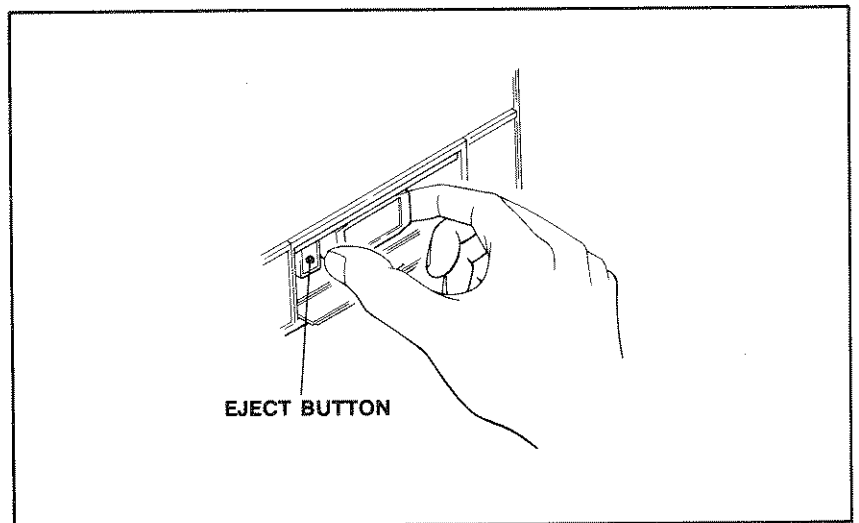


Figure 3-3. Inserting a bubble cassette.

## Operating Instructions—370

---

8. Turn the ILLUM control throughout its range. Note that the graticule lines and the readout titles illuminate as the control is turned clockwise. Set the control for desired illumination.

### Positioning Controls

9. Set the DISPLAY CRT CAL control to the ZERO CHK position. Turn the vertical POSITION control throughout its range. Set the control so that the spot coincides vertically with the lower left corner of the graticule.
10. Repeat step 9, using the horizontal POSITION control, until the spot coincides horizontally with the lower left corner of the graticule.
11. Set the CRT CAL control to the CAL CHK position and check that the spot coincides with the upper right corner of the graticule. Then set the CRT CAL control to the OFF position.
12. Set the COLLECTOR SUPPLY POLARITY control to - (full wave). Note that the spot moves to the upper right corner of the graticule.
13. Set the COLLECTOR SUPPLY POLARITY control to + (full wave). Note that the spot returns to the lower left corner of the graticule.

### Vertical and Horizontal Sensitivity

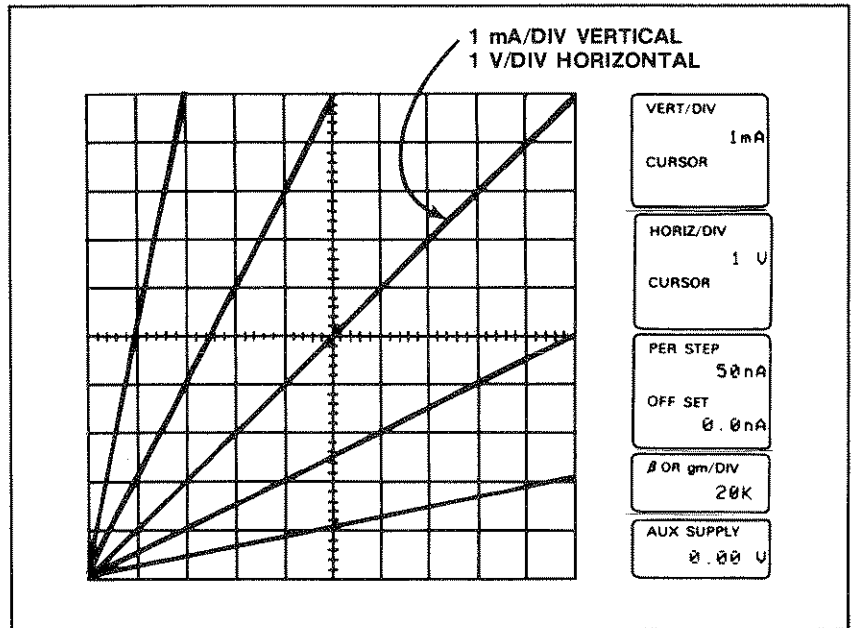
14. Install the diode adapter (A1005) into the right-hand set of adapter connectors.
15. Install a 1 k, 1/2 watt resistor in the diode adapter.
16. Reset the following 370 controls:

VERTICAL	1 mA
HORIZONTAL	1 V

### NOTE

*To enable the collector supply, make certain that the plastic protective cover is installed and the lid is completely closed.*

17. Set the LEFT-RIGHT-STANDBY control to RIGHT and turn the VARIABLE COLLECTOR SUPPLY control until a trace appears diagonally across the crt. Adjust the trace intensity for a visible trace.
18. Rotate the VERTICAL control clockwise and note that as the vertical deflection factor decreases, the line slope increases (see Figure 3-4). Turn the VERTICAL control counterclockwise from the 1 mA position and note the decreasing slope. Also note that the VERT/DIV readout changes in accordance with the position of the VERTICAL control. Reset the VERTICAL control to 1 mA.

Figure 3-4. Display of  $I$  vs.  $E$  for 1 k resistor.

19. Rotate the HORIZONTAL control clockwise and note that as the horizontal deflection factor increases, the line slope decreases (see Figure 3-4). Turn the HORIZONTAL control counterclockwise from the 1 V position and note the change in slope. Also note that the HORIZ/DIV readout changes as the HORIZONTAL control is rotated. Reset the HORIZONTAL control to 1 V.
20. Set the CRT CAL control to ZERO CHK. Note that the diagonal trace reduces to a spot in the lower left corner of the graticule. This spot denotes the point of zero deflection of the vertical and horizontal amplifiers. Set the control to the CAL CHK position. Note that the diagonal trace reduces to a spot in the upper right corner of the graticule. The position of this spot indicates 10 divisions of vertical and horizontal deflection. Set the control to OFF.
21. Press DISPLAY INVERT (red LED turns on) and rotate the COLLECTOR SUPPLY VARIABLE control first counterclockwise, then clockwise. Note that the display is now inverted and originates in the upper right corner of the graticule. Press the DISPLAY INVERT button (red LED turns off).

**WARNING**

*Up to 2000 V may appear at the front-panel collector terminals. To avoid injury or equipment damage, do not remove the protective cover or defeat the protective interlock switch.*

*Prolonged use at the 50w and 220w Power ranges can cause high temperatures that may damage the instrument or the DUT and cause injury if the Protective Cover or DUT are touched. Test time for these power settings should be limited to:*

*5 min. for 220w range  
9 min. for 50w range*

**Collector Supply**

22. Reset the MAX PEAK VOLTS control to 80, then 400. Note that when the LOW-HIGH control is on LOW, you cannot select 2000 V, but when the LOW-HIGH selector is set to HIGH, only the 2000 V range is available (2000 LED turns on), and the setting of the MAX PEAK VOLTS control has no effect.
23. Set the HIGH-LOW selector to LOW, the MAX PEAK VOLTS control to 16, and turn the COLLECTOR SUPPLY VARIABLE control until the diagonal trace reaches graticule center. Set the MAX PEAK POWER WATTS to 220. Note that the diagonal trace lengthens as the wattage is increased. Refer to the SERIES RESISTORS TABLE denoted on the front panel. Note that the series resistor decreases as the maximum peak power is increased.
24. Press RECALL to reset the 370 controls back to the reference settings mentioned earlier, then reset the following controls:

HORIZONTAL	100 mV COLLECTOR
VERTICAL	1 mA
LEFT-RIGHT-STANDBY	STANDBY
25. Open the lid and replace the resistor in the diode adapter with a silicon diode. Connect the diode cathode to the adapter emitter terminal. Close the lid.
26. Set the LEFT-RIGHT-STANDBY control to RIGHT and turn the COLLECTOR SUPPLY VARIABLE control clockwise. Note the display of the forward voltage characteristic of the diode. (see Figure 3-5).
27. Set the COLLECTOR SUPPLY POLARITY control to - (full wave) and rotate the COLLECTOR SUPPLY VARIABLE control clockwise. Note the display of the reverse voltage characteristic of the diode (see Figure 3-6).

28. Set the COLLECTOR SUPPLY POLARITY control to +DC, adjust the trace intensity, and turn the COLLECTOR SUPPLY VARIABLE control clockwise. Note that the display of the forward voltage diode characteristic is now a spot, which indicates the current conducted by the diode and the voltage across the diode.
29. Turn the VARIABLE COLLECTOR SUPPLY control counterclockwise. Note that the spot traces out the diode characteristic curve.

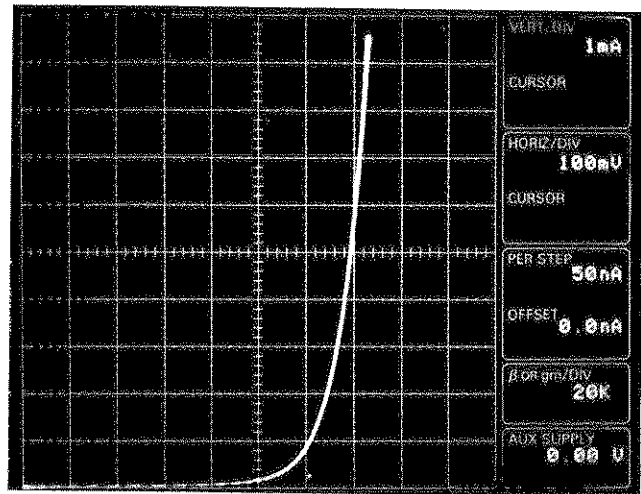


Figure 3-5. Display of signal diode forward-bias characteristics.

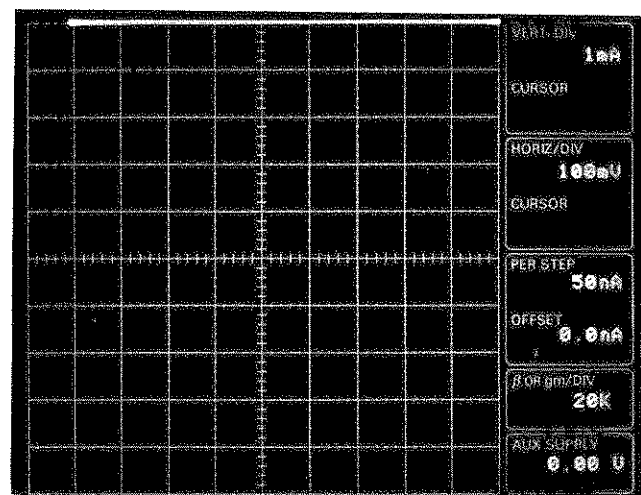


Figure 3-6. Display of signal diode reverse-bias characteristics.

### Operating Instructions—370

30. Reduce the intensity, then reset the following controls:

LEFT-RIGHT-STANDBY	LEFT
DISPLAY MODE	NON STORE
VERTICAL	1 $\mu$ A
HORIZONTAL	2 V
COLLECTOR SUPPLY POLARITY	AC

31. Turn the COLLECTOR SUPPLY VARIABLE control to 100%, adjust the trace intensity for a visible display, and adjust the LOOPING COMPENSATION control for minimum trace width (see Figure 3-7). Use the TRACE ROTATION control to align the trace with the horizontal graticule line.

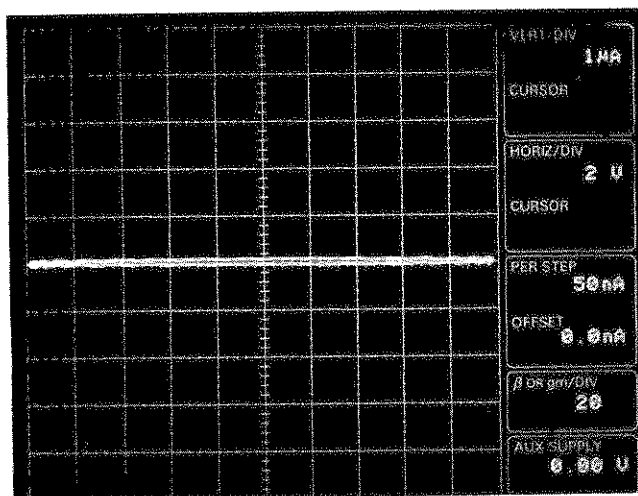


Figure 3-7. Adjustment of LOOPING COMPENSATION control.

32. Press RECALL, reduce the display intensity, then reset the following controls:

VERTICAL	2 mA
POLARITY:	AC
LEFT-RIGHT-STANDBY:	STANDBY

33. Open the lid and replace the diode in the adapter with an 8-volt Zener diode. Connect the Zener diode cathode to the emitter terminal. Close the lid.

34. Set the LEFT-RIGHT-STANDBY control to RIGHT and turn the COLLECTOR SUPPLY VARIABLE control clockwise. Note that the display shows both the forward and reverse characteristics of the Zener diode (see Figure 3-8).

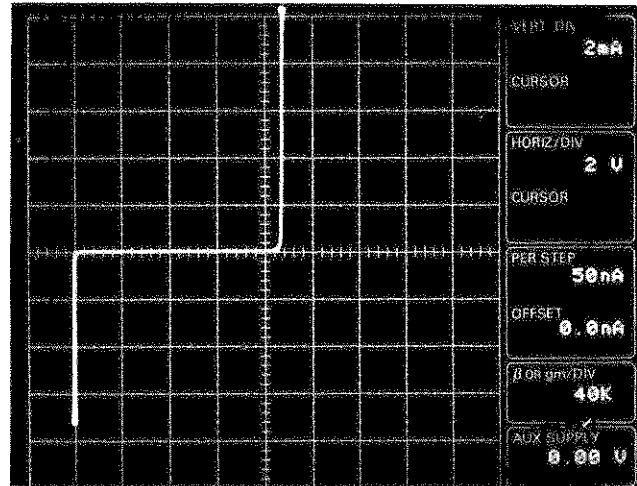


Figure 3-8. Display of Zener diode I vs. E characteristic.

#### Display Offset and Magnifier

35. Set the DISPLAY MAG MODE control to X1 HORIZ and press MAG OFFSET INCR until the Zener breakdown portion of the display is within 0.5 division of the center vertical line. Multiply the divisions of offset (4) by the HORIZ/DIV readout (2 V) to calculate the approximate breakdown voltage of the Zener diode. For the diode in the example shown in Figure 3-8, the approximate Zener breakdown voltage is 4 div times 2 V/div = 8 volts.
36. Set the MAG MODE control to X10 HORIZ position. Note that the HORIZ/DIV readout value has changed to indicate the 10 times multiplication. By expanding the scale, a more precise measurement can be made. Set the CURSOR MODE control to + CROSS and position the cross hairs to the Zener breakdown part of the display. The breakdown voltage and current are displayed on the CURSOR READOUT section of the crt.

### Step Generator

37. Press RECALL, reduce the intensity, and reset the following controls:

VERTICAL	1 mA
DISPLAY	NON STORE
HORIZONTAL:	1 V COLLECTOR
NUMBER OF STEPS:	1
LEFT-RIGHT-STANDBY:	STANDBY

38. Remove the diode adapter (A1005) and replace it with a transistor adapter (A1007).
39. Place an NPN silicon transistor into the right transistor test socket of the transistor adapter.
40. Set the LEFT-RIGHT-STANDBY control to RIGHT and turn the VARIABLE COLLECTOR SUPPLY clockwise until the peak collector-emitter voltage is about 10 volts.
41. Turn the STEP/OFFSET AMPLITUDE control clockwise until a step waveform appears on the crt. Note that the DUT collector current is proportional to the step waveform amplitude. Set the STEP/OFFSET AMPLITUDE for a 0.5 to 1-division step waveform.
42. Be sure the PEAK POWER WATTS control is set within the power dissipation rating of the transistor under test. Set the NUMBER OF STEPS control to 10. Note the display of collector current vs collector-emitter voltage for ten different values of base current (see Figure 3-9A).
43. Set the HORIZONTAL control counterclockwise to 100 mV BASE. Note the display of the collector current vs. base-emitter voltage for ten different values of base current (see Figure 3-9B).
44. Set the VERTICAL control counterclockwise to STEP GEN and the HORIZONTAL control clockwise to 1 V COLLECTOR. Note the display of the base current (one step per vertical division) vs the collector-emitter voltage (see Figure 3-10A).
45. Set the HORIZONTAL control counterclockwise to 100 mV Base. Note the display of base current, one step per vertical division, vs base-emitter voltage (see Figure 3-10B).
46. Set the VERTICAL control to 1 mA and the HORIZONTAL control to STEP GEN. Note the display of collector current vs. base-current, one step per horizontal division (see Figure 3-11). Set the HORIZONTAL control to 1 V collector.



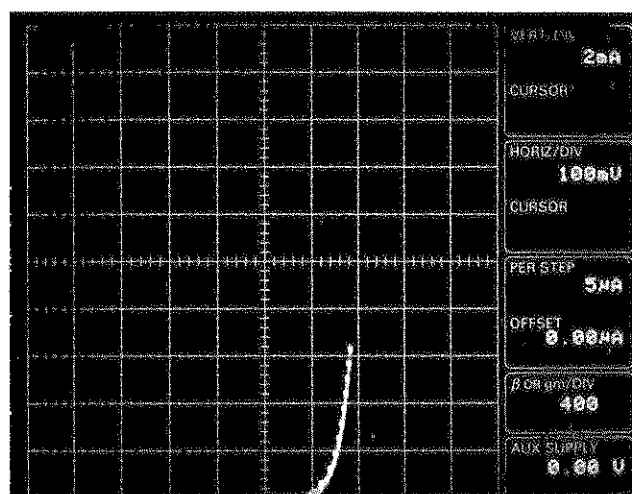
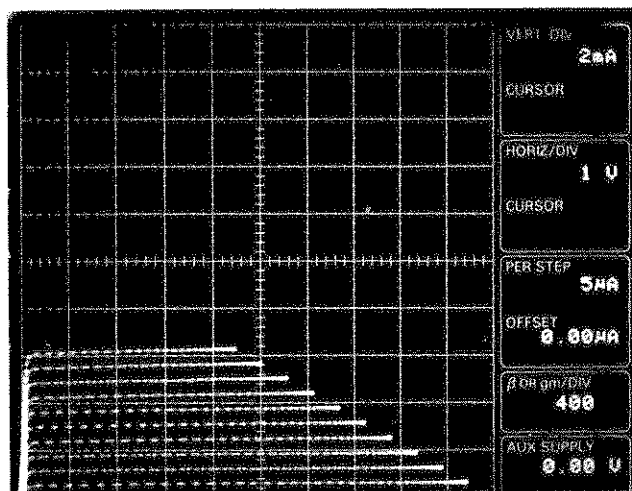


Figure 3-9. (A) IC vs VCE for 10 steps of base current at 5 uA per step. (B) IC vs. VBE for 10 steps of base current at 5 uA per step.

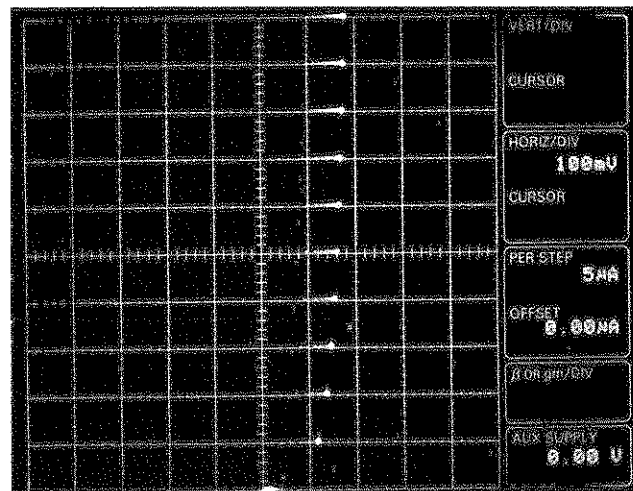
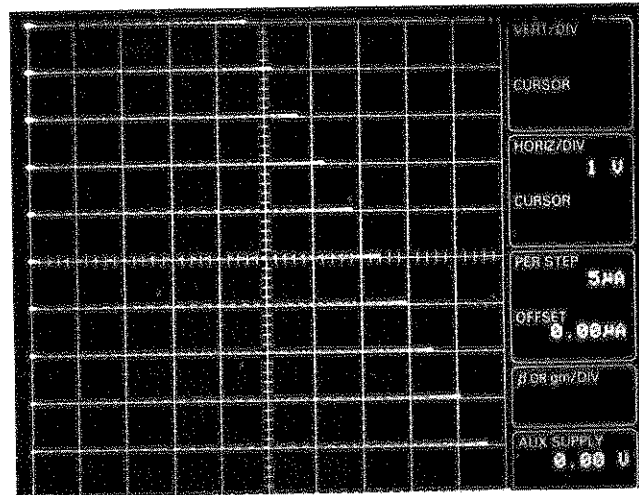


Figure 3-10. (A) IB vs. VCE, Ib @ 5 uA per division; (B) IB vs. VBE, IB @ 5 uA per division.

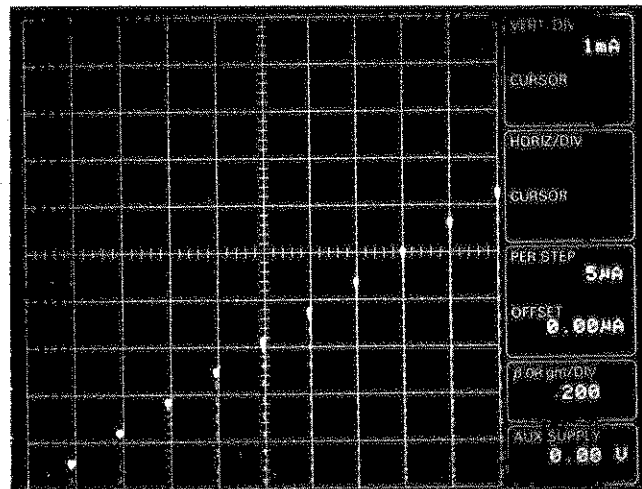


Figure 3-11. IC vs. IB, IB @ 5 uA per division.

47. Press NON STORE DISPLAY and MEASUREMENT SINGLE. Note that each time the SINGLE button is pressed, a single family of characteristic curves is displayed.

48. Reset the following controls:

DISPLAY	STORE
MEASUREMENT:	REPEAT
PULSE:	LONG

Note that the collector supply is in the DC mode and that the steps are displayed as a diagonal array of dots on the crt screen. Readjustment of the display intensity may be necessary.

#### NOTE

*The following five steps require the optional FET adapter. If you do not have an adapter on hand, either proceed to step 54, or insert a long-lead FET into the transistor adapter with the source, gate, and drain leads corresponding to the emitter, base and collector leads.*

## Operating Instructions—370

49. Set the 370 LEFT-RIGHT-STANDBY control to STANDBY and remove the transistor adapter. (Leave the transistor in the adapter). Install the A1009 FET adapter (optional) in the front-panel jacks and place an N-channel junction FET into the right test socket of the adapter. If you have no A1009 FET adapter, use the A1007 adaptor, inserting D, S, and G leads into C, B, and E sockets, respectively.
50. Press RECALL and reset the following controls:
- |                       |                 |
|-----------------------|-----------------|
| INTENSITY:            | Visible Display |
| DISPLAY               | NON STORE       |
| VERTICAL:             | 5 mA            |
| STEP/OFFSET AMPLITUDE | 100 mV          |
| PULSE:                | OFF             |
51. Set the LEFT-RIGHT-STANDBY control to RIGHT and turn the VARIABLE COLLECTOR SUPPLY control slowly clockwise. Note the display of drain current vs drain-source voltage with voltage steps of 0.1 V/step applied to the gate (see Figure 3-12). Since the steps applied to the gate are positive-going, the curves displayed represent enhancement mode operation of the FET. (Set number of steps to zero to display the curve obtained with zero volts applied to the gate, then set number of steps to 10.)

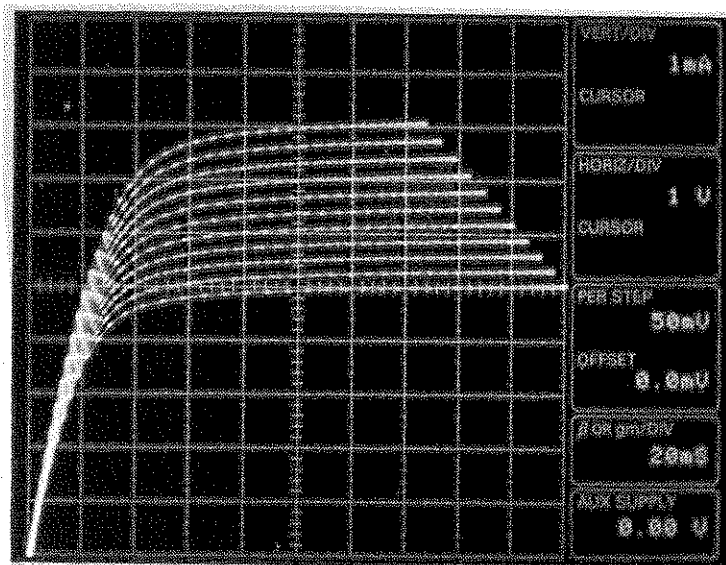


Figure 3-12. Display of FET common-source characteristic curves:  $I_D$  vs  $V_{DS}$  for 10 steps of gate voltage at 0.05 volt/step.

52. Press the STEP GENERATOR POLARITY INVERT button (red LED turns on) and note the display of the depletion mode of FET operation. Press the STEP GENERATOR POLARITY INVERT button for a normal display.

53. Set the 370 LEFT-RIGHT-STANDBY control to STANDBY. Remove the FET test adapter and replace it with the A1007 transistor test adapter (with the transistor still installed.) Close the lid.

54. Press RECALL and reset the following controls:

VERTICAL	1 mA
STEP/OFFSET AMPLITUDE	100 mV
NUMBER OF STEPS	1
LEFT-RIGHT-STANDBY	RIGHT

55. Turn the COLLECTOR SUPPLY VARIABLE control clockwise until the trace reaches the center vertical graticule line. Press and hold the OFFSET AID button until a step is just visible on the crt, and note the offset value (approximately 500 mV). The offset readout indicates the base-to-emitter turn-on voltage of the transistor.

**Configuration**

56. Press RECALL and reset the following controls:

VERTICAL	1 mA
HORIZONTAL	1 V
STEP/OFFSET AMPLITUDE:	500 $\mu$ A
NUMBER OF STEPS:	10

57. Turn the COLLECTOR SUPPLY VARIABLE control clockwise for a full-length trace, then adjust the AMPLITUDE control to display the characteristic curves with the emitter grounded and current steps applied to the base (see Figure 3-13A).

58. Set the LEFT-RIGHT-STANDBY control to STANDBY. Connect a patch cord with banana plugs on each end between the STEP GEN OUT connector and the EXT BASE or EMITTER IN connector.

59. Reset the following controls:

LEFT-OFF-RIGHT	RIGHT
CONFIGURATION	BASE = OPEN (EXT) EMITTER = COMMON

Note a display similar to that seen in Step 57. Remove the patch cord.

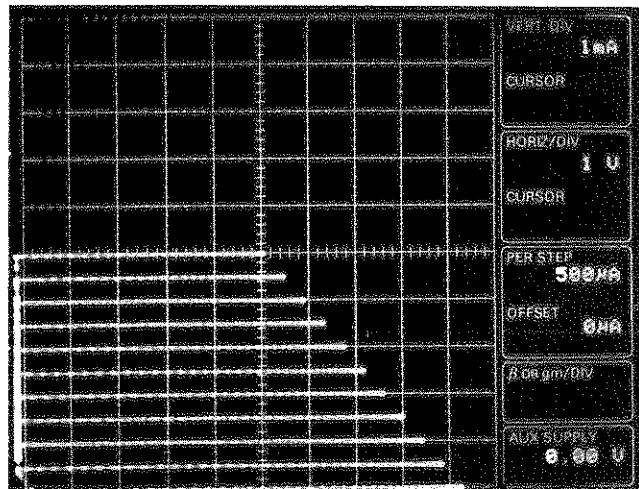
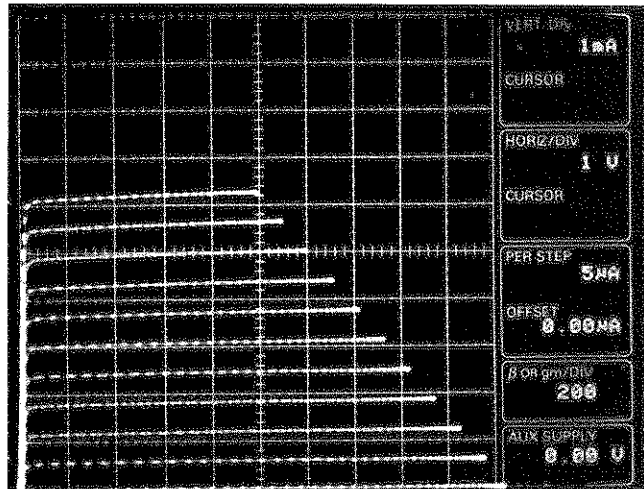


Figure 3-13. (A) CONFIGURATION control set to BASE STEP GEN (NORM). (B) CONFIGURATION control set to EMITTER STEP GEN.

60. Reset the following controls:

COLLECTOR SUPPLY POLARITY	+ LEAKAGE
VERTICAL	1 nA EMITTER
HORIZONTAL	2 V

61. Turn the VARIABLE COLLECTOR SUPPLY control clockwise and note the emitter leakage current display with the base terminal open.

62. Set the CONFIGURATION control to BASE = SHORT (EMITTER), EMITTER = COMMON and note the emitter leakage current display with the base terminal shorted to ground.

63. Press RECALL and reset the following controls:

VERTICAL	1 mA
STEP/OFFSET AMPLITUDE	500 $\mu$ A
COLLECTOR SUPPLY POLARITY	+ (steps)
CONFIGURATION	BASE = COMMON, EMITTER = STEP GEN

Turn the COLLECTOR SUPPLY VARIABLE control clockwise and note the display of collector current vs collector-emitter voltage with current steps applied to the transistor emitter (see Figure 3-13B).

64. Reset the following controls:

MEASUREMENT	SINGLE
CONFIGURATION	BASE COMMON, EMITTER OPEN (EXT)

Reconnect the patch cord between the STEP GEN OUT connector and the EXT BASE OR EMITTER connector.

65. Set MEASUREMENT to REPEAT and note a display similar to that seen in step 63.

66. Set the LEFT-RIGHT-STANDBY control to STANDBY. Remove the patch cord.

### Digital Storage and Bubble Memory

67. Press RECALL and reset the following controls:

VERTICAL	1 mA
HORIZONTAL	1 V
MEMORY	2
STEP/OFFSET AMPLITUDE	10 $\mu$ A

68. Set the LEFT-RIGHT-STANDBY control to RIGHT. Turn the VARIABLE COLLECTOR SUPPLY clockwise to display a family of curves.

69. Press STORE. Digitally stored curves should be displayed on the crt (see Figure 3-14).

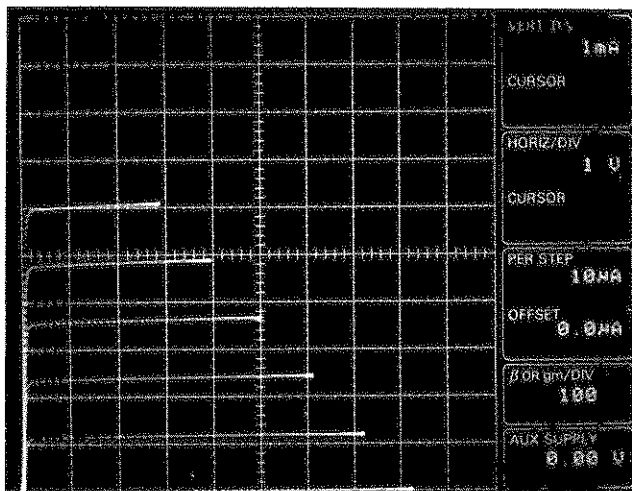


Figure 3-14. Digitally stored curves.

70. Push ENTER. The MEMORY BUSY indicator flashes for a short period, indicating that the curves are being written into the bubble cassette. (Pressing the Enter button while in NON STORE mode displays "OPERATION ERR" message at the error message region of the crt. If you want to store the SETUPS, then press the SAVE button (the BUSY indicator blinks). Remember the memory location number of the bubble memory you have written into (2 in this case).
71. Set the LEFT-RIGHT-STANDBY control to STANDBY, turn the power off, then turn it on. This resets the 370 to the default status, and the default READOUT is displayed (Refer to Step 1).



72. Select the previous memory ID (2) with the MEMORY control. Press RECALL to set the 370 to the setup of Step 70. (The SETUP ID "SET 02" is displayed at the bottom center of the crt.) Press the VIEW button. The VIEW LED turns on and the curves of Step 69 are displayed. (The CURVE ID "CRVXX" is displayed at the bottom right of the crt.) Readjustment of the VIEW intensity control may be needed for the VIEW curves. See Figure 3-15.

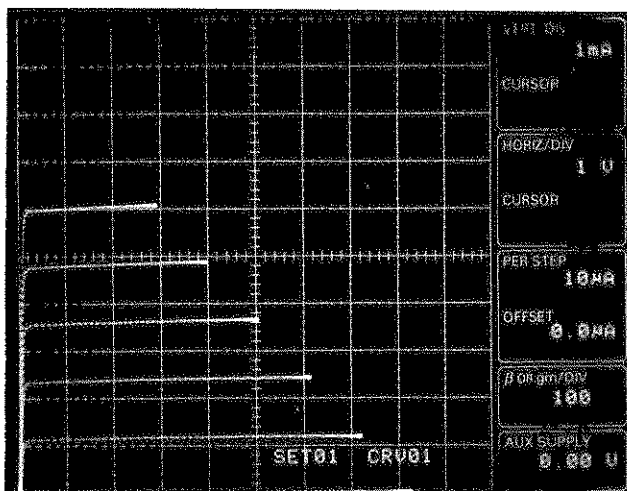


Figure 3-15. VIEW curve display.

73. To add text to the stored curves or the front panel settings, simultaneously press ENTER and FAST/SHIFT to enter the text edit mode. A "TEXT EDIT MODE" message is displayed in the ERROR MESSAGE area of the crt and the EDIT CURSOR is displayed at the TEXT area (top) of the crt. In this mode, use the VERTICAL control to select the characters, and the HORIZ control to position the EDIT CURSOR. Press both ENTER and FAST/SHIFT to exit the Text Edit Mode. Press ENTER or SAVE to store the text. Figure 3-16 shows the TEXT EDIT MODE.
74. Set the DISPLAY MODE control to COMPARE and LEFT-RIGHT-STANDBY control to RIGHT. Both the digitally stored curves and restored (from the bubble) curves are displayed. Confirm and compare both curves by changing a setting (for example, the VARIABLE COLLECTOR SUPPLY control).

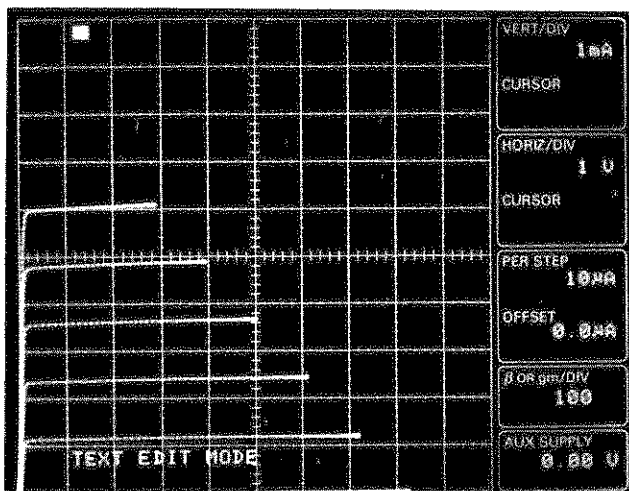


Figure 3-16. Text edit mode.

**ACQ Mode (STORE Mode)**

75. Press RECALL, select MEMORY 1, and reset the following controls:

HORIZ	100 mV
VERT	1 mA
NUMBER OF STEPS	1
STEP AMPLITUDE	100 $\mu$ A
LEFT-RIGHT-STANDBY:	STANDBY
ACQ MODE:	HORIZ ENV
DISPLAY MODE:	STORE

76. Set the LEFT-RIGHT-STANDBY control to RIGHT and turn the VARIABLE COLLECTOR SUPPLY clockwise. Note the envelope display of the collector current vs base-emitter voltage for a value of base current. The display shows a horizontal min/max envelope of the storage display (see Figure 3-17). If you set the ACQ MODE control to VERT ENV, a vertical envelope is displayed on the crt.

77. Set the ACQ MODE control to 32 AVG. The averaging count (this case, 1 through 32) is displayed at the upper right corner of the crt (see Figure 3-18), and the acquired curves are averaged.

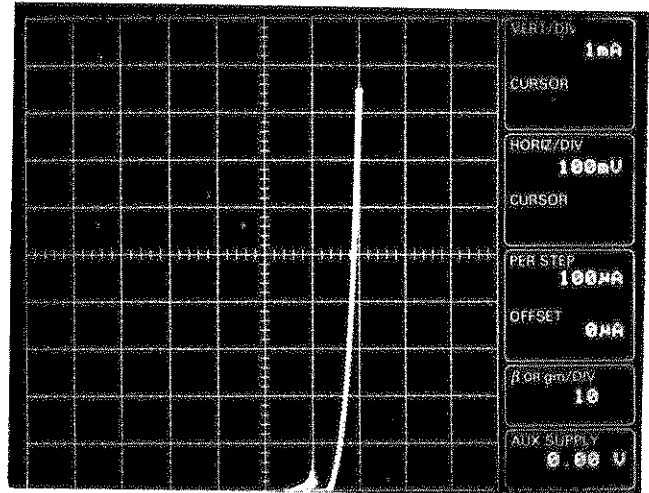


Figure 3-17. Stored envelope display.

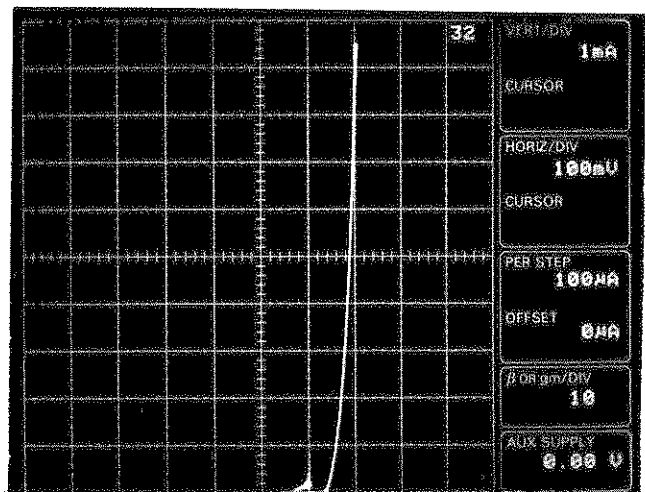


Figure 3-18. Averaging display.

## Operating Instructions—370

---

78. Set the MEMORY control to display 2. Press RECALL. Characteristic curves similar to step 69 are displayed.

### Cursors

79. Set the CURSOR MODE control to DOT. A bright dot appears at the lower left corner of the graticule (0 VERT/div, 0 HORIZ/div position of the stored curve). The dot vertical and horizontal position are displayed on the CURSOR READOUT section of the crt.
80. Press the up or right arrow. The dot should move up on the stored curve. Press the down or left arrow. The dot should move down on the stored curve. You can hasten dot movement by pressing both the FAST/SHIFT button and the arrow key. The dot position can be monitored with the CURSOR READOUT display.
81. Set the CURSOR MODE control to CROSS. A crosshair should be displayed on the crt. The arrows of the CURSOR button indicate the direction of crosshair movement. You can use the FAST/SHIFT button to hasten crosshair movement. The position of the crosshair intersection is indicated by the CURSOR READOUT display. Press the arrow keys to match the CURSOR READOUT with the dot CURSOR READOUT. By switching the CURSOR mode control to DOT, you can see that the dot and crosshair intersections overlap.
82. Set the CURSOR mode control to window (dot lower left). A box appears at the edge of the graticule. Press the right or up-arrow button to move the left or bottom edge of the box. You can press both buttons at once. The position of the lower left corner of the box can be monitored by the CURSOR READOUT.

Set the CURSOR MODE control to window (upper right) and press the left or down-arrow button to move the right or top edge of the box. The position of the upper right corner of the box can also be monitored by the CURSOR READOUT. You can use the FAST/SHIFT button to hasten the box-size transformation. Use the four arrow buttons to set a window of the desired size and position.

### Plotter Output

83. If you have a Plotter with an interface that is based on Centronics specifications and accepts HPGL commands, connect the plotter interface cable to the 370 plotter interface connector on the rear panel. Then press the Plotter button. Note that the 370 plots the crt displays, together with the graticule lines, setup readouts, and the titles. Note also that the 370 operates normally during the plotting.

This completes the first-time operation.

## GENERAL OPERATING INFORMATION

### CRT

The 370 crt has a permanently-etched, 10 x 10 internal graticule. Illumination of the graticule is controlled by the GRAT ILLUM control. A protective shield for the crt is fitted between the bezel and the crt.

A blue filter is provided to improve the contrast of the display under high ambient lighting conditions.

### Readout

The readout, located on the right of the graticule and referred to as the Setup Readout, consists of the alphanumeric displays and titles for each. The alphanumeric displays show numbers and units (e.g., 5 mA, 2 V), the values of which are a function of front-panel or GPIB-programmed control settings. The titles are words etched to the crt. These words indicate the characteristics of the crt display to which each alphanumeric display is related (e.g., VERT/DIV, PER STEP, etc.). Illumination of the alphanumeric displays is controlled by the READOUT CURSOR control, and illumination of the titles is controlled by the GRAT ILLUM control. The 370 crt has four other readouts: TEXT, ERROR MESSAGE, CURVE/SETUP ID, and AVERAGE COUNT. Illumination of these readout displays is controlled by the READOUT CURSOR control.

### Intensity

The NON STORE/STORE intensity control regulates the intensity of the non store or store display on the crt. This control should be adjusted so that the display is easily visible but not overly bright. Readjustment may be required for different displays.

### CAUTION

*Use particular care when displaying a spot. A high-intensity spot may burn the crt phosphor and cause permanent damage to the crt.*

The intensity of the VIEW MODE display is controlled by the VIEW intensity control, and the intensity of the readouts and the cursors (except the dot) is controlled by the READOUT CURSOR intensity control. The dot intensity cannot be adjusted independently.

### Focus

The focus of the crt display is controlled by the FOCUS control. This control should be adjusted for optimum display definition.

### Positioning

The vertical and horizontal position of the display on the graticule is regulated by five controls: the vertical and horizontal POSITION controls, the POLARITY switch, the MAG control INVERT button, and the CRT CAL switch.

The position controls provide fine vertical and horizontal positioning of the display.

The POLARITY control positions the zero signal point of a display (located by setting the CRT CAL control to ZERO CHK) to a position convenient for making measurements on an NPN device, a PNP device or when making an AC measurement.

The MAG controls provide calibrated vertical or horizontal offset (or positioning) of the display. These controls may be used either to make a measurement or to position magnified portions of a display on the graticule. The MAG MODE control determines whether the display will be offset vertically or horizontally; the MAG OFFSET buttons provide the offset. Under unmagnified conditions, approximately 10 divisions of offset are available. When the MAG MODE control is set to one of its X10 positions, approximately 100 divisions of offset are available.

When making a measurement using MAG, the graticule becomes a window. As the MAG OFFSET buttons are pressed, the window moves either vertically or horizontally along the display.

Setting the CRT CAL control to ZERO allows positioning the zero reference point on the graticule. Under normal operating conditions (MAG MODE control set to OFF), when the CRT CAL control is set to ZERO CHK, a zero reference spot appears on the graticule. This spot indicates the point where zero signal is being measured by the vertical and horizontal display amplifiers. With CRT CAL set to ZERO, the positioning controls place the spot at a point on the graticule that makes measurement convenient. To ensure the accuracy of the MAG OFFSET buttons settings, the zero reference spot should be adjusted (using the positioning controls) to the appropriate graticule for the offset being used.

Setting the CRT CAL control to the CAL CHK Position allows checking the calibration of the display amplifiers. Under normal operating conditions (MAG MODE control OFF), when the CRT CAL control is set to CAL CHECK, a calibration reference spot appears on the crt. This spot represents a signal applied to both the vertical and the horizontal display amplifiers that should cause 10 divisions of vertical and horizontal deflection on the graticule. If the position of this spot is compared with the position of the spot obtained when the CRT CAL control is set to ZERO, the accuracy of calibration of the display amplifiers can be determined.

The DISPLAY INVERT button provides a means of inverting the crt display. When the DISPLAY INVERT button is pushed, the display amplifier inputs are reversed, causing the display to be vertically and horizontally inverted about the center of the graticule.

### Vertical Measurement and Deflection Factor

In the vertical dimension, the display on the crt measures either collector current (IC), emitter current (IE), or the output of the Step Generator. The COLLECTOR SUPPLY POLARITY control and the VERTICAL CURRENT/DIV control determine which of these measurements are made.

The Vertical deflection factor of the crt display is controlled by the VERTICAL switch, the MAG MODE control and the POLARITY switch. The VERT/DIV readout crt combines the effect of these three controls to produce the vertical deflection factor.

Under normal operating conditions, with the POLARITY control set to +(full-wave), AC, or -(full-wave) and the MAG MODE control set to OFF, collector current is measured vertically, and the VERTICAL control determines the vertical sensitivity of the display.

When measuring collector current, the VERTICAL control provides deflection factors (unmagnified) ranging from 1  $\mu$ A/division to 2 A/division. The vertical deflection factor is indicated by the VERT/DIV readout.

When COLLECTOR SUPPLY POLARITY is set to +LEAKAGE or -LEAKAGE, emitter current is displayed on the vertical axis. Additionally, the vertical sensitivity increases by 1000 times. (The vertical deflection factor is indicated by the VERT/DIV readout.) When POLARITY is set to LEAKAGE, the output of the Collector Supply is dc voltage, like that obtained when the POLARITY control is set to +DC or -DC, rather than a voltage sweep.

When the VERTICAL control is set to STEP GEN, steps indicating the Step Generator output are displayed vertically. The vertical display shows one step per division. The amplitude of each step, as shown by the PER STEP readout, determines the vertical deflection factor.

The vertical sensitivity can be increased by 10 times for any of the previously mentioned measurements by setting the MAG MODE control to VERT X10. The magnified vertical deflection factor is indicated by the VERT/DIV readout1.

### Horizontal Measurement and Deflection Factor

In the horizontal dimension, the display on the crt measures one of the following:

1. Collector to emitter voltage (VCE).
2. Collector to base voltage (VCB).
3. Base to emitter voltage (VBE).
4. Emitter to base voltage (VEB).
5. Step Generator output.

The HORIZONTAL VOLTS/DIV switch, the CONFIGURATION control and the vertical parameter determine the horizontal parameter.

1. The VERT/DIV readout does not indicate deflection factors less than 100 pA/division.

## Operating Instructions—370

The horizontal deflection factor of the display on the crt is controlled by the HORIZONTAL control and the MAG MODE switch. The HORIZ/DIV readout of the crt indicates the horizontal deflection factor.

When collector current is the vertical measurement parameter (the CONFIGURATION control is set to the EMITTER COMMON group and the MAG MODE control is at OFF), VCE or VBE is displayed on the horizontal axis. To measure VCE, the HORIZONTAL control must be set within the COLLECTOR range that has deflection factors between 50 mV/division and 500 V/division. To measure VBE, the HORIZONTAL control must be set on a BASE/EMITTER range that has deflection factors between 50 mV/division and 2 V/division. In both cases, the horizontal deflection factors are indicated by the HORIZ/DIV readout.

When the CONFIGURATION control is set to the BASE COMMON group, the horizontal display measures collector to base voltage (VCB) with the HORIZONTAL control in the COLLECTOR range, or emitter to base voltage (VEB) with the HORIZONTAL control in the BASE range. It should be noted that VEB in this case does not indicate a measurement of the emitter-base voltage under a reverse-biased condition. It is a measurement of the forward-biased base-emitter voltage with the horizontal sensing leads reversed.

When emitter current is being measured by the vertical display, the only significant measurements made by the horizontal display are VCE and VCB. When making these measurements, the HORIZONTAL control should be set within the COLLECTOR range.

When the HORIZONTAL control is set to STEP GEN, steps indicating the Step Generator output are displayed horizontally. The horizontal display shows one step per division and the amplitude of each step, as shown by the PER STEP readout determines the horizontal deflection factor.

The horizontal deflection factor can be increased by 10 times for any of the previously mentioned measurements by setting the MAG MODE control to HORIZ X10. The magnified horizontal deflection is indicated by the HORIZ/DIV readout.

### Measurements

Table 3-2 shows the measurements that are being made vertically and horizontally by the display for the various positions of the VERTICAL switch, the HORIZONTAL control and the CONFIGURATION switch. Those control position combinations not covered by the table are not considered useful.

### Display Offset and Magnifier

The MAG MODE control and the MAG OFFSET buttons provide a calibrated display offset of  $\pm 10$  divisions ( $\pm 100$  divisions when the display is magnified) and a 10 times display magnifier. The display offset and the display magnifier affect either the vertical and horizontal component of the display. Use of the calibrate display offset is discussed in the positioning section. Use of the magnifier is discussed in both the Vertical and Horizontal Measurement and Deflection Factor sections.



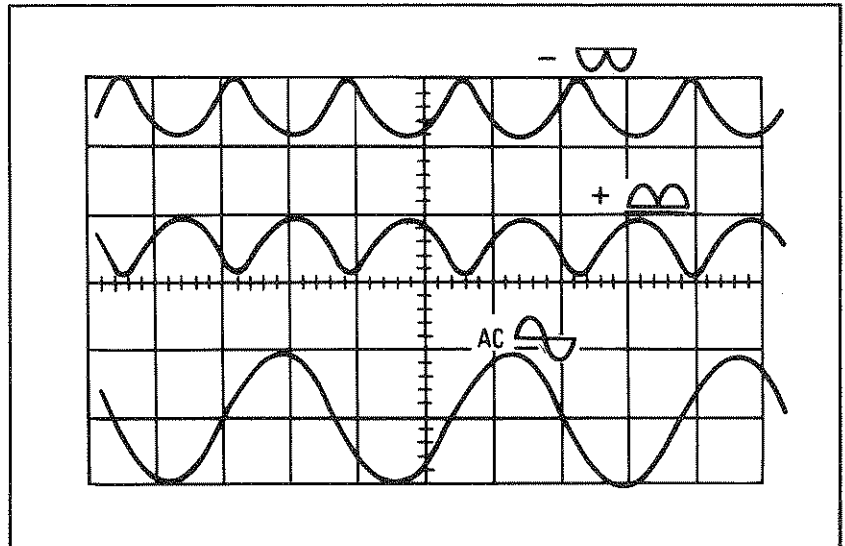
**Table 3-2**  
**Measurements Made by the 370 Display**

Switch Settings			Measured by Display	
VERTICAL	HORIZONTAL	CONFIGURATION	Vertically	Horizontally
COLLECTOR	COLLECTOR	EMITTER COMMON	$I_C$	$V_{CE}$
COLLECTOR	BASE	EMITTER COMMON	$I_C$	$V_{BE}$
COLLECTOR	STEP GEN	EMITTER COMMON	$I_C$	$I_B$ or $V_{BE}$
COLLECTOR	COLLECTOR	BASE COMMON	$I_C$	$V_{CB}$
COLLECTOR	BASE	BASE COMMON	$I_C$	$V_{EB}^1$
COLLECTOR	STEP GEN	BASE COMMON	$I_C$	$I_B$ or $V_{EB}^1$
EMITTER	COLLECTOR	EMITTER COMMON	$I_E$	$V_{CE}$
EMITTER	COLLECTOR	BASE COMMON	$I_B$	$V_{CB}$
STEP GEN	COLLECTOR	EMITTER COMMON	$I_B$ or $V_{BE}$	$V_{CE}$
STEP GEN	BASE	EMITTER COMMON	$I_B$ or $V_{BE}$	$V_{BE}$
STEP GEN	COLLECTOR	BASE COMMON	$I_B$ or $V_{BE}$	$V_{CB}$
STEP GEN	BASE	BASE COMMON	$I_B$ or $V_{EB}^1$	$V_{EB}^1$

<sup>1</sup>  $V_{EB}$  indicates a measurement of forward voltage base-emitter, with the horizontal voltage sensing leads reversed.

**Collector Supply**

The Collector Supply provides operating voltage for the device under test. The voltage is either a sine wave or a full-wave rectified sine wave (see Figure 3-19). This voltage is applied to the front-panel collector terminals.



**Figure 3-19. Different Collector Supply Outputs.**

**WARNING**

*Up to 2000 V may appear at the front-panel collector terminals. To avoid injury or equipment damage, do not remove the protective cover or defeat the protective interlock switch.*

The MAX PEAK VOLTS control and the VARIABLE COLLECTOR SUPPLY control determine the peak voltage output of the Collector Supply, which may be varied from 0 volts to 2000 volts. The MAX PEAK VOLTS control provides four peak voltage ranges: 16 volts, 80 volts, 400 volts and 2000 volts. The VARIABLE COLLECTOR SUPPLY allows continuous voltage variation of the peak voltage within each peak voltage range.

The MAX PEAK POWER WATTS control determines the maximum power output of the Collector Supply. Power output is controlled by placing a resistor, selected from the SERIES RESISTORS, in series with the Collector Supply output. The series resistance limits the amount of current that can be conducted by the Collector Supply. In setting the peak power output using the MAX PEAK POWER WATTS switch, the proper series resistor is automatically selected. If the peak voltage range is changed by the MAX PEAK VOLTS Switch, the output of the VARIABLE COLLECTOR SUPPLY automatically goes to zero.

The Collector Supply CONFIGURATION control determines the polarity and the type of the Collector Supply output. It also provides an initial display position on the graticule as discussed in the section on positioning. When the POLARITY control is set to +(full-wave), the Collector Supply output is positive-going full-wave rectified sine wave. When the control is set to -(full-wave), the Collector Supply output is a negative-going full-wave rectified sine wave. The AC position of the POLARITY control provides a Collector Supply output which is an unrectified sine wave.

When the POLARITY control is set to  $\pm$ DC or  $\pm$ LEAKAGE, the Collector Supply output is a DC voltage equal to the peak voltage set by the MAX PEAK VOLTS control and the VARIABLE COLLECTOR SUPPLY control. This DC voltage may be either positive or negative. The DC mode is very useful when the normal display is exhibiting excessive looping.

Occasionally some of the characteristic curves displayed on the crt consist of loops rather than lines (see Figure 3-20). This effect is called looping and is most noticeable at very low or high current. Looping is usually caused by internal stray capacitance or device capacitance, or by heating of the device under test. The LOOPING COMPENSATION control provides complete compensation for non heat-related looping. It does not compensate for any added capacitance introduced by the device under test, only for internal and adapter capacitance. (The control has some effect in reducing stray capacitance in small diodes, and voltage-driven three-terminal devices.) If uncompensated looping hinders a measurement, set the MODE control to +DC or -DC. If the collector sweep mode of operation is desired, an imaginary line lying inside the loop and equidistant from each side of the loop is the best approximation of the actual characteristic curve (see Figure 3-20). Looping due to heating can be reduced by using the PULSE switch.

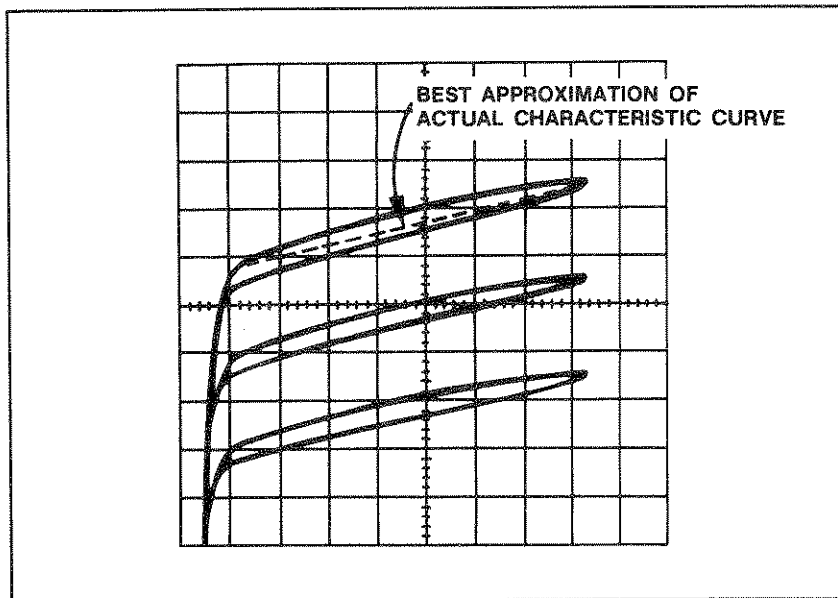


Figure 3-20. Display Looping.

### Interlock System

The 370 uses an interlock system. To use the 370, the plastic protective cover must be installed over the adapter connectors. When the protective box is in place and the lid closed, the DISABLED indicator turns off and the red WARNING indicator turns on. The red WARNING indicator indicates that the Collector Supply is enabled and that a dangerous voltage may appear at the Collector terminals.

### Step Generator

The Step Generator provides current or voltage that can be applied to the base or the emitter of the device under test. The output of the Step Generator is a family of ascending steps of current or voltage (see Figure 3-21). When these steps (together with the Collector Supply output) are applied to the device under test, families of characteristic curves of the device are displayed on the crt.

The NUMBER OF STEPS control determines the number of steps per family and has a range of from 1 step to 10 steps. The AMPLITUDE control determines the amplitude of each step and provides both current steps and voltage steps. The range of step amplitudes available are from 50 nA/step to 200 mA/step for current steps and from 50 mV/step to 2 V/step for voltage steps. Pressing the STEP MULTI .1X button divides the step amplitude by 10. When voltage steps are being applied to the base of a transistor, the base current increases very rapidly with increasing base voltage. To avoid damage to the transistor when using voltage steps, current limiting is provided through the LIMIT switch.

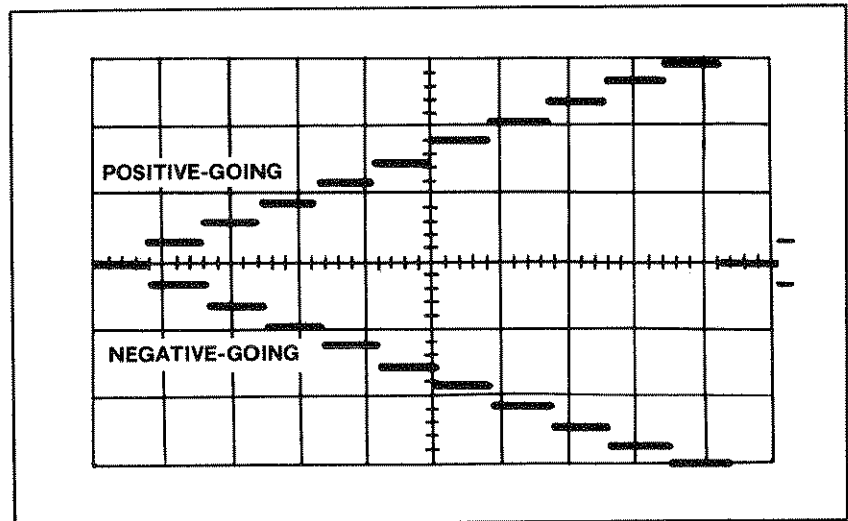


Figure 3-21. Step Generator output.

The MEASUREMENT buttons determine whether step families are generated repetitively or one family at a time. Pressing the REPEAT button turns the Step Generator on and provides repetitive families of steps. When the SINGLE button is pushed, one step family is generated and the Step Generator turns off. To obtain another step family, the SINGLE button must be pressed again.

The OFFSET buttons allow current or voltage to be either added or subtracted from the Step Generator output. This causes the level at which the steps begin to be shifted either in the direction of the ascending steps (aiding) offset or in the opposite direction of the steps (opposing) offset. When the AID button and the OPPOSE button are pressed simultaneously, the step offset returns to zero. When the AID button is pressed, current or voltage may be added to the Step Generator output. The amount of current or voltage added to the Step Generator output when the AID button is pressed is displayed at the OFFSET READOUT. Pressing the OPPOSE button allows either current or voltage to be subtracted from the Step Generator output, the amount subtracted from the Step Generator output is displayed at the OFFSET READOUT.

Opposing offset is most useful when generating voltage steps to test field effect transistors. When current steps are being generated, the maximum opposing voltage is limited to approximately 7 volts. This voltage limiting protects the base-emitter junction of a bipolar transistor from reverse breakdown.

The STEP GENERATOR POLARITY INVERT button allows the Step Generator output (both steps and offset) to be inverted. It has no effect when the CONFIGURATION control is set to BASE COMMON. Use caution to avoid causing reverse current to flow between the base and emitter terminals. Voltage limiting occurs when current steps are being generated and the OPPOSE button is pressed.

When LONG or SHORT is selected by the PULSE switch, steps are generated in pulses having a duration of either 300  $\mu$ s or 80  $\mu$ s (offset is unaffected). Pulsed operation is useful when testing a device at power levels that might damage the device if applied for a sustained length of time. Pulsed steps of 300  $\mu$ s duration occur when LONG is selected. When SHORT is selected, the duration of the pulsed steps is 80  $\mu$ s. When either LONG or SHORT is selected, the Collector Supply mode is automatically set to DC.

### Front-Panel Terminals

The Front-Panel Terminals provide a means of connecting the Collector Supply output, the Step Generator output and the display amplifiers to the device under test.

The front-panel CONFIGURATION switch determines the state of the base and the emitter terminals of the device under test. The control settings are divided in two groups: EMITTER COMMON and BASE COMMON. In the EMITTER COMMON range, the emitter terminal is connected to ground and the CONFIGURATION control determines the state of the base terminal. With the control set to STEP GEN, the Step Generator output is applied to the base terminal. In the OPEN (EXT) position, the base terminal is left open. In this case measurements may be made with the base terminal left open or with an externally generated signal applied to it through the EXT BASE or EMITTER IN connector. When the CONFIGURATION control is set to SHORT (EMITTER), the base terminal is shorted to the emitter.

In the BASE COMMON group, the base terminal is connected to ground and the CONFIGURATION control determines the state of the emitter terminal. With the control set to STEP GEN, the Step Generator output is inverted and applied to the emitter terminal. When the control is set to OPEN (EXT), the emitter terminal is left open. In this case, measurements may be made with the emitter terminal left open or with an externally generated signal applied through the EXT BASE or EMITTER IN connector.

Devices to be tested are connected to the 370 through adapter connectors. These connectors allow two devices to be set up at the same time for comparison testing. The LEFT-RIGHT-STANDBY control determines which device is under test. The 370 test adapters may be plugged into the adapter connectors. These adapters provide sockets into which devices with various lead arrangements may be placed for testing. Refer to ACCESSORIES for test fixture adapter information.







The connectors labeled "SENSE" Allow Kelvin sensing of voltages measured under high current conditions. Kelvin sensing means that current is supplied to a device under test through one set of contacts and the voltage is measured through another set of contacts. This method of sensing voltage eliminates errors in voltage measurements due to contact resistance.

The STEP GEN OUTPUT connector allows the Step Generator output to be used externally. The EXT BASE or EMITTER IN connector allows application of an externally generated signal to either the base or the emitter of the device under test. The external signal is applied to whichever terminal is chosen by the CONFIGURATION switch. The GROUND connector provides a 370 ground reference for signals generated or used external to the 370.

**Collector Supply and Step Generator Output Polarities**

Table 3-3 shows the polarities of the Collector Supply and the Step Generator output for various settings of the Collector Supply POLARITY control and the CONFIGURATION switch.

**Table 3-3  
Polarities of the Collector Supply and  
Step Generator Output**

Switches		Polarities	
Collector Supply POLARITY	CONFIGURATION	Collector Supply	Step Generator
- 	EMITTER COMMON	Negative going	Negative going <sup>1</sup>
- 	BASE COMMON	Negative going	Positive going
+ 	EMITTER COMMON	Positive going	Positive going <sup>1</sup>
+ 	BASE COMMON	Positive going	Negative going
AC 	EMITTER COMMON	Positive and Negative going	Positive going <sup>1</sup>
AC 	BASE COMMON	Positive and Negative going	Negative going

<sup>1</sup> May be inverted by pressing the POLARITY INVERT button.

**Digital Storage and Bubble Memory**

The digital storage mode displays acquired characteristic curves with a bright, flicker-free trace. This mode digitally stores characteristic curves in the internal memory, converts the curves to analog-signals, and displays them on the crt. The mode is activated by pressing STORE. The NON STORE/STORE INTENSITY control adjusts the store intensity.

Stored curves and non-stored curves are measured the same. The resolution of acquisition is 100 points/division in both axis.

The 370 has two ACQUISITION modes (STORE MODE), AVERAGE and ENVELOPE. In AVERAGE mode, either 4 times or 32 times averaging is selected by the ACQ MODE switch. Acquired curves are averaged and displayed on the crt after calculation. A running count of the acquisition is displayed on the crt.

After the acquisition count exceeds the selected average number (4 or 32), the 370 continues the averaging but acquisition count stops incrementing.

The average method for subjected data in a displayed curve is expressed by an equation that provides a pseudo moving-average calculation.

$$D_{na} = (D_{n-1} \times (N - 1) + D_n) / N, \text{ where:}$$

$D_{na}$  = averaged one data in curve,

Dn-1 = previous data,

Dn = currently acquired data,

N = average number (4 or 32).

Averaging is useful for reducing uncorrelated noise in signals and improves its signal-to-noise ratio.

In ENVELOPE mode, either HORIZONTAL ENVELOPE or VERTICAL ENVELOPE is selected by the ACQ MODE switch. The 370 repetitively acquires the curves and displays the resultant waveform envelope. The waveform is compared to the maximum and minimum values of the same data point from previous sweeps. If the data point is either greater than the previous maximum value or less than the previous minimum value, the previous data point value is replaced by the new value. If the data point falls between the currently held maximum or minimum value for that point, it is discarded.

Enveloping is useful for revealing subtle variations in signals and allows the 370 to be left unattended for a long period of time while monitoring signals for time and amplitude variations such as thermal drift.

The 370 has an internal bubble memory system. This system enables acquired curves, text or setups to be stored in the Bubble Memory. Acquired curves (and text) can be stored in the Bubble Memory by pressing the ENTER button. Stored curves (and text) are restored (viewed) by pressing the VIEW button. VIEW curve intensity is controlled by the VIEW INTENSITY control. Pressing COMPARE displays both acquired curves and restored (from the Bubble Memory) curves. In this mode, measurements with the acquired curves can be made and the VIEW curves may be used for the reference. (In the VIEW mode, any setting change erases the curves).

Setups (and text) can be stored in the Bubble Memory by pressing the SAVE button. Stored setups (and text) are restored by pressing the RECALL button. Intensity of the setups displayed on the crt (and the text) is controlled by the READOUT/CURSOR INTENSITY control.

Bubble Memory provides a external storage for the characteristic curves or setups with the 370. As many as 16 families of curves and 16 setups can be stored or restored. Storage capacity is 128k byte. The Bubble Memory cassette tranfers data to/from the 370 in 8-bit parallel format.

#### **Handling a Bubble Memory cassette**

The Bubble Memory cassette is easy to store and handle. However, it is important to take a few simple cautions to prevent damage to the cassette and to ensure the integrity of data stored on the bubble memory.

Store bubble cassettes in antistatic-treated plastic case. Never drop a bubble cassette.

Keep bubble cassettes away from magnetic fields and from ferromagnetic materials that might become magnetized. Strong magnetic fields can damage the magnetically recorded data on the Bubble Memory.

## MEASURING EXAMPLES

This part of the Operating Instructions describes the use of the 370 to measure some basic parameters of bipolar transistors, field effect transistors, silicon controlled rectifiers, signal and rectifier diodes, Zener diodes. For each of the devices discussed, this section includes tables of 370 control settings required to make an accurate measurement without damaging the device under test. Below each table is a block diagram showing the connections of the collector supply, the step generator and the display amplifiers to the device under test, and a picture of a typical characteristic for the semiconductor type being discussed. Also included is a list of common measurements that may be made on the given devices with the 370 and a brief set of instructions on how to make each of these measurements.

This section has been written with the assumption that the reader is familiar with the operation of the 370 as described at the beginning of this section. It is also assumed that the reader is familiar with the parameters under discussion.

### BIPOLAR TRANSISTORS

Control	Required Setting
HORIZONTAL	COLLECTOR
POLARITY	For the Common-Emitter Family, + (full-wave) or - (full-wave) depending on the transistor type.
MAX PEAK POWER WATTS	Less than maximum power rating of device
STEP/OFFSET AMPLITUDE	AMPS
STEP MULTI	Pressed when using low base current
PULSE	Pushed up when using low base current
CONFIGURATION	EMITTER COMMON BASE STEP GEN for common-emitter family BASE COMMON EMITTER STEP GEN for common-base family
STEP GENERATOR OFFSET	AID pressed if more than 10 steps are desired

#### Some Common Measurements

- (Static) The static forward current transfer ratio (emitter grounded),  $h_{FE}$ , is  $I_C/I_B$ .
- (Small Signal) The small-signal short-circuit forward current transfer ratio (emitter grounded),  $h_{fe}$ , is  $I_C/I_B$ . To determine  $h_{fe}$  at various points in a family of curves, multiply the vertical separation of two adjacent curves by the OR gm PER DIV readout.



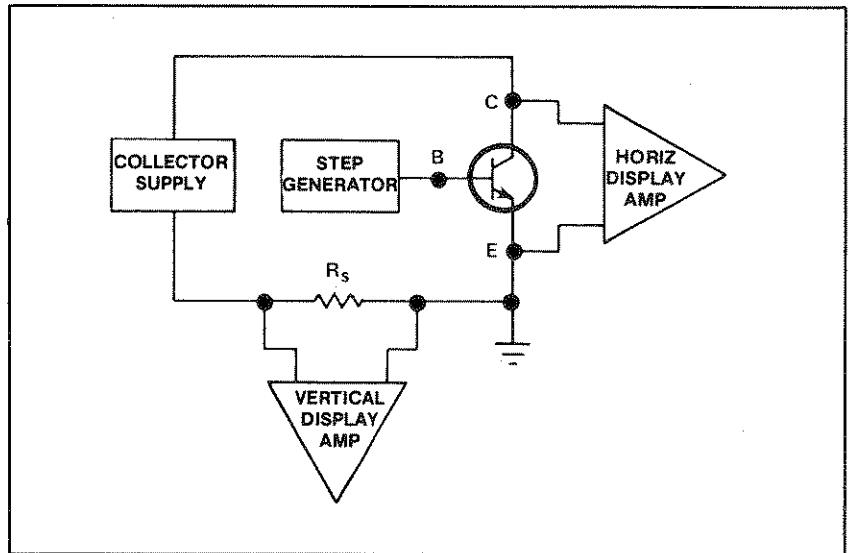


Figure 3-22. Bipolar Transistor Common-emitter Configuration.

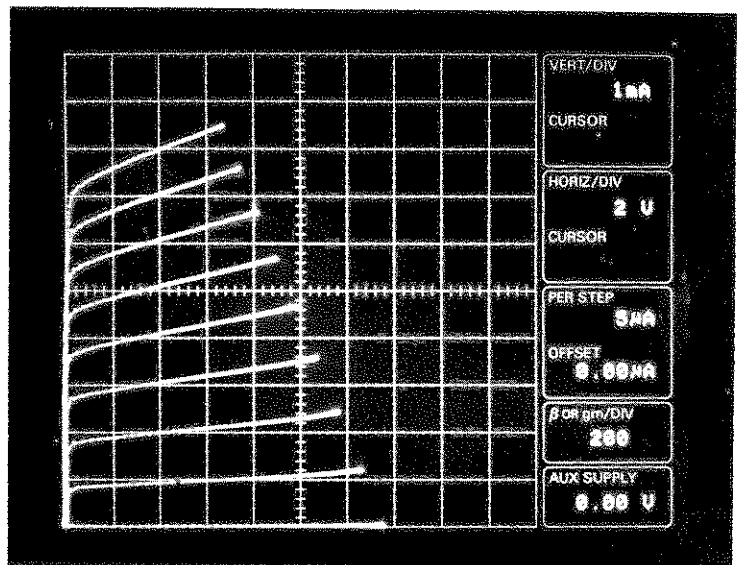


Figure 3-23. Bipolar Transistor Family of Curves.

## Operating Instructions—370

VCE (Sat)	Saturation current and voltage is measured by expanding the display of the saturation region of the device by decreasing the horizontal deflection factor with the HORIZONTAL control or the DISPLAY MAG switch. Saturation current can be adjusted to the desired operating point with the STEP/OFFSET AMPLITUDE switch.
IC vs VBE	Base-emitter voltage can be measured by setting the HORIZONTAL control to the BASE range.
ICEO and BVCEO	Collector-emitter leakage current and collector-emitter breakdown voltage (base open) are measured by setting the CONFIGURATION control to BASE OPEN (OR EXT). For small leakage currents set the POLARITY control to LEAKAGE. To measure breakdown voltage, increase both the horizontal deflection factor and the collector supply voltage.
ICES and BVCES	Collector-emitter leakage current and collector-emitter breakdown voltage (base shorted to emitter) are measured the same as ICEO and BVCEO, except that the CONFIGURATION control is set to BASE SHORT.

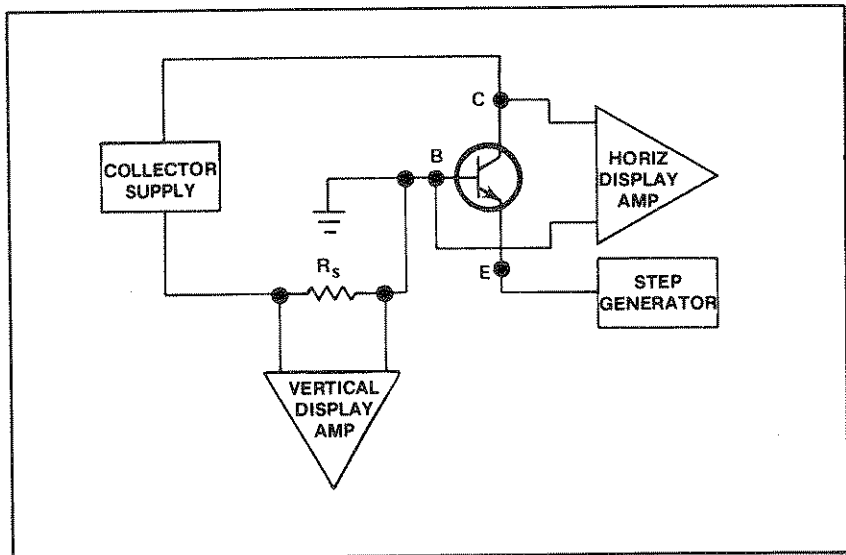


Figure 3-24. Bipolar Transistor Common-base Configuration.

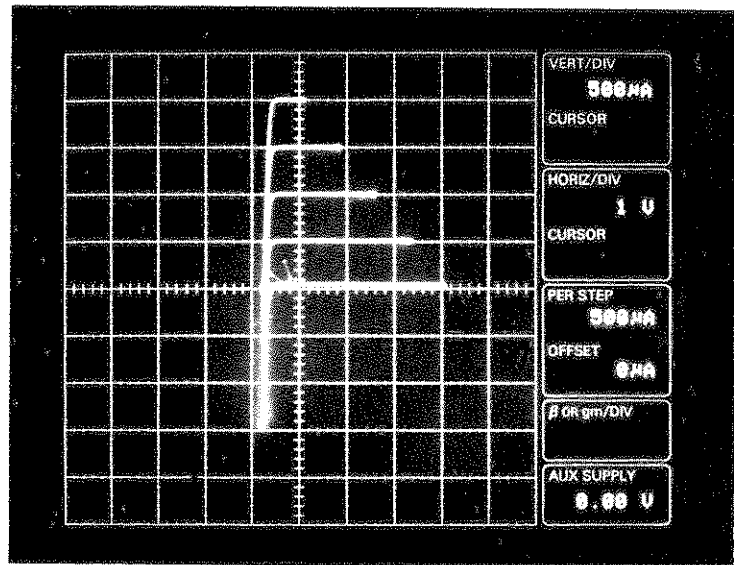


Figure 3-25. Bipolar Transistor Family of Curves.

ICER and BVCER	Collector-emitter leakage current and collector-emitter breakdown voltage (with a specified resistance between the base terminal and the emitter terminal) are measured the same as ICEO and BVCEO except that a specified resistance is connected between the base terminal and the emitter terminal.
(Small Signal)	<p data-bbox="940 1247 1235 1268">Some Common Measurements</p> <p data-bbox="940 1297 1500 1404">The small-signal short-circuit forward-current transfer ratio (base grounded), <math>h_{fb}</math>, can be measured from the common-base family display but is determined most easily by calculating it from the equation <math>h_{fb} = \beta / (1 + \beta)</math>.</p>
ICBO and BVCBO	Collector-base leakage current and collector-base breakdown voltage (emitter open) is measured the same as ICEO and BVCEO, except that the CONFIGURATION control is set to EMITTER OPEN (OR EXT).
IEBO and BVEBO	Emitter-base leakage current and emitter-base breakdown voltage (collector open) is measured the same as ICBO and BVCBO, except that the device terminals are inverted in the device testing socket (collector lead in the emitter terminal of the socket and the emitter lead in the collector terminal).

**FIELD EFFECT TRANSISTORS**

Control	Required Setting	
HORIZONTAL	COLLECTOR	
POLARITY	+ (full-wave) for N-channel device; - (full-wave) for P-channel device	
PEAK POWER WATTS	Less than Maximum power rating of the device	
STEP/OFFSET AMPLITUDE	VOLTS	
STEP MULTI X.1	Pressed	
CONFIGURATION	EMITTER COMM	BASE STEP GEN
	Enhancement	Depletion
STEP GENERATOR POLARITY INVERT	Released	Pressed
STEP GENERATOR OFFSET with POLARITY INVERT button pressed	OPPOSE	ZERO or AID

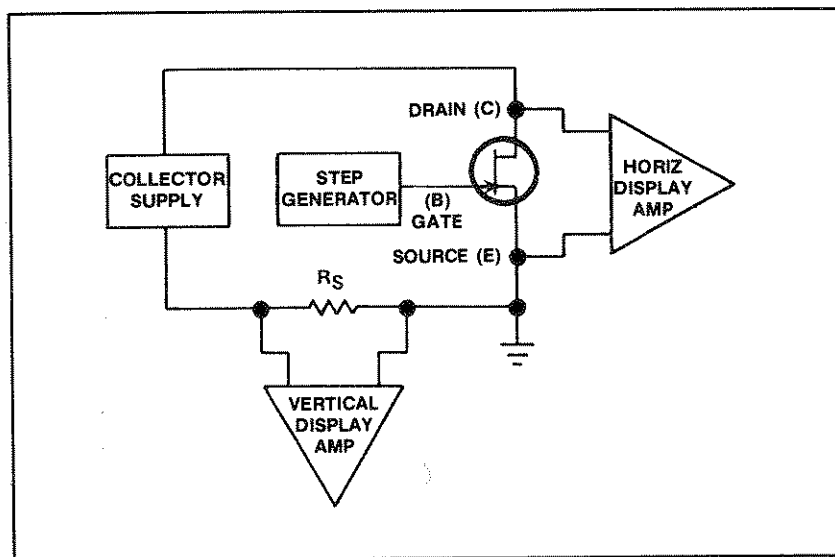


Figure 3-26. Common-source FET Configuration Diagram.

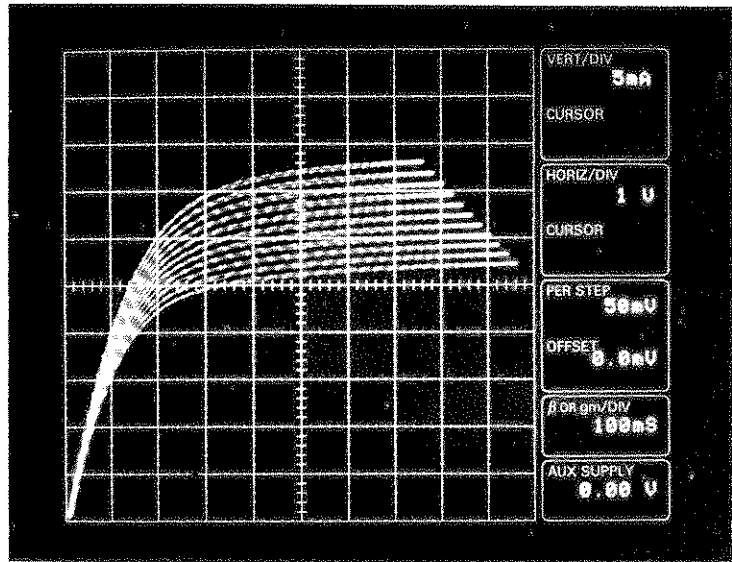


Figure 3-27. Common-source FET Configuration Family of Curves.

#### Some Common Measurements

gm (Static)	The static transconductance (source grounded) is $I_D/V_{GS}$ .
gm (Small Signal)	The small-signal transconductance (source grounded) formula is $I_D/V_{GS}$ . To determine gm at various points in a family of curves, multiply the vertical separation of two adjacent curves by the OR gm PER DIV readout.
IDSS	Drain-source current with zero VGS is measured from the common-source family, with the CONFIGURATION control set to BASE SHORT. It should be measured above the knee of the curve.
Pinch-Off Voltage (Vp)	Pinch-off voltage (Vp) is measured by increasing the depletion voltage with the STEP GENERATOR OFFSET buttons and the STEP/OFFSET AMPLITUDE control until the specified pinch-off current is reached by the zero step.

BVGSS

Gate-source breakdown voltage is measured with the drain shorted to the source; place the gate lead of the device in the drain terminal of the test socket, and the source lead in the gate terminal and the drain lead in the source terminal. Set the CONFIGURATION control to BASE SHORT and reverse the collector supply polarity. This measurement should not be made on an insulated-gate device.

SILICON CONTROLLED RECTIFIERS (SCRs)

Control	Required Setting
HORIZONTAL	COLLECTOR
PEAK POWER WATTS	Less than device maximum power rating
POLARITY	+
PULSE	Set to LONG or SHORT when using high gate voltage or current
CONFIGURATION	EMITTER COMMON BASE STEP GEN

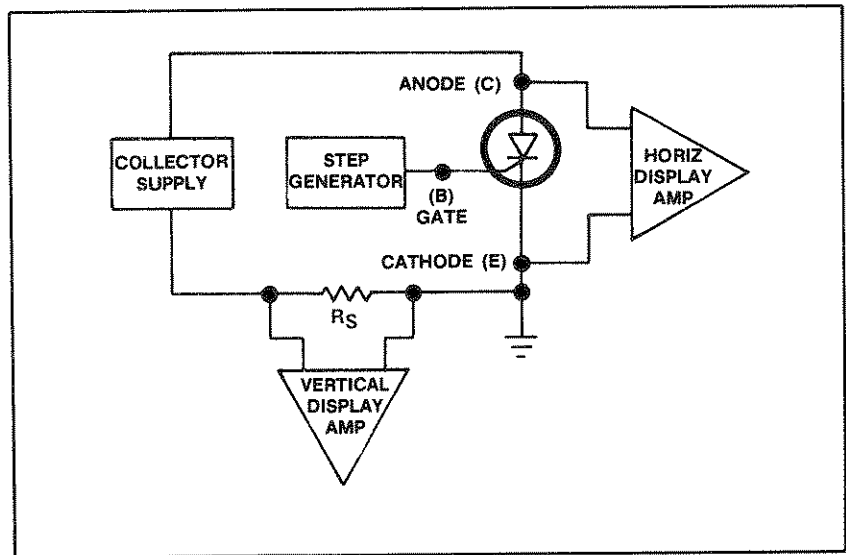


Figure 3-28. Silicon-controlled Rectifier Configuration Diagram.

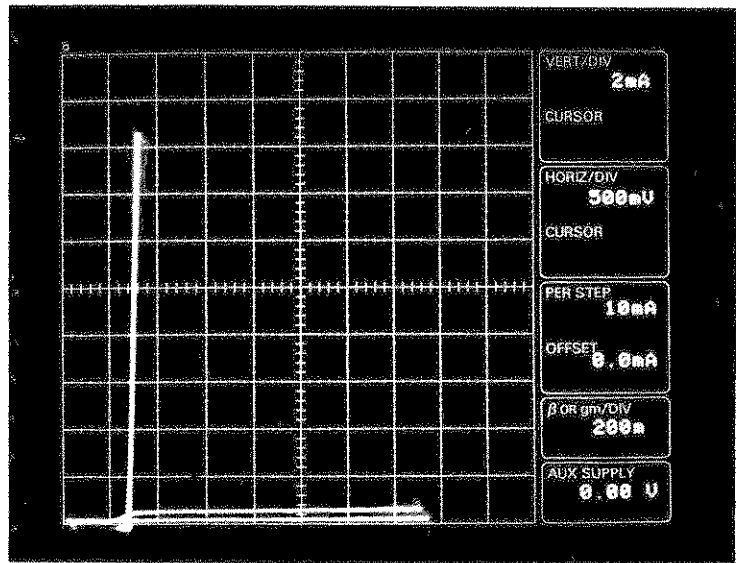


Figure 3-29. Silicon-controlled Rectifier Curve.

#### Some Common Measurements

Turn-on	The gate voltage of current at which the device turns on is measured by applying a specified voltage between the anode and cathode terminals, using the VARIABLE COLLECTOR SUPPLY control and applying current or voltage steps in small increments to the gate with the STEP/OFFSET AMPLITUDE switch.
Forward Blocking Voltage	To measure the forward blocking voltage, set the CONFIGURATION control to BASE OPEN (or SHORT, depending on the specification) and turn the VARIABLE COLLECTOR SUPPLY control clockwise until the device switches to its low impedance state. The voltage at which switching occurs is the forward blocking voltage.
Holding Current	Holding current is measured in the same manner as forward blocking voltage. Holding current is the minimum current conducted by the device, while operating in its low impedance state, without turning off.
Reverse Blocking Voltage	The reverse blocking voltage is measured the same way as the forward blocking voltage, except that the POLARITY control is set to - ( ).

**SIGNAL DIODES AND RECTIFYING DIODES**

Control	Required Setting
HORIZONTAL	COLLECTOR
PEAK POWER WATTS	Less than device maximum power rating
POLARITY	+
CONFIGURATION	EMITTER COMMON

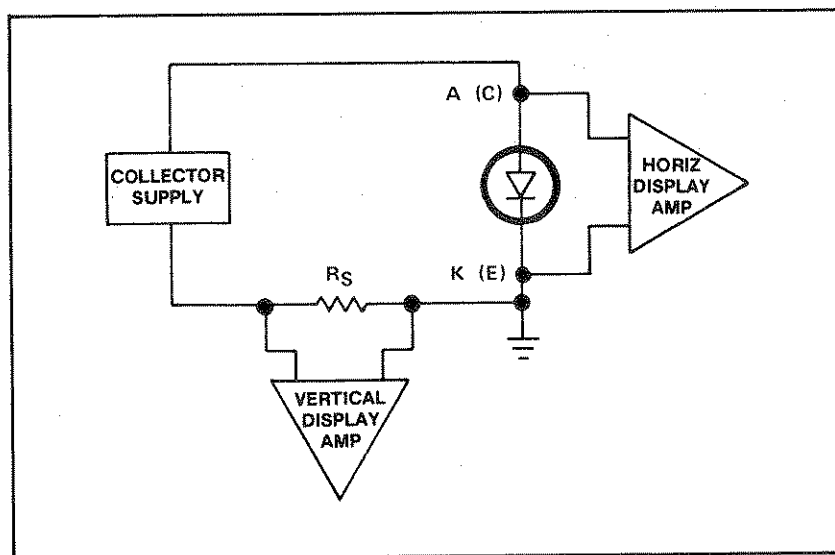


Figure 3-30. Diode Configuration Diagram.



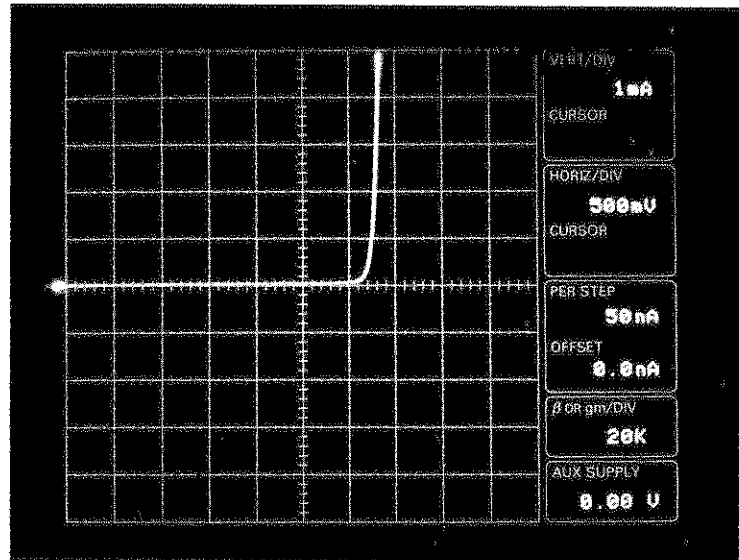


Figure 3-31. Diode Curve.

## Some Common Measurements

## IF and VF

To measure forward current and voltage, insert the cathode of the diode in the emitter terminal of the test socket and the anode of the diode in the collector terminal. Apply voltage to the device with the VARIABLE COLLECTOR SUPPLY control.

## IR and VR

Current and voltage in the reverse direction are measured in the same manner as in the forward direction except that the POLARITY control is set to -. To measure small amounts of reverse current, set the POLARITY control to LEAKAGE.

ZENER DIODES

Control	Required Setting
HORIZONTAL	COLLECTOR
PEAK POWER WATTS	Less than device maximum power rating
POLARITY	—
Terminal Selector	EMITTER COMMON

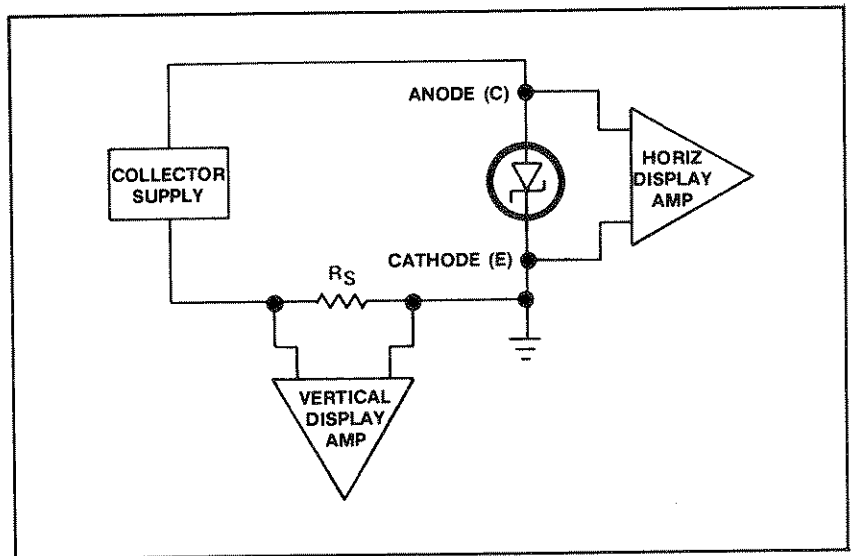


Figure 3-32. Zener Diode Configuration Diagram.

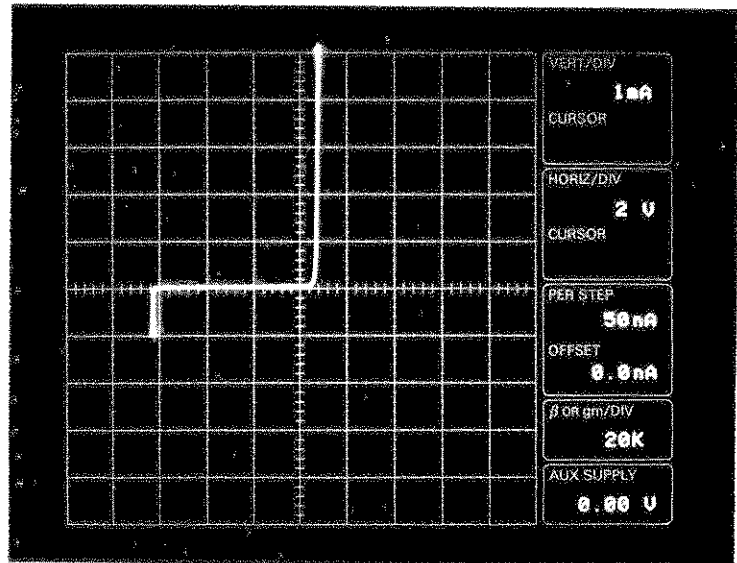


Figure 3-33. Zener Diode Curve.

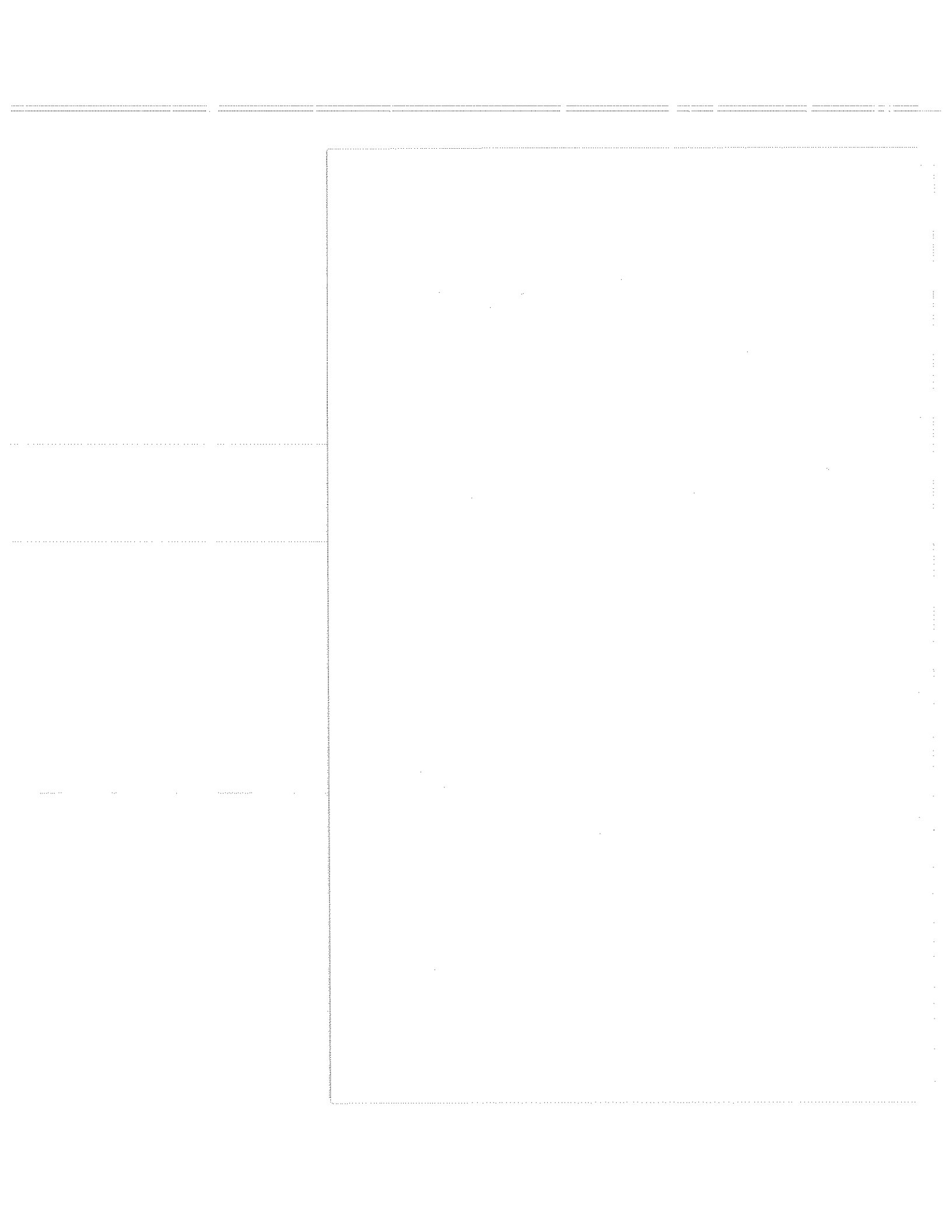
#### Some Common Measurements

##### VZ and IR

To measure Zener voltage or reverse current, insert the diode cathode in the emitter terminal of the test socket and the anode of the diode in the collector terminal. Apply voltage to the device with the VARIABLE COLLECTOR SUPPLY control. For measurements of small amounts of reverse current, set the POLARITY control to LEAKAGE.

##### IF and VF

Current and voltage in the forward direction are measured in the same manner as in the reverse direction, except that the POLARITY control is set to +. For a display of currents and voltages in both directions, set the POLARITY control to AC.



# SECTION 4 PROGRAMMING

## INTRODUCTION TO GPIB

### INTRODUCTION

The 370 front-panel functions can be remotely controlled, except for selected functions such as the COLLECTOR SUPPLY MAX PEAK VOLTS HIGH-LOW switch. Waveform data can be transmitted to perform remote characteristic curve analysis.

The IEEE Std 488 General Purpose Interface Bus (GPIB) port allows the 370 to be used with a wide variety of systems and controllers. The 370 complies with the Tektronix Interface Standard for GPIB Codes, Formats, Conventions, and Features, making the 370 compatible with other Tektronix/Sony-Tektronix instruments and, as much as possible, with GPIB instruments from other manufacturers.

### Setting the GPIB ADDRESS Switches

The rear-panel GPIB ADDRESS switches set the 370 GPIB address. The instrument primary address (0 through 31) is the value of the lower five bits. The internal microcomputer reads these switches at power-up and again each time the RESET TO LOCAL and the FAST button are pressed simultaneously.

Selecting a primary address of 31 logically removes the 370 from the bus; it does not respond to any GPIB address, but remains both unlistened and untalked. Remember, if these switches are reset after the 370 has powered-up, press both the RESET TO LOCAL and the FAST button simultaneously to cause the microcomputer to update the primary address.

### NOTE

*Do not use a 0 address when connected to a Tektronix 4050-Series controller. The controller reserves this address. The Tektronix 4041 powers up with a default address of 30, but this value is changed by using the SET DRIVER command.*

### Setting the TERM Switch

The leftmost switch of the GPIB ADDRESS switches selects the terminator for messages on the bus. If LF OR EOI is selected, the 370 interprets either the data byte LF or the last message (EOI asserted concurrently with a data byte) as the end of a message. If EOI is selected, the 370 interprets the byte sent with the end message (EOI asserted) as the end of a message. This switch also selects the output terminator. Set

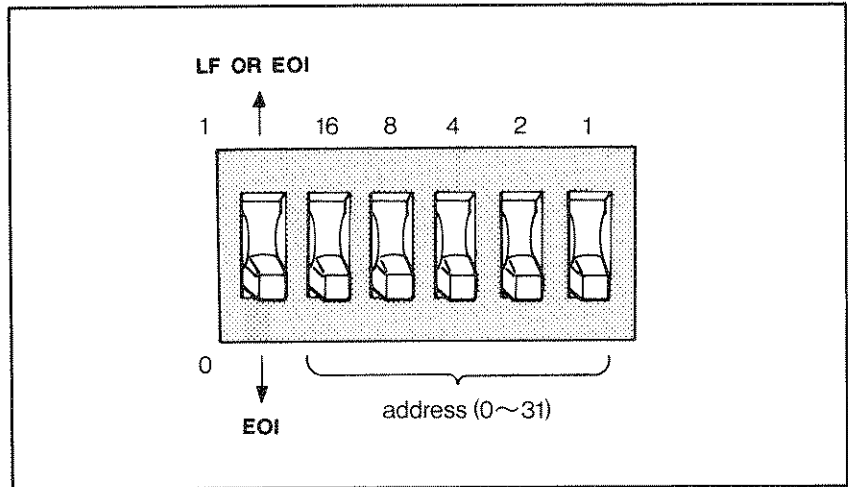


Figure 4-1. Rear-panel GPIB ADDRESS switches

to LF OR EOI, the 370 adds CR and LF (with EOI asserted concurrently) after the last byte of the message. Set to EOI, the 370 asserts EOI concurrently with the last byte of the message.

When operating with Tektronix controllers, EOI should be selected. The other position of this switch is provided to accommodate other controllers, such as the HP 9826A.

#### IEEE 488 FUNCTIONS

The 370 is compatible with IEEE standard 488-1978. The connector, and signal levels at the connector also comply with the standard. Table 4-1 lists 370 interface capabilities, as defined in the standards.

Table 4-1  
370 IEEE 488 INTERFACE FUNCTIONS

Function	Implemented As
Source handshake	SH1
Acceptor handshake	AH1
Talker	T6
Listener	L4
Service request	SR1
Remote Local	RL2
Parallel poll	PP0
Device clear	DC1
Device trigger	DT0
Controller	C0

**Source Handshake (SH1)**

The 370 can transfer messages to other devices on the bus. Although three-state drivers are used on the data lines, T1 (DAV delay for data setting) is greater than 2  $\mu$ s.

**Acceptor Handshake (AH1)**

The 370 can receive messages on the bus.

**Talker (T6)**

The 370 performs basic talker functions, including serial poll. The instrument unaddresses as a talker when addressed as a listener. Neither talk only mode nor secondary address are available.

**Listener (L4)**

The 370 performs basic listener functions. The instrument unaddresses as a listener when addressed as a talker. Neither listen only mode nor secondary address are available.

**Service Request (SR1)**

The 370 performs all service request functions, and asserts SRQ for the conditions listed under Status Byte and reports status when polled.

**Remote/Local (RL2)**

The 370 performs the basic remote/local function. There is no local lockout capability. The front-panel RESET TO LOCAL button returns the instrument from remote to local control. The GTL (go to local) message also returns the instrument from remote to local control. The 370 must be under remote control to execute device-dependent messages that change settings.

**Parallel Poll (PP0)**

The 370 does not respond to parallel polls.

**Device Clear (DC1)**

The 370 responds to the DCL (device clear) and SDC (selected device clear) interface messages by resetting the input and output buffers to restart bus communications. When these messages are executed, outstanding SRQ conditions are cleared and the EVENT query response is set to zero. Power-up status, if selected internally, is an exception.

**Device Trigger (DT0)**

The 370 device trigger function is not implemented.

**Controller (C0)**

The 370 does not act as a controller.

## GETTING STARTED

### INTRODUCTION

Programming the 370 via the GPIB is reasonably simple if you are already familiar with a GPIB controller. If not, talking to the 370 over the bus may be the easiest way to get started.

The 370 language includes mnemonic labels for control of the front panel and other parameters, and to transfer measurement data. Put these mnemonic labels into a GPIB input/output statement in the controller language to begin. The controller must handle details such as asserting REN, unaddressing bus devices, and addressing the 370 to start communication, but these are steps taken by most controllers when executing a GPIB I/O statement. Some sample programs and exercises adapted for the Tektronix 4041 controller (in 4041 BASIC) are included in this section.

### Setting programmable controls

The 370 commands are inserted in the following GPIB output statement. Throughout the 4041 BASIC examples in this section, the letter z represents the value of the 370 GPIB address. (Any constant can represent the number for the GPIB address).

```
100 Open #1:"gpiB0 (pri="&str$(z)&","eom=<0>):"  
110 PRINT #Z:"VERT COLLECT:2.0E-3"  
120 PRINT #Z:"HORIZ COLLECT:1.0E-0"  
130 PRINT #Z:"STPGEN CURRENT:2.0E-6,NUMBER:10"
```

or

```
100 Open #1:"gpiB0 (pri="&str$(z)&","eom=<0>):"  
110 PRINT #1:"VERT COLLECT: 2.0E-3; HORIZ COLLECT:1.0E+0; STEPGEN  
CURRENT: 2.0E=6, NUMBER:10"
```

As this last statement shows, all three commands can be strung together, delimited by semicolons.

The program looks like the following:

- Line 100: This statement designates an instrument at primary address z on the currently selected GPIB as logical unit 1, and defines the end-of-message terminator as "EOI only".
- Line 110: The vertical setting changes the vertical signal source to collector current with 2 mA/div sensitivity.
- Line 120: The horizontal setting changes the horizontal signal source to collector voltage with 1 volt/div sensitivity.



Line 130:           The step generator setting changes the signal source to the current source, amplitude factor to 2 micro ampere, and number of steps to 10.

If the 370 generates an SRQ message, add an SRQ handler sequence to the program, as follows:

```

90  ON SRQ THEN CALL SRQHAND.
100 Open #1:"gpib0 (pri=" & str$(z) & ",eom=<0> ):"
110 PRINT #1:"VERT COLLECT: 2.0E-3; HORIZ COLLECT: 1.0E+0; STPGEN
    CURRENT: 2E-6, NUMBER: 10"
1500 Sub srqhand local status, address
1510 Poll status, address;Z
1520 Print "370 SEND SRQ, STATUS = ";status
1530 Input #1 prompt 'EVENT?':event$
1540 Print event$
1550 Resume
1560 End

```

Besides printing a code for the status byte, the routine asks for the error that caused the SRQ (EVENT?). This offers much more specific information about the problem. The meaning of each event code is listed in Table 4-2 in this section.

Summarizing, whatever controller is used or statement sent, the action shown in Figure 4-2 must be taken to get a message to the 370.

The unlisten (UNL) and untalk (UNT) message are optional in the syntax diagram of bus traffic. (See Figure 4-2. Syntax diagrams are explained later in this section.) However, one or both are sent by most controllers when bus transmission begins or ends, in order to generate a clear communication channel. The controller sends the GPIB address entered as part of the controller GPIB I/O statement. The controller either converts it to the 370 listen address or expects to receive the listen address with the offset included (i.e. 32). The controller then sends the device-dependent message inserted into the statement, and may finish by sending UNL and UNT. If the controller does not assert REN automatically for GPIB I/O, it can be set with an earlier control statement. The 370 does not balk if REN is not set, except if commands are sent that change front-panel settings or stored data.

Most important is the device-dependent message. See "Command List" for a listing of the 370 control mnemonic labels. For details on command syntax and instrument response, turn to "370 GPIB COMMANDS". Detailed descriptions are arranged by function. The front-panel functions are described in Section 2 and Section 3.

## Programming—370

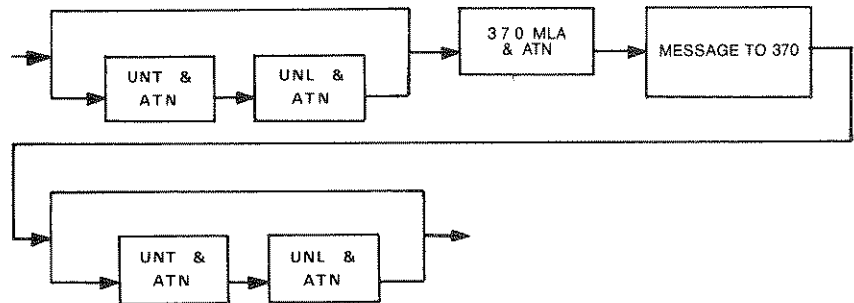


Figure 4-2. Untalk and Unlisten Message Syntax Diagram.

### Querying programmable controls

The 370 returns the state of programmable controls when queried, in two steps:

1. Query the 370. The query is a mnemonic label for a function name, followed by a question mark.
2. Read the response. For most controllers, a GPIB input statement will suffice.

For example, to determine the current horizontal and vertical settings, the queries "HORIZ?" and VERT? prompt the 370 to produce the desired response, as follows:

```
200 Print #1:"HORIZ?;VERT?"
210 INPUT #1:P$
220 Print P$
```

If a query or command with a long return (e.g., CURVE?, HELP?, SET?, WFMPRE?) is included as part of a program, the character string P\$ must be dimensioned large enough to accommodate that message.

In summary, the syntax diagram in Figure 4-3 shows the steps required to receive a message from the 370.

The syntax diagram in Figure 4-3 can be appended to the end of the one shown in Figure 4-2. Together, they describe the two steps necessary to obtain output from the 370. The message in Figure 4-2 includes the query, and the response in Figure 4-3 comes from the 370 to answer that query.

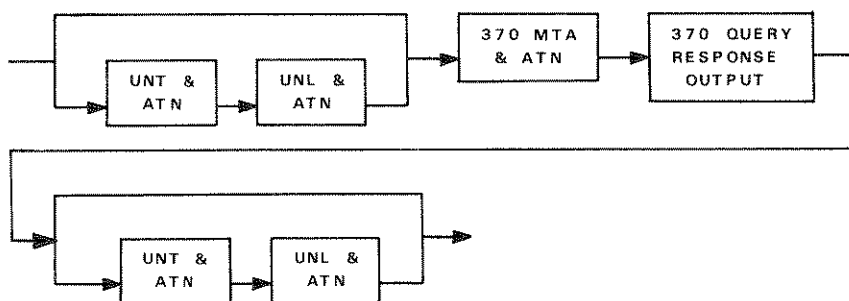


Figure 4-3. Message Receive Syntax Diagram.

## EXERCISE ROUTINES

### Listen/Talk.

This discussion puts the statements for message I/O together to exercise the 370 as a listener and a talker. This routine waits for input and sends it repeatedly. If the 370 responds with a message, that message is printed before another message is requested. Enter any of the commands or queries described under the heading of "370 GPIB COMMAND." (The HELP query returns an list of the available commands and queries.)

An included SRQ Handler prints the status byte and event response.

When the 370 is talked with nothing to say, it outputs a byte with all bits set to one and asserts EOI. The routine does't have to search the output character strings for a query and branch to input the response. Instead, the response is read after every message and printed (a blank line if the 370 sends a byte with all ones.)

The basis for the following 370 routine is that the address value is the variable z, as previously discussed. It is also assumed that the input and output character strings fit p\$. This is discussed further under Instrument Setting Query (SET?), the next topic. Following is the listen/talk routine.

```

100 Open #1:"gpiB0 (pri="&str$(z)&",eom=<0>):"
110 On srq then call srqhand
120 Enable sra
130 start: !
140 Input prompt "Enter message ":p$
150 Print #1:p$
160 Input #1:p$
170 Print p$
180 Goto start

```

## Programming—370

```
190 End
1500 Sub srqhand local status, address
1510 Poll status, address;Z
1520 Print "370 SEND SRQ, STATUS = ";status
1530 Input #1 prompt 'EVENT?':event$
1540 Print event$
1550 Resume
1560 End
```

### ACQUIRING INSTRUMENT SETTINGS WITH SET?

The SET query enables the 370 to learn instrument settings both for reference and to be able to restore the instrument to those settings. This query the instrument to output a message that includes a response for each programmable function.

The response format allows it to be used to restore the instrument settings with no operator intervention. First, set up for the measurement (and try it) from the 370 front panel. Store the message as it is transmitted by the 370, using the SET query. The controller must be ready for a character string at least 500 characters. (The exact size depends on the current settings.) Then, perform any desired instrument operations. Finally, restore the 370 to the original settings by transmitting back to the instrument the stored SET?

### Learn Settings

```
DIM S$ TO 500
INPUT PROMPT "SET?" #Z: S$
S$
```

```
CURSOR OFF;MEASURE REPEAT;ACQUIRE NORMAL;DISPLAY
STORE, INVERT:OFF, CRTCAL:OFF;HORIZ COLLECT:500.OE-
3,OFFSET:0.0;VERT COLLECT:50.OE-6,OFFSET:0.0;MAG OFF;PKVOLT
16;PKPOWER
0.08;CSPOL NNORMAL;CONFIG BSGEN;STPGEN
NUMBER: 4,PULSE:LONG,OFFSET:
0.00, INVERT:ON,MULT:OFF,CLIMIT:0.02,CURRENT:20.OE-G;AUX 0.00;VCSFPLY
36.6;RQS ON;OPC OFF;HILOWSW LOW
```

### Send settings back to the 370

```
PRINT #1:S$
```

### RESETTING THE 370 AND INTERFACE MESSAGE

The INIT command resets the 370 programmable controls to the power-up state. INIT is sent in the same manner as other commands.

Interface message DCL (device clear) or SDC (selected device clear) clears the 370 I/O buffer and can be used to restart bus communications with the curve tracer. DCL or SDC does not interrupt message execution. If the 370 is waiting for the talk address so

it can execute an output query, output is aborted and the buffers are cleared by DCL (decimal code 20), or any device-dependent input. The decimal code for other universal commands are 63 for UNL (unlisten), and 95 for UNT(untalk).

To execute addressed commands such as GTL(go to local), precede the decimal codes with the 370 listen address. The code for the addressed commands are 1 for GTL, and 4 for SDC(selected device clear). Use the WBYTE statement to send universal commands.

```
100 wbyte atn (dcl)
```

When the IFC line is asserted by the controller (for example, when the BASIC statement INIT is executed), the 370 talker and listener functions are initialized (same as UNT, UNL, and SPD).

### ACQUIRING A WAVEFORM

The waveform in digital storage can be requested as a block of binary data.

The following are three types of sample programs that receive waveform data from the 370. Line number 100 in each sample program defines the End-of-message terminator as "EOI only". This prevents binary bytes that are equivalent to ASCII "CR/LF" character strings from stopping a data transfer.

The EX1 program receives the waveform preamble and curve data separately into w\$ and d\$. These variables are in ASCII format, so the curve data must be converted to numerical data.

The EX2 program receives curve data only. Curve data is sent into the array "cuv". The EX3 program also receives curve data into numerical variable "d", which is one of the differences between EX2 and EX3 in the resultant array.

Curve data transfer requires four bytes for each pair of data points; two bytes for the X axis, and two bytes for the Y axis. The EX3 program automatically combines these two bytes (16 bits) and results in an integer value.

Data Acquisition examples follow:

```
WFMPRE WFID:"INDEX 2/VERT 2mA/HORIZ 2V/STEP 20uA/OFFSET 0.0uA/BGM 100
/AUX 0.00 V/ACQ NOR/TEXT
", ENCDG:BIN,NR.PT:1024,PT.FMT:XY,XMULT:+2.OE-2,XZERO:0,XOFF:
12,XUNIT:V,YMULT:+2.OE-
5,YZERO:0,YOFF:12,YUNIT:A,BYT/NR:2,BN.FMT:PR,BIT/NR:10,CRVCHK:
CHKSMO,LN.FMT:VECTOR;CURVE CURV ID:"INDEX 2",%<wfm data>
```

```
EX1
100 Open #1:"GPIB (PRI=1 ,EOM=<O>):"
110 Dim w$ to 500,d$ to 5000
120 Input prompt "wfmpre?" #1:w$
130 Input prompt "curve?" #1:d$
```

## Programming—370

### EX2

```
100 Open #1:"GPIB (PRI=1 ,EOM=<O> ):"
110 Integer a (24),per,byte (2),cuv (4096),chek
120 Print #1:"curve?"
130 Wbyte atn (mla,65)
140 Rbyte a,per ,byte ,cuv ,chek
150 Wbyte atn (unt,unl)
```

### EX3

```
100 Open #1:"GPIB (PRI=1 ,EOM=<O> ):"
110 Integer d (2048)
120 Dim a$ to 5000
130 Input #1 prompt "curve?" dels ", " buffer a$ using "a,16*":b$,d
```

## DEVICE-DEPENDENT MESSAGE STRUCTURE AND EXECUTION

### INTRODUCTION

The 370 device-dependent message structure is compatible with a variety of GPIB systems, and is simple to use. The structure complies with the Tektronix Interface Standard for GPIB Codes, Formats, Conventions, and Features.

### SYNTAX DIAGRAMS

370 messages are shown herein in syntax diagrams that show the sequence of elements transferred over the bus. A circle, oval, or box encloses each element. Circles or ovals are symbols for literal elements; i.e., characters that must be sent verbatim. Since most mnemonic labels can be shortened, the command and query characters required in a 370 literal element appear larger than optional characters. Although mnemonic labels are shown upper-case, the 370 accepts either upper-case or lower-case ASCII characters. Query response characters are shown exactly as are returned.

Boxes are symbols for defined elements, and contain a name that stands for the element defined elsewhere. NUM is such a name and is defined under Numbers. Elements of the syntax diagram are connected by arrows that show the possible paths through the diagram. Parallel paths mean that one, and only one, of the paths must be followed; a path around an element or group of elements indicates an optional skip. Arrows indicate the direction that must be followed (usually the flow is to the right; but, if an element may be repeated, an arrow returns from the right to the left of the element). Some examples of such sequences follow.

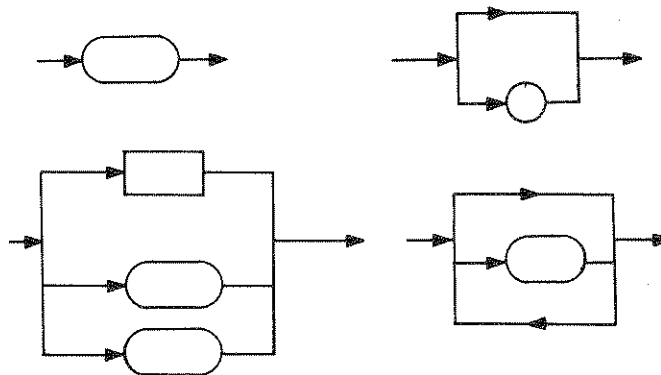


Figure 4-4. syntax element examples.

### 370 INPUT MESSAGES

A remote control message to the 370 comprises one or more message units of two types. The message units either consist of commands that the 370 inputs as control or measurement data, or they consist of queries that request the 370 to output data.

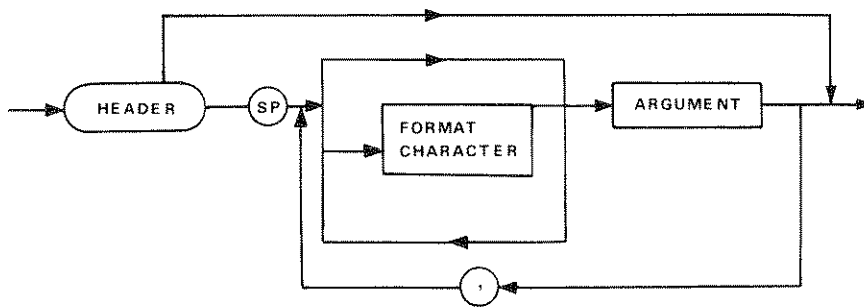


Figure 4-5. Input Message Format.

One or more message units can be transmitted as a message to the 370. Message units contain ASCII characters (binary may be used for waveforms). The 370 accepts either upper-case or lower- case characters for the mnemonic labels shown in the syntax diagrams.

**Message Unit Delimiter (;)**

Message units are separated by the ASCII code for the semicolon (;). A semicolon is optional following the last message unit.

**Message Terminator (TERM)**

The end-of message terminator can be either the END message (EOI asserted concurrently with the last data byte), or the ASCII code for line feed (LF), sent as the last data byte.

The active terminator is selected by the rear-panel TERM switch.

**Format Characters**

Format characters can be inserted at many points to make a message more intelligible, but are required only if included as a literal element (ie., in circle or ovals) with no bypass. Format characters include space (SP), carriage return (CR), and line feed (LF).

**Input Buffering and Execution**

The 370 has a large input buffer that exceeds that required for the WAV? response. The 370 waits until the end of message terminator or message unit delimiter (;) to decode and execute it. When the instrument is under local control, commands that conflict with local control are ignored. If a message contains multiple message units, the 370 detects the message unit delimiter and executes the commands in the message in the order received.

**Command Format**

A command message unit either sets an operating mode or parameter, or it transfers display data to the instrument. The command format to set a mode or parameter includes the following possible path.

**Header**

Header elements are mnemonic labels that represent a function; for example, VCS for variable collector supply and PKV for max peak volts.

**Header Delimiter (SP)**

A space (SP) separates a header from any arguments.

**Argument Delimiter (,)**

A comma (,) separates multiple arguments.

**Argument Format**

The diagram in Figure 4-7 shows that arguments following the header may be numbers, groups of characters, or linked to a character argument.



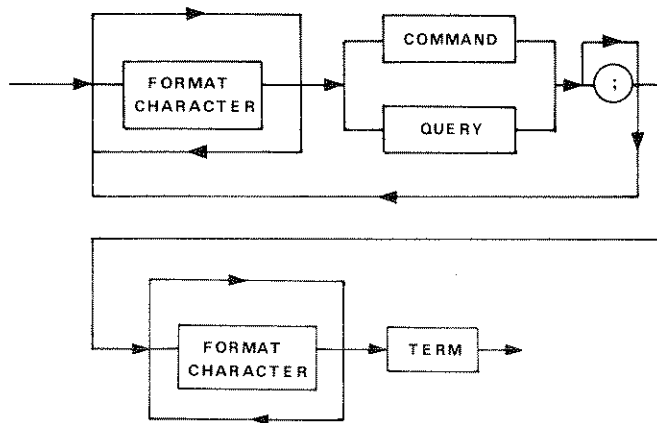


Figure 4-6. Command Format Syntax Diagram.

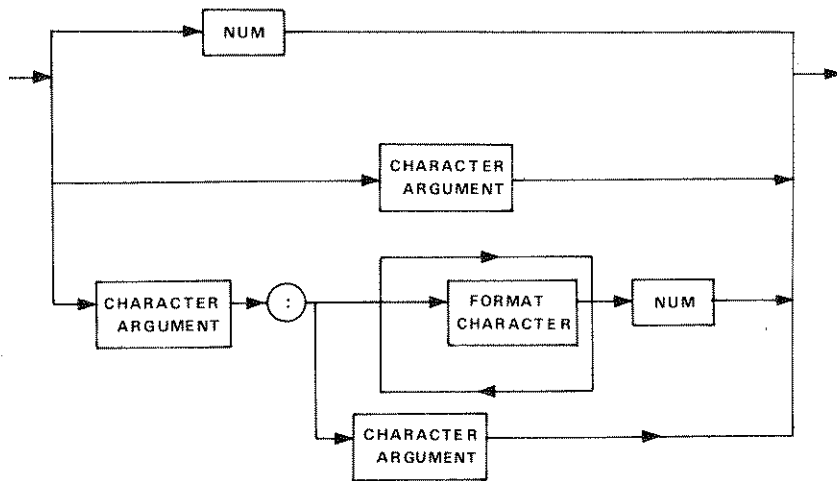


Figure 4-7. Argument Format.

### Numbers

The defined element NUM is a decimal number in any of three formats; NR1, NR2, or NR3. See Figures 4-8, 4-9, and 4-10.

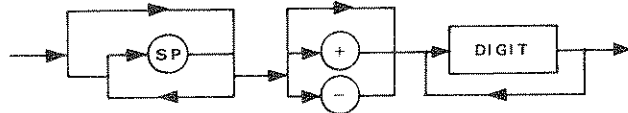


Figure 4-8. NR1 Format. NR1 is an integer (no decimal point).

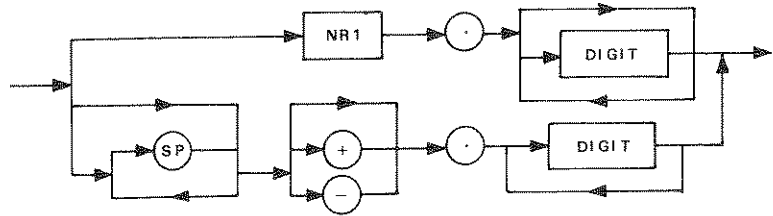


Figure 4-9. NR2 Format. NR2 is a floating point number (decimal point required).

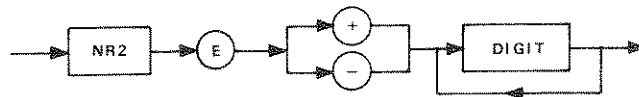


Figure 4-10. NR3 Format. NR3 is a floating-point number in scientific notation.

If NUM exceeds the range of the function, the 370 microcomputer does not execute the command, but issues an error message. Numbers within the range are rounded down.

### Character Argument

Arguments can be either words or mnemonic labels. ON and OFF, for instance, are arguments for the commands that correspond to 370 front-panel push buttons like Display Invert.

### Link Argument Delimiter (:)

The bottom path in Figure 4-7 combines both character and number arguments into a link argument. The link is the colon (:), which delimits the first and second argument.

**String Argument**

A string argument is used when a message is to be displayed on the crt for human interpretation, as with the TEXT command. The characters are enclosed in quotes to delimit them as a string argument.

**Query Format**

A query message unit requests either function or display data from the instrument. The query message unit format is shown below in Figure 4-11.

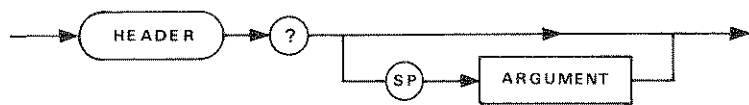


Figure 4-11. Query format.

**Binary Block**

Binary block is a sequence of binary numbers that follows the ASCII code for percent (%) and a two-byte binary integer representing the number of binary numbers plus one and followed by the checksum (the extra byte is the checksum). The checksum is the 2's-complement of the modulo-256 sum of all preceding bytes except the first (%). Thus, the modulo-256 sum of all bytes except the first (%) should equal zero to provide an error-check of binary block transfer. See Figure 4-12.

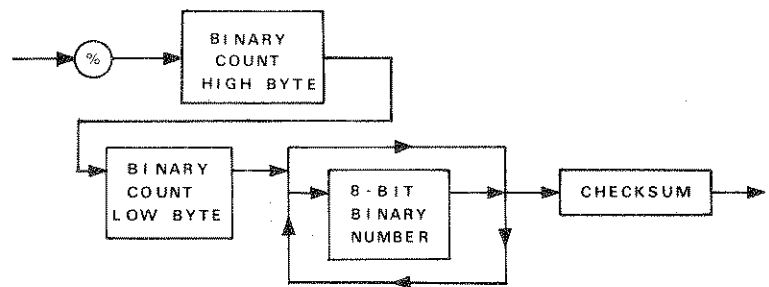


Figure 4-12. Binary Block Format Syntax Diagram.

**370 OUTPUT MESSAGES**

When the 370 executes a query, it buffers an output message unit that is a response to the query. Output message units contain ASCII characters (except when a binary waveform is requested).

### Output Message Format

The output message unit combines the header and related arguments. Message units are combined if the output includes a response to the SET query or more than one query response. See Figure 4-13.

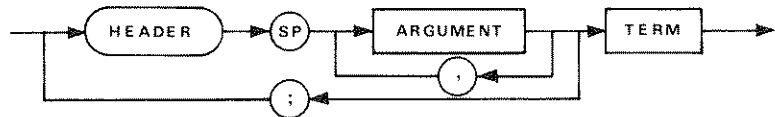


Figure 4-13. Output Message Format.

### Output Message Execution

The 370 begins output when talked, and it continues until it reaches the end of information in its buffer or is interrupted by a device clear (DCL), untalk (UNT), or interface clear (IFC) message. The buffer can be cleared by the DCL message, or if it is listened, by the SDC message or any device-dependent message. If not interrupted, the 370 terminates the output according to the setting of the TERM switch. When the output buffer overflows, all the remaining output is lost.

## 370 GPIB COMMANDS

### INTRODUCTION

370 GPIB commands are divided into three classes, the Front Panel Control commands, display data and crt readout I/O commands, and the System commands. Each class has several command groups, sorted by function. Each command is explained in detail, including a syntax diagram for each. See the discussion of syntax diagrams earlier in this section.

### FRONT-PANEL CONTROLS

Front-panel-related commands and queries are grouped as follows:

- Display Controls
- Cursor Controls
- Collector Supply Controls
- Step Generator Controls
- Configuration
- Others

Table 4-2 relates the front-panel controls to the GPIB commands.

**Table 4-2  
FRONT-PANEL CONTROL COMMANDS AND QUERIES**

<b>Control</b>	<b>Command header</b>
<b>Display Control Command Group</b>	
NON STORE	DISPLAY
STORE	DISPLAY
COMPARE	DISPLAY
VIEW	DISPLAY
INVERT	DISPLAY
CRT CAL	DISPLAY
ENTER	ENTER
VERTICAL CURRENT/DIV	VERT
HORIZONTAL VOLTS/DIV	HORIZ
DISPLAY OFFSET	VERT/HORIZ
MAG MODE	MAG
ACQ MODE	ACQUIRE
<b>Cursor Control Command Group</b>	
OFF	CURSOR
DOT	DOT
CROSS	CROSS
WINDOW	WINDOW
WINDOW	WINDOW
<b>Collector Supply Control Command Group</b>	
MAX PEAK VOLTS	PKVOLT
MAX PEAK POWER WATTS	PKPOWER
POLARITY	CSPOL
VARIABLE	VCSUPPLY
HIGH-LOW SWITCH	HILOWSW?
<b>Step Generator Control Command Group</b>	
STEP/OFFSET AMPLITUDE	STPGEN
NUMBER OF STEPS	STPGEN
INVERT	STPGEN
MULTI .1X	STPGEN
PULSE	STPGEN
CURRENT LIMIT	STPGEN
OFFSET	STPGEN
<b>Configuration Command Group</b>	
BASE STEP GEN	CONFIG
BASE OPEN (EXT)	CONFIG
BASE SHORT (EMITTER)	CONFIG
EMITTER OPEN (EXT)	CONFIG
EMITTER STEP GEN	CONFIG

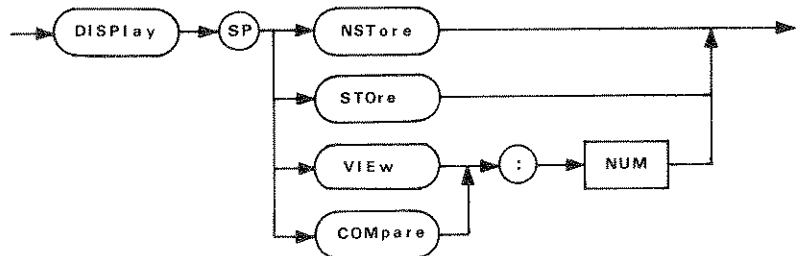
**Table 4-2 (cont)  
FRONT-PANEL CONTROL COMMANDS AND QUERIES**

Other Commands	
MEASUREMENT	MEASURE
RECALL	RECALL
SAVE	SAVE
PLOT	PLOT
Plotter status	PSTATUS
AUX SUPPLY	AUX
LEFT-RIGHT-STANDBY	LRSSW?
SWITCH	
ROTECTIVE COVER	COVER?

**DISPLAY CONTROL COMMAND GROUP**

The commands in this group set and change the 370 display mode, display invert, or crt calibration check (DISPLAY); select the vertical current/div or vertical offset (VERT); select the horizontal volts/div or horizontal offset (HORIZ); select the magnifier mode (MAG); store the digital storage display data in Bubble Memory (ENTER); and select the acquisition mode (ACQUIRE).

**DISPLAY (display mode) Command**

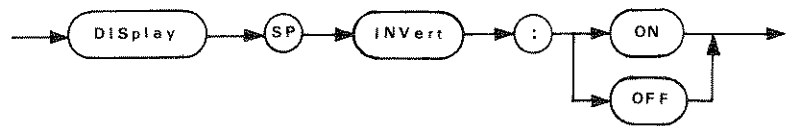


**Figure 4-14. DISPLAY Command Syntax Diagram.**

- NSTORE— Non store mode is enabled. Analog real-time curves are displayed on the crt.
- STORE— Store mode is enabled. Digital storage curves are displayed on the crt.
- VIEW— View mode is enabled. Digital storage curves stored in the Bubble Memory are recalled.

- COMPARE— Both the STORE and VIEW curves are displayed on the crt.
- NUM— 370 display data are recalled from the selected Bubble Memory page. (range is 1-16).

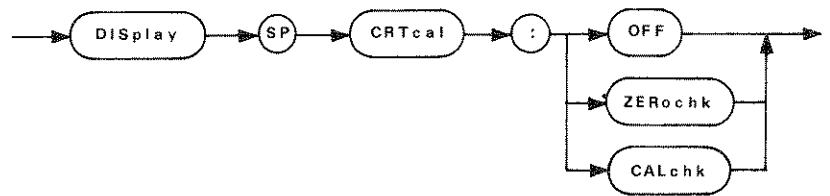
**DISPLAY (display invert) Command**



**Figure 4-15. DISPLAY (Invert) Command Syntax Diagram.**

- ON— Display invert mode is selected.
- OFF— Display invert mode is not selected.

**DISPLAY (crt calibration) command**



**Figure 4-16. DISPLAY (Crt Calibration) Command Syntax Diagram.**

- OFF— Crt calibration is disabled.
- ZEROCHK— Crt zero scale calibration is enabled.
- CALCHK— Crt full scale calibration is enabled.

DISPLAY (display control) query

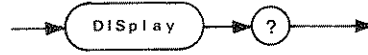


Figure 4-17. DISPLAY Query Syntax Diagram.

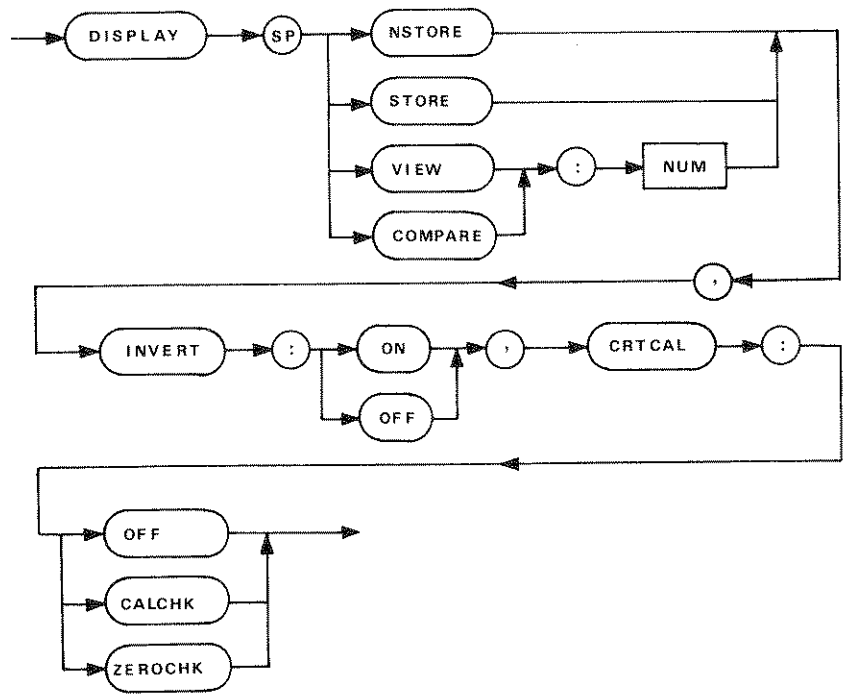


Figure 4-18. Display Query Response Syntax Diagram.

ENTER (store display data) command



Figure 4-19. ENTER Syntax Diagram.



NUM— 370 display data are loaded into the selected Bubble Memory page (range is 1-16). There is no ENTER query.

**NOTE**

*When NON STORE mode is selected, the ENTER command is ignored.*

**VERT (vertical current/div) Command**



**Figure 4-20. VERT Command Syntax Diagram.**

COLLECT— Selects the Collector as the vertical source.

STEP— Selects the Step Generator as the vertical source.

**Programming—370**

NUM— Sets vertical sensitivity (current/div) to the requested argument as shown below.

Argument	Sensitivity
1.OE-6 ≤ 2.OE-6	1 μA
2.OE-6 ≤ 5.OE-6	2 μA
5.OE-6 ≤ 1.OE-5	5 μA
1.OE-5 ≤ 2.OE-5	10 μA
2.OE-5 ≤ 5.OE-5	20 μA
5.OE-5 ≤ 1.OE-4	50 μA
1.OE-4 ≤ 2.OE-4	100 μA
2.OE-4 ≤ 5.OE-4	200 μA
5.OE-4 ≤ 1.OE-3	500 μA
1.OE-3 ≤ 2.OE-3	1 mA
2.OE-3 ≤ 5.OE-3	2 mA
5.OE-3 ≤ 1.OE-2	5 mA
1.OE-2 ≤ 2.OE-2	10 mA
2.OE-2 ≤ 5.OE-2	20 mA
5.OE-2 ≤ 1.OE-1	50 mA
1.OE-1 ≤ 2.OE-1	100 mA
2.OE-1 ≤ 5.OE-1	200 mA
5.OE-1 ≤ 1.OE+0	500 mA
1.OE+0 ≤ 2.OE+0	1 A
2.OE+0	2 A

**NOTE**

When the collector supply polarity is set to +LEAKAGE or -LEAKAGE, the vertical sensitivity (current/div) increases 1000 times (range is 1.OE-9—2.OE-3).

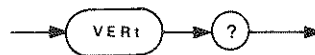
**VERT (vertical display offset) command**



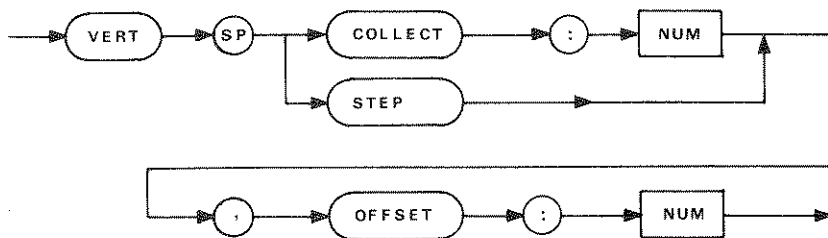
**Figure 4-21. VERT Command Syntax Diagram.**

NUM— Sets the vertical display offset to the requested argument (range is -10.0—+10.0). The offset value resolution is 0.5 div position: numbers less than the resolution are rounded down.

**VERT (vertical) query**

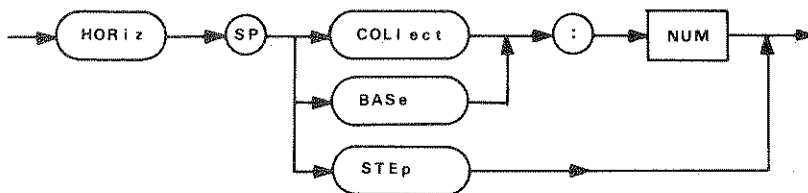


**Figure 4-22. VERT Query Syntax Diagram.**



**Figure 4-23. VERT Query Response Syntax Diagram.**

**HORIZ (horizontal volt/div) Command**



**Figure 4-24. HORIZ Command Syntax Diagram.**

**Programming—370**

NUM— Selects the horizontal sensitivity (volt/div) to the requested argument as shown below:

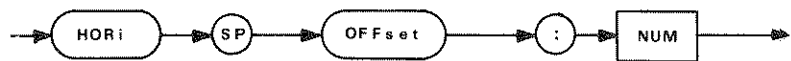
Argument	Selection
5.0E-2 ≤ 1.0E-1	50 mV (BASE)
1.0E-1 ≤ 2.0E-1	0.1 V (BASE)
2.0E-1 ≤ 5.0E-1	0.2 V (BASE)
5.0E-1 ≤ 1.0E+0	0.5 V (BASE)
1.0E+0 ≤ 2.0E+0	1 V (BASE)
2.0E+0	2 V (BASE)
5.0E-2 ≤ 1.0E-1	50 mV (COLLECTOR)
1.0E-1 ≤ 2.0E-1	0.1 V (COLLECTOR)
2.0E-1 ≤ 5.0E-1	0.2 V (COLLECTOR)
5.0E-1 ≤ 1.0E+0	0.5 V (COLLECTOR)
1.0E+0 ≤ 2.0E+0	1 V (COLLECTOR)
2.0E+0 ≤ 5.0E+0	2 V (COLLECTOR)
5.0E+0 ≤ 1.0E+1	5 V (COLLECTOR)
1.0E+1 ≤ 2.0E+1	10 V (COLLECTOR)
2.0E+1 ≤ 5.0E+1	20 V (COLLECTOR)
5.0E+1 ≤ 1.0E+2	50 V (COLLECTOR)
1.0E+2 ≤ 2.0E+2	200 V (COLLECTOR)
2.0E+2 ≤ 5.0E+2	100 V (COLLECTOR)
5.0E+2	500 V (COLLECTOR)

COLLECT— Sets the Collector as the horizontal source.

BASE— Sets the Base as the horizontal source.

STEP— Sets the Step Generator as the horizontal source

**HORIZ (horizontal display offset) command**



**Figure 4-25. HORIZ Command Syntax Diagram.**

NUM— Sets the horizontal display offset to the requested argument (range is -10.0—+10.0). Offset value resolution is 0.5 div; numbers less than the resolution are rounded down.

HORIZ (horizontal) query

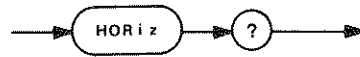


Figure 4-26. HORIZ Query Syntax Diagram.

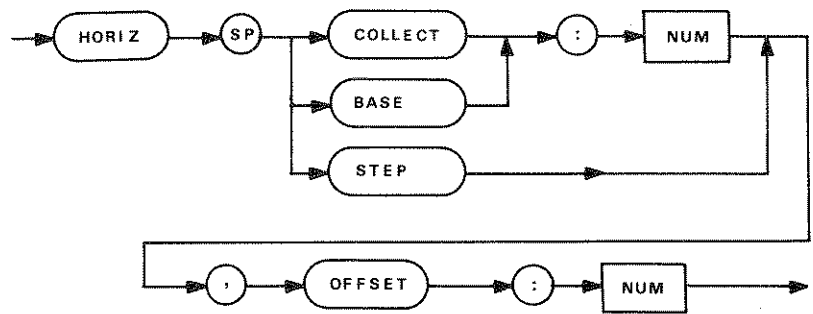


Figure 4-27. HORIZ Query Response.

ACQUIRE (acquire mode) command

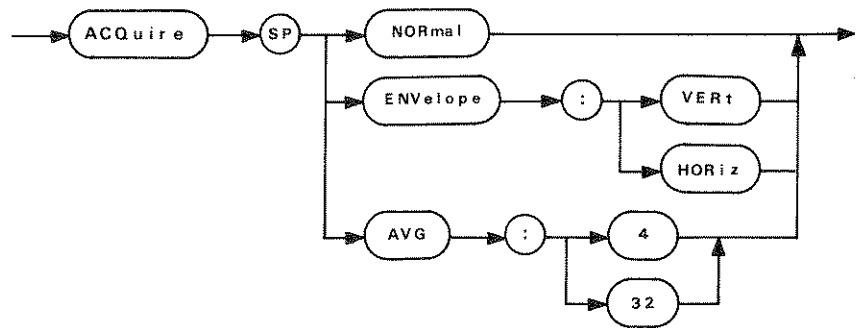


Figure 4-28. ACQUIRE Command Syntax Diagram.

NORMAL— Curve data is acquired normally.

ENVELOPE: VERT,— Curve data is acquired continuously to form an envelope.  
 ENVELOPE: HORIZ

AVG:4, AVG:32— Averages the acquired curve data continuously to reduce uncorrelated noise.

**ACQUIRE (acquire mode) Query**



Figure 4-29. ACQUIRE Query Syntax Diagram.

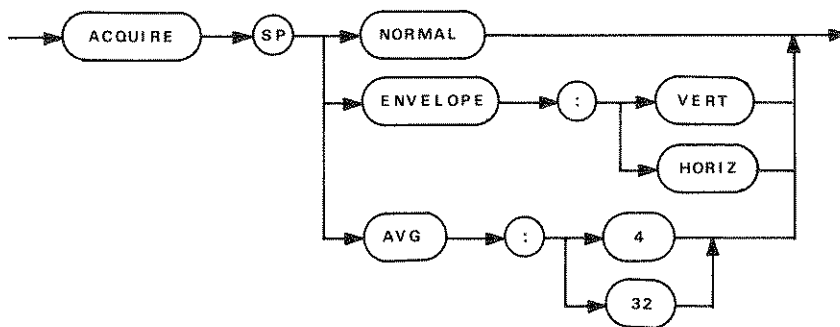


Figure 4-30. ACQUIRE Query Response.

**MAG (MAG mode) Command**

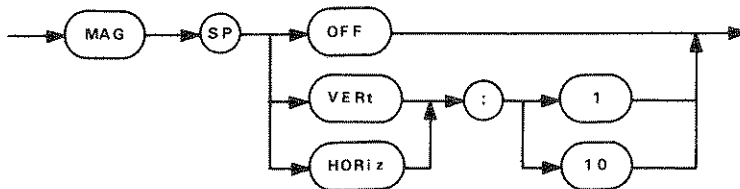


Figure 4-31. MAG Command Syntax Diagram.

OFF— Display magnification is disabled. (The display offset is cancelled in this mode.)

VERT : 1,— The vertical display MAG (VERT x 1 or VERT 10) is enabled.  
VERT : 10

HORIZ:1,— The horizontal display MAG (HORIZ x 1 or HORIZ x 10) is enabled.  
HORIZ:10

**MAG (MAG mode) Query**

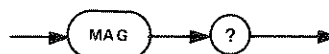


Figure 4-32. MAG Query Syntax Diagram.

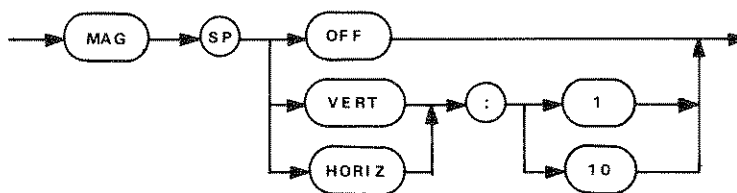


Figure 4-33. MAG Query Response.

**CURSOR CONTROL COMMAND GROUP**

The commands in this group set and change the cursor mode and position.

**CURSOR (cursor off) command**

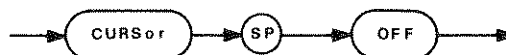


Figure 4-34. CURSOR Command Syntax Diagram.

Currently displayed cursor (dot, cross-hair or window) disappears. There is no CURSOR query.

**DOT (dot cursor) command**

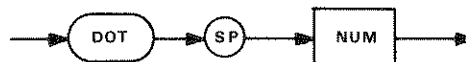


Figure 4-35. DOT Command Syntax Diagram.

NUM— Sets the DOT cursor on the characteristic curve data. The characteristic curve data consists of 1024 dots. The argument range is 1—1024.

DOT (dot cursor) query

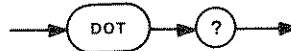


Figure 4-36. DOT Query Syntax Diagram.

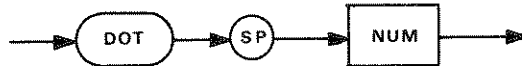


Figure 4-37. DOT Query Response Syntax Diagram.

CROSS (cross-hair cursor) Command

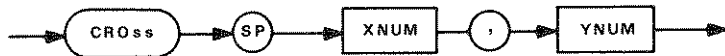


Figure 4-38. CROSS Command Syntax Diagram.

XNUM, YNUM— Positions the cross-hair cursor according to the arguments (range is 0-1000). XNUM sets horizontal position and YNUM sets vertical position.

CROSS (cross-hair cursor) query

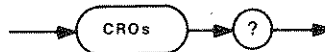


Figure 4-39. CROSS Query Syntax Diagram.

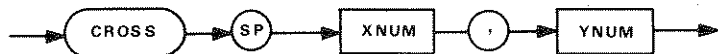
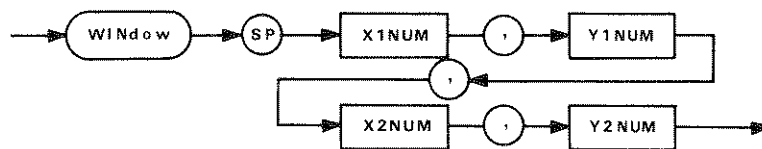


Figure 4-40. CROSS Query Response Syntax Diagram.



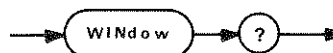
**WINDOW (window cursor) Command**



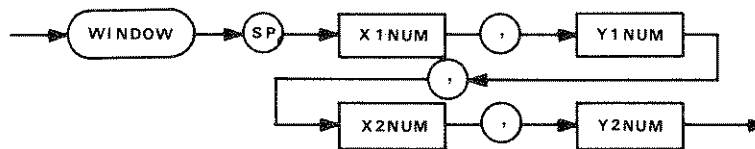
**Figure 4-41. WINDOW Command Syntax Diagram.**

X1NUM, Y1NUM,— Selects and positions the window cursor to the arguments (range is 0-1000). X1NUM and Y1NUM correspond to horizontal and vertical position for the lower-left corner of the window, and X2NUM and Y2NUM for the upper-right corner.

**WINDOW (window cursor) query**



**Figure 4-42. WINDOW Query Syntax Diagram.**

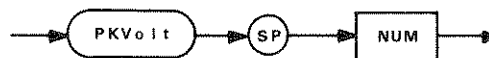


**Figure 4-43. WINDOW Query Response Syntax Diagram.**

**COLLECTOR SUPPLY CONTROL COMMAND GROUP**

These commands set the max peak volts (PKVOLT), max peak power (PKPOWER), collector supply polarity (CSPOL), variable collector supply (VCSUPPLY), and report High-Low switch status (HILOWSW?).

**PKVOLT (max peak volts) command**



**Figure 4-44. PKVOLT Command Syntax Diagram.**

**Programming—370**

NUM—  
Sets the max peak volts to the argument.

Argument	Max peak volts
16≤80	16 (V)
80≤400	80 (V)
400≤2000	400 (V)

**NOTE**

When the collector supply High-Low switch is HIGH, the PKVOLT command is ignored.

**PKVOLT (max peak volts) Query**

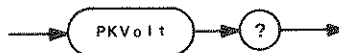


Figure 4-45. PKVOLT Query Syntax Diagram.



Figure 4-46. PKVOLT Query Response.

**PKPOWER (max peak power watts) Command**

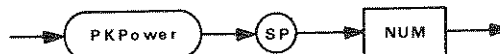


Figure 4-47. PKPOWER Command Syntax Diagram.

NUM— Sets the max peak power to the argument:

Argument	Max peak power
0.08 ≤ 0.4	0.08 (W)
0.4 ≤ 2.0	0.4 (W)
2.0 ≤ 10.0	2.0 (W)
10.0 ≤ 50.0	10.0 (W)
50.0 ≤ 220.0	50.0 (W)
220	220.0 (W)

**PKPOWER (max peak power watts) Query**

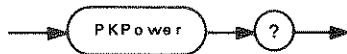


Figure 4-48. PKPOWER Query Syntax Diagram.

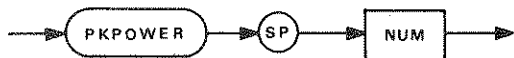


Figure 4-49. PKPOWER Query Response.

**CSPOL (collector supply polarity) Command**

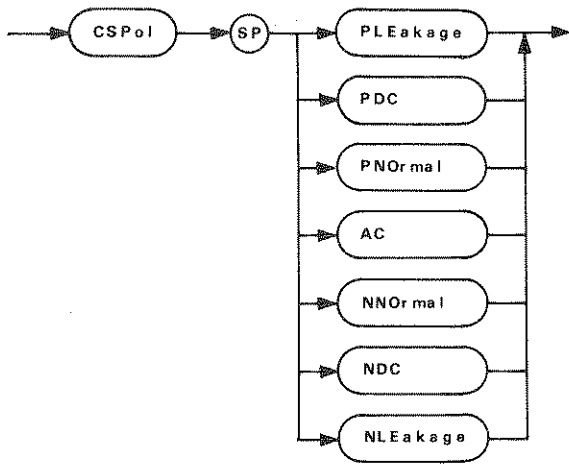


Figure 4-50. CSPOL Command Syntax Diagram.

The collector supply polarity is set to the argument:

Argument	Collector Supply polarity
PLEakage	+ LEAKAGE
PDC	+ DC
PNormal	+ (full-wave)
AC	AC
NNormal	- (full-wave)
NDC	-DC
NLEakage	-LEAKAGE

CSPOL (collector supply polarity) Query



Figure 4-51. CSPOL Query Syntax Diagram.

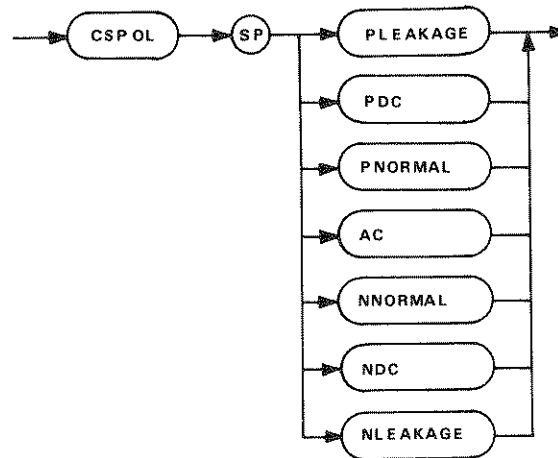


Figure 4-52. CSPOL Query Response Syntax Diagram.

**VCSPPLY (variable collector supply) Command**



**Figure 4-53. VCSPPLY Command Syntax Diagram.**

NUM—

Sets the variable collector supply output to the argument (range is 0.0-100.0). The variable collector supply is specified by the percentage of the selected max peak volts.

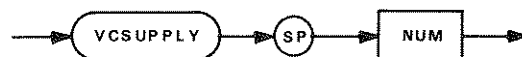
**NOTE**

*When the collector Supply is disabled (PULL is unlocked or series resistance is overheated), the VCSPPLY command is ignored.*

**VCSPPLY (variable collector supply) Query**

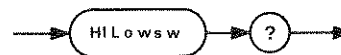


**Figure 4-54. VCSPPLY Query Syntax Diagram.**

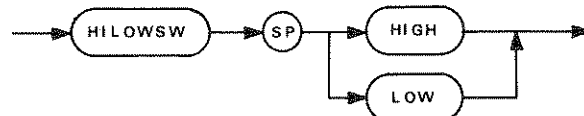


**Figure 4-55. VCSPPLY Query Response Syntax Diagram.**

**HILOSW (high-low switch status) Query**



**Figure 4-56. HILOSW Query Syntax Diagram.**



**Figure 4-57. HILOSW Query Response Syntax Diagram.**

**STEP GENERATOR CONTROL COMMAND GROUP**

These commands set step/offset amplitude, number of steps, step generator polarity, step multi .1X, pulse, current limit, and step offset.

**STPGEN (step/offset amplitude) Command**

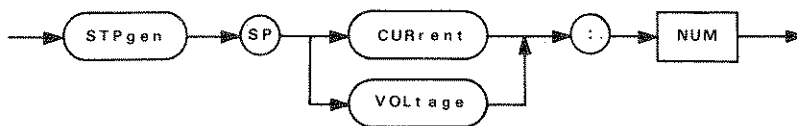


Figure 4-58. STPGEN Command Syntax Diagram.

- CURRENT— Step/offset amplitude is set to AMPS/step.
- VOLTAGE— Step/offset amplitude is set to VOLTS/step.
- NUM— Step/offset amplitude (amps/step or volts/step) is set to the argument in the following table:

Argument	Step/offset amplitude
5.OE-8 ≤ 1.OE-7	50 nA (CURRENT)
1.OE-7 ≤ 2.OE-7	100 nA (CURRENT)
2.OE-7 ≤ 5.OE-7	200 nA (CURRENT)
5.OE-7 ≤ 1.OE-6	500 nA (CURRENT)
1.OE-6 ≤ 2.OE-6	1 μA (CURRENT)
2.OE-6 ≤ 5.OE-6	2 μA (CURRENT)
5.OE-6 ≤ 1.OE-5	5 μA (CURRENT)
1.OE-5 ≤ 2.OE-5	10 μA (CURRENT)
2.OE-5 ≤ 5.OE-5	20 μA (CURRENT)
5.OE-5 ≤ 1.OE-4	50 μA (CURRENT)
1.OE-4 ≤ 2.OE-4	100 μA (CURRENT)
2.OE-4 ≤ 5.OE-4	200 μA (CURRENT)
5.OE-4 ≤ 1.OE-3	500 μA (CURRENT)
1.OE-3 ≤ 2.OE-3	1 mA (CURRENT)
2.OE-3 ≤ 5.OE-3	2 mA (CURRENT)
5.OE-3 ≤ 1.OE-2	5 mA (CURRENT)
1.OE-2 ≤ 2.OE-2	10 mA (CURRENT)
2.OE-2 ≤ 5.OE-2	20 mA (CURRENT)
5.OE-2 ≤ 1.OE-1	50 mA (CURRENT)
1.OE-1 ≤ 2.OE-1	100 mA (CURRENT)
2.OE-1	200 mA (CURRENT)

Argument	Step/offset amplitude
$5.0E-2 \leq 1.0E-1$	50 mV (VOLTAGE)
$1.0E-1 \leq 2.0E-1$	100 mV (VOLTAGE)
$2.0E-1 \leq 5.0E-1$	200 mV (VOLTAGE)
$5.0E-1 \leq 1.0E+0$	500 mV (VOLTAGE)
$1.0E+0 \leq 2.0E+0$	1 V (VOLTAGE)
$2.0E+0$	2 V (VOLTAGE)

**STPGEN (number of steps) command**



Figure 4-59. STPGEN Command Syntax Diagram.

NUM— Sets number of steps specified by argument (range is 0-10).

**STPGEN (step generator invert) Command**

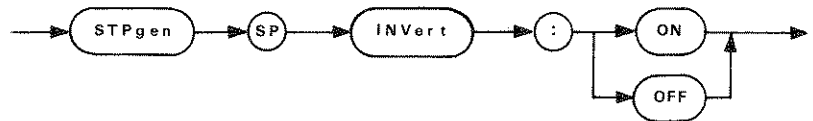


Figure 4-60. STPGEN (invert) Command Syntax Diagram.

ON— Selects step generator invert mode.

OFF— Selects step generator normal mode.

**STPGEN (step generator multi .1X) Command**



Figure 4-61. STPGEN (multi .1X) Command Syntax Diagram.

- ON— Selects step generator .1X multiplier.
- OFF— Turns off step generator .1X multiplier

**STPGEN (pulse mode) Command**

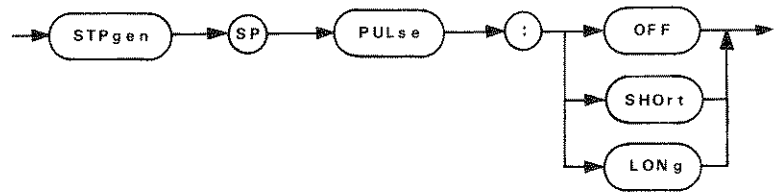


Figure 4-62. STPGEN (pulse) Command Syntax Diagram.

- OFF— Disables pulse mode.
- SHORT— Enables 80-microsecond pulse mode.
- LONG— Enables 300-microsecond pulse mode.

**STPGEN (current limit) Command**



Figure 4-63. STPGEN (current limit) Command Syntax Diagram.

- NUM— Sets Step Generator current limit to argument.

Argument	Current limit
0.02 ≤ 0.1	0.02 (A)
0.1 ≤ 0.5	0.1 (A)
0.5 ≤ 2.0	0.5 (A)
2.0	2.0 (A)



**STPGEN (step generator offset) Command**



Figure 4-64. STPGEN (offset) Command Syntax Diagram.

NUM— Sets the step generator offset value to the argument (range is -10.00 - +10.00).

**STPGEN (step generator) Query**

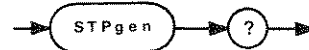


Figure 4-65. STPGEN Query Syntax Diagram.

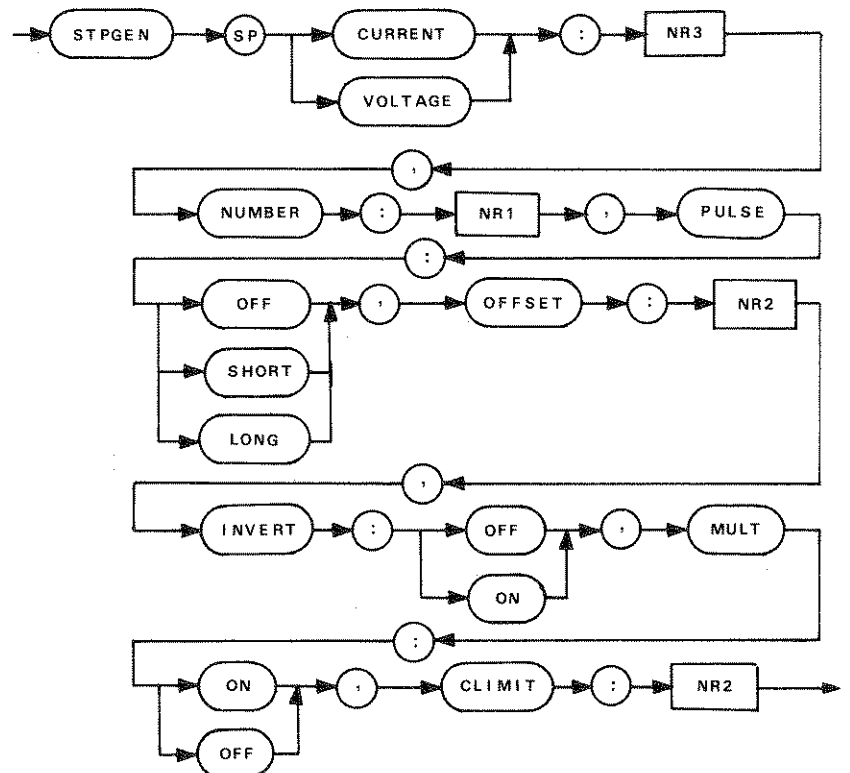


Figure 4-66. STPGEN Query Response Syntax Diagram.

**CONFIGURATION COMMAND GROUP**

The configuration command (CONFIG) selects the base and emitter terminal connections.

**CONFIG (terminal mode) Command**

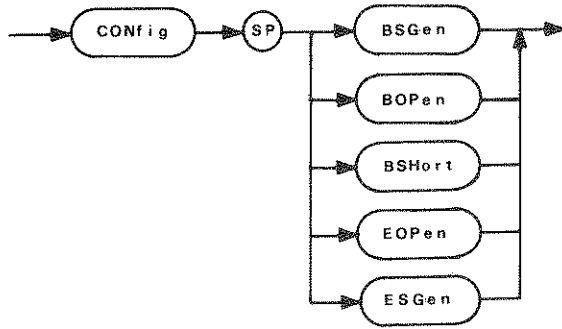


Figure 4-67. CONFIG Syntax Diagram.

Argument	BASE terminal	EMITTER terminal
BSGEN	STEP GENERATOR	common
BOPEN	OPEN (EXT)	common
BSHORT	SHORT (EMITTER)	common
EOPEN	common	OPEN (EXT)
ESGEN	common	STEP GENERATOR

**CONFIG (terminal mode) Query**



Figure 4-68. CONFIG Query Syntax Diagram.

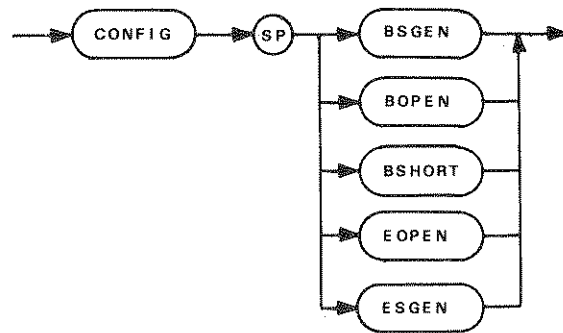


Figure 4-69. CONFIG Query Response Syntax Diagram.

**OTHER COMMANDS**

The commands and queries in this group set measurement mode (MEASURE), recall settings from Bubble Memory (RECALL), store setting in Bubble Memory (SAVE), plot display data (PLOT), request plot status (PSTATUS?), set auxiliary output supply (AUX), report LEFT-RIGHT-STANDBY switch status (LRSSW?), and request protective cover status (COVER?).

**MEASURE (measurement mode) Command**

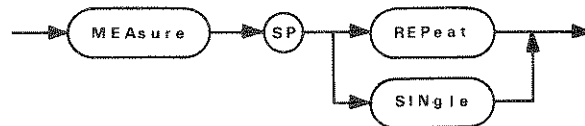


Figure 4-70. MEASURE Command Syntax Diagram.

REPEAT— Enables repetitive stimulation and measurement.

SINGLE— Enables single stimulation and measurement.

**MEASURE (measurement mode) Query**

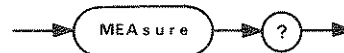


Figure 4-71. MEASURE Query Syntax Diagram.

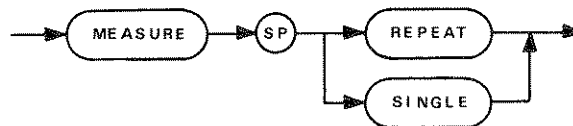


Figure 4-72. MEASURE Query Response Syntax Diagram.

**RECALL (recall settings) Command**

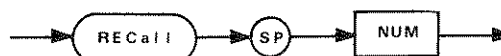


Figure 4-73. RECALL Command Syntax Diagram.

NUM— Recalls control settings from the selected Bubble Memory page (range is 1-16).

There is no RECALL query.

**SAVE (store settings) Command**

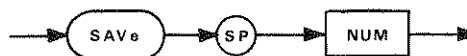


Figure 4-74. Save Command Syntax Diagram.

NUM— Loads the 370 control settings into the selected Bubble Memory page (range is 1-16).

There is no SAVE query.

**PLOT (plot data) command**

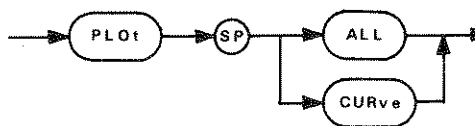


Figure 4-75. PLOT Command Syntax Diagram.

ALL— Outputs all the displayed STORE or VIEW information to a plotter via an 8-bit parallel port.

CURVE— Outputs the displayed STORE or VIEW curve data to a plotter via an 8-bit parallel port.

**NOTE**

To start the plotting operation, either STORE or VIEW mode must be selected. The PLOT command is ignored when the NON STORE or COMPARE mode is selected.

**PSTATUS (plot status) Query**

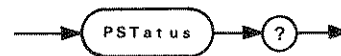


Figure 4-76. PSTATUS Query Syntax Diagram.

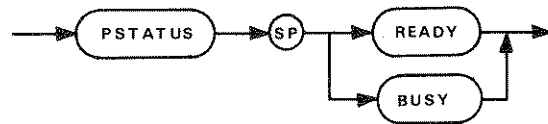


Figure 4-77. PSTATUS Query Response Syntax Diagram.

READY— Plotter is idle.

BUSY— Plotter is busy.

**AUX (set auxiliary supply) Command**

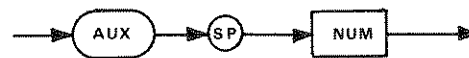


Figure 4-78. AUX Command Syntax Diagram.

NUM— Sets auxiliary supply voltage to the argument (range is -40.00 - +40.00). The resolution of output voltage is 0.02 V. (Less than the resolution is rounded down.)

**AUX Query**

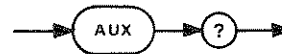


Figure 4-79. AUX Query Syntax Diagram.

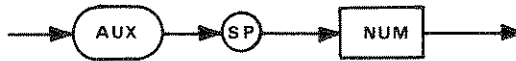


Figure 4-80. AUX Query Response Syntax Diagram.

LRSSW (LEFT-RIGHT-STANDBY switch status) Query

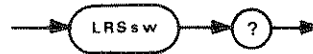


Figure 4-81. LRSSW Query Syntax Diagram.

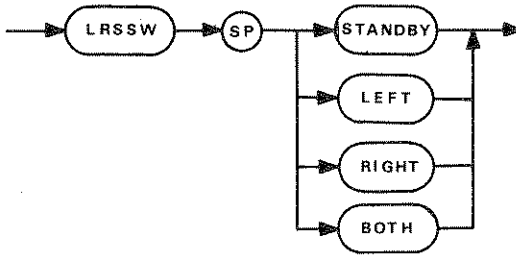


Figure 4-82. LRSSW Query Response Syntax Diagram.

- LEFT— LEFT-RIGHT-STANDBY control is set to LEFT.
- RIGHT— LEFT-RIGHT-STANDBY control is set to RIGHT.
- STANDBY— LEFT-RIGHT-STANDBY switch is set to STANDBY.
- BOTH— LEFT-RIGHT-STANDBY switch is set to both (LEFT and RIGHT).

**DISPLAY-DATA AND CRT READOUT I/O**

These commands and queries display data and crt readout, and transfer display and readout data to and from the 370.

**Table 4-3**  
**DISPLAY-DATA AND CRT READOUT I/O COMMANDS AND QUERIES**

<b>Unit:</b>	<b>Function</b>
<b>Waveform Transfer Command Group</b>	
WFMPRE	Sends waveform parameters to 370
WFMPRE?	Requests waveform parameters from 370
CURVE	Sends binary waveform data to 370
CURVE?	Requests binary waveform data from 370
WAVFRM?	Requests waveform parameters and binary waveform
<b>CRT Readout Transfer Command Group</b>	
READOUT?	Request cursor readouts
TEXT	Send text messages to 370
TEXT?	Request text messages from 370

**WAVEFORM TRANSFER COMMAND GROUP**

The 370 complies with the Tektronix Interface Standard for GPIB Codes, Formats, Conventions, and Features for waveform transfer. Waveform transfers begin with a waveform preamble (WFMPRE) that identifies and scales the data, and ends with data (CURVE) that represents the waveform. A command (WAVFRM) returns the responses to the WFMPRE and CURVE queries.

Up to sixteen different waveforms may be acquired and stored in the 370 Bubble Memory for later use. These can be selected at random, stored in any order, and displayed on the crt when the VIEW mode is selected.

## Programming—370

---

The waveform data consists of two parts.

1. The preamble, which contains items such as waveform size, scaling information, format specifications, and similar items required to determine co-ordinate value, and auxiliary information strings and units.
2. The curve, a set of data that contains the curve co-ordinates and attributes. Waveform transmissions may include both preamble and curve data, or either one can be sent alone. Separate query message may be used to elicit preamble data, curve data, or both.

### NOTE

*For proper interpretation of curve data, a preamble must be transmitted for the selected waveform destination before any waveforms are sent.*

### **WFMPRE (waveform preamble) command**

This command is shown in two forms. The upper response is returned for a waveform "number of points" query in ASCII. The lower response is returned for a binary-encoded waveform.



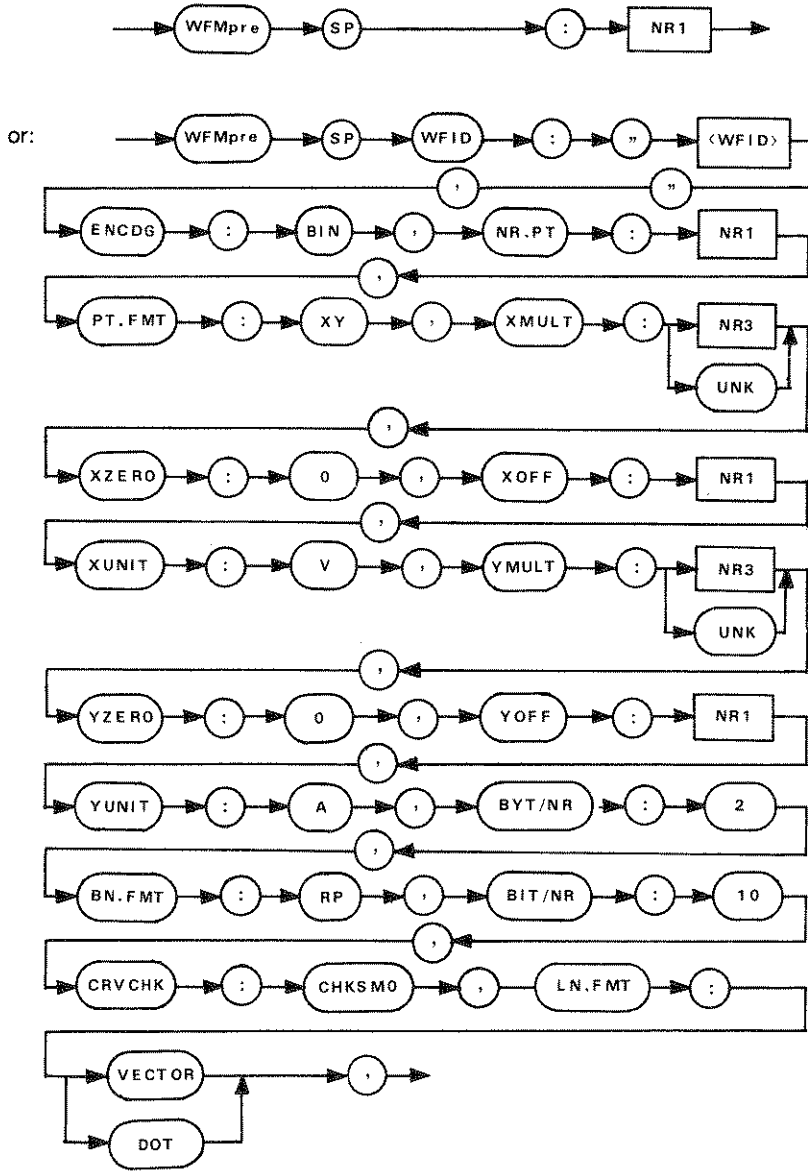


Figure 4-83. WFMPRE Command Syntax Diagram.

<WFID>— Represents the memory location number and the readout characters associated with the display curve.

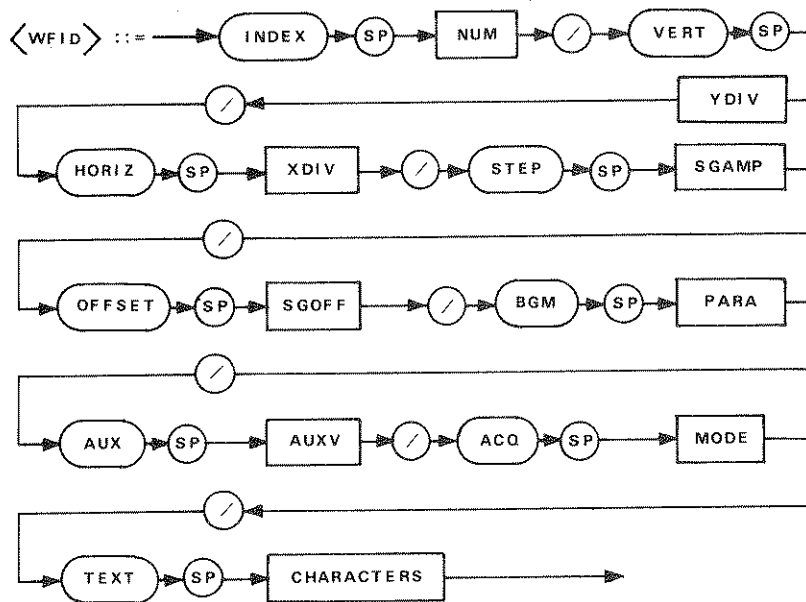


Figure 4-84. <WFID> Syntax Diagram.

- NUM— Specifies Bubble Memory Index Number where the current source waveform will be stored.
- YDIV— Specifies the vertical sensitivity setting to be stored in the Bubble Memory (8 characters).
- XDIV— Specifies the horizontal sensitivity setting to be stored in the Bubble Memory (8 characters).
- SGAMP— Specifies the step/offset amplitude setting to be stored in the Bubble Memory (8 characters).
- SGOFF— Specifies the step generator offset setting to be stored in the Bubble Memory (8 characters).
- PARA— Specifies the Beta or gm setting to be stored in the Bubble Memory (8 characters).

AUXV—	Specifies the AUX setting to be stored in the Bubble Memory (8 characters).
MODE—	Specifies the acquisition mode stored in the Bubble Memory (3 characters): NOR:: = Acquired with NORMAL mode ENV:: = Acquired with vertical or horizontal ENVELOPE mode AVG:: = Acquired with 4 or 32 AVERAGE mode
CHARACTERS—	Specifies the text characters stored in the Bubble Memory (24 characters).
ENCDG:BIN—	Means that binary numbers are used for data transfer.
NR.PT—	Specifies maximum 1024 points in the curve to follow.
PT.FMT:XY—	Means that both X and Y values of each point are transmitted explicitly.
XMULT—	Scales the X values. UNK means the scale factor is unknown.
XZERO:0—	Points to the X origin.
XOFF—	Relates X data to the X origin by the NR1 offset.
XUNIT:V—	Identifies the horizontal display unit (volts).
YMULT—	Scales the Y values. UNK means the unknown scale factor.
YZERO:0—	Points to the Y origin.
YOFF—	Relates Y data to the Y origin by the NR1 offset.
YUNIT:A—	Identifies the vertical display unit (amps).
BYT/NR:2—	Means that binary numbers are transferred as two bytes.
BN.FMT:RP—	Means that binary number stands for a binary positive integer.
BIT/NR:10—	Indicates the precision of the binary numbers.
CRVCHK:CHKSMO—	Specifies that the last byte of binary transfer is a 2's complement, modulo-256 checksum for the preceding bytes (except for the first byte, which is a percent sign parser).
VECTOR:: =	Vector drawing format
DOT:: =	DOT drawing format

**X and Y-Axis Scaling**

X-axis specifications XMULT, XZERO, and XOFF interpret the data as the absolute value of the ordered data points.

$$XN = XZERO + XMULT * (XVALN - XOFF) \text{ where:}$$

XN is the value in XUNITS of point number N, and XVALN is the unscaled integer data at point N

Y-axis specifications YMULT, YZERO, and YOFF interpret the data as the absolute value of the ordered data points.

$$YN = YZERO + YMULT * (YVALN - YOFF) \text{ where:}$$

YN is the value in YUNITS of point number N, and YVALN is the unscaled integer data at point N

**WFMPRE (waveform preamble) Query**



Figure 4-85. WFMPRE Query Syntax Diagram.

WFMPre?— The 370 responds with the current source waveform preamble.

WFMPre?— The 370 responds with the current source waveform points/waveform.



Figure 4-86. WFMPRE NR.PT Query Response Syntax Diagram.

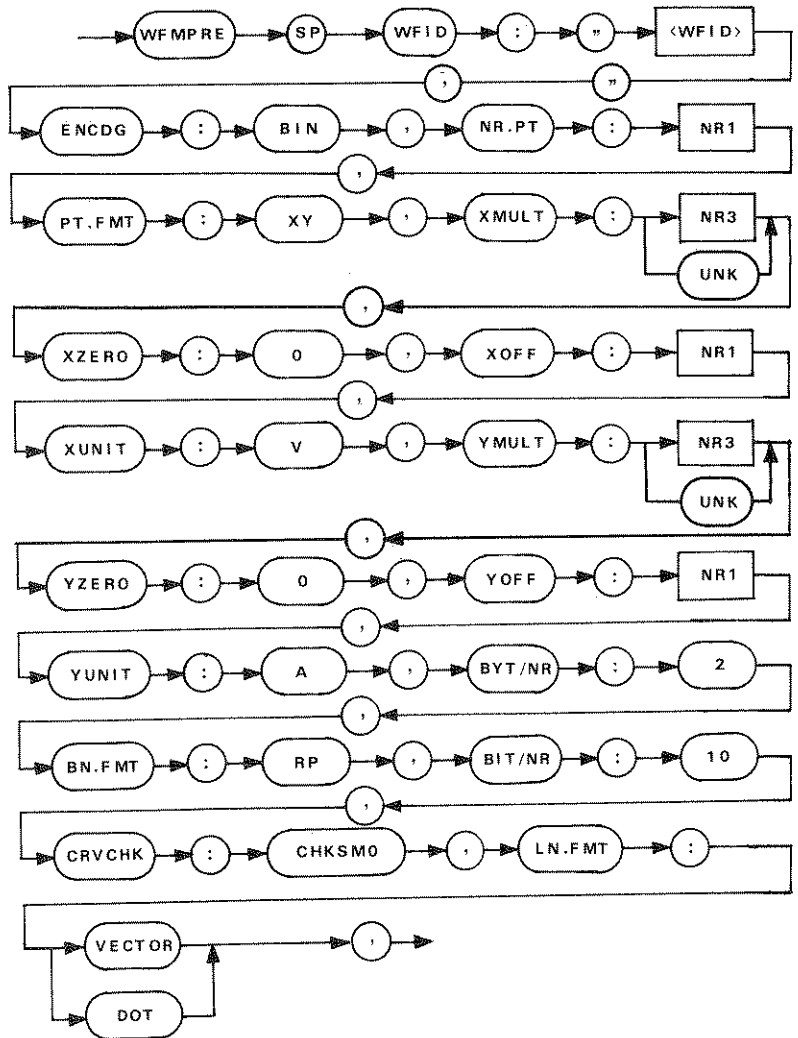


Figure 4-87. WFMPRE Query Response Syntax Diagram.

**CURVE (display curve) Command**

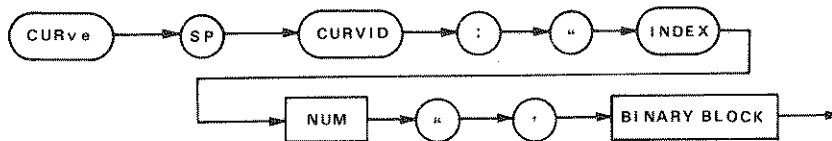


Figure 4-88. CURVE Command Syntax Diagram.

NUM— Loads binary block data into the designated Bubble Memory page (range is 1-16).

BINARY BLOCK— A binary block is a sequence of binary numbers that follows the ASCII code for percent(%) and a two-byte binary integer representing the number of binary numbers plus one and followed by the checksum (extra byte is checksum). The checksum is the 2's complement of the modulo-256 sum of all preceding bytes except the first (%). Thus, the modulo-256 sum of all bytes except the first (%) should equal zero to provide an error check of the binary block transfer.

**CURVE (display curve) Query**



Figure 4-89. CURVE Query Syntax Diagram.

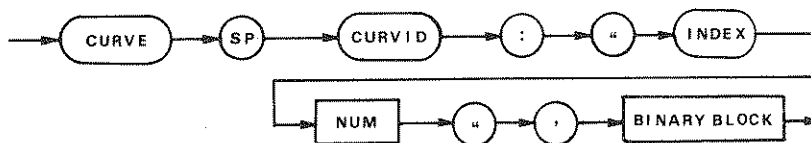


Figure 4-90. CURVE Query Response Syntax Diagram.

**WAVFRM (waveform) Query**

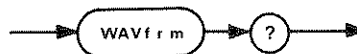


Figure 4-91. WAVFRM Query Syntax Diagram.

The WAVFRM query response is the same as WFMPRE?;CURVE?.

The complete waveform can be transmitted from the 370 using the query WAVFRM?.

**CRT READOUT TRANSFER COMMAND GROUP**

**Crt readout transfers take two major forms:**

1. Readout, which conveys the cursor readout displayed on the crt.
2. Text, which conveys messages to and from the crt by way of the GPIB.

**READOUT (cursor readout) Query**

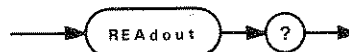


Figure 4-92. Readout Query Syntax Diagram.

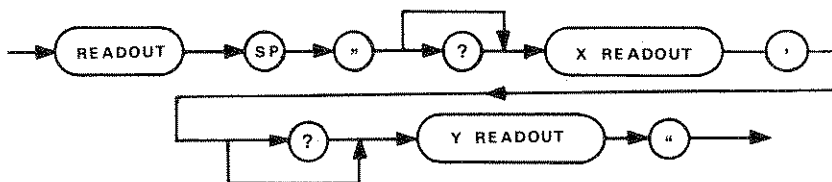


Figure 4-93. READOUT Query Response Syntax Diagram.

**X and Y READOUT—** The 370 returns the cursor readout characters display on the crt. Both X and Y consist of eight characters.

**?—** When data overflows in the dot cursor mode, "?" is added to the beginning of each readout.

**TEXT (display text) Command**



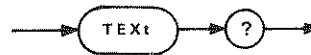
**Figure 4-94. TEXT Command Syntax Diagram.**

**CHARACTERS—** TEXT characters are displayed on the top row of of the crt text area. The text consists of no more than 24 characters.

**NOTE**

*The characters that can be displayed are from character 32 (SP) through 126 (~). The control characters are considered as space characters, except for 13 (CR) and 10 (LF). Neither CR nor LF are available as text characters. If the 117 (u) character is received, it is converted and displayed as "μ" on the crt.*

**TEXT (display text) Query**



**Figure 4-95. TEXT Query Syntax Diagram.**



**Figure 4-96. TEXT Query Response Syntax Diagram.**



## SYSTEM COMMANDS AND QUERIES

### INTRODUCTION

The 370 device-dependent message units set and return parameters of use to the controller in a GPIB system. These commands and queries are listed in Table 4-4 and described in two groups, related to instrument parameters, and status and error reporting.

Table 4-4  
SYSTEM COMMANDS AND QUERIES

Message Unit	Function
<b>Instrument Parameter Command Group</b>	
SET?	Returns values of setting parameters
INIT	Resets programmable parameters to power-up values
TEST?	Initiates diagnostic routine
ID?	Returns model and firmware version number
HELP?	Returns a list of all valid command headers
<b>Status and Error Reporting</b>	
RQS,RQS?	Turns on/off and queries RQS message function
Status Byte	Serial poll response
OPC,OPC?	Turns on/off and queries OPC message function
EVENT?	Returns error condition reported in last status byte

### INSTRUMENT PARAMETER COMMAND GROUP

The queries (SET? and ID?) and commands (INIT and TEST?) in this group return settings and identification parameters, initialize settings, and check the system ROMs and RAMs.

#### SET (instrument settings) Query



Figure 4-97. SET Query Syntax Diagram.

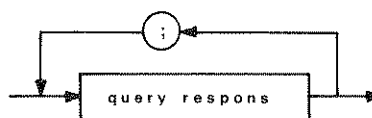


Figure 4-98. SET query Response Syntax Diagram.

## Programming—370

---

The response to the SET query is equivalent to the following query responses:

CONFIG?, CSPOL?, ACQUIRE:, HORIZ?, VERT?, MAG?, DISPLAY?, STPGEN?,  
PKPOWER?, PDVOLT?, VCSPPLY?, AUX?, MEASURE?, REQ?, OPC?, HILOWSW?,  
Cursor Mode.

Where Cursor Mode depends on the current 370 cursor mode (CURSOR OFF or DOT  
<NR1> or CROSS <NR1>, <NR1> or WINDOW <NR1>, <NR1>, <NR1>,  
<NR1>).

The instrument returns a string of commands that can be "learned" for later transfer to  
the 370 when the same setup is desired. The response includes non-programmable  
control commands such as HIGH-LOW Switch status.

### INIT (initialize settings) Command

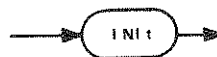


Figure 4-99. INIT Command Syntax Diagram.

INIT resets the instrument the same as if the power was turned off, then turned back on. The instrument functions are reset as follows:

Function	Initial Value
DISPLAY	STORE
CURSOR	OFF
DISPLAY CRTCAL:	OFF
DISPLAY INVERT:	OFF
MEASURE	REPEAT
ACQUIRE	NORMAL
MAG	OFF
VERT OFFSET:	0.00
HORIZ OFFSET:	0.00
VERT COLLECTOR:	2.0E+0
HORIZ COLLECTOR:	2.0E+2
STPGEN CURRENT:	50.0E-9
STPGEN OFFSET:	0.0
STPGEN CLIMIT:	0.02
STPGEN MULTI:	OFF
STPGEN PULSE:	OFF
STPGEN INVERT:	OFF
STPGEN NUMBER:	5
VCSPPPLY	0.0
PKVOLT	16
PKPOWER	0.08
CSPOL	PNORMAL
CONFIG	BSGEN
AUX	0.00
OPC	OFF
RQS	ON

**TEST (internal test) Query**



Figure 4-100. TEST Query Syntax Diagram.

This command checks the system ROMs and RAMs.

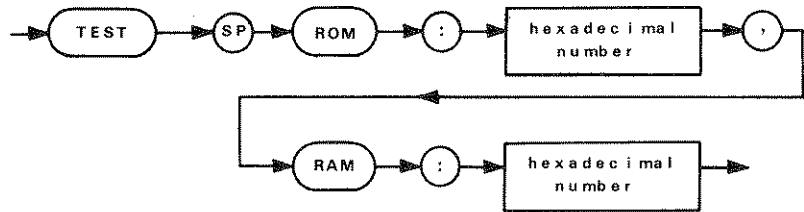


Figure 4-101. TEST query Response Syntax Diagram.

The TEST query response consists of two hexadecimal numbers that indicate if a ROM or RAM IC is found defective. If all ROMs and RAMs are good, the TEST query response is ROM:0000,RAM:0000. When any digit is not equal to zero, contact your local Tektronix Field Service Representative.

**ID (identify) Query**



Figure 4-102. ID Query Syntax Diagram.

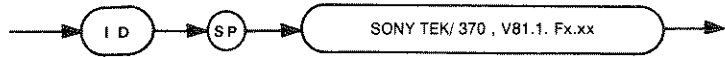


Figure 4-103. ID Query Response Syntax Diagram.

Fx.xx: Instrument firmware version number

**HELP (list of command headers) Query**



Figure 4-104. HELP Query Syntax Diagram.

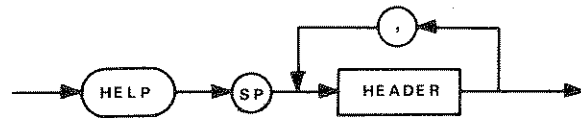


Figure 4-105. HELP Query Response Syntax Diagram.

The response includes a list of all command headers in the 370 GPIB command.

**STATUS AND ERROR REPORTING COMMAND GROUP**

The RQS command controls 370 service requests. The status byte reports instrument status in a format that implements both IEEE 488 and the Tektronix interface Standard for GPIB Codes, Formats, Conventions, and Features. The OPC command controls the 370 operation-complete service request. The Event Query returns detailed information about events reported in the last serial poll status byte.

Responses to the controller are divided into two classes:

1. The status byte is used as a general response. For example, power on, internal error, command error, execution error are all status bytes, and are meant to indicate the general class of condition that initiated the SRQ.
2. The event code subclassifies SRQ responses at a level that is much more specific than that of the status byte.

Status bytes are not stacked; that is, only the current status byte (in the interface) and status byte pending are saved.

**RQS (request service) Command**

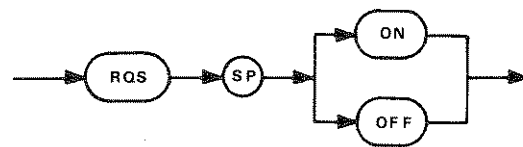


Figure 4-106. RQS Command Syntax Diagram.

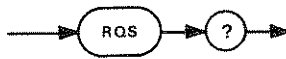
**Programming—370**

- ON— SRQ is asserted when abnormal status conditions occur. Power-up default is ON.
- OFF SRQ is not asserted (is masked) when abnormal status conditions occur.

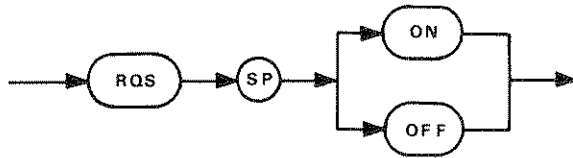
**NOTE**

*When RQS OFF is selected, the 370 responds to a serial poll with status byte of zero.*

**RQS (request service) Query**



**Figure 4-107. RQS Query Syntax Diagram.**



**Figure 4-108. RQS Query Response Syntax Diagram.**

**Status byte (response to serial poll)**

8	7	6	5	4	3	2	1	Decimal	Condition
0	1	0	0	0	0	0	1	65	Power on
0	1	0	0	0	0	1	0	66	Operation-complete
0	1	0	0	0	0	1	1	67	User request
0	1	0	0	0	1	0	0	68	Plotter output complete
0	1	0	0	0	1	0	1	69	Collector supply recover
0	1	1	0	0	0	0	1	97	Command error
0	1	1	0	0	0	1	0	98	Execution error
0	1	1	0	0	0	1	1	99	Internal error

Bits 1 through 4 are the four-bit status code;  
 Bit 6 indicates abnormal (1), or normal (0) condition;

Bits 1 through 4 are the four-bit status code;

Bit 6 indicates abnormal (1), or normal (0) condition;

Bit 7 indicates SRQ asserted (depends on RQS command)

Power on— This occurs when the power is turned off, then turned back on.

Operation-complete— This status byte is set every time a single mode acquisition in store mode is completed.

User request— Occurs when the front-panel RQS key is pressed.

Plotter output-complete— This status byte is set when the 370 completes a plotter output operation.

Collector supply recover— This status byte is set when PLL error or Series-resistor overheat error is recovered.

Command error— This status byte is set when a message cannot be parsed or recognized.

Execution error— This status byte is set when a message is parsed and is recognized, but cannot be executed, such as AUX 50.

Internal error— This status byte indicates that a malfunction has been discovered that could cause the instrument to operate incorrectly.

**OPC (operation-complete service request) Command**

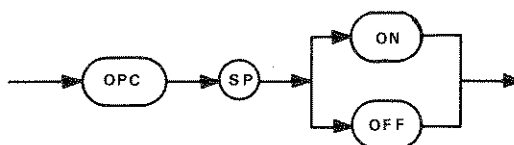


Figure 4-109. OPC Command Syntax Diagram.

This command enables or disables operation-complete service requests.

The 370 asserts the operation complete service request when a single measurement is completed in the STORE display mode. The initial value is OFF at power-up.

**OPC (operation-complete service request) Query**

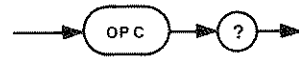


Figure 4-110. OPC Query Syntax Diagram.

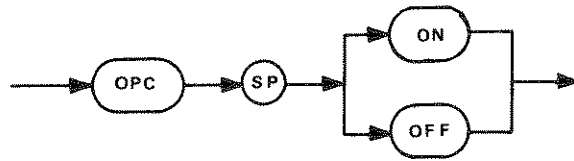


Figure 4-111. OPC Query Response Syntax Diagram.

**EVENT (event information) Query**



Figure 4-112. EVENT Query Syntax Diagram.

The EVENT query returns detailed information about the event reported in the last serial poll status byte.

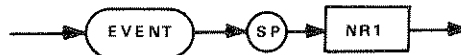


Figure 4-113. EVENT Query Response Syntax Diagram.



NR1 represents an event code defined in Table 4-5. The event is cleared when the event code is reported.

When RQS ON is selected, the 370 responds with the event code that corresponds to the current status byte. If the 370 is polled twice with no intervening event query, the event code that corresponds to the first status byte is discarded and lost. This occurs so that the relationship between the status byte and the corresponding event code will remain consistent.

When RQS OFF is selected, the 370 responds with the status report only by EVENT? query, and the status byte is always cleared. The 370 LIFO (Last In, First Out) Event Buffer retains the most recent ten event codes.

### Event Codes

The Tektronix interface Standard for GPIB Codes, Formats, Conventions, and Features specifies device-dependent event codes by class. Table 4-5 identifies each general class and lists the codes within that class.

**Table 4-5**  
**Status Byte and Event Code**

Status Byte	Event Code	Meaning
System Event		
0	0	No error
65	401	Power on
66	402	Operation complete (MASK OPC)
67	403	User request (RQS key)
68	404	Plotter output complete
69	405	Collector supply recovered
Command Error		
97	101	Command header error
	103	Command argument error
	106	Command syntax error
	108	Checksum error
	109	Byte count error
Execution Error		
98	201	Command not executable in local mode
	203	Output buffer overflow; remaining output lost
	204	Setting conflicts
	205	Argument out of range
Internal Error		
99	303	Phase lock system failed series Resistor is overheated
	305	Plotter fail
	306	Bubble I/O error
	307	

**COMMAND LIST**

Tables 4-6 through 4-8 list all 370 GPIB commands and queries. The first column lists the name or header of the command. The second column lists arguments associated with the command. The third column lists link arguments associated with the first argument. The last column lists brief descriptions of each command and the related argument.

BNF notation is used herein to define communication with the 370. The symbols are as follows:

- < > Defined element.
- :: = Is Defined As.
- { } Grouping.
- [ ] Optional, May Be Omitted.
- ! Exclusive Or (one or the other, but not both).
- ... May be repeated one or more times.

The division of classes and command groups conforms with 370 GPIB Commands discussed earlier.

**Table 4-6  
FRONT PANEL CONTROLS**

DISPLAY COMMAND GROUP			
Command	Argument	Link	Definition
DISplay	NSTore		Selects NON STORE mode.
	STOre		Selects STORE mode.
	VIEW	<NR1>	Selects VIEW mode. <index> ::= 1!2!...!16
	COMpare	<NR1>	Selects COMPARE mode. DISPLAY COMPARE:<index> <index> ::= 1!2!...!16
	INVert	ON OFF	Selects display invert mode. Disables display invert mode.
	CRTcal	ZERochk OFF CALchk	Sets the crt check mode.

Table 4-6 (cont)  
FRONT PANEL CONTROLS

DISPLAY COMMAND GROUP			
Command	Argument	Link	Definition
DISplay?			<p>Responds with display data. DISPLAY &lt;mode1&gt;,&lt;mode2&gt;,&lt;mode3&gt;</p> <p>&lt;mode1&gt; ::= NSTORE:STORE! VIEW:&lt;NR1&gt;! COMPARE: &lt;NR1&gt;</p> <p>&lt;mode2&gt; ::= INVERT:OFF! INVERT:ON</p> <p>&lt;mode3&gt; ::= CRTCAL: ZEROCHK! CRTCAL:OFF! CRTCAL:CALCHK</p>
ENTer	<NR1>		<p>Store the displayed curve data in the memory location specified by the argument. ENTER &lt;index&gt; &lt;index&gt; ::= 1:2:...:16</p>
VERT	STEp COLlect	<NRX>	<p>Selects vertical source and amps/div. Requires an NR1-3 type number for amps/div. Will return NR3 in query form. VERT &lt;source&gt;[:&lt;amp&gt;] Current ranges allowed: COLLECT &lt;amp&gt; ::= {1.0E-6 -2.0E+0} (COLLECTOR POLARITY not leakage mode) COLLECT &lt;amp&gt; ::= {1.0E-9 -2.0E-3} (COLLECTOR POLARITY leakage mode)</p>
	OFFset	<NR2>	<p>Sets vertical display offset VERT OFF:&lt;val&gt; &lt;val&gt; ::= ±10.0 by 0.5</p>

Table 4-6 (cont)  
FRONT PANEL CONTROLS

DISPLAY COMMAND GROUP			
Command	Argument	Link	Definition
VERT?			Responds with the vertical source, amps/div, and display offset: VERT <source> [:<amp>], OFFSET:<val> <source> ::= STEP   COLLECT <amp> ::= amps/div <val> ::= display offset value
HORiz	STEp		Selects the horizontal source and volt/div.
	COLlect BASE	<NRX> <NRX>	Use a NR1-3 type number for volt/div. Returns NR3 in query form Voltage ranges allowed: HORIZ <source> [:<volt>] COLLECT <volt> ::= {5.0E-2 -5.0E+2} BASE <volt> ::= {5.0E-2 -2.0E+0}
	OFFset	<NR2>	Sets horizontal display offset HORIZ OFFSET:<val> val ::= {±10.0 by 0.5}
HORiz?			Responds with horizontal source, volt/div and display offset: HORIZ <source> [:<volt>], OFFSET:<val> <source> ::= STEP   COLLECT   BASE <volt> ::= volt/div <val> ::= display offset value
ACQuire	ENVELOpe NORmal AVG	VERT HORiz  4 32	Sets the acquisition mode.
ACQuire?			Responds with the acquisition mode: ACQUIRE <mode> :<val> <mode> ::= ENVELOPE   NORMAL   AVG <val> ::= VERT   HORIZ   4   32

**Table 4-6 (cont)**  
**FRONT PANEL CONTROLS**

<b>DISPLAY COMMAND GROUP</b>			
<b>Command</b>	<b>Argument</b>	<b>Link</b>	<b>Definition</b>
MAG	VERT	1	Sets volt/div or amps/div magnifier to X 1 or X 10.
		10	
	OFF	1	
	HORiz	10	
MAG?			Responds with the magnifier mode: MAG <mode> [:<val>] <mode> ::= VERT ! OFF ! HORIZ <val> ::= 1 ! 10
<b>CURSOR CONTROL COMMAND GROUP</b>			
<b>Command</b>	<b>Argument</b>	<b>Link</b>	<b>Definition</b>
CURSor	OFF		Currently displayed cursor disappears. CURSOR OFF
DOT	<NR1>		Sets the dot cursor on the specified curve data position. DOT <data> <data> ::= curve data position {1 – 1024}
DOT?			Responds with the dot cursor position: DOT <NR1>
CROss	<NR1> <NR1>		Sets the cross-hair cursor to specified position on crt.  CROSS <data1>, <data2> <data1> ::= horizontal position {0 – 1000} <data2> ::= vertical position {0 – 1000}
CROss			Responds with the cross-hair cursor position: CROSS <NR1>, <NR1>

**Table 4-6 (cont)  
FRONT PANEL CONTROLS**

**DISPLAY COMMAND GROUP**

Command	Argument	Link	Definition
WINdow	<NR1>, <NR1>, <NR1>, <NR1>		Sets the window cursor to the specified position on crt.  WINDOW <data1>,<data2>,<data3>,<data4> <data1> ::= Lower-left horizontal {0-1000} <data2> ::= Lower-left vertical {0-1000} <data3> ::= Upper-right horizontal {0-1000} <data4> ::= Upper right vertical {0 - 1000}
WINdow?			Responds with the window position: WINDOW <NR1>,<NR1>,<NR1>,<NR1>

**COLLECTOR SUPPLY CONTROL COMMAND GROUP**

Command	Argument	Link	Definition
PKVolt	16  80 400		Sets maximum peak volts except 2000. Maximum peak volts 2000 must be set manually. PKVOLT <set> <set> ::= 16   80   400
PKVolt?			Responds with maximum peak volts: PKVOLT <set> <set> ::= 16   80   400   2000
PKPower	220.0 50.0 10.0 2.0 0.4 0.08		Sets max peak power in watts.  PKPOWER <set> <set> ::= 220.0   50.0   10.0   2.0   0.4   0.08
PKPower?			Responds with max peak watts: PKPOWER <set> <set> ::= 220.0   50.0   10.0   2.0   0.4   0.08

Table 4-6 (cont)  
FRONT PANEL CONTROLS

## COLLECTOR SUPPLY CONTROL COMMAND GROUP (cont)

Command	Argument	Link	Definition
CSPol	PLEakage PDC PNOrmal AC NNOormal NDC NLEakage		Selects collector supply polarity and mode.  CSPOL <mode> <mode> ::= PLE ! PDC ! PNO ! AC ! NNO ! NDC ! NLE PLE ::= +LEAKAGE, PDC ::= +DC PNOR ::= +(fullwave), AC ::= AC, NNOR ::= -(fullwave), NDC ::= -DC , NLE ::= -LEAKAGE
CSPol?			Reports collector supply polarity and mode: CSPOL <mode> <mode> ::= PLEAKAGE ! PDC ! PNORMAL ! AC ! NNORMAL ! NDC ! NLEAKAGE
VCSply	<NR2>		Sets the variable collector supply. The argument data is a percentage value. VCSPLY <data> <data> ::= 0.0 ± 100.0 (by 0.1 %)
VCSply?			Reports variable collector supply volts: VCSPLY <data> <data> ::= 0.0 ± 100.0 (by 0.1 %)
HILowsw?			Reports HIGH-LOW switch status: HILOWSW LOW ! HIGH

Table 4-6 (cont)  
FRONT PANEL CONTROLS

STEP GENERATOR COMMAND GROUP			
Command	Argument	Link	Definition
STPgen	CURrent VOLtage	<NRX> <NRX>	Sets step generator source to <amps/step> or <volt/step>. Requires NR1-3 input. STPGEN <source> ::= CUR!VOL:<val> Returns NR3. Step ranges allowed: CURRENT <val> ::= {5.0E-8 - 2.0E-1} VOLTAGE <val> ::= {5.0E-2 - 2.0E+0}
	NUMber	<NR1>	No. of steps to be generated. STPGEN NUMBER:<val> <val> ::= 0:1:2:...:10
	INVert	ON OFF	Sets step generator invert mode. STPGEN INVERT:<mode>
	MULt	ON OFF	Sets step generator .1X mode. STPGEN MULT:<mode>
	PULse	OFF SHORT LONG	Pulse duration 80 sec. 300 sec. STPGEN PULSE:<mode>
	CLimit	<NR2>	Sets step generator current limit STPGEN CLIMIT:<val> <val> ::= 0.02:0.1: 0.5:2.0
	OFFset	<NRX>	Sets Step Generator Offset STPGEN OFFSET:<val> <val> ::= {±10.0 by 0.1}



Table 4-6 (cont)  
FRONT PANEL CONTROLS

STEP GENERATOR COMMAND GROUP			
Command	Argument	Link	Definition
STPgen?			<p>Reports Step Generator source, amps/step or volts/step, number of steps, pulse mode, offset, invert mode, .1X mode, and current limit.</p> <p>STPGEN NUMBER: &lt;num&gt;, PULSE: &lt;pulse&gt;, OFFSET: &lt;offset&gt;, INVERT: &lt;invert&gt;, MULT: &lt;mult&gt;, CLIMIT: &lt;clim&gt;, &lt;amp&gt;</p> <p>&lt;num&gt; ::= number of steps (NR1)            &lt;pulse&gt; ::= pulse mode (ON ; OFF)            &lt;offset&gt; ::= step generator offset (NR2)            &lt;invert&gt; ::= step generator invert mode (ON ; OFF)            &lt;mult&gt; ::= step generator .1X mode (ON ; OFF)            &lt;clim&gt; ::= step generator current limit. (NR2)            &lt;amp&gt; ::= CURRENT:amps/div            VOLTAGE:volts/div</p>
CONFIGURATION COMMAND GROUP			
Command	Argument	Link	Definition
CONfig	BSGen BOPen BSHort ESGen EOPen		<p>Sets Configuration mode.</p> <p>CONFIG &lt;mode&gt;            &lt;mode&gt; ::= BSG ; BOP ; BSH            ESG ; EOP</p> <p>BSG ::= BASE STEP GEN &amp; EMITTER COMMON            BOP ::= BASE OPEN &amp; EMITTER COMMON            BSH ::= BASE SHORT &amp; EMITTER COMMON            ESG ::= BASE COMMON &amp; EMITTER STEP GEN            EOP ::= BASE COMMON &amp; EMITTER OPEN</p>

Table 4-6 (cont)  
FRONT PANEL CONTROLS

Command	Argument	Link	Definition
CONfig?			Reports configuration Config <mode> <mode> ::= BSGEN ; BOPEN ; BSHORT ; ESGEN ; EOPEN

OTHER COMMANDS

Command	Argument	Link	Definition
MEASURE	REPeat SINgle		Selects measurement mode. MEASURE <mode>
MEASURE?			Reports measurement mode: MEASURE REPEAT ; SINGLE
RECall	<NR1>		Recall front-panel setup data from memory location stated by argument. RECALL <index> <index> ::= 1 ; 2 ; ... ; 16
SAVe	<NR1>		Store the displayed setup data in the memory location stated by argument. SAVE <index> <index> ::= 1 ; 2 ; ... ; 16
PLOt	ALL CURve		Selects and starts plotter output. PLOT ALL ; CUR ALL ::= FULL mode CUR ::= CURVE mode
PSTATUS?			Reports plotter status PSTATUS READY ; BUSY READY ::= idle mode BUSY ::= busy mode
AUX	<NR2>		Sets AUX output voltage to argument value. <NR2> = ±40.000 by 0.02 increments.
AUX?			Reports AUX output voltage: AUX <data> <data> ::= ±40.00 (0.02 step)

Table 4-7  
 DISPLAY-DATA AND CRT READOUT I/O

OTHER COMMANDS			
Command	Argument	Link	Definition
LRSsw?			Reports LEFT-RIGHT-STANDBY switch status LRSSW LEFT : RIGHT : STANDBY : BOTH
WAVEFORM TRANSFER Command Group			
Command	Argument	Link	Definition
WFMpre	<string>		Load waveform preamble data. WFMpre WFID: <wfid>, ENCDG: BIN, NR.PT: <point>, PT.FMT: XY, XMULT: <x multi>, XZERO: 0, XOFF: <x off>, XUNIT: V, YMULT: <y multi>, YZERO: 0, YOFF: <y off>, YUNIT: A, BYT/NR: 2, BN.FMT: RP, BIT/NR: 10, CRVCHK: CHKSMO, LN.FMT: <format>  <wfid> ::= "INDEX <num>/ VERT <amp>/ HORIZ <volt>/STEP <step>/OFFSET <offset>/BGM <para>/AUX <aux>/ACQ <acq>/TEXT <txt>" <num> ::= Memory location number <amp> ::= Vertical amp/div readout <volt> ::= Horizontal volts/div readout <step> ::= Step amplitude readout

Table 4-7 (cont)  
 DISPLAY-DATA AND CRT READOUT I/O

WAVEFORM TRANSFER Command Group			
Command	Argument	Link	Definition
			<offset> ::= Step offset readout <para> ::= Beta or gm readout <aux> ::= Aux Supply readout <acq> ::= Curve acquisition mode (AVG ! NOR ! ENV) <txt> ::= Text area readout <point> ::= curve point no. (1 - 1024) <x multi> ::= <NR3> = horizontal scale factor <x off> ::= <NR1> = horizontal scale offset <y multi> ::= <NR3> = vertical scale factor <y off> ::= <NR1> = vertical scale offset <format> ::= VECTOR ! DOT
WFMpre		<NR1>	Sets input points no. from curve command (1 to 1024)
WFMpre?			When WFMpre? is received, 370 reports waveform preamble data: WFMpre WFID:"<wfid> ",ENCDG: BIN,NR.PT:<point>,PT.FMT: XY,XMULT:<x multi>,XZERO: 0,XOFF:<x off>,XUNIT:V, YMULT:<y multi>,YZERO:0, YOFF:<y off>,YUNIT:A,BYT/ NR:2,BN.FMT:RP,BIT/NR:10, CRVCHK:CHKSMO, LN.FMT:<format>  <wfid> ::= INDEX <num>/VERT <amp>/HORIZ <volt>/STEP <step>/OFFSET <offset>/BGM <para>/AUX <aux>/ACQ <acq> /TEXT <txt>

Table 4-7 (cont)  
 DISPLAY-DATA AND CRT READOUT I/O

WAVEFORM TRANSFER Command Group			
Command	Argument	Link	Definition
			<num> ::= Memory location number <amp> ::= Vertical amp/div readout <volt> ::= Horizontal volts/div readout <step> ::= Step amplitude readout <offset> ::= Step offset readout <para> ::= Beta or gm readout <aux> ::= Aux Supply readout <acq> ::= Curve acquisition mode (AVG   NOR   ENV) <txt> ::= Text area readout <point> ::= curve point no. (1 - 1024) <x multi> ::= <NR3> = horizontal scale factor <x off> ::= <NR1> = horizontal scale offset <y multi> ::= <NR3> = vertical scale factor <y off> ::= <NR1> = vertical scale offset <format> ::= VECTOR   DOT
WFMpre?		<NR1>	Reports NR.PT waveform preamble data. WFMPRE NR.PT:<point> <point> ::= 1   2   ...   1024
CURve	<string>		Loads curve data. CURVE CURVID:<crvid>, %<binary data> <crvid> ::= "INDEX <NR1>" <binary data> ::= <binary count> <binary point> <checksum>

Table 4-7 (cont)  
 DISPLAY-DATA AND CRT READOUT I/O

WAVEFORM TRANSFER Command Group			
Command	Argument	Link	Definition
CURve?			Reports curve data. CURVE CURVID:<crvid>, %<binary count> <binary point> <checksum> <crvid> ::= "INDEX <NR1>" <binary count> ::= two bytes representing no. of data points + 1 <binary point> ::= 8-bit byte (001...1FF) <checksum> ::= 2's complement of the modulo 256 sum of the preceding binary data bytes and binary count, except "%" preceding the binary data count.
WAVfrm?			Reports waveform preamble and curve data. Response is the same as is returned for WFMpre?;CURVE?
CRT READOUT TRANSFER Command Group			
Command	Argument	Link	Definition
REAdout?			Sends displayed cursor readout: READOUT <readout> <readout> ::= <amps>,<volts> <readout> ::= ? <amps>,<? <volts> (cursor is overflow)
TEXT	<string>		Displays text on crt. Text "<text>" <text> ::= max. 24 characters
TEXT?			Reports text on crt. Text "<text>" <text> ::= max. 24 characters

**Table 4-8  
SYSTEM COMMANDS and QUERIES**

INSTRUMENT PARAMETER Command Group			
Command	Argument	Link	Definition
SET?			Reports front-panel settings. Response is the same as returned for CONFIG?; CSPOL?; ACQUIRE?; HORIZ?; VERT?; MAG?; DISPLAY?; STPGEN?; PKPOWER?; PKVOLT?; AUX?; MEASURE?; RQS?; OPC?; HILOWSW? followed by cursor mode response.
INIT			Resets instrument as if the power was turned off, then turned back on. Instrument functions are reset as shown below.

Function	INIT Value	Function	INIT Value
DISPLAY	STORE	CURSOR	OFF
DISPLAY CRT	OFF	DISPLAY INV	OFF
HORIZ OFFSET	0.0	STP CUR	50.0E-9
STP OFF	0.0	STP PULSE	OFF
STP INV	OFF	PKPOWER	0.08
CSPOL	PNORMAL	HORIZ COL	2.0E+2
OPC	OFF	ACQ	NORMAL
MEASURE	REPEAT	MAG	OFF
VERT OFFSET:	0.0	AUX	0.00
STP NUM	5	STP CLI	0.02
STP MUL	OFF	VCS	0.0
PKVOLT	16	CONFIG	BSG
VERT COL:	2.0E+0	RQS	ON

Table 4-8 (cont)  
SYSTEM COMMANDS and QUERIES

INSTRUMENT PARAMETER Command Group			
Command	Argument	Link	Definition
TEST?			Initiates ROM and RAM check routine. TEST ROM: <hex>, RAM: <hex>
ID?			Reports the instrument ID: ID SONY-TEK/370, /V81.1, <fwv> <fwv> ::= current ! firmware version
HELp?			Reports list of all valid command headers: CONFIG,READOUT,TEXT,CROSS, DOT,WINDOW,CURSOR,DISPLAY, ACQUIRE,MAG,HORIZ,VERT, STPGEN,MEASURE,ENTER, RECALL,SAVE,PLOT, PSTATUS, HILOWSW.LRSSW,COVER,AUX, PKVOLT,PKPOWER,CSPOL, VCSPLY,WFMPE,CURVE, WAVFRM,RQS,OPC,EVENT, TEST,INIT,ID,SET
STATUS AND ERROR REPORTING Command Group			
Command	Argument	Link	Definition
RQS	ON OFF		Enable service requests. Disable service requests.
RQS?			Reports RQS status. RQS ON   OFF
OPC	ON OFF		Enables operation-complete service request. Disables operation-complete service request.
OPC?			Reports OPC status. OPC ON   OFF
EVEnt?			Returns detailed information about the event. EVENT <code> <code> ::= See Table 4-5.



## OPERATING HINTS

### INTRODUCTION

This section covers some techniques for programming the 370, using 4041 BASIC for examples.

### WAVEFORM DATA TRANSFER

The 370 waveform data consists of two parts, the waveform preamble and the curve data. As described earlier in this section, there are several methods to transfer waveform data to or from the 370. For detailed syntax information of waveform data transfer, see the syntax diagrams earlier in this section.

The following is a sample program to transfer waveform data from one portion of the 370 bubble memory or 4041 cartridge tape to any other portion of those memory devices. This program can be used in user application programs. The subprogram with the assumption that there are sixteen waveform files on the 4041 tape cartridge named WFM17 through WFM32, plus another sixteen files on the 370 bubble cassette.

```

1100 Sub cpwfm (s,d)
1110 If s>32 or s<1 then goto 1280
1120 If d>32 or d<0 then goto 1280
1130 Dim so$ to 50,de$ to 50
1140 If s>16 and s<33 then so$="tape (eom=<0>):wfm"&str$(s)
1150 If s<=16 and s>0 then so$="GPIB0 (pri=1,eom=<0>):"
1160 If d>16 and d<33 then de$="tape (eom=<0>):wfm"&str$(d)
1170 If d<=16 and d>0 then de$="GPIB0 (pri=1,eom=<0>):"
1180 If s>16 and s<33 then goto 1220
1190 Print #so$:"disp view:";s
1200 Wait 1
1210 Print #so$:"wav?"
1220 Input #so$:w$
1230 If d=0 then goto 1270
1240 Rep$(w$,pos(w$,"index",1),8)="index "&str$(d)
1250 Rep$(w$,pos(w$,"index",100),8)="index "&str$(d)
1260 print #de$:w$
1270 wbyte gtl (1)
1280 Return
1290 End

```

Line 1100            Name of the subprogram is cpwfm. This subprogram requires two integer parameters. s—source waveform file number  
d—destination waveform file number If the value of "d" is zero, there is no destination file assigned, but source waveform data is kept in string variable w\$.

Line 1110-1120    Avoid incorrect input for variable s and d.

## Programming—370

---

Line 1130-1170	Define I/O drivers according to the file numbers.
Line 1180	If the source file number indicates a tape file, skip next three lines.
Line 1190-1210	Send waveform data transfer commands to the 370.
Line 1220	Inputs waveform data from source file.
Line 1230	If the destination file number is zero, skip next three lines.
Line 1240-1250	Replace the "index" portion of the waveform data string with the number that reflects the new destination.
Line 1260	Send the waveform data to the destination.
Line 1270	Send "gtl (Go To Local) " command to the 370.
Line 1280-1290	End the subprogram and return to main routine.

To use the data for data processing or data graphing, some modification to the waveform data string is required.

Below is an example of converting the waveform data format.

```
800 Sub getcurv (w$)
810 Pr$=seg$ (w$,1,pos (w$,";",1))
820 Integer cv (val (gp$ ("nr.pt") *2)
830 Cd$=seg$ (w$,pos (w$,";",1)+1,4124)
840 Getmem buffer cd$ using "24x,16%":cv
850 Return
860 End
```

This subprogram separates the waveform data string (which is obtained by subprogram "cpwfm") into waveform preamble (pr\$) and integer curve data (cv).

Line 800	Name of the subprogram is "get curv". It requires waveform string data (w\$) as an input parameter.
Line 810	Get the position of a separator ";" that separates waveform preamble and curve data. Then, place the preamble portion into pr\$.
Line 820	Adequately dimension the integer array cv by a BASIC function "gp\$" (Described later).
Line 830	Put the rest of the string data of w\$ into cd\$.
Line 840	Ignoring the first twenty-four characters (header portion) from cd\$, the binary block data is automatically converted to integer data array "cv".

Line 850-860           End subprogram and return to main routine.

### Adding Miscellaneous Waveform Preamble Data

The waveform preamble data contains various information, such as waveform scale factors, text displayed on the crt, etc. Through the use of record separators like the semicolon ";", comma ",", and space, or sometimes "/", each message unit can easily be separated out from the waveform preamble data string.

The next two examples are BASIC "functions" that separate and return an argument that corresponds to the input "header" string.

#### NOTE

*Subprogram "Setcurv" should be executed to get pr\$ string prior to these function calls.*

```

600 Function gp$ (n$) local c0,c1,c2,c3,c4,c5
610 Dim gp$ to 150
620 Integer c0,c1,c2,c3,c4,c5
630 C0=len (n$)
640 C1=pos (pr$,n$,1)
650 C2=pos (pr$,"",c1)
660 C5=pos (pr$,";",c1)
670 If c2=0 then c2=c5
680 C3=c0+c1+1
690 C4=c2-c3
700 If c1=0 then gp$="?" else gp$=seg$ (pr$,c3,c4)
710 Return
720 End

```

Function gp\$ returns an ASCII string that corresponds to the header string given by n\$.  
Line 600           Define a name of the function and local variables.

Line 610-620       Define type of the variables.

Line 630           Determine header character string length.

Line 640           Get position of the header character string into ct.

Line 650           Get position of the end-of-argument character.

## Programming—370

---

Line 660            Get position of the end-of-message unit character.

Line 670            Determine which is the first delimiter.

Line 680            Get the start position of the argument of interest.

Line 690            Get the length of the argument of interest.

Line 700            If the input header string was not found, return "?" mark. Else return the correct argument.

Line 710-720        End of the function.

```
900 Function rd$ (n$) local c0,c1,c2,c3,c4,c5
910 Dim rd$ to 50
920 Integer c0,c1,c2,c3,c4,c5
930 C0=len (n$)
940 C1=pos (pr$,n$,1)
950 C2=pos (pr$,"/",c1)
960 C5=pos (pr$,"***",c1)
970 If c2>250 then c2=c5
980 C3=c0+c1
990 C4=c2-c3
1000 If c1=0 then rd$="?" else rd$=seg$ (pr$,c3,c4)
1010 Return
1020 End
```

Function rd\$ returns an ASCII character string that corresponds to the header string given by n\$. The only difference between Function gp\$ and rd\$ is the expected message separator. The rd\$ is used to search only in the "WFID" message unit, while gp\$ is used to search the other message units in the waveform preamble.

### Save, Load and Copy instrument Settings

Store often-used setting in the 370. This saves controller space, programming time, and bus transfer time. The settings can be recalled whenever needed. It is also often useful to save, load, and copy instrument settings to or from tape or bubble memory.

The following subprogram transfers instrument setting information from source file or memory (given by an integer variable "s") to the destination file or memory (given by an integer variable "d"). If zero is given for these parameters, it means that the source or target file is a current 370 set-up.

Files from SET 17 through SET 32 are assumed to be on tape.

```
1900 Sub cpset(s,d)
1910 Dim st$ to 500,dd$ to 500
1920 If s>32 or s<0 then goto ex
1930 If d>32 or d<0 then goto ex
1940 !
1950 If s=0 then gosub r1
1960 If s<=16 and s<>0 then gosub r2
1970 If s>16 then gosub r3
1980 !
1990 If d=0 then gosub r4
2000 If d<=16 and d<>0 then gosub r5
2010 If d>16 then gosub r6
2020 Ex: Return
2030 R1: !
2040 Input prompt "SET?" # "GPIBO(PRI=1)":st$
2050 Wbyte gtl(1)
2060 Return
2070 R2: !
2080 Input prompt "SET?" # "GPIBO(PRI=1)":dd$
2090 Print # "GPIBO(PRI=1)": "RECALL "&STR$(s)
2100 Input prompt "SET?" # "GPIBO(PRI=1)":st$
2110 Print # "GPIBO(PRI=1)":dd$
2120 Wbyte gtl(1)
2130 Return
2140 R3: !
2150 Input # "TAPE(EOM=<0>):SET "&STR$(s):st$
2160 Return
2170 R4: !
2180 Print # "GPIBO(PRI=1)":st$
2190 Wbyte gtl(1)
2200 Return
2210 R5: !
2220 Input prompt "SET?" # "GPIBO(PRI=1)":dd$
2230 Print # "GPIBO(PRI=1)":st$
2240 Print # "GPIBO(PRI=1)": "SAVE "&str$(d)
2250 Print # "GPIBO(PRI=1)":dd$
2260 Wbyte gtl(1)
2270 Return
2280 R6: !
2290 Print # "TAPE(EOM=<0>):SET "&str$(d):st$
2300 Return
2310 End
```

## Programming—370

---

Line 1900	Define name of the subprogram
Line 1910-1930	Ignore incorrect input
Line 1950-1970	Determine the device for the source file and branch to the appropriate sub-routine.
Line 1980-2010	Determine the device for the destination file and branch to the appropriate sub-routine.
Line 2020	End of the subprogram
Line 2030-2060	sub-routine to get current 370 settings
Line 2070-2130	sub-routine to get settings from 370 bubble memory
Line 2140-2160	sub-routine to get settings from tape
Line 2170-2200	sub-routine that sets 370 to settings from st\$.
Line 2210-2270	sub-routine to send settings given by st\$ to one portion of the 370 bubble memory.
Line 2280-2310	sub-routine to save settings given by st\$ to tape

### Waveform Graphic Display

Using the subprograms described before, waveform data and preamble data can be plotted on a color graphic display terminal such as Tektronix 4105 terminal.

The following subprogram displays the graticule, curve data and scale factors in three different colors.

```
1400 Sub plotwfm (wf)
1410 PAGE
1420 WINDOW -512,1536,-300,1400
1430 COLOR 5
1440 For i=12 to 1012 step 100
1450 MOVE i,12
1460 DRAW i,1012
1470 MOVE 12,i
1480 DRAW 1012,i
1490 Next i
1500 COLOR 1
1510 MOVE wf (1),wf (2)
1520 For i=3 to 2047 step 2
1530 DRAW wf (i),wf (i+1)
1540 Next i
1550 MOVE 0,1030
1560 GTEXT "MEMORY "&rd$ ("INDEX" )
1570 MOVE 1100,1000
1580 GTEXT "VERT/DIV"
1590 MOVE 1100,900
1600 GTEXT "HORZ/DIV"
1610 MOVE 1100,800
1620 GTEXT "PER STEP"
1630 MOVE 1100,700
1640 GTEXT "OFFSET"
1650 MOVE 1100,600
1660 GTEXT "Beta or gm"
1670 MOVE 1100,500
1680 GTEXT "AUX SUPPLY"
1690 COLOR 3
1700 MOVE 1200,950
1710 GTEXT rd$ ("VERT" )
1720 MOVE 1200,850
1730 GTEXT rd$ ("HORZ" )
1740 MOVE 1200,750
1750 GTEXT rd$ ("STEP" )
1760 MOVE 1200,650
1770 GTEXT rd$ ("OFFSET" )
1780 MOVE 1200,550
1790 GTEXT rd$ ("BGM" )
1800 MOVE 1200,450
1810 GTEXT rd$ ("AUX" )
1820 MOVE 10,950
1830 GTEXT rd$ ("TEXT" )
1840 Return
1850 End
```

## Programming—370

---

Line 1400	Define subprogram name
Line 1410-1420	Clear display graphic area and define display window
Line 1430-1490	Plot graticule in color 5.
Line 1500-1540	Plot curve data in color 1.
Line 1550-1830	Print scale factors and text.
Line 1840-1850	End of the subprogram

### Main Exercise Routine

The following is an example of a main routine that displays a menu to allow users to input numbers to select the listed functions.

```
100 Init all
110 Delete var all
120 Close all
130 Dim w$ to 5000,cd$ to 5000,pr$ to 500
140 Integer s,d
150 Set driver "comm0 (bau=9600):"
160 Set console "comm0:"
170 Open #30:"COMMO:"
180 GINIT 30,4113,1
190 On srq then call srqhand
200 Enable srq
210 P0: PRINT"^^J^^J"
220 Print "Select menu";
230 Print " 1. Copy Settings"
240 Print " 2. Copy waveforms"
250 Print " 3. Plot waveforms on screen"
260 Input prompt " Enter number - ":num
270 Gosub num of p1,p2,p3
280 Goto p0
290 P1: !
300 Print "^^You can choose file numbers from 1 to 32."
310 Print "1 to 16 is for bubble memories in the 370."
320 Print "17 to 32 is for tape files in the 4041 controller."
330 Print "0 is for current settings."
340 Input prompt "Copy from ?":s
350 Input prompt "Copy to ?":d
360 Call epset (s,d)
370 Return
380 P2: !
390 Print "^^You can choose file numbers from 1 to 32."
400 Print "1 to 16 is for bubble memories in the 370."
410 Print "17 to 32 is for tape files in the 4041 controller."
```



```
420 Input prompt "Copy from ?":s
430 Input prompt "Copy to ?":d
440 Call cpwfm (s,d)
450 Return
460 P3: !
470 Print "JYou can choose file numbers from 1 to 32."
480 Print "1 to 16 is for bubble memories in the 370."
490 Print "17 to 32 is for tape files in the 4041 controller."
500 Input prompt "Enter file number you want to display ->":s
510 Call cpwfm (s,0)
520 Call getcurv (w$)
530 Call plotwfm (cv)
540 Return
550 EO: end
```

Line 100-200 Environmental set-ups

Line 210-280 Display main menu and wait for an input for a selection.

Line 290-370 Display message for Copy (transfer) settings and wait for an input for a selection.

Line 380-450 Display message for Copy (transfer) waveforms and wait for an input for a selection.

Line 460-540 Display message for selection of a waveform to plot and wait for an input for the selection.

This main routine also takes care of "SRQ" interrupts. An example of SRQ handling routine is shown below.

```
2400 Sub srqhand
2410 Poll sta,dev
2420 Input prompt "event?" #"GPIBO (pri=1)":event
2430 Print "370 status ";sta
2440 Print "370 event ";event
2450 Resume
2460 End
```

## Programming—370

A complete sample program follows:

```
100   Init all
110   Delete var all
120   Close all
130   Dim w$ to 5000,cd$ to 5000,pr$ to 500
140   Integer s,d
150   Set driver "comm0 (bau=9600):"
160   Set console "comm0:"
170   Open #30:"COMMO:"
180   GINIT 30,4113,1
190   On srq then call srqhand
200   Enable srq
210   P0:   print " ^ J ^ J ^ J "
220       print "Select menu";
230       Print"           1. Copy Settings"
240       Print"           2. Copy Waveforms"
250       Print"           3. Plot Waveforms on screen"
260       Input prompt "   Enter number ---":num
270       Gosub num of p1,p2,p3
280       Goto p0
290   P1:   !
300       Print " ^ JYou can choose file numbers from 1 to 32."
310       Print "1 to 16 is for bubble memories in the 370."
320       Print "17 to 32 is for tape files in the 4041 controller."
330       Print "0 is for current settings."
340       Input prompt "Copy from ?":s
350       Input prompt "Copy to ?":d
360       Call cpset (s,d)
370       Return
380   P2:   !
390       Print " ^ JYou can choose file numbers from 1 to 32."
400       Print "1 to 16 is for bubble memories in the 370."
410       Print "17 to 32 is for tape files in the 4041 controller."
420       Input prompt "Copy from ?":s
430       Input prompt "Copy to ?":d
440       Call cpwfm (s,d)
450       Return
460   P3:   !
470       Print " ^ JYou can choose file numbers from 1 to 32."
480       Print "1 to 16 is for bubble memories in the 370."
490       Print "17 to 32 is for tape files in the 4041 controller."
500       Input prompt "Enter file number you want to display ->":s
510       Call cpwfm (s,0)
520       Call getcurv (w$)
530       Call plotwfm (cv)
540       Return
550   E0:   end
600       Function gp$ (n$) local c0,c1,c2,c3,c4,c5
610       Dim gp$ to 150
620       Integer c0,c1,c2,c3,c4,c5
```

```

630      C0=len (n$)
640      C1=pos (pr$,n$,1)
650      C2=pos (pr$,"",c1)
660      C5=pos (pr$,";",c1)
670      If c2=0 then c2=c5
680      C3=c0+c1+1
690      C4=c2-c3
700      If c1=0 then gp$="?" else gp$=seg$ (pr$,c3,c4)
710      Return
720      End

800  Sub  getcurv (w$)
810      Pr$=seg$ (w$,1,pos (w$,";"*1))
820      Integer cv (val (gp$ ("nr.pt") ) *2)
830      Cd$=seg$ (w$,pos (w$,";"*1)+1,4124)
840      Getmem buffer cd$ using "24x,16%" :cv
850      Return
860      End

900  Function rd$ (n$) local c0,c1,c2,c3,c4,c5
910      Dim rd$ to 50
920      Integer c0,c1,c2,c3,c4,c5
930      C0=len (n$)
940      C1=pos (pr$,n$,1)
950      C2=pos (pr$,"/",c1)
960      C5=pos (pr$,"*",c1)
970      If c2>250 then c2=c5
980      C3=c0+c1
990      C4=c2-c3
1000     If c1=0 then rd$="?" else rd$=seg$ (pr$,c3,c4)
1010     Return
1020     End

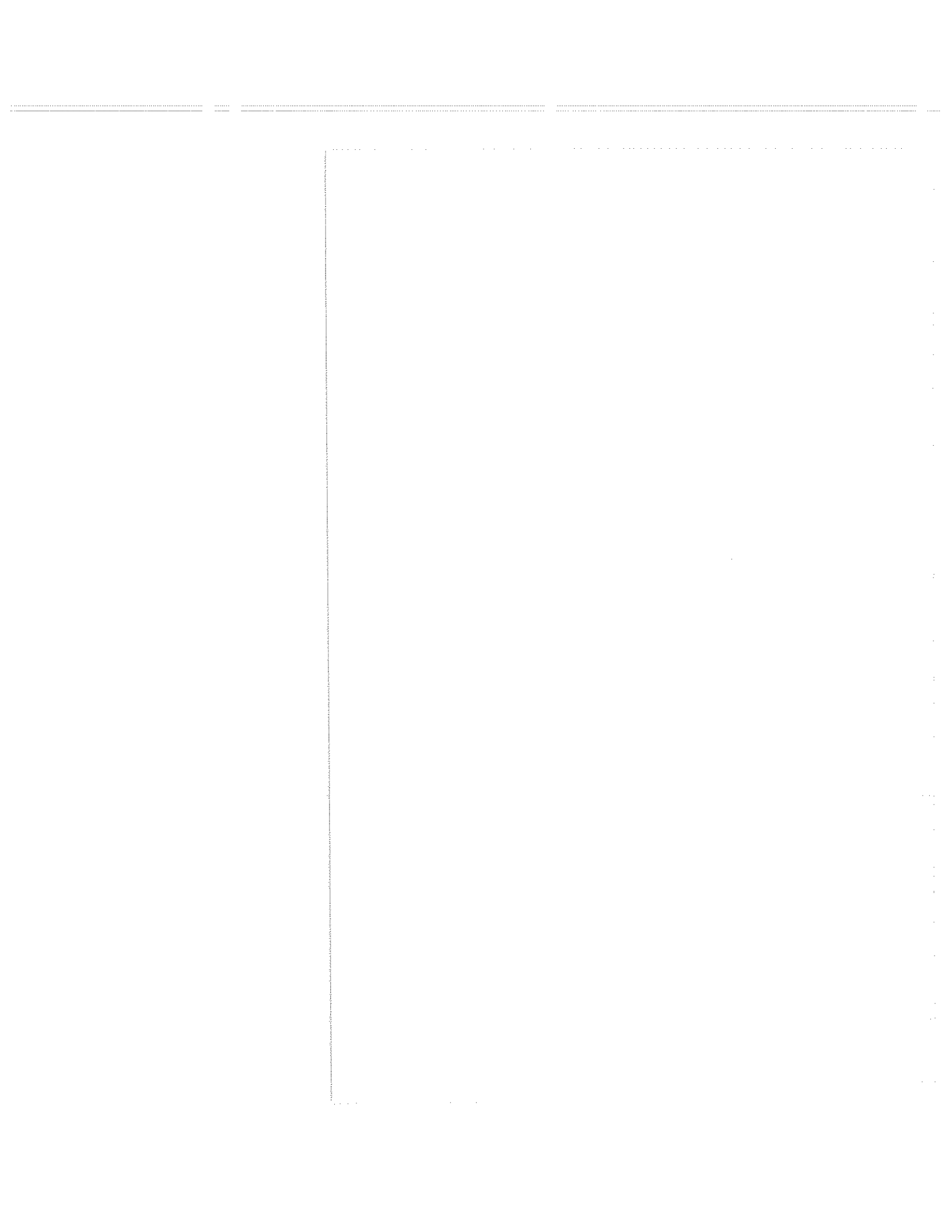
1100 Sub  cpwfm (s,d)
1110     If s>32 or s<1 then goto 1280
1120     If d>32 or d<0 then goto 1280
1130     Dim so$ to 50,de$ to 50
1140     If s>16 and s<33 then so$="tape (eom=<0>):wfm"&str$ (s)
1150     If s<=16 and s>0 then so$="gpib0 (pri=1,emom=<0>):"
1160     If d>16 and d<33 then de$="tape (eom=<0>):wfm"&str$ (d)
1170     If d<=16 and d>0 then de$="gpib0 (pri=1,emom=<0>):"
1180     If s>16 and s<33 then goto 1220
1190     Print #so$:"disp view:";s
1200     Wait 1
1210     Print #so$:"wav?"
1220     Input #so$:w$
1230     If d=0 then goto 1270
1240     Rep$ (w$,pos (w$,"index",1),8)="index "&str$ (d)
1250     Rep$ (w$,pos (w$,"index",100),8)="index "&str$ (d)
1260     Print #de$:w$
1270     Wbyte gtl (1)
1280     Return

```

## Programming—370

```
1290      End
1400 Sub  plotwfm (wf )
1410      Page
1420      WINDOW -512,1536,-300,1400
1430      COLOR 5
1440      For i=12 to 1012 step 100
1450          MOVE i,12
1460          DRAW i,1012
1470          MOVE 12,i
1480          DRAW 1012,i
1490      Next i
1500      COLOR 1
1510      MOVE wf (1),wf (2)
1520      For i=3 to 2047 step 2
1530          DRAW wf (i),wf (i+1)
1540      Next i
1550      MOVE 0,1030
1560      GTEXT "MEMORY "&rd$ ("INDEX")
1570      MOVE 1100,1000
1580      GTEXT "VERT/DIV"
1590      MOVE 1100,900
1600      GTEXT "HORZ/DIV"
1610      MOVE 1100,800
1620      GTEXT "PER STEP"
1630      MOVE 1100,700
1640      GTEXT "OFFSET"
1650      MOVE 1100,600
1660      GTEXT "Beta or gm"
1670      MOVE 1100,500
1680      GTEXT "AUX SUPPLY"
1690      COLOR 3
1700      MOVE 1200,950
1710      GTEXT rd$ ("VERT")
1720      MOVE 1200,850
1730      GTEXT rd$ ("HORIZ")
1740      MOVE 1200,750
1750      GTEXT rd$ ("STEP")
1760      MOVE 1200,650
1770      GTEXT rd$ ("OFFSET")
1780      MOVE 1200,550
1790      GTEXT rd$, ("BGM")
1800      MOVE 1200,450
1810      GTEXT rd$ ("AUX")
1820      MOVE 10,950
1830      GTEXT rd$ ("TEXT")
1840      Return
1850      End
1900 Sub  cpsct (s,d)
1910      Dim st$ to 500,dd$ to 500
```


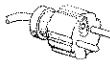



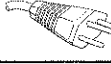
```
1920     If s>32 or s<0 then goto ex
1930     If d>32 or d<0 then goto ex
1940 !
1950     If s=0 then gosub r1
1960     If s<=16 and s<>0 then gosub r2
1970     If s>16 then gosub r3
1980 !
1990     If d=0 then gosub r4
2000     If d<=16 and d<>0 then gosub r5
2010     If d>16 then gosub r6
2020 Ex:  Return
2030 R1:  !
2040     Input prompt "SET?" #GPIBO (PRI=1):":st$
2050     Wbyte gtl (1)
2060     Return
2070 R2:  !
2080     Input prompt "SET?" #GPIBO (PRI=1):":dd$
2090     Print #GPIBO (PRI=1):":RECALL "&str$(s)
2100     Input prompt "SET?" #GPIBO (PRI=1): ""st$
2110     Print #GPIBO (PRI=1):":dd$
2120     Wbyte gtl (1)
2130     Return
2140 R3:  !
2150     Input #TAPPE (EOM=<O>):SET "&str$(s):st$
2160     Return
2170 R4:  !
2180     Print #GPIBO (PRI=1):":st$
2190     Wbyte gtl (1)
2200     Return
2210 RS:  !
2220     Input prompt "SET?" #GPIBO (PRI=1):":dd$
2230     Print #GPIBO (PRI=1):":st$
2240     Print #GPIBO (PRI=1):":SAVE "&str$(d)
2250     Print #GPIBO (PRI=1):":dd$
2260     Wbyte gtl (1)
2270     Return
2280 R6:  !
2290     Print #TAPPE (EOM=<O>):SET "&str$(d):st$
2300     Return
2310     End
2400 Sub  srqhand
2410     Poll sta,dev
2420     Input prompt "event?" #gpib0 (pri=1):":event
2430     Print "370 status ";sta
2440     Print "370 event ";event
2450     Resume
2460     End
```



## SECTION 5 OPTIONS

The following options are available:

- Option 1R Rack Mounting Adapter
- Option A1 - A5 International Power Cords:

Plug Configuration	Usage	Nominal Line-Voltage (AC)	Reference Standards	Option #
	North American 120V/15A	120V	<sup>1</sup> ANSI C73.11 <sup>2</sup> NEMA 5-15-P <sup>3</sup> IEC 83	Standard
	Universal Euro 220V/6-16A	220V	<sup>4</sup> CEE (7), II, IV, VII <sup>3</sup> IEC 83	A1
	UK 240V/6-13A	240V	<sup>5</sup> BS 1363 <sup>3</sup> IEC 83	A2
	Australian 240V/6-10A	240V	<sup>6</sup> AS C112	A3
	North American 240V/15A	240V	<sup>1</sup> ANSI C73.20 <sup>2</sup> NEMA 6-15-P <sup>3</sup> IEC 83	A4
	Switzerland 220V/6-10A	220V	<sup>7</sup> SEV	A5

<sup>1</sup>ANSI—American National Standards Institute  
<sup>2</sup>NEMA—National Electrical Manufacturer's Association

<sup>3</sup>IEC—International Electrotechnical Commission  
<sup>4</sup>CEE—International Commission on Rules for the Approval of Electrical Equipment

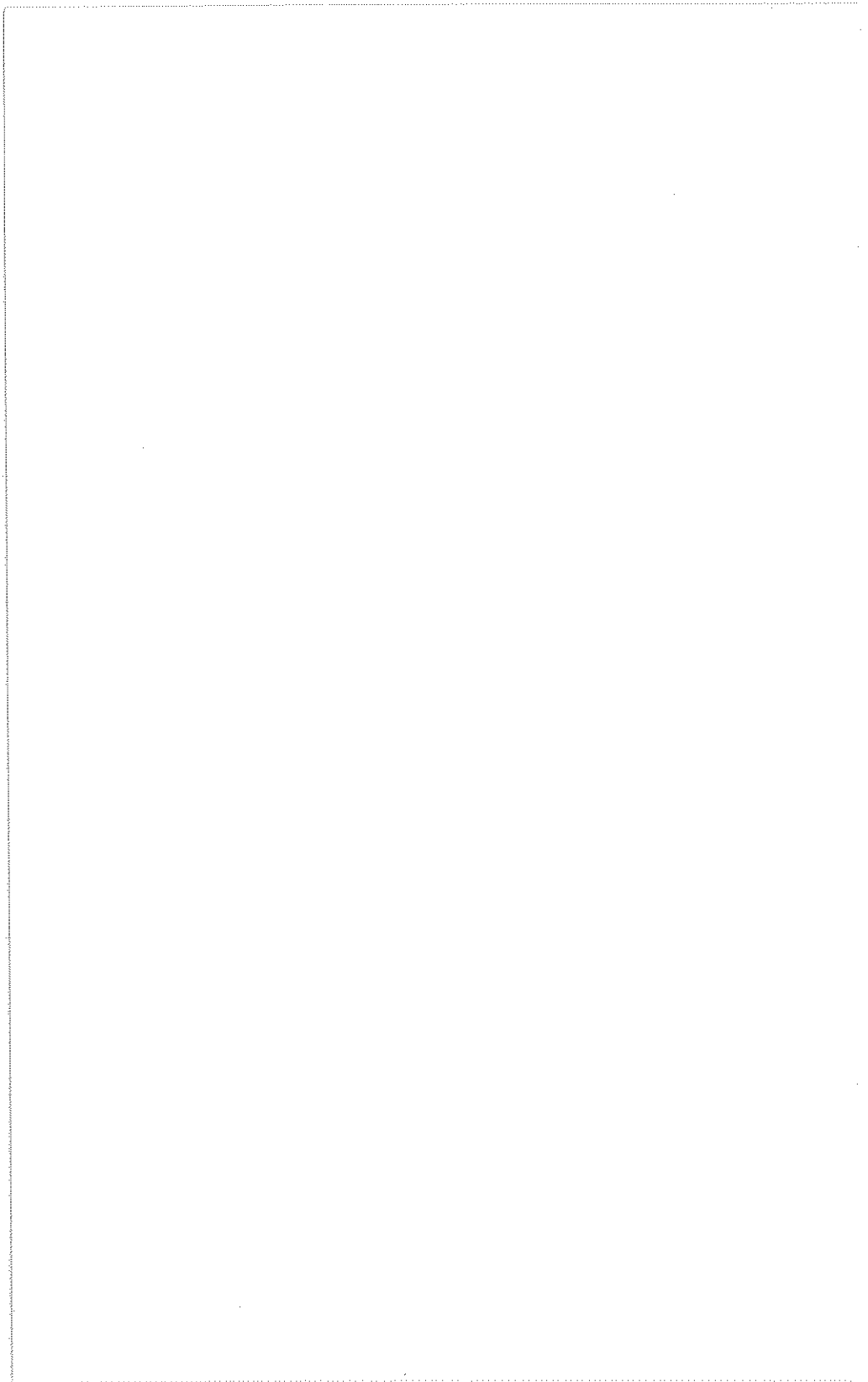
<sup>5</sup>BS—British Standards Institution

<sup>6</sup>AS—Standards Association of Australia

<sup>7</sup>SEV—Schweizerischer Elektrotechnischer Verein

*This instrument is safety class 1 equipment (IEC designation). All accessible conductive parts are directly connected through the grounding conductor of the power cord to the grounding contact of the power plug. Therefore, the power plug must only be inserted in a mating receptacle with a grounding contact. Do not defeat the grounding connection. Any interruption of the grounding connection can create an electric shock hazard.*

*For electric shock protection, connect the instrument to ground before connecting to the instrument input or output terminals.*





# APPENDIX A DIAGNOSTIC ROUTINES AND MESSAGES

This appendix explains the 370 diagnostic routines and lists the messages displayed on the error message area of the crt when the 370 detects operation errors, I/O errors, or emergency errors.

## DIAGNOSTIC ROUTINES

The 370 has four diagnostic routines: Two kinds of Power-on Diagnostic routines, a User-initiated diagnostic routine, and GPIB diagnostic routine.

### Power-on Diagnostic Routines

At power on, the 370 runs the Power On Diagnostic routine to execute the following tests:

- System ROM check
- System RAM check
- Display RAM check
- Acquisition RAM check
- Up/down switch and Push button test

After completing the Power-on Diagnostic routines, the 370 displays a "SELFTEST PASS" message at the error message area of the CRT and sets the initial front-panel setup.

If the 370 power is turned on while the FAST/SHIFT key is pressed, a more detailed Power-on Diagnostic routine occurs in the following order:

- System ROM check
- System RAM check
- Display RAM check
- Acquisition RAM check
- LED check
- Display quality check
- Up/down switch and Push button test

To exit this diagnostic routine, press the FAST/SHIFT key.

## Error Messages—370

### System ROM check

After confirming that the system ROMs are without fault, the 370 diagnoses the system ROMs by checksum. If a system ROM fatal error is found (such as misinsertion), the Bubble memory index display alternately blinks 0 and 1.

If a checksum error is found, the appropriate error message is displayed in the crt error message area. The message format follows:

ROM 000X

The 370 does not advance to the next routine.

### System RAM check

The 370 checks the system RAM by read/write operation. When a system RAM fatal error is found (such as bus shorted), the Bubble memory index display alternately blinks 0 and 2, and the 370 does not advance to the next routine. When read/write errors are found, the error message is displayed in the crt error message areas. The message format follows:

RAM XXXXX YYYYY

### Display RAM check

The 370 checks the Display RAM by read/write operation. When a read/write error is found (such as bus shorted), the Bubble memory index display alternately blinks 0 and 3, and the 370 does not advance to the next routine.

### Acquisition RAM check

The 370 checks the Acquisition RAM by a read/write operation. When a read/write error is found (such as bus shorted), the Bubble memory index display alternately blinks 0 and 4, and the 370 does not advance to the next routine.

Table A-1 shows the Power on System Error Messages displayed on the Bubble memory index display.

**TABLE A-1**  
**Power on System Error Messages**

Display	Description
0/1 (blink)	System ROM error (e.g., misinsertion)
0/2 (blink)	System RAMs error (e.g., bus shorted)
0/3 (blink)	Display RAM read/write error (e.g., bus shorted)
0/4 (blink)	Acquisition RAM read/write error (e.g., bus shorted)

**LED check**

The 370 sequentially lights all front-panel LEDs for visual check.

**Display quality check**

The 370 displays the Logo mark (SONY/TEKTRONIX), and a crt adjustment pattern on the crt for crt control adjustment. When the adjustment is finished, press FAST/SHIFT to exit this routine.

**Up/down control and push button test**

The 370 executes this test (the LEFT-RIGHT-STANDBY control and FAST/SHIFT button are not tested here). If an error is found, the error message is displayed in the crt error message area. The Error Message is in the following format:

KEY ERRO <NUM>

<NUM> identifies the front-panel control as listed in Table A-2.

The following also appears, in the crt text area.

PUSH FAST KEY TO GO ON.

You can ignore the displayed error and carry out the measurement by pressing the FAST/SHIFT key, but the displayed function may not operate correctly.

**User Initiated Diagnostic Routine**

Simultaneously pressing the FAST/SHIFT and NON STORE keys enters the user-initiated diagnostic routine. This routine displays a number of message that corresponds to the front panel control that you have just operated. Thus, you can determine if the front panel controls are operating normally. Table A-2 lists the controls and the corresponding numbers or messages. To exit this routine, press both the FAST/SHIFT key and the NON STORE key again.

**TABLE A-2**  
**Front panel control identification**

Control	Number
NON STORE	1
STORE	2
COMPARE	3
VIEW	4
ENTER	5
SAVE	6

**TABLE A-2 (cont)  
Front panel control identification**

<b>Control</b>	<b>Number</b>
RECALL	7
MEMORY down	8
MEMORY up	9
DISPLAY INVERT	10
CRT CAL up	11
CRT CAL down	12
DISPLAY OFFSET decrement	13
DISPLAY OFFSET increment	14
DISPLAY MAG up	15
DISPLAY MAG down	16
ACQUIIITON MODE up	17
ACQUISITION MODE down	18
ATEP GEN INVERT	19
STEP GEN MULTI	20
NUMBER OF STEPS up	21
NUMBER OF STEPS down	22
PULSE up	23
PULSE down	24
STEP GEN LIMIT up	25
STEP GEN LIMIT down	26
STEP GEN OFFSET decrement	27
STEP GEN OFFSET increment	28
USER REQUEST	29
RESET TO LOCAL	30
PLOT	31
REPEAT	32
SINGLE	33
AUX SUPPLY decrement	34

**TABLE A-2 (cont)**  
**Front panel control identification**

<b>Control</b>	<b>Number</b>
AUX SUPPLY increment	35
CURSOR MODE up	36
CURSOR MODE down	37
UP	38
LEFT	39
DOWN	40
RIGHT	41
FAST/SHIFT	42
CONFIGURATION up	43
CONFIGURATION down	44
MAX PEAK VOLTS up	45
MAX PEAK VOLTS down	46
MAX PEAK POWER WATTS up	47
MAX PEAK POWER WATTS down	48
COLLECTOR SUPPLY POLARITY up	49
COLLECTOR SUPPLY POLARITY down	50
LEFT-RIGHT-STANDBY	LRSSW RIGHT
	LRSSW LEFT LRSSW BOTH LRSSW STANDBY
HIGH-LOW	HILOWSW HIGH HILOWSW LOW
INTERLOCK	COVER ON COVER OFF
VERTICAL CURRENT/DIV	VERT SENSE XX(0-20)
HORIZONTAL VOLTS/DIV	HORIZ SENSE XX(0-19)
STEP/OFFSET AMPLITUDE	STSEP AMP XX(0-26)
VARIABLE COLLECTOR SUPPLY	VCS(%) = XXX.X(0-100)

## Error Messages—370

### GPIB diagnostic routine

The GPIB TEST? command initiates the 370 system ROMs and RAMs diagnostic routine. The 370 responds to this command by returning system ROM and RAM information to the controller as follows:

TEST ROM:000X, RAM:YYYY

### MESSAGES

Messages displayed in the crt error message area when the 370 detects an operation error, I/O error or emergency error are listed in Table A-3.

GPIB error messages are described in detail, under "STATUS AND ERROR REPORTING COMMAND GROUP" and Table 4-5 in Section 4.

**TABLE A-3**  
**Messages**

Message	Description
COL.DISABLED	COLLECTOR SUPPLY is disabled. Wait until the message "COL. RECOVERED" is displayed. If the error persists, contact nearest Tektronix Field Service Representative.
COL.RECOVERD	Collector supply recovered.
HI/LO(W UNMATCH	High-Low control setting does not conform to saved setting at recall. Set the High-Low control to conform with the saved setting.
OPERATION ERR.	Operation error
PLL UNLOCK	PLL unlock
PLOTTER FAIL	Plotter output I/O error. Confirm that plotter is properly connected.
SELFTTEST PASS	The 370 Power-on diagnostic test is successful.
SELFTTEST START	The 370 initiates the Power-on diagnostic routine.
COL.OVERHEAT	Series resistor (Collector Supply) overheat. Wait until "COL. RECOVERED" message is displayed.
TEXT CANCELLED	Text mode is cancelled; text entered is lost.
BUBBLE EJECT	Bubble memory cassette is ejected while the 370 is in SAVE/RECALL or ENTER/VIEW operation.
BUBBLE NO DATA	Bubble memory has no data in the page specified by Bubble Memory index.
BUBBLE NOMEM	Bubble memory cassette not installed.

TABLE A-3 (cont)  
Messages

Message	Description
BUBBLE WPRTE	Bubble cassette "write-protected". Set write-protect key to "write enable" position.
BUBBLE BUS	Bubble Memory internal error. To determine whether the problem is in the bubble memory cassette or in the cassette driver, try a new bubble memory cassette. Attempt to save or recall a waveform or a setting. If the cassette driver is at fault, contact a Tektronix Field Service Representative. However, you can still use the 370, although bubble internal memory functions cannot be used.
BUBBLE BUSY	
BUBBLE MDL	
BUBBLE NHDR	
BUBBLE PARITY	
BUBBLE POVR	
BUBBLE TXMIS	
BUBBLE UCE	
BUBBLE USCE	
BUBBLE UDC	

