



**PLEASE CHECK FOR CHANGE  
INFORMATION AT THE REAR  
OF THIS MANUAL.**

**2336 YA  
OSCILLOSCOPE  
OPERATORS**

**Tektronix, Inc.  
P.O. Box 500  
Beaverton, Oregon 97077  
070-5010-00  
Product Group 38**

**INSTRUCTION MANUAL**

Serial Number \_\_\_\_\_ First Printing OCT 1983

Copyright © 1983 Tektronix, Inc. All rights reserved.  
Contents of this publication may not be reproduced in any  
form without the written permission of Tektronix, Inc.

Products of Tektronix, Inc. and its subsidiaries are covered  
by U.S. and foreign patents and/or pending patents.

TEKTRONIX, TEK, SCOPE-MOBILE, and  are  
registered trademarks of Tektronix, Inc. TELEQUIPMENT is  
a registered trademark of Tektronix U.K. Limited.

Printed in U.S.A. Specification and price change privileges  
are reserved.

## INSTRUMENT SERIAL NUMBERS

Each instrument has a serial number on a panel insert, tag,  
or stamped on the chassis. The first number or letter  
designates the country of manufacture. The last five digits  
of the serial number are assigned sequentially and are  
unique to each instrument. Those manufactured in the  
United States have six unique digits. The country of  
manufacture is identified as follows:

B000000	Tektronix, Inc., Beaverton, Oregon, USA
100000	Tektronix Guernsey, Ltd., Channel Islands
200000	Tektronix United Kingdom, Ltd., London
300000	Sony/Tektronix, Japan
700000	Tektronix Holland, NV, Heerenveen, The Netherlands

# TABLE OF CONTENTS

	Page		Page
<b>LIST OF ILLUSTRATIONS</b> . . . . .	iii	<b>OPERATING CONSIDERATIONS</b> . . . . .	19
<b>LIST OF TABLES</b> . . . . .	v	GRATICULE . . . . .	19
<b>OPERATORS SAFETY SUMMARY</b> . . . . .	vi	GROUNDING . . . . .	19
<b>INTRODUCTION</b> . . . . .	1	SIGNAL CONNECTIONS . . . . .	20
<b>PREPARATION FOR USE</b> . . . . .	2	INPUT COUPLING CAPACITOR	
LINE VOLTAGE SELECTION . . . . .	2	PRECHARGING . . . . .	20
LINE FUSE . . . . .	4	INSTRUMENT COOLING . . . . .	21
POWER CORD . . . . .	5	<b>INSTRUMENT FAMILIARIZATION</b> . . . . .	22
<b>CONTROLS, CONNECTORS, AND INDICATORS</b> . . . . .	6	INTRODUCTION . . . . .	22
POWER AND DISPLAY . . . . .	6	EQUIPMENT REQUIRED . . . . .	22
VERTICAL . . . . .	7	NORMAL SWEEP DISPLAY . . . . .	23
HORIZONTAL . . . . .	10	DISPLAYING A SIGNAL . . . . .	25
A TRIGGER . . . . .	12	<b>OPERATOR'S CHECKS AND ADJUSTMENTS</b> . . . . .	35
B TRIGGER . . . . .	15	INTRODUCTION . . . . .	35
REAR PANEL . . . . .	17	TRACE ROTATION . . . . .	35
		PROBE COMPENSATION . . . . .	36
		ASTIGMATISM . . . . .	37
		VERTICAL GAIN CHECK . . . . .	38

# TABLE OF CONTENTS (cont)

	Page		Page
<b>BASIC APPLICATIONS</b> . . . . .	39	<b>DELAYED-SWEEP TIME MEASUREMENTS</b> . . . . .	59
<b>NONDELAYED MEASUREMENTS</b> . . . . .	39	Time Duration . . . . .	60
AC Peak-to-Peak Voltage . . . . .	39	Rise Time . . . . .	60
Instantaneous DC Voltage . . . . .	41	Time Difference Between Repetitive Pulses . . . . .	62
Algebraic Addition . . . . .	42	Time Difference Between Two	
Common-Mode Rejection . . . . .	44	Time-Related Pulses . . . . .	64
Time Duration . . . . .	45		
Frequency . . . . .	47	<b>OPTIONS</b> . . . . .	66
Rise Time . . . . .	47	OPTION 03 . . . . .	66
Time Difference Between Two			
Time-Related Pulses . . . . .	49	<b>SPECIFICATION</b> . . . . .	67
Phase Difference . . . . .	50	<b>ACCESSORIES</b> . . . . .	90
Amplitude Comparison . . . . .	52	STANDARD ACCESSORIES INCLUDED . . . . .	90
Time Comparison . . . . .	54	OPTIONAL POWER CORDS . . . . .	90
<b>DELAYED-SWEEP MAGNIFICATION</b> . . . . .	56	<b>APPENDIX A</b> . . . . .	91
Magnified Sweep Runs After Delay . . . . .	56		
Pulse Jitter Time Measurement . . . . .	58	<b>CHANGE INFORMATION</b>	
Triggered Magnified Sweep . . . . .	59		



# LIST OF ILLUSTRATIONS

Figure		Page
	The 2336 Oscilloscope . . . . .	.viii
1	LINE VOLTAGE SELECTOR switch, line fuse, and power cord . . . . .	3
2	Optional power cords. . . . .	5
3	Power and display controls and indicators . . . . .	7
4	Vertical controls, connectors, and indicators and calibrator output . . . . .	8
5	Horizontal controls and indicator . . . . .	10
6	A TRIGGER controls, connector, and indicator . . . . .	13
7	B TRIGGER controls, connector, and LCD readout. . . . .	16
8	Rear-panel connectors . . . . .	18
9	Graticule measurement markings . . . . .	19
10	Initial setup for instrument familiarization procedure. . . . .	26
11	Probe compensation. . . . .	37
12	Vertical display accuracy . . . . .	38
13	Peak-to-peak waveform voltage . . . . .	40
14	Instantaneous voltage measurement . . . . .	42
15	Algebraic addition . . . . .	44
16	Common-mode rejection. . . . .	45
17	Time duration. . . . .	46

# LIST OF ILLUSTRATIONS (cont)

Figure		Page
18	Rise time . . . . .	48
19	Time difference between two time-related pulses. . . . .	50
20	Phase difference . . . . .	52
21	High-resolution phase difference. . . . .	52
22	Delayed-sweep magnification. . . . .	57
23	Pulse jitter . . . . .	58
24	Time duration using delayed sweep. . . . .	61
25	Rise time, differential time method. . . . .	62
26	Time difference between repetitive pulses . . . . .	63
27	Time difference between two time-related pulses. . . . .	65

# LIST OF TABLES

Table		Page
1	Line Voltage and Fuse Selection . . . . .	4
2	Option 03 Line Voltage and Fuse Selection . . . . .	4
3	Equipment Required for Instrument Familiarization Procedure . . . . .	23
4	Electrical Characteristics . . . . .	68
5	Environmental Characteristics . . . . .	86
6	Physical Characteristics . . . . .	88
7	Option Electrical Characteristics . . . . .	89

# OPERATORS SAFETY SUMMARY

*The general safety information in this part of the summary is for both operating and servicing personnel. Specific warnings and cautions will be found throughout the manual where they apply and do not appear in this summary.*

## Terms in This Manual

**CAUTION** statements identify conditions or practices that could result in damage to the equipment or other property.

**WARNING** statements identify conditions or practices that could result in personal injury or loss of life.

## Terms as Marked on Equipment

**CAUTION** indicates a personal injury hazard not immediately accessible as one reads the markings, or a hazard to property, including the equipment itself.

**DANGER** indicates a personal injury hazard immediately accessible as one reads the marking.

## Symbols in This Manual



This symbol indicates where applicable cautionary or other information is to be found. For maximum input voltage see Table 4.

## Symbols as Marked on Equipment



**DANGER** – High voltage.



Protective ground (earth) terminal.



**ATTENTION** – Refer to manual.

## **Power Source**

This product is intended to operate from a power source that does not apply more than 250 volts rms between the supply conductors or between either supply conductor and ground. A protective ground connection by way of the grounding conductor in the power cord is essential for safe operation.

## **Grounding the Product**

This product is grounded through the grounding conductor of the power cord. To avoid electrical shock, plug the power cord into a properly wired receptacle before connecting to the product input or output terminals. A protective ground connection by way of the grounding conductor in the power cord is essential for safe operation.

## **Danger Arising From Loss of Ground**

Upon loss of the protective-ground connection, all accessible conductive parts (including knobs and controls that may appear to be insulating) can render an electric shock.

## **Use the Proper Power Cord**

Use only the power cord and connector specified for your product.

Use only a power cord that is in good condition.

For detailed information on power cords and connectors see Figure 2.

## **Use the Proper Fuse**

To avoid fire hazard, use only a fuse of the correct type, voltage rating and current rating as specified in the parts list for your product.

## **Do Not Operate in Explosive Atmospheres**

To avoid explosion, do not operate this product in an explosive atmosphere unless it has been specifically certified for such operation.

## **Do Not Remove Covers or Panels**

To avoid personal injury, do not remove the product covers or panels. Do not operate the product without the covers and panels properly installed.



4117-28

The 2336 Oscilloscope.

# INTRODUCTION

The TEKTRONIX 2336 Oscilloscope is a rugged, light-weight, dual-channel, 100-MHz instrument having a compact crt that provides a sharply defined trace. Its vertical system supplies calibrated deflection factors from 5 mV per division to 5 V per division. Sensitivity can be increased to at least 2 mV per division by the variable VOLTS/DIV VAR control. Trigger circuits enable stable triggering over the full bandwidth of the vertical system. The horizontal system provides calibrated sweep speeds from 0.5 s per division to 50 ns per division, along with delayed-sweep features, thus accommodating accurate relative-time measurements. A X10 magnifier circuit extends the maximum sweep speed to 5 ns per division when the SEC/DIV switch is set to 0.05  $\mu$ s per division.

A 3 1/2 digit LCD (liquid crystal display) readout enables rapid measurement of time difference between any two points on the oscilloscope display. Both time measurement points are displayed simultaneously on the crt screen.

The instrument is shipped with the following standard accessories:

- 2 Probe packages
- 1 Accessory pouch
- 1 Operators manual
- 1 Service manual
- 1 Accessory pouch, zip lock
- 1 Crt filter, clear plastic
- 2 1.0-A AGC fast-blow fuses
- 1 0.5-A AGC fast-blow fuse

For part numbers and further information about both standard and optional accessories, refer to the "Accessories" page at the back of this manual. Your Tektronix representative or local Tektronix Field Office can also provide accessories information.

# PREPARATION FOR USE

Refer to the Safety Summary at the front of this manual for power source, grounding, and other safety considerations pertaining to the use of the 2336. Before connecting the instrument to a power source, read the following information, then verify that the LINE VOLTAGE SELECTOR switch is properly set for the ac power source being used and that the proper power-input fuse is installed.



*This instrument may be damaged if operated with the LINE VOLTAGE SELECTOR switch set for the wrong applied ac power input source voltage or if the wrong line fuse is installed.*

## LINE VOLTAGE SELECTION

The 2336 operates from either a 115-V or a 230-V nominal ac power input source with a line frequency ranging from 48 Hz to 440 Hz. Before connecting the power cord to a power input source, verify that the LINE VOLTAGE SELECTOR switch, located on the rear panel (see Figure 1), is set for the correct nominal ac power input source voltage. To convert the instrument for operation from one line-voltage range to the other, move the LINE VOLTAGE SELECTOR switch to the correct nominal ac source voltage position (see Table 1). If your instrument is equipped with Option 03 (100-V/200-V Power Transformer), use Table 2. The detachable power cord may have to be changed to match the power source outlet.



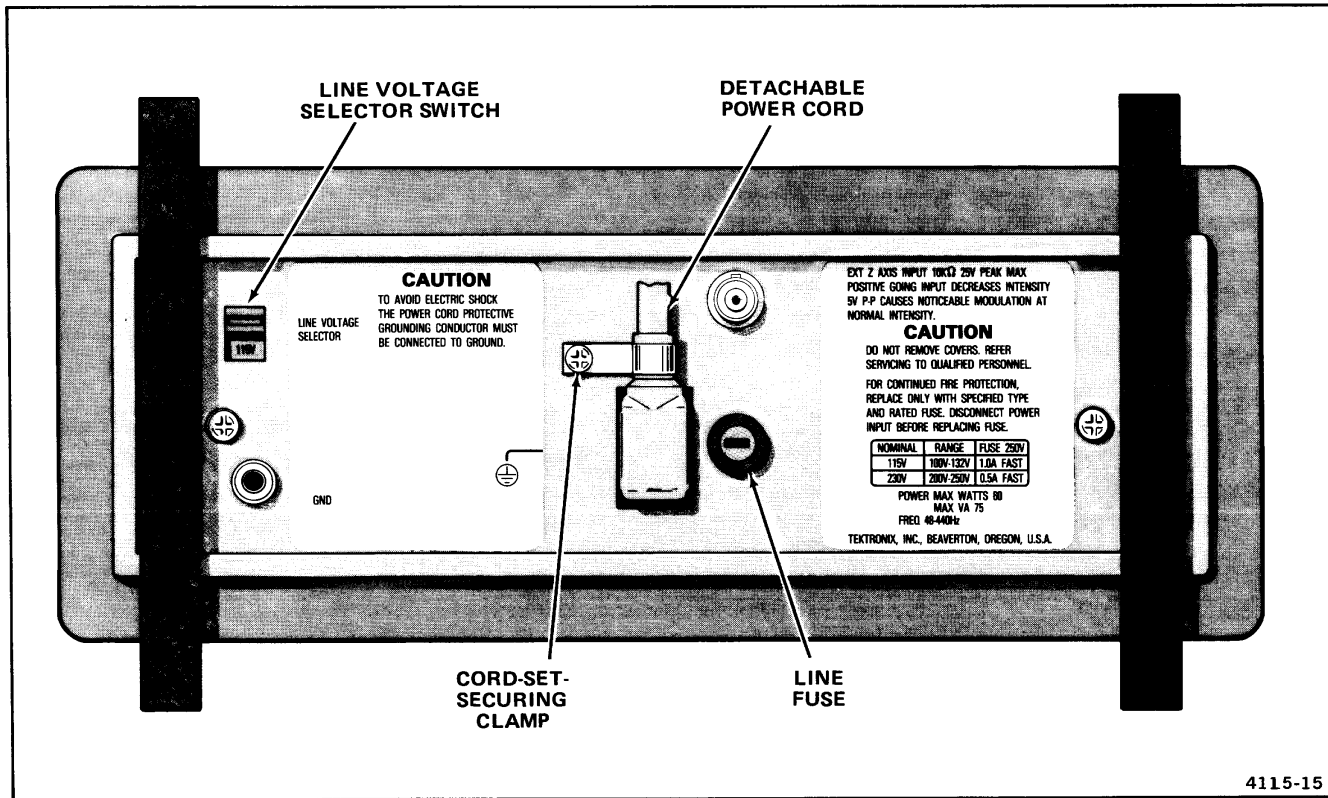

Figure 1. LINE VOLTAGE SELECTOR switch, line fuse, and power cord.

**Table 1**  
**Line Voltage and Fuse Selection**

<b>Line Voltage Selector Switch Position</b>	<b>Voltage Range</b>	<b>Fuse Data</b>
115 V Nominal	100 to 132 V	1.0 A, 250 V, Fast-blow
230 V Nominal	200 to 250 V	0.5 A, 250 V, Fast-blow

**Table 2**  
**Option 03 Line Voltage and Fuse Selection**

<b>Line Voltage Selector Switch Position</b>	<b>Voltage Range</b>	<b>Fuse Data</b>
100 V Nominal	90 to 115 V	1.0 A, 250 V, Fast-blow
200 V Nominal	180 to 230 V	0.5 A, 250 V, Fast-blow

## **LINE FUSE**

To verify that the instrument power-input fuse is of proper value for the nominal ac source voltage, perform the following procedure:

1. Press in the fuse holder cap and release it with a slight counterclockwise rotation.
2. Pull the cap (with the attached fuse inside) out of the fuse holder.
3. Verify proper fuse value (see Tables 1 and 2).

## POWER CORD

This instrument has a detachable, three-wire power cord with a three-contact plug for connection to both the power source and protective ground. Its power cord is secured to the rear panel by a cord-set-securing clamp. The plug protective-ground contact connects (through the power-cord protective grounding conductor) to the accessible metal parts of the instrument. For electrical-shock protection, insert this plug into a power source outlet that has a properly grounded protective-ground contact.

Instruments are shipped with the required power cord as ordered by the customer. Available power cord options are illustrated in Figure 2, and their part numbers are listed on the "Accessories" page at the back of this manual. Contact your Tektronix representative or local Tektronix Field Office for additional power-cord information.

### NOTE

See APPENDIX A at the back of this manual for further power input information.



Plug Configuration	Usage	Nominal Line-Voltage (AC)	Reference Standards	Option #
	North American 120V/ 15A	120V	ANSI C73.11 <sup>a</sup> NEMA 5-15-P <sup>b</sup> IEC 83 <sup>c</sup>	Standard
	Universal Euro 240V/ 10-16A	240V	CEE (7), II, IV, VII <sup>d</sup> IEC 83 <sup>c</sup>	A1
	UK 240V/ 13A	240V	BS 1363 <sup>e</sup> IEC 83 <sup>c</sup>	A2
	Australian 240V/ 10A	240V	AS C112 <sup>f</sup>	A3
	North American 240V/ 15A	240V	ANSI C73.20 <sup>a</sup> NEMA 6-15-P <sup>b</sup> IEC 83 <sup>c</sup>	A4
<sup>a</sup> ANSI—American National Standards Institute <sup>b</sup> NEMA—National Electrical Manufacturer's Association <sup>c</sup> IEC—International Electrotechnical Commission <sup>d</sup> CEE—International Commission on Rules for the Approval of Electrical Equipment <sup>e</sup> BS—British Standards Institution <sup>f</sup> AS—Standards Association of Australia				2931-05

Figure 2. Optional power cords.

# CONTROLS, CONNECTORS, AND INDICATORS

This section of the manual will familiarize the operator with the location and function of instrument controls, connectors, and indicators.

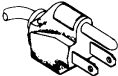
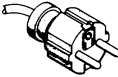
## POWER AND DISPLAY

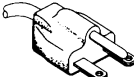
Refer to Figure 3 for location of items 1 through 8.

- ① **POWER Switch**—Turns instrument power on and off. Press in for ON; press again for OFF.
- ② **FOCUS Control**—Adjusts for optimum display definition.
- ③ **ASTIG Control**—Screwdriver control used in conjunction with the FOCUS control to obtain a well-defined display over the entire graticule area. It does not require readjustment during normal operation of the instrument.
- ④ **INTEN Control**—Determines the brightness of the crt display (has no effect when BEAM FIND switch is pressed in).
- ⑤ **BEAM FIND Switch**—When held in, compresses the display to within the graticule area and provides a visible viewing intensity to aid in locating off-screen displays.
- ⑥ **TRACE ROTATION Control**—Screwdriver control used to align the crt trace with the horizontal graticule lines.
- ⑦ **Internal Graticule**—Eliminates parallax viewing error between the trace and graticule lines. Rise-time amplitude measurement points are indicated at the left edge of the graticule.
- ⑧ **SERIAL and Mod Slots**—The SERIAL slot is imprinted with the instrument's serial number. The Mod slot contains the option number that has been installed in the instrument.

## VERTICAL

Refer to Figure 4 for location of items 9 through 19.

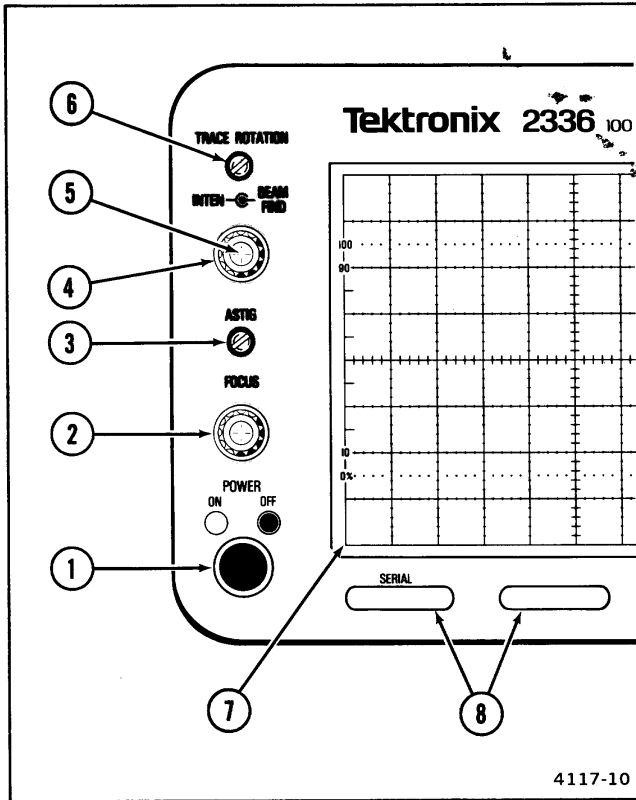

Figure 3. Power and display controls and indicators.

- 9 **AMPL CAL Connector**—Provides a 0.2-V, positive-going square-wave voltage (at approximately 1 kHz) that permits the operator to compensate voltage probes and to check oscilloscope vertical operation. It is not intended to verify time-base calibration.
- 10 **CH 1 OR X and CH 2 OR Y Connectors**—Provide for application of external signals to the inputs of the vertical deflection system or for an X-Y display. In the X-Y mode, the signal connected to the CH 1 OR X connector provides horizontal deflection, and the signal connected to the CH 2 OR Y connector provides vertical deflection.
- 11 **Input Coupling Switches (AC-GND-DC)**—Select the method of coupling input signals to the vertical deflection system.

**AC**—Input signal is capacitively coupled to the vertical amplifier. The dc component of the input signal is blocked. Low-frequency limit (−3 db point) is approximately 10 Hz.

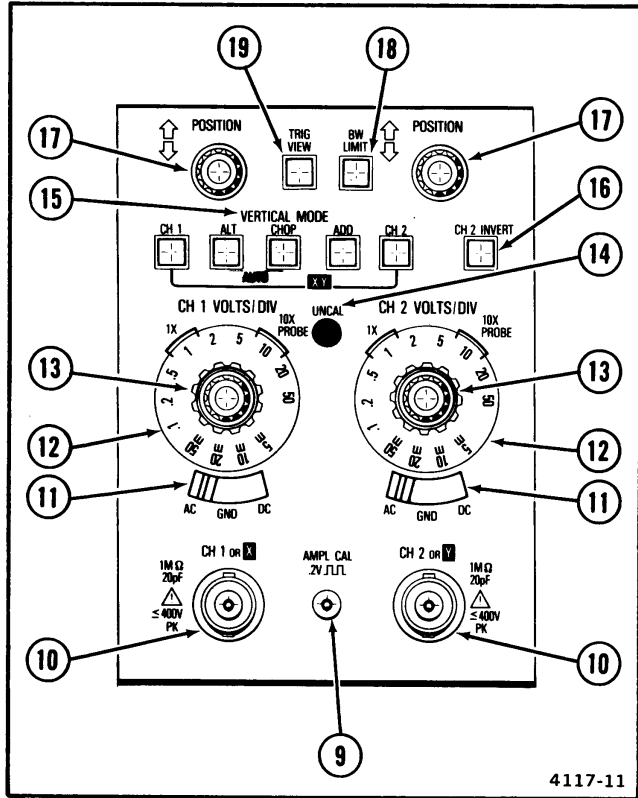

Figure 4. Vertical controls, connectors, and indicators and calibrator output.

**GND**—The input of the vertical amplifier is grounded to provide a zero (ground) reference voltage display (does not ground the input signal). Allows precharging the input coupling capacitor.

**DC**—All frequency components of the input signal are coupled to the vertical deflection system.

**12 CH 1 VOLTS/DIV and CH 2 VOLTS/DIV Switches**—Select the vertical deflection factor in a 1-2-5 sequence. VAR control must be in detent to obtain a calibrated deflection factor.

**1X PROBE**—Indicates the deflection factor selected when using either a 1X probe or coaxial cable.

**10X PROBE**—Indicates the deflection factor selected when using a 10X probe.

**13 VAR Controls**—Provide continuously variable uncalibrated deflection factors between the calibrated settings of the VOLTS/DIV switches when rotated clockwise out of the detent position. Channel 1 VOLTS/DIV VAR control is inoperative when X-Y VERTICAL MODE is selected.

**14** **UNCAL Indicator**—LED illuminates to indicate that either Channel 1 or Channel 2 VOLTS/DIV VAR control is out of calibrated detent (vertical deflection factor is uncalibrated).

**15** **VERTICAL MODE Switches**—Five push-button switches that select the mode of operation for the vertical amplifier system.

**CH 1**—Selects only the Channel 1 input signal for display.

**ALT**—The display alternates between Channel 1 and Channel 2 vertical input signals. The alternation occurs during retrace at the end of each sweep. This mode is useful for viewing both vertical input signals at sweep speeds from 0.2 ms per division to 0.05  $\mu$ s per division.

**CHOP**—The display switches between the Channel 1 and Channel 2 vertical input signals during the sweep. The switching rate is approximately 275 kHz. This mode is useful for viewing both Channel 1 and Channel 2 vertical inputs at sweep speeds from 0.5 ms per division to 0.5 s per division.

**ADD**—Selects the algebraic sum of the Channel 1 and Channel 2 input signals for display.

**CH 2**—Selects only the Channel 2 input signal for display.

**AUTO**—Press in both ALT and CHOP buttons. The A Sweep circuitry automatically selects the most useful switching method (ALT or CHOP) for dual displays.

**X-Y**—Press in both CH 1 and CH 2 buttons. The X-signal is applied through the Channel 1 input connector, and the Y-signal is applied through the Channel 2 input connector.

**16** **CH 2 INVERT Switch**—Inverts Channel 2 display when button is pressed in. Push button must be pressed in a second time to release it and regain a noninverted display.

**17** **POSITION Controls**—Determine the vertical position of the displays on the crt. When X-Y VERTICAL MODE is selected, the Channel 2 POSITION control moves the display vertically (Y-axis), and the Horizontal POSITION control moves the display horizontally (X-axis).

**18 BW LIMIT Switch**—Limits the bandwidth of the vertical amplifier to approximately 20 MHz when pressed in. Push button must be pressed a second time to release it and regain full 100-MHz bandwidth operation. Provides a method for reducing interference from unwanted high-frequency signals when viewing low-frequency signals.

**19 TRIG VIEW Switch**—Press in and hold this push button to display a sample of the signal present in the A Trigger amplifier (for all A TRIGGER SOURCE switch settings except VERT MODE). All other signal displays are removed while the TRIG VIEW push button is held in.

## HORIZONTAL

Refer to Figure 5 for location of items 20 through 26.

**20 B DELAY TIME POSITION-Δ TIME POSITION Controls**—Select the amount of delay time between start of the A Sweep and start of the B Sweep. Delay time is variable to at least 10 times the A SEC/DIV switch setting. The B DELAY TIME POSITION (outer knob) controls the reference point when the

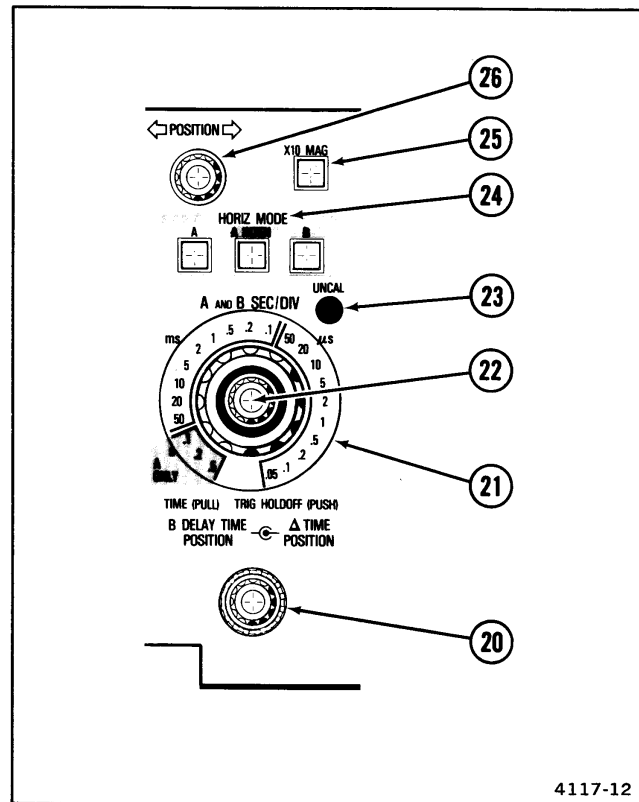

Figure 5. Horizontal controls and indicator.



B TRIGGER SOURCE switch is set to either  $\Delta$  TIME or RUN AFTER DLY. The  $\Delta$  TIME (inner knob) controls the time-measurement point only when the B TRIGGER SOURCE switch is set to  $\Delta$  TIME. When the time-measurement point is to the left of the reference point, the LCD readout indicates a negative time difference.

- 21 **A AND B SEC/DIV Switches**—Selects the sweep speed for the A and B Sweep generators in a 1-2-5 sequence. The A SEC/DIV switch sets the time between the B Sweeps (delay time). For calibrated sweep rates, the TIME (PULL) VAR control must be in the calibrated detent (fully clockwise position).

**A SEC/DIV**—The A Sweep speed is shown between the two black lines on the clear plastic skirt. This switch also selects the delay time (used in conjunction with the B DELAY TIME POSITION control) for delayed sweep operation.

**B SEC/DIV**—The B Sweep speed is set by pulling the inner knob and rotating it to a setting shown by the white line scribed on the knob. The B Sweep circuit is used for delayed sweep operation only.

- 22 **TIME (PULL) VAR Control**—Provides continuously variable, uncalibrated A Sweep speeds between SEC/DIV switch settings to at least 2.5 times the calibrated setting (extends slowest sweep speed to at least 1.25 s per division). To operate this control, pull out the VAR knob and rotate it counterclockwise out of the detent.

- 23 **UNCAL Indicator LED**—Illuminates to indicate that the A Sweep speed is uncalibrated when the TIME (PULL) VAR control is rotated out of the calibrated detent.

- 24 **HORIZ MODE Switches**—Three push-button switches that select the mode of operation for the horizontal deflection system.

**A**—Horizontal deflection is provided by the A Sweep generator at a sweep speed determined by the setting of the A SEC/DIV switch.

**A INTEN**—Horizontal deflection is provided by the A Sweep generator at a speed determined by the A SEC/DIV switch. The B Sweep generator provides an intensified zone on the display. The

length of the intensified zone is determined by the setting of the B SEC/DIV switch. The location of the intensified zone is determined by the setting of the B DELAY TIME POSITION- $\Delta$  TIME POSITION controls.

B—Horizontal deflection is provided by the B Sweep generator at a sweep speed determined by the setting of the B SEC/DIV switch. The start of the B Sweep is delayed from the start of the A Sweep by a time determined by the settings of the A SEC/DIV switch and the B DELAY TIME POSITION- $\Delta$  TIME POSITION controls.

- 25 **X10 MAG Switch**—When pressed in, increases the displayed sweep speed by a factor of 10. Extends fastest sweep speed to 5 ns per division. Push button must be pressed in a second time to release it and regain the X1 sweep speed.
- 26 **POSITION Control**—Positions the display horizontally in all modes. Provides both coarse and fine control action. Reverse the direction of rotation to actuate fine positioning feature. When X-Y VERTICAL MODE is selected, the Horizontal POSITION control moves the display horizontally (X-axis).

## A TRIGGER

Refer to Figure 6 for location of items 27 through 34.

- 27 **SLOPE Switch**—Selects the slope of the signal that triggers the sweep.
- + (**plus**)—When push button is released out, sweep is triggered from the positive-going slope of the trigger signal.
  - (**minus**)—When push button is pressed in, sweep is triggered from the negative-going slope of the trigger signal.
- 28 **LEVEL Control**—Selects the amplitude point on the trigger signal at which the sweep is triggered. The LEVEL control is usually adjusted for the desired display after trigger SLOPE, COUPLING, and SOURCE switch settings have been selected.
- 29 **Trigger Mode Switches**—Three push-button switches that determine the trigger mode for the A Sweep.
- AUTO**—Permits triggering on waveforms with repetition rates down to approximately 10 Hz.

Sweep free runs and provides a baseline trace either in the absence of an adequate trigger signal or when the repetition rate of the trigger signal is below approximately 10 Hz.

**NORM**—Sweep is initiated when an adequate trigger signal is applied. In the absence of a trigger signal, no baseline trace will be present.

**SGL SWP**—Press in the spring-return push button momentarily to arm the A Sweep circuit for a single sweep display. This mode operates the same as NORM, except only one sweep is displayed for each trigger signal. Another single sweep cannot be displayed until the SGL SWP push button is momentarily pressed in again to reset the A Sweep circuit. This mode is useful for displaying and photographing either nonrepetitive signals or signals that cause unstable conventional displays (e.g., signals that vary in amplitude, shape, or time).

- 30 **TRIG'D-READY Indicator LED**—Illuminates when either AUTO or NORM Trigger Mode is selected to indicate that the A Sweep is triggered (TRIG'D). When SGL SWP Trigger Mode is selected, the LED illuminates to indicate that the trigger circuit is armed (READY) for a single sweep display.

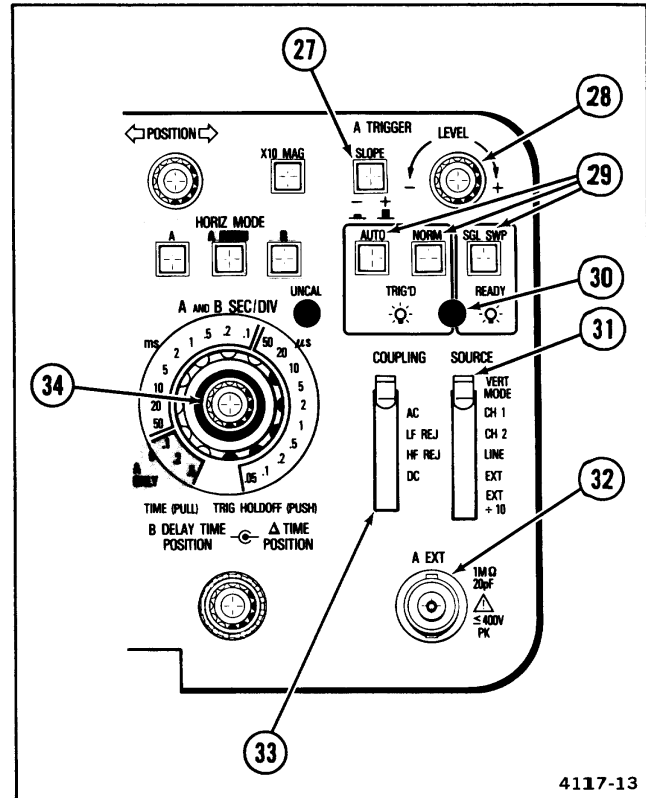

Figure 6. A TRIGGER controls, connector, and indicator.

**31 SOURCE Switch**—Determines the source of the trigger signals coupled to the input of the trigger circuit.

**VERT MODE**—The internal trigger source is determined by the signals selected for display by the VERTICAL MODE switches.

**CH 1**—The signal applied to the CH 1 input connector is the source of the trigger signal.

**CH 2**—The signal applied to the CH 2 input connector is the source of the trigger signal.

**LINE**—Provides a trigger signal from a sample of the ac-power-source waveform. This trigger source is useful when channel input signals are time related (multiple or submultiple) to the frequency of the power-input source voltage.

**EXT**—Permits triggering on signals applied to the External Trigger Input connector (A EXT).

**EXT÷10**—External trigger signals are attenuated by a factor of 10.

**32 A EXT Connector**—Provides a means of applying external signals to the trigger circuit.

**33 COUPLING Switch**—Determines the method used to couple the trigger signal to the input of the trigger circuit.

**AC**—Signals above 20 Hz are capacitively coupled, blocking any dc components of the signal. Signals below 20 Hz are attenuated.

**LF REJ**—Signals are capacitively coupled. The dc component is blocked, and signals below approximately 50 kHz are attenuated. This position is useful for providing a stable display of the high-frequency components of a complex waveform.

**HF REJ**—Signals are capacitively coupled. The dc component is blocked, and signals below approximately 20 Hz and above approximately 50 kHz are attenuated. This position is useful for providing a stable display of the low-frequency components of a complex waveform.

**DC**—All components of the signal are coupled to the A Trigger circuitry. This position is useful for displaying low-frequency or low-repetition-rate signals.

- 34 **TRIG HOLDOFF (PUSH) VAR Control**—Provides continuous control of holdoff time between sweeps. This control improves the ability to trigger on aperiodic signals (such as complex digital waveforms) and increases the minimum holdoff time to at least 2.5 times at any sweep speed.

## B TRIGGER

Refer to Figure 7 for location of items 35 through 39.

- 35 **LEVEL Control**—Selects the amplitude point on the trigger signal at which the sweep is triggered. This control is usually adjusted for the desired display after Trigger SLOPE and SOURCE switch settings have been selected.
- 36 **SOURCE Switch**—Determines the mode of operation for the B Sweep and the signal source for the B Trigger.

**$\Delta$  TIME**—Provides two intensified zones on the crt trace for differential time measurements. The time difference between the two intensified zones

is determined by the B DELAY TIME POSITION and  $\Delta$  TIME POSITION controls. Time difference is displayed on the LCD Readout. With the HORIZ MODE set to A INTEN, alternation of the reference intensified zone and measurement intensified zone occurs at the end of each sweep. With the HORIZ MODE set to B, the start of the B Sweep alternates between the setting of the reference intensified zone and the setting of the measurement intensified zone.

**RUNS AFTER DLY**—The B Sweep starts immediately after the delay time selected by the DELAY TIME POSITION control and is independent of the B Trigger signal.

**VERT MODE**—Allows the internal trigger source to be determined by the vertical mode of operation.

**CH 1**—The signal applied to the CH 1 input connector is the source of the trigger signal.

**CH 2**—The signal applied to the CH 2 input connector is the source of the trigger signal.

**EXT**—Permits triggering on signals applied to the External Trigger Input (B EXT) connector.

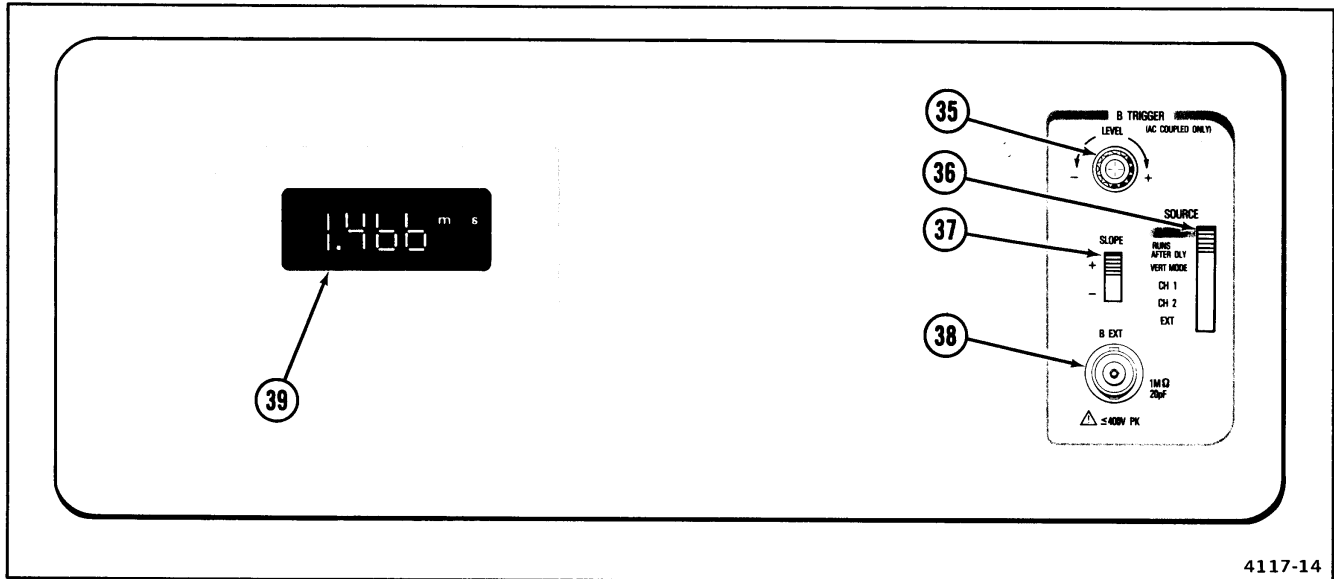

Figure 7. B TRIGGER controls, connector, and LCD readout.

**37) SLOPE Switch**—Selects the slope of the signal that triggers the sweep.

+ (**plus**)—Sweep is triggered on the positive-going portion of the trigger signal.

– (**minus**)—Sweep is triggered on the negative-going portion of the trigger signal.

**38) B EXT Connector**—Provides a means of introducing external signals into the B Trigger Generator.

**39) Readout**—Consists of a 3 1/2 digit LCD (liquid crystal display) unit which is used when the B TRIGGER SOURCE switch is set to  $\Delta$  TIME. Negative polarity indication is automatic for negative time measurements. No polarity indication is displayed for positive values. The decimal point location is controlled by the A SEC/DIV switch, DELAY TIME POSITION, and  $\Delta$  TIME POSITION controls. The readout displays UNCAL when the TIME (PULL) VAR control is out of calibrated detent. It indicates units of time

difference between the two intensified zones on the crt display in seconds (s), milliseconds (ms), microseconds ( $\mu$ s), or nanoseconds (ns).

## REAR PANEL

Refer to Figure 8 for location of items 40 and 41.

**40) GND Connector**—Provides direct connection to instrument chassis ground.

**41) EXT Z AXIS INPUT Connector**—Provides a means of connecting external signals to the Z-Axis amplifier to intensity modulate the crt display. Applied signals do not affect display waveshape. Signals with fast rise time and fall time provide the most abrupt intensity change. Positive-going signals decrease the intensity, and a 5-V p-p signal will produce noticeable modulation. Z-axis signals must be time-related to the display to obtain a stable presentation on the crt.

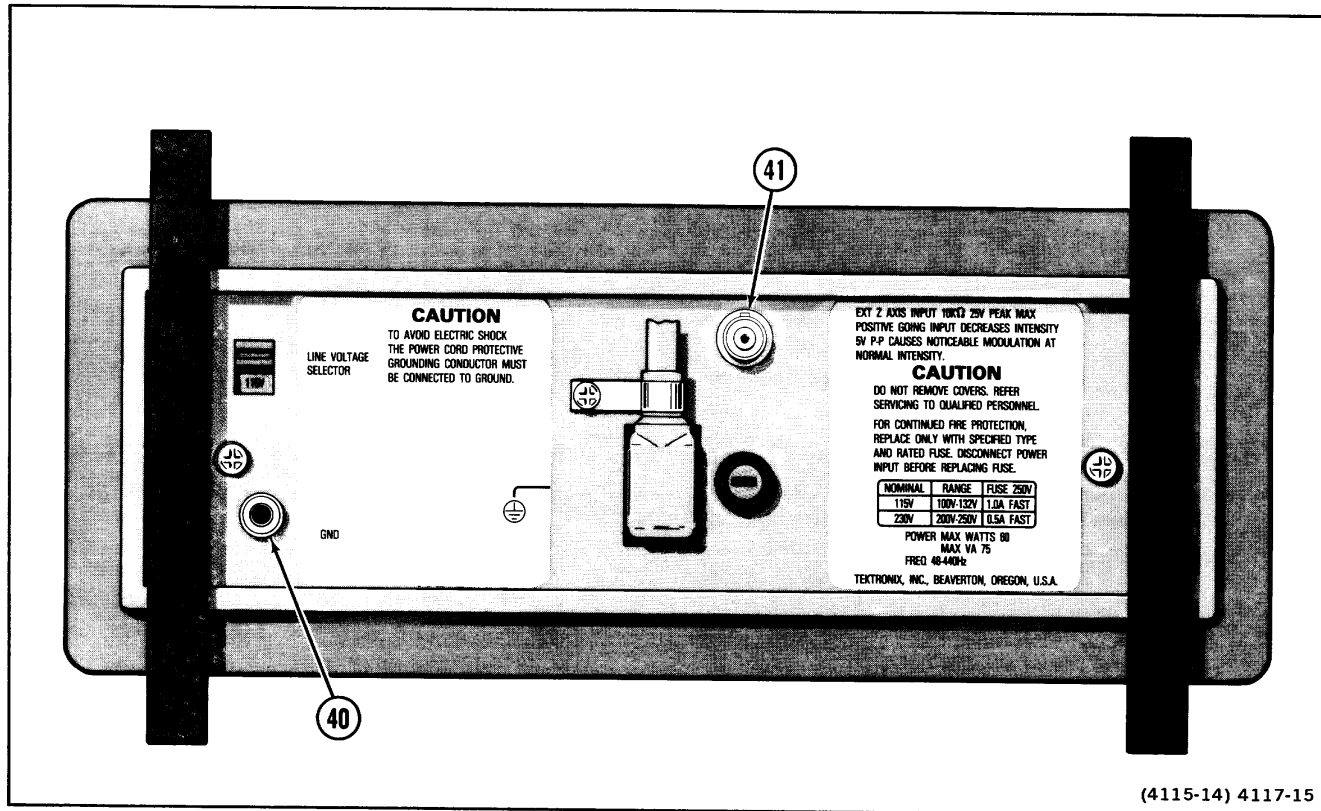

Figure 8. Rear-panel connectors.



# OPERATING CONSIDERATIONS

This section contains basic operating information and techniques that should be considered before attempting any measurements.

## GRATICULE

The graticule is internally marked on the faceplate of the crt to enable accurate measurements without parallax error (see Figure 9). It is marked with eight vertical and ten horizontal major divisions. In addition, each major division is divided into five subdivisions. The vertical deflection factors and horizontal timing are calibrated to the graticule so that accurate measurements can be made directly from the crt. Also, percentage marks for the measurement of rise and fall times are located on the left side of the graticule.

## GROUNDING

The most reliable signal measurements are made when the 2336 and the unit under test are connected by a

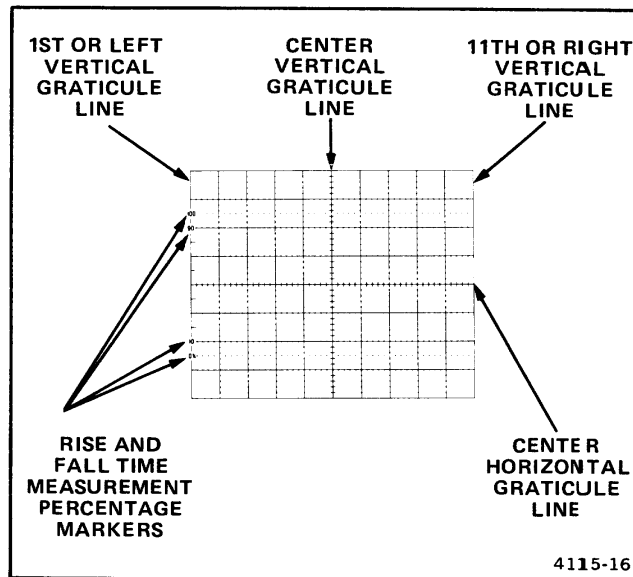

Figure 9. Graticule measurement markings.

common reference (ground lead) in addition to the signal lead or probe. The probe's ground lead provides the best grounding method for signal interconnection and ensures the maximum amount of signal-lead shielding in the probe cable. A separate ground lead can also be connected from the unit under test to the oscilloscope GND connector located on the rear panel.

## SIGNAL CONNECTIONS

### Probes

Generally, probes offer the most convenient means of connecting an input signal to the instrument. They are shielded to prevent pickup of electromagnetic interference, and the supplied 10X probe offers a high input impedance that minimizes circuit loading. This allows the circuit under test to operate with a minimum of change from the normal condition of the circuit when measurements are being made.

### Coaxial Cables

Cables may also be used to connect signals to the input connectors, but they may have considerable effect on the accuracy of a displayed waveform. To maintain the original

frequency characteristics of an applied signal, only high-quality, low-loss coaxial cables should be used. Coaxial cables should be terminated at both ends in their characteristic impedance. If this is not possible, use suitable impedance-matching devices.

## INPUT COUPLING CAPACITOR PRECHARGING

When the input coupling switch is set to GND, the input signal is connected to ground through the input coupling capacitor in series with an 800-k $\Omega$  resistor to form a precharging network. This network allows the input coupling capacitor to charge to the average dc-voltage level of the signal applied to the probe. Thus, any large voltage transients that may accidentally be generated will not be applied to the amplifier input when input coupling is switched from GND to AC. The precharging network also provides a measure of protection to the external circuitry by reducing the current levels that can be drawn from the external circuitry during capacitor charging.

The following procedure should be used whenever the probe tip is connected to a signal source having a different

dc level than that previously applied, especially if the dc-level difference is more than 10 times the VOLTS/DIV switch setting:

1. Set the AC-GND-DC switch to GND before connecting the probe tip to a signal source.

#### NOTE

*The outer shells of the A EXT, CH 1 OR X, and CH 2 OR Y connectors are attached to the 2336 chassis ground.*

2. Touch the probe tip to the oscilloscope chassis ground.

3. Wait several seconds for the input coupling capacitor to discharge.

4. Connect the probe tip to the signal source.

5. Wait several seconds for the input coupling capacitor to charge.

6. Set the AC-GND-DC switch to AC. The display will remain on the screen, and the ac component of the signal can be measured in the normal manner.

## INSTRUMENT COOLING

To maintain adequate instrument cooling, the ventilation holes on both sides of the equipment cabinet must remain free of obstructions.

# INSTRUMENT FAMILIARIZATION

## INTRODUCTION

The procedures in this section are designed to assist you in quickly becoming familiar with the 2336. It provides information which demonstrates the use of all the controls, connectors, and indicators and will enable you to efficiently operate the instrument.

Before proceeding with these instructions, verify that the LINE VOLTAGE SELECTOR switch is placed in the proper position and that the correct line fuse is installed for the available ac-power-input source voltage. Refer to the "Preparation for Use" instructions in this manual for this information. Verify that the POWER switch is OFF (push button out), then plug the power cord into the ac-power-input-source outlet.

If during the performance of these procedures an improper indication or instrument malfunction is noted, first verify correct operation of associated equipment. Should the malfunction persist, refer the instrument to qualified service personnel for repair or adjustment.

## EQUIPMENT REQUIRED

The equipment listed in Table 3, or the equivalent, is required to complete these familiarization procedures for the 2336.

## NORMAL SWEEP DISPLAY

**Table 3**  
**Equipment Required for Instrument**  
**Familiarization Procedure**

Description	Minimum Specification
Calibration Generator	Standard-amplitude accuracy, $\pm 0.25\%$ ; signal amplitude, 2 mV to 50 V; output signal, 1-kHz square wave. Fast-rise repetition rate, 1 to 100 kHz; rise time, 1 ns or less; signal amplitude, 100 mV to 1 V; aberrations, $\pm 2\%$ .
Dual-Input Coupler	Connectors, bnc female-to-dual-bnc male.
Cable (2 required)	Impedance, 50 $\Omega$ ; length, 42 in.; connectors, bnc.
Adapter	Connectors, bnc female-to-bnc female.
Termination	Impedance, 50 $\Omega$ ; connectors, bnc.

First obtain a Normal Sweep Display (baseline trace), using the following procedure.

1. Preset the instrument front-panel controls as follows:

### Display

INTEN	Fully counterclockwise (minimum)
ASTIG	Midrange
FOCUS	Midrange

### Vertical (both CH 1 and CH 2 if applicable)

AC-GND-DC	AC
VOLTS/DIV	50 m (1X)
VOLTS/DIV VAR	Calibrated detent (fully counterclockwise)
VERTICAL MODE	Select CH 1
CH 2 INVERT	Off (push button out)
BW LIMIT	Not limited (push button out)
POSITION	Midrange

## Horizontal

A AND B SEC/DIV  
TIME (PULL) VAR

Locked together at 0.5 ms  
Pull out the VAR knob and  
set it to the calibrated detent  
(fully clockwise), then push  
in the VAR knob.

HORIZ MODE  
X10 MAG  
POSITION  
B DELAY TIME  
POSITION  
 $\Delta$  TIME POSITION

Select A  
Off (push button out)  
Midrange  
  
Fully counterclockwise  
Midrange

## A Trigger

SLOPE  
LEVEL  
Trigger Mode  
COUPLING  
SOURCE  
TRIG HOLDOFF  
(PUSH) VAR

+ (push button out)  
Midrange  
Select AUTO  
AC  
VERT MODE  
  
Fully clockwise and pushed in

## B Trigger

SLOPE  
LEVEL  
SOURCE

+ (up)  
Midrange  
 $\Delta$  TIME

2. Press in the POWER switch button (ON) and allow the instrument to warm up for 20 minutes.

3. Adjust the INTEN control for desired display brightness.

4. Adjust the Vertical and Horizontal POSITION controls to center the trace on the screen.

### NOTE

*Normally, the resulting trace will be parallel with the center horizontal graticule line and should not require adjustment. If trace alignment is required, see the "Trace Rotation" adjustment procedure under "Operator's Checks and Adjustments."*

## DISPLAYING A SIGNAL

After obtaining a Normal Sweep Display (baseline trace), you are now ready to connect an input signal and display it on the crt screen.

1. Connect the calibration generator standard-amplitude output to both the CH 1 and CH 2 inputs as shown in Figure 10.

2. Set the calibration generator for a standard-amplitude 1-kHz square-wave signal and adjust its output to obtain a vertical display of 4 divisions.

3. Adjust the Channel 1 POSITION control to center the display vertically on the screen.

4. Adjust the A TRIGGER LEVEL control for a stable triggered display.

### NOTE

*The A TRIGGER TRIG'D-READY light should illuminate to indicate that the A Sweep is triggered.*

5. Rotate the FOCUS control between its maximum clockwise and counterclockwise positions. The display should become blurred on either side of the optimum control setting.

6. Set the FOCUS control for a sharp, well-defined display over the entire trace length. If a well-focused display cannot be obtained, see the "Astigmatism" adjustment procedure under "Operator's Checks and Adjustments." The ASTIG adjustment is used in conjunction with the FOCUS control to initially obtain a well-defined display over the entire trace length. Once set, the ASTIG control usually requires little or no adjustment.

7. Move the display off the screen using the Channel 1 POSITION control.

8. Press in and hold the BEAM FIND push button; the display should reappear on the screen. Adjust the Channel 1 and Horizontal POSITION controls to center the trace both vertically and horizontally. Release the BEAM FIND button; the display should remain within the viewing area.

9. Adjust the INTEN control counterclockwise until the display disappears.

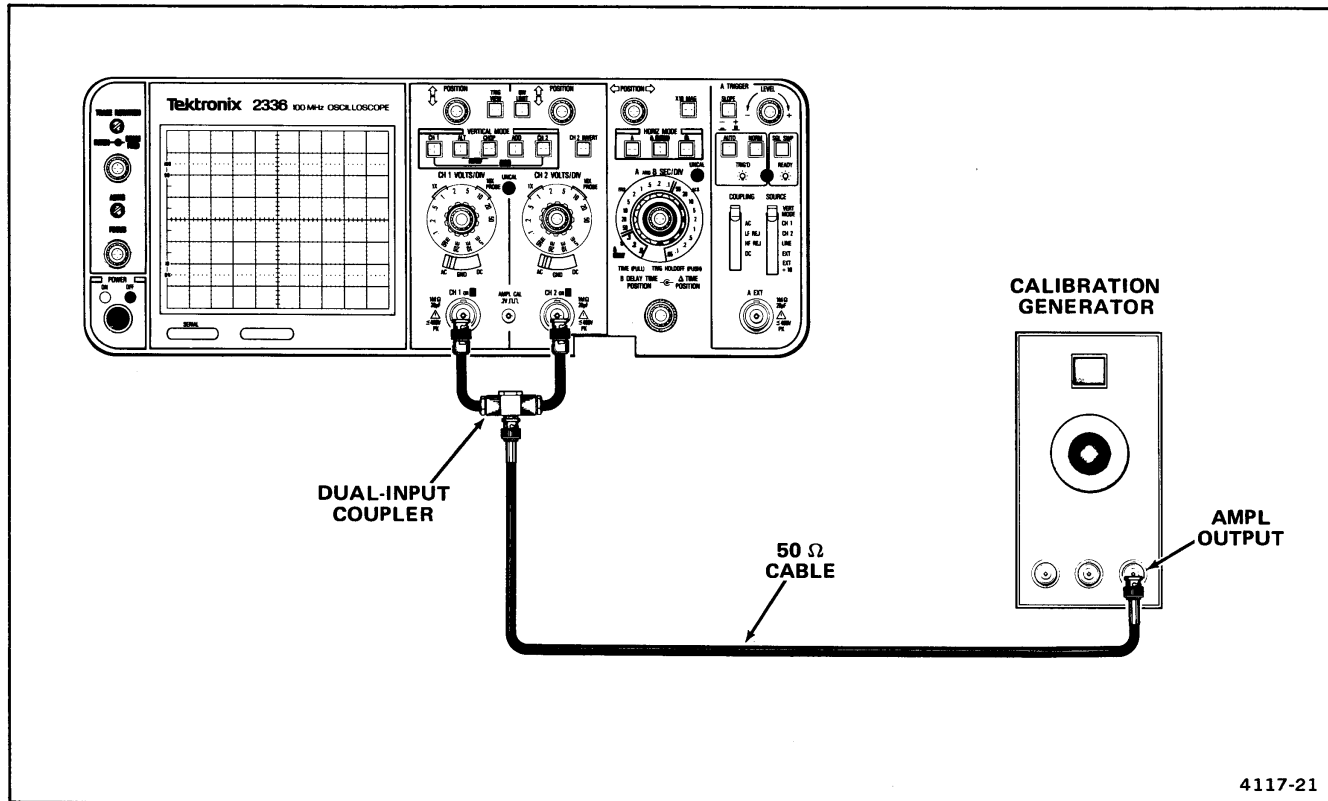

4117-21

Figure 10. Initial setup for instrument familiarization procedure.



10. Press in and hold the BEAM FIND push button; the display should reappear. Release the BEAM FIND button and adjust the INTEN control to desired display brightness.

### Using the Vertical Section

1. Set the Channel 1 AC-GND-DC switch to GND.
2. Adjust the trace to the center horizontal graticule line.
3. Set the Channel 1 AC-GND-DC switch to DC.
4. Observe that the bottom of the display remains at the center horizontal graticule line (ground reference).
5. Set the Channel 1 AC-GND-DC switch to AC.
6. Observe that the display is centered approximately at the center horizontal line.
7. Set the CH 1 VOLTS/DIV switch to 0.1 and observe that a 2-division vertical display appears.

8. Rotate the CH 1 VOLTS/DIV VAR control fully clockwise. Note that the vertical UNCAL light illuminates when the VOLTS/DIV VAR control is out of the calibrated detent.

9. Observe that maximum vertical deflection occurs when the VOLTS/DIV VAR control is fully clockwise.

10. Rotate the CH 1 VOLTS/DIV VAR control fully counterclockwise to its calibrated detent.

11. Select CH 2 VERTICAL MODE and perform preceding steps 1 through 10 using Channel 2 controls. Performance should be similar to Channel 1.

12. Set both Channel 1 and Channel 2 AC-GND-DC switches to DC. Ensure that both CH 1 and CH 2 VOLTS/DIV switches are set to 0.1 for 2-division displays.

13. Select ADD VERTICAL MODE and observe that the resulting display is 4 divisions in amplitude. Both Channel 1 and Channel 2 POSITION controls should move the display. Recenter the display on the screen.

14. Press in the CH 2 INVERT push button to invert the Channel 2 signal.

15. Observe that the display is a straight line, indicating that the algebraic sum of the two signals is zero.

16. Set the CH 2 VOLTS/DIV switch to 50 m (1X).

17. Observe the 2-division display, indicating that the algebraic sum of the two signals is no longer zero.

18. Press in the CH 2 INVERT push button again to release it. Observe a noninverting display having a 6-division signal amplitude.

19. Select CH 1 VERTICAL MODE and set CH 1 VOLTS/DIV switch to 50 m (1X).

20. Adjust the Channel 1 POSITION control to center the display on the screen.

21. Set the A TRIGGER SOURCE switch to CH 1.

22. Press in and hold the TRIG VIEW push button. Observe the Channel 1 trigger signal that is present in the A Trigger amplifier.

#### NOTE

*When in the TRIG VIEW mode, a trigger signal is displayed on the crt screen for every A TRIGGER COUPLING switch position and for every A TRIGGER SOURCE switch position except VERT MODE.*

23. Still holding in the TRIG VIEW push button, rotate the A TRIGGER LEVEL control between its maximum clockwise and counterclockwise positions.

24. Observe that maximum signal amplitude and most stable display occurs when the displayed signal is at the approximate center of the graticule area.

25. Release the TRIG VIEW button and set the A TRIGGER COUPLING switch to AC. Note that a normal display is regained.

26. Set both Channel 1 and Channel 2 AC-GND-DC switches to GND.

27. Position Channel 1 trace two divisions above the center graticule line.

28. Select CH 2 VERTICAL MODE and position the Channel 2 trace two divisions below the center graticule line.

29. Select ALT VERTICAL MODE and rotate the A SEC/DIV switch throughout its range. The display will alternate between channels at all sweep speeds. This mode is most useful for sweep speeds from 0.05  $\mu$ s to 0.2 ms per division.

30. Select CHOP VERTICAL MODE and rotate the A SEC/DIV switch throughout its range. A dual-trace display will be presented at all sweep speeds, but unlike the ALT mode, both Channel 1 and Channel 2 signals are displayed for each sweep speed on a time-shared basis. This mode is most useful for sweep speeds from 0.5 ms to 0.5 s per division.

31. Set the A TRIGGER SOURCE switch to VERT MODE.

32. Observe the switching between Channel 1 and Channel 2 at the higher sweep speeds (indicated by the segmented trace).

33. Select AUTO VERTICAL MODE by simultaneously pressing in both ALT and CHOP push buttons.

34. Rotate the A SEC/DIV switch throughout its range. Note that a dual-trace display is present at all sweep speeds.

35. Select CH 1 VERTICAL MODE and set Channel 1 AC-GND-DC switch to DC. Recenter the display on the screen.

### Using the Horizontal Section

1. Return the A SEC/DIV switch to 0.5 ms and note the display for future comparison in step 3.

2. Set the A SEC/DIV switch to 5 ms and press in the X10 MAG push button.

3. Observe that the display is similar to that obtained in step 1.

4. Rotate the Horizontal POSITION control throughout its range. Observe that the display can be positioned off the screen horizontally with X10 MAG selected.

5. Press in the X10 MAG push button again to release it for X1 sweep.

6. Return the A and B SEC/DIV switches to 0.5 ms.

7. Rotate the TRIG HOLDOFF (PUSH) VAR knob out of detent to its maximum counterclockwise position.

8. Observe that the crt trace becomes dimmer as the holdoff between sweeps is increased.

9. Return the TRIG HOLDOFF (PUSH) VAR control to its calibrated detent (fully clockwise). Note the display for future comparison in step 11.

10. Pull out the TIME (PULL) VAR knob and rotate the control out of detent to its maximum counterclockwise position.

11. Observe that the sweep rate is approximately 2.5 times slower than in step 9, as indicated by more cycles displayed on the screen.

12. Return the TIME (PULL) VAR control to its calibrated detent (fully clockwise) and push in the knob.

### Using the A Trigger Section

1. Rotate the A TRIGGER LEVEL control between its maximum clockwise and counterclockwise positions. The display will free-run near each limit of rotation. Observe that the TRIG'D-READY light illuminates only when the display is triggered.

2. Adjust the A TRIGGER LEVEL control for a stable display.

3. Press in the A TRIGGER SLOPE push button to the - (minus) position. Observe that the display starts on the negative-going slope of the applied signal.

4. Press in the A TRIGGER SLOPE push button again to release it to the + (plus) position. Observe that the

display starts on the positive-going slope of the applied signal.

5. Select the A TRIGGER NORM mode.

6. Rotate the A TRIGGER LEVEL control between its maximum clockwise and counterclockwise positions. Observe that the display is presented when correctly triggered.

7. Set the A TRIGGER COUPLING switch to DC and the A TRIGGER SOURCE switch to VERT MODE.

8. Rotate the Channel 1 POSITION control until the display becomes unstable. Note that changing the vertical POSITION control setting affects the dc trigger level with the A TRIGGER SOURCE switch set to VERT MODE.

9. Adjust the Channel 1 POSITION control to center the display on the screen.

10. Set the A TRIGGER COUPLING switch to AC and the A TRIGGER SOURCE switch to CH 1.

11. Remove the calibration signal from the CH 1 input connector.

12. Press in the A TRIGGER SGL SWP push button momentarily for single-sweep operation.

13. Observe that the TRIG'D-READY light illuminates, indicating that the A trigger circuit is armed (READY) for a single-sweep display. No display should be present on the crt screen.

14. Reconnect the calibration signal to the CH 1 input connector. A single sweep of the applied signal should appear on the screen. When the TRIG'D-READY light is out, another single sweep cannot be displayed until the SGL SWP button is pressed in again to reset the A Trigger circuit.

15. Select the A TRIGGER AUTO mode and set the A TRIGGER SOURCE switch to EXT.

16. Remove the calibration signal from the CH 2 input connector and connect it to the A EXT input connector.

17. Set the Channel 1 VOLTS/DIV switch to 0.5 (1X) and adjust the output of the calibration generator to provide a 4-division display. Adjust the A TRIGGER LEVEL control for a stable display.

18. Set the A TRIGGER SOURCE switch to EXT  $\div$  10.

19. Observe that adjustment of the A TRIGGER LEVEL control provides a triggered display over a narrower range than in preceding step 17, indicating trigger-signal attenuation.

### Using the Delayed-Sweep Controls

1. Remove the calibration signal from the A EXT input connector and connect it to the CH 2 input connector.

2. Set the A TRIGGER SOURCE switch to VERT MODE and adjust the A TRIGGER LEVEL control for a stable display.

3. Set B SEC/DIV switch to 0.1 ms and select the A INTEN HORIZ MODE. Ensure that the B TRIGGER SOURCE switch is set to  $\Delta$  TIME.

4. Observe that two intensified zones, approximately 1 division in length, appear on the display.

5. Rotate both the B DELAY TIME POSITION control (reference point) and the  $\Delta$  TIME POSITION control (measurement point) throughout their ranges; the intensified zones move continuously across the display as the controls are rotated.

6. Observe that the time difference between the start of the reference intensified zone and the start of the measurement intensified zone is displayed on the LCD Readout.

7. Select the B HORIZ MODE and observe that the intensified zones, previously viewed with A INTEN selected, are displayed on the crt screen.

8. Rotate both the B DELAY TIME POSITION and the  $\Delta$  TIME POSITION controls and observe that both displays move continuously across the crt screen.

9. Select the A INTEN HORIZ MODE and set the B TRIGGER SOURCE switch to RUNS AFTER DLY. Instead of two intensified zones, there is now only one intensified zone. This intensified zone can be continuously positioned on the screen by adjusting only the B DELAY TIME POSITION control. The LCD Readout is disabled.

### Using the B Trigger Section

1. Set the B SEC/DIV switch to 1 ms and set the B TRIGGER SOURCE switch to VERT MODE.

2. Rotate the B DELAY TIME POSITION control throughout its range and observe that the intensified zone appears to jump between positive slopes of the display.

3. Set the B TRIGGER SLOPE switch to – (minus) and observe that the intensified portion begins on the negative slope. Return the B DELAY TIME POSITION control to its fully counterclockwise position.

4. Rotate the B TRIGGER LEVEL control and observe that the intensified zone of the display disappears when this control is out of triggerable range. Readjust the B TRIGGER LEVEL control for a stable display.

5. Select the B HORIZ MODE and rotate the B DELAY TIME POSITION control clockwise. Observe that the length of the display decreases.

6. Operation with the B TRIGGER SOURCE switch set to CH 1, CH 2, or EXT is similar to operation with the B TRIGGER SOURCE switch set to VERT MODE.

### Using the X-Y Mode

1. Set both the CH 1 and CH 2 VOLTS/DIV switches to 1 (1X) and adjust the generator output to provide a 5-division display.

2. Select X-Y VERT MODE by simultaneously pressing in the CH 1 and CH 2 push buttons.

3. Increase the INTEN control setting until two dots are displayed diagonally. This display can then be positioned horizontally with the Horizontal POSITION control and vertically with the Channel 2 POSITION control. Note that the dots are separated by 5 horizontal divisions and 5 vertical divisions.

4. Set both the CH 1 and CH 2 VOLTS/DIV switches to 2 (1X). Note that the dots are now separated by 2 1/2 horizontal divisions and 2 1/2 vertical divisions.

5. Select CH 1 VERTICAL MODE and adjust the INTEN control for normal brightness.

### Using the Z-Axis Input

1. Disconnect the dual-input coupler from the CH 2 input connector and connect a bnc female-to-bnc female adapter to the disconnected end of the coupler.

2. Connect a 42-inch, 50- $\Omega$  bnc cable from the Z-AXIS INPUT connector (located on the rear panel) to the dual-input coupler via the bnc female-to-bnc female adapter.

3. Set the Channel 1 VOLTS/DIV switch to 1 (1X) and adjust the output of the calibration generator to provide a 5-division display.

4. Observe that the positive peaks of the waveform are blanked, indicating intensity modulation (adjust INTEN control as necessary).

5. Disconnect the 50- $\Omega$  bnc cable from the Z-AXIS INPUT connector and disconnect the dual-input coupler from the CH 1 input connector.

### Using the Bandwidth Limit Switch

1. Connect a fast-rise + output calibration signal through a 42-inch, 50- $\Omega$  cable and a 50- $\Omega$  termination to the CH 1 input connector.

2. Set the CH 1 VOLTS/DIV switch to 50 (1X) and adjust the calibration generator output to provide a 4-division display.

3. Set the A SEC/DIV switch to 0.5  $\mu$ s and adjust the calibration generator fast-rise + output signal frequency to 1 MHz. Adjust the generator amplitude to provide approximately 5 cycles of the displayed signal.

4. Press in the BW LIMIT push button and observe the rounding-off of the front corners of the display. This indicates a decrease in the frequency response of the vertical amplifier.



# OPERATOR'S CHECKS AND ADJUSTMENTS

## INTRODUCTION

To verify the operation and accuracy of your instrument, perform the following check and adjustment procedures before making a measurement. If adjustments are required beyond the scope of these operator's checks and adjustments, refer the instrument to a qualified service technician for calibration. Before proceeding with these instructions, verify that the LINE VOLTAGE SELECTOR switch is placed in the proper position and that the correct line fuse is installed for the ac-power-input source voltage to be used. Refer to the "Preparation for Use" information in this manual for procedures relating to ac-power-input source voltage and fuse selection. Verify that the POWER switch is OFF (push button out), then plug the power cord into the ac-power-input source outlet. Push in the POWER switch (ON) to apply power to the instrument and allow sufficient time for warm-up before starting these checks and adjustments. Warm-up time required to meet all the instrument's specification is 20 minutes.

## TRACE ROTATION

1. Preset instrument controls and obtain a Normal Sweep Display (refer to "Instrument Familiarization").
2. Use the Channel 1 POSITION control to move the baseline trace to the center horizontal graticule line.

### NOTE

*Normally, the resulting trace will be parallel to the center horizontal graticule line, and the Trace Rotation adjustment should not be required.*

3. If the resulting trace is not parallel to the center horizontal graticule line, use a small-bladed screwdriver to adjust the TRACE ROTATION control (see Figure 3) and align the trace with the center horizontal graticule line.

## PROBE COMPENSATION

Misadjustment of probe compensation is one of the sources of measurement error. Most attenuator probes are equipped with compensation adjustments. To ensure optimum measurement accuracy, always compensate the oscilloscope probe before making measurements. Probe compensation is accomplished as follows:

1. Preset instrument controls and obtain a Normal Sweep Display (refer to "Instrument Familiarization").
2. Connect the two 10X probes (supplied with the instrument) to the CH 1 and CH 2 input connectors.
3. Set both VOLTS/DIV switches to 0.5 m and set both AC-GND-DC switches to DC.
4. Select CH 1 VERTICAL MODE and insert the tip of the probe connected to the Channel 1 input connector to the AMPL CAL output.
5. Using the approximately 1-kHz AMPL CAL square-wave signal as the input, obtain a display of the signal (refer to "Instrument Familiarization").
6. Set the A SEC/DIV switch to display several cycles of the AMPL CAL signal. Use the Channel 1 POSITION control to vertically center the display.
7. Check the waveform presentation for overshoot and rolloff (see Figure 11). If necessary, adjust the probe compensation for flat tops on the waveforms. Refer to the instructions supplied with the probe for details of compensation adjustment.
8. Select CH 2 VERTICAL MODE and connect the Channel 2 probe tip to the AMPL CAL output.
9. Use the Channel 2 POSITION control to vertically center the display and repeat step 7 for the Channel 2 probe.
10. Disconnect the probes from the instrument.

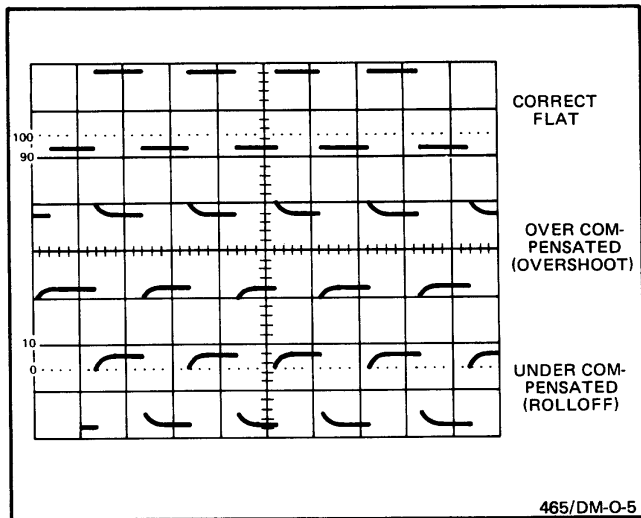

Figure 11. Probe compensation.

## ASTIGMATISM

1. Preset instrument controls and obtain a Normal Sweep Display (refer to "Instrument Familiarization").

2. Set:

Channel 1 AC-GND-DC  
INTEN

DC  
Visible display

3. Connect a 10X probe to the Channel 1 input connector and connect the probe tip to the AMPL CAL output.

4. Adjust the Channel 1 POSITION control to center the display on the screen.

5. Adjust the A TRIGGER LEVEL control for a stable display of the AMPL CAL signal.

6. Slowly adjust the FOCUS control to its optimum setting (best defined display). If the ASTIG adjustment is correctly set, all portions of the trace will come into sharpest focus at the same position of the FOCUS control.

### NOTE

*The setting of the ASTIG adjustment should be correct for any display. However, it may be necessary to reset the FOCUS control slightly when the INTEN control setting is changed.*

7. If focusing is not uniform over the entire graticule area, use a small-bladed screwdriver to adjust the ASTIG control (see Figure 3).

8. Since the ASTIG and FOCUS adjustments interact, repeat steps 6 and 7 for the best defined display over the entire crt graticule area.

## VERTICAL GAIN CHECK

1. Preset instrument controls and obtain a Normal Sweep Display (refer to "Instrument Familiarization").

2. Set:

AC-GND-DC (both)                      DC

3. Connect a 10X probe to the Channel 1 input connector and connect the probe tip to the AMPL CAL output.

4. Adjust the INTEN control for desired brightness and adjust the FOCUS control for best defined display.

5. Adjust the A TRIGGER LEVEL control for a stable display of the AMPL CAL signal.

6. Adjust the Channel 1 POSITION control to vertically center the display.

7. Check for a vertical display amplitude of 4 divisions  $\pm 0.2$  division (3.8 to 4.2 divisions). See Figure 12.

8. Repeat steps 3 through 7 using Channel 2.

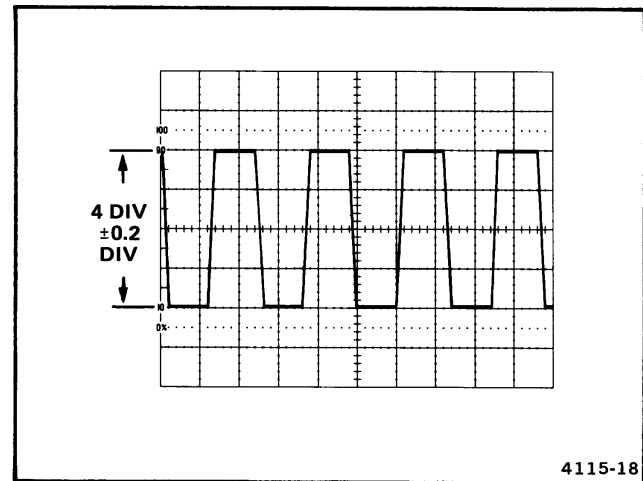

Figure 12. Vertical display accuracy.

# BASIC APPLICATIONS

After becoming familiar with all the capabilities of the 2336 Oscilloscope, the operator can then adopt a convenient method for making a particular measurement. The following information describes the recommended procedures and techniques for making basic measurements with your instrument. When a procedure first calls for presetting instrument controls and obtaining a Normal Sweep Display, refer to the "Instrument Familiarization" section and perform steps 1 through 4 under "Normal Sweep Display."

## NONDELAYED MEASUREMENTS

### AC Peak-to-Peak Voltage

To perform a peak-to-peak voltage measurement, use the following procedure:

#### NOTE

*This procedure may also be used to make voltage measurements between any two points on the waveform.*

1. Preset instrument controls and obtain a Normal Sweep Display.

2. Apply the ac signal to either vertical-channel input connector and set the VERTICAL MODE switch to display the channel used.

3. Set the appropriate VOLTS/DIV switch to display about five divisions of the waveform, ensuring that the VOLTS/DIV VAR control is in the calibrated detent.

4. Adjust the A TRIGGER LEVEL control to obtain a stable display.

5. Set the A SEC/DIV switch to a position that displays several cycles of the waveform.

6. Vertically position the display so that the negative peak of the waveform coincides with one of the horizontal graticule lines (see Figure 13, Point A).

7. Horizontally position the display so that one of the positive peaks coincides with the center vertical graticule line (see Figure 13, Point B).

8. Measure the vertical deflection from peak to peak (see Figure 13, Point A to Point B).

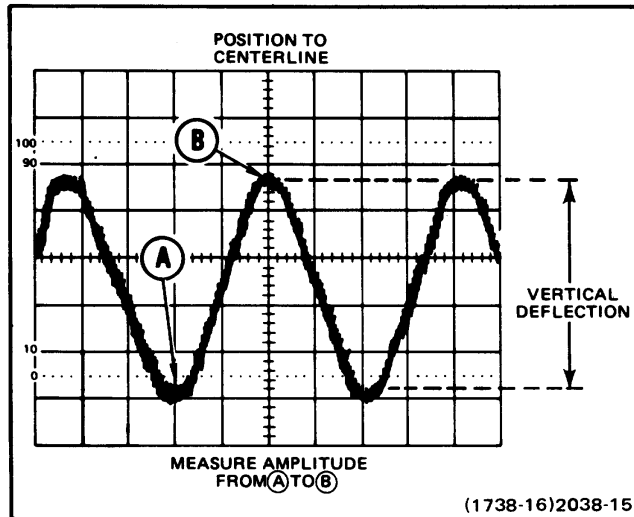

Figure 13. Peak-to-peak waveform voltage.

## NOTE

*If the amplitude measurement is critical or if the trace is thick (as a result of hum or noise on the signal), a more accurate value can be obtained by measuring from the top of a peak to the top of a valley. This will eliminate trace thickness from the measurement.*

9. Calculate the peak-to-peak voltage, using the following formula:

$$\text{Volts (p-p)} = \text{vertical deflection (divisions)} \times \text{VOLTS/DIV switch setting} \times \text{probe attenuation factor}$$

**EXAMPLE:** The measured peak-to-peak vertical deflection is 4.6 divisions (see Figure 13) with a VOLTS/DIV switch setting of 0.5, using a 10X probe.

Substituting the given values:

$$\text{Volts (p-p)} = 4.6 \text{ div} \times 0.5 \text{ V/div} \times 10 = 23 \text{ V.}$$

## Instantaneous DC Voltage

To measure the dc level at a given point on a waveform, use the following procedure:

1. Preset instrument controls and obtain a Normal Sweep Display.
2. Apply the signal to either vertical-channel input connector and set the VERTICAL MODE switch to display the channel used.
3. Verify that the VOLTS/DIV VAR control is in the calibrated detent and set the AC-GND-DC switch to GND.
4. Vertically position the baseline trace to the center horizontal graticule line.
5. Set the AC-GND-DC switch to DC. If the waveform moves above the centerline of the crt, the voltage is positive. If the waveform moves below the centerline of the crt, the voltage is negative.

## NOTE

*If using Channel 2, ensure that the CH 2 INVERT switch is in its noninverting mode (push button out).*

6. Set the AC-GND-DC switch to GND and position the baseline trace to a convenient reference line, using the Vertical POSITION control. For example, if the voltage to be measured is positive, position the baseline trace to the bottom graticule line. If a negative voltage is to be measured, position the baseline trace to the top graticule line. Do not move the Vertical POSITION control after this reference line has been established. The ground reference line can be checked at any later time by switching the AC-GND-DC switch to GND.

7. Set the AC-GND-DC switch to DC.

8. If the voltage-level measurement is to be made with respect to a voltage level other than ground, apply the reference voltage to the unused vertical-channel input connector. Then position its trace to the reference line.

9. Adjust the A TRIGGER LEVEL control to obtain a stable display.

10. Set the A SEC/DIV switch to a position that displays several cycles of the signal.

11. Measure the divisions of vertical deflection between the reference line and the desired point on the waveform at which the dc level is to be determined (see Figure 14).

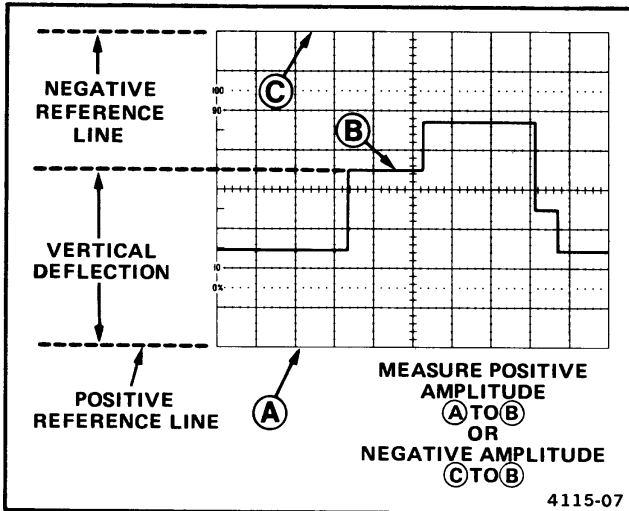

Figure 14. Instantaneous voltage measurement.

12. Calculate the instantaneous voltage, using the following formula:

$$\text{Instantaneous Voltage} = \text{vertical deflection (divisions)} \times \text{polarity (+ or -)}$$

$$\times \frac{\text{VOLTS/DIV switch setting}}{\text{probe attenuation factor}}$$

**EXAMPLE:** The measured vertical deflection from the reference line is 4.6 divisions (see Figure 14), the waveform is above the reference line, the VOLTS/DIV switch is set to 2, and a 10X attenuator probe is being used.

Substituting the given values:

$$\text{Instantaneous Voltage} = 4.6 \text{ div} \times (+1) \times 2 \text{ V/div} \times 10 = 92 \text{ V.}$$

### Algebraic Addition

With the VERTICAL MODE switch in the ADD position, the waveform displayed is the *algebraic sum* of the signals applied to the Channel 1 and Channel 2 inputs



(CH 1 + CH 2). If the CH 2 INVERT push button is pressed in, the waveform displayed is the *difference* between the signals applied to the Channel 1 and Channel 2 inputs (CH 1 – CH 2). The total deflection factor in the ADD mode is equal to the deflection factor indicated by either VOLTS/DIV switch (when both VOLTS/DIV switches are set to the same deflection factor). A common use for the ADD mode is to provide a dc offset for a signal riding on top of a high dc level.

The following general precautions should be observed when using the ADD mode.

- a. Do not exceed the input voltage rating of the oscilloscope.
- b. Do not apply signals that exceed the equivalent of about eight times the VOLTS/DIV switch settings, since large voltages may distort the display. For example, with a VOLTS/DIV switch setting of 0.5, the voltage applied to that channel should not exceed approximately 4 volts.
- c. Use Channel 1 and Channel 2 POSITION control settings which most nearly position the signal on each

channel to midscreen when viewed in either CH 1 or CH 2 VERTICAL MODE. This ensures the greatest dynamic range for ADD mode operation.

- d. To attain similar response from each channel, set both the Channel 1 and Channel 2 AC-GND-DC switches to the same position.

**EXAMPLE:** Using the graticule center line as 0 V, the Channel 1 signal is at a 3-division, positive dc level (see Figure 15A).

1. Multiply 3 divisions by the VOLTS/DIV switch setting to determine the dc-level value.

2. To the Channel 2 input connector, apply a negative dc level (or positive level, using the CH 2 INVERT switch) whose value was determined in step 1 (see Figure 15B).

3. Select ADD VERTICAL MODE to place the resultant display within the operating range of the vertical POSITION controls (see Figure 15C).

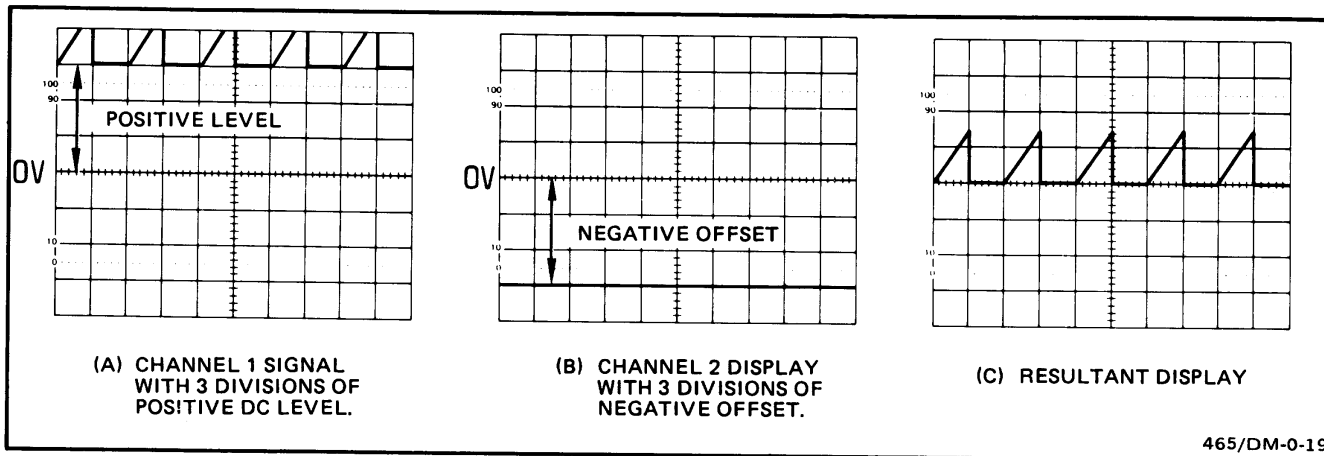

Figure 15. Algebraic addition.

## Common-Mode Rejection

The ADD mode can also be used to display signals that contain undesirable frequency components. These undesirable components can be eliminated through common-mode rejection. The precautions given under the preceding "Algebraic Addition" procedure should be observed.

**EXAMPLE:** The signal applied to the Channel 1 input connector contains unwanted ac-input-power-source frequency components (see Figure 16A). To remove the undesired components, use the following procedure:

1. Preset instrument controls and obtain a Normal Sweep Display.

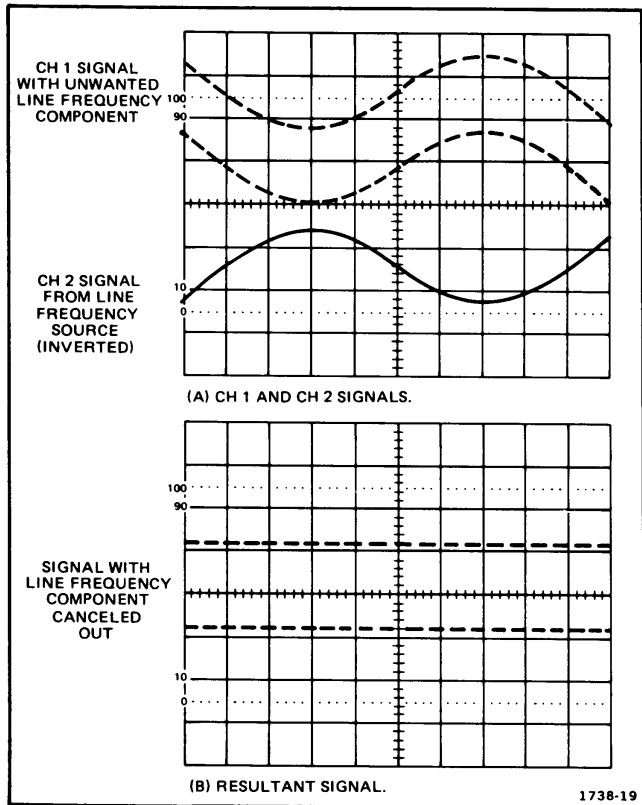

Figure 16. Common-mode rejection.

2. Apply the signal containing the unwanted line-frequency components to the Channel 1 input.
3. Apply a line-frequency signal to the Channel 2 input.
4. Select ALT VERTICAL MODE and press in the CH 2 INVERT push button.
5. Adjust the Channel 2 VOLTS/DIV switch and VAR control so that the Channel 2 display is approximately the same amplitude as the undesired portion of the Channel 1 display (see Figure 16A).
6. Select ADD VERTICAL MODE and slightly readjust the Channel 2 VOLTS/DIV VAR control for maximum cancellation of the undesired signal component (see Figure 16B).

### Time Duration

To measure time between two points on a waveform, use the following procedure:

1. Preset instrument controls and obtain a Normal Sweep Display.

2. Apply the signal to either vertical-channel input connector and set the VERTICAL MODE switch to display the channel used.

3. Adjust the A TRIGGER LEVEL control to obtain a stable display.

4. Set the A SEC/DIV switch to display one complete period of the waveform. Ensure that the TIME (PULL) VAR control is in the calibrated detent.

5. Position the display to place the time-measurement points on the center horizontal graticule line (see Figure 17).

6. Measure the horizontal distance between the time-measurement points.

7. Calculate time duration, using the following formula:

$$\text{Time Duration} = \frac{\text{horizontal distance (divisions)} \times \text{A SEC/DIV switch setting}}{\text{magnification factor}}$$

**EXAMPLE:** The distance between the time-measurement points is 8 divisions (see Figure 17), and the A SEC/DIV switch is set to 2 ms. A magnification factor of 1 is used.

Substituting the given values:

$$\text{Time Duration} = 8.3 \text{ div} \times 2 \text{ ms/div} = 16.6 \text{ ms}$$

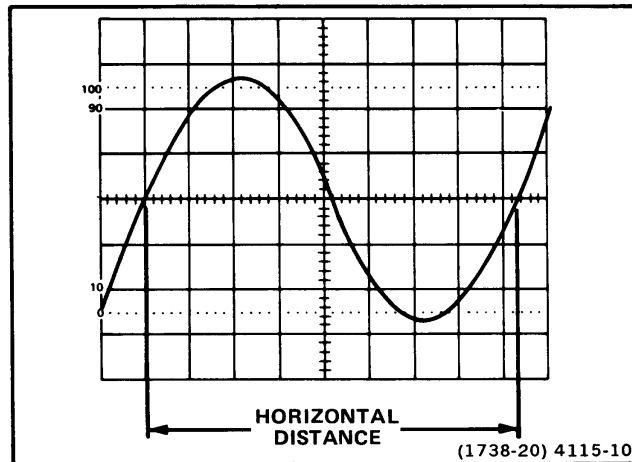

Figure 17. Time duration.

## Frequency

The frequency of a recurrent signal can be determined from its time-duration measurement as follows:

1. Measure the time duration of one waveform cycle using the preceding "Time Duration" measurement procedure.
2. Calculate the reciprocal of the time-duration value to determine the frequency of the waveform.

**EXAMPLE:** The signal in Figure 17 has a time duration of 16.6 ms.

Calculating the reciprocal of time duration:

$$\text{Frequency} = \frac{1}{\text{time duration}} = \frac{1}{16.6 \text{ ms}} = 60 \text{ Hz}$$

## Rise Time

Rise-time measurements use the same methods as time duration, except that the measurements are made between

the 10% and 90% points on the leading edge of the waveform (see Figure 18). Fall time is measured between the 90% and 10% points on the trailing edge of the waveform.

1. Preset instrument controls and obtain a Normal Sweep Display.
2. Apply the signal to either vertical-channel input connector and set the VERTICAL MODE switch to display the channel used.
3. Set the A TRIGGER SLOPE switch to + (plus). Use a sweep-speed setting that displays several complete cycles or events (if possible).
4. Set the VOLTS/DIV switch and VAR control for an exact 5-division display.
5. Adjust vertical positioning so that the zero reference of the waveform touches the 0% graticule line and the top

of the waveform touches the 100% graticule line (see Figure 18).

6. Set the A SEC/DIV switch for a single-waveform display, with the rise time spread horizontally as much as possible.

7. Horizontally position the display so the 10% point on the waveform intersects the second vertical graticule line (see Figure 18, Point A).

8. Measure the horizontal distance between the 10% and 90% points and calculate the time duration using the following formula:

$$\text{Rise Time} = \frac{\text{horizontal distance (divisions)} \times \text{SEC/DIV switch setting}}{\text{magnification factor}}$$

**EXAMPLE:** The horizontal distance between the 10% and 90% points is 5 divisions (see Figure 18), and the A SEC/DIV switch is set to 1  $\mu\text{s}/\text{division}$ . A magnification factor of 1 is used.

Substituting the given values in the formula:

$$\text{Rise Time} = \frac{5 \text{ div} \times 1 \mu\text{s}/\text{div}}{1} = 5 \mu\text{s}$$

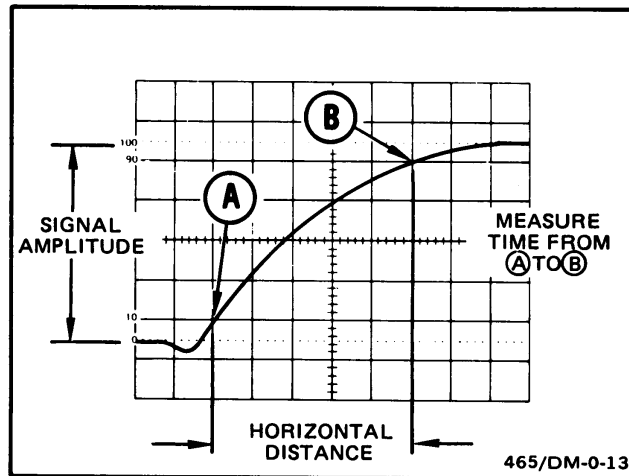

Figure 18. Rise time.

## Time Difference Between Two Time-Related Pulses

The calibrated sweep speed and dual-trace features of the 2336 allow measurement of the time difference between two separate events. To measure time difference, use the following procedure:

1. Preset instrument controls and obtain a Normal Sweep Display.

2. Set the A TRIGGER SOURCE switch to CH 1.

3. Set both AC-GND-DC switches to the same position, depending on the type of coupling desired.

4. Using either probes or cables with equal time delays, connect a known reference signal to the Channel 1 input and the comparison signal to the Channel 2 input.

5. Set both VOLTS/DIV switches for 4- or 5-division displays.

6. Select either ALT or CHOP VERTICAL MODE, depending on the frequency of input signals (or select AUTO VERTICAL MODE if automatic selection is desired).

7. If the two signals are of opposite polarity, press in the CH 2 INVERT push button to invert the Channel 2 display (signals may be of opposite polarity due to 180° phase difference; if so, note this for use later in the final calculation).

8. Adjust the A TRIGGER LEVEL control for a stable display.

9. Set the A TIME/DIV switch to a sweep speed which provides three or more divisions of horizontal separation between the reference points on the two displays. Center each of the displays vertically (see Figure 19).

10. Measure the horizontal difference between the two signal reference points and calculate the time difference using the following formula:

$$\text{Time Difference} = \frac{\text{SEC/DIV switch setting} \times \text{horizontal difference (divisions)}}{\text{magnification factor}}$$

**EXAMPLE:** The A SEC/DIV switch is set to 50  $\mu\text{s}$ , the X10 MAG switch is pressed in and the horizontal

difference between waveform measurement points is 4.5 divisions.

Substituting the given values in the formula:

$$\text{Time Difference} = \frac{50 \mu\text{s}/\text{div} \times 4.5 \text{ div}}{10} = 22.5 \mu\text{s}$$

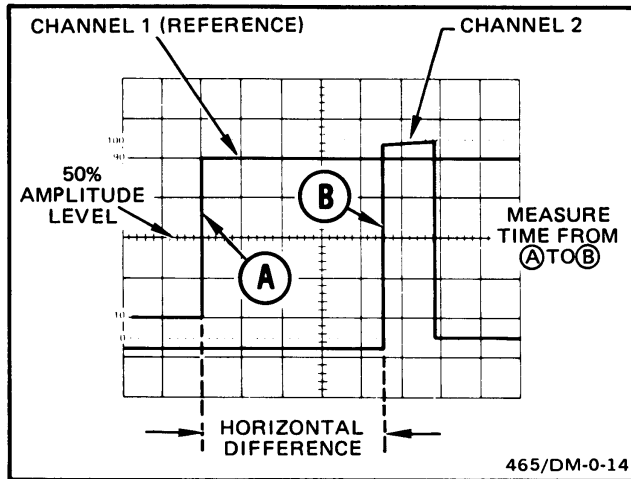

Figure 19. Time difference between two time-related pulses.

## Phase Difference

In a similar manner to “Time Difference,” phase comparison between two signals of the same frequency can be made using the dual-trace feature of the 2336. This method of phase difference measurement can be used up to the frequency limit of the vertical system. To make a phase comparison, use the following procedure:

1. Preset instrument controls and obtain a Normal Sweep Display, then set the A TRIGGER SOURCE switch to CH 1.

2. Set both AC-GND-DC switches to the same position, depending on the type of coupling desired.

3. Using either probes or coaxial cables with equal time delays, connect a known reference signal to the Channel 1 input and the unknown signal to the Channel 2 input.

4. Select either ALT or CHOP VERTICAL MODE, depending on the frequency of the input signals (or select AUTO VERTICAL MODE if automatic selection is desired). The reference signal should precede the comparison signal in time.



5. If the two signals are of opposite polarity, press in the CH 2 INVERT push button to invert the Channel 2 display.

6. Set both VOLTS/DIV switches and both VAR controls so the displays are equal in amplitude.

7. Adjust the A TRIGGER LEVEL control for a stable display.

8. Set the A SEC/DIV switch to a sweep speed which displays about one full cycle of the waveforms.

9. Position the displays and adjust the TIME (PULL) VAR control so that one reference-signal cycle occupies exactly 8 horizontal graticule divisions at the 50% rise-time points (see Figure 20). Each division of the graticule now represents  $45^\circ$  of the cycle ( $360^\circ \div 8$  divisions), and the horizontal graticule calibration can be stated as  $45^\circ$  per division.

10. Measure the horizontal difference between corresponding points on the waveforms at a common horizontal

graticule line (50% of rise time) and calculate the phase difference using the following formula:

$$\text{Phase Difference} = \frac{\text{horizontal difference (divisions)}}{\text{horizontal graticule calibration (deg/div)}} \times$$

**EXAMPLE:** The horizontal difference is 0.6 division with a graticule calibration of  $45^\circ$  per division as shown in Figure 20.

Substituting the given values into the phase difference formula:

$$\text{Phase Difference} = 0.6 \text{ div} \times 45^\circ / \text{div} = 27^\circ$$

More accurate phase measurements can be made by using the X10 MAG function to increase the sweep rate without changing the SEC/DIV TIME (PULL) VAR control setting.

**EXAMPLE:** If the sweep rate were increased 10 times with the magnifier (X10 MAG push button in), the magnified horizontal graticule calibration would be  $45^\circ$  per division divided by 10 (or  $4.5^\circ$  per division).

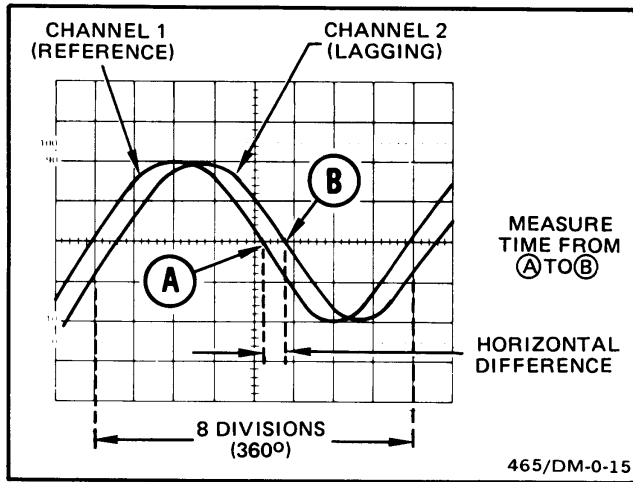

Figure 20. Phase difference.

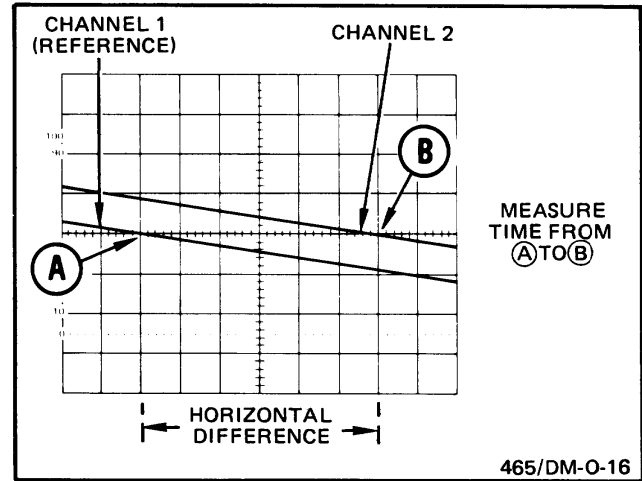

Figure 21. High-resolution phase difference.

Figure 21 shows the same signals illustrated in Figure 20, but magnifying the displays results in a horizontal difference of 6 divisions between the two signals.

Substituting the given values in the phase difference formula:

$$\text{Phase Difference} = 6 \text{ div} \times 4.5^\circ / \text{div} = 27^\circ$$

## Amplitude Comparison

In some applications it may be necessary to establish a set of deflection factors other than those indicated by the VOLTS/DIV switch settings. This is useful for comparing unknown signals to a reference signal of known amplitude. To accomplish this, a reference signal of known amplitude is first set to an exact number of vertical divisions by adjusting the VOLTS/DIV switch and VAR control.

Unknown signals can then be quickly and accurately compared with the reference signal without disturbing the setting of the VOLTS/DIV VAR control. The procedure is as follows.

1. Preset instrument controls and obtain a Normal Sweep Display.

2. Apply the reference signal to either vertical channel input and set the VERTICAL MODE switch to display the channel used.

3. Set the amplitude of the reference signal to an exact number of vertical divisions by adjusting the VOLTS/DIV switch and VOLTS/DIV VAR control.

4. Establish a vertical conversion factor, using the following formula (reference signal amplitude must be known):

$$\text{Vertical Conversion Factor} = \frac{\text{reference signal amplitude (volts)}}{\text{vertical deflection (divisions)} \times \text{VOLTS/DIV switch setting}}$$

5. Disconnect the reference signal and apply the unknown signal to be measured to the same channel input. Adjust the VOLTS/DIV switch to a setting that provides sufficient vertical deflection to make an accurate measurement. *Do not* readjust the VOLTS/DIV VAR control.

6. Establish an arbitrary deflection factor, using the following formula:

$$\text{Arbitrary Deflection Factor} = \text{vertical conversion factor} \times \text{VOLTS/DIV switch setting}$$

7. Measure the vertical deflection of the unknown signal in divisions and calculate its amplitude using the following formula:

$$\text{Unknown Signal Amplitude} = \text{arbitrary deflection factor} \times \text{vertical deflection (divisions)}$$

**EXAMPLE:** The reference signal amplitude is **30** volts, with a VOLTS/DIV switch setting of 5 and the VOLTS/DIV VAR control adjusted to provide a vertical deflection of exactly 4 divisions.

Substituting these values in the vertical conversion factor formula:

$$\text{Vertical Conversion Factor} = \frac{30 \text{ V}}{4 \text{ div} \times 5 \text{ V/div}} = 1.5$$

Continuing, for the unknown signal the VOLTS/DIV switch setting is 1 and the peak-to-peak amplitude spans five vertical divisions. The arbitrary deflection factor is then determined by substituting values in the formula:

$$\text{Arbitrary Deflection Factor} = 1.5 \times 1 \text{ V/div} = 1.5 \text{ V/div}$$

The amplitude of the unknown signal can then be determined by substituting values in the unknown signal amplitude formula:

$$\text{Amplitude} = 1.5 \text{ V/div} \times 5 \text{ div} = 7.5 \text{ V}$$

## Time Comparison

In a similar manner to "Amplitude Comparison", repeated time comparisons between unknown signals and a

reference signal (e.g., on assembly line test) may be easily and accurately measured with the 2336. To accomplish this, a reference signal of known time duration is first set to an exact number of horizontal divisions by adjusting the A SEC/DIV switch and the TIME (PULL) VAR control. Unknown signals can then be compared with the reference signal without disturbing the setting of the TIME (PULL) VAR control. The procedure is as follows:

1. Set the time duration of the reference signal to an exact number of horizontal divisions by adjusting the A SEC/DIV switch and TIME (PULL) VAR control.
2. Establish a horizontal conversion factor, using the following formula (reference signal time duration must be known):

$$\text{Horizontal Conversion Factor} = \frac{\text{reference signal time duration (seconds)}}{\text{horizontal distance (divisions)} \times \text{A SEC/DIV switch setting}}$$

3. For the unknown signal, adjust the A SEC/DIV switch to a setting that provides sufficient horizontal deflection to make an accurate measurement. Do not readjust the TIME (PULL) VAR control.

4. Establish an arbitrary deflection factor, using the following formula:

$$\begin{array}{l} \text{Arbitrary} \\ \text{Deflection} \\ \text{Factor} \end{array} = \begin{array}{l} \text{horizontal} \\ \text{conversion} \\ \text{factor} \end{array} \times \begin{array}{l} \text{A SEC/DIV} \\ \text{switch} \\ \text{setting} \end{array}$$

5. Measure the horizontal distance of the unknown signal in divisions and calculate its time duration using the following formula:

$$\begin{array}{l} \text{Time} \\ \text{Duration} \end{array} = \begin{array}{l} \text{arbitrary} \\ \text{deflection} \\ \text{factor} \end{array} \times \begin{array}{l} \text{horizontal} \\ \text{distance} \\ \text{(divisions)} \end{array}$$

6. Frequency of the unknown signal can then be determined by calculating the reciprocal of its time duration.

**EXAMPLE:** The reference signal time duration is 2.19 ms, the A SEC/DIV switch setting is 0.2 ms, and the TIME (PULL) VAR control is adjusted to provide a horizontal distance of exactly 8 divisions.

Substituting the given values in the horizontal conversion factor formula:

$$\begin{array}{l} \text{Horizontal} \\ \text{Conversion} \\ \text{Factor} \end{array} = \frac{2.19 \text{ ms}}{8 \text{ div} \times 0.2 \text{ ms/div}} = 1.37$$

Continuing, for the unknown signal the A SEC/DIV switch setting is 50  $\mu\text{s}$ , and one complete cycle spans 7 horizontal divisions. The arbitrary deflection factor is then determined by substituting values in the formula:

$$\begin{array}{l} \text{Arbitrary} \\ \text{Deflection} \\ \text{Factor} \end{array} = 1.37 \times 50 \mu\text{s/div} = 68.5 \mu\text{s/div}$$

The time duration of the unknown signal can then be computed by substituting values in the formula:

$$\begin{array}{l} \text{Time} \\ \text{Duration} \end{array} = 68.5 \mu\text{s/div} \times 7 \text{ div} = 480 \mu\text{s/div}$$

The frequency of the unknown signal is then calculated:

$$\text{Frequency} = \frac{1}{480 \mu\text{s}} = 2.083 \text{ kHz}$$

## DELAYED-SWEEP MAGNIFICATION

The delayed-sweep feature of the 2336 can be used to provide higher apparent magnification than is provided by the X10 MAG function. Apparent magnification occurs as a result of displaying a selected portion of the A trace at a faster sweep speed (B Sweep speed). The A SEC/DIV switch setting determines how often the B trace will be displayed. Since the B Sweep can occur only once for each A Sweep, the A Sweep time duration sets the amount of time elapse between succeeding B Sweeps.

The intensified zone is an indication of both the location and length of the B Sweep interval within the A Sweep interval. Positioning of the intensified zone (i.e., setting the amount of time between start of the A Sweep and start of the B Sweep) is accomplished with the B DELAY TIME POSITION control. With either the A INTEN or the B HORIZ MODE selected and with the B TRIGGER SOURCE switch set to RUNS AFTER DLY, the B DELAY TIME POSITION control provides continuously variable positioning of the start of the B Sweep. The range of this control is sufficient to place the B Sweep interval at any location within the A Sweep interval. When the A INTEN HORIZ MODE is selected, the B SEC/DIV switch setting determines the B Sweep speed and concurrently sets the length of the intensified zone on the A trace.

Using delayed-sweep magnification may produce a display with some slight horizontal movement (pulse jitter). Pulse jitter includes not only the inherent uncertainty of triggering the delayed sweep at exactly the same trigger point each time, but also jitter that may be present in the input signal. If pulse jitter needs to be measured, use the "Pulse Jitter Time Measurement" procedure which follows the discussion of "Magnified Sweep Runs After Delay."

When looking at a signal having pulse jitter, it is often useful to be able to hold that signal stationary on the screen. Operating the B Sweep in a triggered mode will produce a more stable display, since the delayed display is triggered at the same level each time. This capability is provided by the 2336 and is explained in the "Triggered Magnified Sweep" discussion.

### Magnified Sweep Runs After Delay

The following procedure explains how to operate the B Sweep in a nontriggered mode and to determine the resulting apparent magnification factor.

1. Preset instrument controls and obtain a Normal Sweep Display.

2. Set the B TRIGGER SOURCE switch to RUNS AFTER DLY.

3. Apply the signal to either vertical-channel input connector and set the VERTICAL MODE switch to display the channel used.

4. Set the appropriate VOLTS/DIV switch to produce a display of approximately 5 divisions in amplitude and center the display.

5. Set the A SEC/DIV switch to a sweep speed which displays at least one complete waveform cycle.

6. Select the A INTEN HORIZ MODE and adjust the B DELAY TIME POSITION control to position the intensified zone to the portion of the display to be magnified (see Figure 22A).

7. Set the B SEC/DIV switch to a setting which intensifies the full portion of the A trace to be magnified. The intensified zone will be displayed as the B trace. The start of the intensified zone remains as previously positioned in step 6.

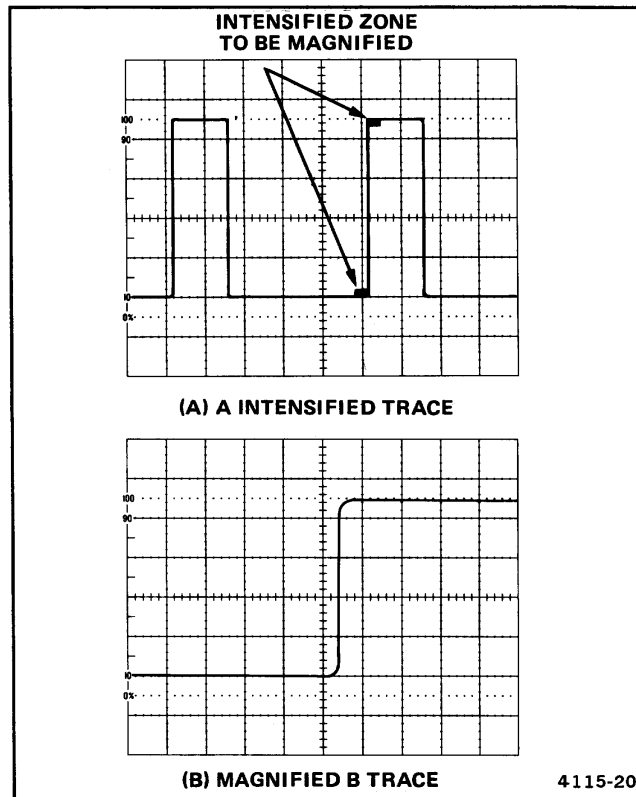

Figure 22. Delayed-sweep magnification.

8. Select the B HORIZ MODE to magnify the intensified portion of the A Sweep (see Figure 22B).

9. The apparent sweep magnification can be calculated from the following formula:

$$\text{Apparent Delayed Sweep Magnification} = \frac{\text{A SEC/DIV switch setting}}{\text{B SEC/DIV switch setting}}$$

**EXAMPLE:** Determine the apparent magnification of a display with an A SEC/DIV switch setting of 0.1 ms and a B SEC/DIV switch setting of 1  $\mu$ s.

Substituting the given values:

$$\text{Apparent Magnification} = \frac{1 \times 10^{-4} \text{ s}}{1 \times 10^{-6} \text{ s}} = 10^2 = 100$$

### Pulse Jitter Time Measurement

1. Perform steps 1 through 8 of the preceding "Magnified Sweep Runs After Delay" procedure.

2. Referring to Figure 23, measure the difference between Point A and Point B in divisions and calculate the pulse jitter time using the following formula:

$$\text{Pulse Jitter Time} = \text{horizontal difference (divisions)} \times \text{B SEC/DIV switch setting}$$

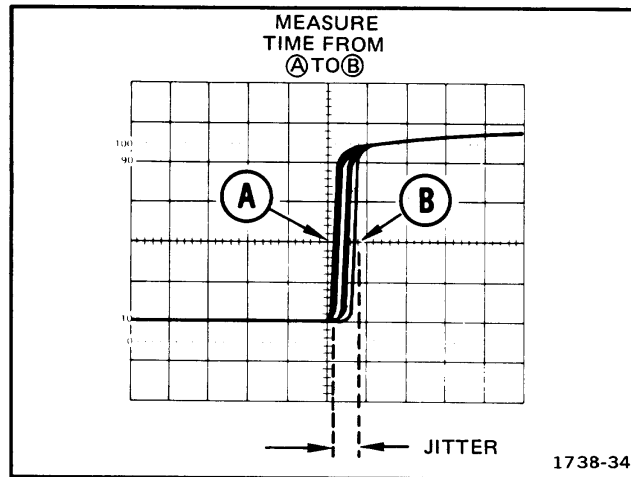

Figure 23. Pulse jitter.



## Triggered Magnified Sweep

The following procedure explains how to operate the B Sweep in a triggered mode and to determine the resulting apparent magnification factor.

1. Perform steps 1 through 8 of the preceding "Magnified Sweep Runs After Delay" procedure.
2. Set the B TRIGGER SOURCE switch to the same position to which the A TRIGGER SOURCE switch is set. If external triggering is used, connect the required signal to the B EXT input connector.

### NOTE

*The B DELAY TIME POSITION control will not provide continuously variable delay when the B TRIGGER SOURCE switch is set to VERT MODE, CH 1, CH 2, or EXT. Adjustment of the B DELAY TIME POSITION control will still position the B Sweep with respect to the A Sweep, but the B Sweep will occur only when properly triggered. The intensified zone seen in the A INTEN HORIZ MODE display will move from trigger point to trigger point as the B DELAY TIME POSITION control is rotated.*

3. Adjust the B TRIGGER LEVEL control so the intensified zone on the A trace is stable. If an intensified zone cannot be obtained, see step 4.

4. Inability to intensify the desired portion of the trace indicates that the signal does not meet the triggering requirements. If the condition cannot be remedied either by using the B Sweep triggering controls or by increasing display amplitude, you should do the following in the sequence indicated: lower the VOLTS/DIV switch setting, set the B TRIGGER SOURCE switch to EXT and trigger the B Sweep externally, and then reset the VOLTS/DIV switch for the desired display amplitude.

5. The apparent magnification factor can be calculated from the same formula shown in step 9 of the "Magnified Sweep Runs After Delay" procedure.

## DELAYED-SWEEP TIME MEASUREMENTS

Operating the 2336 Oscilloscope with HORIZ MODE set to either A INTEN or B will permit time measurements to be made with a greater degree of accuracy than can be attained with HORIZ MODE set to A. With the B TRIGGER SOURCE switch set to  $\Delta$  TIME, two intensified zones

are displayed on the crt. The intensified zones consist of a reference point (moved by rotating the B DELAY TIME POSITION control) and a measurement point (moved by rotating the  $\Delta$  TIME POSITION control). The time difference between the reference point and the measurement point is displayed on the LCD readout. The following procedures describe how these measurements are accomplished.

### Time Duration

1. Preset instrument controls and obtain a Normal Sweep Display.
2. Apply the signal to either vertical-channel input connector and set the VERTICAL MODE switch to display the channel used.
3. Set the appropriate VOLTS/DIV switch to produce a display of approximately 5 divisions in amplitude and center the display.
4. Select the A INTEN HORIZ MODE and set the A SEC/DIV switch to a sweep speed that displays the entire portion of the waveform for which time duration is to be measured.

5. For the most accurate measurements, set the B SEC/DIV switch to the fastest sweep speed that provides a usable (visible) intensified zone.

6. Adjust the B DELAY TIME POSITION control to move the start of the reference point so that it just touches the intersection of the signal and the center horizontal graticule line (see Figure 24A, Point A).

7. Adjust the  $\Delta$  TIME POSITION control to move the start of the measurement point along the center horizontal graticule line to the beginning of the next waveform cycle (see Figure 24A, Point B).

8. Press in the B HORIZ MODE push button and adjust the  $\Delta$  TIME POSITION control to superimpose the waveforms as shown in Figure 24B.

9. Read the time duration (or waveform period) on the LCD readout.

### Rise Time

Rise-time measurements use the same methods as time duration, except that the measurements are made between

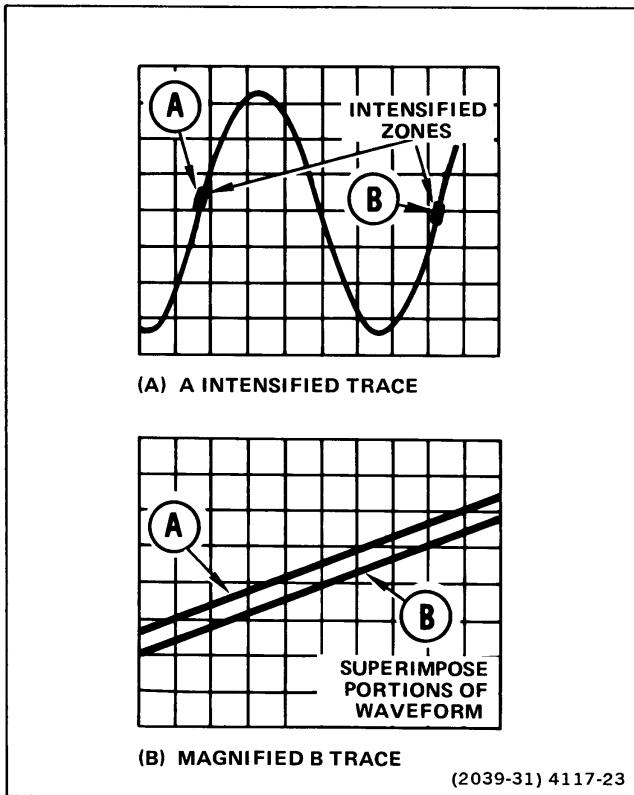

Figure 24. Time duration using delayed sweep.

the 10% and 90% points on the leading edge of the waveform. Fall time is measured between the 90% and 10% points on the trailing edge of the waveform.

1. Preset instrument controls and obtain a Normal Sweep Display.

2. Apply the signal to either vertical-channel input connector and set the VERTICAL MODE switch to display the channel used.

3. Set the appropriate VOLTS/DIV switch and VAR control for an exact 5-division display.

4. Vertically position the trace so that the zero reference of the waveform touches the 0% graticule line and the top of the waveform touches the 100% graticule line (see Figure 25).

5. Set the A SEC/DIV switch for a single-waveform display, with the rise time spread horizontally as much as possible. Ensure that the A SEC/DIV TIME (PULL) VAR control is in the calibrated detent.

6. Horizontally position the display so the 10% point on the waveform intersects the third vertical graticule line.

7. Select the A INTEN HORIZ DISPLAY and set the B SEC/DIV switch to the fastest sweep speed that provides a usable (visible) intensified zone.

8. Adjust the B DELAY TIME POSITION control to move the start of the reference point (left-hand edge) until it just touches the intersection of the signal and the 10% graticule line (see Figure 25, Point A).

9. Adjust the  $\Delta$  TIME POSITION control to move the start of the measurement point (left-hand edge) until it just touches the intersection of the signal and the 90% graticule line (see Figure 25, Point B).

10. Read the rise time on the LCD readout.

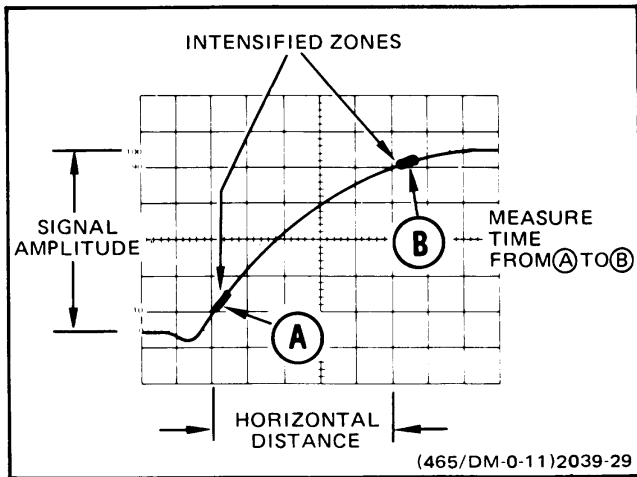

Figure 25. Rise time, differential time method.

### Time Difference Between Repetitive Pulses

1. Preset instrument controls and obtain a Normal Sweep Display.

2. Apply the signal to either vertical-channel input connector and set the VERTICAL MODE switch to display the channel used.

3. Set the appropriate VOLTS/DIV switch to produce a display of approximately 5 divisions in amplitude and vertically center the display.

4. Set the A SEC/DIV switch to display the measurement points of interest within the graticule area.

5. Select the A INTEN HORIZ MODE and set the B SEC/DIV switch to the fastest sweep speed that provides a usable (visible) intensified zone.

6. Adjust the B DELAY TIME POSITION control to move the reference point to the first pulse (see Figure 26A, Point A).

7. Adjust the  $\Delta$  TIME POSITION control to move the measurement point to the second pulse (see Figure 26A, Point B).

8. Press in the B HORIZ MODE push button and adjust the  $\Delta$  TIME POSITION control to superimpose the waveforms as shown in Figure 26B.

9. Read the time difference on the LCD readout.

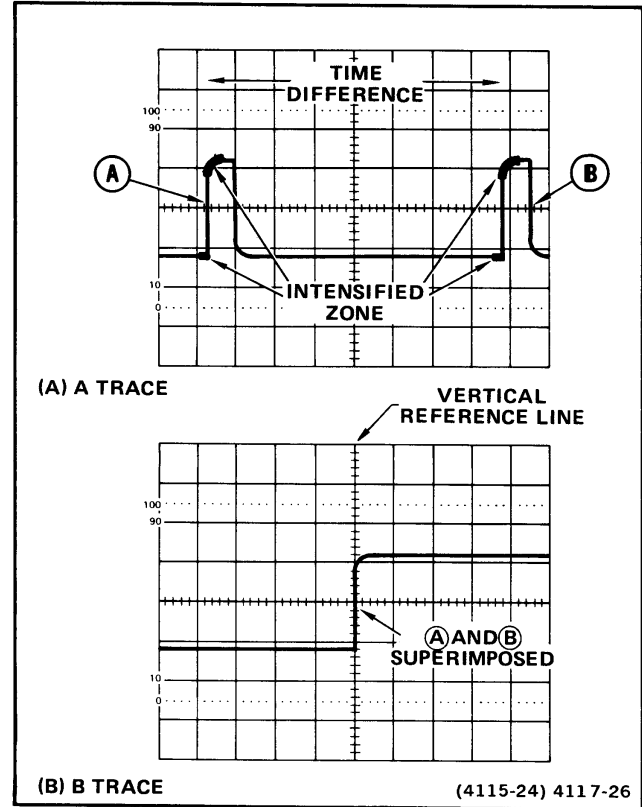

Figure 26. Time difference between repetitive pulses.

## Time Difference Between Two Time-Related Pulses

1. Preset instrument controls and obtain a Normal Sweep Display.
2. Using probes or cables having equal time delays, apply the reference signal to the Channel 1 input and apply the comparison signal to the Channel 2 input.
3. Set both VOLTS/DIV switches to produce a display of either 4 or 5 divisions in amplitude.
4. Select either ALT or CHOP VERTICAL MODE, depending on the input frequencies (or select AUTO VERTICAL MODE if automatic selection is desired).
5. Set the A SEC/DIV switch to display the measurement points of interest within the graticule area.
6. Select the A INTEN HORIZ MODE and set the B SEC/DIV switch to the fastest sweep speed that provides a usable (visible) intensified zone.
7. Adjust the B DELAY TIME POSITION control to move the reference point to the reference signal (see Figure 27A, Point A).
8. Adjust the  $\Delta$  TIME POSITION control to move the measurement point to the comparison signal (see Figure 27A, Point B).
9. Press in the B HORIZ MODE push button and adjust the B DELAY TIME POSITION and the  $\Delta$  TIME POSITION controls to superimpose the reference- and comparison-signal leading edges as shown in Figure 27B.
10. Read the time difference on the LCD readout.

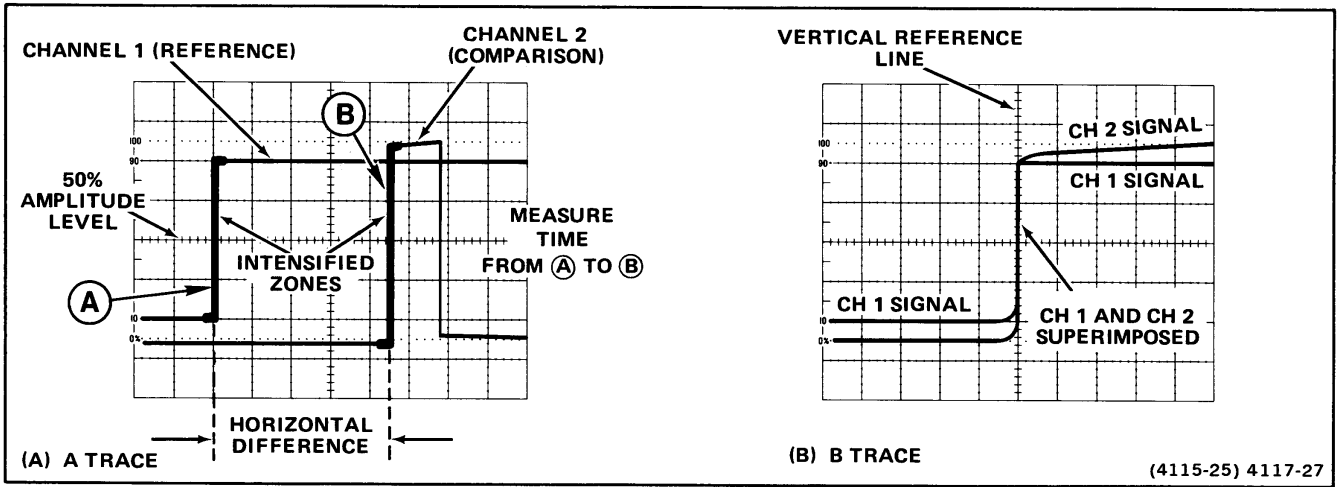

Figure 27. Time difference between two time-related pulses.

# OPTIONS

## OPTION 03

There is presently only one option available for the 2336. A brief description of this option is given in the following discussion. For further information about instrument options, see your Tektronix Catalog or contact your Tektronix Field Office or representative.

Option 03 (100-V/200-V Power Transformer) permits operation of the instrument from either a 100-V or a 200-V nominal ac-power-input source at a line frequency from 48 Hz to 440 Hz. This option does not affect the basic instrument operating instructions presented in this manual.



# SPECIFICATION

The following electrical characteristics (Table 4) are valid for the 2336 when it has been adjusted at an ambient temperature between  $+20^{\circ}\text{C}$  and  $+30^{\circ}\text{C}$ , has had a warmup period of at least 20 minutes, and is operating at an ambient temperature between  $-15^{\circ}\text{C}$  and  $+55^{\circ}\text{C}$  (unless otherwise noted).

Items listed in the "Performance Requirements" column are verifiable qualitative or quantitative limits, while items listed in the "Supplemental Information" column are either explanatory notes, calibration setup descriptions, performance characteristics for which no absolute limits are specified, or characteristics that are impractical to check.

Environmental characteristics of the 2336 are given in Table 5. All environmental tests performed meet the requirements of MIL-T-28800B, Type III, Class 3 equipment, except where otherwise noted.

Physical characteristics of the instrument are listed in Table 6, and option electrical characteristics are presented in Table 7.

**Table 4**  
**Electrical Characteristics**

Characteristics	Performance Requirements	Supplemental Information
<b>VERTICAL DEFLECTION SYSTEM</b>		
Deflection Factor Range	5 mV per division to 5 V per division in a 1, 2, 5 sequence.	
Accuracy	±3% on all ranges when VOLTS/DIV is calibrated at 5 mV per division; add 0.05% per °C deviation from 25°C.	
Uncalibrated (VAR) Range	Continuously variable between VOLTS/DIV switch settings. Reduces deflection factor at least 2.5 to 1 on all VOLTS/DIV switch settings.	Reduces deflection factor to at least 2 mV per division with VOLTS/DIV switch set to 5 mV.
Frequency Response  -15°C to +40°C	Dc to at least 100 MHz. Reduces to 88 MHz at 2 mV per division. <sup>a</sup>	6-division reference signal from a 25-Ω source; centered vertically, with VOLTS/DIV VAR control in calibrated detent.

<sup>a</sup>Performance Requirement not checked in Service Manual.

Table 4 (cont)

Characteristics	Performance Requirements	Supplemental Information
<b>VERTICAL DEFLECTION SYSTEM (cont)</b>		
Frequency Response (cont) +40°C to +55°C	Dc to at least 85 MHz. <sup>a</sup> Reduces to 70 MHz at 2 mV per division. <sup>a</sup>	
Ac Coupled Lower -3 dB Point 1X Probe	10 Hz or less. <sup>a</sup>	
10X Probe	1 Hz or less. <sup>a</sup>	
Step Response		5-division reference signal, dc coupled at all deflection factors, from a 25-Ω source; centered vertically with VOLTS/DIV VAR control in calibrated detent. BW LIMIT push button must be out for full bandwidth operation.

<sup>a</sup>Performance Requirement not checked in Service Manual.

Table 4 (cont)

Characteristics	Performance Requirements	Supplemental Information
<b>VERTICAL DEFLECTION SYSTEM (cont)</b>		
<p>Step Response (cont)</p> <p>Rise Time (5 mV per division to 5 V per division)</p> <p>–15°C to +40°C</p> <hr/> <p>+40°C to +55°C</p>	<p>3.5 ns or less.</p> <hr/> <p>4.15 ns or less.<sup>a</sup></p>	<p>Rise time is calculated from the formula:</p> $\text{Rise Time} = \frac{0.35}{\text{BW (in MHz)}}$
<p>Aberrations</p> <p>Positive-Going Step (Excluding ADD Mode)</p> <p>5 mV per division to 0.2 V per division</p>	<p>+3%, –3%, 3% p-p or less.</p>	
<p>Negative-Going Step</p>		<p>Add 2% to all positive-going step specifications; checked at 5 mV per division.</p>

<sup>a</sup>Performance Requirement not checked in Service Manual.

Table 4 (cont)

Characteristics	Performance Requirements	Supplemental Information
<b>VERTICAL DEFLECTION SYSTEM (cont)</b>		
Aberrations (cont) ADD Mode		Add 4% to all positive-going step specifications; checked at 5 mV per division.
Position Effect		Total aberrations less than +5%, -5%, 5% p-p; checked at 5 mV per division.
Temperature Effect		Add 0.15% per °C deviation to aberrations specifications from 25°C.
Common-Mode Rejection Ratio	At least 10 to 1 at 50 MHz for common-mode signals of 6 divisions or less.	VAR control adjusted for best CMRR at 10 mV per division at 50 kHz; checked at 10 mV per division.
Channel 2 Invert Trace Shift	Less than 0.4 division from center screen when switching from normal to inverted.	

**Table 4 (cont)**

Characteristics	Performance Requirements	Supplemental Information
<b>VERTICAL DEFLECTION SYSTEM (cont)</b>		
Input Gate Current –15°C to +30°C	0.5 nA or less.	0.1-division trace shift when moving Input Coupling switch from GND to AC at 5 mV per division.
+30°C to +55°C	4.0 nA or less. <sup>a</sup>	0.8-division trace shift when moving Input Coupling switch from GND to AC at 5 mV per division.
Attenuator Isolation (CH 1 to CH 2)	At least 100 to 1.	With one vertical input set at 0.5 V per division, apply 4-V p-p 25-MHz signal; set the other vertical input to 10 mV per division. Check for less than 4 divisions of signal.
POSITION Control Range	At least +12 and –12 divisions from graticule center.	

<sup>a</sup>Performance Requirement not checked in Service Manual.

Table 4 (cont)

Characteristics	Performance Requirements	Supplemental Information
<b>VERTICAL DEFLECTION SYSTEM (cont)</b>		
Step Attenuator Balance	Less than or equal to 0.2-division trace shift when rotated from 5 mV per division to 5 V per division.	Double for each 10°C deviation from 25°C.
Chop Frequency	275 kHz $\pm$ 30%.	
Input Characteristics Resistance	1 M $\Omega$ $\pm$ 2%. <sup>a</sup>	
Capacitance	20 pF $\pm$ 10%. <sup>a</sup>	
Maximum Input Voltage  DC Coupled	400 V (dc + peak ac) or 500 V p-p ac at 1 kHz or less. <sup>a</sup>	
AC Coupled	400 V (dc + peak ac) or 500 V p-p ac at 1 kHz or less. <sup>a</sup>	

<sup>a</sup>Performance Requirement not checked in Service Manual.

Table 4 (cont)

Characteristics	Performance Requirements	Supplemental Information
<b>TRIGGER SYSTEM</b>		
Sensitivity		With VOLTS/DIV VAR control in calibrated detent. In EXT ÷ 10, multiply input requirements by 10.
A TRIGGER AC Coupled Signal	0.3 division internal or 50 mV external from 20 Hz to 20 MHz; increasing to 1.1 divisions internal or 150 mV external at 100 MHz.	
LF REJ Coupled Signal	0.3 division internal or 50 mV external from 50 kHz ±10 kHz to 20 MHz; increasing to 1.1 divisions internal or 150 mV external at 100 MHz.	Attenuates signals below 50 kHz ±10 kHz (−3 dB at 50 kHz).
HF REJ Coupled Signal	0.3 division internal or 50 mV external from 20 Hz ±4 Hz to 50 kHz ±10 kHz.	Attenuates signals below 20 Hz ±4 Hz and above 50 kHz ±10 kHz (−3 dB at 20 Hz and 50 kHz).
DC Coupled Signal	0.3 division internal or 50 mV external from dc to 20 MHz; increasing to 1.1 divisions internal or 150 mV external at 100 MHz.	



Table 4 (cont)

Characteristics	Performance Requirements	Supplemental Information
<b>TRIGGER SYSTEM (cont)</b>		
Sensitivity (cont) B TRIGGER (Ac Coupled Signal)	0.3 division internal or 50 mV external from 30 Hz to 20 MHz; increasing to 1.1 divisions internal or 150 mV external at 100 MHz.	
Trigger Jitter	0.2 division or less at 5 ns per division (X10 MAG on) with 100 MHz applied and at the rated trigger sensitivity.	VOLTS/DIV VAR control must be in calibrated detent.
External Trigger Inputs Maximum Input Voltage 	400 V (dc + peak ac) or 500 V p-p ac at 1 kHz or less. <sup>a</sup>	
Input Resistance	1 M $\Omega$ $\pm$ 10%. <sup>a</sup>	
Input Capacitance	20 pF $\pm$ 30%. <sup>a</sup>	
LEVEL Control Range EXT	At least $\pm$ 1 V, 2 V p-p.	

<sup>a</sup>Performance Requirement not checked in Service Manual.

Table 4 (cont)

Characteristics	Performance Requirements	Supplemental Information
<b>TRIGGER SYSTEM (cont)</b>		
LEVEL Control Range (cont) EXT ÷ 10	At least $\pm 10$ V, 20 V p-p. <sup>a</sup>	
Trigger View (A Trigger) Deflection Factor EXT	100 mV per division $\pm 40\%$ .	
EXT ÷ 10	1 V per division $\pm 40\%$ .	
Centering of Trigger Point		Within 1 division of center screen.
Bandwidth	To at least 80 MHz.	4-division reference signal from a 25- $\Omega$ source; centered vertically.
Delay Difference	3 ns $\pm 2$ ns.	5-division signal with 5-ns rise time or less from 25- $\Omega$ source, centered vertically; equal cable length from signal source to vertical channel and external trigger inputs, terminated in 50 $\Omega$ at each input.

<sup>a</sup>Performance Requirement not checked in Service Manual.

Table 4 (cont)

Characteristics	Performance Requirements		Supplemental Information
<b>HORIZONTAL DEFLECTION SYSTEM</b>			
Sweep Rate Calibrated Range A Sweep	0.5 s per division to 0.05 $\mu$ s per division in a 1, 2, 5 sequence. X10 MAG extends maximum sweep speed to 5 ns per division.		
B Sweep	50 ms per division to 0.05 $\mu$ s per division in a 1, 2, 5 sequence. X10 MAG extends maximum sweep speed to 5 ns per division.		
Accuracy  +20°C to +30°C  -15°C to +55°C	<b>Unmagnified</b>	<b>Magnified</b>	Accuracy specification applies over the full 10 divisions with X10 MAG on and off. Exclude the first and last 40 ns of the sweep on all sweep speeds with X10 MAG on and off.
	$\pm 2\%$	$\pm 3\%$	
	$\pm 3\%$ <sup>a</sup>	$\pm 4\%$ <sup>a</sup>	

<sup>a</sup>Performance Requirement not checked in Service Manual.

Table 4 (cont)

Characteristics	Performance Requirements	Supplemental Information
<b>HORIZONTAL DEFLECTION SYSTEM (cont)</b>		
Linearity	±5%.	Over any 2-division portion of the full 10 divisions, displayed at all sweep speeds. Exclude the first and last displayed divisions of the 5- and 10-ns per division sweep speeds with X10 MAG on.
Variable Range (VAR)	Continuously variable between calibrated settings of the SEC/DIV switches.	Extends maximum A Sweep speed to at least 1.25 s per division.
A Sweep Length	10.5 to 11.5 divisions.	Checked at 1 ms per division.
A Trigger Holdoff (VAR)	At least 2.5 times the minimum holdoff at any sweep speed. <sup>a</sup>	
Magnifier Registration	±0.2 division from graticule center (X10 MAG on to X10 MAG off).	
POSITION Control Range	Start of sweep must position to right of graticule center. End of sweep must position to left of graticule center.	Checked at 1 ms per division.

<sup>a</sup>Performance Requirement not checked in Service Manual.

Table 4 (cont)

Characteristics	Performance Requirements	Supplemental Information
<b>HORIZONTAL DEFLECTION SYSTEM (cont)</b>		
Differential Time Measurement Accuracy  +15°C to +35°C	±1% of reading ±1 count.	Exclude delayed operation when knobs are locked at any sweep speed or when the A SEC/DIV switch is at either 0.1 μs per division or 0.05 μs per division. Exclude the first 0.25 division on all A Sweep speeds.
-15°C to +55°C	±2.5% of reading ±1 count. <sup>a</sup>	
Delay Time Jitter	±0.005% of 10 times the A SEC/DIV switch setting (less than one part in 20,000) over the full delay time range.	
<b>X-Y OPERATION</b>		
Deflection Factor Range	5 mV per division to 5 V per division in a 1, 2, 5 sequence.	No X-axis variable.

<sup>a</sup>Performance Requirement not checked in Service Manual.

Table 4 (cont)

Characteristics	Performance Requirements	Supplemental Information
<b>X-Y OPERATION (cont)</b>		
Bandwidth X-Axis	Dc to at least 2 MHz.	
Y-Axis	Dc to at least 100 MHz.	
Input Characteristics Resistance	1 M $\Omega$ $\pm$ 2%. <sup>a</sup>	
Capacitance	20 pF $\pm$ 10%. <sup>a</sup>	
Phase Difference Between X- and Y-Axis Amplifiers	$\leq$ 3° from dc to 200 kHz.	
Accuracy X-Axis 0°C to +40°C	$\pm$ 5% of indicated deflection.	
-15°C to +55°C	$\pm$ 8% of indicated deflection. <sup>a</sup>	

<sup>a</sup>Performance Requirement not checked in Service Manual.

Table 4 (cont)

Characteristics	Performance Requirements	Supplemental Information
<b>CALIBRATOR</b>		
Waveshape		Positive-going square wave.
Duty Cycle		50% ±10%.
Output Voltage 0°C to +40°C	0.2 V ±1%.	
-15°C to +55°C	0.2 V ±1.5%. <sup>a</sup>	
Repetition Rate		1 kHz ±25%.
Output Impedance		200 Ω ±1%.

<sup>a</sup>Performance Requirement not checked in Service Manual.

Table 4 (cont)

Characteristics	Performance Requirements	Supplemental Information
<b>Z-AXIS INPUT</b>		
Sensitivity	5 V p-p signal referenced to ground causes noticeable modulation of display at normal intensity.	Positive-going signal decreases intensity; negative-going signal increases intensity.
Usable Frequency Range	Dc to 20 MHz.	
Input Resistance		10 kΩ ±6%.
Input Capacitance		Less than 15 pF.
Maximum Input Voltage	±25 V (dc + peak ac) dc to 10 MHz, derate above 10 MHz. <sup>a</sup>  $V \text{ (dc + peak ac)} = \frac{250}{f \text{ (in MHz)}}$	
Input Coupling	Dc.	

<sup>a</sup>Performance Requirement not checked in Service Manual.



Table 4 (cont)

Characteristics	Performance Requirements	Supplemental Information
<b>POWER SOURCE</b>		
Voltage Ranges, AC rms 115 V Nominal	100 V to 132 V.	
230 V Nominal	200 V to 250 V. <sup>a</sup>	
Line Frequency	48 Hz to 440 Hz. <sup>a</sup>	
Power Consumption Typical	35 W at 115 V, 60 Hz. <sup>a</sup>	
Maximum	60 W at 132 V, 48 Hz. <sup>a</sup>	Measured at worst-case load and frequency.
VA Maximum	75 VA. <sup>a</sup>	

<sup>a</sup>Performance Requirement not checked in Service Manual.

**Table 4 (cont)**

Characteristics	Performance Requirements	Supplemental Information
<b>CATHODE-RAY TUBE</b>		
Display Area	8- by 10-divisions with 0.8-centimeter divisions; internal, nonilluminated, rise time graticule. <sup>a</sup>	
Trace Rotation Range	Adequate to align trace with horizontal graticule lines.	
Standard Phosphor	P31. <sup>a</sup>	
Raster Distortion Geometry		Less than 0.1 division of bowing or tilt, horizontal and vertical.
Nominal Accelerating Voltage	18 kV. <sup>a</sup>	
Electrode Voltages to Ground Heater Voltage Between CRT Pins 1 and 14		6.3 Vrms ±0.3 V; elevated to –1960 V.

<sup>a</sup>Performance Requirement not checked in Service Manual.

Table 4 (cont)

Characteristics	Supplemental Information		
<b>INTERNAL POWER SUPPLIES</b>			
	<b>Initial Setting</b>	<b>Maximum p-p Ripple</b>	<b>High-Voltage Oscillator Frequency, p-p Ripple</b>
Low-Voltage Supply Accuracy (+20°C to +30°C)			
-10 V	±1.2%	1 mV	
-5 V	±0.9%	1 mV	
+5 V	±0.7%	1 mV	
+10 V	±0.9%	1 mV	
+40 V	±0.2%	1 mV	
+102 V	±2.0%	1 V	
High-Voltage Supply Accuracy (+20°C to +30°C)			
-1960 V (cathode)	±1.0%	2 V	400 mV
+16 kV (anode)	±4.0%	5 V	500 mV

**Table 5**  
**Environmental Characteristics**

Characteristics	Description
	<p><b>NOTE</b></p> <p><i>All of the environmental tests performed meet the requirements of MIL-T-28800B, Type III, Class 3 equipment, except storage temperature and humidity requirements, which are reduced to prevent potential damage to the LCD readout. All other instrument characteristics in this table meet the full requirement of Class 3 testing.</i></p>
Temperature	
Operating	-15°C to +55°C.
Nonoperating (Storage)	-40°C to +80°C.
Altitude	
Operating	To 15,000 ft. Maximum operating temperature decreased 1°C per 1,000 ft above 5,000 ft.
Nonoperating (Storage)	To 50,000 ft.
Humidity	
Operating	+55°C, 90% relative humidity, for at least 72 hours.
Nonoperating (Storage)	+60°C, 90% relative humidity, for at least 72 hours.

Table 5 (cont)

Characteristics	Description
Vibration (Operating)	15 minutes along each of 3 major axes at a total displacement of 0.025 inch p-p (4 g at 55 Hz), with frequency varied from 10 Hz to 55 Hz to 10 Hz in 1-minute sweeps. Hold 10 minutes at each major resonance, or if none exists, hold 10 minutes at 55 Hz (procedure differs from MIL-T-28800B).
Shock (Operating and Nonoperating)	50 g, half-sine, 11-ms duration, 3 shocks per axis in each direction, for a total of 18 shocks.
EMI	Will meet MIL-STD-461A requirements using procedures outlined in MIL-STD-462, except use 10 Volts/Meter in place of 1 Volt/Meter for RS-03; use 500 Hz to 30 kHz in place of 30 Hz to 30 kHz for RE-01.
Transportation	Meets the limits of National Safe Transit Association test procedure 1A-B with a 36-inch drop.

**Table 6**  
**Physical Characteristics**

<b>Characteristics</b>	<b>Description</b>
<b>Weight</b>	
With Accessories and Accessory Pouch	8.8 kg (19.5 lb).
Without Accessories and Accessory Pouch	7.9 kg (17.5 lb).
<b>Shipping Weight</b>	
Domestic	10.9 kg (24.0 lb).
Export	15.0 kg (33.0 lb).
<b>Height</b>	
With Feet and Pouch	210 mm (8.3 in).
Without Pouch	135 mm (5.3 in).
<b>Width</b>	
With Handle	315 mm (12.4 in).
Without Handle	274 mm (10.8 in).
<b>Depth</b>	
With Front Cover	432 mm (17.0 in).
With Handle Extended	527 mm (20.8 in).

**Table 7**  
**Option Electrical Characteristics**

Characteristics	Performance Requirements	Supplemental Information
<b>100-V/200-V POWER TRANSFORMER (OPTION 03)</b>		
Voltage Ranges, AC rms		
100 V Nominal	90 V to 115 V. <sup>a</sup>	
200 V Nominal	180 V to 230 V. <sup>a</sup>	
Line Frequency	48 Hz to 440 Hz. <sup>a</sup>	
Power Consumption		
Typical	35 W at 100 V, 60 Hz. <sup>a</sup>	
Maximum	60 W at 115 V, 48 Hz. <sup>a</sup>	Measured at worst-case load and frequency.
VA Maximum	75 VA. <sup>a</sup>	

<sup>a</sup>Performance Requirement not checked in Service Manual.

# ACCESSORIES

## STANDARD ACCESSORIES INCLUDED

2 Probes, 10X, 2-m length, with accessories	010-6108-03
1 Accessory Pouch	016-0674-00
1 Accessory Pouch, Zip Lock	016-0537-00
1 Operators Manual	070-4117-00
1 Service Manual	070-4118-00
2 Fuses, 1.0 A, AGC, Fast-Blow	159-0022-00
1 Fuse, 0.5 A, AGC, Fast-Blow	159-0025-00
1 Crt Filter, Blue Plastic (installed)	337-2760-00
1 Crt Filter, Clear Plastic	337-2781-00
1 Detachable Power Cord (installed)	161-0104-00

## OPTIONAL POWER CORDS

Option A1, 2.5-meter length	161-0104-06
Option A2, 2.5-meter length	161-0104-07
Option A3, 2.5-meter length	161-0104-05
Option A4, 2.5-meter length	161-0104-08



**APPENDIX A**  
**ALTERNATE POWER INPUT VOLTAGE CONFIGURATIONS**

CATEGORY	POWER CORD & PLUG TYPE	FACTORY INSTALLED INSTRUMENT FUSE	FUSE HOLDER CAP	LINE VOLTAGE SELECTOR SWITCH		REGULATING RANGE (ac)
				MARKINGS	FACTORY SETTING	
US DOMESTIC STANDARD	US 115 V	1.0 A, FB AGC/3AG	AGC/3AG	115 V/230 V	115 V	100 V to 132 V
OPTION A1	EURO 240 V 10-16 A	0.5 A, 5 X 20 mm	5 X 20 mm	115 V/230 V	230 V	200 V to 250 V
OPTION A2 <sup>*</sup>	UK 240 V/13 A	0.5 A 5 X 20 mm	5 X 20 mm	115 V/230 V	230 V	200 V to 250 V
OPTION A3	AUSTRALIA 240 V, 10 A	0.5 A 5 X 20 mm	5 X 20 mm	115 V/230 V	230 V	200 V to 250 V
OPTION A4	NORTH AMERICA 240 V, 15 A	0.5 A, FB, AGC/3AG	AGC/3AG	115 V/230 V	230 V	200 V to 250 V
OPTION 03	JAPAN STANDARD 100 V	1.0 A, FB, AGC/3AG	AGC/3AG	100 V/200 V (marked on cabinet)	100 V	90 V to 115 V
	JAPAN 200 V	0.5 A, FB, AGC/3AG	AGC/3AG	100 V/200 V (marked on cabinet)	200 V	180 V to 230 V

**\*Line cord plug fuse is 13 A Type C.**

# Tektronix®

COMMITTED TO EXCELLENCE

## MANUAL CHANGE INFORMATION

Product: 2336YA OPERATORS

Date: 12/6/83

Change Reference: C1/1283

Manual Part No.: 070-5010-00

EFF SN: BEAVERTON B010140 unless otherwise noted.  
GUERNSEY 100000 unless otherwise noted.

Page 1 Standard accessories list

ADD: The following items as shown below:

1 Probe, 1X  
3 Adapters, Probe Tip  
3 Tips, Spring

CHANGE: The following item quantities as shown below:

2 Operators Manuals  
2 Service Manuals

Page 90 STANDARD ACCESSORIES INCLUDED List

ADD: The following items as shown below:

1	Probe, 1X, P6101	010-6101-03
3	Adapters, Probe Tip	103-0051-01
3	Tips, Spring	206-0060-00

CHANGE: The following item part numbers and quantities as shown below:

2	Operators Manuals	070-5010-00
2	Service Manuals	070-5011-00

# Scans By *Artek Media*

Artek Media  
1042 Plummer Cir. SW  
Rochester, MN 55902

[www.artekmedia.com](http://www.artekmedia.com)

“High resolution scans of obsolete technical manuals”

If you are looking for a quality scanned technical manual in PDF format please visit our WEB site at [www.artekmedia.com](http://www.artekmedia.com) or drop us an email at [manuals@artekmedia.com](mailto:manuals@artekmedia.com) and we will be happy to email you a current list of the manuals we have available.

If you don't see the manual you need on the list drop us a line anyway we may still be able to point you to other sources. If you have an existing manual you would like scanned please write for details, This can often be done very reasonably in consideration for adding your manual to our library.

Typically the scans in our manuals are done as follows;

- 1) Typed text pages are typically scanned in black and white at 300 dpi.
- 2) Photo pages are typically scanned in gray scale mode at 600 dpi
- 3) Schematic diagram pages are typically scanned in black and white at 600 dpi unless the original manual had colored high lighting (as is the case for some 70's vintage Tektronix manuals).

If you purchased this manual from us (typically through our Ebay name of ArtekMedia) thank you very much. If you received this from a well-meaning “friend” for free we would appreciate your treating this much like you would “share ware”. By that we mean a donation of at least \$5-10 per manual is appreciated in recognition of the time (a manual can take as much as 40 hours to reproduce, book, link etc.), energy and quality of effort that went into preserving this manual. Donations via PayPal go to: [manuals@artekmedia.com](mailto:manuals@artekmedia.com) or can be mailed to us the address above.

Thanks



Dave & Lynn Henderson  
Artek Media