



**PLEASE CHECK FOR CHANGE INFORMATION
AT THE REAR OF THIS MANUAL.**

**2445
OSCILLOSCOPE
OPERATORS**

INSTRUCTION MANUAL

**Tektronix, Inc.
P.O. Box 500
Beaverton, Oregon 97077**

Serial Number _____

070-3830-00
Product Group 38

First Printing OCT 1982
Revised JUL 1983

Copyright © 1982 Tektronix, Inc. All rights reserved.
Contents of this publication may not be reproduced in any
form without the written permission of Tektronix, Inc.

Products of Tektronix, Inc. and its subsidiaries are covered
by U.S. and foreign patents and/or pending patents.

TEKTRONIX, TEK, SCOPE-MOBILE, and  are
registered trademarks of Tektronix, Inc. TELEQUIPMENT
is a registered trademark of Tektronix U.K. Limited.

Printed in U.S.A. Specification and price change privileges
are reserved.

INSTRUMENT SERIAL NUMBERS

Each instrument has a serial number on a panel insert, tag,
or stamped on the chassis. The first number or letter
designates the country of manufacture. The last five digits
of the serial number are assigned sequentially and are
unique to each instrument. Those manufactured in the
United States have six unique digits. The country of
manufacture is identified as follows:

B000000	Tektronix, Inc., Beaverton, Oregon, USA
100000	Tektronix Guernsey, Ltd., Channel Islands
200000	Tektronix United Kingdom, Ltd., London
300000	Sony/Tektronix, Japan
700000	Tektronix Holland, NV, Heerenveen, The Netherlands

TABLE OF CONTENTS

	Page		Page
LIST OF ILLUSTRATIONS	ii	SECTION 5 OPERATOR'S CHECKS AND ADJUSTMENTS	
LIST OF TABLES	ii	INTRODUCTION	5-1
OPERATORS SAFETY SUMMARY	iii	INITIAL SETUP	5-1
		TRACE ROTATION ADJUSTMENT	5-1
SECTION 1 SPECIFICATION		ASTIGMATISM ADJUSTMENT	5-2
INTRODUCTION	1-1	AUTO DC BALANCE ADJUSTMENT	5-2
PERFORMANCE CONDITIONS	1-1	PROBE LOW-FREQUENCY COMPENSATION	5-2
		MATCHING CHANNEL 2 DELAY	5-3
SECTION 2 PREPARATION FOR USE		AMPLITUDE CHECK	5-4
SAFETY	2-1	TIMING CHECK	5-4
LINE VOLTAGE SELECTION	2-1	SECTION 6 BASIC APPLICATIONS	
LINE FUSE	2-1	INDEX OF PROCEDURES	6-1
POWER CORD	2-1	VOLTAGE MEASUREMENT	6-1
INSTRUMENT COOLING	2-1	VOLTAGE RATIO	6-2
START-UP	2-2	ALGEBRAIC ADDITION AND ELIMINATING COMMON-MODE SIGNALS	6-3
REPACKAGING FOR SHIPMENT	2-2	TIME INTERVAL	6-4
		FREQUENCY	6-4
SECTION 3 CONTROLS, CONNECTORS, AND INDICATORS		TIME DIFFERENCE BETWEEN TWO TIME-RELATED PULSES	6-5
POWER AND DISPLAY	3-1	TIME RATIO	6-5
VERTICAL	3-2	PHASE DIFFERENCE BETWEEN TWO TIME-RELATED SIGNALS	6-6
HORIZONTAL AND DELTA MEASUREMENT	3-4	SMALL-ANGLE PHASE DIFFERENCE	6-6
TRIGGER	3-7	DELAYED-SWEEP OPERATION	6-7
REAR PANEL	3-9	SECTION 7 OPTIONS AND ACCESSORIES	
READOUT DISPLAY	3-11	INTRODUCTION	7-1
		OPTION 1R	7-1
SECTION 4 OPERATING CONSIDERATIONS		POWER CORD OPTIONS	7-1
GRATICULE	4-1	STANDARD ACCESSORIES	7-2
TIME AND VOLTAGE MEASUREMENTS	4-1	OPTIONAL ACCESSORIES	7-2
GROUNDING	4-1	APPENDIX A POWER-UP TESTS	
SIGNAL CONNECTIONS	4-2	KERNEL TESTS	A-1
INPUT-COUPLING CAPACITOR PRECHARGING	4-2	CONFIDENCE TESTS	A-1
EXTERNAL TRIGGERING	4-2	CHANGE INFORMATION	

LIST OF ILLUSTRATIONS

Figure		Page
	The 2445 Oscilloscope	iv
2-1	Line selector switch, line fuse, and detachable power cord.	2-2
3-1	Power and display controls	3-1
3-2	Vertical controls and CH 1 OR X and CH 2 connectors.	3-2
3-3	Channel 3 and Channel 4 controls and connectors and CALIBRATOR output	3-3
3-4	Horizontal and delta measurement controls	3-4
3-5	Trigger controls and indicators.	3-7
3-6	Rear-panel controls and connectors.	3-10
3-7	Readout display locations	3-11
4-1	Graticule measurement markings	4-1
5-1	Probe low-frequency compensation.	5-3
6-1	Instantaneous dc levels	6-1
6-2	Voltage ratios	6-2
6-3	Eliminating common-mode signals	6-3
6-4	Measuring rise times.	6-4
6-5	Time difference between two time-related pulses (cursor method)	6-5
6-6	Time ratios (duty cycles)	6-6
6-7	Phase difference between two time-related signals	6-7
6-8	Small-angle phase difference	6-7
6-9	Time difference between two time-related pulses (delayed-sweep method)	6-9

LIST OF TABLES

Table		Page
1-1	Electrical Characteristics.	1-2
1-2	Environmental Characteristics	1-9
1-3	Mechanical Characteristics.	1-10
2-1	Voltage, Fuse, and Power-Cord Data.	2-3
A-1	Confidence Test Numbers and Descriptions	A-1

OPERATORS SAFETY SUMMARY

The general safety information in this part of the summary is for both operating and servicing personnel. Specific warnings and cautions will be found throughout the manual where they apply and do not appear in this summary.

Terms in This Manual

CAUTION statements identify conditions or practices that could result in damage to the equipment or other property.

WARNING statements identify conditions or practices that could result in personal injury or loss of life.

Terms as Marked on Equipment

CAUTION indicates a personal injury hazard not immediately accessible as one reads the markings, or a hazard to property, including the equipment itself.

DANGER indicates a personal injury hazard immediately accessible as one reads the marking.

Symbols in This Manual



This symbol indicates where applicable cautionary or other information is to be found. For maximum input voltage see Table 1-1.

Symbols as Marked on Equipment



DANGER – High voltage.



Protective ground (earth) terminal.



ATTENTION – Refer to manual.

Power Source

This product is intended to operate from a power source that does not apply more than 250 volts rms between the supply conductors or between either supply conductor and ground. A protective ground connection by way of the grounding conductor in the power cord is essential for safe operation.

Grounding the Product

This product is grounded through the grounding conductor of the power cord. To avoid electrical shock, plug the power cord into a properly wired receptacle before connecting to the product input or output terminals. A protective ground connection by way of the grounding conductor in the power cord is essential for safe operation.

Danger Arising From Loss of Ground

Upon loss of the protective-ground connection, all accessible conductive parts (including knobs and controls that may appear to be insulating) can render an electric shock.

Use the Proper Power Cord

Use only the power cord and connector specified for your product.

Use only a power cord that is in good condition.

For detailed information on power cords and connectors see Table 2-1.

Use the Proper Fuse

To avoid fire hazard, use only a fuse of the correct type, voltage rating and current rating as specified in the parts list for your product.

Do Not Operate in Explosive Atmospheres

To avoid explosion, do not operate this product in an explosive atmosphere unless it has been specifically certified for such operation.

Do Not Remove Covers or Panels

To avoid personal injury, do not remove the product covers or panels. Do not operate the product without the covers and panels properly installed.

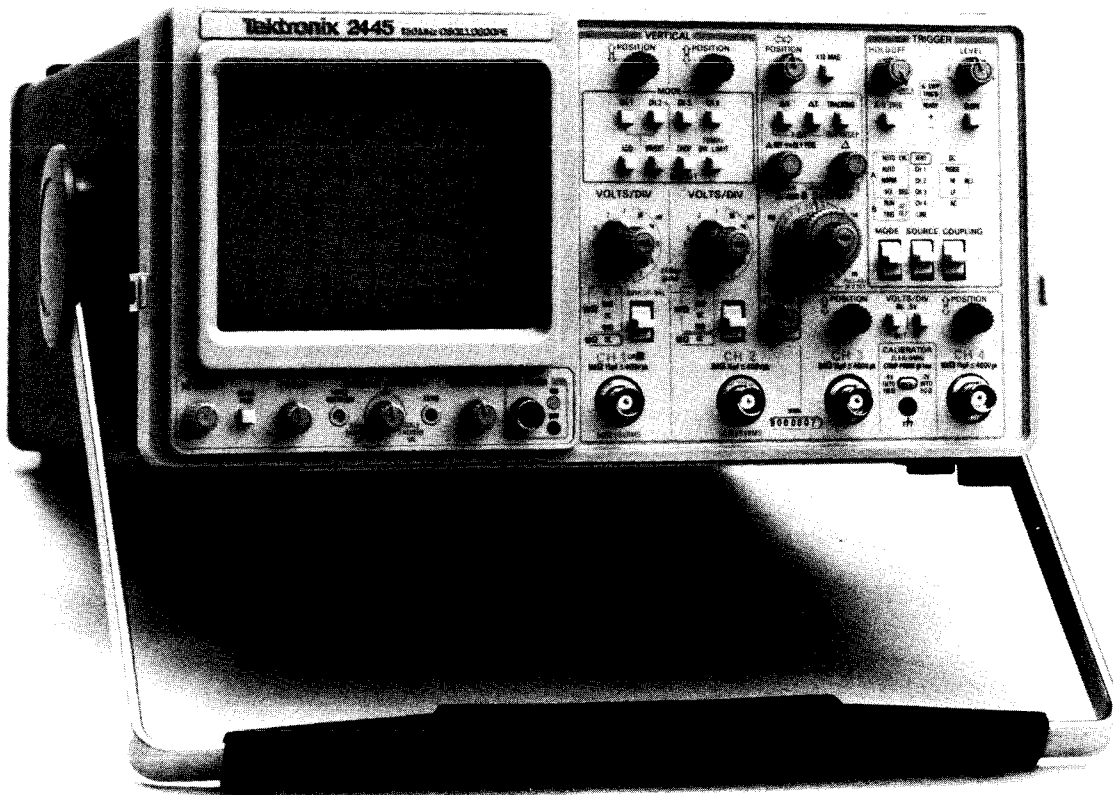

The 2445 Oscilloscope.

3830-01

SPECIFICATION

INTRODUCTION

The TEKTRONIX 2445 Oscilloscope is a portable 150-MHz instrument having a four-channel vertical deflection system. Channel 1 and Channel 2 provide calibrated deflection factors from 2 mV per division to 5 V per division. For each of these channels, input impedance is selectable between two values: either 1 M Ω in parallel with 15 pF, or 50 Ω internal termination. Input-signal coupling with 1-M Ω impedance can be selected as either AC or DC. Channel 3 and Channel 4 have deflection factors of either 0.1 V or 0.5 V per division. Each of these channels has an input impedance of 1 M Ω in parallel with 15 pF, with DC input-signal coupling. Trigger circuits enable stable triggering over the full bandwidth of the vertical system.

The horizontal deflection system provides calibrated sweep speeds from 1.5 s per division to 1 ns per division. Drive for the horizontal deflection system is obtained from a choice of A, B delayed, A alternated with B delayed sweeps, or CH 1 (for the X-Y display mode).

The 2445 incorporates alphanumeric crt readouts of the vertical and horizontal scale factors, the trigger levels, time-difference measurement values, voltage-difference measurement values, and certain auxiliary information.

The 2445 Oscilloscope is shipped with the following standard accessories:

- 2 Probe packages
- 1 Snap-lock accessories pouch
- 1 Zip-lock accessories pouch
- 1 Operators manual
- 1 Service manual
- 1 Power cord (installed)
- 1 2-A, 250-V fuse
- 1 Clear plastic crt filter
- 1 Blue plastic crt filter (installed)
- 1 Front-panel cover
- 1 Operators pocket reference card

For part numbers and further information about both standard and optional accessories, refer to "Options and Accessories" (Section 7) of this manual. Your Tektronix representative or local Tektronix Field Office can also provide accessories information and ordering assistance.

PERFORMANCE CONDITIONS

The following electrical characteristics (Table 1-1) are valid for the 2445 when it has been adjusted at an ambient temperature between +20°C and +30°C, has had a warm-up period of at least 20 minutes, and is operating at an ambient temperature between -15°C and +55°C (unless otherwise noted).

Items listed in the "Performance Requirements" column are verifiable qualitative or quantitative limits that define the measurement capabilities of the instrument.

Environmental characteristics are given in Table 1-2. The 2445 Oscilloscope meets the environmental requirements of MIL-T-28800C for Type III, Class 3, Style C equipment, with the humidity and temperature requirements defined in paragraphs 3.9.2.2, 3.9.2.3, and 3.9.2.4.

Mechanical characteristics of the 2445 are listed in Table 1-3.

Table 1-1
Electrical Characteristics

Characteristics	Performance Requirements		
VERTICAL DEFLECTION SYSTEM—CHANNEL 1 AND CHANNEL 2			
Deflection Factor			
Range	2 mV per division to 5 V per division in a 1-2-5 sequence of 11 steps.		
Accuracy			
+15°C to +35°C	Within ±2% at any VOLTS/DIV setting for a 4- or 5-division signal centered on the screen.		
–15°C to +15°C and +35°C to +55°C	Add 1% to +15°C-to-+35°C specification.		
ΔV Accuracy (using cursors over entire graticule area)			
+15°C to +35°C	± (2% of reading + 0.03 division + signal aberrations).		
–15°C to +15°C and +35°C to +55°C	Add 1% of reading to +15°C-to-+35°C specification.		
ΔV Range	± 8 times the VOLTS/DIV switch setting.		
Variable Range	Continuously variable between VOLTS/DIV switch settings. Extends deflection factor of the 5 V per division setting to at least 12.5 V per division.		
Frequency Response (3-dB bandwidth)	Six-division reference signal from a terminated 50-Ω system, with VAR VOLTS/DIV control in calibrated detent.		
	VOLTS/DIV setting	With standard-accessory probe or internal 50-Ω termination	With 50-Ω external termination on 1-MΩ input
–15°C to +55°C	2 mV	DC to 80 MHz	DC to 80 MHz
–15°C to +35°C	5 mV or greater	DC to 150 MHz	DC to 130 MHz
+35°C to +55°C	5 mV or greater	DC to 100 MHz	DC to 100 MHz
AC Coupled Lower –3 dB Point			
1X Probe	10 Hz or less.		
10X Probe	1 Hz or less.		
Step Response			
Rise Time	2.33 ns or less for VOLTS/DIV switch settings of 5 mV and up (calculated).		
	4.4 ns or less for VOLTS/DIV switch setting of 2 mV (calculated).		
	Rise time calculated from: bandwidth x rise time = 0.35.		
Common-mode Rejection Ratio (CMRR)	At least 20:1 at 50 MHz for common-mode signals of eight divisions or less, with VAR VOLTS/DIV control adjusted for best CMRR at 50 kHz at any VOLTS/DIV switch setting from 5 mV to 5 V; at least 20:1 at 20 MHz at 2 mV per division.		

Table 1-1 (cont)



Characteristics	Performance Requirements	
VERTICAL DEFLECTION SYSTEM—CHANNEL 1 AND CHANNEL 2 (cont)		
Channel Isolation	100:1 or greater attenuation of the deselected channel at 100 MHz; 50:1 or greater attenuation at 150 MHz, for an eight-division input signal from 2 mV per division to 500 mV per division, with equal VOLTS/DIV switch settings on both channels.	
Displayed Channel 2 Signal Delay with Respect to Channel 1 Signal	Adjustable through a range of at least –500 ps to +500 ps.	
Input R and C (1 M Ω)		
Resistance	1 M Ω \pm 0.5%.	
Capacitance	15 pF \pm 2 pF.	
Maximum Input Voltage 	400 V (dc + peak ac). 800 V p-p ac at 10 kHz or less.	
Input R (50 Ω)		
Resistance	50 Ω \pm 1%.	
VSWR (DC to 150 MHz)	1.3:1 or less.	
Maximum Input Voltage 	5 V rms; 50 mW-seconds during any 100-ms interval for instantaneous voltage from 5 V to 50 V.	
Cascaded Operation	CH 2 SIGNAL OUT into Channel 1 input; DC coupled using a 50- Ω RG-58C/U coaxial cable, terminated in 50 Ω at the Channel 1 input. Channel 1 and Channel 2 VOLTS/DIV switch set to 2 mV.	
Bandwidth	Dc to 50 MHz or greater.	
Deflection Factor	400 μ V per division \pm 10%.	
VERTICAL DEFLECTION SYSTEM—CHANNEL 3 AND CHANNEL 4		
Deflection Factor		
Values	0.1 V per division and 0.5 V per division.	
Accuracy	Within \pm 10%.	
Frequency Response (3-dB Bandwidth)	Six-division reference signal, from a terminated 50- Ω system.	
	With standard accessory probe	With external 50- Ω termination
	DC to 150 MHz	DC to 130 MHz
Step Response		
Rise Time	2.33 ns or less (calculated from bandwidth).	
Channel Isolation	50:1 or greater attenuation of the deselected channel at 100 MHz with an eight-division input signal.	

Table 1-1 (cont)

Characteristics	Performance Requirements
VERTICAL DEFLECTION SYSTEM—CHANNEL 3 AND CHANNEL 4 (cont)	
Input R and C Resistance	1 MΩ ±1%.
Capacitance	15 pF ±3 pF.
Maximum Input Voltage 	400 V (dc + peak ac); 800 V p-p ac at 10 kHz or less.
VERTICAL DEFLECTION SYSTEM—ALL CHANNELS	
Low-frequency Linearity	0.1 division or less compression or expansion of a two-division, center-screen signal when positioned anywhere within the graticule area.
Bandwidth Limiter	Reduces upper 3-dB bandpass to a limit of 13 MHz to 24 MHz.
Vertical Signal Delay	At least 20 ns of the sweep is displayed before the triggering event is displayed.
Chopped Mode Switching Rate	Vertical display switches sequentially through the selected channels at the chop switching rate. If the B SEC/DIV switch is set to sweep speeds outside the range of 20 μs per division to 2 μs per division, the switching rate is 1 MHz ±0.2% (dual-channel cycle rate of 500 kHz). If the B SEC/DIV switch is set within the range of 20 μs per division to 2 μs per division, the switching rate is 2.5 MHz ±0.2% (dual-channel cycle rate of 1.25 MHz). At all sweep speeds, the chop switching rate is desynchronized with the sweep frequency to minimize waveform breaks when viewing repetitive signals.
TRIGGERING	
Minimum P-P Signal Amplitude for Stable Triggering from Channel 1 or Channel 2 Source DC Coupled	0.35 division from dc to 50 MHz, increasing to 1 division at 250 MHz.
NOISE REJ Coupled	1.2 divisions or less from dc to 50 MHz, increasing to 3 divisions at 250 MHz.
AC Coupled	0.35 division from 60 Hz to 50 MHz, increasing to 1 division at 250 MHz. Attenuates signals below 60 Hz.
HF REJ Coupled	0.35 division from dc to 30 kHz.
LF REJ Coupled	0.35 division from 80 kHz to 50 MHz, increasing to 1 division at 250 MHz.
Minimum P-P Signal Amplitude for Stable Triggering from Channel 3 or Channel 4 Source	Amplitudes are one-half of Channel 1 or Channel 2 source specification.
Minimum P-P Signal Amplitude for Stable Triggering from Composite, Multiple Channel Source in ALT Vertical Mode	Add 1 division to single-channel source specifications.

Table 1-1 (cont)

Characteristics	Performance Requirements
TRIGGERING (cont)	
Maximum P-P Signal Rejected by NOISE REJ COUPLING for Signals Within the Vertical Bandwidth Channel 1 or Channel 2 Source	0.4 division or greater for VOLTS/DIV switch settings of 10 mV and higher.
Channel 3 or Channel 4 Source	0.2 division or greater.
Jitter	Less than 100 ps at 150 MHz with A and B SEC/DIV switch set to 10 ns and X10 MAG on.
LEVEL Control Range Channel 1 or Channel 2 Source	± 18 times the VOLTS/DIV switch setting.
Channel 3 or Channel 4 Source	± 9 times the VOLTS/DIV switch setting.
LEVEL Control Readout Accuracy (for triggering signals with transition times greater than 10 ns) Channel 1 or Channel 2 Source DC Coupled +15°C to +35°C	Within \pm [2% of setting + 2% of p-p signal + 0.2 division + (0.5 mV x probe attenuation factor)].
-15°C to +55°C (excluding +15°C to +35°C)	Add (1.5 mV x probe attenuation factor) to the specification listed for +15°C to +35°C.
NOISE REJ Coupled	Add ± 0.6 division to the DC Coupled specification.
Channel 3 or Channel 4 Source	Within \pm [2% of setting + 3% of p-p signal + 0.1 division + (0.5 mV x probe attenuation factor)].
SLOPE Selection	Conforms to trigger-source waveform or ac power-source waveform.
AUTO LVL Mode Maximum Triggering Signal Period A SEC/DIV Switch Setting Less than 10 ms	At least 20 ms.
A SEC/DIV Switch Setting from 10 ms to 50 ms	At least four times the A SEC/DIV switch setting.
A SEC/DIV Switch Setting from 100 ms to 500 ms	At least 200 ms.
AUTO Mode Maximum Triggering Signal Period A SEC/DIV Switch Setting Less than 10 ms	At least 80 ms.
A SEC/DIV Switch Setting from 10 ms to 50 ms	At least 16 times the A SEC/DIV switch setting.
A SEC/DIV Switch Setting from 100 ms to 500 ms	At least 800 ms.
AUTO LVL Mode Trigger Acquisition Time	Eight to 100 times the AUTO LVL Mode maximum triggering-signal period, depending on the triggering-signal period and waveform.

Table 1-1 (cont)

Characteristics	Performance Requirements	
HORIZONTAL DEFLECTION SYSTEM		
A Sweep Time Base Range	1 s per division to 10 ns per division in a 1-2-5 sequence of 25 steps. X10 MAG feature extends maximum sweep speed to 1 ns per division.	
B Sweep Time Base Range	50 ms per division to 10 ns per division in a 1-2-5 sequence of 21 steps. X10 MAG feature extends maximum sweep speed to 1 ns per division.	
SEC/DIV VAR Control	Continuously variable and calibrated between settings of the SEC/DIV switch. Extends slowest A Sweep speed to 1.5 s per division. Operates in conjunction with the A SEC/DIV switch when A and B are locked together; operates in conjunction with the B SEC/DIV switch when A and B are not locked together.	
Timing Accuracy (+15°C to +35°C, SEC/DIV switch set to 0.1 s per division or less) A and B Sweep Accuracy, Time Intervals Measured at Vertical Center with SEC/DIV VAR Control in Detent	Unmagnified	Magnified
	$\pm (0.7\% \text{ of time interval} + 0.6\% \text{ of full scale}).$	$\pm (1.2\% \text{ of time interval} + 0.6\% \text{ of full scale}).$
	0.6% of full scale is 0.06 division.	
Δt Accuracy, Time Intervals Measured with Cursors, Anywhere on the Graticule (A Sweep Only)	Unmagnified	Magnified
	$\pm (0.5\% \text{ of time interval} + 0.3\% \text{ of full scale}).$	$\pm (1\% \text{ of time interval} + 0.3\% \text{ of full scale}).$
Δt Accuracy, Time Intervals Measured with Delayed B Sweep with Both Delays Set at 1% or More of Full Scale from Minimum Delay (no ? displayed in readout)	$\pm (0.3\% \text{ of time interval} + 0.1\% \text{ of full scale}).$	
Delay Accuracy, A Sweep Trigger Point to Start of B Sweep	$\pm (0.3\% \text{ of delay setting} + 0.6\% \text{ of full scale}) - 25 \text{ ns}.$	
Timing Accuracy (A SEC/DIV switch set to 0.5 s or 0.2 s per division)	Add $\pm 0.5\%$ of time interval to all accuracy specifications.	
Timing Accuracy (A SEC/DIV switch set to 1 s per division)	Add $\pm 2\%$ of time interval to all accuracy specifications.	
Timing Accuracy (SEC/DIV VAR control out of detent)	Add 2% of time interval to the A and B Sweep Accuracy specification.	
Timing Accuracy (-15°C to $+15^\circ\text{C}$ and $+35^\circ\text{C}$ to $+55^\circ\text{C}$)	Add $\pm 0.2\%$ of time interval to all Δt and delay specifications. Add $\pm 0.5\%$ of time interval to A and B Sweep accuracy specifications.	
Δt Readout Resolution	Greater of either 20 ps or 0.025% of full scale.	
Δt Range	± 10 times the A SEC/DIV switch setting.	
Delay Pickoff Jitter	Within 0.004% (one part or less in 25,000) of the maximum available delay, plus 100 ps.	

Table 1-1 (cont)

Characteristics	Performance Requirements
HORIZONTAL DEFLECTION SYSTEM (cont)	
Delay Time Position Range	0 to 9.95 times the A SEC/DIV switch setting. Main sweep triggering event is observable on delayed sweep with zero delay setting.
X-Y Operation	
X-Axis Deflection Factor	
Range	Same as Channel 1.
Accuracy	Same as Channel 1.
Variable Range	Same as Channel 1.
X-Axis Bandwidth	Dc to 3 MHz.
Input R and C	Same as Channel 1.
Phase Difference Between X and Y with Normal Bandwidth	1° or less from dc to 1 MHz; 3° or less from 1 MHz to 2 MHz.
X-Axis Low-Frequency Linearity	0.2 division or less compression or expansion of a two-division, center-screen signal when positioned within the display area.
CURSOR AND FRONT-PANEL DISPLAY	
Cursor Position Range	
Delta Volts (ΔV)	At least the center 7.6 vertical divisions.
Delta Time (Δt)	At least the center 9.6 horizontal divisions.
Minimum Setup Time Required to Maintain Front-panel Settings at Power-down	10 seconds or less.
Z-AXIS INPUT	
Sensitivity	Positive voltage decreases intensity. From dc to 2 MHz, +2 V blanks a maximum-intensity trace; from 2 MHz to 20 MHz, +2 V modulates a normal-intensity trace.
Input Resistance	10 k Ω \pm 10%.
Maximum Input Voltage 	\pm 25 V peak; 25 V p-p ac at 10 kHz or less.
SIGNAL OUTPUTS	
CALIBRATOR	
Output Voltage and Current	0.4 V \pm 1% into a 1-M Ω load, 0.2 V \pm 1.5% into a 50- Ω load, or 8 mA \pm 1.5% into a short circuit, with the A SEC/DIV switch set to 1 ms per division.
Repetition Period	Two times the A SEC/DIV switch setting within the range of 200 ns to 200 ms.
Accuracy	\pm 0.1%, measured with SGL SEQ A TRIGGER MODE selected.

Table 1-1 (cont)

Characteristics	Performance Requirements
SIGNAL OUTPUTS (cont)	
CALIBRATOR (cont)	
Symmetry	Duration of high portion of output cycle is 50% of output period \pm (lesser of 500 ns or 25% of period).
Jitter of Pulse Period or Pulse Width	10 ns or less.
CH 2 SIGNAL OUT	
Output Voltage	20 mV per division \pm 10% into 1 M Ω ; 10 mV per division \pm 10% into 50 Ω .
Offset	\pm 10 mV into 50 Ω , when dc balance has been performed within \pm 5 $^{\circ}$ C of the operating temperature.
A GATE OUT and B GATE OUT	
Output Voltage	2.4 V to 5 V positive-going pulse, starting at 0 V to 0.4 V.
Output Drive	Will supply 400 μ A during HI state; will sink 2 mA during LO state.
CRT	
Display	80 mm x 100 mm.
Standard Phosphor	P31.
Nominal Accelerating Potential	16 kV.
AC POWER SOURCE	
Source Voltage	
Ranges	
115 V	90 V to 132 V.
230 V	180 V to 250 V.
Source Frequency	48 Hz to 440 Hz.
Fuse Rating	2 A, 250 V, AGC/3AG, Fast blow; or 1.6 A, 250 V, 5 x 20 mm, Quick-acting (F).
Power Consumption	
Typical	70 W (140 VA).
Maximum	120 W (180 VA).
Primary Circuit Dielectric Voltage Withstand Test	1500 V rms, 60 Hz for 10 s without breakdown.
Primary Grounding	Type test to 0.1 Ω maximum. Routine test to check grounding continuity between chassis ground and protective earth ground.

Table 1-2
Environmental Characteristics

Characteristics	Performance Requirements
	The 2445 Oscilloscope meets the environmental requirements of MIL-T-28800C for Type III, Class 3, Style C equipment, with the humidity and temperature requirements defined in paragraphs 3.9.2.2, 3.9.2.3, and 3.9.2.4.
Temperature	
Operating	–15° C to +55° C.
Nonoperating (storage)	–62° C to +85° C.
Altitude	
Operating	To 15,000 ft. Maximum operating temperature decreases 1° C for each 1,000 ft above 5,000 ft.
Nonoperating (storage)	To 50,000 ft.
Humidity (operating and nonoperating)	Stored at 95% relative humidity for five cycles (120 hours) from 30° C to 60° C, with operational performance checks at 30° C and 55° C.
Vibration (operating)	15 minutes along each of three axes at a total displacement of 0.025 inch p-p (4 g at 55 Hz), with frequency varied from 10 Hz to 55 Hz in one-minute sweeps. Held 10 minutes at each major resonance, or if none existed, held 10 minutes at 55 Hz (75 minutes total test time).
Shock (operating and nonoperating)	50 g, half-sine, 11-ms duration, three shocks on each face, for a total of 18 shocks.
Transit Drop (not in shipping package)	12-inch drop on each corner and each face (MIL-T-28800C, para 3.9.5.2 and 4.5.5.4.2).
Bench Handling (with and without cabinet installed)	MIL-STD-810C, Method 512.2, Procedure V (MIL-T-28800C, para 4.5.5.4.3).
EMI (electromagnetic interference)	Meets MIL-T-28800C; applicable parts of MIL-STD-461B, Type III test and measurement equipment; VDE 0871, Category B; Part 15 of FCC Rules and Regulations, Subpart J, Class A; and Tektronix Standard 062-2866-00.
Topple (operating with cabinet installed)	Set on rear feet and allowed to topple over onto each of four adjacent faces (Tektronix Standard 062-2858-00).
Packaged Transportation Drop	Meets the limits of the National Safe Transit Association test procedure 1A-B-2; 10 drops of 36 inches (Tektronix Standard 062-2858-00).
Packaged Transportation Vibration	Meets the limits of the National Safe Transit Association test procedure 1A-B-1; excursion of 1 inch p-p at 270 Hz (1 g) for 30 minutes (Tektronix Standard 062-2858-00).

Table 1-3
Mechanical Characteristics

Characteristics	Description
Weight With Accessories and Pouch	10.2 kg (22.4 lb).
Without Accessories and Pouch	9.3 kg (20.5 lb).
Domestic Shipping Weight	12.8 kg (28.2 lb).
Height With Feet and Accessories Pouch	190 mm (7.5 in).
Without Accessories Pouch	160 mm (6.3 in).
Width (with handle)	330 mm (13.0 in).
Depth With Front-Panel Cover	434 mm (17.1 in).
With Handle Extended	505 mm (19.9 in).
Cooling	Forced-air circulation.
Finish	Tektronix Blue vinyl-clad material on aluminum cabinet.
Construction	Aluminum-alloy chassis (sheet metal). Die-cast aluminum front panel. Glass-laminate circuit boards.

PREPARATION FOR USE

SAFETY

This section tells how to prepare for and to proceed with the initial start-up of the TEKTRONIX 2445 Oscilloscope.

Refer to the Safety Summary at the front of this manual for power source, grounding, and other safety considerations pertaining to the use of the instrument. Before connecting the oscilloscope to a power source, read entirely both this section and the Safety Summary.

CAUTION

This instrument may be damaged if operated with the LINE VOLTAGE SELECTOR switch set for the wrong applied ac input-source voltage or if the wrong line fuse is installed.

LINE VOLTAGE SELECTION

The 2445 operates from either a 115-V or a 230-V nominal ac power-input source having line frequency ranging from 48 Hz to 440 Hz. Before connecting the power cord to a power-input source, verify that the LINE VOLTAGE SELECTOR switch, located on the rear panel (see Figure 2-1), is set for the correct nominal ac input-source voltage. To convert the instrument for operation from one line-voltage range to the other, move the LINE VOLTAGE SELECTOR switch to the correct nominal ac source-voltage setting (see Table 2-1). The detachable power cord may have to be changed to match the particular power-source output.

LINE FUSE

To verify that the instrument power-input fuse is of proper value for the nominal ac source voltage selected, perform the following procedure:

1. Press in the fuse-holder cap and release it with a slight counterclockwise rotation.

2. Pull the cap (with the attached fuse inside) out of the fuse holder.
3. Verify proper fuse value (see Table 2-1).
4. Install the proper fuse and reinstall the fuse-holder cap.

NOTE

The two types of fuses listed are not directly interchangeable; they require different types of fuse caps.

POWER CORD

This instrument has a detachable, three-wire power cord with a three-contact plug for connection to both the power source and protective ground. The power cord is secured to the rear panel by a cord-set-securing clamp. The protective-ground contact on the plug connects (through the power-cord protective grounding conductor) to the accessible metal parts of the instrument. For electrical-shock protection, insert this plug into a power-source outlet that has a properly grounded protective-ground contact.

Instruments are shipped with the required power cord as ordered by the customer. Available power-cord information is presented in Table 2-1, and part numbers are listed in "Options and Accessories" (Section 7). Contact your Tektronix representative or local Tektronix Field Office for additional power-cord information.

INSTRUMENT COOLING

To prevent instrument damage from overheated components, adequate internal airflow must be maintained at all times. Before turning on the power, first verify that both the air-intake holes on the bottom of the cabinet and the fan-exhaust holes in the rear panel are free of any obstruction to airflow.

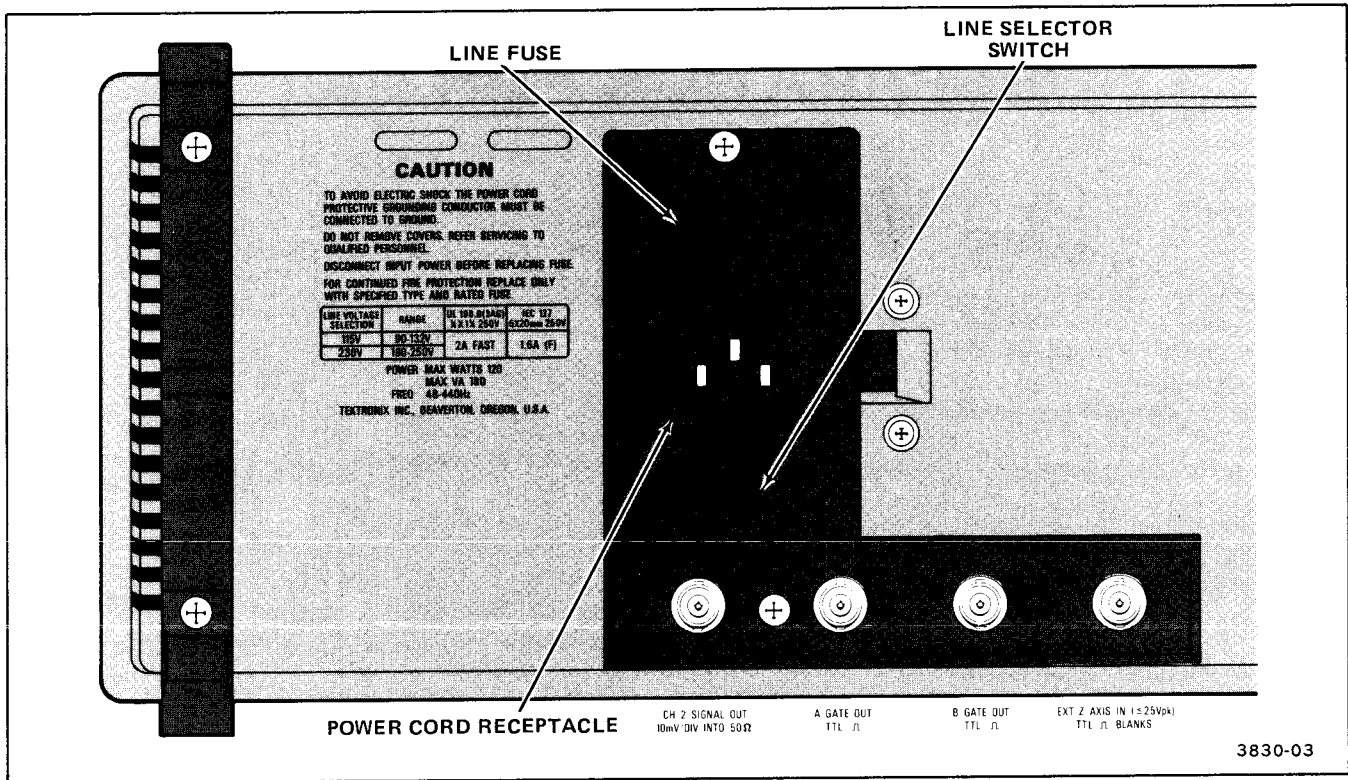

Figure 2-1. Line selector switch, line fuse, and detachable power cord.

START-UP

The 2445 automatically performs power-up tests each time the instrument is turned on. The purpose of these tests is to provide the user with the highest possible confidence level that the instrument is fully functional. If no faults are encountered, the power-up tests normally will be completed in under five seconds, after which the instrument will enter the normal operating mode. A failure of any of the power-up tests will be indicated by either a flashing TRIG'D indicator on the instrument front panel or a bottom-line readout on the crt in the form: **TEST XX FAIL YY** (where XX is the test number and YY is the failure code of the failed test).

If a failure of any power-up test occurs, the instrument may still be usable for some applications. To put the instrument into the operating mode after a power-up test failure, press the A/B TRIG button. If the instrument then functions for your particular measurement requirement, it may be used, but refer it to a qualified service technician for repair of the problem at the earliest convenience. Additional information on the power-up tests may be found in Appendix A at the rear of this manual. Consult your service department, your local Tektronix Service Center, or nearest Tektronix representative if additional assistance is needed.

REPACKAGING FOR SHIPMENT

If this instrument is to be shipped by commercial transportation, it is recommended that it be packaged in the original manner. The carton and packaging material in which your instrument was shipped to you should be saved and used for this purpose.

If the original packaging is unfit for use or is not available, repackage the instrument as follows:

1. Obtain a corrugated cardboard shipping carton having inside dimensions at least six inches greater than the instrument dimensions and having a carton test strength of at least 275 pounds.
2. If the instrument is to be shipped to a Tektronix Service Center for service or repair, attach a tag to the instrument showing the following: owner of the instrument (with address), the name of a person at your firm who can be contacted, complete instrument type and serial number, and a description of the service required.

3. Wrap the instrument with polyethylene sheeting or equivalent to protect the outside finish and prevent entry of packing materials into the instrument.
4. Cushion the instrument on all sides by tightly packing dunnage or urethane foam between the carton and the instrument, allowing three inches on each side.
5. Seal the carton with shipping tape or with an industrial stapler.
6. Mark the address of the Tekronix Service Center and your return address on the carton in one or more prominent locations.

Table 2-1
Voltage, Fuse, and Power-Cord Data

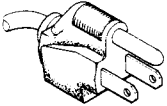
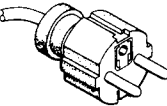
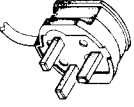
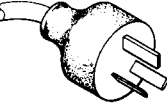
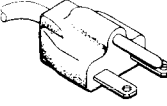
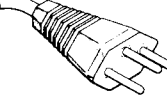
Plug Configuration	Category	Power Cord And Plug Type	Line Voltage Selector Setting	Voltage Range (AC)	Factory Installed Instrument Fuse	Fuse Holder Cap	Reference Standards ^b
	U.S. Domestic Standard	U.S. 120V 15A	115V	90V to 132V	2A, 250V AGC/3AG Fast-blow (UL 198.6)	AGC/3AG	ANSI C73.11 NEMA 5-15-P IEC 83 UL 198.6
	Option A1	EURO 240V 10-16A	230V	180V to 250V	1.6A, 250V 5x20 mm Quick-Acting (F) (IEC 127)	5x20 mm	CEE(7), II, IV, VII IEC 83 IEC 127
	Option A2	UK ^a 240V 6A	230V	180V to 250V	1.6A, 250V 5x20 mm Quick-Acting (F) (IEC 127)	5x20 mm	BS 1363 IEC 83 IEC 127
	Option A3	Australian 240V 10A	230V	180V to 250V	1.6A, 250V 5x20 mm Quick-Acting (F) (IEC 127)	5x20 mm	AS C112 IEC 127
	Option A4	North American 240V 15A	230V	180V to 250V	2A, 250V AGC/3AG Fast-blow (UL 198.6)	AGC/3AG	ANSI C73.20 NEMA 6-15-P IEC 83 UL 198.6
	Option A5	Switzerland 220V 6A	230V	180V to 250V	1.6A, 250V 5x20 mm Quick-Acting (F) (IEC 127)	5x20 mm	SEV IEC 127

^a A 6A, Type C fuse is also installed inside the plug of the Option A2 power cord.

^b Reference Standards Abbreviations:

ANSI—American National Standards Institute
AS—Standards Association of Australia
BS—British Standards Institution
CEE—International Commission on Rules for the Approval of Electrical Equipment

IEC—International Electrotechnical Commission
NEMA—National Electrical Manufacturer's Association
SEV—Schweizerischer Elektrotechnischer Verein
UL—Underwriters Laboratories Inc.

3832-02

CONTROLS, CONNECTORS, AND INDICATORS

The following descriptions are intended to familiarize the operator with the location and function of the instrument's controls, connectors, and indicators.

POWER AND DISPLAY

Refer to Figure 3-1 for location of items 1 through 9.

- ① **INTENSITY Control**—Adjusts brightness of the crt trace display. This control does not affect intensity of the crt readout display.
- ② **BEAM FIND Switch**—When held in, compresses the display to within the graticule area. Aids the operator in locating off-screen displays.
- ③ **FOCUS Control**—Adjusts the display for optimum definition.
- ④ **TRACE ROTATION Control**—Operator-adjusted screwdriver control used to align the crt trace with the horizontal graticule lines. Once adjusted, it does not require readjustment during normal operation of the instrument.
- ⑤ **READOUT INTENSITY Control**—Adjusts the intensity of the crt readout display. This control is also used to either enable or disable the scale-factor display. Setting the control to MIN reduces the readout intensity to minimum. Clockwise rotation from midrange increases the readout intensity and enables the scale-factor display; counterclockwise rotation from midrange also increases the intensity but disables the scale-factor display. Delta Volts and Delta Time readouts and control messages will continue to be enabled even when the scale-factor display is disabled.
- ⑥ **ASTIG Control**—Operator-adjusted screwdriver control used in conjunction with the FOCUS control to obtain a well-defined display over the entire graticule area. Once adjusted, it does not require readjustment during normal operation of the instrument.

- ⑦ **SCALE ILLUM Control**—Adjusts the light level of the graticule illumination.
- ⑧ **POWER Switch**—Turns instrument power on and off. Press in for ON; press again for OFF. An internal indicator in the switch shows green when the switch is on and black when it is off. Front-panel settings that were unchanged for at least 10 seconds prior to power-off will be returned when power is reapplied to the instrument.
- ⑨ **CRT**—Has an 80-mm vertical and 100-mm horizontal display area. Internal graticule lines eliminate parallax-viewing error between the trace and the graticule lines. Rise-time measurement points are indicated at the left edge of the graticule.

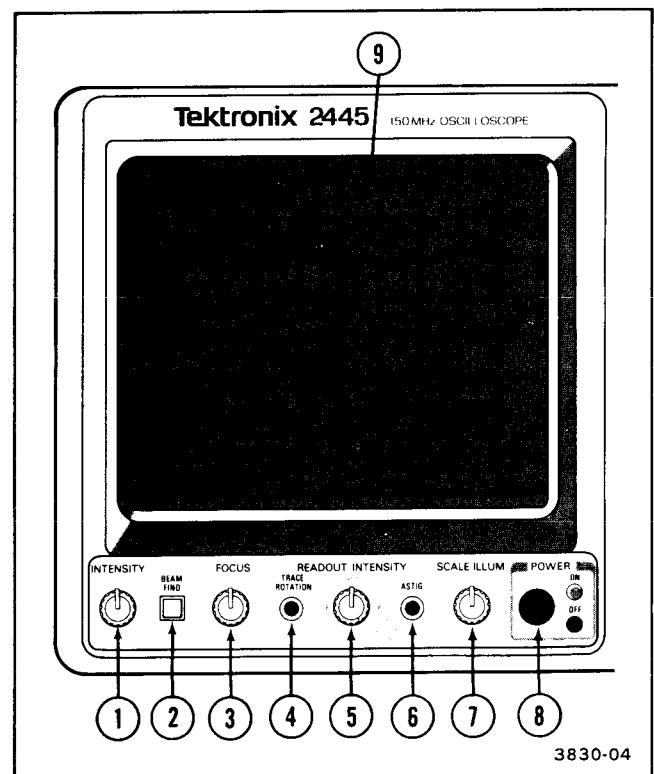

Figure 3-1. Power and display controls.

VERTICAL

Refer to Figure 3-2 for location of items 10 through 17.

10 CH 1 OR X and CH 2 Input Connectors—Provide for application of external signals to the inputs of Channel 1 and Channel 2 vertical attenuators. A signal applied to the CH 1 OR X connector provides the horizontal deflection for an X-Y display. Any one or all of the channels (including Channel 1) may supply the signal for the X-Y display vertical deflection. These connectors each include a coding-ring contact that activates the scale-factor-switching circuitry whenever a scale-factor-switching probe is connected. The internal circuitry recognizes Tektronix attenuation-coded probes.

11 Input Coupling Switches and Indicators—Select the method of coupling input signals to the Channel 1 and Channel 2 vertical attenuators and indicate the selection made. If the Channel 1 and Channel 2 input signals are both AC coupled and if both input coupling switches are pushed up together, the instrument automatically performs a dc balance of Channel 1 and Channel 2 vertical circuitry.

1 MΩ AC—Input signal is capacitively coupled to the vertical attenuator. The dc component of the input signal is blocked. The low-frequency limit (−3 dB point) is 10 Hz or less when using either a 1X probe or a coaxial cable and is 1 Hz or less when using a properly compensated 10X probe.

1 MΩ GND—The input of the vertical amplifier is grounded to provide a zero (ground) reference-voltage display. Input resistance is 1 MΩ to ground. This position of the switch allows precharging of the input-coupling capacitor to prevent a sudden shift of the trace if AC input coupling is selected later.

1 MΩ DC—All frequency components of the input signal are coupled to the vertical attenuator. Input resistance is 1 MΩ to ground.

1 MΩ GND—In this position, the switch operates exactly the same as previously described.

50 Ω DC—All frequency components of the input signal are coupled to the vertical attenuator, with the input terminated by 50 Ω to ground. If excessive signal is applied to either the CH 1 or the

CH 2 input connector while 50 Ω DC input coupling is selected, input coupling will revert to 1 MΩ GND and a crt readout will indicate the overloaded condition. Moving the input coupling switch of the affected channel removes the overload message. While power is off, coupling is at 1 MΩ GND.

12 Channel 1 and Channel 2 VOLTS/DIV Switches—Select vertical deflection factor settings in a 1-2-5 sequence with 11 positions. The VAR control must be in the detent (fully clockwise) position to obtain a calibrated deflection factor. Basic deflection factors are from 2 mV per division to 5 V per division. Deflection factors shown in the crt readout reflect actual deflection factors in use when Tektronix attenuation-coded probes are connected to the inputs.

13 VAR Controls—Provide continuously variable, uncalibrated deflection factors between the calibrated settings of the VOLTS/DIV switches. These controls vary the deflection factors from calibrated (fully clockwise detent position) to at least 2.5 times the calibrated deflection factor (fully counterclockwise position). When out of the calibrated detent, a greater than (>) sign appears in front of the associated VOLTS/DIV readout display.

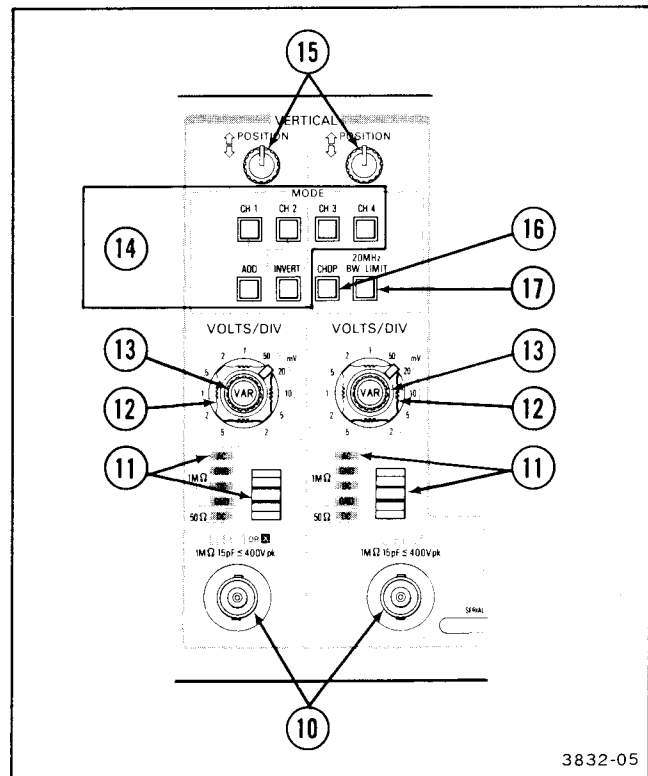

Figure 3-2. Vertical controls and CH 1 OR X and CH 2 connectors.

- 14 **MODE Switches**—Select the indicated channel(s) for display when latched in. Any combination of the five possible signal selections can be displayed by pressing in the appropriate push buttons. The Channel 1 signal will be displayed if none of the MODE switches are latched in.

The algebraic sum of Channel 1 and Channel 2 is displayed when the ADD push button is latched in. When both ADD and INVERT buttons are latched in, the waveform displayed is the difference between the Channel 1 and Channel 2 signals. The INVERT button also inverts the polarity of the signal output at the CH 2 SIG OUT connector on the rear panel. At the same time, the Channel 2 trigger-signal polarity is inverted so that if CH 2 is selected as the TRIGGER SOURCE, the displayed slope will agree with the TRIGGER SLOPE switch setting.

When multiple channels are selected, they are displayed sequentially in order of priority. The established priority order is: CH 1, CH 2, ADD, CH 3, then CH 4.

- 15 **POSITION Controls**—Set vertical position of the Channel 1 and Channel 2 signal displays. Clockwise rotation of a control moves the associated trace upward. When the X-Y display feature is in use, Channel 1 POSITION control moves the display horizontally; clockwise moves it to the right. The Channel 2, Channel 3, and Channel 4 vertical POSITION controls move the associated X-Y display vertically.

- 16 **CHOP-OUT: ALT Switch**—Selects the vertical display mode for multiple-channel displays.

CHOP (latched in)—When more than one channel is selected, the vertical display switches sequentially through the selected channels at the chop-switching rate.

The chop frequency changes between 1 MHz and 2.5 MHz, depending on the SEC/DIV switch setting. At all sweep speeds, the chop-switching rate is desynchronized with the sweep frequency to minimize waveform breaks when viewing repetitive signals.

OUT: ALT (released out)—When more than one channel is selected, the vertical display switches sequentially through the selected channels. Alternate switching occurs during sweep-retrace times. If both A and B Sweeps are displayed, alternate switching occurs at the completion of the B Sweep.

The position of this switch has no effect on the switching rate of multiple X-Y displays. When more than one X-Y display is selected, switching occurs at 2.5 MHz.

- 17 **20 MHz BW LIMIT Switch**—Reduces upper 3 dB bandpass of the vertical deflection system to a limit of 13 to 24 MHz when latched in. Full instrument bandwidth is available when push button is out.

Refer to Figure 3-3 for location of items 18 through 22.

- 18 **CH 3 and CH 4 Input Connectors**—Provide for application of external signals to Channel 3 and Channel 4. Input coupling from these connectors is DC only. Coding-ring contacts, identical in operation to the CH 1 OR X and CH 2 input connectors, are also provided. Channel 3 and Channel 4 are most useful as digital signal and trigger signal input channels, given their limited choice of deflection factors.

- 19 **POSITION Controls**—Set vertical position of the Channel 3 and Channel 4 signal displays. The controls operate identically to the Channel 2 POSITION control, but with less range on their associated traces.

- 20 **Channel 3 and Channel 4 VOLTS/DIV Switches**—Select either of two basic deflection factors for Channel 3 and Channel 4. With the push button OUT, the basic deflection factor (using a 1X probe or a coaxial cable input connection) is 0.1 V per division; when it is latched IN, deflection factor is 0.5 V per division.

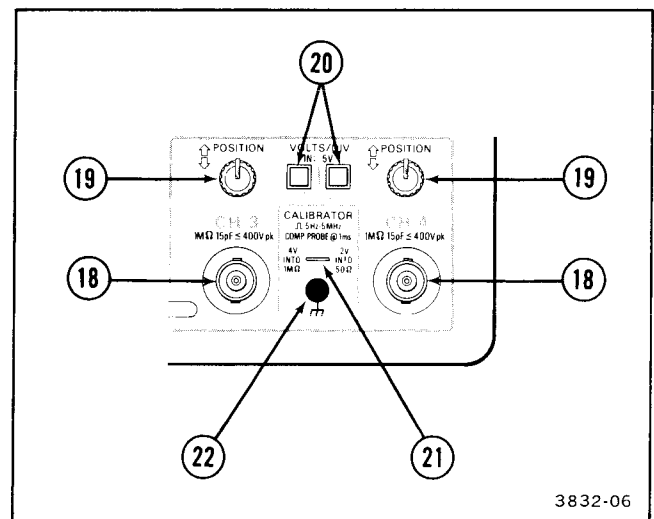

Figure 3-3. Channel 3 and Channel 4 controls and connectors and CALIBRATOR output.

21 CALIBRATOR Connector—Provides a 0.4-V p-p square-wave signal into a 1-M Ω load, a 0.2-V p-p square-wave signal into a 50- Ω dc-coupled load, or an 8-mA p-p square-wave current signal into a short circuit at a sweep speed of 1 ms per division. The CALIBRATOR output signal is useful for checking the sweep, the delays, and the vertical deflection accuracies, as well as compensating voltage probes and checking the accuracy of current probes. The repetition rate of the square wave changes with the setting of the A SEC/DIV switch. For all sweep-speed settings from 100 ms per division to 100 ns per division, the A Sweep display, as seen on the instrument supplying the CALIBRATOR signal, will be five cycles per 10 divisions. At 100 ms per division and slower, the CALIBRATOR frequency will be 5 Hz; at 100 ns per division and faster, the frequency will be 5 MHz. The signal amplitude at 5 MHz will be at least 50% of the signal amplitude obtained when the sweep speed is set to 1 ms per division.

NOTE

Due to internal circuitry constraints, the calibrator signal is not synchronized during trace holdoff. This does not affect the accuracy of the calibrator signal that is present during a trace display. However, if the 2445 CALIBRATOR signal is used to calibrate other instruments, the sweep of the 2445 must be shut off. If it is not, the signal will appear to jitter and will give false (low) frequency counts. The sweep of the 2445 is easily shut off by setting the TRIGGER MODE switch to SGL SEQ.

22 Auxiliary Ground Jack—Provides an auxiliary signal ground when interconnecting equipment under test and the oscilloscope. Hookup is made via a banana-tip connector.

HORIZONTAL AND DELTA MEASUREMENT

Refer to Figure 3-4 for items 23 through 33.

23 A SEC/DIV Switch—Selects 25 calibrated A Sweep speeds from 1 s per division to 10 ns per division, or delay ranges from 10 s to 200 ns, in a 1-2-5 sequence. Extreme counterclockwise switch rotation selects the X-Y display mode. In X-Y, the signal applied to the CH 1 OR X input connector drives the horizontal deflection system.

24 B SEC/DIV Switch—Selects 21 calibrated B Sweep speeds from 50 ms per division to 10 ns per division in a 1-2-5 sequence. This switch also controls Horizontal Display Mode switching, as explained in the following descriptions.

Knobs Locked—When both the A SEC/DIV and B SEC/DIV switches are set to the same sweep speed and the B SEC/DIV knob is pushed in, the two knobs are locked together; in this position, only the A Sweep is displayed on the crt.

PULL-INTEN—Pulling the B SEC/DIV knob to the out position intensifies the A Sweep display for the duration of the B Sweep time. When both the A SEC/DIV and B SEC/DIV switches are set to the same sweep speed, the B Sweep is not displayed, but it runs at one of two speeds: either 100 times faster than the A Sweep speed or at 5 ns per division, whichever is slower. The A and B SEC/DIV knobs are interlocked to prevent the B SEC/DIV switch from ever being set to a slower sweep speed than the A SEC/DIV switch setting.

The position of the intensified zone on the A Sweep indicates the delay time between the start of the A Sweep and start of the B Sweep interval. Its position is controlled by the Δ REF OR DLY POS control.

For single-trace displays, when either the Delta Time (Δt) or the reciprocal Delta Time ($1/\Delta t$) function is activated, two intensified zones will

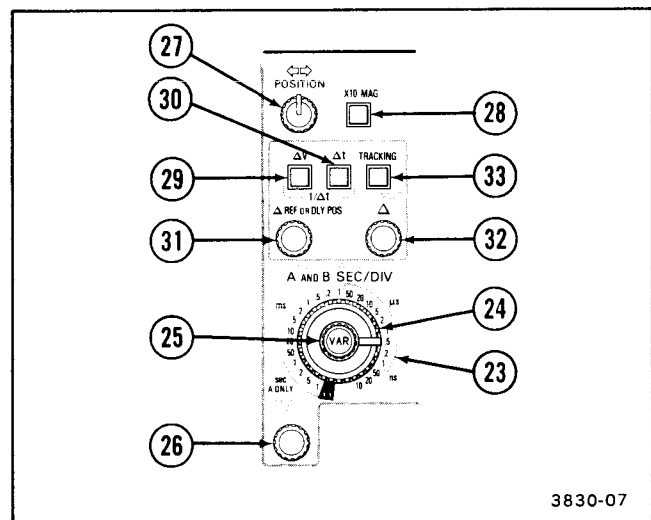

Figure 3-4. Horizontal and delta measurement controls.

appear on the A Sweep if the B TRIGGER MODE is set to RUN AFT DLY. When the B TRIGGER MODE is set to TRIG AFT DLY, intensified zones appear on the A Sweep only if proper B Sweep triggering occurs before the end of the A Sweep. When set to RUN AFT DLY, the position of the Reference zone is controlled by the Δ REF OR DLY POS control as before, and the position of the Delta zone is controlled by the Δ control. In TRIG AFT DLY mode, if the B Sweep is triggered, the positions of both intensified zones are determined by the first triggering events that occur after delay times set by the Δ REF OR DLY POS and the Δ controls have elapsed.

When more than one trace is displayed using ALT VERT MODE, and if the A Sweep is being triggered from a single source, with the Δt or $1/\Delta t$ function selected, the Reference zone will appear on the first selected trace from the following sequence: CH 1, CH 2, ADD, CH 3, then CH 4. The Delta zone appears on the second selected trace, and both zones appear on any additional traces. With CHOP VERT MODE or multiple-channel triggering, both zones appear on all traces.

Pulling the B SEC/DIV knob to the out position will cancel the Delta Volts (ΔV) function, if it is activated. Pushing in the B SEC/DIV knob to the locked position will cancel the **NO ΔV WITH DELAY** message on the crt readout, if it is being displayed.

PULL-ADJ CH 2 DLY—When the A SEC/DIV switch is set to 10 ns per division, pulling the B SEC/DIV knob to the out position activates the Channel 2 delay-offset (CH 2 DLY) adjustment feature. See “Matching Channel 2 Delay” in Section 5, “Operator’s Checks and Adjustments,” to use this feature.

TURN-ALT—Pulling the B SEC/DIV knob to the out position, then turning it to a faster sweep-speed setting than the A SEC/DIV sweep-speed setting, produces the Alternate (ALT) Horizontal Display Mode. The A Sweep with an intensified zone will be alternately displayed with the B Sweep, provided the B TRIGGER MODE is set either to RUN AFT DLY or to TRIG AFT DLY with a proper B triggering signal occurring before the end of the A Sweep. The position of the intensified zone on the A Sweep indicates the approximate delay of the B Sweep, and the length of the intensified zone indicates the approximate B Sweep duration set by the B SEC/DIV switch.

If either Δt or $1/\Delta t$ is also activated, intensified zones and associated B Sweeps will be established in the same manner as described in “PULL-INTEN.”

PUSH-B—Pushing in the B SEC/DIV knob when the B SEC/DIV switch is set to a faster sweep speed than the A SEC/DIV switch presents only the B Sweep trace(s) on the crt display.

- 25 **SEC/DIV VAR Control**—Continuously varies the sweep speed between settings of either the A or the B SEC/DIV switch. This control affects the A Sweep speed when the A and B SEC/DIV switches are locked together. When any of the delayed-sweep horizontal modes are displayed, the control affects only the B Sweep speed.

Fully counterclockwise rotation extends the sweep speed of the slowest A SEC/DIV switch setting (1 s per division) to 1.5 s per division. Fully clockwise rotation (detent position) produces the sweep speed indicated by the position of the SEC/DIV switches. The crt readout displays the actual time-per-division scale factor for all settings of the VAR control.

This control produces fine resolution over a portion of its range, after which it changes to coarse resolution. It reenters the fine-resolution range upon reversing the direction of rotation.

- 26 **TRACE SEP Control**—Provides for vertical positioning of the B trace downward from the A trace when TURN-ALT Horizontal Display Mode is selected. Counterclockwise rotation moves the B trace downward. At the fully clockwise stop position of the control, there is no separation between the A and B traces. When the PUSH-B Horizontal Display Mode is selected and when either Δt or $1/\Delta t$ measurement mode is active, the TRACE SEP control provides for vertical positioning of the trace or traces associated with the Δ control.

- 27 **Horizontal POSITION Control**—Sets the horizontal position of the sweep displays on the crt. Clockwise rotation of the control positions the display to the right. This control produces fine resolution over a portion of its range, after which it changes to coarse resolution. It reenters the fine-resolution range upon reversing the direction of rotation. The Horizontal POSITION control does not affect the X-Y display position on the crt.

28 X10 MAG Switch—Horizontally magnifies the portion of the sweep display positioned at the center vertical graticule line by a factor of 10 when pressed in. When the A trace and the B trace are displayed alternately (TURN-ALT Horizontal Display Mode selected), only the B trace is magnified. Using X10 magnification extends the fastest sweep speed to 1 ns per division. The push button must be pressed in a second time to release it and regain the X1 sweep-speed magnification.

29 ΔV Switch—Activates the Delta Volts (ΔV) measurement function, when momentarily pressed in alone, and cancels any other Delta measurement function in effect. In the A Sweep mode (A and B SEC/DIV switches locked together), two horizontal cursors are superimposed on the crt display. The crt readout displays the equivalent voltage represented by the separation between the two cursors. The position of one cursor on the display is set by the Δ REF OR DLY POS control and the position of the other is set by the Δ control. With multiple-channel displays, the deflection factor of the first channel selected in the display sequence determines the scale factor of the Delta Volts readout on the crt. The Delta Volts readout is displayed as a percentage ratio if either one of the following conditions exists: (1) the channel determining the scale factor is uncalibrated (VAR control out of detent), or (2) ADD is displayed alone when the Channel 1 and Channel 2 deflection factors are not the same (VOLTS/DIV switches are at different settings or are uncalibrated). Either pressing in the ΔV switch or pulling the B SEC/DIV knob to the out position when the Delta Volts function is active, cancels it. Attempting to activate the Delta Volts function while the A and B SEC/DIV knobs are unlocked causes the message **NO ΔV WITH DELAY** to appear in the top row of the crt readout. If displayed, the error message will be canceled (removed from the display) by any of the following actions: pressing either the ΔV or Δt switch; pushing in the B SEC/DIV if it is out or pulling it out if it is in; or locking the A and B SEC/DIV knobs together (set to the same sweep speed with the B SEC/DIV knob in).

30 Δt Switch—Activates the Delta Time measurement function and cancels any other Delta measurements in effect, when momentarily pressed in alone. When the Delta Time function is active, momentarily pressing in the Δt push button cancels the function.

When the A and B SEC/DIV knobs are locked together (A trace only), two vertical cursors are superimposed on the crt display while the Delta Time function is active. In any of the delay-time Horizontal Display modes (PULL-INTEN, TURN-ALT, or PUSH-B),

two separate delay times are established by the Delta Time function. One cursor position (or delay time) is set by the Δ REF OR DLY POS control, and the other is set by the Δ control. The crt readout displays either the time difference between the two delays or the equivalent time difference between the two vertical cursors.

If the SEC/DIV VAR control is not in the detent position, Δt cursor difference on the A trace only displays is expressed as a ratio, with five divisions corresponding to a 100% ratio. For the delay-time Horizontal Display modes, the SEC/DIV VAR control varies the B-sweep scale factor as it is rotated, but it has no effect on the delay time.

Pressing in the ΔV and Δt push buttons together activates the $1/\Delta t$ measurement function and cancels any other Delta measurement functions in effect. The crt waveform display and operation of both the Δ REF OR DLY POS and Δ controls remain the same as explained for Δt operation. However, with $1/\Delta t$ selected, the crt readout shows the reciprocal of the time-difference measurement, with units being frequency (Hz, kHz, MHz, or GHz).

For A trace only displays, with the SEC/DIV VAR control out of the detent (fully clockwise) position, the time difference between $1/\Delta t$ cursors is displayed in degrees of phase, with five divisions equal to 360 degrees. As with Δt measurements, the position of the SEC/DIV VAR control has no effect on delay-time displays except to change the B Sweep scale factor, and the readout remains in units of frequency.

When the $1/\Delta t$ function is active, pressing both the ΔV and the Δt push buttons together cancels the function and exits the Delta measurement mode. Pressing either ΔV or Δt alone cancels the $1/\Delta t$ function and activates the function associated with the button pressed.

31 Δ REF OR DLY POS Control—Sets the reference B Sweep delay time or positions the Reference cursor when ΔV , Δt , or $1/\Delta t$ Measurement Mode is active. When any delay-time Horizontal Display Mode (PULL-INTEN, TURN-ALT, or PUSH-B) is selected, the reference B Sweep delay time is determined by the rotation of the Δ REF OR DLY POS control in conjunction with the A SEC/DIV switch setting.

This control produces fine resolution over a portion of its range, after which it changes to coarse resolution. It reenters the fine-resolution range upon reversing the direction of rotation.

- 32 **Δ Control**—Sets the alternate B Sweep delay time or positions the Delta-time cursor (vertical line) when either the Δt or $1/\Delta t$ Measurement Mode is active. When the ΔV Measurement Mode is active (A Sweep Horizontal Display Mode only), the control positions one of the two horizontal voltage cursors that appear on the crt display.

This control produces fine resolution over a portion of its range, after which it changes to coarse resolution. It reenters the fine-resolution range upon reversing the direction of rotation.

- 33 **TRACKING-OUT:INDEP Switch**—Selects either the TRACKING or INDEP (independent) mode for the Δ REF OR DLY POS control. When in the TRACKING mode (push button latched in), the difference between alternate delay times or cursors (in either time or volts Measurement Mode) does not change with rotation of the Δ REF OR DLY POS control. When the Δ REF OR DLY POS control is rotated, the positions of both delays or of both cursors move equally until the limit of either is reached.

If OUT:INDEP is selected (push button released), the cursors (or delay positions) are independently movable using the Δ REF OR DLY POS and Δ controls. In either mode (TRACKING or INDEP) the Delta cursor remains independently movable using the Δ control.

TRIGGER

Refer to Figure 3-5 for items 34 through 42.

- 34 **MODE Switch and Indicators**—Selects the trigger mode of either the A Sweep or the B Sweep. A single push of the switch steps the MODE selection once; holding the switch up or down causes the MODE selection to step repeatedly. Indicators show the selected trigger mode of either the A Sweep or the B Sweep according to the selected Horizontal Display Mode and as directed by the A/B TRIG switch.

A Trigger Modes:

AUTO LVL—Automatically establishes the trigger level on a triggering signal and free runs the sweep in the absence of a triggering signal. The LEVEL control covers a range between the positive and negative peaks of repetitive triggering signals. If the triggering signal amplitude changes, the trigger level does not change unless a trigger is no longer produced at the established level. The signal

peak-reference levels and the trigger level are redefined whenever triggering ceases, whenever the LEVEL control is turned to either extreme, or when the MODE switch is pushed up. If the LEVEL control is set near either end position, the trigger level set by AUTO LVL will be near the corresponding signal peak. If the LEVEL control is set in the midrange between either end, the trigger level set by AUTO LVL will be near the midpoint of the trigger signal amplitude. The established trigger level remains in effect when switching to AUTO or NORM Trigger MODE unless the LEVEL control is moved.

If VERT TRIGGER SOURCE is selected, the lowest-numbered displayed channel (or the algebraic sum of Channel 1 and Channel 2 if ADD vertical display is selected) becomes the trigger-signal source. If Trigger MODE is changed from AUTO LVL to AUTO while more than one channel is displayed, the single-channel trigger source is retained, and the VERT SOURCE indicator is turned off. To regain the VERT TRIGGER SOURCE, press up momentarily on the SOURCE switch.

AUTO—Sweep free runs in the absence of a triggering signal. The triggering level changes only when the LEVEL control is adjusted to a new position.

NORM—Sweep is triggered and runs when a triggering signal compatible with the LEVEL setting is applied. Sweep free runs either when the input coupling of the selected trigger SOURCE is

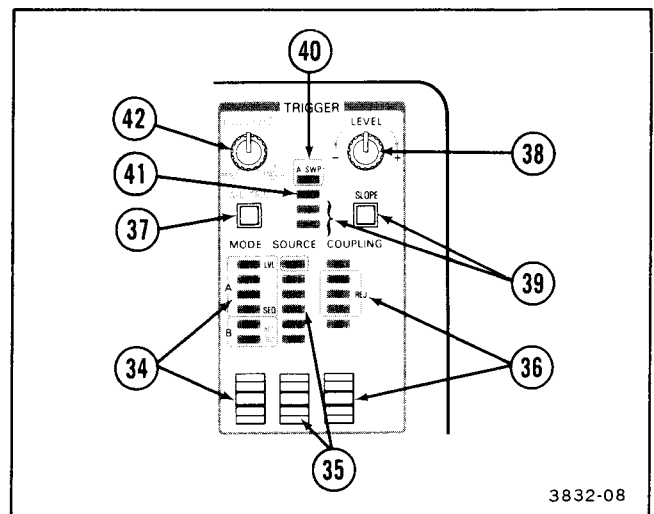

Figure 3-5. Trigger controls and indicators.

Controls, Connectors, and Indicators—2445 Operators

set to GND or when the input coupling of both Channel 1 and Channel 2 is set to GND, with ADD VERTICAL MODE and VERT TRIGGER SOURCE selected.

SGL SEQ—When armed by pushing the MODE switch down momentarily, the sweep runs one or more times to produce a single sweep of each of the traces defined by the following controls: VERTICAL MODE, A and B SEC/DIV, and Δt . Each sweep requires a distinct A Sweep triggering event. The READY indicator remains illuminated until the final trace in the sequence is completed. At the end of the sequence the crt readout is written once to present scale factors and other readout data, and scale illumination flashes on momentarily for oscilloscope photography purposes.

B Trigger Modes:

RUN AFT DLY—The B Sweep runs immediately after the established delay time has elapsed. Delay time is set by the A SEC/DIV switch and the Δ POS OR DLY REF control when no Delta Time measurements are selected (neither Δt nor $1/\Delta t$).

When either Δt or $1/\Delta t$ measurements are made, two delay times are established: one by the Δ REF OR DLY POS control and the other by the Δ control.

TRIG AFT DLY—The B Sweep runs when triggered by a triggering signal after the established delay time has elapsed, provided the A Sweep has not terminated. Since the B Sweep runs at the time the triggering signal occurs, the display is stable, even with jittering signals; but the actual delay time is greater than the delay-time setting. Therefore, the crt readout shows a question mark in this mode.

35 **SOURCE Switch and Indicators**—Selects the trigger signal source for either the A or the B Sweep. Indicators show the selection made. A single push of the switch steps the SOURCE selection once; holding the switch up or down causes the SOURCE selection to step repeatedly. Indicators do not illuminate for B triggering signals when RUN AFT DLY is selected.

VERT—The sweep triggers on the displayed channel when only one channel is selected. If multiple vertical displays are selected, both the Trigger MODE in use and position of the CHOP/ALT button affect the trigger-source selection.

When ALT VERTICAL MODE is selected, each displayed channel in turn provides the triggering signal, and the respective LED indicator for each displayed channel is illuminated, except in the case of AUTO LVL MODE triggering. For AUTO LVL triggering or CHOP VERTICAL MODE, the lowest numbered channel, or ADD if it is displayed, is the triggering-signal source. The LED indicator for the lowest numbered channel displayed is illuminated, except if ADD is selected. Then, the CH 1, CH 2, and VERT indicators are illuminated.

CH 1, CH 2, CH 3, or CH 4—A triggering signal is obtained from the corresponding vertical channel.

LINE (A Trigger Only)—A triggering signal is obtained from a sample of the ac power-source waveform. This trigger source is useful when vertical input signals are time related (multiple or submultiple) to the frequency of the ac power-source voltage.

36 **COUPLING Switch and Indicators**—Selects the method of coupling the triggering signal to the A and the B trigger generator circuitry. A single push of the switch steps the COUPLING selection once; holding the switch up or down causes the COUPLING selection to step repeatedly. Indicators show the coupling method selected for either the A triggering signals (when an A TRIGGER MODE is in effect) or the B triggering signals when TRIG AFT DLY is selected for the B TRIGGER MODE. Indicators do not illuminate for B triggering signals when RUN AFT DLY is selected.

DC—All frequency components of the signal are coupled to the trigger-generator circuitry. This coupling method is useful for triggering on most signals.

NOISE REJ—All frequency components of the input signal are coupled to the trigger-generator circuitry, but the peak-to-peak signal amplitude required to produce a trigger event is increased. This coupling method is useful for improving trigger stability on signals accompanied by low-level noise.

HF REJ—Attenuates high-frequency triggering-signal components above 50 kHz. This coupling method is useful for eliminating radio-frequency interference and high-frequency noise components from the signal applied to the trigger-generator

circuitry; it allows stable triggering on the low-frequency components of a complex waveform.

LF REJ—Signals are capacitively coupled, and the dc component of the triggering signal is blocked. Attenuates the low-frequency signal components below 50 kHz. This coupling method is useful for producing stable triggering on the high-frequency components of a complex waveform. Low-frequency components such as power-supply hum are removed from the signal applied to the trigger-generator circuitry.

AC—Signals are capacitively coupled. Frequency components below 60 Hz are attenuated, and the dc component of the input signal is blocked. This coupling method is useful for signals that are superimposed on slowly changing dc voltages. This method will work for most signals when trigger-level readout is not desired.

- 37 **A/B TRIG Switch**—Directs the MODE, SOURCE, COUPLING, SLOPE, and LEVEL controls to either the A Trigger or the B Trigger, under the allowed switching conditions. Controls are normally directed to the A Trigger when the A and B SEC/DIV knobs are locked together (A Sweep display only). Controls are normally directed to the B Trigger when the B TRIGGER MODE is set to TRIG AFT DLY and the A and B SEC/DIV knobs are unlocked (PULL-INTEN, TURN-ALT, or PUSH-B Horizontal Display Mode). Pressing and holding in the A/B TRIG switch will direct the trigger controls away from their normal trigger direction, but releasing the A/B TRIG switch will redirect the trigger controls back to the original triggers.

If the A and B SEC/DIV knobs are unlocked and either the B TRIGGER MODE is set to RUN AFT DLY or the A TRIGGER MODE is set to SGL SEQ, the A/B TRIG switch will direct the trigger controls to the opposite trigger each time it is momentarily pressed and released.

Locking the A and B SEC/DIV knobs together will switch the trigger controls to the A Trigger if they are currently directed to the B Trigger. Pulling the B SEC/DIV knob to the out position will cause the trigger controls to revert to the B Trigger if the B TRIGGER MODE is set to TRIG AFT DLY. However, if the B TRIGGER MODE is set to RUN AFT DLY when the B SEC/DIV knob is unlocked from the A SEC/DIV knob, the trigger controls remain directed to the A Trigger until the B Trigger is reselected by the A/B TRIG switch.

- 38 **LEVEL Control**—Sets the amplitude point on the triggering signal at which either A or B Sweep triggering occurs. This control produces fine resolution for a portion of its range, after which it changes to coarse resolution. It reenters the fine-resolution range upon reversing the direction of rotation.

When the A TRIGGER MODE is set to AUTO LVL, the effect of the LEVEL control is spread over the A Sweep triggering-signal amplitude from peak to peak. In this case, rotating the control to either extreme causes the triggering level to be redefined by the AUTO LVL circuitry.

- 39 **SLOPE Switch and Indicators**—Selects the slope of the signal that triggers either the A Sweep or the B Sweep. Indicators illuminate to show slope selection made for the A Sweep and for TRIG AFT DLY B Sweeps. The + and – indicators do not illuminate for B triggering when RUN AFT DLY is selected.

- 40 **A SWP TRIG'D Indicator**—Illuminates to indicate that the A Sweep is triggered. It extinguishes after a nominal length of time when a triggering signal is not received following completion of the sweep.

- 41 **READY Indicator**—Illuminates when SGL SEQ MODE is selected and the A Sweep is armed and waiting for a triggering event to occur. It extinguishes following the completion of all the traces selected for the SGL SEQ display.

- 42 **HOLDOFF Control**—Varies the amount of holdoff time between the end of the sweep and the time a triggering signal can initiate the next sweep. The ability to obtain stable triggering on some aperiodic signals is improved using this control. In the B ENDS A position (fully clockwise) trigger holdoff time is reduced to minimum, and the A Sweep terminates immediately at the end of the B Sweep. This enables the fastest possible sweep-repetition rate at slow A Sweep speeds.

REAR PANEL

Refer to Figure 3-6 for location of items 43 through 49.

- 43 **A GATE OUT and B GATE OUT Connectors**—Provide TTL-compatible, positive-going gate signals that are HI during their respective sweeps and LO while the sweep is not running.

Controls, Connectors, and Indicators—2445 Operators

- ④④ **CH 2 SIGNAL OUT Connector**—Provides an output signal that is a normalized representation of the Channel 2 input signal. The output amplitude into a 1-M Ω load is approximately 20 mV per division of input signal. Into a 50- Ω load, the output amplitude is approximately 10 mV per division of input signal.
- ④⑤ **EXT Z-AXIS IN Connector**—Provides an input connection point to apply external Z-axis modulation signals to the Z-Axis Amplifier. Either the sweep or the X-Y display may be intensity modulated. Positive-going signals decrease the intensity. From dc to 2 MHz, an input-signal amplitude of +2 V will blank a maximum-intensity trace; from 2 MHz to 20 MHz, an input-signal amplitude of +2 V will produce noticeable modulation on a normal-intensity trace.
- ④⑥ **Fuse Holder**—Contains the ac power-source fuse.
- ④⑦ **Detachable Power Cord Receptacle**—Provides the connection point for the ac power source to the instrument.
- ④⑧ **LINE VOLTAGE SELECTOR Switch**—Selects the nominal instrument operating voltage range. When set to 115V, the instrument operates from a power-source voltage having a range of 90 V to 132 V ac. Set to 230V, the instrument operates on an input-voltage range of 180 V to 250 V ac.
- ④⑨ **Mod Slots**—Contain the identification numbers of any installed instrument modifications.

Modulating signals with fast rise and fall times produce the most abrupt intensity changes. External Z-axis signals must be time related to the displayed signal frequency to obtain a stable intensity-modulation pattern on the crt.

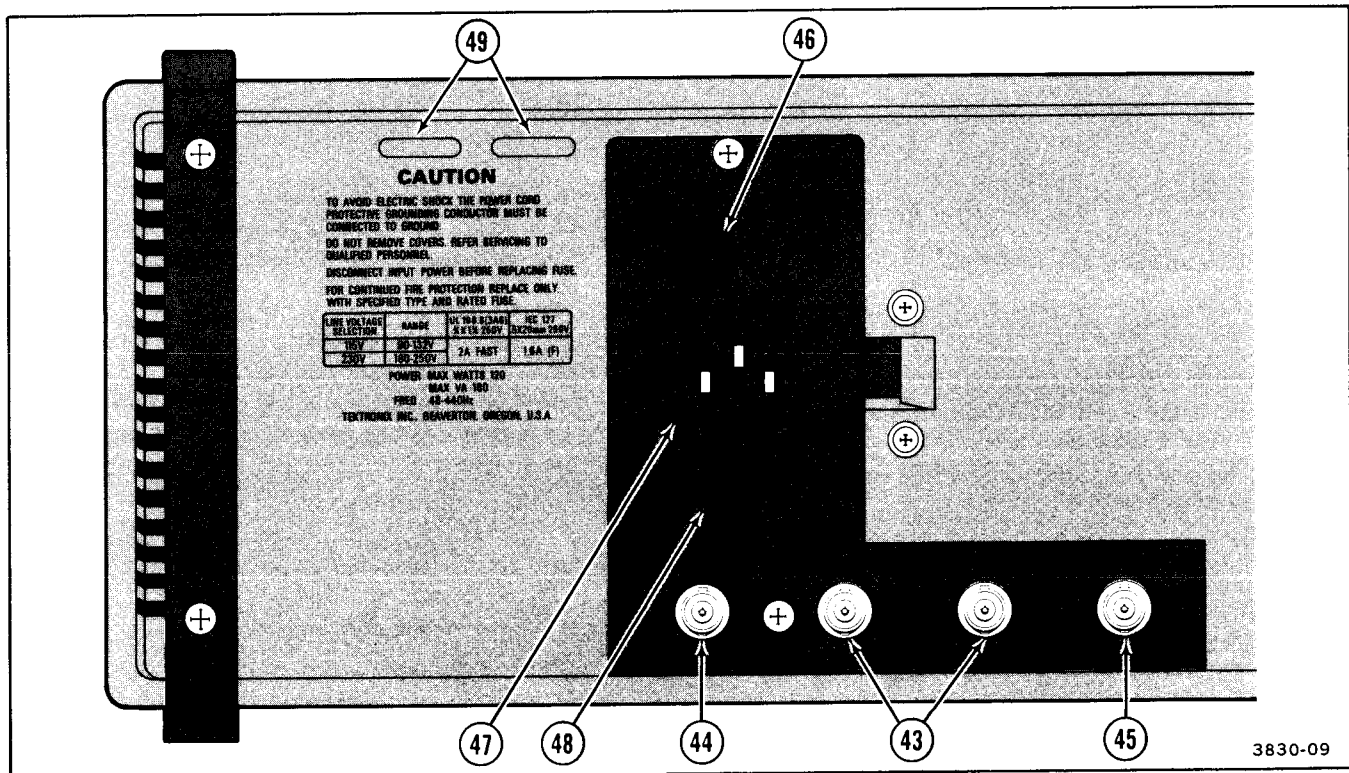

Figure 3-6. Rear-panel controls and connectors.

READOUT DISPLAY

The Readout System provides an alphanumeric display of information on the crt along with the analog waveform display. The readout is displayed in two rows of 32 characters each. One row is within the top graticule division, and the other row is within the bottom graticule division. The locations and types of information displayed under normal operating modes are illustrated in Figure 3-7.

NOTE

Other information is displayed when the instrument is in a diagnostic mode or has experienced a fault. If the normally blank spaces of the bottom row of the display are filled with dots, refer the instrument to a qualified service person for recalibration.

Each of the scale-factor displays appears when the respective vertical channel or sweep is displayed. When X-Y mode is selected, the Channel 1 scale factor is displayed, and CH 1 X appears in place of the A Sweep scale factor.

Special characters or abbreviations are displayed to indicate GND or AC coupling of Channel 1 or Channel 2 signals, ADD, CH 2 INVERT, Vertical bandwidth limited, or HOLDOFF not set to minimum.

The Trigger-Level readout shows the signal voltage (at the probe tip of encoded probes) that will initiate the sweep. The readout appears only if the following conditions exist: a single vertical channel is selected as the trigger source, the vertical input coupling is not AC, the VOLTS/DIV VAR control of the source channel is in the calibrated detent, and trigger coupling is either DC or NOISE REJ.

A question mark may appear in a DLY (delay time), a Δt (delta time), or a $1/\Delta t$ readout when the SEC/DIV knobs are unlocked (not with cursors). This indicates that either the delay time (or one of the two delay times) is set at less than 0.5% of the maximum delay or the B TRIGGER MODE is set to TRIG AFT DLY. A question mark will also appear in a $1/\Delta t$ display readout when the difference between the two delays (or the distance between the two cursors displayed when the A and B SEC/DIV knobs are locked together) is less than 1% of full scale.

The 50 Ω OVERLOAD display appears if excessive signal is applied to either the CH 1 or the CH 2 input connector while 50 Ω DC input coupling is selected. The readout will return to the normal display when the input coupling of the overloaded channel is switched.

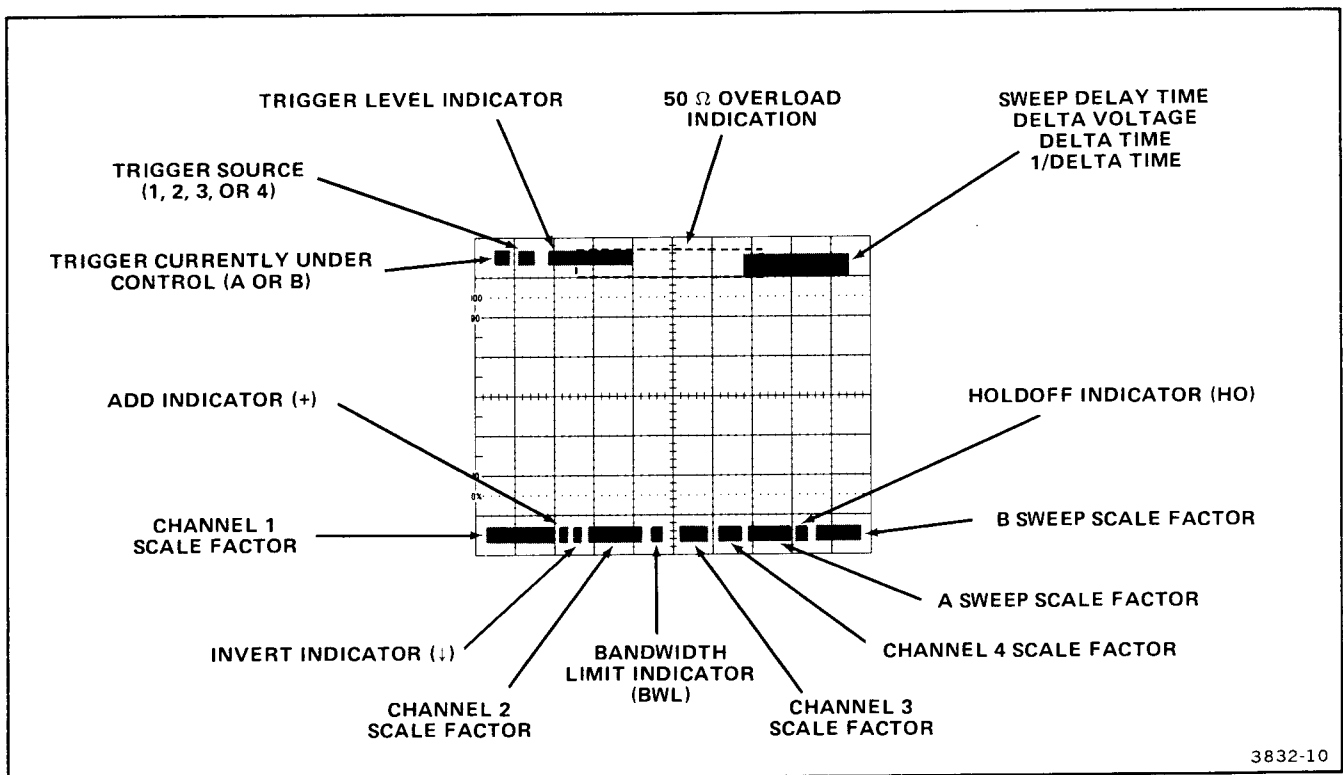

Figure 3-7. Readout display locations.

OPERATING CONSIDERATIONS

This section contains basic operating information and techniques that should be considered before attempting to make any measurements with your instrument.

GRATICULE

The graticule is internally marked on the faceplate of the crt to eliminate parallax-viewing error and to enable accurate measurements (see Figure 4-1). It is marked with eight vertical and ten horizontal major divisions. In addition, each major division is divided into five subdivisions. The vertical deflection factors and horizontal timing are calibrated to the graticule so that accurate measurements can be made directly from the crt. Also, percentage marks for the measurement of rise and fall times are located on the left side of the graticule.

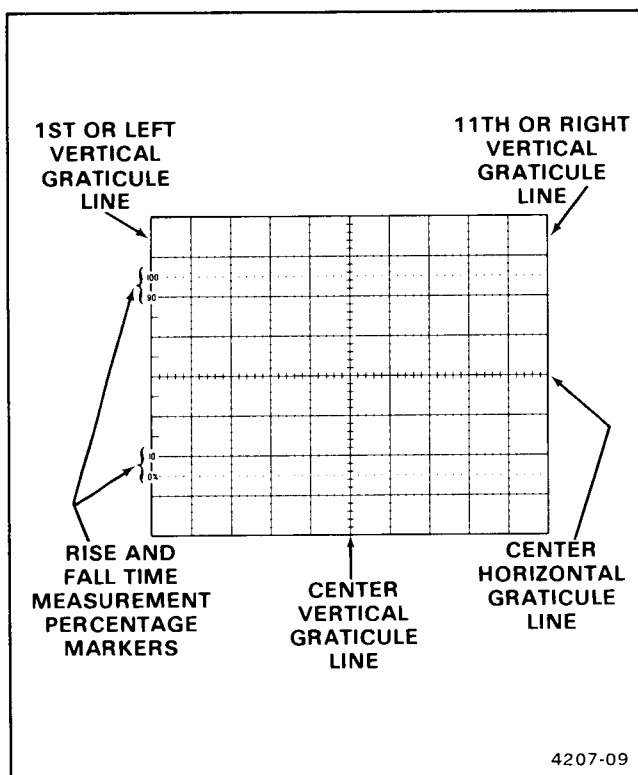

Figure 4-1. Graticule measurement markings.

TIME AND VOLTAGE MEASUREMENTS

The 2445 provides three basic ways to make time measurements and two basic ways to make voltage measurements. These methods require varying degrees of time and care and can result in varying degrees of accuracy.

Using graticule markings for determining voltage or time values produces the least accurate measurement values. This method should be used only for measuring very-low-repetition-rate signals or for single-shot measurements which require a photograph for viewing.

The Δt and ΔV cursors provide for better accuracy and easier operation than using the graticule, and they should be used in most measurement situations. Use of the cursors avoids vertical- and horizontal-gain errors and crt-linearity errors. Cursors also eliminate the inconvenience of counting and interpolating graticule markings.

The Delayed Sweep mode provides the highest accuracy for making time measurements. This method avoids errors introduced either by visual-resolution limits or by slight mismatches between the sweep and the cursors.

More details relating to various measurement techniques are contained in Section 6, "Basic Applications."

GROUNDING

The most reliable signal measurements are made when the 2445 and the unit under test are connected by a common reference (ground lead) in addition to the signal lead or probe. The probe's ground lead provides the best grounding method for signal interconnection and ensures the maximum amount of signal-lead shielding in the probe cable. A separate ground lead can also be connected from the unit under test to the oscilloscope ground receptacle on the front panel.

SIGNAL CONNECTIONS

Probes

Generally, probes offer the most convenient means of connecting an input signal to the instrument. Shielded to prevent pickup of electromagnetic interference, the standard 10X probes supplied with this instrument offer a high input impedance that minimizes circuit loading. This allows the circuit under test to operate with a minimum of change from the normal, unloaded condition. Also, the subminiature body of these probes has been designed for ease of use either when probing circuitry containing close lead spacing or when probing in a confined space.

Both the probe itself and the probe accessories should be handled carefully at all times to prevent damage. Avoid dropping the probe body. Striking a hard surface can cause damage to both the probe body and the probe tip. Exercise care to prevent the cable from being crushed or kinked. Do not place excessive strain on the cable by pulling.

The standard-accessory probe is a compensated 10X voltage divider. It is a resistive voltage divider for low frequencies and a capacitive voltage divider for high-frequency signal components. Inductance introduced by either a long signal or ground lead forms a series-resonant circuit. This circuit will affect system bandwidth and will ring if driven by a signal containing significant frequency components at or near the circuit's resonant frequency. Oscillations (ringing) can then appear on the oscilloscope display and distort the true signal waveform. Always keep both the ground lead and the probe signal-input connections as short as possible to maintain the best waveform fidelity.

Misadjustment of probe compensation is a common source of measurement error. Due to variations in oscilloscope input characteristics, probe compensation should be checked and adjusted, if necessary, whenever the probe is moved from one oscilloscope to another or between channels of a multichannel oscilloscope. See the procedure in Section 5, "Operators's Checks and Adjustments," or consult the probe instruction manual.

Coaxial Cables

Cables may also be used to connect signals to the input connectors, but they may have considerable effect on the accuracy of a displayed waveform. To maintain the original

frequency characteristics of an applied signal, only high-quality, low-loss coaxial cables should be used. Coaxial cables should be terminated at both ends in their characteristic impedance. If this is not possible, use suitable impedance-matching devices.

INPUT-COUPLING CAPACITOR PRECHARGING

When the input coupling switch is set to GND, the input signal is connected to ground through the input-coupling capacitor in series with a 1-M Ω resistor to form a precharging network. This network allows the input-coupling capacitor to charge to the average dc voltage level of the signal applied to the probe. Thus, any large voltage transients that may accidentally be generated will not be applied to the amplifier input when input coupling is switched from GND to AC. The precharging network also provides a measure of protection to the external circuitry by reducing the current levels that can be drawn from the external circuitry during capacitor charging.

EXTERNAL TRIGGERING

Both the A and the B trigger signals may be independently obtained from any of the four vertical input channels. When viewing signals that require a trigger source different from one of the displayed vertical signals (traditionally referred to as "external triggering"), any free vertical channel may be used to input a trigger signal. The signal can be viewed on the crt to aid in setting the trigger circuit controls by selecting that respective channel for the vertical display (replaces the usual "trigger view" feature). After establishing the correct triggering, the trigger signal display can then be removed from the vertical signal display or allowed to remain, at the operator's discretion.

Channel 1 and Channel 2 can condition a wide range of signals to produce triggers—over the full vertical deflection range of the channel from millivolts to hundreds of volts in amplitude. Channel 3 and Channel 4 inputs have a much more limited choice of vertical deflection ranges available (0.1 volt and 0.5 volt per division without external attenuation) and are more useful for digital signal amplitudes. However, signals much larger can be processed, provided they do not exceed the maximum-rated signal amplitude for the input.

OPERATOR'S CHECKS AND ADJUSTMENTS

INTRODUCTION

To verify the operation and accuracy of your instrument before making measurements, perform the following check and adjustment procedures. If adjustments are required beyond the scope of these operator's checks and adjustments, refer the instrument to a qualified service technician.

Before proceeding with these instructions, refer to "Preparation for Use" (Section 2).

Verify that the POWER switch is OFF (push button out), then plug the power cord into the power outlet.

If indications specified in these procedures cannot be obtained, refer the instrument to a qualified service technician.

INITIAL SETUP

1. Press in the POWER switch button (ON) and allow the instrument to warm up (20 minutes is recommended for maximum accuracy).

2. Set instrument controls to obtain a baseline trace:

Display

READOUT INTENSITY	Midrange between "MIN" and fully clockwise
FOCUS	Midrange

Vertical

POSITION	Midrange
MODE	CH 1
BW LIMIT	Off (button out)
CH 1 VOLTS/DIV	10 mV
CH 1 Input Coupling	1 M Ω GND

Horizontal

A AND B SEC/DIV	Locked together at 1 ms
SEC/DIV VAR	Calibrated detent
POSITION	Midrange
10X MAG	Off (button out)

Trigger

HOLDOFF	Fully counterclockwise
LEVEL	Midrange
MODE	AUTO LVL
SOURCE	VERT
COUPLING	DC
SLOPE	+

3. Adjust the INTENSITY and READOUT INTENSITY controls for desired display and readout brightness and best trace definition.

4. Adjust the Vertical and Horizontal POSITION controls to position the trace within the graticule area.

TRACE ROTATION ADJUSTMENT

1. Preset instrument controls and obtain a baseline trace as described in "Initial Setup."

2. Use the Channel 1 POSITION control to move the baseline trace to the center horizontal graticule line.

NOTE

Normally, the resulting trace will be parallel to the center horizontal graticule line, and the Trace Rotation adjustment should not be required.

3. If the trace is not parallel to the center horizontal graticule line, use a small-bladed screwdriver to adjust the TRACE ROTATION control (see Figure 3-1) and align the trace with the center horizontal graticule line.

ASTIGMATISM ADJUSTMENT

1. Preset instrument controls and obtain a baseline trace as described in "Initial Setup." Set 20 MHz BW LIMIT On (in)
2. Connect a 10X probe to the CH 1 OR X input connector and connect the probe tip to the CALIBRATOR output.
3. Adjust the Channel 1 POSITION control to center the display on the screen.
4. Set A and B SEC/DIV controls at 1 μ s.
5. Slowly adjust the FOCUS control to its optimum setting (best-defined display).

NOTE

If the ASTIG adjustment is correctly set already, all portions of the trace will come into sharpest focus at the same position of the FOCUS control.

6. If focusing is not uniform over the entire graticule area, use a small-bladed screwdriver to adjust the ASTIG control (see Figure 3-1).
7. Since the ASTIG and FOCUS adjustments interact, repeat steps 5 and 6 until the best-defined display over the entire graticule area is obtained.

NOTE

Once it is set, the ASTIG adjustment should be correct for any display. However, it may be necessary to reset the FOCUS control slightly when the INTENSITY control setting is changed.

AUTO DC BALANCE ADJUSTMENT

The 2445 can automatically perform a dc-balance adjustment of Channel 1 and Channel 2. This adjustment assures that the trace shifts associated with attenuator stepping, changing the variable volts per division setting, and switching Channel 2 between noninverted and inverted

operation are within nominal limits. The dc balance attained by the Auto DC Balance adjustment remains valid as long as the instrument is operating within 5°C of the ambient temperature at which the adjustment was performed provided a 20-minute warm-up period is allowed before performing the adjustment. To initiate the adjustment, set both the Channel 1 and Channel 2 input coupling switches to AC. Then simultaneously push up on both switches. An alternate method of entering the auto-adjustment mode is possible with only one of the input coupling switches set to AC. Press up and hold the input coupling switch that is not set to AC, then press up the other input coupling switch. With either method, the instrument will enter an auto-adjustment mode for about ten seconds. When the Auto DC Balance adjustment cycle is complete, the instrument will return to the normal operating mode.

NOTE

If a circuit defect prevents accurate dc balance, the routine halts and LIMIT is displayed. Push the Trigger COUPLING switch up to continue balancing the remainder of the circuitry.

If power to the instrument is interrupted before the balancing cycle is completed, an error will be detected by the next power-on self test. Press A/B TRIG to exit the diagnostic monitor and restart the Auto DC Balance adjustment to allow the cycle to be completed.

PROBE LOW-FREQUENCY COMPENSATION

Misadjustment of probe compensation is one of the sources of measurement error. The attenuator probes are equipped with compensation adjustments. To ensure optimum measurement accuracy, always check probe compensation before making measurements. Probe low-frequency compensation is accomplished as follows:

1. Preset instrument controls and obtain a baseline trace as described in "Initial Setup." Set 20 MHz BW LIMIT On (in).
2. Connect the two 10X probes (supplied with the instrument) to the CH 1 OR X and the CH 2 input connectors. Observe that the CHANNEL 1 SCALE FACTOR on the readout display changes from 10 mV to 100 mV when the 10X probe is attached.

MATCHING CHANNEL 2 DELAY

3. Connect the Channel 1 probe (using the probe hook tip) to the oscilloscope CALIBRATOR output.

4. Set triggering controls for a stable display. The display should be five cycles of the CALIBRATOR square-wave signal, with an amplitude of four divisions. Center the display on the screen.

5. Check the waveform for overshoot and rolloff (see Figure 5-1). If necessary, use a small-bladed screwdriver to adjust the probe low-frequency compensation for a square front corner on the waveform.

6. Release the CH 1 VERTICAL MODE switch, select CH 2 VERTICAL MODE, and connect the Channel 2 probe input to the CALIBRATOR output. Observe that the CH 2 SCALE FACTOR on the readout display indicates 100 mV with the 10X probe attached.

7. Use the Channel 2 POSITION control to vertically center the display and repeat step 5 for the Channel 2 probe.

NOTE

Refer to the instruction manual supplied with the probe for more complete information about low-frequency and high-frequency compensation of the probes.

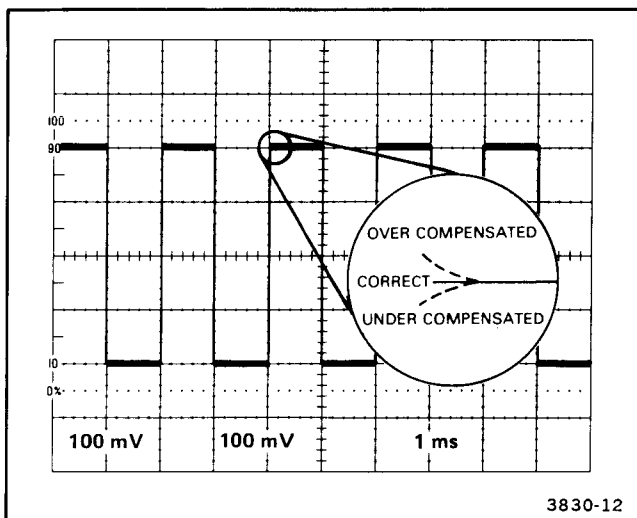

Figure 5-1. Probe low-frequency compensation.

The apparent signal delay in Channel 2 may be adjusted up to ± 500 ps to match the apparent delay present in any of the other three channels. This adjustment is most commonly used to eliminate delay differences between Channel 1 and Channel 2 that may be introduced by the probes and has no effect on common-mode rejection when ADD VERTICAL MODE is selected. Matching Channel 1 and Channel 2 delay is accomplished as follows:

1. Preset the instrument controls and obtain a baseline trace as described in "Initial Setup."

2. Connect the two 10X probes (supplied with the instrument) to the CH 1 OR X and CH 2 input connectors.

3. Check and adjust, if necessary, the probes' low-frequency compensation. Refer to "Probe Low-Frequency Compensation" in this section.

4. Connect both probes via hook tips to a pulse generator fast-rise output.

5. Press in both the CH 1 and CH 2 VERTICAL MODE switches.

6. Set oscilloscope triggering controls for a stable display.

7. Set the A AND B SEC/DIV switches to 10 ns.

8. Adjust the Channel 1 and Channel 2 POSITION controls to vertically overlay the two displayed signals.

9. Pull out the B SEC/DIV switch and observe the message **CH 2 DELAY – TURN Δ** in the upper right-hand corner of the screen.

NOTE

*The 2445 can be set to preclude operator adjustment of Channel 2 delay. If the delay-offset feature is disabled, the message **CH 2 DLY DISABLED** appears in the top row of the readout when attempting to activate the feature. Refer the instrument to a qualified service technician if adjustment of the delay matching is required.*

Operator's Checks and Adjustments—2445 Operators

10. Set X10 MAG ON (button in) and adjust the Δ control until the two signals are overlaid horizontally.

NOTE

The Δ REF OR DLY POS control may also be used to make the Channel 2 delay-offset adjustment when the feature is enabled.

11. Push in the B SEC/DIV switch.

AMPLITUDE CHECK

1. Preset instrument controls and obtain a baseline trace as described in "Initial Setup."

2. Connect a 10X probe to the CH 1 OR X input connector and connect the probe tip to the CALIBRATOR output.

3. Adjust the Channel 1 POSITION control to center the display on the screen.

4. Adjust triggering controls to obtain a stable display.

5. CHECK—Amplitude of the CALIBRATOR signal is between 3.88 and 4.12 divisions as measured on the center vertical graticule line.

6. Repeat this procedure using the Channel 2 connector and controls.

TIMING CHECK

The CALIBRATOR signal on the 2445 automatically changes repetition rate with the setting of the A SEC/DIV switch within the range of 100 ms to 100 ns. This feature allows the operator to make a quick and easy check of the basic operation and adjustment of the oscilloscope timing. Use the following procedure:

1. Preset instrument controls and obtain a baseline trace as described in "Initial Setup."

2. Connect a 10X probe to the CH 1 OR X input connector and connect the probe tip to the CALIBRATOR output.

3. Adjust the Channel 1 POSITION control to center the display on the screen.

4. Adjust triggering controls to obtain a stable display.

5. CHECK—Timing accuracy by confirming that five complete cycles of the square-wave signal are displayed over 10 major divisions (± 0.1 division) along the center horizontal graticule line for all A SEC/DIV settings from 100 ms to 100 ns. Confirm that the number of cycles displayed in 10 divisions goes to 2 1/2 and 1 for respective A SEC/DIV settings of 50 ns and 20 ns and that the displayed transition time of the signal remains approximately the same when the A SEC/DIV switch is changed to 10 ns. (The horizontal divisions in which the transition time of the signal at 10 ns per division is displayed should be two times the horizontal divisions occupied by the transition at 20 ns per division.) Return the A SEC/DIV switch to 1 ms and confirm that the display changes to 1/2 cycle over 10 divisions when the X10 MAG switch is pressed in.

BASIC APPLICATIONS

The TEKTRONIX 2445 Oscilloscope provides an accurate and flexible measurement system. After becoming familiar with the controls, indicators, operating considerations, and capabilities of the instrument, an operator can easily develop his own convenient methods for making particular measurements. The information in this section is designed to enhance operator understanding and to assist in developing efficient techniques for making your specific measurements. Recommended methods for making the basic types of measurements with the 2445 are described in the procedures contained in this section.

When a procedure first calls for presetting instrument controls and obtaining a baseline trace, refer to "Initial Setup" in Section 5, "Operator's Checks and Adjustments."

INDEX OF PROCEDURES

Voltage Measurement	6-1
Voltage Ratio	6-2
Algebraic Addition and Eliminating Common-mode Signals	6-3
Time Interval	6-4
Frequency	6-4
Time Difference Between Two Time-related Pulses . . .	6-5
Time Ratio	6-5
Phase Difference Between Two Time-related Signals. . .	6-6
Small-angle Phase Difference	6-6
Delayed-sweep Operation	6-7

VOLTAGE MEASUREMENT

The 2445 has a built-in Delta Volts function that reduces voltage measurement to a simple process. The following procedure may be used to make voltage measurements between any two points on a waveform (e.g., ac peak-to-peak voltages, instantaneous voltage levels, and pulse heights).

1. Preset instrument controls and obtain a baseline trace.
2. Apply the signal to either the CH 1 OR X or the CH 2 input connector and select the VERTICAL MODE switch to display the channel used.
3. Set the appropriate VOLTS/DIV switch to display between three and eight divisions of the waveform, ensuring

that the VOLTS/DIV VAR control is in the calibrated detent.

4. Adjust the A TRIGGER LEVEL control to obtain a stable display.

5. Set the A SEC/DIV switch to a position that displays a few cycles of the waveform.

6. Activate the Delta Volts measurement function by momentarily pressing in the ΔV button. Observe that two horizontal cursors and a ΔV readout appear on the screen.

The Reference cursor can be positioned by the Δ REF OR DLY POS control, and the Delta cursor can be positioned by the Δ control. Voltage difference between the two cursors is displayed by the readout located in the upper right-hand corner of the screen. Changing the VOLTS/DIV switch position automatically changes the readout scale. This scale also automatically compensates for the attenuation factor of attenuator probes equipped with readout encoding.

7. Position the two cursors on the desired points of the waveform (see Figure 6-1).

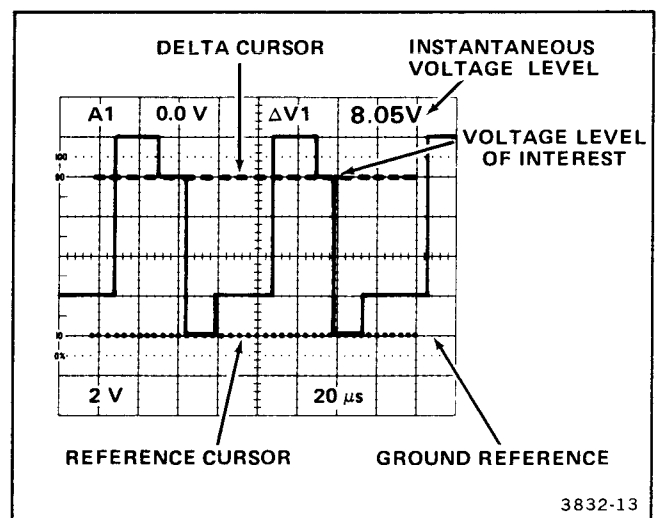

Figure 6-1. Instantaneous dc levels.

Basic Applications—2445 Operators

To measure peak-to-peak voltage, align the Reference cursor with the bottom of the waveform and align the Delta cursor with the top of the waveform.

To measure instantaneous voltage levels, align the Reference cursor with ground reference, obtained by momentarily switching the Input Coupling switch to GND.

8. Read the voltage difference between the two cursors from the crt readout. A negative number indicates the Delta cursor is below the Reference cursor.

NOTE

In certain situations, such as comparing a test-signal amplitude to a reference amplitude, it may be more convenient to position the cursors in the Tracking mode. To activate Tracking mode, push in the TRACKING button. In this mode, the Δ REF OR DLY POS control will move both cursors equally at the same time. The Δ control will continue to move the Delta cursor independently.

VOLTAGE RATIO

The Delta Volts function also may be used to measure and compute the ratio, in terms of percent, between two different signal voltages (e.g., a test voltage and a reference voltage). These test and reference voltages may be either part of the same waveform or parts of totally separate signals. To measure a voltage ratio in the general-case situation of two separate signals, use the following procedure:

1. Preset instrument controls and obtain a baseline trace.

2. Apply the reference signal to either the CH 1 OR X or the CH 2 input connector and select the VERTICAL MODE switch to display the channel used.

3. Set the appropriate VOLTS/DIV switch to display more than five divisions of the waveform.

4. Adjust the A TRIGGER LEVEL control to obtain a stable display.

5. Adjust the appropriate VOLTS/DIV VAR control so that the reference portion of the waveform is exactly five divisions.

NOTE

The VOLTS/DIV switch and the VOLTS/DIV VAR control must remain at these settings for the remainder of the measurement.

6. Remove the reference-signal connection and apply the test signal to the same input connector.

7. Activate the Delta Volts measurement function by momentarily pressing in the Δ V button. Observe that two horizontal cursors and a **RATIO** readout appear on the screen.

The Reference cursor is positioned by the Δ REF OR DLY POS control, while the Delta cursor is positioned by the Δ control. The readout in the upper right-hand corner of the screen will display the ratio, in terms of percent, between the separation of the two cursors and the five-division reference signal. When the two cursors are separated by five divisions, the readout indicates **100%**.

8. Align the Reference cursor with the bottom of the test-signal waveform and the Delta cursor with the top of the waveform (see Figure 6-2).

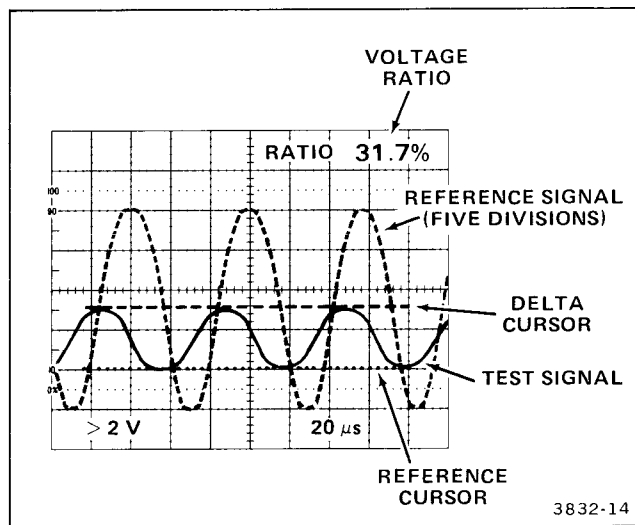

Figure 6-2. Voltage ratios.

9. Read the ratio between the test signal and the reference signal on the crt readout. If the Reference cursor is above the Delta cursor, the readout will show a negative number, and this has no other significance.

NOTE

In certain situations, such as checking test limits, it may be more convenient to use the cursors in the Tracking mode. To activate Tracking mode, push in the TRACKING button at the same time that ΔV is selected (step 7). In this mode, the Δ REF OR DLY POS control will move both cursors equally at the same time. The Δ control will continue to move the Delta cursor independently and can be used to preset a desired voltage-ratio test limit. The Δ REF OR DLY POS control can then be used to position the test limits (cursors) either on various test signals or on various portions of a test signal.

ALGEBRAIC ADDITION AND ELIMINATING COMMON-MODE SIGNALS

With the ADD VERTICAL MODE button pressed in, the waveform displayed is the algebraic sum of the signals applied to the CH 1 OR X and the CH 2 input connectors (CH 1 + CH 2). If the INVERT push button is pressed in, the waveform displayed is the difference between the signals applied to the Channel 1 and Channel 2 inputs (CH 1 – CH 2). When both VOLTS/DIV switches are set to the same deflection factor, the ADD trace deflection factor is equal to the deflection factor indicated by either VOLTS/DIV switch.

Two common uses for ADD mode are: (1) the providing of a dc offset for an ac signal riding on top of a high dc level and (2) the canceling out of undesirable signal components through common-mode rejection.

NOTE

The following general precautions should be observed when using ADD mode.

1. Do not exceed the input-voltage rating of the oscilloscope or probe.
2. Do not apply signals that exceed the equivalent of about eight times the VOLTS/DIV switch settings, since large voltages may distort the display. For example, with a VOLTS/DIV switch setting of 0.5, the voltage applied to that channel should not exceed 4 V.
3. Use Channel 1 and Channel 2 POSITION control settings which most nearly position the signal on each channel to midscreen, when viewed separately. This ensures the greatest dynamic range for ADD mode operation.
4. To attain similar responses from both channels, set both the Channel 1 and the Channel 2 Input Coupling switches to the same position.

The following procedure shows how to eliminate unwanted ac input-power frequency components. Similar methods could be used either to eliminate other unwanted frequency components or to provide a dc offset.

1. Preset instrument controls and obtain a baseline trace.
2. Apply the signal containing the unwanted line-frequency components to the CH 1 OR X input connector.
3. Apply a line-frequency signal to the CH 2 input connector. To maximize cancellation, the signal applied to Channel 2 must be in phase with the unwanted line-frequency component on the Channel 1 input.
4. Select both CH 1 and CH 2 VERTICAL MODE.
5. Set both VOLTS/DIV switches to produce displays of approximately four or five divisions in amplitude.
6. Adjust the Channel 2 VOLTS/DIV switch and VAR control so that the Channel 2 display is approximately the same amplitude as the undesired portion of the Channel 1 display (see Figure 6-3A).

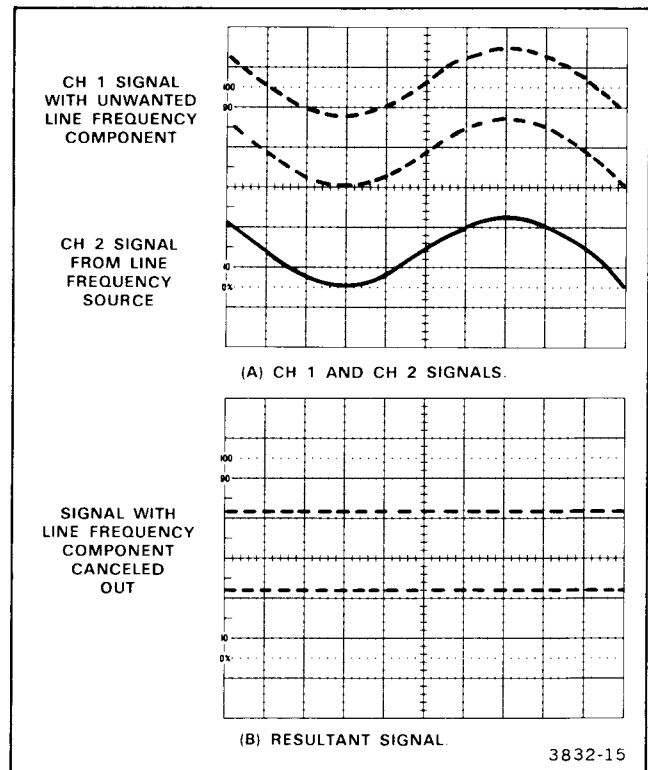

Figure 6-3. Eliminating common-mode signals.

Basic Applications—2445 Operators

7. Select both ADD and INVERT, release the CH 1 and CH 2 buttons, and slightly readjust the Channel 2 VAR control for maximum cancellation of the undesired signal component (see Figure 6-3B).

TIME INTERVAL

The built-in Delta Time function greatly simplifies making various timing measurements. To measure the time interval between any two points on a waveform (e.g., rise time, fall times, and periods), use the following procedure.

1. Preset instrument controls and obtain a baseline trace.

2. Apply the signal to any vertical input connector and select the VERTICAL MODE switch to display the channel used.

3. Set the appropriate VOLTS/DIV switch for a convenient amplitude display of the waveform.

4. Adjust the A TRIGGER LEVEL control to obtain a stable display.

5. Set the A SEC/DIV switch to a position that conveniently displays the complete portion of interest of the waveform.

6. Activate the Delta Time measurement function by momentarily pressing in the Δt button. Observe that two vertical cursors and a Δt readout appear on the screen.

The Reference cursor is positioned by the Δ REF OR DLY POS control, and the Delta cursor is positioned by the Δ control. A crt readout in the upper right-hand corner of the screen displays the time difference between the two cursors. Changing the SEC/DIV switch position automatically changes the readout scale.

7. Position the cursors to the desired points of the waveform.

To measure rise time or fall time, the Reference cursor should be aligned to the 10% point on the waveform and the Delta cursor should be aligned to the 90% point on the waveform. The 10% and 90% points are most easily found

by adjusting the VOLTS/DIV VAR control until the waveform exactly fills the screen between the 0% and 100% graticule lines, then utilizing the 10% and 90% horizontal graticule lines (see Figure 6-4).

To measure waveform periods, align the cursors to identical points on two adjacent cycles of the waveform.

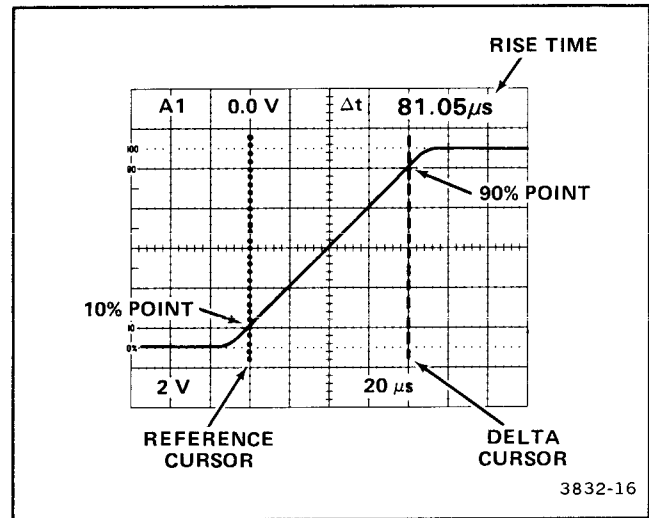

Figure 6-4. Measuring rise times.

8. Read the time difference between the two cursors from the crt readout. If the Delta cursor is left of the Reference cursor, the readout will display a negative number.

NOTE

In certain situations, such as checking test limits, it may be more convenient to use the cursors in the Tracking mode. To activate Tracking mode, push in the TRACKING button. In this mode, the Δ REF OR DLY POS control will move both cursors equally at the same time. The Δ control will continue to move the Delta cursor independently.

FREQUENCY

For frequency measurements, use the same method as previously described for waveform periods under "Time Interval" measurements, except that in step 6 both the ΔV and Δt buttons must be pushed in together. The crt readout will then display the frequency ($1/\Delta t$) in terms of Hz.

TIME DIFFERENCE BETWEEN TWO TIME-RELATED PULSES

The time difference between two time-related pulses can be measured in a manner similar to that previously described for measuring time interval.

1. Using either probes or cables with equal time delays, connect one signal to the CH 1 OR X input connector and the other signal to the CH 2 input connector. The procedure for matching probe delays is found under "Matching Channel 2 Delay" in Section 5, "Operator's Checks and Adjustments."
2. Select both CH 1 and CH 2 VERTICAL MODE switches.
3. Set TRIGGER controls so that either one (but not both) of the signals or a third time-related signal is the triggering signal source.
4. Activate the Delta Time measurement function and set the cursors to similar reference points (such as leading edges) on the two signal displays (see Figure 6-5).
5. Read time difference from the crt readout.

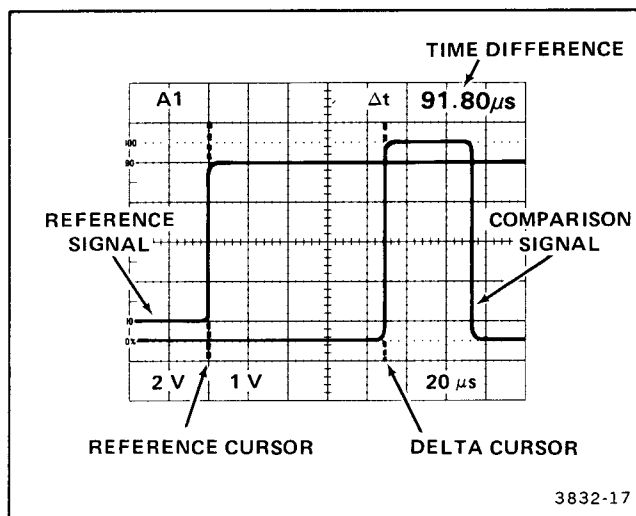

Figure 6-5. Time difference between two time-related pulses (cursor method).

TIME RATIO

The Delta Time function also can be used to measure and compute the ratio, in terms of percent, between two different time intervals (e.g., a test interval and a reference interval used to measure a duty cycle). To measure a time ratio, use the following procedure:

1. Preset instrument controls and obtain a baseline trace.
2. Apply the reference signal to either the CH 1 OR X or the CH 2 input connector and select the VERTICAL MODE switch to display the channel used.
3. Set the appropriate VOLTS/DIV switch for a convenient amplitude display of the waveform.
4. Adjust the A TRIGGER LEVEL control to obtain a stable display.
5. Set the A SEC/DIV switch and the A SEC/DIV VAR control to obtain a reference interval of exactly five horizontal divisions.

NOTE

The A SEC/DIV switch and the A SEC/DIV VAR control must remain at these settings for the remainder of the measurement.

6. If the test interval is part of a different signal, apply the test signal to one of the unused vertical-input connectors and select the VERTICAL MODE switch to display the channel used.
7. Activate the Delta Time measurement function by momentarily pressing in the Δt button. Observe that two vertical cursors and a **RATIO** readout appear on the screen.

The Reference cursor is positioned by the Δ REF OR DLY POS control, and the Delta cursor is positioned by the Δ control. The crt readout located in the upper right-hand corner of the screen will display the ratio, in terms of percent, between the separation of the two cursors and the five-division reference interval. When the two cursors are separated by five divisions, the readout indicates 100%.

Basic Applications—2445 Operators

8. Align the Reference cursor to the left edge of the test interval and the Delta cursor to the right edge of the test interval (see Figure 6-6).

9. Read the ratio between the test interval and the reference interval from the crt readout.

If the Delta cursor is left of the Reference cursor, the readout will show a negative number.

NOTE

In certain situations, such as checking test limits, it may be more convenient to use the cursors in the Tracking mode. To activate Tracking mode, push in the TRACKING button. In this mode, the Δ REF OR DLY POS control will move both cursors equally at the same time. The Δ control will continue to move the Delta cursor independently.

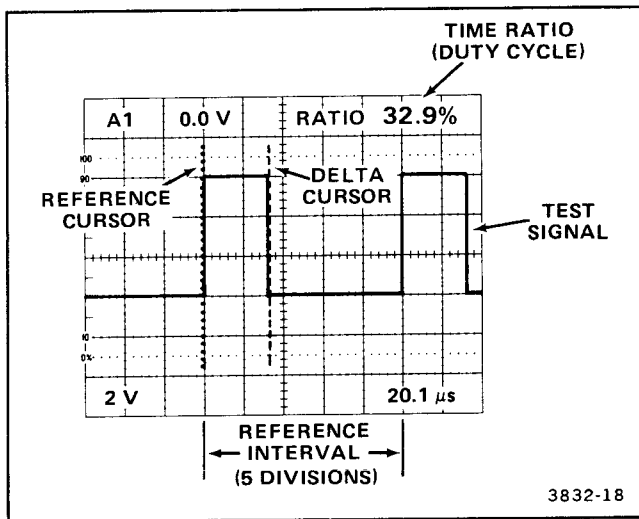

Figure 6-6. Time ratios (duty cycles).

PHASE DIFFERENCE BETWEEN TWO TIME-RELATED SIGNALS

The phase difference between two signals of equal frequency is determined in a manner similar to that described in the preceding procedure for measuring time ratio. To measure the phase difference between two time-related signals, use the following procedure:

1. Preset instrument controls and obtain a baseline trace.

2. Using either probes or cables with equal time delays, apply the reference signal to the CH 1 OR X input connector and the comparison signal to the CH 2 input connector. The procedure for matching delays is found under "Matching Channel 2 Delay" in Section 5.

3. Press in both CH 1 and CH 2 VERTICAL MODE buttons.

4. Set the Channel 1 and Channel 2 VOLTS/DIV switches and adjust the VAR controls to obtain equal amplitudes of the reference and the comparison signals.

5. Use the Vertical POSITION controls to center both displays vertically within the graticule area.

6. Set the A SEC/DIV switch and the SEC/DIV VAR control to display one cycle of the reference signal over five horizontal divisions.

7. Activate the 1/Delta Time measurement function by pressing in both the Δt and the ΔV buttons together.

8. Use the Δ REF OR DLY POS control to align the Reference cursor with a zero-crossing of the reference signal (see Figure 6-7). Use the center horizontal graticule line as the zero reference for aligning the crossover point.

9. Use the Δ control to align the Delta cursor with the nearest zero-crossing of the comparison signal on the same slope as the reference signal zero-crossing.

10. Read phase difference in degrees from the crt readout.

SMALL-ANGLE PHASE DIFFERENCE

If the phase difference between the two signals being measured is small, increased resolution for setting the cursors can be obtained by using the X10 MAG feature.

1. Perform steps 1 through 6 of the preceding "Phase Difference" procedure to obtain a five-division display of one cycle of the reference and comparison signals.

2. Use the Horizontal POSITION control to move the zero-crossing points of the signals being measured to the center vertical graticule line.

DELAYED-SWEEP OPERATION

The 2445 offers three delayed-sweep operating modes: the A Intensified Sweep, the A Intensified Sweep alternated with the B Delayed Sweep, and the B Delayed Sweep. Appropriate use for these modes varies with the particular application, but in general they are used most frequently for making timing measurements and for examining specific points of interest within a waveform or pulse train.

A Intensified Horizontal Display Mode

The A Intensified Horizontal Display mode is entered by pulling out the B SEC/DIV knob (PULL-INTEN) while both the A SEC/DIV and the B SEC/DIV switches are at the same setting. In this mode only the A Sweep is displayed, with a short intensified zone imposed on it. The position and length of the intensified zone indicates the delay-time position and the B Sweep interval respectively. A DLY readout appearing in the crt display gives the time delay between the start of the A Sweep and the start of the B Sweep. Positioning the intensified zone to a point of interest on the A Sweep trace is accomplished using the Δ REF OR DLY POS control. Rotating the control continuously changes the DLY readout seen on the crt. With the B TRIGGER MODE set to RUN AFT DLY, the position of the intensified zone on the A Sweep trace also is continuously variable and follows the delay change smoothly.

NOTE

If the B TRIGGER MODE is set to TRIG AFT DLY for triggered B Sweep operation, the Δ REF OR DLY POS control does not continuously position the intensified zone on the A Sweep trace. In this case, the intensified zone jumps to each succeeding B Trigger point within the A Sweep interval as delay time is changed.

Once the intensified zone is positioned at the point of interest, switching to the Alternate Horizontal Display mode (TURN-ALT) offers a convenient sweep display for either examining that point in greater detail or making time measurements.

Alternate Horizontal Display Mode

In this mode, both the A Intensified Sweep and the B Delayed Sweep traces are displayed. The mode is entered by first entering the A Intensified Horizontal Display mode (PULL-INTEN) then setting the B SEC/DIV switch to a faster sweep speed than the A SEC/DIV switch setting. The length of the intensified-zone display now becomes a function of the B Sweep speed. Increasing the B Sweep

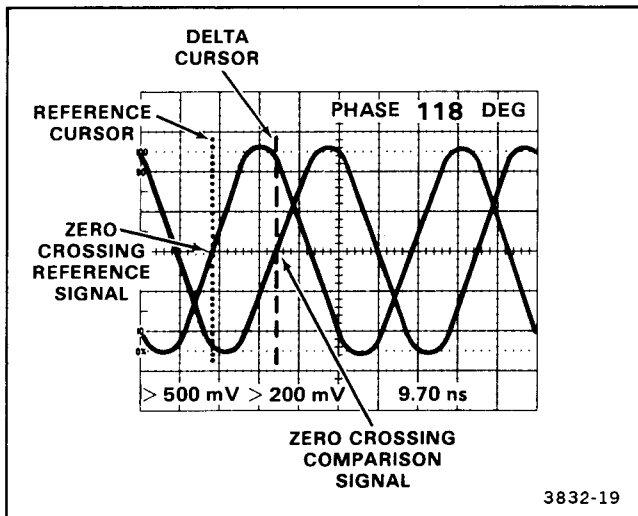

Figure 6-7. Phase difference between two time-related signals.

3. Press in the X10 MAG push button to obtain the magnified display and use the Horizontal POSITION and Δ REF OR DLY POS controls to align the reference zero-crossing with the Reference cursor.

4. Align the Delta cursor with the second comparison zero-crossing (see Figure 6-8).

5. Read the (magnified) phase difference in degrees from the crt readout. Divide this reading by 10 to obtain the correct phase difference between the two signals.

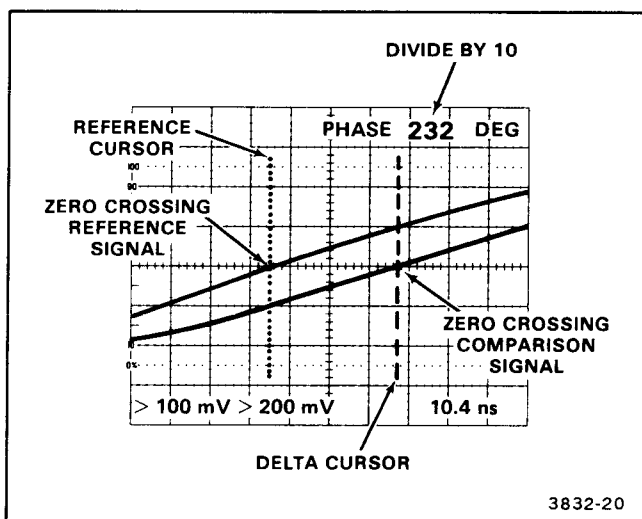

Figure 6-8. Small-angle phase difference.

Basic Applications—2445 Operators

speed shortens the length of the zone. The intensified zone on the A Sweep trace is used to identify the point of interest to be examined or measured, while the alternate B Delayed Sweep trace magnifies and displays the intensified segment. Apparent horizontal magnification of the waveform occurs as a result of displaying the selected portion of the A Sweep at a faster B Sweep speed.

Vertical separation of the A and B Sweep traces is variable using the TRACE SEP control. The control has enough range to position the B Sweep trace from zero (overlayed on the A Sweep trace) to three or more divisions downward from the A Sweep trace.

Time measurements can be readily made on waveforms by employing the DLY readout and the Δ REF OR DLY POS control. Delay time from the A trigger point to the beginning of the B Sweep is read directly from the DLY readout in the crt display. After noting a first delay-time position, a second measurement point can be aligned with the same reference graticule line, and the new delay time read. Time difference between the two points is then determined by computing the difference between the two delay-time readings. The computed time difference between the two delay times is more accurate than either of the delay-time readings.

B Delayed Horizontal Display Mode

Once the point of interest to be examined or measured is identified, the A Intensified Sweep trace can be eliminated to provide an uncluttered display for ease of viewing. Displaying only the B Delayed Sweep (PUSH-B) is accomplished by pushing in the B SEC/DIV knob after first establishing the Alternate Horizontal Display mode. Pulling the B SEC/DIV knob back out returns the A Intensified trace to the display, if needed to reidentify a measurement point. Rotating the B SEC/DIV knob back to the same setting as the A SEC/DIV switch, with the B SEC/DIV knob pushed in, locks the two knobs together and returns the Horizontal Display mode back to A Sweep only.

Delta Time Feature with Delayed Sweep

The Delta Time function can be used in any of the delayed-sweep modes to obtain direct-reading time-difference measurements. When activated, two separate B Delayed Sweep intervals are produced in the A Sweep interval. Delay time for each B Sweep interval is independently adjustable. The Δ REF OR DLY POS control positions one of the delay times, usually referred to as the Reference intensified zone or the Reference delay. Positioning of the second delay time, referred to as the Delta intensified zone or the Delta delay, is accomplished with the Δ control.

NOTE

If the Tracking mode of delay-time positioning is selected (TRACKING/INDEP button in), the Δ REF OR DLY POS control simultaneously moves both the Reference and the Delta delays equal amounts. The Δ control, however, continues to independently position the Delta delay regardless of the position of the TRACKING/INDEP button.

Delta Time measurements using the A Intensified Horizontal Display mode are made by simply setting the start of each intensified zone to the separate measurement points and noting the Δt readout in the crt display. This method produces the least accurate results, since it is difficult to determine exact alignment with the measurement points.

Much more accurate measurements are possible using the Alternate Horizontal Display mode. In this mode, a separate B Delayed Sweep trace is present for each displayed intensified zone. As explained before, the intensified zones are positioned to the points of interest; but instead of aligning the start of the zones to the measurement points, both the Reference and the Delta delays are adjusted to overlay the two points precisely, using the respective B Delayed traces. An example application of this method is given in the following procedure.

This procedure describes the steps necessary to make time measurements between two time-related pulses applied on separate input channels. However, the same principles apply for measuring time differences between successive pulses, pulse periods, or other time intervals on a single-channel input signal.

1. Preset instrument controls and obtain a baseline trace.
2. Using either probes or cables with equal time delays, apply a known reference signal to the CH 1 OR X input connector and apply the comparison signal to the CH 2 input connector.

NOTE

If the repetition rates of the pulses to be measured are not the same, use the slower repetition-rate signal as the Trigger SOURCE signal. Using the faster repetition-rate signal as the Trigger SOURCE will present multiple triggering-point possibilities during the period of the slower signal.

3. Select both CH 1 and CH 2 VERTICAL MODE.

4. Set both VOLTS/DIV switches to produce displays of approximately four to five divisions in amplitude.

5. Press up on the Trigger MODE switch to acquire the correct AUTO LVL for triggering.

6. Use the Channel 1 and Channel 2 POSITION controls to vertically center both displays.

7. Set the A SEC/DIV switch to display the measurement points of interest within the graticule area.

8. Activate the A Intensified Sweep by pulling out the B SEC/DIV knob.

9. Activate the Delta Time measurement function by momentarily pressing the Δt switch; select the independent mode of delay-time positioning (TRACKING/INDEP button out).

10. Adjust the Δ REF OR DLY POS control to align the start of the Reference intensified zone with the start of the reference-signal point of interest. Use the Δ control to align the start of the Delta intensified zone with the start of the comparison-signal point of interest (see Figure 6-9A).

11. Rotate the B SEC/DIV switch three to six positions clockwise to obtain a high degree of resolution of the measurement points. Use X10 MAG as required for optimum resolution. Observe that two alternate B Delayed Sweep traces (one for each intensified zone) appear in the display.

12. If desired, the B Delayed Sweep traces can be displayed alone, without the A Intensified trace. Pressing in the B SEC/DIV knob eliminates the A Intensified trace from the display.

13. Center the B Delayed traces vertically using the Channel VERTICAL POSITION controls and the TRACE SEP control as necessary.

14. Adjust both the Δ REF OR DLY POS control and the Δ control to superimpose the measurement points of the two B Delayed Sweeps (see Figure 6-9B).

15. Read time difference directly from the crt Δt readout.

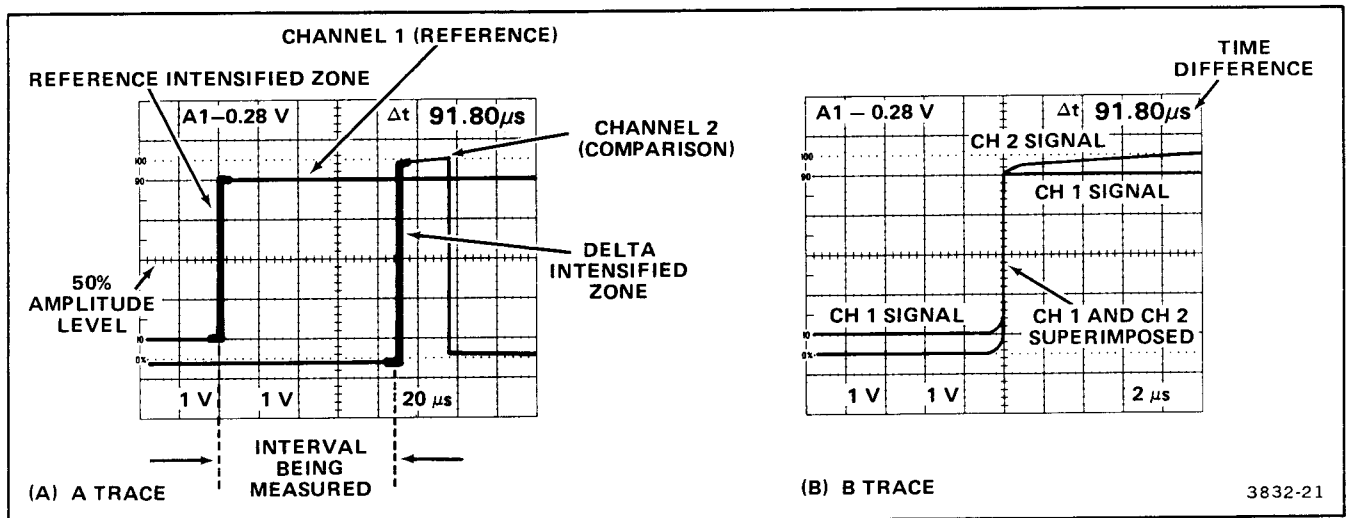

Figure 6-9. Time difference between two time-related pulses (delayed-sweep method).

OPTIONS AND ACCESSORIES

INTRODUCTION

This section contains a general description of instrument options available at the time of publication of this manual. Also included is a complete list (with Tektronix part numbers) of standard accessories included with each instrument and a partial list of optional accessories. Additional information about instrument options, option availability, and other accessories can be obtained either by consulting the current Tektronix Product Catalog or by contacting your local Tektronix Field Office or representative.

OPTION 1R

When the 2445 Oscilloscope is ordered with Option 1R, it is shipped in a configuration that permits easy installation into a 19-inch-wide electronic-equipment rack.

An optional rear-support kit also is available for use when rackmounting the 2445. Using this optional rear-support kit enables the rackmounted instrument to meet all electrical and environmental specifications of the standard 2445 Oscilloscope.

Connector-mounting holes are provided in the front panel of the rackmounted instrument. These enable convenient accessing of the four BNC connectors (CH 2 SIGNAL OUT, A GATE OUT, B GATE OUT, and EXT Z AXIS IN) located on the rear panel. Additional cabling and connectors required to implement any front-panel access to the rear-panel connectors are supplied by the user; however, these items can be separately ordered from Tektronix.

Complete rackmounting instructions are provided in a separate document shipped with the 2445 Option 1R. These instructions also contain appropriate procedures to convert a standard instrument into the Option 1R configuration by using the rackmounting conversion kit.

POWER CORD OPTIONS

Instruments are shipped with the detachable power-cord configuration ordered by the customer. Descriptive information about the international power-cord options is provided in Section 2, "Preparation for Use." The following list identifies the Tektronix part numbers for the available power cords and associated fuses.

Option A1 (Universal Euro)

Power cord (2.5 m)	161-0104-06
Fuse (1.6 A, 250 V, 5 x 20 mm, Quick-acting)	159-0098-00

Option A2 (UK)

Power cord (2.5 m)	161-0104-07
Fuse (1.6 A, 250 V, 5 x 20 mm, Quick-acting)	159-0098-00

Option A3 (Australian)

Power cord (2.5 m)	161-0104-05
Fuse (1.6 A, 250 V, 5 x 20 mm, Quick-acting)	159-0098-00

Option A4 (North American)

Power cord (2.5 m)	161-0104-08
Fuse (2 A, 250 V, AGC/3AG, Fast-blow)	159-0021-00

Option A5 (Switzerland)

Power cord (2.5 m)	161-0154-00
Fuse (1.6 A, 250 V, 5 x 20 mm, Quick-acting)	159-0098-00

STANDARD ACCESSORIES

The following standard accessories are provided with each instrument:

Qty	Description	Part Number
2	Probes (10X, 1.3 m) with Accessories	010-6131-01
1	Accessory Pouch, Snap Fastener	016-0692-00
1	Accessory Pouch, Zip-lock Fastener	016-0537-00
1	Operators Manual	070-3830-00
1	Service Manual	070-3829-00
1	Reference Card	070-4178-00
1	Fuse (2 A, 250 V, AGC/3AG)	159-0021-00
1	Power Cord (installed)	161-0104-00
1	CRT Filter, Blue Plastic (installed)	378-0199-00
1	CRT Filter, Clear Plastic	378-0208-00
1	Front-Panel Cover	200-2742-00

OPTIONAL ACCESSORIES

The following optional accessories are recommended for use with the 2445 Oscilloscope.

Description	Part Number
Protective Cover, Waterproof, Blue Vinyl	016-0720-00
Probe Package (use with standard-accessory probes for added input-signal connections)	010-6131-01
Rackmounting Conversion Kit	016-0691-00
Rear-Support Kit (for use with rackmounted instruments)	016-0096-00
Polarized Collapsible Viewing Hood	016-0180-00
Folding Viewing Hood, Light-shielding	016-0592-00
Collapsible Viewing Hood, Binocular	016-0566-00
Oscilloscope Camera	See C30B Series
SCOPE-MOBILE Cart	200C
Carrying Strap	346-0058-00

POWER-UP TESTS

Power-up tests are divided into two main parts: Kernel tests and Confidence tests.

KERNEL TESTS

The Kernel tests confirm proper operation of the memory associated with the basic instrument's microprocessor (RAM and ROM) and of any instrument options that are present. A failure of a Kernel test is indicated by a flashing TRIG'D indicator on the instrument front panel.

Even with a Kernel failure, the instrument may still be put into the operating mode by pressing in the A/B TRIG button. However, its operation will be unpredictable.

CONFIDENCE TESTS

The Confidence tests are performed after successful completion of all Kernel tests. Confidence testing for any options present in the instrument will automatically be included. A failure of any Confidence test at power on is indicated in the bottom line of the crt readout. The failure display has the following format:

TEST XX FAIL YY

where XX is the two-digit hexadecimal test number and YY represents the failure code for the failed test.

Brief descriptions of the tests are listed in Table A-1. A Confidence test failure may not render the instrument inoperable. The instrument may still be placed into the operating mode by pressing in the A/B TRIG button; however, it may not meet all specifications.

Table A-1
Confidence Test Numbers and Descriptions

Test Number	Description
01	IRQ—Checks that interrupts are occurring and that correct time interval exists between interrupt occurrences.
02	SWITCH STUCK—Checks for momentary switches that may be stuck closed.
03	READOUT BOARD—Checks interfaces with the Readout circuit board and the readout RAM.
04	EAROM—Checks the EAROM interface and verifies the calibration constants stored in the EAROM.
05	MAIN BOARD—Partially checks the Main circuit board by operating the Auto Level function on the Line Trigger source.