

Performance Verification

Tektronix

**TDS 620 & 640
Digitizing Oscilloscopes**

070-8649-00

**Please check for change information at the
rear of this manual.**

First Printing AUG 1992

Instrument Serial Numbers

Each instrument manufactured by Tektronix has a serial number on a panel insert or tag, or stamped on the chassis. The first letter in the serial number designates the country of manufacture. The last five digits of the serial number are assigned sequentially and are unique to each instrument. Those manufactured in the United States have six unique digits. The country of manufacture is identified as follows:

B010000	Tektronix, Inc., Beaverton, Oregon, USA
E200000	Tektronix United Kingdom, Ltd., London
J300000	Sony/Tektronix, Japan
H700000	Tektronix Holland, NV, Heerenveen, The Netherlands

Instruments manufactured for Tektronix by external vendors outside the United States are assigned a two digit alpha code to identify the country of manufacture (e.g., JP for Japan, HK for Hong Kong, IL for Israel, etc.).

Tektronix, Inc., P.O. Box 500, Beaverton, OR 97077

Printed in U.S.A.

Copyright © Tektronix, Inc., 1992. All rights reserved. Tektronix products are covered by U.S. and foreign patents, issued and pending. The following are registered trademarks: TEKTRONIX, TEK, TEKPROBE, and SCOPE-MOBILE.

WARRANTY

Tektronix warrants that this product will be free from defects in materials and workmanship for a period of three (3) years from the date of shipment. If any such product proves defective during this warranty period, Tektronix, at its option, either will repair the defective product without charge for parts and labor, or will provide a replacement in exchange for the defective product.

In order to obtain service under this warranty, Customer must notify Tektronix of the defect before the expiration of the warranty period and make suitable arrangements for the performance of service. Customer shall be responsible for packaging and shipping the defective product to the service center designated by Tektronix, with shipping charges prepaid. Tektronix shall pay for the return of the product to Customer if the shipment is to a location within the country in which the Tektronix service center is located. Customer shall be responsible for paying all shipping charges, duties, taxes, and any other charges for products returned to any other locations.

This warranty shall not apply to any defect, failure or damage caused by improper use or improper or inadequate maintenance and care. Tektronix shall not be obligated to furnish service under this warranty a) to repair damage resulting from attempts by personnel other than Tektronix representatives to install, repair or service the product; b) to repair damage resulting from improper use or connection to incompatible equipment; or c) to service a product that has been modified or integrated with other products when the effect of such modification or integration increases the time or difficulty of servicing the product.

THIS WARRANTY IS GIVEN BY TEKTRONIX WITH RESPECT TO THIS PRODUCT IN LIEU OF ANY OTHER WARRANTIES, EXPRESSED OR IMPLIED. TEKTRONIX AND ITS VENDORS DISCLAIM ANY IMPLIED WARRANTIES OF MERCHANTABILITY OR FITNESS FOR A PARTICULAR PURPOSE. TEKTRONIX' RESPONSIBILITY TO REPAIR OR REPLACE DEFECTIVE PRODUCTS IS THE SOLE AND EXCLUSIVE REMEDY PROVIDED TO THE CUSTOMER FOR BREACH OF THIS WARRANTY. TEKTRONIX AND ITS VENDORS WILL NOT BE LIABLE FOR ANY INDIRECT, SPECIAL, INCIDENTAL, OR CONSEQUENTIAL DAMAGES IRRESPECTIVE OF WHETHER TEKTRONIX OR THE VENDOR HAS ADVANCE NOTICE OF THE POSSIBILITY OF SUCH DAMAGES.



This is the Performance Verification for the TDS 620 and TDS 640 Oscilloscopes. It contains procedures suitable for determining if the instrument functions, was adjusted properly, and meets the performance characteristics as warranted.

A copy of *Specification*, found in Appendix B of the TDS 620 and TDS 640 User Manual, is also included here as a convenient reference.

Related Manuals

The following documents are related to the use or service of the oscilloscope.

- The TDS 620 and TDS 640 User Manual (Tektronix part number 070-8506-01).
- The TDS Family Programmer Manual (Tektronix part number 070-8318-04) describes using a computer to control the oscilloscope through the GPIB interface.
- The TDS 620 and 640 Reference (Tektronix part number 070-8505-01) gives you a quick overview of how to operate your oscilloscope.
- The TDS 620 Service Manual (Tektronix part number 070-8507-00) and the TDS 640 Service Manual (070-8508-00) provide information for maintaining and servicing your oscilloscope to the module level.
- The TDS Family Option 2F Instruction Manual (Tektronix part number 070-8582-00) describes use of the Advanced DSP Math option (for TDS oscilloscopes equipped with that option only).
- The TDS Family Option 13 RS-232/Centronics Hardcopy Interface Instruction Manual (Tektronix part number 070-8567-00) describes using the optional Centronics  hardcopy (for TDS oscilloscopes equipped with that option only).



Contents

Safety	v
--------------	---

Performance Verification Procedures

Performance Verification	1-1
Brief Procedures	1-1
General Instructions	1-1
Conventions	1-2
Self Tests	1-3
Verify Internal Adjustment, Self Compensation, and Diagnostics	1-3
Functional Tests	1-5
Verify All Input Channels	1-6
Verify the Time Base	1-7
Verify the Main and Delayed Trigger Systems	1-8
Performance Tests	1-10
Prerequisites	1-10
Equipment Required	1-11
Signal Acquisition System Checks	1-13
Check Accuracy of Offset (Zero Setting)	1-13
Check DC Gain and Voltage Measurement Accuracy	1-15
Check Analog Bandwidth	1-21
Check Delay Between Channels	1-25
Time Base System Checks	1-28
Check Accuracy for Long-Term Sample Rate, Delay Time, and Delta Time Measurements	1-28
Trigger System Checks	1-31
Check Accuracy (Time) for Pulse-Glitch or Pulse-Width Triggering	1-31
Check Accuracy, Trigger-level or Threshold, DC Coupled ...	1-34
Sensitivity, Edge Trigger, DC Coupled	1-37
Output Signal Checks	1-44
Check Outputs — AUX 1 (for TDS 620) or CH 3 (for TDS 640) and Main and Delayed Trigger	1-44
Check Probe Compensator Output	1-47

Specification

Specification	2-1
General	2-1
User Interface	2-1
Menus	2-2
Indicators	2-2
General Purpose Knob	2-2
GUI	2-2

Signal Acquisition System 2-2
Horizontal System 2-3
Trigger System 2-3
Acquisition Control 2-4
On-Board User Assistance 2-4
 Help 2-4
 Autoset 2-4
Measurement Assistance 2-5
 Cursor 2-5
 Measure 2-5
 Digital Signal Processing (DSP) 2-5
Storage and I/O 2-5
Display 2-6
 Zoom 2-6
Typical Characteristics 2-15



Change Information

Safety

Please take a moment to review these safety precautions. They are provided for your protection and to prevent damage to the oscilloscope. This safety information applies to all operators and service personnel.

Symbols and Terms

These two terms appear in manuals:

-  statements identify conditions or practices that could result in damage to the equipment or other property.
-  statements identify conditions or practices that could result in personal injury or loss of life.

These two terms appear on equipment:

- *CAUTION* indicates a personal injury hazard not immediately accessible as one reads the marking, or a hazard to property including the equipment itself.
- *DANGER* indicates a personal injury hazard immediately accessible as one reads the marking.

This symbol appears in manuals:



Static-Sensitive Devices

These symbols appear on equipment:



DANGER
High Voltage



Protective
ground (earth)
terminal



ATTENTION
Refer to
manual

Specific Precautions

Observe all of these precautions to ensure your personal safety and to prevent damage to either the oscilloscope or equipment connected to it.

Power Source

The oscilloscope is intended to operate from a power source that will not apply more than 250 V_{RMS} between the supply conductors or between either supply conductor and ground. A protective ground connection, through the grounding conductor in the power cord, is essential for safe system operation.

Grounding the Digitizing Oscilloscope

The oscilloscope is grounded through the power cord. To avoid electric shock, plug the power cord into a properly wired receptacle where earth ground has been verified by a qualified service person. Do this before making connections to the input or output terminals of the oscilloscope.

Without the protective ground connection, all parts of the oscilloscope are potential shock hazards. This includes knobs and controls that may appear to be insulators.

Use the Proper Power Cord

Use only the power cord and connector specified for your product. Use only a power cord that is in good condition.

Use the Proper Fuse

To avoid fire hazard, use only the fuse specified in the parts list for your product, matched by type, voltage rating, and current rating.

Do Not Remove Covers or Panels

To avoid personal injury, do not operate the oscilloscope without the panels or covers.

Electric Overload

Never apply to a connector on the oscilloscope a voltage that is outside the range specified for that connector.

Do Not Operate in Explosive Atmospheres

The oscilloscope provides no explosion protection from static discharges or arcing components. Do not operate the oscilloscope in an atmosphere of explosive gases.



Performance Verification Procedures



Performance Verification

These procedures verify both the TDS 620 and the TDS 640 Digitizing Oscilloscopes.

Brief Procedures

The *Self Tests* use internal routines to confirm basic functionality and proper adjustment. No test equipment is required to do these test procedures.

The *Functional Tests* use the probe-compensation output at the front panel as a test-signal source for further verifying that the oscilloscope functions properly. A standard-accessory probe, included with this oscilloscope, is the only equipment required.

General Instructions

Besides the *Brief Procedures*, use the *Performance Tests*, starting on page 1-10, to verify oscilloscope performance. You may not need to perform all of these tests, depending on what you want to accomplish:

- Do the *Self Tests* starting on page 1-3. These tests will quickly confirm that the oscilloscope functions and was adjusted properly.

Advantages: These procedures are quick to do, require no external equipment or signal sources, and perform extensive functional and accuracy testing to provide high confidence that the oscilloscope will perform properly. They can be used as a quick check before making a series of important measurements.

- To further check functionality, first do the *Self Tests* just mentioned; then do the *Functional Tests* starting on page 1-5.

Advantages: These procedures require minimal additional time to perform, require no additional equipment other than a standard-accessory probe, and more completely test the internal hardware of the oscilloscope. They can be used to quickly determine if the oscilloscope is suitable for putting into service, such as when it is first received.

- If more extensive confirmation of performance is desired, do the *Performance Tests*, beginning on page 1-10, after doing the *Functional* and *Self Tests* just referenced.

Advantages: These procedures add direct checking of warranted specifications. They require more time to perform and suitable test equipment is required. (See *Equipment Required* beginning on page 1-11.)

If you are not familiar with operating this oscilloscope, read *At a Glance* in Section 3 of the *TDS 620 & TDS 640 User Manual*.

Conventions

Throughout these procedures the following conventions apply:

- Each test procedure uses the following general format:

Title of Test

Equipment Required

Prerequisites

Procedure

- Each procedure consists of as many steps, substeps, and subparts as required to do the test. Steps, substeps, and subparts are sequenced as follows:

1. First Step

- a. First Substep

- First Subpart
- Second Subpart

- b. Second Substep

2. Second Step

- In steps and substeps, the lead-in statement in italics instructs you what to do, while the instructions that follow tell you how to do it: in the example step below, *“Initialize the oscilloscope”* by doing “Press save/recall **SETUP**. Now, press the main-menu button... .”

Initialize the oscilloscope: Press save/recall **SETUP**. Now, press the main-menu button **Recall Factory Setup**; then the side-menu button **OK Confirm Factory Init**.

- Where instructed to use a front-panel button or knob, or select from a main or side menu, or verify a readout or status message, the name of the button or knob appears in boldface type: “press **SHIFT**; then **UTILITY MENU**,” “press the main-menu button **System**”.



The symbol at the left is accompanied by information you must read to do the procedure properly.

- Refer to Figure 1-1 (TDS 640 model shown): “Main menu” refers to the menu that labels the seven menu buttons under the display; “side menu” refers to the menu that labels the five buttons to the right of the display. “Pop-up menu” refers to a menu that pops up when a main-menu button is pressed.

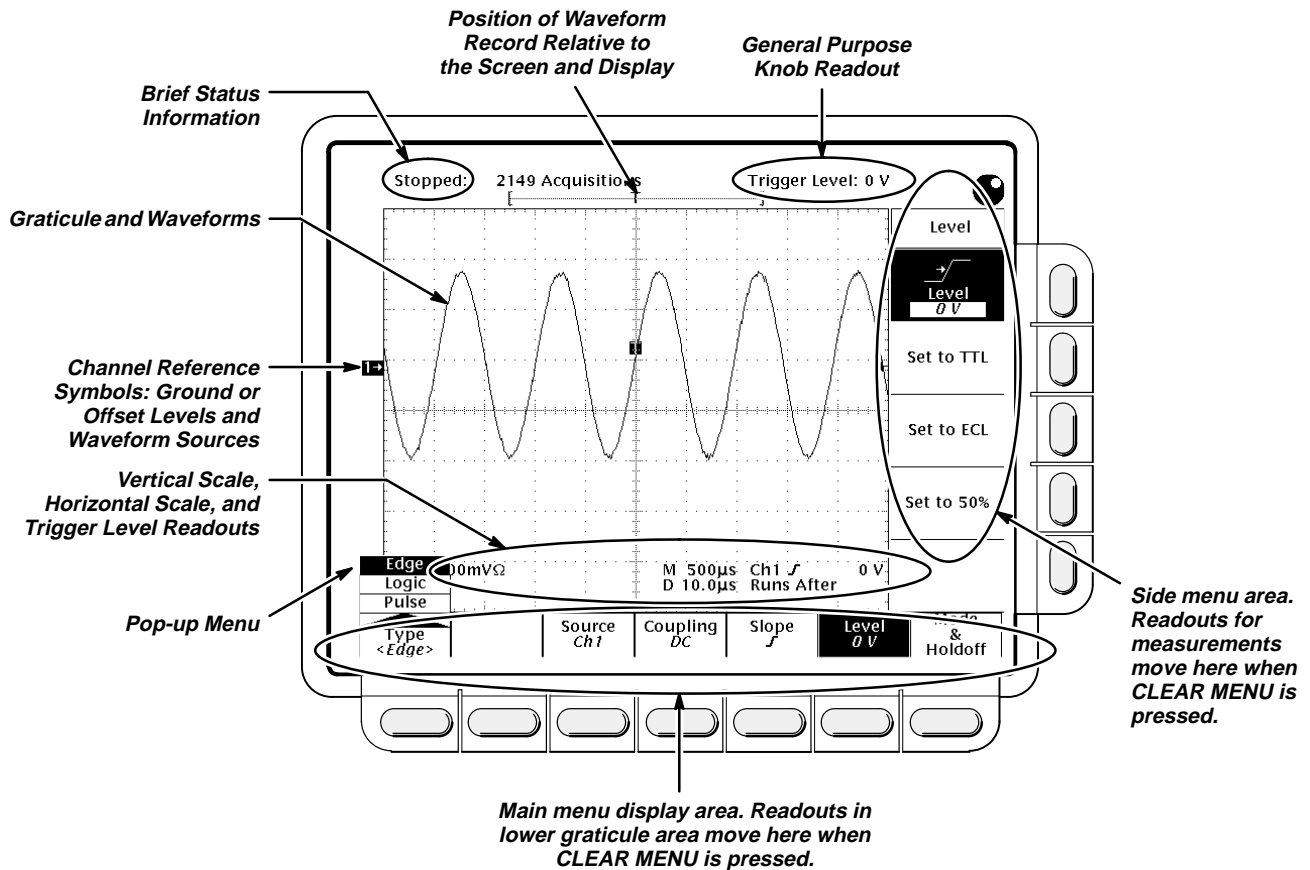

Figure 1-1: Map of Display Functions

Self Tests

This procedure uses internal routines to verify that the oscilloscope functions and was adjusted properly. No test equipment or hookups are required.

Verify Internal Adjustment, Self Compensation, and Diagnostics

Equipment Required: None.

Prerequisites: Power on the oscilloscope and allow a 20 minute warm-up before doing this procedure.

Procedure:

1. *Verify that internal diagnostics pass:* Do the following substeps to verify passing of internal diagnostics.
 - a. *Display the System diagnostics menu:*
 - Press **SHIFT**; then press **UTILITY**.
 - Repeatedly press the main-menu button **System** until **Diag/Err** is highlighted in the pop-up menu.



- b. *Run the System Diagnostics:* Press the main-menu button **Execute**; then press the side-menu button **OK Confirm Run Test**.
- c. *Wait:* The internal diagnostics do an exhaustive verification of proper oscilloscope function. This verification will take up to two minutes. While it progresses, a “clock” icon (shown at left) is displayed on-screen. When finished, the resulting status will appear on the screen.
- d. *Confirm no failures are found:* Verify that no failures are found and reported on-screen.
- e. *Confirm the three adjustment sections have passed status:*
 - Press **SHIFT**; then press **UTILITY**.
 - Press the main-menu button **System** until **Cal** is highlighted in the pop-up menu.
 - Verify that the word **Pass** appears in the main menu under the following menu labels: **Voltage Reference**, **Frequency Response**, and **Pulse Trigger**. (See Figure 1-2.)

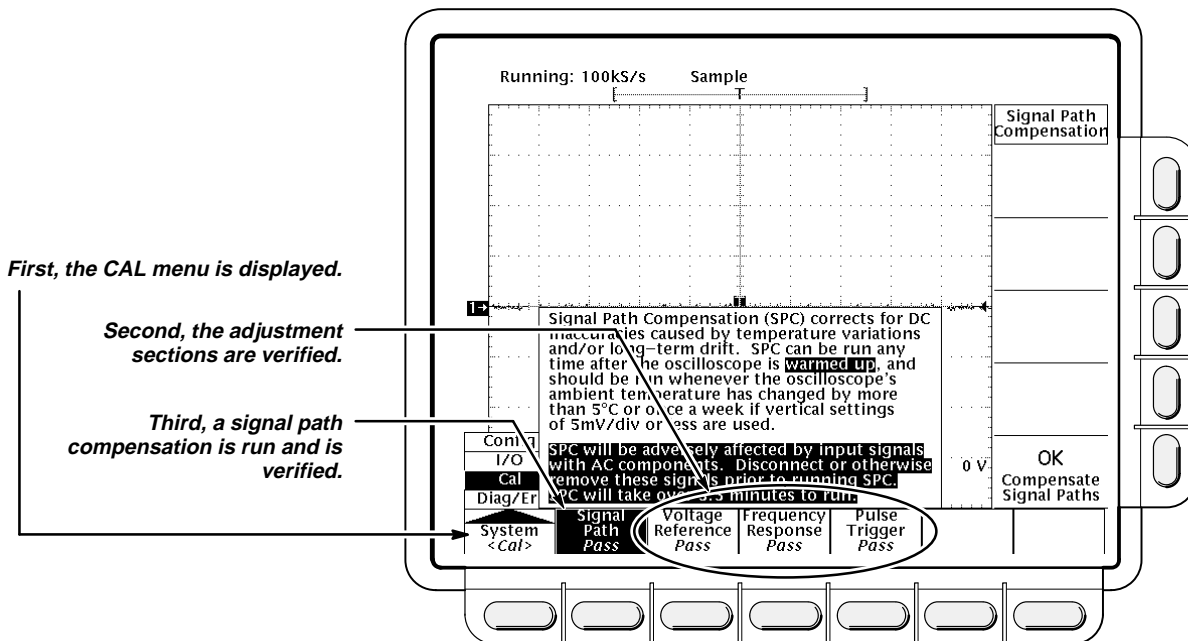

Figure 1-2: Verifying Adjustments and Signal Path Compensation



- f. *Run the signal-path compensation:* Press the main-menu button **Signal Path**; then press the side-menu button **OK Compensate Signal Paths**.
- g. *Wait:* Signal path compensation runs in about three to four minutes. While it progresses, a “clock” icon (shown at left) is displayed on-screen. Do not turn off the instrument while signal path compensation is in progress. If power is lost, there will be an entry in the Error Log and signal path compensation will have to be redone. When compensation completes, the status message will be updated to **Pass** or **Fail** in the main menu (see step h).

- h. *Confirm signal-path compensation returns passed status:* Verify that the word **Pass** appears under **Signal Path** in the main menu. (See Figure 1-2.)
2. *Return to regular service:* Press **CLEAR MENU** to exit the system menu.

Functional Tests

Use these procedures to confirm that the oscilloscope functions properly. The only equipment required is one of the standard-accessory probes.



The standard P6205 probes supplied with this oscilloscope provide an extremely low loading capacitance (<2 pF) to ensure the best possible signal reproduction. These probes should not be used to measure signals exceeding 40 volts. Above 40 volts, damage to the probe may result. To make measurements beyond 40 volts, use the P6139A probe (good to 500 volts), or refer to the catalog for a recommended probe.



These procedures verify that the oscilloscope features *operate*. They do *not* verify that they operate within limits.

Therefore, when the instructions in the functional tests ask you to verify that the on-screen signal “is about five divisions in amplitude” or “has a period of about six horizontal divisions,” etc., do **NOT** interpret the quantities given as limits. Operation within limits is checked in *Performance Tests*, which begin on page 1-10.



DO NOT make changes to the front-panel settings that are not called out in the procedures. Each verification procedure will require you to set the oscilloscope to certain default settings before verifying functions. If you make changes to these settings, other than those called out in the procedure, you may obtain invalid results. If this happens, just redo the procedure from step 1.

When you are instructed to press a menu button, the button may already be selected (its label will be highlighted). If this is the case, it is not necessary to press the button.

Verify All Input Channels

Equipment Required: One P6139A or P6205 probe.

Prerequisites: None.

Procedure:

1. *Install the test hookup and preset the oscilloscope controls:*

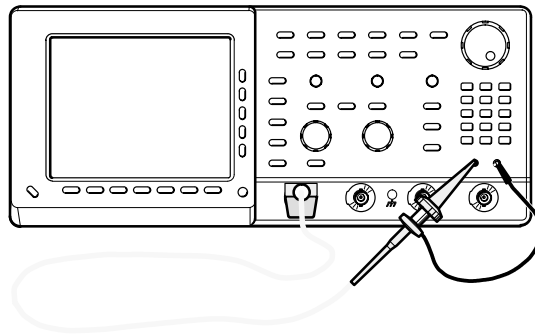





Figure 1-3: Universal Test Hookup for Functional Tests

- a. *Hook up the signal source:* Install the probe on **CH 1**. Connect the probe tip to **PROBE COMPENSATION SIGNAL** on the front panel; connect the probe ground to **PROBE COMPENSATION GND**.
 - b. *Initialize the oscilloscope:*
 - Press save/recall **SETUP**.
 - Press the main-menu button **Recall Factory Setup**.
 - Press the side-menu button **OK Confirm Factory Init**.
2. *Verify that all input channels operate:* Do the following substeps—test CH 1 first, *skipping substep a since CH 1 is already set up for verification from step 1*.
 - a. *Select an unverified channel:*
 - Press **WAVEFORM OFF** to remove the channel just verified from display.
 - Press the front-panel button that corresponds to the channel you are to verify.
 - Move the probe to the channel you selected.
 - b. *Set up the selected channel:*
 - Press **AUTOSET** to obtain a viewable, triggered display in the selected channel.
 - Set the horizontal **SCALE** to 250 μ s. Press **CLEAR MENU** to remove any menu that may be on the screen.

- c. *Verify that the channel is operational:* Confirm that the following statements are true.
- The vertical scale readout for the channel under test shows a setting of 200 mV, and a square wave probe-compensation signal about 2.5 divisions in amplitude is on-screen. (See Figure 1-1 on page 1-3 to locate the readout.)
 - The vertical **POSITION** knob moves the signal up and down the screen when rotated.
 - Turning the vertical **SCALE** knob counterclockwise decreases the amplitude of the waveform on-screen, turning the knob clockwise increases the amplitude, and returning the knob to 200 mV returns the amplitude to about 2.5 divisions.
- d. *Verify that the channel acquires in all acquisition modes:* Press **SHIFT**; then press **ACQUIRE MENU**. Use the side menu to select, in turn, each of the three hardware acquire modes and confirm that the following statements are true. Refer to the icons at the left of each statement as you confirm those statements.
- 

 - **Sample** mode displays an actively acquiring waveform on-screen. (Note that there is noise present on the peaks of the square wave.)
- 

 - **Envelope** mode displays an actively acquiring waveform on-screen with the noise displayed.
- 

 - **Average** mode displays an actively acquiring waveform on-screen with the noise reduced.
- e. *Test all channels:* Repeat substeps a through d until all four input channels are verified.
3. *Remove the test hookup:* Disconnect the probe from the channel input and the probe-compensation terminals.

Verify the Time Base

Equipment Required: One P6139A or P6205 probe.

Prerequisites: None.

Procedure:

1. *Install the test hookup and preset the oscilloscope controls:*
 - a. *Hook up the signal source:* Install the probe on **CH 1**. Connect the probe tip to **PROBE COMPENSATION SIGNAL** on the front panel; connect the probe ground to **PROBE COMPENSATION GND**. (See Figure 1-3 on page 1-6.)
 - b. *Initialize the oscilloscope:*
 - Press save/recall **SETUP**.
 - Press the main-menu button **Recall Factory Setup**; then press the side-menu button **OK Confirm Factory Init**.

- c. *Modify default settings:*
 - Press **AUTOSET** to obtain a viewable, triggered display.
 - Set the horizontal **SCALE** to 250 μ s.
 - Press **CLEAR MENU** to remove the menus from the screen.
2. *Verify that the time base operates:* Confirm the following statements.
 - a. One period of the square wave probe-compensation signal is about four horizontal divisions on-screen for the 250 μ s horizontal scale setting (set in step 1c).
 - b. Rotating the horizontal **SCALE** knob clockwise expands the waveform on-screen (more horizontal divisions per waveform period), counterclockwise rotation contracts it, and returning the horizontal scale to 250 μ s returns the period to about four divisions.
 - c. The horizontal **POSITION** knob positions the signal left and right on-screen when rotated.
3. *Remove the test hookup:* Disconnect the probe from the channel input and the probe-compensation terminals.

Verify the Main and Delayed Trigger Systems

Equipment Required: One P6139A or P6205 probe.

Prerequisites: None.

Procedure:

1. *Install the test hookup and preset the oscilloscope controls:*
 - a. *Hook up the signal source:* Install the probe on **CH 1**. Connect the probe tip to **PROBE COMPENSATION SIGNAL** on the front panel; connect the probe ground to **PROBE COMPENSATION GND**. (See Figure 1-3 on page 1-6.)
 - b. *Initialize the oscilloscope:*
 - Press save/recall **SETUP**.
 - Press the main-menu button **Recall Factory Setup**.
 - Press the side-menu button **OK Confirm Factory Init**.
 - c. *Modify default settings:*
 - Press **AUTOSET** to obtain a viewable, triggered display.
 - Set the horizontal **SCALE** for the **M** (main) time base to 250 μ s.
 - Press **TRIGGER MENU**.
 - Press the main-menu button **Mode & Holdoff**.
 - Press the side-menu button **Normal**.
 - Press **CLEAR MENU** to remove the menus from the screen.

2. *Verify that the main trigger system operates:* Confirm that the following statements are true.
 - The trigger level readout for the main trigger system changes with the **TRIGGER LEVEL** knob.
 - The **TRIGGER LEVEL** knob can trigger and untrigger the square wave signal as you rotate it. (Leave the signal *untriggered*, which is indicated by the display not updating.)
 - Pressing **SET LEVEL TO 50%** triggers the signal that you just left untriggered. (Leave the signal triggered.)
3. *Verify that the delayed trigger system operates:*
 - a. *Select the delayed time base:*
 - Press **HORIZONTAL MENU**.
 - Press the main-menu button **Time Base**.
 - Press the side-menu button **Delayed Triggerable**; then press the side-menu button **Delayed Only**.
 - Set the horizontal **SCALE** for the **D** (delayed) time base to 250 μ s.
 - b. *Select the delayed trigger level menu:*
 - Press **SHIFT**; then press **DELAYED TRIG**.
 - Press the main-menu button **Level**; then press the side-menu button **Level**.
 - c. *Confirm that the following statements are true:*
 - The trigger-level readout for the delayed trigger system changes with the general purpose knob.
 - The general purpose knob can trigger and untrigger the square wave probe-compensation signal as you rotate it. (Leave the signal *untriggered*, which is indicated by the display not updating.)
 - Pressing the side-menu button **Set to 50%** triggers the probe-compensation signal that you just left untriggered. (Leave the signal triggered.)
 - d. *Verify the delayed trigger counter:*
 - Press the main-menu button **Delay by Time**.
 - Use the keypad to enter a delay time of 1 second. Press **1**, then press **ENTER**.
 - Verify that the trigger **READY** indicator on the front panel flashes about once every second as the waveform is updated on-screen.
4. *Remove the test hookup:* Disconnect the standard-accessory probe from the channel input and the probe-compensation terminals.

Performance Tests

This subsection contains procedures for checking that the TDS 620 and TDS 640 Digitizing Oscilloscopes perform as warranted. Since both models are covered by these procedures, instructions that apply only to one of the models are clearly identified. Otherwise, all test instructions apply to both the TDS 620 and the TDS 640.

The procedures are arranged in four logical groupings: *Signal Acquisition System Checks*, *Time Base System Checks*, *Triggering System Checks*, and *Output Signal Checks*. They check all the Section 2, *Specification Warranted Characteristics* that are designated as checked and appear in **boldface** type.



These procedures *extend* the confidence level provided by the basic procedures described on page 1-1. Do the basic procedures first, then perform these procedures if desired.

Prerequisites

The tests in this subsection comprise an extensive, valid confirmation of performance and functionality when the following requirements are met:

- The cabinet must be installed on the oscilloscope.
- You must have performed and passed the procedures under *Self Tests*, found on page 1-3, and those under *Functional Tests*, found on page 1-5.
- A signal-path compensation must have been done within the recommended calibration interval and at a temperature within ± 2 °C of the present operating temperature. (If at the time you did the prerequisite *Self Tests*, the temperature was within the limits just stated, consider this prerequisite met.)
- The oscilloscope must have been last adjusted at an ambient temperature between +20°C and +30°C, must have been operating for a warm-up period of at least 20 minutes, and must be operating at an ambient temperature between 0°C and +50°C. (The warm-up requirement is usually met in the course of meeting the first prerequisite listed above.)

Related Information—Read *General Instructions* and *Conventions* starting on page 1-1. Also, if you are not familiar with operating the oscilloscope, read *At a Glance* in Section 3 of the *TDS 620 & TDS 640 User Manual* before doing any of these procedures.

Equipment Required

These procedures use external, traceable signal sources to directly check warranted characteristics. The list of required test equipment is shown in Table 1-1.

Table 1-1: Test Equipment

Item Number and Description	Minimum Requirements	Example	Purpose
1 Attenuator, 10X (two required)	Ratio: 10X; impedance 50 Ω ; connectors: female BNC input, male BNC output	Tektronix part number 011-0059-02	Signal Attenuation
2 Attenuator, 5X	Ratio: 5X; impedance 50 Ω ; connectors: female BNC input, male BNC output	Tektronix part number 011-0060-02	Signal Attenuation
3 Adapter, BNC female to Clip Leads	BNC female to Clip Leads	Tektronix part number 013-0076-00	Signal Coupling for Probe Compensator Output Check
4 Terminator, 50 Ω	Impedance 50 Ω ; connectors: female BNC input, male BNC output	Tektronix part number 011-0049-01	Signal Termination for Channel Delay Test
5 Cable, Precision Coaxial (two required)	50 Ω , 36 in, male to male BNC connectors	Tektronix part number 012-0482-00	Signal Interconnection
6 Connector, Dual-Banana (two required)	Female BNC to dual banana	Tektronix part number 103-0090-00	Various Accuracy Tests
7 Connector, BNC "T"	Male BNC to dual female BNC	Tektronix part number 103-0030-00	Checking Trigger Sensitivity
8 Coupler, Dual-Input	Female BNC to dual male BNC	Tektronix part number 067-0525-02	Checking Delay Between Channels
9 Generator, DC Calibration	Variable amplitude to $\frac{1}{2}$ V, accuracy to 0.1%	Data Precision 8200	Checking DC Offset, Gain, and Measurement Accuracy
10 Generator, Calibration	500 mV square wave calibrator amplitude; accuracy to 0.25%	PG 506A ¹	To check accuracy of the CH 3 (for the TDS 640) or AUX 1 (for the TDS 620) Signal Out
11 Generator, Leveled Sine Wave, Medium-Frequency	200 kHz to 250 MHz; Variable amplitude from 5 mV to 4 V p-p into 50 Ω	TEKTRONIX SG 503 Leveled Sine Wave Generator ¹	Checking Trigger Sensitivity at low frequencies

¹Requires a TM 500 or TM 5000 Series Power Module Mainframe.

Table 1-1: Test Equipment (Cont.)

Item Number and Description	Minimum Requirements	Example	Purpose
12 Generator, Leveled Sine Wave, High-Frequency	250 MHz to 500 MHz; Variable amplitude from 500 mV to 4 V p-p into 50 Ω ; 6 MHz reference	TEKTRONIX SG 504 Leveled Sine Wave Generator ¹ with a TM 500 Series Power Module with SG 504 Output Head	Checking Analog Bandwidth and Trigger Sensitivity at high frequencies
13 Generator, Time Mark	Variable marker frequency from 10 ms to 10 ns; accuracy within 2 ppm	TEKTRONIX TG 501A Time Mark Generator ¹	Checking Sample-Rate and Delay-time Accuracy
14 Probe, 10X, included with this instrument	A P6139A or P6205 probe ²	Tektronix number P6139A or Tektronix number P6205	Signal Interconnection

¹Requires a TM 500 or TM 5000 Series Power Module Mainframe.

²Warning: The Standard P6205 probes supplied with this oscilloscope provide an extremely low loading capacitance (<2pF) to ensure the best possible signal reproduction. These probes should not be used to measure signals exceeding 40V, or errors in signal measurement will be observed. Above 40V, damage to the probe may result. To make measurements beyond 40V, use either the P6139A probe (good to 500V), or refer to the catalog for a recommended probe.

Signal Acquisition System Checks

These procedures check the characteristics that relate to the signal-acquisition system and are listed as checked under *Warranted Characteristics* in Section 2, *Specification*.

Check Accuracy of Offset (Zero Setting)

Equipment Required: None.

Prerequisites: The oscilloscope must meet the prerequisites listed on page 1-10.

1. *Preset the instrument controls:*
 - a. *Initialize the oscilloscope:*
 - Press save/recall **SETUP**.
 - Press the main-menu button **Recall Factory Setup**.
 - Press the side-menu button **OK Confirm Factory Init**.
 - Press **CLEAR MENU** to remove the menus from the screen.
 - b. *Modify the default settings:*
 - Set the horizontal **SCALE** to 1 ms.
 - Press **SHIFT**; then press **ACQUIRE MENU**.
 - Press the main-menu button **Mode**; then press the side-menu button **Average 16**.
 - Press **DISPLAY**.
 - Press the main-menu button **Graticule**; then press the side-menu button **Frame**.
 - Press **CURSOR**.
 - Press the main-menu button **Function**; then press the side-menu button **H Bars**.
 - Press **CLEAR MENU**.
 - Be sure to disconnect any input signals from all four channels.
2. *Confirm input channels are within limits for offset accuracy at zero offset:* Do the following substeps—test CH 1 first, *skipping substep a since CH 1 is already set up to be checked from step 1*.
 - a. *Select an unchecked channel:* Press **WAVEFORM OFF** to remove the channel just confirmed from the display. Then, press the front-panel button that corresponds to the channel you are to confirm.

Table 1-2: DC Offset Accuracy (Zero Setting)

Vertical Scale Setting	Vertical Position and Offset Setting ¹	Offset Accuracy Limits
1 mV	0	± mV
100 mV	0	± mV
1 V	0	± mV

¹Vertical position is set to 0 divisions and vertical offset to 0 V when the oscilloscope is initialized in step 1.

- b. *Set the vertical scale:* Set the vertical **SCALE** to one of the settings listed in Table 1-2 that is not yet checked. (Start with the first setting listed.)
- c. *Display the test signal:* The baseline DC test level was initialized for all channels in step 1 and is displayed as you select each channel and its vertical scale. Be sure *not* to use the vertical **POSITION** knob while checking any channel for accuracy of offset, since varying the position invalidates the check.
- d. *Measure the test signal:* Rotate the general purpose knob to superimpose the active cursor over the baseline DC test level. (Ignore the other cursor.)
- e. Read the measurement results at the absolute (@:) cursor readout, not the delta (Δ:) readout on screen (see Figure 1-4).

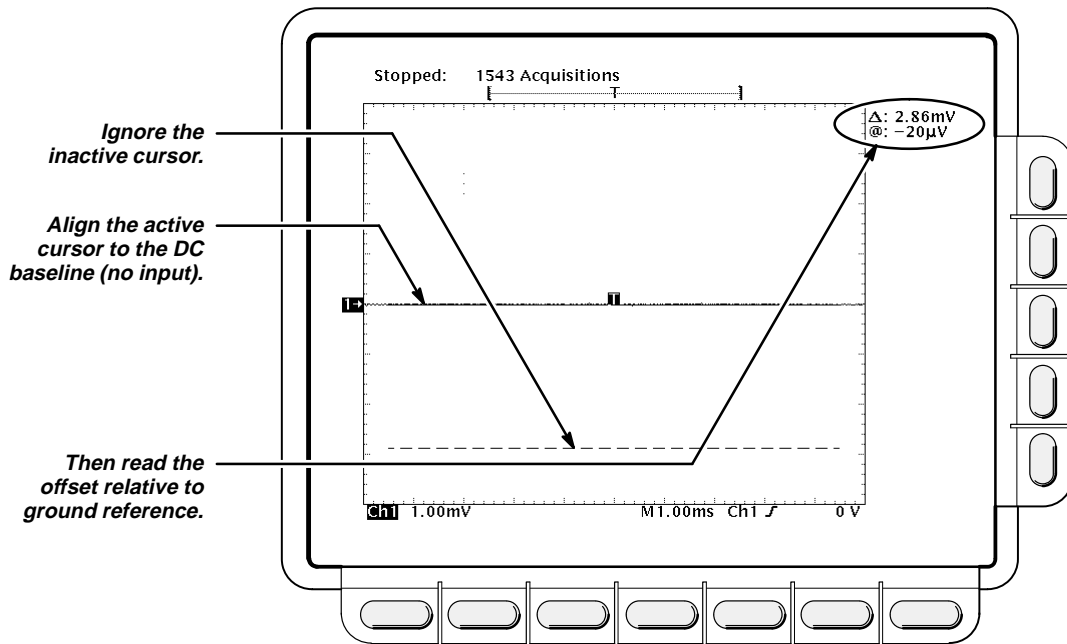

Figure 1-4: Measurement of DC Offset Accuracy at Zero Setting

- f. *Check against limits:* Do the following subparts in the order listed.
 - CHECK that the measurement results are within the limits listed for the current vertical scale setting.
 - Repeat substeps b through f until all vertical scale settings listed in Table 1-2, are checked for the channel under test.
- g. *Test all channels:* Repeat substeps a through f for all input channels.

Check DC Gain and Voltage Measurement Accuracy

WARNING

Performance of this procedure requires input voltages up to 92 VDC. Be sure to set the DC calibration generator to 0 volts before connecting, disconnecting, and/or moving the test hookup during the performance of this procedure.

Equipment Required: Two dual-banana connectors (Item 6), one BNC T connector (Item 7), one DC calibration generator (Item 9), and two precision coaxial cables (Item 5).

Prerequisites: The oscilloscope must meet the prerequisites listed on page 1-10.

Procedure:

1. *Install the test hookup and preset the instrument controls:*

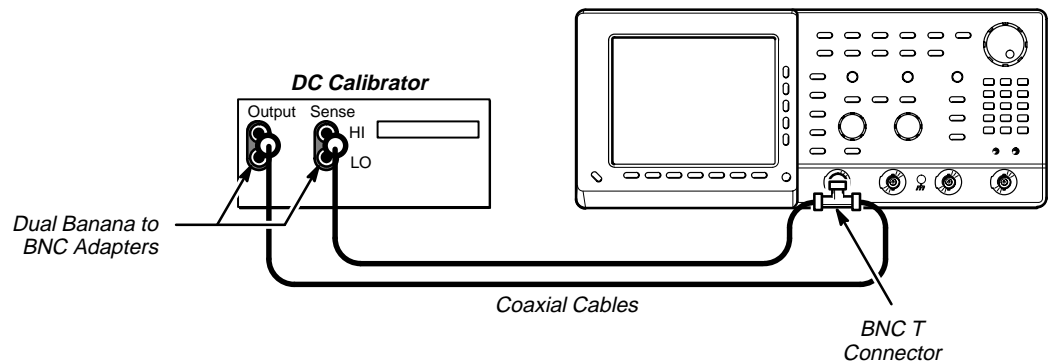

Figure 1-5: Initial Test Hookup

- a. *Hook up the test-signal source:*
 - Set the output of a DC calibration generator to 0 volts.

- Connect the output of a DC calibration generator through a dual-banana connector followed by a 50 Ω precision coaxial cable to one side of a BNC T connector.
 - Connect the Sense output of the generator through a second dual-banana connector followed by a 50 Ω precision coaxial cable to the other side of the BNC T connector. Now connect the BNC T connector to **CH 1**.
- b. *Initialize the oscilloscope:*
- Press save/recall **SETUP**.
 - Press the main-menu button **Recall Factory Setup**.
 - Press the side-menu button **OK Confirm Factory Init**.
- c. *Modify the default settings:*
- Press **SHIFT**; then **ACQUIRE MENU**.
 - Press the main-menu button **Mode**; then press the side-menu button **Average 16**.
 - Press **CURSOR**.
 - Press the main-menu button **Function**; then press the side-menu button **H Bars**.
 - Press **DISPLAY**.
 - Press the main-menu button **Graticule**; then press the side-menu button **Frame**.
2. *Confirm input channels are within limits for DC delta voltage accuracy: Do the following substeps—test CH 1 first (skipping step 2a since CH 1 is already selected from step 1).*
- a. *Select an unchecked channel:*
- Set the generator output to 0 V.
 - Press **WAVEFORM OFF** to remove the channel just confirmed from the display.
 - Press the front-panel button that corresponds to the next channel you are to confirm.
 - Move the test hookup to the channel you select.
- b. *Display the test signal:*
- Press **VERTICAL MENU**. Press the main-menu button **Position**.
 - Use the keypad to set vertical position to –2.5 divisions (press **–2.5**, then **ENTER**, on the keypad).

c. *Measure the test signal:*

- Press **CURSOR**. Press **TOGGLE**. Use the general purpose knob to precisely align the active cursor to the DC baseline level on screen.
- Set the generator output to 500 mV.
- Press **SET LEVEL TO 50%**
- Press **TOGGLE**. Use the general purpose knob to precisely align the alternate cursor to the 500 mV DC test level on screen.
- Press **CLEAR MENU**. Read the measurement results from the delta (Δ) readout, not the absolute (@:) readout. See Figure 1-6.

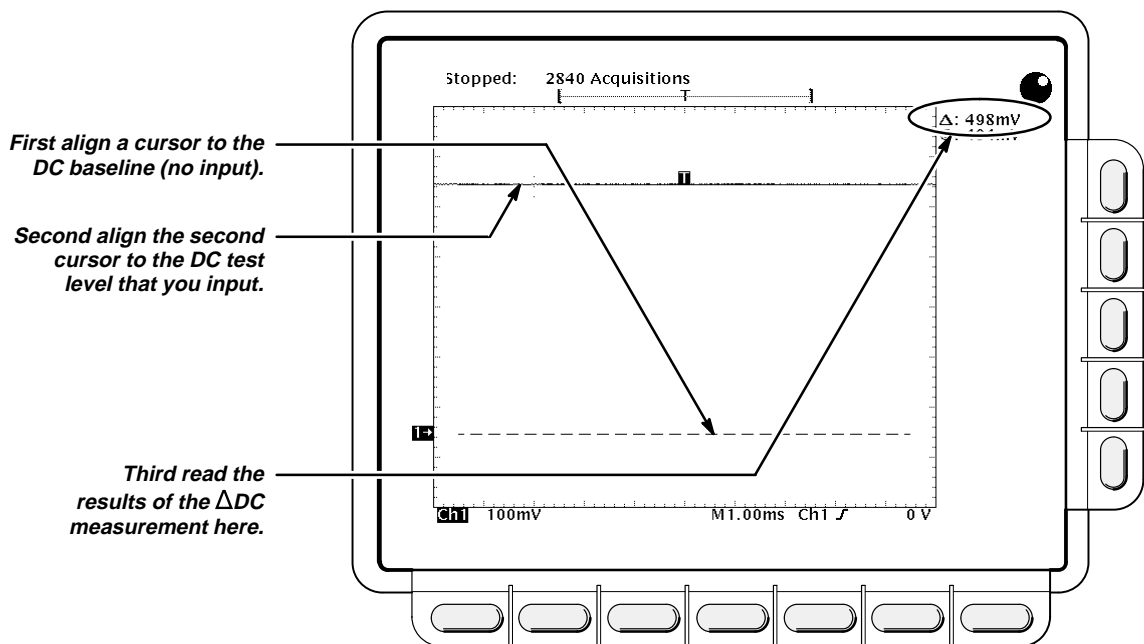

Figure 1-6: Measurement of the DC Accuracy for Delta Measurements

- d. *Check against limits:* CHECK that the Δ : readout on screen is within 482 mV to 518 mV.
 - e. *Test all channels:* Repeat substeps a through d for all four channels.
3. *Reestablish the initial test hookup setup:*
- a. *Hook up the test-signal source:*
 - Set the output of the DC calibration generator to 0 volts.
 - Move the BNC T connector back to **CH 1**.

- b. *Initialize the oscilloscope:*
 - Press save/recall **SETUP**.
 - Press the main-menu button **Recall Factory Setup**.
 - Press the side-menu button **OK Confirm Factory Init**.
 - c. *Modify the default settings:*
 - Press **SHIFT**; then press **ACQUIRE MENU**.
 - Press the main-menu button **Mode**; then press the side-menu button **Average 16**.
 - Press **DISPLAY**.
 - Press the main-menu button **Graticule**; then press the side-menu button **Frame**.
4. *Confirm input channels are within limits for DC accuracy at maximum offset and position: Do the following substeps—test CH 1 first (skipping step 4a since CH 1 is already selected from step 3).*
- a. *Select an unchecked channel:*
 - Press **WAVEFORM OFF** to remove the channel just confirmed from the display.
 - Press the front-panel button that corresponds to the channel you are to confirm.
 - *Set the generator output to 0 V.*
 - Move the test hookup to the channel you selected.
 - b. *Turn on the measurement Mean for the channel:*
 - Press **MEASURE**, then press the main-menu button **Select Measurement for CHx**.
 - Press the side-menu button **more** until the menu label **Mean** appears in the side menu (its icon is shown at the left). Press the side-menu button **Mean**.
 - c. *Set the vertical scale:* Set the vertical **SCALE** to one of the settings listed in Table 1-3, on page 1-19, that is not yet checked. (Start with the first setting listed.)



Table 1-3: DC Accuracy

Scale Setting	Position Setting (Divs)	Vertical Offset Setting	Generator Setting	Accuracy Limits
5 mV	-5	+1 V	+1.040 V	+1.0329 V to +1.0471 V
	+5	-1 V	-1.040 V	-1.0329 V to -1.0471 V
200 mV	-5	+10 V	+11.6 V	+11.405 V to +11.795 V
	+5	-10 V	-11.6 V	-11.405 V to -11.795 V
1 V	-5	+92 V	+100 V	+98.81 V to +101.19 V
	+5	-92 V	-100 V	-98.81 V to -101.19 V

d. *Display the test signal:*

- Press **VERTICAL MENU**. Press the main-menu button **Position**.
- Use the keypad to set vertical position to -5 divisions (press **-5**, then **ENTER**, on the keypad). The baseline level will move off screen.
- Press the main-menu button **Offset**.
- Use the keypad to set vertical offset to the positive-polarity setting listed in Table 1-3 for the current vertical scale setting. The baseline level will remain off screen.
- Set the generator to the generator setting indicated in the table for the vertical scale, position, and offset settings you have made. The DC test level should appear on screen. (If it does not return, the DC accuracy check is failed for the current vertical scale setting of the current channel.)

e. *Measure the test signal:* Press **CLEAR MENU**. Read the measurement results at the **Mean** measurement readout. See Figure 1-7.

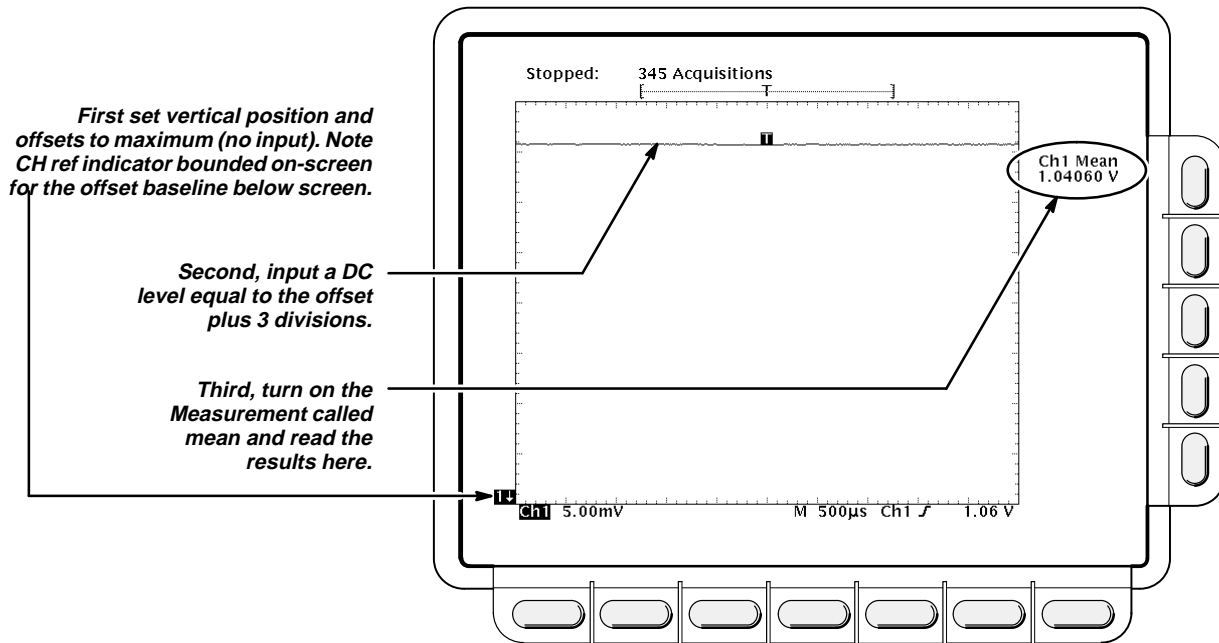

Figure 1-7: Measurement of DC Accuracy at Maximum Offset and Position

- f. *Check against limits:*
 - CHECK that the readout for the measurement **Mean** readout on screen is within the accuracy limits listed for the current vertical scale and position/offset/generator settings.
 - Repeat substep d, reversing the polarity of the position, offset, and generator settings as listed in Table 1-3.
 - CHECK that the **Mean** measurement readout on screen is within the limits listed for the current vertical scale setting and position/offset/generator settings.
 - Repeat substeps c through f until all vertical scale settings, listed in Table 1-3, are checked for the channel under test.
- g. *Test all channels:* Repeat substeps a through f for all four channels.
5. *Disconnect the hookup:*
 - a. *Set the generator output to 0 V.*
 - b. Disconnect the cable from the generator output at the input connector of the channel last tested.

Check Analog Bandwidth

Equipment Required: One high-frequency leveled sine wave generator and its leveling head (Item 12), one medium-frequency leveled sine wave generator and its leveling head (Item 11), plus two 10X attenuators (Item 1).

Prerequisites: See page 1-10.

Procedure:

1. *Install the test hookup and preset the instrument controls:*
 - a. *Initialize the oscilloscope:*
 - Press save/recall **SETUP**. Press the main-menu button **Recall Factory Setup**. Press the side-menu button **OK Confirm Factory Init**.
 - b. *Modify the default settings:*
 - Press **TRIGGER MENU**. Press the main-menu button **Coupling**.
 - Press the side-menu button **Noise Rej**. (When checking 1mV, press the side-menu button **HF Rej**.)
 - Set the horizontal **SCALE** to 50 ns. (When checking 1mV set the horizontal **SCALE** to 10 μ s.) Press **SHIFT**; then press **ACQUIRE MENU**.
 - Press the main-menu button **Mode**; then press the side-menu button **Average 16**.
 - Press **Measure**. Press the main-menu button **High–Low Setup**; then press the side-menu button **Min–Max**.
 - c. *Hook up the test-signal source:* Connect, through its leveling head, the sine wave output of a high-frequency leveled sine wave generator to **CH 1**. Set the output of the generator to a reference frequency of 6 MHz. See Figure 1-8. (When checking 1 mV use a medium frequency sine wave generator, item 11, and set the output of the generator to a reference frequency of 50 kHz.)

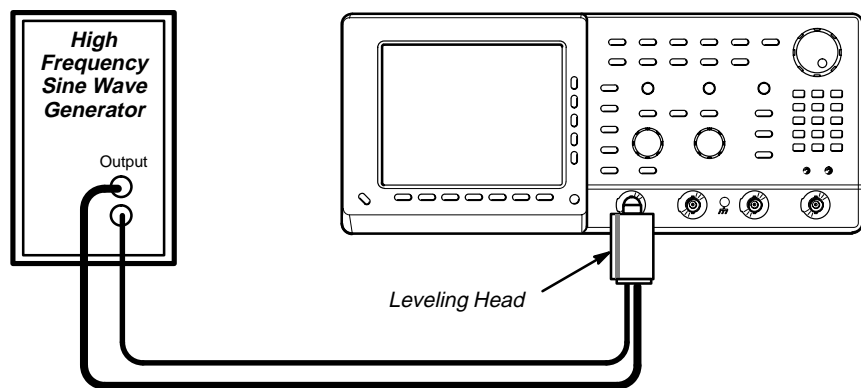

Figure 1-8: Initial Test Hookup

2. *Confirm the input channels are within limits for analog bandwidth:* Do the following substeps—test CH 1 first, *skipping substeps a and b since CH 1 is already set up for testing from step 1.*
 - a. *Select an unchecked channel:*
 - Press **WAVEFORM OFF** to remove the channel just confirmed from display.
 - Press the front-panel button that corresponds to the channel you are to confirm.
 - Move the leveling head to the channel you selected.
 - b. *Match the trigger source to the channel selected:*
 - Press **TRIGGER MENU**. Press the main-menu button **Source**; then press the side-menu button that corresponds to the channel selected.
 - c. *Set its input impedance:*
 - Press **VERTICAL MENU**; then press the main-menu button **Coupling**.
 - Press the side-menu button Ω to toggle it to the 50 Ω setting.
 - d. *Set the vertical scale:* Set the vertical **SCALE** to one of the settings listed in Table 1-4 not yet checked. (Start with the 100 mV setting.)

Table 1-4: Analog Bandwidth

Vertical Scale	Attenuators (10X)	Reference Amplitude (at 6 MHz)	Horizontal Scale	Test Frequency	Limits
100 mV	none	600 mV (6 divisions)	1 ns	500 MHz	≥ 424 mV
1 V	none	5 V (5 divisions)	1 ns	500 MHz	≥ 3.535 V
500 mV	none	3 V (6 divisions)	1 ns	500 MHz	≥ 2.121 V
200 mV	none	1.2 V (6 divisions)	1 ns	500 MHz	≥ 848 mV
50 mV	1	300 mV (6 divisions)	1 ns	500 MHz	≥ 212 mV
20 mV	1	120 mV (6 divisions)	1 ns	500 MHz	≥ 84 mV
10 mV	1	60 mV (6 divisions)	1 ns	500 MHz	≥ 42 mV
5 mV	2	30 mV (6 divisions)	1 ns	500 MHz	≥ 21 mV
2 mV	2	12 mV (6 divisions)	1 ns	300 MHz	≥ 8.48 mV
1 mV	2	6 mV (6 divisions)	1 ns	200 MHz	≥ 4.24 mV

- e. *Display the test signal:* Do the following subparts to first display the reference signal and then the test signal.
 - Press **MEASURE**; then press the main-menu button **Select Measurement for CHx**.

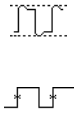

- Press the side-menu button **more** until the menu label **Pk-Pk** appears in the side menu (its icon is shown at the left). Press the side-menu button **Pk-Pk**.
 - Repeatedly press the side-menu button **more** until **Frequency** appears in the side menu (its icon is shown at the left). Press the side-menu button **Frequency**. (For 1mV, press the side-menu button **Noise Rej.**)
 - Press **CLEAR MENU**.
 - Set the generator output so the CHx Pk-Pk readout equals the reference amplitude in Table 1-4 that corresponds to the vertical scale set in substep d.
 - Press **SET LEVEL TO 50%** as necessary to trigger a stable display.
- f. *Measure the test signal:*
- Set the frequency of the generator, as shown on screen, to the test frequency in Table 1-4 that corresponds to the vertical scale set in substep d.
 - Set the horizontal **SCALE** to to the horizontal scale setting in Table 1-4 that corresponds to the vertical scale set in substep d. Press **SET LEVEL TO 50%** as necessary to trigger the signal.
 - Read the results at the CHx Pk-Pk readout, which will automatically measure the amplitude of the test signal (see Figure 1-9).

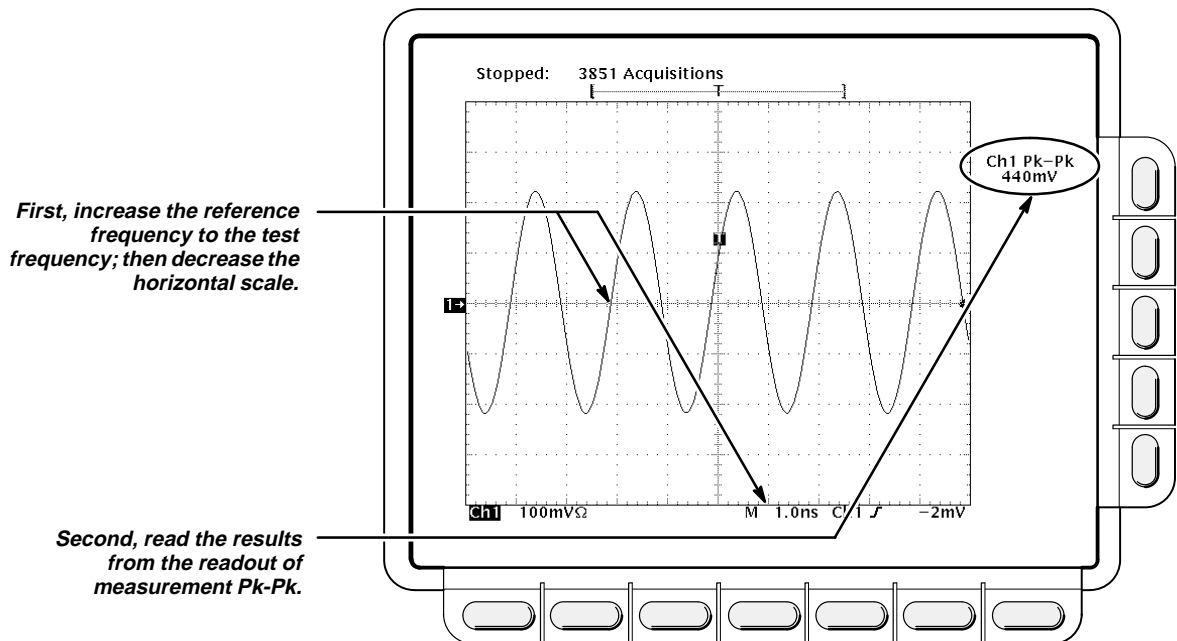

Figure 1-9: Measurement of Analog Bandwidth

g. *Check against limits:*

- CHECK that the **Pk-Pk** readout on screen is within the limits listed in Table 1-4 for the current vertical scale setting.
- When finished checking, set the horizontal **SCALE** back to the 50 ns setting.



You may skip checking the remaining vertical scale settings in Table 1-4 (skip substep, h) if this oscilloscope has performed as follows:

- Passed the 100 mV vertical scale setting just checked.
- Passed the *Verify Internal Adjustment, Self Compensation, and Diagnostics* procedure found under *Self Tests*, on page 1-3.

NOTE

Passing the signal path compensation confirms the signal path for all vertical scale settings for all channels. Passing the internal diagnostics ensures that the factory-set adjustment constants that control the bandwidth for each vertical scale setting have not changed.

h. *Check remaining vertical scale settings against limits (optional):*

- If desired, finish checking the remaining vertical scale settings for the channel under test by repeating substeps d through g for each of the remaining scale settings listed in Table 1-4 for the channel under test.
- When doing substep e, skip the subparts that turn on the CHx Pk-Pk measurement until you check a new channel.
- Install/remove 10X attenuators between the generator leveling head and the channel input as is needed to obtain the six division reference signals listed in the table.

i. *Test all channels:* Repeat substeps a through g for all four channels.

3. *Disconnect the hookup:* Disconnect the test hookup from the input connector of the channel last tested.

Check Delay Between Channels

Equipment Required: One medium-frequency leveled sine wave generator (Item 11), one precision coaxial cable (Item 5), one 50 Ω terminator (Item 4), and a dual-input coupler (Item 8).

Prerequisites: See page 1-10.

Procedure:



DO NOT use the vertical position knob to reposition any channel while doing this check. To do so invalidates the test.

1. *Install the test hookup and preset the instrument controls:*
 - a. *Initialize the front panel:*
 - Press save/recall **SETUP**.
 - Press the main-menu button **Recall Factory Setup**.
 - Press the side-menu button **OK Confirm Factory Init**.
 - b. *Modify the initialized front-panel control settings:*
 - Do *not* adjust the vertical position of any channel during this procedure.
 - Set the horizontal **SCALE** to 500 ps.
 - Press **SHIFT**; then press **ACQUIRE MENU**.
 - Press the main-menu button **Mode**, and then press the side-menu button **Average 16**.
 - c. *Hook up the test-signal source:*
 - Connect, through a 50 Ω precision coaxial cable followed by a 50 Ω termination, the sine wave output of a medium-frequency sine wave generator to a dual-input coupler.
 - Connect the coupler to both **CH 1** and **CH 2**.

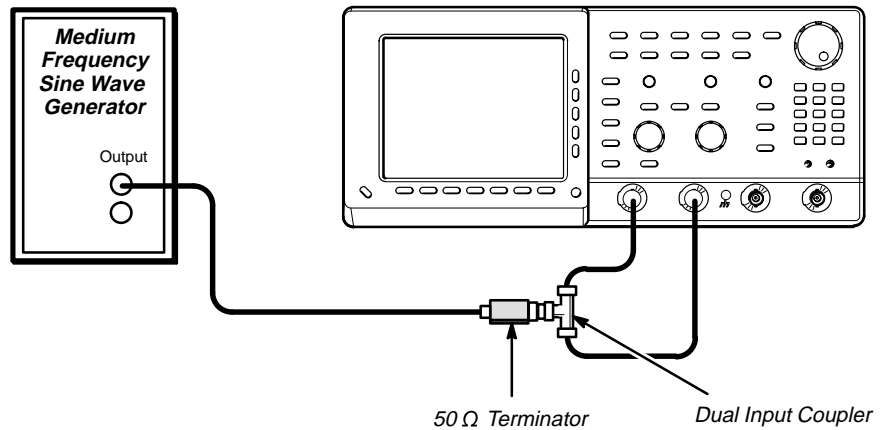

Figure 1-10: Initial Test Hookup

2. Confirm all four channels (CH 1 – CH 4 for TDS 640 or CH 1, CH 2, AUX 1, and AUX 2 for TDS 620) are within limits for channel delay:
 - a. Set up the generator: Set the generator frequency to 250 MHz and the amplitude for about six divisions in CH 1.

Hint: as you are adjusting the generator amplitude, push **SET LEVEL TO 50%** frequently to speed up the updating of the waveform amplitude on screen.
 - b. Save a CH 2 waveform: Press **CH 2**; then press save/recall **WAVEFORM**. Now, press the main-menu button **Save Waveform**; then press the side-menu button **To Ref 2**.
 - c. Save CH 3 (for TDS 640) or AUX 1 (for TDS 620) waveform:
 - TDS 620: Move the coupler from **CH 2** to **AUX 1**, so that **CH 1** and **AUX 1** are driven. Press **WAVEFORM OFF**. Press **AUX 1**; then press the side-menu button **To Ref 3**.

TDS 640: Move the coupler from **CH 2** to **CH 3**, so that **CH 1** and **CH 3** are driven. Press **WAVEFORM OFF**. Press **CH 3**; then press the side-menu button **To Ref 3**
 - d. Display all test signals:
 - TDS 620: Press **WAVEFORM OFF** to remove AUX 1 from the display.

TDS 640: Press **WAVEFORM OFF** to remove CH 3 from the display.
 - TDS 620: Move the coupler from **AUX 1** to **AUX 2**, so that CH 1 and AUX 2 are driven. Press **AUX 2** to display.

TDS 640: Move the coupler from **CH 3** to **CH 4**, so that CH 1 and CH 4 are driven. Press **CH 4** to display.

- Now, press the front-panel button **MORE**. Press the main-menu buttons **Ref 2** and **Ref 3**.
- e. *Measure the test signal:*
- Locate the point on the rising edge of the left-most waveform where it crosses the center horizontal graticule line. This is the *time reference point* for this waveform. Note the corresponding *time reference point* for the right-most waveform. See Figure 1-11.
 - Press **CURSOR**.
 - Press the main-menu button **Function**; then press the side-menu button **V Bars**.
 - Press **CLEAR MENU**.
 - Rotate the General Purpose knob to align one cursor to the *time reference point* of the left-most waveform edge and the other cursor to the *time reference point* of the right-most waveform edge. (Press **TOGGLE** to switch between the two cursors.) See Figure 1-11.
 - Read the measurement results at the Δ : cursor readout, not the @: readout on screen.
- f. *Check against limits:* CHECK that the cursor readout on screen is ≤ 250 ps.
3. *Disconnect the hookup:* Disconnect the cable from the generator output at the input connectors of the channels.

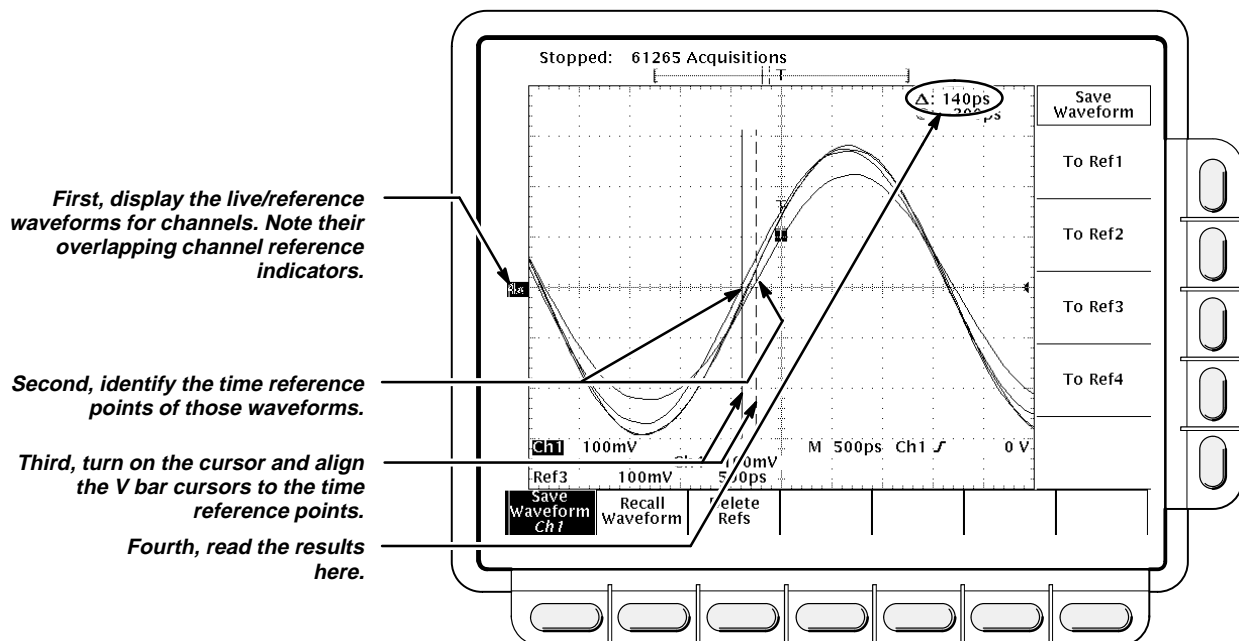

Figure 1-11: Measurement of Channel Delay

Time Base System Checks

These procedures check the characteristics related to the Main and Delayed time base system and are listed as checked under *Warranted Characteristics* in Section 2, *Specification*.

Check Accuracy for Long-Term Sample Rate, Delay Time, and Delta Time Measurements

Equipment Required: One time-mark generator (Item 13) and one precision coaxial cable (Item 5).

Prerequisites: See page 1-10.

Procedure:

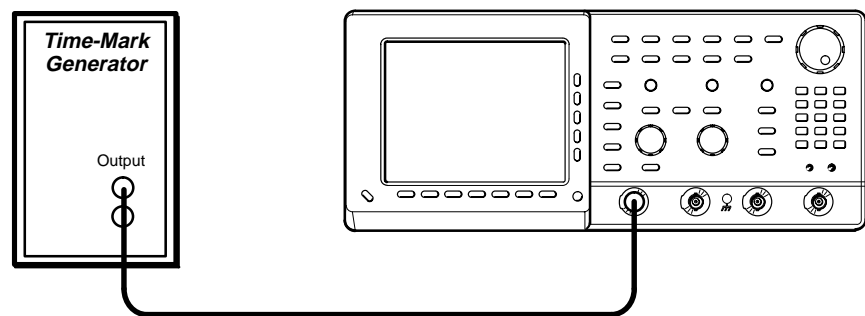

Figure 1-12: Initial Test Hookup

1. *Install the test hookup and preset the instrument controls:*
 - a. *Hook up the test-signal source:*
 - Connect, through a 50 Ω precision coaxial cable, the time-mark output of a time-mark generator to **CH 1**.
 - Set the output of the generator for 10 ms markers.
 - b. *Initialize the oscilloscope:*
 - Press save/recall **SETUP**. Press the main-menu button **Recall Factory Setup**; then press the side-menu button **OK Confirm Factory Init**.
 - c. *Modify the initialized front-panel control settings:*
 - Set the vertical **SCALE** to 500 mV.
 - Press **VERTICAL MENU**; then press the main-menu button **Coupling**. Press the side-menu button Ω to toggle it to the **50 Ω** setting. Press **SET LEVEL TO 50%**.
 - Use the vertical **POSITION** knob to center the test signal on screen.
 - Set the horizontal **SCALE** of the Main time base to 1 ms.

- Press **TRIGGER MENU**; then press the main-menu button **Mode & Holdoff**. Press the side-menu button **Normal**.
 - Press **SET LEVEL TO 50%**.
 - Press **HORIZONTAL MENU**. Press the main-menu button **Record Length**; then press the side-menu button **1000 samples in 20 divs**.
 - Press the main-menu button **Trigger Position**. Press the side-menu button **Pretrigger**. Press the side-menu button **Set to 20%**.
2. *Confirm Main and Delayed time bases are within limits for accuracies:*
- a. *Display the test signal:*
 - Adjust the horizontal **POSITION** so the trigger **T** is aligned to the center vertical graticule line.
 - Press the main-menu button **Time Base**. Press the side-menu buttons **Delayed Only** and **Delayed Runs After Main**.
 - b. *Measure the test signal:*
 - Set the horizontal **SCALE** of the **D** (delayed) time base to 250 ns.
 - Use the keypad to set delayed time to 10 ms. (Press **10**, then **SHIFT**, then **m** followed by **ENTER**.)

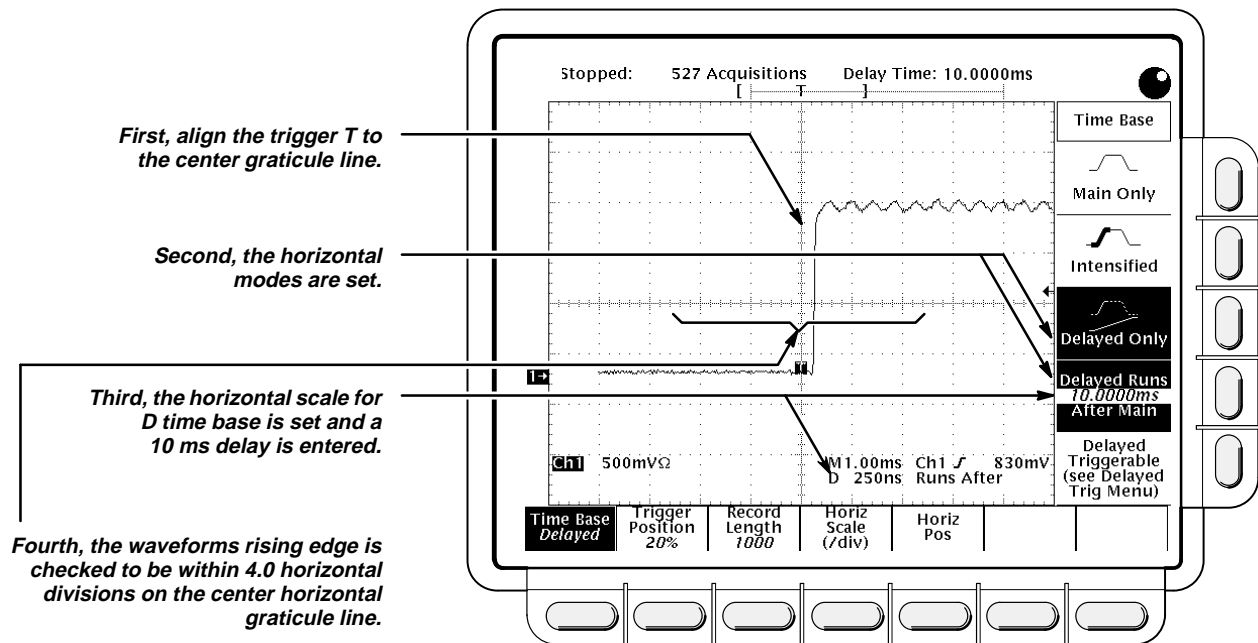

Figure 1-13: Measurement of Accuracy — Long-Term and Delay Time

- c. *Check long-term sample rate and delay time accuracies against limits:* CHECK that the rising edge of the marker crosses the center horizontal graticule line at a point within $\frac{1}{2}$ center graticule.
 - d. *Check delta-time accuracy against limits:*
 - Press the side-menu button **Main Only**. Set horizontal **SCALE** to 2.5 ns.
 - Set the output of the generator for 20 ns markers.
 - Press **SET LEVEL TO 50%**.
 - Press **SHIFT**; then press **ACQUIRE MENU**. Press the main-menu button **Mode**; then press the side-menu button **Average 16**.
 - Press **MEASURE**.
 - Press the main-menu button **High-Low Setup**; then press the side-menu button **Min-Max**.
 - Press the main-menu button **Select Measurement for Ch1**.
 - Press the side-menu button **–more–**, until **PERIOD** appears in the side menu. Press **PERIOD**.
 - Press **CLEAR MENU**.
 - CHECK that the readout for **CH 1 Period** is within 19.760 ns to 20.240 ns.
3. *Disconnect the hookup:* Disconnect the cable from the generator output at the input connector of **CH 1**.

Trigger System Checks

These procedures check those characteristics that relate to the Main and Delayed trigger systems and are listed as checked under *Warranted Characteristics* in Section 2, *Specification*.

Check Accuracy (Time) for Pulse-Glitch or Pulse-Width Triggering

Equipment Required: One medium-frequency leveled sine wave generator (Item 11), one 10X attenuator (Item 1), and one precision coaxial cable (Item 5).

Prerequisites: See page 1-10.

Procedure:

1. *Install the test hookup and preset the instrument controls:*
 - a. *Initialize the instrument:*
 - Press save/recall **SETUP**.
 - Press the main-menu button **Recall Factory Setup**.
 - Press the side-menu button **OK Confirm Factory Init**.
 - b. *Modify the default setup:*
 - Press **VERTICAL MENU**.
 - Press the main-menu button **Coupling**; then press the side-menu button Ω to select 50 Ω coupling.
 - Set the horizontal **SCALE** to 10 ns.

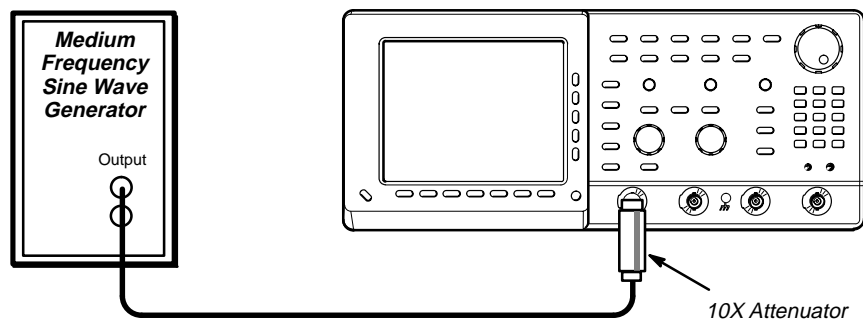

Figure 1-14: Initial Test Hookup

- c. *Hook up the test-signal source:* Connect, through a 50 Ω precision coaxial cable, followed by a 10X attenuator, the output of a medium-frequency leveled sine wave generator (Item 11) to CH 1.

2. *Confirm the trigger system is within time-accuracy limits for pulse-glitch or pulse-width triggering (Horizontal Scale ≥ 2.5 ns):*
 - a. *Display the test signal:* Set the output of the sine wave generator for a 100 MHz, five-division sine wave on screen. Press **SET LEVEL TO 50%**.
 - b. *Set the trigger mode:* Press **TRIGGER MENU**. Now press the main-menu button **Mode & Holdoff**; then press the side-menu button **Normal**.
 - c. *Set upper and lower limits that ensure triggering:*
 - Press the main-menu button **Type**; then repeatedly press the same button until **Pulse** is highlighted in the menu that pops up.
 - Press the main-menu button **Class**; then repeatedly press the same button until **Width** is highlighted in the menu that pops up.
 - Press the main-menu button **Trig When**; then press the side-menu button **Within Limits**.
 - Press the side-menu button **Upper Limit**. Use the keyboard to set the upper limit to 10 ns: press **10**; then **SHIFT**; then **n**; then **ENTER**.
 - Press the side-menu button **Lower Limit**. Use the keypad to set the lower limit to 2 ns.
 - d. *Check against limits:*
 - Press **SET LEVEL TO 50%**.
 - While doing the following subparts, monitor the display (it will stop acquiring) and the front-panel light **TRIG** (it will extinguish) to determine when triggering is lost.
 - Use the general purpose knob to *increase* the **Lower Limit** readout until triggering is lost.
 - CHECK that the **Lower Limit** readout, after the oscilloscope loses triggering, is within 2.5 ns to 7.5 ns, inclusive.
 - Use the keypad to return the **Lower Limit** to 2 ns and reestablish triggering.
 - Press the side-menu button **Upper Limit**; then use the general purpose knob to slowly *decrease* the **Upper Limit** readout until triggering is lost.
 - CHECK that the **Upper Limit** readout, after the oscilloscope loses triggering, is within 2.5 ns to 7.5 ns, inclusive.

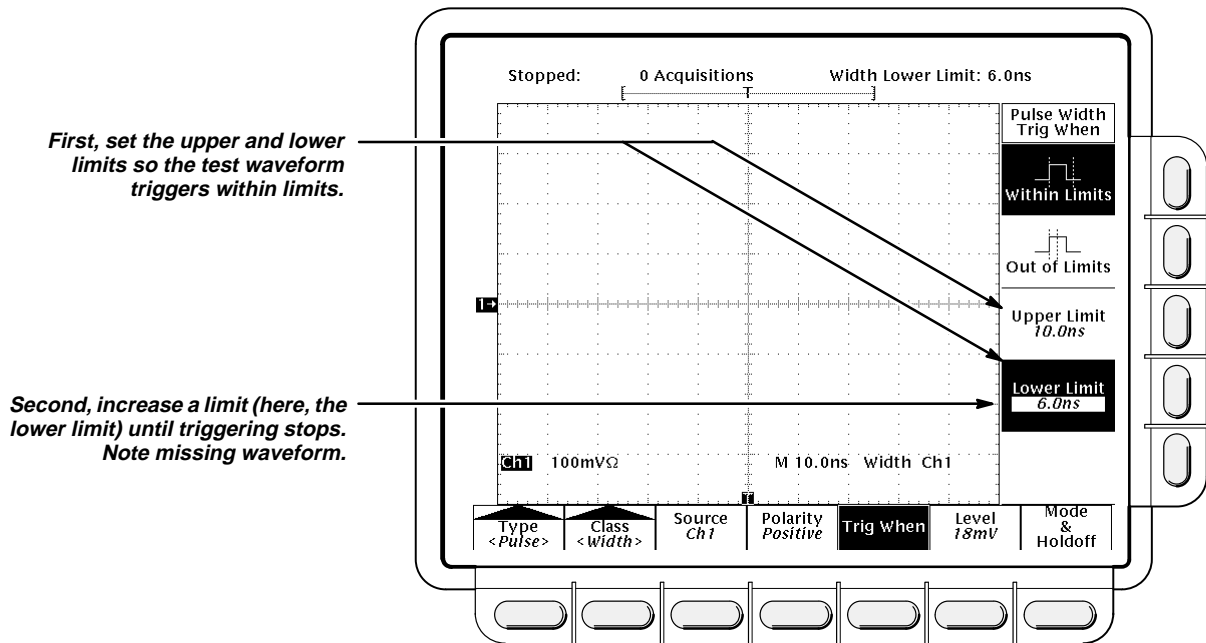

Figure 1-15: Measurement of Time Accuracy for Pulse and Glitch Triggering

3. Confirm the trigger system is within time-accuracy limits for pulse-glitch or pulse-width triggering (horizontal scale $>1 \mu\text{s}$):
 - a. Set upper and lower limits that ensure triggering at 250 kHz:
 - Press the side-menu button **Upper Limit**. Use the keyboard to set the upper limit to 4 μs .
 - Press the side-menu button **Lower Limit**. Use the keypad to set the lower limit to 500 ns.
 - b. Display the test signal:
 - Set the horizontal **SCALE** to 5 μs .
 - Set the output of the sine wave generator for a 250 kHz, five-division sine wave on screen. Set the vertical **SCALE** to 20 mV (the waveform will overdrive the display).
 - Press **SET LEVEL TO 50%**.
 - c. Check against limits: Do the following subparts in the order listed.
 - Use the general purpose knob to *increase* **Lower Limit** readout until triggering is lost.
 - CHECK that the **Lower Limit** readout, after the oscilloscope loses triggering, is within 1 μs to 3 μs , inclusive.
 - Use the keypad to return the **Lower Limit** to 500 ns and reestablish triggering.

- Press the side-menu button **Upper Limit**; then use the general purpose knob to slowly *decrease* the **Upper Limit** readout until triggering is lost.
 - CHECK that the **Upper Limit** readout, after the oscilloscope loses triggering, is within 1 μ s to 3 μ s, inclusive.
4. *Disconnect the hookup*: Disconnect the cable from the generator output at the input connector of **CH 1**.

Check Accuracy, Trigger-level or Threshold, DC Coupled

Equipment Required: One DC calibration generator (Item 9), one BNC T connector (Item 7), and two precision coaxial cables (Item 5).

Prerequisites: The oscilloscope must meet the prerequisites listed under *Performance Tests*, on page 1-10.

Procedure:

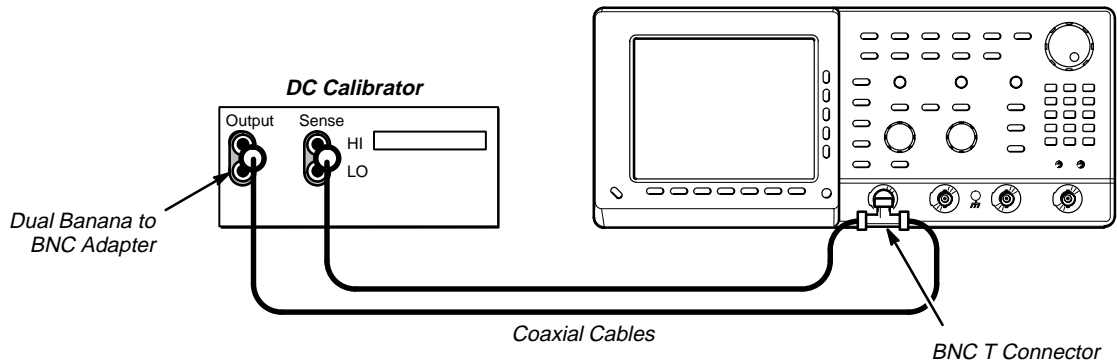

Figure 1-16: Initial Test Hookup

1. *Install the test hookup and preset the instrument controls:*
 - a. *Hook up the test-signal source:*
 - Set the output of the DC calibration generator to 0 volts.
 - Connect the output of the DC calibration generator through a dual-banana connector followed by a 50 Ω precision coaxial cable to one side of a BNC T connector.
 - Connect the Sense output of the generator, through a second dual-banana connector followed by a 50 Ω precision coaxial cable, to other side of the BNC T connector. Now connect the BNC T connector to **CH 1**.

- Press the side-menu buttons **Delayed Only** and **Delayed Triggerable**.
- Set **D** (delayed) horizontal **SCALE** to 500 μ s.

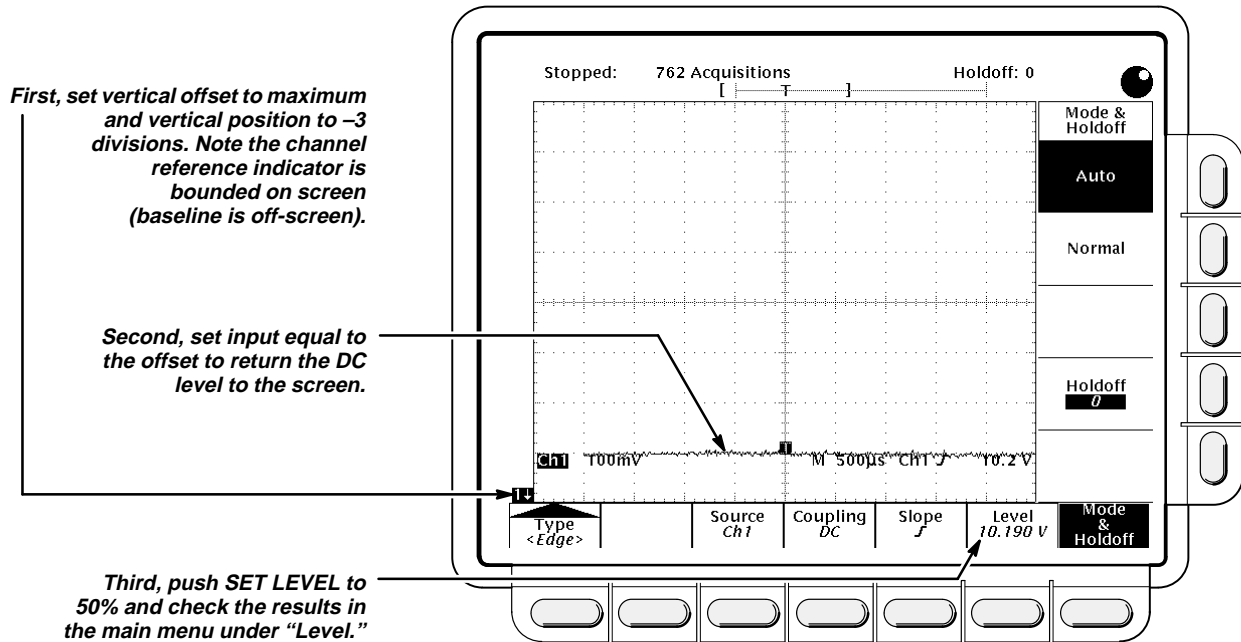

Figure 1-17: Measurement of Trigger-Level Accuracy

- b. *Select the Delayed trigger system:*
 - Press **SHIFT**; then press the front-panel button **DELAYED TRIG**.
 - Press the main-menu button **Level**.
- c. *Measure the test signal:* Press the *side-menu button Set to 50%*. Read the measurement results in the side menu below the label **Level**.
- d. *Check against limits:* Do the following subparts in the order listed.
 - CHECK that the **Level** readout in the side menu is within 9.863 V to 10.137 V, inclusive.
 - Press the main-menu button **Slope**; then press the side-menu button for negative slope. (See icon at left.) Press the main-menu button **Level**.
 - Press the *side-menu button Set to 50%*. Read the measurement results in the side menu below the label **Level**.
 - CHECK that the **Level** readout in the side menu is within 9.863 V to 10.137 V, inclusive.

4. *Modify the initialized front-panel control settings:*

- a. *Select the Delayed time base:*
 - Set **D** (delayed) horizontal **SCALE** to 10 μ s.
 - Press **HORIZONTAL MENU**.
 - Press the main-menu button **Time Base**.
 - Press the side-menu button **Main Only**.
 - Set **M** (main) horizontal **SCALE** to 10 μ s.
 - b. *Measure the test signal:*
 - Press **SET LEVEL TO 50%**. Press **TRIGGER MENU**.
 - Read the measurement results from the readout below the label **Level** in the menu; not the trigger readout in the graticule area.
 - c. *Check against limits:*
 - CHECK that the **Level** readout in the main menu is within 9.863 V to 10.137 V, inclusive (see Figure 1-17).
 - Press the main-menu button **Slope**; then press the side-menu button for negative slope. (See icon at left.) Press **SET LEVEL TO 50%**.
 - Press **TRIGGER MENU**.
 - CHECK that the **Level** readout in the main menu is within 9.863 V to 10.137 V, inclusive.
 - d. *Repeat step 3 (exclude the horizontal **SCALE** change in substep 3a.)*
5. *Disconnect the hookup:*
- a. *First set the output of the DC calibration generator to 0 volts.*
 - b. Disconnect the cable from the generator output at the input connector of **CH 1**.



Sensitivity, Edge Trigger, DC Coupled

Equipment Required: One medium-frequency leveled sine wave generator (Item 11), one high-frequency leveled sine wave generator (Item 12), two precision 50 Ω coaxial cables (Item 5), and one 10X attenuator (Item 1) one BNC T connector (Item 7), and one 5X attenuator (Item 2).

Prerequisites: See page 1-10.

Procedure:

1. *Install the test hookup and preset the instrument controls:*
 - a. *Initialize the oscilloscope:*
 - Press save/recall **SETUP**. Press the main-menu button **Recall Factory Setup**. Press the side-menu button **OK Confirm Factory Init**.

- b. *Modify the initialized front-panel control settings:*
- Set the horizontal **SCALE** for the **M** (main) time base to 25 ns.
 - Press **HORIZONTAL MENU**; then press the main-menu button **Time Base**.
 - Press the side-menu button **Delayed Only**; then press the side-menu button **Delayed Triggerable**.
 - Set the horizontal **SCALE** for the **D** (delayed) time base to 25 ns; then press the side-menu button **Main Only**.
 - Press **TRIGGER MENU**; then press the main-menu button **Mode & Holdoff**. Press the side-menu button **Normal**.
 - Press **VERTICAL MENU**; then press the main-menu button **Coupling**. Press the side-menu button Ω to select the 50 Ω setting.
 - Press **SHIFT**; then press **ACQUIRE MENU**. Press the main-menu button **Mode**; then press the side-menu button **Average 16**.
- c. *Hook up the test-signal source:*
- Connect the signal output of a medium-frequency sine wave generator to a BNC T connector.
 - Connect one output of the T connector to **CH 1** through a 50 Ω precision coaxial cable.
 - Connect the other output of the T connector through a second 50 Ω precision coaxial cable to the **AUX TRIG INPUT** at the rear panel. See Figure 1-18.

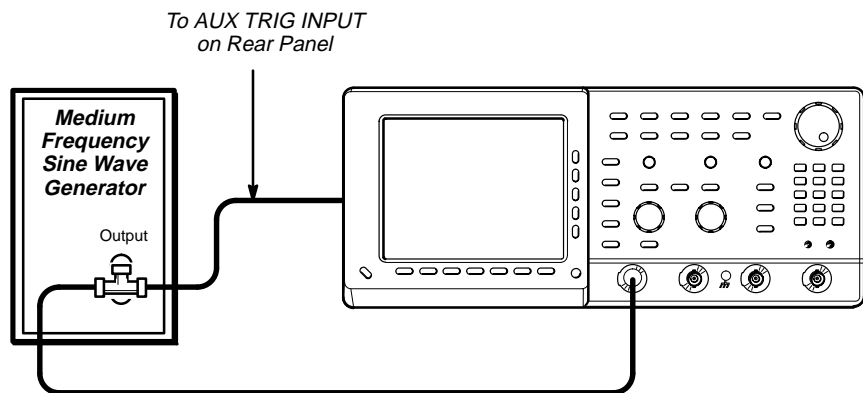

Figure 1-18: Initial Test Hookup

2. *Confirm Main and Delayed trigger systems are within sensitivity limits (50 MHz):*
 - a. *Display the test signal:*



- Set the generator frequency to 50 MHz.
 - Press **MEASURE**.
 - Press the main-menu button **High-Low Setup**; then press the side-menu button **Min-Max**.
 - Press the main-menu button **Select Measurement for Ch1**.
 - Press the side-menu button **–more–** until **Amplitude** appears in the side menu (its icon is shown at the left). Press the side-menu button **Amplitude**.
 - Press **SET LEVEL TO 50%**.
 - Press **CLEAR MENU**.
 - Set the test signal amplitude for about three divisions on screen. Now fine adjust the generator output until the **CH 1 Amplitude** readout indicates the amplitude is 350 mV. (Readout may fluctuate around 350 mV.)
 - Disconnect the 50 Ω precision coaxial cable at **CH 1** and reconnect it to **CH 1** through a 10X attenuator.
- b. *Check the Main trigger system for stable triggering at limits:*
- Read the following definition: A stable trigger is one that is consistent, resulting in a uniform, regular display triggered on the selected slope (positive or negative). This display should *not* have its trigger point switching between opposite slopes, nor should it “roll” across the screen. At horizontal scale settings of 2 ms/division and faster, **TRIG’D** will remain constantly lit. It will flash for slower settings.
 - Press **TRIGGER MENU**; then press the main-menu button **Slope**.
 - Press **SET LEVEL TO 50%**. CHECK that a stable trigger is obtained for the test waveform on both the positive and negative slopes. (Use the side menu to switch between trigger slopes; use the **TRIGGER LEVEL** knob to stabilize the trigger if required.)
 - Leave the Main trigger system triggered on the positive slope of the waveform before continuing to the next step.

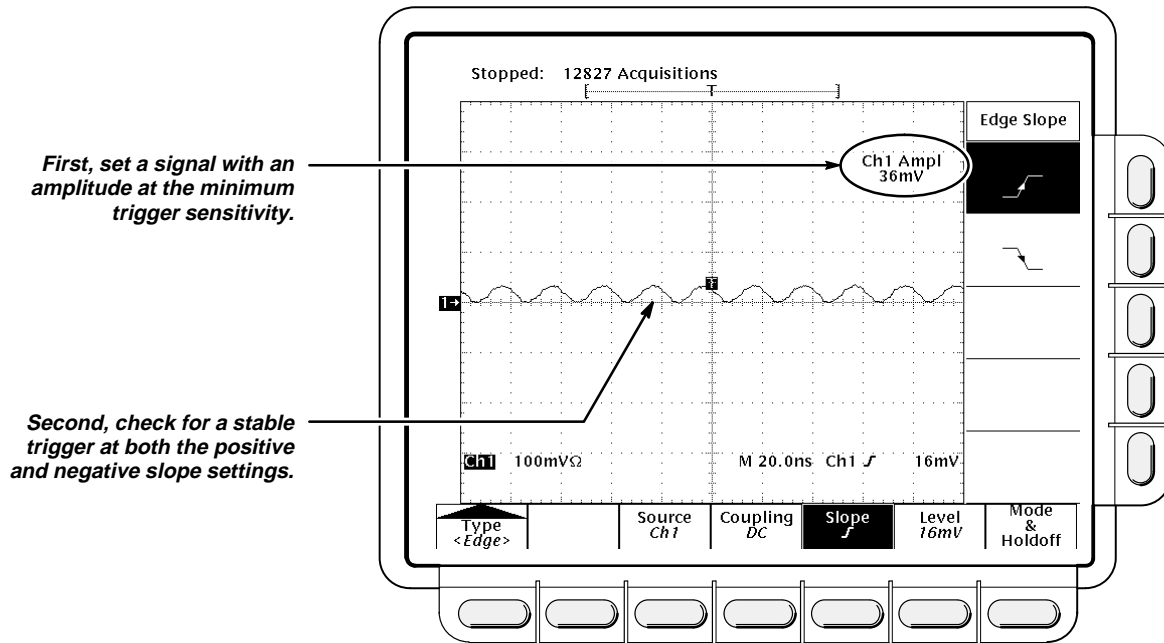

Figure 1-19: Measurement of Trigger Sensitivity

- c. Check Delayed trigger system for stable triggering at limits: Do the following subparts in the order listed.
 - Press **HORIZONTAL MENU**; then press the main-menu button **Time Base**. Press the side-menu button **Delayed Only**; then press **Delayed Triggerable** in the same menu.
 - Press **SHIFT**; then press **DELAYED TRIG**. Press the main-menu button **Level**.
 - Press the main-menu button **Slope**; then use the side menu to switch between trigger slopes. Press the main-menu button **Level**.
 - Press the side-menu button **Set to 50%**. CHECK that a stable trigger is obtained for the test waveform for both the positive and negative slopes of the waveform. (Use the General Purpose knob to stabilize the trigger if required.)
 - Leave the Delayed trigger system triggered on the positive slope of the waveform before continuing to the next step. Also, return to the main time base: Press **HORIZONTAL MENU**; then press the main-menu button **Time Base**. Press the side-menu button **Main Only**.
3. Confirm the AUX Trigger input:
 - a. Display the test signal:
 - Remove the 10X attenuator and reconnect the cable to **CH 1**.
 - Set the test signal amplitude for about 2.5 divisions on screen.

- Now fine adjust the generator output until the **CH 1 Amplitude** readout indicates the amplitude is 250 mV. (Readout may fluctuate around 250 mV.)
 - b. *Check AUX trigger source for stable triggering at limits:* Do the following in the order listed.
 - Use the definition for stable trigger from step 2b.
 - Press **TRIGGER MENU**; then press the main-menu button **Source**.
 - Press the side-menu button **–more–** until the side-menu label **Auxiliary** appears; then press **Auxiliary**.
 - Press **SET LEVEL TO 50%**. CHECK that a stable trigger is obtained for the test waveform on both the positive and negative slopes. Press the main-menu button **Slope**; then use the side menu to switch between trigger slopes. Use the **TRIGGER LEVEL** knob to stabilize the trigger if required.
 - Leave the Main trigger system triggered on the positive slope of the waveform before proceeding to the next check.
 - Press the main-menu button **Source**; then press the side-menu button **–more–** until **CH 1** appears. Press **CH 1**.
- 4. *Confirm that the Main and Delayed trigger systems are within sensitivity limits (500 MHz):*
 - a. *Hook up the test-signal source:* Disconnect the hookup installed in step 1. Connect, through its leveling head, the signal output of a high-frequency leveled sine wave generator to **CH 1**.
 - b. *Set the Main and Delayed Horizontal Scales:*
 - Set the horizontal **SCALE** to 500 ps for the **M** (Main) time base.
 - Press **HORIZONTAL MENU**. Now press the main-menu button **Time base**; then press the side-menu button **Delayed Triggerable**.
 - Press the side-menu button **Delayed Only**.
 - Set the horizontal **SCALE** to 500 ps for the **D** (Delayed) time base. Press the side-menu button **Main Only**.
 - c. *Display the test signal:*
 - Set the generator frequency to 500 MHz.
 - Set the test signal amplitude for about five divisions on screen. Now fine adjust the generator output until the **CH 1 Amplitude** readout indicates the amplitude is 500 mV. (Readout may fluctuate around 500 mV.) Press **SET LEVEL TO 50%**.
 - Disconnect the leveling head at **CH 1** and reconnect it to **CH 1** through a 5X attenuator.

- d. *Check the Main trigger system for stable triggering at limits:*
 - Read the following definition: A stable trigger is one that is consistent, resulting in a uniform, regular display triggered on the selected slope (positive or negative). This display should *not* have its trigger point switching between opposite slopes, nor should it “roll” across the screen. At horizontal scale settings of 2 ms/division and faster, **TRIG'D** will remain constantly lit. It will flash for slower settings.
 - Press **TRIGGER MENU**; then press the main-menu button **Slope**.
 - Press **SET LEVEL TO 50%**. CHECK that a stable trigger is obtained for the test waveform on both the positive and negative slopes. (Use the side menu to switch between trigger slopes; use the **TRIGGER LEVEL** knob to stabilize the trigger if required.)
 - Leave the Main trigger system triggered on the positive slope of the waveform before continuing to the next step.
- e. *Check Delayed trigger system for stable triggering at limits:* Do the following subparts in the order listed.
 - Press **HORIZONTAL MENU**; then press the main-menu button **Time Base**. Press the side-menu button **Delayed Only**; then press **Delayed Triggerable** in the same menu.
 - Press **SHIFT**; then press **DELAYED TRIG**. Press the main-menu button **Level**.
 - Press the side-menu button **Set to 50%**. CHECK that a stable trigger is obtained for the test waveform for both the positive and negative slopes of the waveform. (Use the General Purpose knob to stabilize the trigger if required.)
 - Press the main-menu button **Slope**; then use the side menu to switch between trigger slopes. Press the main-menu button **Level**.
 - Leave the Delayed trigger system triggered on the positive slope of the waveform before continuing to the next step. Also, return to the main time base: Press **HORIZONTAL MENU**; then press the main-menu button **Time Base**. Press the side-menu button **Main Only**.
5. *Confirm that the Main and Delayed trigger systems couple trigger signals from all channels:* Doing the procedure *Check Analog Bandwidth*, which begins on page 1-21, checks coupling. If you have not done that procedure, do so after finishing this procedure. See the following note.

NOTE

Steps 1 through 4 confirmed trigger sensitivity for the Main and Delayed triggering systems using the CH 1 input. Doing the procedure Check Analog Bandwidth ensures that trigger signals are coupled from all four channels.

6. *Disconnect the hookup:* Disconnect the cable from the channel last tested.

Output Signal Checks

The procedure that follows checks those characteristics of the output signals that are listed as checked under *Warranted Characteristics* in Section 2, *Specification*. The oscilloscope outputs these signals at its front and rear panels.

Check Outputs — AUX 1 (for TDS 620) or CH 3 (for TDS 640) and Main and Delayed Trigger

Equipment Required: Two 50 Ω precision cables (Item 5), and one calibration generator (Item 10).

Prerequisites: See page 1-10. Also, the oscilloscope must have passed *Check Accuracy for DC Gain and Voltage Measurements* on page 1-15.

Procedure:

1. *Install the test hookup and preset the instrument controls:*

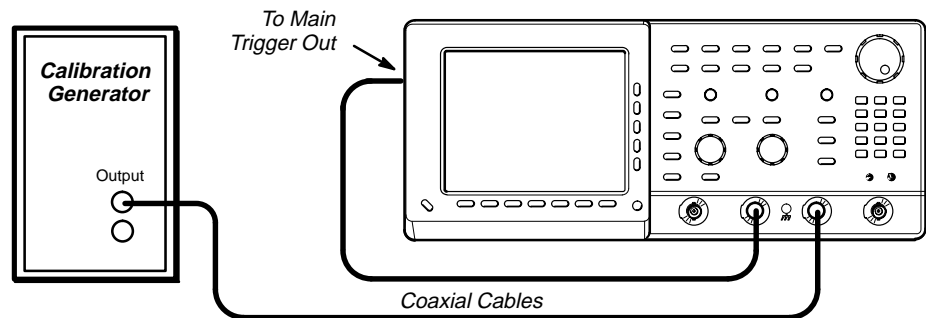
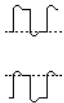

Figure 1-20: Initial Test Hookup

- a. *Hook up test-signal source 1:*
 - TDS 620: Connect the standard amplitude output of a calibration generator through a 50 Ω precision coaxial cable to **AUX 1**
 - TDS 640: Connect the standard amplitude output of a calibration generator through a 50 Ω precision coaxial cable to **CH 3**.
 - Set the output of the calibration generator to 0.500 V.
- b. *Hook up test-signal source 2:* Connect the **Main Trigger Out** at the rear panel to **CH 2** through a 50 Ω precision cable.
- c. *Initialize the oscilloscope:*
 - Press save/recall **SETUP**. Press the main-menu button **Recall Factory Setup**. Press the side-menu button **OK Confirm Factory Init**.

- d. *Modify the initialized front-panel control settings:*
- Press **AUTOSET**. Set the horizontal **SCALE** to 250 μ s.
 - Press **SHIFT**; then press **ACQUIRE MENU**.
 - Press the main-menu button **Mode**; then press the side-menu button **Average**.
 - Select **64** averages using the keypad or the general purpose knob.
2. *Confirm Main and Delayed Trigger outputs are within limits for logic levels:*
- a. *Display the test signal:*
- Press **WAVEFORM OFF** to turn off CH 1.
 - Press **CH 2** to display that channel.
 - Set the vertical **SCALE** to 1 V.
 - Use the vertical **POSITION** knob to center the display on screen.
- b. *Measure logic levels:*
- Press **MEASURE**; then press the main-menu button **Select Measurement for Ch2**.
 - Repeatedly press the side-menu button **–more–** until **High** and **Low** appear in the side menu (their icons are shown at the left). Press both side-menu buttons **High** and **Low**.
- c. *Check Main Trigger output against limits:*
- CHECK that the **Ch2 High** readout is ≥ 2.5 volts and that the **Ch2 Low** readout is ≤ 0.7 volts.
 - Press **VERTICAL MENU**; then press the main-menu button **Coupling**. Now press the side-menu button Ω to toggle it to the 50 Ω setting.
 - CHECK that the **Ch2 High** readout is ≥ 1.0 volt and the **Ch2 Low** readout ≤ 0.25 volts.
- d. *Check Delayed Trigger output against limits:*
- Move the precision 50 Ω cable from the **Main Trigger Output** BNC to the **Delayed Trigger Output** BNC.
 - CHECK that the **Ch2 High** readout is ≥ 1.0 volt and that the **Ch2 Low** readout ≤ 0.25 volts (see Figure 1-21).
 - Press the side-menu button Ω to select the 1 M Ω setting.
 - Press **CLEAR MENU**.
 - CHECK that the **Ch2 High** readout is ≥ 2.5 volts and that the **Ch2 Low** readout is ≤ 0.7 volts.



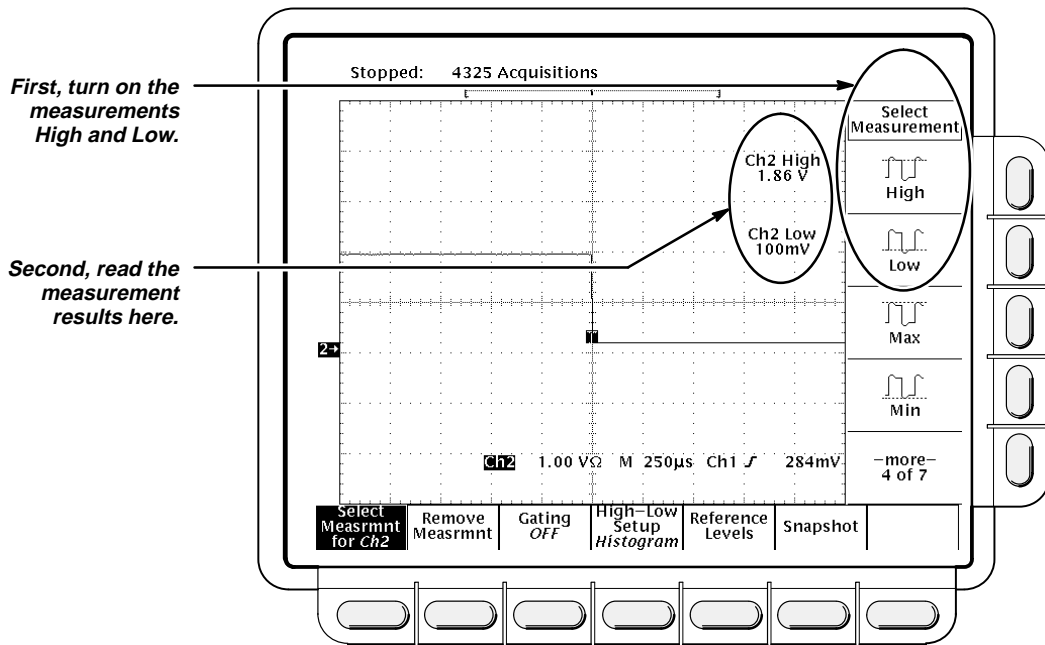

Figure 1-21: Measurement of Main Trigger Out Limits

3. Confirm AUX 1 (for TDS 620) or CH 3 (for TDS 640) output is within limits for gain:
 - a. Measure gain:
 - TDS 620: Move the precision 50 Ω cable from the **DELAYED TRIGGER OUTPUT** BNC to the **SIGNAL OUTPUT** BNC.
 - TDS 640: Move the precision 50 Ω cable from the **DELAYED TRIGGER OUTPUT** BNC to the **CH 3 SIGNAL OUT** BNC.
 - Push **TRIGGER MENU**.
 - Press the main-menu button **Source**
 - TDS 620: Press the side-menu button **Ax1**.
 - TDS 640: Press the side-menu button **Ch3**.
 - Set vertical **SCALE** to 20 mV.
 - Press **SET LEVEL TO 50%**.
 - Press **MEASURE**; then press the main-menu button **Select Measurements for Ch2**.
 - Repeatedly press the side-menu button **—more—** until **Pk-Pk** appears in the side menu (its icon is shown at the left). Press the side-menu button **Pk-Pk**.
 - Press **CLEAR MENU**.



- b. *Check against limits:*
 - CHECK that the readout **Ch2 Pk-Pk** is between 80 mV and 120 mV, inclusive.
 - Press **VERTICAL MENU**; then press the side-menu button Ω to toggle to the 50 Ω setting.
 - Press **CLEAR MENU**.
 - CHECK that the readout **Ch2 Pk-Pk** is between 40 mV and 60 mV, inclusive.
4. *Disconnect the hookup:* Disconnect the cables from the channel inputs and the rear panel outputs.

Check Probe Compensator Output

Equipment Required: One female BNC to clip adapter (item 3), two dual-banana connectors (Item 6), one BNC T connector (Item 7), two 50 Ω precision cables (Item 5), and one DC calibration generator (Item 9).

Prerequisites: See page 1-10. Also, the oscilloscope must have passed *Check Accuracy—Long-Term Sample Rate, Delay Time, and Delta Time Measurements* on page 1-28.

Procedure:

1. *Install the test hookup and preset the instrument controls:*

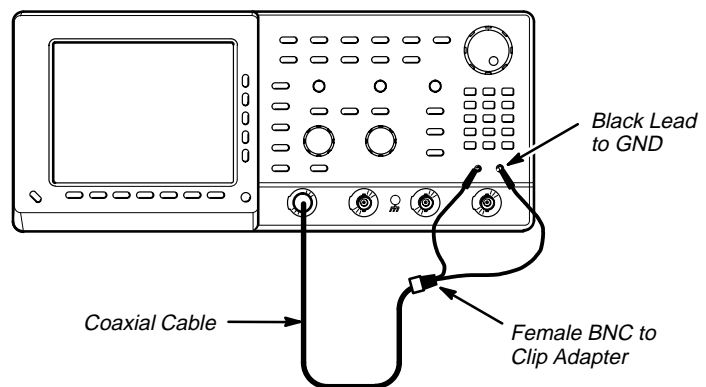

Figure 1-22: Initial Test Hookup

- a. *Hook up test-signal:*
 - Connect one of the 50 Ω cables to **CH 1**.
 - Connect the other end of the cable just installed to the female BNC to clips adapter.

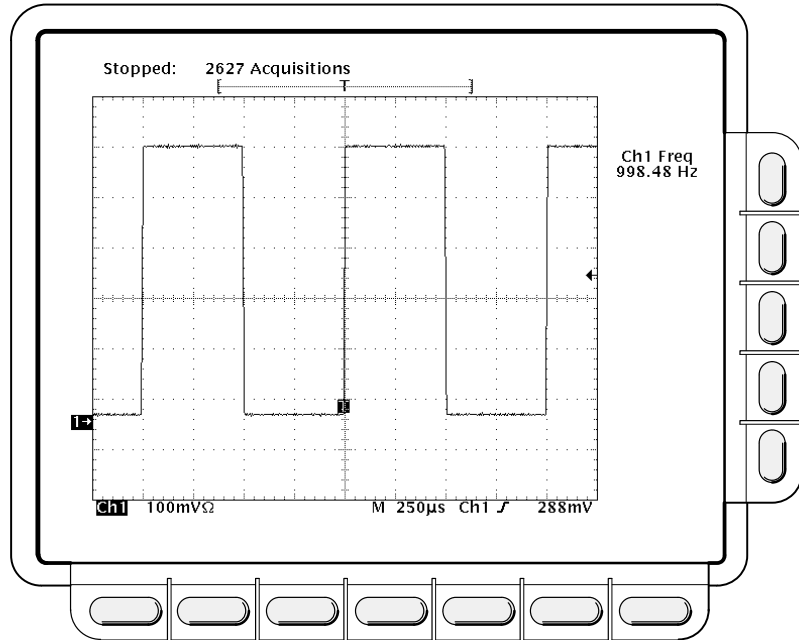

Figure 1-23: Measurement of Probe Compensator Frequency

d. *Hook up the DC standard source:*

- Set the output of a DC calibration generator to 0 volts.
- Connect the output of a DC calibration generator through a dual-banana connector followed by a 50 Ω precision coaxial cable to one side of a BNC T connector (see Figure 1-24).
- Connect the Sense output of the generator through a second dual-banana connector followed by a 50 Ω precision coaxial cable to the other side of the BNC T connector. Now connect the BNC T connector to **CH 1**.

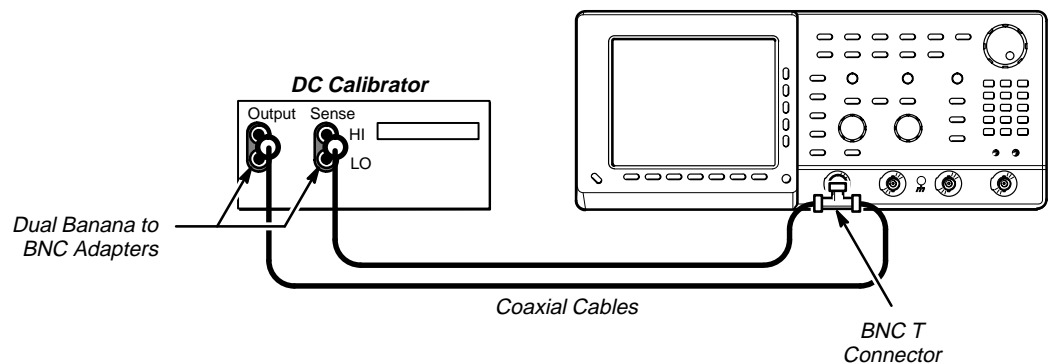

Figure 1-24: Subsequent Test Hookup

- e. *Measure amplitude of the probe compensation signal:*
- Press **SHIFT**; then press **ACQUIRE MENU**. Press the the side-menu button **AVERAGE** then enter 16 using the keypad or the general purpose knob.
 - Adjust the output of DC calibration generator until it precisely overlaps the top (upper) level of the stored probe compensation signal. (This value will be near 500 mV.)
 - Record the setting of the DC generator.
 - Adjust the output of DC calibration generator until it precisely overlaps the base (lower) level of the stored probe compensation signal. (This value will be near zero volts.)
 - Record the setting of the DC generator.
- f. Press **CLEAR MENU** to remove the menus from the display. See Figure 1-25.

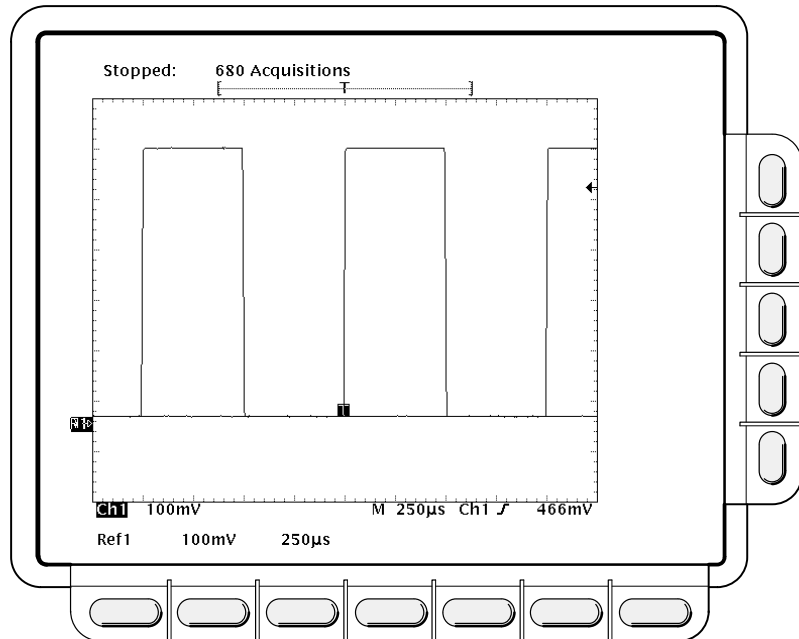

Figure 1-25: Measurement of Probe Compensator Amplitude

- g. *Check against limits:*
- Subtract the value just obtained (base level) from the setting you recorded in step 2e above.
 - CHECK that the difference obtained is within 495 mV to 505 mV, inclusive.
3. *Disconnect the hookup:* Disconnect the cable from **CH 1**.



Specification



Specification

This section describes and lists the traits of the TDS 600 Digitizing Oscilloscopes. Three sets of tables follow, one set for each of three classes of traits: *nominal traits*, *warranted characteristics*, and *typical characteristics*.

General

The Tektronix TDS 600 Digitizing Oscilloscopes are portable, four-channel instruments suitable for use in a variety of test and measurement applications and systems. Key differences between the two models are as follows:

- The TDS 640 supplies four full-featured channels. The TDS 620 supplies four full-featured channels for use with two samplers.
- The TDS 640 has four input channels labeled CH 1, CH 2, CH 3, and CH 4. The TDS 620 has four input channels labeled CH 1, CH 2, AUX 1, and AUX 2.
- The TDS 640 has a maximum sample rate of 2 GSamples/second, on all four channels simultaneously. The TDS 620 has a maximum sample rate of 2 GSamples/second, on any two channels simultaneously.

Key features they have in common are as follows:

- A record length of 2,000 samples and 8-bit vertical resolution.
- An analog bandwidth of 500 MHz.
- Extensive triggering capabilities such as edge, logic, and pulse.
- Limit testing and template generation capability.
- Full programmability and printer/plotter output.
- Advanced functions such as continuously-updated measurements.
- Specialized display modes, such as infinite and variable persistence.
- A unique graphical user interface (GUI), an on-board help mode, and a logical front-panel layout which combine to deliver a new standard in usability.

User Interface

These oscilloscopes use a combination of front-panel buttons, knobs, and on-screen menus to control their many functions. Front-panel controls are grouped according to function: vertical, horizontal, trigger, and special. Any function likely to get adjusted often, such as vertical positioning or the time base setting, is set directly by its own front-panel knob. Functions which are changed less often, such as vertical coupling and horizontal mode, are set indirectly using selected menus.

Menus

Pressing one (sometimes two) front-panel button(s), such as vertical menu, displays a *main* menu of related functions, such as coupling, bandwidth, etc., at the bottom of the screen. Pressing a main-menu button, such as coupling, displays a *side* menu of settings for that function, such as AC, DC, or GND (ground) coupling, at the right side of the screen. Pressing a side-menu button selects a setting such as DC.

Indicators

On-screen readouts help you keep track of the settings for various functions, such as vertical and horizontal scale and trigger level. Some readouts use the cursors or the automatic parameter extraction feature (called measure) to display the results of measurements or the status of the instrument.

General Purpose Knob

The general purpose knob can be assigned to adjust a selected parameter function and can quickly change parameters by toggling the **SHIFT** button. Use the same method as for *selecting* a function, except the final selection in the side menu assigns the general purpose knob to *adjust* some function, such as the position of measurement cursors on screen, or the setting for a channels fine gain.

GUI

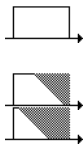

The user interface also makes use of a Graphical User Interface, or GUI, to make setting functions and interpreting the display more intuitive. Some menus and status are displayed using iconic representations of function settings such as those shown here for full, 100 MHz, and 20 MHz bandwidth. Such icons allow you to more readily determine status or the available settings.

Signal Acquisition System

TDS 620

The signal acquisition system of the TDS 620 Digitizing Oscilloscope provides four full-featured vertical channels, CH 1, CH 2, AUX 1 and AUX 2, with calibrated vertical scale factors from 1 mV to 10 V per division. Any two of the four channels can be acquired simultaneously.

TDS 640

The signal acquisition system of the TDS 640 Digitizing Oscilloscope provides four full-featured vertical channels, CH 1, CH 2, CH 3, and CH 4 with calibrated vertical scale factors from 1 mV to 10 V per division. All four channels can be acquired simultaneously.

Both Models

Each of the four channels can be displayed, vertically positioned, and offset, can have their bandwidth limited (100 MHz or 20 MHz) and their vertical coupling specified. Fine gain can also be adjusted.

Besides the four channels, up to three math waveforms and four reference waveforms are available for display. (A math waveform results when you specify dual waveform operations, such as add, on any two channels; a reference waveform results when you save a live waveform in a reference memory.)

Horizontal System

There are three horizontal display modes: main only, main intensified, and delayed only. You can select the horizontal record length setting (see Table 2-1).

Table 2-1: Record Length versus Divisions per Record

Record Length	Divisions per Record (50 Samples/Division)
2000	40 divs
1000	20 divs
500	10 divs

Both the delayed only display and the intensified zone on the main intensified display, may be delayed by time with respect to the main trigger. Both can be set to display immediately after the delay (delayed runs after main mode); the delayed display can also be set to display at the first valid trigger after the delay (delayed-triggerable mode).

The delayed display (or the intensified zone) may also be delayed by a selected number of events. In such a case, the events source is the delayed-trigger source. For any events signal, the delayed-trigger system conditions the signal by determining the source, coupling, etc., of that signal.

Trigger System

The triggering system is comprised of three types of signals for triggering the signal acquisition system:

- **Edge** (main- and delayed-trigger systems): This familiar type of triggering is fully configurable for source, slope, coupling, mode (auto or normal), and holdoff.

- **Logic** (main-trigger system): This type of triggering can be based on pattern (asynchronous) or state (synchronous). In either case, logic triggering is configurable for sources, for boolean operators to apply to those sources, for logic pattern or state on which to trigger, for mode (auto or normal), and for holdoff. Time-qualified logic triggering may be selected in pattern mode.
- **Pulse** (main-trigger system): Pulse triggering is configurable for triggering on runt or glitch pulses, or on pulse widths or periods inside or outside limits that you specify. It is also configurable for source, polarity, mode, and holdoff.

You can choose where the trigger point is located within the acquired waveform record by selecting the amount of pretrigger data displayed. Presets of 20%, 50%, and 80% of pretrigger data can be selected in the horizontal menu, or the general purpose knob can be assigned to set pretrigger data to any value within the 20% to 80% limits.

Acquisition Control

You can specify the mode and manner in which signals are acquired and processed, depending on your measurement requirements:

- You can select the mode for interpolation of points sampled on non-repetitive signals (linear or $\sin(x)/x$). This can increase the apparent sample rate on the waveform when maximum real-time rates are reached.
- Sample, envelope, and average modes can be used to acquire signals.
- The acquisition can be set to stop after a single acquisition (or sequence of acquisitions if acquiring in average or envelope modes), or after a limit condition has been met.

On-Board User Assistance

Use the help and autoset features when setting up the oscilloscope to make measurements.

Help

Help displays operational information about any front-panel control. When help mode is in effect, manipulating any front-panel control causes the oscilloscope to display information about that control. When help is first invoked, an introduction to help is displayed on screen.

Autoset

Autoset automatically sets up the oscilloscope for a viewable display based on the input signal.

Measurement Assistance

The cursor and measure features can help you quickly make measurements, once you are set up to make measurements.

Cursor

Three types of cursors are provided for making parametric measurements on the displayed waveforms. Horizontal bar cursors (H Bar) measure vertical parameters (typically volts). Vertical bar cursors (V Bar) measure horizontal parameters (typically time or frequency). Paired cursors measure both amplitude and time simultaneously. These are delta measurements; that is, measurements based on the difference between two cursors.

Both H Bar and V Bar cursors can also be used to make absolute measurements. These measurements are relative to a defined level or event. For the H Bars, either cursor can be selected to read out its voltage with respect to any channels ground reference level. For the V Bars, it's time with respect to the trigger point (event) of the acquisition and the cursors can control the portion of the waveform on which automatic measurements are made.

For time measurements, units can be either seconds or Hertz (for 1/time).

Measure

Measure can automatically extract parameters from the signal input to the oscilloscope. Any four out of the more than 20 parameters available can be displayed to the screen. The displayed parameters are extracted continuously and the results updated on-screen as the oscilloscope continues to acquire waveforms.

Digital Signal Processing (DSP)

Tektronix' proprietary digital signal processor, (DSP) is an important component of the multiprocessor architecture of these oscilloscopes. This dedicated processor supports advanced analysis of waveforms when doing such compute-intensive tasks as interpolation, waveform math, and signal averaging. It also teams with a custom display system to deliver specialized display modes (See *Display*, later in this description.)

Storage and I/O

Acquired waveforms can be saved in any of four nonvolatile reference (REF) memories. Any or all of the saved waveforms can be displayed for comparison with waveforms currently being acquired.

You can choose the source and destination of waveforms to be saved. You can assign any of the four channels to any REF memory, or to move a stored reference from one REF memory to another. Reference waveforms can also be written into a REF memory location via the GPIB interface.

The oscilloscope is fully controllable and capable of sending and receiving waveforms over the GPIB interface (IEEE Std 488.1-1987/IEEE Std 488.2-1987 standard). This feature makes the instrument ideal for making automated measurements in a production or research and development environment that calls for repetitive data taking. Fault detection features, such as self-compensation and self-diagnostic, are built into the oscilloscope to aid in servicing. These features are also accessible using commands sent from a GPIB controller.

Hardcopy is another standard feature. This feature allows you to output waveforms and other on-screen information to a variety of graphic printers and plotters from the oscilloscope front panel. It provides hardcopies, in a variety of popular output formats, such as TIFF, PCX, BMP, and EPS mono or color, without requiring you to put the oscilloscope into a system-controller environment. The hardcopies obtained are based on what is displayed on-screen at the time hardcopy is invoked, and can be stamped with date and time and spooled to a queue for printing at a later time.

Display

The TDS 600 Digitizing Oscilloscopes offer flexible display options. You can customize the following attributes of your display:

- Intensity: waveforms, readouts, graticule, etc.
- Style of waveform display(s): vectors or dots, intensified or non-intensified samples, and infinite or variable persistence.
- Display format: XY or YT and graticule type.
- Interpolation mode: linear or $\sin(x)/x$.

Zoom

The zoom feature provides an easy way to focus in on those waveform features you wish to examine up close. By invoking zoom, you can expand or compress the waveform parameter using the vertical and horizontal knobs to control the displayed size and position for viewing.

Nominal Traits

This subsection lists the *nominal traits* that describe the TDS 600 Digitizing Oscilloscopes. (Traits that differ according to model or apply only to one model are preceded by the appropriate model number, TDS 620 or TDS 640, in the tables.) Electrical and mechanical traits are included.

Nominal traits are described using simple statements of fact such as “identical” for the trait “Input Channels, Number of,” rather than in terms of limits that are performance requirements.

Table 2-2: Nominal Traits — Signal Acquisition System

Name	Description	
Bandwidth Selections	20 MHz, 100 MHz, and FULL (500 MHz)	
TDS 620: Samplers, Number of	Two, simultaneous	
TDS 640: Samplers, Number of	Four, simultaneous	
Digitized Bits, Number of	8 bits ¹	
TDS 620: Input Channels, Number of	Four, all identical, called CH 1, CH 2, AUX 1, and AUX 2 ²	
TDS 640: Input Channels, Number of	Four, all identical, called CH 1, CH 2, CH 3, and CH 4 ²	
Input Coupling	DC, AC, or GND	
Input Impedance Selections	1 M Ω or 50 Ω	
Ranges, Offset	Volts/Div Setting	Offset Range
	1 mV/div–99.5 mV/div	⌊ V
	100 mV/div–995 mV/div	⌊ V
	1 V/div–10 V/div	⌊ V
Range, Position	⌊ divisions	
TDS 620: Range, Sensitivity, CH 1, CH 2, AUX 1, and AUX 2	1 mV/div to 10 V/div ³	
TDS 640: Range, Sensitivity, CH 1, CH 2, CH 3, and CH 4	1 mV/div to 10 V/div ³	

¹Displayed vertically with 25 digitization levels (DLs) per division and 10.24 divisions dynamic range with zoom off. A DL is the smallest voltage level change that can be resolved by the 8-bit A-D Converter, with the input scaled to the volts/division setting of the channel used. Expressed as a voltage, a DL is equal to 1/25 of a division times the volts/division setting.

²The input characteristics (*Input Coupling, Input Impedance Selections, etc.*) apply to all channels except where otherwise specified.

³The sensitivity ranges from 1 mV/div to 10 V/div in a 1–2–5 sequence of coarse settings. Between a pair of adjacent coarse settings, the sensitivity can be finely adjusted. The resolution of such a fine adjustment is 1% of the more sensitive of the pair. For example, between 50 mV/div and 100 mV/div, the volts/division can be set with 0.5 mV resolution.

Table 2-3: Nominal Traits — Time Base System

Name	Description
TDS 620: Range, Sample-Rate ^{1,3}	10 Samples/sec to 2 GSamples/sec on two channels simultaneously
TDS 640: Range, Sample-Rate ^{1,3}	10 Samples/sec to 2 GSamples/sec on four channels simultaneously
Range, Interpolated Waveform Rate ^{2,3}	5 GSamples/sec to 100 GSamples/sec (200 ps/Sample to 10 ps/Sample)
Range, Seconds/Division	500 ps/div to 5 s/div
Range, Time Base Delay Time	16 ns to 250 s
Record Length	500 samples, 1000 samples, 2000 samples

¹The range of real-time rates, expressed in samples/second, at which a digitizer samples signals at its inputs and stores the samples in memory to produce a record of time-sequential samples.

²The range of waveform rates for interpolated waveform records.

³The Waveform Rate (WR) is the equivalent sample rate of a waveform record. For a waveform record acquired by real-time sampling of a single acquisition, the waveform rate is the same as the real-time sample rate; for a waveform created by interpolation of real-time samples from a single acquisition, the waveform rate is faster than the real time sample rate. For both cases, the waveform rate is 1/(Waveform Interval) for the waveform record, where the waveform interval (WI) is the time between the samples in the waveform record.

Table 2-4: Nominal Traits — Triggering System

Name	Description												
Range, Delayed Trigger Time Delay	16 ns to 250 s												
Range, Events Delay	2 to 10,000,000												
Range (Time) for Pulse-Glitch or Pulse-Width Triggering	2 ns to 1 s												
Ranges, Trigger Level or Threshold	<table border="0"> <thead> <tr> <th>Source</th> <th>Range</th> <th></th> </tr> </thead> <tbody> <tr> <td>Any Channel</td> <td></td> <td>screen</td> </tr> <tr> <td>Auxiliary</td> <td> V</td> <td></td> </tr> <tr> <td>Line</td> <td> V</td> <td></td> </tr> </tbody> </table>	Source	Range		Any Channel		screen	Auxiliary	V		Line	V	
	Source	Range											
	Any Channel		screen										
Auxiliary	V												
Line	V												

Table 2-5: Nominal Traits — Display System

Name	Description
Video Display Resolution	640 pixels horizontally by 480 pixels vertically in a display area of 5.2 inches horizontally by 3.9 inches vertically
Waveform Display Graticule	Single Graticule: 401 × 501 pixels for single, 8 × 10 divisions, where divisions are 1 cm by 1 cm
Waveform Display Grey Scale	Sixteen levels in infinite-persistence and variable-persistence display styles

Table 2-6: Nominal Traits — Interfaces, Output Ports, and Power Fuse

Name	Description
Interface, GPIB	GPIB interface complies with IEEE Std 488.1-1987 and IEEE Std 488.2-1987
Interface, RS-232 (Option 13 only)	RS-232 interface complies with EIA/TIA 574
Interface, Centronics (Option 13 only)	Centronics interface complies with Centronics interface standard C332-44 Feb 1977, REV A
Logic Polarity for Main- and Delayed-Trigger Outputs	Negative TRUE. High to low transition indicates the trigger occurred
Fuse Rating	Either of two fuses ¹ may be used: a .25" × 1.25" (UL 198.6, 3AG): 6 A FAST, 250 V, or a 5 mm × 20 mm, (IEC 127): 5 A (T), 250 V

¹Each fuse type requires its own fuse cap.

Table 2-7: Nominal Traits — Mechanical

Name	Description
Cooling Method	Forced-air circulation with no air filter
Construction Material	Chassis parts constructed of aluminum alloy; front panel constructed of plastic laminate; circuit boards constructed of glass laminate. Cabinet is aluminum and is clad in Tektronix Blue vinyl material.
Finish Type	Tektronix Blue vinyl-clad aluminum cabinet

Table 2-7: Nominal Traits — Mechanical (Cont.)

Name	Description
Weight	<p>Standard Digitizing Oscilloscope 12.3 kg (27 lbs), with front cover. 20.0 kg (44 lbs), when packaged for domestic shipment.</p> <p>Rackmount Digitizing Oscilloscope 12.3 kg (27 lbs) plus weight of rackmount parts, for the rack-mounted Digitizing Oscilloscope (Option 1R). 20.5 kg (45 lbs), when the rackmounted Digitizing Oscilloscope is packaged for domestic shipment.</p> <p>Rackmount conversion kit 2.3 kg (5 lbs), parts only; 3.6 kg (8 lbs), parts plus package for domestic shipping.</p>
Overall Dimensions	<p>Standard Digitizing Oscilloscope Height: 193 mm (7.6 in), with the feet installed. Width: 445 mm (17.5 in), with handle. Depth: 434 mm (17.1 in), with front cover installed.</p> <p>Rackmount Digitizing Oscilloscope Height: 178 mm (7.0 in). Width: 483 mm (19.0 in). Depth: 558.8 mm (22.0 in).</p>

Warranted Characteristics

This subsection lists the *warranted characteristics* that describe the TDS 600 Digitizing Oscilloscopes. Electrical and environmental characteristics are included.

Warranted characteristics are described in terms of quantifiable performance limits which are warranted.

NOTE

*In these tables, the warranted characteristics that are checked in the Performance Verification manual, appear in **boldface type** under the column **Name**.*

Performance Conditions

The electrical characteristics found in these warranted characteristics apply when the oscilloscope has been adjusted at an ambient temperature between +20°C and +30°C, has had a warm-up period of at least 20 minutes, and is operating at an ambient temperature between 0°C and +50°C (unless otherwise noted).

Table 2-8: Warranted Characteristics—Signal Acquisition System

Name	Description	
Accuracy, DC Gain³	Ⓢ	Ⓢ 2.0%
Accuracy, DC Voltage Measurement, Averaged³	Measurement Type Average of ≥ 16 waveforms Delta volts between any two averages of ≥ 16 waveforms ²	DC Accuracy Ⓢ × Reading – Net Offset ¹ + Offset Accuracy + 0.06 div) Ⓢ × Reading + 0.1 div + 0.3 mV)
Accuracy, Offset³	Volts/Div Setting 1 mV/div – 99.5 mV/div 100 mV/div – 995 mV/div 1 V/div – 10 V/div	Offset Accuracy Ⓢ × Net Offset ¹ + 1.5 mV + 0.6 div) Ⓢ × Net Offset ¹ + 15 mV + 0.6 div) Ⓢ × Net Offset ¹ + 150 mV + 0.6 div)

¹Net Offset = Offset – (Position x Volts/Div). Net Offset is the voltage level at the center of the A-D converter's dynamic range. Offset Accuracy is the accuracy of this Voltage level.

²The samples must be acquired under the same setup and ambient conditions.

³To ensure the most accurate measurements possible, run an SPC calibration first. When using the TDS 620 and/or TDS 640 Digitizing Oscilloscope at a Volts/Div setting of ≤ 5 mV/div, an SPC calibration should be run once per week to ensure that instrument performance levels meet specifications.

Table 2-8: Warranted Characteristics—Signal Acquisition System (Cont.)

Name	Description
Analog Bandwidth, DC-50 Ω Coupled, or DC-1 MΩ Coupled with P6139A Probe	Volts/Div
	5 mV/div – 10 V/div
	2 mV/div – 4.98 mV/div
	Bandwidth⁴
	DC – 500 MHz
	DC – 300 MHz
	DC – 200 MHz
Cross Talk (Channel Isolation)	$\geq 100:1$ at 100 MHz and $\geq 30:1$ at the rated bandwidth for the channels sensitivity setting, for any two channels having equal volts/division settings
Delay Between Channels, Full Bandwidth	≤ 250 ps for any two channels with equal volts/division and coupling settings
Input Impedance, DC-1 M Ω Coupled	1 M Ω \square \square pF
Input Impedance, DC-50 Ω Coupled	50 Ω \square $\leq 1.3:1$ from DC – 500 MHz
Input Voltage, Maximum, DC-1 M Ω , AC-1 M Ω , or GND Coupled	\square MHz
Input Voltage, Maximum, DC-50 Ω or AC-50 Ω Coupled	5 V rms, with peaks $\leq \square$ V
Lower Frequency Limit, AC Coupled	≤ 10 Hz when AC-1 M Ω Coupled; ≤ 200 kHz when AC-50 Ω Coupled ⁵

⁴The limits given are for the ambient temperature range of 0°C to +30°C. Reduce the upper bandwidth frequencies by 2.5 MHz for each °C above +30°C.

⁵The AC Coupled Lower Frequency Limits are reduced by a factor of 10, when 10X passive probes are used.

Table 2-9: Warranted Characteristics — Time Base System

Name	Description
Accuracy, Long Term Sample Rate and Delay Time	\square 00 ppm over any ≥ 1 ms interval
Accuracy, Delta Time Measurement	Conditions
	Single Shot, Sample Mode, 100 MHz Bandwidth selected
	Single Shot, Sample Mode, 20 MHz Bandwidth selected
	Time Measurement Accuracy^{1,2}
	\square (1 WI + 100 ppm \times Reading + 500 ps)
	\square (1 WI + 100 ppm \times Reading + 1.3 ns)
	\square (1 WI + 100 ppm \times Reading + 200 ps)

¹For input signals ≥ 5 divisions in amplitude and a slew rate of ≥ 2.0 divisions/ns at the delta time measurement points. Signal must have been acquired at a volts/division setting of ≥ 5 mV/division.

²The WI (waveform interval) is the time between the samples in the waveform record. Also, see the footnotes for *Sample Rate Range* or *Interpolated Waveform Rates* in Table 2-3, on page 2-8.

Table 2-10: Warranted Characteristics — Triggering System

Name	Description		
Accuracy (Time) for Pulse-Glitch or Pulse-Width Triggering	Time Range	Accuracy	
	2 ns to 1 μ s	\pm	\times Setting + 0.5 ns)
	1.02 μ s to 1 s	\pm	\times Setting)
Accuracy, Trigger Level or Threshold, DC Coupled ²	Trigger Source	Accuracy	
	Any Channel	\pm	\times Setting – Net Offset ¹ + 0.2 div \times Volts/div Setting + Offset Accuracy)
	Auxiliary	\pm	\times Setting + 8% of p-p signal + 100 mV)
Sensitivity, Edge-Type Trigger, DC Coupled ³	Trigger Source	Sensitivity	
	Any Channel	0.35 division from DC to 50 MHz, increasing to 1 division at 500 MHz	
	Auxiliary	0.25 volts from DC to 50 MHz	
Width, Minimum Pulse and Rearm, for Pulse-Type Triggering	Pulse Class	Minimum Pulse Width	Minimum Rearm Width
	Glitch	2 ns	2 ns + 5% of Glitch Width Setting 2.5 ns
	Runt	2.5 ns	2 ns + 5% of Width Upper Limit
	Width	2 ns	Setting

¹Net Offset = Offset – (Position \times Volts/Div). Net Offset is the voltage level at the center of the A-D converter's dynamic range. Offset Accuracy is the accuracy of this voltage level.

²Valid for signals having rise and fall times \geq 20 ns.

³The minimum sensitivity for obtaining a stable trigger. A stable trigger results in a uniform, regular display triggered on the selected slope. The trigger point must not switch between opposite slopes on the waveform, and the display must not "roll" across the screen on successive acquisitions. The TRIG'D LED stays constantly lighted when the SEC/DIV setting is 2 ms or faster but may flash when the SEC/DIV setting is 10 ms or slower.

Table 2-11: Warranted Characteristics — Output Ports, Probe Compensator, and Power Requirements

Name	Description	
Logic Levels, Main- and Delayed-Trigger Outputs	Characteristic Vout (HI)	Limits ≥ 2.5 V open circuit; ≥ 1.0 V into a 50 Ω load to ground
	Vout (LO)	≤ 0.7 V into a load of ≤ 4 mA; ≤ 0.25 V into a 50 Ω load to ground
Output Voltage and Frequency, Probe Compensator	Characteristic Voltage	Limits 0.5 V (base-top) $\frac{\square}{\square}$ ≥ 50 Ω load
	Frequency	1 kHz $\frac{\square}{\square}$
Output Voltage, Signal Out¹	20 mV/division $\frac{\square}{\square}$ into a 1 MΩ load; 10 mV/division $\frac{\square}{\square}$ 50 Ω load	
Source Voltage	90 to 250 VAC rms, continuous range	
Source Frequency	47 Hz to 63 Hz	
Power Consumption	≤ 300 W (450 VA)	

¹CH 3 (AUX 1 for TDS 620) signal out is only present at the rear panel if CH 3 (AUX 1) is selected as the trigger source for the main and/or delayed trigger systems.

Table 2-12: Warranted Characteristics — Environmental

Name	Description
Atmospherics	Temperature: 0°C to +50°C, operating; –40°C to +75°C, non-operating Relative humidity: 0 to 95%, at or below +40°C; 0 to 75%, from +41°C to 50°C Altitude: To 15,000 ft. (4570 m), operating; to 40,000 ft. (12,190 m), non-operating
Dynamics	Random vibration: 0.31 g rms, from 5 to 500 Hz, 10 minutes each axis, operating; 3.04 g rms, from 5 to 500 Hz, 10 minutes each axis, non-operating
Emissions	Meets or exceeds the EMC requirements of the following standards: MIL-STD-461C CE-03, part 4, curve #1, RE-02, part 7 VDE 0871, Category B FCC Rules and Regulations, Part 15, Subpart B, Class A
User-Misuse Simulation	Electrostatic Discharge Susceptibility: Up to 8 kV with no change to control settings or impairment of normal operation; up to 15 kV with no damage that prevents recovery of normal operation by the user

Typical Characteristics

This subsection lists the *typical characteristics* which describe the TDS 600 Digitizing Oscilloscopes. (Characteristics that differ according to model or apply only to one model are preceded by the appropriate model number, TDS 620 or TDS 640, in the tables.)

Typical characteristics are described in terms of typical or average performance. Typical characteristics are *not* warranted.

Table 2-13: Typical Characteristics — Signal Acquisition System

Name	Description				
Accuracy, DC Voltage Measurement, Not Averaged	Measurement Type	DC Accuracy			
	Any Sample	$\pm 1.5\% \times \text{Reading} - \text{Net Offset}^1 + \text{Offset Accuracy} + 0.13 \text{ div} + 0.6 \text{ mV}$			
	Delta Volts between any two samples ²	$\pm 1.5\% \times \text{Reading} + 0.26 \text{ div} + 1.2 \text{ mV}$			
Frequency Limit, Upper, 100 MHz Bandwidth Limited	100 MHz				
Frequency Limit, Upper, 20 MHz Bandwidth Limited	20 MHz				
Calculated Rise Time ³	Volts/Div Setting	Calculated Rise Time³			
	5 mV/div–10 V/div	800 ps			
	2 mV/div–4.98 mV/div	1.3 ns			
	1 mV/div–1.99 mV/div	2.0 ns			
Step Response Settling Errors	Volts/Div Setting	Step Response	Settling Error (%)⁴ at		
			20 ns	100 ns	20 ms
	1 mV/div – 99.5 mV/div	≤ 2 V	≤ 0.5	≤ 0.2	≤ 0.1
	100 mV/div – 995 mV/div	≤ 20 V	≤ 1.0	≤ 0.5	≤ 0.2
	1 V/div – 10 V/div	≤ 200 V	≤ 1.0	≤ 0.5	≤ 0.2

¹Net Offset = Offset – (Position x Volts/Div). Net Offset is the voltage level at the center of the A-D converter's dynamic range. Offset Accuracy is the accuracy of this voltage level.

²The samples must be acquired under the same setup and ambient conditions.

³The numbers given are valid 0°C to +30°C and will increase as the temperature increases due to the degradation in bandwidth. Rise time is calculated from the bandwidth. It is defined by the following formula:

$$\text{Rise Time (ns)} = \frac{400}{\text{BW (MHz)}}$$

Note that if you measure rise time, you must take into account the rise time of the test equipment (signal source, etc.) that you use to provide the test signal. That is, the measured rise time (RT_m) is determined by the instrument rise time (RT_i) and the rise time of the test signal source (RT_{gen}) according to the following formula:

$$RT_m^2 = RT_i^2 + RT_{gen}^2$$

⁴The values given are the maximum absolute difference between the value at the end of a specified time interval after the mid-level crossing of the step, and the value one second after the mid-level crossing of the step, expressed as a percentage of the step amplitude.

Table 2-14: Typical Characteristics — Triggering System

Name	Description	
Input, Auxiliary Trigger	The input resistance is $\geq 1.5 \text{ k}\Omega$; the maximum safe input voltage is \geq AC).	
Error, Trigger Position, Edge Triggering	Acquisition Mode	Trigger-Position Error^{1,2}
	Sample, Average	\geq WI + 1 ns)
	Envelope	\geq ns)
Holdoff, Variable, Main Trigger	<p>Minimum: For any horizontal scale setting, the <i>minimum</i> holdoff for a 1x or 5x setting is 10 times that setting, but is never shorter than 1 μs or longer than 5 s. The <i>minimum</i> holdoff for a 2.5x setting is 8 times that setting.</p> <p>Maximum: For any horizontal scale setting, the <i>maximum</i> holdoff is at least 2 times the minimum holdoff for that setting, but is never longer than 10 times the minimum holdoff for that setting.</p>	
Lowest Frequency for Successful Operation of “Set Level to 50%” Function	50 Hz	
Sensitivity, Edge-Type Trigger, Not DC Coupled ³	Trigger Source	Typical Signal Level for Stable Triggering
	AC	Same as the DC-coupled limits for frequencies above 60 Hz. Attenuates signals below 60 Hz.
	Noise Reject	Three and one-half times the DC-coupled limits.
	High Frequency Reject	One and one-half times the DC-coupled limits from DC to 30 kHz. Attenuates signals above 30 kHz.
	Low Frequency Reject	One and one-half times the DC-coupled limits for frequencies above 80 kHz. Attenuates signals below 80 kHz.

¹The trigger position errors are typically less than the values given here. These values are for triggering signals having a slew rate at the trigger point of ≥ 2 division/ns.

²The waveform interval (WI) is the time between the samples in the waveform record. Also, see the footnote for the characteristics *Sample Rate Range or Interpolated Waveform Rates* in Table 2-3, on page 2-8.

³The minimum sensitivity for obtaining a stable trigger. A stable trigger results in a uniform, regular display triggered on the selected slope. The trigger point must not switch between opposite slopes on the waveform, and the display must not “roll” across the screen on successive acquisitions. The TRIG'D LED stays constantly lighted when the SEC/DIV setting is 2 ms or faster but may flash when the SEC/DIV setting is 10 ms or slower.

Table 2-14: Typical Characteristics — Triggering System (Cont.)

Name	Description
Sensitivities, Logic-Type Trigger/Pulse Trigger/Events Delay, DC Coupled ⁴	1.0 division, from DC to 100 MHz with a minimum slew rate of 25 divs/μs at the trigger level or the threshold crossing.
Sensitivities, Pulse-Type Runt Trigger ⁵	1.0 division, from DC to 200 MHz with a minimum slew rate of 25 divs/μs at the trigger level or the threshold crossing.
Sensitivities, Pulse-Type Trigger Width and Glitch ⁶	1.0 division, with a minimum slew rate of 25 divs/μs at the trigger level or the threshold crossing. For <5 nsec pulse width or rearm time, 2 divisions are required.
Width, Minimum Pulse and Rearm, for Logic-Type Triggering or Events Delay ⁷	5 ns

⁴The minimum signal levels required for stable logic or pulse triggering of an acquisition, or for stable counting of a DC-coupled, events-delay signal. Also, see the footnote for *Sensitivity, Edge-Type Trigger, DC Coupled* in this table. (Stable counting of events is counting that misses no events.)

⁵The minimum signal levels required for stable runt pulse triggering of an acquisition. Also, see the footnote for *Sensitivity, Edge-Type Trigger, DC Coupled* in this table. (Stable counting of events is counting that misses no events.)

⁶The minimum signal levels required for stable pulse width or glitch triggering of an acquisition. Also, see the footnote for *Sensitivity, Edge-Type Trigger, DC Coupled* in this table. (Stable counting of events is counting that misses no events.)

⁷The minimum pulse width and rearm width required for logic-type triggering or events delaying to occur.

Table 2-15: Typical Characteristics — Data Handling and Reliability

Name	Description
Time, Data-Retention, Nonvolatile Memory ^{1,2}	5 years

¹The times that reference waveforms, stored setups, and calibration constants are retained when there is no power to the oscilloscope.

²Data is maintained by small lithium-thionyl-chloride batteries internal to the memory ICs. The amount of lithium is so small in these ICs that they can typically be safely disposed of with ordinary garbage in a sanitary landfill.

MANUAL CHANGE INFORMATION

At Tektronix, we continually strive to keep up with the latest electronic developments by adding circuit and component improvements to our instruments as soon as they are developed and tested.

Sometimes, due to printing and shipping requirements, we can not get these changes immediately into printed manuals. Hence, your manual may contain new change information on the following pages.

A single change may affect several sections. Since the change information sheets are carried in the manual until all changes are permanently entered, some duplication may occur. If no such change pages appear following this page, your manual is correct as printed.

