

Technical Reference



TDS 684A & TDS 744 Digitizing Oscilloscope Performance Verification and Specifications

070-8990-02

**Please check for change information
at the rear of this manual.**

Third Edition: November 1994

Copyright © Tektronix, Inc. 1994. All rights reserved.

Tektronix products are covered by U.S. and foreign patents, issued and pending. Information in this publication supercedes that in all previously published material. Specifications and price change privileges reserved.

Printed in the U.S.A.

Tektronix, Inc., P.O. Box 1000, Wilsonville, OR 97070-1000

TEKTRONIX and TEK are registered trademarks of Tektronix, Inc.

WARRANTY

Tektronix warrants that this product will be free from defects in materials and workmanship for a period of three (3) years from the date of shipment. If any such product proves defective during this warranty period, Tektronix, at its option, either will repair the defective product without charge for parts and labor, or will provide a replacement in exchange for the defective product.

In order to obtain service under this warranty, Customer must notify Tektronix of the defect before the expiration of the warranty period and make suitable arrangements for the performance of service. Customer shall be responsible for packaging and shipping the defective product to the service center designated by Tektronix, with shipping charges prepaid. Tektronix shall pay for the return of the product to Customer if the shipment is to a location within the country in which the Tektronix service center is located. Customer shall be responsible for paying all shipping charges, duties, taxes, and any other charges for products returned to any other locations.

This warranty shall not apply to any defect, failure or damage caused by improper use or improper or inadequate maintenance and care. Tektronix shall not be obligated to furnish service under this warranty a) to repair damage resulting from attempts by personnel other than Tektronix representatives to install, repair or service the product; b) to repair damage resulting from improper use or connection to incompatible equipment; or c) to service a product that has been modified or integrated with other products when the effect of such modification or integration increases the time or difficulty of servicing the product.

THIS WARRANTY IS GIVEN BY TEKTRONIX WITH RESPECT TO THIS PRODUCT IN LIEU OF ANY OTHER WARRANTIES, EXPRESSED OR IMPLIED. TEKTRONIX AND ITS VENDORS DISCLAIM ANY IMPLIED WARRANTIES OF MERCHANTABILITY OR FITNESS FOR A PARTICULAR PURPOSE. TEKTRONIX' RESPONSIBILITY TO REPAIR OR REPLACE DEFECTIVE PRODUCTS IS THE SOLE AND EXCLUSIVE REMEDY PROVIDED TO THE CUSTOMER FOR BREACH OF THIS WARRANTY. TEKTRONIX AND ITS VENDORS WILL NOT BE LIABLE FOR ANY INDIRECT, SPECIAL, INCIDENTAL, OR CONSEQUENTIAL DAMAGES IRRESPECTIVE OF WHETHER TEKTRONIX OR THE VENDOR HAS ADVANCE NOTICE OF THE POSSIBILITY OF SUCH DAMAGES.

Table of Contents

General Safety Summary	iii
Preface	vii

Performance Verification Procedures

Conventions	1-2
Brief Procedures	1-5
Self Tests	1-5
Functional Tests	1-7
Performance Tests	1-15
Prerequisites	1-15
Equipment Required	1-16
TDS 684A Test Record	1-19
TDS 744 Test Record	1-23
Signal Acquisition System Checks	1-27
Time Base System Checks	1-41
Trigger System Checks	1-43
Output Signal Checks	1-56
Option 05 Video Trigger Checks	1-64

Specifications

Product Description	2-1
User Interface	2-2
Signal Acquisition System	2-2
Horizontal System	2-3
Trigger System	2-4
Acquisition Control	2-4
On-Board User Assistance	2-5
Measurement Assistance	2-5
Storage	2-6
I/O	2-6
Display	2-7
Nominal Traits	2-9
Warranted Characteristics	2-15
Typical Characteristics	2-21

General Safety Summary

Review the following safety precautions to avoid injury and prevent damage to this product or any products connected to it.

Only qualified personnel should perform service procedures.

While using this product, you may need to access other parts of the system. Read the *General Safety Summary* in other system manuals for warnings and cautions related to operating the system.

Injury Precautions

- | | |
|---|--|
| Use Proper Power Cord | To avoid fire hazard, use only the power cord specified for this product. |
| Avoid Electric Overload | To avoid electric shock or fire hazard, do not apply a voltage to a terminal that is outside the range specified for that terminal. |
| Ground the Product | This product is grounded through the grounding conductor of the power cord. To avoid electric shock, the grounding conductor must be connected to earth ground. Before making connections to the input or output terminals of the product, ensure that the product is properly grounded. |
| Do Not Operate Without Covers | To avoid electric shock or fire hazard, do not operate this product with covers or panels removed. |
| Use Proper Fuse | To avoid fire hazard, use only the fuse type and rating specified for this product. |
| Do Not Operate in Wet/Damp Conditions | To avoid electric shock, do not operate this product in wet or damp conditions. |
| Do Not Operate in Explosive Atmosphere | To avoid injury or fire hazard, do not operate this product in an explosive atmosphere. |

Product Damage Precautions

- | | |
|--------------------------------|---|
| Use Proper Power Source | Do not operate this product from a power source that applies more than the voltage specified. |
|--------------------------------|---|

- Provide Proper Ventilation** To prevent product overheating, provide proper ventilation.
- Do Not Operate With Suspected Failures** If you suspect there is damage to this product, have it inspected by qualified service personnel.
- Do Not Immerse in Liquids** Clean the probe using only a damp cloth. Refer to cleaning instructions.

Safety Terms and Symbols

Terms in This Manual These terms may appear in this manual:



WARNING. *Warning statements identify conditions or practices that could result in injury or loss of life.*



CAUTION. *Caution statements identify conditions or practices that could result in damage to this product or other property.*

Terms on the Product These terms may appear on the product:

DANGER indicates an injury hazard immediately accessible as you read the marking.

WARNING indicates an injury hazard not immediately accessible as you read the marking.

CAUTION indicates a hazard to property including the product.

Symbols on the Product

The following symbols may appear on the product:



DANGER
High Voltage



Protective Ground
(Earth) Terminal



ATTENTION
Refer to
Manual



Double
Insulated

Certifications and Compliances

**CSA Certified Power
Cords**

CSA Certification includes the products and power cords appropriate for use in the North America power network. All other power cords supplied are approved for the country of use.

Preface

This is the Performance Verification and Specifications for the TDS 684A and 744 Oscilloscopes. It contains procedures suitable for determining if each instrument functions, was adjusted properly, and meets the performance characteristics as warranted.

Also contained in this document are technical specifications for these oscilloscopes.

Related Manuals

The following documents are related to the use or service of the digitizing oscilloscope:

- The *TDS 684A & 744 User Manual* (Tektronix part number 070-8991-XX).
- The *TDS Family Programmer Manual* (Tektronix part number 070-8709-XX) describes using a computer to control the digitizing oscilloscope through the GPIB interface.
- The *TDS 684A & 744 Reference* (Tektronix part number 070-8999-XX) gives you a quick overview of how to operate your digitizing oscilloscope.
- The *TDS 684A & 744 Service Manual* (Tektronix part number 070-8992-XX) provides information for maintaining and servicing the digitizing oscilloscope to the module level.



Performance Verification Procedures

Performance Verification Procedures

Two types of Performance Verification procedures can be performed on this product; *Brief Procedures* and *Performance Tests*. You may not need to perform all of these procedures, depending on what you want to accomplish.

- To rapidly confirm that the oscilloscope functions and was adjusted properly, just do the brief procedures under *Self Tests*, which begin on page 1–5.

Advantages: These procedures are quick to do, require no external equipment or signal sources, and perform extensive functional and accuracy testing to provide high confidence that the oscilloscope will perform properly. They can be used as a quick check before making a series of important measurements.

- To further check functionality, first do the *Self Tests* just mentioned; then do the brief procedures under *Functional Tests* that begin on page 1–7.

Advantages: These procedures require minimal additional time to perform, require no additional equipment other than a standard-accessory probe, and more completely test the internal hardware of the oscilloscope. They can be used to quickly determine if the oscilloscope is suitable for putting into service, such as when it is first received.

- If more extensive confirmation of performance is desired, do the *Performance Tests*, beginning on page 1–15, after doing the *Functional* and *Self Tests* just referenced.

Advantages: These procedures add direct checking of warranted specifications. They require more time to perform and suitable test equipment is required. (See *Equipment Required* beginning on page 1–16.)

If you are not familiar with operating this oscilloscope, read the *TDS 684A & 744 Reference* (070-8999-XX) or the *TDS 684A & 744 User Manual* (070-8991-XX). These contain instructions that will acquaint you with the use of the front-panel controls and the menu system.

Conventions

Throughout these procedures the following conventions apply:

- Each test procedure uses the following general format:

Title of Test

Equipment Required

Prerequisites

Procedure

- Each procedure consists of as many steps, substeps, and subparts as required to do the test. Steps, substeps, and subparts are sequenced as follows:

1. First Step

- a. First Substep

- First Subpart

- Second Subpart

- b. Second Substep

2. Second Step

- In steps and substeps, the lead-in statement in italics instructs you what to do, while the instructions that follow tell you how to do it, as in the example step below, “*Initialize the oscilloscope*” by doing “Press save/recall **SETUP**. Now, press the main-menu button...”.

Initialize the oscilloscope: Press save/recall **SETUP**. Now, press the main-menu button **Recall Factory Setup**; then the side-menu button **OK Confirm Factory Init**.

- Where instructed to use a front-panel button or knob, or select from a main or side menu, or verify a readout or status message, the name of the button or knob appears in boldface type: “press **SHIFT**; then **UTILITY**, press the main-menu button **System** until **Cal** is highlighted in the pop-up menu. Verify that the status message is *Pass* in the main menu under the **Voltage Reference** label.”

STOP. The symbol at the left is accompanied by information you must read to do the procedure properly.

- Refer to Figure 1–1: “Main menu” refers to the menu that labels the seven menu buttons under the display; “side menu” refers to the menu that labels

the five buttons to the right of the display. "Pop-up menu" refers to a menu that pops up when a main-menu button is pressed.

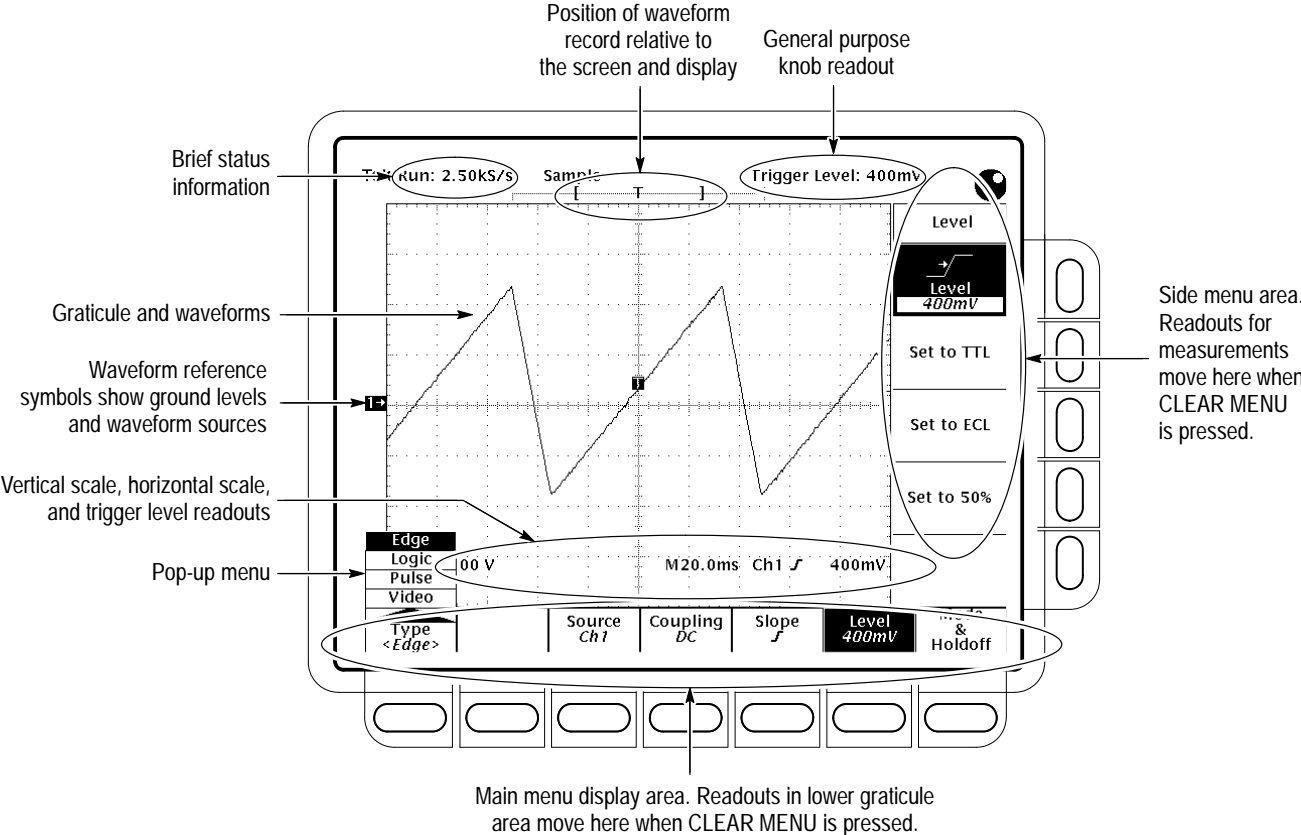

Figure 1-1: Map of Display Functions

Brief Procedures

The *Self Tests* use internal routines to confirm basic functionality and proper adjustment. No test equipment is required to do these test procedures.

The *Functional Tests* utilize the probe-compensation output at the front panel as a test-signal source for further verifying that the oscilloscope functions properly. An optional probe, such as the P6245, is the only extra equipment required.

Self Tests

This procedure uses internal routines to verify that the oscilloscope functions and was adjusted properly. No test equipment or hookups are required.

Verify Internal Adjustment, Self Compensation, and Diagnostics

Equipment Required	None
Prerequisites	Power on the Digitizing Oscilloscope and allow a 20 minute warm-up before doing this procedure.

1. *Verify that internal diagnostics pass:* Do the following substeps to verify passing of internal diagnostics.
 - a. *Display the System diagnostics menu:*
 - Press **SHIFT**; then press **UTILITY**.
 - Repeatedly press the main-menu button **System** until **Diag/Err** is highlighted in the pop-up menu.
 - b. *Run the System Diagnostics:*
 - First disconnect any input signals from all four channels.
 - Press the main-menu button **Execute**; then press the side-menu button **OK Confirm Run Test**.
 - c. *Wait:* The internal diagnostics do an exhaustive verification of proper oscilloscope function. This verification will take up to two minutes. At some time during the wait, a “clock” icon (shown at left) will appear on-screen. When the verification is finished, the resulting status will appear on the screen.
 - d. *Confirm no failures are found:* Verify that no failures are found and reported on-screen.



- e. *Confirm the three adjustment sections have passed status:*
 - Press **SHIFT**; then press **UTILITY**.
 - Highlight **Cal** in the pop-up menu by repeatedly pressing the main-menu button **System**. See Figure 1–2.
 - Verify that the word **Pass** appears in the main menu under the following menu labels: **Voltage Reference**, **Frequency Response**, and **Pulse Trigger**. See Figure 1–2.
- f. *Run the signal-path compensation:* Press the main-menu button **Signal Path**; then press the side-menu button **OK Compensate Signal Paths**.
- g. *Wait:* Signal-path compensation may take fifteen minutes to run. While it progresses, a “clock” icon (shown at left) is displayed on-screen. When compensation completes, the status message will be updated to **Pass** or **Fail** in the main menu. See step h.
- h. *Confirm signal-path compensation returns passed status:* Verify that the word **Pass** appears under **Signal Path** in the main menu. See Figure 1–2.

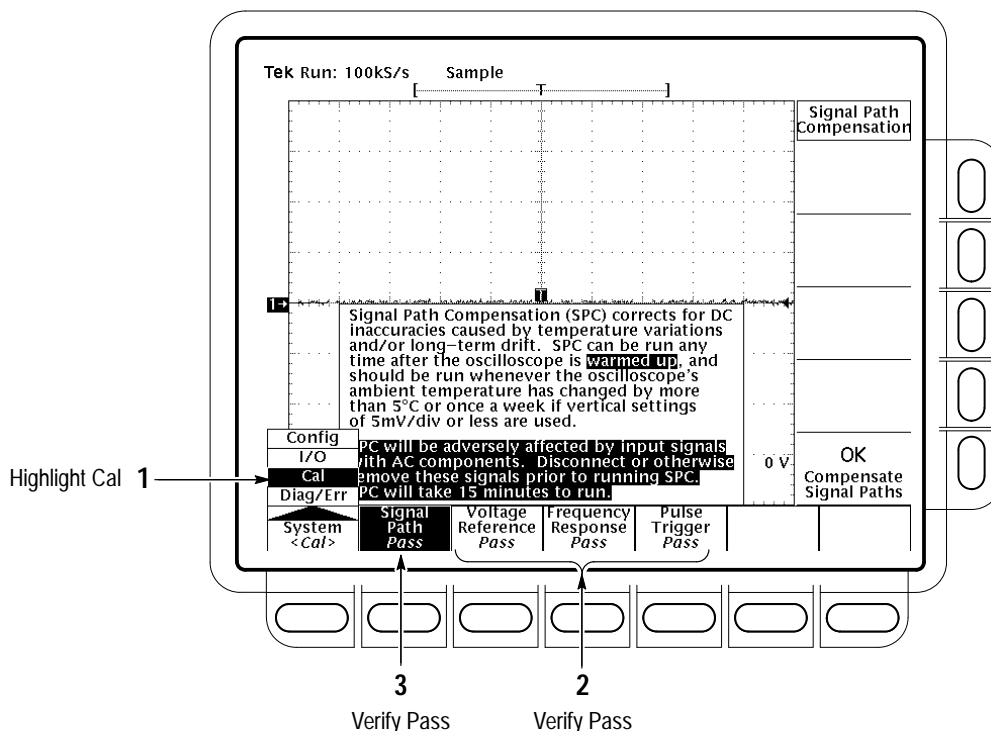

Figure 1–2: Verifying Adjustments and Signal-Path Compensation

- 2. *Return to regular service:* Press **CLEAR MENU** to exit the system menus.

Functional Tests

The purpose of these procedures is to confirm that the oscilloscope functions properly. The only equipment required is one of the standard-accessory probes and, to check the file system, a 3.5 inch, 720 K or 1.44 Mbyte floppy disk.



WARNING. *The optional P6245 probes that can be used with this oscilloscope provide an extremely low loading capacitance (<1 pF) to ensure the best possible signal reproduction. These probes should not be used to measure signals exceeding ± 8 volts, or errors in signal measurement will be observed. Above 40 volts, damage to the probe may result. To make measurements beyond ± 10 volts, use either the P6139A probe (good to 500 volts), or refer to the catalog for a recommended probe.*

STOP. *These procedures verify functions; that is, they verify that the oscilloscope features operate. They do not verify that they operate within limits.*

Therefore, when the instructions in the functional tests that follow call for you to verify that a signal appears on-screen “that is about five divisions in amplitude” or “has a period of about six horizontal divisions,” etc., do NOT interpret the quantities given as limits. Operation within limits is checked in Performance Tests, which begin on page 1–15.

STOP. DO NOT *make changes to the front-panel settings that are not called out in the procedures. Each verification procedure will require you to set the oscilloscope to certain default settings before verifying functions. If you make changes to these settings, other than those called out in the procedure, you may obtain invalid results. In this case, just redo the procedure from step 1.*

When you are instructed to press a menu button, the button may already be selected (its label will be highlighted). If this is the case, it is not necessary to press the button.

Verify All Input Channels

Equipment Required	One probe such as the P6245 or P6139A
Prerequisites	None

1. Install the test hookup and preset the oscilloscope controls:

- a. Hook up the signal source:** Install the probe on **CH 1**. Connect the probe tip to **PROBE COMPENSATION SIGNAL** on the front panel; connect the probe ground (typically black) to **PROBE COMPENSATION GND**. If using a P6245 probe, you may want to attach a Y-lead connector and two SMD KlipChips as shown in Figure 1–3.

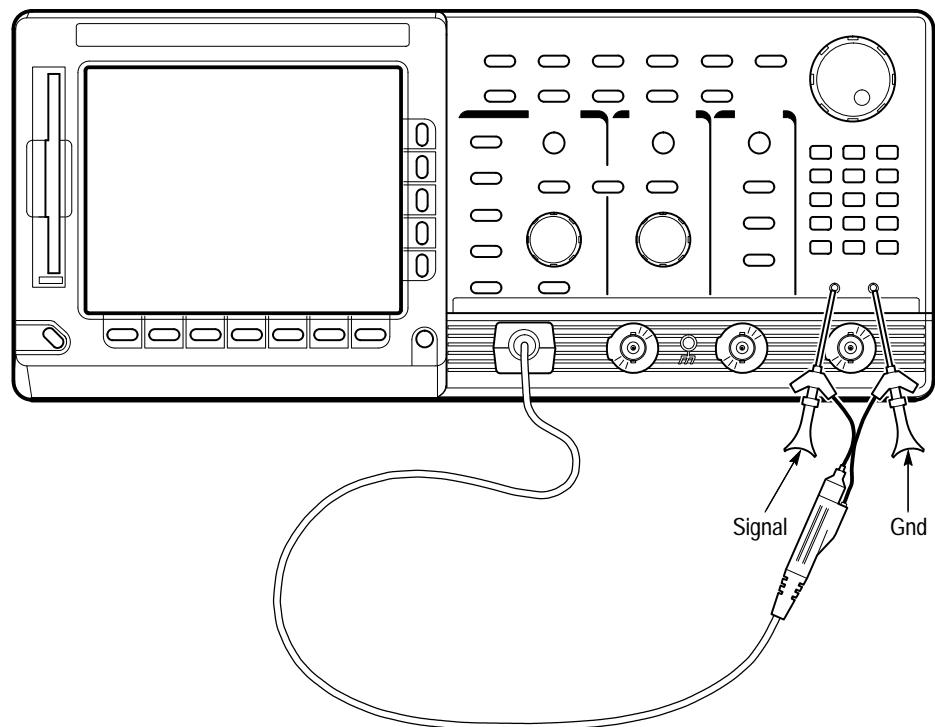
**Figure 1–3: Universal Test Hookup for Functional Tests**

- b. Initialize the oscilloscope:**
 - Press save/recall **SETUP**.
 - Press the main-menu button **Recall Factory Setup**.
 - Press the side-menu button **OK Confirm Factory Init**.

2. *Verify that all channels operate:* Do the following substeps — test CH 1 first, *skipping substep a and b since CH 1 is already set up for verification and as the trigger source from step 1.*
 - a. *Select an unverified channel:*
 - Press **WAVEFORM OFF** to remove the channel just verified from display.
 - Press the front-panel button that corresponds to the channel you are to verify.
 - Move the probe to the channel you selected.
 - b. *Match the trigger source to the channel selected:*
 - Press **TRIGGER MENU**.
 - Press the main-menu button **Source**.
 - Press the side-menu button that corresponds to the channel selected (**Ch2**, **Ch3**, or **Ch4**).
 - c. *Set up the selected channel:*
 - Set the vertical **SCALE** to 200 mV.
 - Set the horizontal **SCALE** to 200 μ s. Press **CLEAR MENU** to remove any menu that may be on the screen.
 - d. *Verify that the channel is operational:* Confirm that the following statements are true.
 - The vertical scale readout for the channel under test shows a setting of 200 mV, and a square-wave probe-compensation signal about 2.5 divisions in amplitude is on-screen. See Figure 1–1 on page 1–3 to locate the readout.
 - The vertical **POSITION** knob moves the signal up and down the screen when rotated.
 - Turning the vertical **SCALE** knob counterclockwise decreases the amplitude of the waveform on-screen, turning the knob clockwise increases the amplitude, and returning the knob to 200 mV returns the amplitude to about 2.5 divisions.
 - e. *Verify that the channel acquires in all acquisition modes:* Press **SHIFT**; then press **ACQUIRE MENU**. Use the side menu to select, in turn, each of the three hardware acquire modes and confirm that the following statements are true. Refer to the icons at the left of each statement as you confirm those statements.



- Sample mode displays an actively acquiring waveform on-screen. (Note that there is noise present on the peaks of the square wave.)



- Peak Detect mode (TDS 744 only) displays an actively acquiring waveform on-screen with the noise present in Sample mode “peak detected.”



- Hi Res mode (TDS 744 only) displays an actively acquiring waveform on-screen with the noise that was present in Sample mode reduced.



- Envelope mode displays an actively acquiring waveform on-screen with the noise displayed.



- Average mode displays an actively acquiring waveform on-screen with the noise reduced.

f. *Test all channels:* Repeat substeps a through e until all four input channels are verified.

3. *Remove the test hookup:* Disconnect the probe from the channel input and the probe-compensation terminals.

Verify the Time Base

Equipment Required	One probe such as the P6245 or P6139A
Prerequisites	None

1. *Install the test hookup and preset the oscilloscope controls:*

a. *Hook up the signal source:* Install the probe on **CH 1**. Connect the probe tip to **PROBE COMPENSATION SIGNAL** on the front panel; connect the probe ground to **PROBE COMPENSATION GND**. See Figure 1–3 on page 1–8.

b. *Initialize the oscilloscope:*

- Press save/recall **SETUP**.
- Press the main-menu button **Recall Factory Setup**; then press the side-menu button **OK Confirm Factory Init**.

c. *Modify default settings:*

- Set the vertical **SCALE** to 200 mV.
- Set the horizontal **SCALE** to 200 μ s.
- Press **CLEAR MENU** to remove the menus from the screen.

2. *Verify that the time base operates:* Confirm the following statements.

- a. One period of the square-wave probe-compensation signal is about five horizontal divisions on-screen for the 200 μs horizontal scale setting (set in step 1c).
 - b. Rotating the horizontal **SCALE** knob clockwise expands the waveform on-screen (more horizontal divisions per waveform period), counter-clockwise rotation contracts it, and returning the horizontal scale to 200 μs returns the period to about five divisions.
 - c. The horizontal **POSITION** knob positions the signal left and right on-screen when rotated.
3. *Remove the test hookup:* Disconnect the probe from the channel input and the probe-compensation terminals.

Verify the Main and Delayed Trigger Systems

Equipment Required	One probe such as the P6245 or P6139A
Prerequisites	None

1. *Install the test hookup and preset the oscilloscope controls:*
 - a. *Hook up the signal source:* Install the probe on **CH 1**. Connect the probe tip to **PROBE COMPENSATION SIGNAL** on the front panel; connect the probe ground to **PROBE COMPENSATION GND**. See Figure 1–3 on page 1–8.
 - b. *Initialize the oscilloscope:*
 - Press save/recall **SETUP**.
 - Press the main-menu button **Recall Factory Setup**.
 - Press the side-menu button **OK Confirm Factory Init**.
 - c. *Modify default settings:*
 - Set the vertical **SCALE** to 200 mV.
 - Set the horizontal **SCALE** for the **M** (main) time base to 200 μs .
 - Press **TRIGGER MENU**.
 - Press the main-menu button **Mode & Holdoff**.
 - Press the side-menu button **Normal**.
 - Press **CLEAR MENU** to remove the menus from the screen.

2. *Verify that the main trigger system operates:* Confirm that the following statements are true.
 - The trigger level readout for the main trigger system changes with the trigger-**LEVEL** knob.
 - The trigger-level knob can trigger and untrigger the square-wave signal as you rotate it. (Leave the signal *untriggered*, which is indicated by the display not updating.)
 - Pressing **SET LEVEL TO 50%** triggers the signal that you just left untriggered. (Leave the signal triggered.)
3. *Verify that the delayed trigger system operates:*
 - a. *Select the delayed time base:*
 - Press **HORIZONTAL MENU**.
 - Press the main-menu button **Time Base**.
 - Press the side-menu button **Delayed Triggerable**; then press the side-menu button **Delayed Only**.
 - Set the horizontal **SCALE** for the **D** (delayed) time base to 200 μ s.
 - b. *Select the delayed trigger level menu:*
 - Press **SHIFT**; then press **DELAYED TRIG**.
 - Press the main-menu button **Level**; then press the side-menu button **Level**.
 - c. *Confirm that the following statements are true:*
 - The trigger-level readout for the delayed trigger system changes as you turn the general purpose knob.
 - As you rotate the general purpose knob, the square-wave probe-compensation signal can become triggered and untriggered. (Leave the signal *untriggered*, which is indicated by the display not updating.)
 - Pressing the side-menu button **Set to 50%** triggers the probe-compensation signal that you just left untriggered. (Leave the signal triggered.)
 - d. *Verify the delayed trigger counter:*
 - Press the main-menu button **Delay by Time**.
 - Use the keypad to enter a delay time of 1 second. Press **1**, then press **ENTER**.

- Verify that the trigger **READY** indicator on the front panel flashes about once every second as the waveform is updated on-screen.
4. *Remove the test hookup:* Disconnect the probe from the channel input and the probe-compensation terminals.

Verify the File System

Equipment Required	One probe such as the P6245 or P6139A One 720 K or 1.44 Mbyte, 3.5 inch DOS-compatible disk. You can use a disk of your own or you can use the Programming Examples Software 3.5 inch disk (Tektronix part number 063-1134-XX) contained in the TDS Family Programmer Manual (Tektronix part number 070-8709-XX).
Prerequisites	None

1. *Install the test hookup and preset the oscilloscope controls:*
 - a. *Hook up the signal source:* Install the probe on **CH 1**. Connect the probe tip to **PROBE COMPENSATION SIGNAL** on the front panel; connect the probe ground to **PROBE COMPENSATION GND**. See Figure 1–3 on page 1–8.
 - b. *Insert the test disk:* Insert the disk in the disk drive to the left of the monitor.
 - Position the disk so the metal shutter faces the drive.
 - Position the disk so the stamped arrow is on the top right side. In other words, place the angled corner in the front bottom location.
 - Push the disk into the drive until it goes all the way in and clicks into place.
 - c. *Initialize the oscilloscope:*
 - Press save/recall **SETUP**.
 - Press the main-menu button **Recall Factory Setup**.
 - Press the side-menu button **OK Confirm Factory Init**.
 - d. *Modify default settings:*
 - Set the vertical **SCALE** to 200 mV.
 - Set the horizontal **SCALE** for the **M** (main) time base to 200 μ s. Notice the waveform on the display now shows two cycles instead of five.
 - Press **CLEAR MENU** to remove the menus from the screen.

e. *Save the settings:*

- Press **SETUP**.
- Press the main-menu button **Save Current Setup**; then press the side-menu button **To File**.
- Turn the general purpose knob to select the file to save. Choose **TEK?????.SET** (or **fdo:**). With this choice, you will save a file starting with **TEK**, then containing 5-numbers, and a **.SET** extension. For example, the first time you run this on a blank, formatted disk or on the Example Programs Disk, the oscilloscope will assign the name **TEK00000.SET** to your file. If you ran the procedure again, the oscilloscope would increment the name and call the file **TEK00001.SET**.
- Press the side-menu button **Save To Selected File**.

2. *Verify the file system works:*

- Press the main-menu button **Recall Factory Setup** and the side-menu button **OK Confirm Factory Init** to restore the 500 μ s time base and the five cycle waveform.
- Press the main-menu button **Recall Saved Setup**; then press the side-menu button **From File**.
- Turn the general purpose knob to select the file to recall. For example, if you followed the instructions above and used a blank disk, you had the oscilloscope assign the name **TEK00000.SET** to your file.
- Press the side-menu button **Recall From Selected File**.
- Verify that Digitizing Oscilloscope retrieved the saved setup from the disk. Do this by noticing the horizontal **SCALE** for the **M** (main) time base is again 200 μ s and the waveform shows only two cycles just as it was when you saved the setup.

3. *Remove the test hookup:*

- Disconnect the probe from the channel input and the probe-compensation terminals.
- Remove the disk from the disk drive. Do this by pushing in the tab at the bottom of the disk drive.

Performance Tests

This section contains a collection of procedures for checking that the TDS 684A and 744 Digitizing Oscilloscopes perform as warranted.

The procedures are arranged in four logical groupings: *Signal Acquisition System Checks*, *Time Base System Checks*, *Triggering System Checks*, and *Output Ports Checks*. They check all the characteristics that are designated as checked in *Specifications*. (The characteristics that are checked appear in **boldface** type under *Warranted Characteristics* in *Specifications*.)

STOP. *These procedures extend the confidence level provided by the basic procedures described on page 1–5. The basic procedures should be done first, then these procedures performed if desired.*

Prerequisites

The tests in this section comprise an extensive, valid confirmation of performance and functionality when the following requirements are met:

- The cabinet must be installed on the Digitizing Oscilloscope.
- You must have performed and passed the procedures under *Self Tests*, found on page 1–5, and those under *Functional Tests*, found on page 1–7.
- A signal-path compensation must have been done within the recommended calibration interval and at a temperature within $\pm 5^{\circ}$ C of the present operating temperature. (If at the time you did the prerequisite *Self Tests*, the temperature was within the limits just stated, consider this prerequisite met.)
- The Digitizing Oscilloscope must have been last adjusted at an ambient temperature between $+20^{\circ}$ C and $+30^{\circ}$ C, must have been operating for a warm-up period of at least 20 minutes, and must be operating at an ambient temperature between $+4^{\circ}$ C and either $+45^{\circ}$ C for the TDS 684A or $+50^{\circ}$ C for the TDS 744. (The warm-up requirement is usually met in the course of meeting the first prerequisite listed above.)

Equipment Required

These procedures use external, traceable signal sources to directly check warranted characteristics. The required equipment list follows this introduction.

Table 1–1: Test Equipment

Item Number and Description	Minimum Requirements	Example	Purpose
1. Attenuator, 10X (two required)	Ratio: 10X; impedance 50 Ω ; connectors: female BNC input, male BNC output	Tektronix part number 011-0059-02	Signal Attenuation
2. Attenuator, 5X	Ratio: 5X; impedance 50 Ω ; connectors: female BNC input, male BNC output	Tektronix part number 011-0060-02	Signal Attenuation
3. Adapter, BNC female to Clip Leads	BNC female to Clip Leads	Tektronix part number 013-0076-00	Signal Coupling for Probe Compensator Output Check
4. Terminator, 50 Ω	Impedance 50 Ω ; connectors: female BNC input, male BNC output	Tektronix part number 011-0049-01	Signal Termination for Channel Delay Test
5. Cable, Precision 50 Ω Coaxial (two required)	50 Ω , 36 in, male to male BNC connectors	Tektronix part number 012-0482-00	Signal Interconnection
6. Connector, Dual-Banana (two required)	Female BNC to dual banana	Tektronix part number 103-0090-00	Various Accuracy Tests
7. Connector, BNC "T"	Male BNC to dual female BNC	Tektronix part number 103-0030-00	Checking Trigger Sensitivity
8. Coupler, Dual-Input	Female BNC to dual male BNC	Tektronix part number 067-0525-02	Checking Delay Between Channels
9. Generator, DC Calibration	Variable amplitude to ± 104 V; accuracy to 0.1%	Data Precision 8200	Checking DC Offset, Gain, and Measurement Accuracy
10. Generator, Calibration	500 mV square wave calibrator amplitude; accuracy to 0.25%	Tektronix PG 506A ¹	To check accuracy of CH 3 Signal Out
11. Generator, Leveled Sine Wave, Medium-Frequency	200 kHz to 250 MHz; Variable amplitude from 5 mV to 4 V _{p-p} into 50 Ω	Tektronix SG 503 Leveled Sine Wave Generator ¹	Checking Trigger Sensitivity at low frequencies
12. Generator, Leveled Sine Wave, High-Frequency	250 MHz to 1 GHz; Variable amplitude from 500 mV to 4 V _{p-p} into 50 Ω ; 6 MHz reference	Tektronix SG 504 Leveled Sine Wave Generator ¹ with SG 504 Output Head	Checking Analog Bandwidth and Trigger Sensitivity at high frequencies
13. Generator, Time Mark	Variable marker frequency from 10 ms to 10 ns; accuracy within 2 ppm	Tektronix TG 501A Time Mark Generator ¹	Checking Sample-Rate and Delay-time Accuracy
14. Probe, 10X	A P6139A or P6245 probe ²	Tektronix part number P6139A or P6245	Signal Interconnection

Table 1–1: Test Equipment (Cont.)

Item Number and Description	Minimum Requirements	Example	Purpose
15. 3.5 inch, 720 K or 1.44 Mbyte, DOS-compatible floppy disk		Programming Examples Software Disk (Tektronix part number 063-1134-XX) that comes with the TDS Family Programmer Manual (Tektronix part number 070-8709-XX)	Checking File System Basic Functionality
16. Generator, Video Signal	Provides PAL compatible outputs	Tektronix TSG 121	Used to Test Video Option 05 Equipped Instruments Only
17. Oscillator, Leveled Sine wave Generator	60 Hz. Sine wave	Tektronix part number SG 502	Used to Test Video Option 05 Equipped Instruments Only
18. Pulse Generator		Tektronix part number PG 502	Used to Test Video Option 05 Equipped Instruments Only
19. Cable, Coaxial (two required)	75 Ω , 36 in, male to male BNC connectors	Tektronix part number 012-1338-00	Used to Test Video Option 05 Equipped Instruments Only
20. Terminator, 75 Ω (two required)	Impedance 75 Ω ; connectors: female BNC input, male BNC output	Tektronix part number 011-0102-01	Used to Test Video Option 05 Equipped Instruments Only

¹ Requires a TM 500 or TM 5000 Series Power Module Mainframe.

² **Warning:** The optional P6245 probes that may be used with this oscilloscope provide an extremely low loading capacitance (<1 pF) to ensure the best possible signal reproduction. These probes should not be used to measure signals exceeding ± 8 V, or errors in signal measurement will be observed. Above 40 V, damage to the probe may result. To make measurements beyond ± 8 V, use either the P6139A probe (good to 500 V), or refer to the catalog for a recommended probe.

TDS 684A Test Record

Photocopy this and the next three pages and use them to record the performance test results for your TDS 684A.

TDS 684A Test Record

Instrument Serial Number: _____ Certificate Number: _____
 Temperature: _____ RH %: _____
 Date of Calibration: _____ Technician: _____

TDS 684A Performance Test		Minimum	Incoming	Outgoing	Maximum
Offset Accuracy					
CH1 Offset	+1 mV	- 1.45 mV	_____	_____	+ 1.45 mV
	+101 mV	- 69.1 mV	_____	_____	+ 69.1 mV
	+1.01 V	- 691 mV	_____	_____	+ 691 mV
CH2 Offset	+1 mV	- 1.45 mV	_____	_____	+ 1.45 mV
	+101 mV	- 69.1 mV	_____	_____	+ 69.1 mV
	+1.01 V	- 691 mV	_____	_____	+ 691 mV
CH3 Offset	+1 mV	- 1.45 mV	_____	_____	+ 1.45 mV
	+101 mV	- 69.1 mV	_____	_____	+ 69.1 mV
	+1.01 V	- 691 mV	_____	_____	+ 691 mV
CH4 Offset	+1 mV	- 1.45 mV	_____	_____	+ 1.45 mV
	+101 mV	- 69.1 mV	_____	_____	+ 69.1 mV
	+1.01 V	- 691 mV	_____	_____	+ 691 mV
DC Voltage Measurement Accuracy (Averaged)					
CH1	5 mV Vert scale setting, -5 Div position setting, +1 V offset	+ 1.029 V	_____	_____	+ 1.0513 V
CH1	5 mV Vert scale setting, +5 Div position setting, -1 V offset	- 1.0513 V	_____	_____	- 1.029 V
CH1	200 mV Vert scale setting, -5 Div position setting, +10 V offset	+ 11.420 V	_____	_____	+ 11.786 V
CH1	200 mV Vert scale setting, +5 Div position setting, -10 V offset	- 11.786 V	_____	_____	- 11.420 V
CH1	1 V Vert scale setting, -5 Div position setting, +10 V offset	+ 17.26 V	_____	_____	+ 18.76 V
CH1	1 V Vert scale setting, +5 Div position setting, -10 V offset	- 18.76 V	_____	_____	- 17.26 V
CH2	5 mV Vert scale setting, -5 Div position setting, +1 V offset	+ 1.029 V	_____	_____	+ 1.0513 V
CH2	5 mV Vert scale setting, +5 Div position setting, -1 V offset	- 1.0513 V	_____	_____	- 1.029 V
CH2	200 mV Vert scale setting, -5 Div position setting, +10 V offset	+ 11.420 V	_____	_____	+ 11.786 V

Performance Tests

TDS 684A Test Record (Cont.)

Instrument Serial Number: _____ Certificate Number: _____
 Temperature: _____ RH %: _____
 Date of Calibration: _____ Technician: _____

TDS 684A Performance Test		Minimum	Incoming	Outgoing	Maximum
CH2	200 mV Vert scale setting, +5 Div position setting, -10 V offset	- 11.786 V	_____	_____	- 11.420 V
CH2	1 V Vert scale setting, -5 Div position setting, +10 V offset	+ 17.26 V	_____	_____	+ 18.76 V
CH2	1 V Vert scale setting, +5 Div position setting, -10 V offset	- 18.76 V	_____	_____	- 17.26 V
CH3	5 mV Vert scale setting, -5 Div position setting, +1 V offset	+ 1.029 V	_____	_____	+ 1.0513 V
CH3	5 mV Vert scale setting, +5 Div position setting, -1 V offset	- 1.0513 V	_____	_____	- 1.029 V
CH3	200 mV Vert scale setting, -5 Div position setting, +10 V offset	+ 11.420 V	_____	_____	+ 11.786 V
CH3	200 mV Vert scale setting, +5 Div position setting, -10 V offset	- 11.786 V	_____	_____	- 11.420 V
CH3	1 V Vert scale setting, -5 Div position setting, +10 V offset	+ 17.26 V	_____	_____	+ 18.76 V
CH3	1 V Vert scale setting, +5 Div position setting, -10 V offset	- 18.76 V	_____	_____	- 17.26 V
CH4	5 mV Vert scale setting, -5 Div position setting, +1 V offset	+ 1.029 V	_____	_____	+ 1.0513 V
CH4	5 mV Vert scale setting, +5 Div position setting, -1 V offset	- 1.0513 V	_____	_____	- 1.029 V
CH4	200 mV Vert scale setting, -5 Div position setting, +10 V offset	+ 11.420 V	_____	_____	+ 11.786 V
CH4	200 mV Vert scale setting, +5 Div position setting, -10 V offset	- 11.786 V	_____	_____	- 11.420 V
CH4	1 V Vert scale setting, -5 Div position setting, +10 V offset	+ 17.26 V	_____	_____	+ 18.76 V
CH4	1 V Vert scale setting, +5 Div position setting, -10 V offset	- 18.76 V	_____	_____	- 17.26 V

Analog Bandwidth

CH1	100 mV	424 mV	_____	_____	N/A
CH2	100 mV	424 mV	_____	_____	N/A
CH3	100 mV	424 mV	_____	_____	N/A
CH4	100 mV	424 mV	_____	_____	N/A

TDS 684A Test Record (Cont.)

Instrument Serial Number: _____ Certificate Number: _____
 Temperature: _____ RH %: _____
 Date of Calibration: _____ Technician: _____

TDS 684A Performance Test	Minimum	Incoming	Outgoing	Maximum
Delay Between Channels				
Delay Between Channels	N/A	_____	_____	100 ps
Time Base System				
Long Term Sample Rate/ Delay Time @ 500 ns/10 ms	-2.0 Div	_____	_____	+2.0 Div
Trigger System Accuracy				
Pulse-Glitch or Pulse-Width, Hor. scale $\leq 1 \mu\text{s}$				
Lower Limit	2.5 ns	_____	_____	7.5 ns
Upper Limit	2.5 ns	_____	_____	7.5 ns
Pulse-Glitch or Pulse-Width, Hor. scale $> 1 \mu\text{s}$				
Lower Limit	1 μs	_____	_____	3 μs
Upper Limit	1 μs	_____	_____	3 μs
Main Trigger, DC Coupled, Positive Slope	9.863 V	_____	_____	10.137 V
Main Trigger, DC Coupled, Negative Slope	9.863 V	_____	_____	10.137 V
Delayed Trigger, DC Coupled, Positive Slope	9.863 V	_____	_____	10.137 V
Delayed Trigger, DC Coupled, Negative Slope	9.863 V	_____	_____	10.137 V
CH1 Sensitivity, 50 MHz, Main	Pass/Fail	_____	_____	Pass/Fail
CH1 Sensitivity, 50 MHz, Delayed	Pass/Fail	_____	_____	Pass/Fail
CH1 AUX Trigger Input	Pass/Fail	_____	_____	Pass/Fail
CH1 Sensitivity, 1 GHz, Main	Pass/Fail	_____	_____	Pass/Fail
CH1 Sensitivity, 1 GHz, Delayed	Pass/Fail	_____	_____	Pass/Fail
Output Signal Checks				
MAIN TRIGGER OUTPUT, 1 M Ω				
High	High $\geq 2.5 \text{ V}$	_____	_____	Low $\leq 0.7 \text{ V}$
Low		_____	_____	
MAIN TRIGGER OUTPUT, 50 Ω				
High	High $\geq 1.0 \text{ V}$	_____	_____	Low $\leq 0.25 \text{ V}$
Low		_____	_____	
DELAYED TRIGGER OUTPUT, 50 Ω				
High	High $\geq 1.0 \text{ V}$	_____	_____	Low $\leq 0.25 \text{ V}$
Low		_____	_____	
DELAYED TRIGGER OUTPUT, 1 M Ω				
High	High $\geq 2.5 \text{ V}$	_____	_____	Low $\leq 0.7 \text{ V}$
Low		_____	_____	

Performance Tests

TDS 684A Test Record (Cont.)

Instrument Serial Number: _____ Certificate Number: _____
 Temperature: _____ RH %: _____
 Date of Calibration: _____ Technician: _____

TDS 684A Performance Test	Minimum	Incoming	Outgoing	Maximum
CH 3 SIGNAL OUTPUT, 1 MΩ	Pk-Pk ≥ 80 mV	_____	_____	Pk-Pk ≤ 120 mV
CH 3 SIGNAL OUTPUT, 50 Ω	Pk-Pk ≥ 40 mV	_____	_____	Pk-Pk ≤ 60 mV
Probe Compensator Output Signal				
Frequency (CH1 Freq.)	950 Hz	_____	_____	1.050 kHz
Voltage (difference)	495 mV	_____	_____	505 mV

TDS 744 Test Record

Photocopy this and the next three pages and use them to record the performance test results for your TDS 744.

TDS 744 Test Record

Instrument Serial Number: _____ Certificate Number: _____
 Temperature: _____ RH %: _____
 Date of Calibration: _____ Technician: _____

TDS 744 Performance Test		Minimum	Incoming	Outgoing	Maximum
Offset Accuracy					
CH1 Offset	+1 mV	- 1.6 mV	_____	_____	+ 1.6 mV
	+101 mV	- 25.1 mV	_____	_____	+ 25.1 mV
	+1.01 V	- 251 mV	_____	_____	+ 251 mV
CH2 Offset	+1 mV	- 1.6 mV	_____	_____	+ 1.6 mV
	+101 mV	- 25.1 mV	_____	_____	+ 25.1 mV
	+1.01 V	- 251 mV	_____	_____	+ 251 mV
CH3 Offset	+1 mV	- 1.6 mV	_____	_____	+ 1.6 mV
	+101 mV	- 25.1 mV	_____	_____	+ 25.1 mV
	+1.01 V	- 251 mV	_____	_____	+ 251 mV
CH4 Offset	+1 mV	- 1.6 mV	_____	_____	+ 1.6 mV
	+101 mV	- 25.1 mV	_____	_____	+ 25.1 mV
	+1.01 V	- 251 mV	_____	_____	+ 251 mV
DC Voltage Measurement Accuracy (Averaged)					
CH1	5 mV Vert scale setting, -5 Div position setting, +1 V offset	+ 1.0355 V	_____	_____	+ 1.0445 V
CH1	5 mV Vert scale setting, +5 Div position setting, -1 V offset	- 1.0445 V	_____	_____	- 1.0355 V
CH1	200 mV Vert scale setting, -5 Div position setting, +10 V offset	+ 11.5385 V	_____	_____	+ 11.6615 V
CH1	200 mV Vert scale setting, +5 Div position setting, -10 V offset	- 11.6615 V	_____	_____	- 11.5385 V
CH1	1 V Vert scale setting, -5 Div position setting, +10 V offset	+ 17.7785 V	_____	_____	+ 18.2215 V
CH1	1 V Vert scale setting, +5 Div position setting, -10 V offset	- 18.2215 V	_____	_____	- 17.7785 V
CH2	5 mV Vert scale setting, -5 Div position setting, +1 V offset	+ 1.0355 V	_____	_____	+ 1.0445V
CH2	5 mV Vert scale setting, +5 Div position setting, -1 V offset	- 1.0445 V	_____	_____	- 1.0355 V
CH2	200 mV Vert scale setting, -5 Div position setting, +10 V offset	+ 11.5385 V	_____	_____	+ 11.6615 V

Performance Tests

TDS 744 Test Record (Cont.)

Instrument Serial Number: _____ Certificate Number: _____
 Temperature: _____ RH %: _____
 Date of Calibration: _____ Technician: _____

TDS 744 Performance Test		Minimum	Incoming	Outgoing	Maximum
CH2	200 mV Vert scale setting, +5 Div position setting, -10 V offset	- 11.6615 V	_____	_____	- 11.5385 V
CH2	1 V Vert scale setting, -5 Div position setting, +10 V offset	+ 17.7785 V	_____	_____	+ 18.2215 V
CH2	1 V Vert scale setting, +5 Div position setting, -10 V offset	- 18.2215 V	_____	_____	- 17.7785 V
CH3	5 mV Vert scale setting, -5 Div position setting, +1 V offset	+ 1.0355 V	_____	_____	+ 1.0445 V
CH3	5 mV Vert scale setting, +5 Div position setting, -1 V offset	- 1.0445 V	_____	_____	- 1.0355 V
CH3	200 mV Vert scale setting, -5 Div position setting, +10 V offset	+ 11.5385 V	_____	_____	+ 11.6615 V
CH3	200 mV Vert scale setting, +5 Div position setting, -10 V offset	- 11.6615 V	_____	_____	- 11.5385 V
CH3	1 V Vert scale setting, -5 Div position setting, +10 V offset	+ 17.7785 V	_____	_____	+ 18.2215 V
CH3	1 V Vert scale setting, +5 Div position setting, -10 V offset	- 18.2215 V	_____	_____	- 17.7785 V
CH4	5 mV Vert scale setting, -5 Div position setting, +1 V offset	+ 1.0355 V	_____	_____	+ 1.0445 V
CH4	5 mV Vert scale setting, +5 Div position setting, -1 V offset	- 1.0445 V	_____	_____	- 1.0355 V
CH4	200 mV Vert scale setting, -5 Div position setting, +10 V offset	+ 11.5385 V	_____	_____	+ 11.6615 V
CH4	200 mV Vert scale setting, +5 Div position setting, -10 V offset	- 11.6615 V	_____	_____	- 11.5385 V
CH4	1 V Vert scale setting, -5 Div position setting, +10 V offset	+ 17.7785 V	_____	_____	+ 18.2215 V
CH4	1 V Vert scale setting, +5 Div position setting, -10 V offset	- 18.2215 V	_____	_____	- 17.7785 V

Analog Bandwidth

CH1	100 mV	424 mV	_____	_____	N/A
CH2	100 mV	424 mV	_____	_____	N/A
CH3	100 mV	424 mV	_____	_____	N/A
CH4	100 mV	424 mV	_____	_____	N/A

TDS 744 Test Record (Cont.)

Instrument Serial Number: _____ Certificate Number: _____
 Temperature: _____ RH %: _____
 Date of Calibration: _____ Technician: _____

TDS 744 Performance Test	Minimum	Incoming	Outgoing	Maximum
Delay Between Channels				
Delay Between Channels	N/A	_____	_____	100 ps
Time Base System				
Long Term Sample Rate/ Delay Time @ 100 ns/10.0015 ms for TDS 744 with serial number B019999 and below or Delay Time @ 100 ns/10.0 ms for TDS 744 with serial number B020000 and above or for TDS 684A	-2.5 Div	_____	_____	+2.5 Div
Trigger System Accuracy				
Pulse-Glitch or Pulse-Width, Hor. scale $\leq 1 \mu\text{s}$ Lower Limit Upper Limit	3.5 ns 2.5 ns	_____	_____	6.5 ns 6.5 ns
Pulse-Glitch or Pulse-Width, Hor. scale $> 1 \mu\text{s}$ Lower Limit Upper Limit	1.9 μs 1.9 μs	_____	_____	2.1 μs 2.1 μs
Main Trigger, DC Coupled, Positive Slope	9.9393 V	_____	_____	10.1147 V
Main Trigger, DC Coupled, Negative Slope	9.9393 V	_____	_____	10.1147 V
Delayed Trigger, DC Coupled, Positive Slope	9.9393 V	_____	_____	10.1147 V
Delayed Trigger, DC Coupled, Negative Slope	9.9393 V	_____	_____	10.1147 V
CH1 Sensitivity, 50 MHz, Main	Pass/Fail	_____	_____	Pass/Fail
CH1 Sensitivity, 50 MHz, Delayed	Pass/Fail	_____	_____	Pass/Fail
CH1 AUX Trigger Input	Pass/Fail	_____	_____	Pass/Fail
CH1 Sensitivity, 500 MHz, Main	Pass/Fail	_____	_____	Pass/Fail
CH1 Sensitivity, 500 MHz, Delayed	Pass/Fail	_____	_____	Pass/Fail
Output Signal Checks				
MAIN TRIGGER OUTPUT, 1 M Ω High Low	High $\geq 2.5 \text{ V}$	_____	_____	Low $\leq 0.7 \text{ V}$
MAIN TRIGGER OUTPUT, 50 Ω High Low	High $\geq 1.0 \text{ V}$	_____	_____	Low $\leq 0.25 \text{ V}$

Performance Tests

TDS 744 Test Record (Cont.)

Instrument Serial Number: _____ Certificate Number: _____
 Temperature: _____ RH %: _____
 Date of Calibration: _____ Technician: _____

TDS 744 Performance Test	Minimum	Incoming	Outgoing	Maximum
DELAYED TRIGGER OUTPUT, 50 Ω High Low	High ≥ 1.0 V	_____	_____	Low ≤ 0.25 V
DELAYED TRIGGER OUTPUT, 1 MΩ High Low	High ≥ 2.5 V	_____	_____	Low ≤ 0.7 V
CH 3 SIGNAL OUTPUT, 1 MΩ	Pk-Pk ≥ 88 mV	_____	_____	Pk-Pk ≤ 132 mV
CH 3 SIGNAL OUTPUT, 50 Ω	Pk-Pk ≥ 44 mV	_____	_____	Pk-Pk ≤ 66 mV
Probe Compensator Output Signal				
Frequency (CH1 Freq.)	950 Hz	_____	_____	1.050 kHz
Voltage (difference)	495 mV	_____	_____	505 mV

Signal Acquisition System Checks

These procedures check those characteristics that relate to the signal-acquisition system and are listed as checked under *Warranted Characteristics* in *Specifications*.

Check Offset Accuracy (Zero Setting)

Equipment Required	None
Prerequisites	The oscilloscope must meet the prerequisites listed on page 1–15

1. *Preset the instrument controls:*
 - a. *Initialize the oscilloscope:*
 - Press save/recall **SETUP**.
 - Press the main-menu button **Recall Factory Setup**.
 - Press the side-menu button **OK Confirm Factory Init**.
 - Press **CLEAR MENU** to remove the menus from the screen.
 - b. *Modify the default settings:*
 - Press **SHIFT**; then press **ACQUIRE MENU**.
 - On the TDS 684A, press the main-menu button **Mode**; then press the side-menu button **Average 16**.
 - On the TDS 744, press the main-menu button **Mode**; then press the side-menu button **Hi Res**.
 - Press **CURSOR**.
 - Press the main-menu button **Function**; then press the side-menu button **H Bars**.
 - Press **CLEAR MENU**.
 - Be sure to disconnect any input signals from all four channels.
2. *Confirm input channels are within limits for offset accuracy at zero offset:*
Do the following substeps — test CH 1 first, *skipping substep a since CH 1 is already set up to be checked from step 1*.
 - a. *Select an unchecked channel:* Press **WAVEFORM OFF** to remove the channel just confirmed from the display. Then, press the front-panel button that corresponds to the channel you are to confirm.

- b. *Set the vertical scale:* Set the vertical **SCALE** to one of the settings listed in Table 1–2 that is not yet checked. (Start with the first setting listed.)
- Press **VERTICAL MENU**. Press the main-menu button **Fine Scale**.
 - Use the keypad to enter the vertical scale. For the 1 mV setting, press **1**, **SHIFT**, **m**, then **ENTER**. For the 101 mV setting, press **101**, **SHIFT**, **m**, then **ENTER**. For the 1.01 V setting, press **1.01**, then **ENTER**.
 - Press **CLEAR MENU**.

Table 1–2: DC Offset Accuracy (Zero Setting)

Vertical Scale Setting	Vertical Position and Offset Setting ¹	TDS 684A Offset Accuracy Limits	TDS 744 Offset Accuracy Limits
1 mV	0	±1.45 mV	±1.6 mV
101 mV	0	±69.1 mV	±25.1 mV
1.01 V	0	±691 mV	±251 mV

¹ Vertical position is set to 0 divisions and vertical offset to 0 V when the oscilloscope is initialized in step 1.

- c. *Display the test signal:* The waveform position and offset were initialized for all channels in step 1 and are displayed as you select each channel and its vertical scale.
- d. *Measure the test signal:* Align the active cursor over the waveform by rotating the general purpose knob. Ignore the other cursor. See Figure 1–4.
- e. Read the measurement results at the absolute (@:) cursor readout, not the delta (Δ:) readout on screen. That is, read the offset relative to the ground reference. See Figure 1–4.
- f. *Check against limits:* Do the following subparts in the order listed.
- **CHECK** that the measurement results are within the limits listed for the current vertical scale setting.
 - Enter voltage on test record.
 - Repeat substeps b through f until all vertical scale settings listed in Table 1–2, are checked for the channel under test.

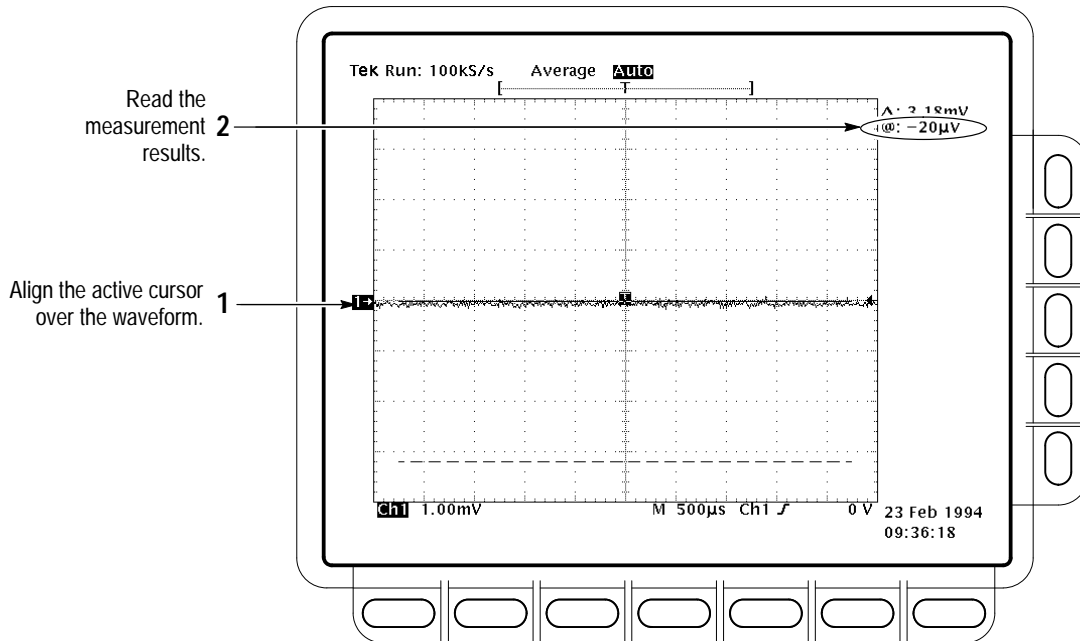

Figure 1-4: Measurement of DC Offset Accuracy at Zero Setting

- g. *Test all channels:* Repeat substeps a through f for all input channels.
- 3. *Disconnect the hookup:* No hookup was required.

Check DC Voltage Measurement Accuracy



WARNING. The generator is capable of outputting dangerous voltages. Be sure to set the DC calibration generator to 0 volts before connecting, disconnecting, and/or moving the test hookup during the performance of this procedure.

Equipment Required	Two dual-banana connectors (Item 6) One BNC T connector (Item 7) One DC calibration generator (Item 9) Two precision coaxial cables (Item 5)
Prerequisites	The oscilloscope must meet the prerequisites listed on page 1-15

1. *Install the test hookup and preset the instrument controls:*
 - a. *Hook up the test-signal source:*
 - Set the output of a DC calibration generator to 0 volts.
 - Connect the output of a DC calibration generator through a dual-banana connector followed by a 50 Ω precision coaxial cable to one side of a BNC T connector. See Figure 1–5.
 - Connect the Sense output of the generator through a second dual-banana connector followed by a 50 Ω precision coaxial cable to the other side of the BNC T connector. Now connect the BNC T connector to **CH 1**. See Figure 1–5.

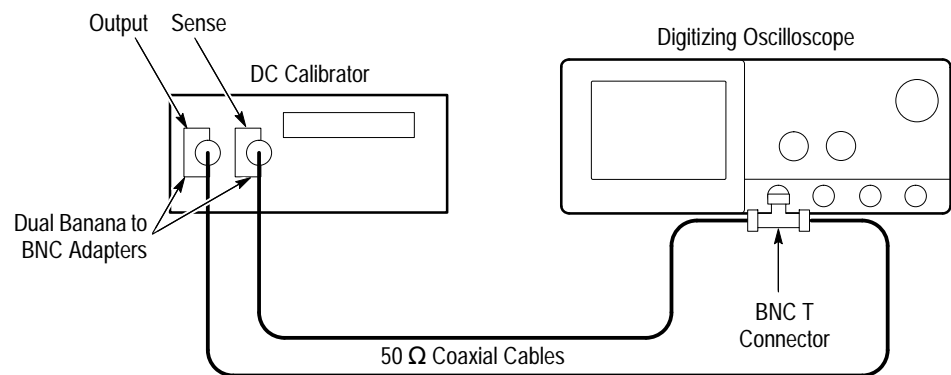

Figure 1–5: Initial Test Hookup

- b. *Initialize the oscilloscope:*
 - Press save/recall **SETUP**.
 - Press the main-menu button **Recall Factory Setup**.
 - Press the side-menu button **OK Confirm Factory Init**.
 - c. *Modify the default settings:*
 - Press **SHIFT**; then press **ACQUIRE MENU**.
 - Press the main-menu button **Mode**; then press the side-menu button **Average 16**.
2. *Confirm input channels are within limits for DC accuracy at maximum offset and position: Do the following substeps — test CH 1 first, skipping substep 2a since CH 1 is already selected from step 1.*

- a. *Select an unchecked channel:*
- Press **WAVEFORM OFF** to remove the channel just confirmed from the display.
 - Press the front-panel button that corresponds to the channel you are to confirm.
 - *Set the generator output to 0 V.*
 - Move the test hookup to the channel you selected.
- b. *Turn on the measurement Mean for the channel:*
- Press **MEASURE**, then press the main-menu button **Select Measrmnt for CHx**.
 - Press the side-menu button **more** until the menu label **Mean** appears in the side menu (its icon is shown at the left). Press the side-menu button **Mean**.
 - Press **CLEAR MENU**.
- c. *Set the vertical scale:* Set the vertical **SCALE** to one of the settings listed in Table 1–3 that is not yet checked. (Start with the first setting listed.)



Table 1–3: DC Accuracy

Scale Setting	Position Setting (Divs)	Offset Setting	Generator Setting	TDS 684A Accuracy Limits	TDS 744 Accuracy Limits
5 mV	–5	+1 V	+1.040 V	+1.029 V to +1.0513 V	+1.0355 V to +1.0445 V
	+5	–1 V	–1.040 V	–1.0513 V to –1.029 V	–1.0445 V to –1.0355 V
200 mV	–5	+10 V	+11.6 V	+11.420 V to +11.786 V	+11.5385 V to +11.6615 V
	+5	–10 V	–11.6 V	–11.786 V to –11.420 V	–11.6615 V to –11.5385 V
1 V	–5	+10 V	+18V	+17.26 V to +18.76 V	+17.7785 V to +18.2215 V
	+5	–10 V	–18 V	–18.76 V to –17.26 V	–18.2215 V to –17.7785 V

- d. *Display the test signal:*
- Press **VERTICAL MENU**. Press the main-menu button **Position**.
 - Use the keypad to set vertical position to –5 divisions (press **–5**, then **ENTER**, on the keypad). The baseline level will move off screen.
 - Press the main-menu button **Offset**.

- Use the keypad to set vertical offset to the positive-polarity setting listed in the table for the current vertical scale setting. The baseline level will remain off screen.
 - Set the generator to the level and polarity indicated in the table for the vertical scale, position, and offset settings you have made. The DC test level should appear on screen. (If it doesn't return, the DC accuracy check is failed for the current vertical scale setting of the current channel.)
- e. *Measure the test signal:* Press **CLEAR MENU**. Read the measurement results at the **Mean** measurement readout. See Figure 1–6.

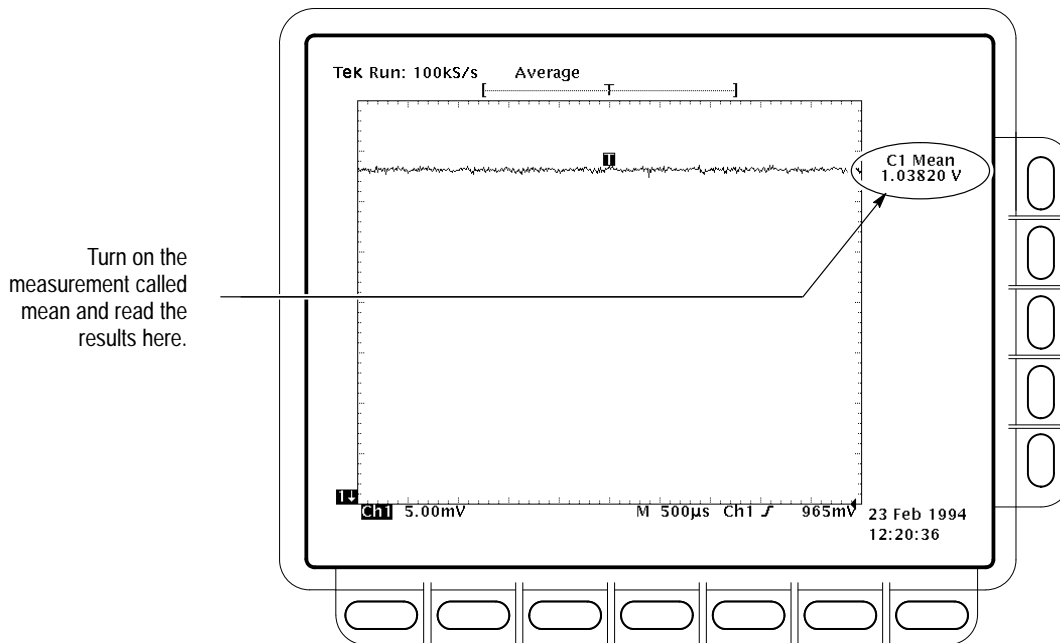

Figure 1–6: Measurement of DC Accuracy at Maximum Offset and Position

- f. *Check against limits:*
- CHECK that the readout for the measurement **Mean** readout on screen is within the limits listed for the current vertical scale and position/offset/generator settings. Enter value on test record.
 - Repeat substep d, reversing the polarity of the position, offset, and generator settings as is listed in the table.
 - CHECK that the **Mean** measurement readout on screen is within the limits listed for the current vertical scale setting and position/offset/generator settings. Enter value on test record.

- Repeat substeps c through f until all vertical scale settings, listed in Table 1–3, are checked for the channel under test.
 - g. *Test all channels:* Repeat substeps a through f for all four channels.
- 3. *Disconnect the hookup:*
 - a. *Set the generator output to 0 V.*
 - b. Disconnect the cable from the generator output at the input connector of the channel last tested.

Check Analog Bandwidth

Equipment Required	One high-frequency leveled sine wave generator and its leveling head (Item 12) Two 10X attenuators (Item 1)
Prerequisites	See page 1–15

1. *Install the test hookup and preset the instrument controls:*
 - a. *Initialize the oscilloscope:*
 - Press save/recall **SETUP**. Press the main-menu button **Recall Factory Setup**; then press the side-menu button **OK Confirm Factory Init**.
 - b. *Modify the default settings:*
 - Press **TRIGGER MENU**. Press the main-menu button **Coupling**.
 - Press the side-menu button **Noise Rej**.
 - Turn the horizontal **SCALE** knob to 50 ns. Press **SHIFT**; then press **ACQUIRE MENU**.
 - Press the main-menu button **Mode**; then press the side-menu button **Average 16**.
 - Press **MEASURE**. Press the main-menu button **High–Low Setup**; then press the side-menu button **Min–Max**.
 - c. *Hook up the test-signal source:* Connect, through its leveling head, the sine wave output of a high-frequency leveled sine wave generator to **CH 1**. Set the output of the generator to a reference frequency of 6 MHz. See Figure 1–7.

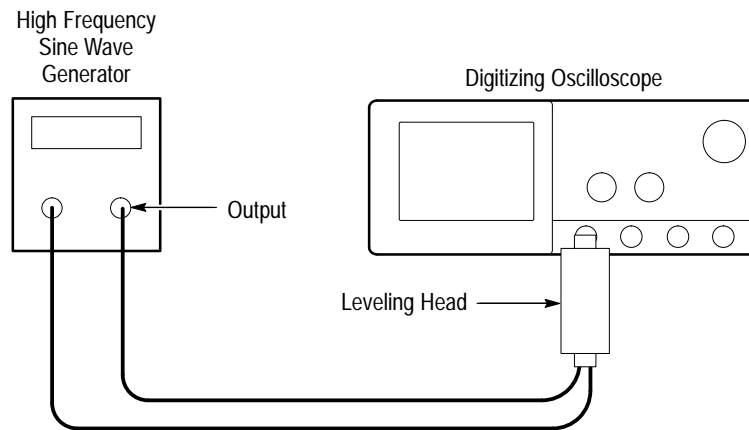

Figure 1-7: Initial Test Hookup

2. *Confirm the input channels are within limits for analog bandwidth: Do the following substeps — test CH 1 first, skipping substeps a and b since CH 1 is already set up for testing from step 1.*
 - a. *Select an unchecked channel:*
 - Press **WAVEFORM OFF** to remove the channel just confirmed from display.
 - Press the front-panel button that corresponds to the channel you are to confirm.
 - Move the leveling head to the channel you selected.
 - b. *Match the trigger source to the channel selected:*
 - Press **TRIGGER MENU**. Press the main-menu button **Source**; then press the side-menu button that corresponds to the channel selected.
 - c. *Set its input impedance:*
 - Press **VERTICAL MENU**; then press the main-menu button **Coupling**.
 - Press the side-menu **Ω** button to toggle it to the **50 Ω** setting.
 - d. *Set the vertical scale: Set the vertical **SCALE** to one of the settings listed in Table 1-4 not yet checked. (Start with the 100 mV setting.)*

Table 1–4: Analog Bandwidth

Vertical Scale	Attenuators (10X)	Reference Amplitude (at 6 MHz)	Horizontal Scale	TDS 684A Test Frequency	TDS 744 Test Frequency	Limits
100 mV	none	600 mV (6 divisions)	1 ns	1 GHz	500 MHz	≥424 mV
1 V	none	5 V (5 divisions)	1 ns	1 GHz	500 MHz	≥3.535 V
500 mV	none	3 V (6 divisions)	1 ns	1 GHz	500 MHz	≥2.121 V
200 mV	none	1.2 V (6 divisions)	1 ns	1 GHz	500 MHz	≥848 mV
50 mV	1	300 mV (6 divisions)	1 ns	1 GHz	500 MHz	≥212 mV
20 mV	1	120 mV (6 divisions)	1 ns	1 GHz	500 MHz	≥84.8 mV
10 mV	1	60 mV (6 divisions)	1 ns	1 GHz	500 MHz	≥42.4 mV
5 mV	2	30 mV (6 divisions)	1 ns	750 MHz	500 MHz	≥21.2 mV
2 mV	2	12 mV (6 divisions)	1 ns	600 MHz	350 MHz	≥8.48 mV
1 mV	2	6 mV (6 divisions)	1 ns	500 MHz	300 MHz	≥4.24 mV

- e. *Display the test signal:* Do the following subparts to first display the reference signal and then the test signal.



- Press **MEASURE**; then press the main-menu button **Select Measrmt for CHx**.
- Press the side-menu button **more** until the menu label **Pk-Pk** appears in the side menu (its icon is shown at the left). Press the side-menu button **Pk-Pk**.
- Repeatedly press the side-menu button **more** until **Frequency** appears in the side menu (its icon is shown at the left). Press the side-menu button **Frequency**.
- Press **CLEAR MENU**.
- Set the generator output so the CHx Pk-Pk readout equals the reference amplitude in Table 1–4 that corresponds to the vertical scale set in substep d.
- Press the front-panel button **SET LEVEL TO 50%** as necessary to trigger a stable display. At full bandwidth (for TDS 684A = 1 GHz, for 744 = 500 MHz frequency), you may also want to make small, manual adjustments to the trigger level. You can use the **TRIGGER LEVEL** knob to do this.

f. Measure the test signal:

- Set the frequency of the generator, as shown on screen, to the test frequency in Table 1–4 that corresponds to the vertical scale set in substep d. See Figure 1–8.
- Set the horizontal **SCALE** to the horizontal scale setting in Table 1–4 that corresponds to the vertical scale set in substep d. Press **SET LEVEL TO 50%** as necessary to trigger the signal.
- Read the results at the CHx Pk-Pk readout, which will automatically measure the amplitude of the test signal. See Figure 1–8.

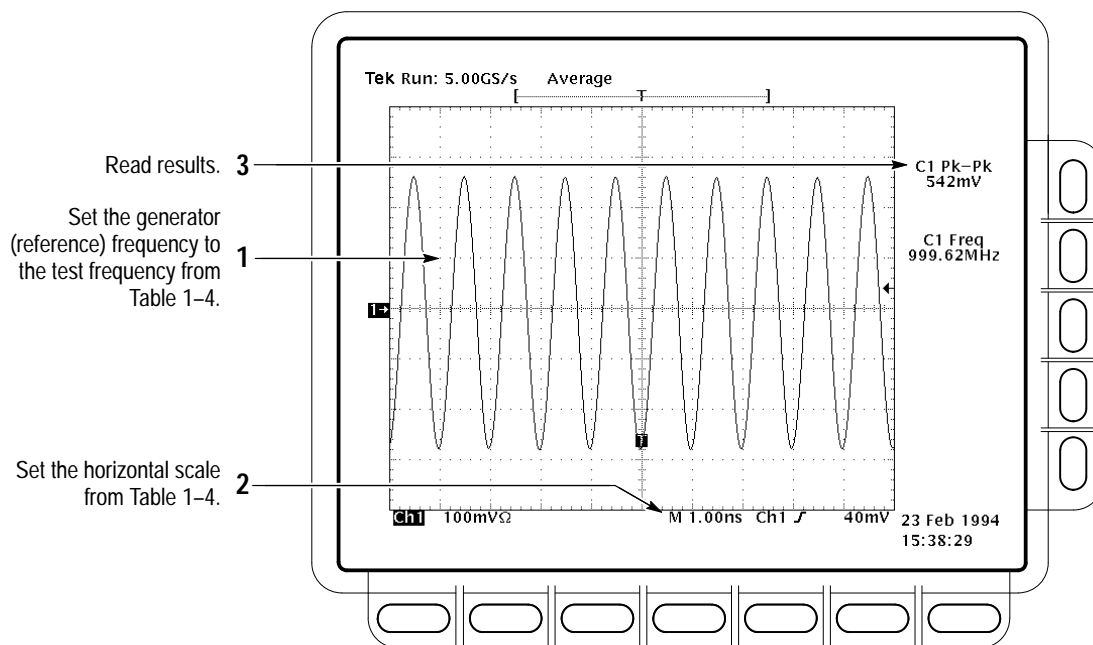

Figure 1–8: Measurement of Analog Bandwidth

g. Check against limits:

- CHECK that the **Pk-Pk** readout on screen is within the limits listed in Table 1–4 for the current vertical scale setting.
- Enter voltage on test record.
- When finished checking, set the horizontal **SCALE** back to the 50 ns setting.

STOP. Checking each channel's bandwidth at all vertical scale settings is time consuming and unnecessary. You may skip checking the remaining vertical scale settings in Table 1–4 (that is, skip the following substep, h) if this digitizing oscilloscope has performed as follows:

- Passed the 100 mV vertical scale setting just checked in this procedure.
 - Passed the *Verify Internal Adjustment, Self Compensation, and Diagnostics* procedure found under *Self Tests*, on page 1–5.
-

NOTE. Passing the signal path compensation confirms the signal path for all vertical scale settings for all channels. Passing the internal diagnostics ensures that the factory-set adjustment constants that control the bandwidth for each vertical scale setting have not changed.

h. Check remaining vertical scale settings against limits (optional):

- If desired, finish checking the remaining vertical scale settings for the channel under test by repeating substeps d through g for each of the remaining scale settings listed in Table 1–4 for the channel under test.
- When doing substep e, skip the subparts that turn on the CHx Pk-Pk measurement until you check a new channel.
- Install/remove 10X attenuators between the generator leveling head and the channel input as needed to obtain the six division reference signals listed in the table.

i. Test all channels: Repeat substeps a through g for all four channels.

- 3.** *Disconnect the hookup:* Disconnect the test hook up from the input connector of the channel last tested.

Check Delay Between Channels

Equipment Required	One medium-frequency leveled sine wave generator (Item 11) One precision coaxial cable (Item 5) One 50 Ω terminator (Item 4) One dual-input coupler (Item 8)
Prerequisites	See page 1–15

STOP. DO NOT use the vertical position knob to reposition any channel while doing this check. To do so invalidates the test.

1. Install the test hookup and preset the instrument controls:

a. Initialize the front panel:

- Press save/recall **SETUP**.
- Press the main-menu button **Recall Factory Setup**.
- Press the side-menu button **OK Confirm Factory Init**.

b. Modify the initialized front-panel control settings:

- Do *not* adjust the vertical position of any channel during this procedure.
- Set the horizontal **SCALE** to 500 ps.
- Press **SHIFT**; then press **ACQUIRE MENU**.
- Press the main-menu button **Mode**, and then press the side-menu button **Average 16**.

c. Hook up the test-signal source:

- Connect, through a 50 Ω precision coaxial cable followed by a 50 Ω termination, the sine wave output of a medium-frequency sine wave generator to a dual-input coupler. See Figure 1–9.
- Connect the coupler to both **CH 1** and **CH 2**. See Figure 1–9.

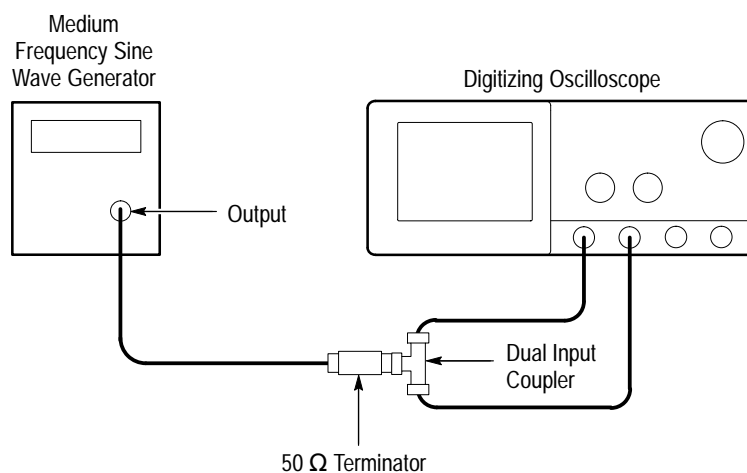

Figure 1–9: Initial Test Hookup

2. *Confirm all four channels (CH 1 through CH 4) are within limits for channel delay:*
 - a. *Set up the generator:* Set the generator frequency to 250 MHz and the amplitude for about six divisions in CH 1.

Hint: As you are adjusting the generator amplitude, push **SET LEVEL TO 50%** frequently to speed up the updating of the waveform amplitude on screen.
 - b. *Save a CH 2 waveform:* Press **CH 2**; then press save/recall **WAVEFORM**. Now, press the main-menu button **Save Wfm**; then press the side-menu button **To Ref 2**.
 - c. *Save CH 3 waveform:*
 - Move the coupler from **CH 2** to **CH 3**, so that **CH 1** and **CH 3** are driven. Press **WAVEFORM OFF**. Press **CH 3**; then press the side-menu button **To Ref 3**.
 - d. *Display all test signals:*
 - Press **WAVEFORM OFF** to remove CH 3 from the display.
 - Display the live waveform. Move the coupler from **CH 3** to **CH 4**, so that CH 1 and CH 4 are driven. Press **CH 4** to display. See Figure 1–10 on page 1–40.
 - Display the reference waveforms. To do this, press the front-panel button **MORE**. Press the main-menu buttons **Ref 2** and **Ref 3**. You may notice their overlapping ground reference indicators. See Figure 1–10 on page 1–40.
 - e. *Measure the test signal:*
 - Locate the time reference points for these waveforms. Do this by first identifying the point on the rising edge of the left-most waveform crosses the center horizontal graticule line. Next, note the corresponding *time reference point* for the right-most waveform. See Figure 1–10 on page 1–40.
 - Press **CURSOR**.
 - Press the main-menu button **Function**; then press the side-menu button **V Bars**.
 - Press **CLEAR MENU**.
 - Align one V bar cursor to the *time reference point* of the left-most waveform edge and the other cursor to the *time reference point* of the right-most waveform edge by rotating the General Purpose knob.

(Press **SELECT** to switch between the two cursors.) See Figure 1–10 on page 1–40.

- Read the measurement results at the Δ : cursor readout, not the @: readout on screen.

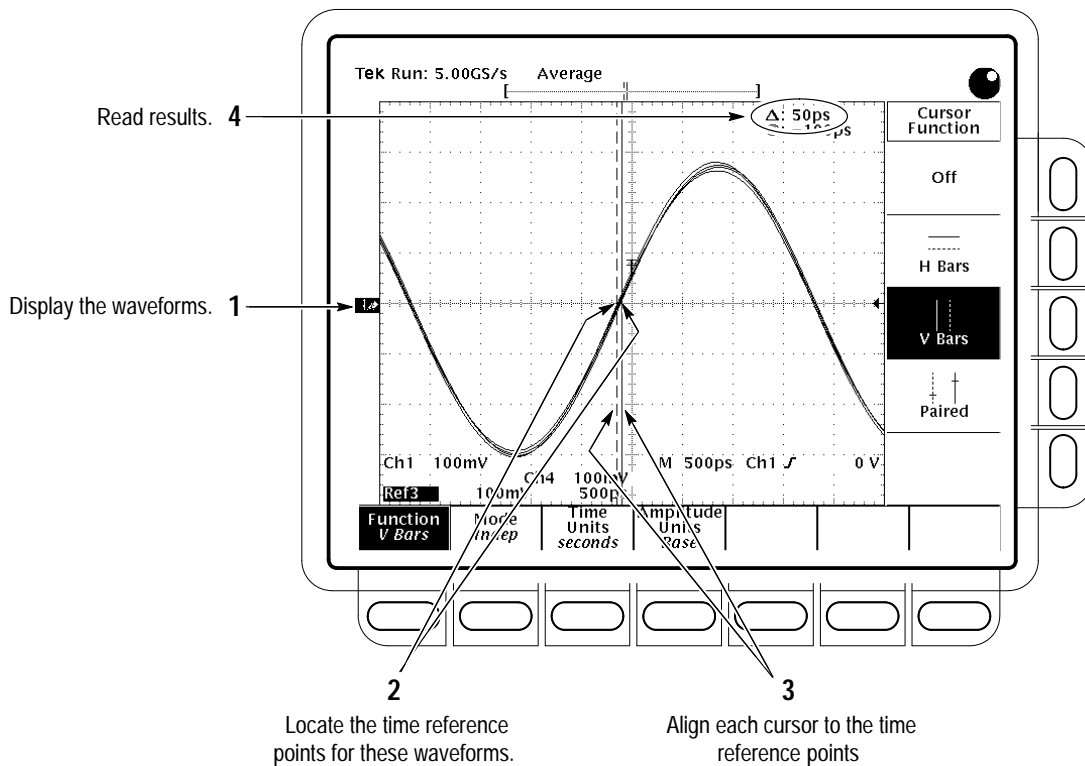

Figure 1–10: Measurement of Channel Delay

- f. *Check against limits:* CHECK that the cursor readout on screen is ≤ 100 ps.
 - g. Enter time on test record.
3. *Disconnect the hookup:* Disconnect the cable from the generator output at the input connectors of the channels.

Time Base System Checks

These procedures check those characteristics that relate to the Main and Delayed time base system and are listed as checked under *Warranted Characteristics in Specifications*.

Check Accuracy for Long-Term Sample Rate, Delay Time, and Delta Time Measurements

Equipment Required	One time-mark generator (Item 13) One 50 Ω , precision coaxial cable (Item 5)
Prerequisites	See page 1–15

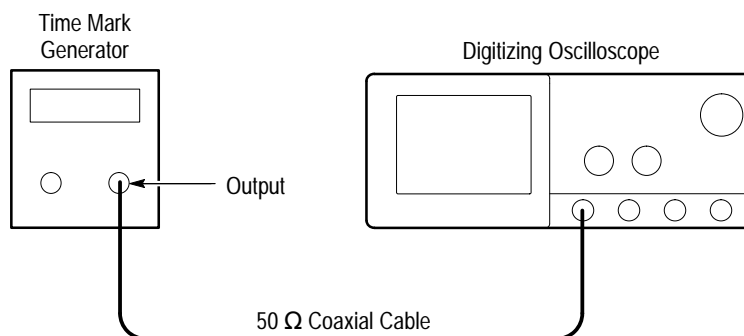

Figure 1–11: Initial Test Hookup

1. *Install the test hookup and preset the instrument controls:*
 - a. *Hook up the test-signal source:* Connect, through a 50 Ω precision coaxial cable, the time-mark output of a time-mark generator to **CH 1**. Set the output of the generator for 10 ms markers.
 - b. *Initialize the oscilloscope:*
 - Press save/recall **SETUP**. Press the main-menu button **Recall Factory Setup**. Press the side-menu button **OK Confirm Factory Init**.
 - c. *Modify the initialized front-panel control settings:*
 - Set the vertical **SCALE** to 500 mV.
 - Press **VERTICAL MENU**; then press the main-menu button **Coupling**. Press the side-menu button **Ω** to toggle it to the **50 Ω** setting.
 - Press **SET LEVEL TO 50%**.
 - Use the vertical **POSITION** knob to center the test signal on screen.

- Set the horizontal **SCALE** of the Main time base to 1 ms.
 - Press **TRIGGER MENU**; then press the main-menu button **Mode & Holdoff**. Press the side-menu button **Normal**.
2. *Confirm Main and Delayed time bases are within limits for accuracies:*
- a. *Display the test signal:*
 - Align the trigger **T** to the center vertical graticule line by adjusting the horizontal **POSITION**. See Figure 1–12 on page 1–43.
 - Press **HORIZONTAL MENU**.
 - Set horizontal modes. To do this, press the main-menu button **Time Base**. Press the side-menu buttons **Delayed Only** and **Delayed Runs After Main**. See Figure 1–12.
 - b. *Measure the test signal:*
 - Set the horizontal **SCALE** of the **D** (delayed) time base to 500 ns for the TDS 684A or to 100 ns for the TDS 744.
 - Set delayed time to 10 ms for the TDS 684A or the TDS 744 with serial # B020000 and up. Set delayed time to 10.0015 ms for the TDS 744 with serial number B019999 and below. Do this on the keypad by pressing **10** for the TDS 684A or later TDS 744 or by pressing **10.0015** for the earlier TDS 744, then **SHIFT**, then **m** followed by **ENTER**.)
 - c. *Check long-term sample rate and delay time accuracies against limits:*
 - **CHECK** that the rising edge of the marker crosses the center horizontal graticule line at a point within either ± 2.0 , for the TDS 684A, or ± 2.5 , for the TDS 744, divisions of center graticule. See Figure 1–12.
 - Enter number of divisions on test record.

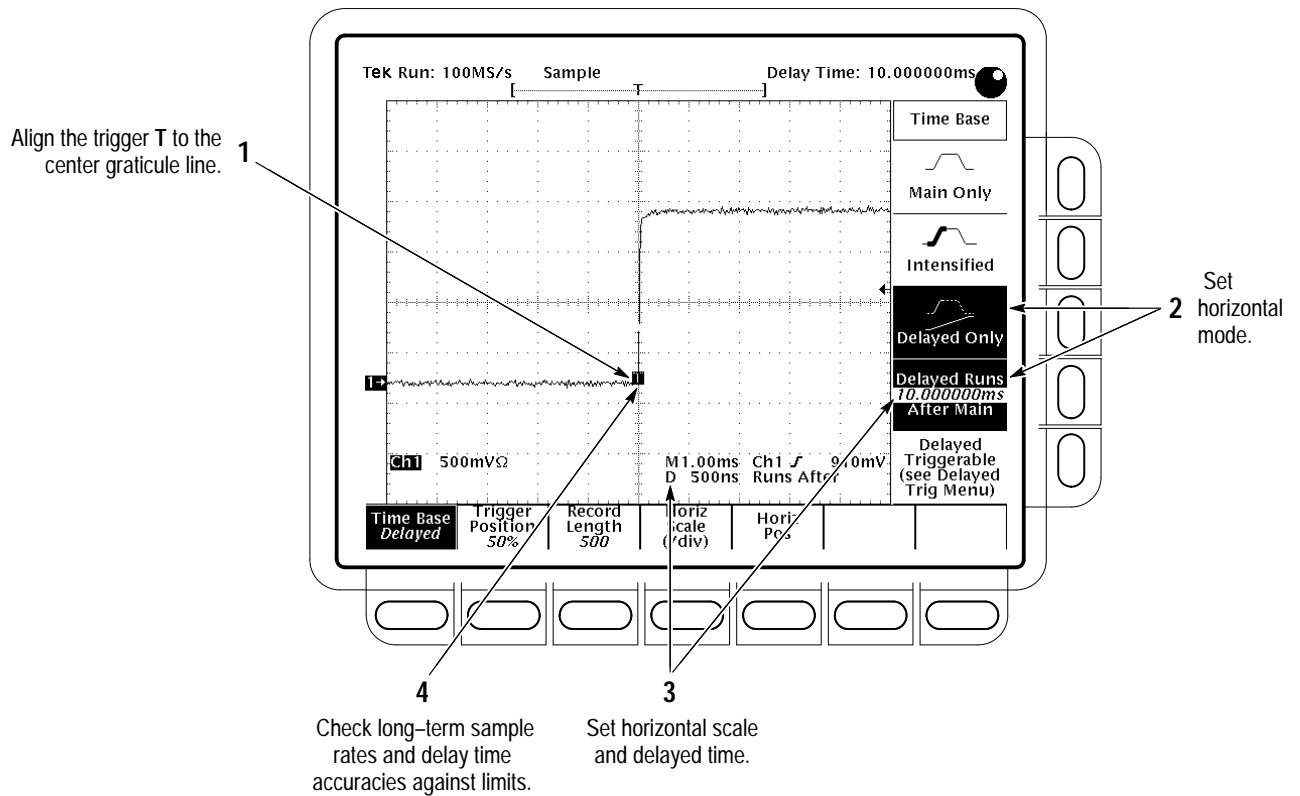

Figure 1-12: Measurement of Accuracy — Long-Term and Delay Time

3. *Disconnect the hookup:* Disconnect the cable from the generator output at the input connector of **CH 1**.

Trigger System Checks

These procedures check those characteristics that relate to the Main and Delayed trigger systems and are listed as checked in *Specifications*.

Check Accuracy (Time) for Pulse-Glitch or Pulse-Width Triggering

Equipment Required	One medium-frequency leveled sine wave generator (Item 11) One 10X attenuator (Item 1) One 50 Ω, precision coaxial cable (Item 5)
Prerequisites	See page 1-15

1. *Install the test hookup and preset the instrument controls:*
 - a. *Initialize the instrument:*
 - Press save/recall **SETUP**.
 - Press the main-menu button **Recall Factory Setup**.
 - Press the side-menu button **OK Confirm Factory Init**.
 - b. *Modify the default setup:*
 - Press **VERTICAL MENU**.
 - Press the main-menu button **Coupling**; then press the side-menu **Ω** button to select **50 Ω** coupling.
 - Set the horizontal **SCALE** to 10 ns on the TDS 684A and 12.5 ns on the TDS 744.

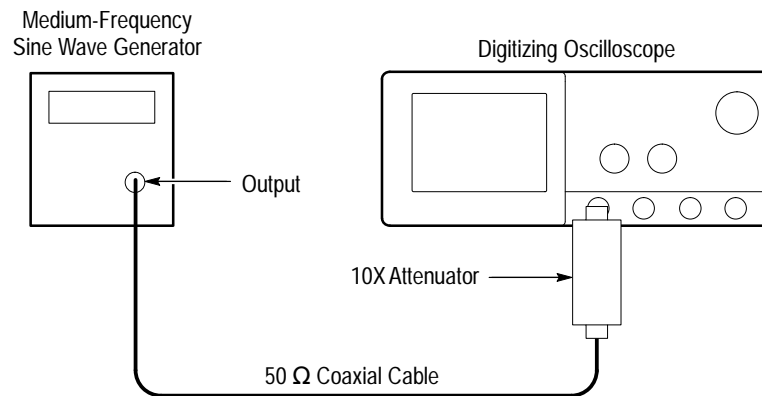

Figure 1-13: Initial Test Hookup

- c. *Hook up the test-signal source:* Connect the output of a medium-frequency leveled sine wave generator (Item 11) to CH 1. Do this through a 50 Ω precision coaxial cable, followed by a 10X attenuator. See Figure 1-13 on page 1-44.
2. *Confirm the trigger system is within time-accuracy limits for pulse-glitch or pulse-width triggering (Horizontal Scale $\leq 1 \mu\text{s}$):*
 - a. *Display the test signal:* Set the output of the sine wave generator for a 100 MHz, five-division sine wave on screen. Press **SET LEVEL TO 50%**.

- b. *Set the trigger mode:* Press **TRIGGER MENU**. Now press the main-menu button **Mode & Holdoff**; then press the side-menu button **Normal**.
- c. *Set upper and lower limits that ensure triggering:* See Figure 1–14.
- Press the main-menu button **Type**; then repeatedly press the same button until **Pulse** is highlighted in the menu that pops up.
 - Press the main-menu button **Class**; then repeatedly press the same button until **Width** is highlighted in the menu that pops up.
 - Press the main-menu button **Trig When**; then press the side-menu button **Within Limits**.
 - Press the side-menu button **Upper Limit**. Use the keyboard to set the upper limit to 10 ns: press **10**, then **SHIFT**, then **n**, and **ENTER**.
 - Press the side-menu button **Lower Limit**. Use the keypad to set the lower limit to 2 ns.
- d. *Change limits until triggering stops:*
- Press **SET LEVEL TO 50%**.
 - While doing the following subparts, monitor the display (it will stop acquiring) and the front-panel light **TRIG** (it will extinguish) to determine when triggering is lost.
 - Use the general purpose knob to *increase* the **Lower Limit** readout until triggering is lost.
 - CHECK that the **Lower Limit** readout, after the oscilloscope loses triggering, is within 2.5 ns to 7.5 ns, inclusive, for the TDS 684A or is within 3.5 ns to 6.5 ns, inclusive, for the TDS 744.
 - Enter time on test record.
 - Use the keypad to return the **Lower Limit** to 2 ns and reestablish triggering.
 - Press the side-menu button **Upper Limit**; then use the general purpose knob to slowly *decrease* the **Upper Limit** readout until triggering is lost.
 - CHECK that the **Upper Limit** readout, after the oscilloscope loses triggering, is within 2.5 ns to 7.5 ns, inclusive, for the TDS 684A or is within 2.5 ns to 6.5 ns, inclusive, for the TDS 744.
 - Enter time on test record.

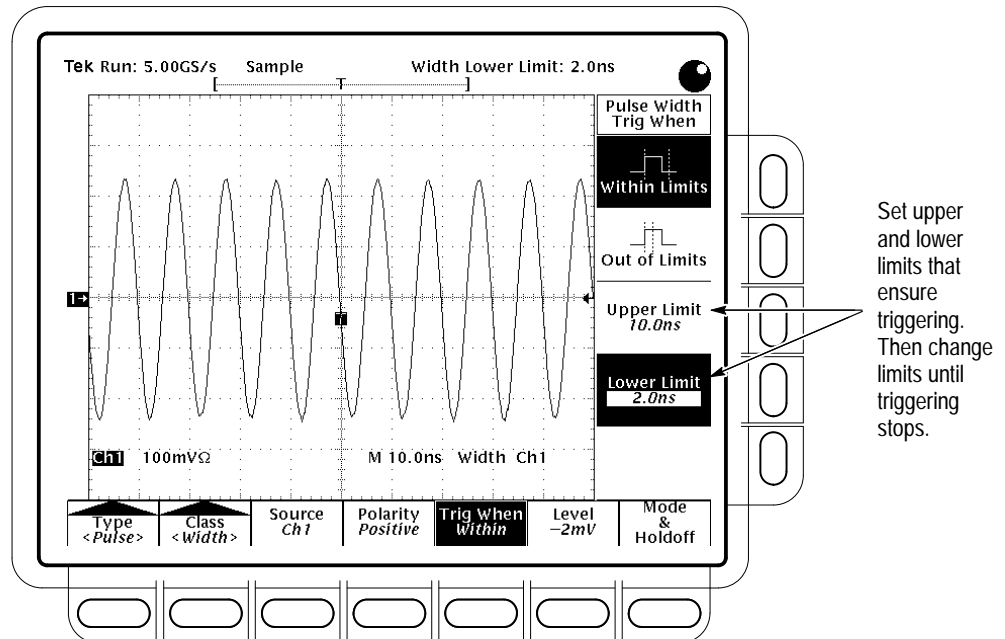

Figure 1-14: Measurement of Time Accuracy for Pulse and Glitch Triggering

3. *Confirm the trigger system is within time-accuracy limits for pulse-glitch or pulse-width triggering (horizontal scale >1 μ s):*
 - a. *Set upper and lower limits that ensure triggering at 250 kHz:*
 - Press the side-menu button **Upper Limit**. Use the keyboard to set the upper limit to 4 μ s.
 - Press the side-menu button **Lower Limit**. Use the keypad to set the lower limit to 500 ns.
 - b. *Display the test signal:*
 - Set the horizontal **SCALE** to 5 μ s.
 - Set the output of the sine wave generator for a 250 kHz, five-division sine wave on screen. Set the vertical **SCALE** to 20 mV (the waveform will overdrive the display).
 - Press **SET LEVEL TO 50%**.
 - c. *Check against limits:* Do the following subparts in the order listed.
 - Use the general purpose knob to *increase* **Lower Limit** readout until triggering is lost.

- CHECK that the **Lower Limit** readout, after the oscilloscope stops triggering, is within 1 μ s to 3 μ s, inclusive, for the TDS 684A or is within 1.9 μ s to 2.1 μ s, inclusive, for the TDS 744.
 - Enter time on test record.
 - Use the keypad to return the **Lower Limit** to 500 ns and reestablish triggering.
 - Press the side-menu button **Upper Limit**; then use the general purpose knob to slowly *decrease* the **Upper Limit** readout until triggering stops.
 - CHECK that the **Upper Limit** readout, after the oscilloscope loses triggering, is within 1 μ s to 3 μ s, inclusive, for the TDS 684A or is within 1.9 μ s to 2.1 μ s, inclusive, for the TDS 744.
 - Enter time on test record.
4. *Disconnect the hookup*: Disconnect the cable from the generator output at the input connector of **CH 1**.

**Check Accuracy,
Trigger-Level or
Threshold, DC Coupled**

Equipment Required	One DC calibration generator (Item 9) One BNC T connector (Item 7) Two 50 Ω , precision coaxial cables (Item 5)
Prerequisites	See page 1–15.

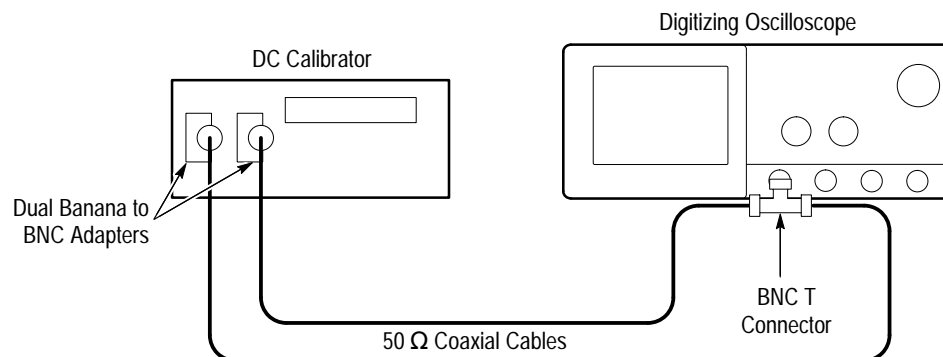

Figure 1–15: Initial Test Hookup

1. *Install the test hookup and preset the instrument controls:*
 - a. *Hook up the test-signal source:*
 - Set the output of the DC calibration generator to 0 volts.

- Connect the output of the DC calibration generator, through a dual-banana connector followed by a 50 Ω precision coaxial cable, to one side of a BNC T connector.
 - Connect the Sense output of the generator, through a second dual-banana connector followed by a 50 Ω precision coaxial cable, to other side of the BNC T connector. Now connect the BNC T connector to **CH 1**.
- b.** *Initialize the oscilloscope:*
- Press save/recall **Setup**.
 - Press the main-menu button **Recall Factory Setup**.
 - Press the side-menu button **OK Confirm Factory Init**.
- 2.** *Confirm Main trigger system is within limits for Trigger-level/Threshold accuracy:*
- a.** *Display the test signal:*
- Set the vertical **SCALE** to 200 mV.
 - Press **VERTICAL MENU**, then press the main-menu button **Position**.
 - Set vertical position to –3 divisions (press **–3**, then **ENTER**, on the keypad.) The baseline level will move down three divisions. See Figure 1–16 on page 1–49.
 - Press the main-menu button **Offset**.
 - Set vertical offset to +10 volts with the keypad. The baseline level will move off screen.
 - Set the standard output of the DC calibration generator equal to the offset (+10 volts). The DC test level will appear on screen. See Figure 1–16.
- b.** *Measure the test signal:*
- Press **SET LEVEL TO 50%**.
 - Press **TRIGGER MENU**.
 - Read the measurement results from the readout below the label **Level** in the main menu, not the trigger readout in the graticule area.

c. *Read results (Check against limits):* See Figure 1–16.

- CHECK that the **Level** readout in the main menu is within 9.863 V to 10.137 V, inclusive, for the TDS 684A or is within 9.9393 V to 10.1147 V, inclusive, for the TDS 744.
- Enter voltage on test record.
- Press the main-menu button **Slope**; then press the side-menu button for negative slope. See icon at left. Repeat substep b.
- CHECK that the **Level** readout in the main menu is within 9.863 V to 10.137 V, inclusive, for the TDS 684A or is within 9.9393 V to 10.1147 V, inclusive, for the TDS 744.
- Enter voltage on test record.

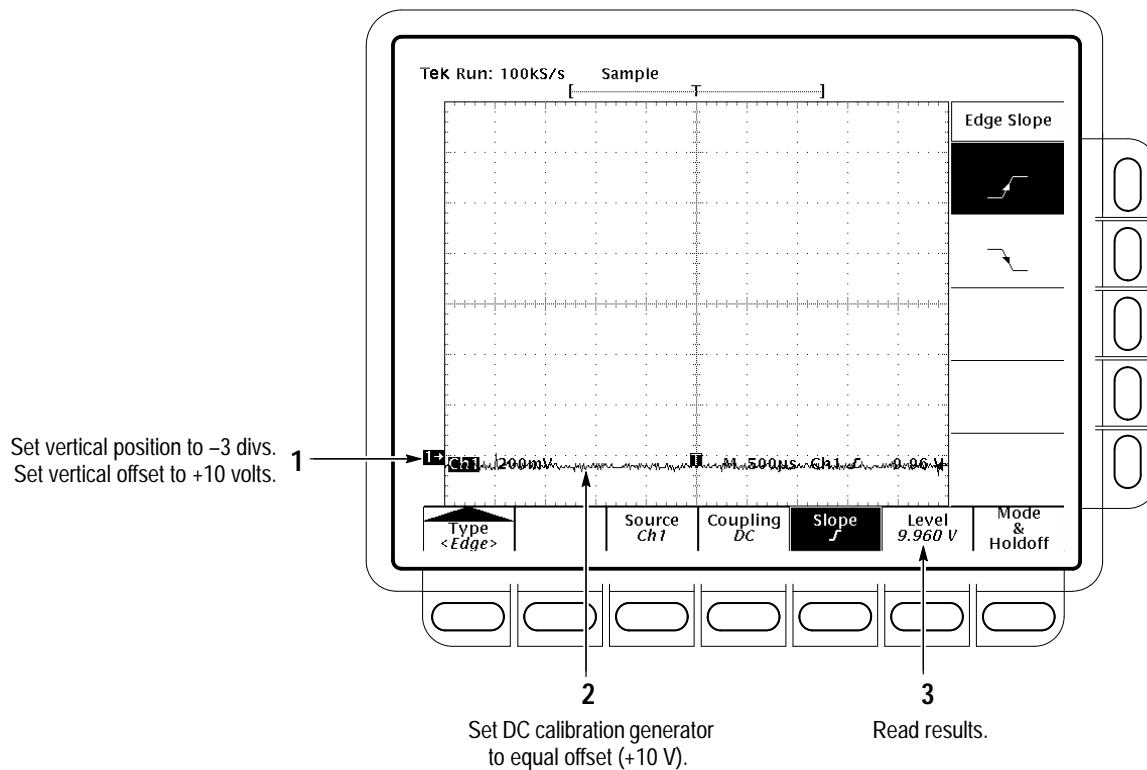

Figure 1–16: Measurement of Trigger-Level Accuracy

3. *Confirm Delayed trigger system is within limits for Trigger-level/Threshold accuracy:*
 - a. *Select the Delayed time base:*

- Press **HORIZONTAL MENU**.
 - Press the main-menu button **Time Base**.
 - Press the side-menu buttons **Delayed Only** and **Delayed Triggerable**.
 - Set **D** (delayed) horizontal **SCALE** to 500 μ s.
- b.** *Select the Delayed trigger system:*
- Press **SHIFT**; then press the front-panel **DELAYED TRIG** button.
 - Press the main-menu button **Level**.
- c.** *Measure the test signal:* Press the side-menu button **SET TO 50%**. Read the measurement results in the side (or main) menu below the label **Level**.
- d.** *Check against limits:* Do the following subparts in the order listed.
- CHECK that the **Level** readout in the side menu is within 9.863 V to 10.137 V, inclusive, for the TDS 684A or is within 9.9393 V to 10.1147 V, inclusive, for the TDS 744.
 - Enter voltage on test record.
 - Press the main-menu button **Slope**; then press the side-menu button for negative slope. See icon at left. Press the main-menu button **Level**. Repeat substep c.
 - CHECK that the **Level** readout in the side menu is within 9.863 V to 10.137 V, inclusive, for the TDS 684A or is within 9.9393 V to 10.1147 V, inclusive, for the TDS 744.
 - Enter voltage on test record.
- 4.** *Disconnect the hookup:*
- a.** *First set the output of the DC calibration generator to 0 volts.*
- b.** Disconnect the cable from the generator output at the input connector of **CH 1**.



Sensitivity, Edge Trigger,
DC Coupled

Equipment Required	One medium-frequency leveled sine wave generator (Item 11) One high-frequency leveled sine wave generator (Item 12) Two precision 50 Ω coaxial cables (Item 5) One 10X attenuator (Item 1) One BNC T connector (Item 7) One 5X attenuator (Item 2)
Prerequisites	See page 1–15.

1. *Install the test hookup and preset the instrument controls:*
 - a. *Initialize the oscilloscope:*
 - Press save/recall **SETUP**.
 - Press the main-menu button **Recall Factory Setup**.
 - Press the side-menu button **OK Confirm Factory Init**.
 - b. *Modify the initialized front-panel control settings:*
 - Set the horizontal **SCALE** for the **M** (main) time base to 20 ns on the TDS 684A or 25 ns on the TDS 744.
 - Press **HORIZONTAL MENU**; then press the main-menu button **Time Base**.
 - Press the side-menu button **Delayed Only**; then press the side-menu button **Delayed Triggerable**.
 - Set the horizontal **SCALE** for the **D** (delayed) time base to 20 ns on the TDS 684A or 25 ns on the TDS 744; then press the side-menu button **Main Only**.
 - Press **TRIGGER MENU**; then press the main-menu button **Mode & Holdoff**. Press the side-menu button **Normal**.
 - Press **VERTICAL MENU**; then press the main-menu button **Coupling**. Press the side-menu button Ω to select the 50 Ω setting.
 - Press **SHIFT**; then press **ACQUIRE MENU**. Press the main-menu button **Mode**; then press the side-menu button **Average 16**.
 - c. *Hook up the test-signal source:*
 - Connect the signal output of a medium-frequency sine wave generator to a BNC T connector. Connect one output of the T connector to **CH 1** through a 50 Ω precision coaxial cable. Connect

the other output of the T connector to the **AUX TRIG INPUT** at the rear panel. See Figure 1–17.

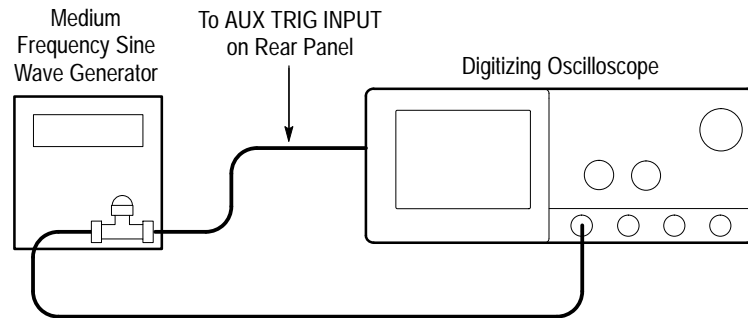

Figure 1–17: Initial Test Hookup

2. Confirm Main and Delayed trigger systems are within sensitivity limits (50 MHz):

a. Display the test signal:

- Set the generator frequency to 50 MHz.
- Press **MEASURE**.
- Press the main-menu button **High-Low Setup**; then press the side-menu button **Min-Max**.
- Press the main-menu button **Select Measrmt for Ch1**.
- Press the side-menu button **–more–** until **Amplitude** appears in the side menu (its icon is shown at the left). Press the side-menu button **Amplitude**.
- Press **SET LEVEL TO 50%**.
- Press **CLEAR MENU**.
- Set the test signal amplitude for about three and a half divisions on screen. Now fine adjust the generator output until the **CH 1 Amplitude** readout indicates the amplitude is 350 mV. Readout may fluctuate around 350 mV.
- Disconnect the 50 Ω precision coaxial cable at **CH 1** and reconnect it to **CH 1** through a 10X attenuator.



b. Check the Main trigger system for stable triggering at limits:

- Read the following definition: A stable trigger is one that is consistent; that is, one that results in a uniform, regular display

triggered on the selected slope (positive or negative). This display should *not* have its trigger point switching between opposite slopes, nor should it “roll” across the screen. At horizontal scale settings of 2 ms/division and faster, **TRIG'D** will remain constantly lit. It will flash for slower settings.

- Press **TRIGGER MENU**; then press the main-menu button **Slope**.
- Press **SET LEVEL TO 50%**. Adjust the **TRIGGER LEVEL** knob so that the **TRIG'D** light is on. Set the level to near the middle of the range where the **TRIG'D** light is on. **CHECK** that the trigger is stable for the test waveform on both the positive and negative slopes. Use the side menu to switch between trigger slopes.
- Enter pass/fail result for main trigger on the test record.
- Leave the Main trigger system triggered on the positive slope of the waveform before continuing to the next step.

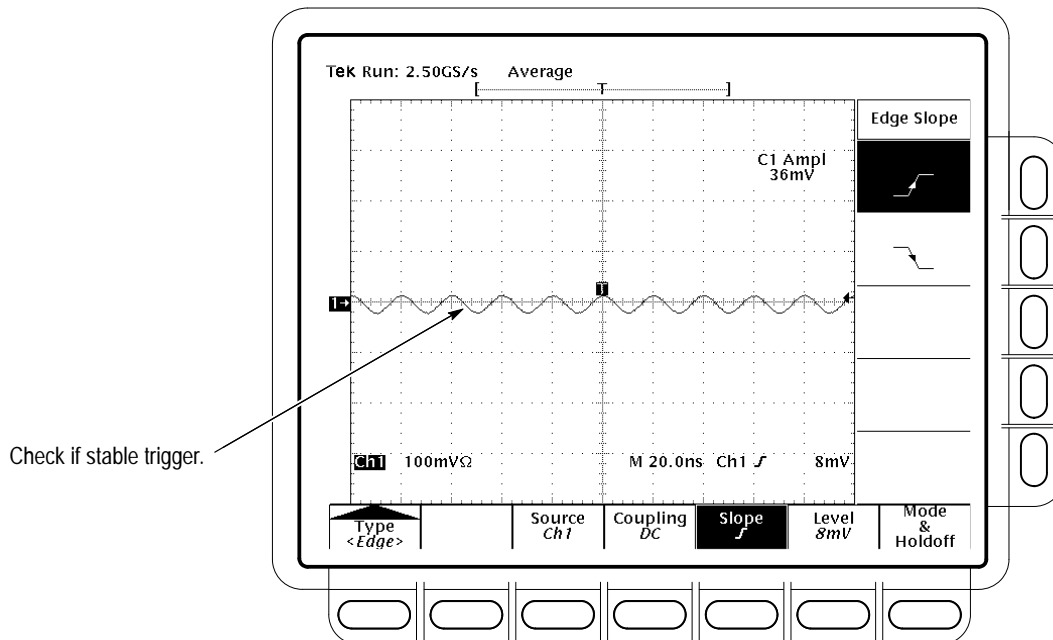

Figure 1-18: Measurement of Trigger Sensitivity — 50 MHz Results Shown on a TDS 684A Screen

- c. *Check Delayed trigger system for stable triggering at limits: Do the following subparts in the order listed.*
 - Press **HORIZONTAL MENU**; then press the main-menu button **Time Base**. Press the side-menu button **Delayed Only**; then press **Delayed Triggerable** in the same menu.
 - Press **SHIFT**; then press **DELAYED TRIG**. Press the main-menu button **Level**.
 - Press the side-menu button **SET TO 50%**.

CHECK that a stable trigger is obtained for the test waveform for both the positive and negative slopes of the waveform. Use the **TRIGGER LEVEL** knob to stabilize the Main trigger. Use the general purpose knob to stabilize the Delayed trigger. Press the main-menu button **Slope**; then use the side menu to switch between trigger slopes. See Figure 1–18.

- Enter pass/fail result for delayed trigger on the test record.
- Leave the Delayed trigger system triggered on the positive slope of the waveform before continuing to the next step. Also, return to the main time base: Press **HORIZONTAL MENU**; then press the main-menu button **Time Base**. Press the side-menu button **Main Only**.
- Press **CLEAR MENU**.

3. *Confirm the AUX Trigger input:*

- a. *Display the test signal:*

- Remove the 10X attenuator and reconnect the cable to **CH 1**.
- Set the test signal amplitude for about 2.5 divisions on screen.
- Now fine adjust the generator output until the **CH 1 Amplitude** readout indicates the amplitude is 250 mV. (Readout may fluctuate around 250 mV.)

- b. *Check the AUX trigger source for stable triggering at limits: Do the following in the order listed.*

- Use the definition for stable trigger from step 2.
- Press **TRIGGER MENU**; then press the main-menu button **Source**.
- Press the side-menu button **–more–** until the side-menu label **DC Aux** appears; then press **DC Aux**.

- Press **SET LEVEL TO 50%**. CHECK that a stable trigger is obtained for the test waveform on both the positive and negative slopes. Press the main-menu button **Slope**; then use the side menu to switch between trigger slopes. Use the **TRIGGER LEVEL** knob to stabilize the trigger if required.
 - Enter the pass/fail result on the test record.
 - Leave the Main trigger system triggered on the positive slope of the waveform before proceeding to the next check.
 - Press the main-menu button **Source**; then press the side-menu button **–more–** until **CH 1** appears. Press **CH 1**.
4. *Confirm that the Main and Delayed trigger systems are within sensitivity limits (full bandwidth, for TDS 684A = 1 GHz, for TDS 744 = 500 MHz):*
- a. *Hook up the test-signal source:* Disconnect the hookup installed in step 1. Connect, through its leveling head, the signal output of a high-frequency leveled sine wave generator to **CH 1**.
 - b. *Set the Main and Delayed Horizontal Scales:*
 - Set the horizontal **SCALE** to 500 ps for the **M** (Main) time base.
 - Press **HORIZONTAL MENU**. Now press the main-menu button **Time base**; then press the side-menu button **Delayed Triggerable**.
 - Press the side-menu button **Delayed Only**.
 - Set the horizontal **SCALE** to 500 ps for the **D** (Delayed) time base. Press the side-menu button **Main Only**.
 - c. *Display the test signal:*
 - Set the generator frequency to full bandwidth (for TDS 684A = 1 GHz, for 744 = 500 MHz).
 - Set the test signal amplitude for about five divisions on screen. Now fine adjust the generator output until the **CH 1 Amplitude** readout indicates the amplitude is 500 mV. (Readout may fluctuate around 500 mV.)
 - Disconnect the leveling head at **CH 1** and reconnect it to **CH 1** through a 5X attenuator.
 - d. Repeat step 2, substeps b and c only, since only the full bandwidth (for TDS 684A = 1 GHz, for 744 = 500 MHz) is to be checked here.

NOTE. You just checked the trigger sensitivity. If desired, you may repeat steps 1 through 4 for the other channels (CH2, CH3, and CH4).

5. *Disconnect the hookup:* Disconnect the cable from the channel last tested.

Output Signal Checks

The procedure that follows checks those characteristics of the output signals that are listed as checked under *Warranted Characteristics* in *Specifications*. The oscilloscope outputs these signals at its front and rear panels.

Check Outputs — CH 3 Main and Delayed Trigger

Equipment Required	Two 50 Ω precision cables (Item 5) One calibration generator (Item 10)
Prerequisites	See page 1–15. Also, the Digitizing Oscilloscope must have passed <i>Check DC Voltage Measurement Accuracy</i> on page 1–29.

1. *Install the test hookup and preset the instrument controls:*

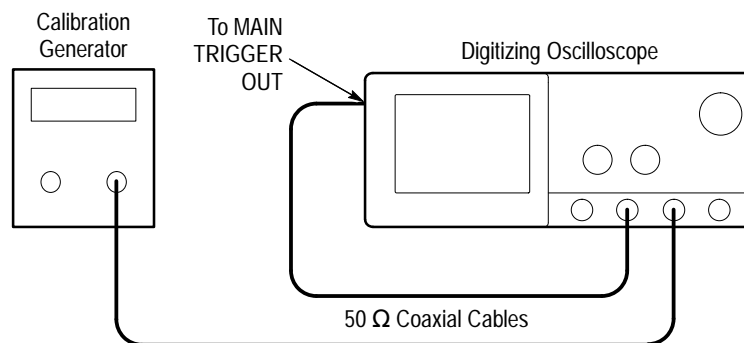

Figure 1–19: Initial Test Hookup

- a. *Hook up test-signal source 1:*
 - Connect the standard amplitude output of a calibration generator through a 50 Ω precision coaxial cable to **CH 3**.
 - Set the output of the calibration generator to 0.500 V.
- b. *Hook up test-signal source 2:* Connect the **Main Trigger Out** at the rear panel to **CH 2** through a 50 Ω precision cable.
- c. *Initialize the oscilloscope:*

- Press save/recall **SETUP**.
 - Press the main-menu button **Recall Factory Setup**.
 - Press the side-menu button **OK Confirm Factory Init**.
- d. *Modify the initialized front-panel control settings:*
- Set the horizontal **SCALE** to 200 μ s.
 - Press **SHIFT**; then press **ACQUIRE MENU**.
 - Press the main-menu button **Mode**; then press the side-menu button **Average**.
 - Select **64** averages.
2. *Confirm Main and Delayed Trigger outputs are within limits for logic levels:*
- a. *Display the test signal:*
- Press **WAVEFORM OFF** to turn off CH 1.
 - Press **CH 2** to display that channel.
 - Set the vertical **SCALE** to 1 V.
 - Use the vertical **POSITION** knob to center the display on screen.
- b. *Measure logic levels:*
- Press **MEASURE**; then press the main-menu button **Select Measurement for Ch2**.
 - Select high and low measurements. To do this, repeatedly press the side-menu button **–more–** until **High** and **Low** appear in the side menu (their icons are shown at the left). Press both side-menu buttons **High** and **Low**.
- c. *Check Main Trigger output against limits:*
- CHECK that the **Ch2 High** readout is ≥ 2.5 volts and that the **Ch2 Low** readout is ≤ 0.7 volts. See Figure 1–20.
 - Enter high and low voltages on test record.
 - Press **VERTICAL MENU**; then press the main-menu button **Coupling**. Now press the side-menu button **Ω** to toggle it to the 50 Ω setting.
 - CHECK that the **Ch2 High** readout is ≥ 1.0 volt and that the **Ch2 Low** readout ≤ 0.25 volts.
 - Enter high and low voltages on test record.



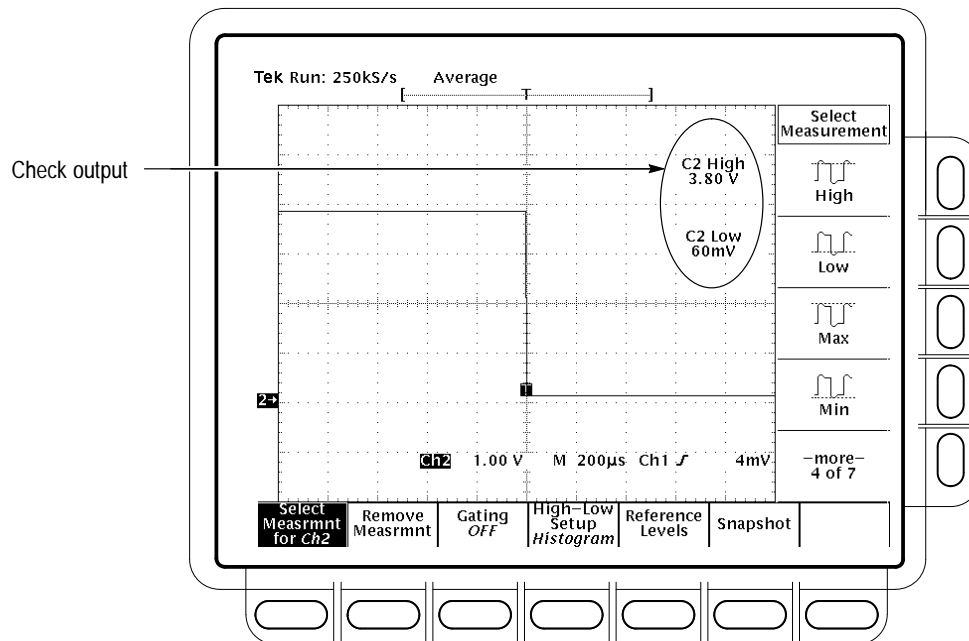

Figure 1-20: Measurement of Main Trigger Out Limits

- d. *Check Delayed Trigger output against limits:* See Figure 1-20.
 - Move the precision 50 Ω cable from the rear-panel **Main Trigger Output** BNC to the rear-panel **Delayed Trigger Output** BNC.
 - CHECK that the **Ch2 High** readout is ≥ 1.0 volt and that the **Ch2 Low** readout ≤ 0.25 volts.
 - Enter high and low voltages on test record.
 - Press the side-menu button Ω to select the 1 M Ω setting.
 - Press **CLEAR MENU**.
 - CHECK that the **Ch2 High** readout is ≥ 2.5 volts and that the **Ch2 Low** readout is ≤ 0.7 volts.
 - Enter high and low voltages on test record.
3. *Confirm CH 3 output is within limits for gain:*
 - a. *Measure gain:*
 - Move the precision 50 Ω cable from the rear-panel **DELAYED TRIGGER OUTPUT** BNC to the rear-panel **SIGNAL OUT** BNC.
 - Push **TRIGGER MENU**.



- Press the main-menu button **Source**.
- Press the side-menu button **Ch3**.
- Set vertical **SCALE** to 100 mV.
- Press **SET LEVEL TO 50%**.
- Press **MEASURE**; then press the main-menu button **Select Measrmt for Ch2**.
- Repeatedly press the side-menu button **–more–** until **Pk-Pk** appears in the side menu (its icon is shown at the left). Press the side-menu button **Pk-Pk**.
- Press **CLEAR MENU**.

b. Check against limits:

- CHECK that the readout **Ch2 Pk-Pk** is between 80 mV and 120 mV, inclusive, for the TDS 684A or is between 88 mV and 132 mV, inclusive, for the TDS 744.
- Enter voltage on test record.
- Press **VERTICAL MENU**; then press the side-menu button **Ω** to toggle to the 50 Ω setting.
- Press **CLEAR MENU**.
- CHECK that the readout **Ch2 Pk-Pk** is between 40 mV and 60 mV, inclusive, for the TDS 684A or is between 44 mV and 66 mV, inclusive, for the TDS 744.
- Enter voltage on test record.

4. Disconnect the hookup: Disconnect the cables from the channel inputs and the rear panel outputs.

**Check Probe
Compensator Output**

Equipment Required	One female BNC to clip adapter (Item 3) Two dual-banana connectors (Item 6) One BNC T connector (Item 7) Two 50 Ω precision cables (Item 5) One DC calibration generator (Item 9)
Prerequisites	See page 1–15. Also, the Digitizing Oscilloscope must have passed <i>Check Accuracy For Long-Term Sample Rate, Delay Time, and Delta Time Measurement</i> on page 1–41.

1. *Install the test hookup and preset the instrument controls:*

a. *Hook up test-signal:*

- Connect one of the 50 Ω cables to **CH 1**. See Figure 1–21.
- Connect the other end of the cable just installed to the female BNC-to-clips adapter. See Figure 1–21.
- Connect the red clip on the adapter just installed to the **PROBE COMPENSATION SIGNAL** on the front panel; connect the black clip to **PROBE COMPENSATION GND**. See Figure 1–21.

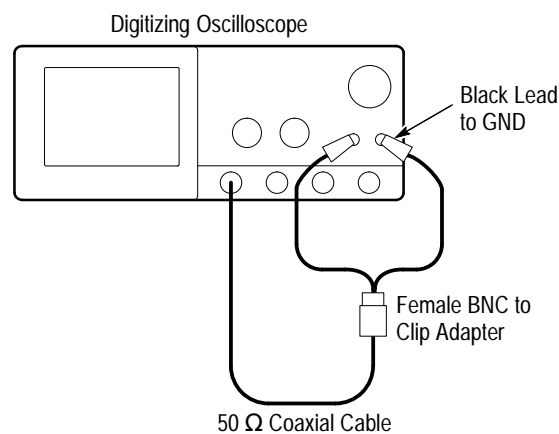

Figure 1–21: Initial Test Hookup

b. *Initialize the oscilloscope:*

- Press save/recall **SETUP**.
- Press the main-menu button **Recall Factory Setup**.
- Press the side-menu button **OK Confirm Factory Init**.

c. *Modify the initialized front-panel control settings:*

- Set the horizontal **SCALE** to 200 μ s.
- Press **SET LEVEL TO 50%**.
- Use the vertical **POSITION** knob to center the display on screen.
- Press **SHIFT**; then press **ACQUIRE MENU**.
- Press the main-menu button **Mode**; then press the side-menu button **Average**.

- Select **128** averages.
2. *Confirm that the Probe Compensator signal is within limits for frequency:*
- a. *Measure the frequency of the probe compensation signal:*
 - Press **MEASURE**; then press the main-menu button **Select Measrmt for Ch1**.
 - Repeatedly press the side-menu button **–more–** until **Frequency** appears in the side menu (its icon is shown at the left). Press the side-menu button **Frequency**.
 - b. *Check against limits:*
 - CHECK that the **CH 1 Freq** readout is within 950 Hz to 1.050 kHz, inclusive. See Figure 1–22.
 - Enter frequency on test record.
 - Press **MEASURE**; then press the main-menu button **Remove Measrmt for Ch1**. Press the side–menu **Measurement 1**.

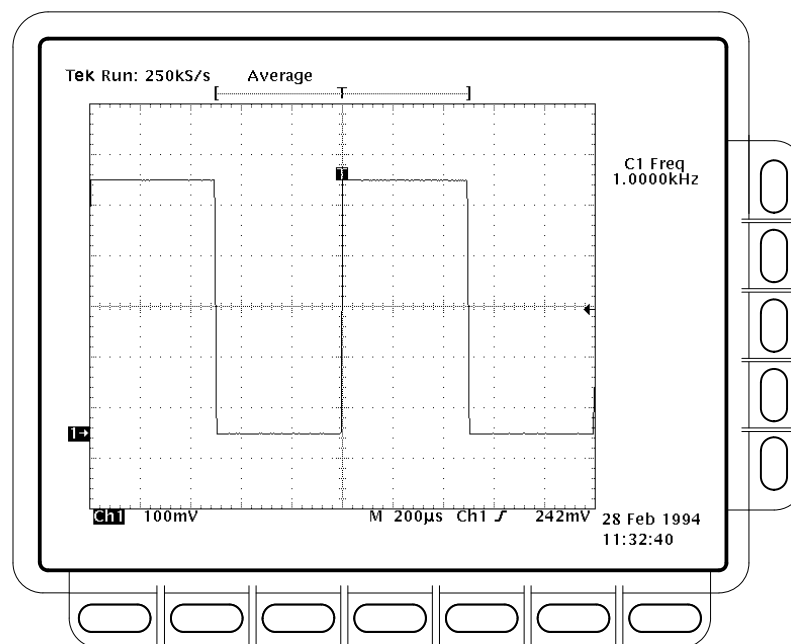

Figure 1–22: Measurement of Probe Compensator Frequency

- c. *Save the probe compensation signal in reference memory:*

- Press **SAVE/RECALL WAVEFORM**; then press the main-menu button **Save Wfm Ch 1**.
 - Press the side-menu button **To Ref 1** to save the probe compensation signal in reference 1.
 - Disconnect the cable from **CH 1** and the clips from the probe compensation terminals.
 - Press **MORE**; then press the main-menu button **Ref 1** to displayed the stored signal.
 - Press **CH 1**.
- d. *Hook up the DC standard source:*
- Set the output of a DC calibration generator to 0 volts.
 - Connect the output of a DC calibration generator through a dual-banana connector followed by a 50 Ω precision coaxial cable to one side of a BNC T connector. See Figure 1–23.
 - Connect the Sense output of the generator through a second dual-banana connector followed by a 50 Ω precision coaxial cable to the other side of the BNC T connector. Now connect the BNC T connector to **CH 1**. See Figure 1–23.

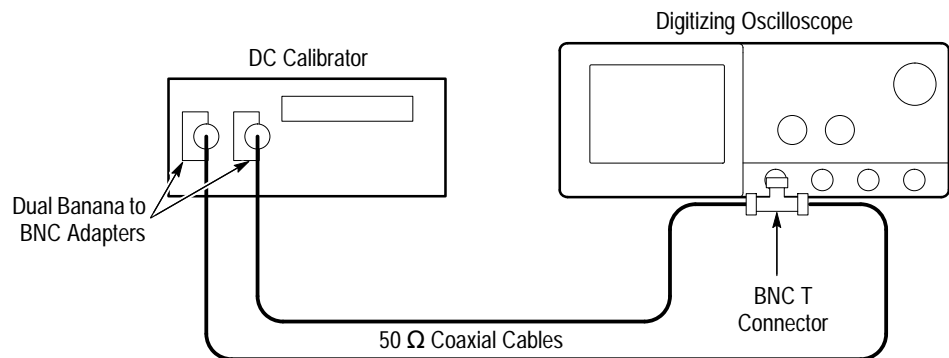

Figure 1–23: Subsequent Test Hookup

- e. *Measure amplitude of the probe compensation signal:*
- Press **SHIFT**; then press **ACQUIRE MENU**. Press the side-menu button **AVERAGE** then enter 16 using the keypad or the general purpose knob.

- Adjust the output of the DC calibration generator until it precisely overlaps the top (upper) level of the stored probe compensation signal. (This value will be near 500 mV.)
 - Record the setting of the DC generator.
 - Adjust the output of the DC calibration generator until it precisely overlaps the base (lower) level of the stored probe compensation signal. (This value will be near zero volts.)
 - Record the setting of the DC generator.
- f. Press **CLEAR MENU** to remove the menus from the display. See Figure 1–24.

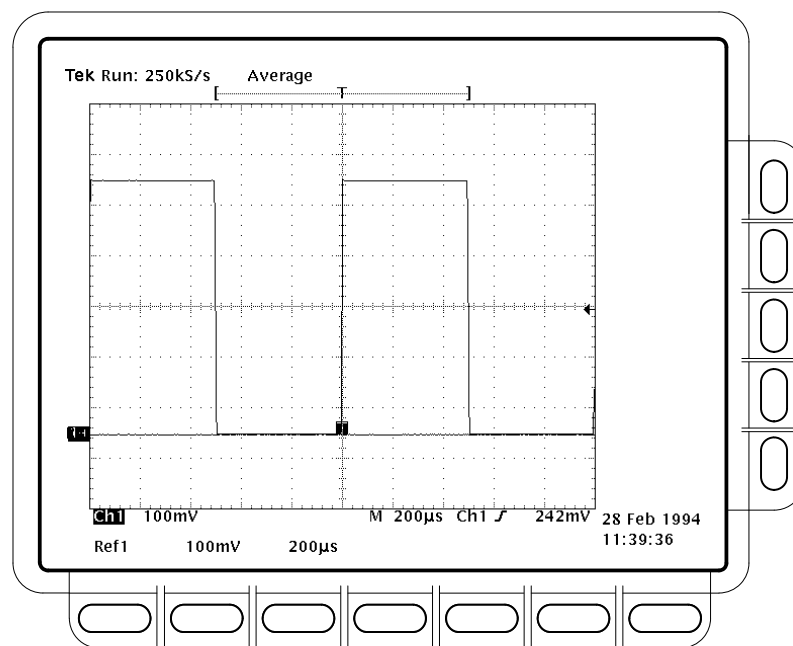

Figure 1–24: Measurement of Probe Compensator Amplitude

- g. *Check against limits:*
- Subtract the value just obtained (base level) from that obtained previously (top level).
 - CHECK that the difference obtained is within 495 mV to 505 mV, inclusive.
 - Enter voltage difference on test record.
3. *Disconnect the hookup:* Disconnect the cable from **CH 1**.

Option 05 Video Trigger Checks

Check Video Trigger

Equipment Required	PAL signal source (Item 16) 60 Hz. sine wave generator (Item 17) Pulse generator (Item 18) Two 75 Ω cables (Item 19) Two 75 Ω terminators (Item 20) One BNC T connector (Item 7) 50 Ω cable (Item 5) 50 Ω terminator (Item 4)
Prerequisites	See page 1–15. These prerequisites include running the signal path compensation routine.

1. *Setup digitizing oscilloscope to factory defaults by completing the following steps:*
 - a. Press save/recall **SETUP**.
 - b. Press the main-menu **Recall Factory Setup**.
 - c. Press the side-menu **OK Confirm Factory Init**.
 - d. Wait for the Clock Icon to leave the screen.
 - e. CONFIRM the digitizing oscilloscope is setup as shown below.
 Channel: CH1
 Volt/div: 100 mV
 Horizontal scale: 500 μ s/div
2. *Setup digitizing oscilloscope for TV triggers by completing the following steps:*
 - a. Press **TRIGGER MENU**.
 - b. Press the main-menu **Type** pop-up until you select **Video**.
 - c. Press the main-menu **Standard** pop-up until you select **625/PAL**.
 - d. Press the main-menu **Line**.
 - e. Use the keypad to set the line number to 7 (press **7**, then **ENTER**).
 - f. Press **VERTICAL MENU**.

- g. Press the main-menu **Bandwidth**.
 - h. Select **250 MHz** from the side menu.
 - i. Press the main-menu **Fine Scale**.
 - j. Use the keypad to set the fine scale to 282mV (press **282**, **SHIFT**, **m**, then **ENTER**).
 - k. Press **HORIZONTAL MENU**.
 - l. Press the main-menu **Horiz Scale**.
 - m. Use the keypad to set the horizontal scale to 200 ns (press **200**, **SHIFT**, **n**, then **ENTER**).
3. *Check Jitter vs. Signal Amplitude*
- a. Setup equipment for Jitter Test. See Figure 1–25.
 - Connect one of the rear panel composite outputs marked **COMPST** on the TSG121 through a 75 Ω cable and a 75 Ω terminator to the CH1 input of the TDS.
 - Press the **100% FIELD** control (the fourth TSG121 front-panel button from the left) of the PAL signal source.

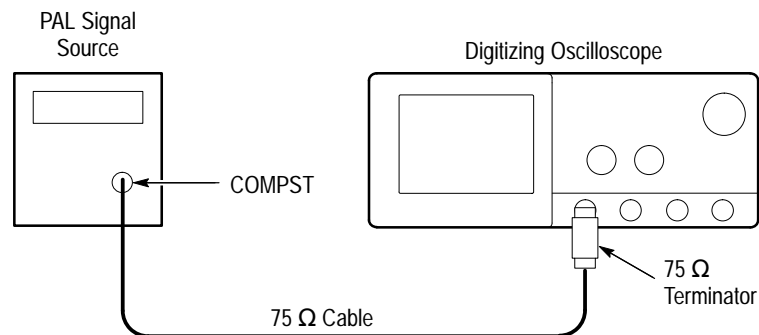

Figure 1–25: Jitter Test Hookup

- b. CHECK that the oscilloscope lights up its front panel **TRIG'D** LED and it displays the waveform on screen. See Figure 1–26.

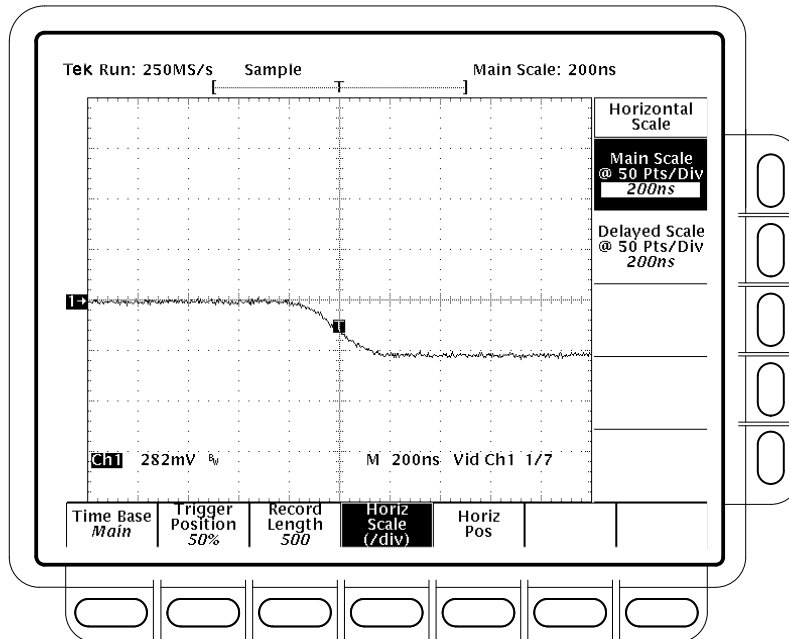

Figure 1-26: Jitter Test Displayed Waveform

- c. Press **SHIFT**; then press **ACQUIRE MENU**.
- d. Press the main-menu **Mode**.
- e. Select the side-menu **Average**. It should be already set to 16.
- f. Press the main-menu **Create Limit Test Template**.
- g. Press the side-menu **V Limit**.
- h. Use the keypad to set V Limit to 180 mdiv (press **180**, **SHIFT**, **m**, then **ENTER**)
- i. Press the side-menu **OK Store Template**.
- j. Press **MORE**.
- k. Press the main-menu **Ref1**.
- l. Press **CH1**.
- m. Press **SHIFT**; then press **ACQUIRE MENU**.
- n. Press the main-menu **Limit Test Setup**.
- o. Toggle the side-menu **Limit Test** to **ON**.
- p. Toggle the side-menu **Ring Bell if Condition Met** to **ON**.

- q. Press the main-menu **Mode**.
- r. Press the side-menu **Envelope**.
- s. Use the keypad to set envelope to use 100 acquisitions (press **100**, then **ENTER**).
- t. Press the main-menu **Stop After** button.
- u. Press the side-menu **Single Acquisition Sequence**.
- v. Confirm that the oscilloscope successfully makes 100 acquisitions. If not successful, the oscilloscope bell will ring. When the word **Run** in the top left corner of the display changes to **STOP**, the test is complete. See Figure 1–27.

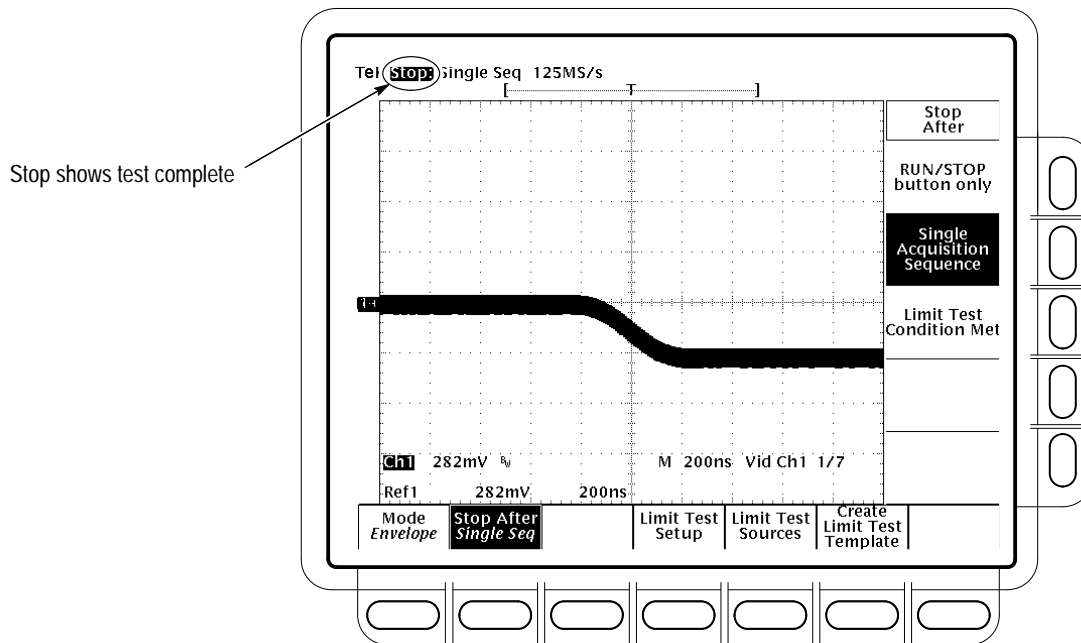

Figure 1–27: Jitter Test When Completed – TDS 684A Shown

- w. Press the main-menu **Limit Test Setup**.
 - x. Toggle the side-menu **Ring Bell if Condition Met** to **OFF**.
 - y. Toggle the side-menu **Limit Test** to **OFF**.
4. *Check Triggered Signal Range.*

Setup oscilloscope for Triggered Signal Test.

- a. Press **MORE**.

- b. Press **WAVEFORM OFF**.
- c. Press **HORIZONTAL MENU**.
- d. Use the keypad to set horizontal scale (/div) to 50 μ s (press **50**, **SHIFT**, **μ** , then **ENTER**).
- e. Press **SHIFT**; then press **ACQUIRE MENU**.
- f. Press the main-menu **Stop After**.
- g. Press the side-menu **RUN/STOP button only**.
- h. Press the main-menu **Mode**.
- i. Press the side-menu **Sample**.
- j. Press **RUN/STOP**.
- k. Press **VERTICAL MENU**.
- l. Use the keypad to set fine scale to 300 mV (press **300**, **SHIFT**, **m**, then **ENTER**).
- m. CONFIRM that the **TRIG'D** LED stays lit and that the waveform on screen is stable. i.e.; does not move horizontally or vertically. Also, CONFIRM that the waveform on the screen has one positive pulse and a number of negative pulses. See Figure 1–28.

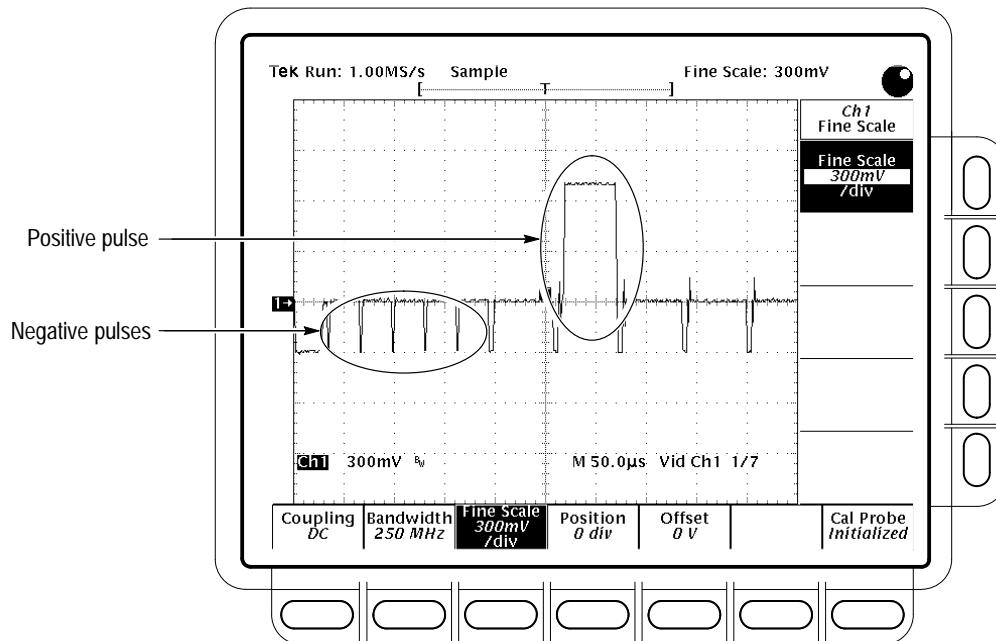

Figure 1–28: Triggered Signal Range Test – 300 mV

- n. Use the keypad to set the fine scale to 75 mV (press **75**, **SHIFT**, **m**, then **ENTER**).
- o. CONFIRM that the **TRIG'D** LED stays lit and that the waveform on screen is stable. i.e.; does not move horizontally or vertically. Also, CONFIRM that the waveform on the screen has one positive pulse and a number of negative pulses. See Figure 1–29.

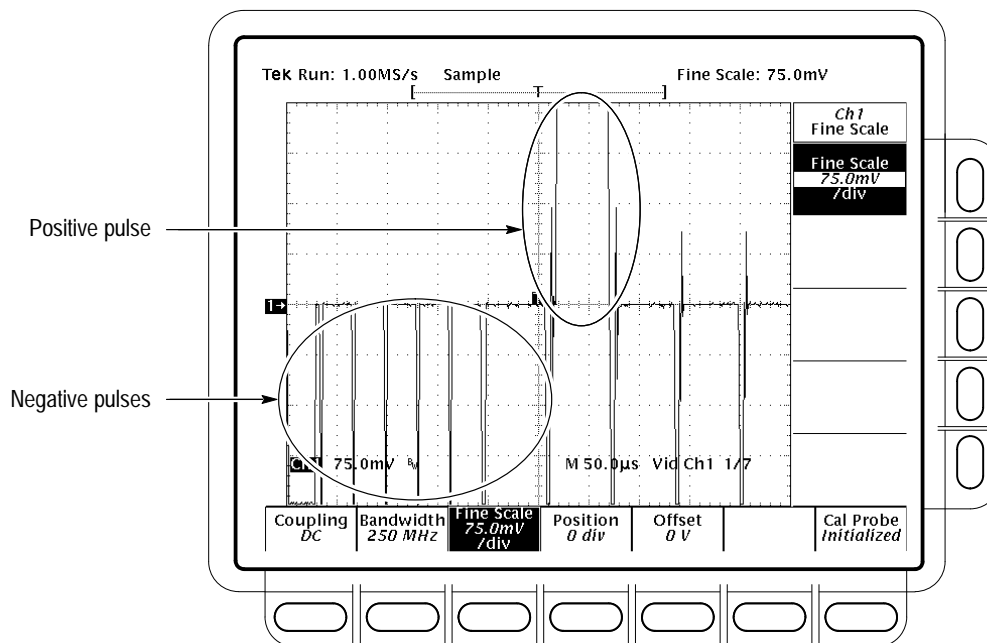

Figure 1–29: Triggered Signal Range Test – 75 mV

- p. Disconnect all test equipment (TSG121) from the digitizing oscilloscope.
5. *Check 60 Hz Rejection.*
 - a. Setup oscilloscope for 60 Hz Rejection Test.
 - Use the keypad to set the Ch1 Fine Scale to 282 mV (press **282**, **SHIFT m**, then **ENTER**).
 - Press **WAVEFORM OFF**.
 - Press **CH2**.
 - Press **VERTICAL MENU**.
 - Use the keypad set the fine scale to 2 V (press **2**, then **ENTER**).
 - Press **HORIZONTAL MENU**.
 - Use the keypad to set the horizontal scale (/div) to 5 ms (press **5**, **SHIFT, m**, then **ENTER**).
 - b. Setup 60 Hz signal generator (SG 502).
 - Connect the output of the SG 502 to the CH2 input through a 50 Ω cable. See Figure 1–30.

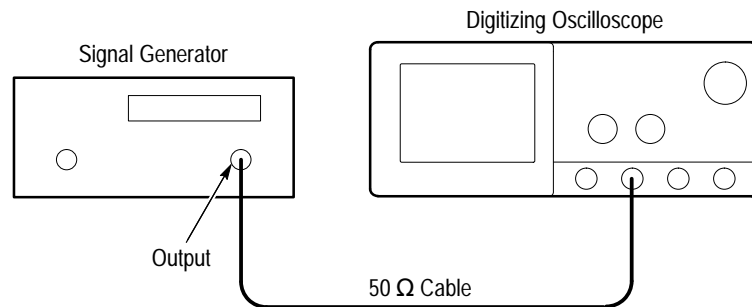

Figure 1–30: 60 Hz Rejection Test Hookup

- Adjust the SG 502 for three vertical divisions of 60 Hz signal. See Figure 1–31. The signal will not be triggered. That is, it will run free.

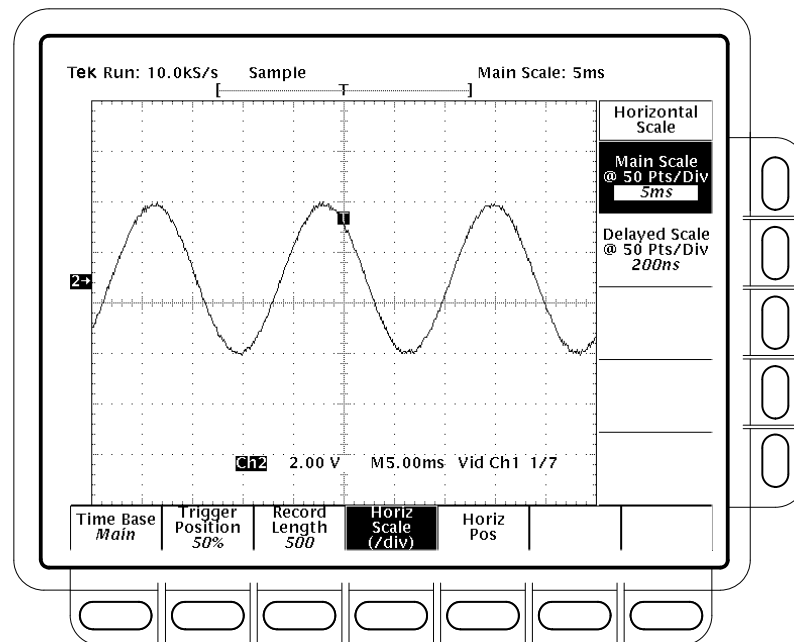

Figure 1–31: 60 Hz Rejection Test Setup Signal

- Check 60 Hz rejection.
 - Use the keypad to set the horizontal scale (/div) to 50 μ s (press **50**, **SHIFT**, **μ** , then **ENTER**).
 - Reconnect the output of the signal generator (SG 502). Connect the composite signal connector of the PAL signal source (labeled

COMPST on the TSG 121) to a 75 Ω cable and a 75 Ω terminator. Connect both signals to the CH1 input through a BNC T. See Figure 1–32.

- Press **VERTICAL MENU**.
- If needed, press the main-menu **Fine Scale**.
- Use the keypad to set fine scale to 500 mV (press **500**, **SHIFT**, **m**, then **ENTER**).
- Connect another composite signal connector of the PAL signal source (labeled **COMPST** on the TSG 121) through a 75 Ω cable and a 75 Ω terminator to the CH2 input. See Figure 1–32.

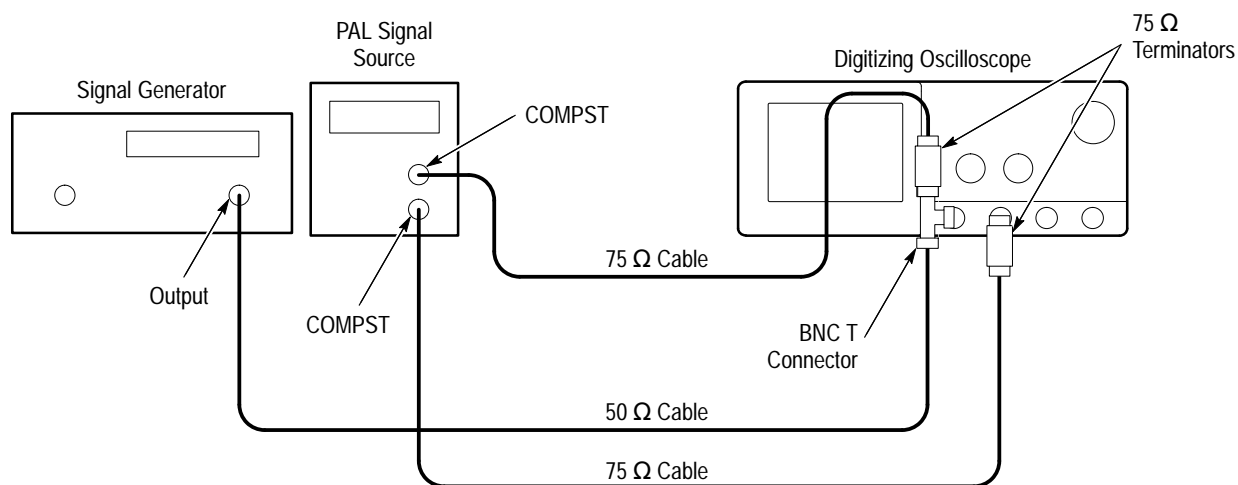

Figure 1–32: Subsequent 60 Hz Rejection Test Hookup

- **CONFIRM** that the **TRIG'D** LED stays lit and that the waveform on screen is stable. In other words, be sure the waveform does not move horizontally or vertically. Also, confirm that the waveform on the screen has one positive pulse and a number of negative pulses. See Figure 1–33.

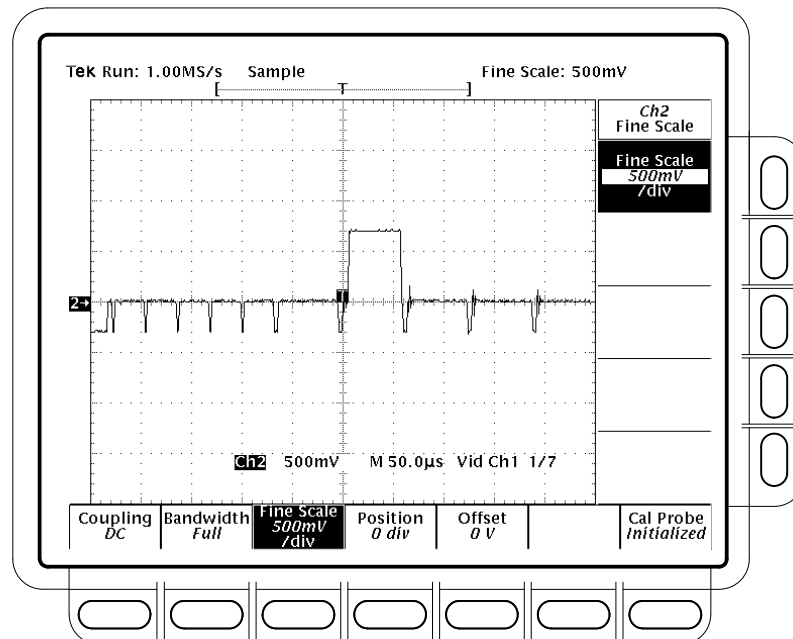

Figure 1-33: 60 Hz Rejection Test Result – TDS 684A Shown

- Disconnect all test equipment from the digitizing oscilloscope.
6. *Check Line Count Accuracy.*
- a. Setup oscilloscope for Line Count Accuracy Test.
 - Press **WAVEFORM OFF**.
 - Press **CH1**.
 - Press **HORIZONTAL MENU**.
 - Press the main-menu **Record Length**.
 - Press the side-menu **–more–** until you see the appropriate menu.
 - Press the side-menu **5000 points in 100divs**.
 - Press the main-menu **Horiz Scale (/div)**.
 - Use the keypad to set the horizontal scale to 200 ns (press **200**, **SHIFT**, **n**, then **ENTER**).
 - b. Check Line Count Accuracy.
 - Connect a composite output signal from the rear of the PAL signal source (labelled **COMPST** on the TSG 121) to the CH1 input through a 75 Ω cable and a 75 Ω terminator. See Figure 1-34.

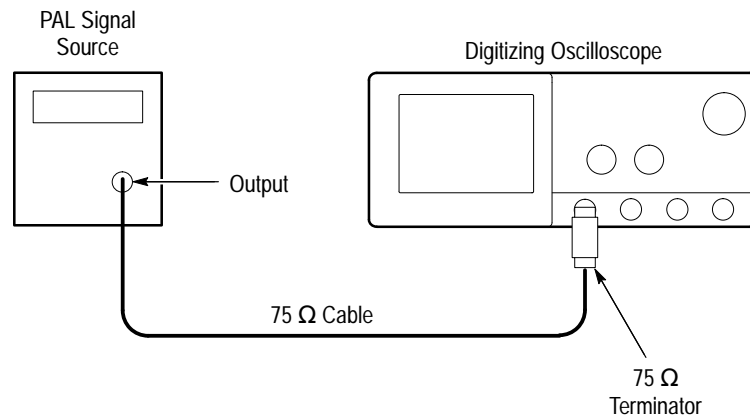

Figure 1-34: Line Count Accuracy Test Hookup

- Press the main-menu **Trigger Position**.
- Press the side-menu to **Set to 50%**.
- Press the main-menu to **Horiz Pos**.
- Press the side-menu to **Set to 50%**.
- Use the **HORIZONTAL POSITION** knob to move the falling edge of the sync pulse to two divisions to the left of center screen. See Figure 1-35.

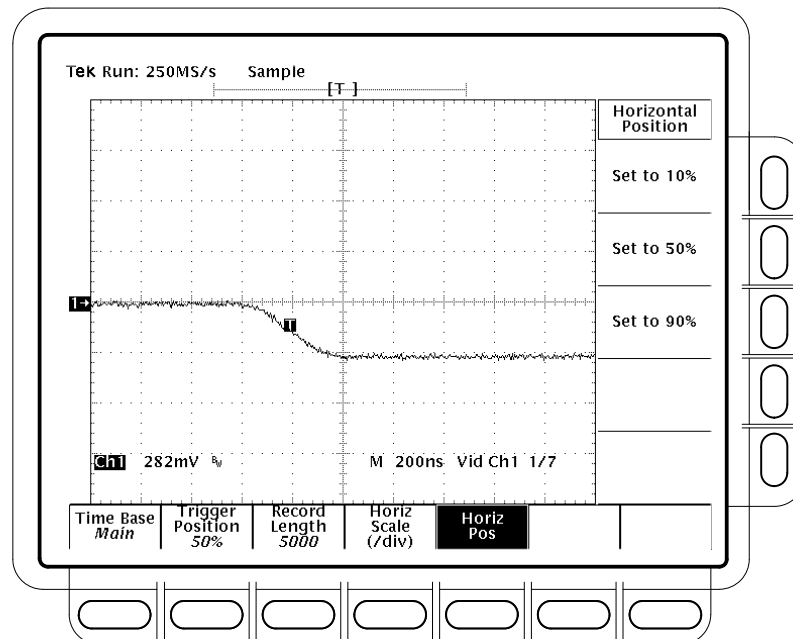

Figure 1–35: Line Count Accuracy Test Setup Waveform – TDS 684A Shown

- Press **CURSOR**.
- Press the main-menu **Function**.
- Press the side-menu **V Bars**.
- Using the General Purpose knob, place the left cursor directly over the trigger ‘T’ icon.
- Press **SELECT**.
- Turn the General Purpose knob to adjust the right cursor for a cursor delta reading of **6.780us**.
- Use the **HORIZONTAL POSITION** knob to position the right cursor to center screen.
- Verify that the cursor is positioned on a positive slope of the burst signal. See Figure 1–36.

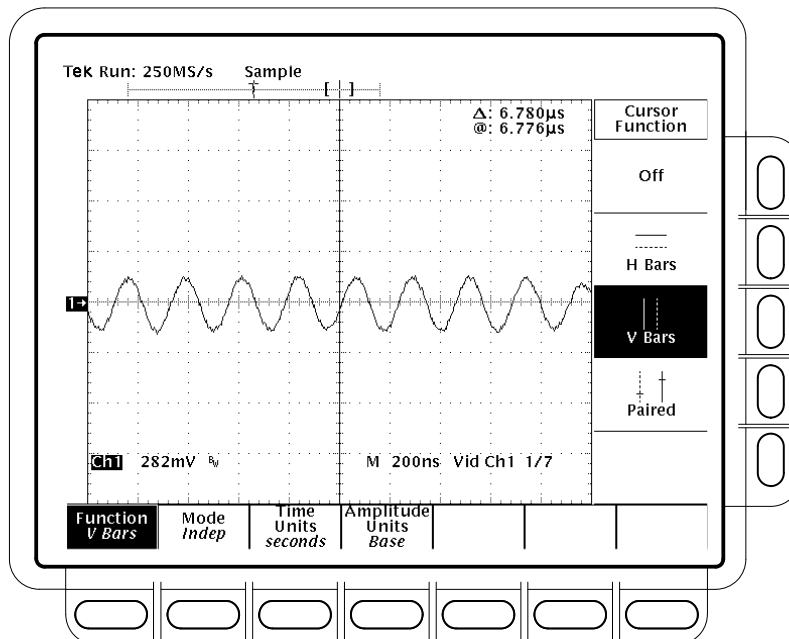

Figure 1-36: Line Count Accuracy Correct Result Waveform

- Disconnect all test equipment (TSG 121) from the digitizing oscilloscope.
 - Turn off cursors by pressing **CURSOR**, then the main-menu **Function** button, and, finally, **Off** from the side menu.
7. *Check the Sync Duty Cycle.*
- a. Setup digitizing oscilloscope for Sync Duty Cycle Test.
 - Press **TRIGGER MENU**.
 - Press the **Standard** pop-up to select **FlexFmt**. (Trigger **Type** should already be set to **Video**)
 - Press the main-menu **Setup**.
 - Press the side-menu **Field Rate**.
 - Use the keypad to set the field rate to 60.05 Hz (press **60.05**, then **ENTER**).
 - Press the side-menu **Lines**.
 - Use the keypad to set the field rate to 793 lines (press **793**, then **ENTER**).

- Press the side-menu **Fields**.
 - Use the keypad to set the number of fields to 1 (press **1**, then **ENTER**).
 - Press the side-menu **Sync Width**.
 - Use the keypad to set the width to 400 ns (press **400**, **SHIFT**, **n**, then **ENTER**).
 - Press the side-menu **–more– 1 of 2**. Then press **V1 Start Time**.
 - Use the keypad to set V1 start time to 10.10 μ s (press **10.10**, **SHIFT**, **μ** , then **ENTER**).
 - Press the side-menu **V1 Stop Time**.
 - Use the keypad to set V1 stop time to 10.50 μ s (press **10.50**, **SHIFT**, **μ** , then **ENTER**).
 - Press the main-menu **Type** pop-up to select **Edge**.
 - Press **HORIZONTAL MENU**.
 - Press the main-menu **Record Length**.
 - Select the side-menu **1000 points in 20div**. If needed, first press the side-menu **–more–** until you see the appropriate side-menu item.
 - Turn the **HORIZONTAL POSITION** knob to position the trigger ‘T’ two divisions to the left of the center screen.
 - Press **MEASURE**.
 - If needed, press the main-menu **Select Measrmnt**.
 - Press the side-menu **Negative Width**.
 - Press the side-menu **Period**.
- b. Setup the pulse generator (PG502) for Sync Duty Cycle Test.
- Set **PULSE DURATION** to 50 ns.
 - Set **PERIOD** to 10 μ s.
 - Set **OUTPUT (VOLTS)** to **–1** for **LOW LEVEL** and **+1** for **HIGH LEVEL**.
 - Depress the **COMPLEMENT** button.
 - Be sure **BACK TERM** is depressed (in).

c. Check Sync Duty Cycle.

- Connect the pulse generator (PG502) through a 50 Ω cable and a 50 Ω terminator to the oscilloscope CH1 input. See Figure 1–37.

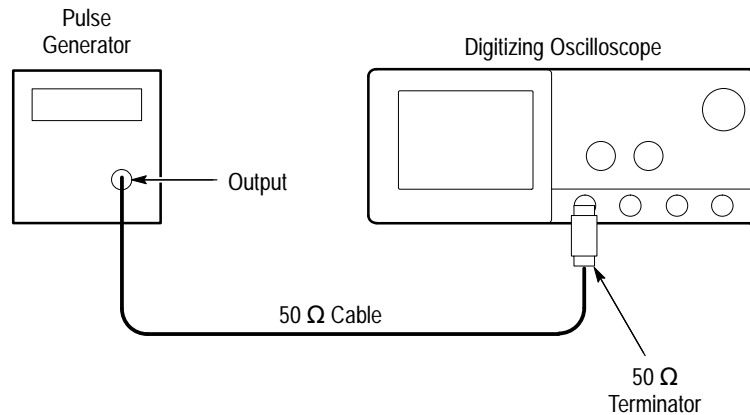

Figure 1–37: PG502 Setup for Sync Duty Cycle Test

- Turn the pulse generator **OUTPUT (VOLTS)** control until the signal on the oscilloscope shows a one division negative going pulse. See Figure 1–38.

NOTE. You may need to adjust the trigger level control to obtain a stable trigger.

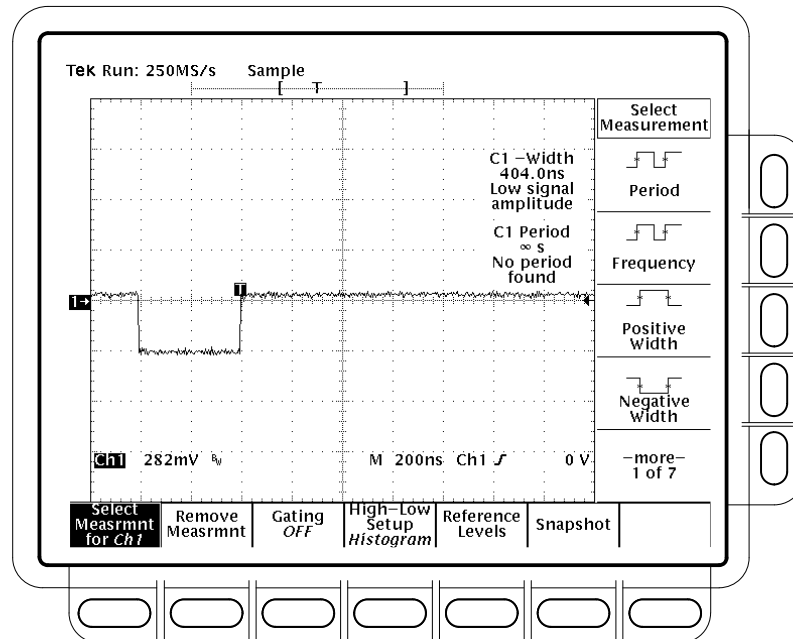

Figure 1–38: Sync Duty Cycle Test: One-Div Neg Pulse Waveform

- Turn the pulse generator **PULSE DURATION** variable control to adjust the negative pulse so the oscilloscope's **CH1 – Width** measurement displays **400ns +/-10 ns**.
- Turn the **HORIZONTAL SCALE** knob to set the oscilloscope time base to **5µs/div**.
- Turn the pulse generator **PERIOD** variable control to adjust the period until the oscilloscope **CH1 Period** measurement reads **21.000µs -25/+50 ns**. See Figure 1–39. Read note shown below.

NOTE. The pulse duration and period adjustments are critical in making this measurement. If the pulse duration and/or the duty cycle are not stable, the **FLEXFMT** function may not function. You must take care when making these adjustments.

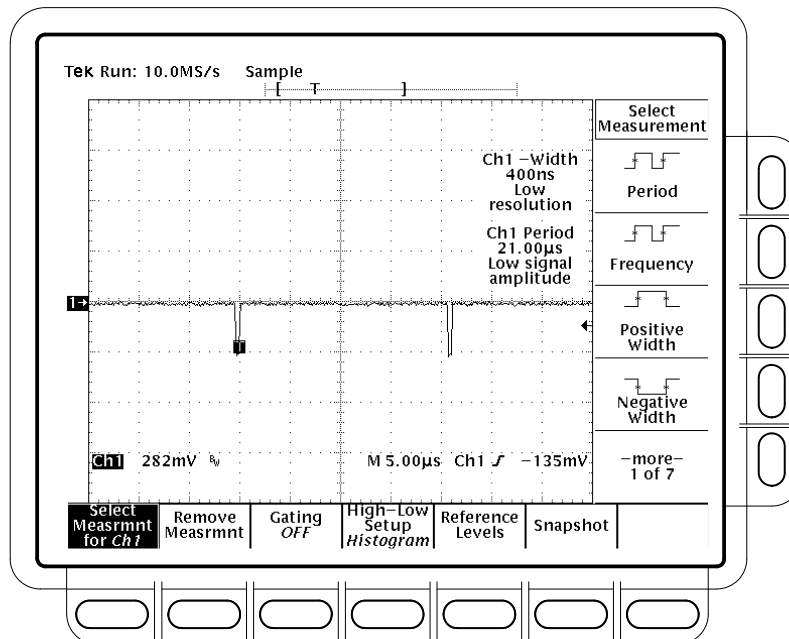

Figure 1-39: Sync Duty Cycle Test: Critically Adjusted Pulse

- Press **TRIGGER MENU**.
- Press the main-menu **Type** pop-up until you select **Video**.
If the **TRIG'D** LED is not lit, check that the **CH1 – Width** and **CH1 Period** measurements are adjusted correctly. See note above. CONFIRM that the setup is correct and the oscilloscope will trigger.
- CONFIRM that the **TRIG'D** LED is lit and the waveform is stable.
- Disconnect the signal source from CH1, wait a few seconds, then reconnect the signal.
- CONFIRM that the **TRIG'D** LED is lit and the waveform is stable.
- Press **Sync Polarity**.
- Press **Pos Sync**.
- Push the pulse generator **COMPLEMENT** button out.
- CONFIRM that the **TRIG'D** LED is lit and the waveform is stable.
- Disconnect the signal source from CH1, wait a few seconds, then reconnect the signal.
- CONFIRM that the **TRIG'D** LED is lit and the waveform is stable.

- Disconnect all test equipment (TSG 121) from the digitizing oscilloscope.
- Press save/recall **SETUP**, press the main-menu button **Recall Factory Setup**, and the side-menu **OK Confirm Factory Init**.



Specifications

Specifications

This section begins with a general description of the traits of the TDS 684A and 744 Digitizing Oscilloscopes. Three sections follow, one for each of three classes of traits: *nominal traits*, *warranted characteristics*, and *typical characteristics*.

Product Description

The TDS 684A and 744 Digitizing Oscilloscopes are portable, four-channel instruments suitable for use in a variety of test and measurement applications and systems. Table 2-1 lists key features.

Table 2-1: Key Features of the TDS 684A and 744 Oscilloscopes

Feature	TDS 684A	TDS 744
Digitizing rate, maximum	5 GS/s on each channel simultaneously	2 GS/s
Analog bandwidth	1 GHz	500 MHz
Channels	Four, each with 8-bit resolution	
Record lengths, maximum	15,000 samples	50,000 samples (130,000 with option 1M)
Acquisition modes	Sample, envelope, and average	Sample, envelope, average, high-resolution, and peak-detect
Trigger modes	Include: edge, logic, and pulse. Video trigger, with option 05, modes include: NTSC, SECAM, PAL, HDTV, and FlexFormat.	
Display	Color for distinguishing among waveforms, measurements, and associated text	
Storage	1.44 Mbyte, 3.5 inch, DOS 3.3-or-later floppy disk. NVRAM storage for saving waveforms, hardcopies, and setups	
I/O	Full GPIB programmability. Hardcopy output using GPIB, RS-232, or Centronics ports	

User Interface

Use a combination of front-panel buttons, knobs, and on-screen menus to control the many functions of the oscilloscope. The front-panel controls are grouped according to function: vertical, horizontal, trigger, and special. Set a function you adjust often, such as vertical positioning or the time base setting, directly by its own front-panel knob. Set a function you change less often, such as vertical coupling or horizontal mode, indirectly using a selected menu.

Menus Pressing one (sometimes two) front-panel button(s), such as vertical menu, displays a *main* menu of related functions, such as coupling, bandwidth, etc., at the bottom of the screen. Pressing a main-menu button, such as coupling, displays a *side* menu of settings for that function, such as AC, DC, or GND (ground) coupling, at the right side of the screen. Pressing a side-menu button selects a setting such as DC.

Indicators On-screen readouts help you keep track of the settings for various functions, such as vertical and horizontal scale and trigger level. Some readouts use the cursors or the automatic parameter extraction feature (called measure) to display the results of measurements made or the status of the instrument.

General Purpose Knob Assign the general purpose knob to adjust a selected parameter function. More quickly change parameters by toggling the **SHIFT** button. Use the same method as for *selecting* a function, except the final side-menu selection assigns the general purpose knob to *adjust* some function, such as the position of measurement cursors on screen, or the setting for a channel fine gain.

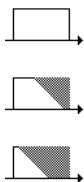

GUI The user interface also makes use of a GUI, or Graphical User Interface, to make setting functions and interpreting the display more intuitive. Some menus and status are displayed using iconic representations of function settings such as those shown here for full, 250 MHz and 20 MHz bandwidth. Such icons allow you to more readily determine status or the available settings.

Signal Acquisition System

The signal acquisition system provides four, full-featured vertical channels with calibrated vertical scale factors from 1 mV to 10 V per division. All channels can be acquired simultaneously.

Each of the full-featured channels can be displayed, vertically positioned, and offset, can have their bandwidth limited (250 MHz or 20 MHz) and their vertical coupling specified. Fine gain can also be adjusted.

Besides these channels, up to three math waveforms and four reference waveforms are available for display. (A math waveform results when you specify dual waveform operations, such as add, on any two channels. A reference waveform results when you save a waveform in a reference memory.)

Horizontal System

There are three horizontal display modes: main only, main intensified, and delayed only. You can select among various horizontal record length settings.

A feature called “Fit to Screen” allows you to view entire waveform records within the 10 division screen area. In other words, waveforms are compressed to fit on the screen. See Table 2–2.

Table 2–2: Record Length vs. Divisions per Record, Samples per Division and Sec/Div Sequence

Record Length	Divisions per Record	
	Sample/Division (Sec/Div Sequence)	
	Fit to Screen OFF 50 (1–2–5)	Fit to Screen ON (Sample/Div & Sec/Div Sequence varies)
500	10 divs	10 divs
1000	20 divs	10 divs
2500	50 divs	10 divs
5000	100 divs	10 divs
15000	300 divs	15 divs
50000 (TDS 744 only)	1,000 divs	10 divs
75000 (TDS 744 opt. 1M only)	1,500 divs	15 divs
100000 (TDS 744 opt. 1M only)	2,000 divs	15 divs
130000 (TDS 744 opt. 1M only)	2,600 divs	13 divs

Both the delayed only display and the intensified zone on the main intensified display may be delayed by time with respect to the main trigger. Both can be set to display immediately after the delay (delayed runs after main mode). The delayed display can also be set to display at the first valid trigger after the delay (delayed-triggerable modes).

The delayed display (or the intensified zone) may also be delayed by a selected number of events. In this case, the events source is the delayed-trigger source. The delayed trigger can also be set to occur after a number of events plus an amount of time.

Trigger System

The triggering system supports a varied set of features for triggering the signal-acquisition system. Trigger signals recognized include:

- Edge (main- and delayed-trigger systems): This familiar type of triggering is fully configurable for source, slope, coupling, mode (auto or normal), and holdoff.
- Logic (main-trigger system): This type of triggering can be based on pattern (asynchronous) or state (synchronous). In either case, logic triggering is configurable for sources, for boolean operators to apply to those sources, for logic pattern or state on which to trigger, for mode (auto or normal), and for holdoff. Time qualification may be selected in pattern mode. Another class of logic trigger, setup/hold, triggers when data in one trigger source changes state within the setup and hold times that you specify relative to a clock in another trigger source.
- Pulse (main-trigger system): Pulse triggering is configurable for triggering on runt or glitch pulses, or on pulse widths or periods inside or outside limits that you specify. It can also trigger on a pulse edge that has a slew rate faster or slower than the rate you specify. The pulse trigger is also configurable for source, polarity, mode, and holdoff.
- Video (with option 05: Video Trigger): Video triggering is compatible with standard NTSC, PAL, SECAM, and HDTV formats. An additional feature called FlexFormat™ (flexible format) allows the user to define the video format on which to trigger.

You can choose where the trigger point is located within the acquired waveform record by selecting the amount of pretrigger data displayed. Presets of 10%, 50%, and 90% of pretrigger data can be selected in the horizontal menu, or the general purpose knob can be assigned to set pretrigger data to any value within the 0% to 100% limits.

Acquisition Control

You can specify a mode and manner to acquire and process signals that matches your measurement requirements.

- Select the mode for interpolation (linear or $\sin(x)/x$). This can increase the apparent sample rate on the waveform when the maximum real-time rate is exceeded.
- Use sample, envelope, and average modes to acquire signals. (with the TDS 744, also use high-resolution and peak-detect modes)

- Set the acquisition to stop after a single acquisition (or sequence of acquisitions if acquiring in average or envelope modes) or after a limit condition has been met.
- Select channel sources for compliance with limit tests. You can direct the TDS to signal you or generate hard copy output either to a printer or to a floppy disk file based on the results. Also, you can create templates for use in limit tests.

On-Board User Assistance

Help and autoset can assist you in setting up the Digitizing Oscilloscope to make your measurements.

Help Help displays operational information about any front-panel control. When help mode is in effect, manipulating any front-panel control causes the Digitizing Oscilloscope to display information about that control. When help is first invoked, an introduction to help is displayed on screen.

Autoset Autoset automatically sets up the Digitizing Oscilloscope for a viewable display based on the input signal.

Measurement Assistance

Once you have set up to make your measurements, the cursor and measure features can help you quickly make those measurements.

Cursor Three types of cursors are provided for making parametric measurements on the displayed waveforms. Horizontal bar cursors (H Bar) measure vertical parameters (typically volts). Vertical bar cursors (V Bar) measure horizontal parameters (typically time or frequency). Paired cursors measure both amplitude and time simultaneously. These are delta measurements; that is, measurements based on the difference between two cursors.

Both H Bar and V Bar cursors can also be used to make absolute measurements. For the H Bars, either cursor can be selected to read out its voltage with respect to any channels ground reference level. For the V Bars, the cursors measure time with respect to the trigger point (event) of the acquisition. The cursors can also control the portion of the waveform on which automatic measurements are made.

For time measurements, units can be either seconds or Hertz (for 1/time).

With the video trigger option installed (Option 05), you can measure the video line number using the vertical cursors. You can measure IRE amplitude (NTSC) using the horizontal cursors with or without the video trigger option installed.

Measure

Measure can automatically extract parameters from the signal input to the Digitizing Oscilloscope. Any four out of the 25 parameters available can be displayed to the screen. The waveform parameters are measured continuously with the results updated on-screen as the Digitizing Oscilloscope continues to acquire waveforms.

Digital Signal Processing (DSP)

An important component of the multiprocessor architecture of this Digitizing Oscilloscope is Tektronix's proprietary digital signal processor, the DSP. This dedicated processor supports advanced analysis of your waveforms when doing such compute-intensive tasks as interpolation, waveform math, and signal averaging. It also teams with a custom display system to deliver specialized display modes (See *Display*, later in this description.)

Storage

Acquired waveforms may be saved in any of four nonvolatile REF (reference) memories or on a 3.5 inch, DOS 3.3-or-later compatible disk. Any or all of the saved waveforms may be displayed for comparison with the waveforms being currently acquired.

The source and destination of waveforms to be saved may be chosen. You can save any of the four channels to any REF memory or move a stored reference from one REF memory to another. Reference waveforms may also be written into a REF memory location via the GPIB interface.

I/O

The oscilloscope is fully controllable and capable of sending and receiving waveforms over the GPIB interface (IEEE Std 488.1–1987/IEEE Std 488.2–1987 standard). This feature makes the instrument ideal for making automated measurements in a production or research and development environment that calls for repetitive data taking. Self-compensation and self-diagnostic features built into the Digitizing Oscilloscope to aid in fault detection and servicing are also accessible using commands sent from a GPIB controller.

The oscilloscope can also output copies of its display using the hardcopy feature. This feature allows you to output waveforms and other on-screen information to a variety of graphic printers and plotters from the TDS front panel, providing hard copies without requiring you to put the TDS into a system-controller environment. You can make hardcopies in a variety of popular output formats,

such as PCX, TIFF, BMP, RLE, EPS, Interleaf, and EPS mono or color. You can also save hardcopies in a disk file in any of the formats above. The hardcopies obtained are based on what is displayed on-screen at the time hardcopy is invoked. The hardcopies can be stamped with date and time and spooled to a queue for printing at a later time. You can output screen information via GPIB, RS-232C, or Centronics interfaces.

Display

The TDS 684A and 744 Digitizing Oscilloscopes offer flexible display options. You can customize the following attributes of your display:

- Color: Waveforms, readouts, graticule, and variable persistence with color coding
- Intensity: waveforms, readouts, and graticule
- Style of waveform display(s): vectors or dots, intensified or non-intensified samples, infinite persistence, and variable persistence with color coding
- Interpolation method: Sin(x)/x or Linear
- Display format: xy or yt with various graticule selections including NTSC and PAL to be used with video trigger (option 05)

Zoom This oscilloscope also provides an easy way to focus in on those waveform features you wish to examine up close. By invoking zoom, you can magnify the waveform using the vertical and horizontal controls to expand (or contract) and position it for viewing.

Nominal Traits

This section contains a collection of tables that list the various *nominal traits* that describe the TDS 684A and 744 oscilloscopes. Electrical and mechanical traits are included.

Nominal traits are described using simple statements of fact such as “Four, all identical” for the trait “Input Channels, Number of,” rather than in terms of limits that are performance requirements.

Table 2-3: Nominal Traits — Signal Acquisition System

Name	Description	
Bandwidth Selections	20 MHz, 250 MHz, and FULL	
Samplers, Number of	Four, simultaneous	
Digitized Bits, Number of	8 bits ¹	
Input Channels, Number of	Four	
Input Coupling	DC, AC, or GND	
Input Impedance Selections	1 M Ω or 50 Ω	
Ranges, Offset	Volts/Div Setting	Offset Range
	1 mV/div – 100 mV/div	± 1 V
	101 mV/div – 1 V/div	± 10 V
	1.01 V/div – 10 V/div	± 100 V
Range, Position	± 5 divisions	
Range, 1 M Ω Sensitivity	1 mV/div to 10 V/div ²	
Range, 50 Ω Sensitivity	1 mV/div to 1 V/div ²	

- ¹ Displayed vertically with 25 digitization levels (DLs) per division and 10.24 divisions dynamic range with zoom off. A DL is the smallest voltage level change of the oscilloscope input that can be resolved by the 8-bit A-D Converter. Expressed as a voltage, a DL is equal to 1/25 of a division times the volts/division setting.
- ² The sensitivity ranges from 1 mV/div to 10 V/div (for 1 M Ω) or to 1 V/div (for 50 Ω) in a 1–2–5 sequence of coarse settings with Fit-to-Screen off. Between coarse settings, the sensitivity can be finely adjusted with a resolution equal to 1% of the more sensitive coarse setting. For example, between 50 mV/div and 100 mV/div, the volts/division can be set with 0.5 mV resolution.

Table 2-4: Nominal Traits — Time Base System

Name	Description
Range, Sample-Rate ^{1,3}	TDS 684A: 5 Samples/sec to 5 GSamples/sec on four channels simultaneously TDS 744: 5 Samples/sec to 2 GSamples/sec when acquiring 1 channel to 1 G Sample/sec when acquiring 2 channels, or to 500 MSamples/sec when acquiring 3 or 4 channels
Range, Interpolated Waveform Rate ^{2,3}	TDS 684A: 10 GSamples/sec to 250 GSamples/sec TDS 744: 1 GSamples/sec to 100 GSamples/sec
Range, Seconds/Division	TDS 684A: 0.2 ns/div to 10 s/div TDS 744: 0.5 ns/div to 10 s/div
Record Length Selection	500 samples, 1000 samples, 2500 samples 5000 samples, 15000 samples The TDS 744 also offers: 50000 samples and, with its option 1M, 75000, 100000, and 130000 samples

- ¹ The range of real-time rates, expressed in samples/second, at which a digitizer samples signals at its inputs and stores the samples in memory to produce a record of time-sequential samples.
- ² The range of waveform rates for interpolated (or equivalent-time on the TDS 744) waveform records.
- ³ The Waveform Rate (WR) is the equivalent sample rate of a waveform record. For a waveform record acquired by real-time sampling of a single acquisition, the waveform rate is the same as the real-time sample rate; for a waveform created by interpolation of real-time samples from a single acquisition or, on applicable products, the equivalent-time sampling of multiple acquisitions, the waveform rate created is faster than the real time sample rate. For all these cases, the waveform rate is 1/(Waveform Interval) for the waveform record, where the waveform interval (WI) is the time between the samples in the waveform record.

Table 2-5: Nominal Traits — Triggering System

Name	Description	
Range, Delayed Trigger Time Delay	16 ns to 250 s	
Range, Events Delay	TDS 684A: 2 to 10,000,000 TDS 744: 1 to 10,000,000	
Range (Time) for Pulse-Glitch, Pulse-Width, Time-Qualified Runt Triggering, or Slew Rate Trigger, Delta Time	1 ns to 1 s	
Ranges, Setup and Hold for TimeSetup/Hold Violation Trigger	Feature	Min to max
	Setup Time	-100 ns to 100 ns
	Hold Time	-1 ns to 100 ns
	Setup + Hold Time	2 ns

Table 2-5: Nominal Traits — Triggering System (Cont.)

Name	Description	
	<p>For Setup Time, positive numbers mean a data transition before the clock edge and negative means a transition after the clock edge.</p> <p>For Hold Time, positive numbers mean a data transition after the clock edge and negative means a transition before the clock edge.</p> <p>Setup + Hold Time is the algebraic sum of the Setup Time and the Hold Time programmed by the user.</p>	
Ranges, Trigger Level or Threshold	Source	Range
	Any Channel	±12 divisions from center of screen
	Auxiliary	±8 V
	Line	±400 V
Video Trigger Modes of Operation (Option 05 Video Trigger)	<p>Supports the following video standards:</p> <ul style="list-style-type: none"> ■ NTSC (525/60) – 2 field mono or 4 field ■ PAL (625/50) – 2 field mono or SECAM, 8 field ■ HDTV – <ul style="list-style-type: none"> (787.5/60) (1050/60) (1125/60) (1250/60) ■ FlexFormat™ (user definable standards) <p>User can specify: field rate, number of lines, sync pulse width and polarity, line rate, and vertical interval timing.</p>	

Table 2-6: Nominal Traits — Display System

Name	Description
Video Display	Color display, 7 inch diagonal, with a display area of 5.04 inches horizontally by 3.78 inches vertically
Video Display Resolution	640 pixels horizontally by 480 pixels vertically
Waveform Display Graticule	Single Graticule: 401 × 501 pixels, 8 × 10 divisions, where divisions are 1 cm by 1 cm
Waveform Display Colors	Sixteen colors in infinite-persistence or variable persistence display with color coding

Table 2-7: Nominal Traits — GPIB Interface, Output Ports, and Power Fuse

Name	Description
Interface, GPIB	GPIB interface complies with IEEE Std 488-1987
Interface, RS-232	RS-232 interface complies with EIA/TIA 574 (talk only)
Interface, Centronics	Centronics interface complies with Centronics interface standard C332-44 Feb 1977, REV A
Interface, Video	VGA video output with levels that comply with EIA RS 343A standard. DB-15 connector
Logic Polarity for Main- and Delayed-Trigger Outputs	Negative TRUE. High to low transition indicates the trigger occurred.
Fuse Rating	Either of two fuses ¹ may be used: a 0.25" × 1.25" (UL 198.6, 3AG): 6 A FAST, 250 V or a 5 mm × 20 mm (IEC 127): 5 A (T), 250 V.

¹ Each fuse type requires its own fuse cap.

Table 2-8: Nominal Traits — Data Handling and Reliability

Name	Description
Time, Data-Retention, Nonvolatile Memory ^{1, 2}	≥ 5 years
Floppy disk	3.5 inch, 720 K or 1.44 Mbyte, DOS 3.3-or-later compatible

¹ The times that reference waveforms, stored setups, and calibration constants are retained when there is no power to the oscilloscope.

² Data is maintained by small lithium-thionyl-chloride batteries internal to the memory ICs. The amount of lithium is so small in these ICs that they can typically be safely disposed of with ordinary garbage in a sanitary landfill.

Table 2-9: Nominal Traits — Mechanical

Name	Description
Cooling Method	Forced-air circulation with no air filter. Clearance is required.
Construction Material	Chassis parts constructed of aluminum alloy; front panel constructed of plastic laminate; circuit boards constructed of glass laminate. Cabinet is aluminum and is clad in Tektronix Blue vinyl material.
Finish Type	Tektronix Blue vinyl-clad aluminum cabinet
Weight	<p>Standard TDS 684A Digitizing Oscilloscope</p> <p>14.1 kg (31 lbs), with front cover. TDS 684A: 24.0 kg (53 lbs), when packaged for domestic shipment TDS 744: 25.4 kg (56 lbs), when packaged for domestic shipment</p> <p>Rackmount TDS 684A Digitizing Oscilloscopes</p> <p>14.1 kg (31 lbs) plus weight of rackmount parts, for the rackmounted Digitizing Oscilloscopes (Option 1R).</p> <p>Rackmount conversion kit</p> <p>2.3 kg (5 lbs), parts only; 3.6 kg (8 lbs), parts plus package for domestic shipping</p>
Overall Dimensions	<p>Standard Digitizing Oscilloscope</p> <p>Height: 193 mm (7.6 in), with the feet installed Width: 445 mm (17.5 in), with the handle Depth: 434 mm (17.1 in), with the front cover installed</p> <p>Rackmount Digitizing Oscilloscope</p> <p>Height: 178 mm (7.0 in) Width: 483 mm (19.0 in) Depth: 558.8 mm (22.0 in)</p>

Warranted Characteristics

This section lists the various *warranted characteristics* that describe the TDS 684A and 744 Digitizing Oscilloscopes. Electrical and environmental characteristics are included.

Warranted characteristics are described in terms of quantifiable performance limits which are warranted.

NOTE. *In these tables, those warranted characteristics that are checked in the procedure Performance Verification appear in **boldface type** under the column **Name**.*

As stated above, this section lists only warranted characteristics. A list of *typical characteristics* starts on page 2–21.

Performance Conditions

The performance limits in this specification are valid with these conditions:

- The oscilloscope must have been calibrated/adjusted at an ambient temperature between +20° C and +30° C.
- The oscilloscope must be in an environment with temperature, altitude, humidity, and vibration within the operating limits described in these specifications.
- The oscilloscope must have had a warm-up period of at least 20 minutes.
- The oscilloscope must have had its signal-path-compensation routine last executed after at least a 20 minute warm-up period at an ambient temperature within $\pm 5^{\circ}$ C of the current ambient temperature.

Table 2-10: Warranted Characteristics — Signal Acquisition System

Name	Description		
Accuracy, DC Gain	TDS 684A: $\pm 1.5\%$ for all sensitivities from 2 mV/div to 10 V/div $\pm 2.0\%$ at 1 mV/div sensitivity TDS 744: $\pm 1\%$ for all sensitivities from 1 mV/div to 10 V/div with offset from 0 V to $\pm 100V$		
Accuracy, Offset	Volts/Div Setting	TDS 684A Offset Accuracy	TDS 744 Offset Accuracy
	1 mV/div – 100 mV/div	$\pm((0.2\% \times \text{Net Offset}^1) + 1.5 \text{ mV} + (0.6 \text{ div} \times \text{V/div}))$	$\pm((0.2\% \times \text{Net Offset}^1) + 1.5 \text{ mV} + (0.1 \text{ div} \times \text{V/div setting}))$
	101 mV/div – 1 V/div	$\pm((0.25\% \times \text{Net Offset}^1) + 15 \text{ mV} + (0.6 \text{ div} \times \text{V/div}))$	$\pm((0.25\% \times \text{Net Offset}^1) + 15 \text{ mV} + (0.1 \text{ div} \times \text{V/div setting}))$
	1.01 V/div – 10 V/div	$\pm((0.25\% \times \text{Net Offset}^1) + 150 \text{ mV} + (0.6 \text{ div} \times \text{V/div}))$	$\pm((0.25\% \times \text{Net Offset}^1) + 150 \text{ mV} + (0.1 \text{ div} \times \text{V/div setting}))$
Analog Bandwidth, DC-50 Ω Coupled and Bandwidth selection is FULL	Volts/Div	684A Bandwidth²	744 Bandwidth²
	10 mV/div – 1 V/div	DC – 1 GHz	DC – 500 MHz
	5 mV/div – 9.95 mV/div	DC – 750 MHz	DC – 500 MHz
	2 mV/div – 4.98 mV/div	DC – 600 MHz	DC – 500 MHz
	1 mV/div – 1.99 mV/div	DC – 500 MHz	DC – 450 MHz
Analog Bandwidth, DC-50 Ω Coupled with P6245 Probe and Bandwidth selection is FULL	Volts/Div as Read Out on Screen	684A Bandwidth²	744 Bandwidth²
	10 mV/div – 100 V/div	(Not Applicable)	(Not Applicable)
	100 mV/div – 10 V/div	DC – 1 GHz	DC – 1 GHz
	50 mV/div – 99.5 mV/div	DC – 750 MHz	DC – 900 MHz
	20 mV/div – 49.8 mV/div	DC – 600 MHz	DC – 600 MHz
	10 mV/div – 19.9 mV/div	DC – 500 MHz	DC – 500 MHz
Analog Bandwidth, DC-1M Ω Coupled with P6139A Probe and Bandwidth selection is FULL	Volts/Div as Read Out on Screen	684A Bandwidth²	744 Bandwidth²
	10 mV/div – 100 V/div	500 MHz	500 MHz
	100 mV/div – 10 V/div	500 MHz	500 MHz
	50 mV/div – 99.5 mV/div	500 MHz	500 MHz
	20 mV/div – 49.8 mV/div	500 MHz	500 MHz
	10 mV/div – 19.9 mV/div	400 MHz	500 MHz
Crosstalk (Channel Isolation)	$\geq 100:1$ at 100 MHz and $\geq 30:1$ at the rated bandwidth for any two channels having equal Volts/Div settings		

Table 2-10: Warranted Characteristics — Signal Acquisition System (Cont.)

Name	Description
Delay Between Channels, Full Bandwidth	≤100 ps for any two channels with equal Volts/Div and Coupling settings
Input Impedance, DC-1 MΩ Coupled	1 MΩ ±0.5% in parallel with 10 pF ±3 pF
Input Impedance, DC-50 Ω Coupled	50 Ω ±1% with VSWR ≤1.3:1 from DC – 500 MHz, ≤1.5:1 from 500 MHz – 1 GHz
Input Voltage, Maximum, DC-1 MΩ, AC-1 MΩ, or GND Coupled	±400 V (DC + peak AC); derate at 20 dB/decade above 1 MHz
Input Voltage, Maximum, DC-50 Ω or AC-50 Ω Coupled	5 V _{RMS} , with peaks ≤ ±30 V
Lower Frequency Limit, AC Coupled	TDS 684A: ≤10 Hz when AC-1 MΩ Coupled; ≤200 kHz when AC-50 Ω Coupled ³

- ¹ Net Offset = Offset – (Position × Volts/Div). Net Offset is the nominal voltage level at the oscilloscope input that corresponds to the center of the A-D converter's dynamic range. Offset Accuracy is the accuracy of this voltage level.
- ² The limits given are for the ambient temperature range of 0°C to +30°C. Reduce the upper bandwidth frequencies by 5 MHz for the TDS 684A or by 2.5 MHz for the TDS 744 for each °C above +30°C.
- ³ The AC Coupled Lower Frequency Limits are reduced by a factor of 10 when 10X passive probes are used.

Table 2-11: Warranted Characteristics — Time Base System

Name	Description
Accuracy, Long Term Sample Rate and Delay Time	TDS 684A: ±100 ppm over any ≥1 ms interval TDS 744: ±25 ppm over any ≥1 ms interval

Table 2-12: Warranted Characteristics — Triggering System

Name	Description	
Sensitivity, Edge-Type Trigger, Coupling set to "DC" ¹	Trigger Source	Sensitivity
	Any Channel	TDS 684A: 0.35 division from DC to 50 MHz, increasing to 1 division at 1 GHz TDS 744: 0.35 division from DC to 50 MHz, increasing to 1 division at 500 MHz
	Auxiliary	TDS 684A: 250 mV from DC to 50 MHz, increasing to 500 mV at 100 MHz TDS 744: 400 mV from DC to 50 MHz, increasing to 750 mV at 100 MHz
Accuracy (Time) for Pulse-Glitch or Pulse-Width Triggering	Time Range	Accuracy
	1 ns to 1 μs	±(20% of Setting + 0.5 ns)
	1.02 μs to 1 s	±(100 ns + 0.01% of Setting)

Table 2–12: Warranted Characteristics — Triggering System (Cont.)

Name	Description
Input Signal Sync Amplitude for Stable Triggering, NTSC and PAL modes (Option 05 Video Trigger)	Field selection “Odd”, “Even”, or “All”: 0.6 division to 4 divisions Field selection “Numeric”: 1 division to 4 divisions (NTSC mode)
Jitter (Option 05 Video Trigger)	60 ns _{p-p} on NTSC or PAL signal

¹ The minimum sensitivity for obtaining a stable trigger. A stable trigger results in a uniform, regular display triggered on the selected slope. The trigger point must not switch between opposite slopes on the waveform, and the display must not “roll” across the screen on successive acquisitions. The TRIG'D LED stays constantly lighted when the SEC/DIV setting is 2 ms or faster but may flash when the SEC/DIV setting is 10 ms or slower.

Table 2–13: Warranted Characteristics — Output Ports, Probe Compensator, and Power Requirements

Name	Description	
Logic Levels, Main- and Delayed-Trigger Outputs	Characteristic	Limits
	Vout (HI) Vout (LO)	≥2.5 V open circuit; ≥1.0 V into a 50 Ω load to ground ≤0.7 V into a load of ≤4 mA; ≤0.25 V into a 50 Ω load to ground
Output Voltage and Frequency, Probe Compensator	Characteristic	Limits
	Output Voltage Frequency	0.5 V (base-top) ±1% into a ≥50 Ω load 1 kHz ±5%
Output Voltage, Signal Out (CH 3 ¹)	For TDS 684A: 20 mV/division ±20% into a 1 MΩ load; 10 mV/division ±20% into a 50 Ω load For TDS 744: 22 mV/division ±20% into a 1 MΩ load; 11 mV/division ±20% into a 50 Ω load	
Source Voltage	90 to 250 VAC _{RMS} , continuous range	
Source Frequency	45 Hz to 440 Hz	
Power Consumption	≤300 W (450 VA)	

¹ CH 3 signal out is present at the rear panel if CH 3 is selected as the trigger source for the main and/or delayed trigger systems. It is not available when a channel other than CH3 is the source for the Video Trigger when Option 05 is installed.

Table 2-14: Warranted Characteristics — Environmental

Name	Description
Atmospherics	Temperature (no diskette in floppy drive): TDS 684A: Operating: +4° C to +45° C TDS 744: Operating: +4° C to +50° C Non-operating: -22° C to +60° C Relative humidity (no diskette in floppy drive): Operating: 20% to 80%, at or below +32° C, upper limit de-rates to 30% relative humidity at +45° C Non-operating: 5% to 90%, at or below +41° C, upper limit de-rates to 30% relative humidity at 60° C Altitude: To 4570 m (15,000 ft.), operating To 12190 m (40,000 ft.), non-operating
Dynamics	Random vibration (floppy diskette not installed): 0.31 g rms, from 5 to 500 Hz, 10 minutes each axis, operating 3.07 g rms, from 5 to 500 Hz, 10 minutes each axis, non-operating
Emissions ^{1, 2}	Meets or exceeds the requirements of the following standards: Vfg. 243/1991 Amended per Vfg. 46/1992 FCC Code of Federal Regulations, 47 CFR, Part 15, Subpart B, Class A EN 50081-1 European Community Requirements EN55022 Radiated Emissions Class B EN55022 Class B Conducted Emission EN60555-2 Power Harmonics
Susceptibility ^{1, 2}	Meets or exceeds the EMC requirements of the following standards: EN 50082-1 European Community Requirements IEC 801-2 Electrostatic Discharge IEC 801-3 Radiated Susceptibility IEC 801-4 Fast Transients IEC 801-5 AC Surge

Table 2-14: Warranted Characteristics — Environmental (Cont.)

Name	Description
Third Party Certification	Conforms to and is certified where appropriate to: UL 1244 CSA-C22.2 No. 231

1,2 VGA output cable needs to be terminated, if connected at all, for the Instrument to meet these standards. The test will pass with LCOM part # CTL3VGAMM-5.

1,2 The GPIB cable connected to the instrument for certain of the emissions tests must be “low EMI” having a high-quality outer shield connected through a low impedance to both connector housings. Acceptable cables are Tektronix part numbers 012-0991-00, -01, -02, and -03. In order to maintain the EMI performance conforming to the above regulations, the following cables, or their equivalent, should be used: a shielded Centronics cable, 3 meters in length, part number 012-1214-00, and a shielded RS-232 cable, 2.7 meters in length, CA part number 0294-9.

Typical Characteristics

This subsection contains tables that list the various *typical characteristics* which describe the TDS 684A and 744 Digitizing Oscilloscopes.

Typical characteristics are described in terms of typical or average performance. Typical characteristics are not warranted.

Table 2-15: Typical Characteristics — Signal Acquisition System

Name	Description		
Accuracy, Delta Time Measurement	<p>The limits are given in the following table for signals having amplitude greater than 5 divisions, reference level = 50%, filter set to (sinX/X), acquired at 5 mV/div or greater. For the TDS 744, pulse duration < 10 div. Channel skew not included.</p> <p>For the Single Shot condition, $1.4 \leq T_r/S_i \leq 4$ for the TDS 684A and $1.4 \leq T_r/S_i \leq 5$ for the TDS 744, where S_i is the sample interval and T_r is the displayed rise time.</p> <p>TDS 684A: For the averaged condition, $1.4 \leq T_r/W_i \leq 40$, where W_i is the Waveform Interval, as described elsewhere in these specifications.</p> <p>TDS 684A: Extra error in the measurement will occur for two-channel measurements due to channel-to-channel skew. This spec is described elsewhere in these specifications.</p>		
	Conditions	Time Measurement Accuracy	
	Single Shot or Sample mode (or HiRes mode on the TDS 744), Full Bandwidth selected	<p>TDS 684A: $\pm(0.20 \times \text{sample interval}) + (100 \text{ ppm} \times \text{Reading}) + (0.05 \times W_i)$</p> <p>TDS 684A example: at 5 GS/s, 5 ns/div, measuring a 40 ns wide pulse, accuracy = $\pm(40 \text{ ps} + 4 \text{ ps} + 5 \text{ ps}) = \pm 49 \text{ ps}$.</p> <p>TDS 744: $\pm \geq 0.15 \text{ sample interval} + 25 \text{ ppm} \times \text{Reading} + t/\text{div}/1000$</p> <p>TDS 744 example: at 4 Gs/s, accuracy = 37.5 ps</p>	
	≥ 100 Averages, Full Bandwidth selected. TDS 744: repetitive	<p>TDS 684A: $\pm(10 \text{ ps} + (100 \text{ ppm} \times \text{Reading}) + (0.25 \times W_i))$</p> <p>TDS 744: $20 \text{ ps} + 25 \text{ ppm} \times \text{Reading} + t/\text{div}/1000$</p>	
Calculated Rise Time ¹	Volts/Div Setting	684A Rise Time	744 Rise Time
	10 mV/div – 1 V/div	450 ps	800 ps
	5 mV/div – 9.95 mV/div	600 ps	800 ps
		750 ps	
	2 mV/div – 4.98 mV/div	900 ps	1.140 ns
1 mV/div – 1.99 mV/div		1.33 ns	

Table 2–15: Typical Characteristics — Signal Acquisition System (Cont.)

Name	Description				
Effective Bits — TDS 684A The chart on the right gives the typical effective bits for a 9-division p-p sine-wave input, 50 mV/div, 10 ns/div (5 GS/s), with a record length of 1000 points:	Input Frequency	Effective Bits			
	98 MHz	6.3 bits			
	245 MHz	6.0 bits			
	490 MHz	5.5 bits			
	990 MHz	5.2 bits			
Effective Bits — TDS 744 The chart on the right gives the typical effective bits for a sine wave adjusted to 9.2 divisions at 1 MHz, 50 mV/div @ 25° C	Input Frequency	Sample Rate			
		2 GS/s	1 MS/s & HiRes		
	1 MHz – 9.2 divs	6.8 bits	9.7 bits		
	500 MHz – 6.5 divs	6.8 bits	N/A		
Frequency Limit, Upper, 250 MHz Bandwidth Limited	250 MHz				
Frequency Limit, Upper, 20 MHz Bandwidth Limited	20 MHz				
Step Response Settling Errors	Volts/Div Setting	± Step Amplitude	Settling Error (%)² at		
			20 ns	100 ns	20 ms
	1 mV/div – 100 mV/div	≤2 V	0.5%	0.2%	0.1%
	101 mV/div – 1 V/div	≤20 V	1.0%	0.5%	0.2%
	1.01 V/div – 10 V/div	≤200 V	1.0%	0.5%	0.2%

¹ The numbers given are valid 0° C to +30° C and will increase as the temperature increases due to the degradation in bandwidth. Rise time is calculated from the bandwidth. It is defined by the following formula:

$$TDS\ 684A\ Rise\ Time\ (ns) = \frac{450}{BW\ (MHz)} \qquad TDS\ 744\ Rise\ Time\ (ns) = \frac{400}{BW\ (MHz)}$$

Note that if you measure rise time, you must take into account the rise time of the test equipment (signal source, etc.) that you use to provide the test signal. That is, the measured risetime (RT_m) is determined by the instrument risetime (RT_i) and the risetime of the test signal source (RT_{gen}) according to the following formula:

$$RT_m^2 = RT_i^2 + RT_{gen}^2$$

² The values given are the maximum absolute difference between the value at the end of a specified time interval after the mid-level crossing of the step, and the value one second after the mid-level crossing of the step, expressed as a percentage of the step amplitude.

Table 2–16: Typical Characteristics — Triggering System

Name	Description	
Accuracy, Trigger Level or Threshold, DC Coupled (for signals having rise and fall times ≥ 20 ns)	Trigger Source	Accuracy
	Any Channel	$\pm((2\% \times \text{Setting} - \text{Net Offset}) + (0.3 \text{ div} \times \text{Volts/div Setting}) + \text{Offset Accuracy})$
	Auxiliary	Not calibrated or specified
Input, Auxiliary Trigger	The input resistance is $\geq 1.5 \text{ k}\Omega$; the maximum safe input voltage is $\pm 20 \text{ V}$ (DC + peak AC).	
Trigger Position Error, Edge Triggering	Acquisition Mode	Trigger-Position Error ^{1,2}
	Sample, Average	$\pm(1 \text{ Waveform Interval} + 1 \text{ ns})$
	Envelope	$\pm(2 \text{ Waveform Intervals} + 1 \text{ ns})$
Holdoff, Variable, Main Trigger	For all Time/Division ranges, the minimum holdoff is 250 ns and the maximum holdoff is 12 seconds. The minimum resolution is 8 ns for settings $\leq 1.2 \mu\text{s}$.	
Lowest Frequency for Successful Operation of "Set Level to 50%" Function	30 Hz	
Sensitivity, Edge Trigger, Not DC Coupled ³	Trigger Source	Typical Signal Level for Stable Triggering
	AC	Same as the DC-coupled limits for frequencies above 60 Hz. Attenuates signals below 60 Hz.
	Noise Reject	Three times the DC-coupled limits.
	High Frequency Reject	One and one-half times the DC-coupled limits from DC to 30 kHz. Attenuates signals above 30 kHz.
	Low Frequency Reject	One and one-half times the DC-coupled limits for frequencies above 80 kHz. Attenuates signals below 80 kHz.
Sensitivities, Logic Trigger and Events Delay, DC Coupled ⁴	1.0 division, from DC to 500 MHz, at vertical settings $> 10 \text{ mV/div}$ and $\leq 1 \text{ V/div}$ at the BNC input	
Sensitivities, Pulse-Type Runt Trigger ⁵	1.0 division, from DC to 500 MHz, at vertical settings $> 10 \text{ mV/div}$ and $\leq 1 \text{ V/div}$ at the BNC input	
Sensitivities, Pulse-Type Trigger Width and Glitch ⁶	1.0 division, at vertical settings $> 10 \text{ mV/div}$ and $\leq 1 \text{ V/div}$ at the BNC input	

Table 2–16: Typical Characteristics — Triggering System (Cont.)

Name	Description			
Width, Minimum Pulse and Rearm, for Logic Triggering or Events Delay	For vertical settings > 10 mV/div and ≤ 1 V/div at the BNC input			
	Triggering Type	Minimum Pulse Width	Minimum Re-Arm Width	Minimum Time Between Channels⁷
	Logic	Not Applicable	1 ns	1 ns
	Events Delay	1 ns (for either + or – pulse widths)	Not Applicable	2 ns
Width, Minimum Pulse and Rearm, for Pulse Triggering The minimum pulse widths and rearm widths and transition times ⁸ required for Pulse-Type triggering.	For vertical settings > 10 mV/div. and 3 1 V/div at the BNC input			
	Pulse Class	Minimum Pulse Width	Minimum Re-Arm Width	
	Glitch	1 ns	2 ns + 5% of Glitch Width Setting	
	Runt	2 ns	2 ns	
	Time-Qualified Runt	2 ns	TDS 684A: 8.5 ns + 5% of Width Setting TDS 744: 7 ns + 5% of Width Setting	
	Width	1 ns	2 ns + 5% of Width Upper Limit Setting	
	Slew Rate	600 ps ⁸	TDS 684A: 8.5 ns + 5% of delta Time Setting TDS 744: 7 ns + 5% of delta Time Setting	
Input Signal Sync Amplitude for Stable Triggering, HDTV and FLEXFMT modes (Option 05 Video Trigger)	All field selections: 0.6 division to 4 divisions			
Jitter for HDTV mode (Option 05 Video Trigger)	17 ns _{p-p}			
Sync Width Flex Format and HDTV modes (Option 05 Video Trigger)	min. 400 ns for HDTV signals			
Sync Duty Cycle, Flex Format and HDTV modes (Option 05 Video Trigger)	min. 50 to 1			
Hum Rejection (Option 05 Video Trigger)	NTSC and PAL: –20 dB without any trigger spec deterioration. Triggering will continue down to 0 dB with some performance deterioration.			

- ¹ The trigger position errors are typically less than the values given here. These values are for triggering signals having a slew rate at the trigger point of ≥ 0.5 division/ns.
- ² The waveform interval (WI) is the time between the samples in the waveform record. Also, see the footnote for the characteristics *Sample Rate Range or Interpolated Waveform Rates* in Table 2–4, on page 2–10.
- ³ The minimum sensitivity for obtaining a stable trigger. A stable trigger results in a uniform, regular display triggered on the selected slope. The trigger point must not switch between opposite slopes on the waveform, and the display must not “roll” across the screen on successive acquisitions. The TRIG'D LED stays constantly lighted when the SEC/DIV setting is 2 ms or faster but may flash when the SEC/DIV setting is 10 ms or slower.

Table 2-16: Typical Characteristics — Triggering System (Cont.)

Name	Description
4	The minimum signal levels required for stable logic or pulse triggering of an acquisition, or for stable counting of a DC-coupled, events-delay signal. Also, see the footnote for <i>Sensitivity, Edge-Type Trigger, DC Coupled</i> in this table. (Stable counting of events is counting that misses no events and produces no extra “phantom” events.)
5	The minimum signal levels required for stable runt pulse triggering of an acquisition. Also, see the footnote for <i>Sensitivity, Edge-Type Trigger, DC Coupled</i> in this table. (Stable counting of events is counting that misses no events.)
6	The minimum signal levels required for stable pulse width or glitch triggering of an acquisition. Also, see the footnote for <i>Sensitivity, Edge-Type Trigger, DC Coupled</i> in this table. (Stable counting of events is counting that misses no events.)
7	For Logic, time between channels refers to the length of time a logic state derived from more than one channel must exist to be recognized. For Events, the time is the minimum time between a main and delayed event that will be recognized if more than one channel is used.
8	For Slew Rate Triggering, this is the minimum transition time, defined to be the time the user’s signal spends between the two trigger threshold settings.

