

2252
PORTABLE
OSCILLOSCOPE
OPERATORS

*Please Check for
CHANGE INFORMATION
at the Rear of This Manual*

First Printing JULY 1990

Copyright © 1990 Tektronix, Inc. All rights reserved. Contents of this publication may not be reproduced in any form without the written permission of Tektronix, Inc.

Products of Tektronix, Inc. and its subsidiaries are covered by U.S. and foreign patents issued and pending.

TEKTRONIX, TEK, SCOPE-MOBILE and  are registered trademarks of Tektronix, Inc.

Printed in U.S.A. Specification and price change privileges are reserved.

INSTRUMENT SERIAL NUMBERS

Each instrument has a serial number on a panel insert, tag, or stamped on the chassis. The first two digits designate the country of manufacture. The last five digits of the serial number are unique to each instrument. The country of manufacture is identified as follows:

- B000000 Tektronix, Inc., Beaverton, Oregon, U.S.A.
- E200000 Tektronix United Kingdom, Ltd., London
- G100000 Tektronix Guernsey, Ltd., Channel Islands
- HK00000 Tektronix, Inc., Hong Kong
- H700000 Tektronix Holland, NV, Heerenveen, The Netherlands
- J300000 Sony/Tektronix, Japan

Certificate of the Manufacturer/Importer

We hereby certify that the 2252 OSCILLOSCOPE
AND ALL INSTALLED OPTIONS

complies with the RF Interference Suppression requirements of
Amtsbl.-Vfg 1046/1984.

The German Postal Service was notified that the equipment is
being marketed.

The German Postal Service has the right to re-test the series
and to verify that it complies.

TEKTRONIX

Bescheinigung des Herstellers/Importeurs

Hiermit wird bescheinigt, daß der/die/das _____
2252 OSCILLOSCOPE AND ALL INSTALLED OPTIONS

in Übereinstimmung mit den Bestimmungen der Amtsblatt-
Verfügung 1046/1984 funkentstört ist.

Der Deutschen Bundespost wurde das Inverkehrbringen
dieses Gerätes angezeigt und die Berechtigung zur
Überprüfung der Serie auf Einhalten der Bestimmungen
ingeräumt.

TEKTRONIX

NOTICE to the user/operator:

The German Postal Service requires that systems assembled by the operator/user of this instrument must also comply with Postal Regulation, Vfg. 1046/1984, Par. 2, Sect. 1.

HINWEIS für den Benutzer/Betreiber:

Die vom Betreiber zusammengestellte Anlage, innerhalb derer dies Gerät eingesetzt wird, muß ebenfalls den Voraussetzungen nach Par. 2, Ziff. 1 der Vfg. 1046/1984 genügen.

NOTICE to the user/operator:

The German Postal Service requires that this equipment, when used in a test setup, may only be operated if the requirements of Postal Regulation, Vfg. 1046/1984, Par. 2, Sect. 1.7.1 are complied with.

HINWEIS für den Benutzer/Betreiber:

Dies Gerät darf in Meßaufbauten nur betrieben werden, wenn die Voraussetzungen des Par. 2, Ziff. 1.7.1 der Vfg. 1046/1984 eingehalten werden.

TABLE OF CONTENTS

	Page
LIST OF ILLUSTRATIONS	viii
LIST OF TABLES	ix
OPERATORS SAFETY SUMMARY	x
SECTION 1—INTRODUCTION	
PRODUCT OVERVIEW	1-1
Description	1-1
Standard Accessories	1-3
PREPARATION FOR USE	1-4
Safety	1-4
Line Fuse	1-4
Line Voltage and Power Cord	1-4
Instrument Cooling	1-6
Start-Up	1-6
Repackaging for Shipment	1-7
SECTION 2—CONTROLS, CONNECTORS, AND INDICATORS	
CRT, Power, and Display	2-1
Vertical	2-3
Horizontal	2-8
Trigger	2-12
A Trigger Modes	2-15
B Trigger Modes	2-16
Rear Panel	2-20
Menu System, Hardcopy, and GPIB Controls and Indicators	2-21

	Page
SECTION 3—OPERATORS FAMILIARIZATION	
INTRODUCTION	3-1
BASIC OPERATION	3-1
Graticule	3-1
Readout Display	3-3
Connecting Input Signals	3-4
Grounding	3-4
Probes	3-4
Coaxial Cables	3-4
External Triggering	3-5
Auto Setup	3-5
Minimum Setup	3-5
Remote Control via the Communications Port	3-5
MENU SYSTEM OPERATION	3-6
Introduction	3-6
Clearing the Menu and Cursors Display	3-7
Setting Measurement Channel	3-7
Recalling the Last Measurement Mode	3-9
Channel 1 and Channel 2 Voltmeter	3-10
Voltmeter Measurements Page 1	3-11
Voltmeter Measurements Page 2, GATED Measurements	3-12
Cursor Volts Measurements	3-12
Time Menus	3-15
Counter/Timer	3-23
C/T Measurement Menu Page 1	3-24
Gated C/T Measurement Menu Page 2	3-25
C/T Control Menu	3-26
Conditions for Cursors Display	3-29
Measurement Cursors	3-29
Track Trig Lvl Cursors	3-29
Track <i>rh</i> Cursors	3-30
Behavior for Horizontal Mode Changes	3-30
Measurement Compatibility and Error Messages	3-31
Measurements in Single Sequence Mode	3-33

SECTION 3—OPERATORS FAMILIARIZATION (cont)

Service Menu Features	3-33
Configure Menu	3-34
Self Cal Measurements	3-37
Internal Settings Menu	3-38
Store/Recall Setup Features	3-39
Factory Stored Setups	3-40
Recall Only Menu	3-41
Store/Recall Setup Menu	3-43
Recovering A Deleted Setup	3-47
Storing Setups in Sequences	3-48
Waveform Digital Acquisition Modes	3-50

SECTION 4—OPERATOR CHECKS AND ADJUSTMENTS

Introduction	4-1
Initial Setup	4-1
Auto Setup Function	4-2
Trace Rotation Adjustment	4-3
Probe Low-Frequency Compensation	4-3
Vertical Deflection Check	4-5
Timing Checks	4-6

SECTION 5—BASIC APPLICATIONS

Introduction	5-1
CH 1/CH 2 Voltmeter Measurements	5-1
Peak Voltage Measurement	5-2
Gated Voltage Measurement	5-4
Voltage Measurement Cursors	5-6
Voltage Difference	5-6
Ground-Referenced Voltage	5-8

Page

SECTION 5—BASIC APPLICATIONS (cont)

Time Measurement Cursors	5-9
Time Difference	5-10
Propagation Delay <i>f</i>	5-10
Rise Time Measurements	5-11
Phase Measurements	5-11
Frequency and Period Measurements	5-14
Time Delay Measurement	5-14
Track Trigger Level Cursors	5-17
Setting Trigger Level	5-20
Use of the Add Mode	5-22
Hardcopy Output	5-25

SECTION 6—PERFORMANCE CHARACTERISTICS

Introduction	6-1
Recommended Calibration Schedule	6-1

SECTION 7—PERFORMANCE CHECK PROCEDURE

Introduction	7-1
Test Equipment Required	7-1
Performance Check Interval	7-1
Preparation	7-1
Index to Performance Check Procedure	7-6
DISPLAY	7-9
Trace Rotation	7-9
Geometry	7-10
VERTICAL	7-11
Input COUPLING Functional Check	7-11
CH 1 and CH 2 VOLTS/DIV Trace Shift	7-12
CH 3 and CH 4 VOLTS/DIV Trace Shift	7-13
CH 1 and CH 2 VAR VOLTS/DIV Trace Shift	7-13
CH 1 and CH 2 Input COUPLING Trace Shift	7-14
CH 2 INVERT Trace Shift	7-14

SECTION 7--PERFORMANCE CHECK PROCEDURE (cont)

VERTICAL (cont)

CH 1 and CH 2 VAR VOLTS/DIV Range	7-14
Low Frequency Linearity Check	7-15
CH 1 and CH 2 Vertical Deflection Accuracy	7-16
CH 3 and CH 4 Vertical Deflection Accuracy	7-17
ADD Mode and CH 2 INVERT Deflection Accuracy	7-18
Vertical POSITION Range (all channels)	7-19
CH 1 to CH 2 Signal Delay Match	7-20
CH 1 to CH 4 Signal Delay Match	7-21
CH 3 to CH 4 Signal Delay Match	7-22
Ch 1 and CH 2 Vertical Bandwidth	7-22
CH 3 and CH 4 Vertical Bandwidth	7-23
SCOPE BW (Bandwidth Limit) Accuracy	7-24
Common-mode Rejection Ratio	7-24
Channel Isolation	7-25
AC-Coupled Lower -3 dB Point	7-26
Vertical ALT and CHOP Modes	7-27
BEAM FIND Functional Check	7-27
A and B Trace Separation	7-28
TRIGGERING	7-29
500 Hz Trigger Sensitivity	7-29
500 kHz Trigger Sensitivity	7-30
25 MHz Trigger Sensitivity	7-31
150 MHz Trigger Sensitivity	7-32
Single Sweep Mode	7-34
Trigger LEVEL Control Range	7-34
TV Field Trigger Sensitivity	7-35
TV Line Trigger Sensitivity	7-36
Line Trigger Functional Check	7-36

Page

SECTION 7—PERFORMANCE CHECK PROCEDURE (cont)

HORIZONTAL	7-37
A and B Sweep Length	7-37
Horizontal POSITION Range	7-38
VAR SEC/DIV Range	7-38
Magnifier Registration	7-39
A and B Timing Accuracy and Linearity	7-39
A and B Magnified Timing Accuracy and Linearity	7-40
Delay Time Jitter	7-42
Delay Time Accuracy	7-43
Delay Time Position Range	7-44
X-Axis Gain Accuracy	7-45
X-Y Phase Difference	7-45
X-Axis Bandwidth	7-46
MEASUREMENT CURSORS	7-47
← SEC → and ← 1/SEC → Cursor Accuracy	7-47
← PHASE → Cursor Accuracy	7-48
← VOLTS → Cursor Accuracy	7-48
\overline{m} VOLTS → Cursor Accuracy	7-49
Tracking Cursors Position Accuracy	7-49
CH 1/CH 2 VOLTMETER	7-51
DC Volts Accuracy	7-51
DC Volts Normal Mode Rejection Ratio	7-52
+ Peak, -Peak, Peak-to-Peak Volts Accuracy	7-53
25 MHz + Peak, -Peak, and Peak-to-Peak Volts Accuracy	7-54
100 MHz + Peak, -Peak, and Peak-to-Peak Volts Accuracy	7-54
Gated Volts Accuracy	7-55
COUNTER/TIMER	7-56
Period	7-56
Width	7-57
Rise Time Accuracy	7-59

SECTION 7—PERFORMANCE CHECK PROCEDURE (cont)

EXTERNAL Z-AXIS AND PROBE ADJUST AND FRONT-PANEL SETUP FUNCTIONS	7-60
Check External Z-Axis Input	7-60
PROBE ADJUST Output	7-61
AUTO SETUP Functional Check	7-61
Run MAKE FACTORY SETTINGS Routine	7-62
OPTION 15	7-63
Signal Output	7-63
A GATE Output	7-64

SECTION 8—OPTIONS AND ACCESSORIES

Introduction	8-1
International Power Cords	8-1
Option 15	8-1
Option 1R Rackmounted Instrument	8-2
Other Available Options	8-2
Standard Accessories	8-3
Optional Accessories	8-3

APPENDIX A – AUTO AND FACTORY SETTINGS AND SETUPS**APPENDIX B – GPIB OPERATION**

LIST OF ILLUSTRATIONS

Figure	Page
1-1 The 2252 Oscilloscope	1-1
1-2 Optional power cords	1-5
2-1 CRT, power, and display controls	2-2
2-2 CH 1 and CH 2 vertical controls and indicators	2-4
2-3 Vertical connectors and CH 3 and CH 4 controls	2-7
2-4 Horizontal controls and indicators	2-9
2-5 Trigger controls and indicators	2-14
2-6 Rear panel	2-20
2-7 Menu controls	2-22
3-1 Graticule measurement markings	3-2
3-2 Readout display locations	3-3
3-3 Menu buttons	3-6
3-4 Typical Store/Recall Setup sequencing	3-39
4-1 Probe compensation	4-4
5-1 +PEAK voltage measurement and tracking cursors	5-4
5-2 Gated voltage measurement	5-6
5-3 Voltage difference measurement using cursors	5-7
5-4 Voltage measurement	5-9
5-5 Making a phase difference measurement	5-13
5-6 Time difference between the two delays	5-17
5-7 A and B Track Trig Lvl cursors	5-18
5-8 Setting a specific trigger level	5-21
5-9 Eliminating common-mode signals	5-24
6-1 Maximum input voltage versus frequency derating curve for the CH 1, CH 2, CH 3, and CH 4 input connectors	6-29
6-2 Dimensional drawing, standard cabinet	6-35
6-3 Dimensional drawing, rackmount cabinet (2240F1R)	6-36

LIST OF TABLES

Table	Page
2-1 VERT Trigger SOURCE	2-18
3-1 Behavior for Horizontal MODE Changes	3-31
5-1 Trigger Cursor Channel	5-20
6-1 Electrical Characteristics	6-2
6-2 Environmental Characteristics	6-28
6-3 Mechanical Characteristics	6-30
7-1 Test Equipment Required	7-3
7-2 Signal-to-Graticule Accuracy	7-16
7-3 Settings for Timing Accuracy Checks	7-41
7-4 Delay Time Accuracy	7-44
A-1 AUTO SETUP Control Settings	A-1
A-2 MIN SETUP Control Settings	A-5
A-3 Factory Settings	A-6

OPERATORS SAFETY SUMMARY

The safety information in this summary is for operating personnel. Warnings and cautions will also be found throughout the manual where they apply.

Terms in This Manual

CAUTION statements identify conditions or practices that could result in damage to the equipment or other property.

WARNING statements identify conditions or practices that could result in personal injury or loss of life.

Terms as Marked on Equipment

CAUTION indicates a personal injury hazard not immediately accessible as one reads the markings, or a hazard to property, including the equipment itself.

DANGER indicates a personal injury hazard immediately accessible as one reads the marking.

Symbols in This Manual



This symbol indicates where applicable cautionary or other information is to be found. For maximum input voltage see Table 6-1.

Symbols as Marked on Equipment



DANGER— High voltage.



Protective ground (earth) terminal.



ATTENTION— Refer to manual.

Power Source

This product is intended to operate from a power source that does not apply more than 250 V rms between the supply conductors or between either supply conductor and ground. A protective ground connection, by way of the grounding conductor in the power cord, is essential for safe operation.

Grounding the Product

This product is grounded through the grounding conductor of the power cord. To avoid electrical shock, plug the power cord into a properly wired receptacle before making any connections to the product input or output terminals. A protective ground connection, by way of the grounding conductor in the power cord, is essential for safe operation.

Danger Arising From Loss of Ground

Upon loss of the protective-ground connection, all accessible conductive parts, including knobs and controls that may appear to be insulating, can render an electric shock.

Use the Proper Power Cord

Use only the power cord and connector specified for your product.

The power cord must be in good condition.

Read Section 1 for power-cord and connector information.

Use the Proper Fuse

To avoid fire hazard, use only a fuse of the correct type, voltage rating and current rating as specified on the back of your product and in Table 6-1.

Do Not Operate in an Explosive Atmosphere

To avoid explosion, do not operate this product in an explosive atmosphere.

Do Not Remove Covers or Panels

To avoid personal injury, do not remove the product covers or panels. Do not operate the product without the covers and panels properly installed.

SECTION 1

INTRODUCTION

2252 Operators

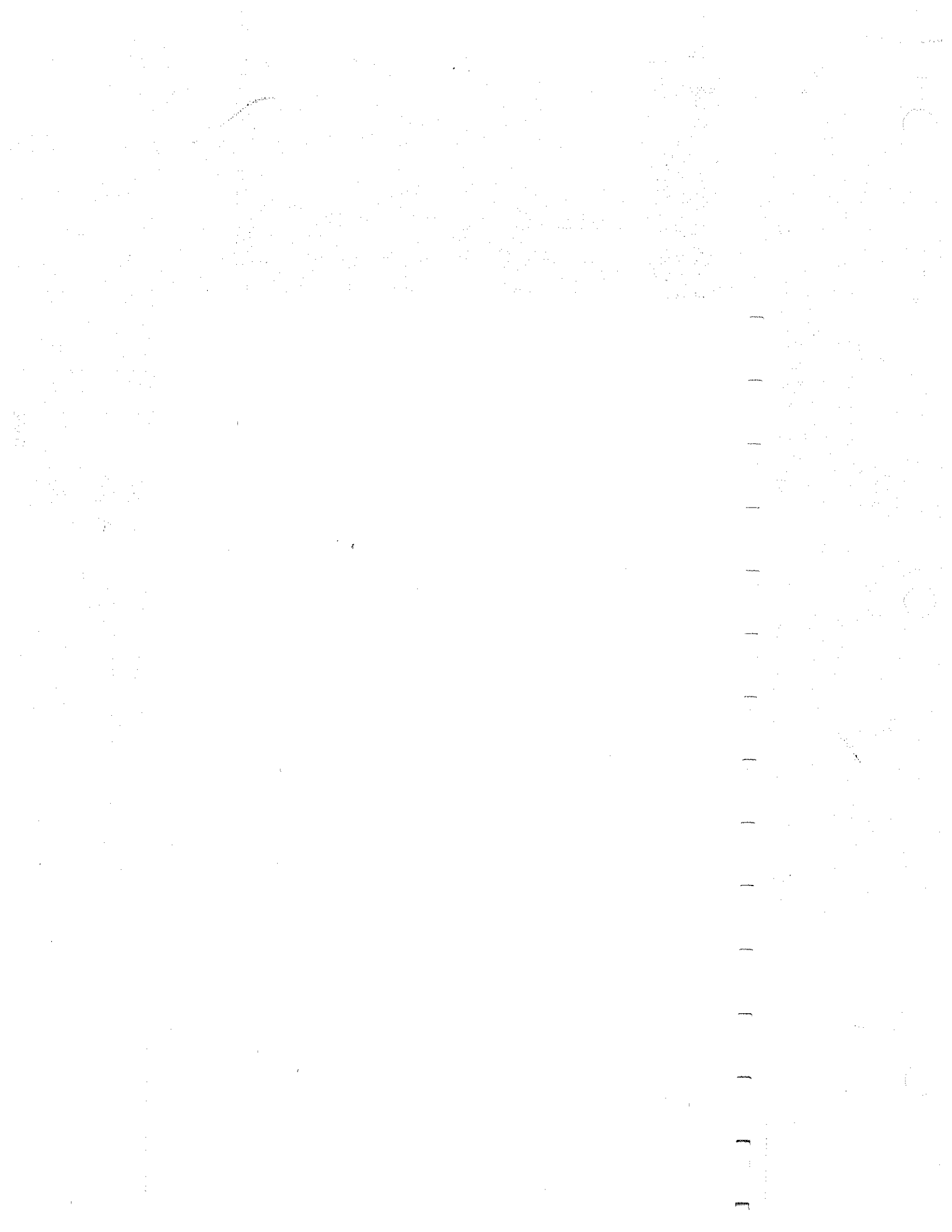

PRODUCT OVERVIEW

Description

The 2252 is a 100 MHz, four-channel, dual-sweep portable oscilloscope for general-purpose use (Figure 1-1). A microprocessor-based operating system controls most of the functions in the instrument, including a fully integrated menu-driven voltage and time measurement system with SmartCursors™. A counter/timer (C/T) is integrated into the trigger system to provide many automated counting and timing measurements with high accuracy. Other features include single-button automatic front-panel setup and a menu-driven store/recall setup function. A menu-driven service mode provides for configuring of certain menu and readout displays, internal calibration, and servicing diagnostics. The instrument provides a hardcopy output of the displayed waveform. The instrument is equipped with a General Purpose Interface Bus (GPIB) that allows it to be operated by the programming of the controller.

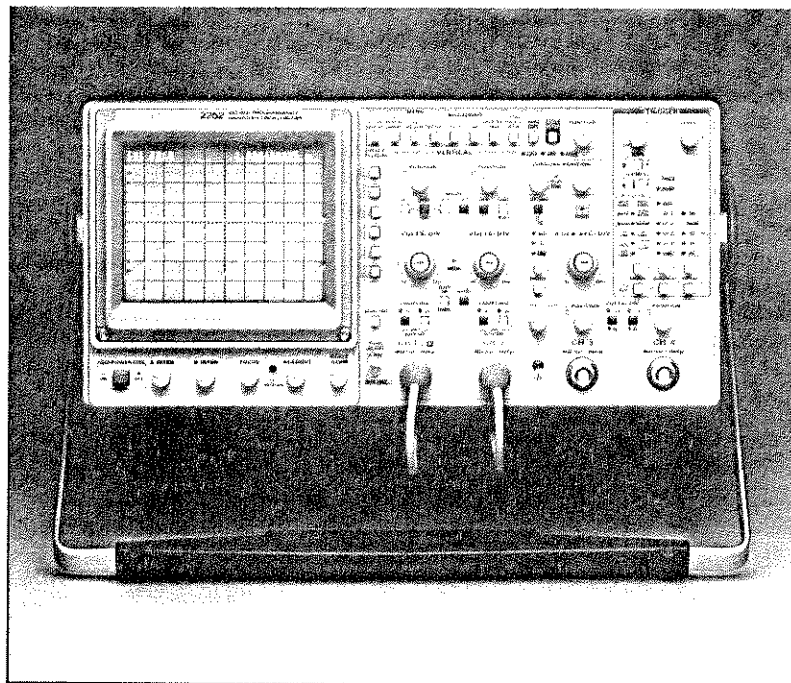

7837-01

Figure 1-1. The 2252 Oscilloscope.

Introduction

The vertical deflection system has four input channels. Two channels have 11 basic deflection factors from 2 mV to 5 V per division, and two channels have two basic deflection factors of 0.1 V and 0.5 V per division. Basic deflection factors can be extended with attenuator probes. VOLTS/DIV readouts are switched to display the correct vertical scale factors when properly coded probes are connected to the vertical input connectors.

The horizontal deflection system provides single, dual, or delayed sweeps from 0.5 s to 20 ns per division (delayed sweep, 5 ms to 20 ns per division). The trigger system provides stable triggering over the full bandwidth of the vertical deflection system.

Alphanumeric crt readouts of the vertical and horizontal scale factors are displayed at the bottom of the screen. On-screen vertical and horizontal cursors provide accurate voltage, time, frequency, and phase measurements; measurement values are displayed at the top of the crt.

Measurement features include voltage, time, frequency, and phase, counter/timer measurements, and risetime/falltime or propagation delay. Voltage measurements include positive peak, negative peak, peak-to-peak, and average dc levels, measured over the entire display or a selected portion (gated measurements).

Counter/timer measurements include frequency, period, width, totalize, frequency ratio, gated frequency, gated period, gated width, gated events, delta time, one-over-delta time, phase, rise/fall time, and propagation delay, using an internal or external frequency standard. Counter/timer measurements can be averaged to increase the number of displayed digits, and measurement trigger points can be indicated with cursors on screen.

Positionable cursors allow absolute voltage, voltage difference, time difference, frequency, and phase measurements. SmartCursors[®] visually track voltage measurements, trigger levels and ground and may be selectively displayed with the waveforms. Time, frequency, and phase measurements referenced to the trigger event or between two user-selected events are available in ALT and B horizontal modes.

By pressing a single button (AUTO SETUP), the front-panel controls can be set up to produce a usable waveform display based on the voltage and time characteristics of the input signals.

The Store/Recall system lets you store and recall up to 20 different front-panel setups. Stored setups can be arranged in sequences as required for specific applications.

The 2252 has a digitizing system capable of converting the A sweep waveform to digital data. The digitized waveform data can then be sent to an external EPSON™ FX-Series compatible printer for hard copies of the waveform or to a host computer via the communications interface for mass data storage and/or waveform analysis. When used with a host computer or system controller, the front panel settings and measurement features of the instrument are all remotely controllable. The externally controllable front panel coupled with the ability to digitize and output the displayed waveform and all measurement results, makes the 2252 a versatile instrument for use in remote automatic testing and production line environments.

The hardcopy feature allows the instrument to output as many as five A sweep displays (CH 1, ADD channels 1 and 2, CH 2, CH 3, and CH 4) to an attached printer via a Centronics interface.

The instrument GPIB meets the standard IEEE 488.2-1987. The GPIB allows the front-panel controls and menus to be operated under control of the programming of the controller. All the front panel controls and menus are accessible via the communications port connector. Digitized waveforms and measurement results can be gathered by the remote controller for long term data collection and/or analysis using system programming.

Standard Accessories

The following items are standard accessories shipped with the 2252 instrument:

- 2 Probes, 10X, 1.5 meter, with accessories
- 1 Power cord
- 1 Power cord clamp
- 1 Operators manual
- 1 Reference guide
- 1 CRT filter, blue plastic (installed)
- 1 Fuse, 2A, 250 V, slow-blow
- 1 Accessory pouch, ziploc
- 1 Instrument Interface Guide

See Section 8 "Options and Accessories" for part numbers and further information about standard accessories and a list of the recommended optional accessories. For more information on accessories and ordering assistance, contact your Tektronix representative or local Tektronix Field Office.

™ EPSON is a trademark of Epson Corporation.

PREPARATION FOR USE

Safety

Refer to the Operators Safety Summary at the front of this manual for power source, grounding, and other safety information about the use of the instrument. Before connecting the 2252 to a power source, read this section and the Safety Summary.

Line Fuse





This instrument can be damaged if the wrong line fuse is installed.

Verify the proper value of the power-input fuse with the following procedure.

1. Press in the fuse-holder cap and release it with a slight counterclockwise rotation.
2. Pull the cap (with the attached fuse inside) out of the fuse holder.
3. Verify proper fuse value.
4. Install the proper fuse and reinstall the fuse-holder cap.

Line Voltage and Power Cord

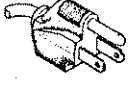
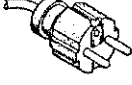
The 2252 operates on line voltages from 90 to 250 V with line frequencies ranging from 48 to 440 Hz. No line voltage selecting is necessary. Instruments are shipped with the power cord that was requested on the order. The power cord must match the power-source outlet; if it does not, contact your Tektronix representative or local Tektronix Field Office. See Figure 1-2 for optional power cords available.

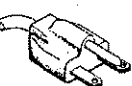
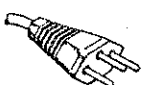
Plug Configuration	Option	Power Cord/ Plug Type	Line Voltage	Reference Standards ^b
	U.S. Std.	U.S. 120V	120V	ANSI C73.11 NEMA 5-15-P IEC 83 UL 198.6
	A1	EURO 220V	220V	CEE(7), II, IV, VII IEC 83 IEC 127
	A2	UK ^a 240V	240V	BS 1363 IEC 83 IEC 127
	A3	Australian 240V	240V	AS C112 IEC 127
	A4	North American 240V	240V	ANSI C73.20 NEMA 6-15-P IEC 83 UL 198.6
	A5	Switzerland 220V	220V	SEV IEC 127
<p>aA 6A, type C fuse is also installed inside the plug of the Option A2 power cord. ^bReference Standards Abbreviations: ANSI – American National Standards Institute AS – Standards Association of Australia BS – British Standards Institution CEE – International Commission on Rules for the Approval of Electrical Equipment IEC – International Electrotechnical Commission NEMA – National Electrical Manufacturer's Association SEV – Schweizerischer Elektrotechnischer Verein UL – Underwriters Laboratories Inc.</p>				

7837-02

Figure 1-2. Optional power cords.

Introduction

The detachable three-wire power cord has a three-contact plug for connection to the power source and the protective ground. The power cord is held to the rear panel by a clamp. The protective ground contact on the plug connects (through the power cord protective-ground conductor) to the accessible metal parts of the instrument.

WARNING

For electrical-shock protection, insert this plug into a power-source outlet that has a properly grounded protective-ground contact.

Instrument Cooling

To prevent instrument damage from overheated components, make sure the internal airflow is not blocked. Before turning on the power, check that the ventilation holes on the bottom and side of the cabinet are not covered.

Start-up

At power on, the instrument does a self-diagnostic check. If the instrument does not turn on and operate normally, turn power off then on again. If the instrument still does not turn on properly, refer the instrument to a qualified service person. TRIGGER MODE LEDs may be flashing to indicate the circuit location of a start-up error; you should report this information to the service person.

When the instrument is turned on, a self-cal routine may run to set the voltage- and timing-measurement constants. The power-on self cal runs only if the stored constants have been lost, possibly due to a dead memory back-up battery. The following warning message will be displayed for 5 seconds: "WARNING PROBABLE BATTERY FAILURE TURN OFF AND ON TO VERIFY". If the message reappears after having turned the power off and on, have the battery checked and/or replaced by a qualified service person. The instrument can still be used for accurate measurements by running the SELF CAL MEASUREMENTS routine from the SERVICE MENU after the instrument has warmed up for at least 20 minutes.

To run the SELF CAL MEASUREMENTS routine, press the top and bottom menu-item select buttons. Press down-arrow button to underline SELF CAL

MEASUREMENTS. Press RUN to start the routine, then QUIT or CLEAR DISPLAY to return to the normal oscilloscope mode.

Repackaging for Shipment

Save the original shipping carton and packing material in case it is ever necessary to reship the instrument by a commercial transport carrier. If the original materials are unfit or not available, then repack the instrument using the following procedure.

1. Use a corrugated cardboard shipping carton with a test strength of at least 275 pounds and an inside dimension at least six inches greater than the instrument dimensions.
2. If instrument is being shipped to a Tektronix Service Center, enclose the following information: owner's address, name and phone number of a contact person, type and serial number of the instrument, reason for returning, and a complete description of the service required.
3. Completely wrap the instrument with polyethylene sheeting or equivalent to protect the outside finish and keep harmful substances out of the instrument.
4. Cushion instrument on all sides with three inches of padding material or urethane foam, tightly packed between the carton and the instrument.
5. Seal the shipping carton with an industrial stapler or strapping tape.
6. Mark the address of the Tektronix Service Center and your own return address on the shipping carton.

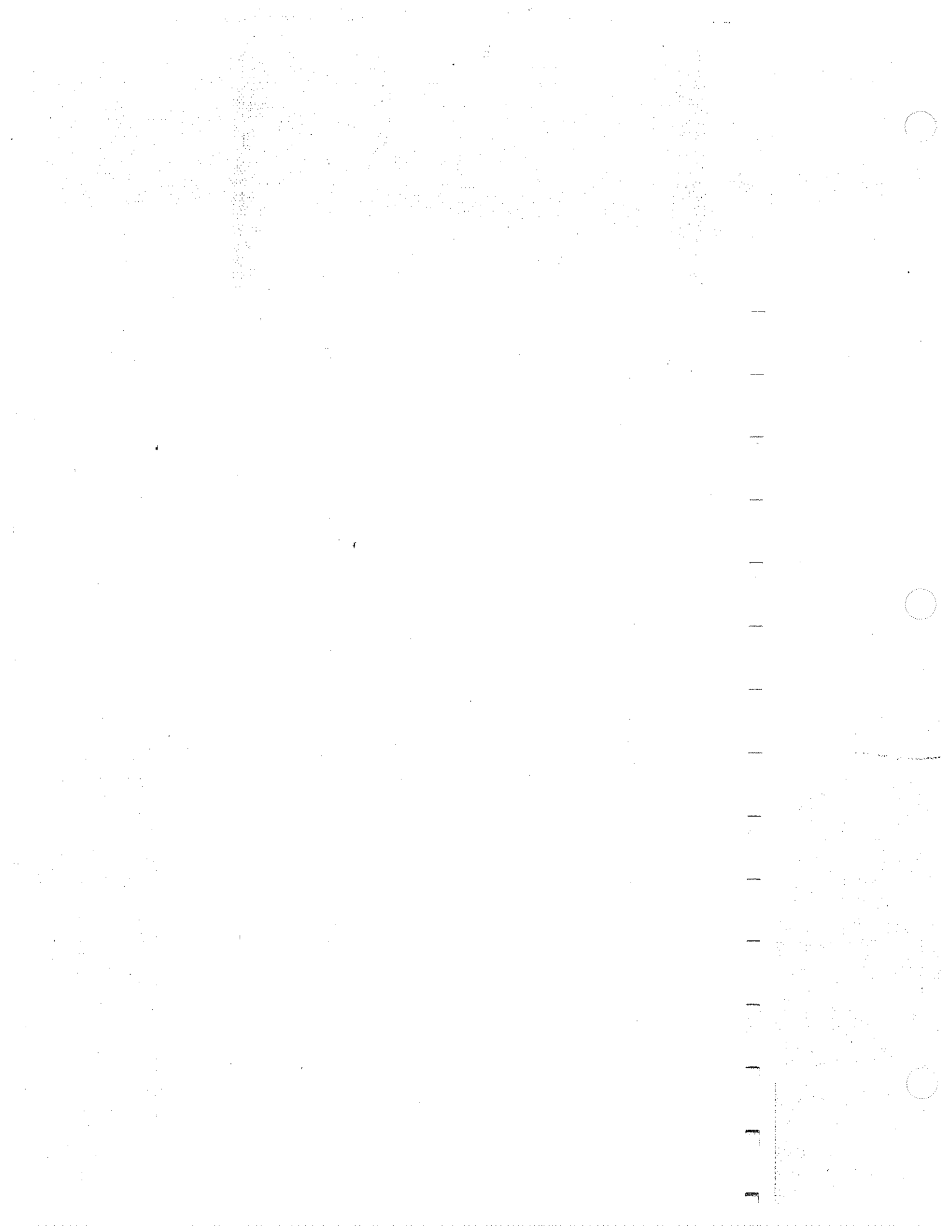

SECTION 2

**CONTROLS,
CONNECTORS,
AND INDICATORS**

2252 Operators

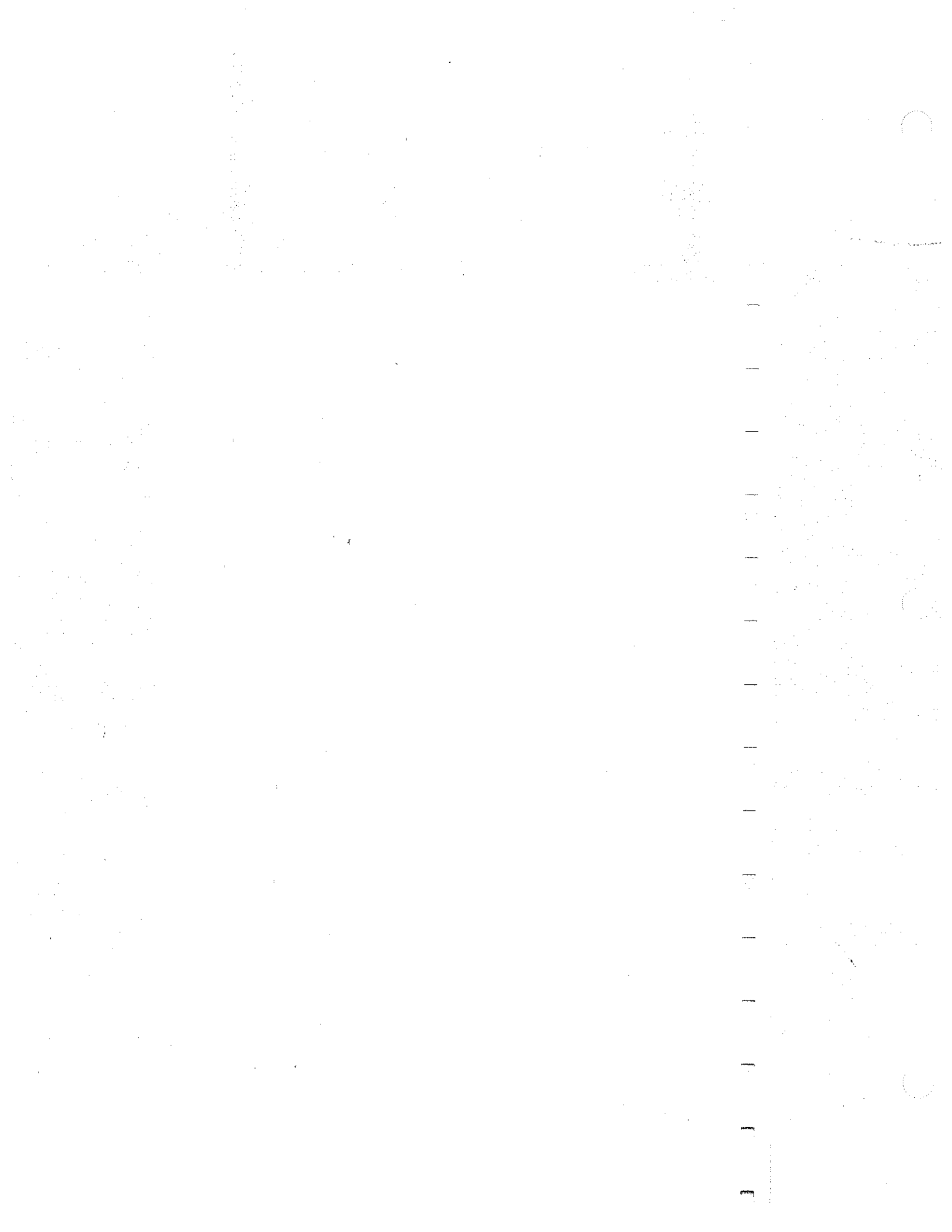

CRT, Power, and Display

Refer to Figure 2-1 for location of items 1 through 9.

- ① **POWER Switch**—Turns on or off instrument power. Press for ON or OFF.

At least one Vertical MODE button will light when the power is turned on. The front-panel setup existing when the power is turned off will return when the power is turned on again.

- ② **A INTEN Control**—Adjusts the brightness of the A trace.

- ③ **B INTEN Control**—Adjusts the brightness of the B Delayed sweep trace and the intensified zone on the A trace.

- ④ **FOCUS Control**—Adjusts the focus of the crt displays (traces, readout, and cursors).

- ⑤ **TRACE ROTATION Control**—Aligns the crt trace with the horizontal graticule lines. This is a screwdriver adjustment.

- ⑥ **READOUT Control**—Adjusts the brightness of the crt readout display (includes all alphanumeric and cursors).

- ⑦ **SCALE ILLUM Control**—Adjusts the illumination level of the graticule.

NOTE

Life of the graticule illumination lamps can be increased by setting the SCALE ILLUM control for the minimum intensity needed for viewing, and turning off scale illumination when not needed.

- ⑧ **BEAM FIND Button**—Locates off-screen and overscanned displays when the button is held in. Limits the vertical and horizontal deflection within the display area and unblanks the crt.

Controls, Connectors, and Indicators

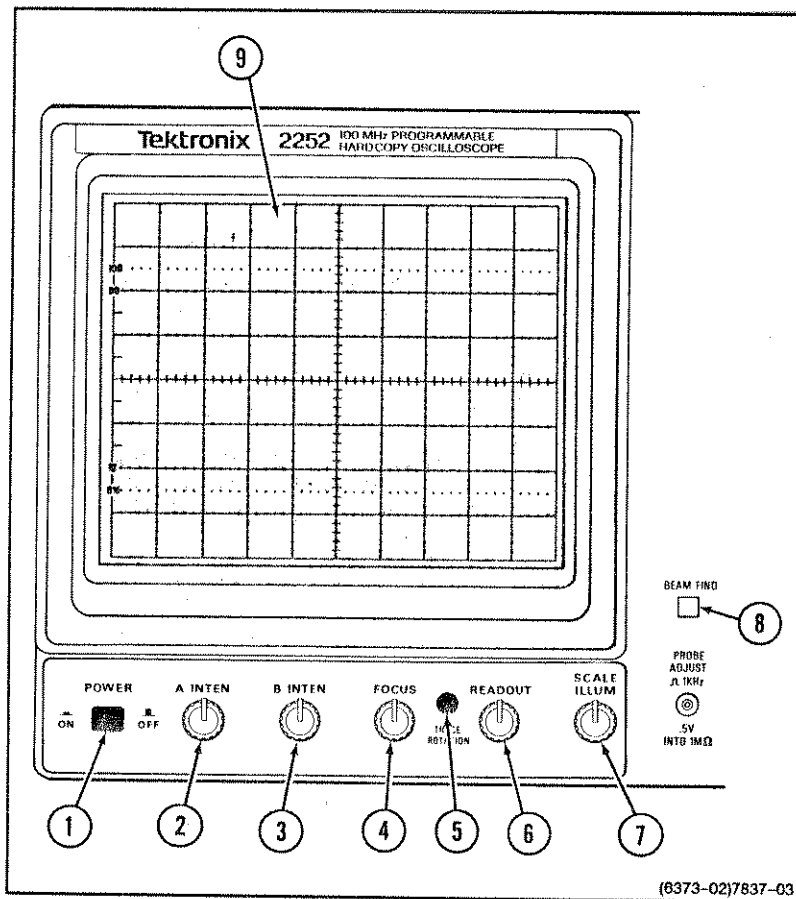

Figure 2-1. CRT, power, and display controls.

- 9 CRT—Displays waveforms and readouts in an 80 mm vertical by 100 mm horizontal graticule area.

Internal graticule lines provide parallax-free viewing of trace and graticule lines. 0%, 10%, 90% and 100% points marked at the left edge of the graticule aid in making rise- and fall-time measurements.

Vertical

Refer to Figure 2-2 for location of items 10 through 17.

- ⑩ **CH 1 and CH 2 POSITION Controls**—Adjust vertical position of the Channel 1 and Channel 2 waveform displays.
- ⑪ **MODE Buttons**—Select the vertical channels for display (CH 1, ADD channels 1 and 2, CH 2, CH 3, and CH 4). The CHOP/ALT MODE button selects method for switching input channels on the display (chopped or alternating).

Except for CHOP/ALT modes, pressing an unlit mode button turns on the mode, and pressing a lit button turns off the mode. CHOP is selected when the CHOP/ALT button is lit; ALT is selected when the button is not lit.

CH 1, CH 2, CH 3, and CH 4—Select vertical channels for display. At least one of the channels or ADD is always on and cannot be turned off until another channel is first turned on.

CHOP/ALT—In the CHOP mode the display chops between selected input channels at a rate of about 625 kHz. In the ALT mode, the selected channels are displayed in sequence (alternating at the end of each sweep).

ADD—Displays the algebraic sum of the Channel 1 and Channel 2 input signals. The ADD display is in addition to any other selected channel displays. In the ADD mode, a plus sign (+) is displayed between the Channel 1 and Channel 2 VOLTS/DIV readouts.

NOTE

In ADD mode when AUTO LEVEL TRIGGER MODE or CHOP Vertical MODE is selected, the algebraic sum of Channel 1 and Channel 2 displays provides the internal signal source for the trigger system when the trigger source is VERT.

Controls, Connectors, and Indicators

- 12 Channel 1 and Channel 2 VOLTS/DIV Switches—Select calibrated deflection factors for Channel 1 and Channel 2 from 2 mV per division to 5 V per division in a 1-2-5 sequence of 11 steps.

The switches are detented, continuous-rotation controls with no end stops. The VOLTS/DIV readouts reflect attenuation factors of coded attenuator probes connected to the vertical inputs.

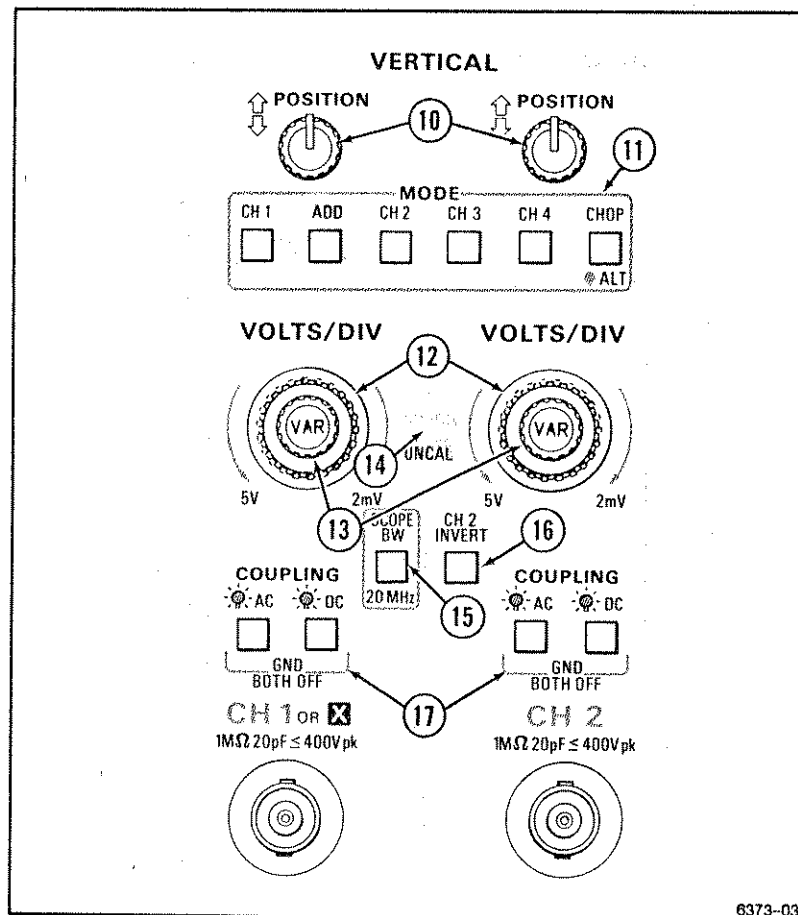

Figure 2-2. CH 1 and CH 2 vertical controls and indicators.

- ⑬ **CH 1 AND CH 2 VOLTS/DIV VAR Controls**—Allows the CH 1 and CH 2 vertical deflection factors to be increased up to at least 2.5 times.

Vertical deflection factors are greater than the VOLTS/DIV switch setting when the UNCAL indicator is lit and a greater-than symbol (>) is displayed to the left of the associated VOLTS/DIV readout.

NOTE

Normally the VOLTS/DIV settings are calibrated when the VAR control is in the fully clockwise (detent) position. However, if a front-panel setup had been recalled from the Store/Recall Setup memory, it is possible for the VOLTS/DIV settings to be calibrated or uncalibrated with the VOLT/DIV VAR control in any position. When the controls are rotated, normal variable operation returns.

- ⑭ **UNCAL Indicator**—Lights when either CH 1 or CH 2 VOLTS/DIV settings are uncalibrated (variable function in effect).

- ⑮ **SCOPE BW Button**—Reduces the bandwidth of the vertical deflection system and trigger system to 20 MHz when the button is lit. The full bandwidth is available when the SCOPE BW button is not lit.

- ⑯ **CH 2 INVERT Button**—Inverts the Channel 2 input signal when the INVERT button is lit.

The Channel 2 input signal in ADD mode and the Channel 2 trigger signal pickoff are also inverted. A down-arrow symbol is displayed between the Channel 1 and Channel 2 VOLTS/DIV readout when the INVERT mode is on.

- ⑰ **COUPLING Buttons**—Select the method of coupling input signals to the Channel 1 and Channel 2 attenuators.

GND—Disconnects the input signal and grounds the input of the associated vertical attenuator to provide a zero (ground) reference voltage display.

The COUPLING switch is in the ground position when the AC and the DC buttons are not lit. A ground symbol (\perp) is displayed to the right of

Controls, Connectors, and Indicators

the associated VOLTS/DIV readout. The ground symbol is also displayed after the value readout of any of the VOLTMETER measurements.

AC—Capacitively couples the input signal to the vertical attenuator when the AC button is lit.

Turning on AC Coupling turns off DC Coupling. AC Coupling blocks the dc component of the input signal. The lower -3 dB frequency limit is 10 Hz or less when using either a 1X probe or properly terminated coaxial cable; it is 1 Hz or less using a compensated 10X probe. With AC Coupling selected, an AC symbol (\sim) is displayed to the right of the associated VOLTS/DIV readout. An AC symbol is also displayed after the value readout of any Peak or Peak-to-Peak voltage measurement.

NOTE

When AC Coupling is selected for DC voltmeter measurements an error message "SELECT DC COUPLING" is displayed.

DC—Couples dc and all frequency components of the input signal to the vertical attenuator when the DC button is lit.

Turning on DC coupling turns off AC coupling. With DC Coupling selected, a DC symbol (---) is displayed to the right of the associated VOLTS/DIV readout. Input resistance is 1 M Ω to ground.

Refer to Figure 2-3 for location of items 18 through 23.

- ⑱ **CH 1 OR X and CH 2 Input Connectors**—Connect signals to the inputs of Channel 1 and Channel 2 vertical attenuators.

Input connectors are BNC type with an outer contact ring for recognizing attenuation factors of coded attenuator probes. A signal connected to the CH 1 OR X input connector produces the horizontal deflection (X-Axis) in the X-Y horizontal mode. Any of the vertical signal channels or ADD can provide vertical deflection (Y-Axis) for an X-Y display.

- ⑲ **PROBE ADJUST Connector**—Outputs a 0.5 V square-wave signal (at about 1 kHz into a 1 M Ω load) for compensating voltage probes and checking the vertical deflection accuracy.

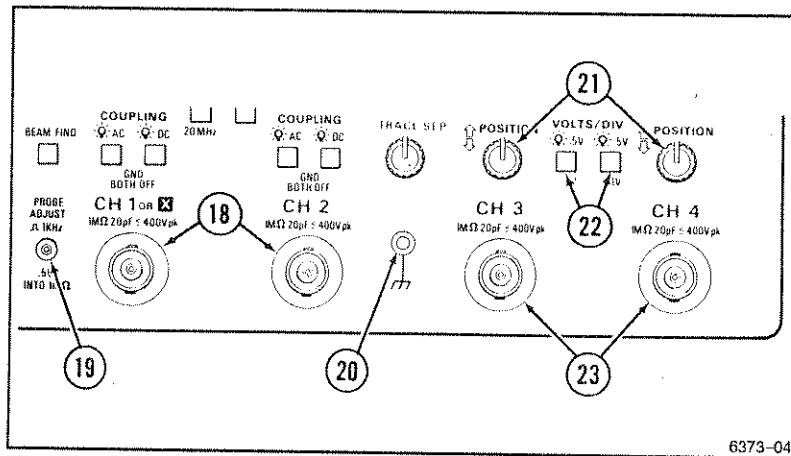

Figure 2-3. Vertical connectors and CH 3 and CH 4 controls.

- 20 **Auxiliary Ground Jack**—Provides an auxiliary chassis ground connection (banana jack) between the equipment under test and the 2252.
- 21 **Channel 3 and Channel 4 POSITION Controls**—Adjust vertical position of Channel 3 and Channel 4 signal displays.
- 22 **Channel 3 and Channel 4 VOLTS/DIV Switches**—Select two basic deflection factors for Channel 3 and Channel 4, 0.5 volt/division (button lit) or 0.1 volt/division (button not lit).

The VOLTS/DIV switch setting displayed in the crt readout reflects the attenuation factor of coded attenuator probes that are connected to the vertical inputs.

- 23 **CH 3 and CH 4 Input Connectors**—Connect signals to the inputs of the Channel 3 and Channel 4 vertical attenuators. Input coupling is dc only.

The input connectors are BNC with probe-coding ring contacts (the same as Channel 1 and Channel 2). The limited choice of deflection factors for the Channel 3 and Channel 4 inputs makes them useful for digital and trigger signals.

Horizontal

Refer to Figure 2-4 for location of items 24 through 31.

- (24) **POSITION Control**—Adjusts the horizontal position of the waveform displays on the crt.
- (25) **X10 MAG Switch**—Magnifies the A and B sweeps by a factor of 10 and extends the fastest sweep speed to 2 ns per division. The center portion of an unmagnified sweep display will be within 0.5 division of the center of a magnified sweep display. No action occurs in X-Y mode.

When X10 MAG is on, a X10 symbol is displayed next to the SEC/DIV readouts. The readouts reflect correct display sweep speeds for the X10 MAG displays and the unmagnified displays.

- (26) **MODE Buttons (Up-Arrow and Down-Arrow) and Indicators**—Select the operating mode of the horizontal deflection system. Pressing the Up-/Down-Arrow buttons selects the horizontal deflection mode as shown by the MODE lights. Not all Menu Measurement modes are compatible with all horizontal deflection modes. See Table 3-1, Behavior for Horizontal MODE Changes, in Section 3.

A—Selects A sweep horizontal deflection. The A sweep speed is determined by the A SEC/DIV switch setting as displayed in the crt readout. Whenever A MODE is selected, the A/B SELECT switch is set to A Trigger.

ALT—Alternates between A sweep (with an intensified zone representing B sweep) and B delayed sweep. Both A and B SEC/DIV switch settings are displayed in the crt readout, but only the B can be adjusted. Whenever ALT MODE is selected, the A/B SELECT switch is set to B Trigger.

The B sweep speed cannot be set slower than the A sweep speed; attempting to do so forces the A sweep speed to follow the B sweep speed. To increase the A sweep speed in the ALT MODE, set the Horizontal MODE to A, adjust the SEC/DIV switch to a faster A sweep setting, and reset the Horizontal MODE switch to ALT. The B sweep speed and the length of the intensified zone are determined by the B SEC/DIV switch setting.

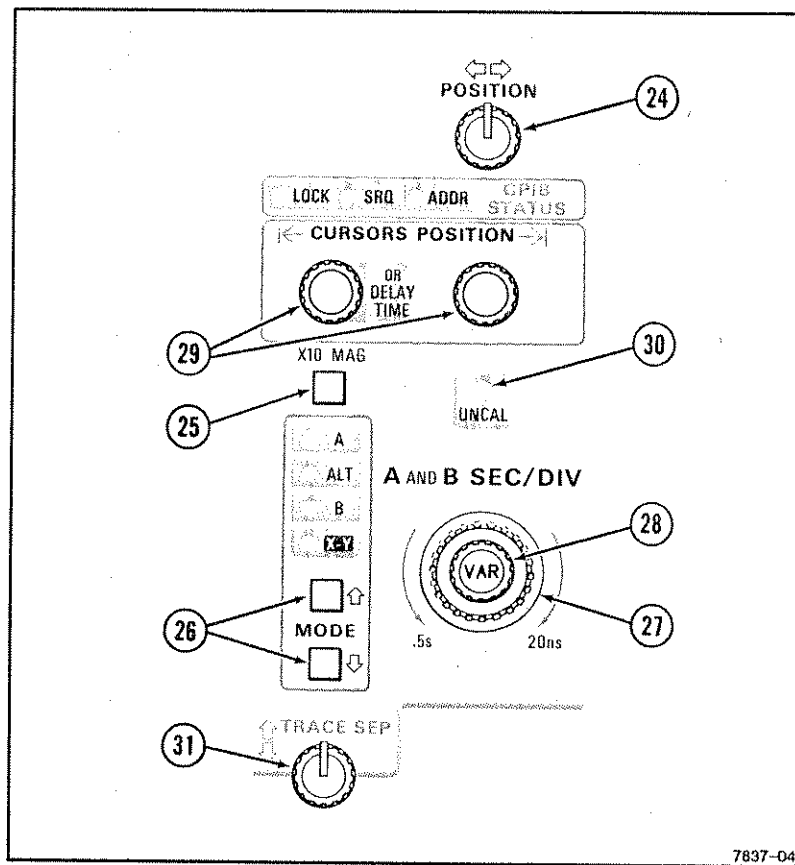

Figure 2-4. Horizontal controls and indicators.

B—Select B sweep horizontal deflection. The B sweep speed is determined by the B SEC/DIV switch setting as displayed in the crt readout. Whenever B MODE is selected, the A/B SELECT switch is set to B Trigger.

The start of the B sweep in RUNS AFTER mode (or the arming of the B Trigger in any triggered mode) is delayed from the start of the A sweep by a time determined by the setting of the ← OR DELAY TIME control. The B SEC/DIV switch setting and the Delay Time Position setting are

displayed in the crt readout. A greater-than sign (>) is displayed in front of the Delay Time readout if the B Trigger MODE is not RUNS AFTER.

X-Y—The signal applied to CH 1 OR X input connector produces the horizontal (X-Axis) deflection. Signals applied to any vertical input connector or ADD may be selected to provide the vertical deflection (Y-Axis).

The X-Y displays are horizontally positioned by the Horizontal POSITION control and vertically positioned by the associated vertical channel POSITION control.

- (27) **A AND B SEC/DIV Switch**—Selects the horizontal deflection rate (sweep speed) for both the A sweep and the B sweep in a 1-2-5 sequence. Calibrated sweep speeds are obtained with the A and B SEC/DIV VAR control in the detent (fully clockwise) position. The A SEC/DIV switch setting is set only from the A Horizontal MODE and the B SEC/DIV switch is set only from the ALT or B Horizontal MODE.

NOTE

The B sweep speed can never be slower than the A sweep speed. When the two sweep speeds are the same, they are "locked." At this point A will follow B to slower SEC/DIV settings (in ALT or B) and B will follow A to faster settings (in A).

A SEC/DIV—The calibrated A sweep speed is selected only in A Horizontal MODE from 0.5 s per division to 20 ns per division (X10 MAG off).

B SEC/DIV—The calibrated B sweep speed is selected either in ALT or B Horizontal MODE from 5 ms per division to 20 ns per division (X10 MAG off).

- (28) **A and B SEC/DIV VAR Control**—Provides continuously variable, uncalibrated A and B sweep speeds to at least 2.5 times slower than the calibrated SEC/DIV setting.

The VAR control extends the slowest A sweep speed to at least 1.25 sec per division. The UNCAL indicator is lit and a greater-than sign (>) is displayed before each SEC/DIV readout value when the sweep speeds are greater than the SEC/DIV settings.

NOTE

Normally the SEC/DIV settings are calibrated when the VAR control is in the fully clockwise (detent) position. However, if a front-panel setup had been recalled from the Store/Recall Setup memory, it is possible for the SEC/DIV settings to be calibrated or uncalibrated with the SEC/DIV VAR control in any position. When the controls are rotated, normal variable operation returns.

- ② **CURSORS POSITION Controls**—Sets the reference and delta cursors on the display.

NOTE

The reference and delta cursors will only track together as long as the reference delay plus the delta delay is less than 10 times the A SEC/DIV setting (10 horizontal graticule divisions). The cursors cannot be positioned left of the 1st or right of the 11th vertical graticule lines.

← **OR DELAY TIME**—This control has the following functions:

1. Positions the reference and delta cursors together in a cursor measurement mode. (Volts measurement in A, ALT, B, or X-Y Horizontal MODES; TIME measurement in A or B Horizontal MODES.)
2. Positions the reference and delta delays together in the TIME measurement modes in the ALT or B Horizontal MODE.
3. Sets the B sweep delay time in the ALT or B Horizontal Mode in DELAY measurement mode.
4. Positions the intensified zone for GATED VOLTMETER and GATED C/T measurements.
5. Selects the character to be altered in the ALTER LABEL menu of Store/Recall.

→ —This control has the following functions:

1. Positions the delta cursor in the cursor measurement mode.
2. Sets the B sweep delta delay in TIME measurement mode when in the ALT or B Horizontal MODES.

Controls, Connectors, and Indicators

3. Sets the width of the intensified zone for GATED VOLTMETER and GATED C/T measurements.
4. Changes the setup number or characters in Store/Recall.

NOTE

The reference and delta cursors will only track together as long as the reference delay plus the delta delay is less than 10 times the A SEC/DIV setting (10 horizontal graticule divisions). Cursors cannot be positioned left of the 1st or right of the 11th vertical graticule lines.

- 30 **UNCAL Indicator**—Lights when the A AND B SEC/DIV settings are uncalibrated (variable function in effect).
- 31 **TRACE SEP Control**—Positions the B sweep trace vertically with respect to the A sweep trace when ALT Horizontal MODE is selected.

Trigger

Refer to Figure 2-5 for location of items 32 through 38.

- 32 **A/B SELECT Button**—Directs the MODE, SOURCE, CPLG, SLOPE, and LEVEL controls and Trigger lights (TRIG'D and READY) to either the A or B Trigger system (A, when lit; B, when not lit).

Either A or B trigger can be selected for any Horizontal MODE; however, A/B SELECT is preset to A when A Horizontal MODE is selected, and B when ALT or B Horizontal MODE is selected. No change occurs when switching from B to X-Y Horizontal MODE.

For dual-channel C/T measurements, this button cycles through three trigger sources: A, B source 1, and B source 2. The button is lit when A is selected and unlit for either B source. If no menu is being displayed, the second-from-top readout line will show which of the three trigger sources is selected, along with slope, as shown below:

FREQ RATIO

A source: TRIG SELECT: A SLOPE: ↑
 B source 1: TRIG SELECT: B chx SLOPE: ↑
 B source 2: TRIG SELECT: B chy SLOPE: ↑

Chx is the numerator channel, and chy is the denominator channel (CH 1, CH 2, CH 3, CH 4, or ADD may be selected for either channel). ↑ is an up-arrow if positive trigger slope or a down-arrow if negative trigger slope.

← SEC →, ← 1/SEC →, ← PHASE →
 (when run in ALT or B horizontal mode)

A source: TRIG SELECT: A SLOPE: ↑
 B source 1: TRIG SELECT: B SLOPE: ↑
 B source 2: TRIG SELECT: B D SLOPE: ↑

PROP DELAY

A source: TRIG SELECT: A SLOPE: ↑
 B source 1: TRIG SELECT: B START SLOPE: ↑
 B source 2: TRIG SELECT: B STOP SLOPE: ↑

- ③ **SLOPE Button**—Selects the slope (positive- or negative-going) of the trigger source signal that triggers either the A sweep, the B sweep, or the C/T. (Button lit = positive-going; button not lit = negative-going.)
- ④ **HOLDOFF Control**—Varies holdoff time between the end of one A sweep and the start of the next A sweep.
- The HOLDOFF control can increase the minimum holdoff time by at least 10 times. Adjusting this control can improve triggering stability of aperiodic signals (i.e., complex digital waveforms).
- ⑤ **LEVEL Control**—Sets the amplitude level on the trigger signal at which either the A sweep, the B sweep, or the C/T is triggered. When a sweep is triggered, the TRIG'D indicator is lit. During C/T measurements, the TRIG'D indicator is unlit for B trigger.

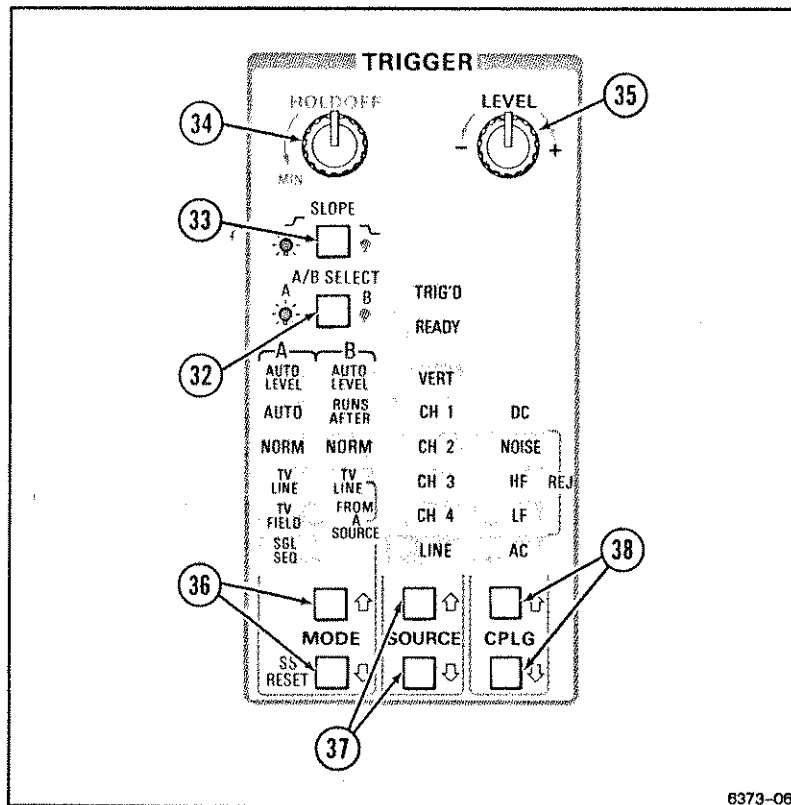

Figure 2-5. Trigger controls and indicators.

Adjusting the LEVEL control fully counterclockwise in AUTO LEVEL Trigger MODE causes the trigger to reacquire and sets the trigger level to the 10% point of the trigger signal; adjusting to the clockwise stop will cause a reacquisition to the 90% level. In either case, the limits of the Trigger LEVEL control will be the 10% and 90% levels of the trigger signal.

- 36** **MODE** Buttons (Up- and Down-Arrows) and Indicators — Select the operating modes of the A and B trigger systems. Pressing the Up-/Down-Arrow buttons selects the operating modes as shown by the Trigger MODE lights.

Selections available for the A Trigger (A/B SELECT button lit) are: AUTO LEVEL, AUTO, NORM, TV LINE, TV FIELD, and SGL SEQ. Selections for the B Trigger (A/B SELECT button not lit) are: AUTO LEVEL, RUNS AFTER, NORM, TV LINE FROM A SOURCE. For RISE, FALL, and PROP DELAY measurements, B Trigger MODE selection is not allowed, and B Trigger MODE lights are off.

If TV Sync Trigger Slope has been preset in the Configuration menu (see Service Menu Features in section 3), the A SLOPE is set to the preset slope when TV LINE or TV FIELD A Trigger MODE is selected. Whenever A Trigger MODE is set to a TV Trigger MODE, B Trigger SLOPE will automatically be set to match A Trigger SLOPE if TV LINE B Trigger MODE is selected. After A SLOPE has been preset, if A Trigger MODE is then taken out of a TV Trigger MODE, A SLOPE is set back to its previously selected (non-preset) value. If, while doing this, B Trigger MODE was still in TV LINE, the B SLOPE will be set automatically to match A SLOPE. If B SLOPE was set to match A SLOPE because B Trigger MODE was TV LINE, then setting B Trigger MODE to any other mode will cause B SLOPE to be set back to its previously selected (non-preset) value.

After the A SLOPE has been preset, it may then be altered as usual, and B SLOPE will automatically be set to match it if B Trigger MODE is TV LINE. If TV Sync Trigger Slope has not been preset in the Configuration menu, the A SLOPE will stay at its prior setting.

A Trigger Modes

AUTO LEVEL—Automatically sets the range of the Trigger LEVEL control to the 10% and 90% levels of the A Trigger source signal and sets the Trigger LEVEL either to the 10%, 50%, or 90% level of the A Trigger source signal, depending on the position of the Trigger LEVEL control.

The auto-level range is reset when triggering is lost, when the Trigger LEVEL control is rotated to either end stop, or when AUTO LEVEL Trigger MODE is selected again. AUTO LEVEL mode is useful for quickly locating and maintaining an appropriate triggering level.

The A sweep free-runs to produce a baseline trace when the A Trigger source signal amplitude is too low or the triggering-source frequency is less than 10 Hz.

AUTO—Triggers the same as the NORM Trigger MODE when an adequate trigger signal is applied. However, the A sweep free-runs when

Controls, Connectors, and Indicators

the A Trigger source signal amplitude is too low or the frequency is less than 10 Hz or the Trigger LEVEL is not appropriate. The triggering level changes only when the Trigger LEVEL control is adjusted to a new level setting.

NORM—Triggers the A sweep when the A Trigger LEVEL control is set within the peak-to-peak limits of an adequate trigger signal. When the A sweep is not triggered, no baseline trace is displayed.

TV LINE—Starts the A sweep at the beginning of a video signal line. SLOPE polarity must match the composite sync polarity to obtain TV LINE triggering on the horizontal sync pulse.

TV FIELD—Starts the A sweep at the beginning of a video signal field. SLOPE polarity must match the composite sync polarity to obtain TV FIELD triggering.

SGL SEQ (Single Sequence)—Sets up the A sweep for single-sequence operation. Each additional press of the down-arrow MODE button, when in single-sequence mode, resets the sweep and makes it ready to accept a trigger. As in NORM trigger MODE, the set triggering level changes only when the TRIGGER LEVEL control is adjusted to a new level setting.

When triggered, the sweep runs to produce a single sweep of each trace as required by the setting of the Vertical MODE and Horizontal MODE switches. Each displayed sweep in the sequence requires a distinct A sweep triggering event. The READY light remains on until the final trace in the sequence is completed. The readout and cursors can be set to turn on briefly at the end of the sequence when using a camera (factory settings default mode), or they can be set to remain on by changing the instrument configuration from the CONFIGURE menu (see "Service Menu Features" in Section 3).

B Trigger Modes

AUTO LEVEL—Sets the range of the Trigger LEVEL control to the 10% and 90% levels of the B Trigger source signal, sets the Trigger LEVEL, and triggers the B sweep and C/T.

NOTE

The B sweep operates in RUNS AFTER mode when the trigger-source signal amplitude is too low or the frequency is below 10 Hz. Switch to NORM triggering if the repetition rate is too slow for autoleveling. The A sweep must be running (free-running or triggered) for B sweep to trigger.

Once set, autoleveling is repeated only if triggering is lost, if the Trigger LEVEL control is rotated to either end stop, or if AUTO LEVEL Trigger MODE is reselected. AUTO LEVEL MODE is useful for quickly locating an appropriate triggering level.

RUNS AFTER—Starts the B sweep immediately after the delay time selected by the ← OR DELAY TIME control.

NORM—The B sweep is triggered when an adequate trigger signal is received after the delay time condition has been met. When there is no trigger signal, there is no B sweep trace.

TV LINE FROM A SOURCE—Starts the B sweep at the beginning of the video signal line received after the delay time has been met.

NOTE

SLOPE polarity defaults to the A Trigger SLOPE. This must match the composite sync polarity (same as A Trigger SLOPE) to obtain correct triggering on the horizontal sync pulse.

- ③7 **SOURCE (Up-Arrow and Down-Arrow) Buttons and Indicators**—Select the trigger source for either the A or the B Trigger system as directed by the A/B SELECT button. Pressing the Up-/Down-Arrow SOURCE buttons selects the trigger source (for A or B trigger system) as shown by SOURCE lights. For the Counter/Timer system, all measurement sources are selected from the SET MEAS'MT CHANNEL menus; the B trigger SOURCE lights stay off.

Controls, Connectors, and Indicators

VERT—Selects the trigger signal from the displayed waveforms.

The TRIGGER MODE and Vertical MODE switch settings determine the trigger signal source selection. When VERT is selected, one or more of the SOURCE lights will be on to indicate the trigger signal source. See Table 2-1 for VERT Trigger SOURCE selections.

CH 1—The signal applied to the CH 1 OR X input connector is the source of the trigger signal.

CH 2—The signal applied to the CH 2 input connector is the source of the trigger signal.

CH 3—The signal applied to the CH 3 input connector is the source of the trigger signal.

CH 4—The signal applied to the CH 4 input connector is the source of the trigger signal.

LINE—The triggering signal is obtained from a sample of the ac power-source waveform. This trigger source is useful when the displayed waveform frequency is time related to the ac power-source frequency.

Table 2-1
VERT Trigger SOURCE

Trigger and Vertical Modes	ADD Mode	Trigger Source Selected
AUTO LEVEL or CHOP	On	Algebraic sum of CH 1 and CH 2 input signals.
	Off	Lowest numbered vertical channel displayed.
NON-AUTO LEVEL and ALT	On or Off	Alternates between displayed vertical channels in the following order: CH 1, CH 2, CH 3, CH 4, and ADD.

38 **CPLG (Up-Arrow and Down-Arrow) Buttons and Indicators**— Select the method of coupling the input trigger signal to the A or B trigger system as directed by the A/B SELECT button. Pressing the Up-/Down Arrow buttons selects the trigger coupling as shown by the CPLG lights.

DC— Couples dc and all frequency components of a triggering signal to the trigger circuitry.

DC coupling is useful for most signals, but it is especially useful for providing a stable display of low-frequency or low-repetition-rate signals.

NOISE REJ (Noise Reject)— Couples all frequency components of the input signal to the trigger circuitry but increases the peak-to-peak signal amplitude required to produce a trigger event.

NOISE REJ coupling is useful for improving stability when the trigger signal is accompanied by low-level noise.

HF REJ (High Frequency Reject)— Attenuates high-frequency triggering signal components above 50 kHz.

HF REJ coupling is useful for providing a stable display of low-frequency components of complex waveforms and eliminates high-frequency interference from the trigger signal.

LF REJ (Low Frequency Reject)— Attenuates low-frequency triggering signal components below 100 kHz and blocks the dc component of the trigger signal.

LF REJ coupling is useful for producing stable triggering on the high-frequency components of complex waveforms and rejecting low-frequency interference or power supply hum from the trigger signal.

AC— Attenuates trigger signal frequency components below 50 Hz and blocks the dc component of the signal.

AC coupling is useful for triggering on ac waveforms that have a large dc offset.

Rear Panel

Refer to Figure 2-6 for location of items 39 through 44.

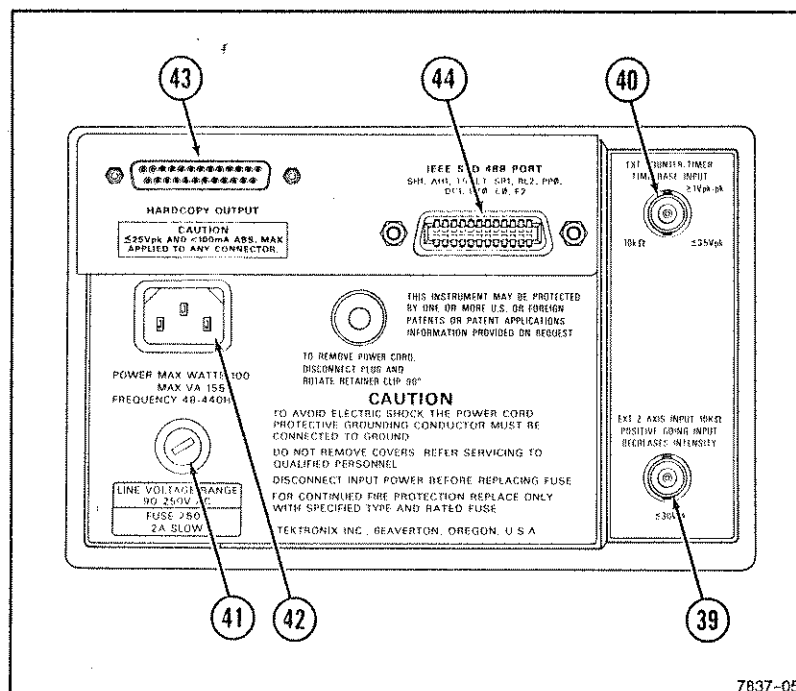

Figure 2-6. Rear panel.

- 39** **EXT Z-AXIS INPUT Connector**— Connects external signals to the Z-Axis amplifier for intensity modulating the crt display.

Signals applied to the EXT Z-AXIS INPUT do not affect display waveshape. Signals with fast rise times and fall times provide the most abrupt intensity change. The active region threshold level is 1.8 V. A Z-Axis voltage above the threshold voltage of 3.8 V produces noticeable modulation. The Z-Axis signals must be time-related to the displayed signal to obtain a fixed intensity-modulated crt display.

- ④① **EXT COUNTER/TIMER TIME BASE INPUT Connector**—Connects an external reference oscillator signal to the Counter/Timer. This signal must be 1, 5, or 10 MHz \pm 2%, with at least 1 Volt p-p amplitude. The Counter/Timer will automatically switch to this signal, when present, and provide an indication in the readout.
- ④② **Fuse Holder**—Contains the primary power fuse.
- ④③ **Power Cord Receptacle**—Connects the ac power source to the instrument power supply.
- The power cord protective-ground connection is connected to the exposed metal parts of the instrument. The power cord must be connected to a properly grounded source for electrical-shock protection.
- ④④ **HARDCOPY OUTPUT Connector**—Outputs the digitized A sweep display(s) via a Centronics-compatible 25-pin female connector to an attached EPSON™ FX-Series compatible printer.
- ④⑤ **GPIB Connector**—Provides the ANSI/IEEE Std. 488.1-1987 compatible electrical and mechanical connection to the GPIB. The controller operates the front panel and sets measurement modes. Digitized waveforms and measurement results can be transferred to a system controller or host computer.

Menu System, Hardcopy, and GPIB Controls and Indicators

Refer to Figure 2-7 for location of items 45 through 51.

- ④⑤ **Menu Item Select Buttons**—Select items from the list displayed on the right side of a displayed menu. A Menu Item Select button that has no corresponding menu item does nothing when pressed. The menu display will clear when the item is selected (unless the SERVICE mode CONFIGURE menu is set for: KEEP MENU ON WHEN ITEM SELECTED? YES). The factory settings default is NO.

™ EPSON is a trademark of Epson Corporation.

Controls, Connectors, and Indicators

You can access the Service Mode by pressing the top and bottom Menu Item Select buttons at the same time. This should only be done when no other menu is displayed, as unwanted selections on the displayed menu could occur. See Service Menu Features in Section 3 for using the operational modes of the SERVICE MENU.

- 46) **CLEAR DISPLAY**—Clears displayed menus, measurement functions, and cursor functions in the following order:
1. Menu display (Service, Measurement, Store/Recall Setup menus and Hardcopy messages).
 2. Measurement function (including TRACK MEASMT cursors if displayed).
 3. TRACK TRIG LVL and TRACK m .

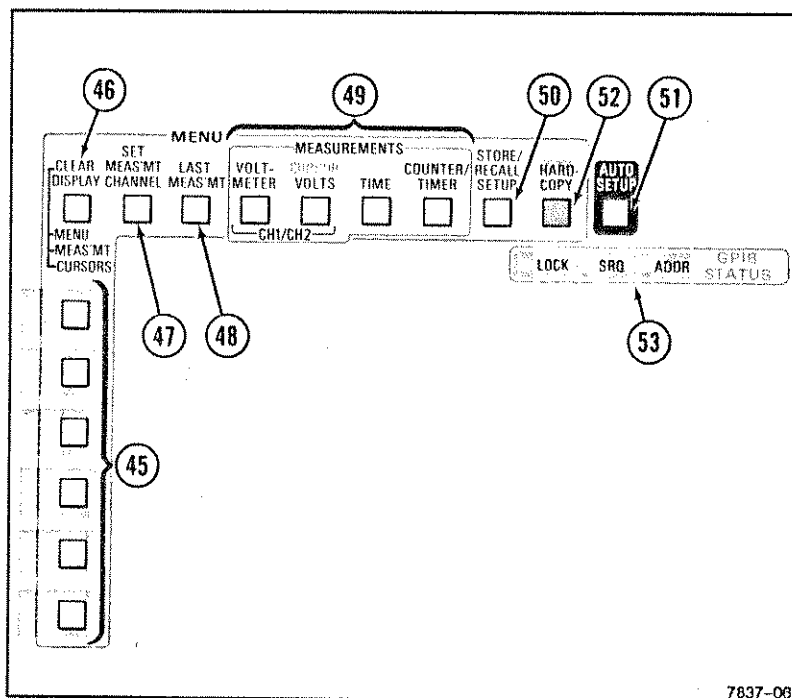

Figure 2-7. Menu controls.

- 47 **SET MEAS'MT CHANNEL**—Displays menus for setting measurement-source channels for active measurement modes.

There are two one-page menus available; one for voltmeter and rise/fall measurements, and one for single-channel Counter/Timer measurements. Two-channel measurements, such as delta time, frequency ratio, and propagation delay, have two-page menus. Each menu lists all valid input channels that can be selected for that measurement mode.

If the SET MEAS'MT CHANNEL button is pressed for an invalid mode, one of the following messages will be displayed for two seconds:

1. **SELECT A MEASUREMENT**—When no measurement mode is active.
2. **NO MEAS CHANNEL NEEDED**—When a selected measurement mode (such as cursor time) does not require a measurement channel to be set.

When a SET MEAS'MT CHANNEL menu is displayed, changing the Horizontal MODE, except between ALT and B, clears the menu.

- 48 **LAST MEAS'MT**—Recalls the last active measurement mode to the display and resets the measurement channel. If the last active measurement mode is already displayed when the LAST MEAS'MT button is pressed, only the measurement channel is reset.

The measurement channel for VOLTMMETER, CURSOR VOLTS, and RISE or FALL measurement modes is set to CH 1, if CH 1 is displayed, otherwise to CH 2. If neither CH 1 nor CH 2 is displayed, CH 1 will be turned on and will be the measurement channel.

The measurement channel for single-channel Counter/Timer measurements is set to the lowest number displayed channel (may be set to CH 1, CH 2, CH 3, CH 4, or ADD).

Measurement channels for time measurement modes (ALT and B Horizontal modes) and dual-channel Counter/Timer measurements are set to the lowest number displayed channel for the delay time (or B source 1) and the next lowest number displayed channel for the delta-delay time, (or B source 2) if more than one channel is displayed. Both are set to the same channel when only one channel is displayed. CH 1 is considered the lowest numbered channel, and ADD is considered the highest numbered channel.

NOTE

When the memory-backup battery is dead or has just been replaced, the last measurement is initialized to ← SEC → at power on. The battery must be replaced by a qualified service person.

- ④ **Measurement Select Buttons**—Calls up Measurement selection menus. Measurements are selected from the list of menu items at the right side of the menu display.

VOLTMETER CH1/CH2—Displays the voltmeter menu. The selected measurement mode is shown by an underlined menu item. Tracking cursors (measurement, ground, trigger level) may be displayed to show the measurement points on the displayed signal (see CURSORS).

CURSOR VOLTS—Calls up the menu for selecting cursor volts measurement modes. The first page of the menu lets you select positionable cursors; page 2 is for selecting the auto-tracking SmartCursors[®].

TIME—Calls up the menu to select the type of timing measurement to be made. Menu choices are listed on the right side of the screen.

COUNTER/TIMER—Calls up the menu to select the type of counter/timer measurement to be made. Menu choices are listed on the right side of the screen.

- ⑤ **STORE/RECALL SETUP Button**—Calls up store and recall menus that let you store and recall up to 20 front-panel setups. When you press the STORE/RECALL button, the STORE/RECALL menu (factory settings default) or the RECALL ONLY menu is displayed depending on how you set the SERVICE mode CONFIGURE menu. See "Service Menu Features" in Section 3 to set CONFIGURE menu.

- ⑥ **AUTO SETUP Button**—Press to automatically set up the front-panel controls to produce a usable crt display. Setups are based on the characteristics of the applied signals.

The voltage and frequency characteristics of the input signal must be within the limits of the 2252 specifications.

In addition, applied signals must be large enough to insure a stable trigger in NOISE REJECT at 2 mV/div and be within the dynamic range of the vertical and trigger system at 5 V/div. The input signal must be DC or periodic within the frequency range of 50 Hz to 100 MHz.

Auto-setup action for each front-panel control is shown in Appendix A of this manual in Table A-1. In addition to the action shown in Table A-1, any selected measurement is re-initialized as if it were manually selected.

Minimum Setup—Pushing and holding the AUTO SETUP button until instrument operation returns enters the Minimum Setup function. This sets up the front-panel controls as the Auto-Setup does but leaves many of the controls unchanged from what the user has previously set. Minimum setup action for each front-panel control is shown in Appendix A.

52 **HARDCOPY Button**—Starts digitizing the A sweep display(s) and outputs the results via the HARDCOPY OUTPUT connector (rear panel) to an attached EPSON™ FX-Series compatible printer. The A sweep displays are digitized between the A SEC/DIV switch settings from 20 ns/div to 0.5 s/div. Ensure that the repetitive trigger events occur less than two seconds apart.

Waveform displays are not digitized for hardcopy use if the X10 MAG is on or if the Horizontal mode is not set to A sweep. The hardcopy output provides 500 points for each waveform display (10 divisions).

Up to five display waveforms (CH 1, CH 2, CH 3, CH 4, and ADD channels 1 and 2) can be digitized for a single hardcopy output. The hardcopy output also consists of graticule measurement markings, readout displays, and cursors. Screen readouts and front-panel LEDs should be disregarded during the digitizing period.

™ EPSON is a trademark of Epson Corporation.

NOTE

*If the **HARDCOPY** button is accidentally pressed when the printer is not ready, the message **PRINTER NOT READY** will appear on the screen after the digitized period is completed. To exit from the Hardcopy mode, press the Menu-Select button opposite the message **ABORT**, **CLEAR DISPLAY** button, or one of the Measurements select buttons. The user can also exit from the hardcopy mode during the digitizing period (when the A sweep speed or trigger rate is very slow) by pressing the Menu-Select button opposite the message **ABORT**.*

53 **GPIB STATUS Indicators**—Indicates the status of the GPIB.

LOCK—Indicates that the GPIB has locked out the front-panel controls of the instrument. This condition can be cleared only over the bus or by cycling the instrument **POWER** switch. The lockout condition is used when the controller wishes the present state of the instrument front panel to be protected when communicating with the instrument.

SRQ—Indicates the instrument is requesting service from the controller. It will also be turned on if an error or a warning condition has been detected. It will be turned off when the controller has polled the instrument for its status and no other conditions are pending.

ADDR—Turns on when the GPIB is in one of the addressed states, **TACS**, (Talker-Active State) or **LACS** (Listener-Active State).

SECTION 3

**OPERATORS
FAMILIARIZATION**

2252 Operators

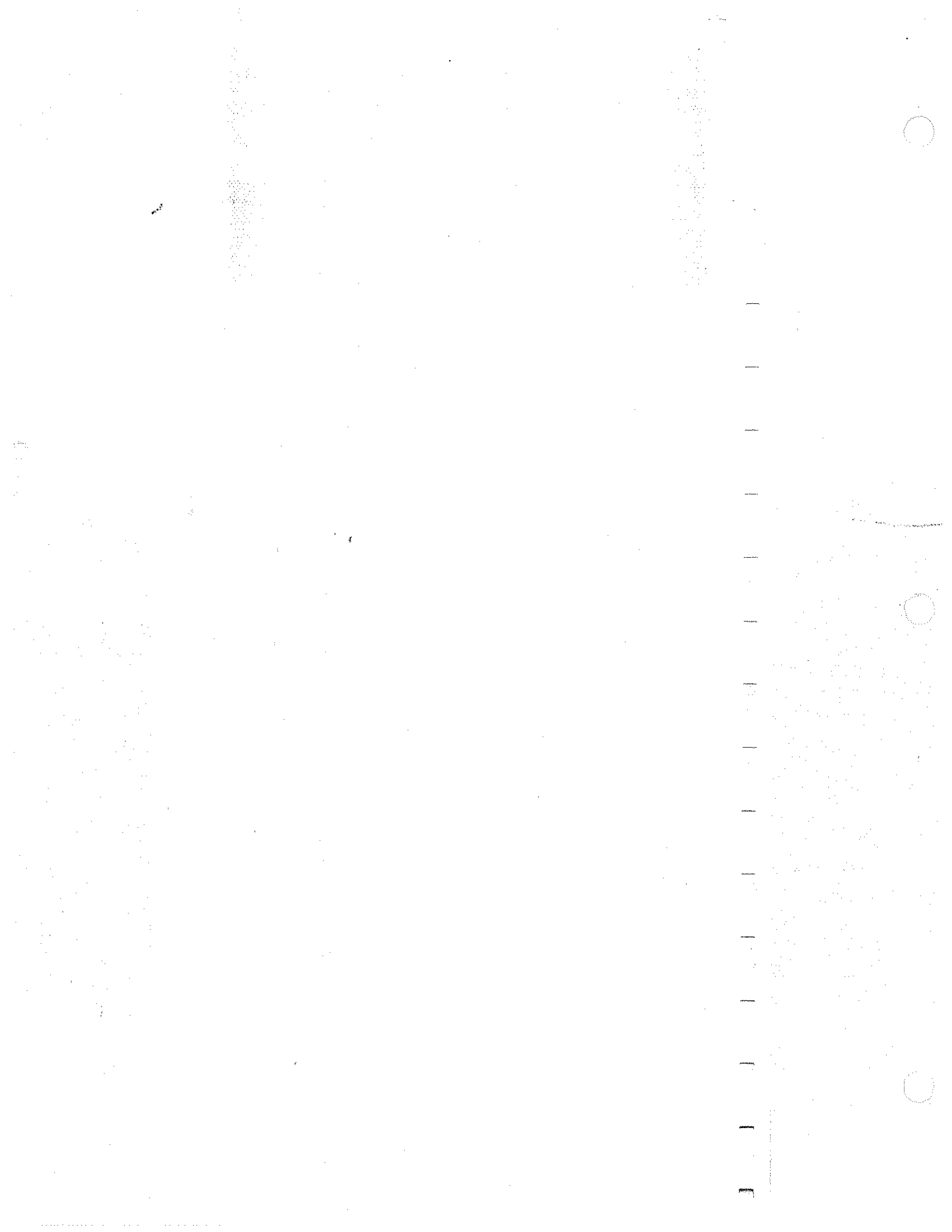

INTRODUCTION

This section is divided into two subsections: BASIC OPERATION and MENU SYSTEM OPERATION. BASIC OPERATION provides some general information about the readout displays, graticule, and signal connections; MENU SYSTEM OPERATION provides detailed information on the menus and functions available under menu control.

BASIC OPERATION

This subsection contains the basic operating information and techniques that should be considered before attempting any measurements. For location and function of instrument controls, connectors, and indicators see How the Controls Work, Section 2 of this manual.

Graticule

The graticule is internally marked on the crt face to provide parallax-free viewing and enable accurate measurements (see Figure 3-1). The graticule is marked with eight vertical and ten horizontal major divisions. Major divisions are further divided into five subdivisions of 0.2 division each, marked along the center vertical and horizontal graticule lines. Percentage marks for rise-time and fall-time measurements are marked on the left side of the graticule. Vertical deflection factors and horizontal timing are calibrated to the graticule so that accurate measurements can be made directly from the crt.

The waveform displays are calibrated to the crt graticule markings for making quick and very accurate measurements of waveform parameters. Voltage measurements are done by counting the vertical graticule divisions and partial divisions occupied by the portion of the display being measured and then multiplying by the VOLTS/DIV setting. Time measurements using the graticule markings are done in a similar manner. Count the number of horizontal graticule divisions and partial divisions occupied by the portion of the waveform being measured and multiply by the SEC/DIV setting.

To improve the accuracy of the estimate, position the display to take advantage of the 0.2 division minor graticule markings on the center graticule lines. Also position one of the measurement points of the waveform as precisely as possible on one of the major graticule marks to be used as a measurement reference point.

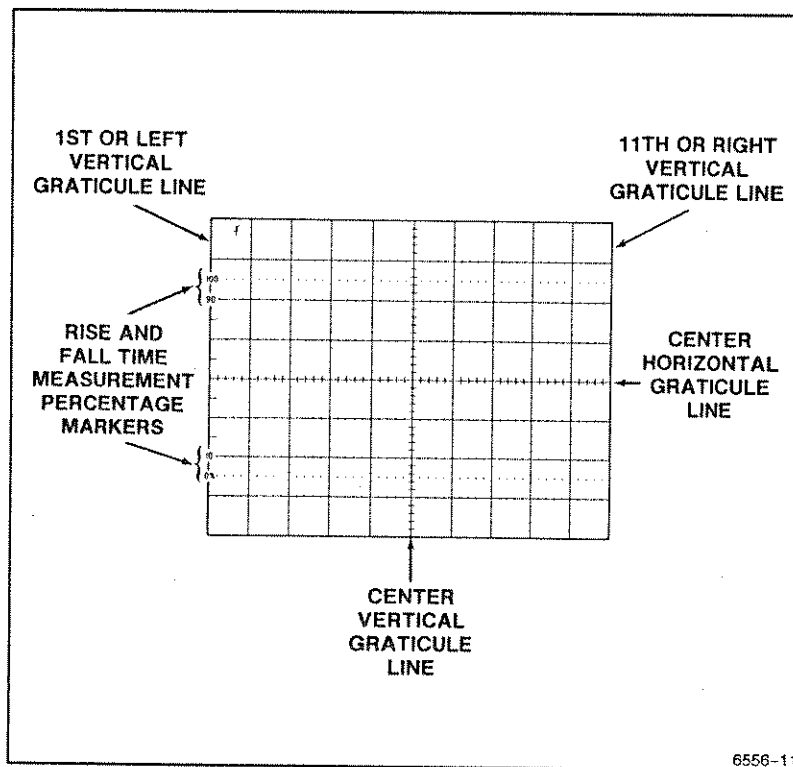

Figure 3-1. Graticule measurement markings.

Readout Display

The crt readout display indicates how the instrument controls are set up. No physical markings are on the rotating switches and control knobs to indicate the control setting. A key to the location and type of readout information displayed is illustrated in Figure 3-2.

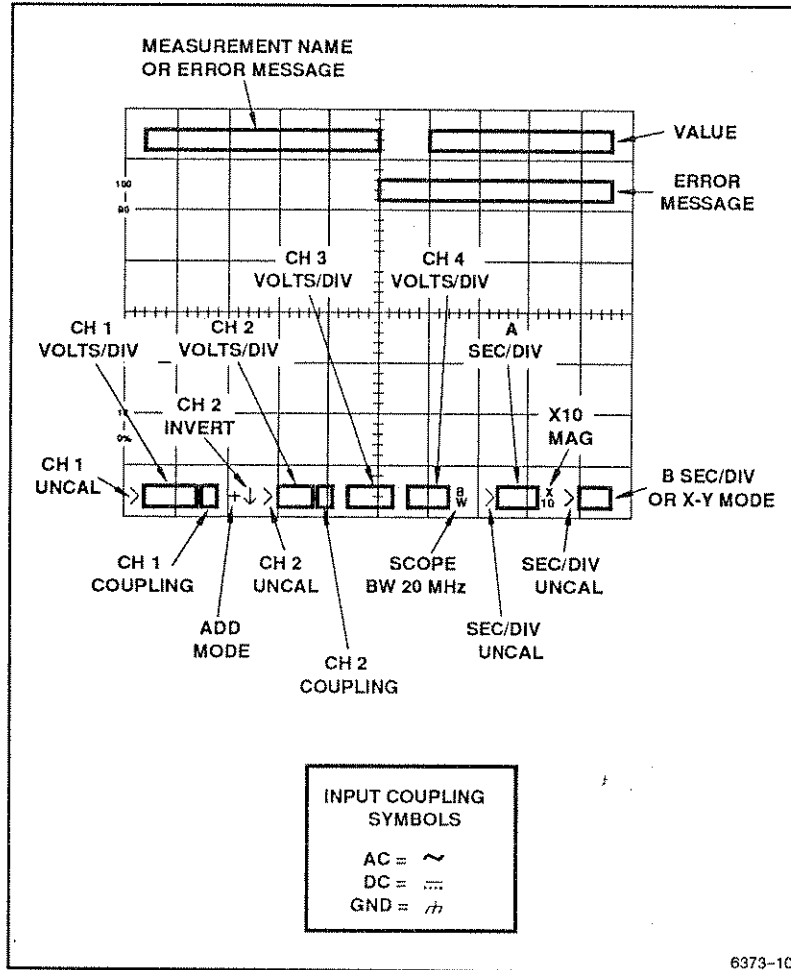

Figure 3-2. Readout display locations.

Connecting Input Signals

Grounding

The most reliable signal measurements are made when the 2252 and the unit under test are connected by a common reference (ground lead) in addition to the single lead or probe. The ground lead of the probe provides the best grounding method for signal interconnection and ensures the maximum amount of signal-lead shielding in the probe cable. A separate ground lead (with a banana plug) can also be connected from the unit under test to the 2252 ground jack on the front panel.

Probes

A probe provides the most convenient way to connect an input signal to the oscilloscope. The standard 10X probes supplied with the 2252 are shielded against electromagnetic interference and have a high input impedance for low circuit loading. The subminiature probe bodies are designed for probing circuitry with closely spaced leads.

SCALE FACTOR SWITCHING. The VOLTS/DIV scale factors, displayed on the crt, reflect the probe attenuation factor when Tektronix coded probes are used.

OPERATING CONSIDERATIONS. To get the best waveform fidelity, keep probe ground and signal leads as short as possible.

Misadjusted probe compensation can cause measurement error. Check and adjust probe compensation whenever a probe is moved to a different channel or oscilloscope. For the probe compensation adjustment procedure, see Section 4, Operator Checks and Adjustments.

For detailed operating considerations and probe maintenance, see the instruction sheet supplied with the probe.

Coaxial Cables

Signal input cable can greatly affect the accuracy of a displayed waveform. To maintain original frequency characteristics of the input signal, use only high-quality, low-loss coaxial cables. Coaxial cables must be terminated at both ends in their characteristic impedance to prevent signal reflections within the cable. Use suitable impedance-matching devices.

External Triggering

Any of the four vertical channels in the 2252 can be used as a source of A and B trigger signals. When you need a trigger signal source different from the one derived from displayed signals, you can use any free vertical input channel. CH 1 and CH 2 can condition a wide range of signals to produce triggers over the full vertical deflection range from millivolts to hundreds of volts. CH 3 and CH 4 have two basic attenuation factors (0.1 and 0.5 volts per division), making them especially useful for triggering on and viewing digital signal levels.

Auto Setup

Pressing the AUTO SETUP button automatically sets up the front-panel controls based on the characteristics of the applied signal. The voltage amplitude, sweep settings, trigger parameters, vertical and horizontal positioning, and trace intensities are preset to produce a usable waveform display. The waveform is horizontally centered and vertically positioned within the crt display. The voltage and frequency characteristics of the input signal must be within the limits of the 2252 specifications given in Section 6.

Auto-setup action for each front-panel control is shown in Appendix A.

Minimum Setup

Pressing and holding the AUTO SETUP button until the instrument returns to normal operation initiates the minimum-setup function. This automatically sets up the front-panel controls but leaves many of the controls unchanged from what the user has set.

Minimum setup action for each front-panel control is shown in Appendix A.

Remote Control via the Communications Port

When connected in a system with a host computer or system controller, the 2252 can be operated by the controller. The front panel controls and measurements are accessible via the communications interface. Digitized waveforms and measurement results can be gathered by the remote controller for long term data collection and /or analysis using system programming. The standard communications interface is a GPIB (general purpose interface bus) for parallel byte-wide data transfer. The GPIB commands understood by the instrument and programming hints are found in Appendix B.

MENU SYSTEM OPERATION

This subsection provides operating details of the measurement menus, service menus, and Store/Recall Setup menus.

Introduction

Pressing one of the menu call-up buttons causes a list of menu items to be displayed on the right-hand side of the crt beside a group of six Menu Item Select buttons (see Figure 3-3). Pressing the menu button next to a menu item on the display selects that function (i.e., to another menu page, a measurement selection, a measurement source channel, service feature, store/recall setup features, or menu off). When a measurement mode, measurement source channel, or service feature in the menu list is selected, that label is underlined.

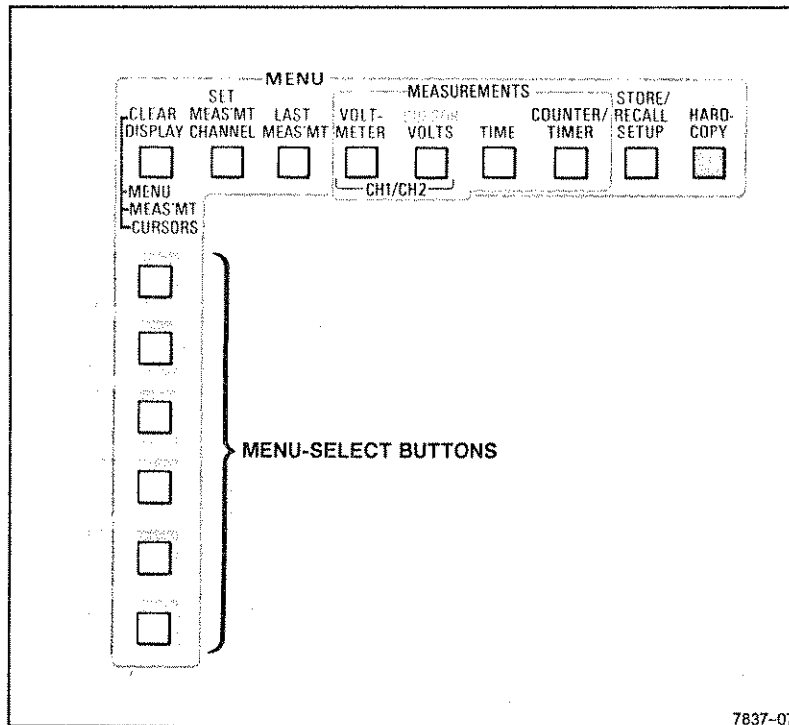

Figure 3-3. Menu buttons.

Normally, the menu display turns off after a measurement function is selected (if not configured to remain on), and the name and value of a selected measurement function appears in the top line of the crt readout. However, when it is possible to make more than one selection from the menu list (or if the menu is configured to remain on), the display menu will remain on for making further choices until the CLEAR DISPLAY button is pressed or MENU OFF selected (if a menu choice). The service menu can be turned off by selecting QUIT from the menu or pressing the CLEAR DISPLAY button.

Clearing the Menu and Cursors Display

The CLEAR DISPLAY button clears displayed menus, turns off measurement functions (including TRACK MEASMT cursors), and turns off the TRACK TRIG LVL and TRACK \overline{h} cursors. Depending on what menus and measurements are displayed at the time, you may have to press the CLEAR DISPLAY button as many as three times to completely clear the display.

If a menu is on, pressing the CLEAR DISPLAY will remove the menu and return the display to a normal operating mode. Measurement functions are turned off with the second press (or the first press if no menu is displayed). Finally, the TRACK TRIG LVL and TRACK \overline{h} cursors are canceled with a third press (or the first press if no menu is displayed and no measurement function is active).

Setting Measurement Channel

Press SET MEAS'MT CHANNEL button to call up one of the menus for setting the measurement channel(s). There are one-page menus available for voltmeter and rise/fall measurements and single-channel C/T measurements, and two-page menus for all the measurements that can have two different measurement channels. Each menu lists input channels that can be selected for the active measurement mode.

If the SET MEAS'MT CHANNEL button is pressed for an invalid mode, one of the following messages will be displayed in the top line for about two seconds.

SELECT A MEASUREMENT — When no measurement mode is active.

NO MEAS CHANNEL NEEDED — When a selected measurement mode (such as cursor time) does not require a measurement channel setting.

When a SET MEAS'MT CHANNEL menu is displayed, switching between A and ALT Horizontal MODES normally clears the menu and turns off the active measurement mode.

Operators Familiarization

Pressing a menu button next to a vertical channel number selects that choice as the source channel for the measurement. For Channel 1 or Channel 2 Voltmeter measurements, the selected source channel need not be displayed and is not automatically turned on when selected. It is possible therefore to view a Channel 1 display and have the Channel 2 voltage measurement value displayed by the readout (and vice versa).

When setting the measurement channel for \leftarrow VOLTS \rightarrow or $\overline{\leftarrow}$ VOLTS \rightarrow , or for RISE, FALL, PRÓPDLY, or gated C/T measurements, or when setting delay-time and delta-time channels, a vertical channel that is selected in the menu is turned on if not previously selected and it remains displayed when deselected as the measurement source channel. Any vertical channel traces turned on that are not wanted in the display must be turned off using the Vertical MODE buttons.

The following illustrations show all the possible menus that may be called up when the SET MEAS'MT CHANNEL button is pressed depending on the measurement mode in effect.

(SET MEASMT CHANNEL)	CH1
	CH2

Voltmeter Measurement Channel Menu; also used to select RISE/FALL measurement source.

(SET COUNTER CHANNEL)	CH1
	CH2
	CH3
	CH4
	ADD

Single-Channel C/T Measurement Channel Menu.

(SET DELAY TIME CHANNEL)	CH1	(SET Δ TIME CHANNEL)	CH1
	CH2		CH2
	CH3		CH3
	CH4		CH4
	ADD		ADD
(TO Δ CHANNEL MENU)		(BACK TO DELAY CHANNEL MENU)	

Delay-Time and Delta-Time Measurement Channel Menus.

(SET SOURCE/ CHANNEL)	CH1	(SET /SOURCE CHANNEL)	CH1
	CH2		CH2
	CH3		CH3
	CH4		CH4
	ADD		ADD
(TO /SOURCE CHANNEL MENU)		(BACK TO SOURCE/ CHANNEL MENU)	

Frequency Ratio Measurement Channel Menus.

(SET START CHANNEL)	CH1	(SET STOP CHANNEL)	CH1
	CH2		CH2
	CH3		CH3
	CH4		CH4
	ADD		ADD
(TO STOP CHANNEL MENU)		(BACK TO START CHANNEL MENU)	

Propagation Delay Measurement Channel Menus.

Recalling the Last Measurement Mode

When an active measurement has been cleared, either by pressing the CLEAR DISPLAY button or changing the Horizontal MODE, it may be reactivated without using the Measurement Menu to reselect it. Press LAST MEAS'MT to recall the last selected measurement mode if no measurement mode is active. The LAST MEAS'MT button may also be used to reinitialize an active measurement mode. A press of the button cancels the active measurement and then recalls it in its initialized state. This feature is useful for returning VOLTS cursors and, under some conditions, TIME cursors or delays to their initialized positions after they have been adjusted away.

The measurement channel for VOLTMETER, CURSOR VOLTS, and RISE or FALL measurement modes is set to CH 1, if CH 1 is displayed, otherwise to CH 2. If neither CH 1 nor CH 2 is displayed, CH 1 will be turned on and will be the measurement channel.

The measurement channel for single-channel C/T measurements is set to the lowest number displayed channel (can be CH1, CH2, CH3, CH4, or ADD).

Measurement channels for TIME measurement modes (ALT and B Horizontal modes) and dual-channel C/T measurements are set to the lowest number displayed channel for the delay time (or B source 1), and the next lowest number displayed channel for the delta-delay time, (or B source 2) if more than one channel is displayed. Both are set to the same channel when only one is displayed. CH1 is considered the lowest numbered channel, and ADD is considered the highest numbered channel.

NOTE

The last measurement is initialized to ← SEC → at power on when the memory-backup battery is dead or has just been replaced. If the battery is dead, refer the instrument to a qualified service person to have it replaced.

Channel 1 and Channel 2 Voltmeter

Press VOLTMETER CH1/CH2 button to display the first page of menu choices. The selected measurement mode is shown by an underlined menu item. Tracking cursors (measurement, ground, or trigger level) may be displayed to show the measurement points on the displayed signal (see Conditions for Cursor Display).

If a single channel (CH 1 or CH 2) is selected for display, it becomes the default measurement source channel. When neither channel is being displayed when a Voltmeter measurement is selected, or recalled by the LAST MEAS'MT button, CH 1 is turned on as the default channel. If both CH 1 and CH 2 are being displayed, the default measurement source channel upon each initialization is also CH 1. Use the SET MEAS'MT CHANNEL function to assign CH 2 as the measurement channel. Turn off the CH 1 display if CH 2 is the desired default measurement source channel. If both CH 1 and CH 2 are turned off while the Voltmeter measurement is active, the error message VOLTMETER SOURCE: CH 1 OR 2 ONLY will be displayed and the voltmeter measurement will be canceled.

Only one active measurement is allowed at a time. The name of the active measurement and measured value are displayed at the top of the screen. A measurement is canceled with no message when the Horizontal Mode is changed to a mode incompatible with the active measurement mode. See Table 3-1 in Behavior for Horizontal MODE Changes for compatible modes.

If a +PEAK, -PEAK, or PK-PK Volts measurement is selected when horizontal mode is either ALT or B, Cursor Knob Allocation Menu 1 is displayed.



Cursor Knob Allocation Menu 1.

If MEAS is selected from this menu, the Voltmeter measurement is performed on an area of the A sweep that is intensified by the B sweep display. The Voltmeter measurement is, in effect, gated by the B sweep, with the gating interval starting approximately at B sweep start \pm (0.5 division + 20 ns) and ending approximately 11 divisions from B sweep start. If measurement tracking cursors are enabled, they will track with the B sweep display. The **← OR DELAY TIME** knob will control the B delayed sweep position, even though the DELAY time is not displayed. When a Volts measurement is selected when B Trigger MODE is not RUNS AFTER, an error message USE RUNS-AFTER-DELAY TRIG MODE will be displayed, and the Volts measurement will not start up. If B Trigger MODE is changed while a Volts measurement is running, the Voltmeter measurement is canceled, without a message, and the DELAY measurement runs.

If DELAY is selected, the **← OR DELAY TIME** knob will control the B delayed sweep position, and the DELAY measurement runs, displaying the delay time value in the top line of the readout.

If horizontal mode is changed to A when the above menu is displayed, the menu will disappear, but the selected Volts measurement will continue running, with the measurement tracking cursors tracking the A sweep (as in the normal, nongated version of the Volts measurement).

(VOLTMETER)	DC	(VOLTS PG 2)	GATED +PEAK
	+PEAK		GATED -PEAK
	-PEAK		GATED PK-PK
	PK-PK		
	SELF CAL		
(TO GATED MEASMT MENU)		(BACK TO PREVIOUS MENU)	

Voltmeter and Gated Voltmeter Selection Menus.

Voltmeter Measurements Page 1

DC—Measures the average DC level of the measurement channel waveform.

+PEAK—Measures the most positive (screen-relative) voltage in the applied waveform.

-PEAK—Measures the most negative (screen-relative) voltage in the applied waveform.

PK-PK—Measures the peak-to-peak voltage of the applied waveform.

SELF CAL—Characterizes the hardcopy and performs a self characterization of the vertical system. Before characterizing the hardcopy, remove the input signals from CH 3 and CH 4. SELF CAL may be performed at any time.

Operators Familiarization

With the selection of SELF CAL, the message CALIBRATE DIGITIZER? is displayed. When YES is selected, the SELF CAL HARDCOPY procedure is displayed for the user. At the completion of the SELF CAL HARDCOPY procedure, the SELF CAL VOLT MEASUREMENTS routine is run. To run only the SELF CAL VOLT MEASUREMENTS routine, select NO. The SELF CAL HARDCOPY procedure characterized channels 1, 2, 3, and 4, and horizontal position. The SELF CAL VOLT MEASUREMENTS does a self-characterization of the vertical channels 1 and 2. Suggested times are: after a warmup period, whenever the ambient operating temperature changes by $\pm 15^\circ\text{C}$, and just prior to making any hardcopies or voltmeter measurements requiring the best possible accuracy.

(TO GATED MEASMT MENU)—Selects the gated-measurement menu.

Voltmeter Measurements Page 2, Gated Measurements

The oscilloscope must be properly triggered for gated measurements. If there is no trigger signal in NORM Trigger MODE, the message LO REP RATE - STILL TRYING will be displayed. If there is no trigger signal in AUTO LEVEL or AUTO Trigger MODE, the readout value will be unstable and meaningless.

Gated Voltmeter measurements are made within the gated (intensified) region on the displayed waveform. The position of the gated zone is set using the \leftarrow OR DELAY TIME control, and the width is set using the \rightarrow control. Gated measurements are not allowed in SGL SEQ Trigger MODE; active gated measurements will be canceled if SGL SEQ Trigger MODE is selected. If a gated voltage measurement is selected after switching to SGL SEQ TRIGGER MODE, the message NOT ALLOWED IN SSEQ is displayed for about two seconds.

GATED + PEAK—Measures the most positive (screen-relative) voltage in the gated (intensified) portion of the waveform.

GATED -PEAK—Measures the most negative (screen-relative) voltage in the gated (intensified) portion of the waveform.

GATED PK-PK—Measures the peak-to-peak voltage in the gated (intensified) portion of the waveform.

(BACK TO PREVIOUS MENU)—Returns the first page of the Voltmeter menu.

Cursor Volts Measurements

Press CURSOR VOLTS to display the measurement choices of menu 1. Select (TO AUTO TRACKING MENU) to obtain the auto tracking SmartCursor[™] choices.

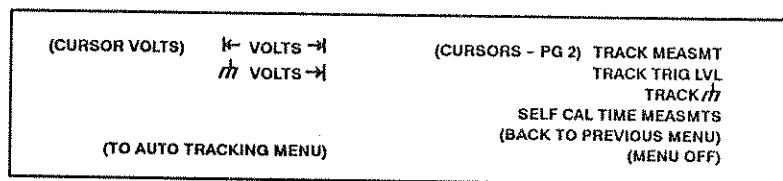

Cursors VOLTS and Auto Tracking Menus.

If ← VOLTS → or ↗ VOLTS ↘ is selected when the Horizontal MODE is either ALT or B, Cursor Knob Allocation Menu 2 is displayed, and the measurement is performed on the B sweep display.

If ← → is selected in the Cursor Knob Allocation menu, the ← OR DELAY TIME knob will control the ← Volts cursor position and the → knob will control the → Volts cursor position in the ← VOLTS → measurement; the → knob will control the → Volts cursor position in the ↗ VOLTS ↘ measurement (the ← OR DELAY TIME knob has no effect).

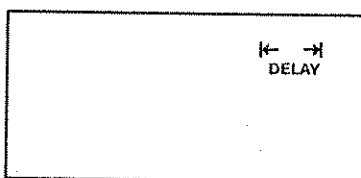

Cursor Knob Allocation Menu 2.

If DELAY is selected, the DELAY measurement runs, displaying the delay time value in the top line of the readout; the ← OR DELAY TIME knob will control B delayed sweep position, and the → knob has no effect. If ← → is reselected, the previously selected Cursor Volts measurement is restarted.

If the Horizontal MODE is changed to A when the above menu is displayed, the menu will disappear, but the selected Volts cursor measurement will continue.

← VOLTS → — Measures the equivalent voltage difference between two horizontal cursors in either A Horizontal MODE or X-Y Horizontal MODE. Both cursors are positioned by the ← OR DELAY TIME control and the delta cursor is positioned by the → control. When the VOLTS cursors measurement is first turned on (or recalled as a last measurement mode), the peak voltages of the source channel signal are measured, and one SmartCursor[™] is placed at the most positive peak and the other is placed at the most negative peak.

\overline{m} VOLTS \rightarrow — Measures the equivalent voltage between the independent cursor and ground. A ground tracking cursor marks the ground position of the selected waveform display in either A Horizontal MODE or X-Y Horizontal MODE. The ground tracking cursor follows the ground level of the source channel waveform as it is positioned vertically. When initialized, the independent SmartCursor[®] is placed on the most positive signal peak.

(TO AUTO TRACKING MENU) — Select the tracking cursor choices of page 2.

All of the tracking cursor selections may be underlined, but only two cursors (of either type — tracking or measurement) may be displayed at a time. If TRACK MEASMT is selected and a Channel 1 or Channel 2 Voltmeter measurement is active, the TRACK \overline{m} cursor is not displayed when TRACK TRIG LVL is also active. If the measurement-tracking cursor is turned off, the ground tracking cursor will return to the display.

The CLEAR DISPLAY button may be used to turn off the MENU, MEASUREMENT, and TRACK TRIG LVL and TRACK \overline{m} cursors in a priority scheme of three levels. MENU first, MEASUREMENT second, and TRACK TRIG LVL and TRACK \overline{m} cursor last. The highest level being displayed is turned off each time the CLEAR DISPLAY button is pressed.

TRACK MEASMT — Press to enable or disable the Channel 1 or Channel 2 Voltmeter measurement-tracking cursors (SmartCursors[®] that show the waveform-measurement points). The state of the TRACK MEASMT feature does not affect the positionable \overline{m} VOLTS \rightarrow cursor operation. The CLEAR MENU button will not turn off the TRACK MEASMT feature; it only turns off the present display of the TRACK MEASMT cursor when it turns off the active measurement mode. The next time a Channel 1 or Channel 2 VOLTMETER measurement mode is selected, the TRACK MEASMT cursor or cursors will again be displayed.

TRACK TRIG LVL — Press to enable or disable the Trigger Level tracking cursor. See Conditions for Cursors Display in this section for conditions required to display the Trigger Level tracking cursors.

TRACK \overline{m} — Press to enable or disable the ground level tracking cursor. The TRACK \overline{m} cursor follows the Vertical MODE in that it follows the lowest displayed channel of either CH 1 or CH 2.

SELF CAL TIME MEASMTS — Self characterizes the horizontal system. SELF CAL may be performed at any time. Suggested times are: after a

warmup period, whenever the ambient operating temperature changes by $\pm 15^\circ\text{C}$, and just prior to making any time measurements requiring the best possible accuracy.

(BACK TO PREVIOUS MENU) – Returns the first page of the Cursors menu.

(MENU OFF) – Clears the menu from the display.

Time Menus

Press the TIME button to call up the time measurement choices. A selected TIME measurement mode is underscored when the menu is displayed. Only one active measurement at a time is allowed. Making a selection removes the menu (unless SERVICE mode CONFIGURE menu is set to keep menu on when measurement selected). The selected measurement type and value are displayed at the top of the screen.

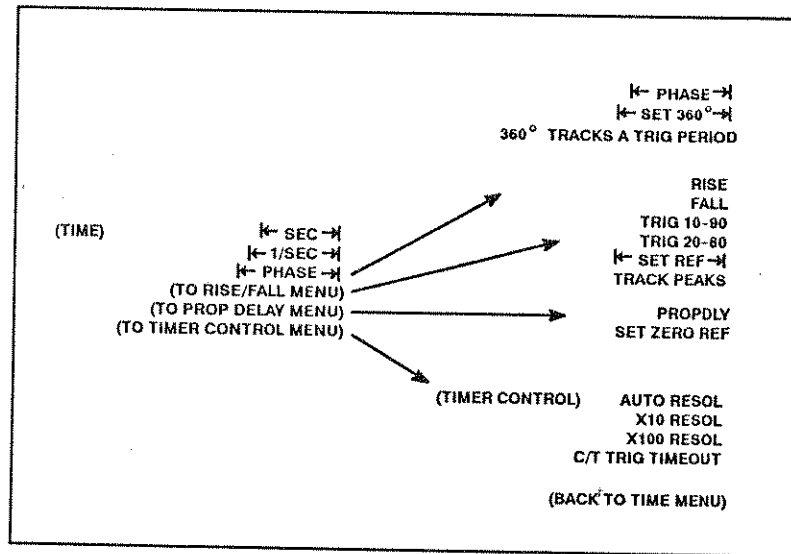

Time Measurement Menus.

In A Horizontal MODE, cursors are always used to make **← SEC →**, **← 1/SEC →**, and **← PHASE →** measurements. If one of these three measurements is selected while in ALT horizontal mode, the C/T will be used to measure the time difference from the reference delay (A sweep start to B

Operators Familiarization

sweep start), to the delta delay (A sweep start to B delta sweep start); intensified zones appear in the A sweep trace in ALT horizontal mode to indicate these time intervals. The ← OR DELAY TIME control knob positions both delay times (reference and delta) together, and the → control knob positions the independent delta delay.

In ← SEC →, ← 1/SEC →, and ← PHASE → measurements made in ALT Horizontal MODE (and when C/T is used in B Horizontal MODE), all B Trigger modes may be selected, and couplings, levels, and slopes may be controlled. B Trigger SOURCE LEDs are turned off (use the SET MEAS'MT CHANNEL menu to alter the measurement channels). The B Trigger light remains off during C/T measurements. However, indication of proper triggering is shown with a steadily blinking Ct character in the top line of the readout. In ← PHASE → in A Horizontal MODE, if 360° TRACKS A TRIG PERIOD is used, the Ct character stays on continuously (no blinking), the A Trigger light indicates when a proper A Trigger is obtained. If a proper external frequency reference source is plugged into the rear-panel EXT COUNTER/TIMER TIMEBASE INPUT connector, the Ct character will have the ET character above it.

← SEC → — Press to measure the equivalent time difference between the two vertical cursors displayed in the A Horizontal MODE or the two time delays in ALT or B Horizontal mode. The position of both cursors or both delays is controlled by the ← OR DELAY TIME control; the position of the delta cursor or the delta delay is controlled by the → control. The measured time difference between the two cursors or delays is displayed in the crt readout. When Horizontal MODE is ALT or B, the C/T is used to measure the time interval between the two delays (cursors can be used in B Horizontal MODE). When the C/T is used, all B trigger modes are available (the selected mode is the same for both B delay and B delta triggers).

If the Horizontal MODE is X-Y, pressing the ← SEC → button causes the message USE A ALT OR B MODE to be displayed for two seconds. Changing the Horizontal MODE to X-Y after ← SEC → has been activated will cancel the measurement with no message.

← 1/SEC → — Measures the time difference in frequency units (hertz) between the cursor positions in A Horizontal MODE or between the delay-time setting and the delta-delay time setting in either ALT or B Horizontal MODE. When Horizontal MODE is ALT or B, the C/T measures the delta time interval and displays the equivalent frequency (cursors can be used in B Horizontal MODE). When the C/T is used, all B Trigger modes are available, as in ← SEC →. Measurement points are the left ends of the two intensified zones in ALT Horizontal MODE.

← PHASE → — Calls up a lower level menu for phase measurement operation.

Cursor positioning for delay and delta time setting are identical to the **← SEC →** mode. The value displayed for the phase-measurement readout has units of degrees and is calculated by the following formula:

$$\text{Phase (in degrees)} = \frac{(\text{time difference})}{(\text{reference time})} \times 360$$

When selecting the **← PHASE →** measurement, a second menu is displayed to permit the user to set the 360 degree phase measurement reference.

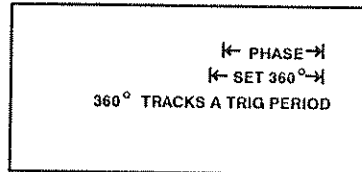

Phase Measurement Set Reference menu.

Select **← PHASE →** to continue with the phase measurement if the current reference setting is correct. When Horizontal MODE is ALT or B, the C/T measures the time difference between the two delays to calculate phase (cursors may be used in B Horizontal MODE). When the C/T is used, all B Trigger modes are available, as in **← SEC →** and **← 1/SEC →** (the selected mode is the same for both B delay and B delta triggers).

To set a new reference manually, press **← SET 360° →** and position the cursors to the new reference value using the **← OR DELAY TIME** and **→** control knobs. After setting the new reference, press **← PHASE →** to continue the phase measurement.

If 360° TRACKS A TRIG PERIOD is selected (underlined), the C/T will ignore the fixed reference (set with **← SET 360° →**) and automatically measure the A trigger period for each phase measurement cycle, and use this as the 360 degree reference. This feature is useful when phase measurements are being performed on signals of varying frequency, and/or highest possible measurement accuracy is desired. The 360° TRACKS A TRIG PERIOD function toggles on or off each time its button is pushed, and can be used while making phase measurements in either A Horizontal MODE (using cursors) or ALT or B Horizontal MODES.

Operators Familiarization

If \leftarrow SEC \rightarrow , \leftarrow 1/SEC \rightarrow , or \leftarrow PHASE \rightarrow measurement is selected while in B Horizontal MODE, Cursor Knob Allocation menu 2 (shown previously in this section under Cursor Volts Measurements) is displayed, and the user can choose one of two possible modes (the selected measurement will start up using the previously selected mode):

If \leftarrow \rightarrow is selected in this menu, the cursor knobs will control the two time cursor positions as in A horizontal mode, except that these cursor positions are scaled to the B sweep time/div setting. The \leftarrow OR DELAY TIME control knob positions both cursors (reference and delta) together, and the \rightarrow control knob positions the independent delta cursor.

If DELAY is selected, the C/T is used to measure the time intervals, as explained above for ALT horizontal mode (except that no intensified zones are displayed in B horizontal mode). The \leftarrow OR DELAY TIME control knob positions both delay times (reference and delta) together, and the \rightarrow control knob positions the independent delta delay.

If horizontal mode is changed from B back to ALT when Cursor Knob Allocation menu 2 is displayed, this menu will disappear, and the measurement will continue, using the C/T to make the measurement.

The following error messages are possible for \leftarrow SEC \rightarrow , \leftarrow 1/SEC \rightarrow , and \leftarrow PHASE \rightarrow , in the modes where the C/T is used:

Message	Reason
NO A SWEEP	No A sweep was detected after timeout (ALT or B Horizontal MODE).
NO B SWEEP	No B sweeps were detected at all (ALT or B Horizontal MODE).
NO B TRIG	No triggered B delay sweep was detected (ALT or B Horizontal MODE).
NO B Δ TRIG	No triggered B delta sweep was detected (ALT or B Horizontal MODE).
NO A TRIG	No A trigger detected after timeout (PHASE in A Horizontal MODE with 360° tracking enabled).
> 10GHz	1/delta time value greater than 10 gigahertz.
< 0.01Hz	1/delta time value less than 0.01 hertz (timeout disabled).

- > 100s Delta time value greater than 100 seconds (timeout disabled).
- A PER > 100s A trigger period greater than 100 seconds (PHASE with 360° tracking enabled, timeout disabled).

(TO RISE/FALL MENU) – selects the rise/fall measurement menu. In this menu, the top two items are the actual measurements. Only one of these two may be selected at a time. When a measurement is selected, the peaks of the signal are automatically measured, the trigger levels are set (as described below), and the measurement starts.

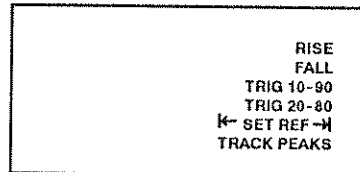

Rise/Fall menu.

The next two menu items determine how the rise/fall trig levels are set; only one of these two may be selected (underlined when selected). When TRIG 10-90 is selected, the rise or fall measurement will trigger at the 10% and 90% points between the positive and negative peaks of the waveform. Selecting TRIG 20-80 will cause the measurement to use the 20% and 80% points.

The K- SET REF -> item toggles on (underlined) or off each time its button is pushed. When on, the K- 0% and 100% -> cursors will appear for manual adjustment of the rise/fall reference levels. When toggled back off again, the rise/fall measurement will resume, using these new levels to calculate and set the 10%-90% (or 20%-80%) trigger levels.

RISE measures the rise time of either CH 1 or CH 2. When this measurement is first selected, the peaks of the signal are measured and stored as the 0% and 100% reference levels. Then the 10% and 90% trigger levels are calculated and set from the reference levels, and the time interval is measured and displayed. During RISE/FALL measurements, all B Trigger mode, source, and coupling LEDs are turned off, and these parameters may not be set. The B Trigger level may not be adjusted; when A is selected, the usual modes, slopes, couplings, and level may be controlled. B Trigger SLOPE is also not settable. B SLOPE LED will be on if doing a RISE measurement and off if doing a FALL measurement.

Operators Familiarization

FALL measurements are the same as **RISE**, except that the fall time is measured.

The following error messages are possible during **RISE** and **FALL** measurements:

Message	Reason
NO A SWEEP [†]	No A sweep was detected after timeout.
NO START	No start trigger was detected.
NO STOP	No stop trigger was detected.
NO RISE	No rising edge was seen by C/T during a rise time measurement, after timeout.
NO FALL	No falling edge was seen by C/T during a fall time measurement, after timeout.
> 100s	Time interval greater than 100 seconds (timeout disabled).
CHANGE A CPLG	A Trigger CPLG set to NOISE REJ (not allowed, because this would cause incorrect measurement triggering).
INCREASE SIGNAL AMPLITUDE	Source signal's pk-pk amplitude is too low for accurate rise/fall measurement; should be at least 4 divisions.
MEAS SOURCE INPUT IS GROUNDED	This message is shown if the source coupling is set to GND.
MEAS SOURCE VAR OUT OF DETENT	Trigger levels cannot be computed correctly unless attenuator is calibrated.

NOTE

For RISE and FALL measurement, if the measurement channel is the same as the A Trigger channel, the A Trigger level is automatically adjusted to try to guarantee that the measurement will trigger properly, as follows:

If A Trigger SLOPE is $_/_$ and measurement is RISE, A Trigger level is set near the 10% level (as determined by the RISE measurement's peak acquisition).

If A Trigger SLOPE is \searrow and measurement is FALL, A Trigger level is set near the 90% level (as determined by the FALL measurement's peak acquisition).

If A Trigger SLOPE is \searrow and measurement is RISE or if A Trigger SLOPE is \swarrow and measurement is FALL, A Trigger level is set near the 50% level.

If the RISE/FALL measurement's peak acquisition should set the 10% and 90% levels incorrectly (for example, if the signal being measured has severe overshoot), the A Trigger level may be set incorrectly as well, causing loss of A sweep. If this happens when A Trigger MODE is AUTO LEVEL, the A sweep will be regained but the RISE/FALL measurement may not be triggering properly. In this case (if the signal overshoot isn't too bad), the \leftarrow SET REF \rightarrow function can be selected to manually set the 0% and 100% levels.

NOTE

RISE and FALL time measurements may have trouble triggering on signals that are around 50 MHz or higher. If this happens, try changing A Trigger SLOPE and/or A Trigger LEVEL.

TRIG 10-90 is the default when RISE or FALL is first called up. When selected, the C/T will set the trigger levels at the 10% and 90% points between the 0% and 100% reference levels.

TRIG 20-80 may be selected after a RISE or FALL measurement has been started up. When selected, the trigger levels are recomputed for the 20% and 80% points between the 0% and 100% reference levels. Selecting either TRIG 10-90 or TRIG 20-80 does not cause another peak acquisition to occur. Instead, the old 0% and 100% reference levels are used.

\leftarrow SET REF \rightarrow may only be selected after a rise or fall measurement has been started up. When selected, the RISE/FALL measurement halts, the message ADJUST REF CURSORS is displayed, and the \leftarrow 0% and 100% \rightarrow cursors appear. The \leftarrow and \rightarrow cursor-positioning knobs may then be adjusted until the desired 0% and 100% reference levels are set. To restart the RISE/FALL measurement, either press the \leftarrow SET REF \rightarrow menu button again or press the RISE or FALL menu button. The new 10%/90% (or 20%/80%) levels will be calculated and set, and the RISE/FALL measurement will continue.

Operators Familiarization

TRACK PEAKS, when selected, will automatically track the waveform peaks and adjust the A Trigger level. Selecting **←SET REF→** will turn TRACK PEAKS mode off.

(TO PROP DELAY MENU) — selects the propagation delay menu. In this menu, **PROPDLY** is the actual measurement.

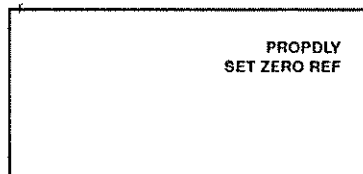

Propagation Delay menu.

PROPDLY measures propagation delay between two trigger sources. When first selected, the peaks of each B Trigger source are acquired and the trigger levels are set; then the measurement starts. B Trigger MODE is not settable, and the B Trigger MODE LEDs are turned off, as are the B Trigger SOURCE LEDs. B Trigger SLOPE and CPLG are settable. B Trigger LEVEL may be set manually after the measurement starts. The triggering range is the same as in B NORM Trigger MODE. The following error messages are possible:

Message	Reason
NO A SWEEP	No A sweep was detected after timeout.
NO START	No start trigger was detected.
NO STOP	No stop trigger was detected.
> 100s	Time Interval greater than 100 seconds (timeout disabled).

SET ZERO REF is a measurement modifier that toggles on (underlined) or off whenever this menu item button is pushed. When turned on, an initial propagation measurement is made by the C/T, and saved as a zero reference. Thereafter (until toggled off), all propagation delay measurements will have this zero reference value subtracted from them. This is useful for zeroing out delay mismatches between channels and probes.

NOTE

For PROPDLY measurement, if the START measurement channel is the same as the A Trigger channel, then A Trigger level is automatically adjusted to try to guarantee that the measurement will trigger properly, as follows:

If A Trigger SLOPE is the same as the measurement's B START slope, the A Trigger level is set near the B START trigger level.

If A Trigger SLOPE is \sim and B START SLOPE is $_$, or if A Trigger SLOPE is $_$ and B START SLOPE is \sim , A Trigger level is set near the 50% level.

(TO TIMER CONTROL MENU)—selects a menu that allows resolution magnifiers to be selected for the C/T-based versions of the time measurements. Only one of the three resolution magnifiers may be selected at a time. The selected resolution magnifier gets underlined. See the C/T Control Menu discussion for a description of resolution magnifier operation.

(TIMER CONTROL)	AUTO RESOL
	X10 RESOL
	X100 RESOL
	<u>C/T TRIG TIMEOUT</u>
	(BACK TO TIME MENU)

Timer Control menu.

Each press of the C/T TRIG TIMEOUT item button toggles this function on and off. Timeout mode gets underlined when it is toggled on. Toggling timeout mode in this menu also changes it in the (C/T CONTROL) menu. The (TIMER CONTROL) menu stays up, unless (BACK TO TIME MENU) is selected. See the C/T Control Menu discussion for the description of this function.

Counter/Timer

Press the COUNTER TIMER button to call up the C/T measurement choices.

In the (CTR/TIMER) menu, selecting a measurement will cause the menu to disappear (if menus are configured to clear after selection). Selecting TOTALIZE causes the totalize RESET label to appear by the top menu item

Operators Familiarization

button (if menus are configured to disappear). While the totalize measurement is running, the RESET label will stay on screen in the absence of any other menu. Canceling the totalize measurement will also cancel the RESET label. The RESET function is momentary, so the label never gets underlined. If another menu is called up then canceled, the RESET label reappears.

C/T Measurement Menu Page 1

(CTR/TIMER)	FREQ PERIOD WIDTH TOTALIZE FREQ RATIO (TO GATED MEASMT MENU)	RESET
-------------	---	-------

Counter/Timer Menu.

Totalize Reset Menu.

For these measurements, all B trigger modes operate as usual for triggering the C/T. B source LEDs are turned off. The measurement source channels can be altered in the SET MEAS'MT CHANNEL menu. All B coupling modes may be used, and B slope may be changed to control which edge polarity triggers the C/T. The B trigger light remains off during C/T measurements. However, indication of proper triggering is shown with a steadily blinking Ct character in the top line of the readout. If an external frequency reference source is plugged into the rear-panel EXT C/T REFERENCE INPUT BNC, the Ct character will have the ET character above it.

In TOTALIZE, the Ct character stays on continuously, and B AUTO LEVEL MODE only works when measurement is first selected. After that, no indication is given if B trigger is lost. However, B AUTO LEVEL MODE may be reselected to acquire a new trigger level.

FREQ – Measures the frequency of the selected source channel.

PERIOD – Measures the period of the selected source channel.

WIDTH – Measures the width of the selected source channel.

TOTALIZE – Displays a running count of trigger edges from the selected source channel.

NOTE

The totalize count is reset to zero whenever a front panel switch/button is moved/pushed.

The following error messages may be displayed for the C/T measurements:

Message	Reason(s)
NO B TRIG	No start trig was detected after timeout. No stop trig was detected after timeout.
< 0.01Hz	Frequency of measured signal less than 0.01 Hertz (timeout disabled).
> 100s	Period or width of measured signal greater than 100 seconds (timeout disabled).
> 999999999	Totalize count greater than 999999999.

FREQ RATIO— Measures the frequencies of the two source channels and displays their ratio. Possible error messages:

Message	Reason(s)
NO CHx TRIG	No start trig was detected after timeout, while trying to measure chx frequency. No stop trig was detected after timeout, while trying to measure chx frequency.
NO CHy TRIG	No start trig was detected after timeout, while trying to measure chy frequency. No stop trig was detected after timeout, while trying to measure chy frequency.
CHx < 0.01Hz	Frequency of chx signal less than 0.01 Hertz (timeout disabled).
CHy < 0.01Hz	Frequency of chy signal less than 0.01 Hertz (timeout disabled).
> 999999999	Frequency ratio greater than 999999999.

(TO GATED MEASMT MENU)— Causes (CTR/TIMER PG 2) menu to appear.

Gated C/T Measurement Menu Page 2

When the (CTR/TIMER PG 2) menu is up, selecting a measurement will start the measurement, but leave the menu up. The selected measurement item is underlined.

GATED FREQ— Measures the frequency of that portion of the selected source channel that appears inside the intensified zone.

Operators Familiarization

GATED PERIOD— Measures the period of that portion of the selected source channel that appears inside the intensified zone.

GATED WIDTH— Measures the width of that portion of the selected source channel that appears inside the intensified zone.

GATED EVENTS— Displays an averaged count of the number of trigger edges from the source channel that occur inside the intensified zone.

These error messages are possible for gated measurements, in addition to those shown above for the nongated versions:

Message	Reason(s)
NO A TRIG	No A sweep was detected after timeout, in gated measurements.
> 999999999	Gated event count greater than 999999999.
(TO C/T CONTROL MENU)	Causes (C/T CONTROL) menu to appear.

(CTR/TIMER PG 2) GATED FREQ GATED PERIOD GATED WIDTH GATED EVENTS (BACK TO PREVIOUS MENU) (TO C/T CONTROL MENU)	(C/T CONTROL) INTENSIFY GATE INTENSIFY CTR AUTO RESOL X10 RESOL X100 RESOL C/T TRIG TIMEOUT
---	---

Gated C/T Menu.

C/T Control Menu.

C/T Control Menu

(Descriptions are applicable for timer control menu also; however, INTENSIFY GATE and INTENSIFY CTR are not available in that menu.)

The C/T control menu contains measurement modifier functions that can increase the versatility of C/T measurements. The first two menu items are applicable only to gated C/T measurements. Only one of these two items can be selected at a time.

INTENSIFY GATE—When a C/T measurement is first called up, this item is selected by default. When selected, an intensified zone will appear on the A sweep display of the channel that the C/T is measuring. The position and width of this intensified zone can be altered in the same manner as in gated Volts measurements. The C/T will only measure trigger edges that occur somewhere inside this zone.

INTENSIFY CTR—When this is selected, the gate signal generated by the C/T hardware will control the position and width of the intensified zone, thus providing an unambiguous display of what the C/T is actually measuring.

The next three menu items allow the selection of a resolution magnifier. Only one of the three may be selected at a time. All C/T measurements except **FREQ RATIO** and **TOTALIZE** can utilize resolution magnifiers. A C/T measurement must have been previously selected before a resolution magnifier selection will have any effect.

AUTO RESOL—This is the default setting when a C/T measurement is first called up. The C/T uses a fixed measurement time interval (approximately 320 milliseconds, or 1 period of the trigger signal, whichever is larger, for single channel measurements; approximately 600 milliseconds for dual channel measurements). The resolution of the measurement is then calculated, and as many fully-resolved digits as possible are displayed.

X10 RESOL—When selected, the C/T will make one trial measurement using the fixed measurement time interval, and calculate and display as many fully-resolved digits as possible. Based on the results of this measurement, it is determined whether or not another digit of resolution is possible. It is possible if:

1. The number of digits displayed after the trial measurement is at least 1 less than the maximum number of digits displayable for that measurement, and:
2. If **PERIOD** measurement, the units of the least-significant digit (LSD) are larger than 100 attoseconds (100×10^{-18} sec), or if any other time-interval measurement, the units of the LSD are larger than 1 picosecond (10^{-12} sec).

If it is not possible, the message **NOT POSSIBLE** → is displayed to the left of the **X10 RESOL** menu label for approximately one second, then the **X10 RESOL** label is deselected and the **AUTO RESOL** label is selected (underlined), and the measurement proceeds in auto resolution mode.

Operators Familiarization

If the selected mode is possible, the measurement time interval required to get one more fully-resolved digit is calculated. If this time is greater than 5 seconds, the message MEASMT TIME XXXXs is displayed to the left of the X10 RESOL label, where XXXX is this measurement time interval in seconds. If this time interval is greater than 9999 seconds, the message MEASMT TIME >9999s is displayed instead. The measurement then proceeds using this new measurement time interval.

X100 RESOL — When selected, the C/T will make one trial measurement using the fixed measurement time interval, and calculate and display as many fully-resolved digits as possible. Based on the results of this measurement, it is determined whether or not two more digits of resolution are possible. It is possible if:

1. The number of digits displayed after the trial measurement is at least 2 less than the maximum number of digits displayable for that measurement, and:
2. If PERIOD measurement, the units of the least-significant digit (LSD) are larger than 1 femtosecond (1×10^{-15} sec), or if any other time-interval measurement, the units of the LSD are larger than 10 picoseconds (10×10^{-12} sec).

If it is not possible, the message NOT POSSIBLE → is displayed to the left of the X100 RESOL menu label for approximately one second, then the X100 RESOL label is deselected and the X10 RESOL label is selected (underlined). If the trial measurement results do not allow X10 RESOL mode either, NOT POSSIBLE → is displayed by the X10 RESOL label for one second, the mode is automatically switched to AUTO RESOL, and the measurement proceeds in auto resolution mode. If X10 RESOL mode is possible, the measurement will proceed as described above for X10 RESOL mode.

If X100 RESOL mode is possible, the measurement time interval required to get two more fully resolved digits is calculated. If this time is greater than 5 seconds, the message MEASMT TIME XXXXs is displayed to the left of the X100 RESOL label, where XXXX is this measurement time interval in seconds. If this time interval is greater than 9999 seconds, the message MEASMT TIME >9999s is displayed instead. The measurement then proceeds using this new measurement time interval.

C/T TRIG TIMEOUT — This is the last item in the C/T control menu. Each time the menu button for this item is pressed, the item is either selected (underlined) or deselected (not underlined). When selected (the default

setting when a C/T measurement is first called up) the C/T will wait for approximately 400 milliseconds to receive a start trigger, or, if a start trigger has been received, the C/T will wait that long for a stop trigger (C/T measurements start and stop synchronously with the trigger signal being measured). If the C/T times out while waiting for a trigger edge, an appropriate error message is displayed (see earlier section on C/T error messages). To measure a signal with a duration longer than 400 milliseconds, C/T TRIG TIMEOUT can be toggled off. This allows signals to be measured that have durations up to 100 seconds (actually, 99.999999 seconds).

Conditions for Cursors Display

The following information is an aid in understanding the order in which the menu measurement cursors are displayed.

Measurement Cursors

One or two measurement cursors may be displayed if any one of the following conditions is met:

VOLTMETER CH1/CH2—TRACK MEASMT is underlined and measurement source channel is on and the VOLTS/DIV VAR control in detent.

CURSOR VOLTS—Measurement source channel must be on and VOLTS/DIV VAR control in detent.

TIME—Horizontal MODE is in A or Horizontal MODE is ALT or B and ← → is selected.

Track Trig Lvl Cursors

If less than two cursors are currently displayed, trigger level cursor(s) for the B Trigger C/T measurement source(s) will be displayed if:

TRACK TRIG LVL is underlined, and

the Horizontal Mode is valid for selected C/T measurement, and

the Trigger Mode and Coupling are valid.

Operators Familiarization

If less than two cursors are currently displayed, trigger level cursor for the A Trigger will be displayed if:

- TRACK TRIG LVL is underlined and the Horizontal Mode is A or ALT, and
- the Trigger Mode, Source, and Coupling are valid, and
- the A trig source channel is not the same as the C/T measurement channel while a C/T measurement is running and displaying a B trig cursor.

If less than two cursors are currently displayed, a trigger level cursor for the B Trigger will be displayed if:

- TRACK TRIG LVL is underlined, and
- the Horizontal Mode is ALT or B, and
- the Trigger Mode, Source, and Coupling are valid.

Track *m* Cursors

If one or no measurement or trigger level cursor is displayed, up to two ground cursors (not more than two cursors total) may be displayed if the following conditions are met:

TRACK *m* is underlined and CH 1 and/or CH 2 Vertical MODE is selected.

Trigger-source channel (CH 1 and/or CH 2) VOLTS/DIV VAR control is in detent.

Behavior for Horizontal Mode Changes

If the Horizontal MODE is changed to a mode that cannot be used for the active measurement, that measurement will be canceled without a message being displayed. Returning to a mode that may be used and pressing the LAST MEAS'MT button will restore the canceled measurement mode (if no other measurement selection is made first). See Table 3-1 for compatible and incompatible modes.

Gated-voltage measurements will not run in SGL SEQ Trigger MODE. Any gated Volts measurement that is active will be canceled if SGL SEQ Trigger MODE is selected. If a gated-voltage measurement is selected while SGL SEQ is also selected, the message NOT ALLOWED IN SSEQ is displayed for

two seconds (only if readout is configured to remain on in SGL SEQ).
 + PEAK, -PEAK and PK-PK will not run in ALT or B Horizontal MODE unless
 B Trigger MODE is RUNS AFTER.

Table 3-1
Behavior for Horizontal MODE Changes

Measurement Mode	Compatible Horizontal Modes	Incompatible Horizontal Modes
← VOLTS →, <i>↗</i> VOLTS →	A, ALT, B, XY	
← SEC →, ← 1/SEC →, ← PHASE →	A, ALT, B	X-Y
DC	A, X-Y	ALT, B
+ PEAK, -PEAK, PK-PK	A, ALT, B, X-Y	
GATED + PEAK, GATED -PEAK, and GATED PK-PK	A	ALT, B, X-Y
FREQ, PERIOD, WIDTH, TOTALIZE, and FREQ RATIO	A	ALT, B, X-Y
GATED C/T (FREQ, PERIOD, WIDTH, and EVENTS)	A	ALT, B, X-Y
RISE/FALL and PROP DELAY	A	ALT, B, X-Y

Measurement Compatibility and Error Messages

Channel 1 or Channel 2 Voltmeter measurements, except DC, cannot be made when the signal is larger than the range of the B trigger level. The displayed error message is OUCH—TURN VOLTS/DIV CCW.

NOTE

When making DC measurements, overranged signals will not cause an error message to be displayed but can display incorrect voltage readings. To obtain accurate DC readings keep the waveform within the graticule limits.

Operators Familiarization

The Channel 1 or Channel 2 Voltmeter measurement of DC cannot be made with the Input COUPLING set to AC; the displayed error message is CH 1 (or CH 2) — SELECT DC COUPLING. If GND Input COUPLING is in use, a ground symbol is displayed after the readout value.

NOTE

A maximum of eight waveforms are allowed to be displayed when making Voltmeter measurements of DC, + Peak, -Peak, or Peak-to-Peak measurements while in Horizontal ALT Mode.

The ADD mode waveforms will not be displayed while making voltage measurements if Vertical Channels 1 through 4 are being displayed with their Delayed waveforms (Horiz ALT Mode selected).

For + PEAK, -PEAK, and PK-PK measurements, the ac symbol (\sim) will be displayed for AC Input COUPLING, and the ground symbol will be displayed for GND Input COUPLING. The symbols will be displayed after the readout units.

A question mark (?) will be displayed in front of the measurement value any time the measurement is uncertain. This can happen in ALT or B MODE + PEAK, -PEAK, and PK-PK measurements.

The following measurements cannot occur when the VOLTS/DIV VAR control for the channel being measured is not in the detent position: + PEAK, -PEAK, PK-PK, DC, GATED + PEAK, GATED -PEAK, GATED PK-PK, \leftarrow VOLTS \rightarrow , and ∇ VOLTS \rightarrow . The displayed error message is MEAS SOURCE VAR OUT OF DETENT.

The following measurements cannot occur when the SEC/DIV VAR control is out of the detent position: \leftarrow SEC \rightarrow , \leftarrow 1/SEC \rightarrow , \leftarrow PHASE \rightarrow , and \leftarrow SET 360° \rightarrow . The displayed error message is VAR SECS/DIV OUT OF DETENT.

When in ALT or B Horizontal MODE, no C/T measurement is running, and the B Trigger MODE is not RUNS AFTER, a greater-than symbol (>) will appear before the delay-time readout. The readout value displayed is the delay time between the A trigger and the time a B trigger can be accepted by the trigger system. A question mark (?) will appear in front of the delay time readout for delay measurements when the DELAY time is set to 0.25 division or less from the beginning of the sweep.

If the oscilloscope is not triggered when a gated voltage measurement mode is selected, the following error message is displayed: LO REP RATE - STILL TRYING.

This can happen if the selected trigger channel has no trigger signal applied in NORM Trigger MODE or if the Trigger LEVEL control is not set to obtain a triggered display. An improperly triggered display in either AUTO LEVEL or AUTO Trigger MODE will cause the measurement readout value to be unstable, but no error message will be displayed.

Measurements in Single Sequence Mode

The following measurements run continuously during SGL SEQ Trigger MODE: DC, +PEAK, -PEAK, PK-PK, \leftarrow VOLTS \rightarrow , and $\#$ VOLTS \rightarrow . The following run continuously in the A Horizontal MODE (with cursors): \leftarrow SEC \rightarrow , \leftarrow 1/SEC \rightarrow , and \leftarrow PHASE \rightarrow . Of the C/T measurements, only TOTALIZE runs continuously in SGL SEQ mode.

For all other C/T measurements, including \leftarrow SEC \rightarrow , \leftarrow 1/SEC \rightarrow , and \leftarrow PHASE \rightarrow in ALT or B Horizontal MODES, one measurement cycle will be performed and the result held in the readout display (if readout is configured to remain on in SGL SEQ mode) each time SGL SEQ Mode is reentered.

The readout and/or cursors are displayed briefly during SGL SEQ Mode for making a photographic record (or they may be configured to remain on—see the discussion on Configure Menu in the Service Menu Features part of this section). The displayed readout is the value of the measurement at the instant it is displayed.

GATED +PEAK, GATED -PEAK, and GATED PK-PK measurements are not available during single sequence mode and will be canceled if active when SGL SEQ is selected.

B Trigger AUTO LEVEL acquisitions do not occur when the A Trigger MODE is SGL SEQ.

Service Menu Features

Most of the items in the SERVICE MENU are for diagnostics, troubleshooting, and calibration. However, there are four menu selections that are also for operational use: CONFIGURE, SELF CAL MEASUREMENTS, MAKE FACTORY SETTINGS, and LOAD STORE/RECALL SETUPS. Press the top and bottom menu-item select buttons to display the SERVICE MENU.

Operators Familiarization

SERVICE MENU/	
DIAGNOSE	↑ MENU
CONFIGURE	↓
SELF CAL MEASUREMENTS	
INTERNAL SETTINGS MENU/	
EXERCISER MENU/	QUIT

Service Menu.

Press the buttons opposite the displayed up- and down-arrows to move the displayed underline to the desired menu item of CONFIGURE, SELF CAL MEASUREMENTS, or INTERNAL SETTINGS MENU. Press RUN or SELECT. At any point in the CONFIGURE routine, select END to return the display to the SERVICE MENU. Select QUIT from the INTERNAL SETTINGS MENU or the main SERVICE MENU to return to the oscilloscope mode.

Configure Menu

The operating-mode features in the CONFIGURE menu seldom need to be changed.

CONFIGURE	END	
ACQUIRE IN PEAK DETECT MODE?	YES	KEEP MENU ON WHEN MEAS SELECTED?
	NO	RECALL ONLY? (IN STORE/RECALL)
RUNNING		KEEP MENU ON WHEN S/R SELECTED?
		KEEP READOUT ON IN SGL SEQ?
		INITIALIZE TIME CURSORS/DELAYS?
		PRESET TV TRIG SLOPE FOR -SYNC?
		PRESET TV TRIG SLOPE FOR +SYNC?

Configure Menu and questions.

Select CONFIGURE from the SERVICE MENU and answer YES or NO to each of the displayed questions. For each answer, YES or NO will be underlined to indicate how the instrument is presently configured. After YES or NO is selected, the next configuration choice is displayed. After answering the last question, the SERVICE MENU display returns. To exit from the

CONFIGURE menu without answering the remaining question(s), press the END button or the CLEAR DISPLAY button. The CONFIGURE items are listed as follows:

ACQUIRE IN PEAK DETECT MODE? (Factory Settings default is YES.) Selecting YES selects the peak detect mode for the hardcopy. Acquisition mode for the GPIB is selecting through the GPIB bus.

If NO is selected, the acquisition mode for the hardcopy is sample.

KEEP MENU ON WHEN MEAS'MT SELECTED? (Factory Settings default is NO.) Selecting NO clears the measurement menu items from the display after a measurement function is selected. Measurement cursors remain displayed. The AUTO TRACKING MENU remains on after a selection has been made.

Selecting YES allows a measurement menu to remain displayed after a function is selected. The measurement menu items can be removed at any time by pressing the CLEAR DISPLAY button once.

RECALL ONLY (IN STORE/RECALL)? (Factory Settings default is NO.) Selecting NO displays the Store/Recall Setup menu when the STORE/RECALL SETUP button is pressed. From the Store/Recall Setup menu you can store, edit, and recall front-panel setups.

Selecting YES displays the Recall Only menu when the STORE/RECALL SETUP button is pressed. From the Recall Only menu you can easily step through all of the stored front-panel setups.

KEEP MENU ON WHEN S/R SELECTED? (Factory Settings default is NO.) Selecting NO clears the menu from the display when some store/recall setup functions are selected.

Selecting YES keeps the Store/Recall Setup menu on the screen when using the store/recall setup functions. The menu can be removed at any time by pressing the CLEAR DISPLAY button once.

KEEP READOUT ON IN SGL SEQ? (Factory Settings default is NO.) Selecting NO will keep the readout off in Single-Sequence Trigger Mode. This mode is useful for single-sequence waveform photography. The readout is displayed briefly after the sequence is completed to expose the film, then cleared to prevent overexposure.

Selecting YES keeps the readout on when in the Single-Sequence Trigger Mode. This mode lets you view any of the measurements that continue to be made during SGL SEQ trigger mode even if no waveform is being displayed. The front panel control settings may also be made in

Operators Familiarization

SGL SEQ without having to select a different Trigger Mode to see the readouts as the controls are changed. The measurement readout is especially useful for the Voltmeter measurements because the signal on the selected input channel is continually monitored. (GATED Voltmeter measurements are not permitted in SGL SEQ Trigger MODE.)

INITIALIZE TIME CURSORS/DELAYS? (Factory Settings default is YES.) If YES is selected, with the following conditions:

← SEC →, ← 1/SEC →, or ← SET 360 ° → is selected, and none of the following conditions is true:

more than one channel is selected and the Horizontal MODE is not "A", or

A Trig MODE is VERT and Vertical MODE is ADD, or

more than one channel is selected and the A Trig MODE is VERT, or

Horizontal MODE is B and cursors have been selected,

the cursors or delays will be initialized as follows:

If the reference delay is appropriate to the measurement mode, it will be set inside a window that extends from 0.25 division after sweep start to one period of the trigger signal left of the 10th division after sweep start, if this window exists. If there is no window, it will be left at its original position.

If the reference cursor is appropriate to the measurement mode, it will be set as specified for the reference delay with the assumption that the sweep start is at the left graticule line.

The delta cursor or delta delay, as appropriate to the measurement, will be set one period of the trigger signal to the right of the reference cursor or delay, if possible; if not possible, it will remain unchanged.

Cursors and delays may remain unchanged if:

1. there is no A trigger, or
2. the trigger source channel's signal has a repetition rate slower than 20 Hz or faster than 100 MHz.

Under the conditions of 1 and 2 above, a question mark may appear before the measurement value and remain until the → or ← knob is moved. The user should, however, always inspect the display to

determine that the cursors or intensified zones mark appropriate places on the waveform. There are waveforms, such as very narrow pulses or multiple crossings of the trigger level within one period, that can cause erroneous initialization with no question mark.

When LAST MEAS'MT is selected and the last measurement was \leftarrow SEC \rightarrow or \leftarrow 1/SEC \rightarrow , or the last action was \leftarrow SET 360° \rightarrow , cursors or delays will be reinitialized as above if configured to initialize time measurements and the instrument's mode is appropriate.

Accuracy of the cursor or delay placement is as specified for the selected measurement.

PRESET TV TRIG SLOPE FOR -SYNC? (Factory Settings default is YES.) Selecting YES will cause the trigger slopes to preset to \sim when TV trig mode is selected, and the configure menu is exited. If NO is selected, a second question is presented:

PRESET TV TRIG SLOPE FOR + SYNC? (Factory Settings default is NO.) Selecting YES will cause the trigger slopes to preset to \surd when TV trig mode is selected, and the configure menu is exited. If NO is selected, the scope will not use a preset slope when a TV trig mode is selected.

When the final question is answered, the SERVICE MENU display returns.

Self Cal Measurements

This selection consists of SELF CAL HARDCOPY procedure, SELF CAL VOLT MEASUREMENTS routine, and SELF CAL TIME MEASUREMENTS routine. The SELF CAL HARDCOPY procedure characterizes channels 1, 2, 3, and 4, and horizontal position. Before performing any SELF CAL, disconnect all input signals. The SELF CAL VOLT MEASUREMENTS and SELF CAL TIME MEASUREMENTS routines do a self-characterization of the vertical channels 1 and 2 and the horizontal timing. With the selection of SELF CAL MEASUREMENTS, the message CALIBRATE DIGITIZER? is displayed. When YES is selected, the SELF CAL HARDCOPY procedure is performed first followed by the SELF CAL VOLT MEASUREMENTS and SELF CAL TIME MEASUREMENTS routines. Selecting NO will bypass the SELF CAL HARDCOPY procedure and run the SELF CAL VOLT MEASUREMENTS and SELF CAL TIME MEASUREMENTS routines.

These routines and procedures store calibration constants that set the accuracy of the internal measurement system. Hardcopy and voltage measurements can be calibrated separately from the timing measurement by selecting the SELF CAL item from the VOLTMETER Measurement Menu. Timing measurement may also be calibrated separately by selecting SELF CAL item from the TIME Measurement Menu.

NOTE

CALIBRATE MEASUREMENTS or SELF CAL can be performed any-time after a 20-minute warmup to ensure the accuracy stated in Section 6.

Internal Settings Menu

The INTERNAL SETTINGS MENU consists of MAKE FACTORY SETTINGS, LOAD STORE/RECALL STORED SETUPS, and ADJUST VERTICAL OUTPUT. All INTERNAL SETTINGS menu items, except ADJUST VERTICAL OUTPUT, are for use by the operator. To return to the main SERVICE MENU, press the up-arrow key to underline INTERNAL SETTINGS MENU and press the button again to display the SERVICE MENU. To return to the oscilloscope mode, select QUIT from the INTERNAL SETTINGS MENU or SERVICE MENU, or press the CLEAR DISPLAY button.

MAKE FACTORY SETTINGS— Sets the front-panel controls and menu configurations as described in Appendix A.

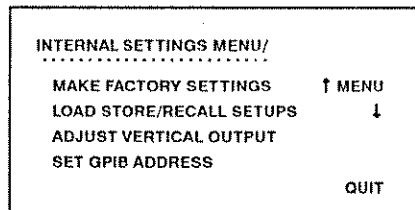

Internal Settings Menu.

LOAD STORE/RECALL SETUPS—Loads eight factory front-panel setups into the Store/Recall memory. The setups are stored in memory locations 01 through 08, and all previously stored setups in locations 01 through 20 will be deleted. When you select this item, a message will be displayed that will give you the choice to continue or not continue with the loading of the factory setups. Don't select YES unless you are sure that you want to delete all of your previously stored setups.

ADJUST VERTICAL OUTPUT—This menu item is to be used by a service technician during calibration and troubleshooting. It is not an operational function.

SET GPIB ADDRESS—Sets the GPIB address number for the 2252. Valid numbers are from 00 to 31. Selecting 31 will remove the instrument off the bus. The factory default GPIB address number is 01.

Store/Recall Setup Features

The menu-driven Store/Recall Setup system allows you to store and recall up to 20 front-panel setups. Front-panel setups are user installed and named, and may be arranged in groupings of measurement setups (sequences) for performing a variety of repetitive tests. Figure 3-4 illustrates a typical beginning arrangement of tests and sequences with the factory setups installed.

	NO.	TEST NAME	STATUS
Factory Setups	01	ADJUST FLAT TOP	blank
	02	AUTO TO 100 MHZ	blank
	03	SELECTABLE TIME	blank
SEQ 1	04	MANUAL D VOLTS	blank
	05	SET CURSORS	blank
	06	ADJUST CH1 V/D	blank
User Added Setups	07	SELECT DELAY	blank
	08	MATCH EDGES	END SEQ
	09	CH1 FREQ	blank
SEQ 2	10	CH2 FREQ	blank
	11	XY CH2 VS CH1	END SEQ
	12	CH1 FALL TIME	blank
SEQ 3	13	CH2 RISE TIME	END SEQ
	14		DELETED
	15		
Empty Setup Memories	16		
	17		
	18		
	19		
	20		

Nonstored locations are not accessed when sequencing.
All 20 locations may be user added and sequenced as needed.

7837-08

Figure 3-4. Typical Store/Recall Setup sequencing.

Operators Familiarization

There are three different configurations that may be selected to permit different accesses to the STORE/RECALL SETUP features. The first is the Recall Only menu for use after the setups have been installed and no further changes are to be routinely made.

The Recall Only menu lets you recall the test sequences to perform a series of repetitive tests. Only the name and number of the stored record are displayed along with up and down arrows for selecting higher or lower numbered setups in a test sequence. If more than one sequence of setups is stored, a menu item (NEXT SEQ) also appears which allows you to change sequences. See the Recall Only Menu discussion.

When configured for full access to the STORE/RECALL SETUP feature, stored setups can be recalled, altered, deleted, or arranged in sequences. This configuration is used when first installing the setups and arranging the sequences. The Store/Recall menu remains displayed after a selection is made so that it is convenient to use for making the initial front panel setups or making extensive changes to existing setups.

The Store/Recall Setup menu with access to Recall Only operates the same as the Store/Recall Setup menu except that the menu display is cleared when the STORE or RECALL item is selected. The first choice in the menu when configured in this manner is SEQUENCE, and, when selected, accesses the Recall Only menu for sequencing the setups. This configuration is useful for making minor changes to existing setups before beginning a measurement series.

Factory Stored Setups

When the 2252 is shipped from the factory, the Store/Recall Setup memory contains eight stored front-panel setups. These factory setups are stored in setup locations 01 through 08. The setups may be recalled and used for demonstration and training, or they may be used as a basis for setups which suit your specific applications. Appendix A lists the front-panel settings for each factory setup. The factory stored setups can be restored to the Store/Recall Setup memory if desired. See Service Menu Features, Internal Settings Menu, LOAD STORE/RECALL SETUPS in this section.

NOTE

Restoring the factory-stored setups to the STORE/RECALL memories erases any user-added setups. A warning message to this effect is displayed when the feature is used.

Recall Only Menu

The Recall Only menu is displayed when the CONFIGURE menu has been appropriately set and there is at least one setup stored in the store/recall memory. The Recall Only menu is used when a number of front panel settings for making a series of measurements have been stored in the correct sequences and no changes to the stored setups are wanted. When configured for Recall Only, the simplified recall only menu will appear when the STORE/RECALL SETUP button is pressed.

A second way to reach the Recall Only menu is from the STORE/RECALL menu when the SEQUENCE choice is displayed in the list. The SEQUENCE choice is given in the Store/Recall menu when the oscilloscope is configured for a menu to be cleared after a selection has been made in the Store/Recall menu. A press of the SEQUENCE menu-select button displays the recall only menu for sequencing through the front-panel setups for a series of measurements. As with all menus, the Recall Only menu can be removed from the display by pressing the CLEAR DISPLAY button.

To configure the oscilloscope to access the Recall Only menu:

1. Press the top and bottom Menu-Select buttons to display the SERVICE MENU.
2. Call up the CONFIGURE menu (see the Configure Menu discussion in SERVICE MENU for the details of how the CONFIGURE menu operates).
3. Follow this step to permit the Recall Only menu to be called up directly with the STORE/RECALL SETUP button. This configuration allows no access to the STORE features of the STORE/RECALL SETUP function. Use step 4 if you want to be able to select the Recall Only menu from the Store/Recall Setup menu.
 - a. Set:

KEEP MENU ON WHEN MEAS SELECTED	YES or NO
RECALL ONLY? (IN STORE/RECALL)	YES
KEEP MENU ON WHEN S/R SELECTED?	NO
 - b. Press the CLEAR DISPLAY button to exit the SERVICE MENU.
 - c. Press the STORE/RECALL SETUP button to display the Recall Only menu.

Operators Familiarization

4. Follow this step to permit access to the Store/Recall menu with the ability to select the Recall Only menu for sequencing. The SEQUENCE choice appears as the first choice in the Store/Recall menu but access to the STORE function is allowed. This configuration is most useful when making changes to a sequence before a measurement series is started.
 - a. Set:

KEEP MENU ON WHEN MEAS SELECTED	YES or NO
RECALL ONLY? (IN STORE/RECALL)	NO
KEEP MENU ON WHEN S/R SELECTED	NO
 - b. Press the CLEAR DISPLAY button to exit from the SERVICE MENU.
 - c. Press the STORE/RECALL SETUP button.
 - d. Press the SEQUENCE button to display the Recall Only menu.

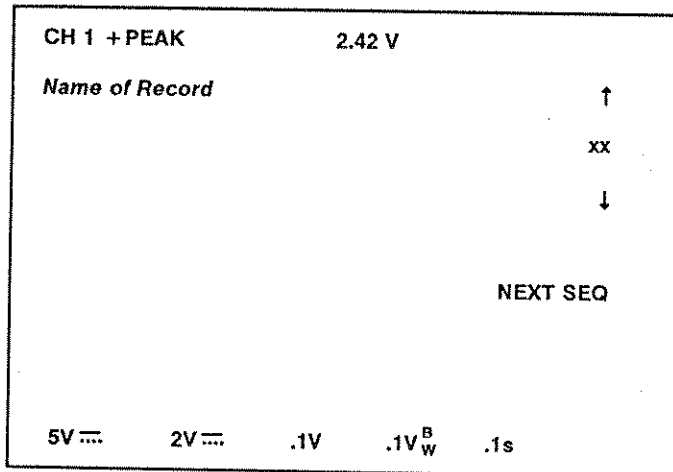

RECALL ONLY menu.

The descriptions of the readout locations and menu items are from top to bottom as follows:

Active Measurement—Indicates the name of the active measurement and the measurement value (top line of readout).

Up-Arrow Button (↑)—Recalls front-panel settings for the next record in the current sequence. If the current record is the last in the sequence (status END or the highest numbered record stored), the next record recalled will be the first record of the current sequence. A sequence starts with either 01 or the first record past a previous record with an END SEQ status.

xx—Recalls the currently displayed record number (xx). The record number will start at 01 when the RECALL ONLY menu is displayed by pressing the STORE/RECALL SETUP button. If the menu is displayed by selecting SEQUENCE from the Store/Recall, the record number will start at the same number as displayed on the Store/Recall Setup menu.

Down-Arrow Button (↓)—Recalls the front-panel settings for the previous record in the current sequence. If the displayed record is the first in a sequence, pressing the down-arrow button will recall the current record.

NEXT SEQ—Changes the current record number to the first step of the next sequence. If presently in the last sequence, pressing NEXT SEQ will change the current record number to 01. This item will not appear if there is only one sequence defined.

Active Front Panel Settings—Indicates the VOLTS/DIV and SEC/DIV settings for the currently active setup (bottom line of readout).

Store/Recall Setup Menu

To configure the oscilloscope to access the full features of the Store/Recall Setup menu when the STORE/RECALL SETUP button is pressed, perform the following procedure:

1. Press the top and bottom Menu-Select buttons to display the SERVICE MENU.

Operators Familiarization

2. Call up the CONFIGURE menu (see the Configure Menu discussion in SERVICE MENU for the details of how the CONFIGURE menu operates).
3. Set:

KEEP MENU ON WHEN MEAS SELECTED	YES or NO
RECALL ONLY? (IN STORE/RECALL)	NO
KEEP MENU ON WHEN S/R SELECTED?	YES
4. Press the CLEAR DISPLAY button to clear the CONFIGURE menu and return to the normal operating mode.
5. Press the STORE/RECALL SETUP button to display the menu.

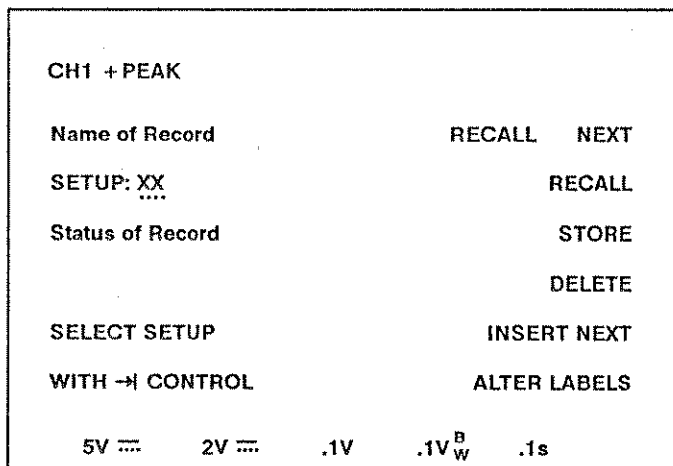

STORE/RECALL Setup menu display.

The descriptions of the readout locations and menu items are from top to bottom as follows:

Active Measurement Display—Indicates the measurement that is currently active (if one is). The measurement value is not displayed.

Name of Record—Name given to the currently displayed record. This is a user-assigned name and it may be altered (see the ALTER LABELS function).

SETUP: xx— Display the setup number from 01 through 20 of the setups. The setups may be scrolled through by rotating the → control.

Status of Record— Indicates the status (blank, EMPTY, END SEQ, or DELETED) of the currently displayed record. The status readout is blank when a front-panel setup is stored at the location and there is no other status to report. EMPTY appears only when there are no stored front-panel setups. END SEQ marks the last setup of a sequence. The END SEQ status is set using the ALTER LABELS function. DELETED appears only on the last setup location, after the DELETE function has been used or a record has been overwritten with the STORE function.

SELECT SETUP WITH → CONTROL— This message tells you to rotate the → control to select a different stored setup number.

RECALL NEXT— Recalls front-panel settings for the next record in the current sequence. If the current record is the last in the sequence (status END SEQ or the highest numbered record stored), the menu item label becomes RECALL FIRST, and, when pressed, the first record of the current sequence will be recalled. A sequence starts with either 01 or the first setup past a previous setup with an END SEQ status.

SEQUENCE— Displayed in place of RECALL NEXT when NO is selected for both the KEEP MENU ON WHEN S/R SELECTED and RECALL ONLY? (IN STORE/RECALL) in the CONFIGURE menu. When SEQUENCE is pressed, the RECALL ONLY MENU is displayed. See Recall Only Menu in this section.

RECALL— Recalls front-panel settings from the current setup number. If the SETUP number location is blank, there are no stored records. A NOTHING STORED message is displayed if RECALL is selected, and the front-panel settings remain unchanged.

STORE— Stores present front-panel settings only at the displayed setup number. The setup name or status of a setup memory are not overwritten by a recalled front-panel setup and must be altered appropriately using the ALTER LABELS function after storing a new setup. Use this function for initially storing at location 01 or for replacing the front-panel settings in any setup number. In most cases, the last setup replaced by the STORE function can be recovered if necessary; see Recovering A Deleted Setup in this section.

DELETE— Deletes the contents of the current setup number. The number of each setup above the deleted one is reduced by one. In most cases, the last setup deleted can be recovered if necessary; see Recovering A Deleted Setup in this section.

Operators Familiarization

INSERT NEXT – Creates a new record of the current front-panel setup and inserts it after the displayed setup number. All setup numbers above the current number are increased by one. The name and status of the new record will be blank and must be entered using the ALTER LABEL function. INSERT NEXT is used storing new front-panel setups in sequence. To change a previously stored setup use the STORE function.

NOTE

If there are already 20 records stored, inserting another record will delete record 20. A message INSERTION WILL CAUSE LOSS OF STEP 20 will be displayed. Selecting INSERT will delete the existing record 20 and replace it with a new one. Selecting ABORT will keep the existing record 20 and not save the new record. If record 20 is displayed, selecting INSERT will cause a message NO MORE STEPS to be displayed.

Active Front Panel Settings – Indicates the VOLTS/DIV and SEC/DIV settings for the currently active setup (bottom line of readout).

ALTER LABELS – Calls up the ALTER LABELS menu to name or alter a currently displayed name or setup status.

ALTER LABELS	
Name of Record	ERASE NAME
SETUP: <u>xx</u>	
Status	TOGGLE STATUS
← MOVES.....	
→ ALTERS CHAR	RETURN

ALTER LABELS menu.

The descriptions of the readout locations and menu items of the **ALTER LABELS** menu are from top to bottom as follows:

Name of Record—Name given to the currently displayed record. A name given to a record can consist of up to 15 characters. The characters available in order are: a space, letters from A to Z, numbers from 0 to 9, a period, and eight special characters ((,), <, >, =, ?, /, Δ).

Characters are selected by placing the underline within the Name of Record brackets < > with the ← OR DELAY TIME control. To select a character over the underline, rotate the → control until the desired character is displayed, then move the underline to the right with the ← OR DELAY TIME control. Repeat the selection procedure until the name of the record is completed.

SETUP: xx—Displays the setup number from 01 through 20 of the displayed record as on page 1 of Store/Recall Setup menu. When the number is underlined with the ← OR DELAY TIME control, the displayed record can be changed with the → control. This allows specific records to be reviewed and altered.

Status of Record—Indicates the status (EMPTY, END SEQ, DELETED, or blank) of the currently displayed record. EMPTY appears only when there are no stored front-panel setups. END SEQ is the end-of-sequence indication. DELETED appears on the last record when it is a record saved from a STORE or DELETE function. A record with the DELETED status cannot be modified. Attempting to do so will display an error message: CANNOT MODIFY DELETED STEP.

← MOVES —This message tells you to rotate the ← OR DELAY TIME control to move an underline through menu-display fields that can be changed by rotating the → control.

→ ALTERS CHAR—This message tells you to rotate the → control to change the information in the selected (underlined) field.

ERASE NAME—Erases the name currently displayed.

TOGGLE STATUS—Toggles status of record between blank and END SEQ. Select END SEQ to mark a record as the last in a sequence.

RETURN—Returns to the Store/Recall Setup menu.

Recovering A Deleted Setup

A setup deleted by a STORE or DELETE function is saved in the store/recall memory for recovery. Only the last deleted setup may be recovered.

Operators Familiarization

Recovery must be done before the STORE or DELETE functions are used again. Also, a setup should be recovered before using the INSERT NEXT function when there are already 19 or more stored setups. A setup that is deleted by the STORE function when 20 setups are stored is not saved and cannot be recovered.

TO RECOVER A DELETED SETUP:

1. Select the Store/Recall Setup menu.
2. Rotate the → control clockwise until the last record is displayed. That record will have a status of DELETED.
3. Press RECALL to recall the front-panel settings for the deleted record.
4. Decide where you want to store the deleted setup. You can replace an existing setup using the STORE function, or you can insert a new setup with the INSERT NEXT function.
 - a. To replace an existing setup, rotate the → control to the setup number that is to be replaced and press the STORE button.
 - b. To insert a new setup, rotate the → control to the setup number that is to precede the new setup and press the INSERT NEXT button.
5. Press ALTER LABELS button.
6. Alter the name and status of the new setup as desired. See ALTER LABELS description in this section.

Storing Setups in Sequences

Front-panel setups are stored in the Store/Recall memory and numbered starting at 01. A total of 20 setup records can be stored and recalled. Stored setups can be recalled individually by setup number, or sequentially within marked sequences. A sequence is defined as starting at setup number 01 or the first record after one marked with a status of END SEQ and ending with the next record with a status of END SEQ or the last stored record.

To store a sequence of front-panel setups, perform the following procedure:

1. Set CONFIGURE in the Service Menu for the following:

KEEP MENU ON WHEN MEAS SELECTED YES or NO

RECALL ONLY? (IN STORE/RECALL) NO

KEEP MENU ON WHEN S/R SELECTED? YES

2. Press the STORE/RECALL SETUP button to call up the Store/Recall Setup menu.
3. Rotate the → control to review the stored setups. Determine whether there are enough EMPTY locations to store all of the setups in your sequence. There are a total of 20 locations available. It is a good idea to use only 19 and leave the 20th open so that the system will have a place to store the last deleted file for recovery when necessary.

If there are not enough locations available to store your setups, you can use DELETE to remove unneeded setups or you can use the STORE function to write over them.

4. Set the front-panel controls as desired for the first setup in your sequence. Set all controls the way you want them; even the intensity control settings can be stored for recall. You can set the front-panel controls in several ways: setting the individual controls manually, inputting the desired signals and pressing the AUTO SETUP button, or by recalling and modifying an already stored setup.
5. Rotate the → control to the setup location that is to precede or start the first setup in the sequence.
6. Press INSERT NEXT (or STORE, if the current setup location is to be written over).
7. Press ALTER LABELS to call up the ALTER LABELS menu and give the desired name to your setup. Also make sure that the status is blank for all of the setups in the sequence, except the last one, and that one should be END SEQ. END SEQ is used to mark the last setup in a sequence using the ALTER LABELS function.
8. Press RETURN to display the Store/Recall Setup menu.
9. Repeat the above process of inserting or storing (writing over) until all the setups in your sequence are stored in memory.
10. If your sequence did not begin at setup location 01, use the ALTER LABELS menu to alter the status of the setup just preceding your first setup in the sequence to END SEQ.

Waveform Digital Acquisition Modes

Two acquisition modes for the hardcopy and GPIB operation may be selected from the Configure part of the SERVICE MENU or from a controller via the GPIB bus. The two digital acquisition modes are Peak Detect and Sample modes.

In Peak Detect mode, the minimum and maximum levels of the input signal within the time represented by 1/25 of a division unmagnified are digitized as data pairs.

In Sample mode, the signal is sampled at a rate that produces 50 samples per graticule division.

SECTION 4

**OPERATOR
CHECKS AND
ADJUSTMENTS**

2252 Operators

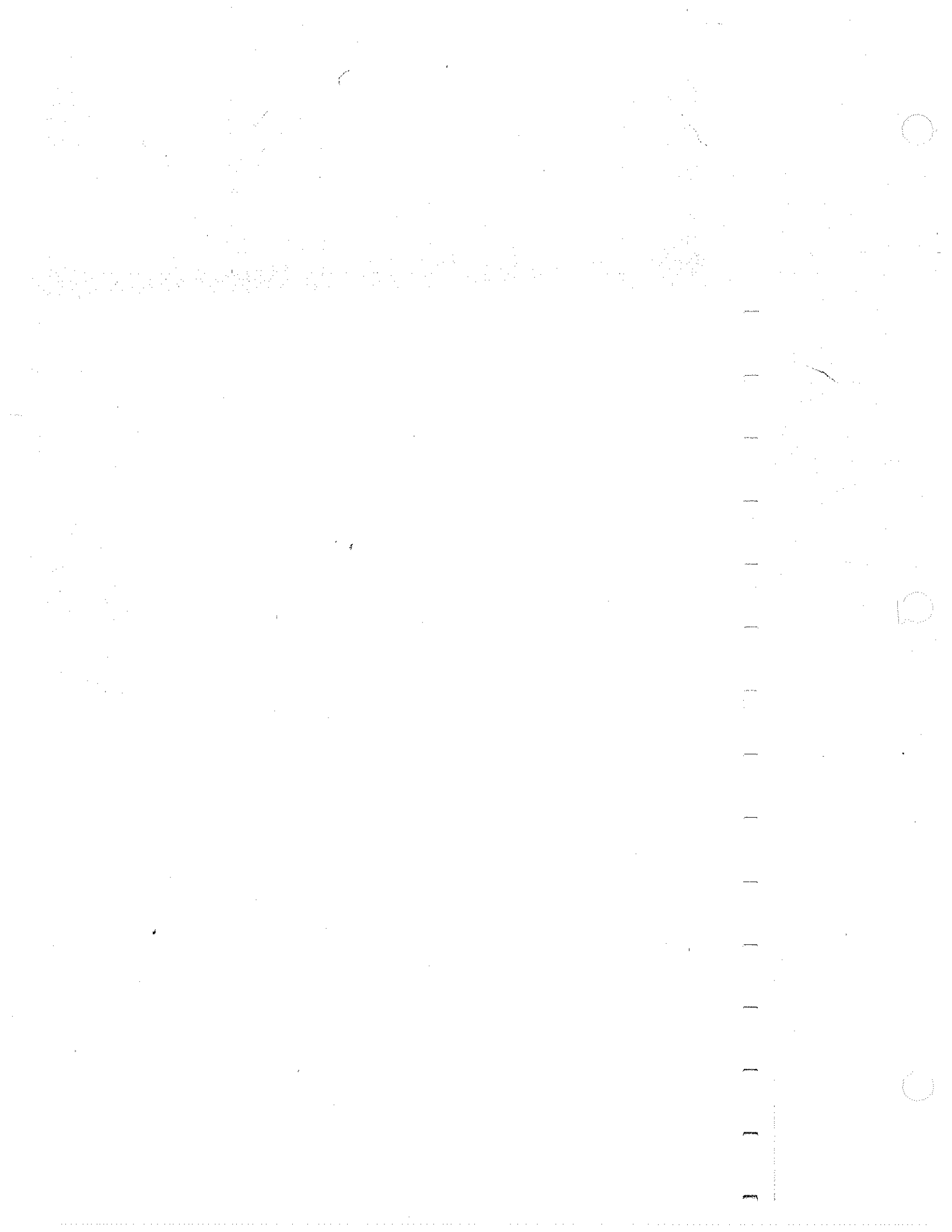

Introduction

The checks and adjustments in this section are for the operator and involve using only controls and adjustments on the outside of the instrument. Internal adjustments must be made by a qualified service person.

Before operating the instrument for the first time and before connecting the power, refer to Section 1 Preparation for Use to prepare the instrument for the initial start-up.

Verify that the POWER switch is OFF (out position). Plug the power cord into a power-source outlet that supplies a voltage within the operating range of the instrument's power supply.

NOTE

If you notice an improper indication or instrument malfunction during these procedures, refer the instrument to a qualified service person.

Initial Setup

The following procedure may be used to set up front-panel controls when the instrument is first turned on or when a signal is not being applied to the input connectors.

1. Press in the POWER switch button (ON) and let the instrument warm up (20 minutes is recommended for maximum accuracy).
2. Set the instrument front-panel controls to obtain a baseline trace:

Vertical Controls

Vertical MODE	CH 1
POSITION	Center the trace
VOLTS/DIV	1 V
VOLTS/DIV VAR	Calibrated detent
Channel 1 COUPLING	GND

Operator Checks and Adjustments

Horizontal Controls

MODE	A
POSITION	Center the trace
X10 MAG	Off
A SEC/DIV	0.1 ms
SEC/DIV VAR	Calibrated detent

Trigger Controls

HOLDOFF	MIN
A/B SELECT	A
MODE	AUTO LEVEL
SOURCE	VERT
CPLG	DC

Display

A INTEN	Desired brightness
FOCUS	Best trace definition
READOUT	Desired brightness
SCALE ILLUM	Desired brightness

MENU System Controls

MEASUREMENT MODES, TRACKING CURSORS, MENUS and STORE/RECALL	All off (Press CLEAR DISPLAY three times to ensure all off.)
--	---

Auto Setup Function

The Auto Setup function can be used to automatically set up the front-panel controls to produce a usable display of the applied signal.

1. Connect signal(s) to be displayed to the appropriate input connector(s).

For triggering to be set up properly when the AUTO SETUP button is pressed, connect the trigger-source signal to the lowest numbered channel that will be turned on.

2. Set:

Vertical MODE	As desired (see NOTE)
Horizontal MODE	As desired
Vertical COUPLING	As desired
3. Press the AUTO SETUP button.

NOTE

Normally, the Auto Setup of the display is sufficient for measurement purposes. If further waveform enhancement is needed, use the appropriate front-panel controls to adjust the display. For Auto Setup action see Appendix A.

Trace Rotation Adjustment

1. Perform the Initial Setup procedure. Position the trace vertically to align it with the center horizontal graticule line and check that the trace is parallel with the graticule line.

NOTE

Normally, the trace will be parallel to the center horizontal graticule line, and the TRACE ROTATION adjustment will not be needed.

2. If necessary, adjust the TRACE ROTATION to make the baseline trace parallel to the center horizontal graticule line. Use a small straight-blade screwdriver or alignment tool.

Probe Low-Frequency Compensation

Misadjustment of probe compensation is a possible source of measurement error. The attenuator probes are equipped with compensation adjustments. To ensure the best measurement accuracy, always check probe compensation before making measurements.

1. Connect the two supplied 10X probes to the CH 1 and CH 2 input connectors.

Operator Checks and Adjustments

2. Connect the probe tips to the PROBE ADJUST connector and the probe ground leads to scope ground.
3. Set:

Vertical MODE	CH 1 & CH 2
Horizontal MODE	A
4. Press AUTO SETUP button.
5. Set the CH 1 VOLTS/DIV setting to 0.1 V (10 mV with probe disconnected) and vertically center the PROBE ADJUST square-wave signal.
6. Check the square-wave signal for overshoot and rolloff (see Figure 4-1). If necessary, use the special adjustment tool supplied in the probe accessory package to adjust the low-frequency compensation for a square front corner on the square wave displayed.
7. Press the CH 2 Vertical MODE button to turn CH 2 on in the display, and press the CH 1 Vertical MODE button to remove the CH 1 trace from the display.

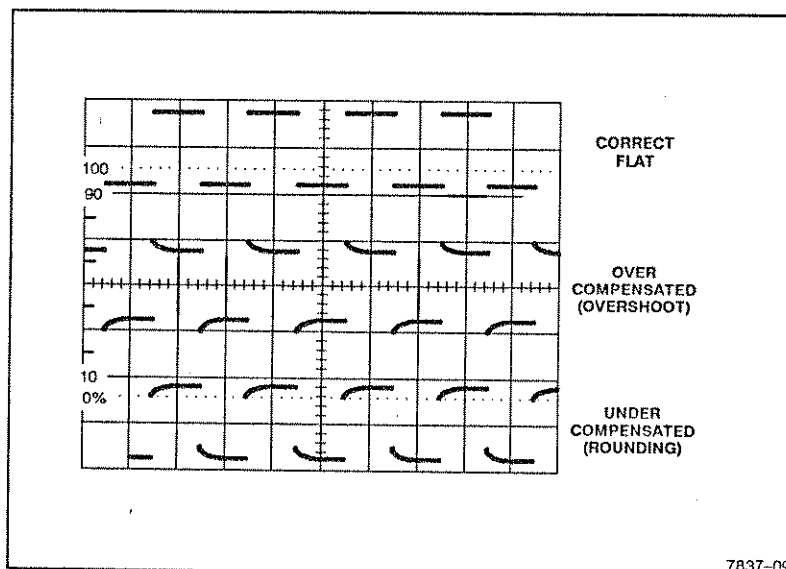

Figure 4-1. Probe compensation.

8. Set the CH 2 VOLTS/DIV setting to 0.1 V (10 mV with probe disconnected) and vertically center the PROBE ADJUST square-wave signal.
9. Repeat Steps 5 and 6 for the second probe on the CH 2 input connector.

NOTE

Refer to the instruction manual supplied with the probe for more detailed information about the probes and the adjustment procedure.

Vertical Deflection Check

The PROBE ADJUST square-wave signal may be used to check the Channel 1 and Channel 2 vertical deflection system in the following procedure:

1. Connect the two 10X probes (supplied) to the CH 1 and CH 2 input connectors.
2. Connect both probe hook tips to the PROBE ADJUST connector.
3. Set:

Vertical MODE	CH 1
Horizontal MODE	A
4. Press AUTO SETUP button.
5. Set CH 1 and CH 2 VOLTS/DIV switches to 0.1 V for the attached 10X probes.
6. Set the bottom of the trace of the PROBE ADJUST square-wave signal to a convenient horizontal graticule line with the Vertical POSITION control.
7. Check for a five-division display of the PROBE ADJUST square-wave signal.
8. Select CH 2 Vertical MODE and repeat steps 6 and 7.
9. Disconnect the probes from the instrument.

Timing Checks

The time measurement cursors may be used to check the horizontal deflection system.

1. Preset instrument controls and obtain a baseline trace and set the A SEC/DIV switch to 0.1 ms. Vertically center the baseline trace.
2. Press the TIME MEASUREMENTS button to call up the Time Measurement Mode menu on the crt and select ← SEC → function for measuring time difference by pressing the Menu Select button opposite menu label.
3. Align the reference cursor to the second vertical graticule line using the ← OR DELAY TIME control (both cursors are positioned together).
4. Adjust the → control for a reading of 800.0 μs.
5. Check that the cursors are eight divisions apart.
6. Press the CLEAR DISPLAY button to remove the cursors from the display.