

2430

DIGITAL OSCILLOSCOPE USER REFERENCE GUIDE

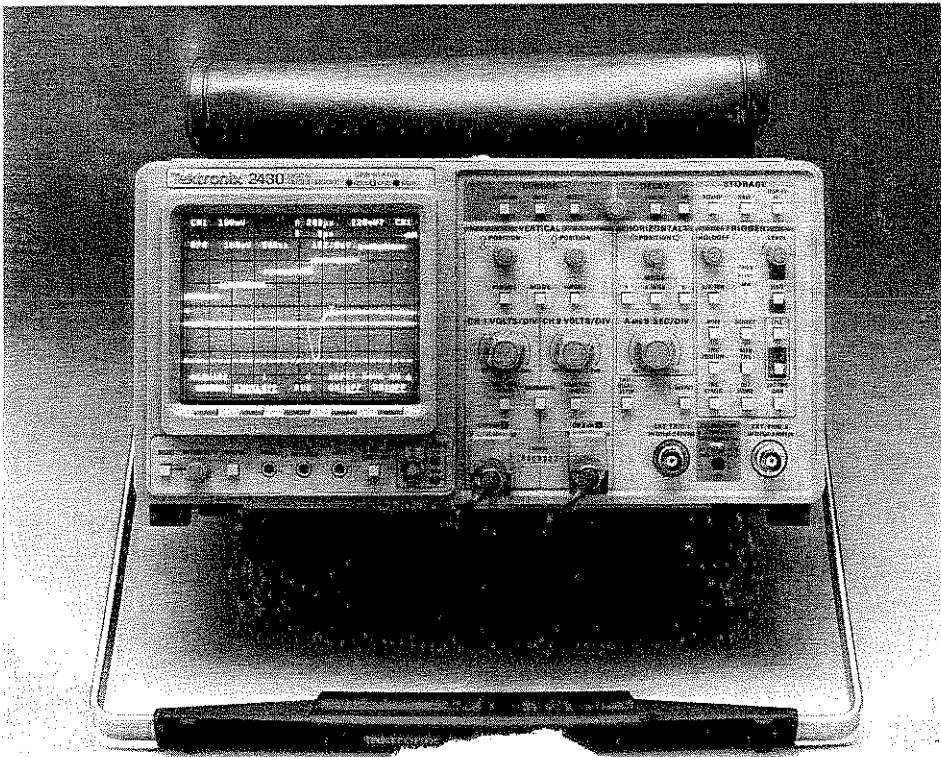

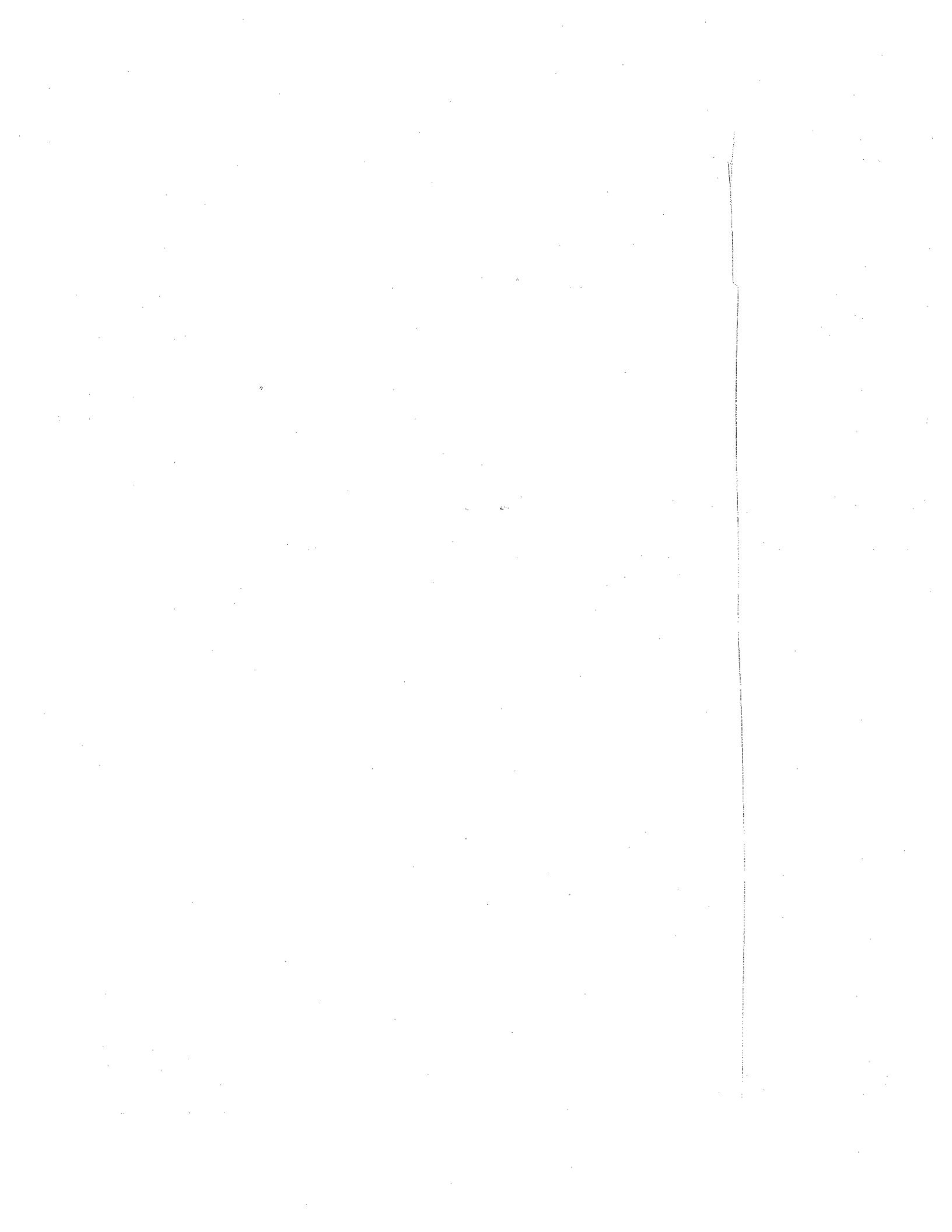

GETTING STARTED

See Front Panel for locating the controls on the 2430.

POWER ON: Press the POWER switch, located on the front panel below the crt.

The 2430 performs a power-on self test each time it is turned on. When the test progresses to the point of being able to display, the message "RUNNING SELF TEST" is shown on the crt. At the end of the self test the message is removed, and the 2430 is in the SAVE* mode.

**NOTE: SAVE mode results in the display being stored in a scratch pad type memory. Whatever display was on screen when the 2430 was powered down, will be displayed at the next power up (within a 3 day period). This display may be expanded or positioned vertically and horizontally, or moved to a Reference Memory.*

If the 2430 fails the self test, it will enter the diagnostic mode and display a list of the major test headings. A PASS or FAIL label is shown to let the user know which area of the tests passed or failed. If the 2430 should fail the power-on test,

with the UNCALD message displayed, either the SELF CAL constants need updating or the EXTENDED CAL has failed.

Allow the 2430 to warm up and do a SELF CAL. If the attenuators or triggers calibration has failed, the previous calibration constants have not been overwritten, and the scope may be used. Press MENU OFF to exit extended diagnostics and enter Scope mode. If the UNCALD message persists after a SELF CAL or some other area has failed, refer the instrument to a qualified service person. More information on the self test and diagnostics is found in Appendix B of the Operators Manual.

CONNECT: A standard accessory P6131 probe to the CH 1 input BNC.

CONNECT: The probe tip to the CALIBRATOR loop; connect the probe ground lead to scope ground.

PRESS: The SAVE/RECALL SETUP button, located below the A and B SEC/DIV knob.

SELECT: INIT PANEL menu choice by pressing the bezel button directly below the INIT PANEL menu label.

The major front-panel controls

are set up as follows for the initial settings.

VERTICAL MODE	CH 1
CH 1 and CH 2	
VOLTS/DIV	1 V (with 10X probe)
A and B SEC/DIV	1 ms
TRIGGER MODE	AUTO LEVEL
TRIGGER	
SOURCE	VERT (CH 1)
Input Coupling	1 MΩ DC
STORAGE MODE	ACQUIRE
ACQUIRE MODE	NORM

VERIFY: That CH1 vertical mode is selected (CH1 VOLT/DIV readout is in upper left corner of CRT. If CH1 vertical mode is not selected then: Press vertical MODE button, and select CH1 (See section 6, Vertical Mode #4, of this guide.)

PRESS ACQUIRE: button on front panel.

VERIFY: That you have a triggered waveform display.

NOTE: The procedure just done should always get you a triggered display. When signals other than the CALIBRATOR square wave are applied to the input, the VOLTS/DIV, SEC/DIV, and Trigger controls must be set to appropriate settings to accommodate the applied signal.

TABLE OF CONTENTS

Section	Page
1. Getting Started/Front Panel	4
2. CRT Readout Display	6
3. Status Menu	7
4. Powering Up	8
5. CRT Display Menu	9
6. Vertical	10
7. Horizontal/Save/Recall Setup	12
8. Cursors	14
9. Delay Functions	15
10. Triggering	16
11. A Trigger	19
12. B Trigger	20
13. Acquisition	22
14. Save and Display Reference	23
15. GPIB Status	24
16. Problems/Solutions	25

FRONT PANEL

1

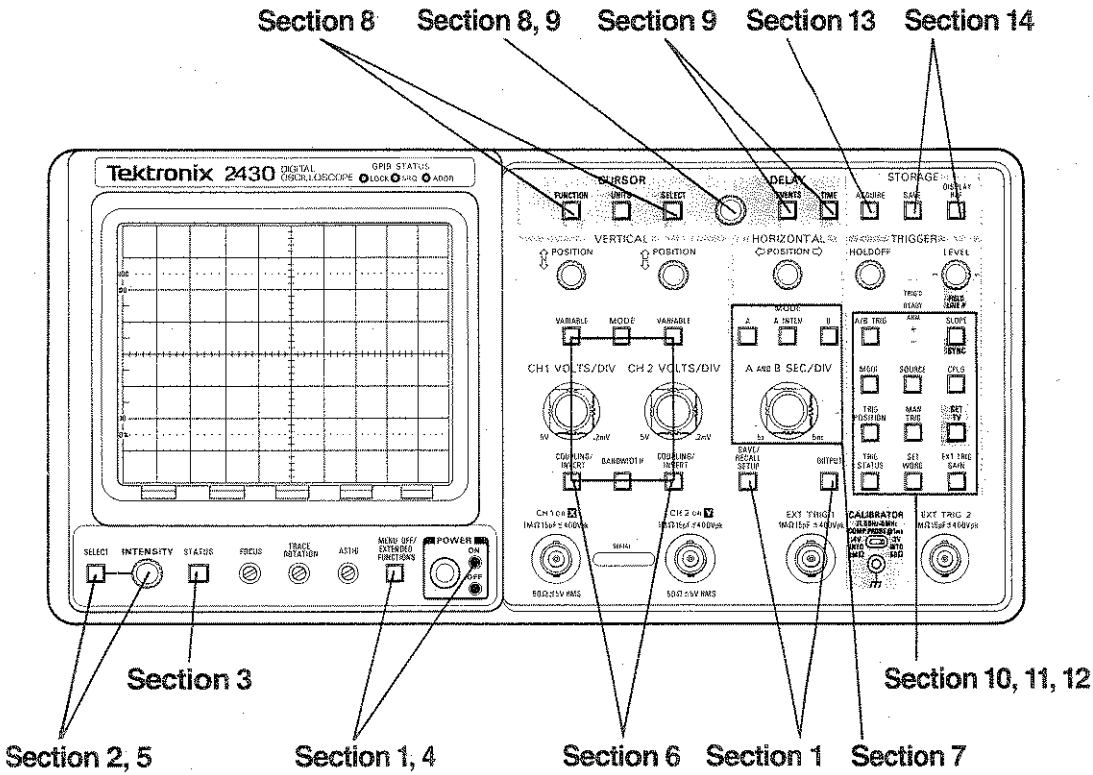

CRT READOUT DISPLAY

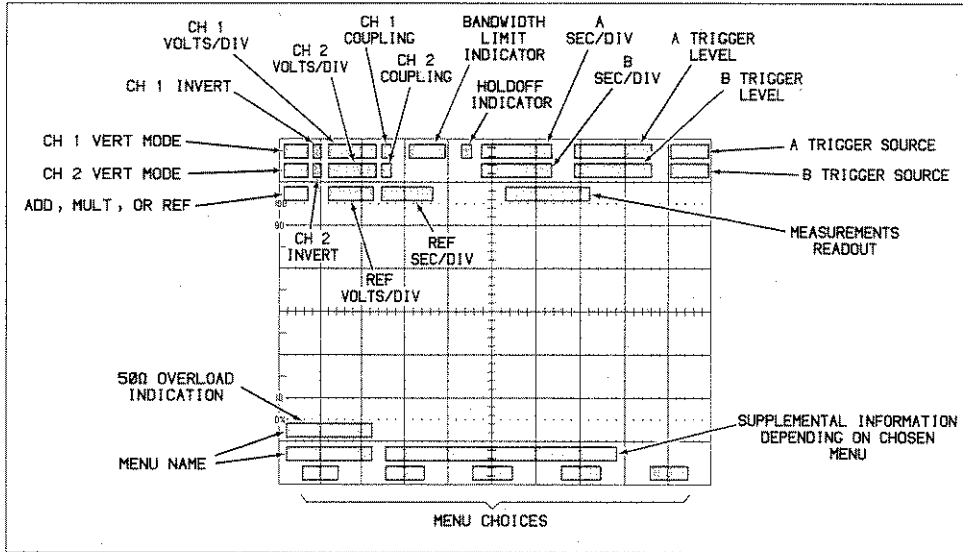

STATUS MENU

In the readout, active sections are underscored. If both A and B Horizontal Mode are underscored, the Horizontal Mode is A INTEN.

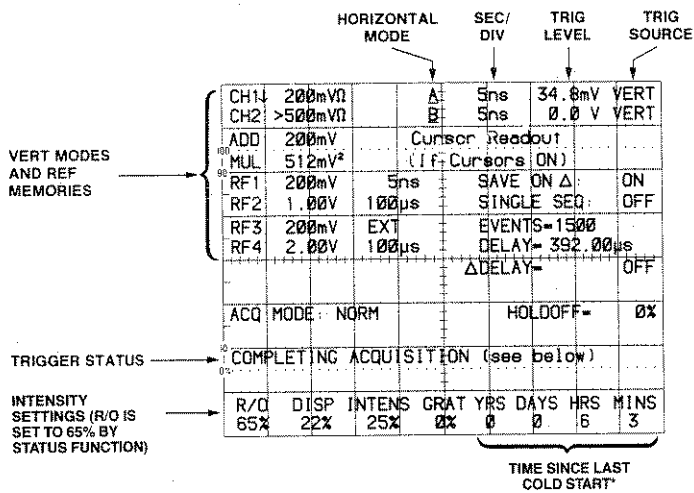

Trigger Status possibilities are:

- COMPLETING ACQUISITION
 - SAVE—TRIGGERS NOT ACTIVE
 - ROLL MODE—TRIGGERS IGNORED
 - ARMED—ACQUIRING PRETRIGGER
 - WAITING FOR A TRIGGER
- TRIG WAIT: EVENTS DELAY TIME B TRIG
- ↓ ↓ ↓
- If events If DELAY If in B and
- ON ON TRIG AFT is ON

4918-06

The above display will appear on screen when the status front panel button is selected. It provides an overview of instrument configuration at the time the selection was made. This menu will enable you to determine if you are currently operating in the desired modes, or if you are set in a conflicting mode (causing the instrument

to appear to operate incorrectly). Special attention should be paid to the TRIGGER STATUS comment and the ACQ MODE statement in the lower left hand quadrant of the screen, which enable you to determine the instruments current activity. It is recommended that you become very familiar with this

entire menu and the location and meaning of the readout characters because it will aid you in determining the cause of possible operational difficulties. *Cold Start is a complete initialization of the system. Normally, only done at the factory.

POWERING UP

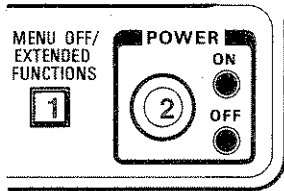

1. MENU OFF/EXTENDED FUNCTIONS An "UNCALD" message in the extended diagnostics menu may indicate that the last attempt of extended calibration failed. In that case the previous good calibration constants are not overwritten and the scope is usable, but needs the calibration checked. Menu Off resets the control settings to their soft front-panel values and redraws the display. Messages sent via the GPIB will be erased.

In the CAL/DIAG menu, PASS or FAIL indicates the result of the last calibration or self diag run. No label will appear if the cal has not been run since the last cold start and UNCALD will appear if 2430 is uncalibrated. Allow the 2430 to warm up, then do a SELF CAL.

2. POWER: Does a power-on self test with each turn on. At power off, the displays (see note below) and front-panel settings are retained. A failure of the self test places the scope in extended diagnostics (see manual). The 2430 may still be used if the failed area does not affect the measurement to be made. Press Menu Off to exit extended diagnostics and enter scope mode.

The Cal/Diag menu displays the message "NOT WARMED UP" for ten minutes after each power-on.

NOTE: If instrument is powered down in an active acquire mode, instrument may power up with no valid vertical channel waveforms. To prevent loss of waveforms, place instrument in SAVE mode before power down.

Power Up On-Screen Menus

1. MENU OFF/ EXTENDED FUNCTIONS	Turns off any menu being displayed or, if none are on, calls up the EXTENDED FUNCTIONS menu. See Appendix B of the Operators Manual for the Extended Functions Calibration and Diagnostics menus.				
	EXT FUNCT				
	SYSTEMS SPECIAL CAL/DIAG				
	SYSTEM (Second-level menu).				
	PWR ON LAST/INIT	BELL ON/OFF	PREFLT ON/OFF	REF4 REF/PNL	TV SYS MINON / M
SPECIAL (Second-level menu). WARNING: SERVICE ONLY--SEE MANUAL (if enabled) DISABLED--SEE MANUAL (if disabled)					
COLD START			FORCE DAC		
CAL/DIAG (Second-level menu).					
PASS SELF CAL	PASS EXT CAL	SELF DIAG	NOT WARMED UP EXT DIAG		

NOTE: If the SPECIAL menu choices are enabled, a Cold Start selection means a partial instrument calibration will be required before use.

If the REF4 menu selection is set to REF (under SYSTEM in the EXTENDED FUNCTIONS), only 1 front-panel setup may be saved or recalled and only the number 1 will be displayed in the SAVE and RECALL second-level menus. When the menu choice is set to PNL, five

front-panel SAVE/RECALL SETUP memory locations are available. Front panel memory 1 is long-term non-volatile storage; memories 2 through 5 are short-term non-volatile storage (3 to 5 days).

CRT DISPLAY MENUS

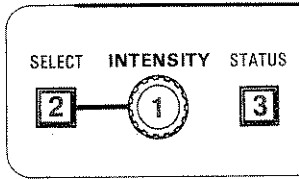

1. INTENSITY control is an infinite turn pot. Its controlling action remains directed to the last selected choice; except when Status is selected; it then becomes the readout intensity control.

2. SELECT button toggles between readout and display after turning on the menu.

3. STATUS display is useful for determining why a display is not seen or triggering is not occurring. Some common conditions to check for are: Channel called up? Display intensity setting? Ground indicator (+)

and trigger position (T) at top and bottom edges (vert. pos.)? Common triggering conditions: Single sequence on? Save Mode? Events on? Delay on? Trig wait state? Ext clk on?

Top three lines of status menu update with front panel control changes. Remaining lines are updated with a press of the status button.

Menu off or calling up another menu turns off the status display.

5

CRT Display On-Screen Menus

<p>2. SELECT</p>	<p>INTENSITY READOUT DISP INTENS GRAT VECTORS ON/OFF</p> <p>INTENS: Controls brightness of intensified zone in 'A' Intensified. GRAT: Controls graticule intensity.</p>
<p>3. STATUS</p>	<p>Presents an instrument status display (see page 7) and increases the readout intensity to 65% to ensure visibility. Intensity adjustment will now control readout intensity. Intensity control will return to function selected before entering STATUS menu mode when the STATUS menu is removed.</p> <p>Pressing MENU OFF or any other front panel control that requires a menu display removes the STATUS display from the CRT.</p>

VERTICAL

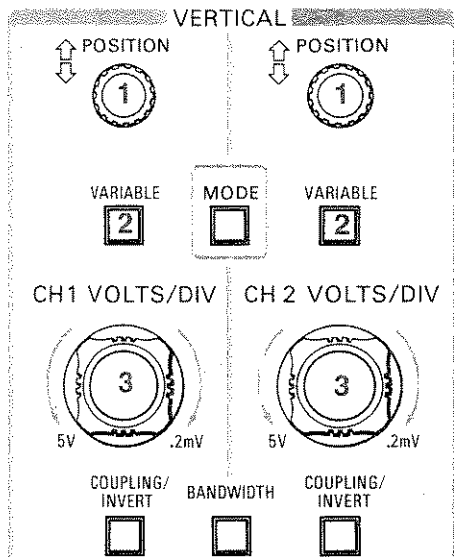

1. VERTICAL POSITION controls.

CH1 is the HORIZONTAL POSITION control in XY mode.

2. CH 2 VARIABLE does not set ADD mode readouts to divisions but CH 1 VARIABLE does. CH 2 is used to develop an inverted cancellation signal.

Arrow menu button functions are continuous when held down. CAL returns V/D to calibrated setting.

3. VOLTS/DIV readouts automatically adjust to the correct readout scale factor when 1X, 10X, 100X, and 1000X Tek coded-attenuator probes are attached.

VOLTS/DIV is the vertical expansion control in SAVE storage mode, and the extended range control in average acquisitions mode.

Vertical On-Screen Menus

2. VARIABLE	CH1 VARIABLE	↓	↑
	CAL		
	CH2 VARIABLE	↓	↑
	CAL		

4. MODE initiates Vertical Mode menu on screen. Active selections are underscored. The resultant signal of a Mult display is scaled down by a factor of 5.12 to maintain the display within the graticule area.

Add and Mult are not displayed in envelope mode.

XY mode automatically turns on the CH 1 and CH 2 signals REF 1 vs. REF 2 may be displayed as XY REF.

NOTE: For Vertical Mode menu, bezel buttons operate in push/push fashion, causing modes to be selected by repeated activation. YTI XY modes toggle in push/push fashion. Active selections are underscored.

5. COUPLING/INVERT button may be used to switch through the available coupling choices after menu is called up.

AC coupling and 50Ω termination are mutually exclusive.

6. BANDWIDTH Button may be used to scroll through menu choices after menu is called up.

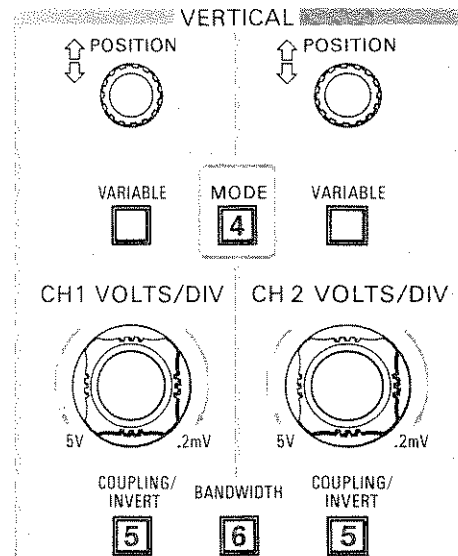

6

Vertical On-Screen Menus (cont.)

4. VERTICAL MODE	In YT Mode				
	VERTICAL MODE	CH1	CH2	ADD	MULT YTI XY
5. COUPLING INVERT	In XY Mode				
	VERTICAL MODE	CH1 vs CH2			YTI XY
6. BANDWIDTH	CH1 COUPLING	AC	DC	GND	50Ω ON/OFF INVERT ON/OFF
	CH2 COUPLING	AC	DC	GND	50Ω ON/OFF INVERT ON/OFF
	BANDWIDTH	20 MHz	USB = xxxx Hz 50 MHz	USR = xxxx s. FULL	
	The number xxxx depends on the Acquisition Mode, the SEC/DIV setting, and the bandwidth selected.				

HORIZONTAL/SAVE/RECALL SETUP

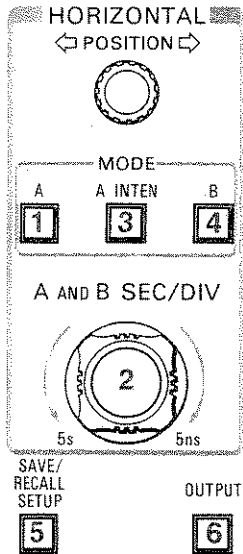

1. **A** activates "A" sweep function.
2. **A** and **B SEC/DIV** control determines sweep rate for A and B sweep functions. Used in SAVE mode to horizontally expand display. Do not change horizontal mode after entering SAVE storage mode if using horizontal expansion. Roll Mode becomes available on Trigger Mode selection menu at 100 ms/div.
3. **A INTEN** selects A INTENSIFIED operating mode. SEC/DIV control (2) controls the B intensified time/div.
4. **B** selects B Delayed sweep operation. A AND B SEC/DIV will now control B sweep rate.
5. **SAVE/RECALL SETUP** initializes the SAVE/RECALL SETUP menu including INIT PANEL.

NOTE: If the REF4 menu selection is set to REF (under SYSTEM in the EXTENDED FUNCTIONS), only 1 front-panel setup may be saved or recalled and only the number 1 will be displayed in the SAVE and RECALL second-level menus. When the menu choice is set to PNL, five front-panel SAVE/RECALL SETUP memory locations are available. Front panel memory 1 is long-term non-volatile storage; memories 2 through 5 are short-term non-volatile storage (3 to 5 days).

NOTE: INIT PANEL completely initializes the front-panel and other operating features to factory-defined states. See Table C-16, in Appendix C of Operators Manual, for the complete listing of INIT STATES.

Save/Recall Setup On-Screen Menus

5. SAVE/ RECALL SETUP	SAVE/RECALL SETUP					INIT
	SAVE	RECALL				PANEL
	SAVE (Second-level menu.)					
	SAVE SETUP	1	2	3	4	5
RECALL (Second-level menu.)						
RECALL SETUP	1	2	3	4	5	

Output On-Screen Menus

6. OUTPUT

----- XY ----- GPIB -----
 PLOT FORMAT STATUS SETUP TRANSMIT/(PRINT)

PLOT and TRANSMIT/(PRINT) switch to ABORT when the functions are active. TRANSMIT/(PRINT) is not displayed in OFF BUS mode.

XY FORMAT (Second-level menu).

XY FORMAT PEN LIFT
 READOUT GRAT OPEN/CLOSE PLOT

Pressing PLOT in this level menu reverts back to the first level menu with ABORT displayed.

GPIB SETUP (Second-level menu).

MODE TERM ADDR ENCDG DEBUG
 ON/OFF

GPIB ENCDG (Third-level menu).

ASCII RP BIN RI BIN

GPIB MODE (Third-level menu).

T/ONLY L/ONLY T/L PRINTER OFF BUS

Selecting PRINTER changes TRANSMIT to PRINT in the OUTPUT control menu. Selecting OFF BUS turns off the TRANSMIT/PRINT choice.

GPIB T/ONLY (Fourth-level menu.)

CURVE ONLY WFM/PRE/CURVE

GPIB TERM (Third-level menu.)

EOI LF/EOI

GPIB ADDR (Third-level menu.)

GPIB ADDRESS = nn ↓
 ↑

A GPIB menu detailing current instrument GPIB configuration

can be displayed by pushing the STATUS selection of the first level OUTPUT menu. (See

page 24 of this guide for interpretation of on-screen display.)



CURSORS

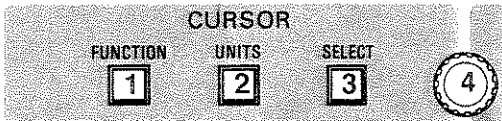

1. FUNCTION activates cursor function menu on screen.

If the attach cursors menu of an active cursor function has been replaced by some other menu, pressing the function button twice, or turning off and then back on the selected cursors, returns it to the display.

2. UNITS activates units selection menu on screen.

3. SELECT selects cursor under control of the CURSOR/DELAY knob (4).

NOTE: Cursors will not position off screen. They will remain at screen perimeter. SELECT button will bring cursor and window of waveform being measured, on screen.

4. CURSOR/DELAY knob controls active cursor positioning and Delay time period for selected function.

When time cursors are displayed and active, the Cursor/Delay knob may be used to scroll through the entire record length. Cursors will operate similarly for Ref. waveforms when attached to displayed Reference waveform.

Cursor/Delay knob is a shared control; positions cursors for cursor functions; sets delay times or delay events number for Delay functions.

NOTE: Bezel buttons operate in a push/push mode, selecting and deselecting function. Selection of alternate function will deselect a previous mode.

Cursor On-Screen Menu

1. FUNCTION

CURSOR FUNCTION	VOLTS	TIME	V@T	SLOPE	1/TIME
-----------------	-------	------	-----	-------	--------

Second-level ATTACH CURSORS menu.

In YT Mode.

ATTACH CURSORS TO:

CH1	CH2	(func)	(func) Δ	REF n	(no delta delay)
CH1	CH1 Δ	(func)	(func) Δ	REF n	(delta delay-CH1 on)
CH2	CH2 Δ	(func)	(func) Δ	REF n	(delta delay-CH2 on)
CH1	CH2 Δ	(func)	(func) Δ	REF n	(delta delay-CH1 and CH2)

Function is either ADD or MULT; they are mutually exclusive.
Pressing REF rolls through the displayed reference waveforms.
Only waveforms called up for display are included in the ATTACH CURSORS menu.

In XY Mode.

ATTACH CURSORS TO:
CH1 vs CH2 XYREF

2. UNITS

UNITS	VOLTS	CURS	REF = xxxxxx		
VOLTS	%	dB	NEW REF	Δ !ABS	(in VOLTS or V@T)

UNITS	SLOPE	CURS	REF = xxxxxx		
SLOPE	%	dB	NEW REF	(in SLOPE)	

UNITS	1/TIME	CURS	REF = xxxxxx		
Hz	%	DEGREES	NEW REF	Δ !ABS	(in 1/TIME)

UNITS	TIME	CURS	REF = xxxxxx		
SEC	%	DEGREES	NEW REF	Δ !ABS	(in TIME)

DELAY FUNCTIONS



1. CURSOR/DELAY control knob sets delay times or delay event number for Delay functions. It defaults to cursors control when neither Delay function menu is displayed.

2. EVENTS selects Delay By Events function and connects events count selection to CURSOR/DELAY control knob (1).

3. TIME selects Delay By Time, and switches between Main Delay and Delta Delay functions. CURSOR/DELAY control knob (1) is used to set time delay.

Triggers must be supplied via the B trigger circuitry to obtain Event triggering when Events is on. 'A' delayed by 'B' events and 'B' delayed by time may be used sequentially.

Delay On-Screen Menus

2. DELAY by EVENTS	EVENTS START AT A TRIG EVENTS COUNT = xxxxx B TRIGS	EVENTS ON/OFF
3. DELAY by TIME	DELAY TIME = xxxxxx B	ΔTIME ON/OFF (with ΔTIME OFF)
	DELAY TIME = xxxxxx B Δ DELAY TIME = xxxxxx B	ΔTIME ON/OFF (with ΔTIME ON)
DELAY by TIME button is pressed to switch the effect of the Cursor/Delay position knob between the Main DELAY TIME and the Δ (delta) DELAY TIME when Δ TIME is ON.		

NOTE: For a more complete explanation of delay trigger functions see your Operators Manual, page 3-14 and 3-15, and a trigger state diagram on Appendix C, page 7.

TRIGGERING

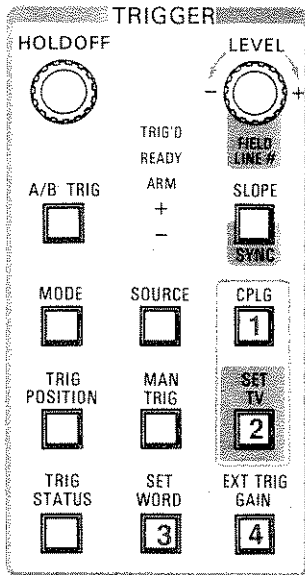

1. Trigger **CPLG**: switches through the menu choices (except TV) when pushed repeatedly.

2. **SET TV** Initiates Video trigger mode selection menu (on scopes equipped with Video trigger only). In addition, TV coupling is selected via the coupling menu.

Video signal must be interlaced for field 2 to appear in on-screen readout.

3. **SET WORD** activates the Word Recognizer Probe configuration menu.

4. **EXT TRIG GAIN** activates the external trigger input gain configuration menu.

Trigger On-Screen Menus

1. TRIGGER CPLG	Without the Video option.	
	A COUPLING DC AC	----- REJECT ----- NOISE HF LF
2. SET TV (Video Option only)	With the Video option installed.	
	A COUPLING DC/AC TV	----- REJECT ----- NOISE HF LF
3. SET WORD	A TV COUPLING FIELD 1 FIELD 2 ALT TV LINE	CLAMP ON/OFF (for interlaced signals)
	A TV COUPLING FIELD	CLAMP ON/OFF (for non-interlaced signals)
3. SET WORD	RADIX OCTIHEX <input type="checkbox"/> <input type="checkbox"/>	CLOCK ASYNC <input type="checkbox"/> <input type="checkbox"/>
	SET BITS	
	SET BITS (Second-level menu).	
3. SET WORD	In Hexadecimal:	
	TRIG WORD: CLK = * HHHH x xxxx xxxx xxxx xxxx	NOTE: * = Clock slope selection will appear in this location.
	1 0 X ← →	
3. SET WORD	In Octal:	
	TRIG WORD: CLK = * 000000 x xxx xxx xxx xxx xxx	
	1 0 X ← →	
4. EXT TRIG GAIN	EXT GAIN EXT 1 EXT 1÷5	EXT 2 EXT 2÷5

TRIGGERING

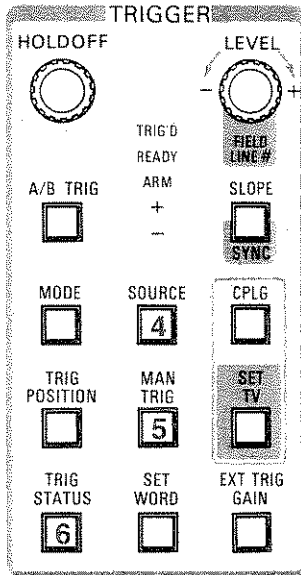

4. Trigger **SOURCE** button will toggle between 1 and 2 if channel or external trigger is the selected source.

A and B trigger conditions must be met to obtain a trigger in A 'AND' B. 'AND' source not available for B Trigger. An attempt to select WORD as the trigger source without a WORD Recognizer Probe attached, displays the message "WORD PROBE FAULT." Source remains at the last valid choice.

5. **MAN** Trigger forces a manual trigger. Any delay time readouts are invalid after a manual trigger.

NOTE: Has effect only if trigger system is in 'READY' state.

6. **TRIG STATUS** activates the trigger status menu, which details the current trigger mode, source, coupling, and trigger position selection for the A and B triggers.

Trigger On-Screen Menus (cont.)

<p>4. TRIGGER SOURCE</p>	<p>A TRIG SOURCE VERT CHAN EXT CH1 112 112 LINE A*B:WORD CH2 ADD/ MULT</p>
<p>6. TRIG STATUS</p>	<p>TRIG STATUS MODE SOURCE CPLG TRIG POS</p> <p>A (Setup conditions for the A Trigger Controls.) B (Setup conditions for the B Trigger Controls.)</p>

A TRIGGER

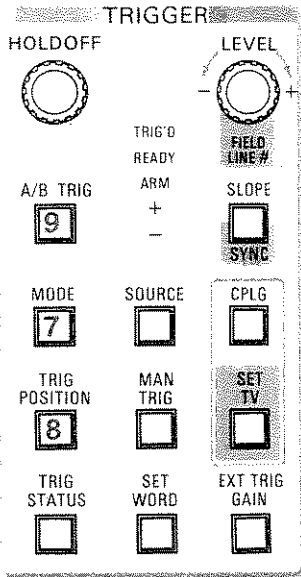

7. Trigger **MODE** steps through the mode choices, except single seq, when pushed repeatedly.

8. **TRIG POSITION** steps through the menu choices when pushed repeatedly.

9. **A/B TRIG** selects between A and B Trigger menu displays for configuration. SLOPE, MODE, SOURCE, CPLG, LEVEL, and TRIG POSITION controls are shared by A and B trigger system.

Trigger On-Screen Menus (cont.)

7. TRIGGER MODE	<p>A TRIGGER MODE AUTO SINGLE LEVEL AUTO NORMAL SEQ</p> <p>switches to ROLL at 100 ms/div and slower.</p>
8. TRIG POSITION	<p>A TRIGGER POSITION <u>1/8</u> <u>1/4</u> 1/2 3/4 7/8</p>

NOTE: If position other than 1/8, 1/4, 1/2, 3/4, 7/8 is made over GPIB, then no on-screen selection will be underlined.

11

B TRIGGER

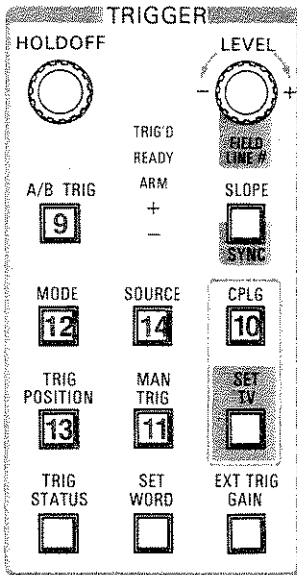

9. **A/B TRIG** switches the effect of the trigger controls between the A and B trigger systems.

10. Trigger **CPLG** button switches through the menu choices when pushed repeatedly.

11. **MAN** Trigger forces a manual trigger. Any delay time readouts are invalid after a manual trigger.

12. **MODE** toggles between RUNS AFTER and TRIG AFTER when pressed repeatedly.

EXT CLK "ON" sets the time cursor readouts and the delay time numbers to units of CLK. A clock signal must be provided via the B trigger circuitry to obtain triggering.

13. **TRIG POSITION** in the A and B waveform record is independently selected.

14. **SOURCE** activates the B Trigger Source selection menu.

B Trigger On-Screen Menus

12. TRIGGER MODE	<table style="width: 100%; border-collapse: collapse;"> <tr> <td style="width: 20%;"><u>B TRIG</u></td> <td style="width: 20%;">RUNS AFTER</td> <td style="width: 20%;">TRIG AFTER</td> <td style="width: 40%;">EXT CLK ON/OFF</td> </tr> </table>	<u>B TRIG</u>	RUNS AFTER	TRIG AFTER	EXT CLK ON/OFF																																																												
<u>B TRIG</u>	RUNS AFTER	TRIG AFTER	EXT CLK ON/OFF																																																														
10. TRIGGER CPLG	<p>In B TRIG AFTER Delay Mode.</p> <table style="width: 100%; border-collapse: collapse;"> <tr> <td style="width: 20%;"><u>B COUPLING</u></td> <td style="width: 20%;">-----</td> <td style="width: 20%;">REJECT</td> <td style="width: 40%;">-----</td> </tr> <tr> <td><u>B EXT CLK CPLG</u></td> <td>-----</td> <td>REJECT</td> <td>----- (with EXT CLOCK ON)</td> </tr> <tr> <td><u>B EVENTS CPLG</u></td> <td>-----</td> <td>REJECT</td> <td>----- (with DELAY by EVENTS ON)</td> </tr> <tr> <td><u>B CLK EVENTS</u></td> <td>-----</td> <td>REJECT</td> <td>----- (with both ON)</td> </tr> <tr> <td>DC AC</td> <td></td> <td>NOISE HF LF</td> <td></td> </tr> </table> <p>In B RUNS AFTER Delay Mode.</p> <table style="width: 100%; border-collapse: collapse;"> <tr> <td style="width: 20%;"><u>B COUPLING</u></td> <td style="width: 20%;">-----</td> <td style="width: 20%;">REJECT</td> <td style="width: 40%;">-----</td> </tr> <tr> <td><u>EXT CLK CPLG</u></td> <td>-----</td> <td>REJECT</td> <td>----- (with EXT CLOCK ON)</td> </tr> <tr> <td><u>EVENTS CPLG</u></td> <td>-----</td> <td>REJECT</td> <td>----- (with DELAY by EVENTS ON)</td> </tr> <tr> <td><u>CLK EVENTS</u></td> <td>-----</td> <td>REJECT</td> <td>----- (with both ON)</td> </tr> <tr> <td>DC AC</td> <td></td> <td>NOISE HF LF</td> <td></td> </tr> </table>	<u>B COUPLING</u>	-----	REJECT	-----	<u>B EXT CLK CPLG</u>	-----	REJECT	----- (with EXT CLOCK ON)	<u>B EVENTS CPLG</u>	-----	REJECT	----- (with DELAY by EVENTS ON)	<u>B CLK EVENTS</u>	-----	REJECT	----- (with both ON)	DC AC		NOISE HF LF		<u>B COUPLING</u>	-----	REJECT	-----	<u>EXT CLK CPLG</u>	-----	REJECT	----- (with EXT CLOCK ON)	<u>EVENTS CPLG</u>	-----	REJECT	----- (with DELAY by EVENTS ON)	<u>CLK EVENTS</u>	-----	REJECT	----- (with both ON)	DC AC		NOISE HF LF																									
<u>B COUPLING</u>	-----	REJECT	-----																																																														
<u>B EXT CLK CPLG</u>	-----	REJECT	----- (with EXT CLOCK ON)																																																														
<u>B EVENTS CPLG</u>	-----	REJECT	----- (with DELAY by EVENTS ON)																																																														
<u>B CLK EVENTS</u>	-----	REJECT	----- (with both ON)																																																														
DC AC		NOISE HF LF																																																															
<u>B COUPLING</u>	-----	REJECT	-----																																																														
<u>EXT CLK CPLG</u>	-----	REJECT	----- (with EXT CLOCK ON)																																																														
<u>EVENTS CPLG</u>	-----	REJECT	----- (with DELAY by EVENTS ON)																																																														
<u>CLK EVENTS</u>	-----	REJECT	----- (with both ON)																																																														
DC AC		NOISE HF LF																																																															
14. TRIGGER SOURCE	<p>In B TRIG AFTER Delay Mode.</p> <table style="width: 100%; border-collapse: collapse;"> <tr> <td style="width: 20%;"><u>B TRIG SOURCE</u></td> <td style="width: 20%;"></td> <td style="width: 20%;"></td> <td style="width: 40%;"></td> </tr> <tr> <td><u>B EXT CLOCK SOURCE</u></td> <td></td> <td></td> <td>(with EXT CLOCK ON)</td> </tr> <tr> <td><u>B EVENTS SOURCE</u></td> <td></td> <td></td> <td>(with DELAY by EVENTS ON)</td> </tr> <tr> <td><u>B EXT CLK EVENTS SOURCE</u></td> <td></td> <td></td> <td>(with both ON)</td> </tr> <tr> <td>VERT</td> <td>CHAN</td> <td>EXT</td> <td></td> </tr> <tr> <td>CH1</td> <td>112</td> <td>112</td> <td>WORD</td> </tr> <tr> <td>CH2</td> <td></td> <td></td> <td></td> </tr> <tr> <td>ADD</td> <td></td> <td></td> <td></td> </tr> </table> <p>In B RUNS AFTER Delay Mode.</p> <table style="width: 100%; border-collapse: collapse;"> <tr> <td style="width: 20%;"><u>B TRIG SOURCE</u></td> <td style="width: 20%;"></td> <td style="width: 20%;"></td> <td style="width: 40%;"></td> </tr> <tr> <td><u>EXT CLK SOURCE</u></td> <td></td> <td></td> <td></td> </tr> <tr> <td><u>EVENTS SOURCE</u></td> <td></td> <td></td> <td></td> </tr> <tr> <td><u>EVENTS, EXT CLK SOURCE</u></td> <td></td> <td></td> <td></td> </tr> <tr> <td>VERT</td> <td>CHAN</td> <td>EXT</td> <td></td> </tr> <tr> <td>CH1</td> <td>112</td> <td>112</td> <td>WORD</td> </tr> <tr> <td>CH2</td> <td></td> <td></td> <td></td> </tr> <tr> <td>ADD</td> <td></td> <td></td> <td></td> </tr> </table>	<u>B TRIG SOURCE</u>				<u>B EXT CLOCK SOURCE</u>			(with EXT CLOCK ON)	<u>B EVENTS SOURCE</u>			(with DELAY by EVENTS ON)	<u>B EXT CLK EVENTS SOURCE</u>			(with both ON)	VERT	CHAN	EXT		CH1	112	112	WORD	CH2				ADD				<u>B TRIG SOURCE</u>				<u>EXT CLK SOURCE</u>				<u>EVENTS SOURCE</u>				<u>EVENTS, EXT CLK SOURCE</u>				VERT	CHAN	EXT		CH1	112	112	WORD	CH2				ADD			
<u>B TRIG SOURCE</u>																																																																	
<u>B EXT CLOCK SOURCE</u>			(with EXT CLOCK ON)																																																														
<u>B EVENTS SOURCE</u>			(with DELAY by EVENTS ON)																																																														
<u>B EXT CLK EVENTS SOURCE</u>			(with both ON)																																																														
VERT	CHAN	EXT																																																															
CH1	112	112	WORD																																																														
CH2																																																																	
ADD																																																																	
<u>B TRIG SOURCE</u>																																																																	
<u>EXT CLK SOURCE</u>																																																																	
<u>EVENTS SOURCE</u>																																																																	
<u>EVENTS, EXT CLK SOURCE</u>																																																																	
VERT	CHAN	EXT																																																															
CH1	112	112	WORD																																																														
CH2																																																																	
ADD																																																																	
13. TRIG POSITION	<table style="width: 100%; border-collapse: collapse;"> <tr> <td style="width: 20%;"><u>B TRIGGER POSITION</u></td> <td style="width: 20%;"></td> <td style="width: 20%;"></td> <td style="width: 20%;"></td> <td style="width: 20%;"></td> </tr> <tr> <td>1/8</td> <td>1/4</td> <td>1/2</td> <td>3/4</td> <td>7/8</td> </tr> </table>	<u>B TRIGGER POSITION</u>					1/8	1/4	1/2	3/4	7/8																																																						
<u>B TRIGGER POSITION</u>																																																																	
1/8	1/4	1/2	3/4	7/8																																																													

ACQUISITION

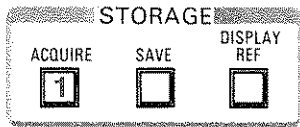

1. ACQUIRE starts/restarts the acquisition from SAVE mode. If single seq trigger mode is on, turn it off to gain access to the acquire menu when fast completing sequences are being acquired.

At the completion of a single seq acquisition, the scope switches to SAVE storage mode.

Save On Delta will be automatically turned off upon entering SAVE when a discrepancy is detected between the Reference envelope and the live waveform. If GPIB mode is set for PRINTER output, screen data will be printed, then Save On Delta will be reinitialized to continue monitoring the incoming live acquisitions (not done in ROLL mode).

If GPIB mode is selected for the talk/listen mode, the 2430 will issue a SRQ notifying the Controller of the SAVE event.

Average and Envelope acquisitions in progress will be

restarted by any of the following front-panel control changes:

- 1) Any vertical or horiz mode change,
- 2) A volts/div setting change of either channel,
- 3) A vertical position change of either channel, (Avg. but not Envelope),
- 4) Input coupling changes to either channel,
- 5) Changes in the trigger mode,
- 6) Pressing the menu/off button to turn off menus,
- 7) Delay-by-events or delay-by-time changes (Average only)
- 8) Changing the trigger slope.

These results are seen on screen.

Envelope turns off ADD or MULT vertical mode choices.

REPET mode extends bandwidth to 150 MHz for repetitive waveforms.

Storage On-Screen Menus

1. ACQUIRE	ACQUIRE	nnn	nnn	REPET	SAVE ON Δ
	NORMAL	ENVELOPE	AVG	ON/OFF	ON/OFF
	(nnn selection)	ENVELOPE--1,2,4,8,16,32,64,128,256,CONT		AVG--2,4,8,16,32,64,128,256	

SAVE AND DISPLAY REFERENCE



1. SAVE mode is entered at the end of a single seq, a discrepancy with save-on-delta reference, as a result of pressing the save front-panel button, and temporarily during an XY plotter or printer output. Pressing STACK REF in the SAVE-REF SOURCE menu treats the

reference memories as a stack; waveforms are saved in a predetermined ref memory, depending on what is displayed.

2. DISPLAY REF toggles between display and horiz. position selection menus.

Storage On-Screen Menus (cont.)

<p>1. SAVE</p>	<p>-----SAVEREF SOURCE ----- STACK CH1 CH2 (function) REF REF</p> <hr/> <p>Second-level menu displayed after a SAVEREF SOURCE (except STACK REF) is selected. REF4 is omitted if the extra front-panel setups have been turned on for the SAVE/RECALL SETUP feature.</p> <p>---- SAVEREF DESTINATION ----- SAVEREF REF1 REF2 REF3 REF4 SOURCE</p> <hr/> <p>Second-level menu if in Δ (delta) DELAY by TIME.</p> <p>SAVEREF SOURCE - (channel) DELAY 1 DELAY 2</p> <hr/> <p>Second-level menu if REF is selected.</p> <p>SAVEREF SOURCE - REF SAVEREF REF1 REF2 REF3 REF4 SOURCE</p>
<p>2. DISPLAY REF</p>	<p>In YT Mode.</p> <p>DISPLAY REF HORIZ REF1 REF2 REF3 REF4 POS REF</p> <hr/> <p>EMPTY appears above reference menu choice if no waveform stored. PANEL appears above REF4 if selected for saving front-panel setups.</p> <p>In XY Mode.</p> <p>XYREF HORIZ POS REF</p> <hr/> <p>Second-level menu displayed when HORIZ POS REF is called.</p> <p>----- HORIZONTAL POSITION ----- DISPLAY (In YT Mode) REF1P REF2P REF3P REF4P REF</p> <hr/> <p>----- HORIZONTAL POSITION ----- DISPLAY (In XY Mode) XY REFP REF</p>

GPIB STATUS

GPIB Status On-Line Screen

CH1100mV	A	1ms	0.0	V VERT
<u>ADDR</u> 0	<u>RQS</u> ON	<u>PENDING</u>		
<u>MODE</u> T/L	<u>OPC</u> ON	<u>EVENTS</u>		
<u>TERM</u> EOI	<u>CER</u> ON			
	<u>EXR</u> ON		401	
<u>FASTXMIT</u>	<u>EXW</u> ON			
OFF	<u>INR</u> ON			
1 WFMS REQSTD	<u>PID</u> OFF			
	<u>USER</u> OFF			
<u>SOURCE</u> CH1	<u>PATH</u> ON			
<u>TARGET</u> REF1	<u>LONG</u> ON			
<u>ENCDG</u> RIBINARY	<u>DEBUG</u> OFF			
<u>BINWFM</u> + 2430 RI	<u>DEVDEP</u> ON			

The above menu will appear on screen when STATUS is selected from the output menu. The underscored items are configurable functions while the remainder of the listings will vary with current instrument setup.

Interpretation of GPIB STATUS menu listings:

ADDR = ADDRESS SELECTION
 MODE = MODE SELECTION
 TERM = TERMINATION
 SOURCE = WAVEFORM DATA SOURCE
 TARGET = WAVEFORM DATA TARGET
 ENCDG = ENCODING
 BINWFM = INCOMING BINARY WAVEFORM INTERPRETATION MODE

RQS= ASSERT SRQ IF PENDING EVENT
 OPC= ASSERT SRQ ON OPERATION COMPLETE
 CER= ASSERT SRQ ON COMMAND ERROR
 EXP= ASSERT SRQ ON EXECUTION ERROR
 EXW= ASSERT SRQ ON EXECUTION WARNING
 INR= ASSERT SRQ ON INTERNAL ERROR
 PID= ASSERT SRQ ON PROBE IDENTIFICATION
 USER= ASSERT SRQ ON BEZEL BUTTON PUSH
 PATH= SEND COMPLETE PATH IN QUERY RESPONSE
 LONG= USE LONG FORM IN QUERY RESPONSE
 DEBUG= TURN ON DEBUG MODE
 DEVDEP= ASSERT SRQ IF TRANSMIT PUSHED
 401= POWER ON SRQ (TYPICAL EVENT)

PROBLEMS/SOLUTIONS

Symptom	Problem	Solution
Fails Power-on self test with UNCALD message displayed.	<ul style="list-style-type: none"> a. Self Cal testing failed. b. Extended Cal failed for Attenuator or Triggers. 	<p>Allow to warm up and do Self Cal.</p> <p>If condition persists, refer to qualified service personnel.</p> <p>Go to faster sweep speed.</p>
<p>Simple waveform on screen won't trigger (almost but not quite).</p> <p>Switch to Envelope mode and the entire waveform envelopes (fills in)</p> <p>A known high-frequency signal looks like a much lower frequency.</p>	Aliased display	Go to faster sweep speed.
<p>2430 seems locked in Save mode.</p> <p>(Vertical Position may or may not function.)</p>	<ul style="list-style-type: none"> a. "A" Trigger mode is in Single Sequence mode. b. Delay-by-Events mode is On and there are no Events to be counted. c. External Clock mode is On. d. You have a Reference Waveform on screen. 	<p>Change the "A" Trigger mode to Auto Level, Auto, or Normal. Then push Acquire, and adjust trigger level.</p> <p>Look at "B" Trigger Source menu and ensure the selected source is correct and the "B" Trigger Level is set appropriately then push Acquire.</p> <p>Select "B" Trigger Mode and turn Ext. Clock mode Off then push Acquire.</p> <p>Push "Display Ref" and turn the indicated reference off. Then push Acquire.</p>
No Intensified Zones.	<ul style="list-style-type: none"> a. "Intens" control is turned down. b. Delay time is beyond the "A" sweep range. 	<p>Push intensity "Select" and then the "Intens" menu key, and turn the intensity up.</p> <p>Push "Time" button and reduce the delay time until the intensified zone is positioned on screen.</p>

PROBLEMS/SOLUTIONS

Symptom	Problem	Solution
A high-speed signal appears to be somewhat sine-wave modulated. (Only at 200 ns/div or faster).	"Repet" mode is not turned on.	Display the "Acquire" menu, then using the menu key, turn "Repet" on.
Volts Cursors jumpy or are unstable when making Volts-at-Time or Slope Cursor measurements.	The Cursor is following the waveform normally and the signal is noisy.	Use the Averaging feature from the Acquire menu or use Save Storage Mode when possible for making measurements on noisy signals.
Cursor won't position to a specific point on the waveform.	The waveform doesn't have a digitized point at the desired location.	Either increase your sweep speed to increase the number of samples or Save the waveform and then expand.
The 2430's Calibrator waveform will not fill in "Repet" mode at 200 ns/div or faster.	The Calibrators rep rate is determined by the internal clock which is also setting the sampling rate.	No real solution. Note the amplitude accuracy of the display is not affected.
In Delay-by-Time you are looking at "B" sweep and expanding your signal using the sec/div control. Suddenly your signal disappears and you are somewhere else on your overall waveform.	The maximum time delay is 2621.4 times the "B" sweep speed. You just exceeded that limit and the time delay counter reset itself inside the limits.	Move your "A" Trigger point closer to the event you wish to observe. Use Delay-by-Events or reset the Trigger level, Trigger Position, etc.
Dashed line or line broken by vertical fill seen as the waveform display at power on.	Invalid Ch 1 or Ch 2 waveform data in memory	Press ACQUIRE to fill Ch 1 and Ch 2 memory with valid data. Press SAVE before turning 2430 off.



MANUAL CHANGE INFORMATION

Date: 4-24-86 Change Reference: C1/0486 (REV)

Product: 2430 USER REFERENCE GUIDE Manual Part No.: 070-5497-00

DESCRIPTION Product Group 37

EFFECTIVE SERIAL NUMBER: B011410

PAGE 8: Below is a new "Power Up On-Screen Menus" chart.

Power Up On-Screen Menus

1.MENU OFF/ EXTENDED FUNCTIONS	Turns off any menu being displayed or, if none are on, calls up the EXTENDED FUNCTIONS menus. See Appendix B in the Operators Manual for the Extended Functions Calibration and Diagnostics menus.
	EXT FUNCT
	SYSTEM SPECIAL CAL/DIAG
	SYSTEM (Second-level menu)
	PANEL MISC PREFLT ON OFF TV OPT
	SYSTEM PANEL (Third-level menu)
	PWR ON REF4 LAST INIT REF PNL ↑
	SYSTEM MISC (Third-level menu)
	BELL TRIG T PG SIZE ON OFF ON OFF 11 12 ↑
	SYSTEM TV OPT (Third-level menu)
	TV SYS CNT RST M NON/M BOTH F1 ↑
	SPECIAL (Second-level menu) WARNING: SERVICE ONLY--SEE MANUAL (if enabled) DISABLED--SEE MANUAL (if disabled)
	COLD CAL PATH FORCE START ON OFF DAC
	CAL/DIAG (Second-level menu)
	<status> <status> <status> NOT WARMED UP SELF EXT SELF EXT CAL CAL DIAG DIAG

PAGE 8: Replace the NOTE located in the description for the POWER button with the following note.

NOTE: The 2430 will power-up in either the Acquire mode or Save mode, whichever mode it was in when last powered down. The 2430 will display the following message if the instrument powers-up in the Save mode:

2430 is in SAVE mode
Press ACQUIRE to begin acquiring
new waveforms.

PAGE 23: Below is the menu that now appears when calling up the second-level menu for the HORIZ POS REF in the YT Mode.

-----	HORIZONTAL POSITION	-----	REF HPOS
REF1P	REF2P	REF3P	REF4P
			IND LOCK
