

Tektronix®

COMMITTED TO EXCELLENCE

For Service Manuals Contact
MAURITRON TECHNICAL SERVICES
8 Cherry Tree Rd, Chinnor
Oxon OX9 4QY
Tel:- 01844-351694 Fax:- 01844-352554
Email:- enquiries@maurtron.co.uk

434 OSCILLOSCOPE

(SN B500000 and up)

INSTRUCTION / MANUAL

Tektronix, Inc.
P.O. Box 500
Beaverton, Oregon 97077

070-1915-00
Product Group 40

Serial Number _____

First Printing JAN 1975
Revised JAN 1988

Copyright © 1975 Tektronix, Inc. All rights reserved.
Contents of this publication may not be reproduced in any
form without the written permission of Tektronix, Inc.

Products of Tektronix, Inc. and its subsidiaries are covered
by U.S. and foreign patents and/or pending patents.

TEKTRONIX, TEK, SCOPE-MOBILE, and  are
registered trademarks of Tektronix, Inc. TELEQUIPMENT
is a registered trademark of Tektronix U.K. Limited.

Printed in U.S.A. Specification and price change privileges
are reserved.

INSTRUMENT SERIAL NUMBERS

Each instrument has a serial number on a panel insert, tag,
or stamped on the chassis. The first number or letter
designates the country of manufacture. The last five digits
of the serial number are assigned sequentially and are
unique to each instrument. Those manufactured in the
United States have six unique digits. The country of
manufacture is identified as follows:

B000000	Tektronix, Inc., Beaverton, Oregon, USA
100000	Tektronix Guernsey, Ltd., Channel Islands
200000	Tektronix United Kingdom, Ltd., London
300000	Sony/Tektronix, Japan
700000	Tektronix Holland, NV, Heerenveen, The Netherlands

TABLE OF CONTENTS

SECTION 1	SPECIFICATION	Page
	Introduction	1-1
	Table 1-1 Electrical	
	Vertical Deflection System	1-2
	Triggering	1-3
	Horizontal Deflection System	1-4
	Calibrator	1-6
	Z-Axis Input	1-6
	Power Source	1-6
	Display	1-6
	Table 1-2 Environmental	1-7
	Table 1-3 Physical	1-8
SECTION 2	OPERATING INSTRUCTIONS	
	General	2-1
	Safety Information	2-1
	Operating Voltage	2-1
	Operating Temperature	2-1
	Operating Position	2-1
	Rackmounting	2-1
	Controls and Connectors	
	General	2-2
	Display	2-2
	Vertical	2-2
	Triggering	2-3
	Sweep	2-4
	Storage	2-4
	Power and External Blanking	2-5
	General Operating Information	
	Intensity Control	2-5
	Astigmatism and Focus Adjustment	2-5
	Trace Alignment Adjustment	2-5
	Graticule	2-5
	Light Filter	2-6
	Beam Finder	2-6
	Bandwidth Limiter	2-6
	Vertical Channel Selection	2-6
	Vertical Gain Adjustment	2-6
	Step Attenuator Balance Adjustment	2-7
	Signal Connections	2-7
	Loading Effect of 434	2-7
	Ground Considerations	2-8
	Input Coupling	2-8
	Deflection Factor	2-8
	Dual-Trace Operation	2-8
	Algebraic Addition	2-9
	Trigger Source	2-9
	Trigger Coupling	2-9
	Trigger Slope	2-10
	Trigger Level	2-10
	Sweep Mode	2-10
	Horizontal Sweep Rates	2-12
	Sweep Magnification	2-12
	Horizontal Position Control	2-12
	External Horizontal Input	2-12
	Intensity Modulation	2-12
	Calibrator	2-13
	Simplified Operating Instructions	
	General	2-13
	Normal Sweep Display	2-13
	Magnified Sweep Display	2-13
	External Horizontal Display	2-13

TABLE OF CONTENTS (cont)

SECTION 2	OPERATING INSTRUCTIONS (cont)	Page
	Storage Operation	
	General	2-14
	Slow and Medium Sweep Rates	2-14
	Integrated Fast-Rise Waveforms	2-14
	Fast Single-Sweep Enhancement	2-15
	Applications	
	General	2-15
	Peak-To-Peak Voltage Measurements—AC	2-15
	Instantaneous Voltage Measurement—DC	2-16
	Comparison Measurements	2-17
	Time Duration Measurements	2-19
	Determining Frequency	2-19
	Risetime Measurements	2-19
	Time Difference Measurements	2-20
	Multi-Trace Phase Difference Measurements	2-21
	High Resolution Phase Measurements	2-22
	Common-Mode Rejection	2-22

WARNING

THE FOLLOWING SERVICING INSTRUCTIONS ARE FOR USE BY QUALIFIED PERSONNEL ONLY. TO AVOID PERSONAL INJURY, DO NOT PERFORM ANY SERVICING OTHER THAN THAT CONTAINED IN OPERATING INSTRUCTIONS UNLESS YOU ARE QUALIFIED TO DO SO.

SECTION 3	CIRCUIT DESCRIPTION	
	Introduction	3-1
	Block Diagram	3-1
	Circuit Operation	
	General	3-3
	Channel 1 Input Amp And Preamp	3-3
	Channel 2 Input Amp And Preamp	3-5
	Channel Switch	3-6
	Vertical Output Amplifier	3-9
	Trigger Pickoff And Generator	3-10
	Sweep Generator	3-13
	Horizontal Amplifier	3-16
	Power Supply Primary	3-18
	Power Supply Secondary	3-23
	CRT Circuit	3-24
	Calibrator	3-26
	Storage Circuit	3-27

For Service Manuals Contact
MAURITRON TECHNICAL SERVICES
 8 Cherry Tree Rd, Chinnor
 Oxon OX9 4QY
 Tel: 01844-351694 Fax: 01844-352554
 Email: enquiries@mauritron.co.uk

SECTION 4	MAINTENANCE	
	Introduction	4-1
	Cabinet Removal	4-1
	Preventive Maintenance	
	General	4-1
	Cleaning	4-1
	Lubrication	4-2
	Transistor Checks	4-2
	Recalibration	4-2
	Troubleshooting	
	Introduction	4-2
	Troubleshooting Aids	4-2
	Troubleshooting Equipment	4-4
	Troubleshooting Techniques	4-4

TABLE OF CONTENTS (cont)

SECTION 4	MAINTENANCE (cont)	PAGE
	Corrective Maintenance	
	General	4-8
	Obtaining Replacement Parts	4-8
	Soldering Techniques	4-8
	Component Replacement	4-9
	Recalibration After Repair	4-11
	Instrument Repackaging	4-12
SECTION 5	CALIBRATION	
	Introduction	5-1
	Tektronix Field Service	5-1
	Using This Procedure	5-1
	Test Equipment Required	
	General	5-1
	Special Calibration Fixtures	5-1
	Calibration Equipment Alternatives	5-1
	Test Equipment	5-2
	Index to Calibration Procedure	5-4
	Preliminary Procedure for Complete Calibration	5-5
	Preliminary Control Settings	5-5
	A. Power Supply And Display Adjustment	5-6
	B. Vertical System Adjustment	5-14
	C. Trigger Circuit Adjustment	5-21
	D. Horizontal System Calibration	5-24
	E. Calibrator Circuit Adjustment	5-27
SECTION 6	RACKMOUNTING	
	Introduction	6-1
	Rack Dimensions	6-1
	Mounting Procedure	6-1
	Portable Conversion	6-2
	Rear Panel Signal Connections	6-2
SECTION 7	REPLACEABLE ELECTRICAL PARTS	
SECTION 8	DIAGRAMS AND CIRCUIT BOARD ILLUSTRATIONS	
	Symbols and Reference Designators	8-1
	Voltage and Waveform Test Conditions	8-2
	Diagrams	
	Circuit Board Illustrations	
SECTION 9	REPLACEABLE MECHANICAL PARTS	
CHANGE INFORMATION		

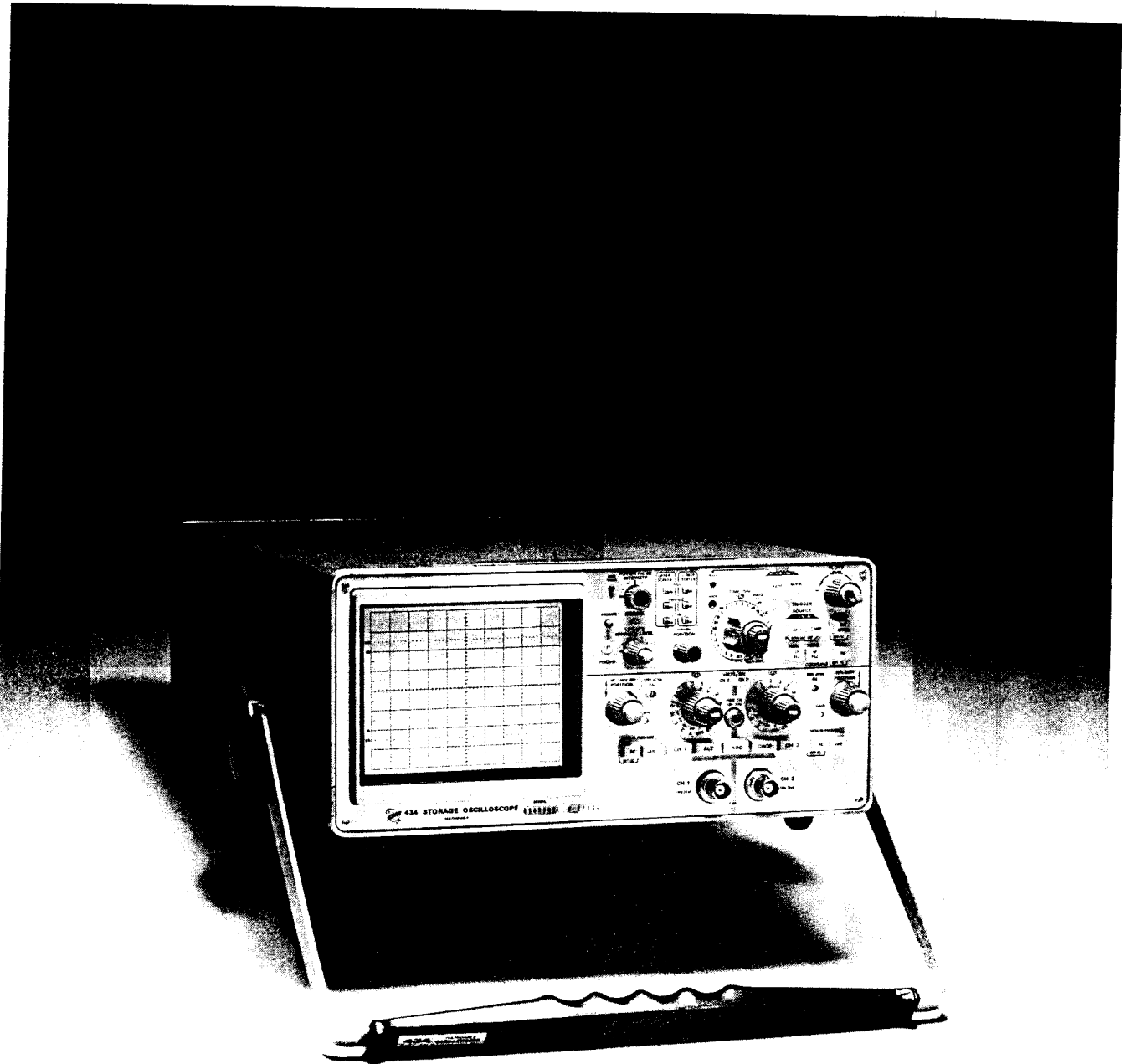

For Service Manuals Contact
MAURITRON TECHNICAL SERVICES
8 Cherry Tree Rd, Chinnor
Oxon OX9 4QY
Tel: 01844-351694 Fax: 01844-352554
Email: enquiries@maurtron.co.uk

1915-9

Fig. 1-1. 434 Oscilloscope.

434 (SN B500000 and up)

@

SPECIFICATION

Introduction

The Tektronix 434 Oscilloscope is a solid-state portable instrument that combines small size and light weight with the ability to make precision waveform measurements. It is designed for general-purpose applications where display storage is desired, along with conventional (non-store) operation. The instrument is mechanically designed to withstand the shock, vibration, and other extremes of environment associated with portability.

The dual-channel DC-to-25 megahertz vertical system provides calibrated deflection factors from 1 millivolt to 10 volts/division. The trigger circuits provide stable triggering over the full range of vertical frequency response. The horizontal deflection system provides calibrated unmagnified sweep rates from 5 seconds to 0.2 microsecond/division. A push-to-turn direct-reading six-position magnifier allows sweep magnification up to a maximum of 50 times and provides a maximum sweep rate of 0.02 microsecond/division.

X-Y measurements can be made applying the vertical (Y) signal to one of the vertical input connectors (appropriate vertical mode of operation selected) and the horizontal (X) signal to the EXT HORIZ connector on the instrument rear panel (TIME/DIV switch set to EXT HORIZ).

The cathode-ray tube is a direct view, bistable storage tube having an 8 X 10 division display area divided into two 4 X 10 division storage screens. The storage screens are independently controlled for split-screen applications. A non-storing area to the left of the storage screens permits beam location without disturbing a stored display.

The regulated low-voltage power supply assures that instrument performance is not affected by variations in line voltage and frequency.

Information given in this instruction manual applies to the R434 also unless otherwise indicated. The R434 is electrically identical to the 434, but is adapted for mounting in a standard 19-inch rack. Rackmounting instructions and a dimensional drawing for the R434 are provided in Section 6 of this manual.

The electrical characteristics which follow are divided into two categories. Characteristics listed in the Performance Requirement column are instrument specifications, and are checked in the Performance Check procedure provided in the Calibration section. Data in the Supplemental Information column does not constitute instrument specifications and is provided for reference only. The following electrical characteristics apply over an ambient temperature range of -15°C to $+55^{\circ}\text{C}$, except as otherwise indicated. Warm-up time for given accuracy is 30 minutes.

For Service Manuals Contact
MAURITRON TECHNICAL SERVICES
8 Cherry Tree Rd, Chinnor
Oxon OX9 4QY
Tel:- 01844-351694 Fax:- 01844-352554
Email:- enquiries@mauritron.co.uk

TABLE 1-1
ELECTRICAL

Characteristic	Performance Requirement		Supplemental Information															
VERTICAL DEFLECTION SYSTEM																		
Deflection Factor																		
Channel 1 or 2 calibrated range																		
Without probe	1 mV to 10 V/div in 13 steps. Steps in a 1-2-5 sequence.																	
With 10X probe	10 mV to 100 V/div in 13 steps. Steps in a 1-2-5 sequence.																	
Accuracy	Within 3% of indicated deflection.																	
Uncalibrated (VAR) range	Provides continuously variable deflection factors between the calibrated steps. Extends maximum uncalibrated deflection factor to at least 25 volts/division.		Each deflection factor increased by a factor of at least 2.5:1.															
Frequency Response			Bandwidth measured with 6 division reference, vertically centered. VAR V/DIV in Calibrated position.															
Upper -3 dB Frequency AC or DC Coupled 6 Division Reference	-15°C to +30°C	+30°C to +55°C																
With Standard X10 Probe or from 25 Ω Source	At least 25 MHz at 10 mV/DIV to 10 V/DIV, decreasing to 18 MHz to 1 mV/DIV.	At least 22 MHz at 10 mV/DIV to 10 V/DIV, decreasing to 16 MHz at 1 mV/DIV.																
Without Probe or from 25 Ω Source					<table border="1" style="width: 100%; border-collapse: collapse;"> <thead> <tr> <th></th> <th>-15°C to +30°C</th> <th>+30°C to +55°C</th> </tr> </thead> <tbody> <tr> <td>10 mV/DIV to 10 V/DIV</td> <td>25 MHz</td> <td>25 MHz</td> </tr> <tr> <td>5 mV/DIV</td> <td>23 MHz</td> <td>21 MHz</td> </tr> <tr> <td>2 mV/DIV</td> <td>20 MHz</td> <td>18 MHz</td> </tr> <tr> <td>1 mV/DIV</td> <td>18 MHz</td> <td>16 MHz</td> </tr> </tbody> </table>		-15°C to +30°C	+30°C to +55°C	10 mV/DIV to 10 V/DIV	25 MHz	25 MHz	5 mV/DIV	23 MHz	21 MHz	2 mV/DIV	20 MHz	18 MHz	1 mV/DIV
	-15°C to +30°C	+30°C to +55°C																
10 mV/DIV to 10 V/DIV	25 MHz	25 MHz																
5 mV/DIV	23 MHz	21 MHz																
2 mV/DIV	20 MHz	18 MHz																
1 mV/DIV	18 MHz	16 MHz																
Lower -3 dB Frequency																		
DC (Direct) Coupled	Within Gain Accuracy to DC.																	
AC (Capacitive) Coupled																		
X1 Probe or No Probe	10 Hz or less																	
X10 Probe	1 Hz or less																	

TABLE 1-1 (cont)

Specification—434 (SN B500000 and up)

Characteristic	Performance Requirement		Supplemental Information	
Step Response				
Risetime				
With Standard X10 Probe or from 25 Ω Source	-15°C to +30°C	+30°C to +55°C	6 Division Positive-going step, centered vertically, VAR V/DIV in Calibrated position.	
	14 ns or less 10 mV/DIV to 10 V/DIV, increasing to 19.5 ns or less at 1 mV/DIV.	16 ns or less 10 mV/DIV to 10 V/DIV, increasing to 22 ns or less at 1 mV/DIV.		
Without Probe, from 25 Ω Source			-15°C to +30°C	
			10 mV/DIV 5 mV/DIV 2 mV/DIV 1 mV/DIV	14.0 ns or less 15.2 ns or less 17.5 ns or less 19.5 ns or less
Input RC Characteristics				
Resistance	1 megohm within 2%.			
Capacitance	Approximately 24 picofarads.			
Vertical Display Modes	Channel 1 only. Channel 2 only. Dual-Trace, alternate between channels. Dual-Trace, chop between channels. Added algebraically			
Input Coupling Modes	AC (capacitive) coupled, DC (direct) coupled, or AC Pre-Charge.			
Maximum Safe Input Voltage				
DC Coupled			250 V (DC plus peak AC) 500 V peak to peak AC (1 kHz or less)	
AC Coupled			500 V (DC plus peak AC) 500 V peak to peak AC (1 kHz or less)	
Chopped Mode Rate	Approximately 100 kilohertz.			
Signal Delay (Delay Line)	Allows viewing leading edge of a triggering waveform.			
Step Attenuator Balance			Adjustable for no trace shift when deflection factor is changed from 1 mV/DIV to 10 mV/DIV.	
Polarity Inversion	Display signal from Channel 2 can be inverted.			
	TRIGGERING			
Trigger Source	Internal from Channel 1 only or from displayed channel(s). Internal from AC power source. External from signal applied to EXT TRIG INPUT connector. External from signal applied to EXT TRIG INPUT connector attenuated 10 times.		For Service Manuals Contact MAURITRON TECHNICAL SERVICES 8 Cherry Tree Rd, Chinnor Oxon OX9 4QY Tel: 01844-351694 Fax: 01844-352554 Email: enquiries@mauritron.co.uk	

TABLE 1-1 (cont)

Characteristic	Performance Requirement	Supplemental Information
Trigger Coupling	AC AC low-frequency reject High-frequency reject DC The combination of high-frequency reject and AC low-frequency reject.	
Coupling and Sensitivity		
Coupling	To 5 MHz	At 25 MHz
DC Internal	0.3 Div deflection	1 Div deflection
DC External	50 mV	175 mV
AC	Same as DC at 20 Hz and above, requirements increase below 20 Hz.	
AC LF REJ	Same as AC at 150 kHz and above, requirements increase below 150 kHz.	
AC HF REJ	Same as AC at 15 kHz and below, requirements increase above 15 kHz.	
External Input RC Characteristics		
Resistance		1 MΩ (within 2% at DC) NOTE: In LF REJ mode with 1:1 attenuation the 1 MΩ DC coupled is shunted by 100 kΩ AC coupled. Effective input resistance decreases with increasing frequency to approximately 100 kΩ at 20 kHz and above.
Capacitance		Approximately 100 picofarads 1:1. Approximately 70 picofarads 1:10.

HORIZONTAL DEFLECTION SYSTEM

Sweep Mode	Normal—Stable display presented only with signals meeting limits specified in Fig. 1-2. No display presented in the absence of an adequate trigger signal. Automatic—Stable display presented only with signals meeting limits specified in Fig. 1-2. Presents a free-running	
------------	--	--

TABLE 1-1 (cont)

Characteristic	Performance Requirement		Supplemental Information
	trace in the absence of an adequate trigger signal. Single Sweep—Sweep Generator produces only one sweep when triggered. Further sweeps are locked out until RE-SET button is pressed.		
Calibrated Sweep Rates (unmagnified)	0.2 microsecond to 5 seconds/division in 23 steps in a 1-2-5 sequence.		
Magnifier	Direct-reading, six position, push to turn switch with up to 50 times maximum magnification. Extends the fastest sweep rate to 20 nanoseconds/division.		
Sweep Time Accuracy +20°C to +30°C	Unmagnified	Magnified	Over full 10 displayed horizontal divisions. Exclude the following portions of the sweep when checking magnified timing: X2 magnification — first and last 0.5 div. X5 magnification — first and last one div. X10 magnification — first and last two div. X20 magnification — first and last five div. X50 magnification — first and last ten div.
	Within 3%	Within 4%	
-15°C to +55°C	Within 4%	Within 5%	
	<p>For Service Manuals Contact MAURITRON TECHNICAL SERVICES 8 Cherry Tree Rd, Chinnor Oxon OX9 4QY Tel: 01844-351694 Fax: 01844-352554 Email: enquiries@maurtron.co.uk</p>		
Uncalibrated (variable) Sweep Rates	Provides continuously variable sweep rates between the calibrated steps. Extends the slowest uncalibrated sweep rate to at least 12.5 seconds/division.		At least 2.5:1.
EXT HORIZ Input			
Resistance			Approximately 50 kilohms.
Sensitivity	≈0.5 volt/division		
Bandwidth			DC to 500 kHz (10 div reference signal).

Specification—434 (SN B500000 and up)

TABLE 1-1 (cont)

Characteristic	Performance Requirement	Supplemental Information
CALIBRATOR		
Output Voltage (+20°C to +30°C)	0.6 volt with 1.0%, open circuit.	0.6 volt within 2.0% open circuit from -15°C to +55°C.
Repetition Rate (+20°C to +30°C)	One kilohertz within 1.0%.	1 kHz within 2.0% from -15°C to +55°C.
Output Resistance		Approximately 575 ohms.
Z AXIS INPUT		
Sensitivity	Five volt peak to peak signal causes noticeable modulation at normal intensity.	Positive-going signal decreases intensity.
Usable Frequency Range	DC to 20 megahertz.	
Input Resistance		Approximately 50 kilohms.
POWER SOURCE		
Line Voltage Range	115 volts nominal 90 to 136 volts	230 volts nominal 180 to 272 volts
Line Voltage Frequency Range	48 to 440 hertz	
Power Consumption	90 volt amperes or 60 watts maximum.	
DISPLAY		
Graticule		For Service Manuals Contact MAURITRON TECHNICAL SERVICES 8 Cherry Tree Rd, Chinnor Oxon OX9 4QY Tel: 01844-351694 Fax: 01844-352554 Email: enquiries@mauritron.co.uk
Type	Internal	
Area	Eight divisions vertical by 10 divisions horizontal. Each division equals .98 centimeter.	
Beam Finder	Limits display within graticule area when pressed.	
Storage Writing Speed		Measured within the center 6 vertical and 8 horizontal divisions (Some writing speed degradation with usage is normal)
Standard CRT	100 Div/ms minimum (400 Div/ms enhanced)	
Option 1 CRT	500 Div/ms minimum (5 Div/ μ s enhanced)	

TABLE 1-2
ENVIRONMENTAL

Characteristic	Performance Requirement	Supplemental Information
Temperature		
Operating	-15°C to +55°C	
Non-Operating	-55°C to +75°C	
Altitude		
Operating	To 15,000 feet	Maximum allowable operating temperature decreased by 1°C per 1000 feet from 5000 feet to 15,000 feet.
Non-Operating	To 50,000 feet	
Humidity		
Operating and Non-Operating	Five cycles (120 hours) referenced to MIL-E-16400F.	
Vibration		
Operating and Non-Operating	15 minutes along each of the 3 major axes at a total displacement of 0.025 inch peak to peak (4 g's at 55 Hertz) with frequency varied from 10 to 55 to 10 Hertz in one minute sweeps. Hold for three minutes at 55 Hertz. All major resonances must be above 55 Hertz.	
Shock		
Operating and Non-Operating	30 g's, 1/2 sine, 11 milliseconds duration, two shocks per axis each direction for a total of 12 shocks.	
Transportation	Tested to National Safe Transit Committee procedure 1A with a 30 inch drop.	
Electromagnetic Interference Optional EMI mesh filter installed	As tested in MIL-I-6181D	
Radiated	150 kilohertz to one gigahertz with mesh filter installed.	Mesh filter reduces light output approximately 56%.
Conducted	150 kilohertz to 25 megahertz.	

Specification—434 (SN B500000 and up)

TABLE 1-3
PHYSICAL

Characteristic	Performance Requirement
Construction	
Chassis	Aluminum alloy.
Panel	Aluminum alloy with anodized finish.
Cabinet	Blue vinyl-coated aluminum.
Circuit Boards	Glass-epoxy laminate or polyphenylene oxide.

TABLE 1-3 (cont)

Characteristic	Performance Requirement
Overall Dimensions	
Height	5.6 inches.
Width	13 inches including handle.
Depth	18.6 inches.
Weight (Including Panel Cover and Accessories)	20 pounds, 6 ounces.
Domestic Shipping Weight	30 pounds, 2 ounces.
Export-Packed Shipping Weight	35 pounds, 2 ounces.

For Service Manuals Contact
MAURITRON TECHNICAL SERVICES
 8 Cherry Tree Rd, Chinnor
 Oxon OX9 4QY
 Tel:- 01844-351694 Fax:- 01844-352554
 Email:- enquiries@mauritron.co.uk

OPERATING INSTRUCTIONS

General

To effectively use the 434 Oscilloscope, the operation and capabilities of the instrument must be known. This section describes the operation of front-panel controls, gives simplified and general operating information, and lists some basic applications for this instrument.

SAFETY INFORMATION

The 434 is designed to operate from a single-phase power source with one of the current-carrying conductors (the Neutral conductor) at ground (earth) potential. Operation from power sources where both current-carrying conductors are live with respect to ground (such as phase-to-phase on a three-wire system) is not recommended, since only the Line Conductor has over-current (fuse) protection within the instrument.

The instrument has a three-wire power cord with a three-terminal polarized plug for connection to the power source and safety-earth. The ground (earth) terminal of the plug is directly connected to the instrument frame. For electric-shock protection, insert this plug only in a mating outlet with a safety-earth contact.

Power Cord Conductor Identification

Conductor	Color	Alternate Color
Ungrounded (Line)	Brown	Black
Grounded (Neutral)	Blue	White
Grounding (Earthing)	Green-Yellow	Green-Yellow

OPERATING VOLTAGE

The 434 can be operated from a nominal line voltage of 115 volts or 230 volts, 48 to 440 hertz. The Line Voltage Selector switch must be set to indicate the available line voltage. Since turn-on surge current is about the same for both ranges, the line fuse (3 amperes, fast-blow) is the same for both ranges. Maximum power consumption is about 60 watts.

OPERATING TEMPERATURE

The 434 requires very little air circulation for proper operation. A thermal cutout in the instrument provides thermal protection and disconnects the instrument power if the internal temperature exceeds a safe operating level. Power is automatically restored when the temperature returns to a safe level.

The 434 can be operated where the ambient temperature is between -15°C and $+55^{\circ}\text{C}$. The maximum operating temperature must be derated 1°C for each 1000 feet of altitude above 5000 feet. This instrument can be stored in ambient temperatures between -55°C and $+75^{\circ}\text{C}$. After storage at temperatures beyond the operating limits, allow the chassis temperature to come within the operating limits before power is applied.

NOTE

The crt performance may be degraded if a continuously stored display is maintained for over four hours at ambient temperatures below $+40^{\circ}\text{C}$ or for over one hour at ambient temperatures greater than $+40^{\circ}\text{C}$.

OPERATING POSITION

The handle of the 434 can be positioned for carrying or as a tilt-stand for the instrument. To position the handle, press in at both pivot points (see Fig. 2-1) and turn the handle to the desired position. Fourteen positions are provided for convenient carrying or viewing. The instrument can also be set on the rear feet for either operation or storage.

RACKMOUNTING

Complete information for mounting the 434 in a cabinet rack is given in Section 6 of this manual.

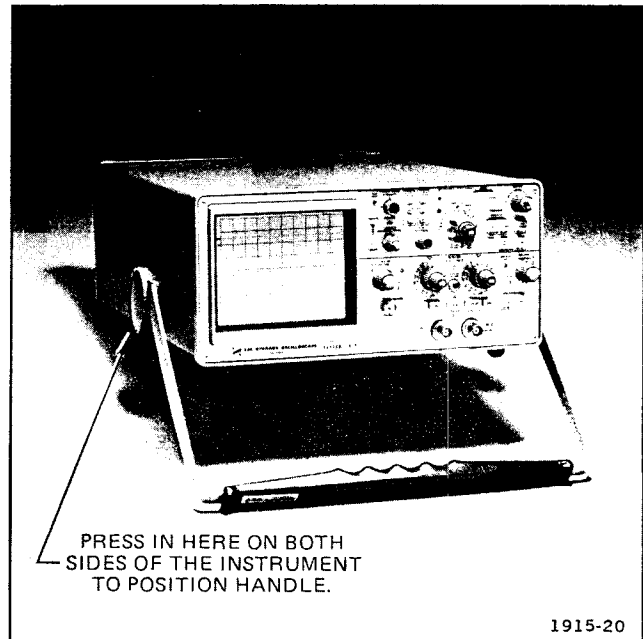
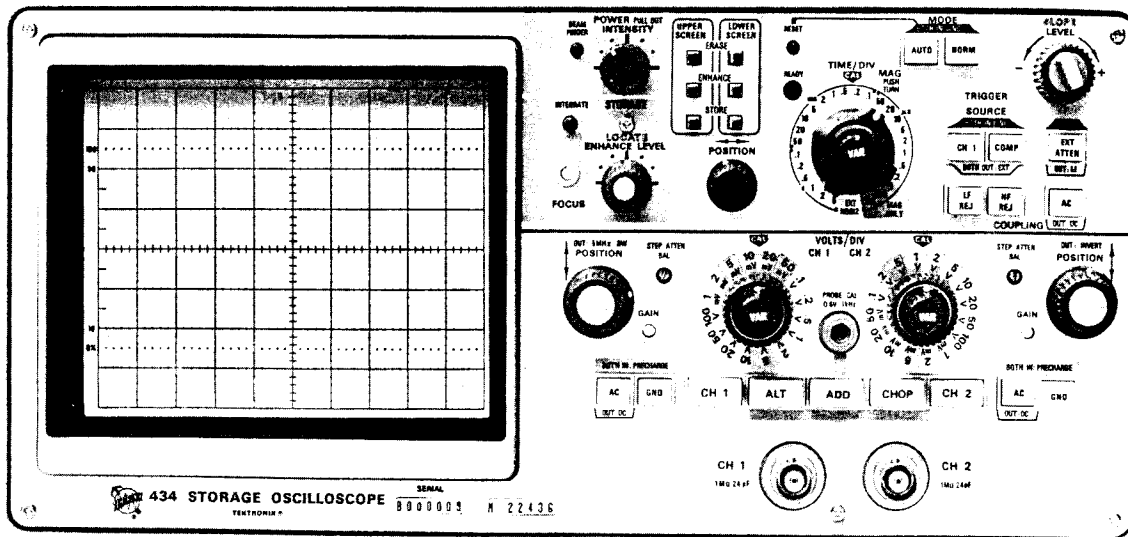
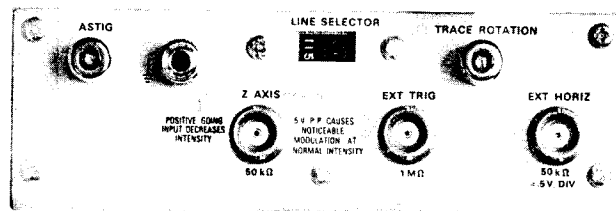

Fig. 2-1. Handle positioned to provide a stand for the instrument.



(A) FRONT PANEL



(B) REAR PANEL

1915-4

Fig. 2-2. Front- and rear-panel controls and connectors.

CONTROLS AND CONNECTORS

General

A brief description of the function and operation of the instrument's controls and connectors follows. Fig. 2-2 shows the front and rear panels of the instrument. More detailed information is given in this section under General Operating Information.

Display

INTENSITY and POWER	A combination control that turns instrument power on or off (pull ON-push OFF) and also controls the brightness of the display.
BEAM FINDER	Compresses the display within the graticule area independently of display position or applied signals.
ASTIG (Rear Panel)	Screwdriver adjustment which adjusts to provide optimum display definition. Used in conjunction with the FOCUS control.

FOCUS
(Front Panel)

Screwdriver adjustment which adjusts to provide optimum display definition. Used in conjunction with the ASTIG control.

TRACE ROTATION
(Rear panel)

Screwdriver adjustment to align trace with horizontal graticule lines.

Vertical (both channels if applicable)

VOLTS/DIV

Selects vertical deflection factor in a 1-2-5 sequence (Variable control must be in the CAL position for indicated deflection).

Variable

Provides continuously variable deflection factors between the calibrated settings of the VOLTS/DIV switch.

POSITION

Controls the vertical position of the trace.

5 MHz BW A push-push switch that limits the complete vertical amplifier system bandwidth to approximately 5 MHz.

INVERT (CH 2 only) A push-push switch to invert the Channel 2 display.

GAIN Screwdriver adjustment to set the gain of the vertical amplifier.

STEP ATTEN BAL Screwdriver adjustment to balance the input amplifier in the 1 mV, 2 mV, 5 mV, and 10 mV positions of the VOLTS/DIV switches.

Input Coupling (AC/DC, GND) Selects method of coupling input signal to input amplifier.

AC: In the AC position (button in) of this push-push switch, signals are capacitively coupled to the vertical amplifier. The DC component of the input signal is blocked. Low frequency -3 dB down point is about 10 hertz.

DC: In the DC position (button out) of the AC push-push switch, all components of the input signal are passed to the input amplifier.

GND: In the GND position (button in) of this push-push switch, the input of the vertical amplifier is disconnected from the input connector and grounded. Allows precharging of the input coupling capacitor.

CH 1 and CH 2 Input Input connectors that allow application of external signals to the inputs of the vertical amplifier. Includes a coding ring for probes with scale factor switching.

Mode (Not labeled) Selects mode of operation for vertical input amplifiers.

CH 1: Displays Channel 1 only.

ALT: Dual-trace display of signals on both channels. Display switched between channels at the end of each sweep.

ADD: Signals applied to the CH 1 and CH 2 Input connectors are algebraically added and the

algebraic sum is displayed on the CRT. The INVERT switch in Channel 2 allows the display to be CH 1 + CH 2 or CH 1 - CH 2.

CHOP: Dual-trace display of signals on both channels. Display switched at a repetition rate of approximately 100 kHz.

CH 2: Displays Channel 2 only.

Triggering

SOURCE

Selects source of trigger signal.

CH 1: A pushbutton switch that in the CH 1 position (button in) selects CH 1 as an internal trigger source.

COMP: A pushbutton switch that in the COMP position (button in) allows the internal trigger source to be determined by the vertical mode of operation.

LINE: When both the CH 1 and COMP switches are pressed in, a portion of the line frequency voltage is used as a trigger signal.

EXT: When both the CH 1 and COMP switches are out, signals applied to the EXT TRIG connector are used for triggering.

EXT ATTEN

In the 1:10 position (button in) of this push-push switch, external trigger signals are attenuated by a factor of 10. In the 1:1 position (button out) external trigger signals are not attenuated.

COUPLING

Determines method of coupling trigger signal to trigger circuit.

AC: In the AC position (button in) of this push-push switch, DC is rejected and signals below about 20 hertz are attenuated. Accepts signals between about 20 hertz and 25 megahertz.

DC: When both the AC and the LF REJ push-push switches are out, signals are directly coupled to the trigger circuit. Accepts all signals from DC to 25 megahertz

**For Service Manuals Contact
MAURITRON TECHNICAL SERVICES
8 Cherry Tree Rd, Chinnor
Oxon OX9 4QY
Tel:- 01844-351694 Fax:- 01844-352554
Email:- enquiries@mauritron.co.uk**

Operating Instructions—434 (SN B500000 and up)

COUPLING (cont)	if LF REJ and HF REJ are in out position.	MODE	Determines the operating mode for the sweep generator.
	LF REJ: Rejects DC and attenuates signals below approximately 30 kilohertz. Accepts signals between about 30 kilohertz and 25 megahertz.		AUTO: In the AUTO position (button in) of this pushbutton switch, the sweep is initiated by the applied trigger signal. In the absence of an adequate trigger signal, the sweep free runs and provides a bright reference trace.
	HF REJ: Attenuates signals above approximately 50 kilohertz. Accepts signals between DC and approximately 50 kilohertz.		NORM: In the NORM position (button in) of this pushbutton switch, the sweep is initiated by the applied trigger signal. In the absence of an adequate trigger signal, there is no trace.
LEVEL	Selects the amplitude point on the trigger signal at which the sweep is triggered.		
SLOPE	Selects slope of trigger signal which starts the sweep.		SINGLE SWEEP: When both the AUTO and NORM switches are pressed in the sweep operates in the Single Sweep mode. After a sweep is displayed, further sweeps cannot be presented until the RESET button is pressed.
	+: Sweep can be triggered from positive-going portion of trigger signal.		
	-: Sweep can be triggered from negative-going portion of trigger signal.	RESET	When the RESET button is pressed (in the SINGLE SWEEP mode), a single display will be presented (with correct triggering). After the sweep is completed, the RESET button must be pressed again before another sweep can be displayed.
EXT TRIG (Rear panel)	Input connector for external trigger signals.		
Sweep			
POSITION	Controls horizontal position of the display.		
TIME/DIV	Selects the sweep rate of the sweep generator (Variable control must be in the CAL position for indicated sweep rate). Extreme counterclockwise position of switch selects External Horizontal mode of operation.	READY Light	Indicates sweep has been reset and a single display will be presented upon receipt of an adequate trigger signal.
		EXT HORIZ (Rear panel)	Input connector for external horizontal signal when TIME/DIV switch is set to EXT HORIZ.
MAG	Push-to-turn switch (concentric with TIME/DIV switch) provides sweep magnification up to a maximum of 50 times. Extends fastest sweep rate to 0.02 μ s/div.	Storage	
		STORE (Upper and lower)	In the STORE position (button in), the CRT operates in the storage mode. In the Non-Store position (button out), the CRT operates in the conventional mode.
Variable (Not labeled)	Provides uncalibrated sweep rates between the calibrated settings selected by the TIME/DIV switch. The sweep rate in each TIME/DIV switch position can be reduced to at least the sweep rate of the next adjacent position to provide continuously variable sweep rates.	ENHANCE (Upper and lower)	In the ENHANCE position (button in) the writing rate for single-sweep displays is increased (using the ENHANCE LEVEL control).
		ERASE (Upper and lower)	A momentary contact switch that, when pushed, erases a stored display from the CRT.

Operating Instructions—434 (SN B500000 and up)

ENHANCE LEVEL Provides a selectable increase in writing speed capability for single-sweep displays. Effective only when either or both ENHANCE push-buttons are depressed.

INTEGRATE A pushbutton switch that permits storage of very fast repetitive signals by allowing the writing-gun beam to accumulate charges on the target while the flood-gun beams are turned off.

LOCATE A pushbutton switch that unblanks the CRT and provides a visible indication of the position of the display signal while the sweep is held off. The LOCATE control shifts the start of the sweep approximately 0.2 division to the left. For instrument operation in Single-Sweep and Store modes simultaneously, when the sweep start is positioned at the graticule edge, the locate spot is shifted into the non-storing locate zone to allow vertical positioning of the trace without storing.

Calibrator

PROBE CAL
0.6 V 1 kHz Provides a 0.6 volt calibrator signal to permit probe compensation, adjustment of amplifier GAIN, and checking basic horizontal timing.

Power and External Blanking

POWER and INTENSITY A combination control, part of which is a push-pull switch to control application of power to the instrument.

LINE SELECTOR
(115 V—230 V) Rear-panel switch which allows the instrument to be operated from a nominal line-voltage of either 115 volts or 230 volts.

Z AXIS Input connector for external blanking signals.

GENERAL OPERATING INFORMATION

Intensity Control

The setting of the INTENSITY control should not affect the correct focus of the display. An automatic-focusing control is ganged to the INTENSITY control to provide automatic adjustment of display focus along with adjustment of display intensity. Maximum intensity is reached with the control advanced to approximately three o'clock. Further advancing the control overrides the blanking, thus

in single-sweep operation, a spot can be obtained at the start of the sweep for vertical and horizontal beam location. A range is provided between the point of maximum intensity and blanking override. This allows the operator to adjust the INTENSITY control within this range to improve the focus for single-sweep storage near the writing speed limit.

The light filter and optional EMI mesh filter reduce the observed light output from the CRT. When using these filters, avoid advancing the INTENSITY control to a setting that could cause phosphor damage. When the highest intensity display is desired, remove the filters. Apparent trace intensity can also be improved in such cases by reducing the ambient light or using a viewing hood.

Astigmatism and Focus Adjustment

If the CRT display is not well-defined, adjust the ASTIG (rear panel) and FOCUS (front panel) screwdriver adjustments as follows.

1. Connect the output of the PROBE CAL 0.6 V 1 kHz jack to either channel input and set the VOLTS/DIV switch of that channel to present a three-division display. Set the vertical MODE switch to display the channel selected.
2. Set the TIME/DIV switch to .5 ms.
3. Adjust the INTENSITY control to the desired setting.
4. Simultaneously adjust the ASTIG and FOCUS adjustments so the horizontal and vertical portions of the display are equally focused.

Trace Alignment Adjustment

If a free-running trace is not parallel to the horizontal graticule line, set the TRACE ROTATION adjustment (rear panel) as follows. Position the trace to the center horizontal line. Adjust TRACE ROTATION so the trace is parallel with the horizontal graticule line.

Graticule

The graticule of the 434 is internally marked on the faceplate of the CRT to provide accurate, no-parallax measurements. The graticule is marked with eight vertical and 10 horizontal divisions. Each division is .98 centimeter square. In addition, each major division is divided into five minor divisions at the center vertical and horizontal lines. The vertical gain and horizontal timing are calibrated to the graticule so accurate measurements can be made from the CRT.

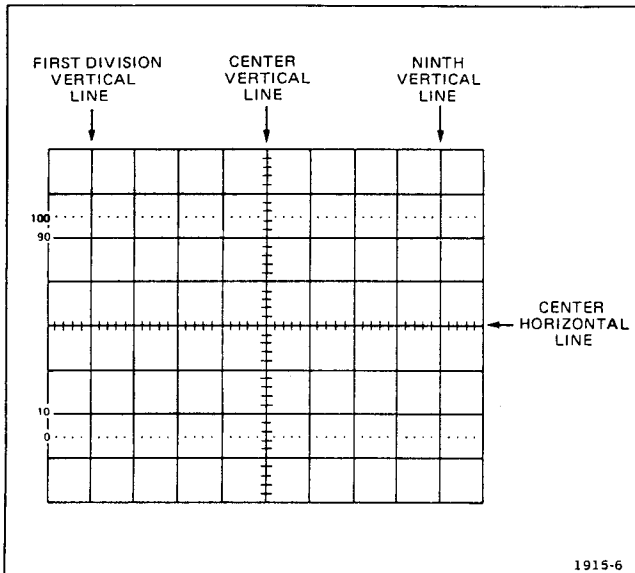

Fig. 2-3. Definition of measurement lines on 434 graticule.

Fig. 2-3 shows the graticule of the 434 and defines the various measurement lines. The terminology defined here will be used in all discussions involving graticule measurements.

Light Filter

The tinted light filter provided minimizes light reflections from the face of the CRT to improve contrast when viewing the display under high ambient light conditions. The mesh filter (available as an optional accessory) provides shielding against radiated EMI (electro-magnetic interference) and also serves as a light filter. A clear filter is provided as a standard accessory and may be substituted for the tinted or mesh filters during oscilloscope photography. The clear filter allows graticule illumination and improves

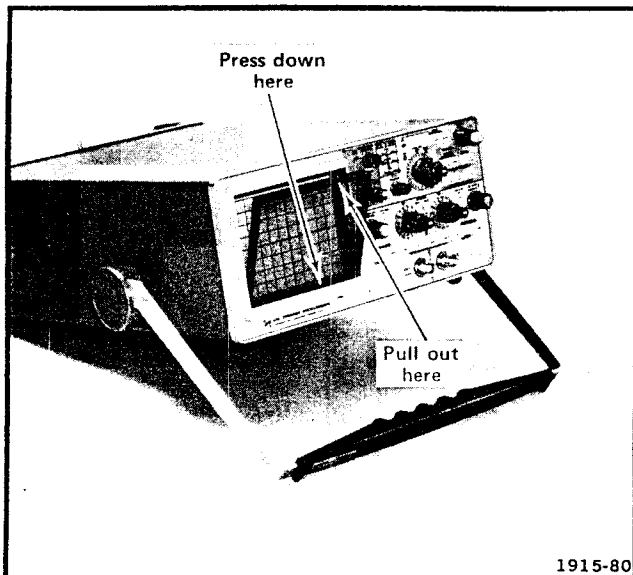

Fig. 2-4. Removing the filter.

image contrast for photography. To remove either filter, press down at the bottom of the frame and pull the top of the filter away from the CRT faceplate (see Fig. 2-4).

Beam Finder

The BEAM FINDER switch provides a means of locating a display which overscans the viewing area either vertically or horizontally. When the BEAM FINDER pushbutton is pressed, the display is compressed within the graticule area. To locate and reposition an overscanned display, use the following procedure.

1. Press the BEAM FINDER button.
2. While the BEAM FINDER button is held in, increase the vertical deflection factor until the vertical deflection is reduced to about three divisions. The horizontal deflection needs to be reduced only in the EXT HORIZ mode of operation. This can only be accomplished by reducing the amplitude of the external horizontal signal applied to the EXT HORIZ input connector.
3. Adjust the vertical and horizontal POSITION controls to center the display about the vertical and horizontal center lines.
4. Release the BEAM FINDER button; the display should remain within the viewing area.

Bandwidth Limiter

The 5 MHz BW switch provides a method of reducing interference from unwanted high-frequency signals when viewing low-frequency signals. When set to the 5 MHz position (out), the upper -3 dB bandwidth point of the Vertical Deflection system is limited to about five megahertz. Then unwanted high-frequency signals (such as television broadcast radiation interference) are reduced in the displayed waveform. Fig. 2-5 illustrates the use of this feature. The waveform in Fig. 2-5A is the display produced when a low-level, low-frequency signal is viewed in the presence of strong 50-megahertz radiation (switch pressed in). Fig. 2-5B shows the resultant CRT display when the high-frequency interference is reduced by setting the BW switch to the 5 MHz position (out).

Vertical Channel Selection

Either of the input channels can be used for single-trace displays. Apply the signal to the desired input connector and set the Vertical Mode switch to display the channel used. However, since CH 1 triggering is provided only in Channel 1 and the INVERT feature is provided only in Channel 2, the correct channel must be selected to take advantage of these features. For dual-trace displays, connect the signals to both input connectors and set the Vertical Mode switch to one of the dual-trace positions.

Vertical Gain Adjustment

To check the gain of either channel, set the VOLTS/DIV switch to .1 and connect the PROBE CAL 0.6 V 1 kHz connector to the input connector of the channel used. The vertical deflection should be exactly six divisions. If not, adjust the front-panel GAIN adjustment for exactly six divisions of deflection.

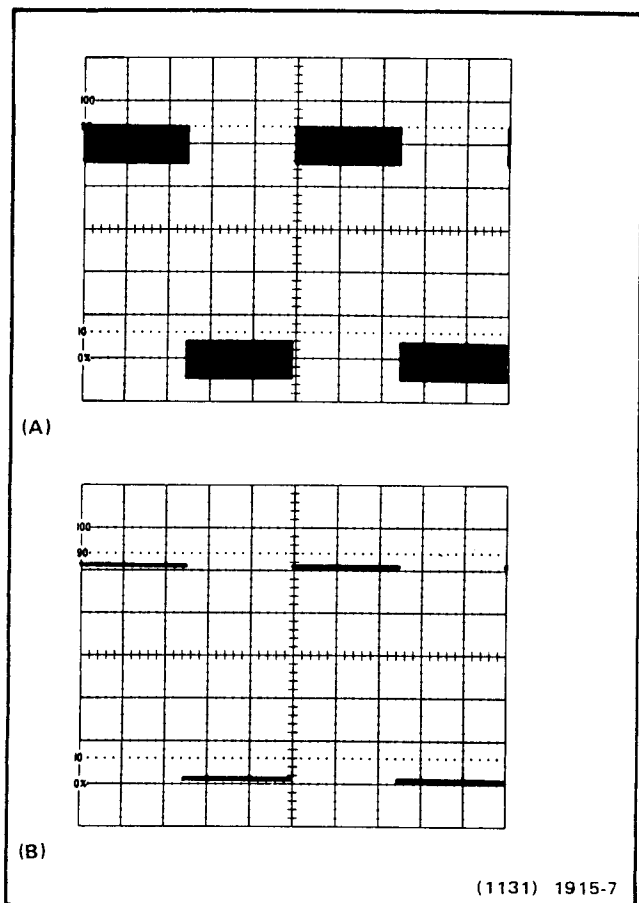

Fig. 2-5. (A) CRT display showing high-frequency interference when attempting to view low-level, low-frequency signal, (B) resultant display when 5 MHz BW switch is set to its out position.

NOTE

If the gain of the two channels must be closely matched (such as for ADD mode operation), the adjustment procedure given in the Calibration section should be used.

The best measurement accuracy when using probes is provided if the GAIN adjustment is made with the probes installed. Also, to provide the most accurate measurements, calibrate the vertical gain of the 434 at the temperature at which the measurement is to be made.

Step Attenuator Balance Adjustment

To check the step attenuator balance of either channel, set the Input Coupling to GND and the Sweep MODE switch to AUTO. Change the VOLTS/DIV switch from 10 mV to 1 mV. If the trace moves vertically, adjust the front-panel STEP ATT BAL adjustment as follows:

1. With the Input Coupling set to GND and the VOLTS/DIV switch set to 10 mV, move the trace to the center

horizontal line of the graticule with the vertical POSITION control.

2. Set the VOLTS/DIV switch to 1 mV and adjust the STEP ATT BAL adjustment to return the trace to the center horizontal line.

3. Repeat steps 1 and 2 for minimum trace shift as the VOLTS/DIV switch is changed from 10 mV to 1 mV.

Signal Connections

In general, probes offer the most convenient means of connecting a signal to the input of the 434. Tektronix probes are shielded to prevent pickup of electrostatic interference. A 10X attenuator probe offers a high input impedance and allows the circuit under test to perform very close to normal operating conditions. However, a 10X probe also attenuates the input signal 10 times. A Tektronix field effect transistor probe offers the same high-input impedance as the 10X probes. However, it is particularly useful since it provides wide-band operation while presenting no attenuation (1X gain) and a low input capacitance. A standard 1X probe can be used for signal connections, although it does not provide as high an input impedance and may result in a lower overall bandwidth. Specialized probes are also available from Tektronix, Inc. for high-voltage measurement, current measurement, etc. See the Tektronix, Inc. catalog for characteristics and compatibility of probes for use with this system.

In high-frequency applications requiring maximum overall bandwidth, use coaxial cables terminated in their characteristic impedances at the 434 input connectors. High-level, low-frequency signals can be connected directly to the 434 input connectors using short unshielded leads. This coupling method works best for signals below about one kilohertz and deflection factors above one volt/division. When this coupling method is used, establish a common ground between the 434 and the equipment under test. Attempt to position the leads away from any source of interference to avoid errors in the display. If interference is excessive with unshielded leads, use a coaxial cable or a probe.

Loading Effect of 434

As nearly as possible, simulate actual operating conditions in the equipment under test. Otherwise the equipment under test may not produce a normal signal. The 10X attenuator and field effect transistor probes mentioned previously offer the least circuit loading. See the probe instruction manual for loading characteristics of the probes.

When the signal is coupled directly to the input of the 434, the input impedance is about one megohm paralleled

Operating Instructions—434 (SN B500000 and up)

by about 24 pF. When the signal is coupled to the input through a coaxial cable, the effective input capacitance is increased. The actual input capacitance depends upon the type and length of cable used and the frequency of the signal.

Ground Considerations

Reliable signal measurements cannot be made unless both the oscilloscope and the unit under test are connected together by a common reference (ground) lead in addition to the signal lead or probe. Although the three-wire AC power cord provides a common connection when used with equipment with similar power cords, the ground loop produced may make accurate measurements impossible. The ground straps supplied with the probes provide an adequate ground. The shield of a coaxial cable provides a common ground when connected between two coaxial connectors (or with suitable adapters to provide a common ground). When using unshielded signal leads, a common ground lead should be connected from the 434 chassis to the chassis of the equipment under test.

Input Coupling

The Channel 1 and 2 Input Coupling switches allow a choice of input coupling methods. The type of display desired and the applied signal will determine the coupling to use.

DC Coupling can be used for most applications. This position allows measurement of the DC component of a signal. It must also be used to display signals below about 100 hertz (10 hertz with a 10X probe) as they will be attenuated in the AC position.

With AC Coupling, the DC component of the signal is blocked by a capacitor in the input circuit. The low-frequency response in the AC position is about 10 hertz (-3 dB point). Therefore, some low-frequency attenuation can be expected near this frequency limit. Attenuation in the form of waveform tilt will also appear in square waves which have low-frequency components. AC coupling provides the best display of signals with a DC component which is much larger than the AC components.

The GND position provides a ground reference at the input of the 434 without the need to externally ground the input connectors. The signal applied to the input connector is internally disconnected, but not grounded, and the input circuit is held at ground potential. This also allows pre-charging the input coupling capacitor to prevent application of high-amplitude voltage spikes to the amplifier input.

Deflection Factor

The amount of vertical deflection produced by a signal is determined by the signal amplitude, the attenuation factor of the probe (if used), the setting of the VOLTS/DIV switch and the setting of the Variable VOLTS/DIV control. The calibrated deflection factors indicated by the VOLTS/DIV switches apply only when the Variable VOLTS/DIV control is set to the calibrated detent position.

The Variable VOLTS/DIV controls provide continuously variable (uncalibrated) vertical deflection factors between the calibrated settings of the VOLTS/DIV switches. The Variable control extends the maximum vertical deflection factor of the 434 to at least 25 volts/division (10 V position).

The 434 Oscilloscope features vertical deflection scale-factor switching. When probes having a scale-factor switching connector are used, the correct deflection factor can be read directly from the instrument front panel.

Dual-Trace Operation

Alternate Mode. The ALT position of the Vertical Mode switch produces a display which alternates between Channel 1 and 2 with each sweep of the CRT. Although the ALT mode can be used at all sweep rates, the CHOP mode provides a more satisfactory display at sweep rates below about 0.5 millisecond/division. At these slow sweep rates, alternate mode switching becomes visually perceptible.

Proper internal triggering in the ALT mode can be obtained in either the COMP or the CH 1 position of the TRIGGER SOURCE switch. When in the COMP position, the sweep is triggered from the signal on each channel. This provides a stable display of two unrelated signals, but does not indicate the time relationship between the signals. In the CH 1 position, the two signals are displayed showing true time relationship. If the signals are not time related, the Channel 2 waveform will be unstable in the CH 1 SOURCE switch position.

Chopped Mode. The CHOP position of the Vertical Mode switch produces a display which is electronically switched between channels. In general, the CHOP mode provides the best display at sweep rates slower than about 0.5 millisecond/division or whenever dual-trace, non-repetitive phenomena is to be displayed. At faster sweep rates, the chopped switching becomes apparent and may interfere with the display.

Proper internal triggering for the CHOP mode is provided with the TRIGGER SOURCE switch set to CH 1. If the COMP position is used, the sweep circuits are triggered

from the between-channel switching signal and both waveforms will be unstable. External triggering from a signal which is time-related to either signal provides the same result as CH 1 triggering.

Two signals which are time-related can be displayed in the chopped mode showing true time relationship. However, if the signals are not time-related, the Channel 2 display will appear unstable.

Two non-repetitive, transient or random signals occurring within the time interval determined by the TIME/DIV switch (10 times sweep rate) can be compared using the CHOP mode. To trigger the sweep correctly, the Channel 1 signal must precede the Channel 2 signal. Since the display shows true time relationship, time-difference measurements can be made.

Algebraic Addition

General. The ADD position of the Vertical Mode switch can be used to display the sum or difference of two signals, for common-mode rejection to remove an undesired signal, or for DC offset (applying a DC voltage to one channel to offset the DC component of a signal on the other channel).

Deflection Factor. The overall deflection in the ADD position of the vertical mode switch with both VOLTS/DIV switches set to the same position is the same as the deflection factor indicated by either VOLTS/DIV switch. The amplitude of an added mode display can be determined directly from the resultant CRT deflection, multiplied by the deflection factor indicated by either VOLTS/DIV switch. However, if the Channel 1 and 2 VOLTS/DIV switches are set to different deflection factors, the resultant voltage is difficult to determine from the CRT display. In this case, the voltage amplitude of the resultant display can be determined accurately only if the amplitude of the signal applied to either channel is known.

Precautions. The following general precautions should be observed when using the ADD mode.

1. Do not exceed the input voltage rating of the 434.
2. Do not apply signals that exceed an equivalent of about eight times the VOLTS/DIV switch setting. For example, with a VOLTS/DIV switch setting of .5, the voltage applied to that channel should not exceed about four volts. Larger voltages may distort the display.
3. Use Channel 1 and 2 POSITION control settings which most nearly position the signal of each channel to

mid-screen when viewing in either the CH 1 or CH 2 positions of the Vertical Mode switch. This insures the greatest dynamic range for ADD mode operation.

4. For similar response from each channel, set the Channel 1 and 2 Input Coupling switches to the same position.

Trigger Source

COMP. In the COMP position of the TRIGGER SOURCE switch, the trigger signal is obtained from the displayed signal. This position provides the most convenient operation when displaying single channel displays. However, for dual-trace displays, special considerations must be made to provide the correct display. See Dual-Trace Operation in this section for dual-trace triggering information.

CH 1. The CH 1 position of the TRIGGER SOURCE switch provides a trigger signal from only the signal applied to the CH 1 connector. This position provides a stable display of the Channel 1 signal and is useful for certain dual-trace applications (see Dual-Trace Operation).

EXT. An external signal connected to the EXT TRIG connector can be used to trigger the sweep in the EXT position of the TRIGGER SOURCE switch. The external signal must be time-related to the displayed signal to produce a stable display. An external trigger signal can be used to provide a triggered display when the internal signal is too low in amplitude for correct triggering, or contains signal components on which it is not desired to trigger. It is also useful when signal tracing in amplifiers, phase-shift networks, wave-shaping circuits, etc. The signal from a single point in the circuit can be connected to the EXT TRIG connector through a signal probe or cable. The sweep is then triggered by the same signal at all times and allows examination of amplitude, time relationship or wave-shape changes of signals at various points in the circuit without resetting the TRIGGER controls.

Trigger Coupling

Four methods of coupling the trigger signal to the trigger circuits can be selected with the TRIGGER COUPLING switch. Each position permits selection or rejection of the frequency components of the trigger signal which trigger the sweep.

AC. In the AC position of the TRIGGER COUPLING switch, the DC component of the trigger signal is blocked. Signals with low-frequency components below about 20 hertz are attenuated. In general, AC coupling can be used for most applications. However, if the signal contains unwanted low-frequency signals or if the sweep is to be triggered at a low-repetition rate or DC level, one of the

Operating Instructions—434 (SN B500000 and up)

remaining TRIGGER COUPLING switch positions will provide a better display.

The triggering point in the AC position depends upon the average voltage level of the trigger signals. If the trigger signals occur at random, the average voltage level will vary, causing the triggering point to vary also. This shift of the triggering point may be enough so it is impossible to maintain a stable display. In such cases, use DC coupling.

LF REJ. In the LF REJ position, DC is rejected and low-frequency signals below about 30 kilohertz are attenuated. Therefore, the sweep is triggered only by the higher-frequency components of the trigger signal. This position is particularly useful for providing stable triggering if the trigger signal contains line-frequency components. Also, in the ALT position of the Vertical Mode switch the LF REJ position provides the best display at fast sweep rates when comparing two unrelated signals (TRIGGER COUPLING switch set to COMP).

HF REJ. The HF REJ position passes all low-frequency signals between DC and about 50 kilohertz. Signals outside the above range are attenuated. When triggering from complex waveforms, this position is useful for providing stable display of the low-frequency components.

DC. DC coupling can be used to provide stable triggering with low-frequency signals which would be attenuated in the AC position, or with low repetition rate signals. It can also be used to trigger the sweep when the trigger signal reaches a DC level selected by the setting of the LEVEL control. When using internal triggering, the setting of the Channel 1 and 2 POSITION controls affect the DC triggering point of a display when the TRIGGER SOURCE switch is in the COMP position.

DC trigger coupling should not be used in the ALT dual-trace mode if the TRIGGER SOURCE switch is set to COMP. If used, the sweep will trigger on the DC level of one trace and then either lock out completely or free run on the other trace. Correct DC triggering for this mode can be obtained with the TRIGGER SOURCE switch set to CH 1.

With both the LF REJ and HF REJ buttons pushed, only those signals between approximately 30 kilohertz and 50 kilohertz will be passed to the Trigger Generator without being attenuated.

Trigger Slope

The TRIGGER SLOPE switch determines whether the trigger circuit responds to the positive-going or negative-

going portion of the trigger signal. When the SLOPE switch is in the positive-going (+) position, the display starts with the positive-going portion of the waveform; in the negative-going (–) position, the display starts with the negative-going portion of the waveform (see Fig. 2-6). When several cycles of a signal appear in the display, the setting of the SLOPE switch is often unimportant. However, if only a certain portion of a cycle is to be displayed, the setting of the SLOPE switch is important to provide a display which starts on the desired slope of the input signal.

Trigger Level

The TRIGGER LEVEL control determines the voltage level on the triggering waveform at which the sweep is triggered. When the LEVEL control is set in the + region, the trigger circuit responds at a more positive point on the trigger signal. In the – region, the trigger circuit responds at a more negative point on the trigger signal. Fig. 2-6 illustrates this effect with different settings of the SLOPE switch.

To set the LEVEL control, first select the TRIGGER source, coupling, and slope. Then, set the LEVEL control fully counterclockwise and rotate it clockwise until the display starts at the desired point.

Sweep Mode

AUTO. The AUTO position of the Sweep MODE switch provides a triggered display when the LEVEL control is correctly set (see Trigger Level in this section) and an adequate trigger signal is available.

When the trigger repetition rate is less than about 10 hertz, or in the absence of an adequate trigger signal, the Sweep Generator free runs at the sweep rate selected by the TIME/DIV switch to produce a reference trace. When an adequate trigger signal is again applied, the free-running condition ends and the Sweep Generator is triggered to produce a stable display (with correct LEVEL control setting).

NORM. Operation in the NORM position of the Sweep MODE switch is the same as in the AUTO position when a trigger signal is applied. However, when no trigger signal is present, the Sweep Generator remains off and there is no display.

Use the NORM mode to display signals with repetition rates below about 10 hertz. This mode provides an indication of an adequate trigger signal as well as the correctness of trigger control settings, since there is no display without proper triggering.

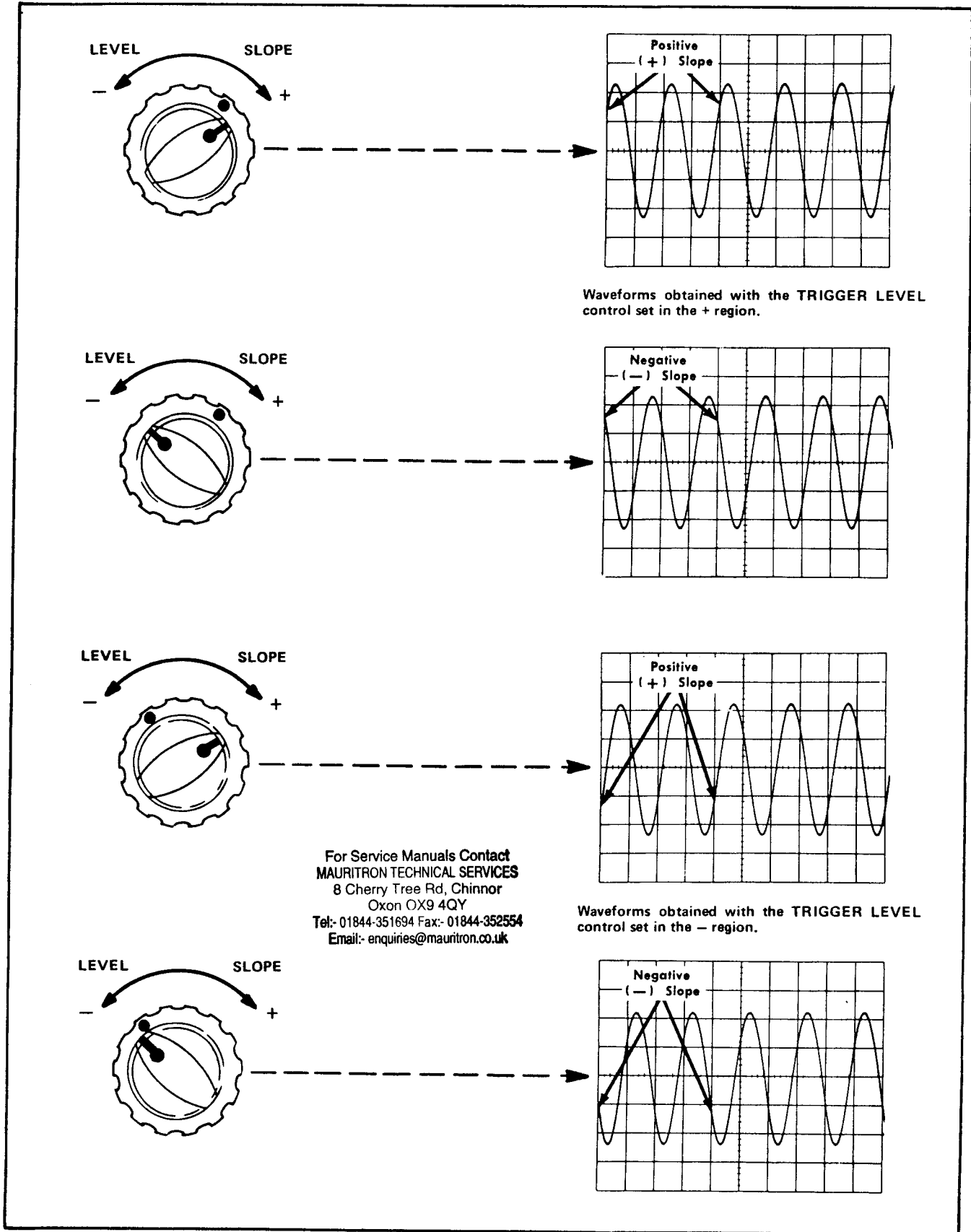

Fig. 2-6. Effect of the TRIGGER LEVEL control and SLOPE switch on the CRT display.

Operating Instructions—434 (SN B50000 and up)

SINGLE SWEEP. When the signal to be displayed is not repetitive or varies in amplitude, shape, or time, a conventional repetitive display may produce an unstable presentation. To avoid this, use the single-sweep feature of the 434. The SINGLE SWEEP mode can also be used to photograph a non-repetitive signal.

To use the SINGLE SWEEP mode, first make sure the trigger circuit will respond to the event to be displayed. Set the Sweep MODE switch to AUTO or NORM and obtain the best possible display in the normal manner (for random signals, set the trigger circuit to trigger on a signal which is approximately the same amplitude and frequency as the random signal). Then, set the Sweep MODE to SINGLE SWEEP and press the RESET button. When the RESET button is pushed, the next trigger pulse initiates the sweep and a single trace will be presented on the screen. After this sweep is complete, the Sweep Generator is "locked out" until reset. The READY light is illuminated when the Sweep Generator has been reset and is ready to produce a sweep. To prepare the circuit for another single-sweep display, press the RESET button again.

Horizontal Sweep Rates

The TIME/DIV switch provides 23 calibrated unmagnified sweep rates ranging from 0.2 microsecond to 5 seconds/division. The three fastest indicated sweep rates can be achieved only by using sweep magnification. The VAR control provides continuously variable sweep rates between the settings of the TIME/DIV switch. The accuracy specifications for the calibrated sweep rates apply over the full ten horizontal divisions of deflection.

Sweep Magnification

The sweep magnifier expands the sweep up to a maximum of 50 times. The center part of the unmagnified display is the portion visible on the screen in magnified form. Equivalent length of the magnified sweep is ten divisions multiplied by the amount of magnification (50 divisions at 50 times magnification); any 10-division portion can be viewed by adjusting the horizontal POSITION control to bring the desired portion onto the viewing area. The dual-range feature of the horizontal POSITION control (see Horizontal Position Control discussion which follows) is particularly useful when the magnifier is on.

To use the magnified sweep, first position the portion of the unmagnified display to be expanded to the center of the graticule. Push in on the TIME/DIV knob and turn clockwise until the desired amount of magnification is achieved (up to a maximum of 50 times). The equivalent time/division is indicated directly by the TIME/DIV knob, and is a calibrated sweep rate when the VAR control is in its calibrated detent.

Horizontal Position Control

The dual-range horizontal POSITION control used in the 434 provides a combination of coarse and fine adjustments in a single control. When this control is rotated, fine positioning is provided for a range of about 0.3 division for normal sweep, or about 15 divisions for magnified operation and the trace can be positioned precisely. Then, after the fine range is exceeded, the coarse adjustment comes into effect to provide rapid positioning of the trace. To use this control effectively for precise positioning, first turn the control to move the trace slightly beyond the desired position (coarse range). Then reverse the direction of rotation to use the fine range to establish the precise trace position desired.

External Horizontal Input

In some applications it is desirable to display one signal versus another signal rather than against time (internal sweep). The EXT HORIZ position of the TIME/DIV switch provides a means for applying an external signal to the horizontal amplifier for this type of display.

Connect the external horizontal signal to the EXT HORIZ connector. The deflection factor is about 0.5 volt/division. The X and Y channels of this instrument are not time matched and some inherent phase shift is apparent. Take this inherent phase shift into account when making measurements. For aid in interpreting lissajous displays, refer to the reference books listed under Applications.

Intensity Modulation

Intensity (Z-axis) modulation can be used to relate a third item of electrical phenomena to the vertical (Y-axis) and the horizontal (X-axis) coordinates without changing the wave shape. A Z-axis modulating signal applied to the CRT circuit changes the intensity of the displayed waveform to provide this display. "Gray scale" intensity modulation can be obtained by applying signals which do not completely blank the display. Large amplitude signals of the correct polarity will completely blank the display; the sharpest display is provided by signals with a fast rise and fall. The voltage amplitude required for visible trace modulation depends on the setting of the INTENSITY control. At normal intensity level, a five-volt peak-to-peak signal produces a visible change in brightness.

Time markers applied to the Z AXIS input connector provide a direct time reference on the display. With uncalibrated horizontal sweep or X-Y mode operation, the time markers provide a means of reading time directly from the display. However, if the markers are not time-related to the displayed waveform, a single-sweep display should be used (for internal sweep only) to provide a stable display.

Calibrator

The internal calibrator of the 434 provides a convenient signal for checking vertical gain. The calibrator output signal available at the front-panel PROBE CAL 0.6 V 1 kHz jack is also very useful for checking and adjusting probe compensation as described in the probe instruction manual.

SIMPLIFIED OPERATING INSTRUCTIONS

General

The following operating instructions will allow calibrated measurements in most applications. The operator should be familiar with the complete function and operation of the instrument as described in this section before using this procedure.

Normal Sweep Display

1. Set the input coupling switches to AC, the Variable VOLTS/DIV controls to their detent positions, and the Vertical Mode switch to CH 1 (use ALT or CHOP for dual-trace display).

2. Set the sweep MODE switch to AUTO, the TRIGGER SLOPE switch to +, the TRIGGER COUPLING switch to AC, and the TRIGGER SOURCE switch to COMP.

3. Set the TIME/DIV switch to 1 ms/DIV and the VAR TIME/DIV control to its calibrated position.

4. Set the POWER switch to the on position and allow several minutes warmup.

5. Connect a signal to the CH 1 input connector.

6. Advance the INTENSITY control until the display is visible (if the display is not visible with the INTENSITY control at midrange, press the BEAM FINDER button and adjust the VOLTS/DIV switch until the display is reduced in size vertically; then center the compressed display with the vertical and horizontal POSITION controls; release the BEAM FINDER button).

7. Set the VOLTS/DIV switch and the vertical POSITION control for a display which remains within the display area vertically.

8. Set the TRIGGER LEVEL control for a stable display.

9. Set the TIME/DIV switch and the horizontal POSITION control for a display which remains within the display area horizontally.

Magnified Sweep Display

1. Follow steps 1-9 for normal sweep.

2. Adjust the horizontal POSITION control to move the area to be magnified to within the center horizontal division of the graticule. There should be equal amounts of the area of interest on either side of the center graticule line. If necessary, change the setting of the TIME/DIV switch and the POSITION control to obtain the desired display.

3. Push in and turn the VOLTS/DIV knob to achieve the desired amount of magnification. The position of the TIME/DIV knob indicates directly the magnified time/div. Adjust the horizontal POSITION control for precise positioning of the magnified display.

External Horizontal Display

1. Set the INTENSITY control fully counterclockwise.

2. Set the Input Coupling switches to AC and the Variable VOLTS/DIV controls to their detent positions.

3. Set the TIME/DIV switch to EXT HORIZ, the Vertical Mode switch to CH 1, and the Sweep MODE to AUTO.

4. Set the POWER switch to the on position and allow several minutes warmup.

5. Connect the X (horizontal) signal to the EXT HORIZ input connector on the instrument rear panel and the Y (vertical) signal to the CH 1 input connector.

6. Advance the INTENSITY control until the display is visible (if display is not visible, push the BEAM FINDER button and adjust the CH 1 VOLTS/DIV switch until the display is reduced in size vertically; the horizontal deflection can only be changed by changing the amplitude of the signal applied to the EXT HORIZ input connector (sensitivity is ≈ 0.5 volt/division); then center the compressed display with the CH 1 and the horizontal POSITION controls; release the BEAM FINDER button).

Operating Instructions—434 (SN B500000 and up)

7. Adjust the CH 1 VOLTS/DIV switch and the amplitude of the external horizontal signal to obtain a display which remains within the display area.

STORAGE OPERATION

General

The following demonstrations are intended to illustrate the various types of stored displays that are possible and the techniques required to obtain them.

Slow and Medium Sweep Rates

Repetitive-Sweep Storage. This method of storage is used for repetitive waveforms that produce normally bright displays on the CRT screen.

1. Set up a display of the PROBE CAL 0.6 V 1 kHz waveform in the manner described in "Normal Sweep Display".

2. Turn the INTENSITY control fully counterclockwise.

3. Press in both STORE buttons. The normal storage-mode background light level will be present on the storage screens.

4. Advance the INTENSITY control slowly in the clockwise direction to produce a waveform display of normal intensity, then return the control to the minimum (counterclockwise) position. A stored waveform of moderate brightness should remain. Each half of the CRT display area can be stored or erased independently. To erase the stored display, press in the appropriate ERASE pushbutton(s).

Single-Sweep Storage. This method is used for single-sweep events that produce adequate stored displays.

1. Set up a display of the PROBE CAL 0.6 V 1 kHz waveform in the manner described in "Normal Sweep Display".

2. Set the Sweep MODE to SINGLE SWEEP.

3. Press in both STORE buttons.

4. Apply a single sweep of the trace by pressing the RESET pushbutton. A stored display of the calibrator waveform should remain on the storage screen. If it does not, repeat the demonstration with the display intensity increased slightly.

5. During single-sweep operation, the LOCATE pushbutton can be used to locate the trace or display while the sweep is held off. Pressing the LOCATE button unblanks the CRT and allows the display to be positioned before storing. This shifts the start of the sweep approximately 0.2 division to the left. For instrument operation in Single-Sweep and Store modes simultaneously, when the sweep start is positioned at the graticule edge, the locate spot is shifted into the non-storing locate zone to allow vertical positioning of the trace without storing.

Integrated Fast-Rise Waveforms

The INTEGRATE pushbutton permits storage of waveforms at relatively fast sweep speeds with relatively low repetition rates. Waveforms which would be difficult to see because of the low duty cycle of the sweep, or have poor resolution due to required high setting of the INTENSITY control, can often be stored using the Integrate method to produce higher brightness or better resolution. For a demonstration on how to store the rising edge of the PROBE CAL 0.6 volt 1 kHz signal, proceed as follows:

1. Set up a display of the PROBE CAL waveform in the manner described in "NORMAL SWEEP DISPLAY". Use + Slope and trigger on the rising portion of the waveform. Set the sweep to 0.05 or 0.02 $\mu\text{sec}/\text{DIV}$, turn the INTENSITY control nearly fully clockwise in order to find the start of the waveform, and position the rising portion of the waveform on screen. Reduce the intensity to midrange.

2. Press in both STORE buttons. The normal storage-mode background light will be present on the CRT.

3. Advancing the INTENSITY control in the clockwise direction will not produce a stored display of the rising portion of the waveform. Reduce the intensity to midrange and press both ERASE buttons to clear the screen if necessary.

4. Press the INTEGRATE button momentarily. A fraction of a second to several seconds is reasonable.

The lower the intensity, the longer the integration period required to store the trace. If the trace does not fully store on the first attempt, repeat the integration for a somewhat longer period, or with somewhat higher intensity. Using lower intensity and longer integration produces better resolution on jitter-free signals.

For Service Manuals Contact
MAURITRON TECHNICAL SERVICES
8 Cherry Tree Rd, Chinnor
Oxon OX9 4QY
Tel: 01844-351694 Fax: 01844-352554
Email: enquiries@mauritron.co.uk

CAUTION

Do not attempt to store extremely fast-rising or fast-falling portions of waveforms viewed at relatively slow sweep rates. The high trace intensity required (due to the intensity difference between the horizontal and the vertical segments) could cause storage target damage.

Fast Single-Sweep Enhancement

The Enhance mode provides a method of storing single-sweep displays that exceed the normal writing speed of the instrument. This mode is not normally used for repetitive sweeps.

1. Apply a 30 kHz (350 kHz for Option 1 CRT) sine-wave signal for a CRT display of approximately 3.2 divisions P-P amplitude to one of the vertical input connectors.

2. Set up a normal-intensity non-stored display of the signal in the manner given in "Normal Sweep Display".

3. Set the Sweep MODE to SINGLE SWEEP.

4. Press in both STORE buttons.

5. With the TIME/DIV switch set to 10 μ s (2 μ s for Option 1 CRT), apply a single sweep of the trace by pressing the RESET button. Note that a complete stored display cannot be obtained for any setting of the INTENSITY control.

6. Depress both ENHANCE buttons, then simultaneously press both ERASE buttons to clear the storage screens.

7. While repeatedly erasing and applying single sweeps, adjust the ENHANCE LEVEL control sufficiently clockwise to completely store the display without fading up the target excessively.

8. For instruments equipped with the option 1 CRT, if portions of the CRT target become faded up and cannot be erased in the normal manner due to inadvertent operation in Repetitive Sweep and Enhanced modes simultaneously, proceed as follows:

Store the entire target by using a repetitive sweep at approximately 1 ms/DIV with Intensity at mid-range. Slowly position the trace from top to bottom to store the entire target area. Switch to Single-Sweep (or non-enhanced storage mode) and erase. The target is now ready for normal storage or single-sweep enhanced storage operation.

NOTE for OPTION ONE instruments

After sustained use (6 hours or more) of the Option One instrument in the Non-Store mode or in Store mode with nothing written, the writing speed may be improved by leaving the CRT target fully stored for five to fifteen minutes. This procedure may be repeated every few hours to refresh the target in applications requiring maximum stored writing rate in a usage where the target is stored a small percentage of the time.

APPLICATIONS

General

The following information describes the procedures and techniques for making basic measurements with a 434 Oscilloscope. These applications are not described in detail, since each application must be adapted to the requirements of the individual measurement. This instrument can also be used for many applications which are not described in this manual. Contact your local Tektronix Field Office or representative for assistance in making specific measurements with this instrument. Also, the following books describe oscilloscope measurement techniques which can be adapted for use with this instrument.

Harley Carter, "An Introduction to the Cathode Ray Oscilloscope", Phillips Technical Library, Cleaver-Hume Press Ltd., London, 1960.

J. Czech, "Oscilloscope Measuring Technique", Phillips Technical Library, Springer-Verlag, New York, 1965.

Robert G. Middleton and L. Donald Payne, "Using the Oscilloscope in Industrial Electronics", Howard W. Sams & Co. Inc., The Bobbs-Merrill Company Inc., Indianapolis, 1961.

Rufus P. Turner, "Practical Oscilloscope Handbook", Volumes 1 and 2, John F. Rider Publisher Inc., New York, 1964.

Peak-to-Peak Voltage Measurements—AC

To make peak-to-peak voltage measurements, use the following procedure:

1. Apply the signal to either input connector.

2. Set the Vertical Mode switch to display the channel used.

3. Set the Input Coupling switch to AC if the DC component of the signal is large enough to shift the display out of the graticule area.

4. Set the VOLTS/DIV switch to display about 3 to 8 divisions of waveform.

Operating Instructions—434 (SN B500000 and up)

NOTE

For low-frequency signals below 100 Hz, the AC position causes some attenuation of the displayed waveform. Typical attenuation with a X1 probe or without a probe is 1 to 2% at 50 Hz, 20 to 25% at 10 Hz, and approximately 50% at 5 Hz. With a X10 probe, corresponding frequencies would be 5 Hz, 1 Hz, and 0.5 Hz, respectively.

5. Set the TRIGGERING controls to obtain a stable display. Set the TIME/DIV switch to a position that displays several cycles of the waveform.

6. Turn the vertical POSITION control so the lower portion of the waveform coincides with one of the graticule lines below the center horizontal line, and the top of the waveform is on the viewing area. With the horizontal POSITION control, move the display so one of the upper peaks lies near the center vertical line (see Fig. 2-7).

7. Measure the divisions of vertical deflection peak to peak. Make sure the Variable VOLTS/DIV control is in the CAL position.

NOTE

This technique can also be used to make measurements between two points on the waveform, rather than peak to peak.

8. Multiply the distance measured in step 7 by the VOLTS/DIV switch setting. Also include the attenuation factor of the probe, if using a probe that does not have a scale-factor switching connector.

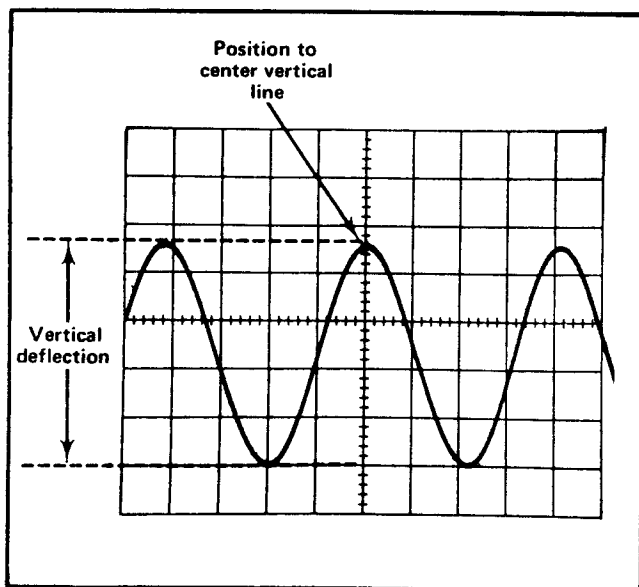

Fig. 2-7. Measuring peak-to-peak voltage of a waveform.

EXAMPLE. Assume that the peak-to-peak vertical deflection is 4.6 divisions (see Fig. 2-7) with a VOLTS/DIV switch setting of .5 V.

$$\text{Volts Peak to Peak} = \text{vertical deflection (divisions)} \times \text{VOLTS/DIV setting}$$

Substituting the given values:

$$\text{Volts Peak to Peak} = 4.6 \times 0.5 \text{ V}$$

The peak-to-peak voltage is 2.3 volts.

Instantaneous Voltage Measurements—DC

To measure the DC level at a given point on a waveform, use the following procedure:

1. Connect the signal to either input connector.
2. Set the Vertical Mode switch to display the channel used.
3. Set the VOLTS/DIV switch to display about six divisions of the waveform.
4. Set the Input Coupling switch to GND.
5. Set the Sweep MODE switch to AUTO.
6. Position the trace to the bottom line of the graticule or other reference line. If the voltage is negative with respect to ground, position the trace to the top line of the graticule. Do not move the vertical POSITION control after this reference line has been established.

NOTE

To measure a voltage level with respect to a voltage other than ground, make the following changes in step 6. Set the Input Coupling switch to DC and apply the reference voltage to the INPUT connector. Then position the trace to the reference line.

7. Set the Input Coupling switch to DC. The ground reference line can be checked at any time by switching to the GND position.

8. Set the TRIGGERING controls to obtain a stable display. Set the TIME/DIV switch to a setting that displays several cycles of the signal.

9. Measure the distance in divisions between the reference line and the point on the waveform at which the DC level is to be measured. For example, in Fig. 2-8 the measurement is made between the reference line and point A.

10. Establish the polarity of the signal. If the waveform is above the reference line the voltage is positive; below the line, negative (with the INVERT switch in for Channel 2).

11. Multiply the distance measured in step 9 by the VOLTS/DIV switch setting. Include the attenuation factor of the probe, if using a probe that does not have a scale factor switching connector.

EXAMPLE. Assume that the vertical distance measured is 4.6 divisions (see Fig. 2-8) and the waveform is above the reference line with a VOLTS/DIV switch setting of 2 V.

Using the formula:

$$\text{Instantaneous Voltage} = \text{vertical distance (divisions)} \times \text{polarity} \times \text{VOLTS/DIV setting}$$

Substituting the given values:

$$\text{Instantaneous Voltage} = 4.6 \times +1 \times 2 \text{ V}$$

The instantaneous voltage is +9.2 volts.

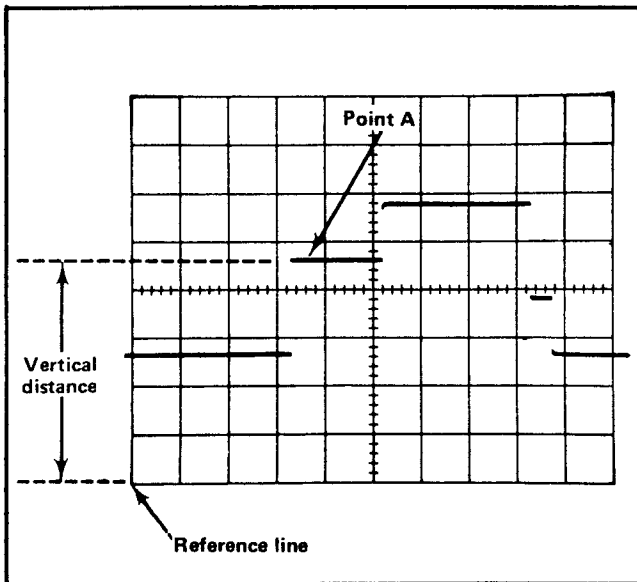

Fig. 2-8. Measuring instantaneous DC voltage with respect to a reference voltage.

Comparison Measurements

In some applications it may be desirable to establish arbitrary units of measurement other than those indicated by the VOLTS/DIV switch or TIME/DIV switch. This is particularly useful when comparing unknown signals to a reference amplitude or repetition rate. One use for the comparison-measurement technique is to facilitate calibration of equipment (e.g., on an assembly-line test) where the desired amplitude or repetition rate does not produce an exact number of divisions of deflection. The adjustment will be easier and more accurate if arbitrary units of measurement are established so that correct adjustment is indicated by an exact number of divisions of deflection. Arbitrary sweep rates can be useful for comparing harmonic signals to a fundamental frequency, or for comparing the repetition rate of the input and output pulses in a digital count-down circuit. The following procedure describes how to establish arbitrary units of measure for comparison measurements. Although the procedure for establishing vertical and horizontal arbitrary units of measurement is much the same, both processes are described in detail.

Vertical Deflection Factor. To establish an arbitrary vertical deflection factor based upon a specific reference amplitude, proceed as follows:

1. Connect the reference signal to the INPUT connector. Set the TIME/DIV switch to display several cycles of the signal.

2. Set the VOLTS/DIV switch and the Variable VOLTS/DIV control to produce a display an exact number of graticule divisions in amplitude. Do not change the Variable VOLTS/DIV control after obtaining the desired deflection. This display can be used as a reference for amplitude comparison measurements.

3. To establish an arbitrary vertical deflection factor so the amplitude of an unknown signal can be measured accurately at any setting of the VOLTS/DIV switch, the amplitude of the reference signal must be known. If it is not known, it can be measured before the Variable VOLTS/DIV control is set in step 2.

4. Divide the amplitude of the reference signal (volts) by the product of the vertical deflection established in step 2 (divisions) and the setting of the VOLTS/DIV switch. This is the vertical conversion factor.

$$\text{Vertical Conversion Factor} = \frac{\text{reference signal amplitude (volts)}}{\text{vertical deflection (divisions)} \times \text{VOLTS/DIV switch setting}}$$

Operating Instructions—434 (SN B50000 and up)

5. To measure the amplitude of an unknown signal, disconnect the reference signal and connect the unknown signal to the input connector. Set the VOLTS/DIV switch to a setting that provides sufficient vertical deflection to make an accurate measurement. Do not readjust the Variable VOLTS/DIV control.

6. Measure the vertical deflection in divisions and calculate the amplitude of the unknown signal using the following formula:

$$\text{Signal Amplitude} = \text{VOLTS/DIV switch setting} \times \text{vertical conversion factor} \times \text{vertical deflection (divisions)}$$

EXAMPLE. Assume a reference signal amplitude of 30 volts, a VOLTS/DIV switch setting of 5 V, and the Variable VOLTS/DIV control is adjusted to provide a vertical deflection of four divisions.

Substituting these values in the vertical conversion factor formula (step 4):

$$\text{Vertical Conversion Factor} = \frac{30 \text{ V}}{4 \times 5 \text{ V}} = 1.5$$

Then, with a VOLTS/DIV switch setting of 10, the peak-to-peak amplitude of an unknown signal which produces a vertical deflection of five divisions can be determined by using the signal amplitude formula (step 6):

$$\text{Signal Amplitude} = 10 \text{ V} \times 1.5 \times 5 = 75 \text{ volts}$$

Sweep Rates. To establish an arbitrary horizontal sweep rate based upon a specific reference frequency, proceed as follows:

1. Connect the reference signal to the INPUT connector. Set the VOLTS/DIV switch for four or five divisions of vertical deflection.

2. Set the TIME/DIV switch and the Variable TIME/DIV control so one cycle of the signal covers an exact number of horizontal divisions. Do not change the Variable TIME/DIV control after obtaining the desired deflection. This display can be used as a reference for frequency comparison measurements.

3. To establish an arbitrary sweep rate so the repetition rate of an unknown signal can be measured accurately at

any setting of the TIME/DIV switch, the repetition rate of the reference signal must be known. If it is not known, it can be measured before the Variable TIME/DIV control is set in step 2.

4. Divide the repetition rate of the reference signal (seconds) by the product of the horizontal deflection established in step 2 (divisions) and the setting of the TIME/DIV switch. This is the horizontal conversion factor.

$$\text{Horizontal Conversion Factor} = \frac{\text{reference signal repetition rate (seconds)}}{\text{horizontal deflection (divisions)} \times \text{TIME/DIV switch setting}}$$

5. To measure the repetition rate of an unknown signal, disconnect the reference signal and connect the unknown signal to the input connector. Set the TIME/DIV switch to a setting that provides sufficient horizontal deflection to make an accurate measurement. Do not readjust the Variable TIME/DIV control.

6. Measure the horizontal deflection in divisions and calculate the repetition rate of the unknown signal using the following formula:

$$\text{Repetition Rate} = \text{TIME/DIV switch setting} \times \text{horizontal conversion factor} \times \text{horizontal deflection (divisions)}$$

EXAMPLE. Assume a reference signal frequency of 455 hertz (repetition rate 2.19 milliseconds), and a TIME/DIV switch setting of .2 ms, with the Variable TIME/DIV control adjusted to provide a horizontal deflection of eight divisions. Substituting these values in the horizontal conversion factor formula (step 4):

$$\text{Horizontal Conversion Factor} = \frac{2.19 \text{ milliseconds}}{.2 \times 8} = 1.37$$

Then, with a TIME/DIV switch setting of 50 μ s, the repetition rate of an unknown signal which completes one cycle in seven horizontal divisions can be determined by using the repetition rate formula (step 6):

$$\text{Repetition Rate} = 50 \mu\text{s} \times 1.37 \times 7 = 480 \mu\text{s}$$

This answer can be converted to frequency by taking the reciprocal of the repetition rate (see application on Determining Frequency).

Time Duration Measurements

To measure time between two points on a waveform, use the following procedure:

1. Connect the signal to one of the input connectors.
2. Set the Vertical Mode switch to display the channel used.
3. Set the VOLTS/DIV switch to display about four divisions of the waveform.
4. Set the TRIGGERING controls to obtain a stable display.
5. Set the TIME/DIV switch to the fastest sweep rate that displays less than eight divisions between the time measurement points (see Fig. 2-9).
6. Adjust the vertical POSITION control to move the points between which the time measurement is made to the center horizontal line.
7. Adjust the horizontal POSITION control to center the time-measurement points within the center eight divisions of the graticule.
8. Measure the horizontal distance between the time measurement points. Be sure the Variable TIME/DIV control is set to CAL.

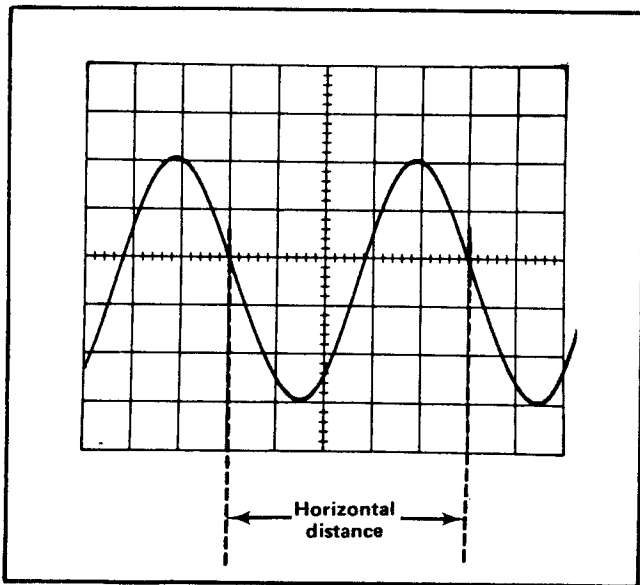

Fig. 2-9. Measuring time duration between points on a waveform.

9. Multiply the distance measured in step 8 by the setting of the TIME/DIV switch.

EXAMPLE. Assume that the horizontal distance between the time measurement points is five divisions (see Fig. 2-9) and the TIME/DIV switch is set to .1 ms.

Using the formula:

$$\text{Time Duration} = \text{horizontal distance (divisions)} \times \text{TIME/DIV setting}$$

Substituting the given values:

$$\text{Time Duration} = 5 \times 0.1 \text{ ms}$$

The time duration is 0.5 millisecond.

Determining Frequency

The time measurement technique can also be used to determine the frequency of a signal. The frequency of a periodically recurrent signal is the reciprocal of the time duration (period) of one cycle.

Use the following procedure:

1. Measure the time duration of one cycle of the waveform as described in the previous application.
2. Take the reciprocal of the time duration to determine the frequency.

EXAMPLE. The frequency of the signal shown in Fig. 2-9, which has a time duration of 0.5 millisecond, is:

$$\text{Frequency} = \frac{1}{\text{time duration}} = \frac{1}{0.5 \text{ ms}} = 2 \text{ kHz}$$

Risetime Measurements

Risetime measurements employ basically the same techniques as time-duration measurements. The main difference is the points between which the measurement is made. The following procedure gives the basic method of measuring risetime between the 10% and 90% points of the waveform.

1. Connect the signal to either input connector.
2. Set the Vertical Mode switch to display the channel used.

Operating Instructions—434 (SN B50000 and up)

3. Set the VOLTS/DIV switch and Variable control to produce a display exactly five divisions in amplitude.
4. Center the display about the center horizontal line with the vertical POSITION control.
5. Set the TRIGGERING controls to obtain a stable display.
6. Set the TIME/DIV switch to the fastest sweep rate that will display less than eight divisions between the 10% and 90% points on the waveform.
7. Adjust the horizontal POSITION control to move the 10% point of the waveform to the second vertical line of the graticule (see Fig. 2-10).
8. Measure the horizontal distance between the 10% and 90% points. Be sure the Variable TIME/DIV control is set to CAL.
9. Multiply the distance measured in step 8 by the setting of the TIME/DIV switch.

EXAMPLE. Assume that the horizontal distance between the 10% and 90% points is six divisions (see Fig. 2-10) and the TIME/DIV switch is set to 1 μ s.

Using the time duration formula to find risetime:

$$\begin{array}{rcl} \text{Time} & & \\ \text{Duration} & = & \text{horizontal distance} \times \text{TIME/DIV} \\ \text{(Risetime)} & & \text{(divisions)} \quad \text{setting} \end{array}$$

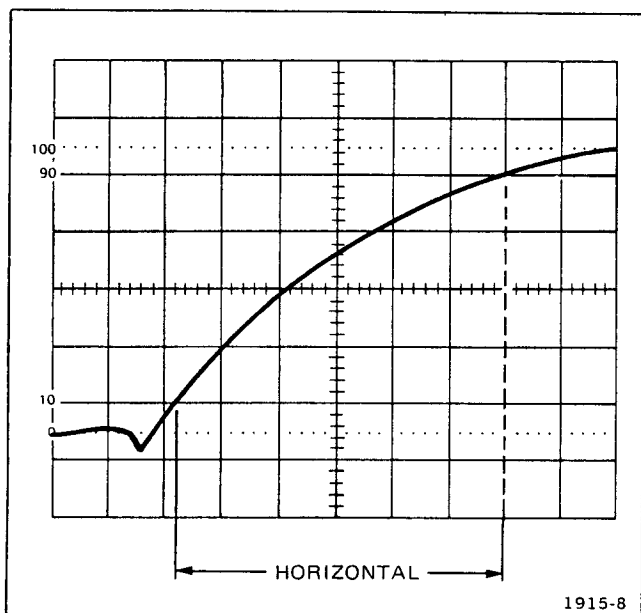

Fig. 2-10. Measuring risetime.

Substituting the given values:

$$\text{Risetime} = 6 \times 1 \mu\text{s}$$

The risetime is 6 microseconds.

Time Difference Measurements

The calibrated sweep rate and dual-trace features of the 434 allow measurement of time difference between two separate events. To measure time difference use the following procedure:

1. Set the Input Coupling switches to the same position, depending on the type of coupling desired.
2. Set the Vertical Mode switch to either CHOP or ALT. In general, CHOP is more suitable for low-frequency signals and the ALT position is more suitable for high-frequency signals. More information on determining the mode is given under Dual-Trace Operation in this section.
3. Set the TRIGGER SOURCE switch to CH 1.
4. Connect the reference signal to the CH 1 connector and the comparison signal to the CH 2 connector. The reference signal should precede the comparison signal in time. Use coaxial cables or probes which have equal time delay to connect the signals to the input connectors.
5. If the signals are of opposite polarity, set the INVERT switch out to invert the Channel 2 display (signals may be of opposite polarity due to 180° phase difference; if so, take this into account in the final calculation).
6. Set the VOLTS/DIV switches to produce four or five division displays.
7. Set the TRIGGER LEVEL control for a stable display.
8. If possible, set the TIME/DIV switch for a sweep rate which shows three or more divisions between the two waveforms.
9. Adjust the vertical POSITION controls to center each waveform (or the points on the display between which the measurement is being made) in relation to the center horizontal line.

Operating Instructions—434 (SN B500000 and up)

10. Adjust the horizontal POSITION control so the Channel 1 (reference) waveform crosses the center horizontal line at a vertical graticule line.

11. Measure the horizontal distance between the Channel 1 waveform and the Channel 2 waveform (see Fig. 2-11).

12. Multiply the measured distance by the setting of the TIME/DIV switch.

EXAMPLE. Assume that the TIME/DIV switch is set to $50 \mu\text{s}$ and the horizontal distance between waveforms is 4.5 divisions (see Fig. 2-11).

Using the formula:

$$\text{Time Delay} = \text{TIME/DIV setting} \times \text{horizontal distance (divisions)}$$

Substituting the given values:

$$\text{Time Delay} = 50 \mu\text{s} \times 4.5$$

The time delay is 225 microseconds.

Multi-Trace Phase Difference Measurements

Phase comparison between two signals of the same frequency can be made using the dual-trace feature of the

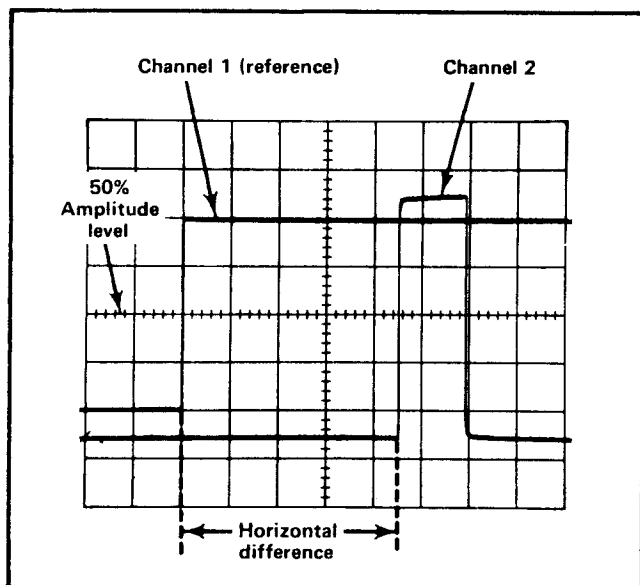

Fig. 2-11. Measuring time difference between two pulses.

434. This method of phase difference measurement can be used up to the frequency limit of the vertical system. To make the comparison, use the following procedure.

1. Set the Input Coupling switches to the same position, depending on the type of coupling desired.

2. Set the Vertical Mode switch to either CHOP or ALT. In general, CHOP is more suitable for low-frequency signals and the ALT position is more suitable for high-frequency signals. More information on determining the mode is given under Dual-Trace Operation in this section.

3. Set the TRIGGER SOURCE switch to CH 1.

4. Connect the reference signal to the CH 1 connector and the comparison signal to the CH 2 connector. The reference signal should precede the comparison signal in time. Use coaxial cables or probes which have similar time delay characteristics to connect the signals to the input connectors.

5. If the signals are of opposite polarity, set the INVERT switch out to invert the Channel 2 display. (Signals may be of opposite polarity due to 180° phase difference; if so, take this into account in the final calculation.)

6. Set the VOLTS/DIV switches and the Variable VOLTS/DIV controls so the displays are equal and about five divisions in amplitude.

7. Set the TRIGGER controls to obtain a stable display.

8. Set the TIME/DIV switch to a sweep rate which displays about one cycle of the waveform.

9. Move the waveforms to the center of the graticule with the vertical POSITION controls.

10. Turn the Variable TIME/DIV control until one cycle of the reference signal (Channel 1) occupies exactly eight divisions between the second and tenth vertical lines of the graticule (see Fig. 2-12). Each division of the graticule represents 45° of the cycle ($360^\circ \div 8 \text{ divisions} = 45^\circ/\text{division}$). The sweep rate can be stated in terms of degrees as $45^\circ/\text{division}$.

11. Measure the horizontal difference between corresponding points on the waveforms.

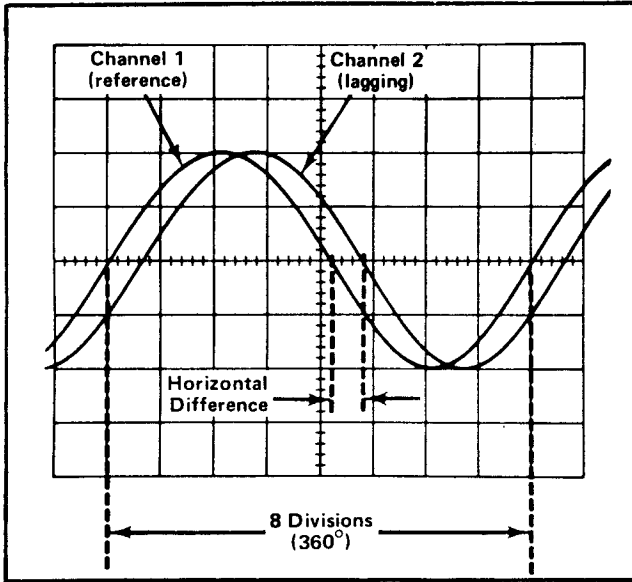

Fig. 2-12. Measuring phase difference.

12. Multiply the measured distance (in divisions) by $45^\circ/\text{division}$ (sweep rate) to obtain the exact amount of phase difference.

EXAMPLE. Assume a horizontal difference of 0.6 division with a sweep rate of $45^\circ/\text{division}$ as shown in Fig. 2-12.

Using the formula:

$$\text{Phase Difference} = \frac{\text{horizontal difference (divisions)}}{\text{horizontal difference (divisions)}} \times \text{sweep rate (degrees/div)}$$

Substituting the given values:

$$\text{Phase Difference} = 0.6 \times 45^\circ$$

The phase difference is 27° .

High Resolution Phase Measurements

More accurate dual-trace phase measurements can be made by increasing the sweep rate (without changing the Variable TIME/DIV control setting). One of the easiest ways to increase the sweep rate is with the MAG switch. The magnified sweep rate (in terms of degrees/division) is determined by dividing the sweep rate obtained previously by the amount of sweep magnification.

EXAMPLE. If the sweep rate were increased 10 times with the magnifier, the magnified sweep rate would be

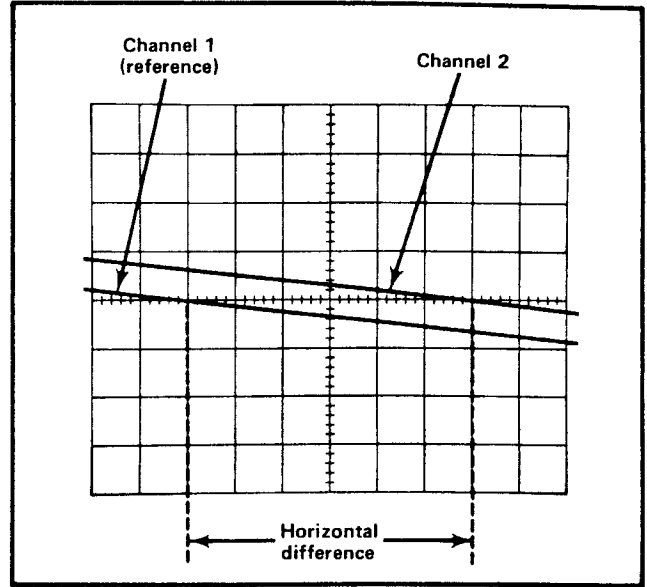

Fig. 2-13. High resolution phase-difference measurement with increased sweep rate.

$45^\circ/\text{division} \div 10 = 4.5^\circ/\text{division}$. Fig. 2-13 shows the same signals as used in Fig. 2-12 but with the MAG switch set for 10X magnification. With a horizontal difference of six divisions, the phase difference is:

$$\text{Phase Difference} = \text{Horizontal difference (divisions)} \times \text{magnified sweep rate (degrees/div)}$$

Substituting the given values:

$$\text{Phase Difference} = 6 \times 4.5^\circ$$

The phase difference is 27° .

Common-Mode Rejection

The ADD feature of the 434 can be used to display signals which contain undesirable components. These undesirable components can be eliminated through common-mode rejection. The precautions given under Algebraic Addition should be observed.

1. Connect the signal containing both the desired and undesired information to the CH 1 connector.
2. Connect a signal similar to the unwanted portion of the Channel 1 signal to the CH 2 connector. For example, in Fig. 2-14, a line-frequency signal is connected to Channel 2 to cancel out the line-frequency component of the Channel 1 signal.

3. Set both Input Coupling switches to DC (AC if DC component of input signal is too large).

4. Set the Vertical Mode switch to ALT. Set the VOLTS/DIV switches so the signals are about equal in amplitude.

5. Set the TRIGGER SOURCE switch to COMP.

6. Set the Vertical Mode switch to ADD. Set the INVERT switch so the common-mode signals are of opposite polarity.

7. Adjust the Channel 2 VOLTS/DIV switch and Variable VOLTS/DIV control for maximum cancellation of the common-mode signal.

8. The signal which remains should be only the desired portion of the Channel 1 signal. The undesired signal is cancelled out.

EXAMPLE. An example of this mode of operation is shown in Fig. 2-14. The signal applied to Channel 1 contains unwanted line-frequency components (Fig. 2-14A). A corresponding line-frequency signal is connected to Channel 2 (Fig. 2-14B). Fig. 2-14C shows the desired portion of the signal as displayed when common-mode rejection is used.

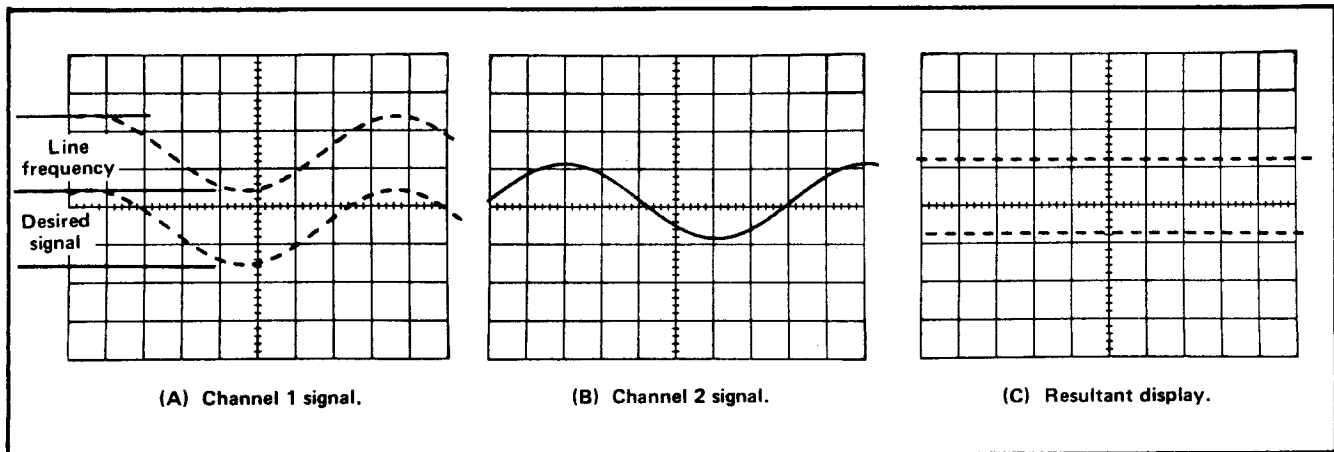

Fig. 2-14. Using the ALG ADD feature for common-mode rejection. (A) Channel 1 signal contains desired information along with line-frequency component. (B) Channel 2 signal contains line-frequency only, (C) resultant CRT display using common-mode rejection.

For Service Manuals Contact
MAURITRON TECHNICAL SERVICES
 8 Cherry Tree Rd, Chinnor
 Oxon OX9 4QY
 Tel:- 01844-351694 Fax:- 01844-352554
 Email:- enquiries@mauritron.co.uk

CIRCUIT DESCRIPTION

Introduction

This section of the manual contains a description of the circuitry used in the 434 Oscilloscope. The description begins with a discussion of the instrument using the basic block diagram shown in Fig. 3-1. Then, each circuit is described in detail, using a detailed block diagram to show the interconnections between the stages in each major circuit and the relationship of the front-panel controls to the individual stages.

A complete block diagram is located in the Diagrams section at the rear of this manual. This block diagram shows the overall relationship between all of the circuits. Complete schematics of each circuit are also given in the Diagrams section. Refer to these diagrams throughout the following circuit description for electrical values and relationship.

BLOCK DIAGRAM

General

The following discussion is provided to aid in understanding the overall concept of the 434 before the individual circuits are discussed in detail. A basic block diagram of the 434 is shown in Fig. 3-1. Only the basic interconnections between the individual blocks are shown on this diagram. Each block represents a major circuit within this instrument. The number on each block refers to the complete circuit diagram which is located at the rear of this manual.

Signals to be displayed on the CRT are applied to the CH 1 and/or CH 2 input connectors. The input signals are then amplified by the Channel 1 Input Amp and Preamp and/or the Channel 2 Input Amp and Preamp circuits. Each vertical circuit includes separate vertical deflection factor, position, input coupling, gain, variable attenuation, and balance controls. A sample of the Channel 1 signal is supplied to the Trigger Pickoff circuit. The Channel 2 Preamp circuit contains an invert feature to invert the Channel 2 signal as displayed on the CRT. The output of both Vertical Preamp circuits is connected to the Channel Switch circuit. This circuit selects the channel(s) to be displayed. An output signal from this circuit is connected to the Z Axis Amplifier circuit to blank out the between-channel switching transients when in the chopped mode of operation. A sample of the signal present in the Channel Switch circuit is supplied to the Trigger Pickoff circuit.

The output of the Channel Switch circuit is connected to the Vertical Output Amplifier through the Delay Line. The Vertical Output Amplifier circuit provides the final amplification for the signal before it is connected to the vertical deflection plates of the CRT. This circuit includes the BEAM FINDER switch which compresses the vertical and horizontal deflection within the viewing area to aid in locating an off-screen display.

The Trigger Pickoff and Generator circuit selects a trigger signal (determined by the TRIGGER SOURCE switch) and produces an output pulse which initiates the sweep signal produced by the Sweep Generator circuit. The internal trigger signal is selected from the Channel 1 circuit or the Channel Switch circuit. A sample of the line voltage applied to the instrument or an external signal applied to the EXT TRIG input connector can also be used to generate a sweep-starting pulse. The trigger circuit contains level, slope, coupling, and source controls.

The Sweep Generator circuit produces a linear sawtooth output signal when initiated by the Trigger Generator circuit. The slope of the sawtooth produced by the Sweep Generator circuit is controlled by the TIME/DIV switch. The operating mode of the Sweep Generator circuit is controlled by the sweep MODE switch. In the AUTO mode of operation, the absence of an adequate trigger signal causes the sweep to free run. In the NORM mode, a horizontal sweep is presented only when correctly triggered by an adequate trigger signal. The SINGLE SWEEP mode of operation allows one (and only one) sweep to be initiated after the circuit is reset with the RESET button. The Sweep Generator also produces an unblanking gate signal to unblank the CRT so the display can be presented. This gate signal is coincident with the sawtooth produced by the Sweep Generator circuit. Additionally, the Sweep Generator circuit produces an alternate trace sync pulse which is connected to the Channel Switch circuit. This pulse switches the display between channels at the end of each sweep when in the ALT mode of operation.

The output of the Sweep Generator circuit is amplified by the Horizontal Amplifier circuit to produce horizontal deflection for the CRT in all positions of the TIME/DIV switch except EXT HORIZ. This circuit contains a six-position magnifier switch to increase the sweep rate up to a maximum of 50 times. Other horizontal deflection signals can be connected to the Horizontal Amplifier by using the

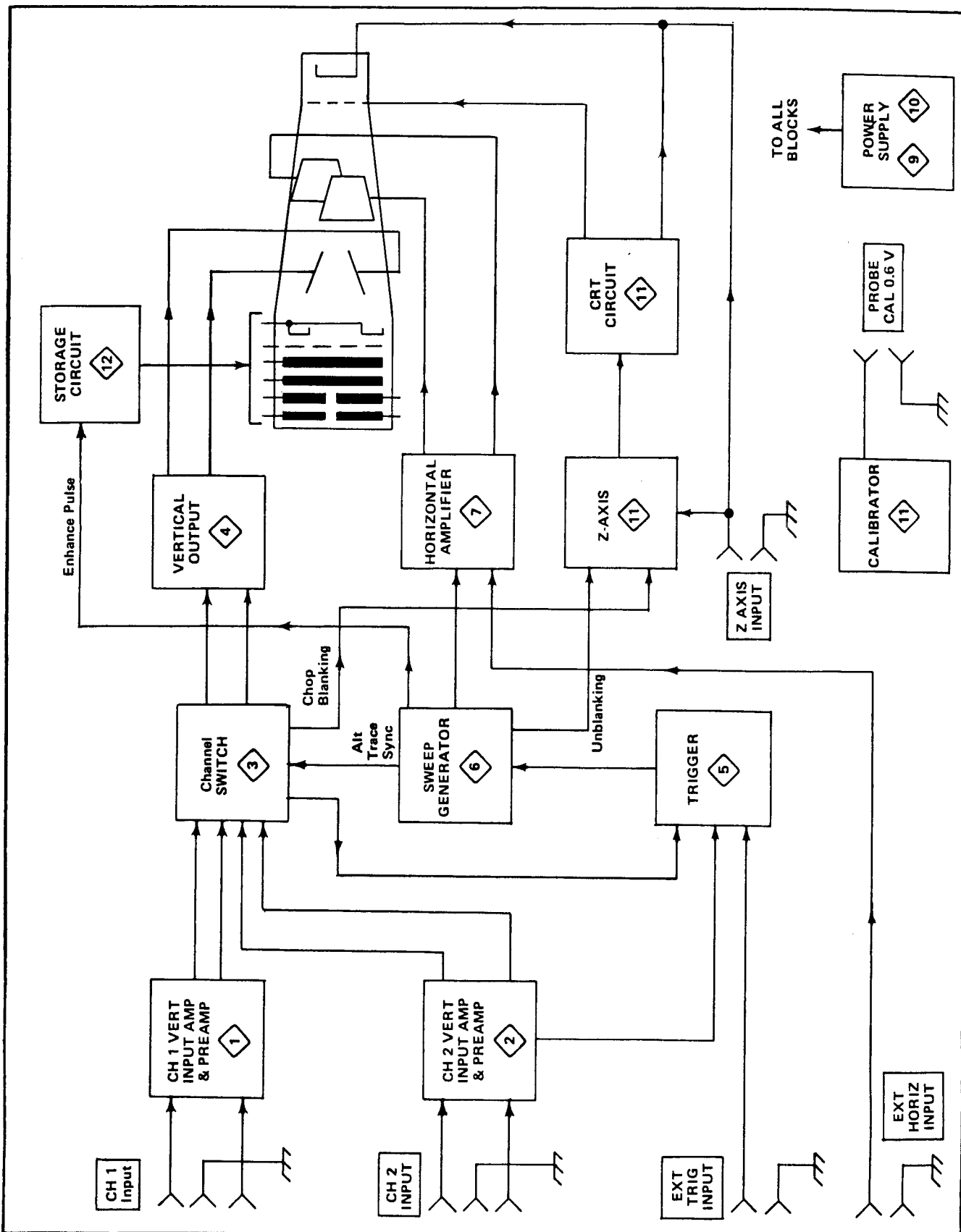

Fig. 3-1. Basic block diagram of the 434.

EXT HORIZ mode of operation. When the TIME/DIV switch is set to EXT HORIZ, the X signal is connected to the Horizontal Amplifier circuit via the EXT HORIZ input connector on the instrument rear panel.

The CRT circuit determines the CRT intensity by summing the signal inputs from the INTENSITY control, Channel Switch circuit (chopped blanking), Sweep Generator (unblanking), and the Z AXIS input connector. The CRT circuit also contains the controls necessary for operation of the cathode-ray tube. Trace storage is accomplished by the Storage circuit.

The Power Supply circuit provides all the voltages necessary for operation of this instrument. The Calibrator circuit provides a square-wave output with accurate amplitude and frequency which can be used to check the calibration of the instrument and the compensation of probes.

CIRCUIT OPERATION

General

This section provides a detailed description of the electrical operation and relationship of the circuits in the 434. The theory of operation for circuits unique to this instrument is described in detail in this discussion. Circuits which are commonly used in the electronics industry are not described in detail. If more information is desired on these commonly used circuits, refer to the following textbooks:

Phillip Cutler, "Semiconductor Circuit Analysis", McGraw-Hill, New York, 1964.

Lloyd P. Hunter (Ed.), "Handbook of Semiconductor Electronics", second edition, McGraw-Hill, New York, 1962.

Jacob Millman and Herbert Taub, "Pulse, Digital, and Switching Waveforms", McGraw-Hill, New York, 1965.

The following circuit analysis is written around the detailed block diagrams which are given for each major circuit. These detailed block diagrams give the names of the individual stages within the major circuits and show how they are connected together to form the major circuit. The block diagrams also show the inputs and outputs for each circuit and the relationship of the front-panel controls to the individual stages. The circuit diagrams from which the detailed block diagrams are derived are shown in the Diagrams section.

CHANNEL 1 INPUT AMP AND PREAMP

General

Input signals for vertical deflection on the CRT can be connected to the CH 1 connector. The Channel 1 Input Amp and Preamp circuits provide control of input coupling, vertical deflection factor, balance, vertical position, and vertical gain. A sample of the Channel 1 input signal is also provided to the Trigger Pickoff and Generator circuit to provide internal triggering from the Channel 1 signal only. Fig. 3-2 shows a detailed block diagram of the Channel 1 Input Amp and Preamp circuits. A schematic of these circuits is shown on diagram 1 at the rear of the manual.

Input Coupling

Input signals applied to the CH 1 connector can be AC-coupled, DC-coupled, or internally disconnected. When Input Coupling switch S8A is in the DC position, the input signal is coupled directly to the Input Attenuator circuit. In the AC position, the input signal passes through capacitor C8. This capacitor prevents the DC component of the signal from passing to the amplifier. When the GND pushbutton is pressed in, switch S8B opens the signal path and the input to the amplifier is connected to ground. This provides a ground reference without the need to disconnect the applied signal from the CH 1 input connector. Resistor R8 allows C8 to be precharged so the trace remains on screen when switched to AC coupling with a high DC level applied. Variable capacitor C9 adjusts the basic input time constant for a nominal value of one megohm X 24 picofarads.

Input Attenuator

The effective overall Channel 1 deflection factor of the 434 is determined by the CH 1 VOLTS/DIV switch. In all positions of the CH 1 VOLTS/DIV switch above 5 mV, the basic deflection factor of the Vertical Deflection System is 10 millivolts per division of CRT deflection. To increase this basic deflection factor to the values indicated by the VOLTS/DIV switch, precision attenuators are switched into the circuit. In the 1, 2, 5, and 10 mV positions, input attenuation is not used. Instead, the gain of the Preamp

For Service Manuals Contact
MAURITRON TECHNICAL SERVICES
8 Cherry Tree Rd, Chinnor
Oxon OX9 4QY
Tel: 01844-351694 Fax: 01844-352554
Email: enquiries@mauritron.co.uk

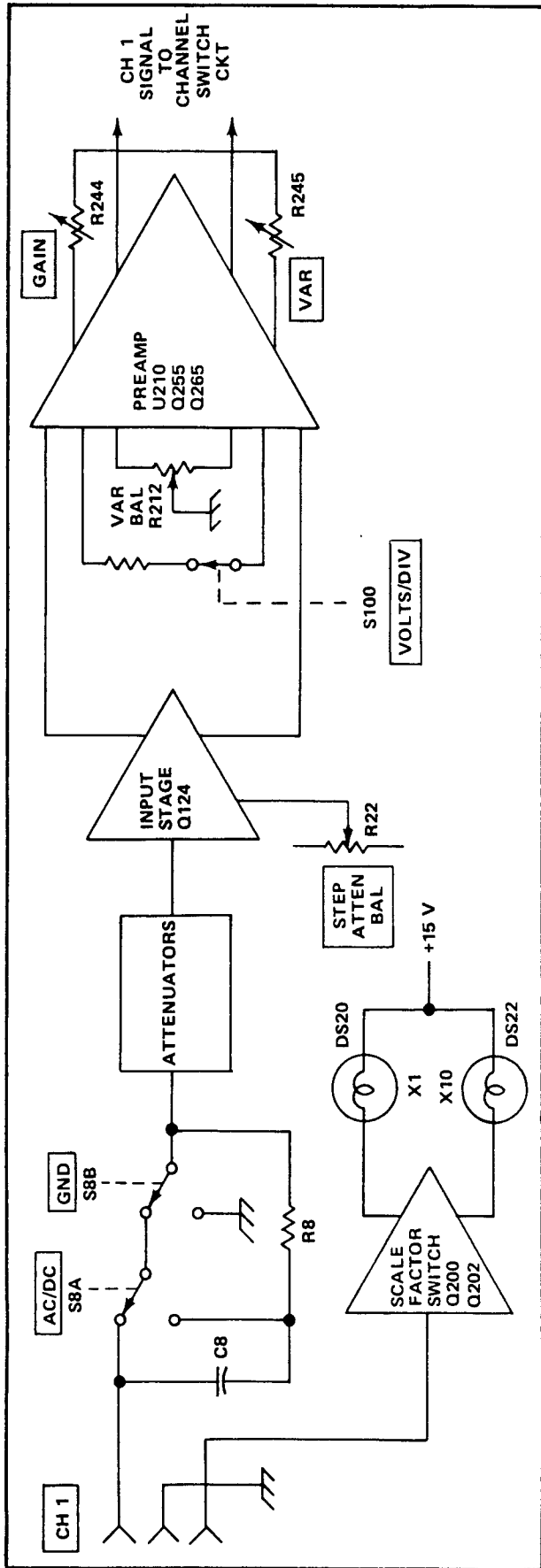

Fig. 3-2. Channel 1 Input Amp and Preamp detailed block diagram.

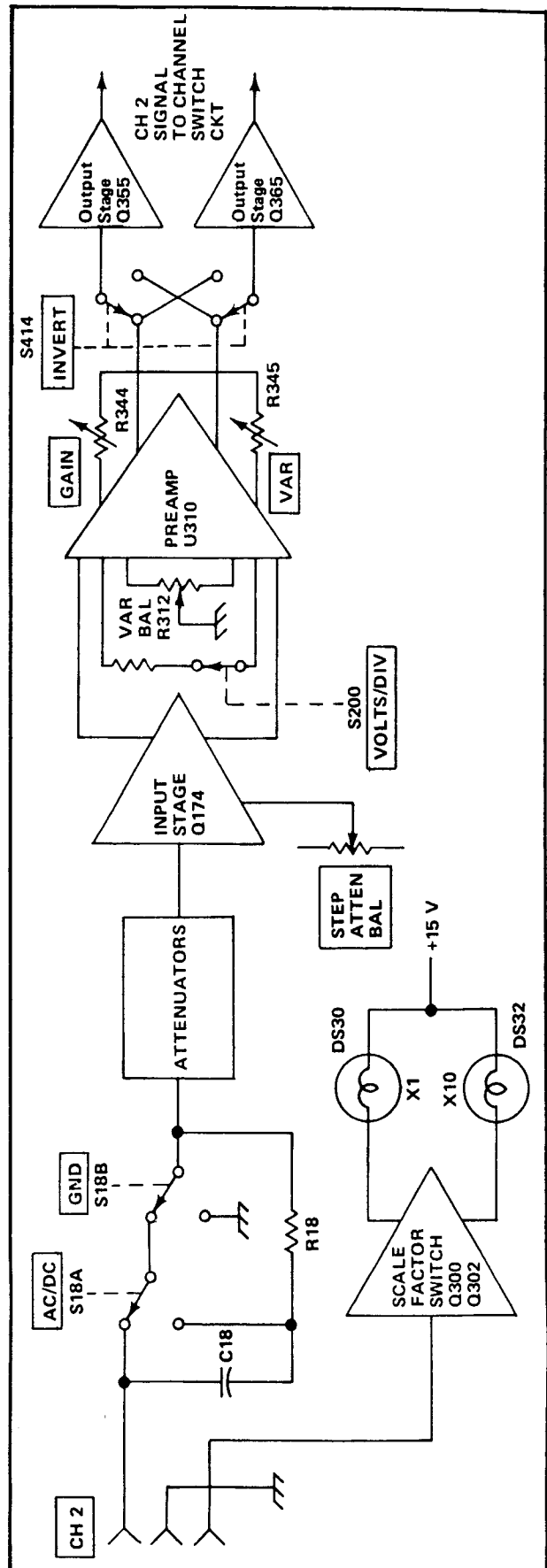

Fig. 3-3. Channel 2 Input Amp and Preamp detailed block diagram.

Circuit Description—434 (SN B500000 and up)

Circuit is changed to decrease the deflection factor (see Preamp Circuit discussion).

For the CH 1 VOLTS/DIV switch positions above 10 mV, the attenuators are switched into the circuit singly or in pairs to produce the vertical deflection factor indicated by the VOLTS/DIV switch. These attenuators are frequency-compensated voltage dividers. In addition to providing constant attenuation at all frequencies within the bandwidth of the instrument, the Input Attenuators are designed to maintain the same input RC characteristics (one megohm X 24 picofarads) for each setting of the CH 1 VOLTS/DIV switch. Each attenuator contains an adjustable series capacitor to provide correct attenuation at high-frequencies and an adjustable shunt capacitor to provide correct input capacitance.

NOTE

Each attenuator is a hybrid encapsulated assembly; therefore, replacement of individual components is not possible. Should defects occur, the attenuator must be replaced as a unit.

Scale-Factor Switching Circuit

The vertical deflection factor of Channel 1 is indicated by back-lighting the appropriate figures imprinted on the flange of the CH 1 VOLTS/DIV knob. When a X1 probe is connected to the CH 1 input connector, the base of Q200 is connected to +15 volts through R200. Q200 is biased into saturation and conducts current through indicator DS20. DS20 indicates the correct deflection factors for X1 probes. When Q200 conducts, the voltage level at its collector is very close to zero volts; therefore, there is insufficient bias at the base of Q202 to cause it to conduct, and X10 indicator DS22 remains dark.

When a X10 probe with a scale factor switching connector is attached to the CH 1 input connector, the base of Q200 is grounded. Q200 does not conduct, and its collector rises to approximately +15 volts. X1 indicator DS20 is dark and Q202 is forward biased into conduction. Q202 conducts current through X10 indicator DS22, which now indicates the correct vertical deflection factor, including the X10 attenuation ratio of the attached probe.

Input Stage

The Channel 1 signal from the Input Attenuator is connected to the Input Stage through C121, R121, and R122. R120 provides the input resistance for this stage. R121 limits the current drive to the gate of Q124A. Dual-diode CR122 protects the circuit by clamping the gate of Q124A at about -15.5 or +15.5 volts if a high-amplitude signal is applied to the CH 1 connector. FET Q124B is a

relatively constant current source for Q124A, and also provides temperature compensation of Q124A. R125 isolates the input of the Preamp Stage from the source of Q124A.

Preamp Stage

The Preamp Stage U210 is a multiple-stage integrated circuit amplifier. Adjusting the gain of this stage sets the overall gain for Channel 1. Basic gain of the amplifier is set by adjusting R244. VAR control R245 permits continuously variable uncalibrated deflection factors between the calibrated settings of the VOLTS/DIV switch. R212 adjusts for no base line shift of the CRT display when rotating the VAR control.

In the 1, 2, 5, and 10 mV positions of the VOLTS/DIV switch no attenuation is used in the Input Attenuator stage. The correct vertical deflection factors are obtained by changing the gain of the Channel 1 Preamp Stage. This is accomplished by changing the value of the gain-setting resistance connected between pins 7 and 8 of U210. The STEP ATTEN BAL screwdriver adjustment R22 located on the instrument front panel adjusts for no baseline shift of a CRT display when switching between the 1, 2, 5, and 10 mV positions of the CH 1 VOLTS/DIV switch.

Variable capacitors C217, C220, C223, C225, and C226 are compensation adjustments to provide optimum high-frequency response through the channel amplifier. A sample of the signal being amplified in Channel 1 is taken from pin 19 of U210 and connected to the Trigger Pickoff and Generator circuit to allow Channel 1 only triggering operation. Q255 and Q265 in the Output Amplifier stage are connected as common-base amplifiers to provide low input impedance load for the Preamp Stage. They also provide isolation between the Preamp Stage and the Channel Switch circuitry.

CHANNEL 2 INPUT AMP AND PREAMP

General

The Channel 2 Input Amp and Preamp circuits are basically the same as the Channel 1 Input Amp and Preamp circuits. Only the differences between the two circuits are described here. Portions of this circuit not described in the following description operate in the same manner as for the Channel 1 Input Amp and Preamp. Fig. 3-3 shows a detailed block diagram of the Channel 2 Input Amp and Preamp. A schematic of these circuits is shown on diagram 2 at the rear of this manual.

Preamp Stage

Basically the Channel 2 Preamp Stage operates as described for Channel 1. However, the Channel 2 Preamp

Circuit Description—434 (SN B500000 and up)

stage does not make available a sample of the Channel 2 signal for triggering use. Also, INVERT switch S414 has been added in the Channel 2 circuit. This switch allows the displayed signal from Channel 2 to be inverted.

CHANNEL SWITCH

General

The Channel Switch circuit determines whether the CH 1 and/or CH 2 Vertical Preamp output signal is connected to the Vertical Output Amplifier circuit. In the ALT and CHOP modes of operation, both channels are alternately displayed on a shared-time basis. Fig. 3-4 shows a detailed block diagram of the Channel Switch circuit. A schematic of this circuit is shown on diagram 3 at the rear of this manual.

Diode Gate

The Diode Gates, consisting of four diodes each, can be thought of as switches which allow either of the Vertical Preamp output signals to be coupled to the Delay-Line Driver stage. CR404, CR405, CR406, and CR408 control the Channel 1 signal output, and CR410, CR411, CR412, and CR414 control the Channel 2 signal output. These diodes are in turn controlled by the Switching Multivibrator for dual-trace displays, or by the Vertical Mode switch for single-trace displays.

CH 1. In the CH 1 mode of operation, -15 volts is applied to the junction of CR411-CR412 in the Channel 2 Diode Gate through Vertical Mode switch S45A, R427, and CR433 (see simplified diagram in Fig. 3-5). This forward biases CR411-CR412 and reverse biases CR410-CR414, since the input to the Delay-Line Driver Stage is at about +6 volts. CR410-CR414 block the Channel 2 signal so it cannot pass to the Delay-Line Driver stage. At the same time in the Channel 1 Diode Gate, CR405-CR406 are connected to +15 volts through R420. CR405-CR406 are held reverse biased, while CR404-CR408 are forward biased. Therefore, the Channel 1 signal can pass to the Delay-Line Driver stage.

CH 2. In the CH 2 mode of operation, the above conditions are reversed. CR405-CR406 are connected to -15 volts through S45E, R429, and CR431, and CR411-CR412 are connected to +15 volts through R425 (see simplified diagram in Fig. 3-6). The Channel 1 Diode Gate blocks the signal, and the Channel 2 Diode Gate allows it to pass.

Switching Multivibrator

ALT. In this mode of operation, the Switching Multivibrator operates as a bistable multivibrator. -15 volts is connected to the emitter of Q435 (Alternate Trace Switching Amplifier stage) through R437. Q435 is forward biased and supplies current to the "on" transistor in the

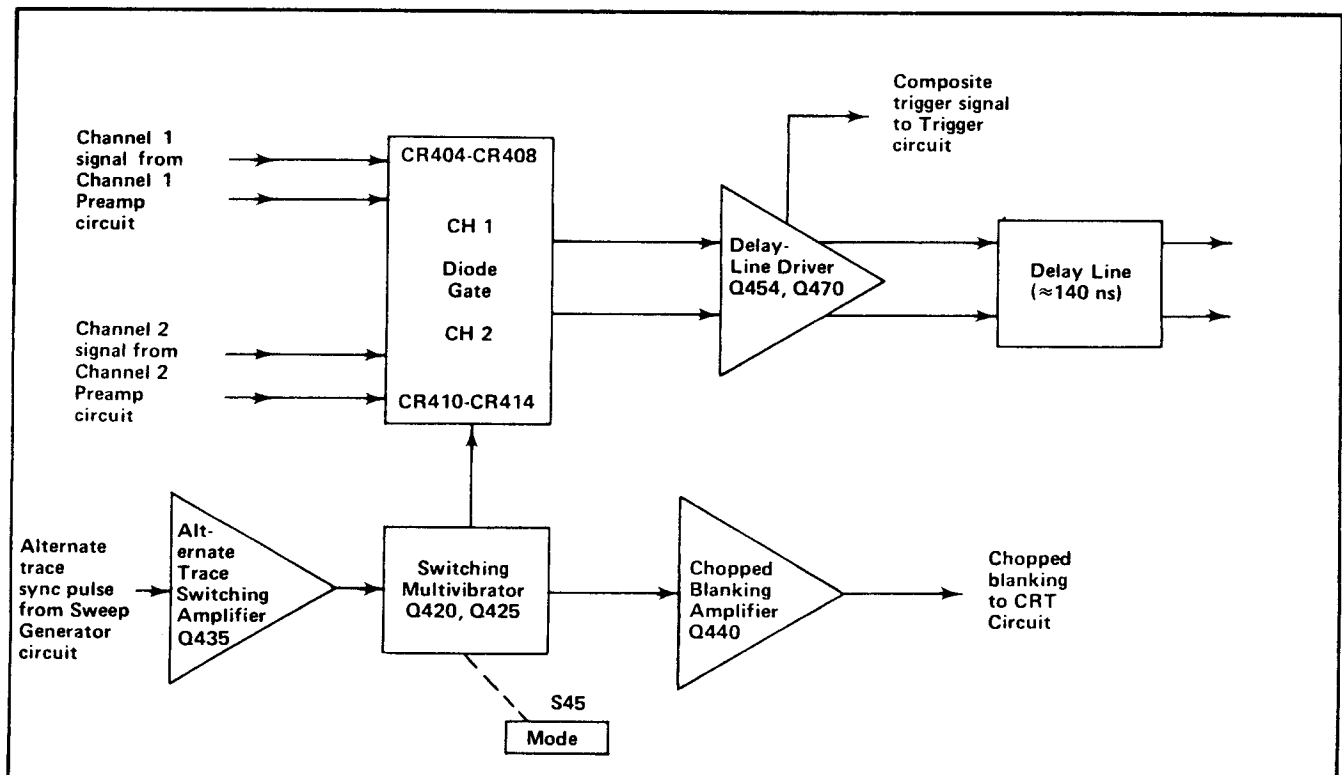

Fig. 3-4. Channel Switch detailed block diagram.

For Service Manuals Contact
MAURITRON TECHNICAL SERVICES
 8 Cherry Tree Rd, Chinnor
 Oxon OX9 4QY
 Tel: 01844-351694 Fax: 01844-352554
 Email: enquiries@mauritron.co.uk

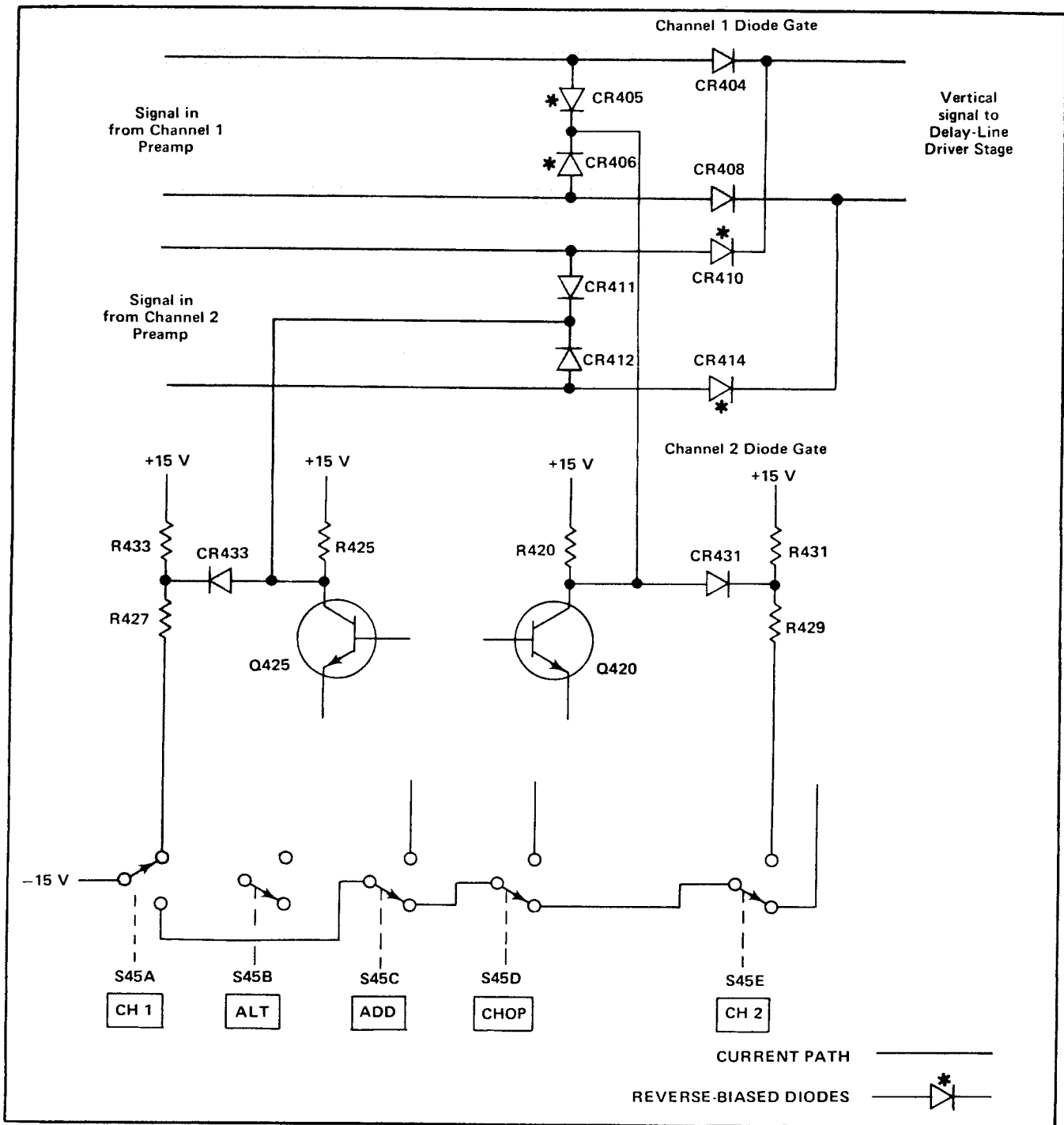

Fig. 3-5. Effect of Diode Gates on signal path (simplified path). Conditions shown for CH 1 mode of operation.

Switching Multivibrator stage through R435 and CR428 or CR426. For example, if Q420 is conducting, current is supplied to Q420 through CR426. The current flow through collector resistor R420 drops the CR405-CR406 cathode level negative with respect to the cathodes of CR404 & CR408, so the Channel 1 Diode Gate is blocked, as for Channel 2 only operation. The signal passes through the Channel 2 Diode Gate to the Delay-Line Driver.

The alternate-trace sync pulse is applied to Q435 through C430 at the end of each sweep. This differentiated negative-going sync pulse momentarily interrupts the current through Q435, and both Q420 and Q425 are turned off. When Q435 turns on again after the alternate-trace sync pulse, the charge on C425 determines whether Q420 or Q425 conducts. For example, when Q420 is conducting, C425 is charged more positively on the CR426 side to the

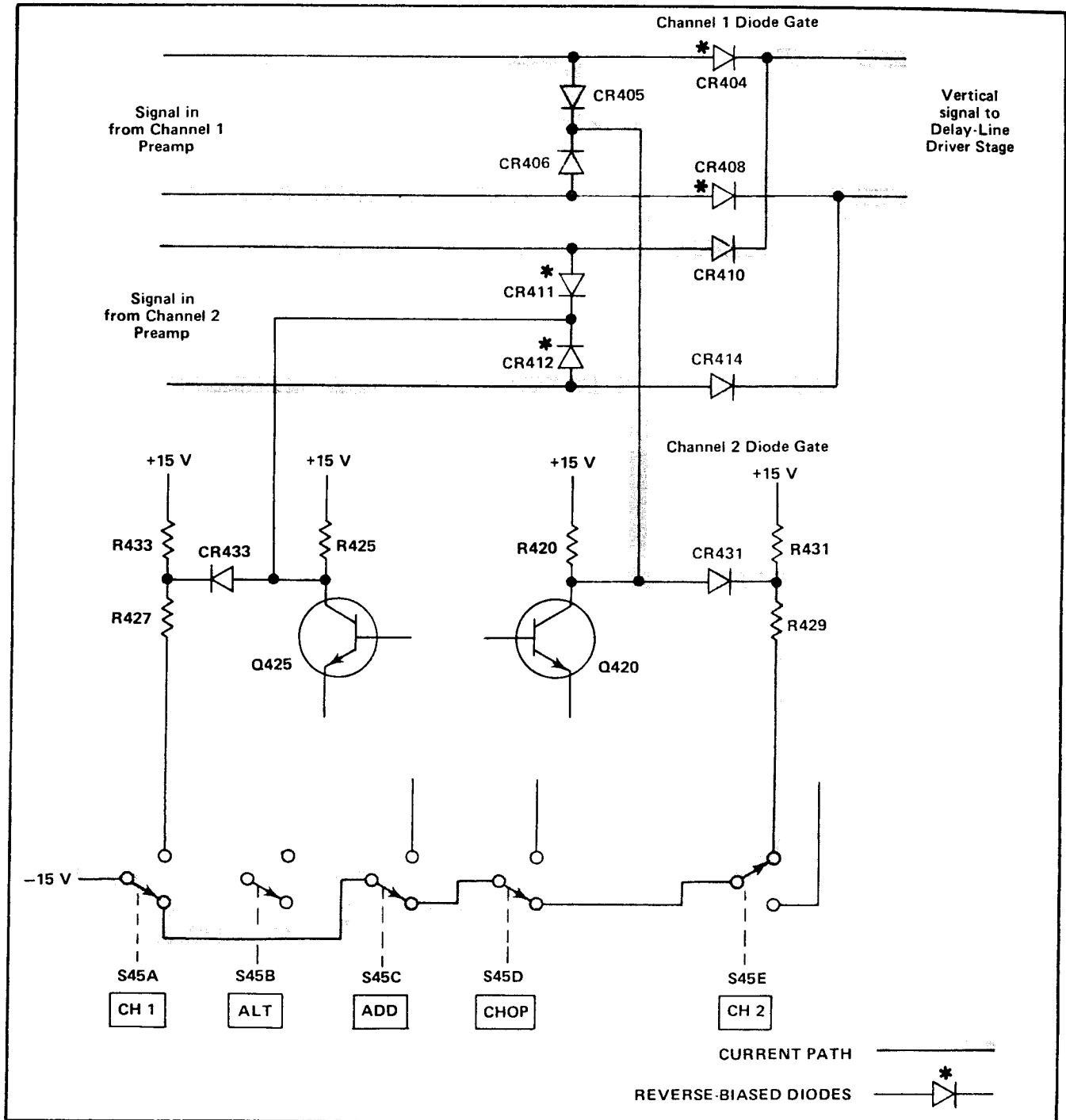

Fig. 3-6. Effect of Diode Gates on signal path (simplified path). Conditions shown for CH 2 mode of operation.

emitter level of Q420, and more negatively (toward the collector level of Q435 through R428, CR432 and R432) on the CR428 side. This charge is stored while Q435 is off, and holds the emitter of Q425 more negative than the emitter of Q420. When both Q420 and Q425 are off the voltage at their bases becomes approximately equal. When Q435 comes back on, the transistor with the most negative emitter will start conducting first, with the resulting

negative movement at its collector holding the other transistor off. The conditions described previously are reversed; now the Channel 2 Diode Gate is reverse biased, and the Channel 1 signal passes through the Channel 1 Diode Gate.

CHOP. In the CHOP mode of operation, the Switching Multivibrator stage free runs as an astable multivibrator at

Circuit Description—434 (SN B500000 and up)

about a 100 kHz rate. The emitters of Q420 and Q425 are connected to -15 volts through R428, R426, the primary of T435, and R438. At the time of turn-on, one of the transistors begins to conduct; for example, Q420. The negative level at the collector of Q420 forward biases CR405-CR406 and back biases CR404 and CR408, preventing the Channel 1 signal from reaching the Delay-Line Driver stage. Meanwhile, the Channel 2 Diode Gate passes the Channel 2 signal to the Delay-Line Driver stage.

The frequency-determining components in the CHOP mode are C425-R419-R426-R428. Switching action occurs as follows: when Q420 is on, C425 attempts to charge to -15 volts through R428. The emitter of Q425 slowly goes toward -15 volts as C425 charges. The base of Q425 is held at a negative point determined by the voltage divider R423-R421 between -15 volts and the collector voltage of Q420. When the emitter voltage of Q425 reaches a level slightly more negative than its base, Q425 conducts. Its collector level goes negative and pulls the base of Q420 negative through divider R422-R424 to cut Q420 off. This switches the Diode Gate stage to connect the opposite half to the Delay-Line Driver stage. Again C425 begins to charge toward -15 volts, but this time through R426. The emitter of Q420 slowly goes negative as C425 charges, until Q420 turns on. Q425 is shut off and the cycle begins again. Diodes CR426 and CR428 are prevented from conducting by CR432 and R432, so they are effectively removed from the circuit in the CHOP mode.

The Chopped Blanking Amplifier stage, Q440, provides an output pulse to the Z Axis Amplifier circuit which blanks out the transitions between the Channel 1 and the Channel 2 traces. When the Switching Multivibrator stage changes states, the voltage across T435 momentarily increases. A negative pulse is applied to the base of Q440 to turn it off. The width of the pulse at the base of Q440 is determined by R436 and C436. Q440 is quickly driven into cutoff and the positive-going output pulse, which is coincident with trace switching, is connected to the Z Axis Amplifier circuit through CR440 and R445.

ADD. In the ADD mode of operation, the Diode Gate stage allows both signals to pass to the Delay-Line Driver stage. The Diode Gates are both held on by -15 volts applied to their cathodes through R450 and R452. Since both signals are applied to the Delay-Line Driver stage, the output signal is the algebraic sum of the signals on both Channels 1 and 2.

Delay-Line Driver

Output of the Diode Gate stage is applied to the Delay-Line Driver stage Q454 and Q470. Q454 and Q470 are connected as feedback amplifiers with C456-R456-R457 and C472-R472-R474 providing feedback from the collector to the base of the respective transistor. A sample of the signal in the collector circuit of Q470 is used for triggering in the COMP mode of trigger operation. Switch S479 connects capacitor C479 between the output signal lines to reduce the upper -3 dB bandwidth limit of the Vertical Amplifier system to approximately 5 megahertz. C460-R460 and C461-R461 provide high frequency compensation of the Delay Line termination. The output of the Delay-Line Driver stage is connected to the Vertical Output Amplifier through the Delay Line.

VERTICAL OUTPUT AMPLIFIER

General

The Vertical Output Amplifier circuit provides the final amplification for the vertical deflection signal. This circuit includes the Delay Line and the BEAM FINDER pushbutton. The BEAM FINDER pushbutton compresses an overscanned display to within the viewing area when pressed. Fig. 3-7 shows a detailed block diagram of the Vertical Output Amplifier circuit. A schematic of this circuit is shown on diagram 4 at the rear of this manual.

Delay Line

Delay Line DL500 provides approximately 140 nano-seconds delay for the vertical signal to allow the Sweep

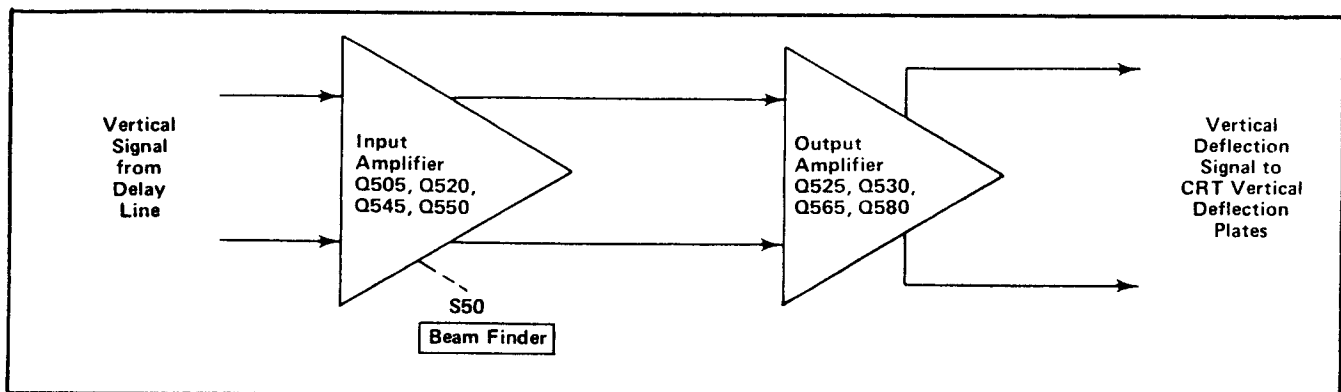

Fig. 3-7. Vertical Output Amplifier detailed block diagram.

For Service Manuals Contact
MAURITRON TECHNICAL SERVICES
8 Cherry Tree Rd, Chinnor
Oxon OX9 4QY
Tel: 01844-351694 Fax: 01844-352554
Email: enquiries@mauritron.co.uk

Circuit Description—434 (SN B500000 and up)

Generator circuits time to initiate a sweep before the vertical signal reaches the vertical deflection plates of the CRT. This allows the instrument to display the leading edge of the signal originating the trigger pulse when using internal triggering.

Input Amplifier

Q505 and Q545 are connected as common-base amplifiers to provide a low input impedance to properly terminate the Delay Line. It also provides isolation between the Delay Line and the following stages. Q520 and Q550 limit the maximum dynamic swing of the amplifier by turning on and conducting when excessive amounts of signal are present at the amplifier input. When closed, the BEAM FINDER switch S50 forward biases CR521 and CR551, thereby setting a more positive level at the bases of Q520 and Q550. This more positive level makes Q520 and Q550 conduct on smaller-than-normal overdrive signals, causing the overall dynamic swing of the Vertical Output Amplifier to be limited within the CRT graticule area. Q515 and Q555 are emitter followers to provide low output impedance.

Output Amplifier

Q525 and Q565 comprise an emitter-coupled push-pull amplifier that drives the output power amplifiers Q530 and Q580. R568, R571, R572 and R574 set the gain of the stage by controlling the signal degeneration between the emitters of Q525 and Q565. R572 is a thermistor which reduces in resistance with increases in ambient temperature. This increases the gain of the stage, to counteract the reduction in overall amplifier gain that occurs when the ambient temperature increases. Variable capacitor C572 and the series RC network C570 and R570 provide high-frequency compensation to optimize amplifier frequency response. L533 and L584 are high-frequency peaking adjustments to provide additional amplifier compensation.

TRIGGER PICKOFF AND GENERATOR

General

The Trigger Pickoff circuit selects and amplifies the internal trigger signal to the level necessary to drive the Trigger Generator circuit. Input signal for the Trigger Pickoff circuit is either a sample of the signal applied to Channel 1, or a sample of the composite vertical signal from the Channel Switch circuit.

The Trigger Generator circuit produces trigger pulses to start the Sweep Generator circuit. These trigger pulses are derived either from the internal trigger signal from the vertical deflection system, an external signal connected to the EXT TRIG input connector, or a sample of the line voltage applied to the instrument. Controls are provided in

this circuit to select trigger level, slope, coupling, and source. Fig. 3-8 shows a detailed block diagram of the Trigger Pickoff & Generator circuit. A schematic of this circuit is shown on diagram 5 at the back of this manual.

Trigger Pickoff

Diode Gate. The Diode Gates, consisting of two diodes each, can be thought of as switches which allow either of the two internal trigger signals to be coupled to the Trigger Pickoff Amplifier. CR280 and CR285 control the Channel 1 signal, and CR270 and CR275 control the composite signal. These diodes are in turn controlled by the TRIGGER SOURCE switches.

For CH 1 trigger operation, +15 volts is applied to the anode of CR270 through COMP Source switch S72B. R270 is forward biased and pulls the collector circuit of Q280 positive, which back biases and turns off CR275. CR285 remains forward biased, and couples the CH 1 trigger signal to the base of Q275. In the COMP mode of trigger operation, +15 volts is applied to the anode of CR280 through COMP Source switch S72B and R282. CR280 is now forward biased, pulling the cathode of CR280 positive, which back biases and turns off CR285. CR275 remains forward biased and couples the amplified COMP trigger signal present in the collector circuit of Q280 to the base of Q275. R274 and R284 set the DC level at the collector of Q275 to zero volts for no-signal, zero-volt input level conditions.

Q275 and Q278 comprise an emitter-coupled comparator amplifier. Q275 by itself is a feedback amplifier, with R285 providing feedback from the collector to the base of Q275. The DC level at the base of Q278 determines the DC level at the base of Q275.

Trigger Source

The TRIGGER SOURCE switches S72A and S72B select the source of the trigger signal. Four trigger sources are available: CH 1, COMP, external, and line. EXT ATTEN switch S70 provides 10 times attenuation for the external trigger signal. The internal trigger signals (CH 1 and COMP) are obtained from the Trigger Pickoff circuit discussed above.

The line trigger signal is obtained from the secondary of transformer T1802 in the Power Supply Primary circuit. This sample of the line frequency, about .7 volt RMS, is coupled to the Trigger Generator circuit in the LINE mode of operation. The TRIGGER COUPLING switches should not be in the LF REJ mode of operation when using this trigger source, as the signal will be blocked by the LF reject circuit.

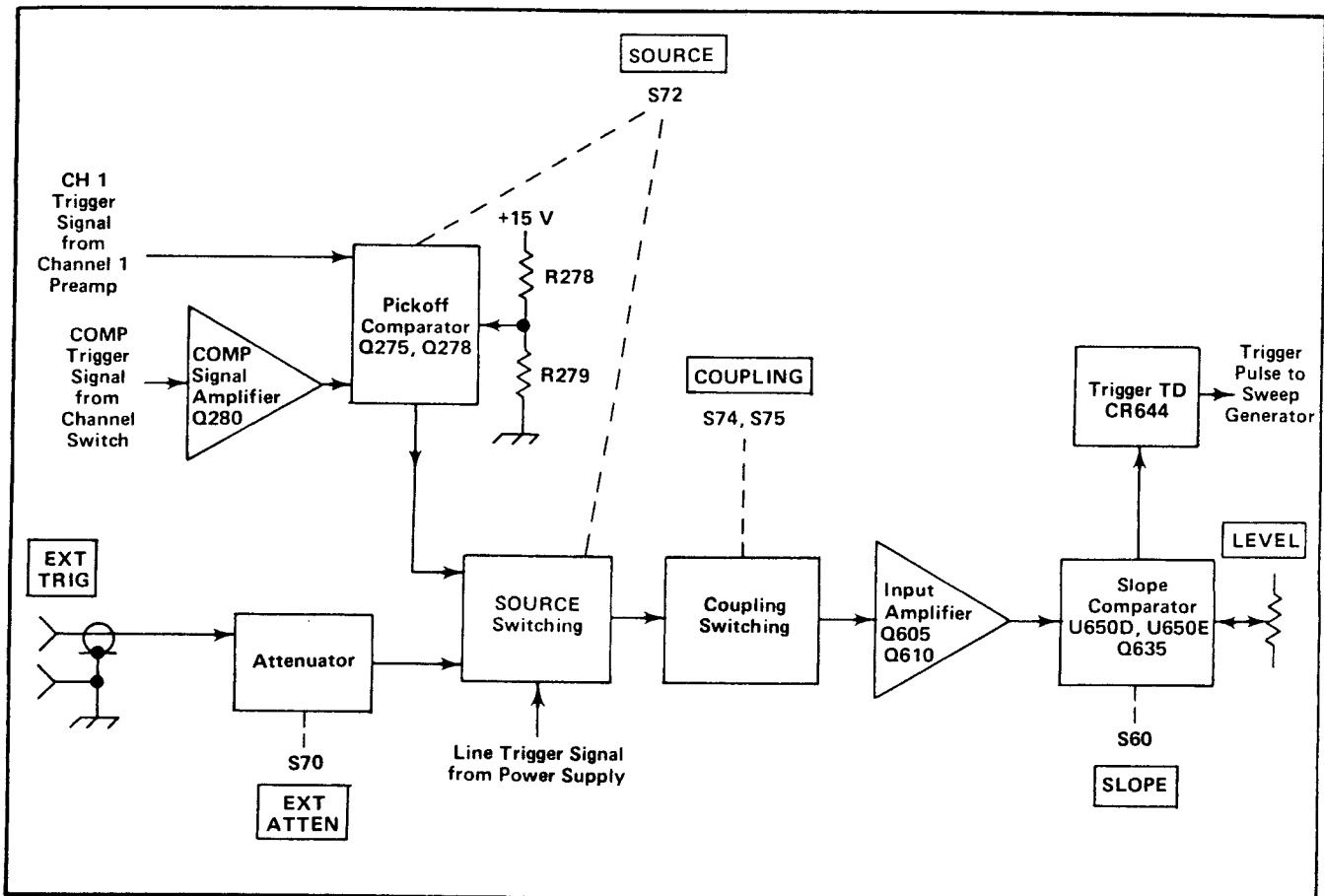

Fig. 3-8. Trigger Pickoff and Generator detailed block diagram.

External trigger signals applied to the EXT TRIG input connector can be used to trigger the Sweep Generator in the EXT TRIG mode of operation. Input resistance at DC is about one megohm paralleled by about 100 picofarads (about 70 picofarads when EXT ATTEN switch S70 is in the 1:10 position). Setting the EXT ATTEN switch to the 1:10 position attenuates the input signal by a factor of 10 to provide more LEVEL control range.

Trigger Coupling

The TRIGGER COUPLING switches S74, S75A, and S75B offer a means of accepting or rejecting certain components of the trigger signal. In the AC and LF REJ mode of trigger coupling, the DC component of the trigger signal is blocked by coupling capacitor C72 or C74. Frequency components below about 60 hertz are attenuated when using AC coupling and below about 50 kilohertz when using LF REJ coupling. The higher-frequency components of the trigger signal are passed without attenuation.

In the HF REJ mode of trigger coupling, the trigger signal is DC coupled to the input if the AC and LF REJ

pushbuttons are not also depressed. High-frequency components of the trigger signal (above about 50 kilohertz) are attenuated, while the lower-frequency components are passed without attenuation. The DC mode of trigger coupling passes all signals from DC to 25 megahertz.

Input Source Follower

The Input Source Follower, Q605A, provides a high input impedance for the trigger signal. It also provides isolation between the Trigger Generator circuit and the trigger signal source. Diode CR603 protects Q605A if an excessive negative input voltage is applied to the EXT TRIG input connector. The output at the anode of VR605 is connected to emitter follower stage Q610. Q605B is a relatively constant current source for Q605A, and provides temperature compensation of Q605A.

Slope Comparator

U650D and U650E are connected as an emitter-coupled difference amplifier (comparator) to provide selection of the slope and level at which the sweep is triggered. The reference voltage for the comparator is provided by the LEVEL control R60B and the Trigger Level Centering

Circuit Description—434 (SN B500000 and up)

adjustment R629. The Trigger Level Centering adjustment sets the level at the base of U650E so the display is correctly triggered when the LEVEL control is centered. The LEVEL control varies the base level of U650E to select the point on the trigger signal where triggering occurs. Diodes CR615 and CR616 prevent overdrive occurring in the Slope Comparator. Q618 is a relatively constant current source for U650D and U650E.

The slope of the input signal which triggers the Sweep Generator is determined by the SLOPE switch S60. When the SLOPE switch is set to +, +5 volts is connected to the base of Q635 through R635 and to the anode of CR634. See Fig. 3-9. This forward biases CR634, which turns on and pulls the cathode of CR634 positive also. At the same time the base-emitter junction of Q635 is zero biased, which turns off Q635. With Q635 turned off, its collector falls to a level of about +2 volts set by the voltage divider R637-R638. This back biases CR635, and the trigger signal in the collector circuit of U650D is allowed to pass to the Trigger TD CR644. The trigger signal in the collector circuit of U650E is conducted by CR634 and blocked from reaching the Trigger TD by back-biased diode CR632. The trigger signal in the collector circuit of U650D is amplified and inverted with respect to the input trigger signal. Since the output pulse from the Trigger Generator is derived from the negative-going portion of the signal applied to the

Trigger TD, the sweep is triggered on the positive-going slope of the input trigger signal.

When the SLOPE switch is set to -, conditions are reversed. The base of Q635 is returned to ground through R634 and R635. See Fig. 3-10. This back biases CR634 and forward biases the base-emitter junction of Q635 sufficiently to drive Q635 into saturation. The collector of Q635 rises to within about 0.2 volt of the emitter, which forward biases CR635. Now CR630 is back-biased and CR632 is forward biased, allowing the trigger signal present in the collector circuit of U650E to be applied to the Trigger TD. The trigger signal in the collector circuit of U650E is in phase with respect to the input trigger signal, so the sweep is triggered on the negative-going slope of the input trigger signal.

Trigger TD

The Trigger TD stage shapes the output of the Slope Comparator to provide a trigger pulse with a fast leading edge. Tunnel diode CR644 is quiescently biased so it is on and in its low-voltage stage. The current from one of the transistors in the Slope Comparator stage is diverted through the Trigger TD stage. As the current increases due to a change in the trigger signal, tunnel diode CR644 switches to its high-voltage state. The tunnel diode remains

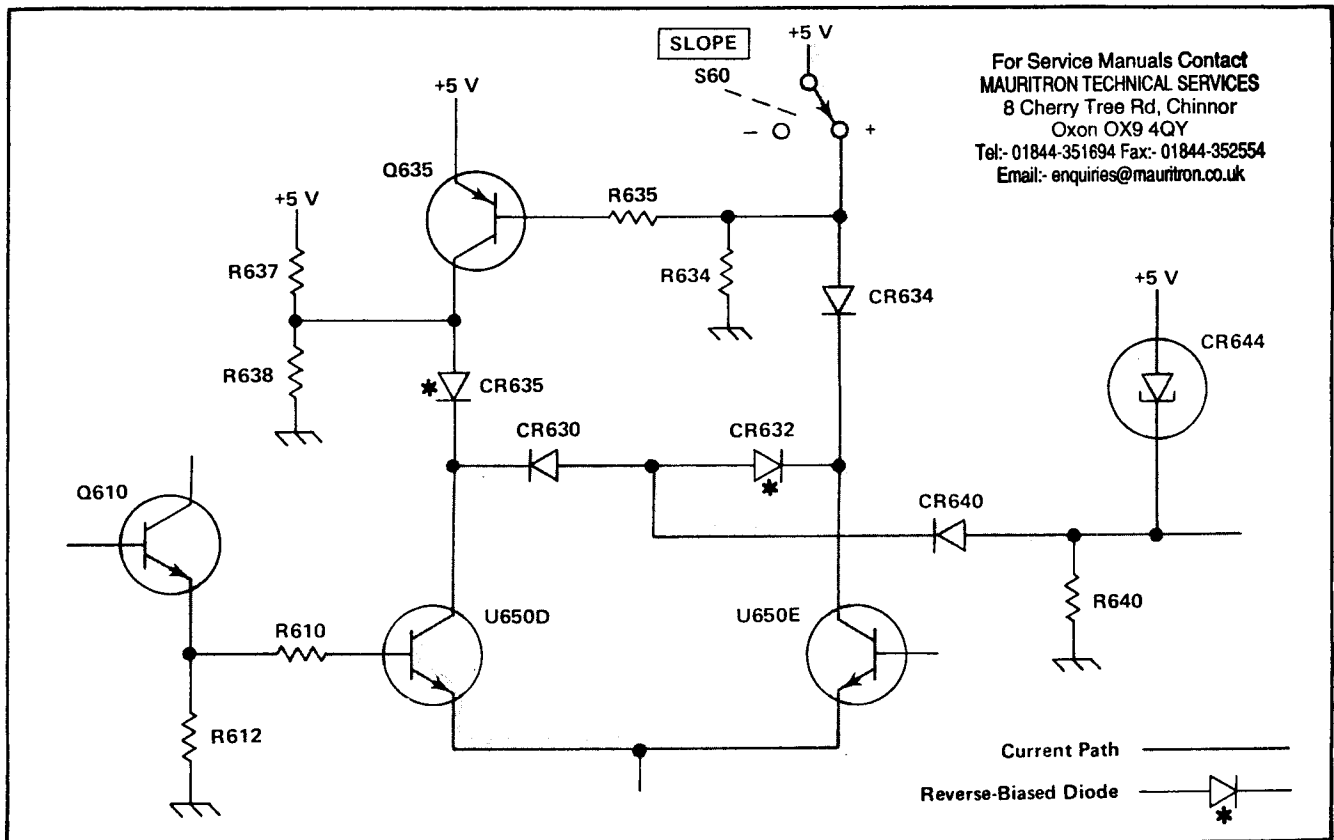

Fig. 3-9. Trigger signal path for positive-slope triggering (simplified Trigger Generator diagram).

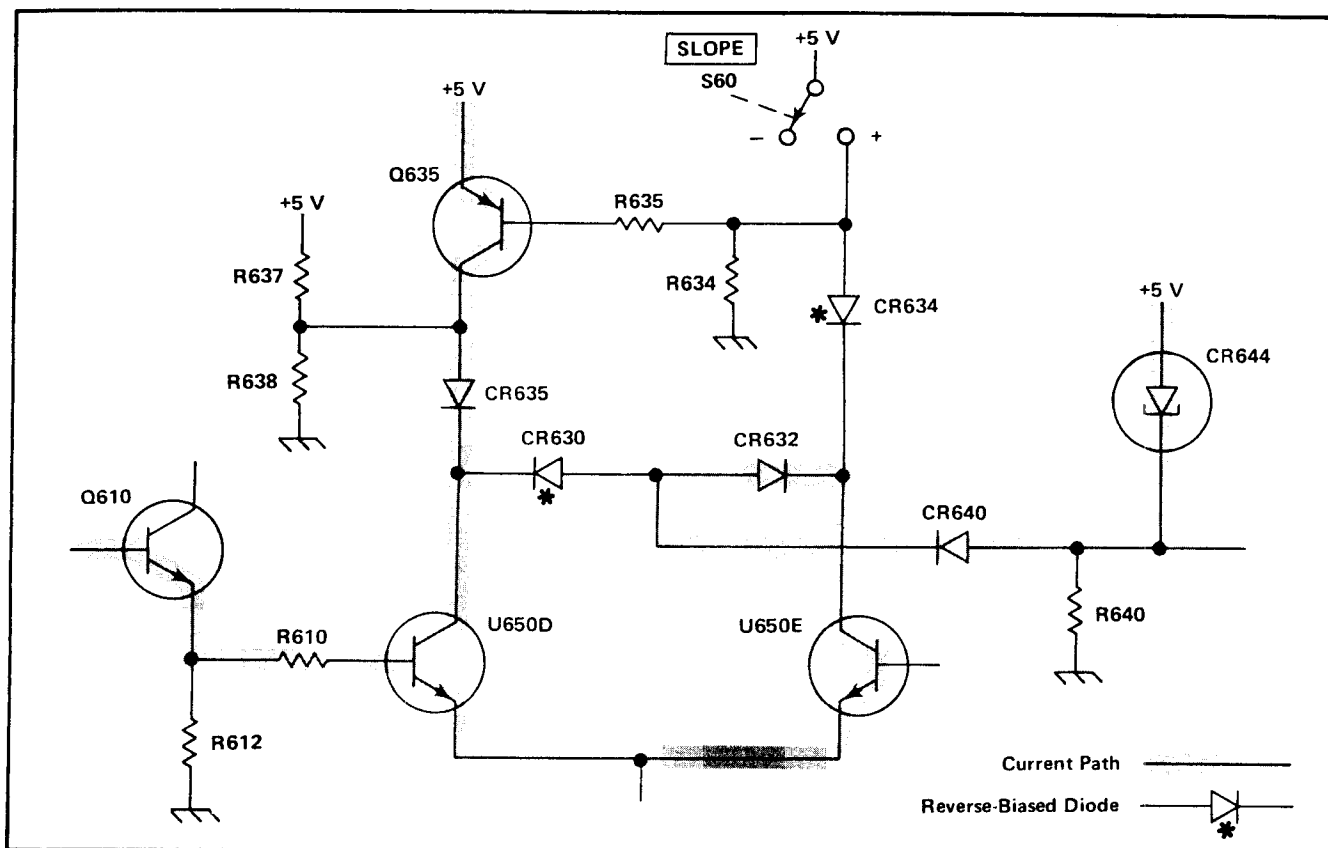

Fig. 3-10. Trigger signal path for negative-slope triggering (simplified Trigger Generator diagram).

in this condition until the current from the Slope Comparator stage decreases due to a change in the trigger signal applied to the input. Then the current through CR644 decreases and it reverts to its low-voltage state.

SWEEP GENERATOR

General

The Sweep Generator circuit produces a sawtooth voltage which is amplified by the Horizontal Amplifier circuit to provide horizontal sweep deflection on the CRT. This output signal is generated on command (trigger pulse) from the Trigger Generator circuit. The Sweep Generator also produces an unblanking gate to unblank the CRT during sweep time and an alternate trace sync gate to switch vertical channels during sweep retrace time. Fig. 3-11 shows a detailed block diagram of the Sweep Generator circuit. A schematic of this circuit is shown on diagram 6 at the back of this manual.

The Sweep MODE switch allows three modes of operation. In the NORM mode, a sweep is produced only when a trigger pulse is received from the Trigger Generator circuit. Operation in the AUTO mode is much the same as NORM, except that a free-running trace is displayed in the absence

of an adequate trigger signal. In the SINGLE SWEEP mode, operation is also similar to NORM except that the sweep is not recurrent. The following circuit description is given with the sweep MODE switch set to NORM. Differences in operation for the other two modes are discussed later.

Normal Sweep Mode Operation

Sweep Gate. The negative-going trigger pulse generated in the Trigger Generator circuit is applied to the Sweep Gate stage through inverting amplifier Q645 and C663-R663. CR678 is quiescently biased on in its low-voltage state. When the positive-going trigger pulse is applied to the anode of CR678, the current through the tunnel diode increases and it rapidly switches to its high-voltage state, where it remains until reset by the Sweep Reset Multivibrator stage at the end of the sweep. The positive-going level at the anode of CR678 is connected to the base of U680A through R680. U680A is turned on and its collector goes negative. This negative-going step is connected to the base of U680B through C686-R686. U680B is turned off and its collector goes positive. This positive-going step is connected to the base of the Sweep Gate Amplifier.

Sweep Gate Amplifier. The Sweep Gate Amplifier U680C is an emitter follower quiescently conducting

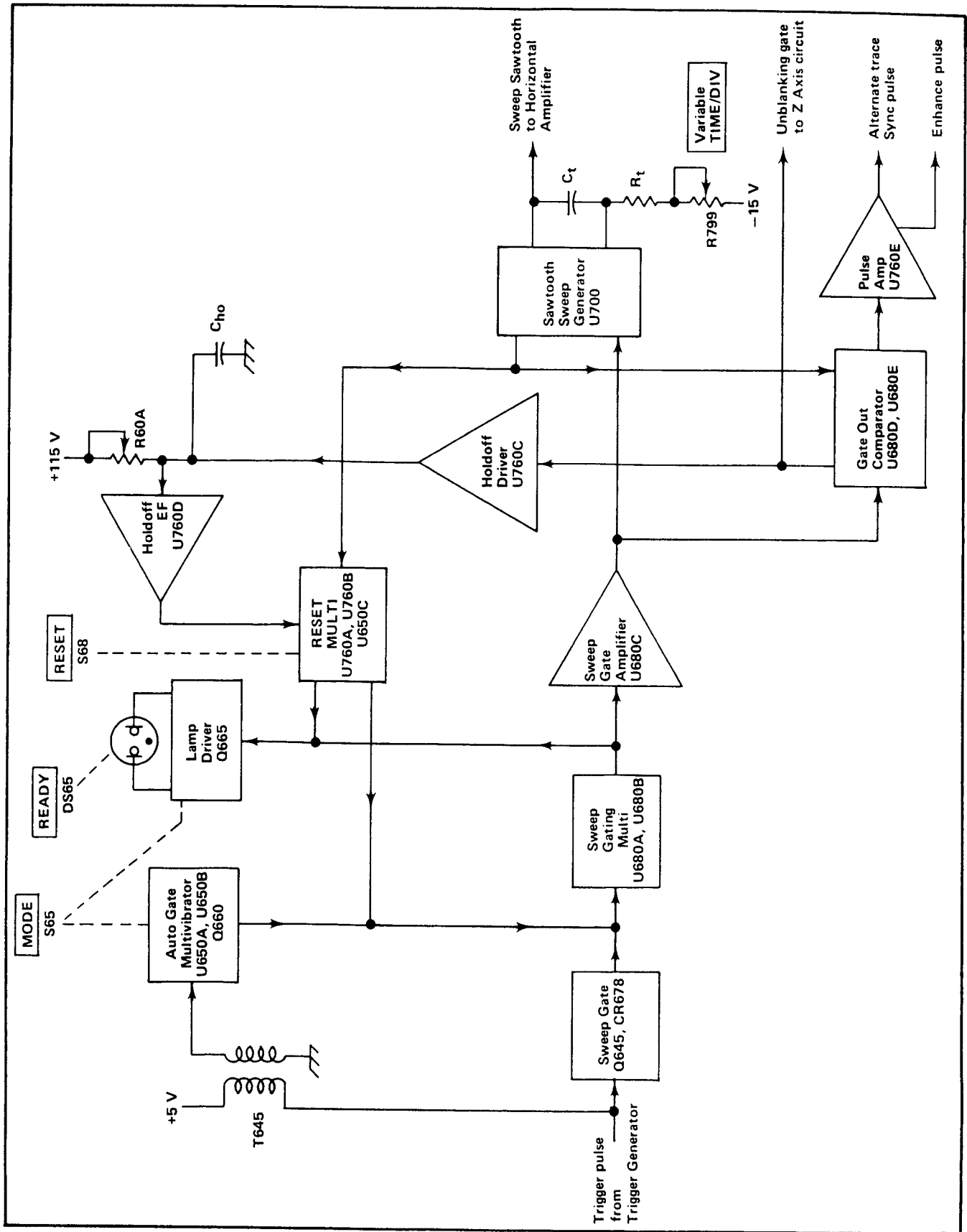

Fig. 3-11. Sweep Generator detailed block diagram.

Circuit Description—434 (SN B500000 and up)

current through R742, R796, R794, R692, and R690. When sweep triggering occurs, the positive-going excursion at the base of U680C is present in the emitter circuit and is applied to pin 1 of the Sawtooth Sweep Generator U700 and the base of U680D.

Gate Output Comparator. The positive-going signal at the base of U680D turns U680D on, and turns U680E off. The negative-going excursion at the collector of U680D is applied to the emitter of Holdoff Driver U760C, and is also coupled to the Z-Axis circuit through R790, CR794, and CR795 to unblank the CRT during sweep time. At the same time that the collector of U680D is going negative, the collector of U680E is going positive. This positive-going voltage is applied to the base of the Pulse Amplifier U760E and a positive-going Alternate Trace Sync Pulse is coupled from the emitter to the Channel Switch circuit while a negative going Enhance Pulse is coupled from the collector to the Storage circuit.

Holdoff Driver. The negative-going signal at the collector of U680D when the sweep begins is connected to the Holdoff Capacitor through U760C. This negative-going signal discharges the Holdoff Capacitor completely at the start of each sweep to provide accurate sweep holdoff time. CR785 clamps the collector of U760C so it does not go more negative than about -0.5 volt.

Sawtooth Sweep Generator. The basic sweep generator is a Miller Integrator circuit. When pin 1 of U700 is positive, the timing capacitor, C_T , begins to charge through the timing resistor, R_T . The timing resistor and capacitor are selected by the TIME/DIV switch S700 to provide the various sweep rates listed on the front panel. Diagram 8 shows a complete diagram of the TIME/DIV switch. The Sweep Cal adjustment R727 allows calibration of this circuit for accurate sweep timing. The Variable TIME/DIV control R799 provides continuously variable uncalibrated sweep rates by varying the charge rate of the timing capacitor. R703 is an Offset adjustment to adjust the quiescent DC level at pin 9 of U700 to zero volts. This reduces timing current errors between positions of the TIME/DIV switch.

The output sawtooth voltage signal at pin 8 of U700 is applied to the Horizontal Amplifier input. Voltage divider R705-R706 determines the amplitude of the sawtooth ramp. When the ramp reaches this predetermined level, a reset pulse is generated at pin 4 of U700. This reset pulse is applied to the base of U760A in the Sweep Reset Multivibrator and to the base of U680E in the Gate Output Comparator.

Sweep Reset Multivibrator. Quiescently, U760A is turned off and U760B is turned on. The sweep reset pulse (a narrow, positive-going, rectangular pulse) is applied to

the base of U760A through R700 and CR710. U760A is turned on and its collector goes negative. This negative movement is coupled to the base of U760B and turns it off, causing its collector to go positive. The positive movement at the collector of U760B is coupled to the base of U650C which, prior to this, had been turned off. The increase in forward bias of the base-emitter junction of U650C drives it into saturation. The collector of U650C moves negative until it is only a few tenths of a volt more positive than the grounded emitter. The negative movement of the collector of U650C is coupled to the anode of Sweep Gating Tunnel Diode CR678 through R678, causing CR678 to switch from its high-voltage state to a low-voltage state where it is conducting almost no current. As long as U650C is turned on, CR678 is prevented from switching to its high voltage state.

Holdoff Emitter Follower. When the sweep reset pulse causes U760A and U760B to reverse states, the pulse also causes U680E and U680D in the Gate Output Comparator to switch states. The reset pulse turns on U680E which causes U680D to turn off. The positive movement at the collector of U680D when it turns off causes U760C to turn off and the Holdoff Capacitor, C_{HO} , starts to charge positive through R778 and R60A. This positive movement is coupled through Holdoff Emitter Follower U760D and emitter resistor R774 to the anode of diode CR765. When sufficient forward bias is achieved, CR765 will turn on and couple the positive-going movement to the base of U760B in the Sweep Reset Multivibrator, causing U760B to turn on and U760A to turn off. The negative movement at the collector of U760B turns U650C off and CR678 conducts current in its low-voltage state, ready to receive the next trigger pulse.

R60A varies the charge rate of the Holdoff Capacitor to provide a stable display at fast sweep rates. This change in holdoff allows sweep synchronization for less display jitter at the faster sweep rates, and has very little effect at slow sweep rates. R60A is ganged with the TRIGGER LEVEL control and is adjusted by rotating the LEVEL knob. The Holdoff Capacitor is changed by the TIME/DIV switch for the various sweep rates to provide the correct holdoff time.

Auto Sweep Mode Operation

Operation of the Sweep Generator circuit in the AUTO mode is the same as for the NORM mode just described when an adequate trigger pulse is present. However, when an adequate trigger pulse is not present, a free-running reference trace is produced in the AUTO mode. This occurs as follows:

Auto Multivibrator. U650A and U650B form a mono-stable multivibrator. Quiescently with no trigger pulses being generated by the Trigger Generator circuit, U650B is conducting and U650A is biased off by only about 150 millivolts. With U650A not conducting, its collector moves

Circuit Description—434 (SN B500000 and up)

positive, which forward biases CR660 allowing Q660 to conduct. Q660 conducts its current through R646, C663-R663, and Sweep Gating Tunnel Diode CR678. The added current through tunnel diode CR678 automatically switches it to its high-voltage state at the end of the sweep holdoff period. The result is that the Sweep Generator circuit is automatically retriggered at the end of each hold-off period, and a free-running sweep is produced. Since the sweep free-runs at the sweep rate of the Sweep Generator, a bright reference trace is produced even at fast sweep rates.

When trigger pulses are being produced by the Trigger Generator circuit, positive-going pulses are coupled to the base of U650A by transformer T645. These positive pulses turn on U650A, which causes U650B to turn off. The collector of U650A goes negative and the collector of U650B goes positive, which combines to turn off CR660 and Q660. When U650A turned on and its collector went negative, capacitor C650 discharged very rapidly. If the multivibrator does not receive another trigger pulse, C650 will recharge to approximately +15 volts in about 115 milliseconds. The auto gate level at the collector of transistor Q660 will be negative when the Trigger Generator circuit is producing trigger pulses, and positive when the Trigger Generator circuit is not producing trigger pulses. In both the NORM and SINGLE SWEEP modes of operation, -15 volts is applied to the anode of CR660 through R660 to back bias CR660 and prevent Q660 from conducting.

Single Sweep Mode Operation

General. Operation of the Sweep Generator in the SINGLE SWEEP mode of operation is similar to operation in the other modes. However, after one sweep has been produced, the Sweep Reset Multivibrator stage does not reset. All succeeding trigger pulses are locked out until the RESET button is pushed.

In the SINGLE SWEEP mode of operation, -15 volts is applied to the top of READY light DS65 and to the cathode of CR770. Diode CR770 is forward biased and holds CR65 back biased to prevent the Sweep Reset Multivibrator from resetting at the end of the sweep holdoff time.

Single-Sweep Reset. The Single Sweep Reset circuit produces a pulse to reset the Sweep Reset Multivibrator stage so another sweep can be produced in the SINGLE SWEEP mode of operation. After a sweep has been produced in the SINGLE SWEEP mode, U760A is on and U760B is off. Pressing the RESET pushbutton applies +15 volts to the voltage divider made up of R784, R783, and R782. C782 capacitively couples a positive-going spike to the anode of CR765. CR765 becomes forward biased and turns on, coupling the positive-going spike to the base of U760B. U760B now turns on and U760A turns off. When U760B turns on, its collector goes negative, which turns Q665 off and also turns U650C off, allowing the Sweep

Gating Tunnel Diode CR678 to accept the next trigger pulse.

When Q665 turns off, its collector goes positive, allowing sufficient voltage to be impressed across READY light DS65 to turn the READY light on. This indicates that the Sweep Generator is ready to produce a sweep upon receipt of the next trigger pulse. When the next trigger pulse is received, the collector of U680B in the Sweep Gating Multivibrator will go positive and turn on Q665. The collector of Q665 will go negative, causing the READY LIGHT to turn off.

HORIZONTAL AMPLIFIER

General

The Horizontal Amplifier circuit provides the output signal to the CRT horizontal deflection plates. The signal applied to the input of the Horizontal Amplifier is determined by the TIME/DIV switch. The signal can be a sawtooth waveform generated internally within the instrument, or some external signal applied to the EXT HORIZ input connector located on the instrument rear panel. The Horizontal Amplifier circuit also contains the horizontal magnifier circuit and the horizontal positioning network. Fig. 3-12 shows a detailed block diagram of the Horizontal Amplifier circuit. A schematic of this circuit is shown on diagram 7 at the rear of this manual.

Input Paraphase Amplifier

The input signal for the Horizontal Amplifier is selected by the TIME/DIV switch, S700A. In all positions of the switch except EXT HORIZ, the sawtooth from the Sweep Generator circuit is connected to the base of Input Amplifier Q825A. In the EXT HORIZ position of the switch, the signal applied to the base of Q825A is obtained from the EXT HORIZ input connector.

Q825A and Q825B comprise an emitter-coupled paraphase amplifier. This stage converts the single-ended input signal to a push-pull signal necessary to drive the horizontal deflection plates of the CRT. R816, R817, R826 and R827 control the emitter degeneration between Q825A and Q825B to set the gain of the stage. The adjustment of R817 determines overall horizontal amplifier gain. Q818 is a constant current source for Q825A and Q825B. Horizontal positioning is provided by the POSITION control (R55A-R55B) connected to the base of Q825B. This control is a dual-range control to provide a combination of coarse and fine adjustment in a single control. When the control is rotated, fine control R556B provides positioning for a range of about 0.3 major division for a normal (unmagnified) display. Then after the fine range is exceeded, the coarse control R55A provides rapid positioning of the trace. Pressing the LOCATE button applies -15 volts to the base of Q825B through R95 and R811. This provides a small

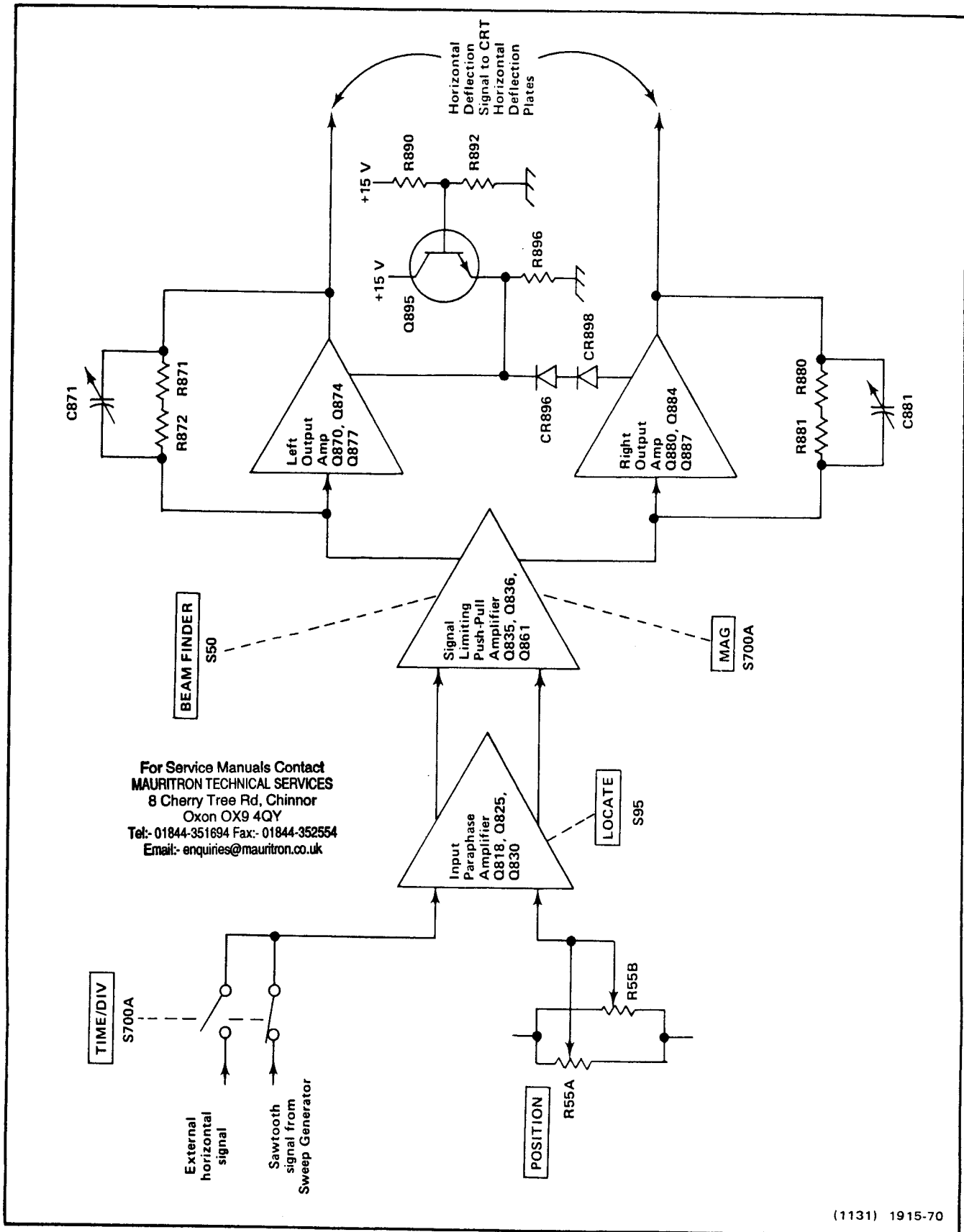

(1131) 1915-70

Fig. 3-12. Horizontal Amplifier detailed block diagram.

Circuit Description—434 (SN B500000 and up)

amount of positioning of the display in the direction of the non-store pre-view area to aid in locating display prior to storing a single-sweep. The output signals from the collectors of Q825A and Q825B are applied to the bases of emitter followers Q830A and Q830B respectively.

Signal Limiting Push-Pull Amplifier

Q835 and Q836 form a push-pull amplifier stage with Q835A and Q836A comprising a cascade amplifier in one side and Q835B and Q836B a cascade amplifier in the other side. Sweep magnification is accomplished by modifying the gain setting resistance between the emitters of Q835A and Q835B. CR835 and CR865 limit the difference in signal amplitude between the bases of emitter followers Q836A and Q836B. This prevents amplifier over-drive when the sweep is magnified or positioned to one extreme or the other. CR836 and CR866 provide additional overdrive protection.

Q861 is a relatively constant current source for Q835 and Q836. When the BEAM FINDER push-button is pushed the current through Q861 is reduced by approximately two milliamperes. This reduces the dynamic range of the signal limiting push-pull amplifier stage, thereby limiting the trace to within the CRT graticule area. The Magnifier Registration adjustment R868 balances the quiescent DC current to the bases of Q870 and Q880 so a centerscreen display does not change position when the sweep is magnified.

Output Amplifier

The push-pull output of the Signal Limiting Push-Pull Amplifier stage is connected to the Output Amplifier through CR870 and CR880. Each half of the Output Amplifier can be considered as a single-ended feedback amplifier which amplifies the signal current at the input to produce a voltage output to drive the horizontal deflection plates of the CRT. The amplifiers have a low input impedance and require very little voltage change at the input to produce the desired output change.

Q895 is a relatively constant voltage source. The base of Q895 is biased to set the emitter at approximately +5 volts and the anode of CR898 at approximately +6.5 volts. This sets the base of Q880 and the base of Q870 very near the same quiescent DC level. CR870 and CR880 become back biased and are turned off when overdrive in the positive direction occurs at their cathodes.

Transistors Q870 and Q880 are inverting amplifiers whose collector signals drive the emitters of complementary amplifiers Q874-Q877 and Q884-Q887 respectively. The output signal from complementary amplifier Q874-Q877 drives the left horizontal deflection plate of the CRT, and

the output signal from complementary amplifier Q884-Q887 drives the right horizontal deflection plate. C871 and C881 adjust the transient response of the amplifier so it has good linearity at fast sweep rates.

POWER SUPPLY PRIMARY

General Information

The Power Supply Primary circuit consists of a Power Inverter and several Inverter control circuits. The Line Voltage Selector switch allows the 434 to be operated from either a 115 volt or a 230 volt AC line voltage. Fig. 3-13 shows a detailed block diagram of the Power Supply Primary circuit. A detailed schematic of this circuit appears on diagram 9 at the rear of this manual.

Line Input

Power is applied through the line fuse F1801, thermal cutout S1802, the Line Filter, and Line Voltage Selector switch S1803. Thermal cutout S1802 opens to interrupt instrument power if the internal temperature of the instrument exceeds a safe operating level. When the temperature returns to normal, S1802 closes to re-apply instrument power. The Line Filter prevents the instrument from injecting power supply frequency interference into the power line, and prevents interference on the power line from entering the instrument.

The Line Voltage Selector switch S1803 can be set to operate the instrument from either a 115 volt or 230 volt nominal line voltage. In the 115-volt position of S1803, CR1821, C1822, and C1823 operate as a full-wave voltage doubler. Note that only two of the four diodes in CR1821 will be conducting. The voltage across the series capacitors (C1822 and C1823) will be equal to about the peak-to-peak line voltage. In the 230-volt position of S1803, CR1821 operates as a full-wave bridge rectifier, while capacitors C1822 and C1823 operate as energy-storage filter capacitors. As a result, the DC voltage from the Line Input circuit to the Inverter circuit will be about the same for either 115 volt or 230 volt operation.

Thermistors RT1821 and RT1822 limit the surge current demanded by the instrument power supply when it is first turned on (most of this current is used to charge C1822 and C1823). After the instrument is in operation, RT1821 and RT1822 warm up and their resistance drops, so that they have little effect on circuit operation. When the POWER switch is turned off, the Line Stop circuit stops the Inverter and C1822 and C1823 slowly discharge through R1822 and R1823 (see Line Stop).

WARNING

Because the discharge is slow, dangerous potentials will exist across capacitors C1822, C1823, and other connected components for several minutes after the POWER switch is turned off. The presence of voltage in the circuit is indicated by relaxation oscillator R1824, C1824, and DS1824. Neon bulb DS1824 blinks until the potential drops to approximately 100 V.

If the POWER switch is turned back on before RT1821 and RT1822 cool off, the charge on C1822 and C1823 limits the current surge. The discharge time of C1822 and C1823 is about equal to the recovery time of RT1821 and RT1822.

Line voltage transient protection is provided by DS1801 and DS1802. With S1803 in the 115-volt position, only DS1801 is connected across the line to protect against line

voltage surges exceeding about 230 volts. With S1803 in the 230-volt position, DS1801 and DS1802 are connected in series across the line to protect against line voltage surges exceeding about 460 volts. Protection is provided when one or both bulbs break down and conduct sufficient current to open the line fuse F1801.

Start Network

The input line voltage is connected to the voltage divider composed of R1828 and R1829. On each positive half cycle of the line voltage, C1829 charges through R1828. Some of the current from R1828 flows through CR1842 and L1835 to charge C1835. When the charge on C1829 reaches about 32 volts, VR1831 conducts to discharge C1829 through the base-emitter junction of Q1844. This turns on Q1844, which discharges C1835 through L1835 to start the Inverter. After the Inverter is operating, the recurrent 25 kilohertz square-wave voltage at the collector of Q1844 discharges C1829 on each cycle through CR1842. The time

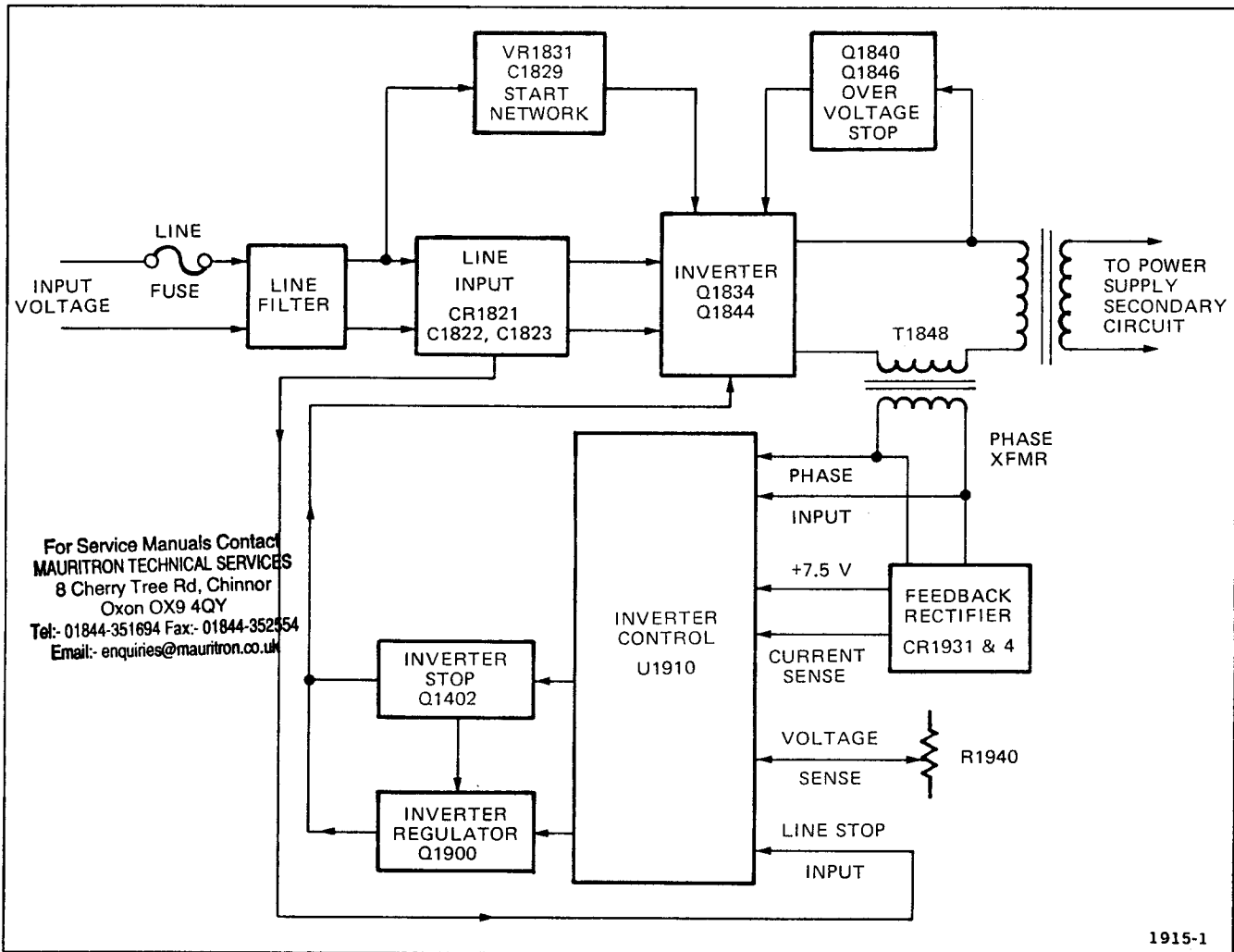

For Service Manuals Contact
MAURITRON TECHNICAL SERVICES
 8 Cherry Tree Rd, Chinnor
 Oxon OX9 4QY
 Tel:- 01844-351694 Fax:- 01844-352454
 Email:- enquiries@mauritron.co.uk

1915-1

Fig. 3-13. Power Supply detailed block diagram.

Circuit Description—434 (SN B500000 and up)

required to charge C1842 to 32 volts is much longer than the period of the 25 kilohertz waveform. This disables the Start Network while the instrument is operating.

Inverter

Refer to the simplified schematic shown in Fig. 3-14. Once the Inverter has been started by the Start Network, the Inverter is self-oscillating. Feedback necessary for oscillation is provided by base-drive transformer T1831. The series-resonant circuit, consisting of L1835 and C1835, has a nominal resonant frequency of about 25 kilohertz. To provide regulation of the voltages induced in the secondary circuit, the action of regulator transistor Q1900 varies the frequency of oscillation on the low side of resonance by holding both Q1834 and Q1844 off for a time during each half cycle as determined by the Regulator circuit (see Inverter Regulator for a more detailed discussion of regulation).

Transistors Q1834 and Q1844 are a switching pair, where only one transistor can conduct at a time. The direction of current flow in the feedback winding of T1831 determines which transistor will conduct. Transistors Q1834 and Q1844 change states every half cycle. The switching action provides a square-wave voltage at the

emitter of Q1834, which has a peak-to-peak voltage about equal to the DC voltage from the Line Input circuit. This square-wave voltage supplies the drive necessary to maintain oscillation in the resonant circuit. When both Q1834 and Q1844 are being held off by Q1900, resonant circuit current flows through CR1834 or CR1844. The resonant circuit current drives the primary of the power transformer T1860 and thus supplies power to the Secondary circuit.

In normal operation, the sequence of events during one cycle of operation is as follows:

1. Assume the current in the resonant circuit is at 0 ampere and beginning to increase in the direction to cause conduction in CR1834. At the time the current reaches 0 ampere, regulator transistor Q1900 is turned on by the Inverter Control circuit. The Regulator transistor holds both Q1834 and Q1844 off for a controlled amount of time. During this time, resonant circuit current flows through CR1834.
2. At a controlled time after the resonant circuit current passes through 0 ampere, regulator transistor Q1900 is turned off by the Inverter Control circuit. When Q1900 is turned off, the direction of current flow in the feedback

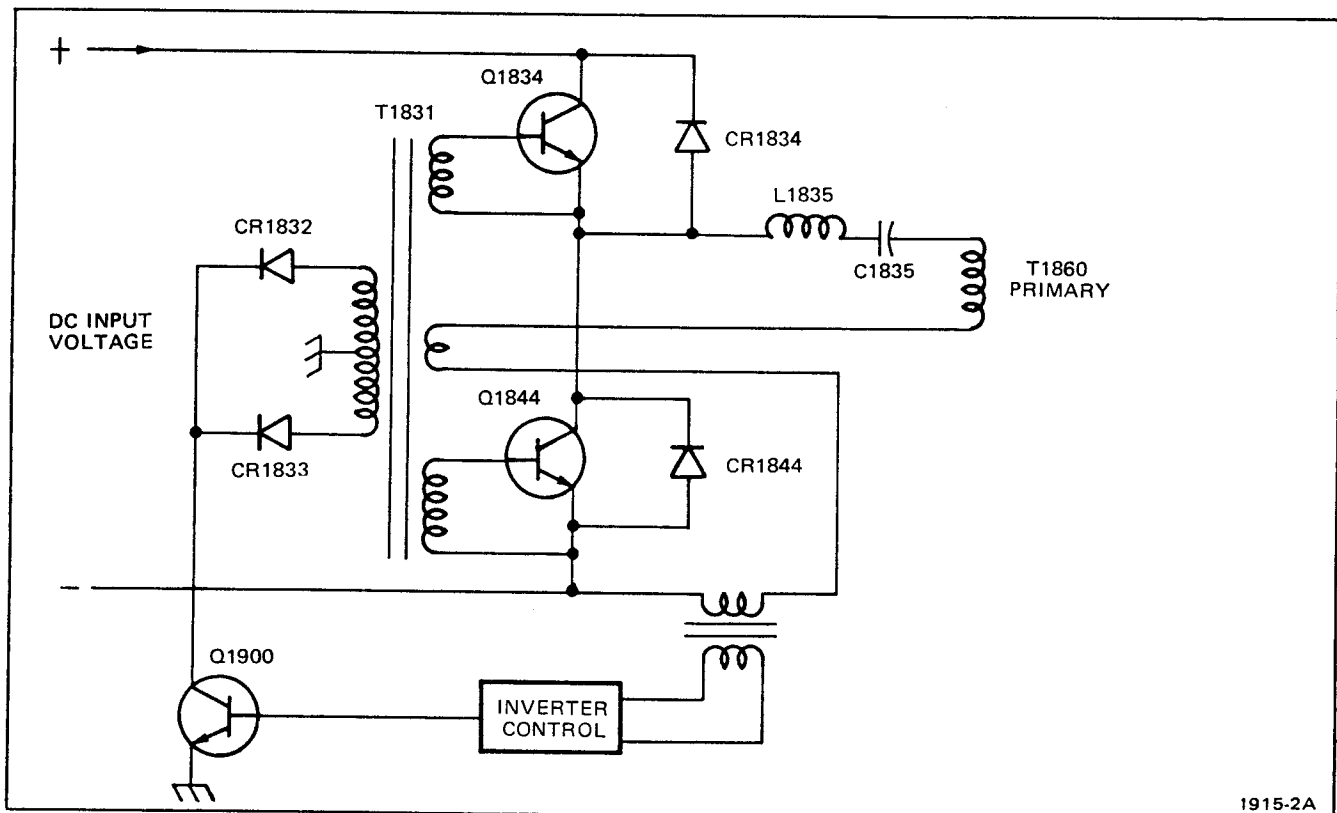

Fig. 3-14. Simplified Inverter Circuit.

Circuit Description—434 (SN B500000 and up)

winding T1831 is such that it induces a voltage in the base windings of T1831, which turns on Q1844 and holds off Q1834. Transistor Q1844 conducts while the resonant circuit current builds up to maximum and falls off toward 0 ampere.

3. When the resonant circuit current reaches 0 ampere and begins to increase in the opposite direction, regulator transistor Q1900 is again turned on by the Inverter Control circuit. This holds both Q1834 and Q1844 off for a controlled amount of time. While Q1900 is on, resonant circuit current flows through CR1844.

4. When Q1900 is turned off by the Inverter Control circuit, the direction of current flow in the feedback winding of T1831 is such that the induced voltage in the base windings of T1831 turns on Q1834 and holds off Q1844. Transistor Q1834 conducts as the resonant circuit current increases to maximum and falls off toward 0 ampere.

5. When the resonant circuit current reaches 0 ampere and begins to increase in the opposite direction the cycle begins to repeat.

Inverter Regulator

The purpose of the Inverter Regulator is to maintain constant voltages on the outputs of the secondary supplies. This is accomplished by varying the Inverter frequency. The nominal resonant frequency of L1835 and C1835 is about 25 kilohertz. Regulation is achieved by forcing the Inverter to operate on the low side of resonance. At the lowest line voltage and the highest load, the Inverter will operate at a frequency close to resonance. If either the line voltage is increased or the load decreased, the Inverter frequency will decrease. Operating the Inverter below resonance increases the impedance of the series combination of L1835 and C1835. The increased impedance reduces the power transmitted to the primary of T1860.

U1910 contains the Regulator circuit consisting of a voltage amplifier and variable pulse-width monostable multivibrator. Operating power for U1910 and phase sensing information is provided by current transformer T1848. Diodes CR1931, CR1932, CR1933, and CR1934 are connected as a bridge rectifier to deliver both positive and negative operating voltages to U1910. The +7.5 volts on pin 6 of U1910 is shunt regulated within U1910. The -2 volts on pin 7 is unregulated. The output of T1848 is also connected to pins 10 and 11 of U1910 to sense the direction of current flow in the Inverter. When the Inverter current changes directions, the monostable multivibrator is triggered to its unstable state. The output of pin 9 of U1910 drives the regulator transistor Q1900 which controls the

Inverter switching transistors Q1834 and Q1844. Pin 15 of U1910 is the voltage sense input. The voltage ramp on pin 12 of U1910 is used to time the variable pulse width of the monostable multivibrator.

Circuit operation is as follows:

1. When the monostable multivibrator in U1910 is in the stable state, pin 9 of U1910 is low, which holds off Q1900.

2. When the Inverter current changes directions, the polarity of the voltage on pins 10 and 11 of U1910 reverses. This triggers the monostable multivibrator to its unstable state.

3. During the unstable state of the multivibrator, pin 9 of U1910 is high. This turns on Q1900, which shorts a winding of T1848 through CR1832 and CR1833. Shorting one winding of T1848 holds the voltages on all the other windings at 0 volt. This holds both Q1834 and Q1844 off for a time during each half cycle to slow down the Inverter operating frequency.

4. While the multivibrator is in the stable state, pin 12 is low. When the multivibrator is triggered to its unstable state, pin 12 is released which allows C1919 to charge through R1919. The resulting ramp is used to time the unstable state of the multivibrator.

5. Timing the unstable state of the multivibrator is accomplished by comparing the voltage sensed at pin 15 of U1910 with the ramp on pin 12. When the voltages are equal, the monostable multivibrator returns to its stable state.

6. When the multivibrator returns to its stable state, pin 9 of U1910 steps low, turning off Q1900. This allows either Q1834 or Q1844 to turn on. Which transistor turns on is determined by the direction of Inverter current flow in the feedback winding of T1848.

7. If the voltage on the +15 volt unfiltered supply rises, then the voltage on pin 15 of U1910 also rises. Therefore, C1919 takes longer to charge to the voltage level on pin 15 of U1910. This increases the amount of time the multivibrator is in the unstable state, which increases the time Q1900 is biased on by pin 9 of U1910. Holding Q1900 on longer holds Q1834 and Q1844 off longer. The longer Q1834 and Q1844 are held off, the slower the Inverter frequency will be and the less power will be supplied to

@

For Service Manuals Contact
MAURITRON TECHNICAL SERVICES
8 Cherry Tree Rd, Chinnor
Oxon OX9 4QY
Tel: 01844-351954 Fax: 01844-352654
Email: enquiries@mauritron.co.uk

3-21

Circuit Description—434 (SN B50000 and up)

T1860 (due to the increased impedance of the series resonant circuit L1835-C1835). This reduces the voltage of the +15 volt unfiltered supply.

8. If the voltage on the +15 volt unfiltered supply drops the process reverses. Capacitor C1919 charges up to the voltage on pin 15 of U1910 sooner, which turns off regulator transistor Q1900 sooner. This speeds up the Inverter frequency, supplies more power to the power transformer, and raises the voltage on the +15 volt unfiltered supply.

9. Holding the +15 volt unfiltered supply at +15 volts holds the other supply voltages constant due to the turns ratio of the power transformer T1860. Also, due to the turns ratio of T1860, a change in any supply voltage is sensed as a change in the +15 volt supply and initiates regulation as just described.

Inverter Current Limit

The Current Limit circuit is also contained within U1910. Circuit operation is similar to voltage regulation except that the pulse width of the monostable multivibrator is varied so Inverter current never exceeds a safe level. Under normal operating conditions, the Current Limit circuit does not affect Inverter operation. When Inverter current becomes excessive, usually due to turn on surge or an excessive load on one of the secondary supplies, the Current Limit circuit takes over control of the monostable multivibrator.

The circuit operates as follows:

1. In normal operation the divider action of R1922, R1925, and R1926 holds pin 13 of U1910 slightly above ground.

2. The voltage on the secondary of T1848 is proportional to Inverter current. This voltage is rectified by the bridge rectifier consisting of CR1931, CR1932, CR1933, and CR1934. The positive output of this bridge is regulated at +7.5 volts at pin 6 of U1910 by a shunt regulator within U1910. Therefore the negative output of this bridge rectifier is proportional to Inverter current (an increase in Inverter current causes the voltage to go more negative).

3. Under normal conditions, the negative output of the bridge rectifier just mentioned is about -2 volts. The three series diodes CR1923, CR1924, and CR1925 drop about 2 volts (three forward biased diode drops), which holds TP1924 at about 0 volt.

4. Assume Inverter current becomes excessive. The negative output of the bridge rectifier (the cathode of CR1925) goes more negative. Since the voltage drop across series diodes CR1923, CR1924, and CR1925 is fixed at about 2 volts, the voltage on TP1924 goes more negative. This pulls pin 13 of U1910 more negative through R1921 and R1925.

5. When pin 13 of U1910 goes negative, it holds the monostable multivibrator in its unstable state longer during each Inverter half cycle of operation than for normal voltage regulation (see Inverter Regulator). Switching transistors Q1834 and Q1844 are held off longer by the multivibrator, which reduces the operating frequency of the Inverter and increases the impedance of the resonant circuit composed of L1835 and C1835. This increased impedance reduces the current in the Inverter circuit. Inverter current is limited to a value that holds pin 13 of U1910 near ground.

6. If the circuit remains in current limit longer than about 30 milliseconds (time determined by C1912 connected to pin 1 of U1910), pin 8 of U1910 steps high which turns on Q1902 and Q1900. This holds Inverter switching transistors Q1834 and Q1844 off, which stops the Inverter.

7. Transistors Q1902 and Q1900 are held on for about 250 milliseconds after pin 8 of U1910 steps high by the current being discharged from C1902 through R1901 and the base-emitter junctions of Q1902 and Q1900. When this current becomes insufficient to bias on Q1902 and Q1900, they turn off and allow the Inverter to restart. When the Inverter restarts, current is supplied from T1831 through CR1901 and R1901 to charge C1901.

8. If Inverter current again becomes excessive, the procedure repeats. The Inverter will start up, operate in current limit for about 30 milliseconds, and be shut down for about 250 milliseconds. On each repetition of this procedure the instrument emits a faint squeak or click.

Line Stop

The Line Stop circuit stops the Inverter when the POWER switch is turned off or the AC line voltage drops below a certain value. This circuit function is necessary to limit turn-on surge current when instrument power is turned off, then back on before RT1821 and RT1822 have time to cool and recover (see Line Input). If the Line Stop circuit did not function, the Inverter would continue to operate for a few milliseconds and rapidly drain the charge on C1822 and C1823. Since most of the turn-on surge current charges C1822 and C1823, the slow discharge of these capacitors provides a decreasing amount of surge current protection

while RT1821 and RT1822 cool and provide an increasing amount of surge current protection. See Fig. 3-15 for a simplified schematic of the Line Stop circuit.

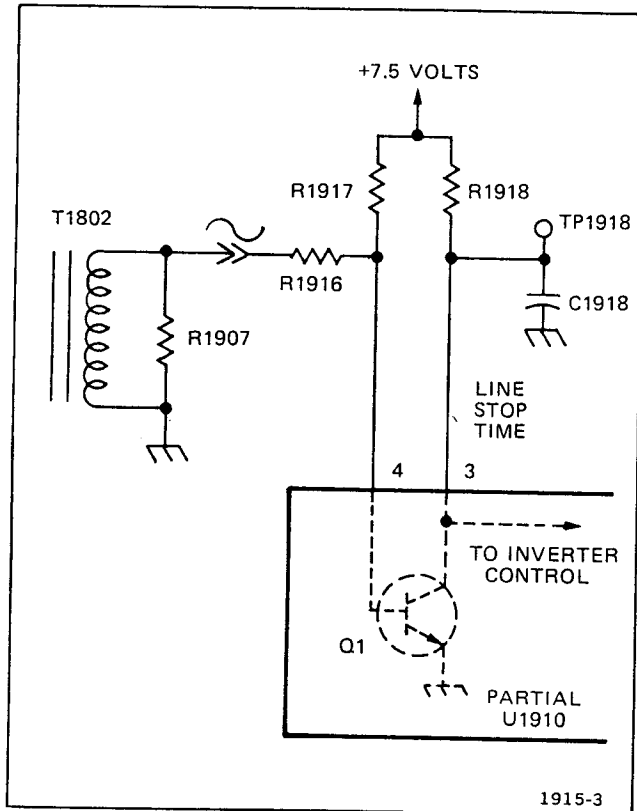

Fig. 3-15. Simplified Line-Stop Circuit.

The Line Stop circuit operates as follows:

1. Transformer T1802 supplies a sample of the line frequency to pin 4 of U1910 (the base of Q1, see Fig. 3-15). During a portion of each positive half cycle of this voltage, Q1 is biased on. The higher the AC line voltage the sooner during the positive half cycle Q1 will be biased on. In normal operation, C1918 charges toward +7.5 volts through R1918. When Q1 is biased on, C1918 rapidly discharges through Q1.

2. When the AC voltage from T1802 becomes insufficient to bias on Q1 during a portion of the positive half-cycle, due to a low AC line voltage or the instrument being turned off, C1918 is allowed to continue charging toward +7.5 volts. When the charge on C1918 (pin 3 of U1910) reaches +0.7 volt, pin 8 of U1910 goes positive. This turns on Q1902 and Q1900, stopping the Inverter. Now, C1822 and C1823 have only one discharge path (through R1822 and R1823).

Over-Voltage Stop

The circuit composed of Q1840, Q1846 and associated components provides a means to stop the Inverter if the voltage across the primary of T1860 exceeds a safe level. This voltage can become excessive if the load on the secondary of T1860 is removed or if the normal regulating path through Q1900 and T1831 is inoperative.

The circuit operates as follows:

1. Capacitor C1818 is charged to the peak value of the voltage across the primary of T1860 through CR1848.

2. When the voltage across the primary of T1860 exceeds a safe level, VR1846 conducts through R1847 and the base-emitter junction of Q1840. Transistor Q1840 is turned on and Q1846 fires to hold Q1840 on until C1848 and the voltage across the primary of T1860 have both reached 0 volt.

3. While Q1840 is turned on, it shorts the base winding of Q1844. This holds the voltages on all windings of T1831 at about 0 volt, which stops the Inverter resonant circuit oscillation long enough to stop Inverter operation.

4. After the voltage across C1848 and the Primary of T1860 have dropped to about 0 volt, there is insufficient current to keep Q1846 conducting. Therefore, Q1846 resets. This turns off Q1840 and allows the Start Network to restart the Inverter. If the voltage across the primary of T1860 again becomes excessive, the Over-Voltage Stop circuit will repeat the process. The Inverter circuit can alternately shutdown and start up until the circuit defect is repaired. Often, however, Q1840 shorts from collector to emitter, which prevents the Inverter from restarting.

POWER SUPPLY SECONDARY

The Power Supply Secondary circuit rectifies the AC voltages present in the secondary windings of T1860 to provide the DC voltages necessary for instrument operation. The +15 volt supply is regulated by controlling the amount of power supplied by the Power Supply Primary circuit (see Inverter Regulator discussion). Holding the +15 volt supply constant holds the other supplies fairly constant through the turns-ratio of power transformer T1860.

CRT CIRCUIT

General

The CRT circuit produces the high-voltage potentials and provides the control circuits needed for the operation of the cathode-ray tube (CRT). This circuit also contains the Z-Axis Amplifier. A detailed block diagram of this circuit appears on Fig. 3-16. A schematic of this circuit is shown on diagram 11 at the rear of this manual.

High-Voltage Supply

The High-Voltage Supply is actually part of the Power Supply Secondary circuit but is described here because of its close association with the CRT circuit. Diagram 10, at the rear of this manual, contains the High-Voltage Supply circuit.

A regulated square-wave voltage for operation of the High-Voltage Supply circuit is provided by the high-voltage winding of the power transformer (T1860). This square-wave voltage is regulated by the Power Supply Primary circuit (see Inverter Regulator). The regulated square-wave voltage is connected to the high-voltage multiplier. The high-voltage multiplier consists of three half-wave rectifiers connected as a voltage tripler. The output of the high-voltage multiplier is about 4040 volts. The positive output of the multiplier is connected to the output of the High-Voltage Regulator circuit (about +100 volts). The result of this is that the negative output of the high-voltage multiplier will be about -3940 volts with respect to ground (4040 volts more negative than +100 volts). This -3940 volt supply is connected to the CRT cathode, the focus circuitry, and the input to the High-Voltage Regulator circuit.

High-Voltage Regulator

Changing the current demanded from the high-voltage multiplier will change its voltage output. To compensate for this the High-Voltage Regulator varies the positive output of the high-voltage multiplier by an amount equal, but opposite in polarity, to the change from the positive to the negative terminal of the high-voltage multiplier. The result is that the negative output of the high-voltage multiplier is held fairly constant at -3940 volts with respect to ground.

The High-Voltage Regulator operates as follows:

1. Assume that the current demanded from the high-voltage multiplier increases. This results in a decrease in the output of the high-voltage multiplier (its negative output tries to go more positive).

2. A voltage divider consisting of R1762A and R1762B is connected between the negative output of the high-voltage multiplier and +15 volts. The junction of these divider resistors is connected to the input of the High-Voltage Regulator (pin 3 of U1760). Any change in the output of the high-voltage multiplier is sensed at the input of the High-Voltage Regulator through this voltage divider. In this case a positive-going change is sensed.

3. U1760 is a high-gain operational amplifier. The positive-going change at the positive input of U1760 (pin 3) results in a positive-going change at its output (pin 6 of U1760). This positive-going change is connected to the base of Q1789 through R1784. This causes a negative-going change at the output of the High-Voltage Regulator which is the collector of Q1789. This negative-going change is connected to the positive output of the high-voltage multiplier.

4. Under normal conditions the output of the high-voltage multiplier is about 4040 volts. Since the positive output of the high-voltage multiplier is connected to about +100 volts, the negative output will be about -3940 volts with respect to ground (4040 volts more negative than +100 volts). As the output of the high-voltage multiplier tries to decrease, for example by 10 volts, the negative output of the high-voltage multiplier tries to go to -3930 volts. However, the output of the High-Voltage Regulator will force the positive output of the high-voltage multiplier 10 volts more negative. This holds the negative output of the high-voltage multiplier at -3940 volts with respect to ground (4030 volts more negative than +90 volts).

5. At lower frequencies, Q1780 is a fairly constant current source for Q1789. At higher frequencies, the faster changes on the base of Q1789 are coupled to the base of Q1780 through C1785. Therefore, at higher frequencies, Q1780 and Q1789 operate as a complementary symmetry amplifier.

The output of the High-Voltage Supply is set to -3940 volts by adjusting R1765. This adjusts the quiescent voltage at the input of the High-Voltage Regulator which sets its output to the level needed to reference the negative output of the high-voltage multiplier to -3940 volts with respect to ground.

Filament Supply

The filament voltage for the CRT is supplied from a winding of the power transformer T1860. The output of this winding is a 6.3 volt square-wave elevated to -3940 volts through R1993. Elevating the filament to about the same

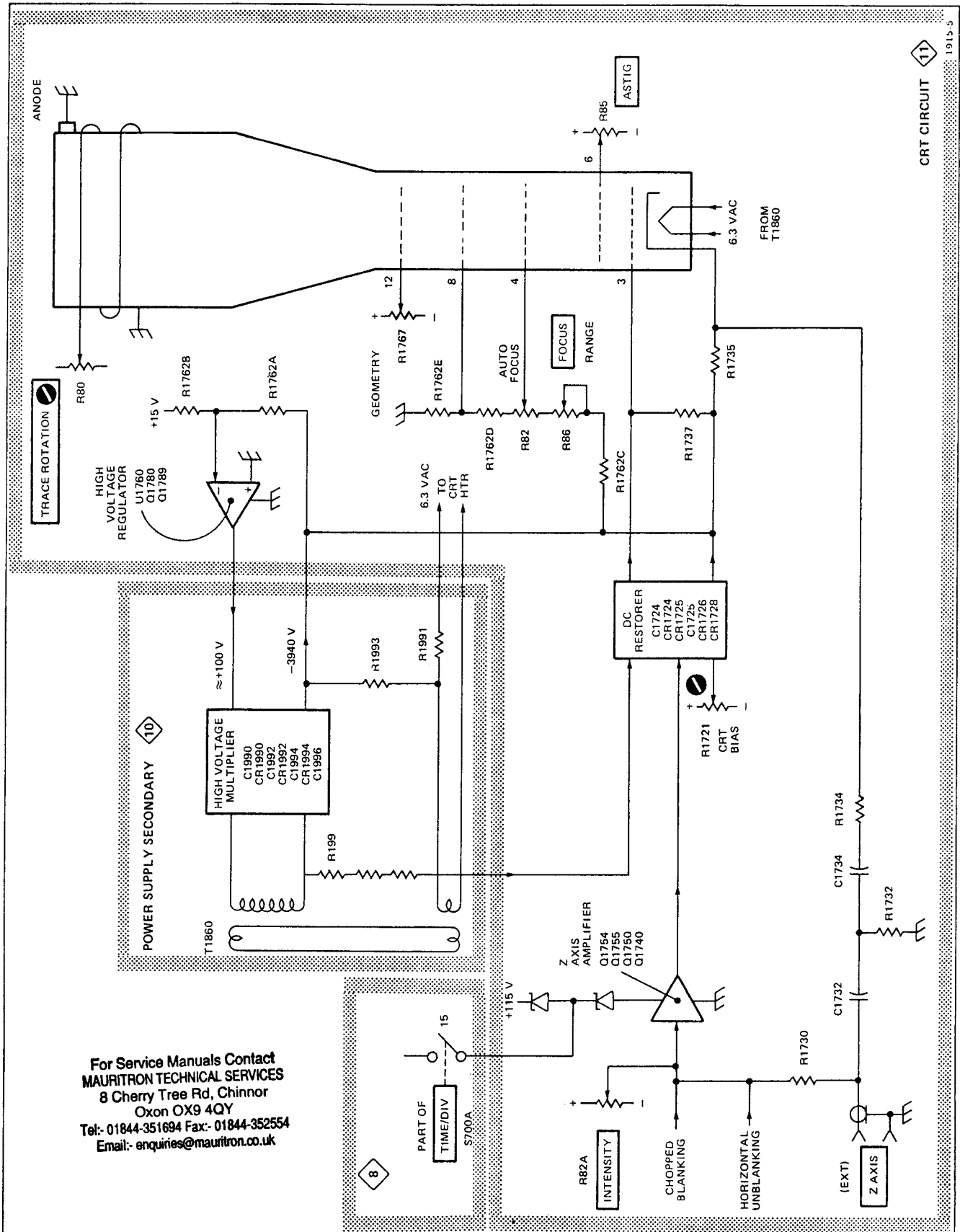

For Service Manuals Contact
MAURITRON TECHNICAL SERVICES
 8 Cherry Tree Rd, Chinnor
 Oxon OX9 4QY
 Tel: 01844-351694 Fax: 01844-352554
 Email: enquiries@maurtron.co.uk

Fig. 3-16. CRT Circuit detailed block diagram.

CRT CIRCUIT

1915-5

Circuit Description—434 (SN B500000 and up)

voltage as the cathode prevents cathode-to-filament breakdown.

Z-Axis Amplifier

The Z-Axis Amplifier circuit controls the CRT intensity level from several inputs. The effect of these input signals is to either increase or decrease the trace intensity, or to completely blank portions of the display. The input transistor (Q1754) is a current-driven, low input impedance amplifier. It provides termination for the input signals as well as isolation between the input signals and the following stages. The current signals from the various control sources are connected to the emitter of Q1754 and the algebraic sum of the signals determines the collector conduction level.

Reducing the input current to Q1754 reduces the display intensity. The collector of Q1754 will go more positive, which reduces the bias on Q1755. The emitter of Q1755 goes more positive, which increases the bias on Q1750. The collector of Q1750 will go more negative. This more negative voltage causes the CRT control grid to go more negative due to the action of the DC Restorer.

At lower frequencies, Q1740 is a fairly constant current source for Q1750. At higher frequencies, the faster changes on the base of Q1750 are coupled to the base of Q1740 through C1742. Therefore, at higher frequencies, Q1740 and Q1750 operate as a complementary symmetry amplifier.

DC Restorer

The DC Restorer takes the low-voltage potentials from the output of the Z-Axis Amplifier and from the CRT bias adjustment and references them to the negative high-voltage on the control grid of the CRT.

The circuit operates as follows:

1. A sample of the square-wave voltage from the high-voltage winding of power transformer T1860 is supplied to the junction of the CR1724 and CR1725 through C1731. This signal is clipped on its positive-going excursions by CR1725 and on its negative-going excursions by CR1724. The levels at which the signal is clipped are determined by the output of the Z-Axis Amplifier (0 to +80 volts) for negative-going excursions and by the voltage set by the CRT bias adjustment (about +80 to +130 volts) for positive-going excursions.

2. This clipped square-wave voltage is coupled through C1725 to CR1726 and CR1728. This voltage then charges C1725 through CR1728 on positive peaks and charges C1724 through CR1726 on negative peaks. The smaller the peak-to-peak amplitude of the clipped square-wave voltage, the smaller will be the difference in the voltages on the high-voltage sides of C1724 and C1725. The smaller this voltage difference, the more positive the voltage on the CRT control grid will be. This results in increased beam current and a brighter display.

3. The action of the DC Restorer is fairly slow. Abrupt changes in the output of the Z-Axis Amplifier are coupled through C1724 to the control grid of the CRT. This provides abrupt intensity changes but cannot maintain a given intensity level, because the charge on C1724 will change due to the currents available through R1737 and from the CRT grid. The abrupt intensity change provided by the signal coupled through C1724 is combined with the sustained intensity change provided by the DC Restorer to provide a uniform intensity across the entire displayed trace.

CRT Controls

Focus of the CRT display is provided by Focus control R82B. This control is part of the voltage divider composed of R1762B, R1762A, R1762C, R86, the parallel combination of R83 and R82B, R1762D, and R1762E. This voltage divider is connected between the negative high-voltage supply and ground. Therefore, the voltage applied to the Focus grid is less negative (more positive) than the voltage on either the control grid or cathode. The Focus control is ganged with the front-panel INTENSITY control, and is automatically adjusted as the setting of the INTENSITY control is changed. Front-panel screwdriver adjustment R86 sets the range of adjustment of the focus control. The ASTIG adjustment R85 is a rear-panel screwdriver adjustment, which is adjusted to obtain optimum definition of the CRT display at specific settings of the INTENSITY control. Geometry adjustment R1767 varies the positive voltage level on the horizontal deflection plate shield to control the overall geometry of the display. The TRACE ROTATION adjustment R80 is a rear-panel screwdriver adjustment. Changing the TRACE ROTATION adjustment changes the amount of current through L100, which varies the magnetic field around the CRT to correctly align the CRT display with the graticule lines.

CALIBRATOR

General

The Calibrator circuit produces a square-wave output with accurate amplitude and frequency. This output is available as a square-wave voltage at the PROBE CAL 0.6 V 1 kHz connector. Fig. 3-17 shows a detailed block diagram

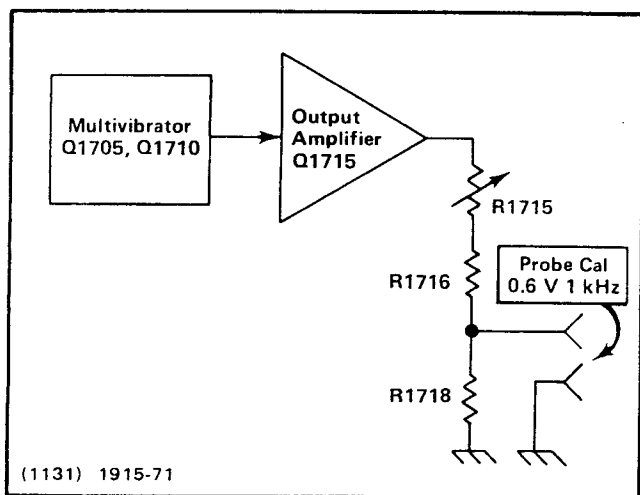

Fig. 3-17. Calibrator detailed block diagram.

of the Calibrator circuit. A schematic of this circuit is shown on diagram 11 at the back of this manual.

Multivibrator

Q1705 and Q1710 along with their associated circuitry comprise an astable multivibrator. Basic frequency of the multivibrator is determined by the RC combination of R1706, R1710, and C1706. R1704 provides a measure of adjustment of calibrator frequency.

In the Calibrator Multivibrator, Q1705 and Q1710 are never both conducting at the same time. Assume for purposes of explanation that Q1705 has just turned off and Q1710 has turned on. When Q1705 turns off, its collector moves positive, which also pulls the base of Q1710 positive. This positive movement turns Q1710 on and charges C1706 positive. Immediately, the emitter of Q1705 begins to discharge toward -15 volts. When the Q1705 side of C1706 has discharged sufficiently to forward bias the base-emitter junction of Q1705, Q1705 turns on and its collector moves negative. The negative movement at the collector of Q1705 turns off Q1710. Now the emitter circuit of Q1710 begins to discharge toward -15 volts. When the Q1710 side of C1706 has discharged sufficiently to forward bias the base-emitter junction of Q1710, Q1710 turns on. At the time Q1710 turns on, a positive movement is coupled from the emitter of Q1710 to the emitter of Q1705 by C1706. This positive movement at the emitter of Q1705 reduces the current flow through Q1705, causing a reinforcing positive movement at the base of Q1710. Q1705 rapidly turns off as Q1710 turns on. The square wave signal at the collector of Q1710 is connected to the Output Amplifier.

Output Amplifier

The output signal from the Calibrator Multivibrator stage overdrives Q1715 to produce an accurate square wave at the output. When the base of Q1715 goes positive, Q1705 is cut off and the output signal drops to 0 volt. When the base goes negative, Q1715 is driven into saturation and the collector of Q1715 rises to about $+15$ volts. The output voltage is connected from the voltage divider R1715-R1716-R1718 to the PROBE CAL 0.6 V 1 kHz connector. R1715 adjusts the overall ratio of the voltage divider to provide an accurate output voltage amplitude.

STORAGE CIRCUIT

The Storage Circuit provides the voltage levels necessary to operate the flood guns, collimation electrodes and target backplates. The storage cathode-ray tube has two targets for split-screen operation; therefore, two identical erase generators are provided, each consisting of an Erase Multivibrator and a Target Control Amplifier. These circuits produce an erase waveform which will erase written information. Additional circuitry includes the Enhance Generator, which permits very fast single sweeps to be stored, and the INTEGRATE switch, which permits a stored image of a number of repetitive sweeps, each of which would be too fast to store alone as a single sweep event. Fig. 3-18 shows a detailed block diagram of the Storage circuit.

Storage Tube Basic Operating Principles

The CRT used in the 434 is a direct-view storage cathode ray tube with a split screen viewing area that permits each half to be individually operated for stored displays. Storage, which is the retention on the CRT screen of a displayed event, is based on a secondary emission principle. A stream of primary electrons strikes an insulated target surface with sufficient energy to dislodge secondary electrons. As the potential increases, each primary electron dislodges more than one secondary electron, resulting in the target material charging positive. The target approaches the backplate potential, yielding a higher energy flood electron and resulting in light output.

The storage cathode ray tube contains special storage elements in addition to the conventional writing gun elements. The operating mode of the tube depends primarily on the voltages applied to these storage electrodes. With one condition of applied potentials, the storage screen or target backplate operates in the ready-to-write state; then, when it is bombarded with high energy writing beam current, the bombarded portion shifts to the stored mode to store a written display. With a different set

For Service Manuals Contact
 MAURITRON TECHNICAL SERVICES
 8 Cherry Tree Rd, Chinnor
 Oxon OX9 4QY
 Tel: 01844-351694 Fax: 01844-352554
 Email: enquiries@maurtron.co.uk

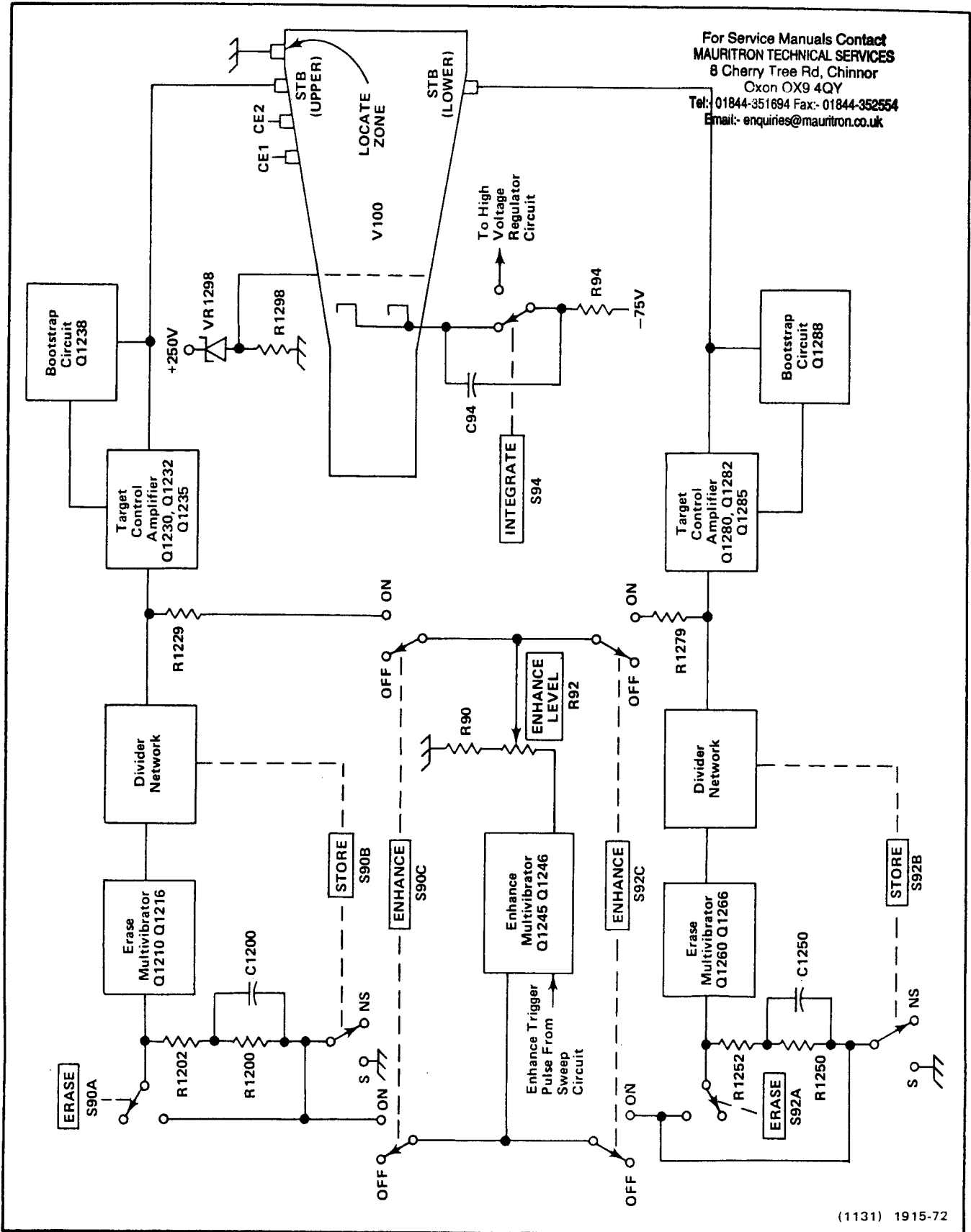

(1131) 1915-72

Fig. 3-18. Storage circuit detailed block diagram.

of applied voltages, the screen (target) operates in the conventional mode, similar to a conventional cathode ray tube.

The storage screens contain a special coated surface which continues to emit light when bombarded by the flood gun electrons, provided the surface has been written by the writing gun beam and shifted to the stored state. The two targets are electrically isolated from each other, which allows simultaneous presentations of stored information on one half and non-store (conventional) information on the other half of the viewing area.

Fig. 3-19 illustrates the basic construction of the 434 storage tube. The flood guns are low-energy electron guns which direct a large area flow, or cones, of electrons toward the entire screen. The collimation electrodes shape the flood spray for uniform coverage of the storage targets. The operating level of the tube is the potential difference between the target backplates and the flood gun cathodes. The collimation electrodes have no effect on the bombarding energy of the flood gun electrons.

In the store mode ready-to-write state, the insulator surface of the target tends to charge down to a potential lower than the backplate potential, and toward the potential of the flood gun cathode. This is due to flood gun current from the insulator surface. The potential to which the target

charges is called its rest potential. This potential is such that the flood gun electron landing energy is not enough to illuminate the phosphor in the target. The target is now ready to write. See Fig. 3-20.

In the writing process, the target is scanned by the writing gun electrons. These high energy electrons increase the target secondary emission over the area they scan, so that the ratio of secondary current to primary current becomes greater than one. (This is shown in Fig. 3-20 as the first crossover point.) When this ratio exceeds one, that part of the bombarded surface shifts to a new stable state. Writing has been accomplished and this segment of the target is now stored.

In the written state, the potential difference between the flood gun cathode and target becomes greater and the flood gun electrons now have a landing energy that is sufficient to provide a visual display. This visual display will continue as long as the flood gun beam covers the target.

At high sweep rates, the writing beam current is not adequate to bring the portion of the target scanned above the crossover point; therefore, the flood gun electrons when landing on the bombarded area will remove the charge developed by the writing gun electrons, and the target will discharge to its initial ready-to-write state without being

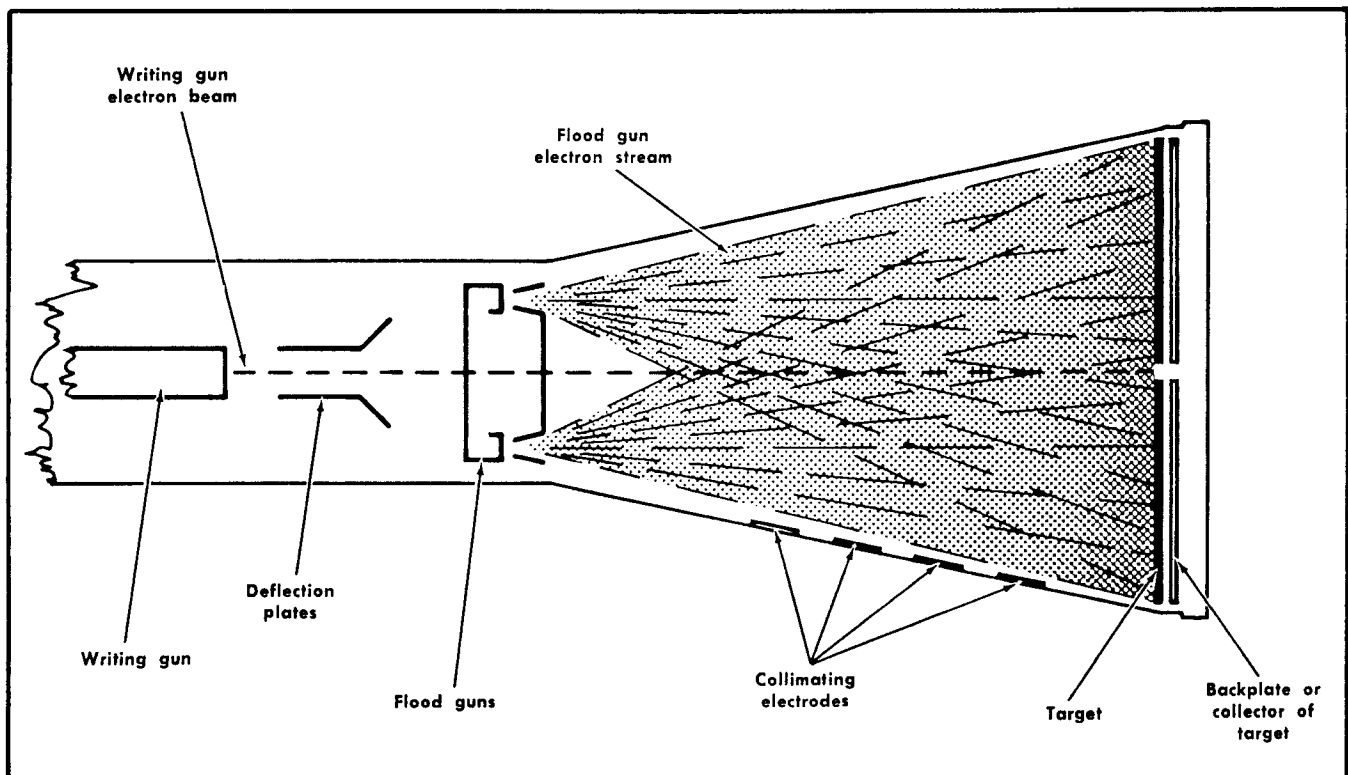

Fig. 3-19. Pictorial diagram of storage tube CRT.

Circuit Description—434 (SN B500000 and up)

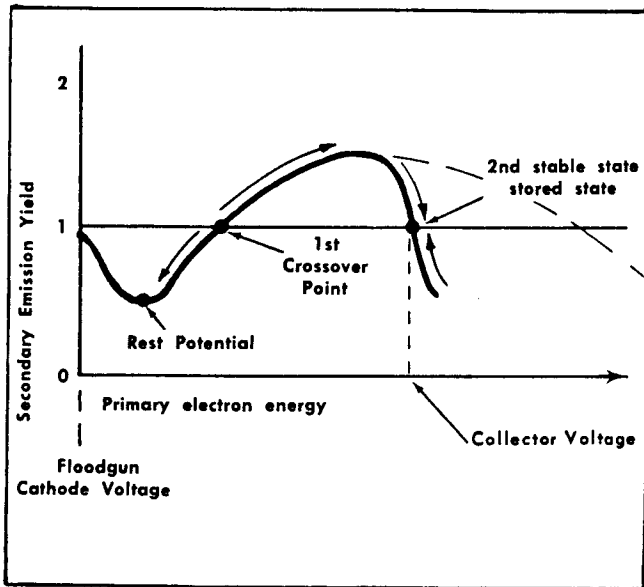

Fig. 3-20. Secondary emission curve.

written. Thus, complete writing is a function of writing beam current density.

When the stored display is no longer desired, the information is erased by a waveform as illustrated in Fig. 3-21. A positive-going pulse is first applied, to raise the backplate voltage above the writing threshold and write the entire target area with flood gun electrons. Next, the backplate voltage is pulled well below the rest potential,

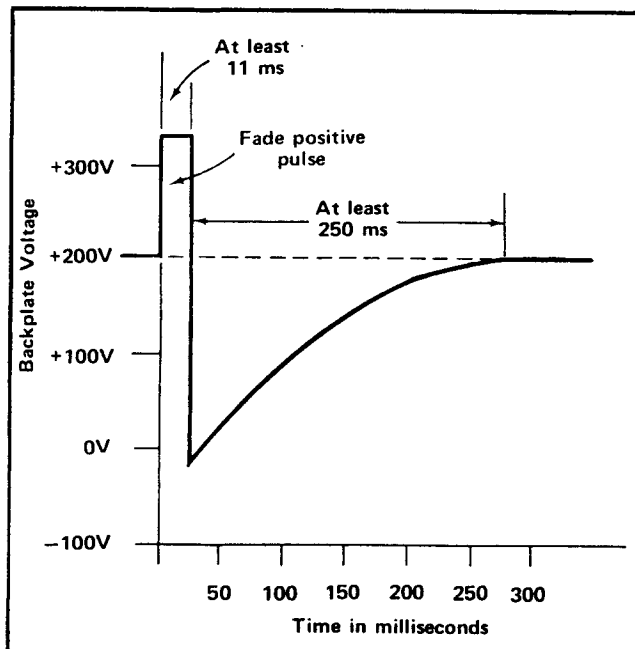

Fig. 3-21. Typical erase cycle waveform.

then as the backplate voltage is gradually returned, the target is charged to the rest potential and the target is in the ready-to-write state.

Flood Guns and Collimation Electrodes

Two low-energy electron guns, or flood guns, are used in the 434. The cathodes are returned to -75 volts through INTEGRATE switch S94 and R94. R1298 and VR1298 set the level of the flood-gun control grid at approximately $+140$ volts.

The collimation electrodes serve as an electrostatic lens to distribute the flood gun electrons uniformly over the storage target, and they have no effect on the landing energy of the electrons. R1295 determines the voltage levels of CE1 and CE2 through emitter followers Q1294 and Q1296 respectively.

Target Control Amplifiers

The Target Control Amplifiers are incorporated to maintain a high degree of control of the upper and lower storage backplate voltages. These are emitter-follower feedback amplifiers consisting of Q1230, Q1232, and Q1235 for the upper target backplate and Q1280, Q1282, and Q1285 for the lower target backplate. A bootstrapping circuit is provided for each Target Control Amplifier to maintain transistor operating voltage during the positive-going portion of the erase waveform (fade positive). The bootstrapping circuits will be described in full detail in the Erase Generator discussion.

A separate STORE switch is provided for each Target Control Amplifier, S90B (upper) and S92B (lower), allowing the target backplates to be operated individually. In the STORE mode, that is, when the STORE buttons are pushed in and the CRT is shifted to the ready-to-write state, the backplate voltages are adjusted individually by the Store Level controls, R1226 and R1276. These adjustments set the value of current to the feedback amplifier null points (Q1230 and Q1280 emitters). In the non-store, or conventional mode, the backplate voltages are established by adjustment of the Non-Store Level adjustments R1224 and R1274.

Erase Generator

NOTE

The following description applies to both erase generators; however, the circuit numbers used are those of the upper circuit.

In order to erase the stored display, a fade-positive pulse is first applied to the storage target backplate. This increases the potential difference between the flood gun cathodes and target backplate, raising the operating level above the upper writing limit and writing the entire target area with flood gun electrons. Next, the backplate voltage is pulled negative, well below the retention threshold. Then as the backplate is gradually returned, the target is charged to the rest potential and returned to the ready-to-write state. The following paragraphs describe how the erase waveform is generated.

The Erase Multivibrator is composed of Q1210, Q1216, and their associated circuitry. This is a monostable multivibrator with Q1210 quiescently saturated and Q1216 biased off. The collector of Q1216 is clamped slightly above ground by the conduction of CR1219. C1214 is charged to the voltage difference between the junction of R1214-R1212 and the collector level of Q1216.

When the ERASE button is pushed, the contacts of S90A are closed, grounding R1203. This produces a negative-going step which turns Q1210 off and Q1216 on. The collector of Q1216 moves down very close to -15 volts as the transistor saturates and conducts current through R1218 and R1239. The output of the feedback amplifier steps positive pulling the target backplate with it. This increases the operating level of the CRT and the entire target area is written.

When Q1216 turns on, the negative-going step produced at its collector is also coupled through C1214, which turns CR1212 off, ensuring cutoff of Q1210. C1214 begins to discharge through R1214, and after an RC-controlled period of time the current through R1214 has diminished sufficiently to allow the voltage at the anode of CR1212 to rise above the turn-on level. The base of Q1210 is also raised to the turn-on level, and the multivibrator is switched back to its quiescent state.

While Q1216 is conducting, the charge on C1219 is removed. When Q1216 turns off, its collector rises rapidly and is clamped slightly above ground by CR1219. This produces a positive-going step which is coupled through C1219, reverse biasing CR1220. This positive movement is applied to the input of the feedback amplifier, causing the output to step sharply negative well below the rest poten-

tial. As C1219 charges, the voltage at the junction of R1220-R1222 decays at an RC-controlled rate until CR1220 turns on and clamps it at about -15.5 volts. This negative-going sawtooth voltage is applied to the feedback amplifier, which produces a positive-going sawtooth at its output to raise the backplate to the ready-to-write state.

When the CRT is shifted from the conventional mode to the store mode, pushing the store button grounds C1200, which produces a negative trigger to switch the Erase Multivibrator to prepare the target for storage by applying an erase waveform. Bootstrapping maintains operating voltage for Q1232 and Q1235 during the fade-positive portion of the erase waveform when the emitter of Q1235 is pulled positive. The voltage drop across zener diode VR1236 sets the base of Q1238 approximately 120 volts below the emitter of Q1235. This voltage drop is kept constant under dynamic conditions by the essentially constant current established through R1236, which is clamped by the Q1238 forward bias voltage. When the emitter of Q1235 is suddenly stepped positive by the erase waveform, the base of Q1238 is stepped positive by the same amplitude. Q1238 emitter follows the base, and the positive-going step is coupled through C1235 to raise the collector of Q1235 positive by essentially the same amplitude as that at its emitter, thus maintaining a fairly constant collector-to-emitter voltage. This action reverse biases CR1235, temporarily disconnecting the $+250$ -volt supply. When the fade positive pulse is terminated and the emitter of Q1235 is pulled negative, CR1237 turns off, disconnecting the bootstrap circuit and allowing the collector of Q1235 to return to its $+250$ -volt level.

Enhance Generator

Writing speed is primarily a function of the writing gun beam current density and physical properties of the storage tube. At very fast sweep speeds, the writing beam does not charge the scanned portion of the target sufficiently to shift it to the stored state, and the flood gun electrons discharge the small deposited charge back down to the rest potential before the next sweep.

Writing beyond the normal writing speed of the CRT is attained through the process of enhancement or integration. First to be discussed will be enhancement.

The enhance generator produces an approximate two-millisecond negative-going pulse which is applied to the feedback amplifier summing point, resulting in a positive-going pulse to the target backplate. This conditions the target so that less writing gun current is required to shift the scanned section to the stored state.

Q1245, Q1246, and their associated circuitry form a monostable multivibrator. Operation of this circuit is similar

Circuit Description—434 (SN B500000 and up)

to that described for the Erase Multivibrator. When either ENHANCE switch (S90C or S92C) is pushed in, Q1245 has a conduction path to ground through R1245. Q1245 saturates and the low voltage-level at the collector of Q1245 keeps Q1246 turned off. The negative-going portion of the Enhance Trigger pulse from the Sweep circuit is coupled through C1240 to switch the Enhance Multivibrator. Q1245 turns off and Q1246 turns on. The collector of Q1246 snaps down to about -15 volts producing a negative-going step which is coupled through C1246, and turns off Q1245. The length of time that the multivibrator remains in this state, and thus the pulse width, is determined by the values of R1244 and C1246. The setting of the ENHANCE LEVEL control, R92, determines the amplitude of the pulse which is applied to the feedback amplifier summing point.

Integrate

The second fast writing technique to be discussed is integration. In this mode of operation, the flood gun beam is interrupted momentarily, allowing the writing gun beam to sum small amounts of charge for successive sweeps so that when the flood electrons are again turned on, the scanned target area shifts to the stored state. This is accomplished by pressing the INTEGRATE switch, S94, which disconnects the flood gun cathodes. This also connects -75 volts to the error signal input terminal of the high-voltage regulator circuit through R1760 to shift the high voltage slightly, correcting for the deflection sensitivity changes that occur when the flood guns are turned off. Releasing the INTEGRATE switch, then, allows the display to shift to the stored state.

For Service Manuals Contact
MAURITRON TECHNICAL SERVICES
8 Cherry Tree Rd, Chinnor
Oxon OX9 4QY
Tel:- 01844-351694 Fax:- 01844-352554
Email:- enquiries@mauritron.co.uk

MAINTENANCE

Introduction

This section of the manual contains maintenance information for use in preventive maintenance, corrective maintenance or troubleshooting of the 434.

Cabinet Removal

WARNING

Dangerous potentials exist at several points throughout the instrument. When the instrument is operated with the covers removed, do not touch exposed connections or components. Because the discharge is slow, dangerous potentials will exist across capacitors C1822 and C1823 and associated components for several minutes after the POWER switch is turned off. Lamp DS1824 will continue to blink, after the POWER switch is turned off, until the voltage across C1822 and C1823 drops to about 100 volts. Disconnect power before cleaning the instrument or replacing parts.

The cabinet can be removed from the oscilloscope as follows:

1. Unwrap the power cord from the instrument feet.
2. Loosen the phillips-head screw located in each instrument foot. See Fig. 4-1.
3. Remove the rear ring assembly from the rear of the instrument.
4. Slide the cabinet to the rear and remove the oscilloscope.

The R434 can be removed from its cabinet in a similar manner. To replace the instrument in its wrap-around cabinet, reverse the removal procedure. The portable wrap-around cabinet should be installed with the carrying handle pivot points positioned toward the bottom of the instrument.

PREVENTIVE MAINTENANCE

General

Preventive maintenance consists of cleaning, visual inspection, lubrication, etc. Preventive maintenance

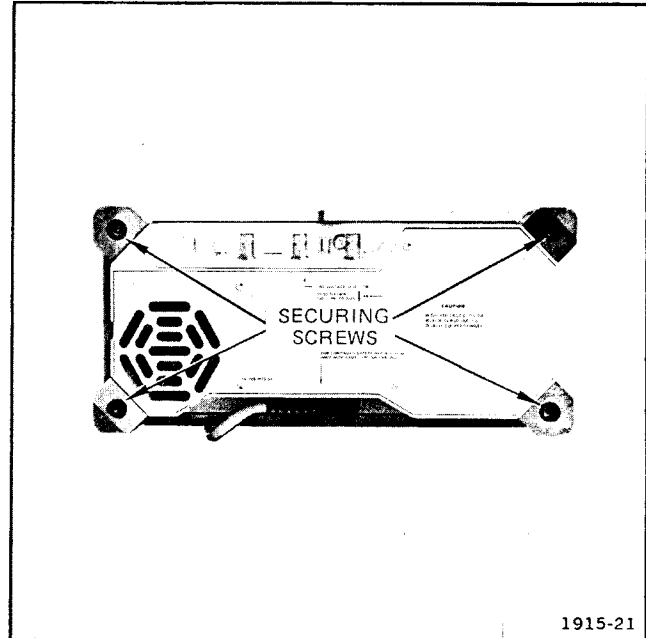

Fig. 4-1. Removing wrap-around cabinet.

performed on a regular basis may prevent instrument breakdown and will improve the reliability of this instrument. The severity of the environment to which the 434 is subjected determines the frequency of maintenance. A convenient time to perform preventive maintenance is preceding recalibration of the instrument.

Cleaning

General. The 434 should be cleaned as often as operating conditions require. Accumulation of dirt in the instrument can cause overheating and component breakdown. Dirt on components acts as an insulating blanket and prevents efficient heat dissipation. It also provides an electrical conduction path which may result in instrument failure.

The cabinet provides protection against dust in the interior of the instrument. Operation without the cabinet in place necessitates more frequent cleaning. The front cover provides dust protection for the front panel and the CRT face. The front cover should be installed for storage or transportation.

CAUTION

Avoid the use of chemical cleaning agents which might damage the plastics used in this instrument. Avoid chemicals which contain benzene, toluene, xylene, acetone or similar solvents.

Exterior. Loose dust accumulated on the outside of the 434 can be removed with a soft cloth or small paint brush. The paint brush is particularly useful for dislodging dirt on and around the front-panel controls. Dirt which remains can be removed with a soft cloth dampened in a mild detergent and water solution. Abrasive cleaners should not be used.

CRT. Clean the blue plastic light filter and the CRT face with a soft, lint-free cloth dampened with denatured alcohol or a mild detergent and water solution. The optional CRT mesh filter can be cleaned in the following manner.

1. Hold the filter in a vertical position and brush lightly with a soft No. 7 watercolor brush to remove light coatings of dust and lint.
2. Greasy residues or dried-on dirt can be removed with a solution of warm water and a neutral pH liquid detergent. Use the brush to lightly scrub the filter.
3. Rinse the filter thoroughly in clean water and allow to air dry.
4. If any lint or dirt remains, use clean low-pressure air to remove. Do not use tweezers or other hard cleaning tools on the filter, as the special finish may be damaged.
5. When not in use, store the mesh filter in a lint-free dust-proof container such as a plastic bag.

Interior. Dust in the interior of the instrument should be removed occasionally due to its electrical conductivity under high-humidity conditions. The best way to clean the interior is to blow off the accumulated dust with dry, low-pressure air. Remove any dirt which remains with a soft paint brush or a cloth dampened with a mild detergent and

water solution. A cotton-tipped applicator is useful for cleaning in narrow spaces or for cleaning circuit boards.

Lubrication

The potentiometers, cam switches and pushbutton switches used in this instrument are factory lubricated and should not require further lubrication for the normal life of the components.

Transistor Checks

Periodic checks of the transistors in the 434 are not recommended. The best check of transistor performance is actual operation in the instrument. More details on checking transistor operation are given under Troubleshooting.

Recalibration

To assure accurate measurements, check the calibration of this instrument after each 1000 hours of operation or every six months if used infrequently. In addition, replacement of components may necessitate recalibration of the affected circuits. Complete calibration instructions are given in the Calibration section.

The calibration procedure can also be helpful in localizing certain troubles in the instrument. In some cases, minor troubles may be revealed and/or corrected by recalibration.

TROUBLESHOOTING

Introduction

The following information is provided to facilitate troubleshooting of the 434. Information contained in other sections should be used along with the following information to aid in locating the defective component. An understanding of the circuit operation is very helpful in locating troubles. See the Circuit Description section for complete information.

Troubleshooting Aids

Diagrams. Complete circuit diagrams are given on fold-out pages in the Diagrams section. The component number and electrical value of each component in this instrument are shown on the diagrams. Important voltages and waveforms are also shown on the diagrams. The portions of the circuit mounted on the circuit boards are enclosed with a blue line.

Circuit Boards. Figs. 8-1 through 8-23 in the Diagrams section show the circuit boards used in the 434. Fig. 4-5 shows the location of each board within the instrument. Each electrical component on the boards is identified by its circuit number. These pictures, used along with the diagrams, aid in locating the components mounted on the circuit boards.

Wiring Color-Code. All insulated wire and cable used in the 434 is color-coded to facilitate circuit tracing. Table 4-1 gives the wiring color-code for the power-supply voltages used in this instrument.

TABLE 4-1
Power Supply Wiring Color Code

Supply	Background Color	Stripe
-15 volt	Purple	Black
+15 volt	Red	Black
+115 volt	Red	Brown
+250 volt	Red	Orange

Resistor Color-Code. In addition to the brown composition resistors, metal-film resistors and some wire-wound resistors are used in the 434. The resistance of a wire-wound resistor is printed on the body of the component. The resistance values of composition resistors and metal-film resistors are color-coded on the components with EIA color-code (some metal-film resistors may have the value printed on the body). The color-code is read starting with the stripe nearest the end of the resistor. Composition resistors have four stripes which consist of two significant figures, a multiplier and a tolerance value (see Fig. 4-2). Metal-film resistors have five stripes consisting of three significant figures, a multiplier and a tolerance value.

Capacitor Marking. The capacitance values of common disc capacitors and small electrolytics are marked in microfarads on the side of the component body. The white ceramic capacitors used in the 434 are color coded in picofarads using a modified EIA code (see Fig. 4-2).

Diode Color-Code. The cathode end of each glass-encased diode is indicated by a stripe, a series of stripes or a dot. For most silicon or germanium diodes with a series of stripes, the color-code identifies the three significant digits

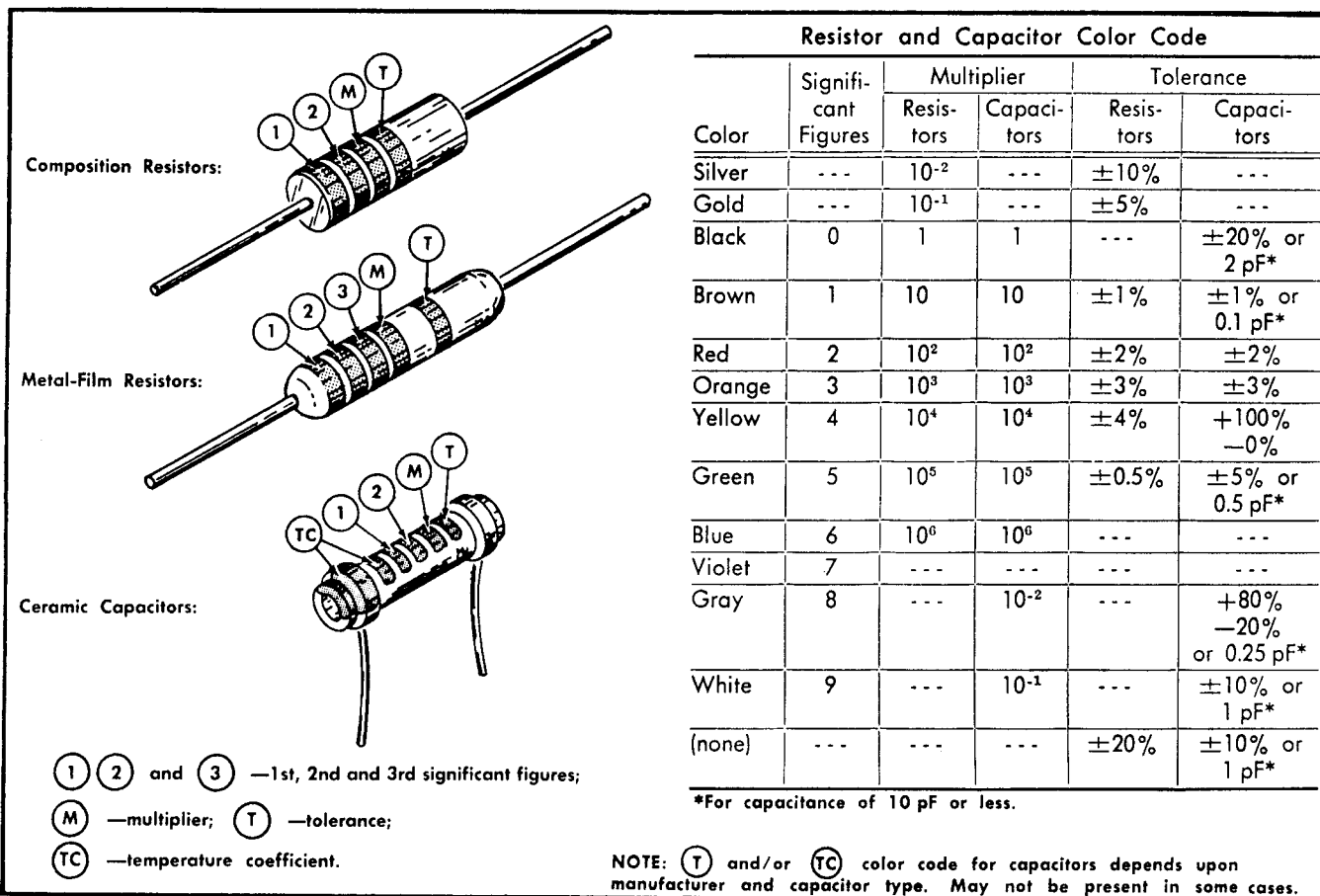

Fig. 4-2. Color-code resistors and ceramic capacitors.

Maintenance—434 (SN B50000 and up)

of the Tektronix Part Number using the resistor color-code system (e.g., a diode color-coded pink or blue-brown-gray-green indicates Tektronix Part Number 152-0185-00). The cathode and anode ends of a metal-encased diode can be identified by the diode symbol marked on the body. See Fig. 4-3.

Semiconductor Lead Configuration. Fig. 4-4 shows the lead configurations of the semiconductors used in this instrument. This view is as seen from the bottom of the device.

Troubleshooting Equipment

The following equipment is useful for troubleshooting the 434.

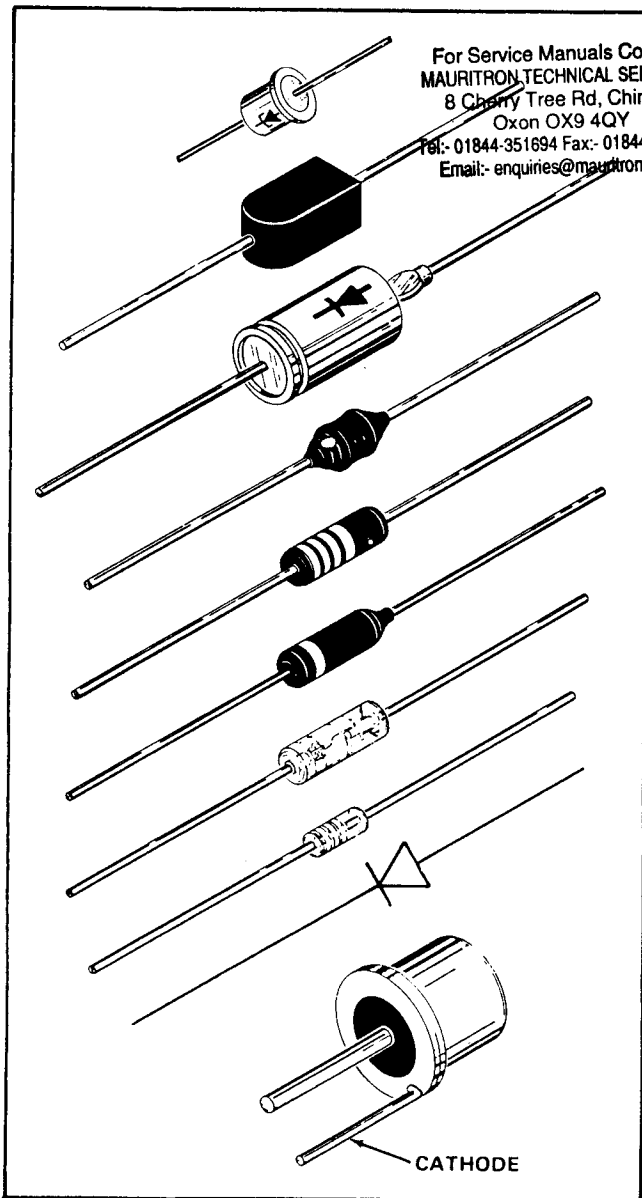

Fig. 4-3. Diode polarity markings.

1. Transistor Tester

Description: Tektronix Type 576 Transistor-Curve Trace or equivalent.

Purpose: To test semiconductors used in this instrument.

2. Multimeter

Description: VTVM, 10 megohm input impedance, 0 to 5000 volts DC and 0 to 300 volts AC range; ohmmeter, 5 ohms to 500 K ohms center scale. Accuracy, within 3%. Test probes must be insulated to prevent accidental shorting.

NOTE

A 20,000 ohms/volt VOM can be used to check the voltages in this instrument if allowances are made for the circuit loading of the VOM at high-impedance points.

Purpose: To check voltages and for general troubleshooting in this instrument.

3. Test Oscilloscope

Description: DC to 25 MHz frequency response, one millivolt to five volts/division deflection factor. A 10X probe should be used to reduce circuit loading.

Purpose: To check waveforms in this instrument.

4. Isolation Transformer

Description: Primary to secondary ratio of 1:1; 100 watt capacity and at least 600 V primary to secondary insulation.

Purpose: To isolate power input of the instrument from ground for personnel safety and to allow grounding points in the internal power supply for troubleshooting purposes.

Troubleshooting Techniques

This troubleshooting procedure is arranged in an order which checks the simple trouble possibilities before proceeding with extensive troubleshooting. The first few checks assure proper connection, operation and calibration. If the trouble is not located by these checks, the remaining steps aid in locating the defective component. When the defective component is located, it should be replaced following the replacement procedures given under Corrective Maintenance.

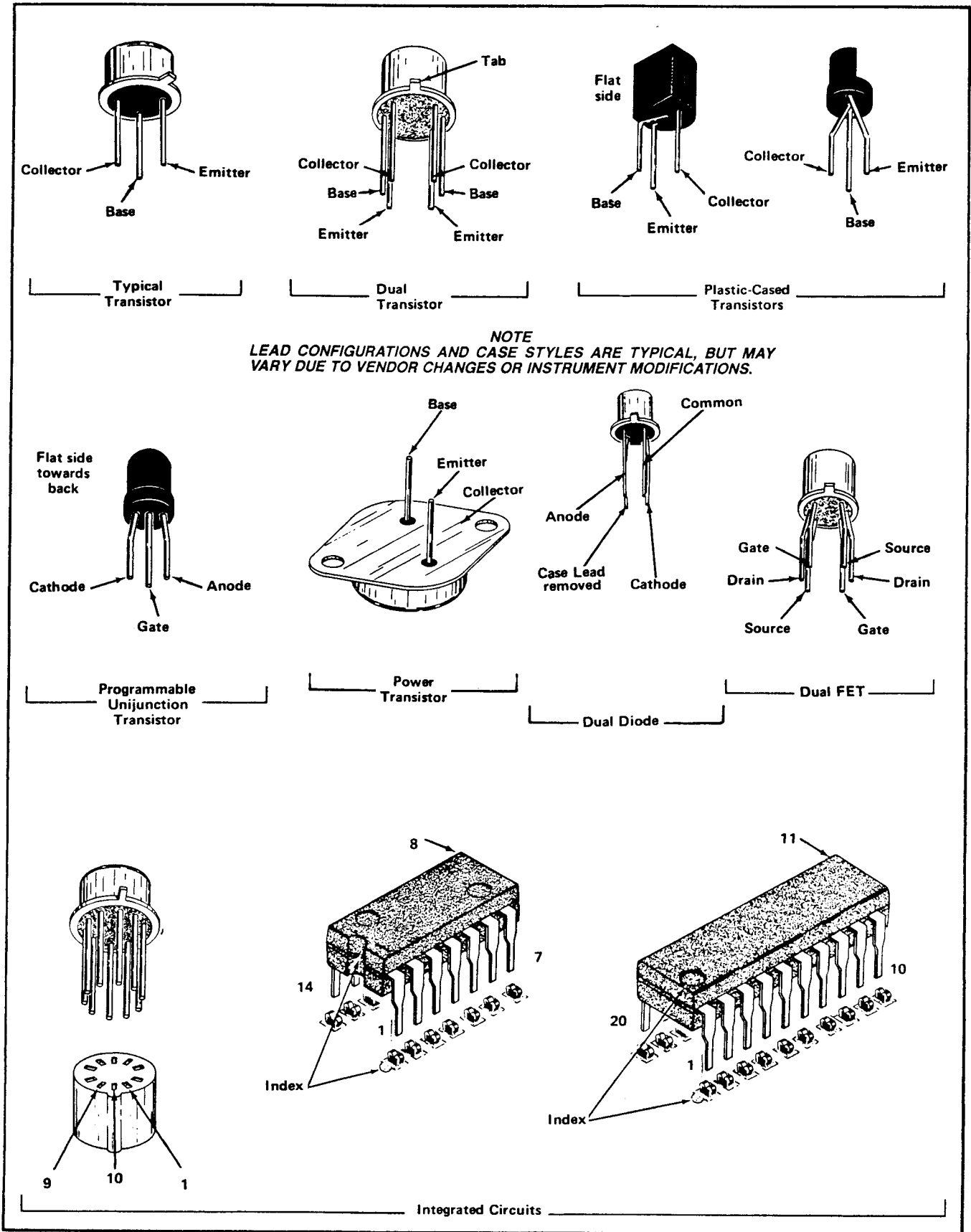
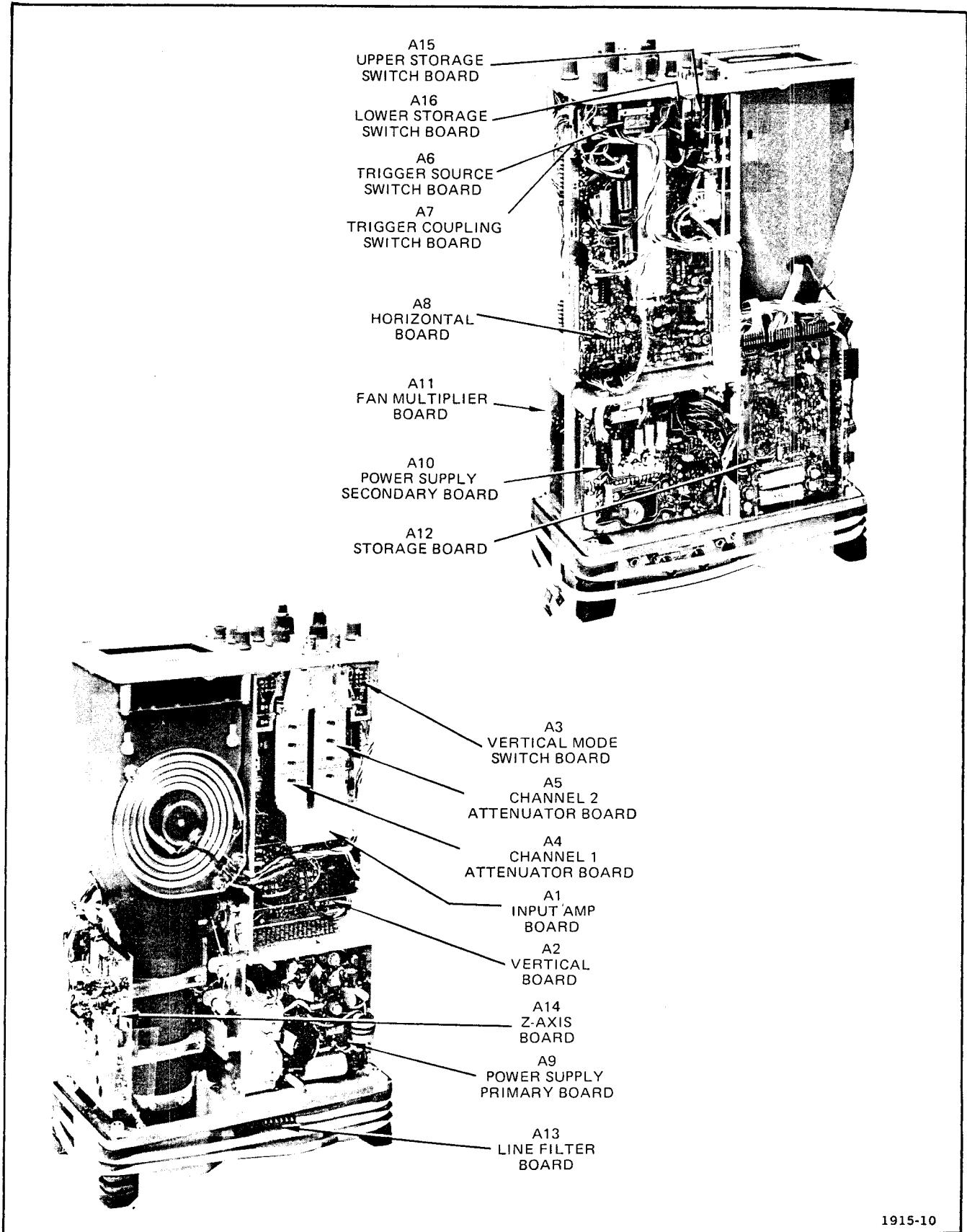

Fig. 4-4. Electrode configuration for semiconductors used in this instrument.



1915-10

Fig. 4-5. 434 circuit board locations.

1. Check Control Settings. Incorrect control settings can indicate a trouble that does not exist. If there is any question about the correct function or operation of any control, see the Operating Instructions section.

2. Check Associated Equipment. Before proceeding with troubleshooting of the 434, check that the equipment used with this instrument is operating correctly. Check that the signal is properly connected and that the interconnecting cables are not defective. Also, check the power source.

3. Visual Check. Visually check the portion of the instrument in which the trouble is located. Many troubles can be located by visual indications such as unsoldered connections, broken wires, damaged circuit boards, damaged components, etc.

4. Check Instrument Calibration. Check the calibration of this instrument, or the affected circuit if the trouble appears in one circuit. The apparent trouble may only be a result of misadjustment or may be corrected by calibration. Complete calibration instructions are given in the Calibration section.

5. Isolate Trouble to a Circuit. To isolate trouble to a circuit, note the trouble symptom. The symptom often identifies the circuit in which the trouble is located. For example, poor focus indicates that the CRT circuit (includes high voltage) is probably at fault. When trouble symptoms appear in more than one circuit, check affected circuits by taking voltage and waveform readings.

Incorrect operation of all circuits often indicates trouble in the power supply. Check first for correct voltage of the individual supplies. However, a defective component elsewhere in the instrument can appear as a power-supply trouble and may also affect the operation of other circuits. Table 4-2 lists the tolerances of the power supplies in this instrument. If a power-supply voltage is within the listed

tolerance, the supply can be assumed to be working correctly. If outside the tolerance, the supply may be misadjusted or operating incorrectly. Use the procedure given in the Calibration section to adjust the power supplies.

After the defective circuit has been located, proceed with steps 6 through 8 to locate the defective component(s).

6. Check Circuit Board Interconnections. After the trouble has been isolated to a particular circuit, check the pin connectors on the circuit board for correct connection. Figs. 8-1 through 8-23 show the correct connections for each board.

The pin connectors used in this instrument also provide a convenient means of circuit isolation. For example, a short in a power supply can be isolated to the power supply itself by disconnecting the pin connectors for that voltage at the remaining boards.

7. Check Voltages and Waveforms. Often the defective component can be located by checking for the correct voltage or waveform in the circuit. Typical voltages and waveforms are given on the diagrams.

NOTE

Voltages and waveforms given on the diagrams are not absolute and may vary slightly between instruments. To obtain operating conditions similar to those used to take these readings, see the first diagram page.

8. Check Individual Components. The following procedures described methods of checking individual components in the 434. Components which are soldered in place are best checked by disconnecting one end. This isolates the measurement from the effects of surrounding circuitry.

A. TRANSISTORS. The best check of transistor operation is actual performance under operating conditions. If a transistor is suspected of being defective, it can best be checked by substituting a new component or one which has been checked previously. However, be sure that circuit conditions are not such that a replacement transistor might also be damaged. If substitute transistors are not available, use a dynamic tester (such as Tektronix Type 576). Static-type testers are not recommended, since they do not check operation under simulated operating conditions.

TABLE 4-2

Power Supply Tolerance and Ripple

Power Supply	Tolerance	Maximum Ripple (Peak-to-peak)	
		Line Frequency	25 Kilohertz
+15 volt	Within 0.113 volt	10 mV	40 mV
-15 volt	Within 0.225 volt	10 mV	40 mV
+115 volt	Within 4.6 volts	0.5 volt	0.5 volt
+250 volt	-10 V to +12.5 V	1 volt	1 volt
-75 volt	Within 2.25 volts	1 volt	1 volt

WARNING

Turn off the POWER switch before removing or replacing transistors.

B. DIODES. A diode can be checked for an open or for a short circuit by measuring the resistance between terminals with an ohmmeter set to the R X 1k scale. The diode resistance should be very high in one direction and very low when the meter leads are reversed. Do not check tunnel diodes or back diodes with an ohmmeter.

CAUTION

Do not use an ohmmeter scale that has a high internal current. High currents may damage the diode. Do not measure tunnel diodes with an ohmmeter; use a dynamic tester (such as a Tektronix Type 576 Transistor-Curve Tracer).

C. RESISTORS. Check the resistors with an ohmmeter. See the Electrical Parts List for the tolerance of the resistors used in this instrument. Resistors normally do not need to be replaced unless the measured value varies widely from the specified value.

D. INDUCTORS. Check for open inductors by checking continuity with an ohmmeter. Shorted or partially shorted inductors can usually be found by checking the waveform response when high frequency signals are passed through the circuit. Partial shorting often reduces high-frequency response (roll-off).

E. CAPACITORS. A leaky or shorted capacitor can best be detected by checking resistance with an ohmmeter on the highest scale. Do not exceed the voltage rating of the capacitor. The resistance reading should be high after initial charge of the capacitor. An open capacitor can best be detected with a capacitance meter or by checking whether the capacitor passes AC signals.

9. Repair and Readjust the Circuit. If any defective parts are located, follow the replacement procedures given in this section. Be sure to check the performance of any circuit that has been repaired or that has had any electrical components replaced.

CORRECTIVE MAINTENANCE

General

Corrective maintenance consists of component replacement and instrument repair. Special techniques required to replace components in this instrument are given here.

Obtaining Replacement Parts

Standard Parts. All electrical and mechanical part replacements for the 434 can be obtained through your local Tektronix Field Office or representative. However, many of the standard electronic components can be obtained locally in less time than is required to order them from Tektronix, Inc. Before purchasing or ordering replacement parts, check the parts list for value, tolerance, rating and description.

NOTE

When selecting replacement parts, it is important to remember that the physical size and shape of a component may affect its performance in the instrument, particularly at high frequencies. All replacement parts should be direct replacements unless it is known that a different component will not adversely affect instrument performance.

Special Parts. In addition to the standard electronic components, some special components are used in the 434. These components are manufactured or selected by Tektronix, Inc. to meet specific performance requirements, or are manufactured for Tektronix, Inc. in accordance with our specifications (see the Cross Index which references Manufacturers Code Number to Manufacturer in the Electrical Parts List). Most of the mechanical parts used in this instrument have been manufactured by Tektronix, Inc. Order all special parts directly from your local Tektronix Field Office or representative.

Ordering Parts. When ordering replacement parts from Tektronix, Inc., include the following information:

1. Instrument type.
2. Instrument serial number.
3. A description of the part (if electrical, include circuit number).
4. Tektronix Part Number.

Soldering Techniques

WARNING

Disconnect the instrument from the power source before soldering.

Maintenance—434 (SN B500000 and up)

Circuit Boards. Use ordinary 60/40 solder and a 35- to 40-watt pencil type soldering iron on the circuit boards. The tip of the iron should be clean and properly tinned for best heat transfer to the solder joint. A higher wattage soldering iron may separate the wiring from the base material.

The following technique should be used to replace a component on a circuit board. Most components can be replaced without removing the boards from the instrument.

CAUTION

The Vertical Mode Switch, the attenuator and the Vertical Input Amplifier circuit boards are made of material easily damaged by excessive heat. When soldering to these boards, do not use a soldering iron with a rating of more than approximately 15 watts. Avoid prolonged applications of heat to circuit-board connections.

1. Grip the component lead with long-nose pliers. Touch the soldering iron to the lead at the solder connection. Do not lay the iron directly on the board as it may damage the board.

2. When the solder begins to melt, pull the lead out gently. This should leave a clean hole in the board. If not, the hole can be cleaned by reheating the solder and placing a sharp object such as a toothpick into the hole to clean it out. A vacuum-type desoldering tool can also be used for this purpose.

3. Bend the leads of the new component to fit the holes in the board. If the component is replaced while the board is mounted in the instrument, cut the leads so they will just protrude through the board. Insert the leads into the holes in the board so the component is firmly seated against the board (or as positioned originally). If it does not seat properly, heat the solder and gently press the component into place.

4. Touch the iron to the connection and apply a small amount of solder to make a firm solder joint; do not apply too much solder. To protect heat-sensitive components, hold the lead between the component body and the solder joint with a pair of long-nose pliers or other heat sink.

5. Clip the excess lead that protrudes through the board (if not clipped in step 3).

6. Clean the area around the solder connection with a flux-remover. Use only water-soluble detergents, ethyl, methyl, or isopropyl alcohol. Do not apply any solvent containing ketones, esters, or halogenated hydrocarbons. Be careful not to remove information printed on the board.

Metal Terminals. When soldering metal terminals, ordinary 60/40 solder can be used. Use a soldering iron with a 40- to 75-watt rating and a 1/8-inch wide wedge-shaped tip.

Observe the following precautions when soldering metal terminals:

1. Apply only enough heat to make the solder flow freely. Use a heat sink to protect heat-sensitive components.

2. Apply only enough solder to form a solid connection. Excess solder may impair the function of the part.

3. If a wire extends beyond the solder joint, clip off the excess.

4. Clean the flux from the solder joint with a flux-remover solvent.

Component Replacement

WARNING

Disconnect the instrument from the power source before replacing components.

Circuit Board Replacement. If a circuit board is damaged beyond repair, the entire assembly including all soldered-on components can be replaced. Part Numbers are given in the Mechanical Parts List for the completely wired board. Most of the components mounted on the circuit boards can be replaced without removing the boards from the instrument. Observe the soldering precautions given under Soldering Techniques in this section.

Most of the connections to the circuit boards in the instrument are made with pin connectors. However, some connections are soldered to the board. Use the following procedure to remove a circuit board:

1. Disconnect all pin connectors from the board and unsolder any soldered connections.

2. Remove all screws holding the board to the chassis.

3. Lift the circuit board out of the instrument. Do not force or bend the board.

Maintenance—434 (SN B500000 and up)

4. To replace the board, reverse the order of removal. Correct location of the pin connectors is shown in Figs. 8-1 through 8-23. Replace the pin connectors carefully so they mate correctly with the pins. If forced into place incorrectly positioned, the pin connectors may be damaged. If the instrument is turned on with connectors incorrectly positioned, circuit damage may result.

Transistor Replacement. Transistors should not be replaced unless actually defective. If removed from their sockets during routine maintenance, return them to their original sockets. Unnecessary replacement of transistors may affect the calibration of this instrument. When transistors are replaced, check the operation of that part of the instrument which may be affected.

WARNING

Turn off the POWER switch before removing or replacing transistors.

Replacement transistors should be of the original type or a direct replacement. Fig. 4-4 shows the lead configuration of the transistors used in this instrument. Some plastic case transistors have lead configurations which do not agree with those shown here. If a transistor is replaced by a transistor made by a different manufacturer than the original, check the manufacturer's basing diagram for correct basing. All transistor sockets in this instrument are wired for the basing used for metal-case transistors. Transistors which have heat radiators or are mounted on the chassis use silicone grease to increase heat transfer. Replace the silicone grease when replacing these transistors.

WARNING

Handle silicone grease with care. Avoid getting silicone grease in the eyes. Wash hands thoroughly after use.

Cathode-Ray Tube Replacement. Use care when handling a CRT. Protective clothing and safety glasses should be worn. Avoid striking it on any object which might cause it to crack or implode. When storing a CRT, place it face down on a smooth surface with a protective cover or soft mat under the faceplate to protect it from scratches.

The CRT shield should also be handled carefully. This shield protects the CRT display from distortion due to magnetic interference. If the shield is dropped or struck sharply, it may lose its shielding ability.

The following procedure outlines the removal and replacement of the cathode-ray tube:

A. REMOVAL:

1. Remove the wrap-around cabinet as described previously.
2. Remove the light filter.
3. Remove the cover plate from the rear casting.
4. Remove the socket from the base of the CRT.
5. Remove the Z Axis and Storage Circuit Boards from the instrument.
6. Disconnect the deflection plate leads from the neck of the CRT. Be careful not to bend or excessively squeeze the pins.
7. Remove the two screws securing the rear of the CRT shield to the rear casting.
8. Remove the delay-line assembly from the CRT shield by removing the lone screw in the middle of the delay line.
9. Remove the two screws securing the CRT shield to the front casting.
10. Remove the CRT assembly from the instrument.
11. Hold the CRT securely in the shield and loosen the CRT clamp at the rear of the CRT shield.

12. Hold one hand on the CRT faceplate and push forward on the CRT base with the other. As the CRT starts out of the shield, grasp it firmly. When the CRT is free of the clamp, slide the shield completely off the CRT. Be careful not to damage the storage leads.

B. REPLACEMENT:

1. Loosen the four hex-head screws on the front part of the CRT shield.
2. Insert the CRT into the shield. Loosen the two securing screws inside the rear of the CRT shield. Be sure the faceplate of the CRT is flush or slightly recessed with the front opening of the CRT shield. Be sure the storage leads are correctly positioned. Do not tighten the CRT clamp yet.

Maintenance—434 (SN B500000 and up)

3. Place the light mask over the CRT faceplate and reinsert the CRT assembly into the instrument. Be sure the CRT faceplate seats properly in the front casting. The lip on the upper edge of the front of the CRT shield must engage the slot in the front casting.

4. Replace the two screws securing the rear of the CRT shield to the rear casting.

5. Seat the CRT firmly against the front casting, making sure the light mask is positioned correctly. Correctly align the CRT in the opening in the front casting by positioning and tightening the four hex-head screws loosened previously in step 1. Also tighten the three screws inside the rear of the CRT shield. Recommended tightening torque for the clamp screw is 4 to 7 inch/lbs.

6. Install the CRT socket on the base of the CRT.

7. Install the Z Axis Circuit Board.

8. Reconnect the deflection plate leads on the neck of the CRT. Be careful not to bend or excessively squeeze the pins.

9. Re-install the delay-line assembly on the bottom of the CRT shield.

10. Reinstall the storage board.

11. Re-install the cover plate on the rear casting.

12. Re-install the CRT light filter in the front casting.

13. Recheck instrument calibration.

Fuse Replacement. The only fuse used in the instrument is the power-line fuse. Use only a 1 1/2 ampere fast-blow fuse as a replacement.

Power Transformer Replacement. If the power transformer becomes defective, be sure to replace only with a direct replacement Tektronix transformer. After the transformer is replaced, check the performance of the complete instrument.

The components located in the power-supply compartment can be reached for maintenance by using the following procedure:

1. Remove the wrap-around cabinet from the instrument as described earlier in this section.

2. Lay the instrument down flat with the power-supply compartment edge facing you.

3. Remove the screw securing the compartment shield to the rear casting.

4. Loosen the two screws securing the compartment shield to the forward power-supply compartment bulkhead and slide the shield out of the instrument.

WARNING

Line AC, high voltage, and stored DC are present in this compartment. It is recommended the instrument not be operated with this shield removed.

After gaining access to the power-supply compartment, the power transformer assembly can be removed as follows:

1. Disconnect the pin connectors from the Power Supply Secondary circuit board.

2. Remove the Power Supply Secondary circuit board (held on by four screws).

3. Unsolder the power transformer leads.

4. Remove the power transformer from the Power Supply Secondary circuit board (held with four screws).

Recalibration After Repair

After any electrical component has been replaced, the calibration of that particular circuit should be checked, as well as the calibration of other closely related circuits. Since the power supply affects all circuits, calibration of the entire instrument should be checked if work has been done in the power supply or if the transformer has been replaced.

Maintenance—434 (SN B500000 and up)

Instrument Repackaging

If the Tektronix instrument is to be shipped to a Tektronix Service Center for service or repair, attach a tag showing: owner (with address) and the name of an individual at your firm that can be contacted, complete instrument serial number and a description of the service required.

Save and re-use the package in which your instrument was shipped. If the original packaging is unfit for use or not available, repackage the instrument as follows:

1. Obtain a carton of corrugated cardboard having inside dimensions of no less than six inches more than the instrument dimensions; this will allow for cushioning. Refer to the following table for carton test strength requirements.

2. Surround the instrument with polyethylene sheeting to protect the finish of the instrument.
3. Cushion the instrument on all sides by tightly packing dunnage or urethane foam between carton and instrument, allowing three inches on all sides.
4. Seal carton with shipping tape or industrial stapler.

SHIPPING CARTON TEST STRENGTH

Gross Weight (lb)	Carton Test Strength (lb)
0-10	200
10-30	275
30-120	375
120-140	500
140-160	600

For Service Manuals Contact
MAURITRON TECHNICAL SERVICES
8 Cherry Tree Rd, Chinnor
Oxon OX9 4QY
Tel: 01844-351694 Fax: 01844-352554
Email: enquiries@mauritron.co.uk

CALIBRATION

Introduction

To ensure instrument accuracy, check the calibration of the 434 every 1000 hours of operation, or every 6 months if used infrequently. Before complete calibration, thoroughly clean and inspect this instrument as outlined in the Maintenance section.

Tektronix Field Service

Tektronix, Inc. provides complete instrument repair and recalibration at local Field Service Centers and the Factory Service Center. Contact your local Tektronix Field Office or representative for further information.

Using This Procedure

To aid in locating a step in the Calibration procedure, an index is given prior to the complete procedure. Completion of each step in the full Calibration procedure ensures that this instrument meets the electrical specifications given in Section 1. Where possible, instrument performance is checked before an adjustment is made. For best overall instrument performance when performing a complete calibration procedure, make each adjustment to the exact setting even if the CHECK— is within the allowable tolerance.

A partial calibration is often desirable after replacing components, or to touch up the adjustment of a portion of the instrument between major recalibration. To adjust only part of the instrument, set the controls as given under Preliminary Control Settings and start with the nearest Equipment Required List preceding the desired portion. To prevent unnecessary recalibration of other parts of the instrument, readjust only if the tolerance given in the CHECK— part of the step is not met. If re-adjustment is necessary, also check the calibration of any steps listed in the INTERACTION— part of the step.

IMPORTANT NOTE

All waveforms shown in this procedure were taken with a Tektronix Oscilloscope Camera System, unless otherwise noted. Limits, tolerances, and waveforms in this procedure are given as calibration guides and should not be interpreted as instrument specifications except as specified in Section 1.

TEST EQUIPMENT REQUIRED

General

The listed test equipment and accessories, or their equivalent, are required for complete calibration of the 434. Specifications given for the test equipment are the minimum necessary for accurate calibration. Therefore, the specifications of any test equipment used must meet or exceed the listed specifications. All test equipment is assumed to be correctly calibrated and operating within the listed specifications. Detailed operating instructions for the test equipment are not given in this procedure. Refer to the instruction manual for the test equipment if more information is needed.

Special Calibration Fixtures

Special Tektronix calibration fixtures are used in this procedure only where they facilitate instrument calibration. These special calibration fixtures are available from Tektronix, Inc. Order by part number through your local Tektronix Field Office or representative.

Calibration Equipment Alternatives

All of the listed test equipment is required to completely calibrate this instrument. The Calibration procedure is based on the first item of equipment given as an example of applicable equipment. When other equipment is substituted, control settings or calibration setup may need to be altered slightly to meet the requirements of the substitute equipment. If the exact item of test equipment given as an example in the Test Equipment list is not available, first check the Specifications column carefully to see if any other equipment is available that might suffice. Then check the Usage column to see what this item of the test equipment is used for. If used for a check or adjustment that is of little or no importance to your measurement requirements, the item and corresponding step(s) can be deleted.

The following procedure is written to completely check and adjust the 434 to the Performance Requirements given in Section 1. If the applications for which you will use the 434 do not require the full available performance from the 434, this procedure and the required equipment list can be shortened accordingly. For example, the basic measurement capabilities only of this instrument can be varied by checking vertical deflection accuracy with a Standard Amplitude Calibrator, the vertical square-wave response with a fast-rise Square-Wave Generator (such as the Tektronix Type 106), and the horizontal timing using a Time-Mark Generator.

TEST EQUIPMENT

Description	Minimum Specifications	Usage	Example
1. Autotransformer with AC voltmeter	Capable of supplying 66 Volt-Amperes at an output voltage of 120 VAC.	Power Supply adjustment.	General Radio W10MT3W Variac Autotransformer.
2. Test-oscilloscope system.	Bandwidth, DC to 25 megahertz; minimum deflection factor, 5 millivolts/division; accuracy within 3%.	Adjust Power Supply operation, CRT grid bias, Sweep Generator offset adjustment, and Z-axis Compensation.	a. Tektronix 7603 or 7403N Oscilloscope with 7A15A or 7A16A Amplifier and 7B50 or 7B53A Time-Base Plug-in units, and a P6053B Probe. b. Telequipment D75 oscilloscope with a 10X Probe.
3. Precision DC voltmeter	Range, 0 to 500 volts; accuracy, within 0.2%.	Calibrator output accuracy check and adjustment. Power Supply adjustment.	a. Tektronix 7D13 Digital Multimeter (test oscilloscope must have Readout System). b. Tektronix DM 501 Digital Multimeter. ¹
4. DC voltmeter	Range, 0 to 4000 volts; accuracy, checked to within 1% at -3940 volts.	High voltage power supply adjustment.	a. Triplet Model 630-NA. b. Simpson Model 262.
5. Time-mark generator	Marker outputs, 20 nano-seconds to 5 seconds; marker accuracy, within 0.1%.	CRT geometry check and adjustment, Horizontal timing check and adjustment. Calibrator repetition rate check and adjustment.	a. Tektronix 2901 Time-Mark Generator. b. Tektronix 184 Time-Mark Generator. c. Tektronix TG 501 Time-Mark Generator. ¹
6. Medium-Frequency, constant-amplitude signal generator	Frequency, 350 kilohertz to 25 megahertz; reference frequency, between 50 and 350 kilohertz, output amplitude, variable from 5 millivolts to 6 volts peak-to-peak into 50 ohms; amplitude accuracy, constant within 3% of reference as output frequency changes.	External Z-axis operation check. Vertical amplifier bandwidth check. Trigger circuit check and adjustment.	a. Tektronix 191 Constant Amplitude Signal Generator. b. Tektronix SG 503 Leveled Signal Generator. ¹
7. Low-frequency signal generator	Frequency, 100 hertz to 30 kilohertz; output amplitude, variable from 35 millivolts to 40 volts.	Trigger circuit check and adjustment.	a. General Radio 1310-B Oscillator. b. Tektronix FG 504 Function Generator. ¹
8. Standard Amplitude Calibrator	Amplitude accuracy, 0.25%; signal amplitude, 5 millivolts to 50 volts; output signal, 1-kilohertz square-wave.	Vertical amplifier gain check and adjustment. External horizontal gain check.	a. Tektronix calibration fixture Part Number 067-0502-01. b. Tektronix PG 506 Calibration Generator. ¹

¹Requires a TM 500-series Power Module.

TEST EQUIPMENT (cont)

Description	Minimum Specifications	Usage	Example
9. Square-wave generator	Frequency, 1 kilohertz and 100 kilohertz; risetime, 1 nanosecond or less from fast-rise output.	Vertical amplifier compensation checks and adjustments.	a. Tektronix Type 106 Square-Wave Generator. b. Tektronix PG 506 Calibration Generator. ¹
10. Adapter	Connectors, GR874 and BNC female.	Vertical amplifier bandwidth checks. Trigger circuit checks and adjustments.	a. Tektronix Part Number 017-0063-00.
11. Adapter	BNC male to miniature probe tip.	Vertical compensation.	a. Tektronix Part Number 013-0084-01.
12. T-connector	Connectors, BNC.	External trigger operation checks. External Z-Axis operation check. ADD mode operation check.	a. Tektronix Part Number 103-0030-00.
13. Attenuator (two required)	Attenuation ratio, 10X; connectors BNC, impedance, 50 ohms.	Vertical amplifier compensation checks and adjustments.	a. Tektronix Part Number 011-0049-01.
14. Termination (two required)	Impedance, 50 ohms; accuracy, $\pm 2\%$, connectors, BNC.	External Z-Axis operation check. Vertical amplifier bandwidth check. Trigger circuit operation checks and adjustments.	a. Tektronix Part Number 011-0049-01.
15. Cable (two required)	Impedance, 50 ohms; type, RG-58/U; length, 42 inches; connectors, BNC.	Used throughout procedure for signal interconnection.	a. Tektronix Part Number 012-0057-01.
16. Screwdriver	Three-inch shaft, 3/32-inch bit.	Used throughout procedure to adjust variable resistors.	a. Xcelite R-3323.
17. Low-capacitance screwdriver	1 1/2-inch shaft.	Used throughout procedure to adjust variable capacitors.	a. Tektronix Part Number 003-0000-00.
18. Tuning tool	Fits 5/64-inch (ID) hex cores.	Vertical amplifier high-frequency compensation adjustments.	a. Tektronix Part Number 003-0307-00 (handle) and 003-0310-00 (insert).

¹Requires a TM 500-series Power Module.

For Service Manuals Contact
MAURITRON TECHNICAL SERVICES
 8 Cherry Tree Rd, Chinnor
 Oxon OX9 4QY
 Tel: 01844-351694 Fax: 01844-352554
 Email: enquiries@mauritron.co.uk

INDEX TO CALIBRATION PROCEDURE

A. Power Supply and Display Adjustment

1. Adjust +15-Volt Power Supply	Page 5-6
2. Adjust High-Voltage Power Supply	Page 5-6
3. Adjust CRT Grid Bias	Page 5-7
4. Adjust Focus and Astigmatism	Page 5-8
5. Adjust Trace Rotation	Page 5-8
6. Pre-Set Collimation and Storage Target Levels	Page 5-8
7. Adjust Upper and Lower Non-Store Levels	Page 5-9
8. Adjust Upper and Lower Storage Levels	Page 5-10
9. Adjust Collimation	Page 5-10
10. Check Stored Writing Speed	Page 5-11
11. Adjust Geometry	Page 5-12
12. Check BEAM FINDER Operation	Page 5-12
13. Check External Z Axis Operation	Page 5-12
14. Check Chopped Operation	Page 5-12
Selecting Components For Optimum Focus After CRT Replacement	Page 5-13

B. Vertical System Adjustment

1. Adjust Channel 1 Balance	Page 5-14
2. Adjust Channel 2 Balance	Page 5-14
3. Adjust CH 1 and CH 2 GAIN	Page 5-15
4. Check CH 1 VAR VOLTS/DIV Range and Attenuator Accuracy	Page 5-15
5. Check CH 2 VAR VOLTS/DIV Range and Attenuator Accuracy	Page 5-16
6. Check ADD Mode Operation	Page 5-16
7. Adjust Channel 1 VOLTS/DIV Switch Compensation	Page 5-16

8. Adjust Channel 1 VOLTS/DIV Switch Compensation	Page 5-17
9. Adjust High Frequency Compensation	Page 5-17
10. Check Vertical Amplifier Bandwidth	Page 5-20
11. Check 5 MHz BW Bandwidth	Page 5-20

C. Trigger Circuit Adjustment

1. Adjust Trigger Level Centering	Page 5-21
2. Adjust CH 1 and COMP Trigger DC Level	Page 5-21
3. Check Trigger Circuit Operation	Page 5-22
4. Check Single Sweep Operation	Page 5-22
5. Check TRIGGER LEVEL Control Range	Page 5-23
6. Check Line Triggering	Page 5-23

D. Horizontal System Adjustment

1. Adjust Sweep Generator Offset Adjustment	Page 5-24
2. Adjust Sweep Cal	Page 5-24
3. Adjust Horizontal Gain	Page 5-25
4. Adjust Magnifier Registration	Page 5-25
5. Check VAR TIME/DIV Range	Page 5-25
6. Adjust High Speed Timing	Page 5-25
7. Check TIME/DIV Accuracy	Page 5-26
8. Check Magnified Sweep Accuracy	Page 5-26
9. Check High Speed Magnified Timing Accuracy	Page 5-26
10. Check External Horizontal Sensitivity	Page 5-26

E. Calibrator Circuit Adjustment

1. Adjust Calibrator Output Voltage Amplitude	Page 5-27
2. Adjust Calibrator Repetition Rate	Page 5-28

PRELIMINARY PROCEDURE FOR COMPLETE CALIBRATION

NOTE

This instrument should be adjusted at an ambient temperature of +25°C (±5°C) for best overall accuracy.

Setup

1. Remove the wrap-around cabinet from the 434 in the manner given in Section 4 of this manual.

2. Connect the autotransformer to a suitable power source.

NOTE

If a line voltage source of exactly 120 VAC RMS is available, it will not be necessary to use the autotransformer.

3. Connect the 434 to the autotransformer output.

4. Set the autotransformer output voltage for exactly 120 VAC RMS.

5. Set the controls as given under Preliminary Control Settings. Allow at least 30 minutes warmup before proceeding.

NOTE

Titles for external controls of this instrument are capitalized in this procedure (e.g., INTENSITY). Internal adjustments are initial capitalized only (e.g., Sweep Cal).

Preliminary Control Settings

Preset the instrument controls to the settings given below when starting a Calibration procedure.

POWER/INTENSITY	Pulled out and rotated fully counterclockwise
POSITION (vertical and horizontal)	Midrange
5 MHz BW	Pushed in
INVERT	Pushed in
Input Coupling	AC
Vertical Mode	CH 1
VOLTS/DIV	.1 V
Variable VOLTS/DIV	CAL
TRIGGER SOURCE	COMP
TRIGGER COUPLING	AC
TRIGGER LEVEL	Midrange
TRIGGER SLOPE	+
Sweep MODE	SINGLE SWEEP
TIME/DIV	1 ms
VAR TIME/DIV	CAL
ENHANCE LEVEL	Fully counterclockwise
STORE (upper & lower)	Non-store
ENHANCE (upper & lower)	Off

A. POWER SUPPLY AND DISPLAY ADJUSTMENT

Equipment Required

- | | | |
|---|--|--|
| <ol style="list-style-type: none">1. Test Oscilloscope2. Medium-Frequency Constant-Amplitude Signal Generator3. Time-Mark Generator4. Precision DC Voltmeter5. DC Voltmeter | <p>For Service Manuals Contact
MAURITRON TECHNICAL SERVICES
8 Cherry Tree Rd, Chinnor
Oxon OX9 4QY
Tel:- 01844-351694 Fax:- 01844-352554
Email:- enquiries@mauriton.co.uk</p> | <ol style="list-style-type: none">6. Autotransformer7. Adapter (GR874 and BNC female connectors)8. 50 Ω BNC Termination9. 42-inch 50 Ω BNC Cables (2 each)10. BNC T-connector11. Three-inch Screwdriver |
|---|--|--|

1. Adjust +15-Volt Power Supply

a. Connect the Precision DC Voltmeter between the +15-volt power supply test point (positive lead of C1974 on Power Supply Secondary circuit board; see Fig. 5-1) and ground.

b. CHECK—Meter reading of +15 volts, ± 0.112 volt (± 0.187 volt if the measurement is being made outside of the +20°C to +30°C temperature range).

c. INTERACTION—May affect the operation of all circuits within the 434.

NOTE

If the adjustment in step 1d is made, the oscilloscope will require complete recalibration.

d. ADJUST— +15 Volts adjustment R1940 (see Fig. 5-1) for a meter reading of +15 volts, ± 0.037 volt.

e. Disconnect the Precision DC Voltmeter from the 434 under test.

2. Adjust High-Voltage Power Supply

a. Connect the DC Voltmeter between the -3940-volt test point TP1762 (see Fig. 5-2) and ground.

b. CHECK—The DC Voltmeter for a reading of -3841.5 to -4038.5 volts.

c. ADJUST—High-Voltage Adjust R1765 (see Fig. 5-2) for a meter reading of -3940 volts.

d. Connect the Precision DC Voltmeter to the output of the High-Voltage Regulator (see Fig. 5-2).

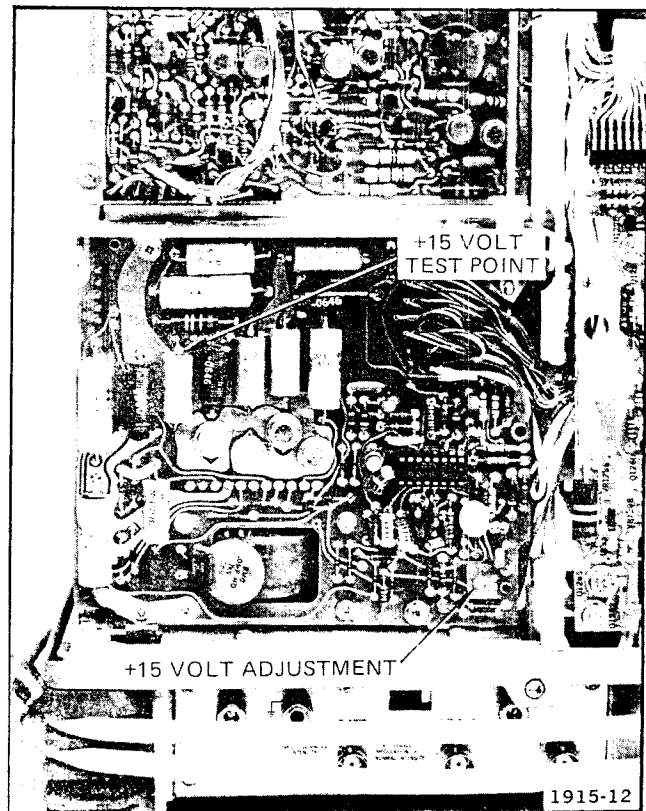

Fig. 5-1. +15 volt adjustment locations.

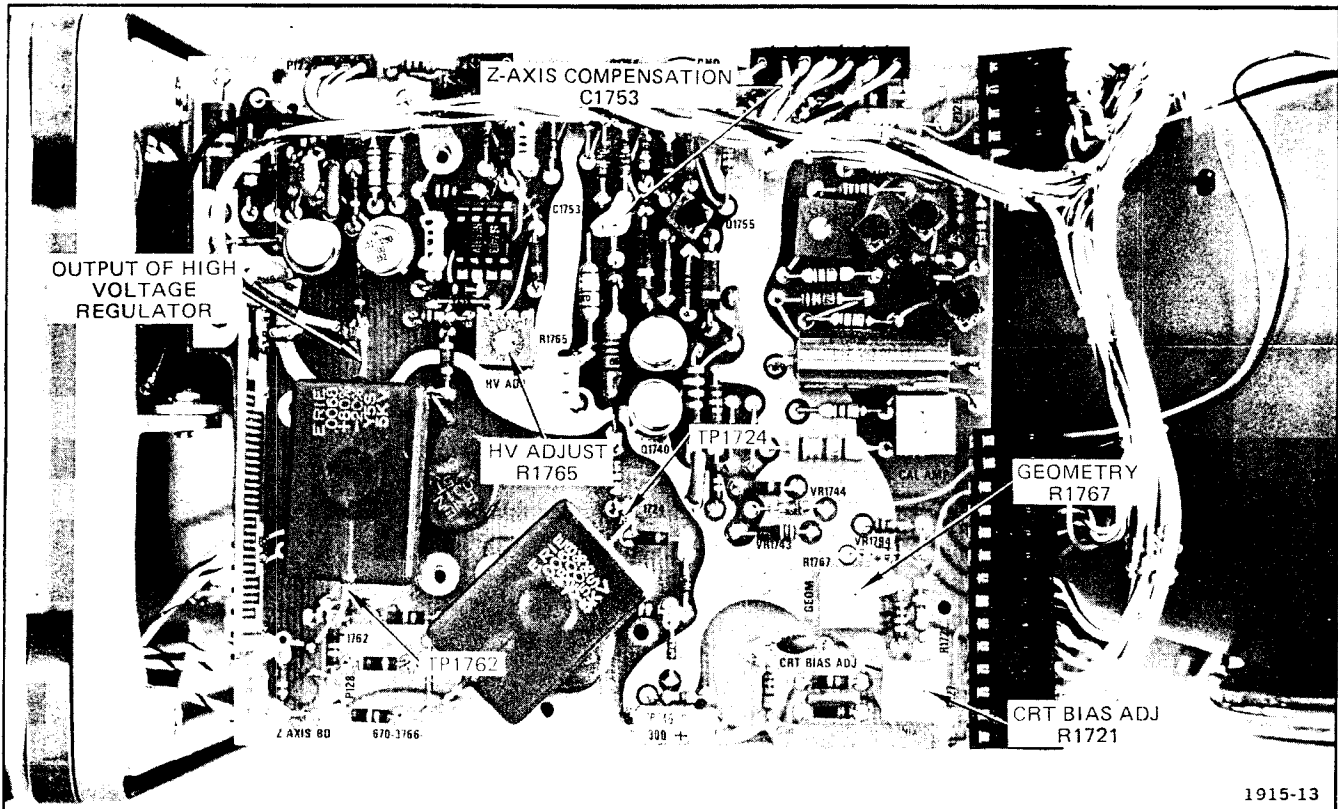

Fig. 5-2. CRT circuit test point and adjustment locations.

e. Check the Precision DC Voltmeter for a reading of 90 to 150 volts.

f. If the output of the High-Voltage Regulator measured in step 2e is outside the specified range, compromise the High-Voltage Adjust (step 2c) until both the High Voltage and the output of the High-Voltage Regulator are within the specified ranges.

High Voltage: -3841.5 to -4038.5 volts

High-Voltage Regulator: 90 to 150 volts.

g. Disconnect the DC Voltmeter and the Precision DC Voltmeter from the 434.

h. INTERACTION—May affect Vertical Gain, Timing, Focus, Astigmatism, and Geometry adjustments.

3. Adjust CRT Grid Bias and Z-axis Compensation

a. Set the DC voltmeter to a 25-volt or higher DC range and attach the plus lead to test point TP1724 on the Z-axis circuit board (see Fig. 5-2) and the minus lead to ground.

b. With the INTENSITY control fully counterclockwise, select the AUTO sweep mode and set the TIME/DIV switch to EXT HORIZ.

c. Turn the INTENSITY control clockwise until the CRT spot is visible (Horizontal and Vertical POSITION controls at mid-range) and position the spot near the center of the screen, but not on a graticule line.

CAUTION

To avoid possible damage to the CRT phosphor, do not allow a bright spot to remain stationary for an extended period of time.

d. ADJUST—The INTENSITY control toward a voltmeter reading of +17 volts. If this increases spot brightness, reduce intensity by adjusting R1721 (CRT Grid Bias adjustment) before adjusting the INTENSITY control for full +17 volts.

e. Adjust R1721 for a dim spot, then adjust FOCUS (front panel screwdriver adjustment) and ASTIG (rear panel screwdriver adjustment) for the best-defined spot.

Calibration—434 (SN B500000 and up)

f. ADJUST—CRT Grid Bias adjustment R1721 (see Fig. 5-2) so the spot on the CRT just disappears.

g. Disconnect the DC voltmeter and connect a 10X probe from the test oscilloscope to TP1724.

h. Set the TIME/DIV switch to 1 μ s/DIV, then set sweep magnification to maximum (.02 μ s/DIV).

i. Set the test oscilloscope horizontal to 5 μ s/DIV and vertical to 5 V/DIV (including the 10X probe attenuation). Adjust the test oscilloscope triggering controls for a stable display of the unblanking waveform.

j. ADJUST—INTENSITY control to obtain a 30-volt peak-to-peak waveform on the test oscilloscope.

k. Position the start of the magnified sweep display within the 434 graticule area.

l. CHECK—For even brightness over approximately the first division of the magnified sweep display (a slight bright spot at the start of the display is acceptable).

m. ADJUST—C1753 (see Fig. 5-2) for a very slight bright spot at the beginning of the magnified sweep display.

n. Disconnect all test equipment from the 434.

4. Adjust Focus and Astigmatism

a. Connect a 50-kilohertz signal from the Medium-frequency, constant-amplitude sine-wave generator to the CH 1 input connector. Set the TIME/DIV switch to 5 or 10 μ s and adjust the signal generator amplitude for a vertical display of about 1.5 to 2 divisions.

b. Adjust the TRIGGER LEVEL control for a stable display and advance the INTENSITY control to a comfortable viewing level.

c. CHECK—CRT display for optimum focus of all portions of the display. The display should remain in focus as the setting of the INTENSITY control is varied.

d. ADJUST—FOCUS adjust R86 (located on the front panel) and ASTIG adjust R85 (located on the rear panel) for optimum definition of all portions of the display.

NOTE

The CRT focus circuit contains two selectable resistors, R83 and R1764. If the CRT is replaced it may be necessary to change the values of these resistors. In Step 4.d., if the adjustment range of the FOCUS control does not allow optimum focus, the value of R1764 (in parallel with R1762C) should be changed. R83 is selected for optimum tracking of the focus voltage with changes in INTENSITY control setting. Refer to the end of Section A, Power Supply and Display for information on how to select R83 and R1764.

5. Adjust Trace Rotation

a. Position the free-running trace to the center horizontal graticule line.

b. CHECK—The trace should be parallel with the center horizontal line.

c. ADJUST—TRACE ROTATION adjustment R80 (located on rear panel) so the trace is parallel with the horizontal graticule lines.

6. Pre-Set Collimation and Storage Target Levels

NOTE

If CRT storage performance has been satisfactory, no adjustment of the storage circuitry is necessary. Proceed with step 11. If it is desired to touch up storage calibration to improve operation of an instrument, proceed with step 7. If this calibration procedure is being performed on an instrument having unknown storage circuitry calibration (such as after replacing a CRT), continue with step 6.

a. Set the Sweep MODE to SINGLE SWEEP.

b. Connect the minus lead of a DC voltmeter to test point TP1236 and the plus lead of the meter to P145-4. See Fig. 5-3 for test point locations.

c. Adjust R1295 (see Fig. 5-3) for a meter reading of 100 volts.

d. Move the plus lead of the meter to P145-8.

e. Adjust Upper Non-Store Level R1224 for a meter reading of 70 volts.

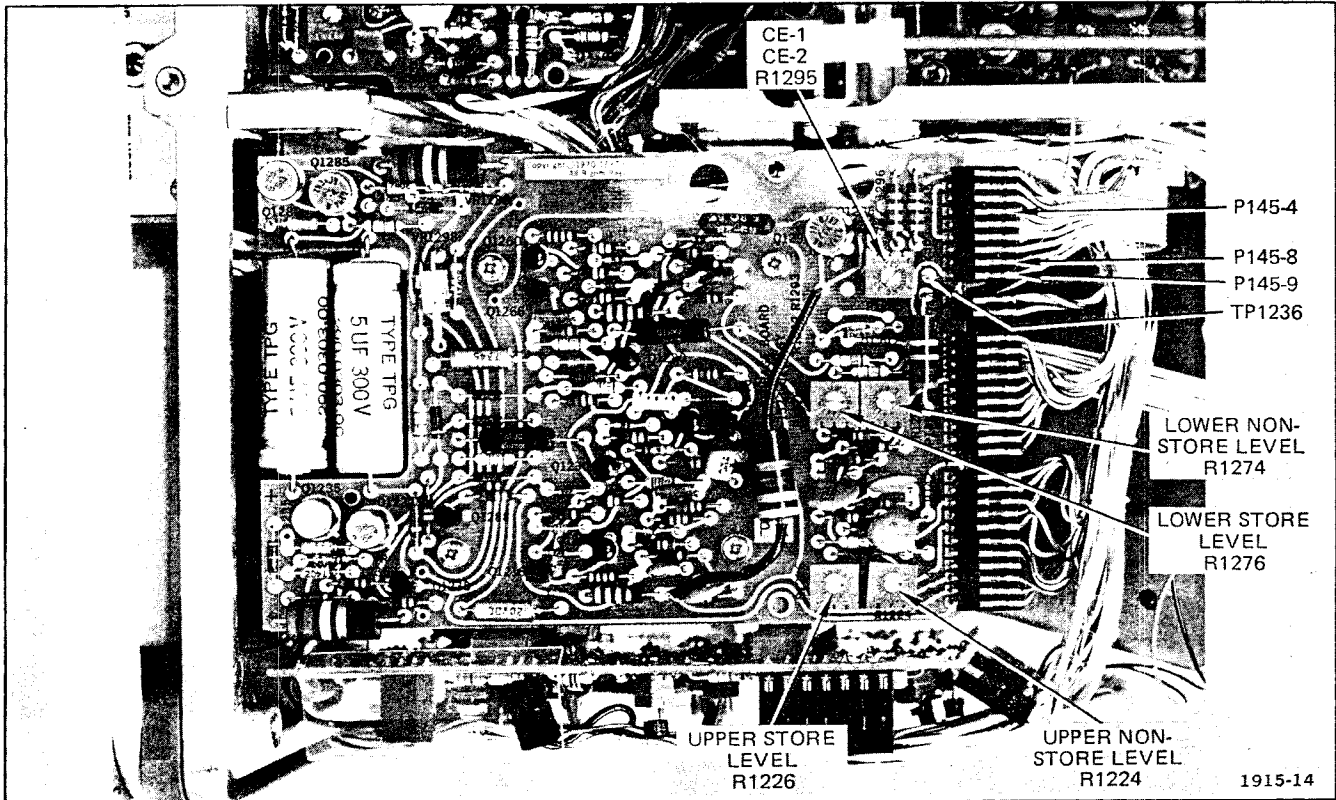

Fig. 5-3. Location of storage circuit adjustments and test points.

f. Set the UPPER SCREEN STORE button to the STORE (button in) position.

g. Adjust Upper Store Level adjustment R1226 for a meter reading of 170 volts.

h. Set the UPPER SCREEN STORE button to non-store (button out) position and move the plus lead of the meter to P145-9 (see Fig. 5-3).

i. Adjust Lower Non-Store Level R1274 for a meter reading of 70 volts.

j. Set the LOWER SCREEN STORE button to the STORE (button in) position.

k. Adjust Lower Store Level R1276 for a meter reading of 170 volts.

7. Adjust Upper and Lower Non-Store Levels

a. Set the Sweep MODE to AUTO and the UPPER SCREEN STORE to STORE (button in).

b. Adjust INTENSITY control for a moderately bright trace.

c. Fully write the entire screen by vertically positioning the trace from one extreme to the other.

d. Set the LOWER SCREEN STORE button to the non-store (button out) position.

e. CHECK—The stored display in the Lower Screen area disappears very quickly and does not linger. Also should have minimum "scalloping" of the Upper Screen stored display.

f. ADJUST—Lower Screen Non-Store Level R1274 for best non-store display compromise as described in step e.

g. Set the LOWER SCREEN STORE button to STORE (button in).

h. Fully write the entire screen by vertically positioning the trace from one extreme to the other.

Calibration—434 (SN B500000 and up)

i. Set the UPPER SCREEN STORE button to the non-store (button out) position.

j. CHECK—The stored display in the Upper Screen area disappears very quickly and does not linger. Also should have minimum "scalloping" of the Lower Screen stored display.

k. ADJUST—Upper Screen Non-Store Level R1224 for best non-store display compromise as described in step j.

8. Adjust Upper and Lower Store Levels

NOTE

Some compromises in the CRT display can be made by adjusting the Store Level controls. When the operating level is increased, the brightness and writing speed increase; however, the contrast ratio decreases. When the operating level is decreased, the contrast ratio increases; however, brightness and writing speed decreases.

a. Set both STORE buttons to their non-store (button out) positions and adjust the INTENSITY control for normal display brightness.

b. Adjust the FOCUS and ASTIG adjustments for a well-defined trace.

c. Set both STORE buttons to their store (button in) position, the TRIGGER SOURCE to LINE, the TRIGGER LEVEL to midrange, and the TIME/DIV to 1 ms/div.

d. Connect the plus lead of the DC voltmeter to P145-8 (see Fig. 5-3).

e. Locate the writing threshold in the following manner:

1. Vertically position the trace from one extreme of the display area to the other in such a manner so as to achieve approximately three written lines per division.

2. Carefully check the written lines for breaks or gaps of 0.025 inch or more. If no breaks or gaps are evident after 10 seconds, note the voltmeter reading, then adjust Upper Store Level R1226 to decrease the operating level by 5 volts.

3. Erase the display, wait 10 seconds, then write again and check for breaks or gaps.

4. Repeat this procedure of decreasing the operating voltage in 5-volt steps until breaks of approximately 0.025 inch occur. This is the writing threshold. Note this voltage and rotate the Upper Store Level adjustment until the original level in step 8 part e2 is reached.

NOTE

Do not change the INTENSITY, FOCUS, or ASTIG control settings.

f. Locate the upper writing limit as follows:

1. Vertically position the trace from one extreme of the display area to the other in such a manner so as to achieve approximately three written lines per division.

2. Carefully check the stored lines for more than normal trace spreading or background fadeup. If no trace spreading or background fadeup is evident after 10 seconds, adjust Upper Store Level R1226 to increase the operating level by 5 volts.

3. Erase the display, wait 10 seconds, then write again and check for breaks or gaps.

4. Repeat this procedure until trace spreading or background fadeup occurs. This is the upper writing limit. Note this voltage.

g. Adjust Upper Store Level R1226 for an operating point midway between the writing threshold and the upper writing limit. Adjust Lower Store Level R1276 to set the lower screen operating level to the same point while measuring the voltage level at P145-9. It is desirable to have both storage targets at the same operating level to minimize the difference in background illumination.

h. Disconnect the DC voltmeter.

i. INTERACTION—Collimation is affected if change in operating level is significant.

9. Adjust Collimation

a. Set the Sweep MODE to AUTO, the TRIGGER LEVEL control fully clockwise, and vertically position the free-running trace from one extreme of the display area to the other to write the entire screen.

b. Rotate the INTENSITY control fully counterclockwise.

Calibration—434 (SN B500000 and up)

c. ADJUST—R1295 (CE-1 and CE-2) throughout its range. Note that as the adjustment is rotated in the clockwise direction, the display grows brighter in the center and then the brightness spreads to the edges of the screen. A further increase in the voltage level at CE-1 and CE-2 will cause slight shadows to occur and then a large bright area in the center. Normally, the optimum setting for R1295 is where the full screen is bright but the shadows haven't yet started to occur.

NOTE

Due to varying CRT storage characteristics, the adjustment of R1295 may need to be compromised slightly to provide optimum performance. If background fadeup occurs around the edges of the CRT viewing area in the Enhance mode or when the ERASE button is pushed, adjust R1295 counterclockwise (lower voltage on CE-1 and CE-2). To provide better storage at the outer divisions of the CRT or to prevent fadeout of a stored waveform, adjust R1295 clockwise (higher voltage on CE-1 and CE-2).

d. Erase the display and disconnect all test equipment.

e. INTERACTION—May affect operating level if changes in collimation settings are significant.

10. Check Stored Writing Speed

NOTE

For all serial numbers, Storage Writing Speed specifications apply to a new CRT. Some degradation with usage is normal. With the Option 1 CRT, sustained use (6 hours or more) of the instrument in Non-Store mode or in Store mode with no writing may result in a decrease in writing speed. Writing speed can be restored by leaving the CRT target fully stored for five to fifteen minutes, then erase and resume desired operation. For this step, timing and triggering calibration must be within specifications. If difficulty is encountered, perform subsections C and D, then continue with this step.

a. Set both STORE buttons to the non-store (button out) position and the TRIGGER SOURCE switch to CH 1.

b. Connect the output of a Time-Mark Generator to the CH 1 input connector via a 42-inch 50 Ω BNC cable.

c. Set the Time-Mark Generator for an output of 10 μ s (1 μ s for Option 1 CRT) markers.

d. Adjust the TRIGGER LEVEL control for a stable display.

e. Set the TIME/DIV switch and the TIME/DIV VAR control for one marker (two markers for Option 1 CRT) per division.

f. Set CH 1 input coupling to GND.

g. Position the trace on screen with the beginning of the trace at the left edge of the graticule.

h. Set the Sweep MODE to SINGLE SWEEP, the TRIGGER SOURCE to LINE, and both STORE buttons to the store (button in) position.

i. Adjust the INTENSITY control until the spot is just extinguished.

j. Press both ERASE buttons, wait 10 seconds, and then press the RESET button. A single sweep should be presented and stored.

k. CHECK—CRT stored display for no breaks or gaps exceeding 0.025 inch within the center 6 vertical and 8 horizontal divisions. Proper storage of a 10 μ s/division (2 μ s/division for Option 1 CRT) sweep indicates a storage writing rate of at least 100 (500 for Option 1 CRT) centimeters per millisecond.

l. Erase the display, reduce the setting of the INTENSITY control, and set CH 1 input coupling to DC.

m. Set the Sweep MODE to AUTO, the STORE buttons to non-store (button out), and TRIGGER SOURCE to CH 1.

n. Set the TIME/DIV switch and the TIME/DIV VAR control for one marker per 4 (5 for Option 1 CRT) divisions.

o. Set the CH 1 input coupling to GND, Sweep MODE to SINGLE SWEEP, TRIGGER SOURCE to LINE, TRIGGER LEVEL to midrange, STORE buttons to store (button in), and ENHANCE buttons On (buttons in).

p. Adjust the INTENSITY control until the spot is just extinguished.

q. Erase the display, wait at least 3 seconds, then push the RESET button. Repeat this procedure while adjusting the ENHANCE LEVEL control to obtain a stored display where the background just starts to fade up.

Calibration—434 (SN B500000 and up)

r. CHECK—CRT stored display for no breaks or gaps exceeding 0.025 inch within the center 6 vertical and 8 horizontal divisions. Proper storage of a 2.5 (0.2 for Option 1 CRT) μs /division sweep indicates an enhanced storage writing speed of at least 400 (5000 for Option 1 CRT) centimeters per millisecond.

s. Set the STORE buttons to non-store (button out), ENHANCE buttons to Off (buttons out), Sweep MODE to AUTO, TRIGGER SOURCE to CH 1, and INTENSITY control for normal display intensity.

11. Adjust Geometry

a. Set the CH 1 input coupling to DC and the TIME/DIV switch to 1 ms/DIV, and the A VAR control to the calibrated detent.

b. Apply 1 ms and .1 ms time marks from the Time-Mark Generator to the CH 1 input connector.

c. Adjust the CH 1 POSITION control and the CH 1 VOLTS/DIV switch so the time marks extend above and below the vertical extremes of the CRT viewing area.

d. Adjust the TRIGGER LEVEL control for a stable display.

3. CHECK—CRT display for no more than 0.1 division of bowing or tilt of time marks in the center 6 X 10 division area, and no more than 0.2 division of misalignment in the extreme upper and lower 1 X 10 division areas.

f. ADJUST—Geometry adjustment R1767 (see Fig. 5-2) for minimum bowing and tilt of time marks.

g. Disconnect all test equipment.

12. Check BEAM FINDER Operation

a. Press the BEAM FINDER button and adjust the INTENSITY control for a visible display.

b. Rotate the CH 1 POSITION and horizontal POSITION controls fully clockwise and then fully counterclockwise.

c. CHECK—It should not be possible to position the free-running trace out of the graticule area when holding the BEAM FINDER button in.

13. Check External Z-axis Operation

a. Connect the output of the Medium-Frequency Constant-Amplitude Signal Generator to the EXT TRIG and Z-axis input connectors via a 50 Ω termination, a BNC T connector, and two 42-inch 50 Ω BNC cables.

b. Adjust the Constant-Amplitude Signal Generator for a 5-volt output amplitude of the reference signal.

c. Set the TIME/DIV switch to 20 μs and the TRIGGER SOURCE to EXT.

d. Adjust the TRIGGER LEVEL control for a stable display.

e. CHECK—CRT display for noticeable intensity modulation of the trace (may require reducing the setting of the INTENSITY control).

f. Increase the output frequency of the Constant-Amplitude Signal Generator to 20 megahertz.

g. Set the TIME/DIV switch to .05 μs .

h. CHECK—CRT display for noticeable intensity modulation of the trace.

i. Disconnect all test equipment.

14. Check Chopped Operation

a. Set the TIME/DIV switch to 2 μs and the TRIGGER SOURCE to COMP.

b. Apply 1 μs time marks to the CH 1 input connector.

c. Adjust the TRIGGER LEVEL control for a stable display.

d. Adjust the TIME/DIV switch and the VAR TIME/DIV control for exactly two markers per division.

e. Disconnect the Time-Mark Generator. Do not change the setting of the TIME/DIV switch or the VAR TIME/DIV control.

f. Set the Vertical Mode to CHOP.

g. Adjust the TRIGGER LEVEL control for a stable display.

h. Adjust the CH 1 and CH 2 POSITION controls to separate the two traces.

i. CHECK—Time duration of chopped waveform should be approximately 4.2 to 6.2 divisions (80 kilohertz to 120 kilohertz, approximately).

SELECTING COMPONENTS FOR OPTIMUM FOCUS AFTER CRT REPLACEMENT

The CRT focus circuitry contains selectable components. If, after replacement of the CRT, adjustment of the FOCUS control (see Step 4 of the Calibration Procedure under A. Power Supply and Display Adjustment) does not result in optimum focus, it may be necessary to select a new value for R1764 and/or R83. Leave R86 set for the best possible focus and perform the following procedure.

Selecting R1764

1. Turn the instrument off and disconnect it from the power line.
2. Measure the resistance of R86 (FOCUS control). To measure R86 connect the leads of an ohmmeter to the following points:
 - a. P128-8.
 - b. The contact on R82B to which a wire from R86 is connected. After measuring the resistance of R86, note the direction of rotation of R86 (FOCUS control) which causes its resistance to increase, for later use in selecting R83.
3. If R86 was near 5 megohms, increase the value of R1764. Complete removal of R1764 should suffice. If R86 was near 0 ohm, decrease the value of R1764. If no resistor was originally installed, select a value of 5 to 10 megohms (1/2 watt composition).
4. Reconnect the instrument to the power line, turn the instrument on, and return to Step 4 of the Power Supply and Display Calibration Procedure.

NOTE

If a value of R1764 below 3 megohms is required, a circuit problem is indicated. Remove power from the instrument and use an ohmmeter to check all connections and resistor values to within 20%. Check connections between the circuit board and R82B for correct order. Restore power to the instrument and recheck the High-Voltage power supply at TP1762 for -3940 volts per Step 2 of the Power Supply and Display Calibration procedure.

Selecting R83

R83 is selected for optimum tracking of the focus voltage with changes in the INTENSITY control setting. Optimum focus at high intensity should be checked at a fast sweep speed but a low sweep repetition rate, as this is the most common usage of high intensity levels. Good focus at high intensity is critical to single shot photography (or single-shot storage in a storage instrument) near the writing speed limit.

To check focus at high intensity:

1. Adjust the FOCUS and ASTIG controls according to the procedure given in Step 4 of the Power Supply and Display calibration procedure. Do not change the setting of the ASTIG control throughout the remaining steps of this procedure.
2. Turn off the instrument and disconnect it from the power line. With an ohmmeter, determine which direction of rotation of FOCUS control R86 causes its resistance to increase (see step 2 of the procedure for selecting R1764). Note this information for future use and remove the ohmmeter. Reconnect the instrument to the power line and turn on the instrument.
3. Connect the Medium-Frequency signal generator to the CH 2 input and push the CH 2 pushbutton. Set the signal generator to about 350 kilohertz.
4. Set the TIME/DIV switch to 1 μ s/DIV. Adjust the signal generator amplitude and the CH 2 VOLTS/DIV control for 1.5 to 2 divisions of vertical display. Adjust the TRIGGER LEVEL control for a stable display.
5. Adjust the INTENSITY control to the three o'clock position. Without changing the setting of the ASTIG control, adjust the FOCUS control for optimum focus (minimum trace thickness in all parts of the sinewave, without dark shadows in the center of the trace). Rotate the FOCUS control through the point of optimum focus several times to verify the optimum setting.
6. Reduce the setting of the INTENSITY control to a very low level. While noting the direction of rotation, readjust the FOCUS control for optimum focus of the low-intensity display. If the direction of rotation needed to obtain a well-focused display is in the direction that increases the resistance of FOCUS control R86 (see step 2 of this procedure), then replace R83 with a resistor of lower value. A 30% decrease in the value of R83 is suggested as a first trial. The probable minimum value required is about 7.5 megohms. If a value below about 3.9 megohms is required, a circuit problem is indicated.
7. After changing the value of R83, repeat Steps 5 through 7 of this procedure (selecting R83).

This completes Step 4d of the Power Supply and Display calibration procedure.

B. VERTICAL SYSTEM ADJUSTMENT

Equipment Required

- | | |
|---|--|
| 1. Standard Amplitude Calibrator | 7. Adapter (GR874 and BNC female connectors) |
| 2. Square-Wave Generator | 8. 50 Ω BNC Termination |
| 3. Medium-Frequency Constant-Amplitude Signal Generator | 9. BNC T-connector |
| 4. 24 pF Input Normalizer | 10. Three-Inch Screwdriver |
| 5. 42-inch 50 Ω BNC Cable (2 required) | 11. Low-Capacitance Screwdriver |
| 6. BNC 50 Ω 10X Attenuator | 12. Tuning Tool |

Control Settings

Preset the instrument controls to the settings given under Preliminary Control Settings except as follows:

Sweep MODE	AUTO
INTENSITY	For visible display
Input Coupling	GND
TRIGGER LEVEL	Fully clockwise

1. Adjust Channel 1 Balance

- a. Change the CH 1 VOLTS/DIV switch from 10 mV to 1 mV.
- b. CHECK—CRT display for not more than 0.1 division of trace shift when switching from 10 mV to 1 mV.
- c. ADJUST—CH 1 STEP ATTEN BAL adjustment (located on front panel) for minimum trace shift when switching from 10 mV to 1 mV.
- d. Set the CH 1 VOLTS/DIV switch to 10 mV.
- e. Rotate the CH 1 VAR VOLTS/DIV control.
- f. CHECK—CRT display for not more than 0.3 division of trace shift when rotating the CH 1 VAR VOLTS/DIV control.
- g. ADJUST—Variable Balance adjust R212 (see Fig. 5-3) for minimum trace shift when rotating the CH 1 VAR VOLTS/DIV control.

- h. Set the CH 1 VOLTS/DIV switch to 10 mV and the CH 1 VAR VOLTS/DIV control to CAL.

2. Adjust Channel 2 Balance

- a. Set the Vertical Mode to CH 2.
- b. Change the CH 2 VOLTS/DIV switch from 10 mV to 1 mV.
- c. CHECK—CRT display for not more than 0.1 division of trace shift when switching from 10 mV to 1 mV.
- d. ADJUST—CH 2 STEP ATTEN BAL adjustment (located on front panel) for minimum trace shift when switching from 10 mV to 1 mV.
- e. Set the CH 2 VOLTS/DIV switch to 10 mV.
- f. Rotate the CH 2 VAR VOLTS/DIV control.
- g. CHECK—CRT display for not more than 0.3 division of trace shift when rotating the CH 2 VAR VOLTS/DIV control.
- h. ADJUST—Variable Balance adjust R312 (see Fig. 5-4) for minimum trace shift when rotating the CH 2 VAR VOLTS/DIV control.
- i. Set the CH 2 VOLTS/DIV switch to 10 mV and the CH 2 VAR VOLTS/DIV control to CAL.

Calibration—434 (SN B50000 and up)

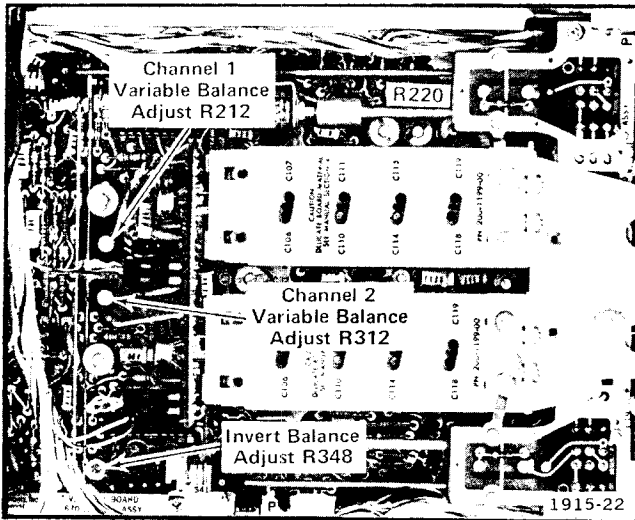

Fig. 5-4. Location of Channel 1 and 2 balance adjustments.

e. ADJUST—CH 2 GAIN adjustment (located on front panel) for exactly 5 divisions of deflection.

f. Change Vertical Mode to CH 1.

g. Remove the Standard Amplitude Calibrator signal from the CH 2 input connector and connect it to the CH 1 input connector.

h. CHECK—CRT display for 5 divisions, ± 0.15 division of deflection.

i. ADJUST—CH 1 GAIN adjustment (located on front panel) for exactly 5 divisions of deflection.

j. Position the free-running trace to the center horizontal graticule line.

k. Set the INVERT switch to the INVERT position (button out).

l. CHECK—CRT display for not more than 1.0 division of trace shift when inverting the Channel 2 display.

m. ADJUST—Invert Balance adjustment R348 (see Fig. 5-4) for minimum trace shift when inverting the Channel 2 display.

n. Push the INVERT button in.

3. Adjust CH 1 and CH 2 GAIN

a. Set input coupling for both channels to DC.

b. Connect the output of the Standard Amplitude Calibrator to the CH 2 input connector via a 42-inch BNC cable.

c. Set the Standard Amplitude Calibrator for a 50-millivolt signal output amplitude.

d. CHECK—CRT display for 5 divisions, ± 0.15 division of deflection.

4. Check CH 1 VAR VOLTS/DIV Range and Attenuator Accuracy

a. With exactly a 5-division amplitude display, rotate the CH 1 VAR VOLTS/DIV control.

b. CHECK—CRT display can be reduced in amplitude to 2 divisions or less.

c. Set the CH 1 VAR VOLTS/DIV control to CAL.

d. CHECK—Using the CH 1 VOLTS/DIV switch and the Standard Amplitude Calibrator settings given in Table 5-1, check to see if the vertical deflection factor accuracy for each position of the CH 1 VOLTS/DIV switch is within 3%.

NOTE

Replacing U210 in Channel 1 or U310 in Channel 2 may affect gain accuracy at 1 and 2 mV/DIV. R220 (CH 1) and R320 (CH 2) are selectable for 1 mV/DIV gain accuracy. R223 (CH 1) and R323 (CH 2) are selectable for 2 mV/DIV gain accuracy. If the 1 mV/DIV or 2 mV/DIV ranges are outside of specified tolerances at the completion of step 3 Gain adjustments, an approximate 2% resistance change of R220, R320, R223, or R323 will result in a 2% gain change for the corresponding range and channel. If the display exceeds 5.15 divisions, increase the resistor value by 2%. If the display is less than 4.85 divisions, decrease the value of the appropriate resistor by 2%.

TABLE 5-1
Vertical Deflection Accuracy

VOLTS/DIV Switch Setting	Standard Amplitude Calibrator Output	Vertical Deflection in Divisions	Maximum Error For $\pm 3\%$ Accuracy
1 mV	5 millivolts	5	± 0.15 division
2 mV	10 millivolts	5	± 0.15 division
5 mV	20 millivolts	4	± 0.12 division
10 mV	50 millivolts	5	Previously set in step 3.
20 mV	0.1 volt	5	± 0.15 division
50 mV	0.2 volt	4	± 0.12 division
.1 V	0.5 volt	5	± 0.15 division
.2 V	1 volt	5	± 0.15 division
.5 V	2 volts	4	± 0.12 division
1 V	5 volts	5	± 0.15 division
2 V	10 volts	5	± 0.15 division
5 V	20 volts	4	± 0.12 division
10 V	50 volts	5	± 0.15 division

5. Check CH 2 VAR VOLTS/DIV Range and Attenuator Accuracy

- a. Remove the Standard Amplitude Calibrator signal from the CH 1 input connector and connect it to the CH 2 input connector and set the Vertical Mode to CH 2.
- b. With the CH 2 VOLTS/DIV switch set to 10 mV, set the Standard Amplitude Calibrator for a 50-millivolt output signal amplitude.
- c. With an exactly 5-division amplitude display, rotate the CH 2 VAR VOLTS/DIV control.
- d. CHECK—CRT display can be reduced in amplitude to 2 divisions or less.
- e. Set the CH 2 VAR VOLTS/DIV control to CAL.
- f. CHECK—Using the CH 2 VOLTS/DIV switch and the Standard Amplitude Calibrator settings given in Table 5-1, check to see if the vertical deflection factor accuracy for each position of the CH 2 VOLTS/DIV switch is within 3%.

6. Check ADD Mode Operation

- a. Apply the Standard Amplitude Calibrator output signal to both the CH 1 and CH 2 input connectors via a BNC T-connector and two 42-inch 50 Ω BNC cables.
- b. Set both VOLTS/DIV switches to .1 V and the Vertical Mode to ADD.
- c. Set the Standard Amplitude Calibrator for a .2 volt output signal.
- d. CHECK—CRT display for 4 divisions, ± 0.12 division of deflection.
- e. Disconnect all test equipment.

7. Adjust Channel 1 VOLTS/DIV Switch Compensation

- a. Set the Channel 1 VOLTS/DIV switch to 10 mV, the Vertical Mode to CH 1, and the CH 1 Input Coupling to DC.
- b. Connect a 10X probe to the CH 1 input.
- c. Connect the square-wave generator high-amplitude output through a GR-to-BNC adapter, a 50 Ω BNC 10X attenuator, a 50 Ω BNC termination, a probe tip-to-BNC adapter to the tip of the 10X probe from the CH 1 input. Set generator for a 5-division, 1-kHz display, and compensate the probe for best front corner of waveform.
- d. Adjust the TRIGGER LEVEL control for a stable display.
- e. CHECK—CRT display at each Channel 1 VOLTS/DIV switch position for optimum square corner and flat top. Typically less than +2%, -2%, or a total of 2% peak to peak aberration within the +20°C to +30°C temperature range. (In order to maintain a 5-division display amplitude, first, remove the 10X attenuator, then the 50 Ω termination; or replace the probe and adapter with a 50 Ω cable. See Table 5-2.)
- f. ADJUST—Channel 1 VOLTS/DIV switch compensation as given in Table 5-2. Adjust for optimum square corner and flat top. Remove the 10X attenuator and/or 50 Ω BNC termination as necessary to maintain a 5-division display amplitude. Fig. 5-5 shows the location of the variable compensation adjustments.

TABLE 5-2
VOLTS/DIV Switch Compensation

VOLTS/DIV Switch Setting	Attenuator/ Compensated	Adjusted for optimum	
		Square Corner	Flat Top
10 mV	÷1		C9 for CH 1 C19 for CH 2
5 mV	Check	If error is greater than 2%, compromise setting at 1 mV, 2 mV, 5 mV, and 10 mV for best overall response.	
2 mV	Check		
1 mV	Check		
20 mV	÷2	C106	C107
50 mV	÷5	C110	C111
.1 V	÷10	C114	C115
Remove external 10X attenuator from generator			
.2 V	Check	If error is greater than 2%, compromise setting at .1 V, .2 V, and .5 V for best over- all response.	
.5 V	Check		
Remove 50 Ω termination and replace probe and adapter with a 50 Ω cable			
1 V	÷100	C118	C119
2 V	Check	If error is greater than 2%, compromise setting at 1 V, 2 V, 5 V, and 10 V for best overall response.	
5 V	Check		
10 V	Check		

8. Adjust Channel 2 VOLTS/DIV Switch Compensation

a. Set the Channel 2 VOLTS/DIV switch to 10 mV, the Vertical Mode to CH 2, and the CH 2 Input Coupling to DC.

b. Move the 10X probe from the CH 1 input to the CH 2 input.

c. Connect the square-wave generator high-amplitude output through a GR-to-BNC adapter, a 50 Ω BNC 10X attenuator, a 50 Ω BNC termination, a probe tip-to-BNC adapter to the tip of the 10X probe from the CH 2 input. Set generator for a 5-division, 1-kHz display.

NOTE

If satisfactory compensation cannot be obtained for CH 2 with 10X probe compensated as stated in Step 7 part c, perform Step 8 first and adjust probe compensation at the end of Step 8 part b. Complete Step 8, then perform Step 7 without readjusting probe compensation (Replace the last sentence of Step 7, part c with: Set generator for a 5-division, 1-kHz display).

d. CHECK—CRT display at each Channel 2 VOLTS/DIV switch position for optimum square corner and flat top. Typically less than +2%, -2%, or a total of 2% peak to peak aberration within the +20°C to +30°C temperature range. (In order to maintain a 5-division display amplitude, first, remove the 10X attenuator, then the 50 Ω termination; or replace the probe and adapter with a 50 Ω cable. See Table 5-2.)

e. ADJUST—Channel 2 VOLTS/DIV switch compensation as given in Table 5-2. Adjust for optimum square corner and flat top. Remove the 10X attenuator and 50 Ω BNC termination as necessary to maintain a 5-division display amplitude. Fig. 5-5 shows the location of the variable compensation adjustments.

f. Disconnect all test equipment.

9. Adjust High Frequency Compensation

a. Connect the positive-going fast-rise output of the Square-Wave Generator (Type 106) to the CH 1 input connector via a GR to BNC adapter, a 42-inch 50 Ω BNC cable, and a 50 Ω BNC termination.

b. Set the Vertical Mode to CH 1 and both VOLTS/DIV switches to 10 mV.

c. Set the Square-Wave Generator for a 6-division display with a repetition rate of 100 kHz. (If generator output cannot be reduced enough, add a 10X attenuator between the cable and the 50 Ω termination.) Switch the TIME/DIV to .2 μs and trigger the waveform in COMP on +SLOPE.

d. Adjust the TRIGGER LEVEL control for a stable display.

e. Center the display on the CRT viewing area with the CH 1 and Horizontal POSITION controls.

f. CHECK—CRT display for aberrations typically less than +4%, -4%, a total of 4% peak to peak within the +20°C to +30°C temperature range. Set magnified sweep to .02 μs/DIV and check for a risetime of 14 ns (0.7 division). If risetime is out of specification or aberrations are greater than typical values; preset R570 and C226 to midrange, L533 core centered in form, and L584 core flush with top of form (see Fig. 5-6).

g. ADJUST—R461 and C461 for flat front portion of waveform top. Switch to 0.2 μs and adjust C572 for maximum overshoot. Adjust L533, C217, C226, R461, and C461 for a flat front corner of waveform top with some aberrations behind the front corner. Adjust L584 for minimum aberrations behind the front corner. Check waveform at various sweep speeds and slightly readjust R570, L533, R461, C461, and C217 as necessary for maximum risetime and minimum aberrations. Readjust C572 only if necessary to reduce front corner spike.

h. Position the top of the display to the bottom graticule line.

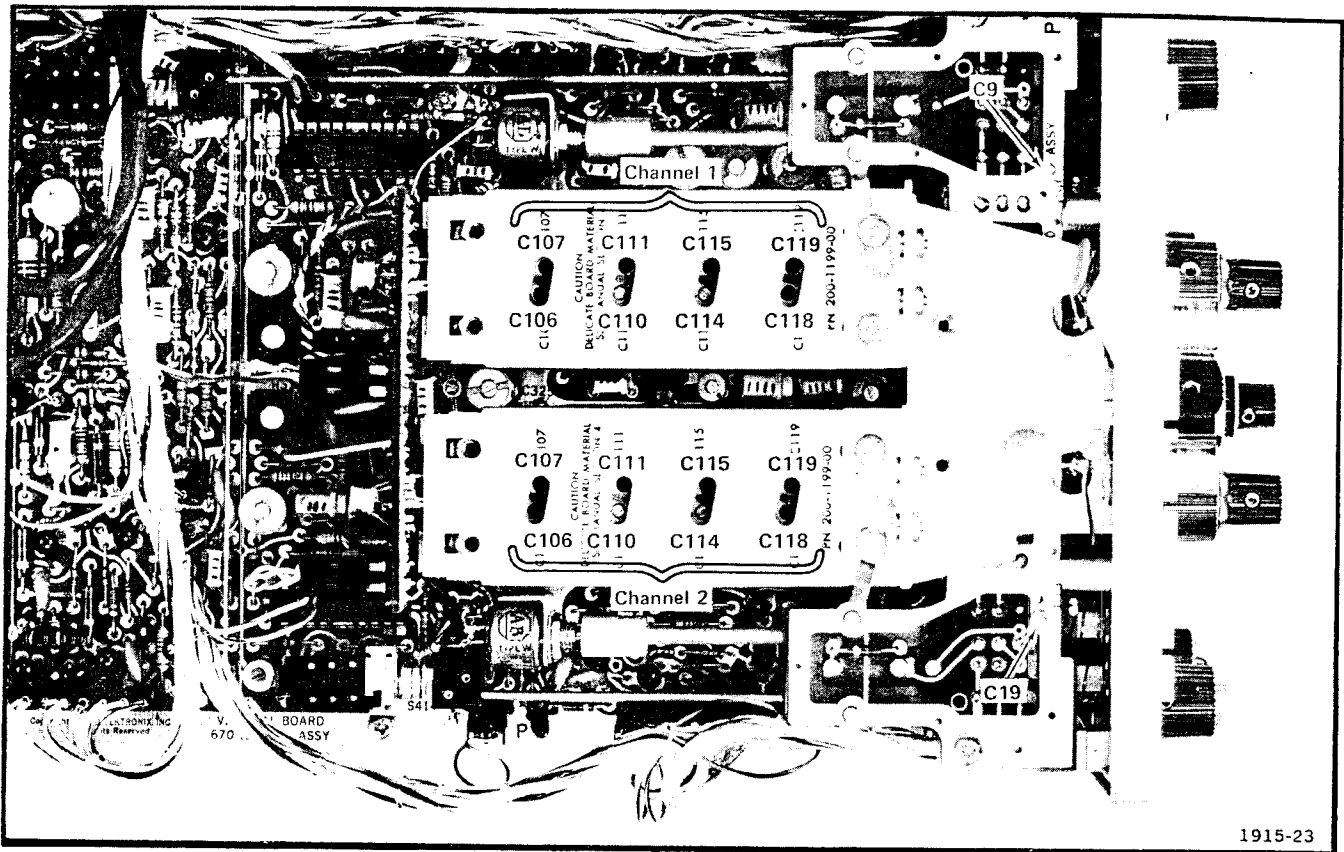

Fig. 5-5. Location of CH 1 and CH 2 Switch Compensation Adjustments.

i. CHECK—CRT display for aberrations, typically less than +7%, -7%, or a total of 7% peak to peak. If aberrations exceed this amount, repeat step 9 parts e through i. Positioning the CRT leads from L533 and L584, the lead from Q530 to L533, the lead from Q580 to L584, and replacing or interchanging Q530 and Q580 all may affect aberrations with the trace at various positions of the CRT screen.

NOTE

The tolerances given in step 9 apply only in the temperature range of +20° C to +30° C. If the results of any portion of steps 9 and 10 are outside of suggested tolerances or typical values, repeat all of both steps for the best overall compromise of Risetime, Bandwidth, and aberrations. If major components have been replaced, it may be necessary to repeat steps 1 through 8 of Section B (vertical) of the Calibration procedure.

j. Remove the Square-Wave Generator signal from the CH 1 input connector and connect it to the CH 2 input connector.

k. Set Vertical Mode to CH 2 and vertically center the display with the CH 2 POSITION control.

l. CHECK—CRT display for optimum risetime with aberrations typically less than +4%, -4%, or a total of 4% peak to peak within the +20° C to +30° C temperature range.

m. ADJUST—C317 and C326 (see Fig. 5-6) for optimum risetime with aberrations typically less than +4%, -4%, or a total of 4% peak to peak within the +20° C to +30° C temperature range.

n. Position the top of the display to the bottom graticule line.

o. CHECK—CRT display for aberrations typically less than +7%, -7%, or a total of 7% peak to peak.

p. Connect the negative-going fast-rise output of the Square-Wave Generator to the CH 2 input connector.

q. Adjust the Square-Wave Generator for a 6-division display.

r. Set TRIGGER SLOPE to - and obtain a stable display.

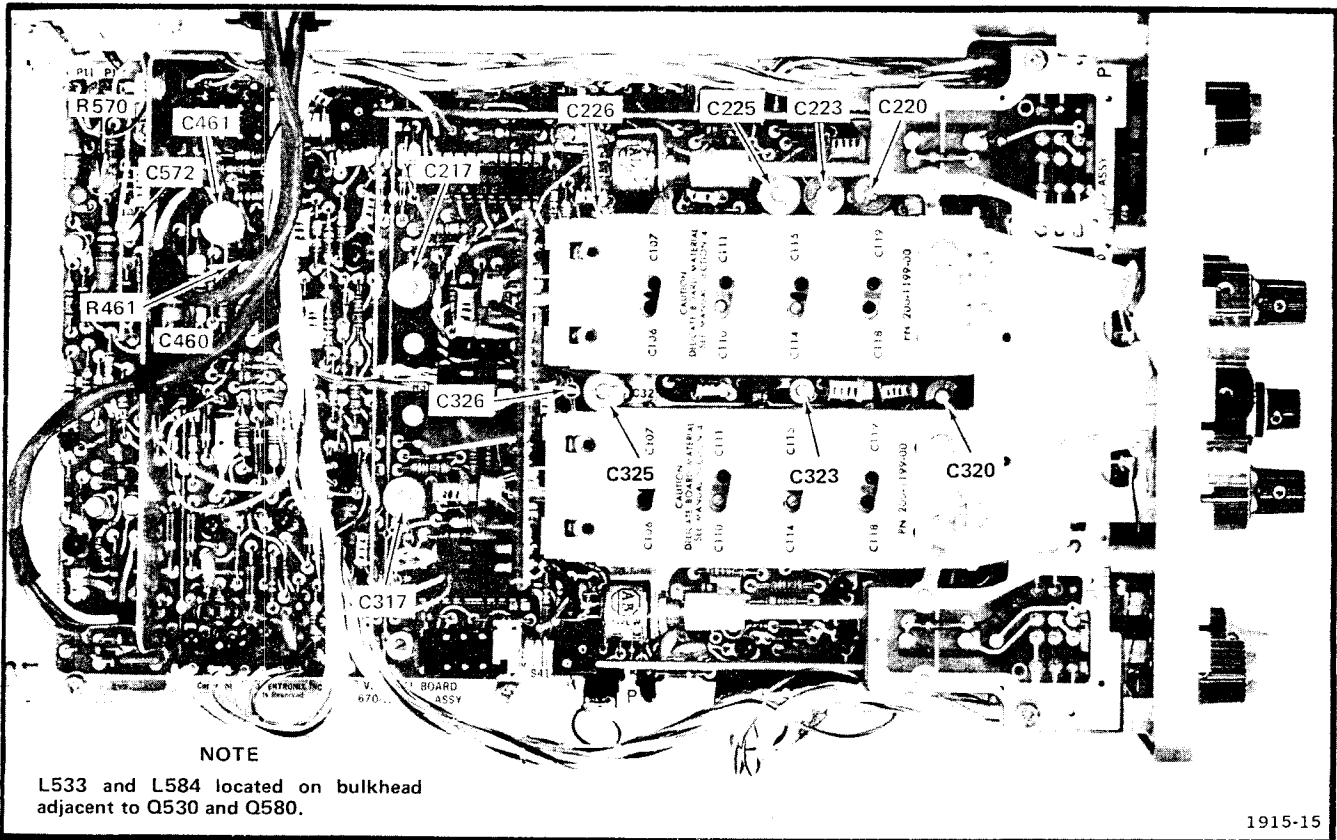

Fig. 5-6. High-frequency Compensation Adjustments.

s. Position the bottom of the display to the top of the graticule.

t. CHECK—CRT display for aberrations typically less than +9%, -9%, or a total of 9% peak to peak.

u. Remove the Square-Wave Generator signal from the CH 2 input connector and connect it to the CH 1 input connector.

v. Set the Vertical Mode to CH 1 and position the bottom of the display to the top of the graticule.

w. CHECK—CRT display for aberrations typically less than +9%, -9%, or a total of 9% peak to peak.

x. Reconnect the positive-going fast-rise output from the Square-Wave Generator to the CH 1 input connector and set the TRIGGER SLOPE switch to +.

y. Set the CH 1 VOLTS/DIV switch to 5 mV.

z. Adjust the Square-Wave Generator for a 6-division display.

aa. Vertically center the display using the CH 1 POSITION control.

ab. CHECK—CRT display in 1 mV, 2 mV, and 5 mV positions of the CH 1 and CH 2 VOLTS/DIV switches. Refer to Table 5-3. Use the 10X BNC attenuator as necessary to maintain a 6-division display amplitude.

TABLE 5-3

Amplifier Compensation

VOLTS/DIV Switch Setting	Compensation Adjustment	Typical Aberration
5 mV	C225 in Channel 1 C325 in Channel 2	Less than +4% -4%, total of 4% peak to peak
2 mV	C223 in Channel 1 C323 in Channel 2	
1 mV	C220 in Channel 1 C320 in Channel 2	

NOTE

If correct compensation cannot be obtained in the 2 mV and 1 mV settings with C220, C223, C320, and C323 adjustments, add or subtract from the value of C222, C322, C228, or C328 in approximately 15 pF increments until the desired compensation is obtained for the range and channel in question.

Calibration—434 (SN B500000 and up)

ac. ADJUST—Refer to Table 5-3 for the correct adjustment and tolerances. See Fig. 5-6 for adjustment locations.

ad. Disconnect all test equipment.

10. Check Vertical Amplifier Bandwidth

a. Connect the output of the Medium-Frequency Constant-Amplitude Signal Generator to the CH 1 input connector via a GR to BNC adapter, a 42-inch 50 Ω BNC cable, a 10X BNC attenuator, and a 50 Ω BNC termination.

b. Set both VOLTS/DIV switches to 10 mV, the Vertical Mode to CH 1, and the TRIGGER LEVEL control fully clockwise.

c. Adjust the signal generator output amplitude for a 6-division display of the reference frequency.

d. Without changing the output amplitude, increase the output frequency until the display is reduced to 4.2 divisions.

e. CHECK—Output frequency of the signal generator must be at least 25 megahertz.

f. Repeat this bandwidth check procedure for all positions listed in Table 5-4. Check both Channel 1 and Channel 2.

TABLE 5-4

Vertical Amplifier Bandwidth

VOLTS/DIV Switch Setting	Minimum Bandwidth	
	-15°C to +30°C	+30°C to +55°C
10 mV	25 megahertz	25 megahertz
5 mV	23 megahertz	21 megahertz
2 mV	20 megahertz	18 megahertz
1 mV	18 megahertz	16 megahertz

11. Check 5 MHz Bandwidth

a. Connect the output of the Medium-Frequency Constant-Amplitude Signal Generator to the CH 1 input connector via a GR to BNC adapter, a 42-inch 50 Ω BNC cable, and a 50 Ω BNC termination.

b. Set the CH 1 VOLTS/DIV switch to 10 mV and the Vertical Mode to CH 1.

c. Set the 5 MHz BW button to the out position.

d. Adjust the output of the signal generator for a 6-division display of the reference frequency.

e. Without changing the output amplitude, increase the frequency of the signal generator until the display is reduced to 4.2 divisions.

f. CHECK—Output frequency of the generator must be 5 megahertz, ± 1 megahertz.

g. Disconnect all test equipment.

For Service Manuals Contact
MAURITRON TECHNICAL SERVICES
8 Cherry Tree Rd, Chinnor
Oxon OX9 4QY
Tel: 01844-351694 Fax: 01844-352554
Email: enquiries@mauritron.co.uk

C. TRIGGER CIRCUIT ADJUSTMENT

Equipment Required

- | | |
|---|--|
| 1. Medium-Frequency Constant-Amplitude Signal Generator | 4. BNC T-connector |
| 2. Low-Frequency Signal Generator | 5. 42-Inch 50 Ω BNC Cable (two required) |
| 3. 50 Ω BNC Termination (two required) | 6. Three-Inch Screwdriver |
| | 7. 50 Ω BNC 10X Attenuator (two required) |

Control Settings

Preset the instrument controls to the settings given under Preliminary Control Settings except as follows:

Sweep MODE	AUTO
TIME/DIV	50 μ s
INTENSITY	Visible Display
TRIGGER COUPLING	AC

1. Adjust Trigger Level Centering

a. Connect the output of the Medium-Frequency Constant-Amplitude Signal Generator to the CH 1 input connector via a GR to BNC adapter, a 42-inch 50 Ω BNC cable, and a 50 Ω BNC termination.

b. Adjust the output of the signal generator for a 0.3 division display of the reference frequency.

c. Vertically center the display around the center graticule line.

d. CHECK—That the TRIGGER LEVEL control can be adjusted for a stable display with the TRIGGER LEVEL control knob pointing somewhere in the word "LEVEL" (check this for both + and - positions of the TRIGGER SLOPE switch).

e. ADJUST—Trigger Level Centering adjustment R629 (see Fig. 5-7) for a stable display in the + position of the TRIGGER SLOPE switch with the TRIGGER LEVEL control centered.

2. Adjust CH 1 and COMP Trigger DC Level

a. Set the TRIGGER COUPLING to DC and the TRIGGER SLOPE switch to +.

b. CHECK—CRT for a stable display.

c. ADJUST—Comp Trigger DC Level adjustment R274 (see Fig. 5-8) for a stable display.

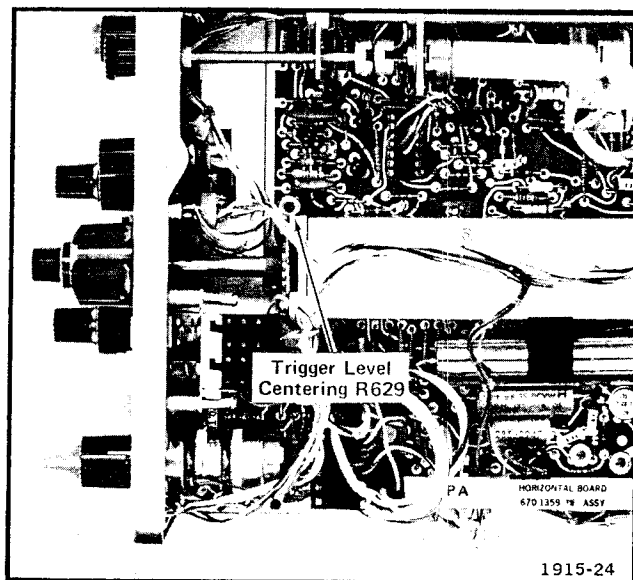

Fig. 5-7. Location of Trigger Level Centering adjustment.

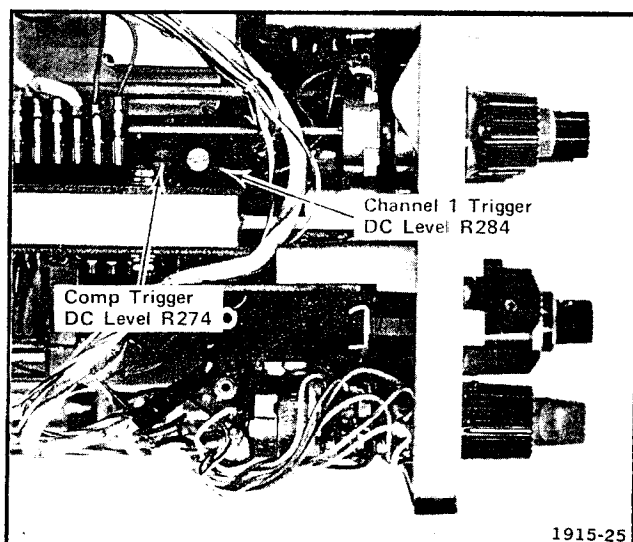

Fig. 5-8. Location of trigger DC level adjustments.

Calibration—434 (SN B500000 and up)

- d. Set the TRIGGER SOURCE to CH 1.
- e. CHECK—CRT for a stable display.
- f. ADJUST—CH 1 Trigger DC Level adjustment R284 (see Fig. 5-8) for a stable display

3. Check Trigger Circuit Operation

NOTE

For EXT trigger checks: Adjust the signal amplitude at the reference frequency, then switch to the check point frequency without changing the amplitude control.

a. Attach a T-connector to a GR-BNC adapter and connect the GR end of the adapter to the Medium Frequency Constant Amplitude signal generator. To each output of the T-connector, attach a 42 inch 50 Ω BNC cable, a 50 Ω BNC 10X attenuator and a 50 Ω BNC termination (in that order). Connect one of the terminations to the CH 1 input connector and the other termination to the EXT TRIG input connector on the rear panel.

NOTE

Set the TIME/DIV switch to view the frequency of the signal being used in each of the following checks.

b. CHECK—Stable display can be obtained using the signal amplitude and coupling modes given in Table 5-5.

TABLE 5-5

Trigger Operation Check

TRIGGER SOURCE	TRIGGER COUPLING	Minimum Signal Amplitude	
		5 MHz	25 MHz
CH 1 & COMP	AC DC LF REJ	0.3 div	1 div
EXT	AC DC LF REJ	50 mV	175 mV

c. Set TRIGGER SOURCE to COMP and TRIGGER COUPLING to HF REJ

d. Adjust the signal generator output for a 0.7 division display of the reference frequency.

- e. CHECK—A stable display can be obtained.
- f. Adjust the signal generator output for a 0.7-division display of a 1-megahertz signal.
- g. CHECK—A stable display cannot be obtained. Push HF REJ button to release.
- h. Disconnect the Medium-Frequency Constant Amplitude signal generator from the 434 and connect the Low-Frequency signal generator to the CH 1 input and EXT TRIG input connectors through a T-connector and unterminated 50 Ω BNC cables.

- i. Set the TRIGGER COUPLING to LF REJ.
- j. Adjust the Low-Frequency Signal Generator for a 0.7-division display of a 30-kilohertz signal.
- k. CHECK—A stable display can be obtained.
- l. Adjust the signal generator for a 0.7-division display of a 100-hertz signal.
- m. CHECK—A stable display cannot be obtained. Push LF REJ button to release.
- n. Adjust the signal generator for a 0.7-division display of a 100-hertz signal.

- o. Set Sweep MODE to NORM.
- p. CHECK—Should be able to obtain a stable display. When the TRIGGER LEVEL control is rotated fully counterclockwise or clockwise, there should be no display presented on the CRT.

4. Check Single Sweep Operation

- a. Adjust the signal generator for a 0.3-division display of a 1-kilohertz signal.
- b. Set the TRIGGER COUPLING to AC.
- c. Adjust the TRIGGER LEVEL control for a stable display.
- d. Set the Sweep MODE to BOTH IN:SINGLE.

- e. Press the RESET button.
- f. CHECK—A single-sweep display (one sweep only) is presented.
- g. Rotate the TRIGGER LEVEL control fully clockwise.
- h. Press the RESET button.
- i. CHECK—The READY light comes on and remains on until the sweep is triggered.
- j. Rotate the TRIGGER LEVEL control through midrange.
- k. CHECK—A single-sweep display (one sweep only) is presented and the READY light goes out.

5. Check TRIGGER LEVEL Control Range

- a. Set the Sweep MODE to AUTO, TRIGGER COUPLING to DC, TRIGGER SOURCE to EXT, and the CH 1 VOLTS/DIV switch to 1 V.
- b. Adjust the signal generator for a 4-division display of a 1-kilohertz signal.
- c. CHECK—Rotate the TRIGGER LEVEL control throughout its range and check that the display can be triggered (stable display) at any point along the slope of the waveform in both the + and – positions of the TRIGGER SLOPE switch. This indicates a control range of at least +2 volts to –2 volts.

- d. Set the EXT ATTEN pushbutton to 1:10 and the CH 1 VOLTS/DIV switch to 10 V.
- e. Adjust the signal generator for a 4-division display of a 1-kilohertz signal.
- f. CHECK—Rotate the TRIGGER LEVEL control throughout its range and check that the display can be triggered (stable display) at any point along the slope of the waveform in both the + and – positions of the TRIGGER SLOPE switch. This indicates a control range of at least +20 volts to –20 volts.
- g. Disconnect all test equipment.

6. Check Line Triggering

- a. Connect a 10X probe (434 standard accessory) to the CH 1 input connector.
- b. Set the TRIGGER SOURCE to LINE, the TRIGGER COUPLING to AC, and the CH 1 VOLTS/DIV switch to 10 V.
- c. Connect the probe tip to the same line-voltage source that is connected to the instrument.
- d. Adjust the TRIGGER LEVEL control for a stable display.
- e. CHECK—Stable CRT display triggered on the correct slope in both the + and – positions of the TRIGGER SLOPE switch.
- f. Disconnect all test equipment.

For Service Manuals Contact
MAURITRON TECHNICAL SERVICES
8 Cherry Tree Rd, Chinnor
Oxon OX9 4QY
Tel: 01844-351694 Fax: 01844-352554
Email: enquiries@mauritron.co.uk

D. HORIZONTAL SYSTEM CALIBRATION

Equipment Required

- | | |
|----------------------------------|----------------------------------|
| 1. Test Oscilloscope | 4. 42-Inch 50 Ω BNC Cable |
| 2. Time-Mark Generator | 5. Three-Inch Screwdriver |
| 3. Standard Amplitude Calibrator | 6. Low-Capacitance Screwdriver |

Control Settings

Preset instrument controls to the settings given under Preliminary Control Settings except as follows:

Sweep MODE	AUTO
INTENSITY	Visible Display

1. Adjust Sweep Generator Offset

- Connect a 1X probe to the test oscilloscope vertical input.
- Connect the tip of the 1X probe to TP701 (see Fig. 5-9).
- Set the test oscilloscope input coupling to ground and establish a 0 V DC reference level.

d. Set the test oscilloscope input coupling to DC and the Volts/Div to 5 mV.

e. CHECK—Test oscilloscope display is within 2 divisions of the 0 V DC reference level.

f. ADJUST—Sweep Generator Offset adjustment R703 (see Fig. 5-9) to center the test oscilloscope display around the 0 V DC reference level.

g. Disconnect all test equipment.

2. Adjust Sweep Cal

- Connect a Time-Mark Generator to the CH 1 input connector via a 42-inch 50 Ω BNC cable.

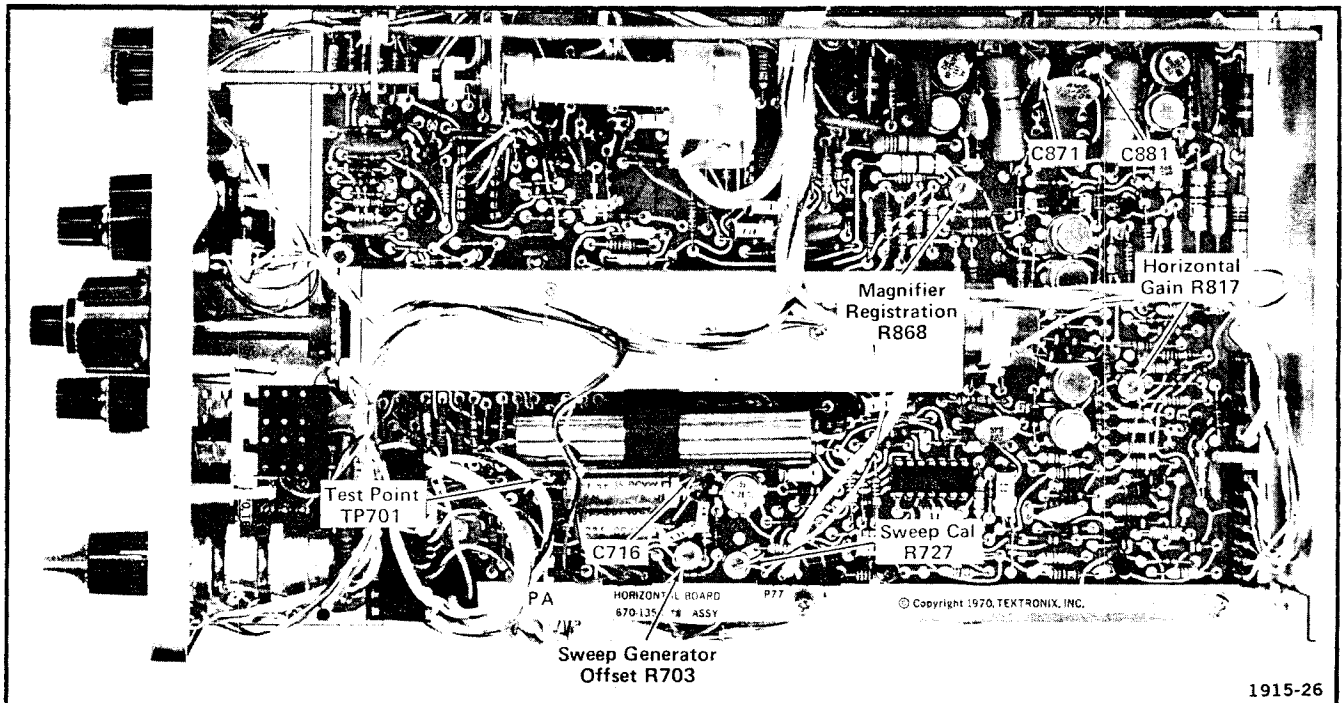

Fig. 5-9. Location of horizontal system adjustments and test points.

NOTE

If the Tektronix Type 184 Time-Mark Generator is used, attach the signal to the CH 1 input connector via a 42-inch 50 Ω BNC cable and a 50 Ω BNC termination

- b. Set the Sweep MODE to NORM.
- c. Set the Time-Mark Generator for 1 ms and .1 ms time marks.
- d. Set the CH 1 VOLTS/DIV switch to .5 V and adjust the TRIGGER LEVEL control for a stable display.
- e. CHECK—CRT display for a sweep duration of approximately 11 ms (indicated by twelve 1-millisecond time marks).
- f. ADJUST—Sweep Cal adjustment R727 (see Fig. 5-9) for a sweep duration of 11 milliseconds.

3. Adjust Horizontal Gain

- a. Horizontally position the display to align the first time mark with the left hand edge of the CRT graticule.
- b. CHECK—Eleventh time mark should align with the right hand edge of the CRT graticule within 0.3 division (0.4 division if this measurement is being made outside the +20° C to +30° C temperature range).
- c. ADJUST—Horizontal Gain adjustment R817 (see Fig. 5-9) for one 1-millisecond time mark per division.

4. Adjust Magnifier Registration

- a. Set the Time-Mark Generator for 5 ms time marks and adjust the TRIGGER LEVEL control for a stable display.
- b. With the TIME/DIV switch set to 1 ms, set the MAG switch to 20 μs (50X magnification).
- c. Horizontally position the middle time mark to the center vertical graticule line.
- d. Set the MAG switch to 1 ms (1X magnification).
- e. CHECK—Middle time mark should remain aligned with the center vertical graticule line within approximately 1 division.

- f. ADJUST—Magnifier Registration adjustment R868 (see Fig. 5-9) to align the middle time mark with the center vertical graticule line.

- g. Repeat steps b through f until the middle time mark remains aligned with the center vertical graticule line.

5. Check VAR TIME/DIV Range

- a. Set the Time-Mark Generator for 10 ms time marks.
- b. Rotate the VAR TIME/DIV control through its range of adjustment and set for minimum spacing between time marks.
- c. CHECK—CRT display for 4 or less divisions between time marks when VAR TIME/DIV control is set to minimum. This indicates a variable range of adjustment of at least 2.5:1.

6. Adjust High Speed Timing

- a. Set the TIME/DIV switch to .2 μs.
- b. Set the Time-Mark Generator for .1 μs time marks.
- c. CHECK—CRT display for two time marks per division within 0.3 division (0.4 division if this measurement is being made outside of the +20° C to +30° C temperature range).
- d. ADJUST—C716 (see Fig. 5-9) for two time marks per division.
- e. With the TIME/DIV switch set to .2 μs, set the MAG switch to .02 μs.
- f. Set the Time-Mark Generator for 10 nanosecond sinewave (20 nanosecond sinewave if using a Type 184).

NOTE

If the Tektronix Type 184 Time-Mark Generator is used, attach a 42-inch 50 Ω BNC cable from the Type 184 trigger output to the 434 EXT TRIG input. Set the Type 184 trigger output to 1 μs. Switch the 434 TRIGGER SOURCE to EXT and adjust the 434 TRIGGER LEVEL for a stable display.

- g. CHECK—CRT display for 2 cycles per division (1 cycle per division if using a 20 nanosecond sinewave) within 0.4 division (0.5 division if this measurement is being made outside of the +20° C to +30° C temperature range). Exclude the first and last 2 divisions of the magnified sweep.

Calibration—434 (SN B500000 and up)

h. ADJUST—C871 and C881 (see Fig. 5-9) for best timing and linearity, excluding the first and last 2 divisions of the magnified sweep.

i. Set the TIME/DIV switch to $1 \mu\text{s}$ and the MAG switch to $.02 \mu\text{s}$. Set the VOLTS/DIV switch to 2 mV.

j. CHECK—CRT display for 2 cycles per division (1 cycle per division if using a 20 nanosecond sine wave) within 0.4 division (0.5 division if this measurement is being made outside of the $+20^\circ\text{C}$ to $+30^\circ\text{C}$ temperature range). Exclude the first and last 10 divisions of magnified sweep.

k. ADJUST—C871 and C881 (see Fig. 5-9) as necessary for the best compromise of timing and linearity between $1 \mu\text{s}$ with 50X magnification (as in step 6 part i) and $.2 \mu\text{s}$ with 10X magnification (as in part 6 part e).

7. Check TIME/DIV Accuracy

a. Set the TRIGGER SOURCE switch to COMP.

b. CHECK—Apply the appropriate time marks and check each position of the TIME/DIV switch for proper timing (unmagnified) over the first 10 divisions of sweep within 0.3 division (0.4 division if this measurement is being made outside of the $+20^\circ\text{C}$ to $+30^\circ\text{C}$ temperature range).

8. Check Magnified Sweep Accuracy

a. Set the TIME/DIV switch to 1 ms.

b. CHECK—Apply the appropriate time marks and check magnified timing at .5 ms, .2 ms, .1 ms, $50 \mu\text{s}$, and $20 \mu\text{s}$ within 0.4 division (0.5 division if this measurement is being made outside of the $+20^\circ\text{C}$ to $+30^\circ\text{C}$ temperature range).

c. Set the TIME/DIV switch to .5 ms.

d. CHECK—Apply the appropriate time marks and check magnified timing at .2 ms and $20 \mu\text{s}$ within 0.4 division (0.5 division if this measurement is being made outside of the $+20^\circ\text{C}$ to $+30^\circ\text{C}$ temperature range).

e. Set the TIME/DIV switch to .2 ms.

f. CHECK—Apply the appropriate time marks and check magnified timing at $50 \mu\text{s}$ and $5 \mu\text{s}$ within 0.4 division (0.5 division if this measurement is being made outside of the $+20^\circ\text{C}$ to $+30^\circ\text{C}$ temperature range).

9. Check High Speed Magnified Timing Accuracy

a. CHECK—Timing accuracy of TIME/DIV and MAG switch combinations given in Table 5-6 within 0.4 division (0.5 division if this measurement is being made outside of the $+20^\circ\text{C}$ to $+30^\circ\text{C}$ temperature range).

NOTE

If the Type 184 Time-Mark Generator is used, see the note in step 6.

TABLE 5-6

High Speed Magnified Timing Accuracy

TIME/DIV	MAG	Portions Excluded
1 μs	.5 μs	First and last .5 division.
	.2 μs	First and last 1 division.
	.1 μs	First and last 2 divisions.
	.05 μs	First and last 5 divisions.
	.02 μs	First and last 10 divisions.
.5 μs	.2 μs	First and last .5 division.
	.1 μs	First and last 1 division.
	.05 μs	First and last 2 divisions.
	.02 μs	First and last 5 divisions.
.2 μs	.1 μs	First and last .5 division.
	.05 μs	First and last 1 division.
	.02 μs	First and last 2 divisions.

b. Disconnect all test equipment.

10. Check External Horizontal Sensitivity

CAUTION

To avoid possible damage to the CRT phosphor, do not allow a bright spot to remain stationary for an extended period of time.

a. Set the TIME/DIV switch to EXT HORIZ and the TRIGGER LEVEL control fully clockwise.

b. Connect the output of the Standard Amplitude Calibrator to the EXT HORIZ input connector via a 42-inch 50Ω BNC cable.

c. Set the Standard Amplitude Calibrator for a 2-volt output signal amplitude.

d. CHECK—CRT display for two dots horizontally separated by approximately 4 divisions (typically within 3.5 to 4.5 divisions).

e. Disconnect all test equipment.

Calibration—434 (SN B500000 and up)

2. Adjust Calibrator Repetition Rate

NOTE

If a frequency counter with an accuracy of at least 0.1% is available (such as Tektronix 7D14 Digital Counter), it can be used to check the accuracy of the Calibrator.

- a. Connect a 10X probe (434 standard accessory) to the CH 1 input connector. Connect the tip of the probe to R1716 (see Fig. 5-10).
- b. Connect the output of the Time-Mark Generator to the CH 2 input connector via a 42-inch 50 Ω BNC cable. Set the Time-Mark Generator for 1-millisecond time marks.
- c. Adjust the VOLTS/DIV switches for approximately 2 divisions of display of each signal.
- d. Vertically position the waveforms around the center of the graticule.
- e. Set the TRIGGER SOURCE switch to COMP and adjust the LEVEL control for a stable display.
- f. Set the TIME/DIV switch to 0.2 ms/DIV then set magnification for 5 μ s/DIV.
- g. Horizontally position the start of the second calibrator cycle to the second vertical graticule line.
- h. CHECK—The time difference between the start of the second calibrator cycle and the second time mark does not exceed 10 microseconds (2 major graticule divisions at 5 μ s/DIV). If this CHECK is being made outside the +20°C to +30°C temperature range, increase the allowable time difference to 20 microseconds (4 major graticule divisions at 5 μ s/DIV).
- i. ADJUST—If the limits of the CHECK step are not met, adjust R1704 to align the second calibrator cycle with the second time mark.
- j. Disconnect all test equipment.
- k. This completes the calibration procedure for the 434 Oscilloscope. Replace the instrument wrap-around cabinet. If the instrument has been completely checked and adjusted to the tolerances given in this procedure, it will meet or exceed the specifications given in Section 1.

For Service Manuals Contact
MAURITRON TECHNICAL SERVICES
 8 Cherry Tree Rd, Chinnor
 Oxon OX9 4QY
 Tel: 01844-351694 Fax: 01844-352554
 Email: enquiries@mauritron.co.uk

RACKMOUNTING

Introduction

The Tektronix R434 Oscilloscope is designed to mount in a standard 19-inch rack. When mounted in accordance with the following mounting procedure this instrument will meet all electrical and environmental characteristics given in section 1.

Rack Dimensions

Height. At least 5 1/4 inches of vertical space is required to mount this instrument in a rack.

Width. Minimum width of the opening between the left and right front rails of the rack must be 17 5/8 inches.

Depth. Total depth necessary to mount the R434 in a cabinet rack is 18 inches. This allows room for air circulation, power cord connection and the necessary mounting hardware.

Mounting Procedure

The following mounting procedure uses the Rack Adapter Assembly and the included Rackmount Hardware Kit to insure meeting the environmental characteristics of the instrument. If alternative methods of mounting are used, the instrument may not meet the given environmental characteristics for shock and vibration.

Use the following procedure to install the R434 in a rack:

1. Remove the instrument from the Rack Adapter Assembly in the manner given for cabinet removal in section 4 of this manual.

2. Select the proper front-rail mounting holes in the instrument using the measurements shown in Fig. 6-1.

3. Slide the Rack Adapter Assembly into the rack and align the screw-holes in the Rack Adapter Assembly front panel with the screw holes in the rack front rails that were selected in step 2.

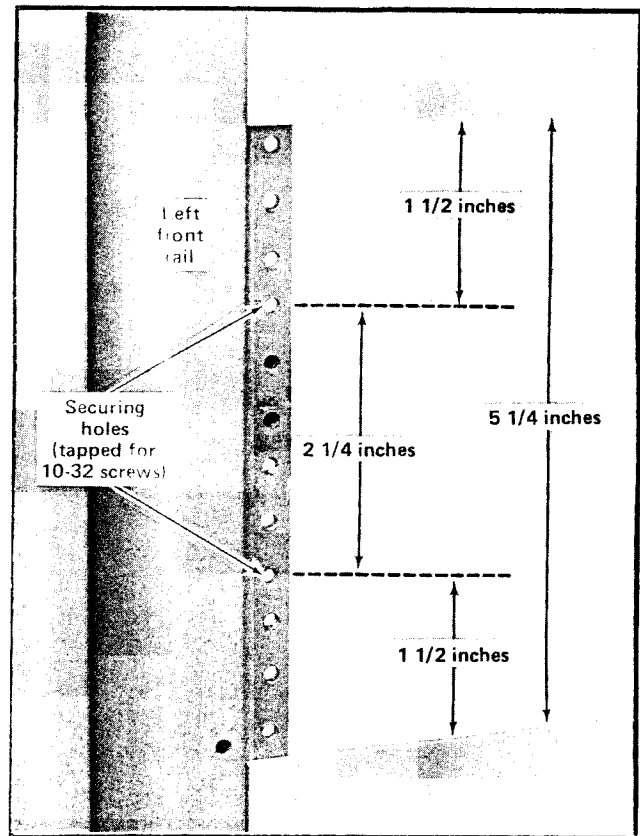

Fig. 6-1. Locating the mounting holes in the rack front rails.

4. Secure the Rack Adapter Assembly to the front-rails of the rack. Use the appropriate screws with a plastic washer and finishing washer on each screw from the hardware kit provided. See Figs. 6-2 and 6-3.

5. Position the bracket extensions (provided in the hardware kit) over the rear supports of the Rack Adapter Assembly.

6. Using the Rack Adapter Assembly and the rear rack rails as guides, loosely secure the bracket extensions to the rear supports of the Rack Adapter Assembly approximately in their final permanent positions. Refer to Fig. 6-4.

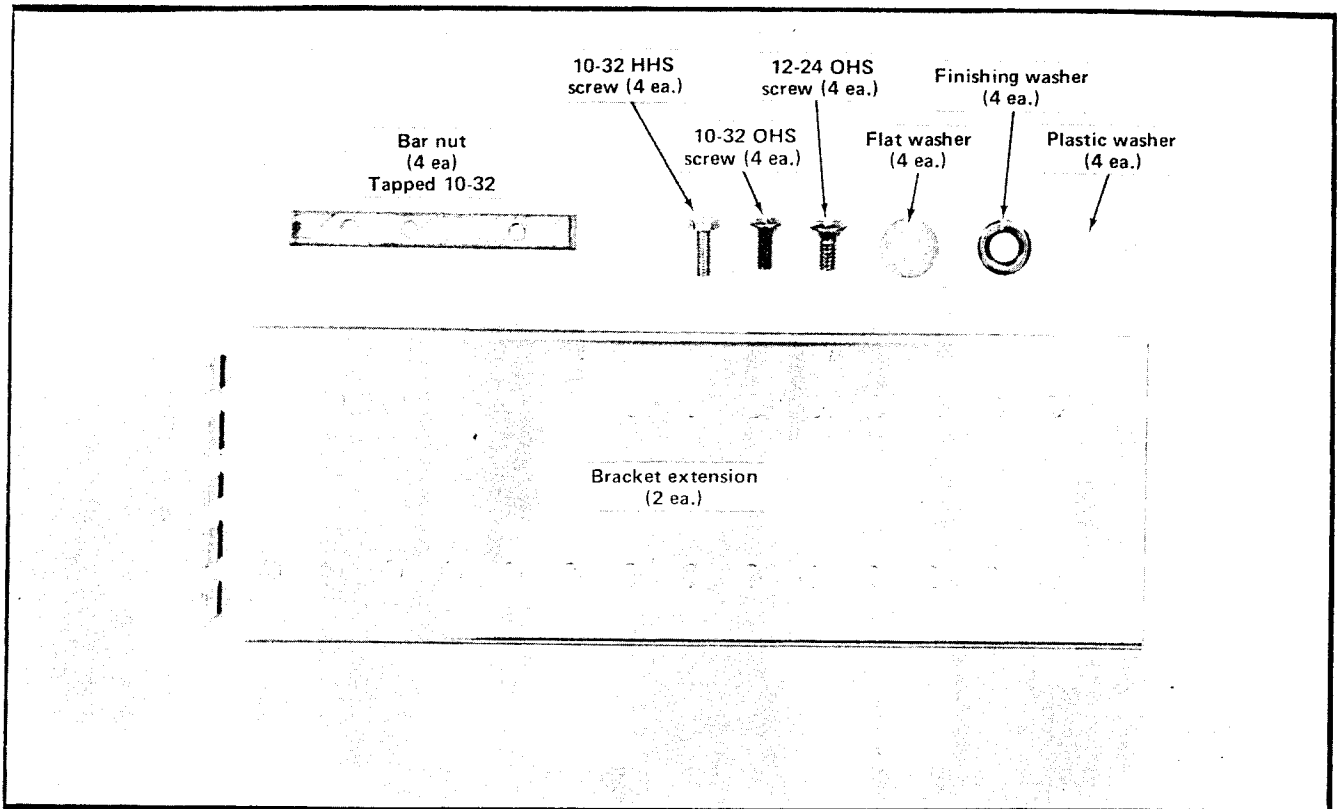

Fig. 6-2. Hardware needed to mount the instrument in the cabinet rack.

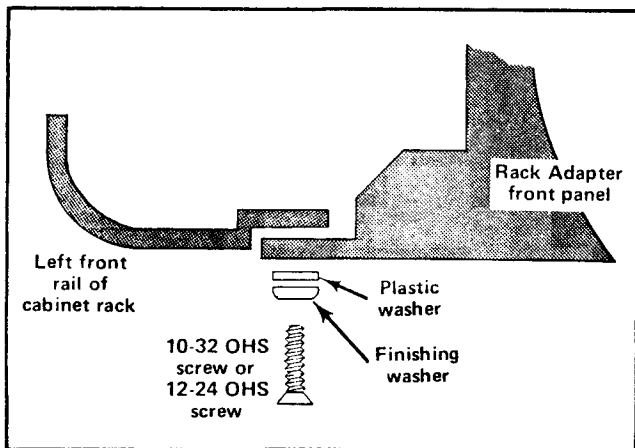

Fig. 6-3. Mounting the instrument to the front rails.

7. Secure the bracket extensions to the rear rails of the rack. Refer to Fig. 6-4 for hardware and positioning information.

8. Tighten the hardware securing the bracket extensions to the rear supports of the Rack Adapter Assembly. The Rack Adapter Assembly should now be completely installed in the rack.

9. Install the 434 Oscilloscope in the Rack Adapter Assembly in the manner given in section 4 of this manual.

Portable Conversion

The 434 is readily converted from a rack-mounted instrument to a portable instrument or vice versa. To rack-mount a portable 434, order the Rack Adapter Assembly Tektronix Part Number 016-0272-00. Remove the instrument from the portable wrap-around cabinet and install it in the Rack Adapter Assembly.

Conversely, to use an R434 as a portable instrument, order the 434 portable oscilloscope wrap-around cabinet Tektronix Part Number 390-0187-02 and the front cover Tektronix Part Number 200-1203-04. Remove the instrument from the Rack Adapter Assembly and install the portable wrap-around and front cover. Refer to section 4 of this manual for instrument removal instructions.

Rear Panel Signal Connections

The three signal input connectors on the rear panel of the 434 are not readily accessible when the instrument is rack mounted. Provisions have been made, however, to make these inputs available at the front panel of the instrument if so desired. Each signal connection requires one 30-inch 50-ohm BNC cable Tektronix Part Number

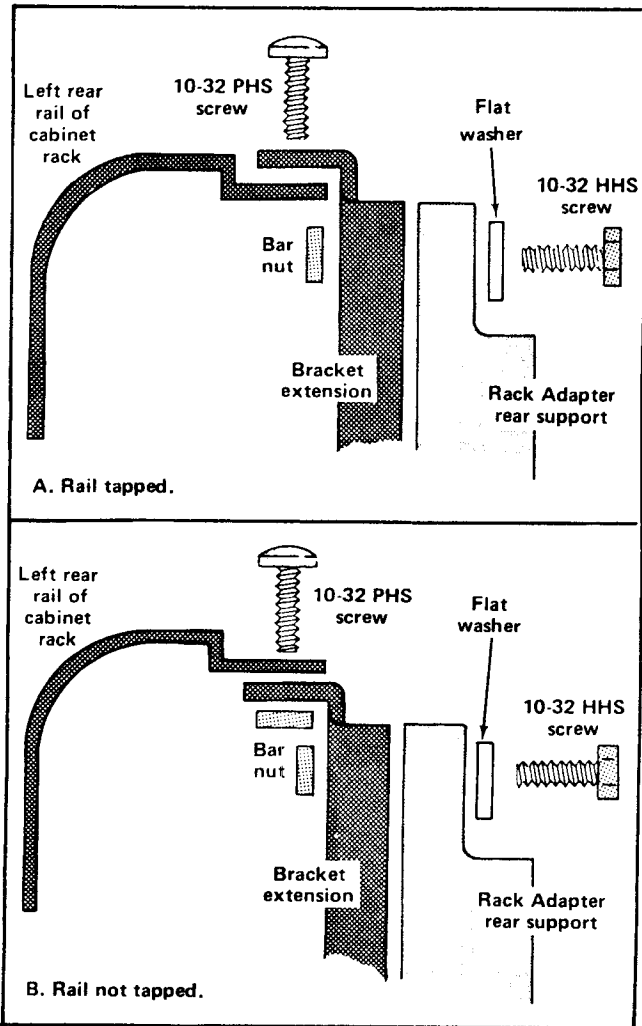

Fig. 6-4. Installing the rear bracket extensions.

012-0117-00, one chassis-mount BNC thru-connector Tektronix Part Number 103-0070-00, and, if vertical clearance above the rear panel connectors is less than approximately 1 1/4 inches, one BNC 90° elbow Tektronix Part Number 103-0031-00.

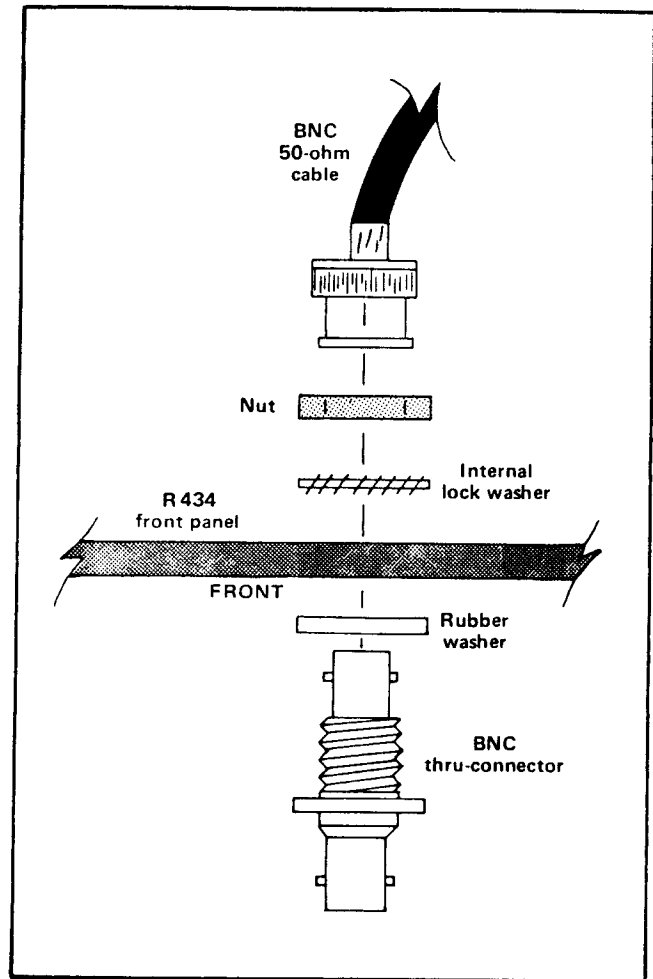

Fig. 6-5. Mounting a chassis-mount BNC thru-connector.

Remove a plastic plug from the front panel of the R434. Mount a BNC thru-connector in the hole in the front panel (see Fig. 6-5). Connect the newly-mounted BNC connector to the desired rear-panel input connector with the 30-inch 50-ohm BNC cable. If insufficient vertical clearance is available over the rear panel connector, use the BNC 90° elbow to make the connection.

For Service Manuals Contact
MAURITRON TECHNICAL SERVICES
 8 Cherry Tree Rd, Chinnor
 Oxon OX9 4QY
 Tel: 01844-351694 Fax: 01844-352554
 Email: enquiries@mauritron.co.uk

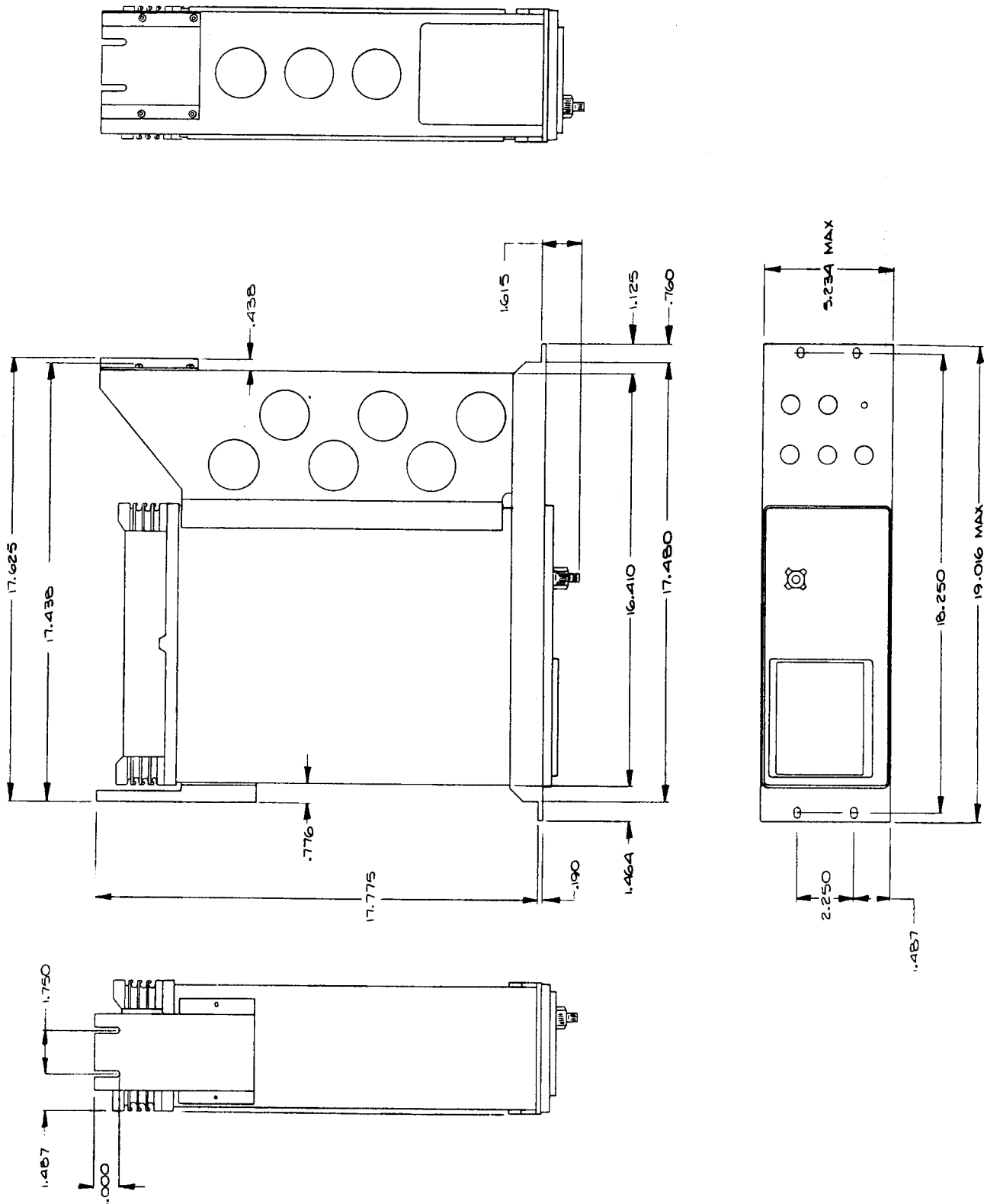

Fig. 6-6. Dimensional drawing.

REPLACEABLE ELECTRICAL PARTS

PARTS ORDERING INFORMATION

Replacement parts are available from or through your local Tektronix, Inc. Field Office or representative.

Changes to Tektronix instruments are sometimes made to accommodate improved components as they become available, and to give you the benefit of the latest circuit improvements developed in our engineering department. It is therefore important, when ordering parts, to include the following information in your order: Part number, instrument type or number, serial number, and modification number if applicable.

If a part you have ordered has been replaced with a new or improved part, your local Tektronix, Inc. Field Office or representative will contact you concerning any change in part number.

Change information, if any, is located at the rear of this manual.

LIST OF ASSEMBLIES

A list of assemblies can be found at the beginning of the Electrical Parts List. The assemblies are listed in numerical order. When the complete component number of a part is known, this list will identify the assembly in which the part is located.

CROSS INDEX-MFR. CODE NUMBER TO MANUFACTURER

The Mfr. Code Number to Manufacturer index for the Electrical Parts List is located immediately after this page. The Cross Index provides codes, names and addresses of manufacturers of components listed in the Electrical Parts List.

ABBREVIATIONS

Abbreviations conform to American National Standard Y1.1.

COMPONENT NUMBER (column one of the Electrical Parts List)

A numbering method has been used to identify assemblies, subassemblies and parts. Examples of this numbering method, and typical expansions are illustrated by the following:

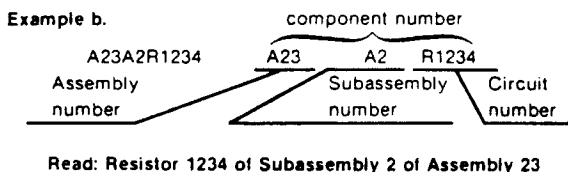
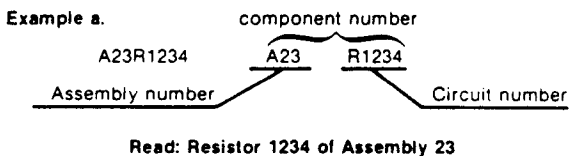

Only the circuit number will appear on the diagrams and circuit board illustrations. Each diagram and circuit board illustration is clearly marked with the assembly number. Assembly numbers are also marked on the mechanical exploded views located in the Mechanical Parts List. The component number is obtained by adding the assembly number prefix to the circuit number.

The Electrical Parts List is divided and arranged by assemblies in numerical sequence (e.g., assembly A1 with its subassemblies and parts, precedes assembly A2 with its subassemblies and parts).

Chassis-mounted parts have no assembly number prefix and are located at the end of the Electrical Parts List.

TEKTRONIX PART NO. (column two of the Electrical Parts List)

Indicates part number to be used when ordering replacement part from Tektronix.

SERIAL/MODEL NO. (columns three and four of the Electrical Parts List)

Column three (3) indicates the serial number at which the part was first used. Column four (4) indicates the serial number at which the part was removed. No serial number entered indicates part is good for all serial numbers.

NAME & DESCRIPTION (column five of the Electrical Parts List)

In the Parts List, an Item Name is separated from the description by a colon (:). Because of space limitations, an Item Name may sometimes appear as incomplete. For further Item Name identification, the U.S. Federal Cataloging Handbook H6-1 can be utilized where possible.

MFR. CODE (column six of the Electrical Parts List)

Indicates the code number of the actual manufacturer of the part. (Code to name and address cross reference can be found immediately after this page.)

MFR. PART NUMBER (column seven of the Electrical Parts List)

Indicates actual manufacturers part number.

CROSS INDEX - MFR. CODE NUMBER TO MANUFACTURER

Mfr. Code	Manufacturer	Address	City, State, Zip Code
00853	SANGAMO WESTON INC COMPONENTS DIV	SANGAMO RD PO BOX 128	PICKENS SC 29671-9716
01121	ALLEN-BRADLEY CO	1201 SOUTH 2ND ST	MILWAUKEE WI 53204-2410
02735	RCA CORP SOLID STATE DIVISION	ROUTE 202	SOMERVILLE NJ 08876
03508	GENERAL ELECTRIC CO SEMI-CONDUCTOR PRODUCTS DEPT	W GENESEE ST	AUBURN NY 13021
03888	PYROFILM DIV DIV OF KDI ELECTRONICS INC	60 S JEFFERSON RD	WHIPPANY NJ 07981-1001
04099	CAPCO INC	1328 WINTERS AVE PO BOX 1028	GRAND JUNCTION CO 81502
04222	AVX CERAMICS DIV OF AVX CORP	19TH AVE SOUTH P O BOX 867	MYRTLE BEACH SC 29577
04713	MOTOROLA INC SEMICONDUCTOR PRODUCTS SECTOR	5005 E MCDOWELL RD	PHOENIX AZ 85008-4229
05397	UNION CARBIDE CORP MATERIALS SYSTEMS DIV	11901 MADISON AVE	CLEVELAND OH 44101
05828	GENERAL INSTRUMENT CORP GOVERNMENT SYSTEMS DIV	600 W JOHN ST	HICKSVILLE NY 11802
07263	FAIRCHILD SEMICONDUCTOR CORP NORTH AMERICAN SALES SUB OF SCHLUMBERGER LTD MS 118	10400 RIDGEVIEW CT	CUPERTINO CAW CA 95014
07716	TRW INC TRW IRC FIXED RESISTORS/BURLINGTON	2850 MT PLEASANT AVE	BURLINGTON IA 52601
09353	C AND K COMPONENTS INC	15 RIVERDALE AVE	NEWTON MA 02158-1057
12697	CLAROSTAT MFG CO INC	LOWER WASHINGTON ST	DOVER NH 03820
12954	MICROSEMI CORP - SCOTTSDALE	8700 E THOMAS RD P O BOX 1390	SCOTTSDALE AZ 85252
12969	UNITRODE CORP	5 FORBES RD	LEXINGTON MA 02173-7305
13511	AMPHENOL CADRE DIV BUNKER RAMO CORP		LOS GATOS CA
14193	CAL-R INC	1601 OLYMPIC BLVD PO BOX 1397	SANTA MONICA CA 90406
14433	ITT SEMICONDUCTORS DIV		WEST PALM BEACH FL
14552	MICROSEMI CROP	2830 S FAIRVIEW ST	SANTA ANA CA 92704-5948
14752	ELECTRO CUBE INC	1710 S DEL MAR AVE	SAN GABRIEL CA 91776-3825
14859	TEXAS INSTRUMENTS INC CONTROL PRODUCTS DIV	300 NORTH MAIN	VERSAILLES KY 40383-1245
14936	GENERAL INSTRUMENT CORP DISCRETE SEMI CONDUCTOR DIV	600 W JOHN ST	HICKSVILLE NY 11802
15238	ITT SEMICONDUCTORS A DIVISION OF INTERNATIONAL TELEPHONE AND TELEGRAPH CORP	500 BROADWAY P O BOX 168	LAWRENCE MA 01841-3002
15454	AMETEK INC RODAN DIV	2905 BLUE STAR ST	ANAHEIM CA 92806-2510
18324	SIGNETICS CORP MILITARY PRODUCTS DIV	4130 S MARKET COURT	SACRAMENTO CA 95834-1222
19701	MEPCO/CENTRALAB A NORTH AMERICAN PHILIPS CO	P O BOX 760	MINERAL WELLS TX 76067-0760
24546	CORNING GLASS WORKS	550 HIGH ST	BRADFORD PA 16701-3737
24931	SPECIALTY CONNECTOR CO INC	2100 EARLYWOOD DR PO BOX 547	FRANKLIN IN 46131
25088	SIEMENS CORP	186 WOOD AVE S	ISELIN NJ 08830-2704
31433	UNION CARBIDE CORP ELECTRONICS DIV	HWY 276 SE PO BOX 5928	GREENVILLE SC 29606
31918	ITT SCHADOW INC	8081 WALLACE RD	EDEN PRAIRIE MN 55344-2224
32997	BOURNS INC TRIMPOT DIV	1200 COLUMBIA AVE	RIVERSIDE CA 92507-2114
33095	SPECTRUM CONTROL INC	2185 WEIGHT ST	ERIE PA 16505
50558	ELECTRONIC CONCEPTS INC	526 INDUSTRIAL WAY WEST	EATONTOWN NJ 07724-2212
51406	MURATA ERIE NORTH AMERICA INC GEORGIA OPERATIONS	2200 LAKE PARK DR	SMYRNA GA 30080
51642	CENTRE ENGINEERING INC	2820 E COLLEGE AVE	STATE COLLEGE PA 16801-7515
52763	STETTNER ELECTRONICS INC	6135 AIRWAYS BLVD PO BOX 21947	CHATTANOOGA TN 37421-2970
52769	SPRAGUE-GOODMAN ELECTRONICS INC	134 FULTON AVE	GARDEN CITY PARK NY 11040-5352
54583	TDK ELECTRONICS CORP	12 HARBOR PARK DR	PORT WASHINGTON NY 11550

CROSS INDEX - MFR. CODE NUMBER TO MANUFACTURER

Mfr. Code	Manufacturer	Address	City, State, Zip Code
54937	DE YOUNG MANUFACTURING INC	12920 NE 125TH WAY	KIRKLAND, WA 98034-7716
56289	SPRAGUE ELECTRIC CO WORLD HEADQUARTERS	92 HAYDEN AVE	LEXINGTON MA 02173-7929
57668	R-OHM CORP	16931 MILLIKEN AVE	IRVINE CA 92713
59660	TUSONIX INC	7741 N BUSINESS PARK DR PO BOX 37144	TUCSON AZ 85740-7144
59821	MEPCO/CENTRALAB A NORTH AMERICAN PHILIPS CO	7158 MERCHANT AVE	EL PASO TX 79915-1207
60705	CERA-MITE CORPORATION	1327 6TH AVE	GRAFTON WI 53024-1831
71590	MEPCO/CENTRALAB INC A NORTH AMERICAN PHILIPS CO	HWY 20 W P O BOX 858	FORT DODGE IA 50501
71744	GENERAL INSTRUMENT CORP LAMP DIV/WORLD WIDE/	4433 N RAVENSWOOD AVE	CHICAGO IL 60640-5802
73138	BECKMAN INDUSTRIAL CORP BECKMAN ELECTRONIC TECHNOLOGIES SUB OF EMERSON ELECTRIC	4141 PALM ST	FULLERTON CA 92635
75042	TRW INC TRW ELECTRONIC COMPONENTS IRC FIXED RESISTORS PHILADELPHIA DIV	401 N BROAD ST	PHILADELPHIA PA 19108-1001
75915	LITTELFUSE TRACTOR INC SUB TRACTOR INC	800 E NORTHWEST HWY	DES PLAINES IL 60016-3049
80009	TEKTRONIX INC	14150 SW KARL BRAUM DR PO BOX 500 MS 53-111	BEAVERTON OR 97077
81073	GRAYHILL INC	561 HILLGROVE AVE PO BOX 10373	LA GRANGE IL 60525-5914
82389	SWITCHCRAFT INC SUB OF RAYTHEON CO	5555 N ELSTRON AVE	CHICAGO IL 60630-1314
83003	VARO INC	2203 WALNUT ST PO BOX 401426	GARLAND TX 75042
90201	AEROVOX MALLORY	101 MALLORY DR	GLASGOW KY 42141
91637	DALE ELECTRONICS INC	2064 12TH AVE PO BOX 609	COLUMBUS NE 68601-3632
TK0213	TOPTRON CORP	TOKYO	JAPAN
TK0961	NEC ELECTRONICS USA INC ELECTRON DIV	401 ELLIS ST PO BOX 7241	MOUNTAIN VIEW CA 94039
TK1036	E F JOHNSON CO	299 10TH AVE SW	WASECA MN 56093
TK1345	ZMAN AND ASSOCIATES	7633 S 180TH	KENT WA 98032
TK2038	MULTICOMP INC	3005 SW 154TH TERRACE #3	BEAVERTON OR 97006
TK2042	ZMAN & ASSOCIATES	7633 SO. 180TH	KENT, WA 98032

For Service Manuals Contact
MAURITRON TECHNICAL SERVICES
8 Cherry Tree Rd, Chinnor
Oxon OX9 4QY
Tel:- 01844-351694 Fax:- 01844-352554
Email:- enquiries@mauritron.co.uk

Replaceable Electrical Parts
434 (SN B500000 and up)

Component No.	Tektronix		Serial/Assembly No.		Name & Description	Mfr. Code	Mfr. Part No.
	Part No.	Effective	Discnt				
A1	670-1357-00				CIRCUIT BD ASSY:INPUT AMPLIFIERS	80009	670-1357-00
A2	670-1365-02				CIRCUIT BD ASSY:VERTICAL	80009	670-1365-02
A3	670-1358-00				CIRCUIT BD ASSY:MODE SWITCH	80009	670-1358-00
A4	670-1356-00				CIRCUIT BD ASSY:ATTENUATOR	80009	670-1356-00
A5	670-1356-00				CIRCUIT BD ASSY:ATTENUATOR	80009	670-1356-00
A6	670-1364-00				CIRCUIT BD ASSY:TRIGGER SELECTOR SW	80009	670-1364-00
A7	670-1363-00				CIRCUIT BD ASSY:TRIGGER COUPLING SW	80009	670-1363-00
A8	670-1359-11				CIRCUIT BD ASSY:HORIZONTAL	80009	670-1359-11
A9	670-3769-00	B500000	B543059		CIRCUIT BD ASSY:PRIMARY POWER SUPPLY (INV)	80009	670-3769-00
A9	670-3769-01	B543060			CIRCUIT BD ASSY:PRIMARY POWER SUPPLY	80009	670-3769-01
A10	670-3770-00	B500000	B514708		CIRCUIT BD ASSY:SECONDARY POWER SUPPLY	80009	670-3770-00
A10	670-3770-01	B514709			CIRCUIT BD ASSY:SECONDARY POWER SUPPLY	80009	670-3770-01
A11	670-3768-00				CIRCUIT BD ASSY:FAN MULTIPLIER	80009	670-3768-00
A12	670-1523-01	B500000	B543059		CIRCUIT BD ASSY:STORAGE	80009	670-1523-01
A12	670-1523-02	B543060			CIRCUIT BD ASSY:STORAGE	80009	670-1523-02
A13	119-0295-01	B500000	B527009		FILTER,RFI:	80009	119-0295-01
A13	119-0295-02	B527010	B543059		FILTER,RFI:	80009	119-0295-02
A13	119-0295-04	B543060			FILTER,RFI:	80009	119-0295-04
A14	670-3766-00	B500000	B526599		CIRCUIT BD ASSY:Z AXIS	80009	670-3766-00
A14	670-3766-01	B526600			CIRCUIT BD ASSY:Z AXIS	80009	670-3766-01
A15	670-1525-00				CIRCUIT BD ASSY:UPPER	80009	670-1525-00
A16	670-1524-00				CIRCUIT BD ASSY:LOWER STORAGE SWITCH	80009	670-1524-00
B1690	147-0035-00				MOTOR,DC:BRUSHLESS,3000 RPM,10-15V	25088	1AD3001-0A
C5	283-0023-00				CAP,FXD,CER DI:0.1UF,+80-20%,12V	71590	2DDU66B104Z
C8	285-0816-02				CAP,FXD,PLASTIC:0.019UF,10%,600V	TK2038	285-0816-02
C9	281-0064-00				CAP,VAR,PLASTIC:0.25-1.5PF,600V	52769	ER-530-013
C15	283-0023-00				CAP,FXD,CER DI:0.1UF,+80-20%,12V	71590	2DDU66B104Z
C18	285-0816-02				CAP,FXD,PLASTIC:0.019UF,10%,600V	TK2038	285-0816-02
C19	281-0064-00				CAP,VAR,PLASTIC:0.25-1.5PF,600V	52769	ER-530-013
C22	283-0067-00				CAP,FXD,CER DI:0.001UF,10%,200V	59660	835-515-YSE0102K
C32	283-0067-00				CAP,FXD,CER DI:0.001UF,10%,200V	59660	835-515-YSE0102K
C45	283-0080-00				CAP,FXD,CER DI:0.022UF,+80-20%,25V	59821	2DDU60E223Z
C47	283-0080-00				CAP,FXD,CER DI:0.022UF,+80-20%,25V	59821	2DDU60E223Z
C70	281-0500-00				CAP,FXD,CER DI:2.2PF,+/-0.5PF,500V	52763	2RDPLZ007 2P200C
C71	283-0023-00				CAP,FXD,CER DI:0.1UF,+80-20%,12V	71590	2DDU66B104Z
C72	283-0006-00				CAP,FXD,CER DI:0.02UF,+80-20%,500V	59660	0841545Z5V00203Z
C73	283-0003-00				CAP,FXD,CER DI:0.01UF,+80-20%,150V	59821	0103Z40Z5UJDCX
C74	283-0128-00				CAP,FXD,CER DI:100PF,5%,500V	59660	871-536T2H101J
C76	281-0510-00				CAP,FXD,CER DI:22PF,+/-4.4PF,500V	52763	2RDPLZ007 22P0MC
C94	283-0189-00				CAP,FXD,CER DI:0.1UF,20%,400V	51642	500400X5R 104M
C106	307-1010-01				ATTENUATOR,FXD:2X	80009	307-1010-01
C107	307-1010-01				ATTENUATOR,FXD:2X	80009	307-1010-01
C110	307-1012-00				ATTENUATOR,FXD:5X	80009	307-1012-00
C111	307-1012-00				ATTENUATOR,FXD:5X	80009	307-1012-00
C114	307-1013-00				ATTENUATOR,FXD:10X	80009	307-1013-00
C115	307-1013-00				ATTENUATOR,FXD:10X	80009	307-1013-00
C118	307-1014-01				ATTENUATOR,FXD:100X ATTEN	80009	307-1014-01
C119	307-1014-01				ATTENUATOR,FXD:100X ATTEN	80009	307-1014-01
C121	283-0001-00				CAP,FXD,CER DI:0.005UF,+100-0%,500V	59821	2DDH61L502P
C124	283-0111-00				CAP,FXD,CER DI:0.1UF,20%,50V	05397	C330C104M5U1CA
C125	283-0080-00				CAP,FXD,CER DI:0.022UF,+80-20%,25V	59821	2DDU60E223Z
C126	283-0111-00				CAP,FXD,CER DI:0.1UF,20%,50V	05397	C330C104M5U1CA
C135	283-0023-00				CAP,FXD,CER DI:0.1UF,+80-20%,12V	71590	2DDU66B104Z
C171	283-0001-00				CAP,FXD,CER DI:0.005UF,+100-0%,500V	59821	2DDH61L502P
C174	283-0111-00				CAP,FXD,CER DI:0.1UF,20%,50V	05397	C330C104M5U1CA
C175	283-0080-00				CAP,FXD,CER DI:0.022UF,+80-20%,25V	59821	2DDU60E223Z
C176	283-0111-00				CAP,FXD,CER DI:0.1UF,20%,50V	05397	C330C104M5U1CA

Replaceable Electrical Parts
434 (SN B500000 and up)

Component No.	Tektronix	Serial/Assembly No.		Name & Description	Mfr.	Mfr. Part No.
	Part No.	Effective	Discont		Code	
C185	283-0023-00			CAP, FXD, CER DI: 0.1UF, +80-20%, 12V	71590	2DDU668104Z
C187	290-0517-00			CAP, FXD, ELCTLT: 6.8UF, 20%, 35V	05397	T368B685M035AZ
C189	290-0517-00			CAP, FXD, ELCTLT: 6.8UF, 20%, 35V	05397	T368B685M035AZ
C216	281-0540-00			CAP, FXD, CER DI: 51PF, 5%, 500V	59660	301-000U2J0510J
C217	281-0093-00			CAP, VAR, CER DI: 5.5-18PF, 350V	52763	302322237
C220	281-0092-00	B500000	B529999	CAP, VAR, CER DI: 9-35PF, 200V	33095	53-717-001 D9-35
C220	281-0167-00	B530000		CAP, VAR, CER DI: 9-45PF, 200V	33095	53-717-001 D9-45
C221	281-0603-00			CAP, FXD, CER DI: 39PF, 5%, 500V	52763	2RDPLZ007 39P0JC
C222	281-0571-00			CAP, FXD, CER DI: 82PF, 20%, 500V (NOMINAL VALUE, SELECTABLE)	59660	308-000 S260720M
C223	281-0092-00	B500000	B529999	CAP, VAR, CER DI: 9-35PF, 200V	33095	53-717-001 D9-35
C223	281-0167-00	B530000		CAP, VAR, CER DI: 9-45PF, 200V	33095	53-717-001 D9-45
C224	281-0579-00			CAP, FXD, CER DI: 21PF, 5%, 500V	52763	2RDPLZ007 21P0JC
C225	281-0091-00			CAP, VAR, CER DI: 2-8PF, 350V	33095	53-717-001 A2-8
C226	281-0064-00			CAP, VAR, PLASTIC: 0.25-1.5PF, 600V	52769	ER-530-013
C227	281-0670-00			CAP, FXD, CER DI: 1.8PF, +/-0.1PF, 500V	52763	2RDPLZ007 1P80BC
C228	281-0509-00			CAP, FXD, CER DI: 15PF, +/-1.5PF, 500V (ADDED IF NECESSARY)	59660	301-000COG0-150K
C231	281-0709-00			CAP, FXD, CER DI: 7PF, +/-0.1PF, 500V	52763	2RDPLZ007 7P00BC
C234	283-0111-00			CAP, FXD, CER DI: 0.1UF, 20%, 50V	05397	C330C104M5U1CA
C252	281-0656-00			CAP, FXD, CER DI: 22PF, 5%, 500V	59660	374-018-COG0220J
C253	283-0111-00			CAP, FXD, CER DI: 0.1UF, 20%, 50V	05397	C330C104M5U1CA
C256	283-0000-00			CAP, FXD, CER DI: 0.001UF, +100-0%, 500V	59660	831-610-Y5U0102P
C258	281-0626-00			CAP, FXD, CER DI: 3.3PF, +/-0.1PF, 500V	52763	2RDPLZ007 3P30BC
C262	281-0656-00			CAP, FXD, CER DI: 22PF, 5%, 500V	59660	374-018-COG0220J
C272	283-0080-00			CAP, FXD, CER DI: 0.022UF, +80-20%, 25V	59821	2DDU60E223Z
C278	281-0536-00			CAP, FXD, CER DI: 1000PF, 10%, 500V	52763	2RDPLZ007 1N00M0
C282	283-0080-00			CAP, FXD, CER DI: 0.022UF, +80-20%, 25V	59821	2DDU60E223Z
C316	281-0540-00			CAP, FXD, CER DI: 51PF, 5%, 500V	59660	301-000U2J0510J
C317	281-0093-00			CAP, VAR, CER DI: 5.5-18PF, 350V	52763	302322237
C320	281-0092-00	B500000	B529999	CAP, VAR, CER DI: 9-35PF, 200V	33095	53-717-001 D9-35
C320	281-0167-00	B530000		CAP, VAR, CER DI: 9-45PF, 200V	33095	53-717-001 D9-45
C321	281-0540-00			CAP, FXD, CER DI: 51PF, 5%, 500V	59660	301-000U2J0510J
C322	281-0571-00			CAP, FXD, CER DI: 82PF, 20%, 500V	59660	308-000 S260720M
C323	281-0123-00			CAP, VAR, CER DI: 5-25PF, 100V	59660	518-000A5-25
C324	283-0109-00			CAP, FXD, CER DI: 27PF, 5%, 1000V	59660	858-534COG0270J
C325	281-0091-00			CAP, VAR, CER DI: 2-8PF, 350V	33095	53-717-001 A2-8
C326	281-0064-00			CAP, VAR, PLASTIC: 0.25-1.5PF, 600V	52769	ER-530-013
C327	281-0661-00			CAP, FXD, CER DI: 0.8PF, +/-0.1PF, 500V	52763	2RDPLZ007 0P80BC
C328	281-0509-00			CAP, FXD, CER DI: 15PF, +/-1.5PF, 500V	59660	301-000COG0-150K
C331	281-0709-00			CAP, FXD, CER DI: 7PF, +/-0.1PF, 500V	52763	2RDPLZ007 7P00BC
C334	283-0111-00			CAP, FXD, CER DI: 0.1UF, 20%, 50V	05397	C330C104M5U1CA
C352	281-0656-00			CAP, FXD, CER DI: 22PF, 5%, 500V	59660	374-018-COG0220J
C353	283-0111-00			CAP, FXD, CER DI: 0.1UF, 20%, 50V	05397	C330C104M5U1CA
C356	283-0000-00			CAP, FXD, CER DI: 0.001UF, +100-0%, 500V	59660	831-610-Y5U0102P
C357	290-0517-00			CAP, FXD, ELCTLT: 6.8UF, 20%, 35V	05397	T368B685M035AZ
C359	290-0517-00			CAP, FXD, ELCTLT: 6.8UF, 20%, 35V	05397	T368B685M035AZ
C360	290-0523-00			CAP, FXD, ELCTLT: 2.2UF, 20%, 20V	05397	T368A225M020AS
C362	281-0656-00			CAP, FXD, CER DI: 22PF, 5%, 500V	59660	374-018-COG0220J
C404	290-0523-00			CAP, FXD, ELCTLT: 2.2UF, 20%, 20V	05397	T368A225M020AS
C408	290-0523-00			CAP, FXD, ELCTLT: 2.2UF, 20%, 20V	05397	T368A225M020AS
C410	290-0523-00			CAP, FXD, ELCTLT: 2.2UF, 20%, 20V	05397	T368A225M020AS
C414	290-0523-00			CAP, FXD, ELCTLT: 2.2UF, 20%, 20V	05397	T368A225M020AS
C421	281-0629-00			CAP, FXD, CER DI: 33PF, 5%, 600V	52763	2RDPLZ007 33P0JC
C424	281-0629-00			CAP, FXD, CER DI: 33PF, 5%, 600V	52763	2RDPLZ007 33P0JC
C425	283-0238-00			CAP, FXD, CER DI: 0.01UF, 10%, 50V	04222	SR205C103KAA
C426	290-0523-00			CAP, FXD, ELCTLT: 2.2UF, 20%, 20V	05397	T368A225M020AS
C430	283-0060-00			CAP, FXD, CER DI: 100PF, 5%, 200V	59660	855-535U2J101J

Replaceable Electrical Parts
434 (SN B50000 and up)

Component No.	Tektronix Part No.	Serial/Assembly No. Effective Discnt	Name & Description	Mfr. Code	Mfr. Part No.
C435	290-0523-00		CAP, FXD, ELCTLT: 2.2UF, 20%, 20V	05397	T368A225M020AS
C436	283-0080-00		CAP, FXD, CER DI: 0.022UF, +80-20%, 25V	59821	2DDU60E223Z
C442	283-0059-00		CAP, FXD, CER DI: 1UF, +80-20%, 25V	31433	C330C105MR5CA
C452	283-0080-00		CAP, FXD, CER DI: 0.022UF, +80-20%, 25V	59821	2DDU60E223Z
C456	281-0562-00		CAP, FXD, CER DI: 39PF, 10%, 500V	52763	2RDPLZ007 39P0KU
C460	281-0504-00		CAP, FXD, CER DI: 10PF, +/-1PF, 500V (SEE CALIBRATION SECTION)	54583	TCC20CH2H100FYA
C461	281-0092-00		CAP, VAR, CER DI: 9-35PF, 200V	33095	53-717-001 D9-35
C463	283-0010-00		CAP, FXD, CER DI: 0.05UF, +80-20%, 50V	04222	SR305E503ZAA
C471	281-0592-00		CAP, FXD, CER DI: 4.7PF, +/-0.5PF, 500V	52763	2RDPLZ007 4P70DC
C472	281-0562-00		CAP, FXD, CER DI: 39PF, 10%, 500V	52763	2RDPLZ007 39P0KU
C479	281-0551-00		CAP, FXD, CER DI: 390PF, 10%, 500V	52763	2RDPLZ007 390PMO
C500	281-0616-00		CAP, FXD, CER DI: 6.8PF, +/-0.5PF, 200V	52763	2RDPLZ007 6P80DC
C510	283-0111-00		CAP, FXD, CER DI: 0.1UF, 20%, 50V	05397	C330C104M5U1CA
C525	283-0032-00		CAP, FXD, CER DI: 470PF, 5%, 500V	59660	831-000-Z5E0471J
C536	283-0057-00		CAP, FXD, CER DI: 0.1UF, +80-20%, 200V	04222	SR306E104ZAA
C540	281-0616-00		CAP, FXD, CER DI: 6.8PF, +/-0.5PF, 200V	52763	2RDPLZ007 6P80DC
C565	283-0032-00		CAP, FXD, CER DI: 470PF, 5%, 500V	59660	831-000-Z5E0471J
C570	281-0512-00		CAP, FXD, CER DI: 27PF, +/-2.7PF, 500V	52763	2RDPLZ007 27POKC
C572	281-0123-00		CAP, VAR, CER DI: 5-25PF, 100V	59660	518-000A5-25
C578	290-0517-00		CAP, FXD, ELCTLT: 6.8UF, 20%, 35V	05397	T368B685M035AZ
C602	283-0003-00		CAP, FXD, CER DI: 0.01UF, +80-20%, 150V	59821	D103Z40Z5UJDC EX
C604	283-0003-00		CAP, FXD, CER DI: 0.01UF, +80-20%, 150V	59821	D103Z40Z5UJDC EX
C605	283-0080-00		CAP, FXD, CER DI: 0.022UF, +80-20%, 25V	59821	2DDU60E223Z
C614	283-0003-00		CAP, FXD, CER DI: 0.01UF, +80-20%, 150V	59821	D103Z40Z5UJDC EX
C622	283-0003-00		CAP, FXD, CER DI: 0.01UF, +80-20%, 150V	59821	D103Z40Z5UJDC EX
C624	283-0081-00		CAP, FXD, CER DI: 0.1UF, +80-20%, 25V	59821	2DDU69E104Z
C645	283-0067-00		CAP, FXD, CER DI: 0.001UF, 10%, 200V	59660	835-515-YSE0102K
C648	283-0026-00		CAP, FXD, CER DI: 0.2UF, +80-20%, 25V	31433	C330C332JIG5CA
C650	290-0527-00		CAP, FXD, ELCTLT: 15UF, 20%, 20V	05397	T368B156M020AS
C663	281-0549-00		CAP, FXD, CER DI: 68PF, 10%, 500V	52763	2RDPLZ007 68P0KU
C670	281-0519-00		CAP, FXD, CER DI: 47PF, +/-4.7PF, 500V	52763	2RDPLZ007 47P0KC
C686	281-0504-00		CAP, FXD, CER DI: 10PF, +/-1PF, 500V	54583	TCC20CH2H100FYA
C688	283-0003-00		CAP, FXD, CER DI: 0.01UF, +80-20%, 150V	59821	D103Z40Z5UJDC EX
C690	283-0003-00		CAP, FXD, CER DI: 0.01UF, +80-20%, 150V	59821	D103Z40Z5UJDC EX
C692	281-0511-00		CAP, FXD, CER DI: 22PF, +/-2.2PF, 500V	52763	2RDPLZ007 22P0KC
C700	281-0551-00		CAP, FXD, CER DI: 390PF, 10%, 500V	52763	2RDPLZ007 390PMO
C701	281-0617-00		CAP, FXD, CER DI: 15PF, 10%, 200V	52763	2RDPLZ007 15P0KC
C702	290-0136-00		CAP, FXD, ELCTLT: 2.2UF, 20%, 20V	05397	T322B225M020AS
C706	283-0067-00		CAP, FXD, CER DI: 0.001UF, 10%, 200V	59660	835-515-YSE0102K
C709	281-0651-00		CAP, FXD, CER DI: 47PF, 5%, 200V	52763	2RDPLZ007 47P0JT
C710	295-0150-00		CAP SET, MATCHED: 10UF, 0.1UF, 995PF, MATCHED 1% (C710 INDIVIDUAL TIMING CAPACITORS IN THIS ASSY MUST BE ORDERED BY THE 9-DIGIT PART NUMBER, LETTER SUFFIX & TOLERANCE PRINTED ON THE TIMING CAPACITOR TO BE REPLACED. THE LETTER SUFFIX & THE TOLERANCE SHOULD BE THE SAME FOR ALL OF THE TIMING CAPACITORS IN THE ASSEMBLY.)	TK2038	295-0150-00
C715	283-0599-00		CAP, FXD, MICA DI: 98PF, 5%, 500V	00853	D105F980J0
C716	281-0123-00		CAP, VAR, CER DI: 5-25PF, 100V	59660	518-000A5-25
C718	290-0246-00		CAP, FXD, ELCTLT: 3.3UF, 10%, 15V	12954	D3R3EA15K1
C720	290-0247-00		CAP, FXD, ELCTLT: 5.6UF, 10%, 6V	05397	T322B565K006AS
C722	290-0247-00		CAP, FXD, ELCTLT: 5.6UF, 10%, 6V	05397	T322B565K006AS
C730	283-0067-00		CAP, FXD, CER DI: 0.001UF, 10%, 200V	59660	835-515-YSE0102K
C732	283-0004-00		CAP, FXD, CER DI: 0.02UF, +80-20%, 150V	59660	855-558Z5V0203Z
C734	283-0059-00		CAP, FXD, CER DI: 1UF, +80-20%, 25V	31433	C330C105MR5CA
C742	283-0081-00		CAP, FXD, CER DI: 0.1UF, +80-20%, 25V	59821	2DDU69E104Z
C755	281-0519-00		CAP, FXD, CER DI: 47PF, +/-4.7PF, 500V	52763	2RDPLZ007 47P0KC

Replaceable Electrical Parts
434 (SN B500000 and up)

Component No.	Tektronix	Serial/Assembly No.		Name & Description	Mfr.	Mfr. Part No.
	Part No.	Effective	Dscont		Code	
C761	290-0527-00			CAP, FXD, ELCTLT: 15UF, 20%, 20V	05397	T368B156M020AS
C764	281-0519-00			CAP, FXD, CER DI: 47PF, +/-4.7PF, 500V	52763	2RDPLZ007 47POKC
C780	281-0543-00			CAP, FXD, CER DI: 270PF, 10%, 500V	52763	2RDPLZ007 27POMO
C782	281-0519-00			CAP, FXD, CER DI: 47PF, +/-4.7PF, 500V	52763	2RDPLZ007 47POKC
C784	283-0001-00			CAP, FXD, CER DI: 0.005UF, +100-0%, 500V	59821	2DDH61L502P
C794	281-0562-00			CAP, FXD, CER DI: 39PF, 10%, 500V	52763	2RDPLZ007 39POKU
C796	290-0267-00			CAP, FXD, ELCTLT: 1UF, 20%, 35V	05397	T320A105M035AS
C797	283-0004-00			CAP, FXD, CER DI: 0.02UF, +80-20%, 150V	59660	855-558Z5V0203Z
C798	290-0267-00			CAP, FXD, ELCTLT: 1UF, 20%, 35V	05397	T320A105M035AS
C801	290-0246-00			CAP, FXD, ELCTLT: 3.3UF, 10%, 15V	12954	D3R3EA15K1
C805	290-0246-00			CAP, FXD, ELCTLT: 3.3UF, 10%, 15V	12954	D3R3EA15K1
C812	283-0177-00			CAP, FXD, CER DI: 1UF, +80-20%, 25V	04222	SR302E105ZAATR
C871	281-0064-00			CAP, VAR, PLASTIC: 0.25-1.5PF, 600V	52769	ER-530-013
C872	283-0001-00			CAP, FXD, CER DI: 0.005UF, +100-0%, 500V	59821	2DDH61L502P
C874	283-0008-00			CAP, FXD, CER DI: 0.1UF, 20%, 500V	51642	500-500-X7R-104M
C876	283-0002-00			CAP, FXD, CER DI: 0.01UF, +80-20%, 500V	59821	D103Z40Z5ULADEG
C881	281-0064-00			CAP, VAR, PLASTIC: 0.25-1.5PF, 600V	52769	ER-530-013
C882	283-0001-00			CAP, FXD, CER DI: 0.005UF, +100-0%, 500V	59821	2DDH61L502P
C884	283-0008-00			CAP, FXD, CER DI: 0.1UF, 20%, 500V	51642	500-500-X7R-104M
C886	283-0002-00			CAP, FXD, CER DI: 0.01UF, +80-20%, 500V	59821	D103Z40Z5ULADEG
C896	283-0017-00	B500000	8540631	CAP, FXD, CER DI: 1UF, +80-20%, 3V	59660	5515-001X5T0105Z
C896	281-0775-00	B540632		CAP, FXD, CER DI: 0.1UF, +/-1PF, 50V	04222	MA205E104MAA
C1200	283-0003-00			CAP, FXD, CER DI: 0.01UF, +80-20%, 150V	59821	D103Z40Z5ULDCX
C1202	290-0529-00			CAP, FXD, ELCTLT: 47UF, 20%, 20V	05397	T362C476M020AS
C1206	283-0000-00			CAP, FXD, CER DI: 0.001UF, +100-0%, 500V	59660	831-610-Y5U0102P
C1208	283-0000-00			CAP, FXD, CER DI: 0.001UF, +100-0%, 500V	59660	831-610-Y5U0102P
C1214	283-0167-00			CAP, FXD, CER DI: 0.1UF, 10%, 100V	04222	3430-100C-104K
C1219	290-0135-00			CAP, FXD, ELCTLT: 15UF, 20%, 20V	05397	T110B156M020AS
C1235	290-0303-00			CAP, FXD, ELCTLT: 5UF, +50-10%, 300V	56289	34D505G300EJ4
C1240	281-0523-00			CAP, FXD, CER DI: 100PF, 20%, 350V	52763	2RDPLZ007 100PMU
C1246	283-0268-00			CAP, FXD, CER DI: 0.015UF, 20%, 50V	04222	3439-050C-153K
C1250	283-0003-00			CAP, FXD, CER DI: 0.01UF, +80-20%, 150V	59821	D103Z40Z5ULDCX
C1256	283-0000-00			CAP, FXD, CER DI: 0.001UF, +100-0%, 500V	59660	831-610-Y5U0102P
C1258	283-0000-00			CAP, FXD, CER DI: 0.001UF, +100-0%, 500V	59660	831-610-Y5U0102P
C1264	283-0167-00			CAP, FXD, CER DI: 0.1UF, 10%, 100V	04222	3430-100C-104K
C1269	290-0135-00			CAP, FXD, ELCTLT: 15UF, 20%, 20V	05397	T110B156M020AS
C1285	290-0303-00			CAP, FXD, ELCTLT: 5UF, +50-10%, 300V	56289	34D505G300EJ4
C1698	290-0536-00			CAP, FXD, ELCTLT: 10UF, 20%, 25V TANTALUM	05397	T368B106M025AS
C1702	283-0594-00			CAP, FXD, MICA DI: 0.001UF, 1%, 100V	00853	D151F102F0
C1706	285-0758-01			CAP, FXD, PLASTIC: 0.05UF, 2%, 400V	TK2038	285-0758-01
C1719	290-0135-00			CAP, FXD, ELCTLT: 15UF, 20%, 20V	05397	T110B156M020AS
C1721	290-0164-00			CAP, FXD, ELCTLT: 1UF, +50-10%, 150V	56289	500D105F150BA2R2
C1724	283-0071-00	B500000	8529999	CAP, FXD, CER DI: 0.0068UF, +80-20%, 5KV	51406	DHA 34Y5S682Z5KV
C1724	285-0509-01	B530000		CAP, FXD, PPR DI: 0.0068UF, 20%, 5000V	14752	C-2541
C1725	283-0021-00			CAP, FXD, CER DI: 0.001UF, 20%, 5000V	51406	DHR17Y55102M5KV
C1731	283-0211-00			CAP, FXD, CER DI: 0.1UF, 10%, 200V	04222	SR406C104KAA
C1732	283-0087-00			CAP, FXD, CER DI: 300PF, 10%, 1000V	59660	0838020X5F00301K
C1734	283-0162-00	B500000	8529999	CAP, FXD, CER DI: 0.01UF, +80-20%, 5000V	51406	DHA42Y5S103Z5KV
C1734	285-1138-00	B530000		CAP, FXD, PLASTIC: 0.01UF, 10%, 8K VDC	04099	TEK45-3
C1740	283-0211-00			CAP, FXD, CER DI: 0.1UF, 10%, 200V	04222	SR406C104KAA
C1742	283-0110-00			CAP, FXD, CER DI: 0.005UF, +80-20%, 150V	59660	855-547-E-502Z
C1753	281-0064-00			CAP, VAR, PLASTIC: 0.25-1.5PF, 600V	52769	ER-530-013
C1757	281-0592-00			CAP, FXD, CER DI: 4.7PF, +/-0.5PF, 500V	52763	2RDPLZ007 4P70DC
C1760	281-0525-00			CAP, FXD, CER DI: 470PF, +/-94PF, 500V	52763	2RDPLZ007 470PMO
C1762	281-0523-00			CAP, FXD, CER DI: 100PF, 20%, 350V	52763	2RDPLZ007 100PMU
C1763	281-0523-00			CAP, FXD, CER DI: 100PF, 20%, 350V	52763	2RDPLZ007 100PMU
C1768	283-0000-00			CAP, FXD, CER DI: 0.001UF, +100-0%, 500V	59660	831-610-Y5U0102P
C1787	283-0000-00			CAP, FXD, CER DI: 0.001UF, +100-0%, 500V	59660	831-610-Y5U0102P

Replaceable Electrical Parts
434 (SN B500000 and up)

Component No.	Tektronix Part No.	Serial/Assembly No. Effective	Discont	Name & Description	Mfr. Code	Mfr. Part No.
C1788	285-1112-00			CAP, FXD, PLASTIC: 0.1UF, 20%, 400V	14752	230B1E104
C1789	283-0211-00	B500000	B542499	CAP, FXD, CER DI: 0.1UF, 10%, 200V	04222	SR406C104KAA
C1789	283-0189-00	B542500		CAP, FXD, CER DI: 0.1UF, 20%, 400V	51642	500400X5R 104M
C1790	283-0071-00	B500000	B529999	CAP, FXD, CER DI: 0.0068UF, +80-20%, 5KV	51406	DHA 34Y5S682Z5KV
C1790	285-0509-01	B530000		CAP, FXD, PPR DI: 0.0068UF, 20%, 5000V	14752	C-2541
C1793	283-0188-00			CAP, FXD, CER DI: 1000PF, 20%, 6000V	51406	DHR19X5T102M-6KV
C1796	290-0523-00			CAP, FXD, ELCTLT: 2.2UF, 20%, 20V	05397	T368A225M020AS
C1798	290-0523-00			CAP, FXD, ELCTLT: 2.2UF, 20%, 20V	05397	T368A225M020AS
C1804	283-0263-00			CAP, FXD, CER DI: 2200PF, 20%, 3000V	59660	828556Y5R0222M
C1806	283-0263-00			CAP, FXD, CER DI: 2200PF, 20%, 3000V	59660	828556Y5R0222M
C1821	283-0006-00	B500000	B543059	CAP, FXD, CER DI: 0.02UF, +80-20%, 500V	59660	0841545Z5V00203Z
C1821	283-0183-00	B543060		CAP, FXD, CER DI: 0.045UF, 20%, 500V	04222	3422500E453M
C1822	290-0483-00			CAP, FXD, ELCTLT: 430UF, +50-10%, 200V	56289	36D7762
C1823	290-0483-00			CAP, FXD, ELCTLT: 430UF, +50-10%, 200V	56289	36D7762
C1824	283-0057-00			CAP, FXD, CER DI: 0.1UF, +80-20%, 200V	04222	SR306E104ZAA
C1825	283-0280-00			CAP, FXD, CER DI: 2200PF, 10%, 2000V	60705	564CBA202EH222
C1826	285-0981-00			CAP, FXD, PLASTIC: 2UF, 10%, 400V	04099	TEK-3
C1827	283-0280-00			CAP, FXD, CER DI: 2200PF, 10%, 2000V	60705	564CBA202EH222
C1829	283-0041-00			CAP, FXD, CER DI: 0.0033UF, 5%, 500V	59660	841-542B332J
C1834	290-0284-00			CAP, FXD, ELCTLT: 4.7UF, 10%, 35V	05397	T110B475K035AS
C1835	283-0980-00			CAP, FXD, PLASTIC: 0.02UF, 5%, 1000V	50558	PA6-1799J
C1841	290-0284-00			CAP, FXD, ELCTLT: 4.7UF, 10%, 35V	05397	T110B475K035AS
C1848	290-0159-00			CAP, FXD, ELCTLT: 2UF, +50-10%, 150V	56289	30D205F150BB2
C1849	283-0078-00	B500000	B514708	CAP, FXD, CER DI: 0.001UF, 20%, 500V	59660	0801 547X5F0102M
C1849	283-0054-00	B514709		CAP, FXD, CER DI: 150PF, 5%, 200V	59660	855-535 U2J0151J
C1901	290-0573-00			CAP, FXD, ELCTLT: 2.7UF, 20%, 50V	05397	T368B275M050AS
C1902	283-0003-00			CAP, FXD, CER DI: 0.01UF, +80-20%, 150V	59821	D103Z40Z5UJDCX
C1904	283-0003-00			CAP, FXD, CER DI: 0.01UF, +80-20%, 150V	59821	D103Z40Z5UJDCX
C1912	290-0524-00	B500000	B514708	CAP, FXD, ELCTLT: 4.7UF, 20%, 10V	05397	T368A475M010AZ
C1912	290-0526-00	B514709		CAP, FXD, ELCTLT: 6.8UF, 20%, 6.0/6.3VDC	05397	T368A685M006AS
C1914	281-0523-00			CAP, FXD, CER DI: 100PF, 20%, 350V	52763	2RDPLZ007 100PMU
C1915	281-0523-00			CAP, FXD, CER DI: 100PF, 20%, 350V	52763	2RDPLZ007 100PMU
C1918	290-0573-00			CAP, FXD, ELCTLT: 2.7UF, 20%, 50V	05397	T368B275M050AS
C1919	283-0594-00			CAP, FXD, MICA DI: 0.001UF, 1%, 100V	00853	D151F102FO
C1921	283-0010-00			CAP, FXD, CER DI: 0.05UF, +80-20%, 50V	04222	SR305E503ZAA
C1924	283-0111-00	B500000	B529199	CAP, FXD, CER DI: 0.1UF, 20%, 50V	05397	C330C104MSU1CA
C1924	290-0523-00	B529200		CAP, FXD, ELCTLT: 2.2UF, 20%, 20V	05397	T368A225M020AS
C1940	283-0239-00			CAP, FXD, CER DI: 0.022UF, 10%, 50V	04222	3439-050C-223K
C1943	290-0572-00	B500000	529199	CAP, FXD, ELCTLT: 0.1UF, 20%, 50V	05397	T368A104050AZ
C1943	290-0523-00	B529200		CAP, FXD, ELCTLT: 2.2UF, 20%, 20V	05397	T368A225M020AS
C1944	283-0003-00			CAP, FXD, CER DI: 0.01UF, +80-20%, 150V	59821	D103Z40Z5UJDCX
C1951	283-0003-00			CAP, FXD, CER DI: 0.01UF, +80-20%, 150V	59821	D103Z40Z5UJDCX
C1960	290-0117-00			CAP, FXD, ELCTLT: 50UF, +75-10%, 50V	56289	30D506G050DD9
C1962	290-0200-00			CAP, FXD, ELCTLT: 12UF, +50-10%, 150V	00853	556DE120T150B
C1964	290-0200-00			CAP, FXD, ELCTLT: 12UF, +50-10%, 150V	00853	556DE120T150B
C1965	290-0200-00			CAP, FXD, ELCTLT: 12UF, +50-10%, 150V	00853	556DE120T150B
C1970	290-0145-00			CAP, FXD, ELCTLT: 10UF, +75-10%, 50V	56289	30D106G050C82R58
C1971	283-0220-00	B515769		CAP, FXD, CER DI: 0.01UF, 20%, 50V	04222	3429 050C 103M
C1972	290-0425-00			CAP, FXD, ELCTLT: 100UF, 20%, 20V	90201	THF107M020P1G
C1974	290-0425-00			CAP, FXD, ELCTLT: 100UF, 20%, 20V	90201	THF107M020P1G
C1976	290-0425-00			CAP, FXD, ELCTLT: 100UF, 20%, 20V	90201	THF107M020P1G
C1978	290-0425-00			CAP, FXD, ELCTLT: 100UF, 20%, 20V	90201	THF107M020P1G
C1980	283-0013-00			CAP, FXD, CER DI: 0.01UF, -0+100%, 1000V	59660	818-602ZSU0103P
C1981	283-0211-00	B500000	B529149	CAP, FXD, CER DI: 0.1UF, 10%, 200V	04222	SR406C104KAA
C1981	283-0189-00	B529150		CAP, FXD, CER DI: 0.1UF, 20%, 400V	51642	500400X5R 104M
C1984	290-0410-00			CAP, FXD, ELCTLT: 15UF, +50-10%, 100V	00853	556DD150T100B
C1990	283-0071-00	B500000	B529999	CAP, FXD, CER DI: 0.0068UF, +80-20%, 5KV	51406	DHA 34Y5S682Z5KV
C1990	285-0509-01	B530000		CAP, FXD, PPR DI: 0.0068UF, 20%, 5000V	14752	C-2541

Replaceable Electrical Parts
434 (SN 850000 and up)

Component No.	Tektronix Part No.	Serial/Assembly No. Effective	Discont	Name & Description	Mfr. Code	Mfr. Part No.
C1991	283-0162-00			CAP, FXD, CER DI: 0.01UF, +80-20%, 5000V	51406	DHA42Y5S103Z5KV
C1992	283-0071-00	B500000	8529999	CAP, FXD, CER DI: 0.0068UF, +80-20%, 5KV	51406	DHA 34Y5S68Z5KV
C1992	285-0509-01	B530000		CAP, FXD, PPR DI: 0.0068UF, 20%, 5000V	14752	C-2541
C1994	283-0011-00			CAP, FXD, CER DI: 0.01UF, +80-20%	51406	DHA23Z5U103Z2KV
CR122	152-0321-00			SEMICON DVC, DI: SW, SI, 30V, 0.1A, DO-7S	07263	FSAI480
CR172	152-0321-00			SEMICON DVC, DI: SW, SI, 30V, 0.1A, DO-7S	07263	FSAI480
CR256	152-0141-02			SEMICON DVC, DI: SW, SI, 30V, 150MA, 30V, DO-35	03508	DA2527 (1N4152)
CR270	152-0141-02			SEMICON DVC, DI: SW, SI, 30V, 150MA, 30V, DO-35	03508	DA2527 (1N4152)
CR273	152-0141-02			SEMICON DVC, DI: SW, SI, 30V, 150MA, 30V, DO-35	03508	DA2527 (1N4152)
CR275	152-0141-02			SEMICON DVC, DI: SW, SI, 30V, 150MA, 30V, DO-35	03508	DA2527 (1N4152)
CR280	152-0141-02			SEMICON DVC, DI: SW, SI, 30V, 150MA, 30V, DO-35	03508	DA2527 (1N4152)
CR283	152-0141-02			SEMICON DVC, DI: SW, SI, 30V, 150MA, 30V, DO-35	03508	DA2527 (1N4152)
CR285	152-0141-02			SEMICON DVC, DI: SW, SI, 30V, 150MA, 30V, DO-35	03508	DA2527 (1N4152)
CR356	152-0141-02			SEMICON DVC, DI: SW, SI, 30V, 150MA, 30V, DO-35	03508	DA2527 (1N4152)
CR404	152-0141-02			SEMICON DVC, DI: SW, SI, 30V, 150MA, 30V, DO-35	03508	DA2527 (1N4152)
CR405	152-0141-02			SEMICON DVC, DI: SW, SI, 30V, 150MA, 30V, DO-35	03508	DA2527 (1N4152)
CR406	152-0141-02			SEMICON DVC, DI: SW, SI, 30V, 150MA, 30V, DO-35	03508	DA2527 (1N4152)
CR408	152-0141-02			SEMICON DVC, DI: SW, SI, 30V, 150MA, 30V, DO-35	03508	DA2527 (1N4152)
CR410	152-0141-02			SEMICON DVC, DI: SW, SI, 30V, 150MA, 30V, DO-35	03508	DA2527 (1N4152)
CR411	152-0141-02			SEMICON DVC, DI: SW, SI, 30V, 150MA, 30V, DO-35	03508	DA2527 (1N4152)
CR412	152-0141-02			SEMICON DVC, DI: SW, SI, 30V, 150MA, 30V, DO-35	03508	DA2527 (1N4152)
CR414	152-0141-02			SEMICON DVC, DI: SW, SI, 30V, 150MA, 30V, DO-35	03508	DA2527 (1N4152)
CR426	152-0141-02			SEMICON DVC, DI: SW, SI, 30V, 150MA, 30V, DO-35	03508	DA2527 (1N4152)
CR428	152-0141-02			SEMICON DVC, DI: SW, SI, 30V, 150MA, 30V, DO-35	03508	DA2527 (1N4152)
CR431	152-0141-02			SEMICON DVC, DI: SW, SI, 30V, 150MA, 30V, DO-35	03508	DA2527 (1N4152)
CR432	152-0141-02			SEMICON DVC, DI: SW, SI, 30V, 150MA, 30V, DO-35	03508	DA2527 (1N4152)
CR433	152-0141-02			SEMICON DVC, DI: SW, SI, 30V, 150MA, 30V, DO-35	03508	DA2527 (1N4152)
CR440	152-0141-02			SEMICON DVC, DI: SW, SI, 30V, 150MA, 30V, DO-35	03508	DA2527 (1N4152)
CR521	152-0141-02			SEMICON DVC, DI: SW, SI, 30V, 150MA, 30V, DO-35	03508	DA2527 (1N4152)
CR551	152-0141-02			SEMICON DVC, DI: SW, SI, 30V, 150MA, 30V, DO-35	03508	DA2527 (1N4152)
CR603	152-0246-00			SEMICON DVC, DI: SW, SI, 40V, 200MA, DO-7	14433	WG1537TK
CR606	152-0141-02			SEMICON DVC, DI: SW, SI, 30V, 150MA, 30V, DO-35	03508	DA2527 (1N4152)
CR610	152-0141-02			SEMICON DVC, DI: SW, SI, 30V, 150MA, 30V, DO-35	03508	DA2527 (1N4152)
CR615	152-0141-02			SEMICON DVC, DI: SW, SI, 30V, 150MA, 30V, DO-35	03508	DA2527 (1N4152)
CR616	152-0141-02			SEMICON DVC, DI: SW, SI, 30V, 150MA, 30V, DO-35	03508	DA2527 (1N4152)
CR623	152-0141-02			SEMICON DVC, DI: SW, SI, 30V, 150MA, 30V, DO-35	03508	DA2527 (1N4152)
CR630	152-0141-02			SEMICON DVC, DI: SW, SI, 30V, 150MA, 30V, DO-35	03508	DA2527 (1N4152)
CR632	152-0141-02			SEMICON DVC, DI: SW, SI, 30V, 150MA, 30V, DO-35	03508	DA2527 (1N4152)
CR634	152-0141-02			SEMICON DVC, DI: SW, SI, 30V, 150MA, 30V, DO-35	03508	DA2527 (1N4152)
CR635	152-0141-02			SEMICON DVC, DI: SW, SI, 30V, 150MA, 30V, DO-35	03508	DA2527 (1N4152)
CR640	152-0141-02			SEMICON DVC, DI: SW, SI, 30V, 150MA, 30V, DO-35	03508	DA2527 (1N4152)
CR644	152-0125-00			SEMICON DVC, DI: TUNNEL, 15PF, 4.7MA, DO-17	03508	STD704
CR655	152-0141-02			SEMICON DVC, DI: SW, SI, 30V, 150MA, 30V, DO-35	03508	DA2527 (1N4152)
CR656	152-0141-02			SEMICON DVC, DI: SW, SI, 30V, 150MA, 30V, DO-35	03508	DA2527 (1N4152)
CR657	152-0141-02			SEMICON DVC, DI: SW, SI, 30V, 150MA, 30V, DO-35	03508	DA2527 (1N4152)
CR660	152-0141-02			SEMICON DVC, DI: SW, SI, 30V, 150MA, 30V, DO-35	03508	DA2527 (1N4152)
CR662	152-0153-00			SEMICON DVC, DI: SW, SI, 10V, 50MA, DO-7	07263	FD7003
CR678	152-0125-00			SEMICON DVC, DI: TUNNEL, 15PF, 4.7MA, DO-17	03508	STD704
CR688	152-0141-02			SEMICON DVC, DI: SW, SI, 30V, 150MA, 30V, DO-35	03508	DA2527 (1N4152)
CR707	152-0153-00			SEMICON DVC, DI: SW, SI, 10V, 50MA, DO-7	07263	FD7003
CR710	152-0141-02			SEMICON DVC, DI: SW, SI, 30V, 150MA, 30V, DO-35	03508	DA2527 (1N4152)
CR765	152-0141-02			SEMICON DVC, DI: SW, SI, 30V, 150MA, 30V, DO-35	03508	DA2527 (1N4152)
CR770	152-0141-02			SEMICON DVC, DI: SW, SI, 30V, 150MA, 30V, DO-35	03508	DA2527 (1N4152)
CR785	152-0141-02			SEMICON DVC, DI: SW, SI, 30V, 150MA, 30V, DO-35	03508	DA2527 (1N4152)
CR792	152-0153-00			SEMICON DVC, DI: SW, SI, 10V, 50MA, DO-7	07263	FD7003
CR794	152-0153-00			SEMICON DVC, DI: SW, SI, 10V, 50MA, DO-7	07263	FD7003
CR795	152-0153-00			SEMICON DVC, DI: SW, SI, 10V, 50MA, DO-7	07263	FD7003
CR829	152-0141-02			SEMICON DVC, DI: SW, SI, 30V, 150MA, 30V, DO-35	03508	DA2527 (1N4152)

Replaceable Electrical Parts
434 (SN B500000 and up)

Component No.	Tektronix Part No.	Serial/Assembly No. Effective	Discont	Name & Description	Mfr. Code	Mfr. Part No.
CR835	152-0153-00			SEMICON DVC,DI:SW,SI,10V,50MA,.DO-7	07263	FD7003
CR836	152-0153-00			SEMICON DVC,DI:SW,SI,10V,50MA,.DO-7	07263	FD7003
CR840	152-0141-02	B500000	B516018	SEMICON DVC,DI:SW,SI,30V,150MA,30V,DO-35	03508	DA2527 (1N4152)
CR840	152-0153-00	B516019		SEMICON DVC,DI:SW,SI,10V,50MA,.DO-7	07263	FD7003
CR859	152-0141-02	B500000	B516018	SEMICON DVC,DI:SW,SI,30V,150MA,30V,DO-35	03508	DA2527 (1N4152)
CR859	152-0153-00	B516019		SEMICON DVC,DI:SW,SI,10V,50MA,.DO-7	07263	FD7003
CR862	152-0141-02			SEMICON DVC,DI:SW,SI,30V,150MA,30V,DO-35	03508	DA2527 (1N4152)
CR864	152-0141-02			SEMICON DVC,DI:SW,SI,30V,150MA,30V,DO-35	03508	DA2527 (1N4152)
CR865	152-0153-00			SEMICON DVC,DI:SW,SI,10V,50MA,.DO-7	07263	FD7003
CR866	152-0153-00			SEMICON DVC,DI:SW,SI,10V,50MA,.DO-7	07263	FD7003
CR870	152-0153-00			SEMICON DVC,DI:SW,SI,10V,50MA,.DO-7	07263	FD7003
CR880	152-0153-00			SEMICON DVC,DI:SW,SI,10V,50MA,.DO-7	07263	FD7003
CR896	152-0141-02			SEMICON DVC,DI:SW,SI,30V,150MA,30V,DO-35	03508	DA2527 (1N4152)
CR898	152-0141-02			SEMICON DVC,DI:SW,SI,30V,150MA,30V,DO-35	03508	DA2527 (1N4152)
CR1210	152-0333-00			SEMICON DVC,DI:SW,SI,55V,200MA,DO-35	07263	FDH-6012
CR1212	152-0333-00			SEMICON DVC,DI:SW,SI,55V,200MA,DO-35	07263	FDH-6012
CR1219	152-0333-00			SEMICON DVC,DI:SW,SI,55V,200MA,DO-35	07263	FDH-6012
CR1220	152-0333-00			SEMICON DVC,DI:SW,SI,55V,200MA,DO-35	07263	FDH-6012
CR1231	152-0333-00			SEMICON DVC,DI:SW,SI,55V,200MA,DO-35	07263	FDH-6012
CR1235	152-0107-00			SEMICON DVC,DI:RECT,SI,400 V,400MA,A1	12969	"G727"
CR1236	152-0107-00			SEMICON DVC,DI:RECT,SI,400 V,400MA,A1	12969	"G727"
CR1237	152-0107-00			SEMICON DVC,DI:RECT,SI,400 V,400MA,A1	12969	"G727"
CR1240	152-0333-00			SEMICON DVC,DI:SW,SI,55V,200MA,DO-35	07263	FDH-6012
CR1242	152-0333-00			SEMICON DVC,DI:SW,SI,55V,200MA,DO-35	07263	FDH-6012
CR1260	152-0333-00			SEMICON DVC,DI:SW,SI,55V,200MA,DO-35	07263	FDH-6012
CR1262	152-0333-00			SEMICON DVC,DI:SW,SI,55V,200MA,DO-35	07263	FDH-6012
CR1269	152-0333-00			SEMICON DVC,DI:SW,SI,55V,200MA,DO-35	07263	FDH-6012
CR1270	152-0333-00			SEMICON DVC,DI:SW,SI,55V,200MA,DO-35	07263	FDH-6012
CR1281	152-0333-00			SEMICON DVC,DI:SW,SI,55V,200MA,DO-35	07263	FDH-6012
CR1285	152-0107-00			SEMICON DVC,DI:RECT,SI,400 V,400MA,A1	12969	"G727"
CR1286	152-0107-00			SEMICON DVC,DI:RECT,SI,400 V,400MA,A1	12969	"G727"
CR1287	152-0107-00			SEMICON DVC,DI:RECT,SI,400 V,400MA,A1	12969	"G727"
CR1691	152-0141-02			SEMICON DVC,DI:SW,SI,30V,150MA,30V,DO-35	03508	DA2527 (1N4152)
CR1692	152-0141-02			SEMICON DVC,DI:SW,SI,30V,150MA,30V,DO-35	03508	DA2527 (1N4152)
CR1694	152-0141-02			SEMICON DVC,DI:SW,SI,30V,150MA,30V,DO-35	03508	DA2527 (1N4152)
CR1696	152-0141-02			SEMICON DVC,DI:SW,SI,30V,150MA,30V,DO-35	03508	DA2527 (1N4152)
CR1699	152-0141-02			SEMICON DVC,DI:SW,SI,30V,150MA,30V,DO-35	03508	DA2527 (1N4152)
CR1724	152-0061-00			SEMICON DVC,DI:SW,SI,175V,0.1A,DO-35	07263	FDH2161
CR1725	152-0061-00			SEMICON DVC,DI:SW,SI,175V,0.1A,DO-35	07263	FDH2161
CR1726	152-0242-00			SEMICON DVC,DI:SIG,SI,225V,0.2A,DO-7	07263	FDH5004
CR1728	152-0242-00			SEMICON DVC,DI:SIG,SI,225V,0.2A,DO-7	07263	FDH5004
CR1740	152-0061-00			SEMICON DVC,DI:SW,SI,175V,0.1A,DO-35	07263	FDH2161
CR1741	152-0061-00			SEMICON DVC,DI:SW,SI,175V,0.1A,DO-35	07263	FDH2161
CR1750	152-0141-02			SEMICON DVC,DI:SW,SI,30V,150MA,30V,DO-35	03508	DA2527 (1N4152)
CR1754	152-0153-00			SEMICON DVC,DI:SW,SI,10V,50MA,.DO-7	07263	FD7003
CR1755	152-0153-00			SEMICON DVC,DI:SW,SI,10V,50MA,.DO-7	07263	FD7003
CR1756	152-0141-02			SEMICON DVC,DI:SW,SI,30V,150MA,30V,DO-35	03508	DA2527 (1N4152)
CR1760	152-0141-02			SEMICON DVC,DI:SW,SI,30V,150MA,30V,DO-35	03508	DA2527 (1N4152)
CR1762	152-0141-02			SEMICON DVC,DI:SW,SI,30V,150MA,30V,DO-35	03508	DA2527 (1N4152)
CR1784	152-0141-02			SEMICON DVC,DI:SW,SI,30V,150MA,30V,DO-35	03508	DA2527 (1N4152)
CR1787	152-0141-02			SEMICON DVC,DI:SW,SI,30V,150MA,30V,DO-35	03508	DA2527 (1N4152)
CR1788	152-0107-00			SEMICON DVC,DI:RECT,SI,400 V,400MA,A1	12969	"G727"
CR1821	152-0396-01	B500000	B543059	SEMICON DVC,DI:RECT,SI,400V,3A	14936	KBPC604-1
CR1821	152-0750-00	B543060		SEMICON DVC,DI:RECT BRDG,600V,3A,FAST RCYV	05828	RKBPC606-12
CR1832	152-0061-00			SEMICON DVC,DI:SW,SI,175V,0.1A,DO-35	07263	FDH2161
CR1833	152-0061-00			SEMICON DVC,DI:SW,SI,175V,0.1A,DO-35	07263	FDH2161
CR1834	152-0400-00			SEMICON DVC,DI:RECT,SI,400V,1A	04713	SR1977K
CR1842	152-0107-00			SEMICON DVC,DI:RECT,SI,400 V,400MA,A1	12969	"G727"

Component No.	Tektronix Part No.	Serial/Assembly No. Effective	Discont	Name & Description	Mfr. Code	Mfr. Part No.
CR1843	152-0107-00			SEMICON DVC,DI:RECT,SI,400 V,400MA,A1	12969	"G727"
CR1844	152-0400-00			SEMICON DVC,DI:RECT,SI,400V,1A	04713	SR1977K
CR1848	152-0107-00			SEMICON DVC,DI:RECT,SI,400 V,400MA,A1	12969	"G727"
CR1901	152-0141-02			SEMICON DVC,DI:SW,SI,30V,150MA,30V,DO-35	03508	DA2527 (1N4152)
CR1904	152-0141-02			SEMICON DVC,DI:SW,SI,30V,150MA,30V,DO-35	03508	DA2527 (1N4152)
CR1923	152-0333-00			SEMICON DVC,DI:SW,SI,55V,200MA,DO-35	07263	FDH-6012
CR1924	152-0333-00			SEMICON DVC,DI:SW,SI,55V,200MA,DO-35	07263	FDH-6012
CR1925	152-0333-00			SEMICON DVC,DI:SW,SI,55V,200MA,DO-35	07263	FDH-6012
CR1931	152-0333-00			SEMICON DVC,DI:SW,SI,55V,200MA,DO-35	07263	FDH-6012
CR1932	152-0333-00			SEMICON DVC,DI:SW,SI,55V,200MA,DO-35	07263	FDH-6012
CR1933	152-0333-00			SEMICON DVC,DI:SW,SI,55V,200MA,DO-35	07263	FDH-6012
CR1934	152-0333-00			SEMICON DVC,DI:SW,SI,55V,200MA,DO-35	07263	FDH-6012
CR1943	152-0141-02			SEMICON DVC,DI:SW,SI,30V,150MA,30V,DO-35	03508	DA2527 (1N4152)
CR1960	152-0413-00			SEMICON DVC,DI:RECT,SI,400V,1.0A,A59	04713	SR2046KRL
CR1962	152-0413-00			SEMICON DVC,DI:RECT,SI,400V,1.0A,A59	04713	SR2046KRL
CR1964	152-0413-00			SEMICON DVC,DI:RECT,SI,400V,1.0A,A59	04713	SR2046KRL
CR1966	152-0413-00			SEMICON DVC,DI:RECT,SI,400V,1.0A,A59	04713	SR2046KRL
CR1968	152-0413-00			SEMICON DVC,DI:RECT,SI,400V,1.0A,A59	04713	SR2046KRL
CR1970	152-0413-00			SEMICON DVC,DI:RECT,SI,400V,1.0A,A59	04713	SR2046KRL
CR1971	152-0413-00			SEMICON DVC,DI:RECT,SI,400V,1.0A,A59	04713	SR2046KRL
CR1972	152-0412-00			SEMICON DVC,DI:RECT,SI,50V,3A	80009	152-0412-00
CR1974	152-0412-00			SEMICON DVC,DI:RECT,SI,50V,3A	80009	152-0412-00
CR1976	152-0412-00			SEMICON DVC,DI:RECT,SI,50V,3A	80009	152-0412-00
CR1978	152-0412-00			SEMICON DVC,DI:RECT,SI,50V,3A	80009	152-0412-00
CR1984	152-0413-00			SEMICON DVC,DI:RECT,SI,400V,1.0A,A59	04713	SR2046KRL
CR1990	152-0429-00			SEMICON DVC,DI:RECT,SI,5000V,10MA,A298J	83003	VG5X-1
CR1992	152-0409-00			SEMICON DVC,DI:RECT,SI,12KV,35MA,2NS	83003	VG12X-1
CR1994	152-0409-00			SEMICON DVC,DI:RECT,SI,12KV,35MA,2NS	83003	VG12X-1
DL500	119-0267-00			DELAY LINE,ELEC:145NS,186 OHM	80009	119-0267-00
DS20	150-0109-00			LAMP, INCAND:18V,0.026A,#CM7220,WIRE LD	71744	CM7220
DS22	150-0109-00			LAMP, INCAND:18V,0.026A,#CM7220,WIRE LD	71744	CM7220
DS30	150-0109-00			LAMP, INCAND:18V,0.026A,#CM7220,WIRE LD	71744	CM7220
DS32	150-0109-00			LAMP, INCAND:18V,0.026A,#CM7220,WIRE LD	71744	CM7220
DS65	150-0035-00			LAMP,GLOW:90V MAX,0.3MA,AID-T,WIRE LD	TK0213	JH005/3011JA
DS1726	150-0035-00			LAMP,GLOW:90V MAX,0.3MA,AID-T,WIRE LD	TK0213	JH005/3011JA
DS1727	150-0035-00			LAMP,GLOW:90V MAX,0.3MA,AID-T,WIRE LD	TK0213	JH005/3011JA
DS1801	119-0181-00			ARSR,ELEC SURGE:230,GAS FILLED	25088	B1-A230
DS1802	119-0181-00			ARSR,ELEC SURGE:230,GAS FILLED	25088	B1-A230
DS1824	150-0035-00			LAMP,GLOW:90V MAX,0.3MA,AID-T,WIRE LD	TK0213	JH005/3011JA
DS1993	150-0035-00			LAMP,GLOW:90V MAX,0.3MA,AID-T,WIRE LD	TK0213	JH005/3011JA
F1801	159-0015-00			FUSE,CARTRIDGE:3AG,3A,250V,0.65SEC (STANDARD ONLY)	75915	312 003
F1801	159-0042-00			FUSE,CARTRIDGE:3AG,0.75A,250V,0.15SEC (OPTIONS A1,A2,A3,A4 ONLY)	75915	312.750
J1	131-0679-02			CONN,RCPT,ELEC:BNC,MALE,3 CONTACT	24931	28JR270-1
J10	131-0679-02			CONN,RCPT,ELEC:BNC,MALE,3 CONTACT	24931	28JR270-1
J70	131-0955-00			CONN,RCPT,ELEC:BNC,FEMALE	13511	31-279
J80	131-0955-00			CONN,RCPT,ELEC:BNC,FEMALE	13511	31-279
J85	131-0955-00			CONN,RCPT,ELEC:BNC,FEMALE	13511	31-279
J95	136-0098-01			JACK,TIP:0.25-32 X 0.562,GRAY	TK1036	105-0813-001
L100	108-0657-00			COIL,TUBE DEFL:TRACE ROTATOR	80009	108-0657-00
L275	108-0443-00			COIL,RF:FIXED,23.5UH	80009	108-0443-00
L279	276-0541-00			SHLD BEAD,ELEK:FERRITE	80009	276-0541-00
L285	108-0443-00			COIL,RF:FIXED,23.5UH	80009	108-0443-00
L289	276-0541-00			SHLD BEAD,ELEK:FERRITE	80009	276-0541-00
L533	114-0309-00			COIL,RF:VARIABLE,9.6-18.7UH,CT	TK1345	114-0309-00
L584	114-0309-00			COIL,RF:VARIABLE,9.6-18.7UH,CT	TK1345	114-0309-00
L1804	108-0660-00			COIL,RF:FIXED,240UH	80009	108-0660-00

Replaceable Electrical Parts
434 (SN B500000 and up)

Component No.	Tektronix	Serial/Assembly No.		Name & Description	Mfr.	Mfr. Part No.
	Part No.	Effective	Discont		Code	
L1825	108-0742-00			COIL, RF: FIXED, 83UH	80009	108-0742-00
L1835	108-0709-00			COIL, RF: FIXED, 1.6MH	54937	108070900
L1964	108-0646-00			COIL, RF: FIXED, 80UH	TK1345	108-0646-00
L1968	108-0646-00			COIL, RF: FIXED, 80UH	TK1345	108-0646-00
L1972	108-0646-00			COIL, RF: FIXED, 80UH	TK1345	108-0646-00
LR9	108-0286-00			COIL, RF: FIXED, 167NH	80009	108-0286-00
LR19	108-0286-00			COIL, RF: FIXED, 167NH	80009	108-0286-00
LR533	108-0659-00			COIL, RF: FIXED, 1.5UH	TK2042	ORDER BY DESCR
LR584	108-0659-00			COIL, RF: FIXED, 1.5UH	TK2042	ORDER BY DESCR
Q124	151-1032-00			TRANSISTOR: FET, DUAL N-CHAN, SI, TO-78A	04713	SFD1032
Q174	151-1032-00			TRANSISTOR: FET, DUAL N-CHAN, SI, TO-78A	04713	SFD1032
Q200	151-0281-00			TRANSISTOR: NPN, SI, 400 MILLIWATTS	80009	151-0281-00
Q202	151-0192-00			TRANSISTOR: NPN, SI, TO-92	04713	SPS8801
Q255	151-0220-00			TRANSISTOR: PNP, SI, TO-92	80009	151-0220-00
Q265	151-0220-00			TRANSISTOR: PNP, SI, TO-92	80009	151-0220-00
Q275	151-0221-00			TRANSISTOR: PNP, SI, TO-92	80009	151-0221-00
Q278	151-0221-00			TRANSISTOR: PNP, SI, TO-92	80009	151-0221-00
Q280	151-0190-01			TRANSISTOR: NPN, SI, TO-92	80009	151-0190-01
Q300	151-0281-00			TRANSISTOR: NPN, SI, 400 MILLIWATTS	80009	151-0281-00
Q302	151-0192-00			TRANSISTOR: NPN, SI, TO-92	04713	SPS8801
Q355	151-0220-00			TRANSISTOR: PNP, SI, TO-92	80009	151-0220-00
Q365	151-0220-00			TRANSISTOR: PNP, SI, TO-92	80009	151-0220-00
Q420	151-0223-00			TRANSISTOR: NPN, SI, 625MW, TO-92	04713	SPS8026
Q425	151-0223-00			TRANSISTOR: NPN, SI, 625MW, TO-92	04713	SPS8026
Q435	151-0223-00			TRANSISTOR: NPN, SI, 625MW, TO-92	04713	SPS8026
Q440	151-0223-00			TRANSISTOR: NPN, SI, 625MW, TO-92	04713	SPS8026
Q454	151-0220-00			TRANSISTOR: PNP, SI, TO-92	80009	151-0220-00
Q470	151-0220-00			TRANSISTOR: PNP, SI, TO-92	80009	151-0220-00
Q505	151-0220-00			TRANSISTOR: PNP, SI, TO-92	80009	151-0220-00
Q515	151-0198-00			TRANSISTOR: SELECTED	04713	SPS8802-1
Q520	151-0230-00			TRANSISTOR: NPN, SI, TO-92	TK0961	2SC1260(2)
Q525	151-0127-00			TRANSISTOR: NPN, SI, TO-18	04713	SL6073A
Q530	151-0124-00			TRANSISTOR: NPN, SI, TO-39	04713	SM8138
Q545	151-0220-00			TRANSISTOR: PNP, SI, TO-92	80009	151-0220-00
Q550	151-0230-00			TRANSISTOR: NPN, SI, TO-92	TK0961	2SC1260(2)
Q555	151-0198-00			TRANSISTOR: SELECTED	04713	SPS8802-1
Q565	151-0127-00			TRANSISTOR: NPN, SI, TO-18	04713	SL6073A
Q580	151-0124-00			TRANSISTOR: NPN, SI, TO-39	04713	SM8138
Q605	151-1041-00			TRANSISTOR: FET, N-CHAN, SI, TO-71	04713	SFD1041
Q610	151-0190-01			TRANSISTOR: NPN, SI, TO-92	80009	151-0190-01
Q618	151-0190-01			TRANSISTOR: NPN, SI, TO-92	80009	151-0190-01
Q635	151-0220-00			TRANSISTOR: PNP, SI, TO-92	80009	151-0220-00
Q645	151-0220-00			TRANSISTOR: PNP, SI, TO-92	80009	151-0220-00
Q660	151-0220-00			TRANSISTOR: PNP, SI, TO-92	80009	151-0220-00
Q665	151-0250-00			TRANSISTOR: NPN, SI, TO-104	07263	S036744
Q818	151-0216-00			TRANSISTOR: PNP, SI, TO-92	04713	SPS8803
Q825	151-0261-00			TRANSISTOR: PNP, SI, TO-77	80009	151-0261-00
Q830	151-0232-00			TRANSISTOR: NPN, SI, TO-78	07263	SP12141
Q835	151-0232-00			TRANSISTOR: NPN, SI, TO-78	07263	SP12141
Q836	151-0261-00			TRANSISTOR: PNP, SI, TO-77	80009	151-0261-00
Q861	151-0192-00			TRANSISTOR: NPN, SI, TO-92	04713	SPS8801
Q870	151-0192-00			TRANSISTOR: NPN, SI, TO-92	04713	SPS8801
Q874	151-0280-00			TRANSISTOR: PNP, SI, TO-39	04713	SS8065
Q877	151-0279-00			TRANSISTOR: SELECTED	04713	SS2821
Q880	151-0164-00			TRANSISTOR: PNP, SI, TO-92	04713	2N2907A
Q884	151-0280-00			TRANSISTOR: PNP, SI, TO-39	04713	SS8065
Q887	151-0279-00			TRANSISTOR: SELECTED	04713	SS2821
Q895	151-0192-00			TRANSISTOR: NPN, SI, TO-92	04713	SPS8801

Replaceable Electrical Parts
434 (SN B500000 and up)

Component No.	Tektronix Part No.	Serial/Assembly No. Effective	Discont	Name & Description	Mfr. Code	Mfr. Part No.
Q1210	151-0224-00			TRANSISTOR: NPN, SI, TO-92	04713	SPS6917
Q1216	151-0224-00			TRANSISTOR: NPN, SI, TO-92	04713	SPS6917
Q1230	151-0342-00			TRANSISTOR: PNP, SI, TO-92	07263	S035928
Q1232	151-0297-00			TRANSISTOR: NPN, SI, TO-39	04713	ST613
Q1235	151-0169-00			TRANSISTOR: NPN, SI, TO-5	04713	ST830
Q1238	151-0292-00			TRANSISTOR: NPN, SI, X-55	80009	151-0292-00
Q1245	151-0224-00			TRANSISTOR: NPN, SI, TO-92	04713	SPS6917
Q1246	151-0224-00			TRANSISTOR: NPN, SI, TO-92	04713	SPS6917
Q1260	151-0224-00			TRANSISTOR: NPN, SI, TO-92	04713	SPS6917
Q1266	151-0224-00			TRANSISTOR: NPN, SI, TO-92	04713	SPS6917
Q1280	151-0342-00			TRANSISTOR: PNP, SI, TO-92	07263	S035928
Q1282	151-0297-00			TRANSISTOR: NPN, SI, TO-39	04713	ST613
Q1285	151-0169-00			TRANSISTOR: NPN, SI, TO-5	04713	ST830
Q1288	151-0292-00			TRANSISTOR: NPN, SI, X-55	80009	151-0292-00
Q1294	151-0150-00			TRANSISTOR: SELECTED	80009	151-0150-00
Q1296	151-0292-00			TRANSISTOR: NPN, SI, X-55	80009	151-0292-00
Q1698	151-0301-00			TRANSISTOR: PNP, SI, TO-18	04713	ST898
Q1705	151-0273-00			TRANSISTOR: SELECTED	03508	X16E3616
Q1710	151-0273-00			TRANSISTOR: SELECTED	03508	X16E3616
Q1715	151-0220-00			TRANSISTOR: PNP, SI, TO-92	80009	151-0220-00
Q1740	151-0406-00			TRANSISTOR: PNP, SI, TO-39	04713	ST1264
Q1750	151-0407-00			TRANSISTOR: NPN, SI, TO-39	80009	151-0407-00
Q1754	151-0223-00			TRANSISTOR: NPN, SI, 625MW, TO-92	04713	SPS8026
Q1755	151-0188-00			TRANSISTOR: PNP, SI, TO-92	80009	151-0188-00
Q1780	151-0280-00			TRANSISTOR: PNP, SI, TO-39	04713	SS8065
Q1789	151-0279-00			TRANSISTOR: SELECTED	04713	SS2821
Q1834	151-0368-00			TRANSISTOR: NPN, SI, TO-3	04713	SJ2754
Q1840	151-0260-00			TRANSISTOR: NPN, SI, TO-39	04713	ST1083
Q1844	151-0368-00			TRANSISTOR: NPN, SI, TO-3	04713	SJ2754
Q1846	151-0519-00			SCR: SI, TO-92	80009	151-0519-00
Q1900	151-0302-00			TRANSISTOR: NPN, SI, TO-18	04713	ST899
Q1902	151-0302-00	B500000	B529199	TRANSISTOR: NPN, SI, TO-18	04713	ST899
Q1902	151-0273-00	B529200		TRANSISTOR: SELECTED	03508	X16E3616
R8	316-0105-00			RES, FXD, CMPSN: 1M OHM, 10%, 0.25W	01121	CB1051
R18	316-0105-00			RES, FXD, CMPSN: 1M OHM, 10%, 0.25W	01121	CB1051
R22	311-0546-00			RES, VAR, NONWW: TRMR, 10K OHM, 0.5W	01121	W-8154A
R32	311-0546-00			RES, VAR, NONWW: TRMR, 10K OHM, 0.5W	01121	W-8154A
R40	311-1115-00			RES, VAR, NONWW: PNL, 2X5K OHM, 0.25W	12697	381-CM39718
R41	321-0121-00			RES, FXD, FILM: 178 OHM, 1%, 0.125W, TC=TO	07716	CEAD178ROF
R42	321-0121-00			RES, FXD, FILM: 178 OHM, 1%, 0.125W, TC=TO	07716	CEAD178ROF
R44	311-1115-00			RES, VAR, NONWW: PNL, 2X5K OHM, 0.25W	12697	381-CM39718
R50	315-0271-00			RES, FXD, FILM: 270 OHM, 5%, 0.25W	57668	NTR25J-E270E
R55	311-0429-00			RES, VAR, NONWW: PNL, 100K X 10K OHM, 0.5W	12697	CM33098
R60	311-1117-00			RES, VAR, NONWW: PNL, 10K X 50K OHM, 0.25W	12697	D381S-CM39717
R61	316-0104-00			RES, FXD, CMPSN: 100K OHM, 10%, 0.25W	01121	CB1041
R70	322-0621-00			RES, FXD, FILM: 900K OHM, 1%, 0.25W, TC=TO	19701	5043RD900KOF
R71	321-0617-00			RES, FXD, FILM: 111K OHM, 1%, 0.125W, TC=TO	19701	5043ED250KOF
R72	316-0471-00			RES, FXD, CMPSN: 470 OHM, 10%, 0.25W	01121	CB4711
R74	315-0104-00			RES, FXD, FILM: 100K OHM, 5%, 0.25W	57668	NTR25J-E100K
R76	315-0273-00			RES, FXD, FILM: 27K OHM, 5%, 0.25W	57668	NTR25J-E27K0
R80	311-0086-00			RES, VAR, NONWW: PNL, 2.5K OHM, 0.5W	01121	W-7699
R82	311-1207-00			RES, VAR, NONWW: PNL, 1K X 5M OHM, 1W	12697	CM-39698
R83	301-0755-00			RES, FXD, FILM: 7.5M OHM, 5%, 0.5W (NOMINAL VALUE, SELECTED)	01121	EB7555
R85	311-1200-00			RES, VAR, NONWW: PNL, 100K OHM, 0.5W	01121	W-7861
R86	311-0647-00			RES, VAR, NONWW: PNL, 5MEG OHM, 0.5W	12697	382CM35127
R90	316-0472-00			RES, FXD, CMPSN: 4.7K OHM, 10%, 0.25W	01121	CB4721
R92	311-1190-00			RES, VAR, NONWW: PNL, 10K OHM, 1W, W/SW	01121	10M551

Replaceable Electrical Parts
434 (SN B500000 and up)

Component No.	Tektronix Part No.	Serial/Assembly No.		Name & Description	Mfr. Code	Mfr. Part No.
		Effective	Dscnt			
R94	316-0221-00			RES,FXD,CMPSN:220 OHM,10%,0.25W	01121	CB2211
R95	315-0562-00			RES,FXD,FILM:5.6K OHM,5%,0.25W	57668	NTR25J-E05K6
R120	321-0481-00			RES,FXD,FILM:1M OHM,1%,0.125W,TC=TO	19701	5043ED1M000F
R121	316-0104-00			RES,FXD,CMPSN:100K OHM,10%,0.25W	01121	CB1041
R122	316-0470-00			RES,FXD,CMPSN:47 OHM,10%,0.25W	01121	CB4701
R125	321-0030-00			RES,FXD,FILM:20.0 OHM,1%,0.125W,TC=TO	57668	CRB14FXE 20 OHM
R126	321-0030-00			RES,FXD,FILM:20.0 OHM,1%,0.125W,TC=TO	57668	CRB14FXE 20 OHM
R134	315-0393-00			RES,FXD,FILM:39K OHM,5%,0.25W	57668	NTR25J-E39K0
R135	315-0151-00			RES,FXD,FILM:150 OHM,5%,0.25W	57668	NTR25J-E150E
R170	321-0481-00			RES,FXD,FILM:1M OHM,1%,0.125W,TC=TO	19701	5043ED1M000F
R171	316-0104-00			RES,FXD,CMPSN:100K OHM,10%,0.25W	01121	CB1041
R172	316-0470-00			RES,FXD,CMPSN:47 OHM,10%,0.25W	01121	CB4701
R175	321-0030-00			RES,FXD,FILM:20.0 OHM,1%,0.125W,TC=TO	57668	CRB14FXE 20 OHM
R176	321-0030-00			RES,FXD,FILM:20.0 OHM,1%,0.125W,TC=TO	57668	CRB14FXE 20 OHM
R184	315-0393-00			RES,FXD,FILM:39K OHM,5%,0.25W	57668	NTR25J-E39K0
R185	315-0151-00			RES,FXD,FILM:150 OHM,5%,0.25W	57668	NTR25J-E150E
R187	315-0820-00			RES,FXD,FILM:82 OHM,5%,0.25W	57668	NTR25J-E82E0
R189	315-0820-00			RES,FXD,FILM:82 OHM,5%,0.25W	57668	NTR25J-E82E0
R200	316-0274-00			RES,FXD,CMPSN:270K OHM,10%,0.25W	01121	CB2741
R201	315-0910-00	B530000		RES,FXD,FILM:91 OHM,5%,0.25W	19701	5043CX91R00J
R202	316-0682-00			RES,FXD,CMPSN:6.8K OHM,10%,0.25W	01121	CB6821
R204	316-0152-00			RES,FXD,CMPSN:1.5K OHM,10%,0.25	01121	CB1521
R210	316-0103-00			RES,FXD,CMPSN:10K OHM,10%,0.25W	01121	CB1031
R212	311-1232-00			RES,VAR,NONW:TRMR,50K OHM,0.5W	32997	3386F-T04-503
R214	316-0103-00			RES,FXD,CMPSN:10K OHM,10%,0.25W	01121	CB1031
R216	321-0107-00			RES,FXD,FILM:127 OHM,1%,0.125W,TC=TO	07716	CEAD127ROF
R219	315-0103-00			RES,FXD,FILM:10K OHM,5%,0.25W (NOMINAL VALUE,SELECTABLE)	19701	5043CX10K00J
R220	321-0094-00			RES,FXD,FILM:93.1 OHM,1%,0.125W,TC=TO (NOMINAL VALUE,SELECTABLE)	91637	CMF55116693R10F
R221	315-0331-00			RES,FXD,FILM:330 OHM,5%,0.25W	57668	NTR25J-E330E
R222	315-0183-00			RES,FXD,FILM:18K OHM,5%,0.25W (NOMINAL VALUE,SELECTABLE)	19701	5043CX18K00J
R223	321-0130-00			RES,FXD,FILM:221 OHM,1%,0.125W,TC=TO (NOMINAL VALUE,SELECTABLE)	19701	5043ED221ROF
R224	315-0391-00			RES,FXD,FILM:390 OHM,5%,0.25W	57668	NTR25J-E390E
R225	321-0172-00			RES,FXD,FILM:604 OHM,1%,0.125W,TC=TO	19701	5033ED604ROF
R226	321-0151-00			RES,FXD,FILM:365 OHM,1%,0.125W,TC=TO	07716	CEAD365ROF
R228	321-0317-00			RES,FXD,FILM:19.6K OHM,1%,0.125W,TC=TO	07716	CEAD19601F
R229	321-0120-00			RES,FXD,FILM:174 OHM,1%,0.125W,TC=TO	07716	CEAD174ROF
R230	321-0172-02			RES,FXD,FILM:604 OHM,0.5%,0.125W,TC=T2	19701	5033RC604ROD
R231	315-0561-00			RES,FXD,FILM:560 OHM,5%,0.25W	19701	5043CX560ROJ
R232	321-0204-00			RES,FXD,FILM:1.30K OHM,1%,0.125W,TC=TO	19701	5033ED1K300F
R235	321-0202-00			RES,FXD,FILM:1.24K OHM,1%,0.125W,TC=TO	24546	NA5501241F
R236	321-0172-02			RES,FXD,FILM:604 OHM,0.5%,0.125W,TC=T2	19701	5033RC604ROD
R238	321-0204-00			RES,FXD,FILM:1.30K OHM,1%,0.125W,TC=TO	19701	5033ED1K300F
R240	321-0050-01			RES,FXD,FILM:32.4 OHM,0.5%,0.125W,TC=TO MI	57668	RB14 DXE 32E4
R242	316-0221-00			RES,FXD,CMPSN:220 OHM,10%,0.25W	01121	CB2211
R244	311-1116-00			RES,VAR,NONW:PNL,100 OHM,0.5W	01121	WA1G032S101MA
R245	311-1125-00			RES,VAR,W:PNL,250 OHM	TK2038	311-1125-00
R246	321-0050-01			RES,FXD,FILM:32.4 OHM,0.5%,0.125W,TC=TO MI	57668	RB14 DXE 32E4
R250	321-0175-00			RES,FXD,FILM:649 OHM,1%,0.125W,TC=TO	19701	5043ED649ROF
R252	321-0181-00			RES,FXD,FILM:750 OHM,1%,0.125W,TC=TO	07716	CEAD750ROF
R253	316-0270-00			RES,FXD,CMPSN:27 OHM,10%,0.25W	01121	CB2701
R255	316-0101-00			RES,FXD,CMPSN:100 OHM,10%,0.25W	01121	CB1011
R256	321-0232-00			RES,FXD,FILM:2.55K OHM,1%,0.125W,TC=TO	19701	5043ED2K550F
R258	321-0255-00			RES,FXD,FILM:4.42K OHM,1%,0.125W,TC=TO	19701	5033ED4K420F
R260	321-0175-00			RES,FXD,FILM:649 OHM,1%,0.125W,TC=TO	19701	5043ED649ROF

For Service Manuals Contact
MAURITRON TECHNICAL SERVICES
8 Cherry Tree Rd, Chinnor
Oxon OX9 4QY
Tel: 01844-351694 Fax: 01844-352554
Email: enquiries@mauritron.co.uk

Replaceable Electrical Parts
434 (SN B500000 and up)

Component No.	Tektronix Part No.	Serial/Assembly No. Effective Dscont	Name & Description	Mfr. Code	Mfr. Part No.
R262	321-0181-00		RES, FXD, FILM: 750 OHM, 1%, 0.125W, TC=TO	07716	CEAD750R0F
R265	316-0101-00		RES, FXD, CMPSN: 100 OHM, 10%, 0.25W	01121	CB1011
R270	316-0104-00		RES, FXD, CMPSN: 100K OHM, 10%, 0.25W	01121	CB1041
R273	321-0256-00		RES, FXD, FILM: 4.53K OHM, 1%, 0.125W, TC=T9	19701	5033ED4K530F
R274	311-1198-00		RES, VAR, NONNW: TRMR, 20K OHM, 0.5W	32997	3386X-T07-203
R275	321-0207-00		RES, FXD, FILM: 1.40K OHM, 1%, 0.125W, TC=TO	19701	5033ED1K400F
R276	321-0177-00		RES, FXD, FILM: 681 OHM, 1%, 0.125W, TC=TO	07716	CEAD681R0F
R277	321-0177-00		RES, FXD, FILM: 681 OHM, 1%, 0.125W, TC=TO	07716	CEAD681R0F
R278	321-0182-00		RES, FXD, FILM: 768 OHM, 1%, 0.125W, TC=TO	07716	CEAD768R0F
R279	321-0182-00		RES, FXD, FILM: 768 OHM, 1%, 0.125W, TC=TO	07716	CEAD768R0F
R280	316-0104-00		RES, FXD, CMPSN: 100K OHM, 10%, 0.25W	01121	CB1041
R281	315-0302-00		RES, FXD, FILM: 3K OHM, 5%, 0.25W	57668	NTR25J-E03K0
R282	316-0152-00		RES, FXD, CMPSN: 1.5K OHM, 10%, 0.25	01121	CB1521
R283	321-0256-00		RES, FXD, FILM: 4.53K OHM, 1%, 0.125W, TC=T9	19701	5033ED4K530F
R284	311-1198-00		RES, VAR, NONNW: TRMR, 20K OHM, 0.5W	32997	3386X-T07-203
R285	321-0242-00		RES, FXD, FILM: 3.24K OHM, 1%, 0.125W, TC=TO	19701	5043ED3K240F
R286	315-0202-00		RES, FXD, FILM: 2K OHM, 5%, 0.25W	57668	NTR25J-E 2K
R287	321-0230-00		RES, FXD, FILM: 2.43K OHM, 1%, 0.125W, TC=TO	19701	5043ED2K430F
R288	321-0230-00		RES, FXD, FILM: 2.43K OHM, 1%, 0.125W, TC=TO	19701	5043ED2K430F
R289	321-0301-00		RES, FXD, FILM: 13.3K OHM, 1%, 0.125W, TC=TO	07716	CEAD13301F
R300	316-0274-00		RES, FXD, CMPSN: 270K OHM, 10%, 0.25W	01121	CB2741
R302	316-0682-00		RES, FXD, CMPSN: 6.8K OHM, 10%, 0.25W	01121	CB6821
R304	316-0152-00		RES, FXD, CMPSN: 1.5K OHM, 10%, 0.25	01121	CB1521
R310	316-0103-00		RES, FXD, CMPSN: 10K OHM, 10%, 0.25W	01121	CB1031
R312	311-1232-00		RES, VAR, NONNW: TRMR, 50K OHM, 0.5W	32997	3386F-T04-503
R314	316-0103-00		RES, FXD, CMPSN: 10K OHM, 10%, 0.25W	01121	CB1031
R316	321-0104-00		RES, FXD, FILM: 118 OHM, 1%, 0.125W, TC=TO	24546	NA55D1180F
R319	315-0103-00		RES, FXD, FILM: 10K OHM, 5%, 0.25W (ADDED IF NECESSARY)	19701	5043CX10K00J
R320	321-0094-00		RES, FXD, FILM: 93.1 OHM, 1%, 0.125W, TC=TO	91637	CMF55116693R10F
R321	315-0241-00		RES, FXD, FILM: 240 OHM, 5%, 0.25W	19701	5043CX240R0J
R322	315-0183-00		RES, FXD, FILM: 18K OHM, 5%, 0.25W (ADDED IF NECESSARY)	19701	5043CX18K00J
R323	321-0130-00		RES, FXD, FILM: 221 OHM, 1%, 0.125W, TC=TO	19701	5043ED221R0F
R324	315-0331-00		RES, FXD, FILM: 330 OHM, 5%, 0.25W	57668	NTR25J-E330E
R325	321-0172-00		RES, FXD, FILM: 604 OHM, 1%, 0.125W, TC=TO	19701	5033ED604R0F
R326	321-0221-00		RES, FXD, FILM: 1.96K OHM, 1%, 0.125W, TC=TO	19701	5043ED1K960F
R328	321-0317-00		RES, FXD, FILM: 19.6K OHM, 1%, 0.125W, TC=TO	07716	CEAD19601F
R329	321-0120-00		RES, FXD, FILM: 174 OHM, 1%, 0.125W, TC=TO	07716	CEAD174R0F
R330	321-0172-02		RES, FXD, FILM: 604 OHM, 0.5%, 0.125W, TC=T2	19701	5033RC604R0D
R331	315-0911-00		RES, FXD, FILM: 910 OHM, 5%, 0.25W	57668	NTR25J-E910E
R332	321-0204-00		RES, FXD, FILM: 1.30K OHM, 1%, 0.125W, TC=TO	19701	5033ED1K300F
R335	321-0202-00		RES, FXD, FILM: 1.24K OHM, 1%, 0.125W, TC=TO	24546	NA55D1241F
R336	321-0172-02		RES, FXD, FILM: 604 OHM, 0.5%, 0.125W, TC=T2	19701	5033RC604R0D
R338	321-0204-00		RES, FXD, FILM: 1.30K OHM, 1%, 0.125W, TC=TO	19701	5033ED1K300F
R340	321-0050-01		RES, FXD, FILM: 32.4 OHM, 0.5%, 0.125W, TC=TO MI	57668	RB14 DXE 32E4
R342	316-0221-00		RES, FXD, CMPSN: 220 OHM, 10%, 0.25W	01121	CB2211
R344	311-1116-00		RES, VAR, NONNW: PNL, 100 OHM, 0.5W	01121	WA1G032S101MA
R345	311-1125-00		RES, VAR, WW: PNL, 250 OHM	TK2038	311-1125-00
R346	321-0050-01		RES, FXD, FILM: 32.4 OHM, 0.5%, 0.125W, TC=TO MI	57668	RB14 DXE 32E4
R347	316-0103-00		RES, FXD, CMPSN: 10K OHM, 10%, 0.25W	01121	CB1031
R348	311-1035-00		RES, VAR, NONNW: TRMR, 50K OHM, 0.5W	73138	82PR50K-40C
R349	316-0103-00		RES, FXD, CMPSN: 10K OHM, 10%, 0.25W	01121	CB1031
R350	321-0175-00		RES, FXD, FILM: 649 OHM, 1%, 0.125W, TC=TO	19701	5043ED649R0F
R352	321-0181-00		RES, FXD, FILM: 750 OHM, 1%, 0.125W, TC=TO	07716	CEAD750R0F
R353	316-0270-00		RES, FXD, CMPSN: 27 OHM, 10%, 0.25W	01121	CB2701
R354	316-0152-00		RES, FXD, CMPSN: 1.5K OHM, 10%, 0.25	01121	CB1521
R355	316-0101-00		RES, FXD, CMPSN: 100 OHM, 10%, 0.25W	01121	CB1011

Replaceable Electrical Parts
434 (SN B500000 and up)

Component No.	Tektronix Part No.	Serial/Assembly No. Effective Dscont	Name & Description	Mfr. Code	Mfr. Part No.
R356	321-0232-00		RES, FXD, FILM: 2.55K OHM, 1%, 0.125W, TC=TO	19701	5043ED2K550F
R358	321-0255-00		RES, FXD, FILM: 4.42K OHM, 1%, 0.125W, TC=TO	19701	5033ED4K420F
R360	321-0175-00		RES, FXD, FILM: 649 OHM, 1%, 0.125W, TC=TO	19701	5043ED649ROF
R362	321-0181-00		RES, FXD, FILM: 750 OHM, 1%, 0.125W, TC=TO	07716	CEAD750ROF
R365	316-0101-00		RES, FXD, CMPSN: 100 OHM, 10%, 0.25W	01121	CB1011
R404	321-0273-00		RES, FXD, FILM: 6.81K OHM, 1%, 0.125W, TC=TO	07716	CEAD68100F
R408	321-0273-00		RES, FXD, FILM: 6.81K OHM, 1%, 0.125W, TC=TO	07716	CEAD68100F
R410	321-0273-00		RES, FXD, FILM: 6.81K OHM, 1%, 0.125W, TC=TO	07716	CEAD68100F
R414	321-0273-00		RES, FXD, FILM: 6.81K OHM, 1%, 0.125W, TC=TO	07716	CEAD68100F
R419	315-0622-00		RES, FXD, FILM: 6.2K OHM, 5%, 0.25W	19701	5043CX6K200J
R420	321-0193-00		RES, FXD, FILM: 1K OHM, 1%, 0.125W, TC=TO	19701	5033ED1K00F
R421	321-0210-00		RES, FXD, FILM: 1.50K OHM, 1%, 0.125W, TC=TO	19701	5033ED1K50F
R422	321-0231-00		RES, FXD, FILM: 2.49K OHM, 1%, 0.125W, TC=TO	19701	5033ED2K49F
R423	321-0231-00		RES, FXD, FILM: 2.49K OHM, 1%, 0.125W, TC=TO	19701	5033ED2K49F
R424	321-0210-00		RES, FXD, FILM: 1.50K OHM, 1%, 0.125W, TC=TO	19701	5033ED1K50F
R425	321-0193-00		RES, FXD, FILM: 1K OHM, 1%, 0.125W, TC=TO	19701	5033ED1K00F
R426	301-0152-00		RES, FXD, FILM: 1.5K OHM, 5%, 0.5W	19701	5053CX1K500J
R427	301-0152-00		RES, FXD, FILM: 1.5K OHM, 5%, 0.5W	19701	5053CX1K500J
R428	301-0152-00		RES, FXD, FILM: 1.5K OHM, 5%, 0.5W	19701	5053CX1K500J
R429	301-0152-00		RES, FXD, FILM: 1.5K OHM, 5%, 0.5W	19701	5053CX1K500J
R430	315-0203-00		RES, FXD, FILM: 20K OHM, 5%, 0.25W	57668	NTR25J-E 20K
R431	316-0104-00		RES, FXD, CMPSN: 100K OHM, 10%, 0.25W	01121	CB1041
R432	316-0183-00		RES, FXD, CMPSN: 18K OHM, 10%, 0.25W	01121	CB1831
R433	316-0104-00		RES, FXD, CMPSN: 100K OHM, 10%, 0.25W	01121	CB1041
R435	301-0102-00		RES, FXD, CMPSN: 1K OHM, 5%, 0.50W	19701	5053CX1K000J
R436	315-0273-00		RES, FXD, FILM: 27K OHM, 5%, 0.25W	57668	NTR25J-E27K0
R437	315-0100-00		RES, FXD, FILM: 10 OHM, 5%, 0.25W	19701	5043CX10RR00J
R438	315-0100-00		RES, FXD, FILM: 10 OHM, 5%, 0.25W	19701	5043CX10RR00J
R439	316-0101-00		RES, FXD, CMPSN: 100 OHM, 10%, 0.25W	01121	CB1011
R440	315-0392-00		RES, FXD, FILM: 3.9K OHM, 5%, 0.25W	57668	NTR25J-E03K9
R442	316-0270-00		RES, FXD, CMPSN: 27 OHM, 10%, 0.25W	01121	CB2701
R445	315-0302-00		RES, FXD, FILM: 3K OHM, 5%, 0.25W	57668	NTR25J-E03K0
R450	321-0263-00		RES, FXD, FILM: 5.36K OHM, 1%, 0.125W, TC=TO	07716	CEAD53600F
R452	321-0263-00		RES, FXD, FILM: 5.36K OHM, 1%, 0.125W, TC=TO	07716	CEAD53600F
R453	316-0101-00		RES, FXD, CMPSN: 100 OHM, 10%, 0.25W	01121	CB1011
R454	321-0208-00		RES, FXD, FILM: 1.43K OHM, 1%, 0.125W, TC=TO	19701	5033ED1K43F
R455	321-0218-00		RES, FXD, FILM: 1.82K OHM, 1%, 0.125W, TC=TO	19701	5033ED1K82F
R456	321-0164-00		RES, FXD, FILM: 499 OHM, 1%, 0.125W, TC=TO	19701	5033ED499ROF
R457	321-0164-00		RES, FXD, FILM: 499 OHM, 1%, 0.125W, TC=TO	19701	5033ED499ROF
R458	321-0088-00		RES, FXD, FILM: 80.6 OHM, 1%, 0.125W, TC=TO	91637	CMF55116G80R60F
R460	321-0314-00		RES, FXD, FILM: 18.2K OHM, 1%, 0.125W, TC=TO	19701	5043ED18K20F
R461	311-1227-00		RES, VAR, NONWV: TRMR, 5K OHM, 0.5W	32997	3386F-T04-502
R463	315-0473-00		RES, FXD, FILM: 47K OHM, 5%, 0.25W	57668	NTR25J-E47K0
R465	323-0155-00		RES, FXD, FILM: 402 OHM, 1%, 0.5W, TC=TO	75042	CECTO-4020F
R466	316-0101-00		RES, FXD, CMPSN: 100 OHM, 10%, 0.25W	01121	CB1011
R470	321-0228-00		RES, FXD, FILM: 2.32K OHM, 1%, 0.125W, TC=TO	19701	5043ED2K32F
R471	321-0202-00		RES, FXD, FILM: 1.24K OHM, 1%, 0.125W, TC=TO	24546	NA55D1241F
R472	321-0164-00		RES, FXD, FILM: 499 OHM, 1%, 0.125W, TC=TO	19701	5033ED499ROF
R474	321-0164-00		RES, FXD, FILM: 499 OHM, 1%, 0.125W, TC=TO	19701	5033ED499ROF
R476	321-0088-00		RES, FXD, FILM: 80.6 OHM, 1%, 0.125W, TC=TO	91637	CMF55116G80R60F
R500	321-0092-00		RES, FXD, FILM: 88.7 OHM, 1%, 0.125W, TC=TO	91637	CMF55116G88R70F
R505	316-0270-00		RES, FXD, CMPSN: 27 OHM, 10%, 0.25W	01121	CB2701
R508	321-0179-00		RES, FXD, FILM: 715 OHM, 1%, 0.125W, TC=TO	07716	CEAD715ROF
R510	321-0074-00		RES, FXD, FILM: 57.6 OHM, 1%, 0.125W, TC=TO	91637	CMF55116G57R60F
R512	316-0820-00		RES, FXD, CMPSN: 82 OHM, 10%, 0.25W	01121	CB8201
R515	315-0680-00		RES, FXD, FILM: 68 OHM, 5%, 0.25W	57668	NTR25J-E68E0
R516	316-0470-00		RES, FXD, CMPSN: 47 OHM, 10%, 0.25W	01121	CB4701
R518	321-0117-00		RES, FXD, FILM: 162 OHM, 1%, 0.125W, TC=TO	07716	CEAD162ROF

Replaceable Electrical Parts
434 (SN B50000 and up)

Component No.	Tektronix	Serial/Assembly No.		Name & Description	Mfr.	Mfr. Part No.
	Part No.	Effective	Discont		Code	
R519	315-0101-00			RES,FXD,FILM:100 OHM,5%,0.25W	57668	NTR25J-E 100E
R520	315-0101-00			RES,FXD,FILM:100 OHM,5%,0.25W	57668	NTR25J-E 100E
R521	321-0178-00			RES,FXD,FILM:698 OHM,1%,0.125W,TC=TO	07716	CEAD698ROF
R525	323-0095-00			RES,FXD,FILM:95.3 OHM,1%,0.5W,TC=TO	75042	CECT0-95R30F
R526	315-0512-00			RES,FXD,FILM:5.1K OHM,5%,0.25W	57668	NTR25J-E05K1
R535	310-0694-00			RES,FXD,WM:1.25K OHM,1%,10W	TK2038	310-0694-00
R536	303-0470-00			RES,FXD,CMPSN:47 OHM,5%,1W	01121	GB4705
R540	321-0092-00			RES,FXD,FILM:88.7 OHM,1%,0.125W,TC=TO	91637	CMF55116G88R70F
R545	316-0270-00			RES,FXD,CMPSN:27 OHM,10%,0.25W	01121	CB2701
R548	321-0179-00			RES,FXD,FILM:715 OHM,1%,0.125W,TC=TO	07716	CEAD715ROF
R549	315-0101-00			RES,FXD,FILM:100 OHM,5%,0.25W	57668	NTR25J-E 100E
R550	315-0101-00			RES,FXD,FILM:100 OHM,5%,0.25W	57668	NTR25J-E 100E
R551	321-0178-00			RES,FXD,FILM:698 OHM,1%,0.125W,TC=TO	07716	CEAD698ROF
R552	321-0117-00			RES,FXD,FILM:162 OHM,1%,0.125W,TC=TO	07716	CEAD162ROF
R553	316-0820-00			RES,FXD,CMPSN:82 OHM,10%,0.25W	01121	CB8201
R555	316-0470-00			RES,FXD,CMPSN:47 OHM,10%,0.25W	01121	CB4701
R565	323-0095-00			RES,FXD,FILM:95.3 OHM,1%,0.5W,TC=TO	75042	CECT0-95R30F
R566	315-0512-00			RES,FXD,FILM:5.1K OHM,5%,0.25W	57668	NTR25J-E05K1
R568	321-0060-00			RES,FXD,FILM:41.2 OHM,0.5%,0.125W,TC=TO	57668	CRB14FXE41.20HM
R570	311-0634-00			RES,VAR,NONWW:TRMR,500 OHM,0.5W	32997	3329H-L58-501
R571	315-0361-00			RES,FXD,FILM:360 OHM,5%,0.25W	19701	5043CX360R0J
R572	307-0124-00			RES,THERMAL:5K OHM,10%,NTC	15454	1DC502K-220-EC
R574	321-0060-00			RES,FXD,FILM:41.2 OHM,0.5%,0.125W,TC=TO	57668	CRB14FXE41.20HM
R576	316-0151-00			RES,FXD,CMPSN:150 OHM,10%,0.25W	01121	CB1511
R578	323-0075-00			RES,FXD,FILM:59.0 OHM,1%,0.5W,TC=TO	91637	CMF65116G59R00F
R586	310-0694-00			RES,FXD,WM:1.25K OHM,1%,10W	TK2038	310-0694-00
R600	322-0481-00			RES,FXD,FILM:1M OHM,1%,0.25W,TC=TO	75042	CEB70-1004F
R602	316-0154-00			RES,FXD,CMPSN:150K OHM,10%,0.25W	01121	CB1541
R603	316-0101-00			RES,FXD,CMPSN:100 OHM,10%,0.25W	01121	CB1011
R604	316-0151-00			RES,FXD,CMPSN:150 OHM,10%,0.25W	01121	CB1511
R605	321-0164-00			RES,FXD,FILM:499 OHM,1%,0.125W,TC=TO	19701	5033ED499ROF
R606	316-0470-00			RES,FXD,CMPSN:100 OHM,10%,0.25W	01121	CB4701
R608	316-0101-00			RES,FXD,CMPSN:100 OHM,10%,0.25W	01121	CB1011
R610	316-0470-00			RES,FXD,CMPSN:47 OHM,10%,0.25W	01121	CB4701
R612	315-0182-00			RES,FXD,FILM:1.8K OHM,5%,0.25W	57668	NTR25J-E1K8
R613	321-0164-00			RES,FXD,FILM:499 OHM,1%,0.125W,TC=TO	19701	5033ED499ROF
R614	316-0151-00			RES,FXD,CMPSN:150 OHM,10%,0.25W	01121	CB1511
R615	315-0332-00			RES,FXD,FILM:3.3K OHM,5%,0.25W	57668	NTR25J-E03K3
R616	315-0911-00			RES,FXD,FILM:910 OHM,5%,0.25W	57668	NTR25J-E910E
R618	321-0164-00			RES,FXD,FILM:499 OHM,1%,0.125W,TC=TO	19701	5033ED499ROF
R620	321-0290-00			RES,FXD,FILM:10.2K OHM,1%,0.125W,TC=TO	19701	5043ED10K20F
R622	321-0258-00			RES,FXD,FILM:4.75K OHM,1%,0.125W,TC=TO	19701	5033ED4K750F
R623	315-0431-00			RES,FXD,FILM:430 OHM,5%,0.25W	19701	5043CX430R0J
R624	316-0101-00			RES,FXD,CMPSN:100 OHM,10%,0.25W	01121	CB1011
R625	315-0751-00			RES,FXD,FILM:750 OHM,5%,0.25W	57668	NTR25J-E750E
R626	315-0112-00			RES,FXD,FILM:1.1K OHM,5%,0.25W	19701	5043CX1K100J
R628	316-0392-00			RES,FXD,CMPSN:3.9K OHM,10%,0.25W	01121	CB3921
R629	311-0644-00			RES,VAR,NONWW:TRMR,20K OHM,0.5W	32997	3329H-G48-203
R634	316-0222-00			RES,FXD,CMPSN:2.2K OHM,10%,0.25W	01121	CB2221
R635	316-0222-00			RES,FXD,CMPSN:2.2K OHM,10%,0.25W	01121	CB2221
R636	301-0391-00			RES,FXD,FILM:390 OHM,5%,0.5W	01121	EB3915
R637	316-0272-00			RES,FXD,CMPSN:2.7K OHM,10%,0.25W	01121	CB2721
R638	316-0222-00			RES,FXD,CMPSN:2.2K OHM,10%,0.25W	01121	CB2221
R640	316-0392-00			RES,FXD,CMPSN:3.9K OHM,10%,0.25W	01121	CB3921
R644	315-0560-00			RES,FXD,FILM:56 OHM,5%,0.25W	57668	NTR25J-E56E0
R645	315-0472-00			RES,FXD,FILM:4.7K OHM,5%,0.25W	57668	NTR25J-E04K7
R646	315-0300-00			RES,FXD,FILM:30 OHM,5%,0.25W	19701	5043CX30R00J
R650	316-0101-00			RES,FXD,CMPSN:100 OHM,10%,0.25W	01121	CB1011

Replaceable Electrical Parts
434 (SN B500000 and up)

Component No.	Tektronix		Serial/Assembly No. Effective Discort	Name & Description	Mfr.	
	Part No.				Code	Part No.
R651	315-0513-00			RES, FXD, FILM: 51K OHM, 5%, 0.25W	57668	NTR25J-E51K0
R652	315-0112-00			RES, FXD, FILM: 1.1K OHM, 5%, 0.25W	19701	5043CX1K100J
R654	321-0085-00			RES, FXD, FILM: 75 OHM, 1%, 0.125W, TC=T0	57668	CRB14FXE 75 OHM
R655	316-0101-00			RES, FXD, CMPSN: 100 OHM, 10%, 0.25W	01121	CB1011
R656	321-0278-00			RES, FXD, FILM: 7.68K OHM, 1%, 0.125W, TC=T0	07716	CEAD76800F
R657	315-0151-00			RES, FXD, FILM: 150 OHM, 5%, 0.25W	57668	NTR25J-E150E
R660	316-0153-00			RES, FXD, CMPSN: 15K OHM, 10%, 0.25W	01121	CB1531
R662	316-0392-00			RES, FXD, CMPSN: 3.9K OHM, 10%, 0.25W	01121	CB3921
R663	315-0101-00			RES, FXD, FILM: 100 OHM, 5%, 0.25W	57668	NTR25J-E 100E
R665	316-0104-00			RES, FXD, CMPSN: 100K OHM, 10%, 0.25W	01121	CB1041
R666	316-0153-00			RES, FXD, CMPSN: 15K OHM, 10%, 0.25W	01121	CB1531
R667	321-0332-00			RES, FXD, FILM: 28.0K OHM, 1%, 0.125W, TC=T0	07716	CEAD28001F
R668	321-0303-00			RES, FXD, FILM: 14.0K OHM, 1%, 0.125W, TC=T0	07716	CEAD 14001F
R669	321-0347-00			RES, FXD, FILM: 40.2K OHM, 1%, 0.125W, TC=T0	91637	CMF55116640201F
R670	321-0291-00			RES, FXD, FILM: 10.5K OHM, 1%, 0.125W, TC=T0	19701	5033ED10K50F
R672	321-0332-00			RES, FXD, FILM: 28.0K OHM, 1%, 0.125W, TC=T0	07716	CEAD28001F
R675	321-0247-00			RES, FXD, FILM: 3.65K OHM, 1%, 0.125W, TC=T0	19701	5043ED3K650F
R678	321-0162-00			RES, FXD, FILM: 475 OHM, 1%, 0.125W, TC=T0	19701	5033ED475ROF
R680	316-0101-00			RES, FXD, CMPSN: 100 OHM, 10%, 0.25W	01121	CB1011
R682	321-0245-00			RES, FXD, FILM: 3.48K OHM, 1%, 0.125W, TC=T0	19701	5033ED3K48F
R684	321-0270-00			RES, FXD, FILM: 6.34K OHM, 1%, 0.125W, TC=T0	19701	5043ED6K340F
R685	321-0085-00			RES, FXD, FILM: 75 OHM, 1%, 0.125W, TC=T0	57668	CRB14FXE 75 OHM
R686	321-0164-00			RES, FXD, FILM: 499 OHM, 1%, 0.125W, TC=T0	19701	5033ED499ROF
R687	321-0262-00			RES, FXD, FILM: 5.23K OHM, 1, 0.125W, TC=T0	19701	5033ED5K230F
R688	316-0101-00			RES, FXD, CMPSN: 100 OHM, 10%, 0.25W	01121	CB1011
R690	316-0101-00			RES, FXD, CMPSN: 100 OHM, 10%, 0.25W	01121	CB1011
R692	321-0232-00			RES, FXD, FILM: 2.55K OHM, 1%, 0.125W, TC=T0	19701	5043ED2K550F
R700	316-0102-00			RES, FXD, CMPSN: 1K OHM, 10%, 0.25W	01121	CB1021
R701	316-0104-00			RES, FXD, CMPSN: 100K OHM, 10%, 0.25W	01121	CB1041
R702	316-0101-00			RES, FXD, CMPSN: 100 OHM, 10%, 0.25W	01121	CB1011
R703	311-0644-00			RES, VAR, NONWV: TRMR, 20K OHM, 0.5W	32997	3329H-G48-203
R704	316-0223-00			RES, FXD, CMPSN: 22K OHM, 10%, 0.25W	01121	CB2231
R705	321-0287-00			RES, FXD, FILM: 9.53K OHM, 1%, 0.125W, TC=T0	19701	5033ED9K530F
R706	321-0264-00			RES, FXD, FILM: 5.49K OHM, 1%, 0.125W, TC=T0	07716	CEAD54900C
R707	316-0101-00			RES, FXD, CMPSN: 100 OHM, 10%, 0.25W	01121	CB1011
R708	316-0561-00			RES, FXD, CMPSN: 560 OHM, 10%, 0.25W	01121	CB5611
R709	316-0101-00			RES, FXD, CMPSN: 100 OHM, 10%, 0.25W	01121	CB1011
R710	316-0220-00			RES, FXD, CMPSN: 22 OHM, 10%, 0.25W	01121	CB2201
R711	315-0110-00			RES, FXD, FILM: 11 OHM, 5%, 0.25W	19701	5043CX11R00J
R712	321-0934-02			RES, FXD, FILM: 19.19K OHM, 0.5%, 0.125W, TC=T2	01121	ADVISE
R714	321-0418-02			RES, FXD, FILM: 221K OHM, 0.5%, 0.125W, TC=T2 MI	01121	ADVISE
R715	322-0510-02			RES, FXD, FILM: 2.0M OHM, 0.5%, 0.25W, TC=T2	03888	PME60C20003D
R718	321-0154-00			RES, FXD, FILM: 392 OHM, 1%, 0.125W, TC=T0	07716	CEAD392ROF
R719	321-0249-00			RES, FXD, FILM: 3.83K OHM, 1%, 0.125W, TC=T0	19701	5033ED3K83F
R720	321-0149-00			RES, FXD, FILM: 348 OHM, 1%, 0.125W, TC=T0	07716	CEAD348ROF
R722	321-0175-00			RES, FXD, FILM: 649 OHM, 1%, 0.125W, TC=T0	19701	5043ED649ROF
R723	321-0155-02			RES, FXD, FILM: 402 OHM, 0.5%, 0.125W, TC=T2	19701	5033RC402ROD
R724	321-0228-00			RES, FXD, FILM: 2.32K OHM, 1%, 0.125W, TC=T0	19701	5043ED2K32F
R725	321-0172-02			RES, FXD, FILM: 604 OHM, 0.5%, 0.125W, TC=T2	19701	5033RC604ROD
R726	321-0193-02			RES, FXD, FILM: 1K OHM, 0.5%, 0.125W, TC=T2	07716	CEA 1KOHM 0.5%T2
R727	311-0607-00			RES, VAR, NONWV: TRMR, 10K OHM, 0.5W	73138	82-25-2
R728	321-0193-00			RES, FXD, FILM: 1K OHM, 1%, 0.125W, TC=T0	19701	5033ED1K00F
R729	316-0123-00			RES, FXD, CMPSN: 12K OHM, 10%, 0.25W	01121	CB1231
R740	321-0209-00			RES, FXD, FILM: 1.47K OHM, 1%, 0.125W, TC=T0	19701	5033ED1K47F
R741	316-0151-00			RES, FXD, CMPSN: 150 OHM, 10%, 0.25W	01121	CB1511
R742	316-0470-00			RES, FXD, CMPSN: 47 OHM, 10%, 0.25W	01121	CB4701
R744	315-0102-00			RES, FXD, FILM: 1K OHM, 5%, 0.25W	57668	NTR25JE01K0
R745	315-0332-00			RES, FXD, FILM: 3.3K OHM, 5%, 0.25W	57668	NTR25J-E03K3

Replaceable Electrical Parts
434 (SN B500000 and up)

Component No.	Tektronix	Serial/Assembly No.		Name & Description	Mfr.	Mfr. Part No.
	Part No.	Effective	Dscnt		Code	
R746	321-0300-00			RES, FXD, FILM: 13.0K OHM, 1%, 0.125W, TC=TO	07716	CEAD13001F
R747	315-0682-00			RES, FXD, FILM: 6.8K OHM, 5%, 0.25W	57668	NTR25J-E06K8
R748	315-0512-00			RES, FXD, FILM: 5.1K OHM, 5%, 0.25W	57668	NTR25J-E05K1
R752	315-0113-00			RES, FXD, FILM: 11K OHM, 5%, 0.25W	19701	5043CX11K00J
R754	315-0392-00			RES, FXD, FILM: 3.9K OHM, 5%, 0.25W	57668	NTR25J-E03K9
R755	315-0242-00			RES, FXD, FILM: 2.4K OHM, 5%, 0.25W	57668	NTR25J-E02K4
R756	315-0242-00			RES, FXD, FILM: 2.4K OHM, 5%, 0.25W	57668	NTR25J-E02K4
R760	321-0222-00			RES, FXD, FILM: 2.00K OHM, 1%, 0.125W, TC=TO	19701	5033ED2K00F
R761	321-0114-00			RES, FXD, FILM: 150 OHM, 1%, 0.125 W, TC=TO	19701	5033ED150R0F
R762	321-0362-00			RES, FXD, FILM: 57.6K OHM, 1%, 0.125W, TC=TO	19701	5043ED57K60F
R763	321-0191-00			RES, FXD, FILM: 953 OHM, 1%, 0.125W, TC=TO	07716	CEAD953R0F
R764	321-0280-00			RES, FXD, FILM: 8.06K OHM, 1%, 0.125W, TC=TO	19701	5033ED8K060F
R765	321-0292-00			RES, FXD, FILM: 10.7K OHM, 1%, 0.125W, TC=TO	07716	CEAD10701F
R766	321-0247-00			RES, FXD, FILM: 3.65K OHM, 1%, 0.125W, TC=TO	19701	5043ED3K650F
R768	321-0280-00			RES, FXD, FILM: 8.06K OHM, 1%, 0.125W, TC=TO	19701	5033ED8K060F
R770	316-0183-00			RES, FXD, CMPSN: 18K OHM, 10%, 0.25W	01121	CB1831
R772	321-0284-00			RES, FXD, FILM: 8.87K OHM, 1%, 0.125W, TC=TO	19701	5043ED8K870F
R774	321-0268-00			RES, FXD, FILM: 6.04K OHM, 1%, 0.125W, TC=TO	19701	5043ED6K040F
R775	316-0101-00			RES, FXD, CMPSN: 100 OHM, 10%, 0.25W	01121	CB1011
R778	315-0204-00			RES, FXD, FILM: 200K OHM, 5%, 0.25W	19701	5043CX200K0J
R780	315-0103-00			RES, FXD, FILM: 10K OHM, 5%, 0.25W	19701	5043CX10K00J
R782	316-0336-00			RES, FXD, CMPSN: 33M OHM, 10%, 0.25	01121	CB3361
R783	316-0220-00			RES, FXD, CMPSN: 22 OHM, 10%, 0.25W	01121	CB2201
R784	316-0102-00			RES, FXD, CMPSN: 1K OHM, 10%, 0.25W	01121	CB1021
R785	321-0193-00			RES, FXD, FILM: 1K OHM, 1%, 0.125W, TC=TO	19701	5033ED1K00F
R786	321-0303-00			RES, FXD, FILM: 14.0K OHM, 1%, 0.125W, TC=TO	07716	CEAD 14001F
R790	315-0820-00			RES, FXD, FILM: 82 OHM, 5%, 0.25W	57668	NTR25J-E82E0
R791	315-0392-00			RES, FXD, FILM: 3.9K OHM, 5%, 0.25W	57668	NTR25J-E03K9
R792	321-0277-00			RES, FXD, FILM: 7.50K OHM, 1%, 0.125W, TC=TO	24546	NA5507501F
R794	321-0222-00			RES, FXD, FILM: 2.00K OHM, 1%, 0.125W, TC=TO	19701	5033ED2K00F
R795	321-0269-00			RES, FXD, FILM: 6.19K OHM, 1%, 0.125W, TC=TO	07716	CEAD61900F
R796	321-0302-00			RES, FXD, FILM: 13.7K OHM, 1%, 0.125W, TC=TO	07716	CEAD 13701F
R799	311-1126-00			RES, VAR, WW: PNL, 10K OHM	TK2038	311-1126-00
R801	315-0162-00			RES, FXD, FILM: 1.6K OHM, 5%, 0.25W	19701	5043CX1K600J
R803	321-0255-00			RES, FXD, FILM: 4.42K OHM, 1%, 0.125W, TC=TO	19701	5033ED4K420F
R804	321-0364-00			RES, FXD, FILM: 60.4K OHM, 1%, 0.125W, TC=TO	19701	5043ED60K40F
R805	315-0332-00			RES, FXD, FILM: 3.3K OHM, 5%, 0.25W	57668	NTR25J-E03K3
R806	316-0563-00			RES, FXD, CMPSN: 56K OHM, 10%, 0.25W	01121	CB5631
R807	321-0290-00			RES, FXD, FILM: 10.2K OHM, 1%, 0.125W, TC=TO	19701	5043ED10K20F
R808	321-0364-00			RES, FXD, FILM: 60.4K OHM, 1%, 0.125W, TC=TO	19701	5043ED60K40F
R809	321-0434-00			RES, FXD, FILM: 324K OHM, 1%, 0.125W, TC=TO	07716	CEAD32402F
R810	321-0336-00			RES, FXD, FILM: 30.9K OHM, 1%, 0.125W, TC=TO	19701	5043ED30K90F
R811	321-0452-00			RES, FXD, FILM: 499K OHM, 1%, 0.125W, TC=TO	19701	5043ED499K0F
R812	321-0259-00			RES, FXD, FILM: 4.87K OHM, 1%, 0.125W, TC=TO	07716	CEAD48700F
R814	321-0208-00			RES, FXD, FILM: 1.43K OHM, 1%, 0.125W, TC=TO	19701	5033ED1K43F
R815	321-0214-00			RES, FXD, FILM: 1.65K OHM, 1%, 0.125W, TC=TO	19701	5033ED1K65F
R816	321-0225-00			RES, FXD, FILM: 2.15K OHM, 1%, 0.125W, TC=TO	19701	5033ED2K15F
R817	311-0644-00			RES, VAR, NONWW: TRMR, 20K OHM, 0.5W	32997	3329H-G48-203
R818	321-0155-00			RES, FXD, FILM: 402 OHM, 1%, 0.125W, TC=TO	07716	CEAD402R0F
R819	321-0296-00			RES, FXD, FILM: 11.8K OHM, 1%, 0.125W, TC=TO	07716	CEAD11801F
R825	321-0214-00			RES, FXD, FILM: 1.65K OHM, 1%, 0.125W, TC=TO	19701	5033ED1K65F
R826	321-0225-00			RES, FXD, FILM: 2.15K OHM, 1%, 0.125W, TC=TO	19701	5033ED2K15F
R827	321-0286-00			RES, FXD, FILM: 9.31K OHM, 1%, 0.125W, TC=TO	19701	5043ED9K310F
R829	321-0222-00			RES, FXD, FILM: 2.00K OHM, 1%, 0.125W, TC=TO	19701	5033ED2K00F
R830	316-0470-00			RES, FXD, CMPSN: 47 OHM, 10%, 0.25W	01121	CB4701
R832	316-0472-00			RES, FXD, CMPSN: 4.7K OHM, 10%, 0.25W	01121	CB4721
R835	321-0292-00			RES, FXD, FILM: 10.7K OHM, 1%, 0.125W, TC=TO	07716	CEAD10701F
R836	321-0247-00			RES, FXD, FILM: 3.65K OHM, 1%, 0.125W, TC=TO	19701	5043ED3K650F

Replaceable Electrical Parts
434 (SN B500000 and up)

Component No.	Tektronix Part No.	Serial/Assembly No. Effective Discnt	Name & Description	Mfr. Code	Mfr. Part No.
R838	321-0204-00		RES,FXD,FILM:1.30K OHM,1%,0.125W,TC=TO	19701	5033ED1K300F
R839	321-0029-00		RES,FXD,FILM:19.6 OHM,1%,0.125W,TC=TO	91637	CMF55116G19R60F
R840	321-0193-07		RES,FXD,FILM:1K OHM,0.1%,0.125W,TC=T9	19701	5033RE1K000B
R841	321-0175-00		RES,FXD,FILM:649 OHM,1%,0.125W,TC=TO	19701	5043ED649R0F
R842	321-0161-00		RES,FXD,FILM:464 OHM,1%,0.125W,TC=TO	07716	CEAD464R0F
R843	316-0473-00		RES,FXD,CMPSN:47K OHM,10%,0.25W	01121	CB4731
R844	321-0118-00		RES,FXD,FILM:165 OHM,1%,0.125W,TC=TO	07716	CEAD165R0F
R846	321-0122-00		RES,FXD,FILM:182 OHM,1%,0.125W,TC=TO	19701	5033ED182R0F
R848	321-0061-00		RES,FXD,FILM:42.2 OHM,0.5%,0.125W,TC=TO	91637	CMF55116G42R20F
R850	321-0034-00		RES,FXD,FILM:22.1 OHM,1%,0.125W,TC=TO	91637	CMF55116G22R10F
R852	321-0003-00		RES,FXD,FILM:10.5 OHM,1%,0.125W	57668	RB14FXE 10E5
R858	321-0029-00		RES,FXD,FILM:19.6 OHM,1%,0.125W,TC=TO	91637	CMF55116G19R60F
R859	321-0193-07		RES,FXD,FILM:1K OHM,0.1%,0.125W,TC=T9	19701	5033RE1K000B
R860	316-0470-00		RES,FXD,CMPSN:47 OHM,10%,0.25W	01121	CB4701
R861	321-0113-00		RES,FXD,FILM:147 OHM,1%,0.125W,TC=TO	07716	CEAD147R0F
R862	321-0186-00		RES,FXD,FILM:845 OHM,1%,0.125W,TC=TO	19701	5043ED845R0F
R863	321-0273-00		RES,FXD,FILM:6.81K OHM,1%,0.125W,TC=TO	07716	CEAD68100F
R864	315-0302-00		RES,FXD,FILM:3K OHM,5%,0.25W	57668	NTR25J-E03K0
R865	321-0292-00		RES,FXD,FILM:10.7K OHM,1%,0.125W,TC=TO	07716	CEAD10701F
R866	321-0247-00		RES,FXD,FILM:3.65K OHM,1%,0.125W,TC=TO	19701	5043ED3K650F
R867	316-0472-00		RES,FXD,CMPSN:4.7K OHM,10%,0.25W	01121	CB4721
R868	311-0635-00		RES,VAR,NONW:TRMR,1K OHM,0.5W	32997	3329H-G48-102
R870	323-0139-00		RES,FXD,FILM:274 OHM,1%,0.5W,TC=TO	19701	5053RD274R0F
R871	323-0327-00		RES,FXD,FILM:24.9K OHM,1%,0.5W,TC=TO	91637	MFF1226G24901F
R872	323-0327-00		RES,FXD,FILM:24.9K OHM,1%,0.5W,TC=TO	91637	MFF1226G24901F
R874	303-0563-00		RES,FXD,CMPSN:56K OHM,5%,1W	01121	GB5635
R875	321-0244-00		RES,FXD,FILM:3.40K OHM,1%,0.125W,TC=TO	19701	5043ED3K400F
R876	316-0471-00		RES,FXD,CMPSN:470 OHM,10%,0.25W	01121	CB4711
R877	323-0188-00		RES,FXD,FILM:887 OHM,1%,0.5W,TC=TO	19701	5053RD887R0F
R879	316-0101-00		RES,FXD,CMPSN:100 OHM,10%,0.25W	01121	CB1011
R880	323-0327-00		RES,FXD,FILM:24.9K OHM,1%,0.5W,TC=TO	91637	MFF1226G24901F
R881	323-0327-00		RES,FXD,FILM:24.9K OHM,1%,0.5W,TC=TO	91637	MFF1226G24901F
R882	321-0143-00		RES,FXD,FILM:301 OHM,1%,0.125W,TC=TO	07716	CEAD301R0F
R884	303-0563-00		RES,FXD,CMPSN:56K OHM,5%,1W	01121	GB5635
R885	321-0244-00		RES,FXD,FILM:3.40K OHM,1%,0.125W,TC=TO	19701	5043ED3K400F
R886	316-0471-00		RES,FXD,CMPSN:470 OHM,10%,0.25W	01121	CB4711
R887	323-0188-00		RES,FXD,FILM:887 OHM,1%,0.5W,TC=TO	19701	5053RD887R0F
R888	316-0104-00		RES,FXD,CMPSN:100K OHM,10%,0.25W	01121	CB1041
R889	316-0101-00		RES,FXD,CMPSN:100 OHM,10%,0.25W	01121	CB1011
R890	321-0256-00		RES,FXD,FILM:4.53K OHM,1%,0.125W,TC=T9	19701	5033ED4K530F
R892	321-0236-00		RES,FXD,FILM:2.80K OHM,1%,0.125W,TC=TO	07716	CEAD28000F
R896	323-0118-00		RES,FXD,FILM:165 OHM,1%,0.5W,TC=TO	07716	CECD165R0F
R898	323-0148-00		RES,FXD,FILM:340 OHM,1%,0.5W,TC=TO	91637	MFF1226G340R0F
R1200	316-0106-00		RES,FXD,CMPSN:10M OHM,10%,0.25W	01121	CB1061
R1202	316-0102-00		RES,FXD,CMPSN:1K OHM,10%,0.25W	01121	CB1021
R1203	316-0103-00		RES,FXD,CMPSN:10K OHM,10%,0.25W	01121	CB1031
R1204	316-0105-00		RES,FXD,CMPSN:1M OHM,10%,0.25W	01121	CB1051
R1206	316-0106-00		RES,FXD,CMPSN:10M OHM,10%,0.25W	01121	CB1061
R1208	316-0103-00		RES,FXD,CMPSN:10K OHM,10%,0.25W	01121	CB1031
R1209	316-0104-00		RES,FXD,CMPSN:100K OHM,10%,0.25W	01121	CB1041
R1210	316-0333-00		RES,FXD,CMPSN:33K OHM,10%,0.25W	01121	CB3331
R1212	316-0563-00		RES,FXD,CMPSN:56K OHM,10%,0.25W	01121	CB5631
R1214	316-0184-00		RES,FXD,CMPSN:5W 180K OHM,10%,0	01121	CB1841
R1216	301-0333-00		RES,FXD,FILM:33K OHM,5%,0.5W	19701	5053CX33K00J
R1217	316-0221-00		RES,FXD,CMPSN:220 OHM,10%,0.25W	01121	CB2211
R1218	321-0330-00		RES,FXD,FILM:26.7K OHM,1%,0.125W,TC=TO	07716	CEAD26701F
R1220	321-0337-00		RES,FXD,FILM:31.6K OHM,1%,0.125W,TC=TO	07716	CEAD31601F
R1222	321-0286-00		RES,FXD,FILM:9.31K OHM,1%,0.125W,TC=TO	19701	5043ED9K310F

Replaceable Electrical Parts
434 (SN B500000 and up)

Component No.	Tektronix Part No.	Serial/Assembly No.		Name & Description	Mfr. Code	Mfr. Part No.
		Effective	Dscont			
R1224	311-1227-00			RES, VAR, NONW: TRMR, 5K OHM, 0.5W	32997	3386F-T04-502
R1226	311-1229-00			RES, VAR, NONW: TRMR, 15K OHM, 0.5W	32997	3386F-T04-153
R1227	321-0270-00			RES, FXD, FILM: 6.34K OHM, 1%, 0.125W, TC=TO	19701	5043ED6K340F
R1229	321-0334-00			RES, FXD, FILM: 29.4K OHM, 1%, 0.125W, TC=TO	07716	CEAD29401F
R1230	321-0373-00			RES, FXD, FILM: 75.0K OHM, 1%, 0.125W, TC=TO	19701	5033ED75K00F
R1231	321-0334-00			RES, FXD, FILM: 29.4K OHM, 1%, 0.125W, TC=TO	07716	CEAD29401F
R1232	306-0124-00			RES, FXD, CMPSN: 120K OHM, 10%, 2W	01121	HB1241
R1236	316-0222-00			RES, FXD, CMPSN: 2.2K OHM, 10%, 0.25W	01121	CB2221
R1237	316-0103-00			RES, FXD, CMPSN: 10K OHM, 10%, 0.25W	01121	CB1031
R1238	316-0823-00			RES, FXD, CMPSN: 82K OHM, 10%, 0.25W	01121	CB8231
R1239	323-0410-00			RES, FXD, FILM: 182K OHM, 1%, 0.5W, TC=TO	75042	CECTO-1823F
R1240	316-0473-00			RES, FXD, CMPSN: 47K OHM, 10%, 0.25W	01121	CB4731
R1242	316-0273-00			RES, FXD, CMPSN: 27K OHM, 10%, 0.25W	01121	CB2731
R1244	315-0184-00			RES, FXD, FILM: 180K OHM, 5%, 0.25W	19701	5043CX180K0J
R1245	316-0103-00			RES, FXD, CMPSN: 10K OHM, 10%, 0.25W	01121	CB1031
R1250	316-0106-00			RES, FXD, CMPSN: 10M OHM, 10%, 0.25W	01121	CB1061
R1252	316-0102-00			RES, FXD, CMPSN: 1K OHM, 10%, 0.25W	01121	CB1021
R1253	316-0103-00			RES, FXD, CMPSN: 10K OHM, 10%, 0.25W	01121	CB1031
R1254	316-0105-00			RES, FXD, CMPSN: 1M OHM, 10%, 0.25W	01121	CB1051
R1256	316-0106-00			RES, FXD, CMPSN: 10M OHM, 10%, 0.25W	01121	CB1061
R1258	316-0103-00			RES, FXD, CMPSN: 10K OHM, 10%, 0.25W	01121	CB1031
R1259	316-0104-00			RES, FXD, CMPSN: 100K OHM, 10%, 0.25W	01121	CB1041
R1260	316-0333-00			RES, FXD, CMPSN: 33K OHM, 10%, 0.25W	01121	CB3331
R1262	316-0563-00			RES, FXD, CMPSN: 56K OHM, 10%, 0.25W	01121	CB5631
R1264	316-0184-00			RES, FXD, CMPSN: 5W 180K OHM, 10%, 0	01121	CB1841
R1266	301-0333-00			RES, FXD, FILM: 33K OHM, 5%, 0.5W	19701	5053CX33K00J
R1267	316-0221-00			RES, FXD, CMPSN: 220 OHM, 10%, 0.25W	01121	CB2211
R1268	321-0330-00			RES, FXD, FILM: 26.7K OHM, 1%, 0.125W, TC=TO	07716	CEAD26701F
R1270	321-0337-00			RES, FXD, FILM: 31.6K OHM, 1%, 0.125W, TC=TO	07716	CEAD31601F
R1272	321-0286-00			RES, FXD, FILM: 9.31K OHM, 1%, 0.125W, TC=TO	19701	5043ED9K310F
R1274	311-1227-00			RES, VAR, NONW: TRMR, 5K OHM, 0.5W	32997	3386F-T04-502
R1276	311-1229-00			RES, VAR, NONW: TRMR, 15K OHM, 0.5W	32997	3386F-T04-153
R1277	321-0270-00			RES, FXD, FILM: 6.34K OHM, 1%, 0.125W, TC=TO	19701	5043ED6K340F
R1279	321-0334-00			RES, FXD, FILM: 29.4K OHM, 1%, 0.125W, TC=TO	07716	CEAD29401F
R1280	321-0373-00			RES, FXD, FILM: 75.0K OHM, 1%, 0.125W, TC=TO	19701	5033ED75K00F
R1281	321-0334-00			RES, FXD, FILM: 29.4K OHM, 1%, 0.125W, TC=TO	07716	CEAD29401F
R1282	306-0124-00			RES, FXD, CMPSN: 120K OHM, 10%, 2W	01121	HB1241
R1286	316-0222-00			RES, FXD, CMPSN: 2.2K OHM, 10%, 0.25W	01121	CB2221
R1287	316-0103-00			RES, FXD, CMPSN: 10K OHM, 10%, 0.25W	01121	CB1031
R1288	316-0823-00			RES, FXD, CMPSN: 82K OHM, 10%, 0.25W	01121	CB8231
R1289	323-0410-00			RES, FXD, FILM: 182K OHM, 1%, 0.5W, TC=TO	75042	CECTO-1823F
R1290	308-0503-00	B500000	B543059	RES, FXD, WW: 6.8 OHM, 5%, 2.5W	14193	SA31-6R80J
R1290	308-0754-00	B543060		RES, FXD, WW: 5.55 OHM, 0.5%, 3W	91637	RS2B-D5R550D
R1291	305-0432-00			RES, FXD, CMPSN: 4.3K OHM, 5%, 2W	01121	HB4325
R1294	301-0683-00			RES, FXD, FILM: 68K OHM, 5%, 0.5W	19701	5053CX68K00J
R1295	311-1235-00			RES, VAR, NONW: 100K OHM, 0.5W	32997	3386F-T04-104
R1296	301-0683-00			RES, FXD, FILM: 68K OHM, 5%, 0.5W	19701	5053CX68K00J
R1297	304-0823-00	B500000	B516018	RES, FXD, CMPSN: 82K OHM, 10%, 1W	01121	GB8231
R1298	316-0184-00			RES, FXD, CMPSN: 5W 180K OHM, 10%, 0	01121	CB1841
R1299	315-0473-00			RES, FXD, FILM: 47K OHM, 5%, 0.25W	57668	NTR25J-E47K0
R1691	303-0150-00			RES, FXD, CMPSN: 15 OHM, 5%, 1W	01121	GB1505
R1692	321-0062-00			RES, FXD, FILM: 43.2 OHM, 0.5%, 0.125W, TC=TO	57668	CRB14 FXE 43.2
R1693	323-0140-00			RES, FXD, FILM: 280 OHM, 1%, 0.5W, TC=TO	75042	CECTO-2800F
R1694	323-0140-00			RES, FXD, FILM: 280 OHM, 1%, 0.5W, TC=TO	75042	CECTO-2800F
R1695	315-0242-00			RES, FXD, FILM: 2.4K OHM, 5%, 0.25W	57668	NTR25J-E02K4
R1697	315-0122-00			RES, FXD, FILM: 1.2K OHM, 5%, 0.25W	57668	NTR25J-E01K2
R1698	315-0363-00			RES, FXD, FILM: 36K OHM, 5%, 0.25W	57668	NTR25J-E36K0
R1700	321-0298-00			RES, FXD, FILM: 12.4K OHM, 1%, 0.125W, TC=TO	07716	CEAD12401F

Replaceable Electrical Parts
434 (SN B500000 and up)

Component No.	Tektronix		Serial/Assembly No.		Name & Description	Mfr. Code	Mfr. Part No.
	Part No.	Effective	Discort				
R1702	321-0304-00				RES, FXD, FILM: 14.3K OHM, 1%, 0.125W, TC=TO	19701	5033ED14K30F
R1704	311-1225-00				RES, VAR, NONWW: TRMR, 1K OHM, 0.5W	32997	3386F-T04-10F
R1705	321-0268-00				RES, FXD, FILM: 6.04K OHM, 1%, 0.125W, TC=TO	19701	5043ED6K040F
R1706	321-0357-00				RES, FXD, FILM: 51.1K OHM, 1%, 0.125W, TC=TO	07716	CEAD51101F
R1708	321-0365-00				RES, FXD, FILM: 61.9K OHM, 1%, 0.125W, TC=TO	07716	CEAD61901F
R1710	321-0358-00				RES, FXD, FILM: 52.3K OHM, 1%, 0.125W, TC=TO	07716	CEAD52301F
R1711	315-0202-00				RES, FXD, FILM: 2K OHM, 5%, 0.25W	57668	NTR25J-E 2K
R1712	315-0470-00				RES, FXD, FILM: 47 OHM, 5%, 0.25W	57668	NTR25J-E47E0
R1715	311-1226-00				RES, VAR, NONWW: TRMR, 2.5K OHM, 0.5W	32997	3386F-T04-252
R1716	322-0301-00				RES, FXD, FILM: 13.3K OHM, 1%, 0.25W, TC=TO	75042	CEBTO-1332F
R1718	321-0172-00				RES, FXD, FILM: 604 OHM, 1%, 0.125W, TC=TO	19701	5033ED604ROF
R1719	315-0270-00				RES, FXD, FILM: 27 OHM, 5%, 0.25W	19701	5043CX27R00J
R1720	315-0913-00				RES, FXD, FILM: 91K OHM, 5%, 0.25W	19701	5043CX91K00J
R1721	311-1232-00				RES, VAR, NONWW: TRMR, 50K OHM, 0.5W	32997	3386F-T04-503
R1722	315-0683-00				RES, FXD, FILM: 68K OHM, 5%, 0.25W	57668	NTR25J-E68K0
R1723	315-0103-00				RES, FXD, FILM: 10K OHM, 5%, 0.25W	19701	5043CX10K00J
R1724	315-0471-00				RES, FXD, FILM: 470 OHM, 5%, 0.25W	57668	NTR25J-E470E
R1725	315-0102-00				RES, FXD, FILM: 1K OHM, 5%, 0.25W	57668	NTR25JE01K0
R1726	315-0103-00				RES, FXD, FILM: 10K OHM, 5%, 0.25W	19701	5043CX10K00J
R1727	315-0103-00				RES, FXD, FILM: 10K OHM, 5%, 0.25W	19701	5043CX10K00J
R1728	315-0103-00				RES, FXD, FILM: 10K OHM, 5%, 0.25W	19701	5043CX10K00J
R1730	301-0473-00				RES, FXD, FILM: 47K OHM, 5%, 0.5W	19701	5053CX47K00J
R1731	315-0155-00	B500000	B516018		RES, FXD, FILM: 1.5M OHM, 5%, 0.25W	19701	5043CX1M500J
R1731	315-0125-00	B516019			RES, FXD, FILM: 1.2M OHM, 5%, 0.25W	19701	5043CX1M200J
R1732	315-0221-00				RES, FXD, FILM: 220 OHM, 5%, 0.25W	57668	NTR25J-E220E
R1734	316-0470-00				RES, FXD, CMPSN: 47 OHM, 10%, 0.25W	01121	CB4701
R1735	315-0103-00				RES, FXD, FILM: 10K OHM, 5%, 0.25W	19701	5043CX10K00J
R1737	315-0226-00				RES, FXD, FILM: 22M OHM, 5%, 0.25W	80009	315-0226-00
R1740	315-0164-00				RES, FXD, FILM: 160K OHM, 5%, 0.25W	57668	NTR25J-E160K
R1741	315-0103-00				RES, FXD, FILM: 10K OHM, 5%, 0.25W	19701	5043CX10K00J
R1742	315-0122-00				RES, FXD, FILM: 1.2K OHM, 5%, 0.25W	57668	NTR25J-E01K2
R1743	301-0393-00				RES, FXD, FILM: 39K OHM, 5%, 0.5W	19701	5053CX39K00J
R1753	315-0221-00				RES, FXD, FILM: 220 OHM, 5%, 0.25W	57668	NTR25J-E220E
R1756	301-0621-00				RES, FXD, FILM: 620 OHM, 5%, 0.5W	19701	5053CX620R0J
R1757	322-0264-00				RES, FXD, FILM: 5.49K OHM, 1%, 0.25W, TC=TO	75042	CEBTO-5491F
R1758	323-0343-00				RES, FXD, FILM: 36.5K OHM, 1%, 0.5W, TC=TO	19701	5053RD36K50F
R1760	315-0566-00				RES, FXD, FILM: 56M OHM, 5%, 0.25W	01121	CB5665
R1761	315-0275-00				RES, FXD, FILM: 2.7M OHM, 5%, 0.25W	01121	CB2755
R1762	307-0478-00				RES NTWK, FXD, FI: HIGH VOLTAGE	80009	307-0478-00
R1763	315-0244-00				RES, FXD, FILM: 240K OHM, 5%, 0.25W	19701	5043CX240K0J
R1764	301-0755-00	B500000	B516018		RES, FXD, FILM: 7.5M OHM, 5%, 0.5W (NOMINAL VALUE, SELECTED)	01121	EB7555
R1764	301-0166-00	B516019			RES, FXD, FILM: 16M OHM, 5%, 0.5W	01121	EB1665
R1765	311-1230-00				RES, VAR, NONWW: TRMR, 20K OHM, 0.5W	32997	3386F-T04-203
R1766	315-0104-00				RES, FXD, FILM: 100K OHM, 5%, 0.25W	57668	NTR25J-E100K
R1767	311-1251-00				RES, VAR, NONWW: TRMR, 200K OHM, 0.25W	32997	3386F-T06-204
R1771	315-0273-00				RES, FXD, FILM: 27K OHM, 5%, 0.25W	57668	NTR25J-E27K0
R1772	301-0152-00				RES, FXD, FILM: 1.5K OHM, 5%, 0.5W	19701	5053CX1K500J
R1773	315-0270-00				RES, FXD, FILM: 27 OHM, 5%, 0.25W	19701	5043CX27R00J
R1774	315-0104-00				RES, FXD, FILM: 100K OHM, 5%, 0.25W	57668	NTR25J-E100K
R1775	321-0266-00				RES, FXD, FILM: 5.76K OHM, 1%, 0.125W, TC=TO	19701	5033ED5K760F
R1776	315-0390-00				RES, FXD, FILM: 39 OHM, 5%, 0.25W	57668	NTR25J-E39E0
R1778	321-0266-00				RES, FXD, FILM: 5.76K OHM, 1%, 0.125W, TC=TO	19701	5033ED5K760F
R1779	321-0259-00				RES, FXD, FILM: 4.87K OHM, 1%, 0.125W, TC=TO	07716	CEAD48700F
R1780	315-0150-00	B500000	B526599		RES, FXD, FILM: 15 OHM, 5%, 0.25W	19701	5043CX15R00J
R1780	315-0180-00	B526600			RES, FXD, FILM: 18 OHM, 5%, 0.25W	19701	5043CX18R00J
R1781	301-0243-00	B500000	B526599		RES, FXD, FILM: 24K OHM, 5%, 0.5W	19701	5053CX24K00J
R1781	315-0822-00	B526600			RES, FXD, FILM: 8.2K OHM, 5%, 0.25W	19701	5043CX8K200J

Replaceable Electrical Parts
434 (SN B500000 and up)

Component No.	Tektronix		Serial/Assembly No.		Name & Description	Mfr. Code	Mfr. Part No.
	Part No.	Effective	Discnt	Effective			
R1782	321-0419-00	B500000	B526599		RES, FXD, FILM: 226K OHM, 1%, 0.125W, TC=TO	07716	CEAD22602F
R1782	321-0394-00	B526600			RES, FXD, FILM: 124K OHM, 1%, 0.125W, TC=TO	07716	CEAD12402F
R1783	321-0408-00	B500000	B526599		RES, FXD, FILM: 174K OHM, 1%, 0.125W, TC=TO	07716	CEAD17402F
R1783	321-0448-00	B526600			RES, FXD, FILM: 453K OHM, 1%, 0.125W, TC=TO	07716	CEAD45302F
R1784	315-0102-00				RES, FXD, FILM: 1K OHM, 5%, 0.25W	57668	NTR25JE01K0
R1786	303-0753-00	B500000	B526599		RES, FXD, CMPSN: 75K OHM, 5%, 1W	01121	GB7535
R1786	303-0104-00	B526600			RES, FXD, CMPSN: 100K OHM, 5%, 1W	01121	GB1045
R1787	315-0150-00	B500000	B526599		RES, FXD, FILM: 15 OHM, 5%, 0.25W	19701	5043CX15R00J
R1787	315-0180-00	B526600			RES, FXD, FILM: 18 OHM, 5%, 0.25W	19701	5043CX18R00J
R1788	315-0102-00				RES, FXD, FILM: 1K OHM, 5%, 0.25W	57668	NTR25JE01K0
R1789	301-0134-00	B500000	B526599		RES, FXD, FILM: 130K OHM, 5%, 0.5W	19701	5053CX130K0J
R1789	303-0104-00	B526600			RES, FXD, CMPSN: 100K OHM, 5%, 1W	01121	GB1045
R1790	315-0102-00				RES, FXD, FILM: 1K OHM, 5%, 0.25W	57668	NTR25JE01K0
R1793	316-0472-00				RES, FXD, CMPSN: 4.7K OHM, 10%, 0.25W	01121	CB4721
R1794	315-0223-00				RES, FXD, FILM: 22K OHM, 5%, 0.25W	19701	5043CX22K00J92U
R1796	315-0220-00				RES, FXD, FILM: 22 OHM, 5%, 0.25W	19701	5043CX22R00J
R1798	315-0100-00				RES, FXD, FILM: 10 OHM, 5%, 0.25W	19701	5043CX10R00J
R1801	315-0753-00				RES, FXD, FILM: 75K OHM, 5%, 0.25W	57668	NTR25J-E75K0
R1802	301-0154-00				RES, FXD, FILM: 150K OHM, 5%, 0.5W	19701	5053CX150K0J
R1803	315-0753-00				RES, FXD, FILM: 75K OHM, 5%, 0.25W	57668	NTR25J-E75K0
R1804	315-0103-00				RES, FXD, FILM: 10K OHM, 5%, 0.25W	19701	5043CX10K00J
R1805	315-0470-00	B543060			RES, FXD, FILM: 47 OHM, 5%, 0.25W	57668	NTR25J-E47E0
R1806	315-0470-00	B543060			RES, FXD, FILM: 47 OHM, 5%, 0.25W	57668	NTR25J-E47E0
R1821	315-0151-00	B500000	B543059		RES, FXD, FILM: 150 OHM, 5%, 0.25W	57668	NTR25J-E150E
R1821	315-0470-00	B543060			RES, FXD, FILM: 47 OHM, 5%, 0.25W	57668	NTR25J-E47E0
R1822	301-0184-00				RES, FXD, FILM: 180K OHM, 5%, 0.5W	57668	TR50J-E180K
R1823	301-0184-00				RES, FXD, FILM: 180K OHM, 5%, 0.5W	57668	TR50J-E180K
R1824	302-0685-00				RES, FXD, CMPSN: 6.8M OHM, 10%, 0.50W	01121	EB6851
R1828	303-0224-00				RES, FXD, CMPSN: 220K OHM, 5%, 1W	01121	GB2245
R1829	315-0433-00				RES, FXD, FILM: 43K OHM, 5%, 0.25W	19701	5043CX43K00J
R1831	307-0113-00				RES, FXD, CMPSN: 5.1 OHM, 5%, 0.25W	01121	CB5165
R1834	301-0220-00				RES, FXD, FILM: 22 OHM, 5%, 0.5W	19701	5053CX22R00J
R1836	302-0105-00				RES, FXD, CMPSN: 1M OHM, 10%, 0.5W	01121	EB1051
R1841	301-0220-00				RES, FXD, FILM: 22 OHM, 5%, 0.5W	19701	5053CX22R00J
R1846	316-0471-00				RES, FXD, CMPSN: 470 OHM, 10%, 0.25W	01121	CB4711
R1847	316-0471-00				RES, FXD, CMPSN: 470 OHM, 10%, 0.25W	01121	CB4711
R1848	316-0274-00				RES, FXD, CMPSN: 270K OHM, 10%, 0.25W	01121	CB2741
R1901	315-0392-00				RES, FXD, FILM: 3.9K OHM, 5%, 0.25W	57668	NTR25J-E03K9
R1902	315-0753-00				RES, FXD, FILM: 75K OHM, 5%, 0.25W	57668	NTR25J-E75K0
R1903	315-0273-00	B514709			RES, FXD, FILM: 27K OHM, 5%, 0.25W	57668	NTR25J-E27K0
R1904	315-0562-00				RES, FXD, FILM: 5.6K OHM, 5%, 0.25W	57668	NTR25J-E05K6
R1905	315-0223-00				RES, FXD, FILM: 22K OHM, 5%, 0.25W	19701	5043CX22K00J92U
R1906	315-0471-00				RES, FXD, FILM: 470 OHM, 5%, 0.25W	57668	NTR25J-E470E
R1907	315-0272-00				RES, FXD, FILM: 2.7K OHM, 5%, 0.25W	57668	NTR25J-E02K7
R1916	315-0123-00	B500000	B514708		RES, FXD, FILM: 12K OHM, 5%, 0.25W	57668	NTR25J-E12K0
R1916	315-0622-00	B514709			RES, FXD, FILM: 6.2K OHM, 5%, 0.25W	19701	5043CX6K200J
R1917	321-0410-00	B500000	B514708		RES, FXD, FILM: 182K OHM, 1%, 0.125W, TC=TO	19701	5033ED182K0F
R1917	321-0381-00	B514709			RES, FXD, FILM: 90.9K OHM, 1%, 0.125W, TC=TO	07716	CEAD90901F
R1918	315-0154-00				RES, FXD, FILM: 150K OHM, 5%, 0.25W	57668	NTR25J-E150K
R1919	321-0373-00				RES, FXD, FILM: 75.0K OHM, 1%, 0.125W, TC=TO	19701	5033ED75K00F
R1921	315-0471-00				RES, FXD, FILM: 470 OHM, 5%, 0.25W	57668	NTR25J-E470E
R1922	321-0313-00				RES, FXD, FILM: 17.8K OHM, 1%, 0.125W, TC=TO	07716	CEAD17801F
R1924	315-0560-00				RES, FXD, FILM: 56 OHM, 5%, 0.25W	57668	NTR25J-E56E0
R1925	315-0202-00	B500000	B514708		RES, FXD, FILM: 2K OHM, 5%, 0.25W	57668	NTR25J-E 2K
R1925	321-0228-00	B514709			RES, FXD, FILM: 2.32K OHM, 1%, 0.125W, TC=TO	19701	5043ED2K32F
R1926	321-0038-00				RES, FXD, FILM: 24.3 OHM, 1%, 0.125W, TC=TO	91637	CMF55116G24R30F
R1940	311-1226-00				RES, VAR, NONW: TRMR, 2.5K OHM, 0.5W	32997	3386F-T04-252
R1941	321-0335-00				RES, FXD, FILM: 30.1K OHM, 1%, 0.125W, TC=TO	57668	RB14FXE30K1

Replaceable Electrical Parts
434 (SN B500000 and up)

Component No.	Tektronix Part No.	Serial/Assembly No. Effective	Discount	Name & Description	Mfr. Code	Mfr. Part No.
R1942	321-0286-00			RES, FXD, FILM: 9.31K OHM, 1%, 0.125W, TC=TO	19701	5043ED9K310F
R1943	315-0201-00	B500000	B529199	RES, FXD, FILM: 200 OHM, 5%, 0.25W	57668	NTR25J-E200E
R1943	315-0560-00	B529200		RES, FXD, FILM: 56 OHM, 5%, 0.25W	57668	NTR25J-E56E0
R1944	321-0282-00			RES, FXD, FILM: 8.45K OHM, 1%, 0.125W, TC=TO	07716	CFAD84500F
R1945	315-0821-00			RES, FXD, FILM: 820 OHM, 5%, 0.25W	19701	5043CX820R0J
R1953	321-0335-00			RES, FXD, FILM: 30.1K OHM, 1%, 0.125W, TC=TO	57668	RB14FXE30K1
R1954	322-0610-00			RES, FXD, FILM: 500K OHM, 1%, 0.25W, TC=TO	07716	CCAD50002F
R1955	321-0402-00			RES, FXD, FILM: 150K OHM, 1%, 0.125W, TC=TO	19701	5033ED150K0F
R1956	321-0420-00			RES, FXD, FILM: 232K OHM, 1%, 0.125W, TC=TO	07716	CEAD23202F
R1957	315-0103-00	B500000	B514708	RES, FXD, FILM: 10K OHM, 5%, 0.25W	19701	5043CX10K00J
R1957	315-0472-00	B514709		RES, FXD, FILM: 4.7K OHM, 5%, 0.25W	57668	NTR25J-E04K7
R1972	308-0742-00			RES, FXD, WW: 0.24 OHM, 5%, 2W	75042	BWH-R2400J
R1990	301-0914-00			RES, FXD, FILM: 910K OHM, 5%, 0.5W	19701	5053CX910K0J
R1991	301-0240-00			RES, FXD, FILM: 24 OHM, 5%, 0.5W	57668	TR50J-E24E
R1992	301-0914-00			RES, FXD, FILM: 910K OHM, 5%, 0.5W	19701	5053CX910K0J
R1993	315-0473-00			RES, FXD, FILM: 47K OHM, 5%, 0.25W	57668	NTR25J-E47K0
R1994	301-0914-00			RES, FXD, FILM: 910K OHM, 5%, 0.5W	19701	5053CX910K0J
R1996	315-0512-00			RES, FXD, FILM: 5.1K OHM, 5%, 0.25W	57668	NTR25J-E05K1
R1998	315-0512-00			RES, FXD, FILM: 5.1K OHM, 5%, 0.25W	57668	NTR25J-E05K1
RT1696	307-0124-00			RES, THERMAL: 5K OHM, 10%, NTC	15454	1DC502K-220-EC
RT1821	307-0350-00			RES, THERMAL: 7.5 OHM, 10%, 3.9%/DEG C	80009	307-0350-00
RT1822	307-0350-00			RES, THERMAL: 7.5 OHM, 10%, 3.9%/DEG C	80009	307-0350-00
S8	260-1227-00			SWITCH, PUSH: DPDT, PUSH-PUSH	31918	ORDER BY DESCR
S18	260-1227-00			SWITCH, PUSH: DPDT, PUSH-PUSH	31918	ORDER BY DESCR
S45	260-1230-00			SWITCH, PUSH: 5 BTN, 2 POLE, VERTICL MODE	59821	2KCC050000793
S50	260-0735-00			SWITCH, PUSH: T, NO CONTACT, RED BUTTON	81073	39-1
S60	-----			(PART OF R60)		
S65	260-1229-01	B500000	B528569	SWITCH, PUSH: DPDT, 2 BUTTON	80009	260-1229-01
S65	260-1229-00	B528570		SWITCH, PUSH: 2 BUTTON, 2 POLE, AUTO-NORM	59821	2KBC020000477
S68	260-0735-00			SWITCH, PUSH: T, NO CONTACT, RED BUTTON	81073	39-1
S70	260-1224-00			SWITCH, PUSH: 1 BUTTON, 2 POLE, EXT ATTEN	31918	ORDER BY DESCR
S72	260-1228-01	B050000	B528579	SWITCH, PUSH: DPDT, 2 BUTTON	80009	260-1228-01
S72	260-1228-00	B528580		SWITCH, PUSH: 2 BUTTON, 2 POLE, TRIG SOURCE	59821	2KBC020000476
S74	260-1224-00			SWITCH, PUSH: 1 BUTTON, 2 POLE, EXT ATTEN	31918	ORDER BY DESCR
S75	260-1226-00			SWITCH, PUSH: DPDT, PUSH-PUSH	59821	2KBB020000474
S90	670-1525-00			CIRCUIT BD ASSY: UPPER	80009	670-1525-00
S92	670-1524-00			CIRCUIT BD ASSY: LOWER STORAGE SWITCH	80009	670-1524-00
S94	260-1285-00			SWITCH, PUSH: SPDT, 1A, 115AC, MOM	09353	P8121
S95	-----			(PART OF R92)		
S100	263-1020-00			SW CAM ACTR AS: VOLTS/DIV	80009	263-1020-00
S200	263-1020-00			SW CAM ACTR AS: VOLTS/DIV	80009	263-1020-00
S414	260-1236-00			SWITCH, PUSH: 1 BUTTON, 2 POLE, BANDWIDTH	59821	2KAB010000391
S479	260-1236-00			SWITCH, PUSH: 1 BUTTON, 2 POLE, BANDWIDTH	59821	2KAB010000391
S700	105-0262-01			ACTR ASSY, CAM S: TIME/DIV	80009	105-0262-01
S1801	260-0834-00			SWITCH, TOGGLE: DPDT, 5A, 125VAC, ON-ON	09353	U21-SHZQE
S1802	260-0879-00			SW, THRMSTC: NC, OPEN 88.0, CL 71.1, 10A, 240V	14859	20700L66-321
S1803	260-1300-01			SWITCH, SLIDE: DPDT, 3A, 125V	82389	11A1354
T435	120-0459-00			XFMR, TOROID:	80009	120-0459-00
T645	120-0724-00	B500000	B516018	XFMR, TOROID:	80009	120-0724-00
T645	120-1045-00	B516019	B516033	TRANSFORMER, RF: TOROID	80009	120-1045-00
T645	120-0724-00	B516034		XFMR, TOROID:	80009	120-0724-00
T1801	120-0725-00	B500000	B527009	TRANSFORMER, CMR:	80009	120-0725-00
T1801	120-1100-00	B527010		TRANSFORMER, RF: COMMON MODE REJ	80009	120-1100-00
T1802	120-0716-00			XFMR, PWR, STPDN: LINE TRIGGER	80009	120-0716-00
T1831	120-0788-00			XFMR, TOROID:	80009	120-0788-00
T1848	120-0747-00			XFMR, TOROID:	TK1345	120-0747-00
T1860	120-0971-00			XFMR, PWR, SDN&SU: POWER & HV	80009	120-0971-00
U210	155-0050-01			MICROCKT, LINEAR: PREAMPLIFIER	80009	155-0050-01

Replaceable Electrical Parts
434 (SN B500000 and up)

Component No.	Tektronix	Serial/Assembly No.		Name & Description	Mfr.	Mfr. Part No.
	Part No.	Effective	Dscont		Code	
U310	155-0050-01			MICROCKT, LINEAR: PREAMPLIFIER	80009	155-0050-01
U650	156-0048-00			MICROCKT, LINEAR: 5 XSTR ARRAY	02735	CA3046
U680	156-0048-00			MICROCKT, LINEAR: 5 XSTR ARRAY	02735	CA3046
U700	155-0028-01	B500000	8542120	MICROCKT, LINEAR: MILLER INTEGRATOR	80009	155-0028-01
U700	155-0028-00	B542121		MICROCKT, LINEAR: MILLER INTEGRATOR	80009	155-0028-00
U760	156-0048-00			MICROCKT, LINEAR: 5 XSTR ARRAY	02735	CA3046
U1690	156-0281-00			MICROCKT, LINEAR: 4-XSTR, HIGH CUR ARRAY	02735	89164
U1760	156-0511-00			MICROCKT, LINEAR: OPNL AMPL	18324	NE531N
U1910	155-0067-02			MICROCKT, DGTL: POWER SPLY RGLTR	80009	155-0067-02
V100	154-0666-10			ELECTRON TUBE: CRT	80009	154-0666-10
V100	154-0666-12			ELECTRON TUBE: CRT, P402, INT SCALE (OPTION 01 ONLY)	80009	154-0666-12
VR124	152-0279-00			SEMICON DVC, DI: ZEN, SI, 5.1V, 5%, 0.4W, DO-7	14552	TD3810989
VR126	152-0279-00			SEMICON DVC, DI: ZEN, SI, 5.1V, 5%, 0.4W, DO-7	14552	TD3810989
VR174	152-0279-00			SEMICON DVC, DI: ZEN, SI, 5.1V, 5%, 0.4W, DO-7	14552	TD3810989
VR176	152-0279-00			SEMICON DVC, DI: ZEN, SI, 5.1V, 5%, 0.4W, DO-7	14552	TD3810989
VR227	152-0279-00			SEMICON DVC, DI: ZEN, SI, 5.1V, 5%, 0.4W, DO-7	14552	TD3810989
VR327	152-0279-00			SEMICON DVC, DI: ZEN, SI, 5.1V, 5%, 0.4W, DO-7	14552	TD3810989
VR525	152-0166-00			SEMICON DVC, DI: ZEN, SI, 6.2V, 5%, 400mW, DO-7	04713	SZ11738RL
VR565	152-0166-00			SEMICON DVC, DI: ZEN, SI, 6.2V, 5%, 400mW, DO-7	04713	SZ11738RL
VR605	152-0226-00			SEMICON DVC, DI: ZEN, SI, 5.1V, 5%, 0.4W, DO-7	04713	SZ12262RL
VR635	152-0195-00			SEMICON DVC, DI: ZEN, SI, 5.1V, 5%, 0.4W, DO-7	04713	SZ11755RL
VR657	152-0168-00			SEMICON DVC, DI: ZEN, SI, 12V, 5%, 0.4W, DO-763B	14552	TD331689
VR741	152-0168-00			SEMICON DVC, DI: ZEN, SI, 12V, 5%, 0.4W, DO-763B	14552	TD331689
VR809	152-0357-00			SEMICON DVC, DI: ZEN, SI, 82V, 5%, 0.4W, DO-7	04713	SZ12461KRL
VR872	152-0306-00			SEMICON DVC, DI: ZEN, SI, 9.1V, 5%, 0.4W, DO-7	12954	1N960B
VR876	152-0304-00			SEMICON DVC, DI: ZEN, SI, 20V, 5%, 0.4W, DO-7	15238	Z5411
VR1234	152-0195-00			SEMICON DVC, DI: ZEN, SI, 5.1V, 5%, 0.4W, DO-7	04713	SZ11755RL
VR1236	152-0428-00			SEMICON DVC, DI: ZEN, SI, 120V, 5%, 0.4W, DO-7	04713	SZ13202 (1N987B)
VR1284	152-0195-00			SEMICON DVC, DI: ZEN, SI, 5.1V, 5%, 0.4W, DO-7	04713	SZ11755RL
VR1286	152-0428-00			SEMICON DVC, DI: ZEN, SI, 120V, 5%, 0.4W, DO-7	04713	SZ13202 (1N987B)
VR1292	152-0304-00	B500000	B516018	SEMICON DVC, DI: ZEN, SI, 20V, 5%, 0.4W, DO-7	15238	Z5411
VR1298	152-0305-00			SEMICON DVC, DI: ZEN, SI, 110V, 5%, 1W, DO-13	04713	1N3045B
VR1743	152-0268-00			SEMICON DVC, DI: ZEN, SI, 56V, 5%, 0.4W, DO-7	04713	SZG35009K91N979B
VR1744	152-0241-00			SEMICON DVC, DI: ZEN, SI, 33V, 5%, 0.4W, DO-7	14552	1N973B
VR1794	152-0285-00			SEMICON DVC, DI: ZEN, SI, 62V, 5%, 0.4W, DO-7	12954	1N980B
VR1831	152-0401-00			SEMICON DVC, DI: SCHOTTKY, SI, 32V, 2A, TO-92	04713	SPT32K
VR1846	152-0287-00	B500000	B516018	SEMICON DVC, DI: ZEN, SI, 110V, 5%, 0.4W, DO-7	12954	1N986B
VR1846	152-0657-00	B516019		SEMICON DVC, DI: ZEN, SI, 108V, 2%, 400mW, DO-7	04713	SZG20107
VR1928	152-0304-00			SEMICON DVC, DI: ZEN, SI, 20V, 5%, 0.4W, DO-7	15238	Z5411
VR1945	152-0212-00			SEMICON DVC, DI: ZEN, SI, 9V, 5%, 0.5W, DO-7	04713	SZ50646RL

DIAGRAMS AND CIRCUIT BOARD ILLUSTRATIONS

Symbols and Reference Designators

Electrical components shown on the diagrams are in the following units unless noted otherwise:

Capacitors = Values one or greater are in picofarads (pF).
 Values less than one are in microfarads (μF).

Resistors = Ohms (Ω).

Graphic symbols and class designation letters are based on ANSI Standard Y32.2-1975.

Logic symbology is based on ANSI Y32.14-1973 in terms of positive logic. Logic symbols depict the logic function performed and may differ from the manufacturer's data.

The overline on a signal name indicates that the signal performs its intended function when it goes to the low state.

Abbreviations are based on ANSI Y1.1-1972.

Other ANSI standards that are used in the preparation of diagrams by Tektronix, Inc. are:

- Y14.15, 1966 Drafting Practices.
- Y14.2, 1973 Line Conventions and Lettering.
- Y10.5, 1968 Letter Symbols for Quantities Used in Electrical Science and Electrical Engineering.

For Service Manuals Contact
MAURITRON TECHNICAL SERVICES
 8 Cherry Tree Rd, Chinnor
 Oxon OX9 4QY
 Tel: 01844-351694 Fax: 01844-352554
 Email: enquiries@maurtron.co.uk

The following prefix letters are used as reference designators to identify components or assemblies on the diagrams.

A	Assembly, separable or repairable (circuit board, etc)	H	Heat dissipating device (heat sink, heat radiator, etc)	S	Switch or contactor
AT	Attenuator, fixed or variable	HR	Heater	T	Transformer
B	Motor	HY	Hybrid circuit	TC	Thermocouple
BT	Battery	J	Connector, stationary portion	TP	Test point
C	Capacitor, fixed or variable	K	Relay	U	Assembly, inseparable or non-repairable (integrated circuit, etc.)
CB	Circuit breaker	L	Inductor, fixed or variable	V	Electron tube
CR	Diode, signal or rectifier	M	Meter	VR	Voltage regulator (zener diode, etc.)
DL	Delay line	P	Connector, movable portion	W	Wirestrap or cable
DS	Indicating device (lamp)	Q	Transistor or silicon-controlled rectifier	Y	Crystal
E	Spark Gap, Ferrite bead	R	Resistor, fixed or variable	Z	Phase shifter
F	Fuse	RT	Thermistor		
FL	Filter				

The following special symbols may appear on the diagrams:

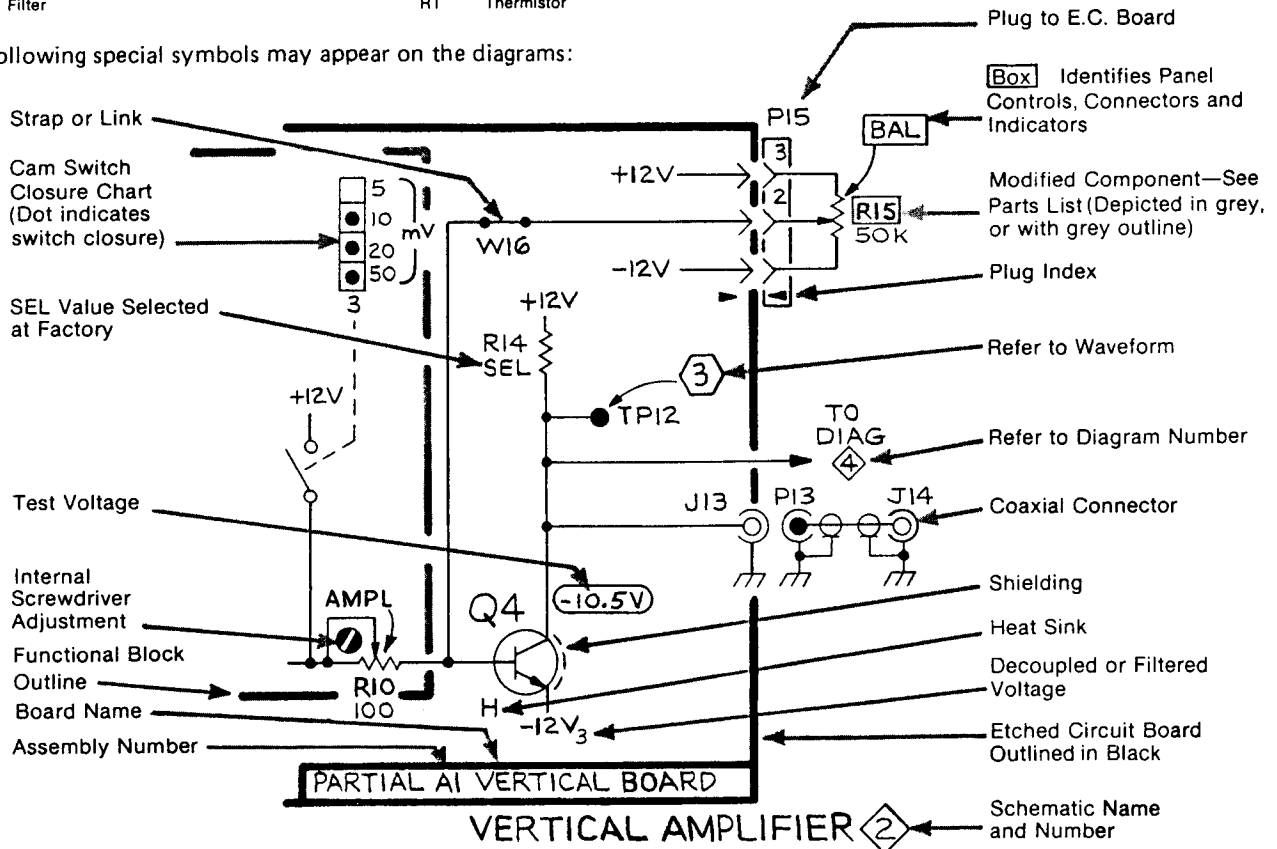

434 SN B500000 and up

VOLTAGE AND WAVEFORM TEST CONDITIONS

Typical voltage measurements and waveform photographs were obtained under the following conditions unless noted otherwise on the individual diagrams. Voltage measurements were taken with no signal applied to the vertical input. Waveform photographs were taken with the PROBE CAL 0.6 V 1 kHz signal applied to the CH 1 input connector.

Test Oscilloscope	
Frequency response	DC to 40 MHz.
Deflection factor	5 millivolts to 50 volts/division.
Probe ground	434 chassis ground.
Trigger source	External to indicate true time relationship between signals.
Recommended type	Tektronix 7504 with 7A16 plug-in unit and P6052 Probe.
Voltmeter	
Type	Digital multimeter.
Input impedance	10 megohms.
Range	0 to 1 kilovolt.
Reference voltage	434 chassis ground.
Recommended type (as used for voltages on diagrams)	Tektronix 7504 with 7D13 Digital Multimeter Plug-In Unit.

434 Conditions

POWER/
INTENSITY Pulled out (on) and set for normal display intensity.

Vertical Controls (both channels if applicable)

POSITION Midrange

OUT: 5 MHz BW Pushed in

OUT: INVERT Push in

VOLTS/DIV .1 V

Variable CAL

Input Coupling DC

Vertical Mode CH 1

Trigger Controls

SLOPE +

LEVEL Midrange

SOURCE CH 1

EXT ATTEN 1:1

COUPLING DC

Sweep Controls

MODE AUTO

TIME/DIV 1 ms

MAG X1

Variable Midrange

Storage Controls (upper and lower if applicable)

STORE Non-store (button out)

ENHANCE Off (button out)

ENHANCE LEVEL Fully counterclockwise

REPLACEABLE MECHANICAL PARTS

PARTS ORDERING INFORMATION

Replacement parts are available from or through your local Tektronix, Inc. Field Office or representative

Changes to Tektronix instruments are sometimes made to accommodate improved components as they become available, and to give you the benefit of the latest circuit improvements developed in our engineering department. It is therefore important, when ordering parts, to include the following information in your order: Part number, instrument type or number, serial number, and modification number if applicable.

If a part you have ordered has been replaced with a new or improved part, your local Tektronix, Inc. Field Office or representative will contact you concerning any change in part number.

Change information, if any, is located at the rear of this manual.

ITEM NAME

In the Parts List, an Item Name is separated from the description by a colon (:). Because of space limitations, an Item Name may sometimes appear as incomplete. For further Item Name identification, the U.S. Federal Cataloging Handbook H6-1 can be utilized where possible.

FIGURE AND INDEX NUMBERS

Items in this section are referenced by figure and index numbers to the illustrations.

INDENTATION SYSTEM

This mechanical parts list is indented to indicate item relationships. Following is an example of the indentation system used in the description column.

```

1 2 3 4 5      Name & Description
Assembly and/or Component
Attaching parts for Assembly and/or Component
    - - - - -
Detail Part of Assembly and/or Component
Attaching parts for Detail Part
    - - - - -
Parts of Detail Part
Attaching parts for Parts of Detail Part
    - - - - -
    
```

Attaching Parts always appear in the same indentation as the item it mounts, while the detail parts are indented to the right. Indented items are part of, and included with, the next higher indentation. The separation symbol - - - - - indicates the end of attaching parts.

Attaching parts must be purchased separately, unless otherwise specified.

**For Service Manuals Contact
MAURITRON TECHNICAL SERVICES
8 Cherry Tree Rd, Chinnor
Oxon OX9 4QY
Tel:- 01844-351694 Fax:- 01844-352554
Email:- enquiries@mauritron.co.uk**

ABBREVIATIONS

ACTR	NUMBER SIZE	ELECTRN	ELECTRON	IN	INCH	SE	SINGLE END
ADPTR	ACTUATOR	ELEC	ELECTRICAL	INCAND	INCANDESCENT	SECT	SECTION
ALIGN	ADAPTER	ELCTLT	ELECTROLYTIC	INSUL	INSULATOR	SEMICOND	SEMICONDUCTOR
AL	ALIGNMENT	ELEM	ELEMENT	INTL	INTERNAL	SHLD	SHIELD
ALUM	ALUMINUM	EPL	ELECTRICAL PARTS LIST	LPHLDR	LAMPHOLDER	SHLDR	SHOULDERED
ASSEM	ASSEMBLED	EOPT	EQUIPMENT	MACH	MACHINE	SKT	SOCKET
ASSY	ASSEMBLY	EXT	EXTERNAL	MECH	MECHANICAL	SL	SLIDE
ATTEN	ATTENUATOR	FIL	FILLISTER HEAD	MTG	MOUNTING	SLFLKG	SELF-LOCKING
AWG	AMERICAN WIRE GAGE	FLEX	FLEXIBLE	NIP	NIPPLE	SLVG	SLEEVING
BD	BOARD	FLH	FLAT HEAD	NON WIRE	NOT WIRE WOUND	SPR	SPRING
BRKT	BRACKET	FLTR	FILTER	OB	ORDER BY DESCRIPTION	SO	SQUARE
BRS	BRASS	FR	FRAME or FRONT	OD	OUTSIDE DIAMETER	SST	STAINLESS STEEL
BRZ	BRONZE	FSTNR	FASTENER	OVH	OVAL HEAD	STL	STEEL
BSHG	BUSHING	FT	FOOT	PH BRZ	PHOSPHOR BRONZE	SW	SWITCH
CAB	CABINET	FXD	FIXED	PL	PLAIN or PLATE	T	TUBE
CAP	CAPACITOR	GSKT	GASKET	PLSTC	PLASTIC	TERM	TERMINAL
CER	CERAMIC	HDL	HANDLE	PN	PART NUMBER	THD	THREAD
CHAS	CHASSIS	HEX	HEXAGON	PNH	PAN HEAD	THK	THICK
CKT	CIRCUIT	HEX HD	HEXAGONAL HEAD	PWR	POWER	TNSN	TENSION
COMP	COMPOSITION	HEX SOC	HEXAGONAL SOCKET	RCPT	RECEPTACLE	TPG	TAPPING
CONN	CONNECTOR	HLCPS	HELICAL COMPRESSION	RES	RESISTOR	TRH	TRUSS HEAD
COV	COVER	HLEXT	HELICAL EXTENSION	RGD	RIGID	V	VOLTAGE
CPLG	COUPLING	HV	HIGH VOLTAGE	RLF	RELIEF	VAR	VARIABLE
CRT	CATHODE RAY TUBE	IC	INTEGRATED CIRCUIT	RTNR	RETAINER	W	WITH
DEG	DEGREE	ID	INSIDE DIAMETER	SCH	SOCKET HEAD	WSHR	WASHER
DWR	DRAWER	IDENT	IDENTIFICATION	SCOPE	OSCILLOSCOPE	XFMR	TRANSFORMER
		IMPLR	IMPELLER	SCR	SCREW	XSTR	TRANSISTOR

CROSS INDEX - MFR. CODE NUMBER TO MANUFACTURER

Mfr. Code	Manufacturer	Address	City, State, Zip Code
00779	AMP INC	2800 FULLING MILL PO BOX 3608	HARRISBURG PA 17105
04811	PRECISION COIL SPRING CO	10107 ROSE ST P O BOX 5450	EL MONTE CA 91734
06950	SCREWCORP VSI AEROSPACE PRODUCTS DIV SUB OF FAIRCHILD INDUSTRIES INC	13001 E TEMPLE AVE PO BOX 730	CITY OF INDUSTRY CA 91746-1417
07416	NELSON NAME PLATE CO	3191 CASITAS	LOS ANGELES CA 90039-2410
09772	WEST COAST LOCKWASHER CO INC	16730 E JOHNSON DRIVE P O BOX 3588	CITY OF INDUSTRY CA 91744
09922	BURNDY CORP	RICHARDS AVE	NORWALK CT 06852
11897	PLASTIGLIDE MFG CORP	2701 W EL SEGUNDO BLVD	HAWTHORNE CA 90250-3318
12327	FREEWAY CORP	9301 ALLEN DR	CLEVELAND OH 44125-4632
12360	ALBANY FASTENERS PAWTUCKET FASTENER DIV	327 PINE ST PO BOX 879	PAWTUCKET RI 02862
13511	AMPHENOL CADRE DIV BUNKER RAMO CORP		LOS GATOS CA
20428	PLASTIC SUPPLIERS	207 LAKEVIEW AVE	BLACKWOOD NJ 08012-3025
22526	DU PONT E I DE NEMOURS AND CO INC DU PONT CONNECTOR SYSTEMS DIV MILITARY PRODUCTS GROUP	515 FISHING CREEK RD	NEW CUMBERLAND PA 17070-3007
22670	G M NAMEPLATE INC	2040 15TH AVE WEST	SEATTLE WA 98119-2728
24546	CORNING GLASS WORKS	550 HIGH ST	BRADFORD PA 16701-3737
24931	SPECIALTY CONNECTOR CO INC	2100 EARLYWOOD DR PO BOX 547	FRANKLIN IN 46131
25088	SIEMENS CORP	186 WOOD AVE S	ISELIN NJ 08830-2704
26233	NYLOK FASTENER CORP	1161 E SANDHILL AVE SUITE D PO BOX 5228	CARSON CA 90749
26365	GRIES DYNACAST CO DIV OF COATS AND CLARK INC	125 BEECHWOOD AVE	NEW ROCHELLE NY 10802
42838	NATIONAL RIVET AND MFG CO	21 EAST JEFFERSON ST	WAUPUN WI 53963-2028
52792	THORNGREN TOOL AND MOLDING CO INC	1100 EVANS AVE PO BOX 210	VALPARAISO IN 46383-3717
70318	ALLMETAL SCREW PRODUCTS CO INC	821 STEWART AVE	GARDEN CITY NY 11530-4810
70485	ATLANTIC INDIA RUBBER WORKS INC	571 W POLK ST	CHICAGO IL 60607
71785	TRW INC TRW CINCH CONNECTORS DIV	1501 MORSE AVE	ELK GROVE VILLAGE IL 60007-5723
73743	FISCHER SPECIAL MFG CO	111 INDUSTRIAL RD	COLD SPRING KY 41076-9749
74445	HOLO-KROME CO	31 BROOK ST	ELMWOOD CT 06110-2350
75915	LITTELFUSE TRACTOR INC SUB TRACTOR INC	800 E NORTHWEST HWY	DES PLAINES IL 60016-3049
77900	SHAKEPROOF DIV OF ILLINOIS TOOL WORKS	SAINT CHARLES RD	ELGIN IL 60120
78189	ILLINOIS TOOL WORKS INC SHAKEPROOF DIV	ST CHARLES ROAD	ELGIN IL 60120
79136	WALDES KOHNOR IN	47-16 AUSTEL PLACE	LONG ISLAND CITY NY 11101-4402
80009	TEKTRONIX INC	14150 SW KARL BRAUM DR PO BOX 500 MS 53-111	BEAVERTON OR 97077
83309	ELECTRICAL SPECIALITY CO SUBSIDIARY OF BELDEN CORP	345 SWIFT AVE	SOUTH SAN FRANCISCO CA 94080-6206
83385	MICRODOT MFG INC GREER-CENTRAL DIV	3221 W BIG BEAVER RD	TROY MI 48098
83486	ELCO INDUSTRIES INC	1101 SAMUELSON RD	ROCKFORD IL 61101
85471	BOYD CORP	13885 RAMOMA AVE	CHINO CA 91710
86928	SEASTROM MFG CO INC	701 SONORA AVE	GLENDALE CA 91201-2431
88245	WINCHESTER ELECTRONICS LITTON SYSTEMS-USECO DIV	13536 SATICOY ST	VAN NUYS CA 91409
90201	AEROVOX MALLORY	101 MALLORY DR	GLASGOW KY 42141
91260	CONNOR SPRING AND MFG CO	1729 JUNCTION AVE	SAN JOSE CA 95112
93907	TEXTRON INC CAMCAR DIV	600 18TH AVE	ROCKFORD IL 61101
98159	RUBBER TECK INC	19115 HAMILTON AVE PO BOX 389	GARDENA CA 90247
S3629	SCHURTER AG H C/O PANEL COMPONENTS CORP	2015 SECOND STREET	BERKELEY CA 94170
TK0392	NORTHWEST FASTENER SALES INC	7923 SW CIRRRUS DRIVE	BEAVERTON OR 97005-6448
TK0433	PORTLAND SCREW CO	6520 N BASIN	PORTLAND OR 97217-3920
TK0435	LEWIS SCREW CO	4300 S RACINE AVE	CHICAGO IL 60609-3320

CROSS INDEX - MFR. CODE NUMBER TO MANUFACTURER

Mfr. Code	Manufacturer	Address	City, State, Zip Code
TK0588	UNIVERSAL PRECISION PRODUCTS	1775 NW 216TH	HILLSBORD OR 97123
TK0858	STAUFFER SUPPLY CO	105 SE TAYLOR	PORTLAND OR 97214
TK0861	H SCHURTER AG DIST PANEL COMPONENTS	2015 SECOND STREET	BERKELEY CA 94170
TK1036	E F JOHNSON CO	299 10TH AVE SW	WASECA MN 56093
TK1319	MORELLIS Q & D PLASTICS	1812 16-TH AVE	FOREST GROVE OR 97116
TK1684	TECHNICAL IMAGES INC	2206 MOUNTAIN VIEW DR	NEWBURG OR 97132-9265
TK2165	TRI-QUEST CORP	3000 LEWIS AND CLARK HWY	VANCOUVER WA 98661-2999

For Service Manuals Contact
MAURITRON TECHNICAL SERVICES
8 Cherry Tree Rd, Chinnor
Oxon OX9 4QY
Tel:- 01844-351694 Fax:- 01844-352554
Email:- enquiries@mauritron.co.uk

Replaceable Mechanical Parts
434 (SN B500000 and up)

Fig. & Index	Tektronix Part No.	Serial/Assembly No. Effective	Discont	Qty	12345 Name & Description	Mfr. Code	Mfr. Part No.
1-1	426-0721-00	B500000	B527439	1	FRAME,LT FILTER:	80009	426-0721-00
	426-0721-02	B527440		1	FRAME,LT FILTER:	80009	426-0721-02
-2	378-0678-00	B500000	B527439	1	FILTER,LT,CRT:BLUE,4.319 X 3.531 X 0.03	80009	378-0678-00
	378-0678-01	B527440		1	FILTER,LT,CRT:BLUE,4.319 X 3.531 X 0.06	80009	378-0678-01
-3	366-0493-01			2	KNOB:RED,VAR,0.127 ID X 0.5 OD X 0.531 H	80009	366-0493-01
	213-0153-00			1	.SETSCREW:5-40 X 0.125,STL	TK0392	ORDER BY DESCR
-4	366-1281-00			2	KNOB:GY,V/DIV,0.189 ID X 1.125 OD X 0.79 H	80009	366-1281-00
	213-0153-00			2	.SETSCREW:5-40 X 0.125,STL	TK0392	ORDER BY DESCR
-5	366-1031-02			1	KNOB:RED,VAR,0.127 ID X 0.392 OD X 0.466 H	TK2165	ORDER BY DESCR
	213-0153-00			1	.SETSCREW:5-40 X 0.125,STL	TK0392	ORDER BY DESCR
-6	366-1279-00			1	KNOB:GY,0.252 ID X 0.925 OD X 0.67 H	80009	366-1279-00
	213-0153-00			2	.SETSCREW:5-40 X 0.125,STL	TK0392	ORDER BY DESCR
-7	366-1282-00	B500000	B540779	1	PUSH BUTTON:GY,0.375 OD X 0.3 H	80009	366-1282-00
	366-1282-01	B540780		1	PUSH BUTTON:GY,0.375 OD X 0.3 H	80009	366-1282-01
-8	366-1283-00			1	KNOB:GY,0.127 ID X 0.706 OD X 0.6 H	80009	366-1283-00
	213-0153-00			1	.SETSCREW:5-40 X 0.125,STL	TK0392	ORDER BY DESCR
-9	366-1059-00			1	PUSH BUTTON:GRAY,0.227 OD X 0.3	80009	366-1059-00
-10	366-1334-00			1	KNOB:GY,0.127 OD X 0.5 OD X 0.531 H	80009	366-1334-00
	213-0153-00			1	.SETSCREW:5-40 X 0.125,STL	TK0392	ORDER BY DESCR
-11	366-1038-00			1	KNOB:GY,0.128 ID X 0.5 OD X 0.645 H	80009	366-1038-00
	213-0153-00			1	.SETSCREW:5-40 X 0.125,STL	TK0392	ORDER BY DESCR
-12	366-0494-00			1	KNOB:GRAY WITH SETSCREW	80009	366-0494-00
	213-0153-00			1	.SETSCREW:5-40 X 0.125,STL	TK0392	ORDER BY DESCR
-13	366-1257-07			1	PUSH BUTTON:SIL GY,AUTO	80009	366-1257-07
	366-1257-05			1	PUSH BUTTON:SIL GY,NORM	80009	366-1257-05
-14	366-1278-00			1	KNOB:GY,0.08 ID X 0.392 OD X 0.466 H	TK2165	ORDER BY DESCR
	213-0153-00			1	.SETSCREW:5-40 X 0.125,STL	TK0392	ORDER BY DESCR
-15	366-1280-00			1	KNOB:GY,0.127 ID X 0.588 OD X 0.6 H	TK2165	ORDER BY DESCR
	213-0153-00			1	.SETSCREW:5-40 X 0.125,STL	TK0392	ORDER BY DESCR
-16	366-1257-08			1	PUSH BUTTON:SIL GY,EXT ATTEN	80009	366-1257-08
	366-1257-06			1	PUSH BUTTON:SIL GY,COMP	80009	366-1257-06
	366-1257-01			1	PUSH BUTTON:SIL GY,CH 1	80009	366-1257-01
-17	366-1257-02			1	PUSH BUTTON:SIL GY,AC	80009	366-1257-02
	366-1257-10			1	PUSH BUTTON:SIL GY,HF REJ	80009	366-1257-10
	366-1257-09			1	PUSH BUTTON:SIL GY,LF REJ	80009	366-1257-09
-18	366-1282-00	B500000	B540779	1	PUSH BUTTON:GY,0.375 OD X 0.3 H	80009	366-1282-00
	366-1282-01	B540780		1	PUSH BUTTON:GY,0.375 OD X 0.3 H	80009	366-1282-01
-19	366-1283-00			1	KNOB:GY,0.127 ID X 0.706 OD X 0.6 H	80009	366-1283-00
	213-0153-00			1	.SETSCREW:5-40 X 0.125,STL	TK0392	ORDER BY DESCR
-20	366-1257-02			2	PUSH BUTTON:SIL GY,AC	80009	366-1257-02
	366-1257-03			2	PUSH BUTTON:SIL GY,GND	80009	366-1257-03
-21	366-1161-29			1	PUSH BUTTON:SIL GY,CH 1	80009	366-1161-29
	366-1161-31			1	PUSH BUTTON:SIL GY,ALT	80009	366-1161-31
	366-1161-27			1	PUSH BUTTON:SIL GY,ADD	80009	366-1161-27
	366-1161-30			1	PUSH BUTTON:SIL GY,CHOP	80009	366-1161-30
	366-1161-28			1	PUSH BUTTON:SIL GY,CH 2	80009	366-1161-28
-22	426-0681-00			12	FRAME,PUSH BTN:	80009	426-0681-00
-23	426-0568-00			5	FRAME,PUSH BTN:	80009	426-0568-00
-24	358-0378-00			3	BUSHING,SLEEVE:0.131 ID X 0.18 OD X 0.125 L	80009	358-0378-00
-25	358-0301-02			2	BUSHING,SLEEVE:0.16 ID X 0.205 OD	80009	358-0301-02
-26	333-1413-04			1	PANEL,FRONT: (ATTACHING PARTS)	80009	333-1413-04
-27	211-0079-00			6	SCREW,MACHINE:2-56 X 0.188,PNH,STL (END ATTACHING PARTS)	TK0435	5549-418
-28	-----			2	SWITCH,PUSH:SPST(SEE S50 & S60 REPL)		
-29	358-0403-00			1	BUSHING,SLEEVE:0.127 ID X 0.256 L,DELIN,0.312 OD W/FLG	80009	358-0403-00
-30	-----			1	SWITCH,PUSH:INTEGRATED(SEE S94 REPL) (ATTACHING PARTS)		
-31	210-0223-00			1	TERMINAL,LUG:0.26 ID,LOCKING,BRZ TIN PL (END ATTACHING PARTS)	86928	5441-37
-32	200-0609-00			1	BASE,LAMPHOLDER:0.4 OD X 0.16"L,GRAY PLSTC	80009	200-0609-00
-33	378-0541-00			1	LENS,LIGHT:FROSTED,PLASTIC	80009	378-0541-00
-34	352-0084-00			1	HOLDER,NEON:T-2 OR SMALLER UNBASED LAMP	80009	352-0084-00
-35	200-0935-00			4	BASE,LAMPHOLDER:0.29 OD X 0.19 L,BK PLSTC	80009	200-0935-00
-36	331-0262-00			4	DIFFUSER,LIGHT:INDICATOR LIGHTS	80009	331-0262-00
-37	352-0157-00			4	LAMPHOLDER:(1)T-2 UNBASED,WHITE	80009	352-0157-00
-38	378-0680-00			4	LENS,KNOB SKIRT:PLASTIC	80009	378-0680-00

Replaceable Mechanical Parts
434 (SN B500000 and up)

Fig. & Index No.	Tektronix Part No.	Serial/Assembly No.		Qty	12345 Name & Description	Mfr.	
		Effective	Dscont			Code	Mfr. Part No.
1-39	136-0098-01			1	JACK, TIP: 0.25-32 X 0.562, GRAY (ATTACHING PARTS)	TK1036	105-0813-001
-40	210-0223-00			1	TERMINAL, LUG: 0.26 ID, LOCKING, BRZ TIN PL (END ATTACHING PARTS)	86928	5441-37
-41	131-0679-02			2	CONN, RCPT, ELEC: BNC, MALE, 3 CONTACT	24931	28JR270-1
-42	-----			1	RES., VAR: ENHANCE LVL/LCT (SEE R92/S95 REPL)		
-43	-----			1	RES., VAR: CH1 POSITION (SEE R40 REPL)		
-44	-----			1	RES., VAR: HORIZONTAL POSITION (SEE R55 REPL)		
-45	-----			1	RES., VAR: LEVEL/SLOPE (SEE R60A, B/S60 REPL)		
-46	-----			1	RES., VAR: CH2 POSITION (SEE R44 REPL) (ATTACHING PARTS)		
-47	210-0583-00			5	NUT, PLAIN, HEX: 0.25-32 X 0.312, BRS CD PL	73743	2X-20319-402
	210-0905-00	B529150		15	WASHER, FLAT: 0.256 ID X 0.438 OD X 0.05, BRS (END ATTACHING PARTS)	83385	ORDER BY DESCR
-48	-----			1	RES., VAR: STEP ATTEN BAL, CH1 (SEE R22 REPL) RES., VAR: STEP ATTEN BAL, CH2 (SEE R32 REPL) (ATTACHING PARTS)		
-49	358-0409-00			2	BSHG, MACH THD: 0.25-32 X 0.159 ID, BRS	80009	358-0409-00
-50	210-0223-00			2	TERMINAL, LUG: 0.26 ID, LOCKING, BRZ TIN PL	86928	5441-37
-51	210-0471-00			2	NUT, SLEEVE: 0.25-32 X 0.594 L X 0.312 HEX, AL	80009	210-0471-00
-52	210-0905-00			2	WASHER, FLAT: 0.256 ID X 0.438 OD X 0.05, BRS (END ATTACHING PARTS)	83385	ORDER BY DESCR
-53	-----			1	CKT BOARD ASSY: UPR STOR SW (SEE A15 REPL) (ATTACHING PARTS)		
-54	211-0156-00			2	SCREW, MACHINE: 1-72 X 0.250, FLH, 82 DEG, STL (END ATTACHING PARTS) CKT BOARD ASSY INCLUDES:	93907	ORDER BY DESCR
-55	131-0589-00			8	.TERMINAL, PIN: 0.46 L X 0.025 SQ PH BRZ	22526	48283-029
-56	-----			1	CKT BOARD ASSY: LWR STOR SW (SEE A16 REPL) (ATTACHING PARTS)		
-57	211-0156-00			2	SCREW, MACHINE: 1-72 X 0.250, FLH, 82 DEG, STL (END ATTACHING PARTS) CKT BOARD ASSY INCLUDES:	93907	ORDER BY DESCR
-58	131-0589-00			8	.TERMINAL, PIN: 0.46 L X 0.025 SQ PH BRZ	22526	48283-029
-59	-----			1	SWTCH, PUSH: 2 BUTTON, AUTO-NORM (SEE S65 REPL) (ATTACHING PARTS)		
-60	211-0034-00			2	SCREW, MACHINE: 2-56 X 0.5, PNH, STL	06950	ORDER BY DESCR
-61	166-0251-00			2	SPACER, SLEEVE: 0.297 L X 0.094 ID, BRS (END ATTACHING PARTS)	80009	166-0251-00
-62	-----			1	CKT BOARD ASSY: TRIG COUPLING SW (SEE A7 REPL) (ATTACHING PARTS)		
-63	211-0017-00			2	SCREW, MACHINE: 4-40 X 0.75, PNH, STL	93907	ORDER BY DESCR
-64	361-0368-00			2	SPACER, PB SW: 3 BUTTON, BLK ABS (END ATTACHING PARTS) CKT BOARD ASSY INCLUDES:	80009	361-0368-00
-65	131-0589-00			3	.TERMINAL, PIN: 0.46 L X 0.025 SQ PH BRZ	22526	48283-029
-66	-----			1	.SWITCH, PUSH: 2 BUTTON, LF/HF (SEE S75 REPL)		
-67	-----			1	.SWITCH, PUSH: 1 BUTTON, AC/DC (SEE S74 REPL)		
-68	-----			1	CKT BOARD ASSY: TRIG SEL SW (SEE A6 REPL)		
-69	131-0589-00			10	.TERMINAL, PIN: 0.46 L X 0.025 SQ PH BRZ	22526	48283-029
-70	-----			1	.SWITCH, PUSH: 2 BTN, CH1/COMP (SEE S72 REPL)		
-71	-----			1	.SWITCH, PUSH: 1 BTN, EXT ATTEN (SEE S70 REPL)		
-72	342-0096-00			1	INSULATOR, PLATE: PUSH SWITCH, PLASTIC	80009	342-0096-00
-73	337-1455-00			1	SHLD-CONT ASSY: CONTACT ASSY, BNC	80009	337-1455-00
	342-0094-00			1	.INSULATOR, PLATE: SHIELD, POLYESTER	80009	342-0094-00
-74	131-1086-00			2	CONTACT, ELEC: ATTN GROUND, ALUMINUM (ATTACHING PARTS)	80009	131-1086-00
-75	211-0007-00			4	SCREW, MACHINE: 4-40 X 0.188, PNH, STL (END ATTACHING PARTS)	TK0435	ORDER BY DESCR
-76	-----			1	CKT BOARD ASSY: MODE SW (SEE A3 REPL) (ATTACHING PARTS)		
-77	211-0116-00	B500000	B540659	2	SCR, ASSEM WSHR: 4-40 X 0.312, PNH, BRS, NP, POZ	77900	ORDER BY DESCR
	211-0292-00	B540660		2	SCR, ASSEM WSHR: 4-40 X 0.29, PNH, BRS NI PL (END ATTACHING PARTS) CKT BOARD ASSY INCLUDES:	78189	51-040445-01
-78	131-0589-00			6	.TERMINAL, PIN: 0.46 L X 0.025 SQ PH BRZ	22526	48283-029
-79	-----			1	.SWITCH, PUSH: CH1 AC/GND (SEE S8A, B REPL) .SWITCH, PUSH: CH2 AC/GND (SEE S18A, B REPL)		

Replaceable Mechanical Parts
434 (SN B500000 and up)

Fig. & Index No.	Tektronix Part No.	Serial/Assembly No.		Qty	12345 Name & Description	Mfr.	
		Effective	Discnt			Code	Mfr. Part No.
1-80	-----			1	.SWITCH,PUSH:VERT MODE(SEE S45A-E REPL)		
-81	337-1434-00			2	.SHIELD,ELEC:AC COUPLING CAP .(ATTACHING PARTS)	80009	337-1434-00
-82	210-0406-00			2	.NUT,PLAIN,HEX:4-40 X 0.188,BRS CD PL	73743	12161-50
-83	210-0288-00			2	.TERM,LUG:0.125 ID,PLAIN,CU BE,CU-SN-ZN PL	80009	210-0288-00
	210-0994-00			2	.WASHER,FLAT:0.125 ID X 0.25 OD X 0.022,STL .(END ATTACHING PARTS)	86928	A371-283-20
-84	358-0363-00			3	BSHG,MACH THD:0.375-32 X 0.253 ID,BRS (ATTACHING PARTS)	80009	358-0363-00
-85	220-0495-00			3	NUT,PLAIN,HEX:0.375-32 X 0.438 HEX,BRS	73743	ORDER BY DESCR
-86	210-0840-00			3	WASHER,FLAT:0.39 ID X 0.562 OD X 0.02,STL	86928	ORDER BY DESCR
-87	344-0195-01			3	CLIP,ELECTRICAL:GROUNDING,PH BRZ ALBALOY PL (END ATTACHING PARTS)	80009	344-0195-01
-88	348-0276-00			1	SHLD GSKT,ELEK:MESH TYPE,0.124 OD,BULK	TK0646	01-0404-3719
-89	386-1854-01			1	SUBPANEL,FRONT: (ATTACHING PARTS)	80009	386-1854-01
	212-0040-00			3	SCREW,MACHINE:8-32 X 0.375,FLH,100 DEG,STL (END ATTACHING PARTS)	83486	ORDER BY DESCR
-90	-----			1	CKT BOARD ASSY:HORIZONTAL(SEE A8 REPL) (ATTACHING PARTS)		
	211-0116-00	B500000	B540659	3	SCR,ASSEM WSHR:4-40 X 0.312,PNH,BRS,NP,POZ	77900	ORDER BY DESCR
	211-0292-00	B540660		3	SCR,ASSEM WSHR:4-40 X 0.29,PNH,BRS NI PL (END ATTACHING PARTS)	78189	51-040445-01
	334-3448-00	B529150		1	CKT BOARD ASSY INCLUDES: .MARKER,IDENT:MARKED NOTICE	07416	ORDER BY DESCR
-91	131-0589-00			37	.TERMINAL,PIN:0.46 L X 0.025 SQ PH BRZ	22526	48283-029
-92	131-0604-00			24	.CONTACT,ELEC:CKT BD SW,SPR,CU BE	80009	131-0604-00
-93	136-0241-00			1	.SKT,PL-IN ELEK:MICROCIRCUIT,10 CONT,PCB MT	71785	133-99-12-064
-94	136-0235-00			5	.SKT,PL-IN ELEK:TRANSISTOR,6 CONTACT	71785	133-96-12-062
	136-0183-00			4	.SKT,PL-IN ELEK:TRANSISTOR,3 CONTACT	80009	136-0183-00
	136-0220-00			11	.SKT,PL-IN ELEK:TRANSISTOR 3 CONTACT	71785	133-23-11-034
-95	136-0269-02			3	.SKT,PL-IN ELEK:MICROCIRCUIT,14 DIP	09922	D1LB14P-108T
-96	214-0579-00			15	.TERM,TEST POINT:BRS CD PL .ACTR ASSY,CAM S:(SEE S700 REPL) (ATTACHING PARTS)	80009	214-0579-00
-97	211-0116-00			10	.SCR,ASSEM WSHR:4-40 X 0.312,PNH,BRS,NP,POZ	77900	ORDER BY DESCR
-98	210-0406-00			10	.NUT,PLAIN,HEX:4-40 X 0.188,BRS CD PL (END ATTACHING PARTS)	73743	12161-50
-99	344-0116-00			1	.ACTUATOR ASSY INCLUDES: .RTNR,CAPACITOR:0.625 DIA,STEEL (ATTACHING PARTS)	90201	TH-17
-100	211-0079-00			1	.SCREW,MACHINE:2-56 X 0.188,PNH,STL	TK0435	5549-418
-101	210-0001-00			1	.WASHER,LOCK:#2 INTL,0.013 THK,STL	77900	1202-00-00-0541C
-102	210-1008-00			1	.WASHER,FLAT:0.09 ID X 0.188 OD X 0.02,BRS	12327	ORDER BY DESCR
-103	210-0405-00			1	.NUT,PLAIN,HEX:2-56 X 0.188,BRS CD PL (END ATTACHING PARTS)	73743	12157-50
-104	200-1208-00			1	.COVER,CAM SW: (ATTACHING PARTS)	80009	200-1208-00
-105	211-0079-00			6	.SCREW,MACHINE:2-56 X 0.188,PNH,STL	TK0435	5549-418
-106	210-0001-00			6	.WASHER,LOCK:#2 INTL,0.013 THK,STL	77900	1202-00-00-0541C
-107	210-0405-00			6	.NUT,PLAIN,HEX:2-56 X 0.188,BRS CD PL (END ATTACHING PARTS)	73743	12157-50
-108	-----			1	.RES.,VAR:VAR TIME/DIV CAL(SEE R799 REPL) (ATTACHING PARTS)		
-109	211-0079-00			2	.SCREW,MACHINE:2-56 X 0.188,PNH,STL	TK0435	5549-418
-110	210-0001-00			2	.WASHER,LOCK:#2 INTL,0.013 THK,STL (END ATTACHING PARTS)	77900	1202-00-00-0541C
-111	384-1055-00			1	.RESISTOR INCLUDES: ...EXTENSION SHAFT:8.543 L X 0.125 OD STL	TK0588	ORDER BY DESCR
-112	213-0153-00			1	...SETScrew:5-40 X 0.125,STL	TK0392	ORDER BY DESCR
-113	105-0232-00			1	.STOP,CAM SWITCH:STATIONARY (ATTACHING PARTS)	80009	105-0232-00
-114	211-0079-00			2	.SCREW,MACHINE:2-56 X 0.188,PNH,STL	TK0435	5549-418
-115	210-0001-00			2	.WASHER,LOCK:#2 INTL,0.013 THK,STL (END ATTACHING PARTS)	77900	1202-00-00-0541C
-116	105-0233-00			1	.STOP,CAM SWITCH:ROTARY	80009	105-0233-00
-117	401-0056-01			1	.BEARING,CAM SW:CENTER	80009	401-0056-01
-118	105-0231-01			1	.ACTUATOR,CAM SW:SWEEP	80009	105-0231-01

Replaceable Mechanical Parts
434 (SN B500000 and up)

Fig. & Index No.	Tektronix Part No.	Serial/Assembly No.		Qty	12345 Name & Description	Mfr.	
		Effective	Discont			Code	Mfr. Part No.
1-119	407-0653-00			1	..BRACKET,COVER:CAM SWITCH,DELTRIN	80009	407-0653-00
-120	214-1127-00			2	..ROLLER,DETENT:0.125 DIA X 0.125,SST	80009	214-1127-00
-121	214-1139-02			2	..SPRING,FLAT:0.885 X 0.156 CU BE GRN CLR	80009	214-1139-02
	214-1139-03			2	..SPRING,FLAT:0.885 X 0.156 CU BE RED CLR	80009	214-1139-03
-122	401-0064-00			1	..BEARING,CAM SW:FRONT W/STOP GUIDE	80009	401-0064-00
-123	210-1131-00			1	..WASHER,FLAT:0.375 ID X 0.562 OD X 0.026	80009	210-1131-00
-124	376-0122-00			1	..COUPLER,CAM SW:TWO SLOT ENGAGE,GRAY PC	80009	376-0122-00
	213-0153-00			1	..SETScrew:5-40 X 0.125,STL	TK0392	ORDER BY DESCR
-125	384-0799-01			1	..SHAFT,CAM SW:5.948 L X 0.248 OD	80009	384-0799-01
-126	214-1541-00			1	..SPRING,HLCPS:0.24 OD X 1.344 L,CLE,MUM	80009	214-1541-00
-127	376-0121-00			1	..COUPLER,CAM SW:28 TOOTH ENGAGE,GRAY PC	80009	376-0121-00
	213-0153-00			1	..SETScrew:5-40 X 0.125,STL	TK0392	ORDER BY DESCR
-128	105-0230-00			1	..ACTUATOR,CAM SW:MAGNIFIER	80009	105-0230-00
					..(ATTACHING PARTS)		
-129	354-0390-00			1	..RING,RETAINING:BASIC EXT,U/O 0.375 DIA SFT	79136	5100-37-ZD
					..(END ATTACHING PARTS)		
-130	401-0064-00			1	..BEARING,CAM SW:FRONT W/STOP GUIDE	80009	401-0064-00
-131	129-0301-00			2	..SPACER,POST:0.312 L,0.156 HEX	80009	129-0301-00
					..(ATTACHING PARTS)		
-132	211-0079-00			2	..SCREW,MACHINE:2-56 X 0.188,PNH,STL	TK0435	5549-418
-133	210-0001-00			2	..WASHER,LOCK:#2 INTL,0.013 THK,STL	77900	1202-00-00-0541C
					..(END ATTACHING PARTS)		
-134	401-0056-00			1	..BEARING,CAM SW:REAR,0.83 DIA CAM	80009	401-0056-00
-135	337-1424-01			1	SHIELD,ELEC:Z AXIS CKT BD	80009	337-1424-01
					(ATTACHING PARTS)		
-136	211-0189-00			2	SCREW,MACHINE:4-40 X 0.875,PNH,NYL	26365	ORDER BY DESCR
-137	210-0869-00			2	WASHER,RECESSED:0.156ID X 0.125D,NYLON	80009	210-0869-00
-138	361-0396-00			2	SPACER,SLEEVE:0.56 L X 0.125 ID,DELTRIN	TK0588	ORDER BY DESCR
					(END ATTACHING PARTS)		
-139	-----			1	CKT BOARD ASSY:Z-AXIS(SEE A14 REPL)		
					(ATTACHING PARTS)		
-140	211-0008-00			2	SCREW,MACHINE:4-40 X 0.25,PNH,STL	93907	ORDER BY DESCR
					(END ATTACHING PARTS)		
					CKT BOARD ASSY INCLUDES:		
-141	131-0589-00			30	.TERMINAL,PIN:0.46 L X 0.025 SQ PH BRZ	22526	48283-029
	131-0608-00			9	.TERMINAL,PIN:0.365 L X 0.025 BRZ GLD PL	22526	48283-036
-142	136-0183-00			4	.SKT,PL-IN ELEK:TRANSISTOR,3 CONTACT	80009	136-0183-00
-143	136-0220-00			5	.SKT,PL-IN ELEK:TRANSISTOR 3 CONTACT	71785	133-23-11-034
-144	136-0514-00	B500000	B542069	1	.SKT,PL-IN ELEK:MICROCIRCUIT,8 DIP	09922	D1LB8P-108
-145	214-0579-00			1	.TERM,TEST POINT:BRS CD PL	80009	214-0579-00
-146	361-0008-00	B500000	B529999	2	.SPACER,SLEEVE:0.28 L X 0.111 ID,PP	80009	361-0008-00
-147	361-0009-00	B500000	B529999	5	.SPACER,SLEEVE:0.406 L X 0.111 ID,PP	80009	361-0009-00
-148	-----			1	CKT BOARD ASSY:STORAGE(SEE A12 REPL)		
					(ATTACHING PARTS)		
-149	211-0116-00	B500000	B540659	4	SCR,ASSEM WSHR:4-40 X 0.312,PNH,BRS,NP,POZ	77900	ORDER BY DESCR
	211-0292-00	B540660		4	SCR,ASSEM WSHR:4-40 X 0.29,PNH,BRS NI PL	78189	51-040445-01
					(END ATTACHING PARTS)		
					CKT BOARD ASSY INCLUDES:		
-150	131-0589-00			32	.TERMINAL,PIN:0.46 L X 0.025 SQ PH BRZ	22526	48283-029
-151	214-0579-00			1	.TERM,TEST POINT:BRS CD PL	80009	214-0579-00
-152	136-0252-07			48	.SOCKET,PIN CONN:W/O DIMPLE	22526	75060-012
	210-1011-00			1	.WASHER,FLAT:0.13 ID X 0.375 OD X 0.01,NYLON	83309	ORDER BY DESCR
-153	407-0905-00			2	BRACKET,CKT BD:ALUMINUM	80009	407-0905-00
-154	407-0875-00			2	BRACKET,CKT BD:ACETAL	80009	407-0875-00
					(ATTACHING PARTS)		
-155	211-0511-00			2	SCREW,MACHINE:6-32 X 0.5,PNH,STL	TK0435	ORDER BY DESCR
	211-0514-00			2	SCREW,MACHINE:6-32 X 0.750,PNH,STL	TK0435	1541-300
-156	220-0444-00			4	NUT,PLAIN,SQ:6-32 X 0.25 SQ,SST	70318	ORDER BY DESCR
					(END ATTACHING PARTS)		
-157	386-1903-00			4	SUPPORT,CRT:FRONT	80009	386-1903-00
					(ATTACHING PARTS)		
-158	212-0084-00			4	SCREW,MACHINE:8-32 X 0.312,LGE HEX HD,STL	83385	ORDER BY DESCR
-159	210-0805-00			4	WASHER,FLAT:0.204 ID X 0.438 OD X 0.032,STL	12327	ORDER BY DESCR
	210-0069-00			4	WASHER,LOCK:#8 SPLIT,0.04 THK STL	86928	ORDER BY DESCR
					(END ATTACHING PARTS)		
-160	348-0006-00			1	GROMMET,RUBBER:BLACK,ROUND,0.562 ID	70485	1720-26006
-161	255-0334-00			1	PLASTIC CHANNEL:12.75 X 0.175 X 0.155,NYLON	11897	122-37-2500
-162	343-0123-01			2	CLP,ELCTRN TUBE:AL,CD PL	80009	343-0123-01

Replaceable Mechanical Parts
434 (SN B500000 and up)

Fig. & Index No.	Tektronix Part No.	Serial/Assembly No. Effective Dscont	Qty	12345 Name & Description	Mfr. Code	Mfr. Part No.
1-				(ATTACHING PARTS)		
-163	211-0600-00		1	SCREW,MACHINE:6-32 X 2.000,FILH,SST	80009	211-0600-00
-164	220-0444-00		1	NUT,PLAIN,SQ:6-32 X 0.25 SQ,SST (END ATTACHING PARTS)	70318	ORDER BY DESCR
-165	343-0124-00		1	CLAMP,LOOP:1.99 ID,NYLON (ATTACHING PARTS)	80009	343-0124-00
-166	211-0599-00		2	SCREW,MACHINE:6-32 X 0.750,FILH,SST	TK0435	ORDER BY DESCR
-167	220-0444-00		2	NUT,PLAIN,SQ:6-32 X 0.25 SQ,SST (END ATTACHING PARTS)	70318	ORDER BY DESCR
-168	352-0091-01		2	RTRNR,LOOP CLAMP:CRT (ATTACHING PARTS)	80009	352-0091-01
-169	211-0590-00		4	SCREW,MACHINE:6-32 X 0.25,PNH,BRS (END ATTACHING PARTS)	TK0435	ORDER BY DESCR
-170	342-0080-00		1	INSULATOR,PLATE:CRT,MYLAR	80009	342-0080-00
-171	252-0571-00		1	NEOPRENE EXTR:CHAN,0.234 X 0.156	85471	ORDER BY DESCR
-172	386-1923-00		1	SPRT,CRT SHIELD:REAR (ATTACHING PARTS)	80009	386-1923-00
	211-0504-00		2	SCREW,MACHINE:6-32 X 0.250,PNH,STL	TK0435	ORDER BY DESCR
	210-0202-00		1	TERMINAL,LUG:0.146 ID,LOCKING,BRZ TIN PL	86928	A-373-158-2
	210-1092-00		2	WASHER,FLAT:0.147 ID X 0.312 OD X 0.028 (END ATTACHING PARTS)	86928	5714-33-32N
	119-0267-01		1	DELAY LINE,ELEC:145NS,186 OHM W/COVERS (ATTACHING PARTS)	80009	119-0267-01
-173	211-0097-00		1	SCREW,MACHINE:4-40 X 0.312,PNH,STL (END ATTACHING PARTS)	TK0435	ORDER BY DESCR
				DELAY LINE ASSY INCLUDES:		
-174	200-1181-00		2	.COVER HALF,DL: (ATTACHING PARTS)	80009	200-1181-00
-175	211-0097-00		3	.SCREW,MACHINE:4-40 X 0.312,PNH,STL	TK0435	ORDER BY DESCR
-176	210-0551-00		3	.NUT,PLAIN,HEX:4-40 X 0.25,ST CD PL (END ATTACHING PARTS)	TK0435	ORDER BY DESCR
-177	-----		1	.DELAY LINE,ELEC:(SEE DL500 REPL)		
	198-0677-00		1	.WIRE SET,ELEC:	80009	198-0677-00
-178	352-0198-00		2	..HLDR,TERM CONN:2 WIRE,BLACK	80009	352-0198-00
-179	352-0200-00		1	..HLDR,TERM CONN:4 WIRE,BLACK	80009	352-0200-00
-180	131-0621-00		4	..CONN,TERM:22-26 AWG,BRS,CU BE GLD PL	22526	46231-000
	131-0622-00		4	..CONTACT,ELEC:28-32 AWG,BRS & CU BE GLD PL	22526	46241-000
-181	348-0003-00		1	..GROMMET,RUBBER:BLACK,ROUND,0.219 ID	70485	141186040
-182	337-1383-00		1	SHIELD,CRT:	80009	337-1383-00
	361-0367-00		1	SPACER,CRT:0.062 X 4.78 X 3.89,BLK ABS	80009	361-0367-00

For Service Manuals Contact
MAURITRON TECHNICAL SERVICES
8 Cherry Tree Rd, Chinnor
Oxon OX9 4QY
Tel: 01844-351694 Fax: 01844-352554
Email: enquiries@mauritron.co.uk

Replaceable Mechanical Parts
434 (SN B500000 and up)

Fig. & Index No.	Tektronix Part No.	Serial/Assembly No.		Qty	12345 Name & Description	Mfr.	
		Effective	Dscont			Code	Mfr. Part No.
2-1	386-1922-01			1	PANEL, REAR: (ATTACHING PARTS)	80009	386-1922-01
-2	211-0007-00			7	SCREW, MACHINE: 4-40 X 0.188, PNH, STL (END ATTACHING PARTS)	TK0435	ORDER BY DESCR
-3	352-0014-00	B500000	B540945	1	FUHLR, EXTR POST: 3AG, 15A, 250A, PNL MT	75915	342001
	204-0832-00	B540946		1	BODY, FUSEHOLDER: 3AG & 5 X 20MM FUSES (ATTACHING PARTS)	TK0861	031 1673
-4	210-0873-00	B500000	B540945	2	WASHER, FLAT: 0.5 ID X 0.688 OD X 0.047, RBR	70485	ORDER BY DESCR
	210-1356-00	B540946		1	WASHER, FLAT: 1.0 X 0.8, 0.5 ID, DD HOLE	80009	210-1356-00
	200-2264-00	B540946		1	CAP, FUSEHOLDER: 3AG FUSES (STANDARD ONLY)	S3629	FEK 031 1666
	200-2265-00			1	CAP, FUSEHOLDER: 5 X 20MM FUSES (OPTIONS A1, A2, A3 & A4 ONLY) (END ATTACHING PARTS)	TK0861	FEK 031.1663
	159-0172-00			1	FUSE, CARTRIDGE: TYPE C, 13AMP (OPTION A2 ONLY)	S3629	PCC-1089
-5	161-0033-06			1	CABLE ASSY, PWR, : 3, 18 AWG, 125V, 72.0 L	80009	161-0033-06
	161-0033-55			1	CABLE ASSY, PWR, : 3, 18 AWG, 125V, 72.0 L (OPTION A1 ONLY, UNIVERSAL EUROPEAN)	80009	161-0033-55
	161-0033-56			1	CABLE ASSY, PWR, : 3, 18 AWG, 125V, 72.0 L (OPTION A2 ONLY, UNITED KINGDOM)	80009	161-0033-56
	161-0033-57			1	CABLE ASSY, PWR, : 3, 18 AWG, 125V, 72.0 L (OPTION A3 ONLY, AUSTRALIAN)	80009	161-0033-57
	161-0033-58			1	CABLE ASSY, PWR, : 3, 18 AWG, 125V, 72.0 L (OPTION A4 ONLY, NORTH AMERICAN) (ATTACHING PARTS)	80009	161-0033-58
-6	210-0413-00			1	NUT, PLAIN, HEX: 0.375-32 X 0.5, BRS CD PL	73743	3145-402
-7	210-0012-00			1	WASHER, LOCK: 0.384 ID, INTL, 0.022 THK, STL (END ATTACHING PARTS)	09772	ORDER BY DESCR
-8	-----			1	SW, THERMOSTATIC: (SEE S1802 REPL) (ATTACHING PARTS)		
-9	211-0007-00			2	SCREW, MACHINE: 4-40 X 0.188, PNH, STL (END ATTACHING PARTS)	TK0435	ORDER BY DESCR
	-----			1	FLTR, LINE ASSY: (SEE A13 REPL) (ATTACHING PARTS)		
-10	211-0007-00			2	SCREW, MACHINE: 4-40 X 0.188, PNH, STL (END ATTACHING PARTS)	TK0435	ORDER BY DESCR
-11	388-4240-00			1	LINE FILTER ASSY INCLUDES: .CIRCUIT BOARD: LINE FILTER (ATTACHING PARTS)	80009	388-4240-00
-12	210-0405-00	B500000	B527009	2	.NUT, PLAIN, HEX: 2-56 X 0.188, BRS CD PL	73743	12157-50
-13	210-1001-00	B500000	B527009	2	.WASHER, FLAT: 0.119 ID X 0.375 OD X 0.021	12360	ORDER BY DESCR
-14	211-0128-00	B500000	B527009	2	.SCREW, MACHINE: 2-56 X 1.375, PNH, STL	TK0858	ORDER BY DESCR
	129-0323-00	B527010		1	.SPACER, POST: 1.0 L, 4-40 EA END, AL, 0.25 HEX	80009	129-0323-00
	129-0367-00	B527010		1	.SPACER, POST: 0.345 L, 4-40 THRU, AL, 0.25 HEX	80009	129-0367-00
	211-0008-00	B527010		3	.SCREW, MACHINE: 4-40 X 0.25, PNH, STL	93907	ORDER BY DESCR
	211-0018-00	B527010		1	.SCREW, MACHINE: 4-40 X 0.875, PNH, STL	TK0435	ORDER BY DESCR
	210-1001-00	B527010		3	.WASHER, FLAT: 0.119 ID X 0.375 OD X 0.021 (END ATTACHING PARTS)	12360	ORDER BY DESCR
-15	-----			1	.COIL, RF: (SEE L1804 REPL) (ATTACHING PARTS)		
-16	213-0088-00			1	.SCREW, TPG, TF: 4-24 X 0.25, TYPE B, PNH, STL (END ATTACHING PARTS)	83385	ORDER BY DESCR
-17	-----			1	.TRANSFORMER: (SEE T1801 REPL)		
-18	210-0201-00			2	.TERMINAL, LUG: 0.12 ID, LOCKING, BRZ TIN PL (ATTACHING PARTS)	86928	A373-157-2
-19	211-0008-00			1	.SCREW, MACHINE: 4-40 X 0.25, PNH, STL	93907	ORDER BY DESCR
-20	210-0406-00			1	.NUT, PLAIN, HEX: 4-40 X 0.188, BRS CD PL (END ATTACHING PARTS)	73743	12161-50
-21	348-0031-00			2	.GROMMET, PLASTIC: 0.127 ID, GRAY ACETAL	80009	348-0031-00
-22	441-0983-00			1	.CHASSIS, SCOPE: W/SHIELD	80009	441-0983-00
-23	131-0955-00			3	CONN, RCPT, ELEC: BNC, FEMALE (ATTACHING PARTS)	13511	31-279
-24	210-0255-00			3	TERMINAL, LUG: 0.391 ID, LOCKING, BRS CD PL (END ATTACHING PARTS)	12327	ORDER BY DESCR
-25	-----			2	RES. , VAR: ASTIG, TRACE ROT (SEE R80, R85 REPL) (ATTACHING PARTS)		
-26	358-0251-00			2	BUSHING, VAR RES: 0.25-32 X 0.424 L, BRS NP	80009	358-0251-00

Replaceable Mechanical Parts
434 (SN B500000 and up)

Fig. & Index No.	Tektronix Part No.	Serial/Assembly No.		Qty	12345 Name & Description	Mfr.	
		Effective	Discort			Code	Mfr. Part No.
2-27	210-0046-00			2	WASHER, LOCK: 0.261 ID, INTL, 0.018 THK, STL (END ATTACHING PARTS)	77900	1214-05-00-0541C
-28	200-0103-00			1	NUT, PLAIN, KNURL: 0.25-28 X 0.375"OD BRASS	80009	200-0103-00
-29	355-0507-00			1	STUD, SHOULDERED: BINDING POST, BRS NP (ATTACHING PARTS)	80009	355-0507-00
-30	210-0455-00	B529690		1	NUT, PLAIN, HEX: 0.25-28 X 0.375, BRS NP	73743	3089-402
-31	210-0046-00			1	WASHER, LOCK: 0.261 ID, INTL, 0.018 THK, STL (END ATTACHING PARTS)	77900	1214-05-00-0541C
-32	-----			1	SWITCH, SLIDE: DPDT, 3A, 125V (SEE S1803 REPL) (ATTACHING PARTS)		
-33	211-0101-00			2	SCREW, MACHINE: 4-40 X 0.25, FLH, 100 DEG, STL (END ATTACHING PARTS)	TK0435	ORDER BY DESCR
-34	334-1904-00			1	MARKER, IDENT: MKD TEKTRONIX, INC, BVTN, OR	22670	ORDER BY DESCR
	386-1927-02			1	PANEL, REAR: TOP (ATTACHING PARTS)	TK1684	
-35	211-0007-00			6	SCREW, MACHINE: 4-40 X 0.188, PNH, STL (END ATTACHING PARTS)	TK0435	ORDER BY DESCR
-36	337-2178-00			1	SHIELD, ELEC: POWER SUPPLY, OUTER (ATTACHING PARTS)	80009	337-2178-00
-37	211-0007-00			4	SCREW, MACHINE: 4-40 X 0.188, PNH, STL (END ATTACHING PARTS)	TK0435	ORDER BY DESCR
-38	-----			1	CKT BOARD ASSY: SECNDRY PWR SPLY (SEE A10REPL) (ATTACHING PARTS)		
-39	211-0008-00	B500000	B515739	4	SCREW, MACHINE: 4-40 X 0.25, PNH, STL	93907	ORDER BY DESCR
	211-0116-00	B515740	B540659	4	SCR, ASSEM WSHR: 4-40 X 0.312, PNH, BRS, NP, POZ	77900	ORDER BY DESCR
	211-0292-00	B540660		4	SCR, ASSEM WSHR: 4-40 X 0.29, PNH, BRS NI PL (END ATTACHING PARTS)	78189	51-040445-01
-40	131-0589-00			5	CKT BOARD ASSY INCLUDES: . TERMINAL, PIN: 0.46 L X 0.025 SQ PH BRZ	22526	48283-029
-41	131-0608-00			25	. TERMINAL, PIN: 0.365 L X 0.025 BRZ GLD PL	22526	48283-036
-42	136-0220-00			2	. SKT, PL-IN ELEK: TRANSISTOR 3 CONTACT	71785	133-23-11-034
-43	136-0260-02	B500000	B542069	1	. SKT, PL-IN ELEK: MICROCIRCUIT, 16 DIP	09922	D1LB16P-108T
	136-0729-00	B542070		1	. SKT, PL-IN ELEK: MICROCKT, 16 CONTACT	09922	D1LB16P-108T
-44	214-0579-00			4	. TERM, TEST POINT: BRS CD PL	80009	214-0579-00
-45	-----			1	. TRANSFORMER: (SEE T1860 REPL) (ATTACHING PARTS)		
-46	211-0008-00			4	. SCREW, MACHINE: 4-40 X 0.25, PNH, STL	93907	ORDER BY DESCR
-47	210-0054-00			4	. WASHER, LOCK: #4 SPLIT, 0.025 THK STL (END ATTACHING PARTS)	78189	ORDER BY DESCR
-48	131-0621-00			8	. CONN, TERM: 22-26 AWG, BRS, CU BE GLD PL	22526	46231-000
	131-0792-00			1	. CONNECTOR, TERM: 18-20 AWG, CU BE GOLD PL	22526	46221
-49	352-0197-00			1	. HLD, TERM CONN: 1 WIRE, BLACK	80009	352-0197-00
-50	352-0198-00			2	. HLD, TERM CONN: 2 WIRE, BLACK	80009	352-0198-00
	352-0199-00			1	. HLD, TERM CONN: 3 WIRE, BLACK	80009	352-0199-00
-51	-----			1	SWITCH, TGLE: DPDT, 5A, 125VAC (SEE S1801 REPL) (ATTACHING PARTS)		
-52	210-0551-00			1	NUT, PLAIN, HEX: 4-40 X 0.25, ST CD PL (END ATTACHING PARTS)	TK0435	ORDER BY DESCR
-53	337-2177-00			1	SHIELD, ELEC: POWER SUPPLY, INNER (ATTACHING PARTS)	80009	337-2177-00
-54	211-0038-00			3	SCREW, MACHINE: 4-40 X 0.312, FLH, 100 DEG, STL (END ATTACHING PARTS)	TK0435	ORDER BY DESCR
-55	-----			1	CKT BOARD ASSY: PRIMARY PWR SPLY (SEE A9 REPL) (ATTACHING PARTS)		
-56	211-0008-00	B500000	B515739	3	SCREW, MACHINE: 4-40 X 0.25, PNH, STL	93907	ORDER BY DESCR
	211-0116-00	B515740	B540659	3	SCR, ASSEM WSHR: 4-40 X 0.312, PNH, BRS, NP, POZ	77900	ORDER BY DESCR
	211-0292-00	B540660		4	SCR, ASSEM WSHR: 4-40 X 0.29, PNH, BRS NI PL	78189	51-040445-01
-57	211-0510-00			4	SCREW, MACHINE: 6-32 X 0.375, PNH, STL (END ATTACHING PARTS)	83385	ORDER BY DESCR
-58	131-0589-00			10	CKT BOARD ASSY INCLUDES: . TERMINAL, PIN: 0.46 L X 0.025 SQ PH BRZ	22526	48283-029
-59	131-0590-00			2	. TERMINAL, PIN: 0.71 L X 0.025 SQ PH BRZ	22526	47331
-60	136-0183-00			1	. SKT, PL-IN ELEK: TRANSISTOR, 3 CONTACT	80009	136-0183-00
-61	136-0220-00			1	. SKT, PL-IN ELEK: TRANSISTOR 3 CONTACT	71785	133-23-11-034
-62	136-0254-00			4	. SOCKET, PIN TERM: U/W 0.031 TO 0.04 DIA PINS	00779	1-331892-5
-63	214-0579-00			3	. TERM, TEST POINT: BRS CD PL	80009	214-0579-00
-64	131-0373-00			1	. TERMINAL, STUD: 0.593 L (ATTACHING PARTS)	88245	MTS-7

Fig. & Index No.	Tektronix Part No.	Serial/Assembly No. Effective Dscnt	Qty	12345	Name & Description	Mfr. Code	Mfr. Part No.
2-65	210-0405-00		1		.NUT, PLAIN, HEX: 2-56 X 0.188, BRS CD PL	73743	12157-50
-66	210-0054-00		1		.WASHER, LOCK: #4 SPLIT, 0.025 THK STL .(END ATTACHING PARTS)	78189	ORDER BY DESCR
-67	-----		2		.TRANSISTORS: (SEE Q1843, Q1844 REPL) .(ATTACHING PARTS)		
-68	355-0518-02		4		.STUD, PRESSMOUNT: 4-40 X 0.625, BRASS	80009	355-0518-02
-69	210-0586-00		4		.NUT, PL, ASSEM WA: 4-40 X 0.25, STL CD PL .(END ATTACHING PARTS)	78189	211-041800-00
-70	214-1581-00		2		.HEAT SINK, XSTR: TO-3, ALUMINA	80009	214-1581-00
-71	129-0080-00		3		.SPACER, POST: 0.875 L, 4-40, NYLON .(ATTACHING PARTS)	80009	129-0080-00
-72	211-0008-00		3		.SCREW, MACHINE: 4-40 X 0.25, PNH, STL	93907	ORDER BY DESCR
-73	210-0004-00		3		.WASHER, LOCK: #4 INTL, 0.015 THK, STL .(END ATTACHING PARTS)	77900	1204-00-00-0541C
-74	-----		2		.CAPACITORS: (SEE C1822, C1823 REPL) .(ATTACHING PARTS)		
-75	212-0507-00		4		.SCREW, MACHINE: 10-32 X 0.375, PNH, STL	TK0435	ORDER BY DESCR
-76	210-0009-00		4		.WASHER, LOCK: #10 EXT, 0.022 THK, STL	78189	1110-00
-77	210-0805-00		8		.WASHER, FLAT: 0.204 ID X 0.438 OD X 0.032, STL .(END ATTACHING PARTS)	12327	ORDER BY DESCR
-78	-----		1		.COIL, RF: (SEE L1835 REPL) .(ATTACHING PARTS)		
-79	211-0008-00		2		.SCREW, MACHINE: 4-40 X 0.25, PNH, STL	93907	ORDER BY DESCR
-80	210-0004-00		2		.WASHER, LOCK: #4 INTL, 0.015 THK, STL .(END ATTACHING PARTS)	77900	1204-00-00-0541C
-81	346-0032-00		3		.STRAP, RETAINING: 0.075 DIA X 4.0 L, MLD RBR	98159	2829-75-4
-82	348-0005-00		1		.GROMMET, RUBBER: BLACK, ROUND, 0.375 ID	70485	230X-36017
	210-1011-00	B528500	1		.WASHER, FLAT: 0.13 ID X 0.375 OD X 0.01, NYLON	83309	ORDER BY DESCR
-83	-----		1		.CKT BOARD ASSY: FAN MULTPLR (SEE A11 REPL) .(ATTACHING PARTS)		
-84	211-0008-00		4		.SCREW, MACHINE: 4-40 X 0.25, PNH, STL	93907	ORDER BY DESCR
-85	129-0551-00		1		.SPACER, POST: 1.58 L, W/4-40, STL, 0.25 HEX	80009	129-0551-00
-86	210-0004-00		1		.WASHER, LOCK: #4 INTL, 0.015 THK, STL	77900	1204-00-00-0541C
-87	210-0994-00		1		.WASHER, FLAT: 0.125 ID X 0.25 OD X 0.022, STL .(END ATTACHING PARTS) CKT BOARD ASSY INCLUDES:	86928	A371-283-20
-88	131-0589-00		12		.TERMINAL, PIN: 0.46 L X 0.025 SQ PH BRZ	22526	48283-029
-89	136-0220-00		1		.SKT, PL-IN ELEK: TRANSISTOR 3 CONTACT	71785	133-23-11-034
-90	136-0269-02	B500000	1	B542069	.SKT, PL-IN ELEK: MICROCIRCUIT, 14 DIP	09922	DILB14P-108T
-91	388-2667-00		1		.CIRCUIT BOARD: MOTOR INTERCONNECT	80009	388-2667-00
-92	369-0042-00		1		.IMPLR, FAN, AXIAL: 2.062 DIA, CCW, 0.080 ID, PLSTC	52792	2062CCW079BRH
-93	147-0035-00		1		.MOTOR, DC: BRUSHLESS, 3000 RPM, 10-15V .(ATTACHING PARTS)	25088	1AD3001-0A
-94	211-0097-00		4		.SCREW, MACHINE: 4-40 X 0.312, PNH, STL	TK0435	ORDER BY DESCR
-95	210-0004-00		4		.WASHER, LOCK: #4 INTL, 0.015 THK, STL	77900	1204-00-00-0541C
-96	210-0406-00		4		.NUT, PLAIN, HEX: 4-40 X 0.188, BRS CD PL	73743	12161-50
-97	426-0781-00		2		.MOUNT, FAN MOTOR: .(END ATTACHING PARTS)	80009	426-0781-00
-98	361-0008-00		1		.SPACER, SLEEVE: 0.28 L X 0.111 ID, PP	80009	361-0008-00
-99	361-0009-00	B500000	2	B529999	.SPACER, SLEEVE: 0.406 L X 0.111 ID, PP	80009	361-0009-00
-100	361-0392-00	B500000	2	B529999	.SPACER, SLEEVE: 0.593 L X 0.125 ID, PP	80009	361-0392-00
	334-3379-00	B528900	1		.MARKER, IDENT: MARKED GROUND SYMBOL	07416	ORDER BY DESCR
-101	426-1237-01		1		.FRAME SECT, CAB.: REAR .(ATTACHING PARTS)	80009	426-1237-01
-102	212-0023-00		1		.SCREW, MACHINE: 8-32 X 0.375, PNH, STL	TK0435	ORDER BY DESCR
-103	212-0040-00		2		.SCREW, MACHINE: 8-32 X 0.375, FLH, 100 DEG, STL .(END ATTACHING PARTS)	83486	ORDER BY DESCR
-104	220-0547-01		1		.NUT BLOCK: 4-40 X 0.282, NI SIL NP .(ATTACHING PARTS)	80009	220-0547-01
-105	211-0007-00		1		.SCREW, MACHINE: 4-40 X 0.188, PNH, STL .(END ATTACHING PARTS)	TK0435	ORDER BY DESCR
-106	407-1643-00		1		.BRKT, POWER SPLY: REAR, ALUMINUM .(ATTACHING PARTS)	80009	407-1643-00
-107	211-0007-00		2		.SCREW, MACHINE: 4-40 X 0.188, PNH, STL .(END ATTACHING PARTS)	TK0435	ORDER BY DESCR
-108	220-0595-00		3		.NUT BLOCK: 0.984 L X 0.375 W X 0.373 DIA .(ATTACHING PARTS)	80009	220-0595-00
-109	211-0507-00		3		.SCREW, MACHINE: 6-32 X 0.312, PNH, STL	83385	ORDER BY DESCR

Replaceable Mechanical Parts
434 (SN B500000 and up)

Fig. & Index No.	Tektronix Part No.	Serial/Assembly No.		Qty	12345 Name & Description	Mfr.	
		Effective	Dscont			Code	Mfr. Part No.
-110	220-0444-00			3	NUT, PLAIN, SQ: 6-32 X 0.25 SQ, SST (END ATTACHING PARTS)	70318	ORDER BY DESCR
-111	407-1645-00			1	BRACKET, HEAT SK: ALUMINUM (ATTACHING PARTS)	80009	407-1645-00
-112	210-0457-00			2	NUT, PL, ASSEM WA: 6-32 X 0.312, STL CD PL (END ATTACHING PARTS)	78189	511-061800-00
-113	348-0031-00			1	GROMMET, PLASTIC: 0.127 ID, GRAY ACETAL	80009	348-0031-00
-114	386-3334-00			1	PLATE, SUPPORT: EXTENSION SHAFT (ATTACHING PARTS)	80009	386-3334-00
-115	211-0097-00			2	SCREW, MACHINE: 4-40 X 0.312, PNH, STL	TK0435	ORDER BY DESCR
-116	210-0004-00			2	WASHER, LOCK: #4 INTL, 0.015 THK, STL (END ATTACHING PARTS)	77900	1204-00-00-0541C
-117	407-1642-00			1	BRKT, POWER SPLY: FRONT, ALUMINUM (ATTACHING PARTS)	80009	407-1642-00
-118	213-0146-00			4	SCREW, TPG, TF: 6-20 X 0.312, TYPE B, PNH, STL	83385	ORDER BY DESCR
	213-0124-00			1	SCREW, TPG, TF: 6-20 X 0.25, TYPE AB, PNH, STL (END ATTACHING PARTS)	TK0435	ORDER BY DESCR
-119	348-0055-00			2	GROMMET, PLASTIC: GRAY, ROUND, 0.207 ID	80009	348-0055-00
-120	358-0215-00			2	GROMMET, PLASTIC: BLACK, U-SHAPED, 0.524 ID	80009	358-0215-00
-121	343-0089-00			2	CLAMP, CABLE: 0.3 DIA, PLASTIC	80009	343-0089-00
-122	-----			2	TRANSISTORS: (SEE Q530, Q580 REPL) (ATTACHING PARTS)		
-123	211-0012-00			4	SCREW, MACHINE: 4-40 X 0.375, PNH, STL	TK0435	ORDER BY DESCR
-124	210-0406-00			4	NUT, PLAIN, HEX: 4-40 X 0.188, BRS CD PL	73743	12161-50
-125	210-0599-00			4	NUT, SLEEVE: 4-40 X 0.219 OD X 0.599 L BRS	80009	210-0599-00
-126	214-0368-00			2	SPRING, HLCP: 0.24 X 0.438, OPEN ENDS, SST	91260	ORDER BY DESCR
-127	343-0097-00			2	RETAINER, XSTR: HEAT SINK, NYLON	80009	343-0097-00
-128	210-0627-00			2	RIVET, SOLID: 0.25 L X 0.042 OD, SHLDR, BRS	80009	210-0627-00
-129	352-0262-00			2	RETAINER, XSTR: HEAT SINK, TO-5, GRAY NYLON	80009	352-0262-00
-130	214-1138-00			2	HEAT SINK, XSTR: 0.2 X 1.0 X 0.06, ALUMINA	80009	214-1138-00
-131	210-0201-00	B500000	B528209	2	TERMINAL, LUG: 0.12 ID, LOCKING, BRZ TIN PL	86928	A373-157-2
	210-0202-00	B528210		2	TERMINAL, LUG: 0.146 ID, LOCKING, BRZ TIN PL	86928	A-373-158-2
	210-0407-00	B528210		2	NUT, PLAIN, HEX: 6-32 X 0.25, BRS CD PL (END ATTACHING PARTS)	73743	3038-402
-132	-----			2	COIL, RF: CHAS MTG (SEE L533, L584 REPL) (ATTACHING PARTS)		
-133	211-0504-00			1	SCREW, MACHINE: 6-32 X 0.250, PNH, STL (END ATTACHING PARTS)	TK0435	ORDER BY DESCR
-134	407-1644-00			1	BRACKET, COIL: ALUMINUM (ATTACHING PARTS)	80009	407-1644-00
-135	213-0088-00			2	SCREW, TPG, TF: 4-24 X 0.25, TYPE B, PNH, STL (END ATTACHING PARTS)	83385	ORDER BY DESCR
-136	124-0118-00			3	TERMINAL BOARD: 1 NOTCH, CERAMIC, CLIP MTD (ATTACHING PARTS)	80009	124-0118-00
-137	361-0007-00			3	SPACER, SLEEVE: 0.188 L X 0.111 ID, POLTHN (END ATTACHING PARTS)	80009	361-0007-00
-138	124-0158-00			1	TERMINAL BOARD: 7 NOTCH, CERAMIC, STUD MTD (ATTACHING PARTS)	80009	124-0158-00
-139	361-0007-00			2	SPACER, SLEEVE: 0.188 L X 0.111 ID, POLTHN (END ATTACHING PARTS)	80009	361-0007-00
-140	210-0201-00			1	TERMINAL, LUG: 0.12 ID, LOCKING, BRZ TIN PL (ATTACHING PARTS)	86928	A373-157-2
-141	213-0088-00			1	SCREW, TPG, TF: 4-24 X 0.25, TYPE B, PNH, STL (END ATTACHING PARTS)	83385	ORDER BY DESCR
-142	384-1342-00			1	EXTENSION SHAFT: 9.4 L X 0.125 OD, SST	80009	384-1342-00
-143	376-0118-00			1	CPLG, EXT SHAFT: 0.806 X 0.312, SST (ATTACHING PARTS)	80009	376-0118-00
-144	210-0449-00			2	NUT, PLAIN, HEX: 5-40 X 0.25, BRS CD PL (END ATTACHING PARTS)	73743	3030-402
-145	384-1053-00			1	EXTENSION SHAFT: 2.741 L X 0.125 OD, SST, GRV	80009	384-1053-00
-146	376-0092-01			1	CPLG HALF, SHAFT: 0.125 ID, DELRIN	80009	376-0092-01
	213-0076-00			2	.SETScrew: 2-56 X 0.125, STL	74445	ORDER BY DESCR
-147	376-0092-03			1	CPLG HALF, SHAFT: 0.125 ID, BLACK POLYAMIDE	80009	376-0092-03
	213-0076-00			2	.SETScrew: 2-56 X 0.125, STL	74445	ORDER BY DESCR
-148	200-0608-00			1	SHIELD, RESISTOR: 0.7 X 1.0 X 0.75, VAR	80009	200-0608-00
-149	-----			1	RES., VAR: INTENSITY (SEE R821, B REPL) (ATTACHING PARTS)		
-150	210-0046-00			1	WASHER, LOCK: 0.261 ID, INTL, 0.018 THK, STL	77900	1214-05-00-0541C

Replaceable Mechanical Parts
434 (SN B500000 and up)

Fig. & Index No.	Tektronix Part No.	Serial/Assembly No.		Qty	12345 Name & Description	Mfr.	
		Effective	Dscont			Code	Mfr. Part No.
2-151	210-0562-00			1	NUT, PLAIN, HEX: 0.25-40 X 0.312 BRS CD PL (END ATTACHING PARTS)	73743	20224-402
-152	348-0031-00			1	GROMMET, PLASTIC: 0.127 ID, GRAY ACETAL	80009	348-0031-00
-153	407-0888-00			1	BRACKET, ANGLE: VAR RESISTOR, ALUMINUM (ATTACHING PARTS)	80009	407-0888-00
-154	210-0457-00			2	NUT, PL, ASSEM WA: 6-32 X 0.312, STL CD PL (END ATTACHING PARTS)	78189	511-061800-00
-155	384-1034-00			1	EXTENSION SHAFT: 3.14 L X 0.125 OD AL	80009	384-1034-00
-156	376-0029-00			1	CPLG, SHAFT, RGD: 0.128 ID X 0.312 OD, AL	80009	376-0029-00
	213-0075-00			2	.SETSCREW: 4-40 X 0.094, STL	74445	ORDER BY DESCR
-157	200-0799-00			1	SHIELD, ELEC: RESISTOR	TK1319	N/A
-158	-----			1	RES., VAR: FOCUS (SEE R86 REPL) (ATTACHING PARTS)		
-159	210-0583-00			1	NUT, PLAIN, HEX: 0.25-32 X 0.312, BRS CD PL	73743	2X-20319-402
-160	210-0046-00			2	WASHER, LOCK: 0.261 ID, INTL, 0.018 THK, STL (END ATTACHING PARTS)	77900	1214-05-00-0541C
-161	407-1271-00			1	BRACKET, ANGLE: FOCUS	80009	407-1271-00
-162	220-0595-00			2	NUT BLOCK: 0.984 L X 0.375 W X 0.373 DIA (ATTACHING PARTS)	80009	220-0595-00
-163	211-0538-00			2	SCREW, MACHINE: 6-32 X 0.312, FLH, 100 DEG, STL	93907	ORDER BY DESCR
-164	220-0444-00			2	NUT, PLAIN, SQ: 6-32 X 0.25 SQ, SST (END ATTACHING PARTS)	70318	ORDER BY DESCR
-165	210-0288-00			1	TERM, LUG: 0.125 ID, PLAIN, CU BE, CU-SN-ZN PL (ATTACHING PARTS)	80009	210-0288-00
-166	211-0007-00			1	SCREW, MACHINE: 4-40 X 0.188, PNH, STL	TK0435	ORDER BY DESCR
-167	210-0586-00			1	NUT, PL, ASSEM WA: 4-40 X 0.25, STL CD PL (END ATTACHING PARTS)	78189	211-041800-00
-168	384-1051-00			2	EXTENSION SHAFT: 3.95 L X 0.125 OD, SST	80009	384-1051-00
-169	376-0029-00			2	CPLG, SHAFT, RGD: 0.128 ID X 0.312 OD, AL	80009	376-0029-00
	213-0075-00			2	.SETSCREW: 4-40 X 0.094, STL	74445	ORDER BY DESCR
-170	384-1052-00	B500000	B540779	1	EXTENSION SHAFT: 8.15 L X 0.081 OD, SST	80009	384-1052-00
	384-1052-01	B540780		1	EXTENSION SHAFT: 8.15 L X 0.081 OD, SST	80009	384-1052-01
-171	384-1066-00	B500000	B540779	1	EXTENSION SHAFT: 6.1 L X 0.081 OD, SST	80009	384-1066-00
	384-1066-01	B540780		1	EXTENSION SHAFT: 6.1 L X 0.081 OD, SST	80009	384-1066-01
-172	376-0114-00	B500000	B542779	2	COUPLING, SWITCH: PUSH BUTTON, BLACK DELRIN	80009	376-0114-00
	376-0114-01	B542780		2	COUPLING, SWITCH: PUSH BUTTON, BLACK DELRIN	80009	376-0114-01
	213-0140-00	B500000	B542779	2	.SETSCREW: 2-56 X 0.094, STL	TK0433	ORDER BY DESCR
	213-0075-00	B542780		2	SETSCREW: 4-40 X 0.094, STL	74445	ORDER BY DESCR
-173	210-0201-00			1	TERMINAL, LUG: 0.12 ID, LOCKING, BRZ TIN PL (ATTACHING PARTS)	86928	A373-157-2
-174	211-0007-00			1	SCREW, MACHINE: 4-40 X 0.188, PNH, STL	TK0435	ORDER BY DESCR
-175	210-0586-00			1	NUT, PL, ASSEM WA: 4-40 X 0.25, STL CD PL (END ATTACHING PARTS)	78189	211-041800-00
-176	337-1452-00			1	SHIELD, ELEC: INPUT AMP CKT BD	80009	337-1452-00
	672-0019-01			1	CIRCUIT BD ASSY: ATTENUATOR (ATTACHING PARTS)	80009	672-0019-01
-177	211-0116-00	B500000	B540659	5	SCR, ASSEM WSHR: 4-40 X 0.312, PNH, BRS, NP, POZ	77900	ORDER BY DESCR
	211-0292-00	B540660		5	SCR, ASSEM WSHR: 4-40 X 0.29, PNH, BRS NI PL (END ATTACHING PARTS)	78189	51-040445-01
-178	-----			1	ATTENUATOR ASSY INCLUDES: .CKT BOARD ASSY: INPUT AMPL (SEE A1 REPL) (ATTACHING PARTS)		
-179	211-0116-00	B500000	B540659	2	.SCR, ASSEM WSHR: 4-40 X 0.312, PNH, BRS, NP, POZ	77900	ORDER BY DESCR
	211-0292-00	B540660		2	.SCR, ASSEM WSHR: 4-40 X 0.29, PNH, BRS NI PL (END ATTACHING PARTS)	78189	51-040445-01
-180	131-0589-00			8	..CTK BOARD ASSY INCLUDES: .TERMINAL, PIN: 0.46 L X 0.025 SQ PH BRZ	22526	48283-029
-181	136-0252-04			18	..SOCKET, PIN TERM: U/W 0.016-0.018 DIA PINS	22526	75060-007
-182	136-0263-03	B500000	B514707	2	..SOCKET, PIN TERM: U/W 0.025 SQ PINS	00779	85864-2
	136-0263-04	B514708		2	..SOCKET, PIN TERM: U/W 0.025 SQ PIN	22526	75377-001
-183	337-1415-00			1	..SHIELD, ELEC: CKT BD	80009	337-1415-00
-184	200-1199-01			2	.COV, ATTN CHAS: (ATTACHING PARTS)	80009	200-1199-01
-185	211-0007-00			8	.SCREW, MACHINE: 4-40 X 0.188, PNH, STL	TK0435	ORDER BY DESCR
-186	210-0994-00			8	.WASHER, FLAT: 0.125 ID X 0.25 OD X 0.022, STL	86928	A371-283-20
	210-0261-00	B528510		2	.TERMINAL, LUG: 0.14 ID, PLAIN, BRASS (END ATTACHING PARTS)	91260	ORDER BY DESCR
-187	-----			2	.CKT BRD ASSY: ATTN (SEE CH1-A4, CH2-A5 REPL)		

Replaceable Mechanical Parts
434 (SN B500000 and up)

Fig. & Index No.	Tektronix Part No.	Serial/Assembly No. Effective Dscnt		Qty	12345 Name & Description	Mfr. Code	Mfr. Part No.
2-					..(ATTACHING PARTS)		
-188	129-0299-00			8	..SPACER, POST:0.333 L, 0.188 HEX, BRS	80009	129-0299-00
-189	210-0004-00			8	..WASHER, LOCK:#4 INTL, 0.015 THK, STL ..(END ATTACHING PARTS)	77900	1204-00-00-0541C
-190	441-0984-03			1	..EACH CKT BOARD ASSY INCLUDES: ..CHASSIS, SCOPE:ATTENUATOR ..(ATTACHING PARTS)	80009	441-0984-03
-191	211-0001-00			3	..SCREW, MACHINE:2-56 X 0.25, PNH, STL	TK0435	ORDER BY DESCR
-192	210-0053-00			3	..WASHER, LOCK:#2 SPLIT, 0.02 THK STL	78189	ORDER BY DESCR
-193	210-1134-00			3	..WASHER, FLAT:0.09 ID X 0.25 OD X 0.02, BRS	12327	ORDER BY DESCR
	210-0405-00			3	..NUT, PLAIN, HEX:2-56 X 0.188, BRS CD PL ..(END ATTACHING PARTS)	73743	12157-50
-194	136-0252-01			8	..SOCKET, PIN TERM:U/W 0.0.19 DIA PINS	00779	1-332095-2
-195	131-1031-00			8	..CONT ASSY, ELEC:CAM SWITCH, TOP	80009	131-1031-00
-196	131-1030-00			8	..CONT ASSY, ELEC:CAM SWITCH, BOTTOM ..(ATTACHING PARTS)	80009	131-1030-00
-197	210-0779-00			8	..RIVET, TUBULAR:0.115 X 0.05, DBL END, CU NKL ..(END ATTACHING PARTS)	42838	RA-29952715
-198	131-0590-00			1	..TERMINAL, PIN:0.71 L X 0.025 SQ PH BRZ	22526	47331
-199	337-1406-00			1	..SHIELD, ELEC:CAM CONT	80009	337-1406-00
-200	384-1056-00			2	..EXTENSION SHAFT:6.58 L X 0.123 OD, EPOX GL	80009	384-1056-00
-201	-----			2	..RES., VAR:(SEE R245-CH1, R345-CH2 REPL) ..(ATTACHING PARTS)		
-202	211-0062-00			4	..SCREW, MACHINE:2-56 X 0.312, PNH, STL	06950	ORDER BY DESCR
-203	210-0001-00			4	..WASHER, LOCK:#2 INTL, 0.013 THK, STL	77900	1202-00-00-0541C
-204	210-0405-00			4	..NUT, PLAIN, HEX:2-56 X 0.188, BRS CD PL ..(END ATTACHING PARTS)	73743	12157-50
-205	407-0900-00			2	..BRACKET, VAR RES:POLYAMIDE ..(ATTACHING PARTS)	80009	407-0900-00
-206	211-0022-00			4	..SCREW, MACHINE:2-56 X 0.188, PNH, STL	TK0435	ORDER BY DESCR
-207	210-0001-00			4	..WASHER, LOCK:#2 INTL, 0.013 THK, STL ..(END ATTACHING PARTS)	77900	1202-00-00-0541C
	-----			2	..SW CAM ACTR AS:(SEE S100 & S200 REPL) ..(ATTACHING PARTS)		
-208	211-0116-00	B500000	B540659	8	..SCR, ASSEM WSHR:4-40 X 0.312, PNH, BRS, NP, POZ	77900	ORDER BY DESCR
	211-0292-00	B540660		8	..SCR, ASSEM WSHR:4-40 X 0.29, PNH, BRS NI PL ..(END ATTACHING PARTS)	78189	51-040445-01
-209	214-1139-02			1	..SPRING, FLAT:0.885 X 0.156 CU BE GRN CLR	80009	214-1139-02
	214-1139-03			1	..SPRING, FLAT:0.885 X 0.156 CU BE RED CLR	80009	214-1139-03
-210	214-1127-00			2	..ROLLER, DETENT:0.125 DIA X 0.125, SST	80009	214-1127-00
-211	210-0406-00			4	..NUT, PLAIN, HEX:4-40 X 0.188, BRS CD PL	73743	12161-50
-212	401-0081-00			1	..BEARING, CAM SW:FRONT 0.83 DIA CAM W/BSHG ..(ATTACHING PARTS)	80009	401-0081-00
-213	354-0391-00			1	..RING, RETAINING: BASIC EXT, U/O 0.438 DIA SFT ..(END ATTACHING PARTS)	79136	5100-43 MD
-214	105-0227-00			1	..ACTUATOR, CAM SW:ATTEN	80009	105-0227-00
-215	210-0406-00			4	..NUT, PLAIN, HEX:4-40 X 0.188, BRS CD PL	73743	12161-50
-216	401-0113-01			1	..BEARING, CAM SW:W/INSERT	80009	401-0113-01
-217	337-1418-01	B500000	B527039	4	..SHIELD, ELEC:CAM SWITCH CASTING	80009	337-1418-01
	337-1418-02	B527040		4	..SHIELD, ELEC:CIRCUIT BOARD STIFFENER ..(ATTACHING PARTS)	80009	337-1418-02
-218	211-0001-00			3	..SCREW, MACHINE:2-56 X 0.25, PNH, STL	TK0435	ORDER BY DESCR
-219	210-0053-00			3	..WASHER, LOCK:#2 SPLIT, 0.02 THK STL	78189	ORDER BY DESCR
-220	210-1008-00			3	..WASHER, FLAT:0.09 ID X 0.188 OD X 0.02, BRS ..(END ATTACHING PARTS)	12327	ORDER BY DESCR
-221	-----			1	..CKT BOARD ASSY:VERTICAL(SEE A2 REPL)		
-222	131-0566-00			2	..BUS, CONDUCTOR:DUMMY RES, 0.094 OD X 0.225 L	24546	OMA 07
-223	-----			2	..SWITCH, PUSH:(SEE S479 & S414 REPL)		
-224	361-0384-00			4	..SPACER, PB SW:0.133 L, RED POLYCARBONATE	80009	361-0384-00
-225	337-1413-00			1	..SHIELD, ELEC:VERT CKT BD	80009	337-1413-00
-226	337-1459-00			1	..SHIELD, ELEC:VERT CKT BD	80009	337-1459-00
-227	-----			2	..RES., VAR:GAIN(SEE CH1-R244, CH2-R344 REPL) ..(ATTACHING PARTS)		
-228	210-0583-00			2	..NUT, PLAIN, HEX:0.25-32 X 0.312, BRS CD PL	73743	2X-20319-402
-229	210-0046-00			2	..WASHER, LOCK:0.261 ID, INTL, 0.018 THK, STL ..(END ATTACHING PARTS)	77900	1214-05-00-0541C
	131-0621-00			4	..CONN, TERM:22-26 AWG, BRS, CU BE GLD PL	22526	46231-000

Fig. & Index No.	Tektronix Part No.	Serial/Assembly No. Effective Dscort	Qty	12345 Name & Description	Mfr. Code	Mfr. Part No.
2-230	407-0883-00		2	..BRACKET,VAR RES:ALUMINUM NI SN PL	80009	407-0883-00
-231	131-1031-00		8	..CONT ASSY,ELEC:CAM SWITCH, TOP	80009	131-1031-00
-232	210-0779-00		8	..RIVET,TUBULAR:0.115 X 0.05,DBL END,CU NKL	42838	RA-29952715
-233	131-0589-00		52	..TERMINAL,PIN:0.46 L X 0.025 SQ PH BRZ	22526	48283-029
-234	136-0252-07		40	..SOCKET,PIN CONN:W/O DIMPLE	22526	75060-012
-235	136-0220-00		25	..SKT,PL-IN ELEK:TRANSISTOR 3 CONTACT	71785	133-23-11-034
	334-3448-00	B529150	1	MARKER, IDENT:MARKED NOTICE	07416	ORDER BY DESCR
-236	426-1221-00		1	FR SECT,SCOPE:MAIN	80009	426-1221-00
-237	136-0466-01		1	SKT,PL-IN ELEK:ELCTRN TUBE,14 CONT W/LEADS	80009	136-0466-01
-238	131-0621-00		82	..CONN,TERM:22-26 AWG,BRS,CU BE GLD PL	22526	46231-000
	131-0622-00		26	..CONTACT,ELEC:28-32 AWG,BRS & CU BE GLD PL	22526	46241-000
	131-0792-00		7	..CONNECTOR,TERM:18-20 AWG,CU BE GOLD PL	22526	46221
-239	131-0707-00		67	..CONTACT,ELEC:22-26 AWG,BRS,CU BE GLD PL	22526	47439-000
-240	352-0161-00		1	..HLDR,TERM CONN:3 WIRE,BLACK	80009	352-0161-00
-241	352-0162-00		1	..HLDR,TERM CONN:4 WIRE,BLACK	80009	352-0162-00
-242	352-0163-00		5	..HLDR,TERM CONN:5 WIRE,BLACK	80009	352-0163-00
-243	352-0164-00		2	..HLDR,TERM CONN:6 WIRE,BLACK	80009	352-0164-00
-244	352-0166-00		2	..HLDR,TERM CONN:8 WIRE,BLACK	80009	352-0166-00
-245	352-0168-00		7	..HLDR,TERM CONN:10 WIRE,BLACK	80009	352-0168-00
-246	352-0169-00		3	..HLDR,TERM CONN:2 WIRE,BLACK	80009	352-0169-00
-247	352-0197-00		1	..HLDR,TERM CONN:1 WIRE,BLACK	80009	352-0197-00
-248	352-0198-00		6	..HLDR,TERM CONN:2 WIRE,BLACK	80009	352-0198-00
-249	352-0199-00		5	..HLDR,TERM CONN:3 WIRE,BLACK	80009	352-0199-00
-250	352-0200-00		3	..HLDR,TERM CONN:4 WIRE,BLACK	80009	352-0200-00
-251	352-0201-00		2	..HLDR,TERM CONN:5 WIRE,BLACK	80009	352-0201-00
-252	352-0202-00		3	..HLDR,TERM CONN:6 WIRE,BLACK	80009	352-0202-00
-253	352-0203-00		2	..HLDR,TERM CONN:7 WIRE,BLACK	80009	352-0203-00
-254	352-0204-00		2	..HLDR,TERM CONN:8 WIRE,BLACK	80009	352-0204-00
-255	352-0205-00		1	..HLDR,TERM CONN:9 WIRE,BLACK	80009	352-0205-00
-256	352-0206-00		2	..HLDR,TERM CONN:10 WIRE,BLACK	80009	352-0206-00
-257	136-0304-02		1	..SKT,PL-IN ELEK:ELECTRON TUBE,14 CONTACT	80009	136-0304-02
-258	343-0254-00		1	CLP,ELCTRN TUBE:DELTRIN	80009	343-0254-00
-259	367-0117-00		1	PULL,SOCKET:CRT,PLASTIC	80009	367-0117-00
-260	200-0917-01		1	COVER,CRT SKT:2.052 OD X 0.291 H,PLASTIC	80009	200-0917-01
	179-2314-00		1	WIRING HARNESS:SWITCH	80009	179-2314-00
	131-0621-00		5	..CONN,TERM:22-26 AWG,BRS,CU BE GLD PL	22526	46231-000
	352-0201-00		1	..HLDR,TERM CONN:5 WIRE,BLACK	80009	352-0201-00
	131-0621-00		20	CONN,TERM:22-26 AWG,BRS,CU BE GLD PL	22526	46231-000
	352-0197-00		1	HLDR,TERM CONN:1 WIRE,BLACK	80009	352-0197-00
	352-0198-00		1	HLDR,TERM CONN:2 WIRE,BLACK	80009	352-0198-00
	352-0199-00		2	HLDR,TERM CONN:3 WIRE,BLACK	80009	352-0199-00
	352-0201-00		2	HLDR,TERM CONN:5 WIRE,BLACK	80009	352-0201-00
	131-0622-00		2	CONTACT,ELEC:28-32 AWG,BRS & CU BE GLD PL	22526	46241-000
	131-0707-00		5	CONTACT,ELEC:22-26 AWG,BRS,CU BE GLD PL	22526	47439-000
	131-0792-00		2	CONNECTOR,TERM:18-20 AWG,CU BE GOLD PL	22526	46221
	131-0049-00		4	TERM,QIK DISC.:22-24 AWG,TIN PL BRS	00779	42765-1

For Service Manuals Contact
MAURITRON TECHNICAL SERVICES
8 Cherry Tree Rd, Chinnor
Oxon OX9 4QY
Tel: 01844-351694 Fax: 01844-352554
Email: enquiries@maurtron.co.uk

Replaceable Mechanical Parts
434 (SN B500000 and up)

Fig. & Index No.	Tektronix Part No.	Serial/Assembly No. Effective	Dscort	Qty	12345 Name & Description	Mfr. Code	Mfr. Part No.
3-1	200-1203-04	B500000	B528469	1	COVER,SCOPE:FRONT	80009	200-1203-04
	200-1203-00	B528470		1	COVER,SCOPE:FRONT	80009	200-1203-00
	367-0195-02			1	HANDLE,CARRYING:12.722 L,BLACK VINYL W/HDW	80009	367-0195-02
-2	200-0602-00			2	.COVER,HDL LATCH:2.12 DIA X 0.7,ACETAL	TK2165	ORDER BY DESCR
-3	334-1701-00			1	.MARKER,IDENT:MKD 434 OSCILLOSCOPE	80009	334-1701-00
-4	367-0140-03	B500000	B504594	1	.HANDLE,CARRYING:12.722 L,VINYL	80009	367-0140-03
	367-0195-00	B504595		1	.HANDLE,CARRYING:12.722 L,BLACK VINYL .(ATTACHING PARTS)	80009	367-0195-00
-5	211-0512-00	B500000	B504594	4	.SCREW,MACHINE:6-32 X 0.5,FLH,100 DEG,STL	TK0435	ORDER BY DESCR
	213-0227-00	B504595		4	.SCREW,TPG,TF:6-32 X 0.5,SPCL TYPE,FLH .(END ATTACHING PARTS)	83486	ORDER BY DESCR
-6	214-0516-00			2	.SPRING,HLCPS:0.959 OD X 1.281 L,CLE,SST	04811	ORDER BY DESCR
-7	214-0513-04	B500000	B504594	2	.INDEX,HDL RING:2.0 DIA X 0.585 THK AL,CD	80009	214-0513-04
	214-1987-00	B504595		2	.INDEX,HDL RING:	80009	214-1987-00
-8	214-0515-02			2	.HUB,HDL INDEX:1.42 DIA X 0.565 THK .(ATTACHING PARTS)	80009	214-0515-02
-9	213-0139-00			2	.SCREW,SLFLKG:10-24 X 0.375,HEX HD,STL CD PL	26233	P38AS 1024 6C
-10	210-1182-00	B500000	B540999	2	.WASHER,SPR TNSN:0.203 X 0.69 X 0.031,SST	80009	210-1182-00
	210-0805-00	B541000		2	.WASHER,FLAT:0.204 ID X 0.438 OD X 0.032,STL .(END ATTACHING PARTS)	12327	ORDER BY DESCR
-11	390-0187-02			1	CABINET,SCOPE:WRAPAROUND	80009	390-0187-02
-12	348-0080-01			4	.FOOT,CABINET:CHARCOAL GRAY,POLYURETHANE	80009	348-0080-01
	255-0427-00			1	.PLASTIC FILM:12.5 X 10.0 X 0.01,POLTEST	20428	ORDER BY DESCR
-13	352-0263-00	B500000	B541074	1	.HLDR,POUCH ASSY:TEK BLUE POLYCARBONATE	80009	352-0263-00
	352-0263-01	B541075		1	.HLDR,POUCH ASSY:TEK BLUE POLYCARBONATE	80009	352-0263-01
-14	426-0720-01			1	FRAME SECT,CAB.:REAR .(ATTACHING PARTS)	80009	426-0720-01
-15	212-0102-00			4	SCREW,EXT RLV:8-32 X 2.0,PNH,STL .(END ATTACHING PARTS)	TK0435	ORDER BY DESCR
	062-1394-00			1	MANUAL,TECH:	80009	062-1394-00
-16	348-0272-00			4	FOOT,CABINET:GRAY POLYURETHANE .(ATTACHING PARTS)	80009	348-0272-00
-17	213-0012-00			8	SCREW,TPG,TC:4-40 X 0.375,TYPE T,FLH,STL .(END ATTACHING PARTS)	83385	ORDER BY DESCR
-18	348-0277-00			1	SHLD GSKT,ELEK:MESH TYPE,0.124 OD,BULK	80009	348-0277-00
	016-0272-00			1	ADPTR,RACK MTG:REAR MOUNT	80009	016-0272-00
-19	134-0067-00			5	.BUTTON,PLUG:0.5 HOLE,GRAY PLASTIC	TK2165	134-0067-00
-20	016-0120-00			1	.HDW KIT,ELEK EQ:RACKMOUNTING HDW	80009	016-0120-00
	129-0103-00			1	.POST,BDG,ELEC:ASSEMBLY	80009	129-0103-00
-21	200-0103-00			1	.NUT,PLAIN,KNURL:0.25-28 X 0.375"OD BRASS	80009	200-0103-00
-22	129-0077-00			1	.STUD,SHOULDERED:0.938 L X 0.375,0.250-28 .(ATTACHING PARTS)	80009	129-0077-00
-23	210-0455-00			1	.NUT,PLAIN,HEX:0.25-28 X 0.375,BRS NP	73743	3089-402
-24	210-0046-00			1	.WASHER,LOCK:0.261 ID,INTL,0.018 THK,STL .(END ATTACHING PARTS)	77900	1214-05-00-0541C
-25	437-0124-00			1	.CAB.,RACK MOUNT:ADAPTER	80009	437-0124-00
-26	407-0250-00			2	.BRACKET,SLIDE:REAR,ALUMINUM .(ATTACHING PARTS)	80009	407-0250-00
-27	210-0458-00			8	.NUT,PL,ASSEM WA:8-32 X 0.344,STL CD PL .(END ATTACHING PARTS)	78189	511-081800-00
ACCESSORIES							
	010-6065-13	B500000	B515339	2	PROBE,VOLTAGE:P6065A,72.0 L,10X,W/ACCESS	80009	010-6065-13
	010-6105-03	B515340		2	PROBE,VOLTAGE:P6105,2 METER,10X,W/ACCESS	80009	010-6105-03
	016-0165-00			1	POUCH,ACCESSORY:	80009	016-0165-00
	070-1142-00			1	MANUAL,TECH:OPERATORS,434	80009	070-1142-00
	070-1915-00			1	MANUAL,TECH:SERVICE	80009	070-1915-00

ACCESSORIES

Fig. & Index No.	Tektronix Part No.	Serial/Model No. Eff	Dscont	Qty	1	2	3	4	5	Name & Description	Mfr Code	Mfr Part Number
	010-6065-13	B500000	B515339	2						PROBE, VOLTAGE: P6065A, 72.0 L, 10X, W/ACCESS	80009	010-6065-13
	010-6105-03	B515340		2						PROBE, VOLTAGE: P6105, 2 METER, 10X, W/ACCESS	80009	010-6105-03
	016-0165-00			1						POUCH, ACCESSORY: W/HARDWARE	80009	016-0165-00
	070-1142-00			1						MANUAL, TECH: OPERATORS	80009	070-1142-00
	070-1915-00			1						MANUAL, TECH: SERVICE	80009	070-1915-00

For Service Manuals Contact
MAURITRON TECHNICAL SERVICES
 8 Cherry Tree Rd, Chinnor
 Oxon OX9 4QY
 Tel:- 01844-351694 Fax:- 01844-352554
 Email:- enquiries@mauritron.co.uk

FIG. 1 FRONT

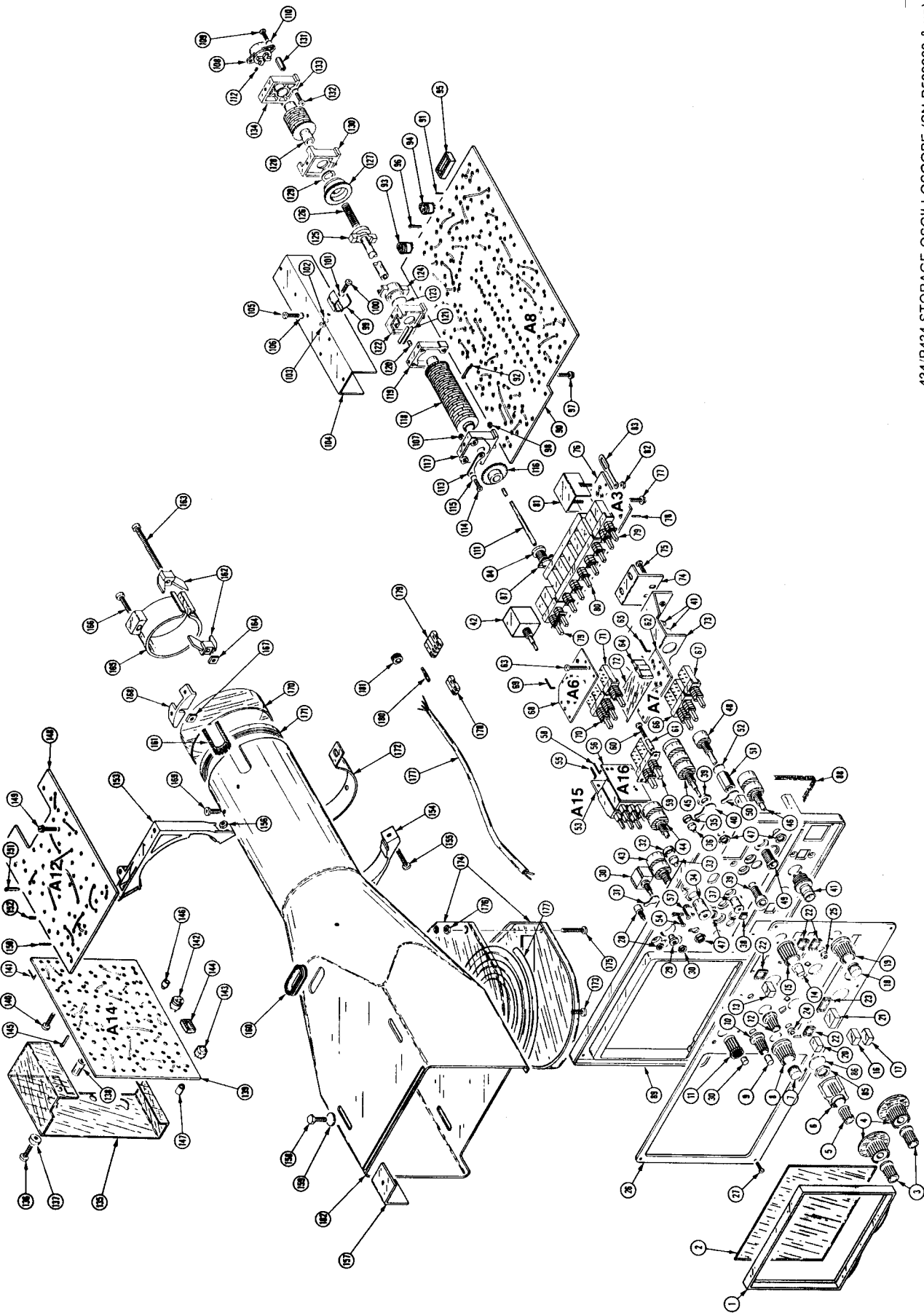

434/R434 STORAGE OSCILLOSCOPE (SN B500000 & up)

FIG. 2 CHASSIS & REAR

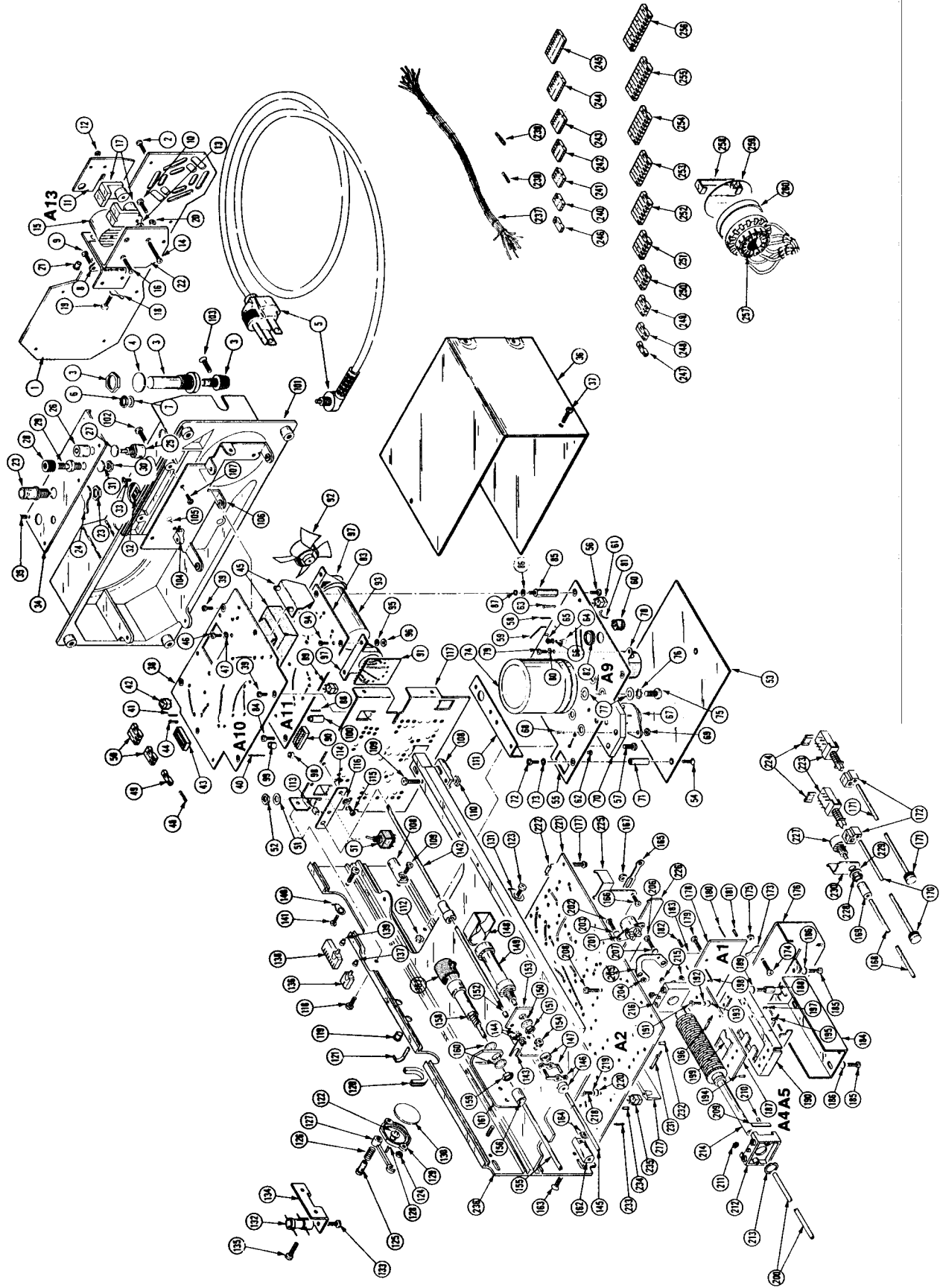
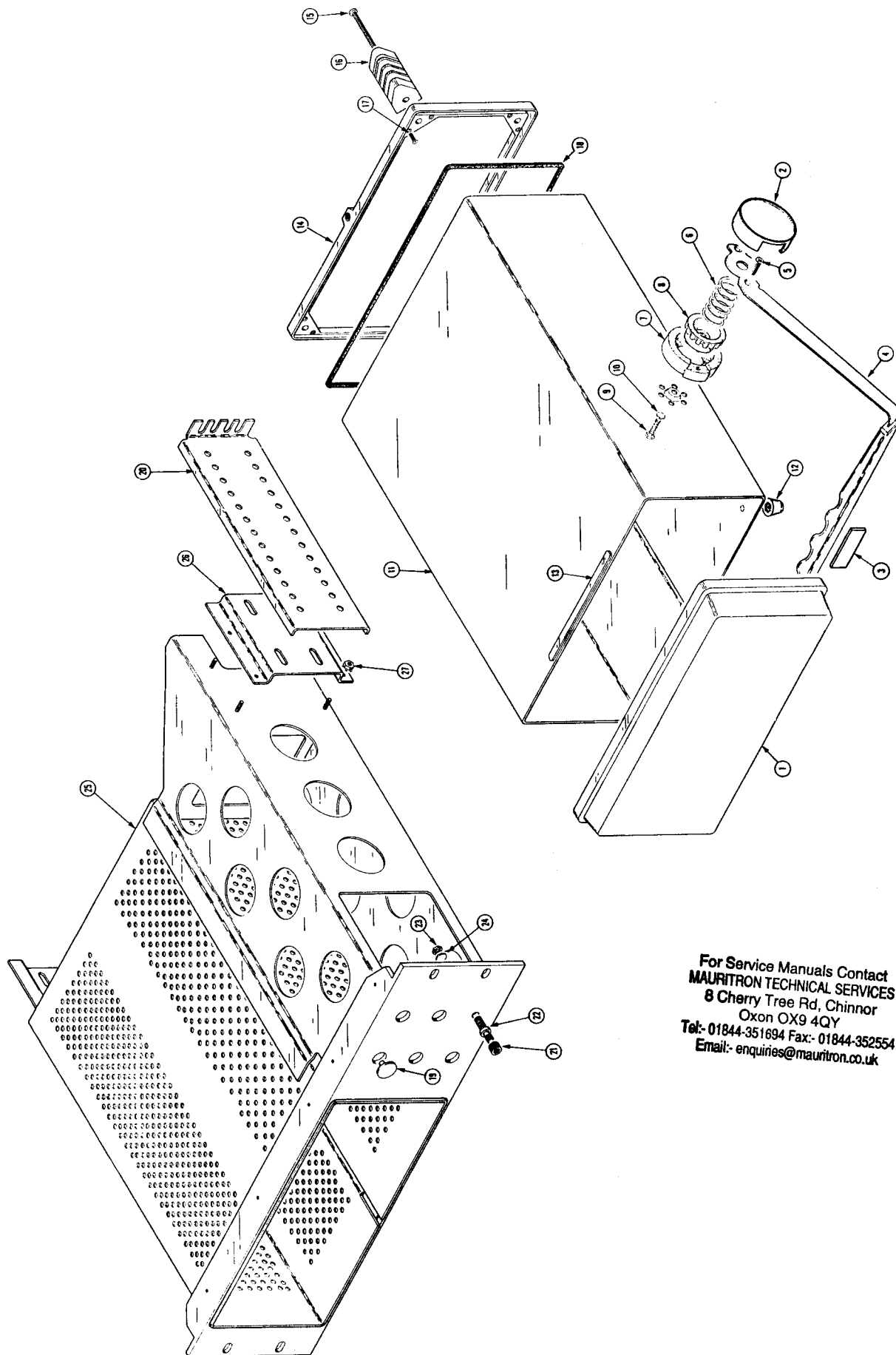

FIG. 3 CABINETS



434/R434 STORAGE OSCILLOSCOPE (SN B500000 & up)

For Service Manuals Contact
MAURITRON TECHNICAL SERVICES
8 Cherry Tree Rd, Chinnor
Oxon OX9 4QY
Tel:- 01844-351694 Fax:- 01844-352554
Email:- enquiries@mauritron.co.uk

1

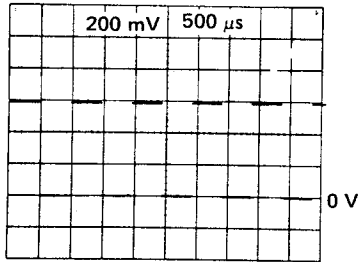

4

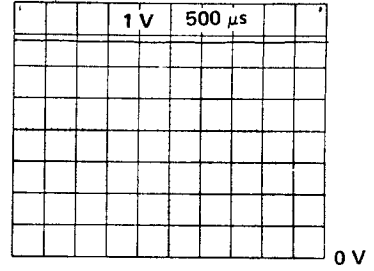

2

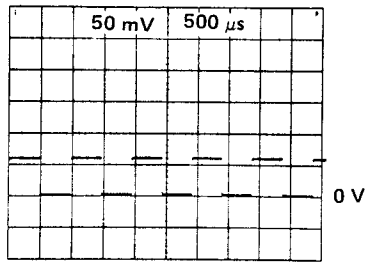

5

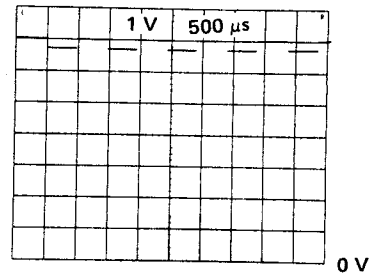

3

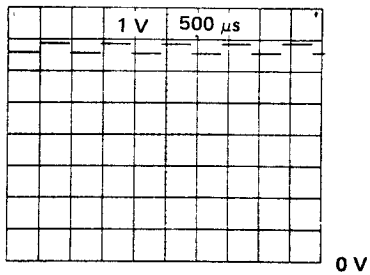

6

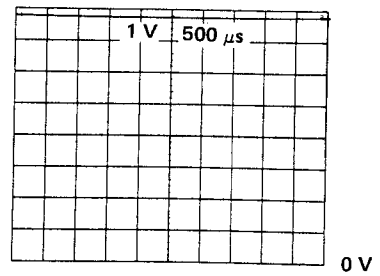

For Service Manuals Contact
MAURITRON TECHNICAL SERVICES
 8 Cherry Tree Rd, Chinnor
 Oxon OX9 4QY
 Tel:- 01844-351694 Fax:- 01844-352554
 Email:- enquiries@maurtron.co.uk

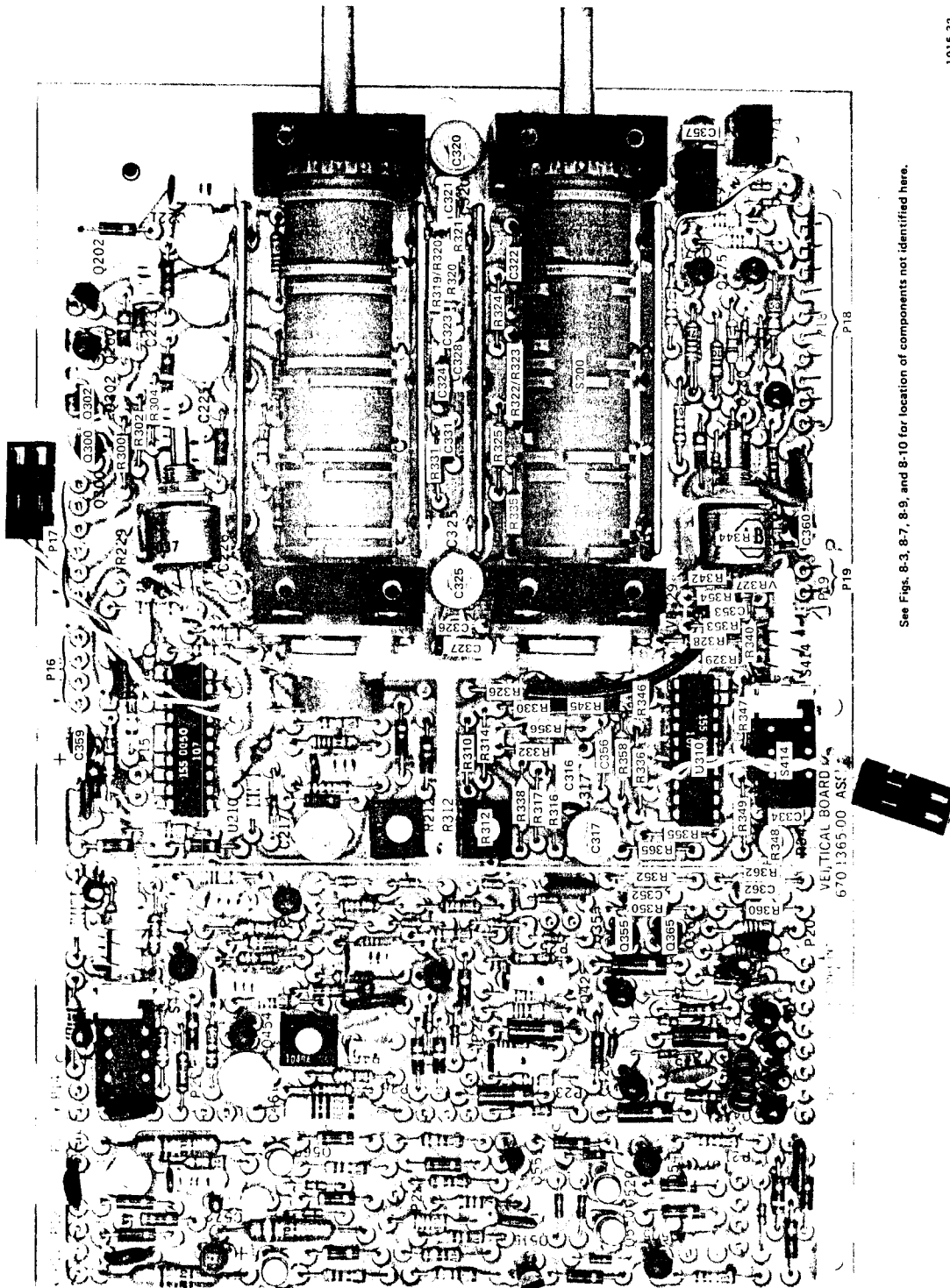

See Figs. 8-3, 8-7, 8-9, and 8-10 for location of components not identified here.

Fig. 8-6. P/O A2. Partial Vertical circuit board.

1915-32
 REV. A, APR. 1975



FIG. 8-1, 8-2, 8-3

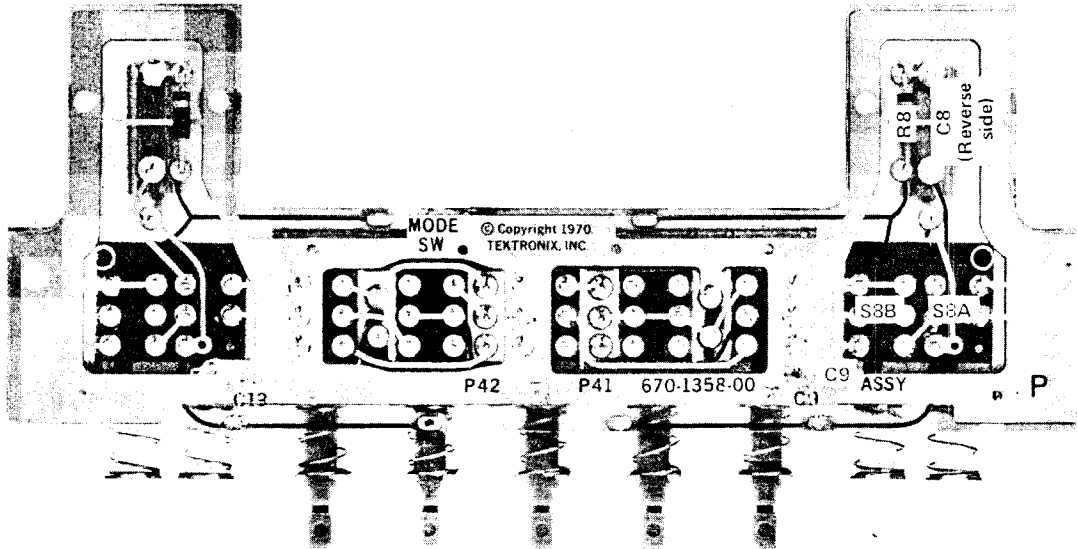

See Figs. 8-4 and 8-8 for location of components not identified here.

1915-27

Fig. 8-1. P/O A3. Partial Vertical Mode Switch circuit board.

©

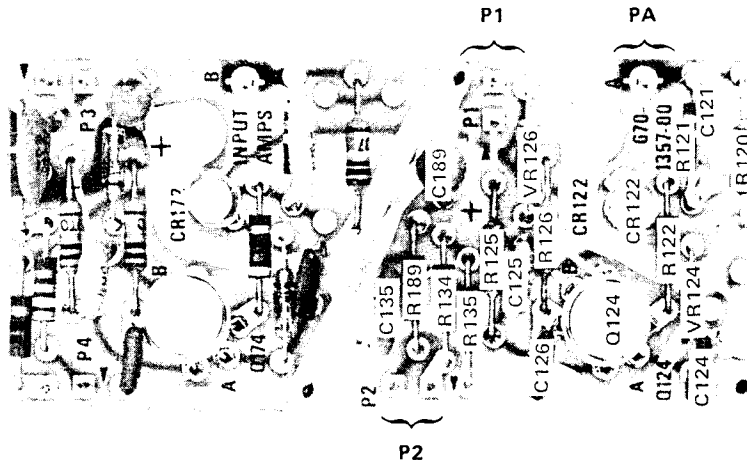

See Fig. 8-5 for location of components not identified here.

1915-28

Fig. 8-2. P/O A1. Partial Input Amplifier circuit board.

©

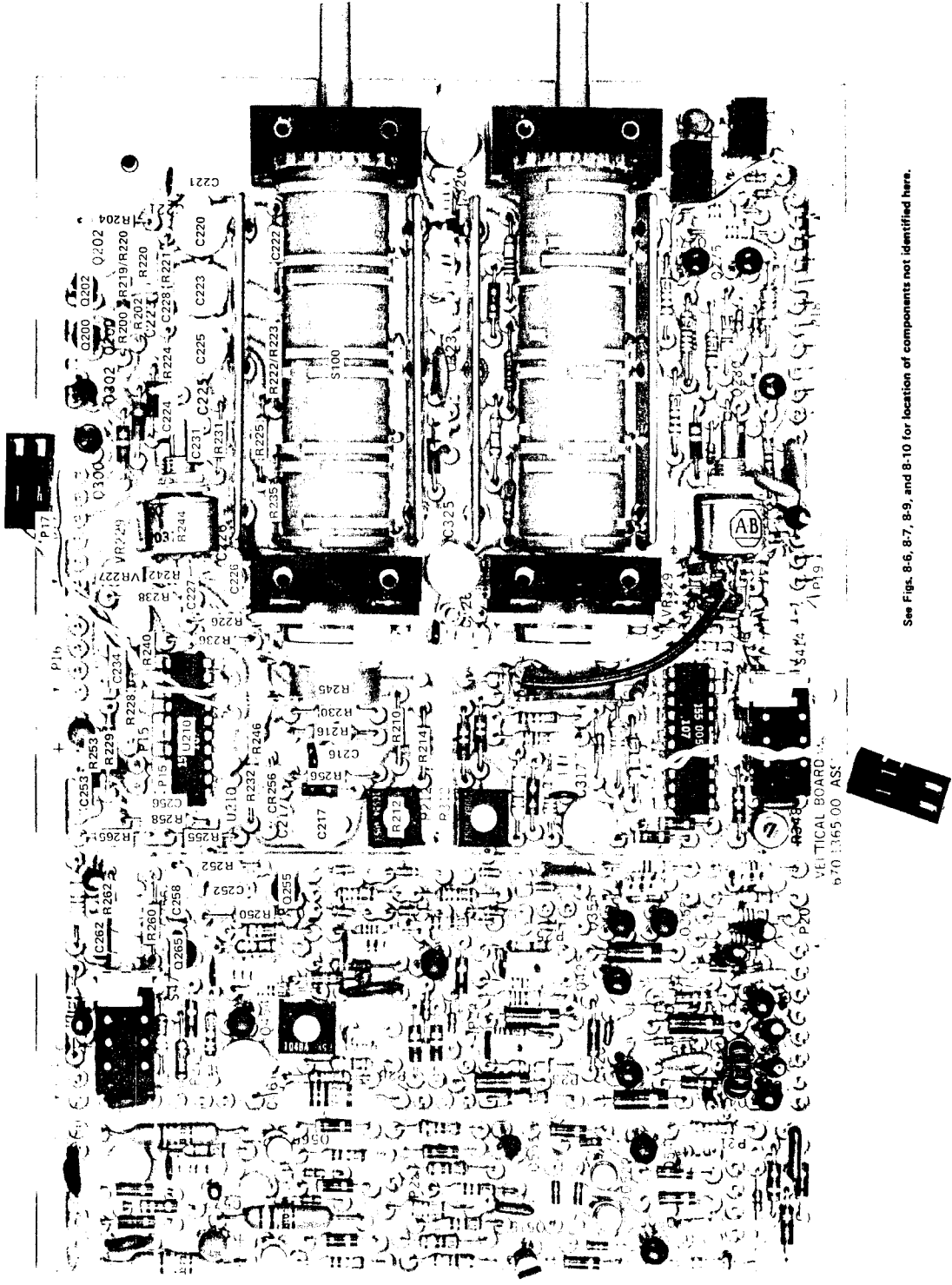

BLOCK DIAGRAM

For Service Manuals Contact
MAURITRON TECHNICAL SERVICES
 8 Cherry Tree Rd, Chinnor
 Oxon OX9 4QY
 Tel: 01844-351694 Fax: 01844-352554
 Email: enquiries@mauritron.co.uk

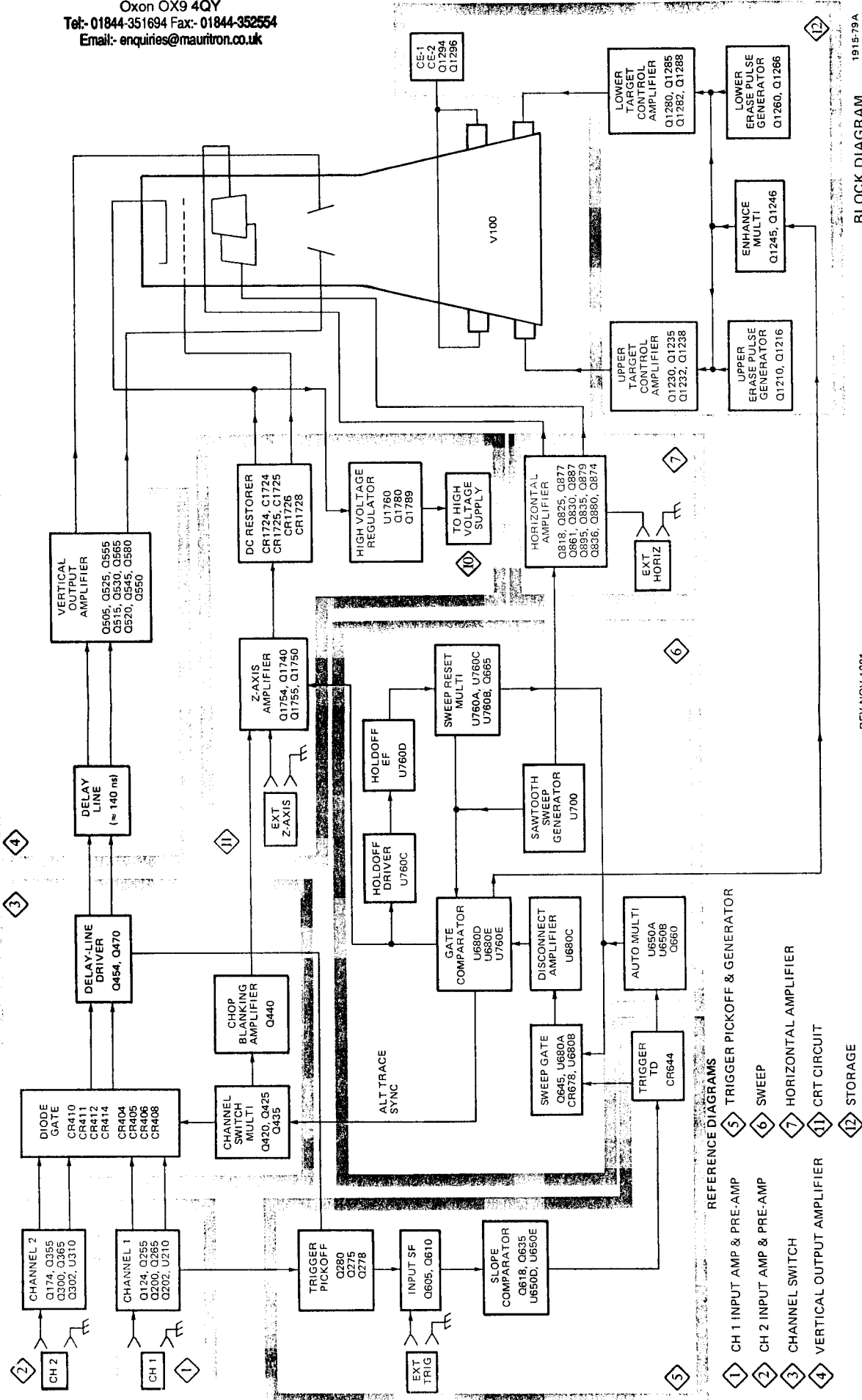

REFERENCE DIAGRAMS

- 1 CH 1 INPUT AMP & PRE-AMP
- 2 CH 2 INPUT AMP & PRE-AMP
- 3 CHANNEL SWITCH
- 4 VERTICAL OUTPUT AMPLIFIER
- 5 TRIGGER PICKOFF & GENERATOR
- 6 SWEEP
- 7 HORIZONTAL AMPLIFIER
- 8 CRT CIRCUIT
- 9 STORAGE

1915-79A

REV NOV 1981

434 SN B500000 and up

For Service Manuals Contact
MAURITRON TECHNICAL SERVICES
8 Cherry Tree Rd, Chinnor
Oxon OX9 4QY
Tel:- 01844-351694 Fax:- 01844-352554
Email:- enquiries@maurtron.co.uk

All components identified here are located on reverse side of circuit board.

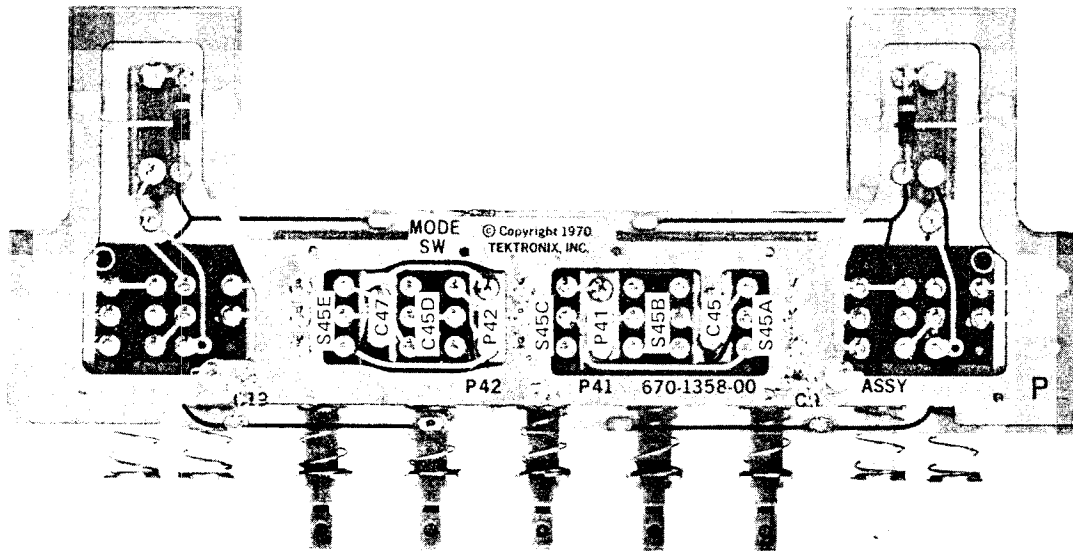

See Figs. 8-1 and 8-4 for location of components not identified here.

1915-34

@

Fig. 8-8. P/O A3. Partial Vertical Mode Switch circuit board.

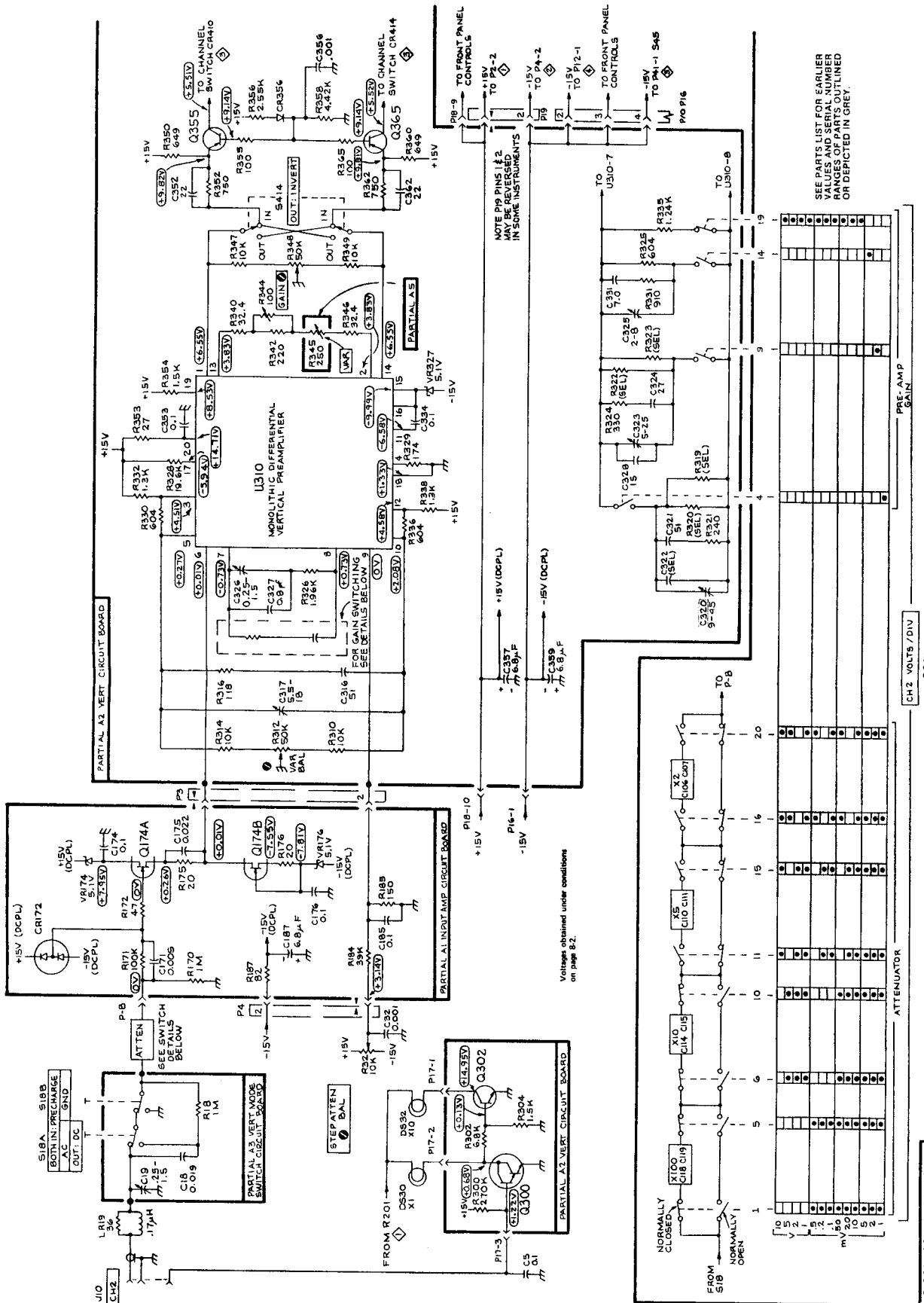

CH 2 INPUT AMPLIFIER & PRE-AMP

1915-51
REV D, NOV 1979

434 (SN B500000 & UP)

DLO 675

For Service Manuals Contact
MAURITRON TECHNICAL SERVICES
8 Cherry Tree Rd, Chinnor
Oxon OX9 4QY
Tel: 01844-351694 Fax: 01844-352554
Email: enquiries@mauritron.co.uk

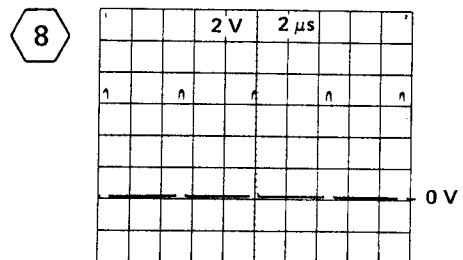
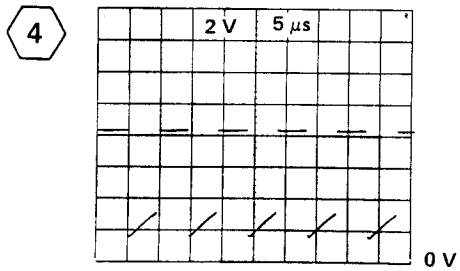
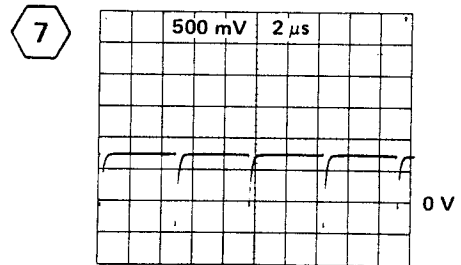
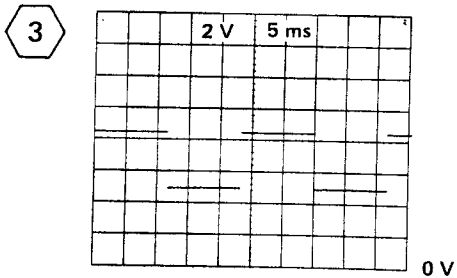
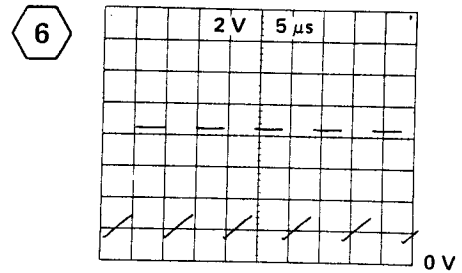
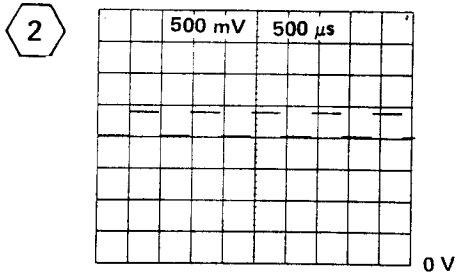
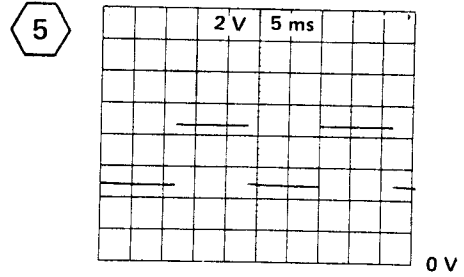
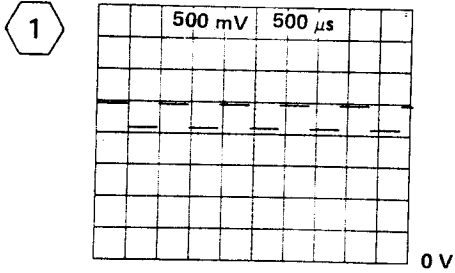

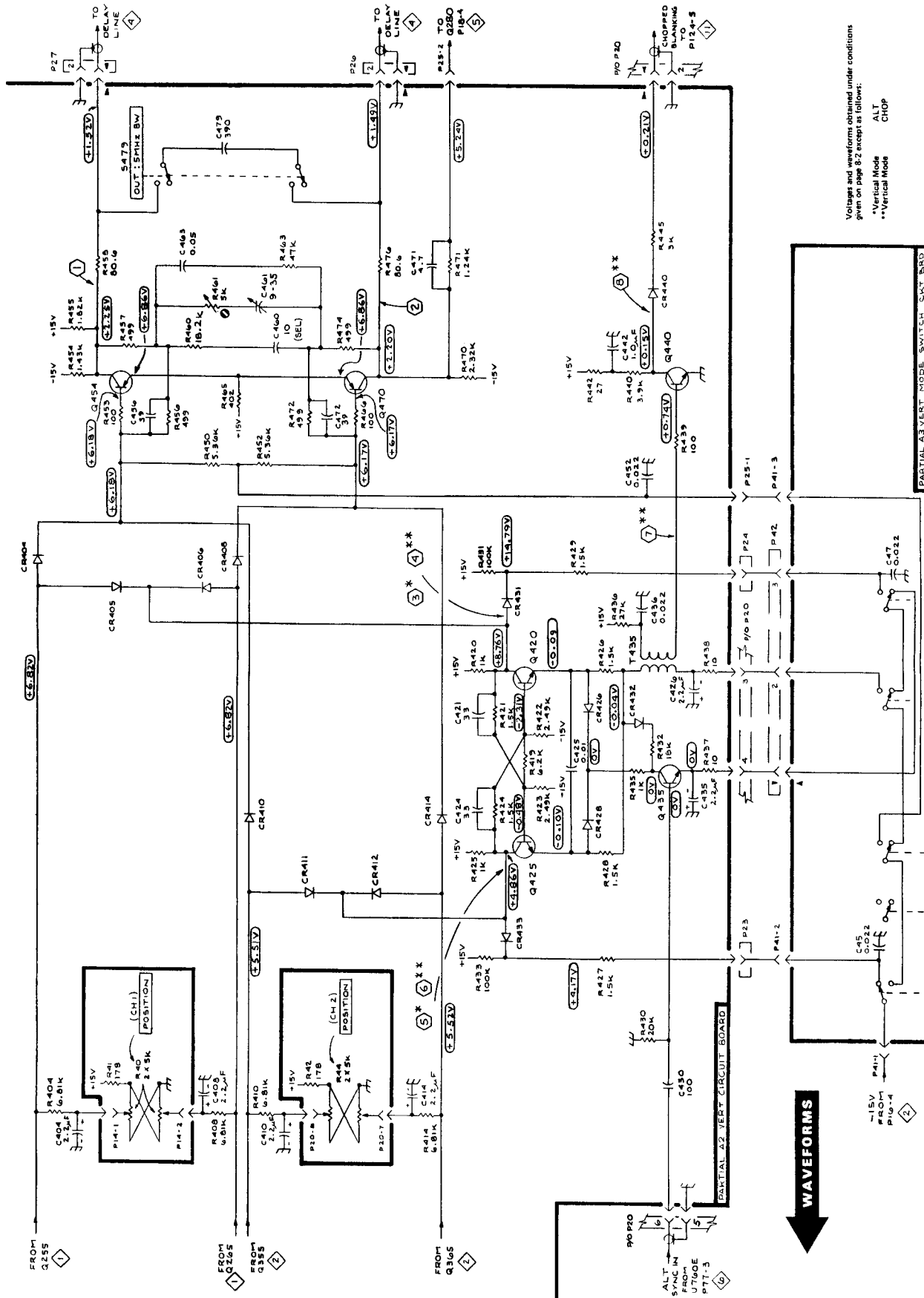

Voltagas and waveforms obtained under conditions given on page 8.2 except as follows:
 *Vertical Mode ALT
 **Vertical Mode CHOP

43-4(SN B500000 f UP)

CHANNEL SWITCH

REV B, NOV 1979

VERTICAL MODE SWITCH

CH1 545A

CHOP 545D

ALT 545B

ADD 545C

CH2 545E

545F

545G

545H

545I

545J

545K

545L

545M

545N

545O

545P

545Q

545R

545S

545T

545U

545V

545W

545X

545Y

545Z

545AA

545AB

545AC

545AD

545AE

545AF

545AG

545AH

545AI

545AJ

545AK

545AL

545AM

545AN

545AO

545AP

545AQ

545AR

545AS

545AT

545AU

545AV

545AW

545AX

545AY

545AZ

545BA

545BB

545BC

545BD

545BE

545BF

545BG

545BH

545BI

545BJ

545BK

545BL

545BM

545BN

545BO

545BP

545BQ

545BR

545BS

545BT

545BU

545BV

545BW

545BX

545BY

545BZ

545CA

545CB

545CC

545CD

545CE

545CF

545CG

545CH

545CI

545CJ

545CK

545CL

545CM

545CN

545CO

545CP

545CQ

545CR

545CS

545CT

545CU

545CV

545CW

545CX

545CY

545CZ

545DA

545DB

545DC

545DD

545DE

545DF

545DG

545DH

545DI

545DJ

545DK

545DL

545DM

545DN

545DO

545DP

545DQ

545DR

545DS

545DT

545DU

545DV

545DW

545DX

545DY

545DZ

545EA

545EB

545EC

545ED

545EE

545EF

545EG

545EH

545EI

545EJ

545EK

545EL

545EM

545EN

545EO

545EP

545EQ

545ER

545ES

545ET

545EU

545EV

545EW

545EX

545EY

545EZ

545FA

545FB

545FC

545FD

545FE

545FF

545FG

545FH

545FI

545FJ

545FK

545FL

545FM

545FN

545FO

545FP

545FQ

545FR

545FS

545FT

545FU

545FV

545FW

545FX

545FY

545FZ

545GA

545GB

545GC

545GD

545GE

545GF

545GG

545GH

545GI

545GJ

545GK

545GL

545GM

545GN

545GO

545GP

545GQ

545GR

545GS

545GT

545GU

545GV

545GW

545GX

545GY

545GZ

545HA

545HB

545HC

545HD

545HE

545HF

545HG

545HH

545HI

545HJ

545HK

545HL

545HM

545HN

545HO

545HP

545HQ

545HR

545HS

545HT

545HU

545HV

545HW

545HX

545HY

545HZ

545IA

545IB

545IC

545ID

545IE

545IF

545IG

545IH

545II

545IJ

545IK

545IL

1

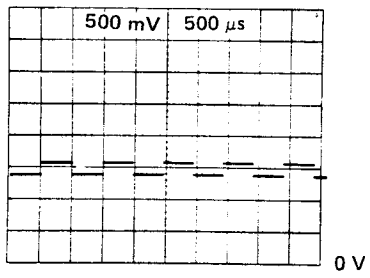

6

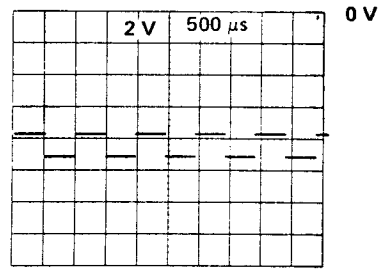

2

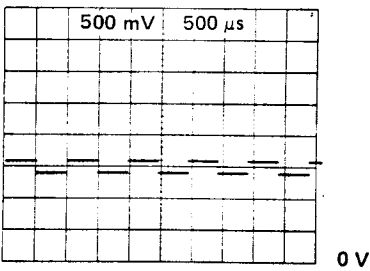

7

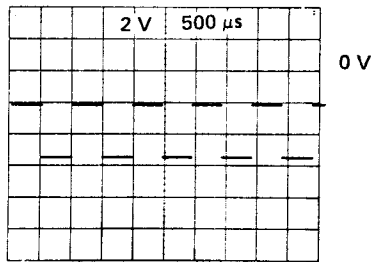

3

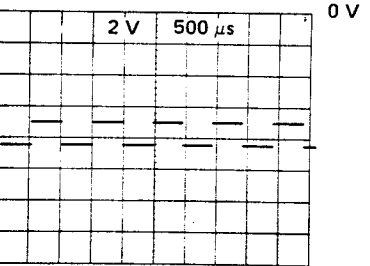

8

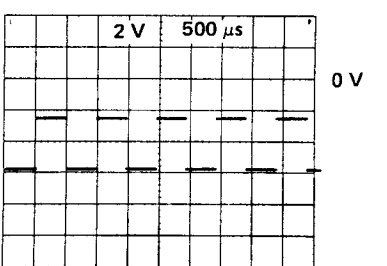

4

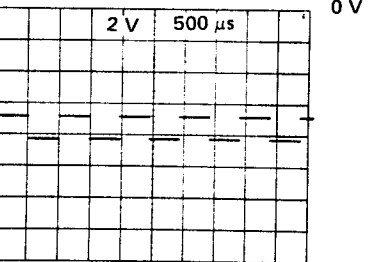

9

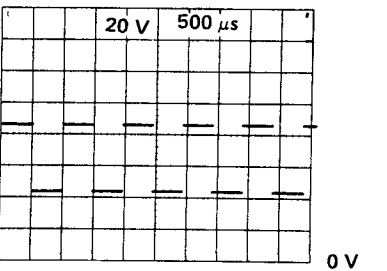

5

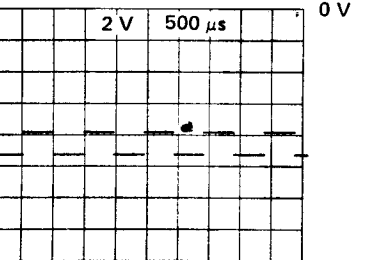

10

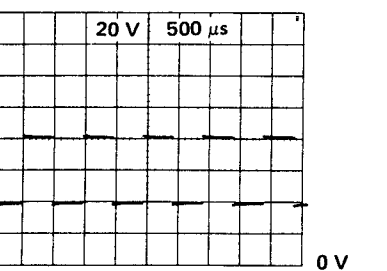

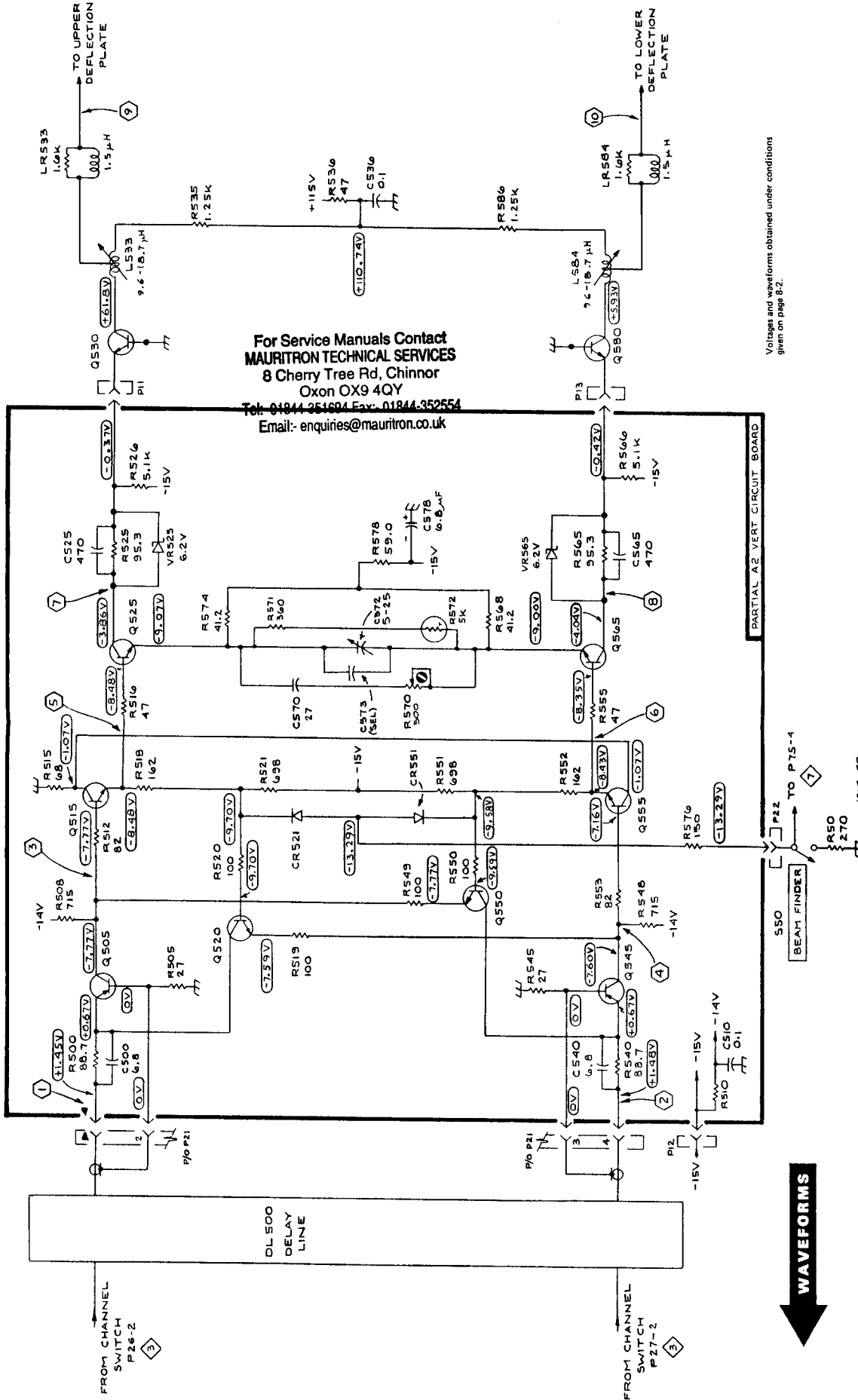

For Service Manuals Contact
MAURITRON TECHNICAL SERVICES
 8 Cherry Tree Rd, Chinnor
 Oxon OX9 4QY
 Tel: 01844 251604 Fax: 01844 352554
 Email: enquiries@mauritron.co.uk

Voltages and waveforms obtained under conditions given on page 62.

1270
 HQ/REB

VERTICAL OUTPUT AMPLIFIER

915-53
 REV B, NOV 1979

434(SNB50000) (UP)



FIG. 8-10, 8-11, 8-12, 8-13

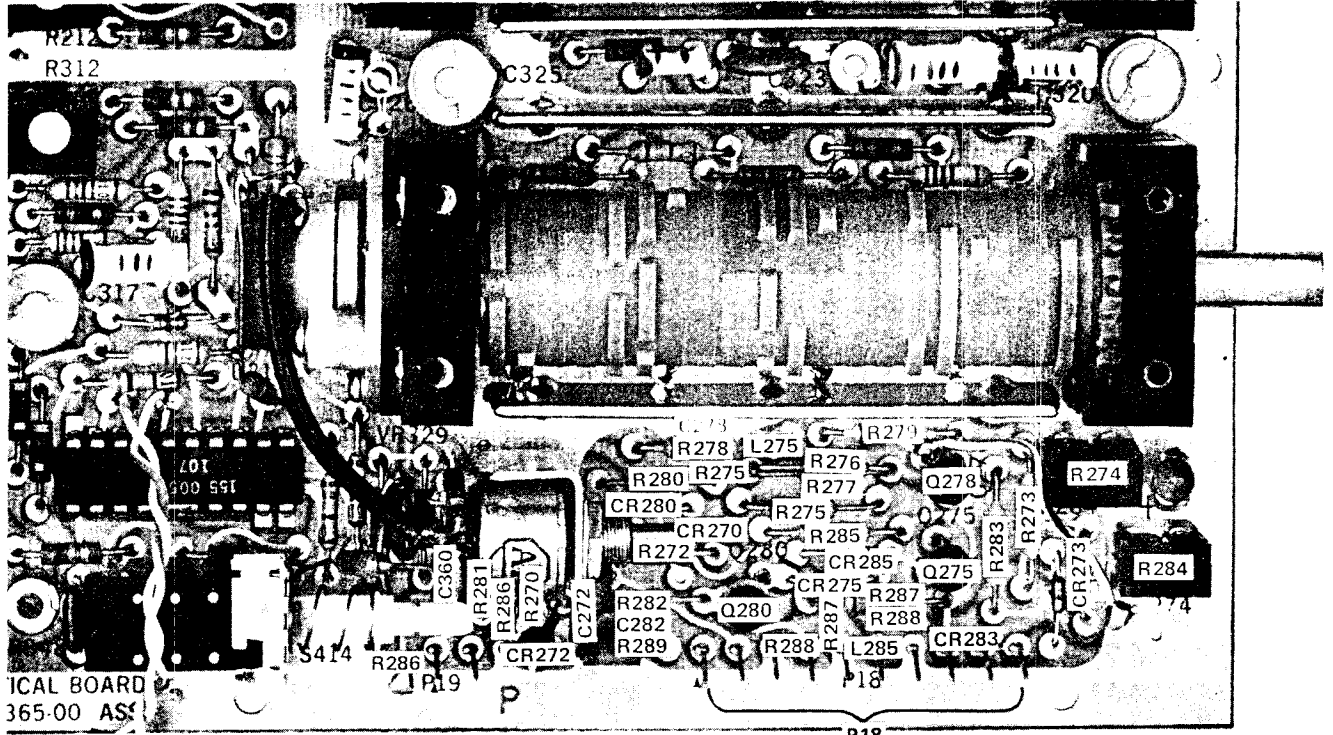

See Figs. 8-3, 8-6, 8-7, and 8-9 for location of components not identified here.

1915-36

Fig. 8-10. P/O A2. Partial Vertical circuit board.

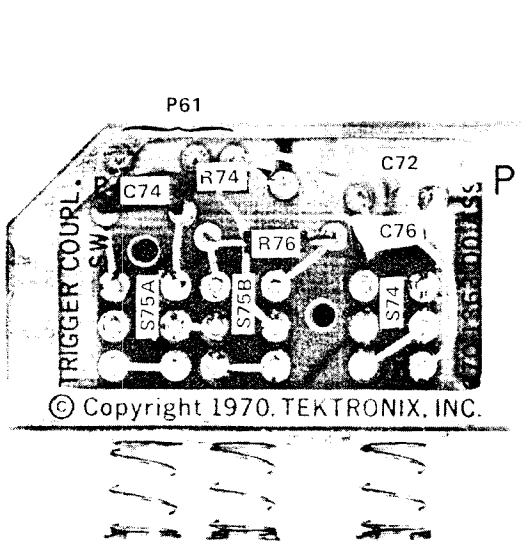

1915-37

Fig. 8-11. A7. Trigger Coupling Switch Circuit board.

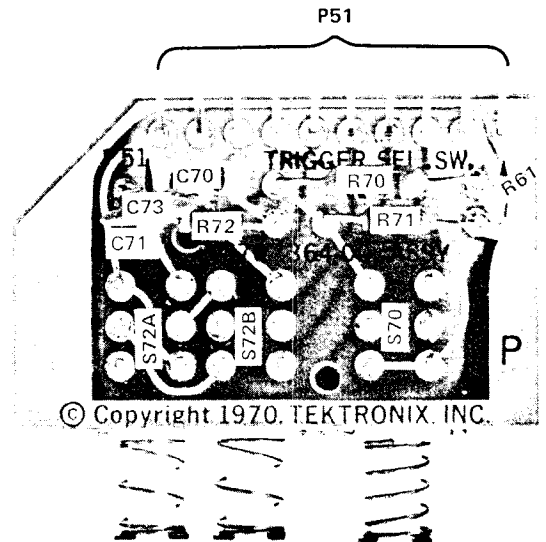

1915-38

Fig. 8-12. A6. Trigger Source Switch circuit board.

For Service Manuals Contact
MAURITRON TECHNICAL SERVICES
 8 Cherry Tree Rd, Chinnor
 Oxon OX9 4QY
 Tel:- 01844-351694 Fax:- 01844-352554
 Email:- enquiries@mauritron.co.uk

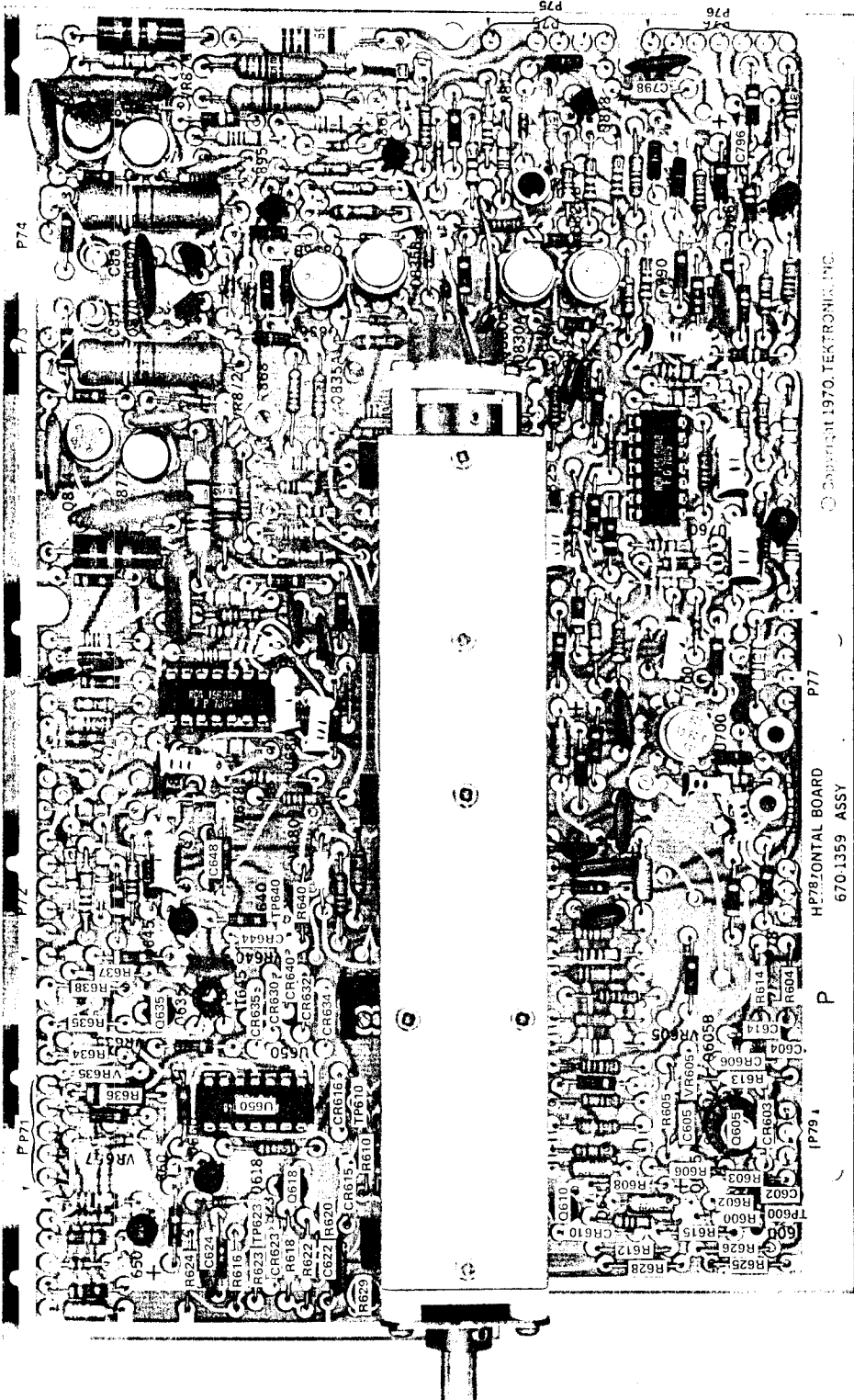

1915-39

See Figs. 8-14, 8-15, and 8-16 for location of components not identified here.

Fig. 8-13. P/O AB. Partial Horizontal circuit board.

1

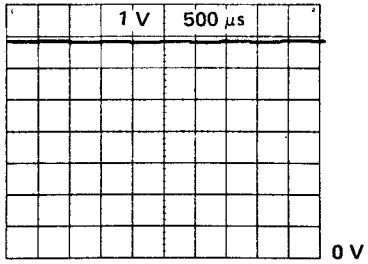

4

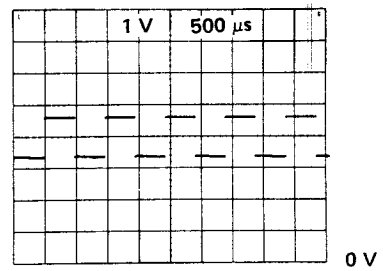

2

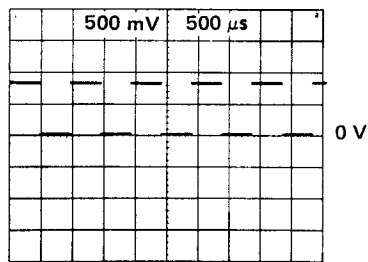

5

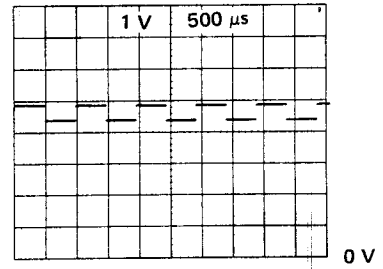

3

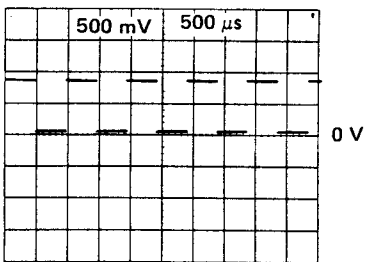

6

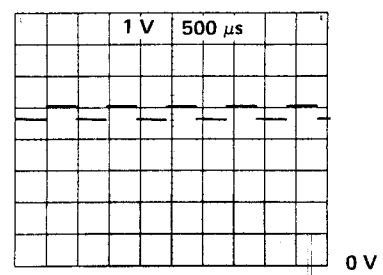

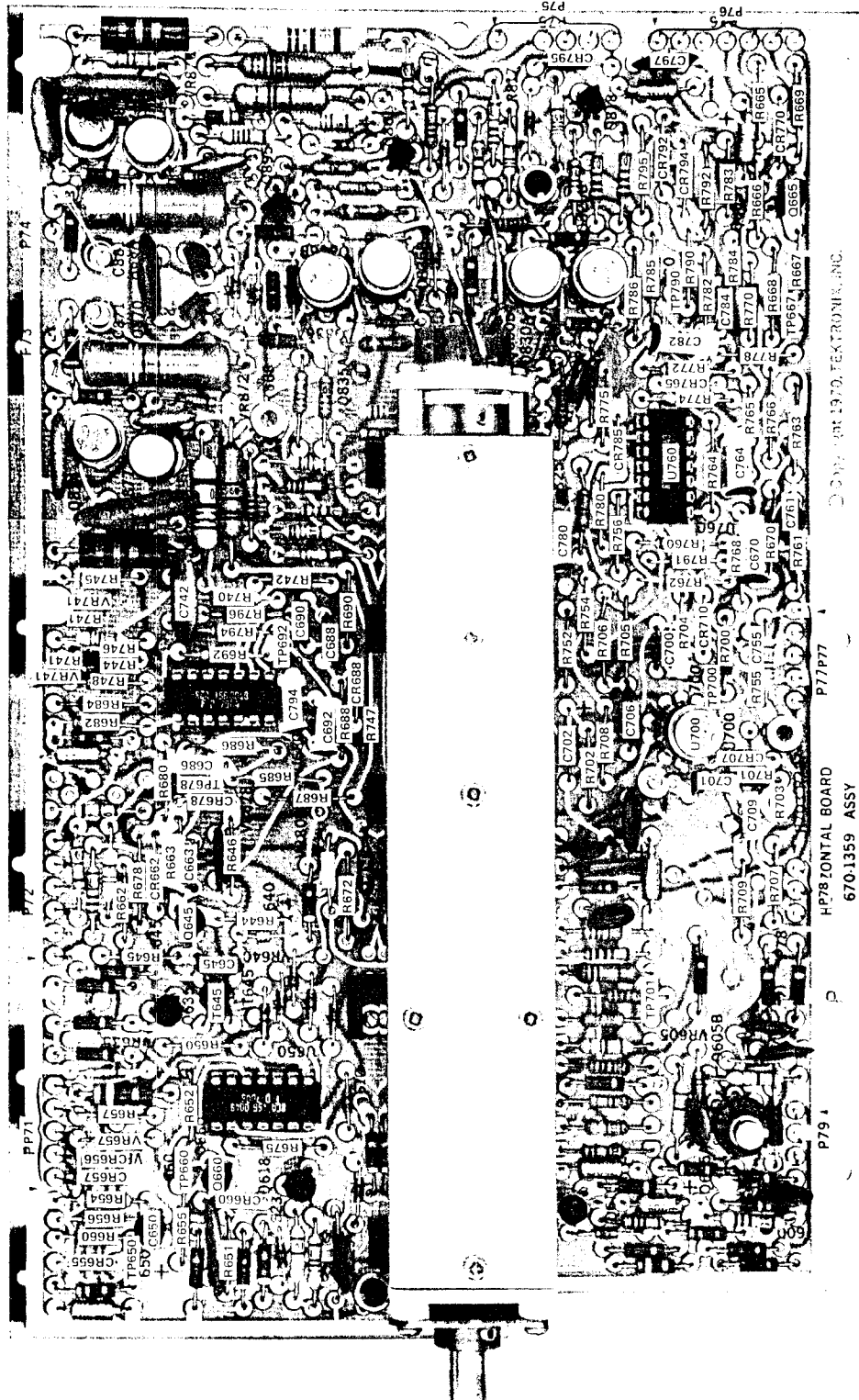

See Figs. 8-13, 8-15, and 8-16 for location of components not identified here.

Fig. 8-14. P/O A8. Partial Horizontal circuit board.

For Service Manuals Contact
MAURITRON TECHNICAL SERVICES
 8 Cherry Tree Rd, Chinnor
 Oxon OX9 4QY
 Tel: 01844-351694 Fax: 01844-352554
 Email: enquiries@mauritron.co.uk

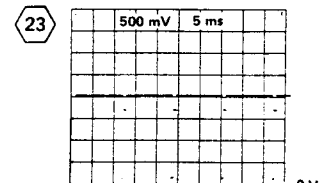
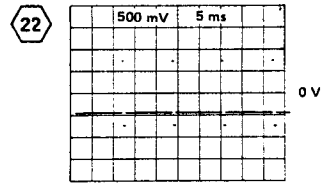
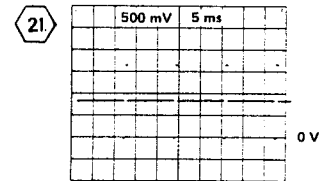
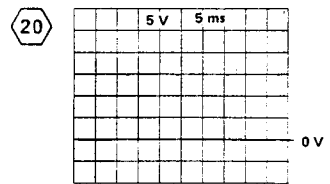
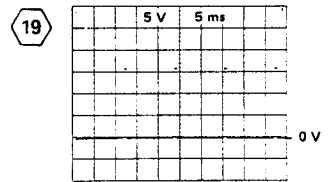
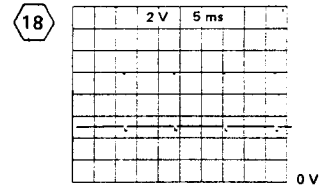
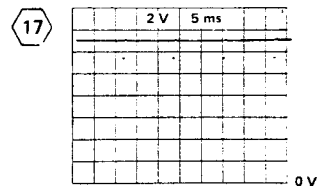
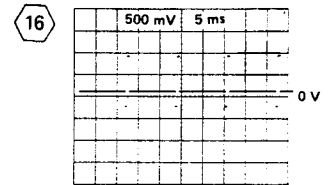
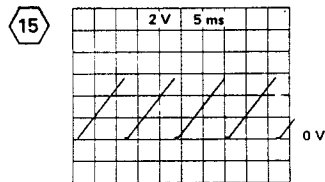
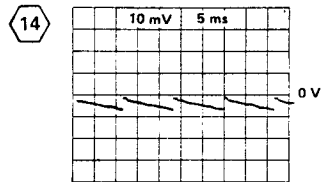
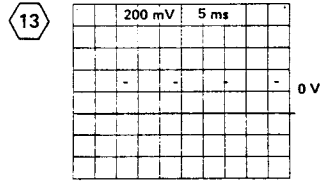
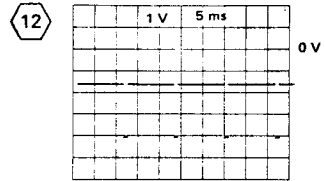
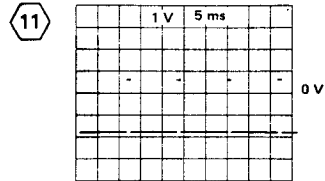
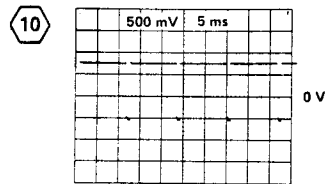
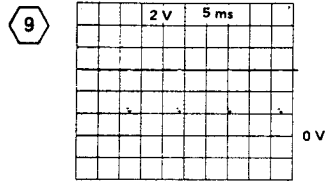
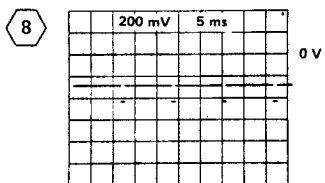
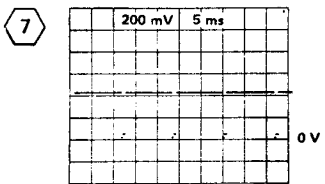
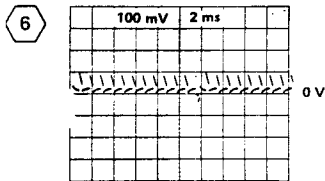
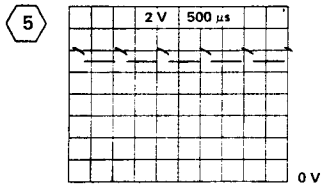
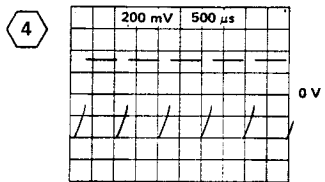
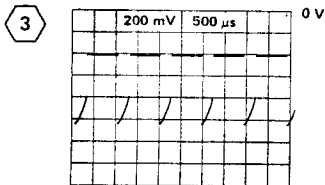
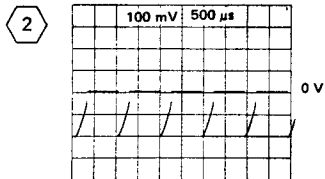
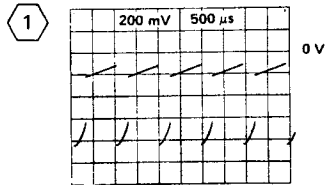

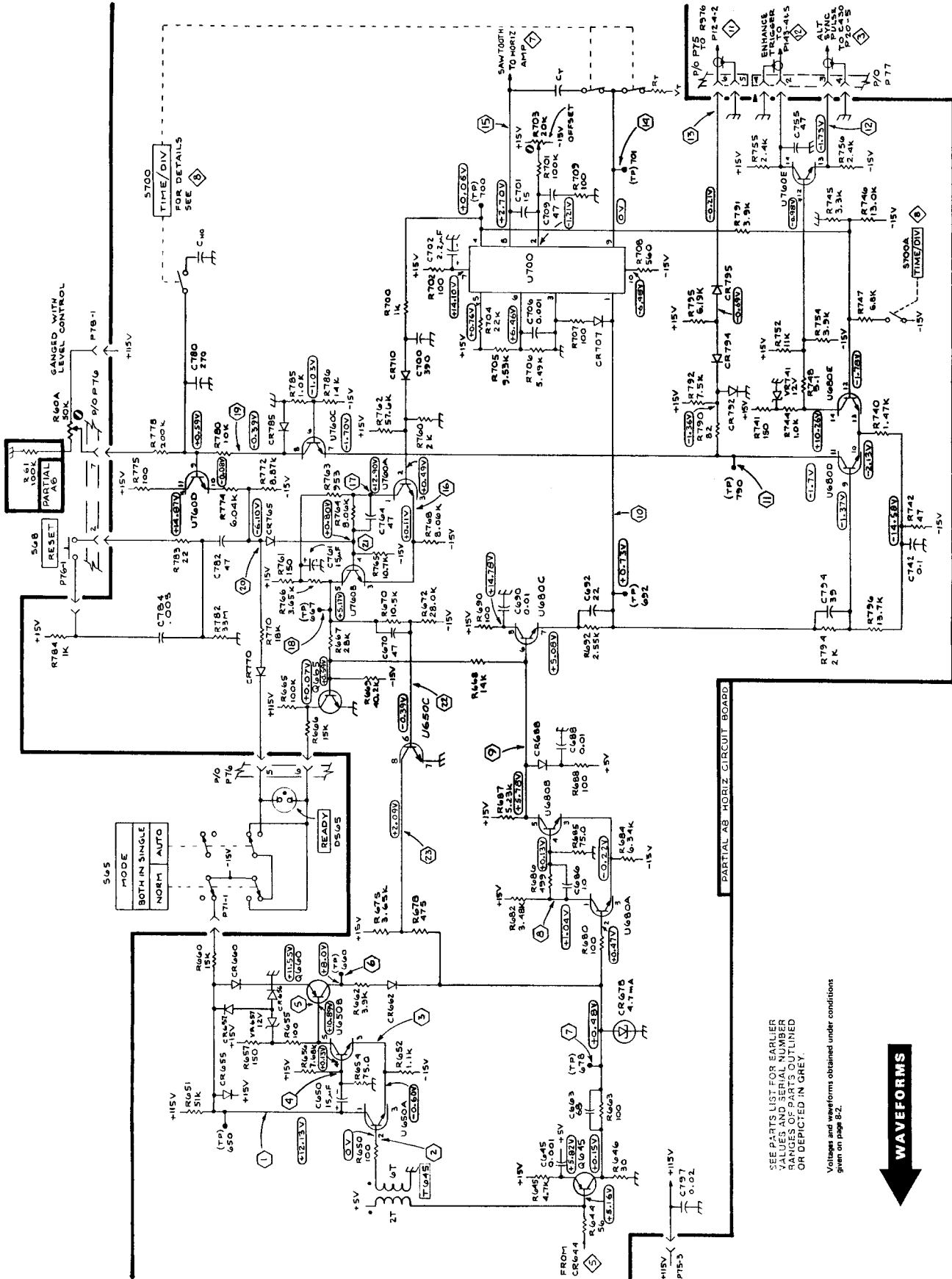

h_q/EEP

SWEEP

1915-55
REV C, NOV 1979

434(SN B500000) (UP)

SEE PARTS LIST FOR EARLIER
VALUES AND SERIAL NUMBER
RANGES OF PARTS OUTLINED
OR DEPICTED IN GREY.

Voltages and waveforms obtained under conditions
given on page 8-2.



For Service Manuals Contact
MAURITRON TECHNICAL SERVICES
 8 Cherry Tree Rd, Chinnor
 Oxon OX9 4QY
 Tel: 01844-351694 Fax: 01844-352554
 Email: enquiries@maurtron.co.uk

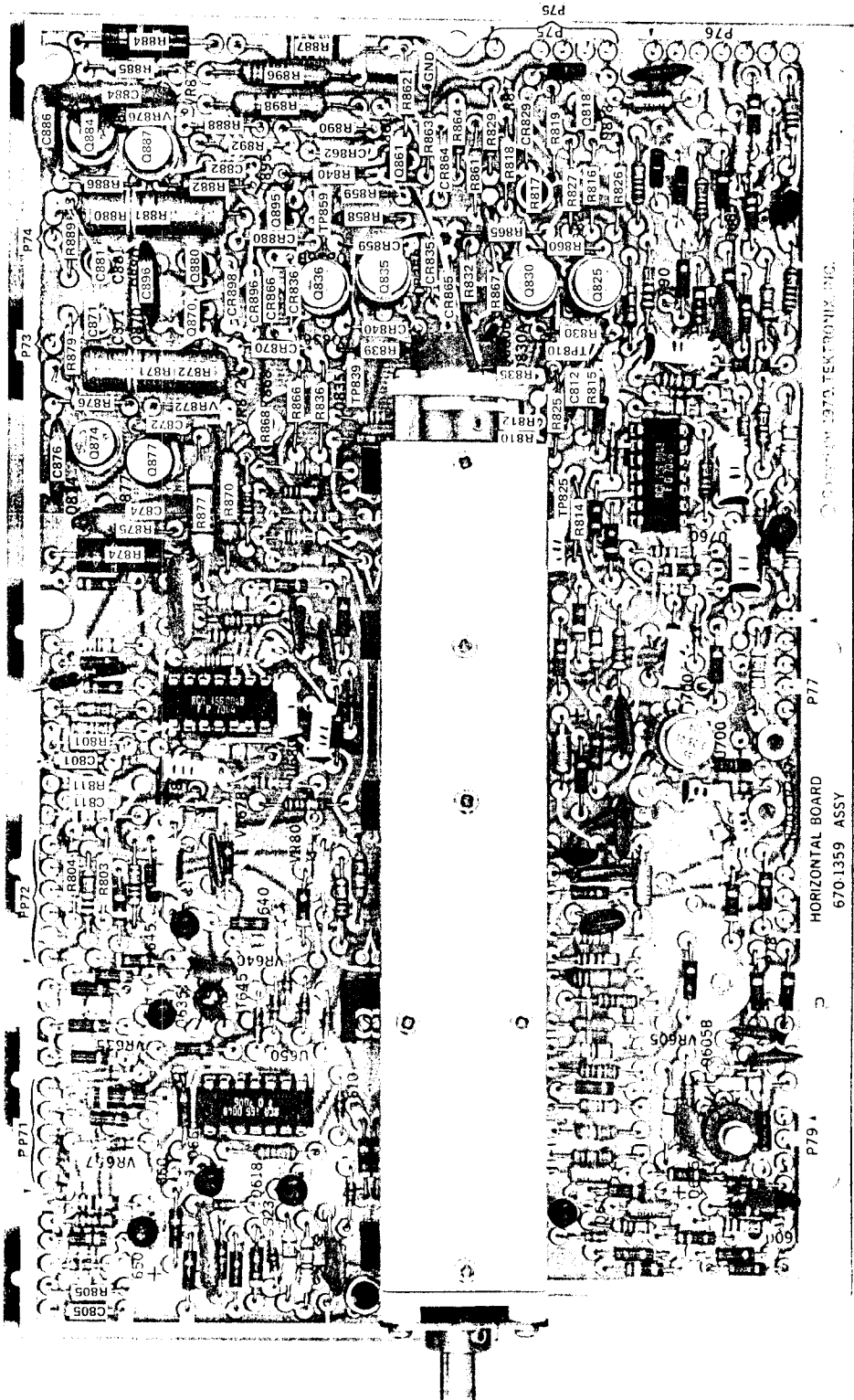

See Figs. 8-13, 8-14, and 8-16 for location of components not identified here.

Fig. 8-15. P/O A8. Partial Horizontal circuit board.

REV B AUG 1980

1915-41

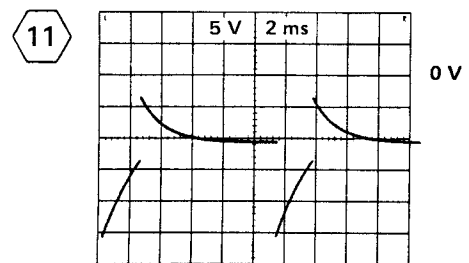
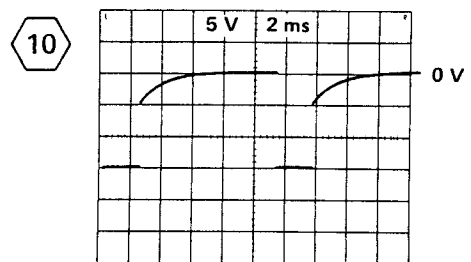
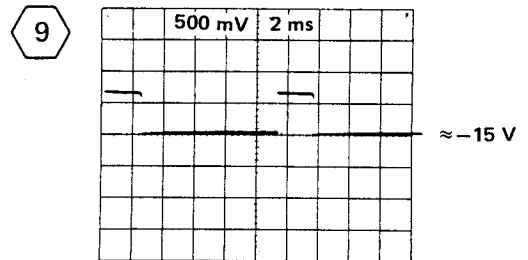
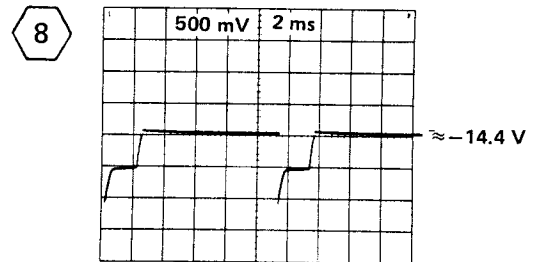
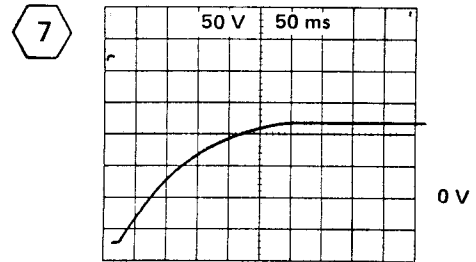
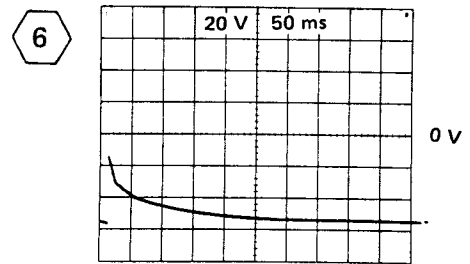
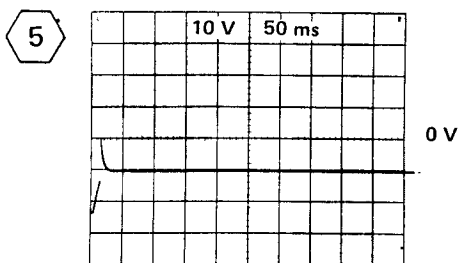
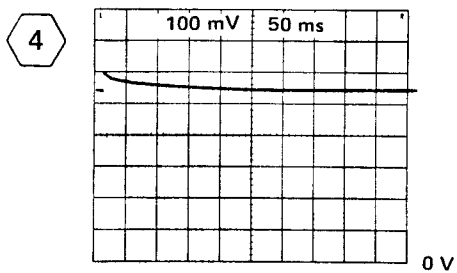
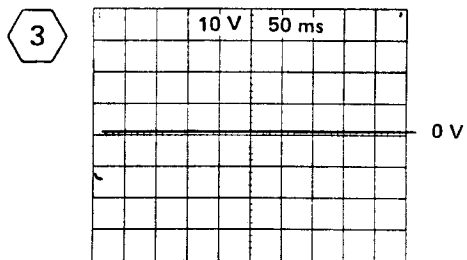
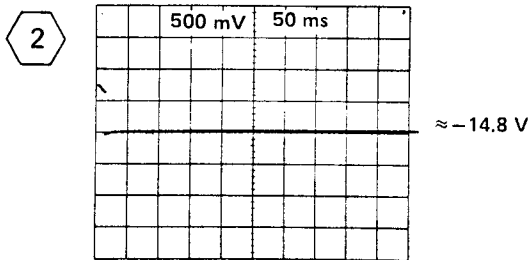
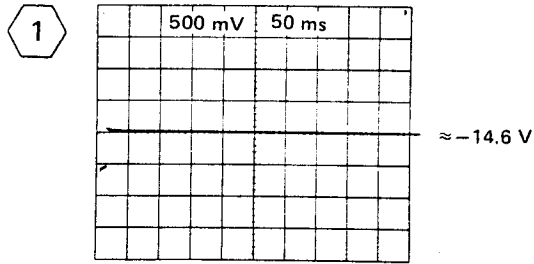

For Service Manuals Contact
MAURITRON TECHNICAL SERVICES
 8 Cherry Tree Rd, Chinnor
 Oxon OX9 4QY
 Tel: 01844-351694 Fax: 01844-352554
 Email: enquiries@mauritron.co.uk

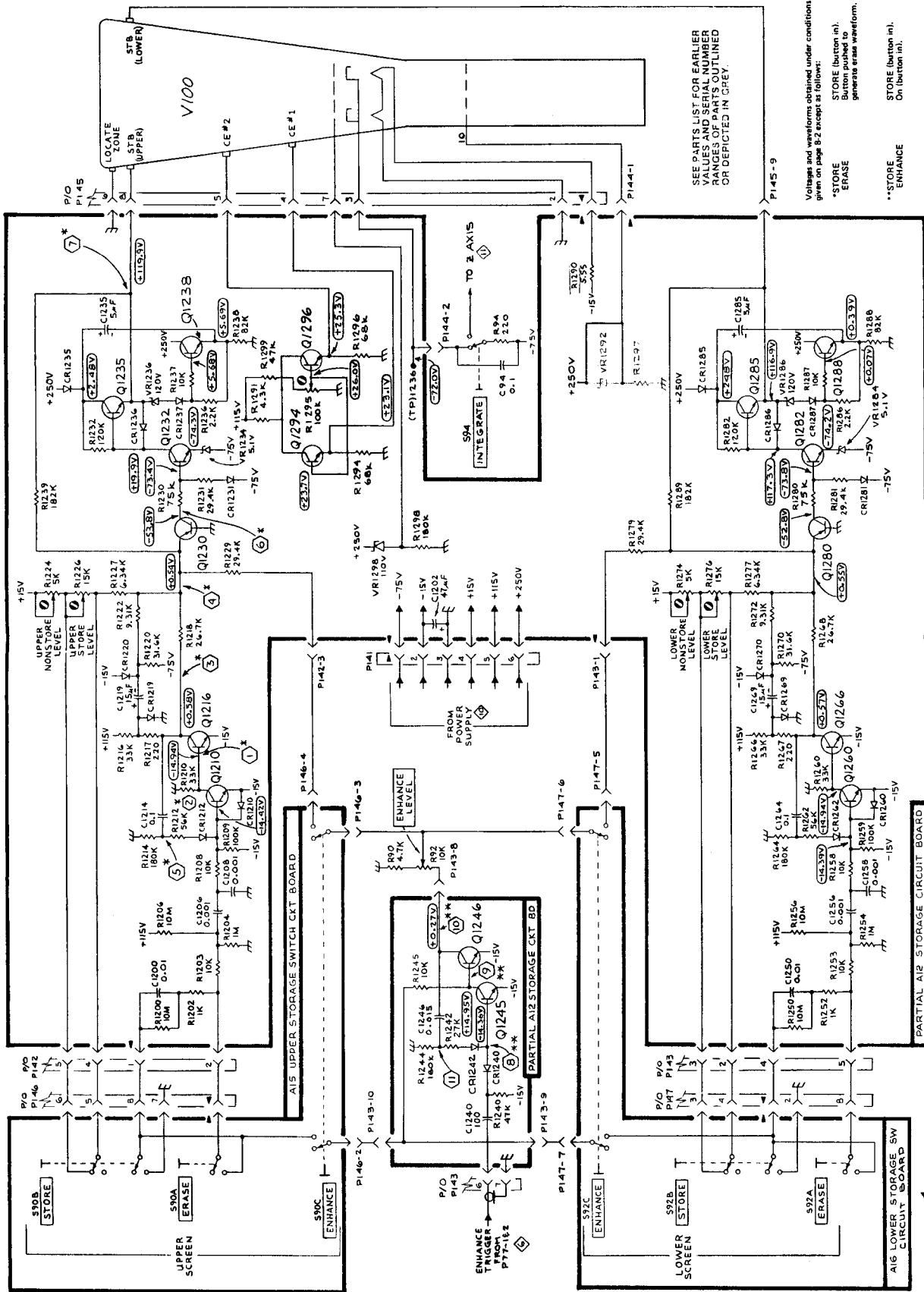

SEE PARTS LIST FOR EARLIER VALUES AND SERIAL NUMBER RANGES OF PARTS OUTLINED OR DEPICTED IN GREY.

Waveforms and waveforms obtained under conditions given on page 8-2 except as follows:
 *STORE (bottom in.)
 *ERASE (bottom in.)
 *ENHANCE (bottom in.)
 *STORE (bottom in.)
 *ENHANCE (bottom in.)
 *STORE (bottom in.)
 *ENHANCE (bottom in.)

1372

mgf/10q

STORAGE

WAVEFORMS

1915-61

REV JAN 1988

4.34(SN8500000 t UP)

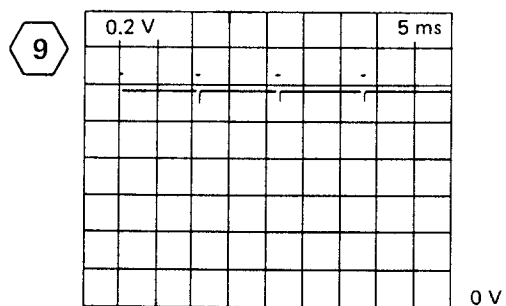
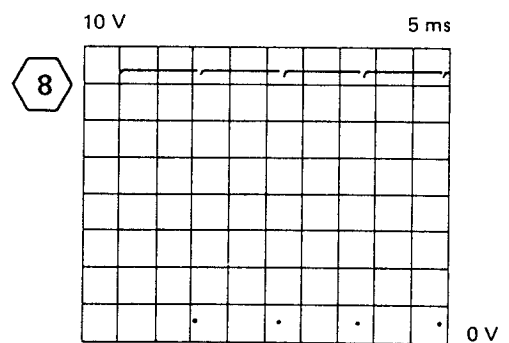
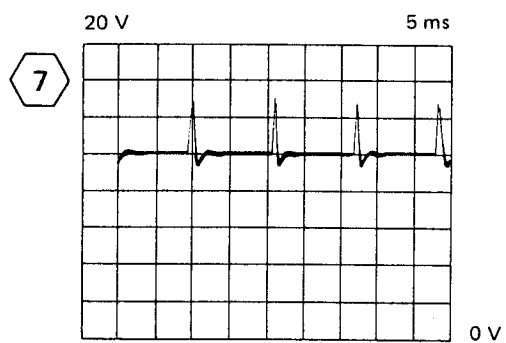
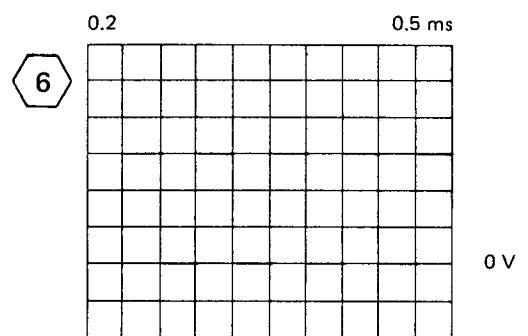
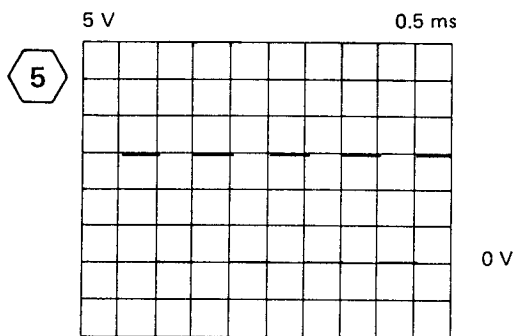
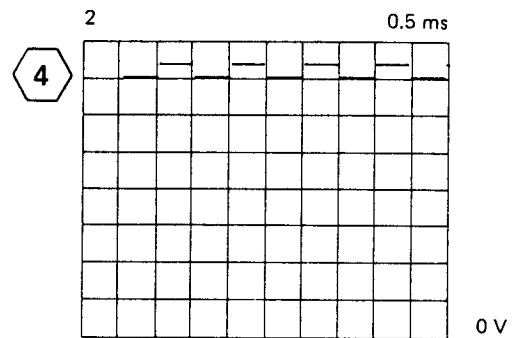
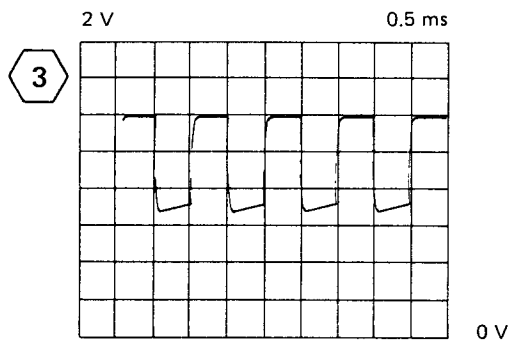
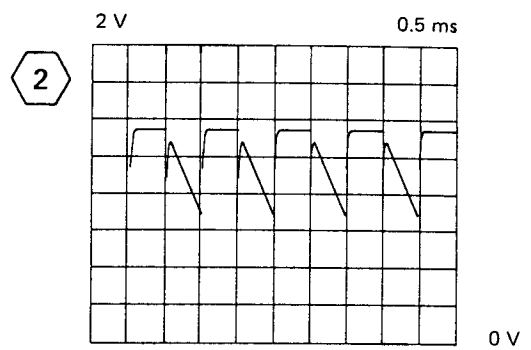
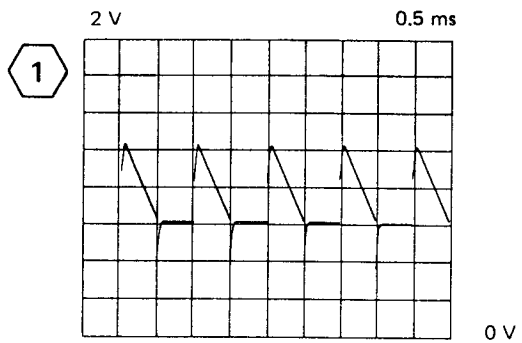

For Service Manuals Contact
MAURITRON TECHNICAL SERVICES
 8 Cherry Tree Rd, Chinnor
 Oxon OX9 4QY
 Tel: 01844-351694 Fax: 01844-352554
 Email: enquiries@mauritron.co.uk

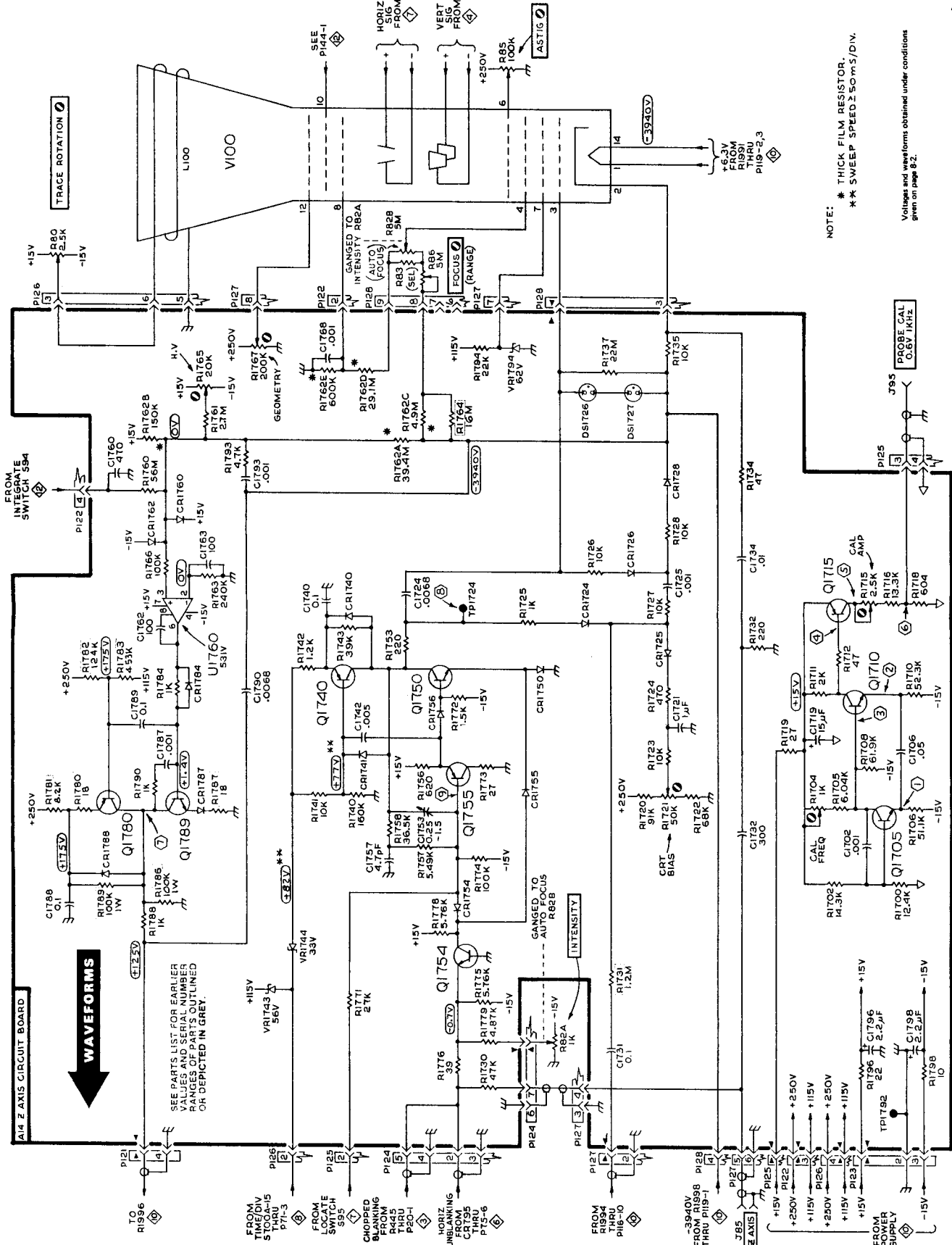

NOTE:
 * THICK FILM RESISTOR,
 ** SWEEP SPEED 250ms/DIV.

Volages and waveforms obtained under conditions given on page B-2.

CRT CIRCUIT & CALIBRATOR

REV. 1, Nov 1979

434 (SN B500000 & UP)

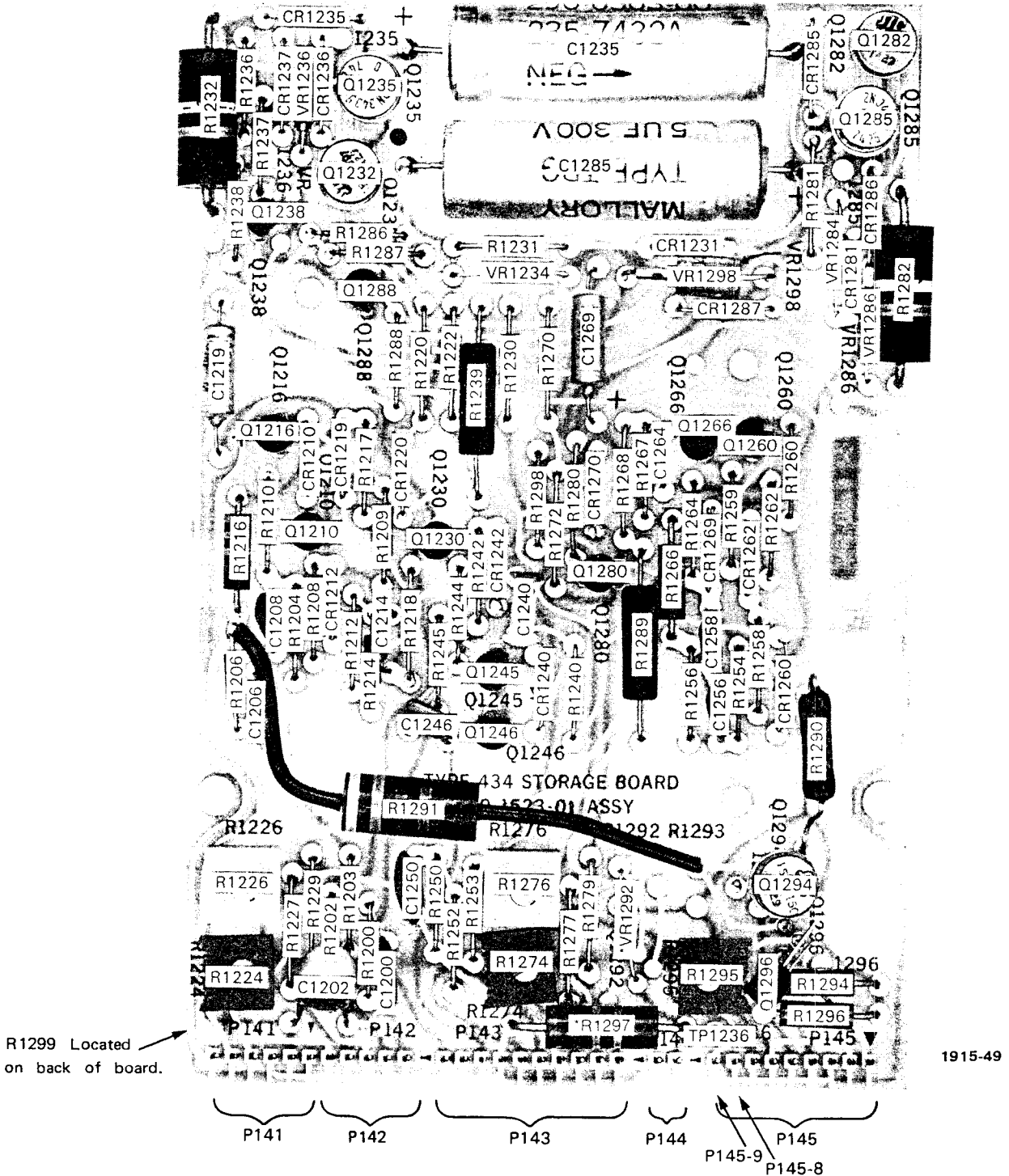

*See Parts List for serial number ranges.

Fig. 8-23. A12. STORAGE CIRCUIT BOARD (SN B50000 & UP).

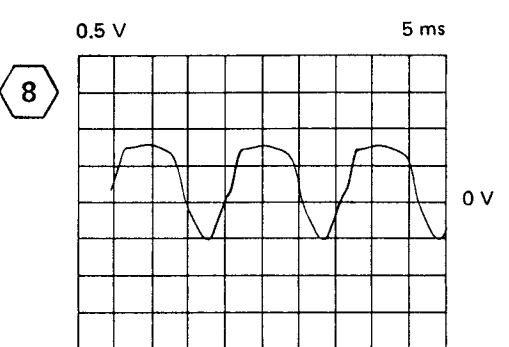
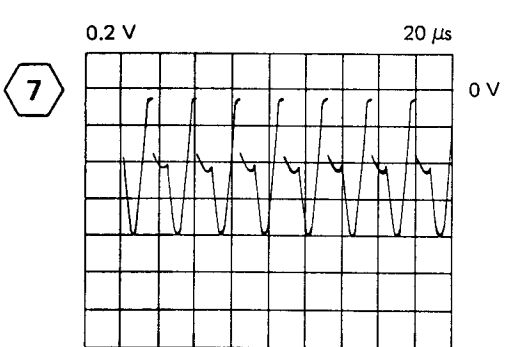
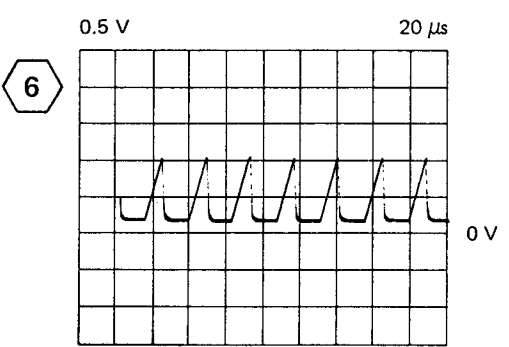
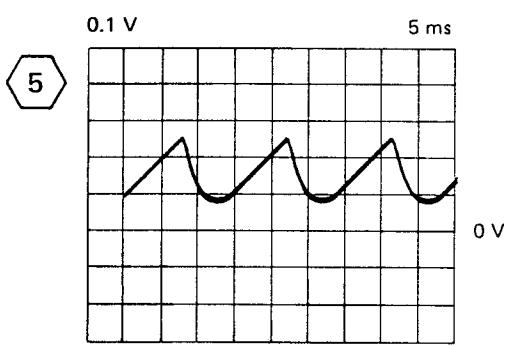
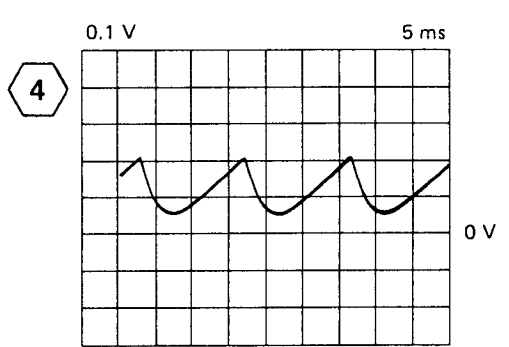
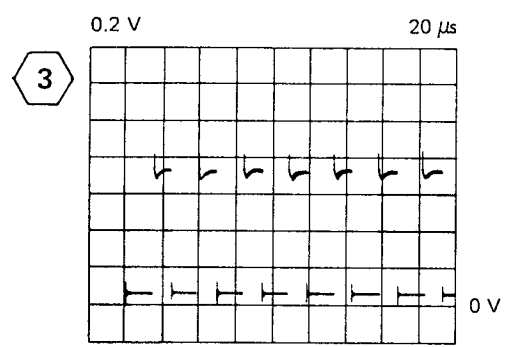
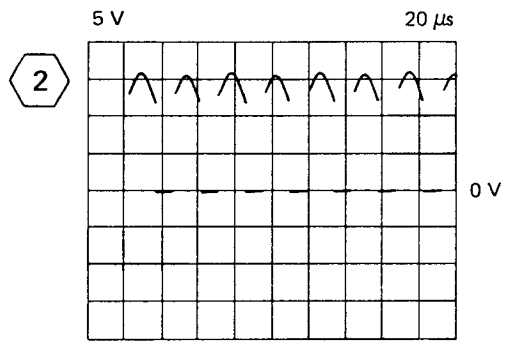
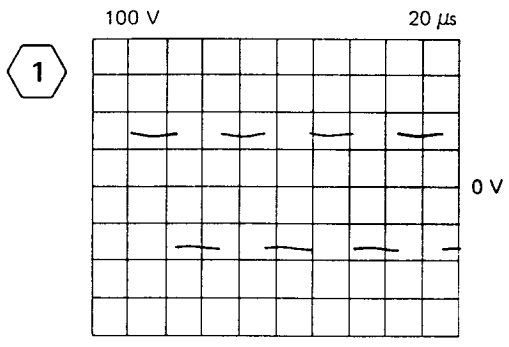

For Service Manuals Contact
MAURITRON TECHNICAL SERVICES
 8 Cherry Tree Rd, Chinnor
 Oxon OX9 4QY
 Tel: 01844-351694 Fax: 01844-352554
 Email: enquiries@mauritron.co.uk

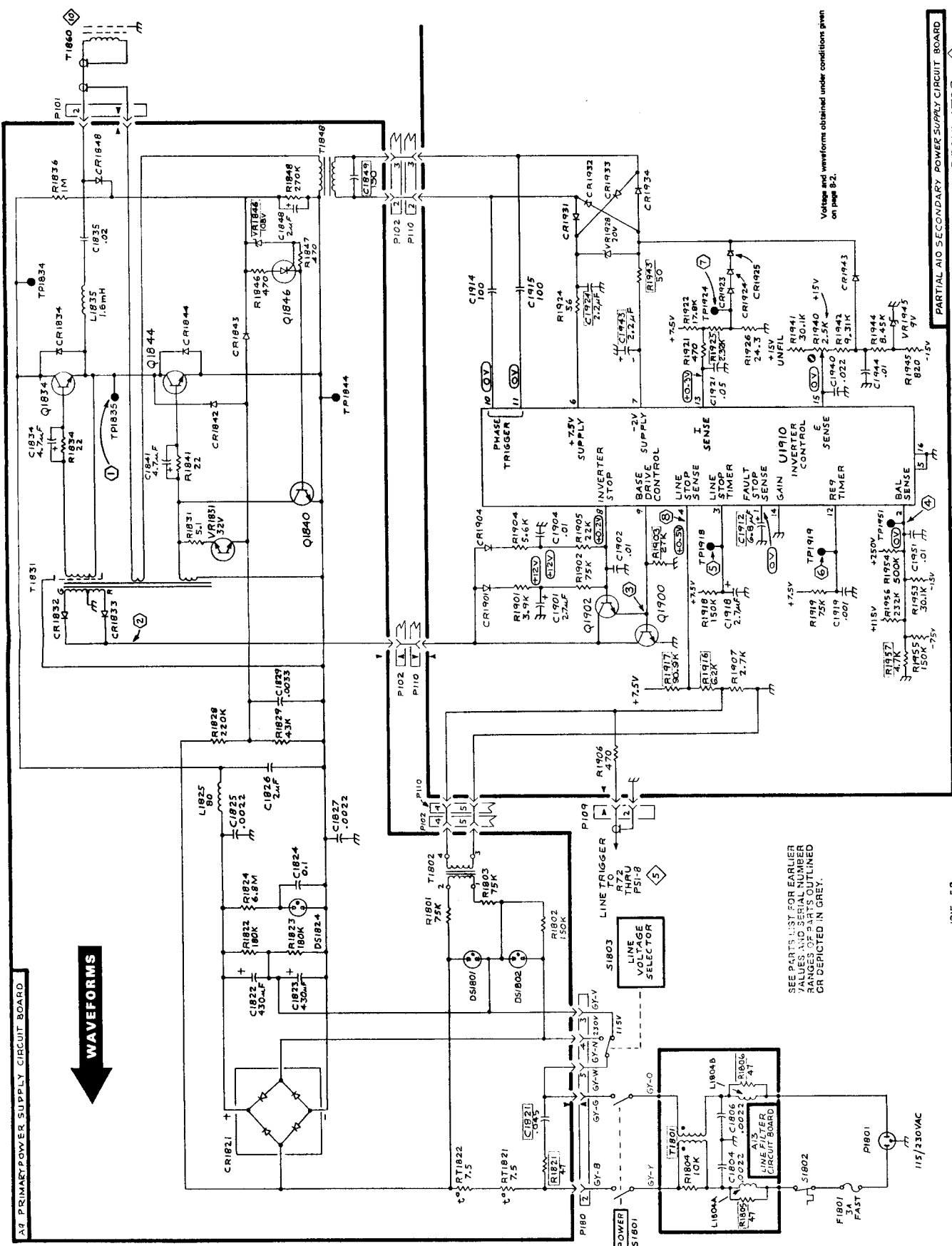

PRIMARY POWER SUPPLY CIRCUIT & REGULATOR

1915-58
REV JUN 1965

434(SN B500000 & UP)

Voltage and waveforms obtained under conditions given on page B-2.

SEE PARTS LIST FOR EARLIER VALUES AND SERIAL NUMBER RANGES OF PARTS OUTLINED OR DEPICTED IN GREY.

For Service Manuals Contact
MAURITRON TECHNICAL SERVICES
8 Cherry Tree Rd, Chinnor
Oxon OX9 4QY
Tel: 01844-351694 Fax: 01844-352554
Email: enquiries@maurtron.co.uk

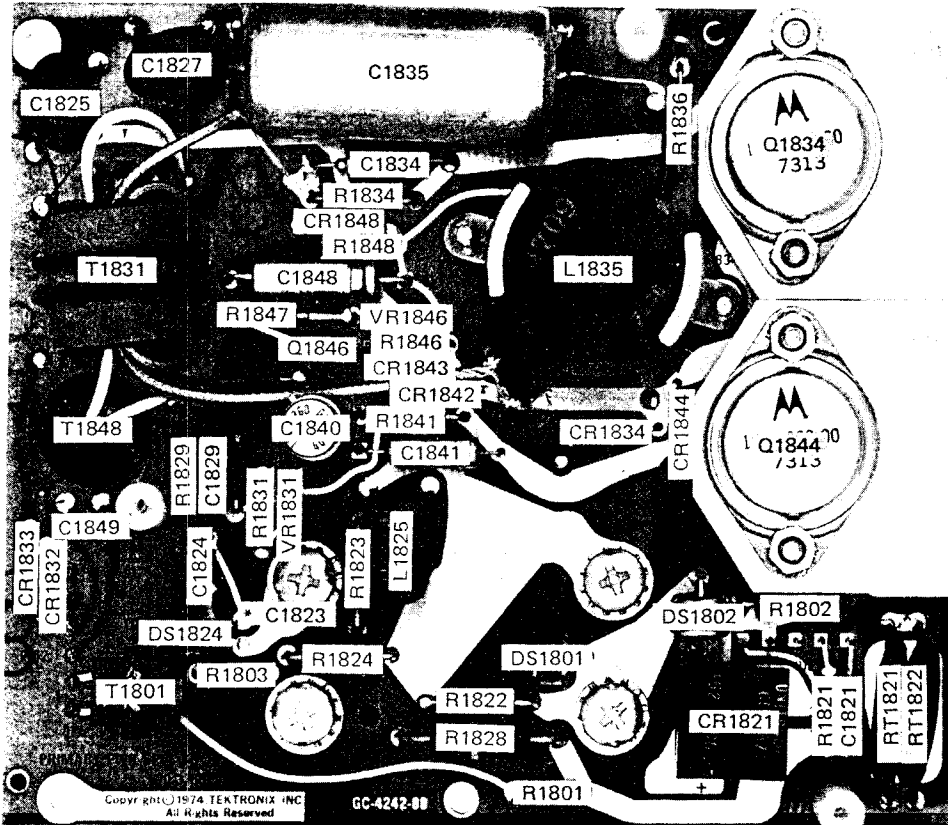

Located on back of board:
C1822

1915-43

Fig. 8-17. P/O A9. PARTIAL PRIMARY POWER SUPPLY CIRCUIT BOARD (SN B500000 & up).

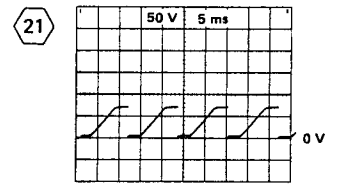
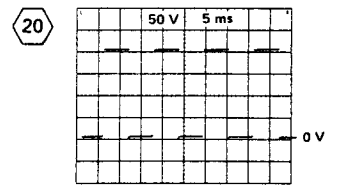
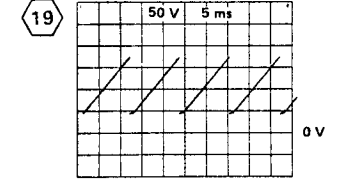
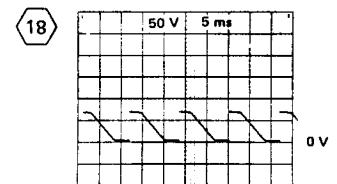
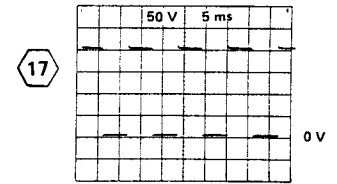
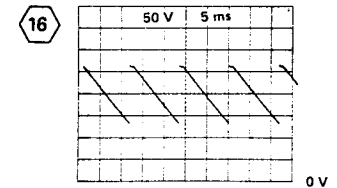
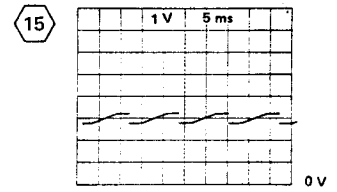
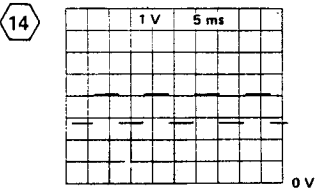
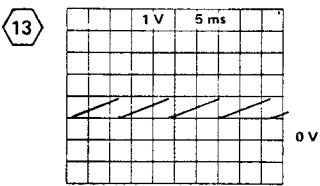
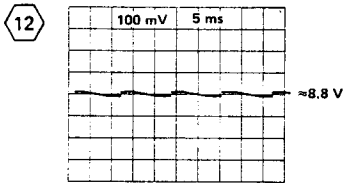
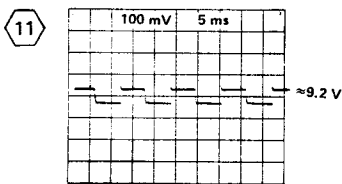
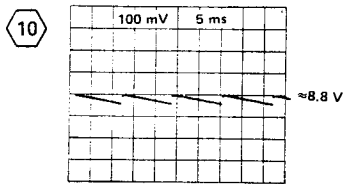
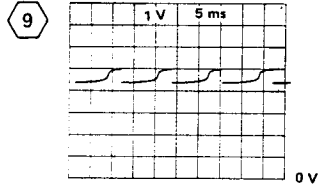
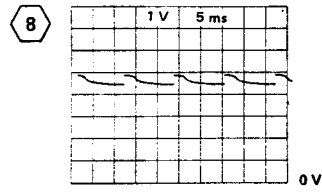
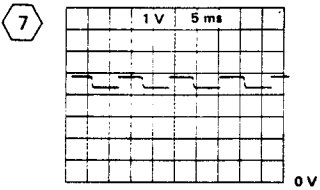
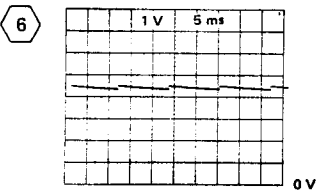
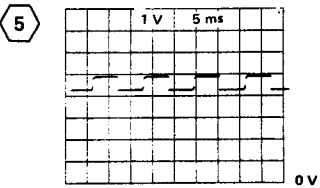
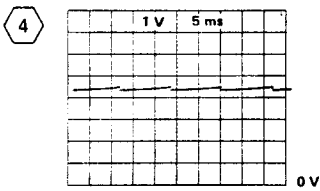
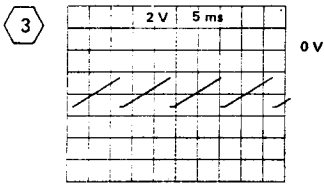
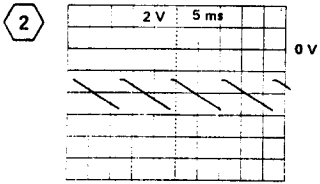
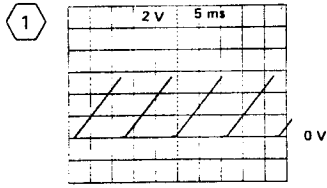

For Service Manuals Contact
MAURITRON TECHNICAL SERVICES
8 Cherry Tree Rd, Chinnor
Oxon OX9 4QY
Tel: 01844-351694 Fax: 01844-352554
Email: enquiries@mauritron.co.uk

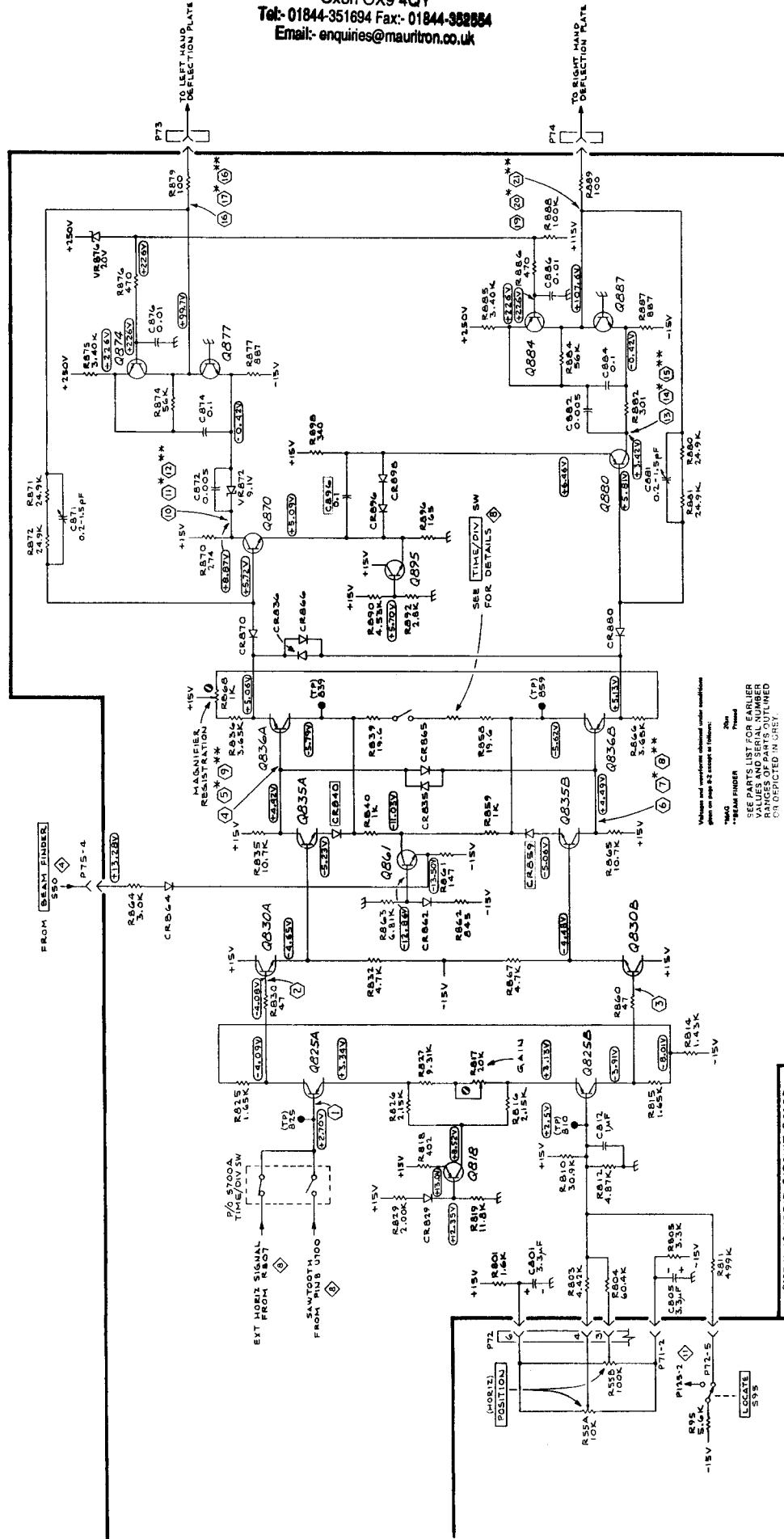

Values and manufacturer denoted under numbers
shown on page 82 control cabinet.

Part
Magnifier FINDER
SEE PARTS LIST FOR EARLIER
VALUES AND SERIAL NUMBER
RANGES AND SERIAL NUMBER
OR REGISTERED IN GREAT

1074
94L
HORIZONTAL AMPLIFIER

1915-56
REV D AUG 1980

4-3-4(SNB50000)EUP

For Service Manuals Contact
MAURITRON TECHNICAL SERVICES
8 Cherry Tree Rd, Chinnor
Oxon OX9 4QY
Tel: 01844-351694 Fax: 01844-352554
Email: enquiries@mauritron.co.uk

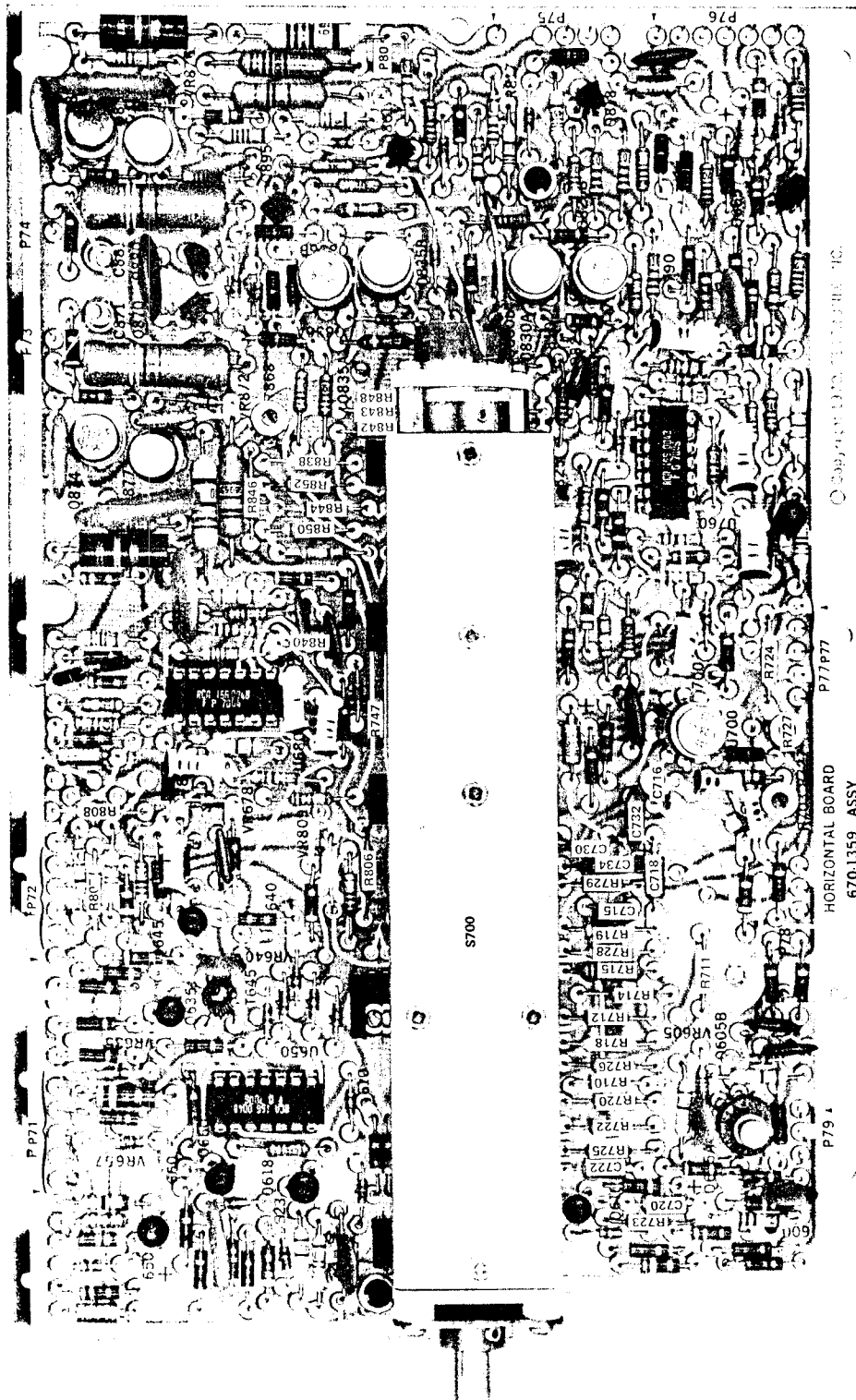

See Figs. 8-13, 8-14, and 8-15 for location of components not identified here.

1915-42

Fig. 8-16. P/O A8. Partial Horizontal circuit board.

REV B AUG 1980