

THE QUALITY OF  
THIS MANUAL IS  
THE BEST THAT  
IS AVAILABLE

Serial Number 5591

1212

For Service Manuals Contact  
MAURITRON TECHNICAL SERVICES  
8 Cherry Tree Rd, Chinnor  
Oxon OX9 4QY  
Tel:- 01844-351694 Fax:- 01844-352554  
Email:- enquiries@mauritron.co.uk

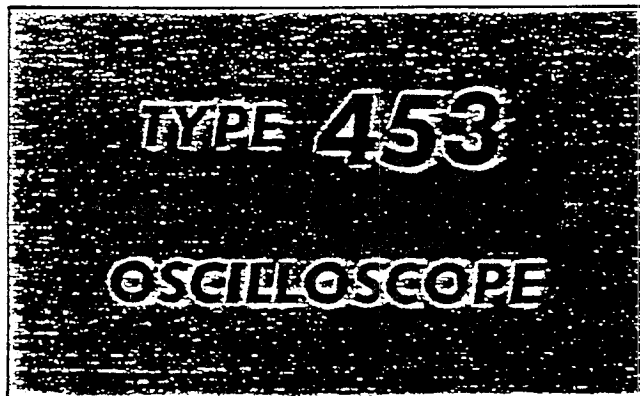

Tektronix, Inc.

S.W. Millikan Way • P. O. Box 500 • Beaverton, Oregon 97005 • Phone 644-0161 • Cables: Tektronix  
070-0478-00

665

## CONTENTS

- Warranty
- Section 1 Characteristics
- Section 2 Operating Instructions
- Section 3 Circuit Description
- Section 4 Maintenance
- Section 5 Performance Check
- Section 6 Calibration
- Section 7 Parts List And Diagrams

A list of abbreviations and symbols used in this manual will be found on page 7. Change information, if any, is located at the rear of the manual.

For Service Manuals Contact  
MAURITRON TECHNICAL SERVICES  
8 Cherry Tree Rd, Chinnor.  
Oxon OX9 4QY  
Tel: 01844-351694 Fax: 01844-352554  
Email: enquiries@mauritron.co.uk

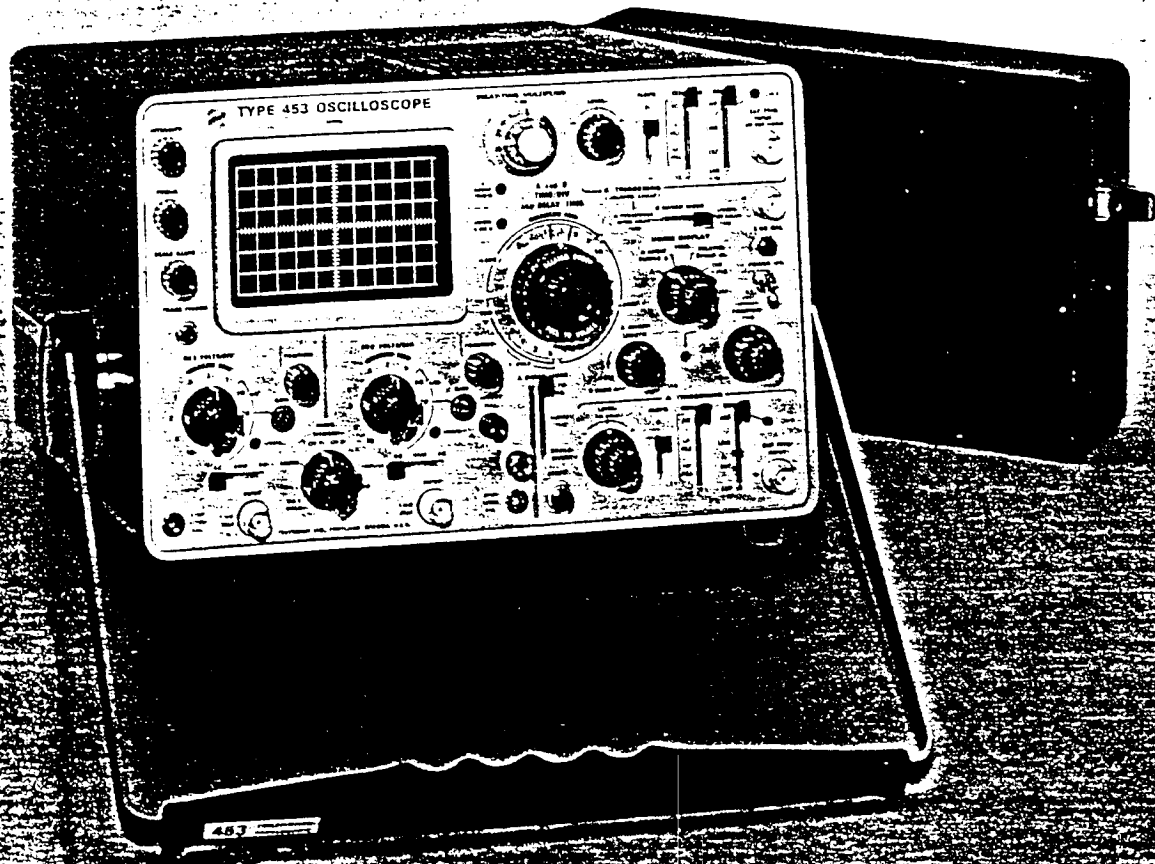

# SECTION 1

## CHARACTERISTICS

### Introduction

The Tektronix Type 453 Oscilloscope is a transistorized portable oscilloscope designed to operate in a wide range of environmental conditions. The light weight of the Type 453 allows it to be easily transported, while providing the performance necessary for accurate high-frequency measurements. The dual-channel, dc-to-50 Mc vertical system provides calibrated deflection factors from 5 millivolts to 10 volts/division. Channels 1 and 2 can be cascaded using an external cable to provide 1 millivolt minimum deflection factor (both VOLTS/DIV switches set to 5 mV). The trigger circuits provide stable triggering over the full range of vertical frequency response. The horizontal sweep provides

a maximum sweep rate of 0.1 microsecond/division (10 nanoseconds/division using 10X magnifier) along with a delayed sweep feature for accurate relative-time measurements. Accurate X-Y measurements can be made with Channel 2 providing the vertical deflection and Channel 1 providing the horizontal deflection (TRIGGER switch set to CH 1 ONLY HORIZ DISPLAY switch set to EXT HORIZ). The regulated dc power supplies maintain constant output over a wide variation of line voltages and frequencies. Total power consumption of the instrument is approximately 100 watts.

The following characteristics apply over an ambient temperature range of  $-15^{\circ}\text{C}$  to  $+55^{\circ}\text{C}$ , except as otherwise indicated. Warm-up time for given accuracy is 20 minutes.

### VERTICAL DEFLECTION SYSTEM

Characteristic	Performance Requirement		Supplemental Information
Deflection Factor	5 millivolts/division to 10 volts/division in 11 calibrated steps for each channel		Steps in 1-2-5 sequence
Deflection Accuracy	Within $\pm 3\%$ of indicated deflection with VARIABLE control fully clockwise		With gain correct at 20 mV
Variable Deflection Factor	Uncalibrated deflection factor at least 2.5 times the VOLTS/DIV switch indication. This provides a maximum uncalibrated deflection factor of 25 volts/division in the 10 volts position.		
Frequency Response (not more than 30% down)	Type 453 Only	With P6010 Probe	
	20 mV to 10 VOLTS/DIV	Dc to 52.5 Mc	Dc to 50 Mc
	10 mV/DIV	Dc to 46.5 Mc	Dc to 45 Mc
	5 mV/DIV	Dc to 41 Mc	Dc to 40 Mc
	Channel 1 and 2 cascaded	Dc to 25 Mc	Dc to 25 Mc
Added	Dc to 52.5 Mc	Dc to 50 Mc	Measured at 20 mV
Risetime (calculated)			
20 mV to 10 VOLTS/DIV	Less than 6.7 nanoseconds	7	
10 mV/DIV	Less than 7.5 nanoseconds	7.8	
5 mV/DIV	Less than 8.75 nanoseconds	8.75	
Channel 1 and 2 cascaded	Less than 14 nanoseconds	14	Measured at 1 millivolt/division
Added	Less than 6.7 nanoseconds	7	Measured at 20 mV
Input $R_c$ Characteristics			Typically 1 megohm ( $\pm 2\%$ ), parallel by 20 pf ( $\pm 3\%$ )
Maximum Input Voltage			600 volts combined dc and peak ac
Input Coupling Modes	Ac or dc, selected by front-panel switch		
AC Low-frequency response			Typically 30% down at 1.6 cps, AC GND DC switch set to AC
Trace Shift Due to Input Grid Current	Less than 0.4 division at 5 mv		
Vertical Display Modes	Channel 1 only Channel 2 only Dual-trace, alternate between channels Dual-trace, chopped between channels Added algebraically		



Characteristics—Type 453

**VERTICAL (cont'd)**

Characteristic	Performance Requirement	Supplemental Information	
Chopped Repetition Rate	Approximately 1-microsecond segments from each channel displayed at repetition rate of 500 kc, $\pm 20\%$		
Attenuator Isolation	Greater than 10,000:1, dc to 20 Mc		
Common Mode Rejection Ratio	Greater than 20:1 at 20 Mc; input signal less than eight times VOLTS/DIV switch setting	With optimum GAIN adjustment at low frequency	
Linear Dynamic Range useful for Common-Mode Rejection in ADD Mode		Less than 10% incremental signal distortion for instantaneous input voltage of $-10$ or $+10$ , times VOLTS/DIV switch setting	
Polarity Inversion	Signal on Channel 2 can be inverted		
Signal Delay		Approximately 140 nanoseconds	
Vertical Linearity	Less than 0.15 division compression or expansion of 2 division signal when positioned to vertical extremes of display area	Includes crt linearity	
Trace Drift (after 15 minute warm up) 20 mV to 10 VOLTS/DIV		Time	Temperature
		Typically less than 0.25 division/hour	Typically less than 0.025 division/degree C
10 mV/DIV	For Service Manuals Contact <b>MAURITRON TECHNICAL SERVICES</b> 8 Cherry Tree Rd, Chinnor Oxon OX9 4QY Tel: 01844-351694 Fax: 01844-352554 Email: enquiries@mauritron.co.uk	Typically less than 0.5 division/hour	Typically less than 0.05 division/degree C
5 mV/DIV		Typically less than 1 division/hour	Typically less than 0.1 division/degree C
Channel 1 Output Signal Output Voltage	Greater than 25 millivolts/division of crt display into 1 megohm load	At CH 1 OUT Connector. Channel 1 VARIABLE VOLTS/DIV control set to CAL	
Frequency Response (not more than 30% down)	Dc to 25 Mc when cascaded with Channel 2 or into 50-ohm load		
Risetime (calculated)	14 nanoseconds		
Output Coupling	Dc		
Output Resistance		Approximately 50 ohms	

**TRIGGERING (A AND B SWEEP)**

Characteristic	Performance Requirement	Supplemental Information
Source	Internal from displayed channel or from Channel 1 only Internal from ac line External External divide by 10	
Coupling	Ac Ac low-frequency reject Ac high-frequency reject Dc	
Polarity	Sweep can be triggered from positive-going or negative-going portion of trigger signal	
Internal Trigger Sensitivity AC	0.2 division of deflection, minimum, 30 cps to 10 Mc; increasing to 1 division at 50 Mc	Typically 30% down at 16 cps
LF REJ	0.2 division of deflection, minimum, 30 kc to 10 Mc; increasing to 1 division at 50 Mc	Typically 30% down at 16 kc
HF REJ	0.2 division of deflection, minimum, 30 cps to 50 kc	Typically 30% down at 16 cps and 100 kc
DC	0.2 division of deflection, minimum, dc to 10 Mc; increasing to 1 division at 50 Mc.	

**TRIGGERING (cont'd)**

Characteristic	Performance Requirement	Supplemental Information
External Trigger Sensitivity AC	50 millivolts, minimum, 30 cps to 10 Mc; increasing to 200 millivolts at 50 Mc	Typically 30% down at 16 cps
LF REJ	50 millivolts, minimum, 30 kc to 10 Mc; increasing to 200 millivolts at 50 Mc	Typically 30% down at 16 kc
HF REJ	50 millivolts, minimum, 30 cps to 50 kc	Typically 30% down at 16 cps and 100 kc
DC	50 millivolts, minimum, dc to 10 Mc; increasing to 200 millivolts at 50 Mc	
Auto Triggering (A Sweep only)	Provides normal triggering capability for trigger signals above 20 cps and produces free-running sweep in absence of trigger signal.	
Single Sweep (A Sweep only)	Triggering capability same as normal trigger Performance Requirement.	
Display Jitter	Less than .1 nanosecond at 10 nanoseconds/division sweep rate (MAG switch set to X10)	
Maximum Input Voltage		600 volts combined dc and peak ac
External Trigger Input R <sub>c</sub> Characteristics (approximate)		1 Megohm paralleled by 20 pf, except in LF REJ
LEVEL Control Range	At least ±2 volts, SOURCE switch in EXT position At least ±20 volts, SOURCE switch in EXT ÷10 position	

**HORIZONTAL DEFLECTION SYSTEM  
A and B Sweep Generator**

Characteristic	Performance Requirement	Supplemental Information
Sweep Rates A Sweep	0.1 microsecond/division to 5 seconds/division in 24 calibrated steps	A Sweep is main and delaying sweep
B Sweep	0.1 microsecond/division to 0.5 second/division in 21 calibrated steps	B Sweep is delayed sweep
Sweep Accuracy — A and B Sweep	0°C to +40°C	-15°C to +55°C
5 SEC to 0.1 SEC/DIV	Within ±3% of indicated sweep rate	Within ±5% of indicated sweep rate
50 mSEC to 0.1 μSEC/DIV	Within ±3% of indicated sweep rate	Within ±4% of indicated sweep rate
Variable Sweep Rate	Uncalibrated sweep rate to at least 2.5 times the TIME/DIV indication, or a maximum of at least 12.5 seconds/division in the 5 SEC position (B Sweep, maximum of 1.25 seconds/division in the .5 SEC position).	
Sweep Length A Sweep	Variable from less than 4 divisions to 11.0, ±0.5 division	A TIME/DIV switch set to 1 mSEC
B Sweep	11.0 divisions, ±0.5 division	B TIME/DIV switch set to 1 mSEC
Sweep Hold-off—A Sweep	Less than one times the A TIME/DIV switch setting	
5 μSEC to 0.1 μSEC/DIV	Less than 2.5 microsecond	
Gate Output Signal Waveshape	Rectangular pulse	
Polarity	Positive-going	
Amplitude	12 volts, ±10%	
Duration	About 11 times TIME/DIV switch setting	
Output resistance	Approximately 1.5 kilohms	

### Sweep Magnifier

Characteristic	Performance Requirement	Supplemental Information
Magnification	Each sweep rate can be increased 10 times the indicated sweep rate by horizontally expanding the center division of display	Extends fastest sweep rate to 10 nanoseconds/division
Magnified Sweep Accuracy	1% tolerance added to specified sweep accuracy	
Magnified Sweep Linearity	$\pm 1.5\%$ for any eight division portion of the total magnified sweep length (excluding first and last 60 nanoseconds of magnified sweep)	
Magnified Registration	Less than $\pm 0.2$ division trace shift at graticule center when switching MAG switch from $\times 10$ to OFF	

For Service Manuals Contact  
**MAURITRON TECHNICAL SERVICES**  
 8 Cherry Tree Rd, Chinnor  
 Oxon OX9 4QY  
 Tel: 01844-351684 Fax: 01844-352554  
 Email: enquiries@mauritron.co.uk

### Sweep Delay

Characteristic	Performance Requirement	Supplemental Information
Controlled Delay Time Range	Continuous from 50 seconds to 1 microsecond	A VARIABLE control set to CAL for indicated delay
Time Accuracy	0°C to +40°C	-15°C to +55°C
1 SEC to 0.1 SEC/DIV	Within $\pm 2.5\%$ of indicated sweep rate	Within $\pm 3.5\%$ of indicated sweep rate
10 nSEC to 1 $\mu$ SEC/DIV	Within $\pm 1.5\%$ of indicated sweep rate	Within $\pm 2\%$ of indicated sweep rate
Incremental Multiplier Linearity	$\pm 0.2\%$	$\pm 0.3\%$
Time Jitter	Less than 1 part in 20,000 of 10 times A TIME/DIV switch setting	

### External Horizontal Amplifier

Characteristic	Performance Requirement	Supplemental Information
Gain to Channel 1 (TRIGGER in CH 1 ONLY)	5 millivolts/division to 10 volts/division in 11 calibrated steps	Steps in 1-2-5 sequence. Channel 1 VARIABLE control does not affect horizontal deflection
Accuracy	0°C to +40°C	-15°C to +55°C
	Within $\pm 5\%$ of indicated deflection	Within $\pm 8\%$ of indicated deflection
Frequency response	Dc to 5 Mc, not more than 30% down	With External Horizontal gain correct at 20 mV
Impedance characteristics		Typically 1 megohm ( $\pm 2\%$ ), paralleled by 20 pf ( $\pm 3\%$ )
Phase difference between X and Y amplifiers at 50 KC		Less than 3°
EXT HORIZ Connector		
Deflection factor	B TRIGGERING SOURCE switch in EXT — 270 millivolts/division, $\pm 15\%$ B TRIGGERING SOURCE switch in EXT $\div 10$ — 2.7 volts/division, $\pm 20\%$	
Frequency response	Dc to 5 Mc, not more than 30% down	
Impedance characteristics (approximate)		1 megohm, paralleled by 20 pf
Phase difference between X and Y amplifiers at 50 KC		Less than 3°

**CALIBRATOR**

Characteristic	Performance Requirement		Supplemental Information
Waveshape	Square wave		
Polarity	Positive going with baseline at zero volts		
Output Voltage	0.1 volt or 1 volt, peak to peak		Selected by CALIBRATOR switch on side panel
Output Current	5-milliamps through PROBE LOOP on side panel		
Repetition Rate	1 kc		
Voltage Accuracy	0°C to +40°C	-15°C to +55°C	
	±1%	±1.5%	
Current Accuracy	±1%	±1.5%	
Repetition Rate Accuracy	±0.5%	±1%	
Risetime	Less than 1 microsecond		
Duty Cycle	49% to 51%		
Output Resistance			Approximately 200 ohms in 1 V position Approximately 20 ohms in .1 V position

**Z AXIS INPUT**

Characteristic	Performance Requirement	Supplemental Information
Sensitivity	5 volt peak-to-peak signal produces noticeable modulation	
Usable Frequency Range	Dc to greater than 50 Mc	
Input Resistance at DC		Approximately 47 kilohms
Input Coupling	Dc coupled	
Polarity of Operation		Positive-going input signal will decrease trace intensity Negative-going signal will increase trace intensity
Maximum Input Voltage		200 volts combined dc and peak ac

**POWER SUPPLY**

Characteristic	Performance Requirement	Supplemental Information
Voltage Requirements		
115-volt range	LOW—96 to 127 volts, rms, ac line voltage provides regulated dc voltages HIGH—103 to 137 volts, rms, ac line voltage provides regulated dc voltages	Applicable when line contains less than 2% total harmonic distortion
230-volt range	LOW—192 to 254 volts, rms, ac line voltage provides regulated dc voltages HIGH—206 to 274 volts, rms, ac line voltage provides regulated dc voltages	
Line Frequency	45 to 440 cps	
Power Consumption		Approximately 100 watts

### CATHODE-RAY TUBE (CRT)

Characteristic	Information
Tube Type	T4530-31-1 rectangular, glass envelope
Phosphor	P31 standard. Others available on special order
Accelerating Potential	Approximately 10 kv (gun potential, 2 kv)
Deflection Type	Internal
Grid Area	6 divisions vertical by 10 divisions horizontal. Each division equals 0.8 centimeter
Illumination	Variable edge lighting
Blanking	Dc-coupled to crt grid from Sweep Generator

### MECHANICAL CHARACTERISTICS

Characteristic	Information
Construction	Aluminum-alloy chassis, panel and cabinet Glass laminate etched-wiring boards
Finish	Anodized panel, blue vinyl-coated cabinet
Overall Dimensions (measured at maximum points)	7.25" high, 12.5" wide, 23.5" long (includes panel cover and handle)
Net Weight	29 lbs. 2 oz. (includes power cord and panel cover without accessories)

### ENVIRONMENTAL CHARACTERISTICS

#### NOTE

The Type 453 has been designed to meet the following environmental characteristics. During production, samples of the Type 453 will be checked to assure that the instrument continues to meet the environmental characteristics. Environmental tests can be grouped into two general categories: Tests which may be repeated an indefinite number of times without physical damage to, or performance deterioration of, the instrument (Category I); and tests which should be repeated only once as they may cause minor damage to the instrument without causing it to malfunction (Category II). The following environmental characteristics will be grouped into these categories. Complete details on environmental test procedures, including failure criteria, etc., may be obtained from Tektronix, Inc. Contact your local Field Office or representative.

### Category I

Characteristic	Requirement
Temperature Operating	Type 453 will perform to limits given in this section over a temperature range of -15°C to +55°C. Maximum operating temperature must be derated 1°C/1000 feet increase in altitude from 5000 to 15,000 feet. Fan at rear of instrument blows filtered air throughout instrument. Automatic resetting thermal cut-out interrupts instrument power if internal temperature exceeds a safe operating level.
Non-Operating	-55°C to +75°C
Altitude Operating	Type 453 will perform to limits given in this section up to 15,000 feet. See derating information under 'Temperature'.
Non-Operating	50,000 feet maximum

For Service Manuals Contact  
**MAURITRON TECHNICAL SERVICES**  
 8 Cherry Tree Rd, Chinnor  
 Oxon OX9 4QY  
 Tel: 01844-351694 Fax: 01844-352554  
 Email: enquiries@mauritron.co.uk

### Category II

Characteristic	Requirement
Humidity Non-Operating	Instrument will perform to limits given in this section following 5 cycles (120 hours) of Mil-Std-202B, Method 106A (exclude freezing and vibration).
Vibration Operating and Non operating	Instrument will perform to limits given in this section following vibration test. Vibrated for 15 minutes along each axis at a total displacement of 0.025-inch peak to peak (4G at 55 cps) from 10-55-10 cps in 1 minute cycles. Held for 3 minutes at 55 cps. Total vibration time, 55 minutes.
Shock Operating and Non-Operating	Instrument will perform to limits given in this section following shock test. 30G, one-half sine, 11 millisecond duration. Two shocks each direction along each axis (total of 12 shocks).
Transportation Non-operating	Meets National Safe Transit type of test when factory packaged. Package shake test—One hour in excess of 1G. Package drop test—30-inch drops on one corner, three edges and all flat surfaces (total of 10 drops).

### ACCESSORIES

Information on accessories for use with this instrument is included at the rear of the mechanical parts list.

# SECTION 2

## OPERATING INSTRUCTIONS

### General

To effectively use the Type 453, the operation and capabilities of the instrument must be known. This section describes the operation of the front-, side- and rear-panel controls and connectors, gives first time and general operating information and lists some basic applications for this instrument.

### Front Cover and Handle

The front cover furnished with the Type 453 provides a dust-tight seal around the front panel. Use the cover to protect the front panel when storing or transporting the instrument. The cover also provides storage space for probes and other accessories (see Fig. 2-1).

The handle of the Type 453 can be positioned for carrying or as a tilt-stand for the instrument. To position the handle, press in at both pivot points (see Fig. 2-2) and turn the handle to the desired position. Several positions are provided for convenient carrying or viewing. The instrument may also be set on the rear-panel feet for operation or storage.

### Voltage Considerations

The Type 453 can be operated from either a 115- or 230-volt nominal line. Switching between ranges is automatically accomplished when the correct power cord for the nominal voltage range is installed in the power receptacle on the

rear of the instrument. Fig. 2-3 shows the power receptacle on the rear of the instrument and the power cords.

### WARNING

The Type 453 should not be operated with power cords which have been altered to prevent the above-mentioned switching. Operation of the instrument in the wrong voltage range will either provide incorrect operation or damage the instrument.

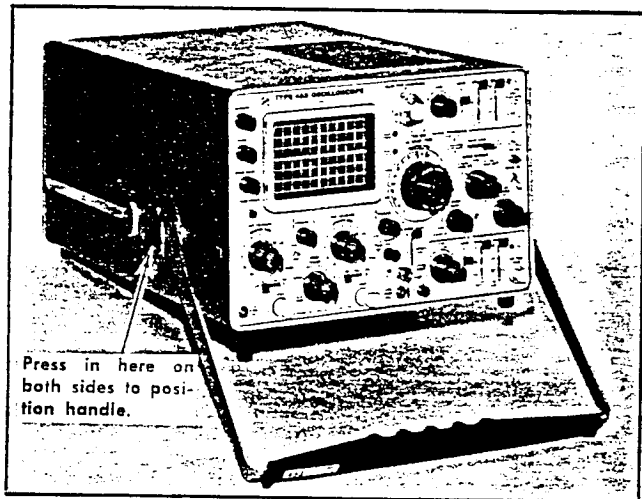

Fig. 2-2. Handle positioned to provide a stand for the instrument.

The LINE VOLTAGE RANGE switch on the rear panel allows the instrument to operate on line voltages above or below the nominal voltage. Each range provides correct regulation at 115- (or 230-) volt nominal line. However, it is recommended that the LOW range be used only when the line voltage is below the lower limit of the HIGH range. The regulating range in each position is given in Table 2-1.

TABLE 2-1

LINE VOLTAGE RANGE switch position	115-volt nominal	230-volt nominal
HIGH	103-137	206-274
LOW	96-127	192-254

### CONTROLS AND CONNECTORS

A brief description of the function or operation of the front-, side- and rear-panel controls and connectors follows (see Fig. 2-4). More detailed information is given in this section under 'General Operating Information.'

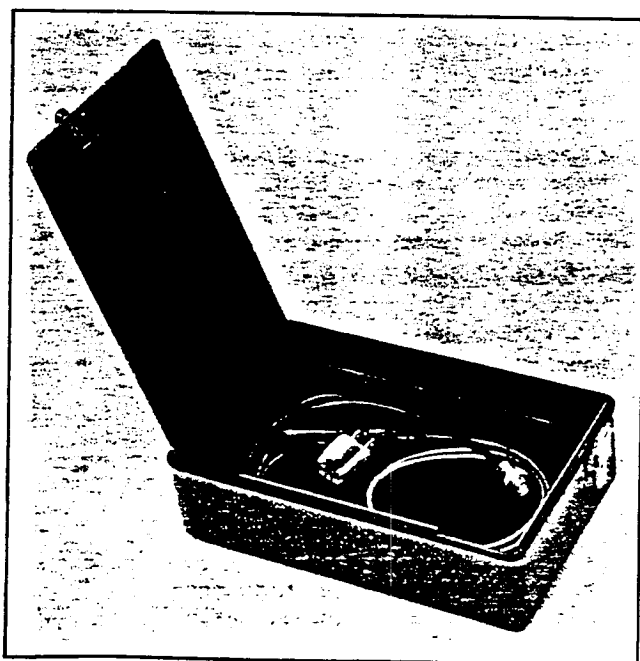

Fig. 2-1. Accessory storage provided in front cover.

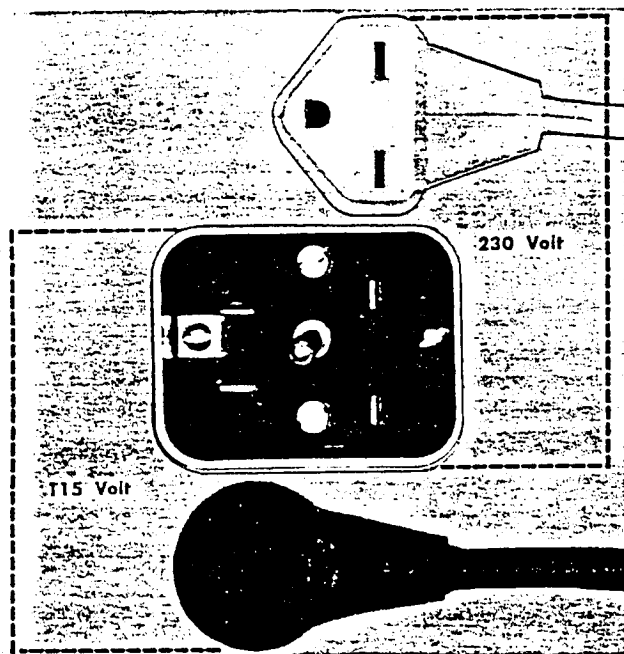

Fig. 2-3. Power receptacle and power cords.

For Service Manuals Contact  
**MAURITRON TECHNICAL SERVICES**  
 8 Cherry Tree Rd, Chinnor  
 Oxon OX9 4QY  
 Tel: 01844-351694 Fax: 01844-352554  
 Email: enquiries@mauritron.co.uk

**Cathode-Ray Tube**

- INTENSITY** Controls brightness of display.
- FOCUS** Provides adjustment for a well-defined display.
- SCALE ILLUM** Controls graticule illumination.
- TRACE FINDER** Returns the display to the screen, when pressed, by reducing horizontal and vertical deflection. Used to locate trace which exceeds scan of display area.

**Vertical (both channels if applicable)**

- VOLTS/DIV** Selects vertical deflection factor (VARIABLE control must be in CAL position for indicated deflection factor).
- VARIABLE** Provides continuously variable deflection factor to at least 2.5 times setting of VOLTS/DIV switch.
- POSITION** Controls vertical position of trace.
- GAIN** Screwdriver adjustment to set gain of the Vertical Preamp. Line between adjustment and 20 mV VOLTS/DIV position indicates that gain should be set with VOLTS/DIV switch in this position.

- AC GND DC** Selects method of coupling input signal to grid of Input Amplifier.  
 AC: Dc component of input signal is blocked. Low frequency limit (30% down) is about 1.6 cps.  
 GND: Input circuit is grounded (does not ground applied signal).  
 DC: All components of the input signal are passed to the Input Amplifier.

- STEP ATTEN BAL** Screwdriver adjustment to balance Input Amplifier in the 5, 10 and 20 mV positions of the VOLTS/DIV switch.
- INPUT MODE** Vertical input connector for signal.  
 Selects vertical mode of operation.  
 CH 1: The Channel 1 signal is displayed.  
 CH 2: The Channel 2 signal is displayed.  
 ALT: Dual trace display of signal on both channels. Display switched at end of each sweep.  
 CHOP: Dual trace display of signal on both channels. Approximately 1 micro-second segments from each channel displayed at a repetition rate of about 500 kc.  
 ADD: Channel 1 and 2 signals are algebraically added and the algebraic sum is displayed on the crt.
- TRIGGER** Selects source of internal triggering signal from vertical system.  
 NORM: Sweep circuits triggered from displayed channel(s). Channel 1 signal available at CH 1 OUT connector.  
 CH 1 ONLY: Sweep circuits triggered only from signal on Channel 1. No signal available at CH 1 OUT connector.
- INVERT** When pulled out, inverts the Channel 2 signal.
- A and B Triggering (both where applicable)**
- EXT TRIG INPUT** Input connector for external triggering signal. Connector in B Triggering section of front panel also serves as external horizontal input when HORIZ DISPLAY switch is in EXT HORIZ position.
- SOURCE** Selects source of triggering signal.  
 INT: Internal triggering provided from Vertical system. When CH 1 light is on, triggering signal is obtained only from the Channel 1 input signal; when the light is off, triggering is obtained from displayed channel(s). Source of internal trigger signal is selected by the TRIGGER switch.  
 LINE: Sweep triggered at line frequency.  
 EXT: Sweep triggered from signal applied to EXT TRIG INPUT connector.  
 EXT ÷10: Attenuates external signals 10 times.
- COUPLING** Determines method of coupling triggering signal to trigger circuit.  
 AC: Rejects dc and attenuates signals below 30 cps.  
 LF REJ: Rejects dc and attenuates signals below 30 kc.  
 HF REJ: Passes signals between 30 cps and 50 kc; rejects dc and attenuates signals outside the above range.  
 DC: Accepts ac and dc triggering signals.

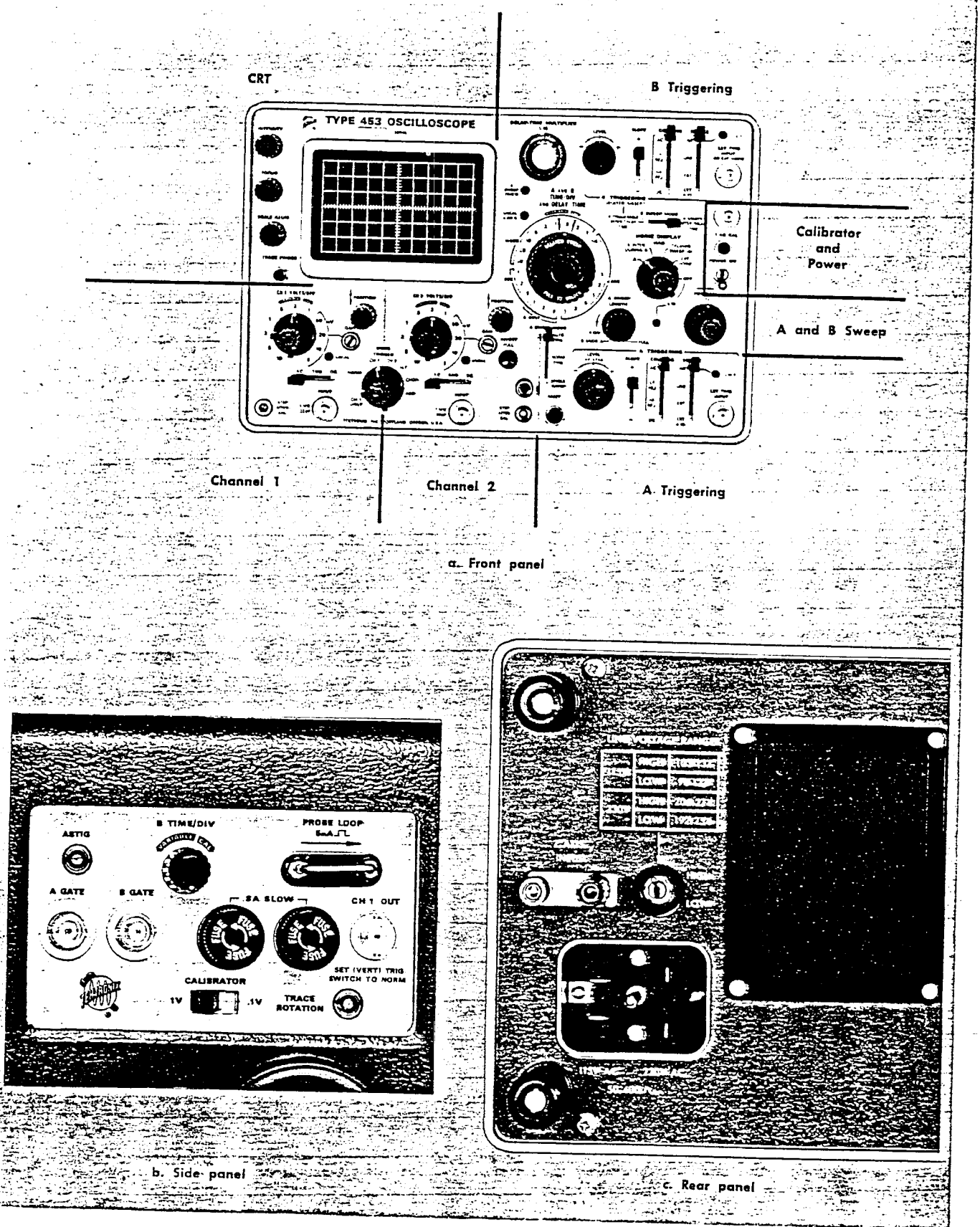

Fig. 2-4. Front-, side-, and rear-panel controls and connectors.



Operating Instructions—Type 453

<p><b>SLOPE</b> Selects portion of triggering signal which will trigger sweep.                      +: Sweep triggered from positive-going portion of triggering signal.                      -: Sweep triggered from negative-going portion of triggering signal.</p> <p><b>LEVEL</b> Selects amplitude point on triggering signal where sweep is triggered.</p> <p><b>HF STAB</b> Provides stable display for signals above about 10 Mc at sweep rates of 10 or 20 nanoseconds/division (MAG switch set to X10). Has negligible effect at lower sweep rates. (A Sweep only.)</p> <p><b>A and B Sweep</b></p> <p><b>DELAY-TIME MULTIPLIER</b> Provides variable sweep delay between 0.50 and 10.00 times the delay time indicated by the A TIME/DIV switch.</p> <p><b>A SWEEP TRIG'D</b> Light indicates that A SWEEP is triggered and will produce a stable display with correct INTENSITY and Horizontal POSITION control settings.</p> <p><b>UNCAL A OR B</b> Light indicates that either A or B VARIABLE control is not in the CAL position.</p> <p><b>A AND B TIME/DIV AND DELAY TIME</b> A TIME/DIV switch selects the sweep rate of the A Sweep circuit and selects the basic delay time (to be multiplied by DELAY-TIME MULTIPLIER setting). B TIME/DIV (DELAYED SWEEP) switch selects sweep rate of the B Sweep circuit. VARIABLE controls must be in the CAL position for calibrated sweep rate.</p> <p><b>A VARIABLE</b> Provides continuously variable sweep rate to at least 2.5 times setting of A TIME/DIV switch. Sweep rate is calibrated when control is set fully clockwise to CAL.</p> <p><b>B SWEEP MODE</b> Selects B Sweep operation mode.  <b>B TRIGGERABLE AFTER DELAY TIME:</b> B Sweep circuit will not produce a sweep until a trigger pulse is received following the delay time selected by the DELAY TIME (A TIME/DIV) switch and the DELAY-TIME MULTIPLIER dial.  <b>B STARTS AFTER DELAY TIME:</b> B Sweep circuit runs immediately following delay time selected by the DELAY TIME switch and DELAY-TIME MULTIPLIER dial.</p> <p><b>HORIZ DISPLAY</b> Selects Horizontal mode of operation.                      A: Horizontal sweep provided by A Sweep. B Sweep inoperative.                      A INTEN DURING B: Sweep rate determined by A TIME/DIV switch. An intensified portion, length of which is about 10 times setting of B TIME/DIV switch, will appear on the sweep. This position provides a check of the duration and position of B Sweep with respect to A Sweep.</p>	<p><b>MAG</b> Increases sweep rate to ten times setting of A or B TIME/DIV switch by horizontally expanding the center division of the display. Light indicates when magnifier is on.</p> <p><b>A SWEEP MODE</b> Determines A Sweep operation mode.  <b>AUTO TRIG:</b> Each sweep may be triggered in the normal manner when the triggering signal repetition rate is above 20 cps. For lower repetition rates or when there is no triggering signal, the sweep generator free runs to produce a bright reference trace at all sweep rates.  <b>NORM TRIG:</b> Sweep is triggered from an internal or external signal using the A Triggering controls.  <b>SINGLE SWEEP:</b> Displays one sweep and then shuts off until reset.</p> <p><b>RESET</b> When light is on, the sweep is ready to produce a display when a trigger is received (SINGLE SWEEP mode). After a sweep is completed, the RESET button must be pressed before another sweep can be presented.</p> <p><b>A SWEEP LENGTH</b> Adjusts length of A Sweep. In the FULL position (clockwise detent), the sweep is about 11 divisions long. As the control is rotated counterclockwise, A Sweep length will be reduced until it is less than 4 divisions long just before the detent in the fully-counterclockwise position is reached. In the B ENDS A position (counterclockwise detent), the A Sweep is reset at the end of the B Sweep. This provides the fastest possible sweep repetition rate for delayed sweep signals.</p> <p><b>POSITION FINE</b> Controls horizontal position of trace.  <b>1 KC CAL</b> Provides more precise horizontal position adjustment.  <b>POWER ON</b> Calibrator output connector.                      Light: Indicates that POWER switch is on and the instrument is connected to a line source.                      Switch: Applies power to the instrument.</p> <p><b>Side Panel</b></p> <p><b>ASTIG</b> Screwdriver adjustment used in conjunction with the FOCUS control to obtain a well-defined display. Does not require readjustment in normal use.</p> <p><b>B TIME/DIV-VARIABLE</b> Provides continuously variable sweep rate to at least 2.5 times setting of B TIME/DIV switch. Sweep rate is calibrated when control is fully clockwise to CAL.</p>	<p>PROBE</p> <p>A GAT</p> <p>B GAT</p> <p>.8A SLC</p> <p>CH 1 C</p> <p>CALIBR</p> <p>TRACE TION</p> <p>Rear F</p> <p>Z AXIS</p> <p>Power</p> <p>LINE V RANC</p> <p>The f trols an this pr iorizatic</p> <p>1. Set t</p> <p>Crt Co</p> <p>INT</p> <p>FO</p> <p>SC</p> <p>Vertical</p> <p>VC</p> <p>VA</p> <p>PO</p> <p>AC</p> <p>MC</p> <p>TRI</p> <p>INT</p> <p>Triggeri</p> <p>LEV</p> <p>SLC</p> <p>CC</p> <p>SO</p>
--	---	--

PROBE LOOP	Current loop providing 5-milliamp square-wave current from calibrator circuit.
A GATE	Output connector providing a rectangular pulse coincident with A Sweep.
B GATE	Output connector providing a rectangular pulse coincident with B Sweep.
.8A SLOW	Fuses for line.
CH 1 OUT	Output connector providing signal output from Channel 1 when the TRIGGER switch is in the NORM position.
CALIBRATOR	Switch selects output voltage of Calibrator. 1-volt or 0.1-volt square wave available.
TRACE ROTATION	Screwdriver adjustment to align trace with horizontal graticule lines.
<b>Rear Panel</b>	
Z AXIS INPUT	Input connector for intensity modulation of the crt display.
Power	Input connector for line power. Left part of connector is for 115-volt input; right part is for 230-volt input. Instrument automatically switched between ranges when correct power cord is installed.
LINE VOLTAGE RANGE	Selects line-voltage regulating range of low-voltage power supplies.

**FIRST-TIME OPERATION**

The following steps will demonstrate the use of the controls and connectors of the Type 453. It is recommended that this procedure be followed completely for first-time familiarization with the instrument.

1. Set the front-panel controls as follows:

<b>Crt Controls</b>	
INTENSITY	Counterclockwise
FOCUS	Midrange
SCALE ILLUM	Counterclockwise
<b>Vertical Controls (both channels if applicable)</b>	
VOLTS/DIV	20 mV
VARIABLE	CAL
POSITION	Midrange
AC GND DC	GND
MODE	CH 1
TRIGGER	NORM
INVERT	Pushed in
<b>Triggering Controls (both A and B if applicable)</b>	
LEVEL	Clockwise (+)
SLOPE	+
COUPLING	AC
SOURCE	INT

<b>Sweep Controls</b>	
DELAY-TIME MULTIPLIER	0.50
A and B TIME/DIV	.5 mSEC
A VARIABLE	CAL
B SWEEP MODE	B STARTS AFTER DELAY TIME
HORIZ DISPLAY	A
MAG	OFF
POSITION	Midrange
A SWEEP LENGTH	FULL
A SWEEP MODE	AUTO TRIG
POWER	ON

<b>Side-Panel Controls</b>	
B TIME/DIV VARIABLE	CAL
CALIBRATOR	.1 V

<b>Rear-Panel Controls</b>	
LINE VOLTAGE RANGE	HIGH*

2. Connect the Type 453 to a power source that meets the voltage and frequency requirements of the instrument.

3. Advance the INTENSITY control until the trace is at the desired viewing level (near midrange).

4. Adjust the FOCUS control for a sharp well-defined display over the entire trace length. (If focused display cannot be obtained, see 'Astigmatism Adjustment' in this section.)

5. Move the trace with the Channel 1 POSITION control so it coincides with one of the horizontal graticule lines. If the trace is not parallel with the graticule line, see 'Trace Alignment Adjustment' in this section.

6. Turn the SCALE ILLUM control clockwise. Note that as the control is advanced beyond about midrange the graticule lines are illuminated (most obvious with mesh or smoke-gray filter installed). Set control so graticule lines are illuminated as desired.

7. Change the CH 1 VOLTS/DIV switch from 20 mV to 5 mV. If the vertical position of the trace shifts, see 'Step Attenuator Balance' in this section.

8. Set the Channel 1 AC GND DC switch to AC and connect the 1 KC CAL connector to both the Channel 1 and 2 INPUT connectors with 50-ohm cables and a BNC T connector.

9. Turn the A Triggering LEVEL control toward 0 until the display becomes stable. Note that the A SWEEP TRIG'D light comes on when the display is stable.

10. Turn the Channel 1 POSITION control to center the display. The display is a square wave, 5 divisions in amplitude with 5 cycles displayed on the screen. If the display is not 5 divisions in amplitude, see 'Vertical Gain Adjustment' in this section.

\*If the line voltage is below 103 (206) volts, set to LOW.

For Service Manuals Contact  
**MAURITRON TECHNICAL SERVICES**  
 8 Cherry Tree Rd. Chinnor  
 Oxon OX9 4QY  
 Tel: 01844-351694 Fax: 01844-352554  
 Email: enquiries@mauritron.co.uk

## Operating Instructions—Type 453

11. Turn the Channel 1 VARIABLE control throughout its range. Note that the UNCAL light comes on when the VARIABLE control is moved from the CAL position (fully clockwise). The deflection should be reduced to about 2 divisions. Return the VARIABLE control to CAL.

12. Turn the Channel 1 POSITION control to move the display to the top of the graticule.

13. Set the MODE switch to CH 2.

14. Turn the Channel 2 POSITION control to center the display. The display will be similar to the previous display for Channel 1. Check Channel 2 step attenuator balance, gain and VARIABLE control as described in steps 7 through 11.

15. Turn the Channel 2 POSITION control to move the display to the bottom of the graticule.

16. Pull the INVERT switch. The display is now at the top of the graticule area. Push the switch in.

17. Set the MODE switch to ALT; the Channel 1 and 2 displays as set up in steps 12 and 15 should both be seen. Turn the TIME/DIV switch throughout its range. Note that the display alternates between channels at all sweep rates.

18. Set the MODE switch to CHOP and the TIME/DIV switch to 10  $\mu$ SEC. Note the switching between channels as shown by the segmented trace. Set the TRIGGER switch to CH 1 ONLY; the trace should appear more solid. Turn the TIME/DIV switch throughout its range. A dual trace display is presented at all sweep rates, but unlike ALT, both channels are displayed on each trace on a time-sharing basis. Return the TIME/DIV switch to .5 mSEC.

19. Set the MODE switch to ADD and the VOLTS/DIV switch to 50 mV. The display should be four divisions in amplitude. Note that either POSITION control moves the display.

20. Pull the INVERT switch. The display is a straight line indicating that the algebraic sum of the two signals is zero.

21. Set either VOLTS/DIV switch to 20 mV. The 3 division display indicates that the algebraic sum of the two signals is no longer zero. Return the MODE switch to CH 1 and both VOLTS/DIV switches to .2. Push in the INVERT switch.

22. Set the CALIBRATOR switch to 1 V. Rotate the A Triggering LEVEL control throughout its range. The display free runs at the extremes of rotation. Note that the A SWEEP TRIG'D light is on only when the display is triggered.

23. Set the A SWEEP MODE switch to NORM TRIG. Again rotate the A Triggering LEVEL control throughout its range. A display will be presented only when it is stable (triggered). The A SWEEP TRIG'D light operates as in AUTO TRIG. Return the A SWEEP MODE switch to AUTO TRIG.

24. Set the A Triggering SLOPE switch to  $-$ . The trace will start on the negative part of the square wave. Return the switch to  $+$ ; the trace starts with the positive part of the square wave.

25. Set the A Triggering COUPLING switch to DC. Turn the Channel 1 POSITION control until the display becomes unstable (only part of square wave visible). Return the

COUPLING switch to AC; the display is again stable. Since changing trace position changes dc level, this shows how dc level changes affect DC trigger coupling. Return the display to the center of the screen.

26. Set the MODE switch to CH 2; the display should be stable. Remove the signal connected to Channel 1; the display will free run. Set the TRIGGER switch to NORM; the display will again be stable. When the TRIGGER switch is changed to NORM, the CH 1 lights in A and B Triggering will go out.

27. Connect the Calibrator signal to both the Channel 2 INPUT and A Triggering EXT TRIG INPUT connectors. Set the A Triggering SOURCE switch to EXT. Operation of the LEVEL, SLOPE, COUPLING and SOURCE controls are the same as described above.

28. Set the SOURCE switch to EXT  $\div$ 10. Operation is the same as for EXT. Note that the LEVEL control has less range in this position, indicating signal attenuation. Return the SOURCE switch to INT.

29. Operation of the B Triggering controls is similar to A Triggering.

30. Set the TIME/DIV switch to 5 mSEC and the MAG switch to  $\times$ 10. The display should be similar to that obtained with the TIME/DIV switch set to .5 mSEC and the MAG switch to OFF. Return the TIME/DIV switch to .5 mSEC and the MAG switch to OFF.

31. Turn the Horizontal POSITION control throughout its range; the display should be positionable across the complete display area. Now turn the FINE control. The display moves a smaller amount and allows more precise positioning. Return the start of the trace to the left graticule line.

32. Pull the DELAYED SWEEP knob out and turn it to 50  $\mu$ SEC (DELAY TIME remains at .5 mSEC). Set the HORIZ DISPLAY switch to A INTEN DURING B. An intensified portion, about one division in length, should be shown at the start of the trace. Rotate the DELAY-TIME MULTIPLIER dial throughout its range; the intensified portion should move along the display.

33. Set the B SWEEP MODE switch to B TRIGGERABLE AFTER DELAY TIME. Again rotate the DELAY-TIME MULTIPLIER dial throughout its range and note that the intensified portion appears to jump between positive slopes of the display. Set the B Triggering SLOPE switch to  $-$ ; the intensified portion begins on the negative slope. Rotate the B Triggering LEVEL control; the intensified portion of the display disappears when the LEVEL control is out of the triggerable range. Return the LEVEL control to 0.

34. Set the HORIZ DISPLAY switch to DELAYED SWEEP (B). Rotate the DELAY-TIME MULTIPLIER dial throughout its range; about one-half cycle of the waveform should be displayed on the screen (leading edge visible only at high INTENSITY setting). The display will remain stable on the screen, indicating that B Sweep is triggered.

35. Set the B SWEEP MODE switch to B STARTS AFTER DELAY TIME. Rotate the DELAY-TIME MULTIPLIER dial throughout its range; the display will move continuously across the screen as the control is rotated.

36. Rotate the DELAY-TIME MULTIPLIER dial fully counterclockwise and set the HORIZ DISPLAY switch to A INTEN

## Operating Instructions—Type 453

DURING B. Rotate the A SWEEP LENGTH control counter-clockwise; the length of the display decreases. Set the control to the B ENDS A position; now the display ends at the end of the intensified portion. Rotate the DELAY-TIME MULTIPLIER dial and note that the sweep length increases as the display moves across the screen. Return the A SWEEP LENGTH control to FULL and the HORIZ DISPLAY switch to A.

37. Set the A SWEEP MODE switch to SINGLE SWEEP. Remove the Calibrator signal from the Channel 2 INPUT connector. Press the RESET button; the RESET light should come on and remain on. Reapply the signal to the Channel 2 INPUT connector; a single trace should be presented and the light should go out. Return the A SWEEP MODE switch to AUTO TRIG.

38. Connect the Calibrator signal to both the Channel 1 and 2 INPUT connectors. Set the HORIZ DISPLAY switch to EXT HORIZ, the TRIGGER switch to CH 1 ONLY and the B Triggering COUPLING switch to DC. Increase the INTENSITY setting until two dots are displayed diagonally. The display can be positioned horizontally with the Channel 1 POSITION control and vertically with the Channel 2 POSITION control.

39. Connect the Calibrator signal to both the Channel 2 INPUT and EXT HORIZ (B Triggering EXT TRIG INPUT) connectors. Set the B Triggering SOURCE switch to EXT; the display should be 5 divisions vertically and about 3.7 divisions horizontally. Set the SOURCE switch to EXT  $\rightarrow$  10; the display should be reduced ten times horizontally. Reduce the INTENSITY setting to normal, return the HORIZ DISPLAY switch to A and the B Triggering SOURCE switch to INT.

40. If an external signal is available (5 volt peak-to-peak minimum) the function of the Z AXIS INPUT circuit can be demonstrated. Connect the external signal to both the Channel 2 INPUT connector and the Z AXIS INPUT binding posts. Set the TIME/DIV switch to display about 5 cycles of the waveform. The positive peaks of the waveform should be blanked and the negative peaks intensified, indicating intensity modulation.

41. This ends the basic operation procedure for the Type 453. Instrument operation not explained here, or operations which need further explanation will be discussed under 'General Operating Information'.

## GENERAL OPERATING INFORMATION

### Cooling

To maintain a safe operating temperature, the Type 453 is cooled with air drawn in at the rear and blown out through holes at the front of the cabinet. A thermal cut-out in the instrument provides thermal protection and disconnects the instrument power if the internal temperature exceeds a safe operating level. Power is automatically restored when the temperature returns to a safe level. The air filter should be cleaned occasionally during normal use. Cleaning instructions are given in Section 4.

Adequate clearance must be provided on all sides of the instrument to allow heat to be dissipated away from the instrument. The clearance provided by the feet at the bot-

tom and rear should be maintained. If possible, allow about an inch of clearance on the sides and top. Do not block or restrict the air flow from the air-escape holes in the cabinet.

### Intensity Control

The setting of the INTENSITY control may affect the correct focus of the display. Slight readjustment of the FOCUS control may be necessary when the intensity level is changed.

To protect the crt phosphor, do not turn the INTENSITY control higher than necessary to provide a satisfactory display. Also, be careful that the INTENSITY control is not set too high when changing from a fast to a slow sweep rate, or when changing the HORIZ DISPLAY switch from the EXT HORIZ to one of the other positions.

### Astigmatism Adjustment

If a well-defined trace cannot be obtained with the FOCUS control, adjust the ASTIG adjustment (side panel) as follows.

#### NOTE

To check for proper setting of the ASTIG adjustment, slowly turn the FOCUS control through the optimum setting. If the ASTIG adjustment is correctly set, the vertical and horizontal portions of the trace will come into sharpest focus at the same position of the FOCUS control. This setting of the ASTIG adjustment should be correct for any display. However, it may be necessary to reset the FOCUS control slightly when the INTENSITY control is changed.

1. Connect a 1 V Calibrator signal to either channel and set the VOLTS/DIV switch of that channel to present a 2-division display.

2. Set the TIME/DIV switch to .2mSEC.

3. With the FOCUS control and ASTIG adjustment set to midrange, adjust the INTENSITY control so the rising portion of the display can be seen.

4. Set the ASTIG adjustment so the horizontal and vertical portions of the display are equally focused, but not necessarily well focused.

5. Set the FOCUS control so the vertical portion of the trace is as thin as possible.

6. Repeat steps 4 and 5 for best overall focus. Make final check at normal intensity.

### Trace Alignment Adjustment

If a free-running trace is not parallel to the horizontal graticule lines, set the TRACE ROTATION adjustment as follows. Position the trace to the graticule centerline. Adjust the TRACE ROTATION adjustment (side panel) so the trace is parallel with the horizontal graticule lines.

### Light Filter

The mesh filter provided with the Type 453 provides shielding against radiated RFI (radio-frequency interference radiation) from the face of the crt. It also serves as a light filter to make the trace more visible under high ambient light conditions. To remove the filter, press down at the bottom of the frame and pull the top of the filter away from the crt faceplate (see Fig. 2-5).

A tinted light filter is also provided. This filter minimizes light reflections from the face of the crt to improve contrast when viewing the display under high ambient light conditions.

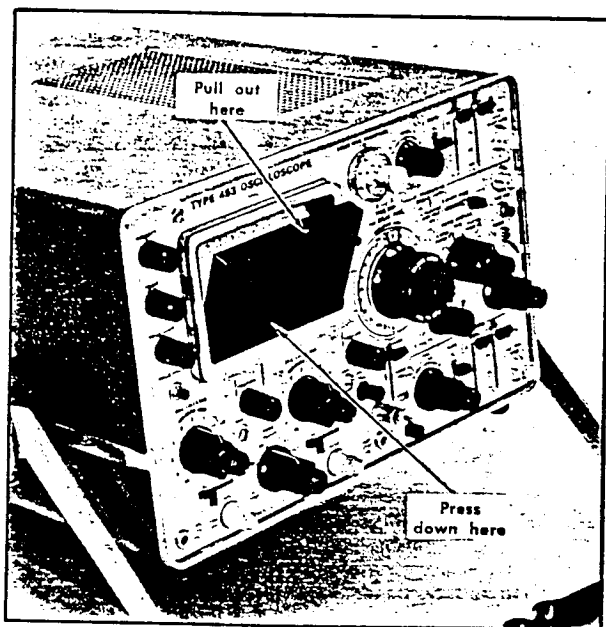

Fig. 2-5. Removing the filter or faceplate protector.

A clear plastic faceplate protector is provided with the Type 453 for use when neither the mesh nor the tinted filter are used. The clear faceplate protector provides the best display for waveform photographs. It is also preferable for viewing high writing rate displays.

A filter or the faceplate protector should be used at all times to protect the crt faceplate from scratches. The faceplate protector and the tinted light filter mount in the same holder. To remove the light filter or faceplate protector from the holder, press it out to the rear. Either can be replaced by snapping it back into the holder.

### Trace Finder

The TRACE FINDER provides a means of locating a display which overscans the viewing area either vertically or horizontally. When the TRACE FINDER button is pressed, the display is compressed within the graticule area. To locate and reposition an overscanned display, use the following procedure.

1. Press the TRACE FINDER button.
2. While the TRACE FINDER button is held in, reduce the deflection to less than 3 divisions by adjusting the amplitude of the input signal or the deflection factor.
3. Adjust the POSITION controls to center the display on the viewing area.
4. Release the TRACE FINDER; the display should be displayed on the viewing area.

### Control Setup Chart

Fig. 2-6 shows the front, side and rear panels of the Type 453. This picture may be reproduced and used as a test-setup record for special measurements, applications or procedures, or it may be used as a training aid for familiarization with this instrument.

### Vertical Channel Selection

Either of the input channels can be used for single-trace displays. Apply the signal to the desired INPUT connector and set the MODE switch to display the channel used. For dual-trace displays, connect the signals to both INPUT connectors and set the MODE switch to one of the dual-trace positions.

### Vertical Gain Adjustment

**Check.** To check the gain of either channel, set the VOLTS/DIV switch to 20 mV. Set the CALIBRATOR switch to .1 V and connect the 1 KC CAL connector to the INPUT of the channel used. The vertical deflection should be exactly 5 divisions. If not, adjust as follows.

**Adjust.** Front-panel GAIN adjustment for exactly 5 divisions of deflection.

#### NOTE

If the gain of the two channels must be closely matched (such as for ADD mode operation), the adjustment procedure given in the Calibration Section should be used.

### Step Attenuator Balance

**Check.** To check the step attenuator balance of either channel, set the AC GND DC switch to GND. Set the A SWEEP MODE switch to AUTO TRIG to produce a free-running trace. Change the VOLTS/DIV switch from 20 mV to 5 mV. If the trace moves vertically, adjust the front-panel STEP ATTEN BAL adjustment as follows.

**Adjust.** Allow at least 10 minutes warm up before performing this adjustment.

1. With the AC GND DC switch set to GND and the VOLTS/DIV switch set to 20 mV, move the trace to the graticule centerline with the Vertical POSITION control.

2. Set the VOLTS/DIV switch to 5 mV and adjust the STEP ATTEN BAL adjustment to return the trace to the graticule centerline.

453 Control Set-up Chart

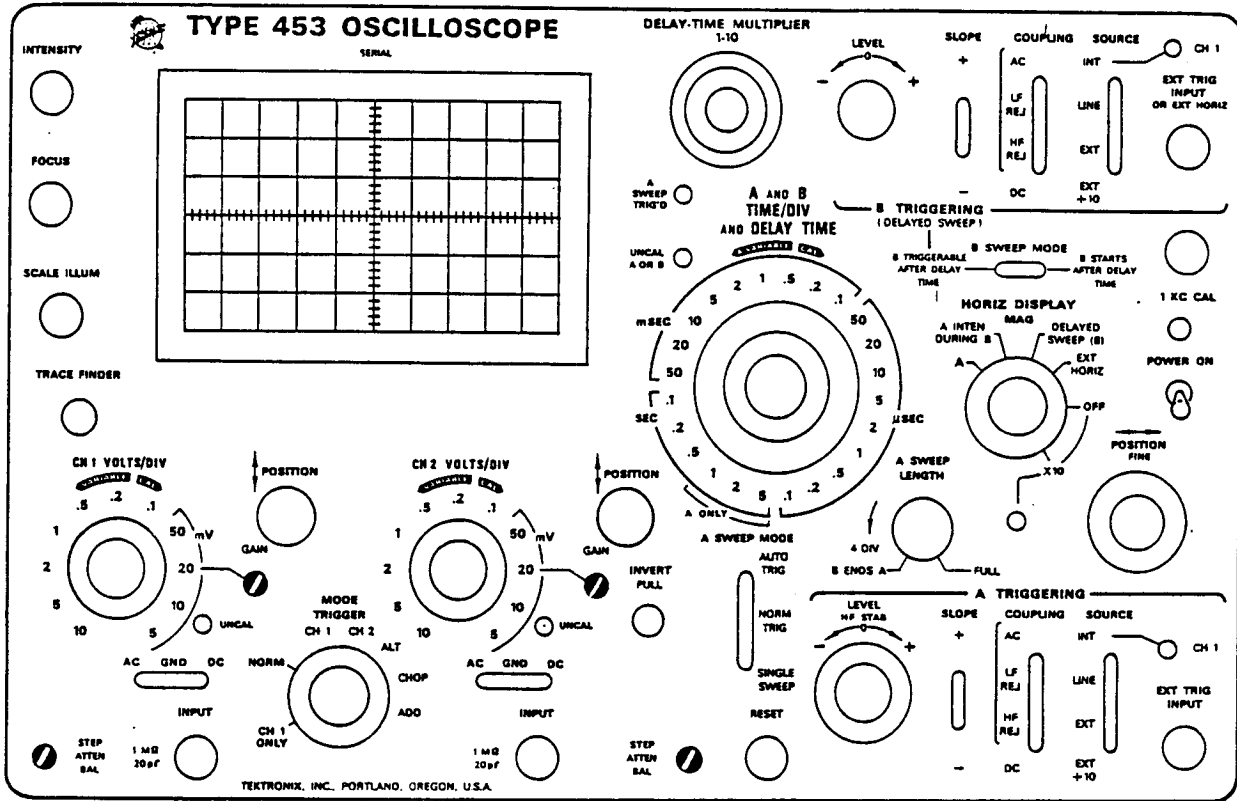

a. Front panel

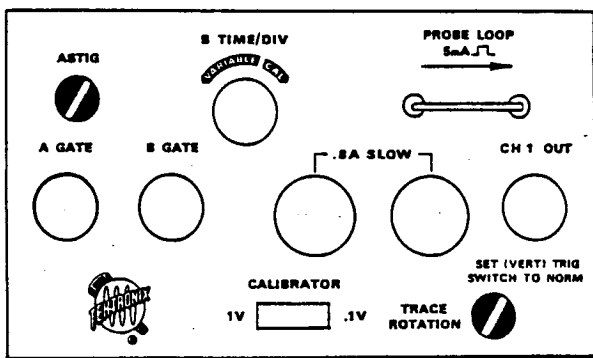

b. Side panel

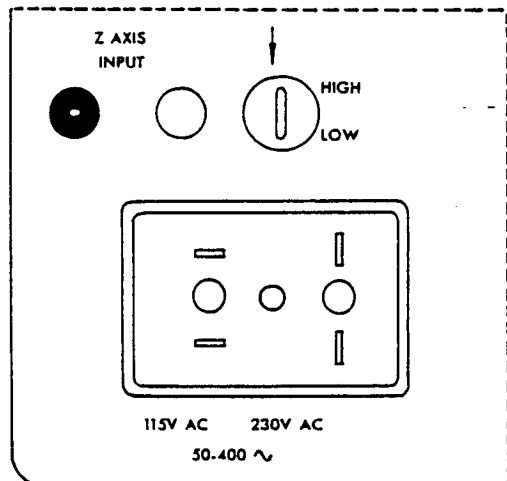

c. Rear panel

For Service Manuals Contact  
MAURITRON TECHNICAL SERVICES  
8 Cherry Tree Rd, Chinnor  
Oxon OX9 4QY  
Tel: 01844-351694 Fax: 01844-352554  
Email: enquiries@mauritron.co.uk

Fig. 2-6. Control set-up chart.

## Operating Instructions—Type 453

3. Recheck step attenuator balance and repeat adjustment until no trace shift occurs as the VOLTS/DIV switch is changed from 20 mV to 5 mV.

### Signal Connections

In general, 10X attenuator probes offer the most convenient means of connecting a signal to the input of the Type 453. A 10X attenuator probe offers a higher input impedance and allows the circuit under test to perform more closely to actual operating conditions. However, the 10X probe also attenuates the input signal 10 times. The probe is shielded to prevent pickup of electrostatic interference. Low-frequency response with AC input coupling is extended to about 0.16 cps (30% down).

In some cases, the signal can be connected to the Type 453 with short unshielded leads. This is particularly true with high-level, low-frequency signals. When such leads are used, be sure to establish a common ground between the Type 453 and the equipment under test. Attempt to position the leads away from any source of interference to avoid errors in the display. If interference is excessive with unshielded leads, use a coaxial cable or a probe.

In high-frequency applications requiring maximum overall bandwidth, use a coaxial cable terminated in its characteristic impedance at the Type 453 INPUT connector.

### Input Coupling

The Channel 1 and 2 AC GND DC switches allow a choice of input coupling. The type of display desired will determine the coupling used.

The DC position can be used for most applications. However, if the dc component of the signal is much larger than the ac component, the AC position will probably provide a better display. DC coupling should be used to display ac signals below about 16 cps as they will be attenuated in the AC position.

In the AC position, the dc component of the signal is blocked by a capacitor in the input circuit. The low-frequency response in the AC position is about 1.6 cps, 30% down. Therefore, some low-frequency distortion can be expected near this frequency limit. Distortion will also appear in square waves which have low-frequency components.

The GND position provides a ground reference at the input of the Type 453. The signal applied to the input connector is internally disconnected but not grounded. The grid of the input tube is at ground potential, eliminating the need to externally ground the input to establish a dc ground reference.

### Deflection Factor

The amount of vertical deflection produced by a signal is determined by the signal amplitude, the attenuation factor of the probe (if used), the setting of the VOLTS/DIV switch and the setting of the VARIABLE VOLTS/DIV control. The calibrated deflection factors indicated by the VOLTS/DIV switches apply only when the VARIABLE control is set to the CAL position.

The VARIABLE VOLTS/DIV control provides variable (uncalibrated) vertical deflection between the calibrated set-

tings of the VOLTS/DIV switch. The VARIABLE control extends the maximum vertical deflection factor of the Type 453 to at least 25 volts/division (10 volts position).

### Loading Effect of the Type 453

As nearly as possible, simulate actual operating conditions in the equipment under test. Otherwise, the equipment under test may not produce a normal signal. The 10X attenuator probes mentioned previously offer the least circuit loading. Tektronix 10X attenuator probes have an input resistance of about 10 megohms with very low shunt capacitance.

When the signal is coupled directly to the input of the Type 453, the input impedance is about 1 megohm paralleled by about 20 pf. When the signal is coupled to the input through a coaxial cable, the input capacitance is greatly increased. Just a few feet of coaxial cable can increase the input capacitance to well over 100 pf.

See the probe Instruction Manual for loading effect of the probes.

### Dual-Trace Operation

**Alternate Mode.** The ALT position of the MODE switch produces a display which alternates between Channel 1 and 2 with each sweep of the crt. Although the ALT mode can be used at all sweep rates, the CHOP mode provides a more satisfactory display at sweep rates below about 0.5 millisecond/division. At these slower sweep rates, alternate mode switching becomes visually perceptible.

Proper internal triggering in the ALT mode can be obtained in either the NORM or CH 1 ONLY positions of the TRIGGER switch. When in the NORM position, the sweep will be triggered from the signal on each channel. This provides a stable display of two unrelated signals, but does not indicate the time relationship between the signals. In the CH 1 ONLY position, the two signals will be displayed showing true time relationship. If the signals are not time related, the Channel 2 waveform will be unstable in the CH 1 ONLY position.

**Chopped Mode.** The CHOP position of the MODE switch produces a display which is electronically switched between channels. In general, the CHOP mode provides the best display at sweep rates slower than about 0.5 milliseconds or whenever dual-trace, single-shot phenomena are to be displayed. At faster sweep rates the chopped switching may become apparent and interfere with the display.

Proper internal triggering for the CHOP mode is provided with the TRIGGER switch set to CH 1 ONLY. If the NORM position is used, the sweep circuits will be triggered from the between-channel switching signal and both waveforms will be unstable. External triggering will provide the same result as CH 1 ONLY triggering.

Two signals which are time-related can be displayed in the chopped mode showing true time relationship. If the signals are not time-related, the Channel 2 display will appear unstable.

Two single-shot, transient, or random signals which occur within the time interval determined by the TIME/DIV switch

(10 times sweep rate) can be compared using the CHOP mode. To trigger the sweep correctly, the Channel 1 signal must precede the Channel 2 signal. Since the signals show true time relationship, time-difference measurements can be made.

### Channel 1 Output and Cascaded Operation

If a lower deflection factor than provided by the VOLTS/DIV switch is desired, Channel 1 can be used as a wide-band preamplifier for Channel 2. Apply the input signal to Channel 1 INPUT connector. Connect a 50-ohm cable between the CH 1 OUT (side panel) and the Channel 2 INPUT connectors. Set the MODE switch to CH 2 and the TRIGGER switch to NORM. With both VOLTS/DIV switches set to 5 mV, the deflection factor will be less than 1 millivolt/division.

To provide calibrated 1 millivolt/division deflection factor, connect the .1 volt Calibrator signal to Channel 1 INPUT. Set the CH 1 VOLTS/DIV switch to .1 and the CH 2 VOLTS/DIV switch to 5 mV. Adjust the Channel 2 VARIABLE VOLTS/DIV control to produce a display exactly five divisions in amplitude. The cascaded deflection factor is determined by dividing the CH 1 VOLTS/DIV switch setting by 5 (CH 2 VOLTS/DIV switch and VARIABLE control remain as set above). For example, with the CH 1 VOLTS/DIV switch set to 5 mV the calibrated deflection factor will be 1 millivolt/division; 10 mV, 2 millivolts/division, etc.

The following operating considerations and basic applications may suggest other uses for this feature.

1. If ac coupling is desired, set the Channel 1 AC GND DC switch to AC and leave the Channel 2 AC GND DC switch set to DC. When both AC GND DC switches are set to DC, dc signal coupling is provided.

2. Keep both Vertical POSITION controls set near mid-range. If the input signal has a dc level which necessitates one of the POSITION controls being turned away from midrange, correct operation can be obtained by keeping the Channel 2 POSITION control near midrange and using the Channel 1 POSITION control to position the trace near the desired location. Then, use the Channel 2 POSITION control for exact positioning. This method will keep both Input Preamps operating in their linear range.

3. The voltage gain from the Channel 1 INPUT connector to the CH 1 OUT connector is about 5X in the 5 mV position, about 2.5X in the 10 mV position and about 1.25X in the 20 mV position.

4. The MODE switch and Channel 1 VARIABLE VOLTS/DIV control have no effect on the signal available at the CH 1 OUT connector.

5. The Channel 1 Input Preamp can be used as an impedance matching stage with or without voltage gain. The input resistance is 1 megohm and the output resistance is about 50 ohms.

6. The dynamic range of the Channel 1 Input Preamp is equal to about 20 times the CH 1 VOLTS/DIV setting. The CH 1 OUT signal is nominally at 0 volt dc for a 0 volt dc input level. The Channel 1 POSITION control can be used to center the output signal within the dynamic range of the amplifier.

7. If dual-trace operation is used, the signal applied to Channel 1 INPUT is displayed when Channel 1 is turned on. When Channel 2 is turned on, the amplified signal is displayed. Thus, Channel 1 trace can be used to monitor the input signal while the amplified signal is displayed by Channel 2.

8. In special applications where the flat frequency response of the Type 453 is not desired, a filter inserted between the CH 1 OUT and Channel 2 INPUT connectors will allow the oscilloscope to essentially take on the frequency response of the filter. Combined with method 7, the input can be monitored by Channel 1 and the filtered signal displayed by Channel 2.

9. By using Channel 1 as a 5X low-level voltage preamplifier (5 mV position), the Channel 1 signal available at the CH 1 OUT connector can be coupled to any source where a low-impedance preamplified signal is needed. Remember that if a 50-ohm load impedance is used, the signal amplitude will be about one-half.

### Algebraic Addition

The ADD position of the MODE switch can be used to display the sum or difference of two signals, for common-mode rejection to remove an undesired signal (about 20:1 rejection at 20 Mc) or for dc offset (applying a dc voltage to one channel to offset the dc component of a signal on the other channel).

The common-mode rejection ratio of the Type 453 is greater than 20:1 at 20 Mc for signal amplitudes up to eight times the VOLTS/DIV switch setting. Rejection ratios of 100:1 can typically be achieved between dc and 5 Mc by careful adjustment of the gain of either channel while observing the displayed common-mode signal.

The following general precautions should be observed when using the ADD mode.

1. Do not exceed the input voltage rating of the Type 453.

2. Do not apply signals that will exceed an equivalent of about 20 times the VOLTS/DIV switch setting. For example, with a VOLTS/DIV switch setting of .5, the voltage applied to that channel should not exceed about 10 volts. Larger voltages may distort the display.

3. Use Vertical POSITION control settings which most nearly position the signal of each channel to mid-screen when viewed in either the CH 1 or CH 2 MODE switch positions. This will insure the greatest dynamic range for ADD mode operation.

### Trigger Source

INT. For most applications, the sweep can be triggered internally. In the INT position of the Triggering SOURCE switch, the trigger signal is obtained from the vertical system. The TRIGGER switch provides further selection of the internal trigger signal: obtained from the Channel 1 signal in the CH 1 ONLY position, or from the displayed signal when in the NORM position. For single-trace displays of either channel, the NORM position provides the most convenient operation. However, for dual-trace displays,

For Service Manuals Contact  
**MAURITRON TECHNICAL SERVICES**  
 8 Cherry Tree Rd, Chinnor  
 Oxon OX9 4QY  
 Tel: 01844-351694 Fax: 01844-352554  
 Email: enquiries@mauritron.co.uk



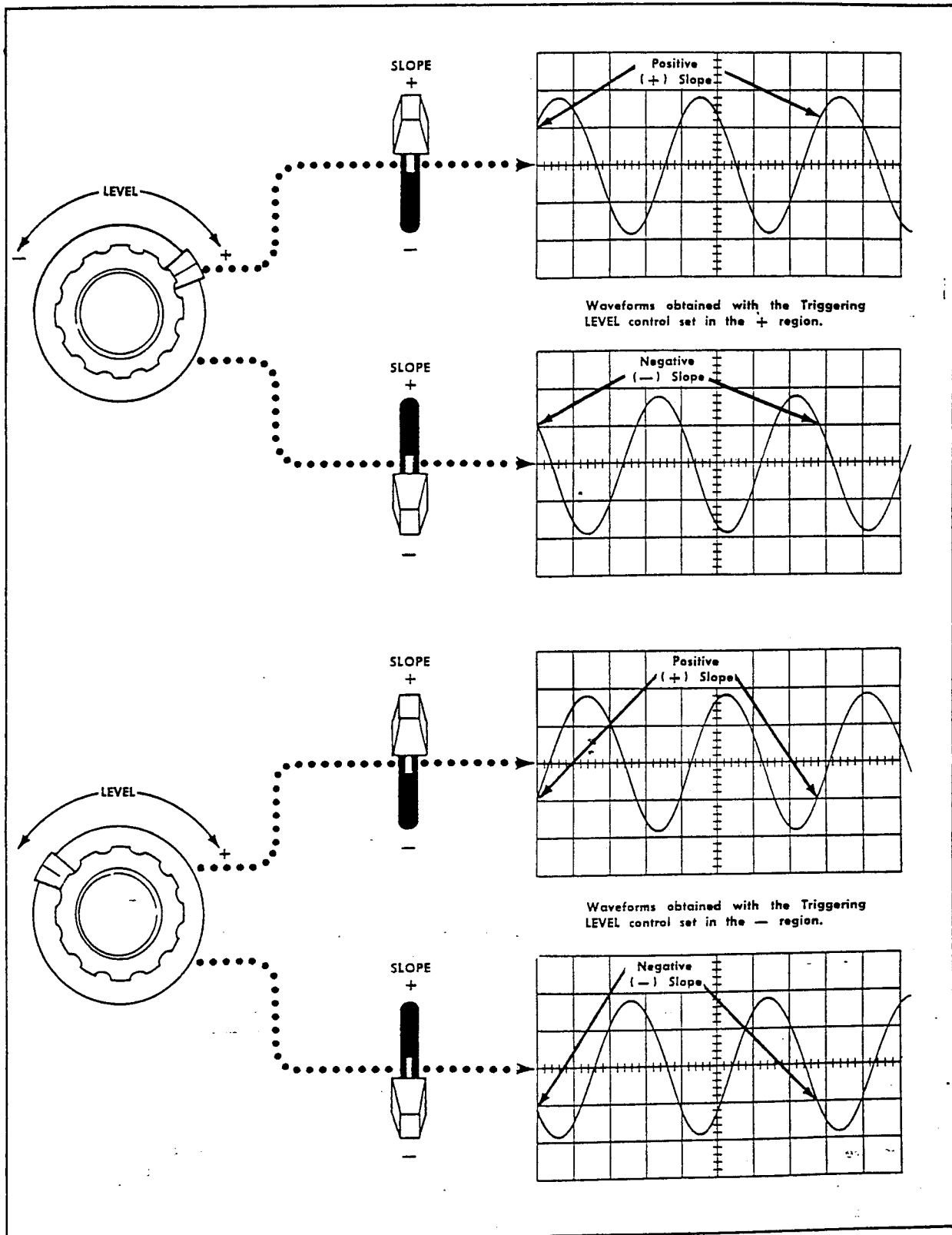

Fig. 2-7. Effects of Triggerring LEVEL control and SLOPE switch.

For Service Manuals Contact  
MAURITRON TECHNICAL SERVICES  
8 Cherry Tree Rd, Chinnor  
Oxon OX9 4QY  
Tel: 01844-351694 Fax: 01844-352554  
Email: enquiries@mauritron.co.uk

## Operating Instructions—Type 453

special considerations must be made to provide the correct display. See 'Dual-Trace Operation' in this section for dual-trace triggering information.

**LINE.** The LINE position of the SOURCE switch connects a sample of the power-line frequency to the Trigger Generator. Line triggering is useful when the input signal is time-related to the line frequency. It is also useful for providing a stable display of a line-frequency component in a complex waveform.

**EXT.** An external signal connected to the EXT TRIG INPUT connector can be used to trigger the sweep in the EXT position of the SOURCE switch. The external signal must be time-related to the displayed signal for a stable display. An external trigger signal can be used to provide a triggered display when the internal signal is too low in amplitude for correct triggering, or contains signal components on which it is not desired to trigger. It is also useful when signal tracing in amplifiers, phase-shift networks, wave-shaping circuits, etc. The signal from a single point in the circuit can be connected to the EXT TRIG INPUT connector through a signal probe or cable. The sweep is then triggered by the same signal at all times and allows amplitude, time relationship or waveshape changes of signals at various points in the circuit to be examined without resetting the triggering controls.

**EXT  $\div$  10.** Operation in the EXT  $\div$  10 position is the same as described for EXT except that the external triggering signal is attenuated ten times. Attenuation of high-amplitude external triggering signals is desirable to broaden the range of the Triggering LEVEL control. When the COUPLING switch is set to LF REJ, attenuation is about 20:1.

### Trigger Coupling

Four methods of coupling the trigger signal to the trigger circuits can be selected with the Triggering COUPLING switch. Each position permits selection or rejection of the frequency components of the trigger signal which will trigger the sweep.

**AC.** The AC position blocks the dc component of the trigger signal. Signals with low-frequency components below about 30 cps will be attenuated. In general, AC coupling can be used for most applications. However, if the trigger signal contains unwanted components or if the sweep is to be triggered at a dc level, one of the remaining COUPLING switch positions will provide a better display.

The triggering point in the AC position depends on the average voltage level of the trigger signal. If the trigger signals occur in a random fashion, the average voltage level will vary, causing the triggering point to vary also. This shift of the triggering point may be enough so it is impossible to maintain a stable display. In such cases, use DC coupling.

**LF REJ.** In the LF REJ position, dc is rejected and signals below about 30 kc are attenuated. Therefore, the sweep will be triggered only by the higher-frequency components of the signal. This position is particularly useful for providing stable triggering if the trigger signal contains line-frequency components. Also, in the ALT position of the MODE switch, the LF REJ position provides the best

display at high sweep rates when comparing two unrelated signals (TRIGGER switch set to NORM).

**HF REJ.** The HF REJ position passes all low-frequency signals between about 30 cps and 50 kc. Dc is rejected and signals outside the given range are attenuated. When triggering from complex waveforms, this position is useful for providing stable display of low-frequency components.

**DC.** DC coupling can be used to provide stable triggering with low-frequency signals which would be attenuated in the AC position, or with low-repetition rate signals. The LEVEL control can be adjusted to provide triggering at the desired dc level on the waveforms. When using internal triggering, the setting of the Vertical POSITION controls will affect the dc trigger level.

DC trigger coupling should not be used in the ALT dual-trace mode if the TRIGGER switch is set to NORM. If used, the sweep will trigger on the dc level of one trace and then either lock out completely or free run on the other trace. Correct dc triggering for this mode can be obtained with the TRIGGER switch set to CH 1 ONLY.

### Trigger Slope

The Triggering SLOPE switch determines whether the trigger circuit responds on the positive-going or negative-going portion of the trigger signal. When the SLOPE switch is in the + (positive-going) position, the display will start with the positive-going portion of the waveform; in the - (negative-going) position, the display will start with the negative-going portion of the waveform (see Fig. 2-7). When several cycles of a signal appear in the display, the setting of the SLOPE switch will probably be unimportant. However, if only a certain portion of a cycle is to be displayed, correct setting of the SLOPE switch will provide a display which starts on the desired slope of the input signal.

### Trigger Level

The Triggering LEVEL control determines the voltage level on the triggering waveform at which the sweep is triggered. When the LEVEL control is set in the + region, the trigger circuit responds at a more positive point on the trigger signal. When the LEVEL control is set in the - region, the trigger circuit responds at a more negative point on the trigger signal. Fig. 2-7 illustrates this effect with different settings of the SLOPE switch.

To set the LEVEL control, first select the Triggering SOURCE, COUPLING and SLOPE. Then set the LEVEL control to 0 (except for DC coupling). If the display does not start at the desired point, adjust the LEVEL control for correct triggering. In the DC position of the COUPLING switch, correct triggering may be obtained at any setting of the LEVEL control, depending on the dc level of the trigger signal. To obtain correct triggering, set the LEVEL control counterclockwise. Then turn the LEVEL control clockwise until the display is triggered at the correct dc level.

### High-Frequency Stability

The HF STAB control is used to provide a stable display of signals requiring sweep rates of 10 or 20 nanoseconds/

## Operating Instructions—Type 453

division. If a stable display cannot be obtained using the LEVEL control (trigger signal must have adequate amplitude), adjust the HF STAB control for minimum horizontal jitter. This control has little effect at lower sweep rates.

### A Sweep Mode

**AUTO TRIG.** Automatic triggering can be used for most applications. It is particularly useful where a reference trace is needed in the absence of a trigger signal. When a trigger signal is available, a stable display can be obtained by correct adjustment of the LEVEL control as described previously. The A SWEEP TRIG'D light indicates when the A Sweep Generator is triggered.

When the trigger repetition rate is less than about 20 cps, or in the absence of a trigger signal, the A Sweep Generator free runs to produce a reference trace. When a trigger signal is again applied, the free running condition ends and the A Sweep Generator is triggered to produce a stable display.

**NORM TRIG.** Operation in the NORM TRIG position when a trigger signal is applied is the same as in the AUTO TRIG position. The A SWEEP TRIG'D light will indicate when the sweep is triggered. However, when a trigger signal is not applied, the A Sweep Generator will remain off and the screen will be blanked.

Use the NORM TRIG mode to display signals with repetition rates below about 20 cps. Also use the mode when a trace is not desired in the absence of trigger signals.

**SINGLE SWEEP.** When the signal to be displayed is not repetitive or varies in amplitude, shape or time, a conventional repetitive display may produce an unstable presentation. To avoid this, use the single-sweep feature of the Type 453.

The SINGLE SWEEP mode can also be used to photograph a non-repetitive signal. To use the SINGLE SWEEP mode, first make sure the trigger circuit will trigger on the event you wish to display. Set the A SWEEP MODE switch to AUTO TRIG or NORM TRIG and obtain the best possible display in the normal manner. Then, set the A SWEEP MODE switch to SINGLE SWEEP and press the RESET button. When the RESET button is pushed, the next trigger pulse will initiate the sweep and a single trace will be presented on the screen. After the sweep is complete, the A Sweep Generator will be 'locked out' until reset. The RESET light located inside the RESET button will light when the A Sweep Generator circuit has been reset and will go out after the sweep is complete. To prepare the circuit for another single-sweep display, press the RESET button again.

### Selecting Sweep Rate

The A AND B TIME/DIV switch selects calibrated sweep rates for the Sweep Generators. The VARIABLE control provides continuously variable sweep rates between the settings of the TIME/DIV switch. Whenever the UNCAL A OR B light is on, the sweep rate of either A or B Sweep Generator, or both, is uncalibrated. The light is off when the A VARIABLE (front panel) and B TIME/DIV VARIABLE (side panel) controls are both set to the CAL position.

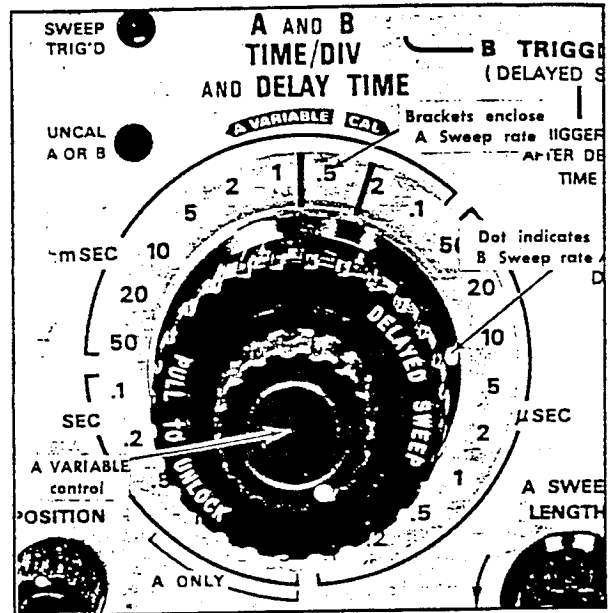

Fig. 2-8. A AND B TIME/DIV switch.

The sweep rate of A Sweep Generator is bracketed by the two black lines on the clear plastic inner flange of the TIME/DIV switch (see Fig. 2-8). The B Sweep Generator sweep rate is indicated by the dot on the DELAYED SWEEP knob. When the dot on the outer knob is set to the same position as the lines on the inner knob, the two knobs lock together and the sweep rate of both Sweep Generators is changed at the same time. However, when the DELAYED SWEEP knob is pulled outward, the inner flange is disengaged and only the B Sweep Generator sweep rate is changed. This allows changing the delayed sweep rate without changing the delay time determined by the A Sweep Generator.

When making time measurements from the graticule, the area between the first and ninth graticule lines provides the most linear time measurement (see Fig. 2-9).

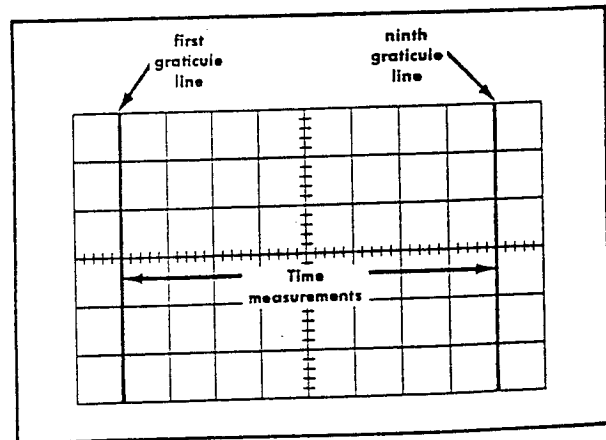

Fig. 2-9. Area of graticule used for accurate time measurements.

Therefore, the first and last division of the display should not be used for making accurate time measurements. Position the start of the timing area to the first graticule line and set the TIME/DIV switch so the end of the timing area falls between the first and ninth graticule lines.

### Sweep Magnification

The sweep magnifier expands the sweep ten times. The center division of the unmagnified display is the portion visible on the screen in magnified form (see Fig. 2-10). Equivalent length of the magnified sweep is about 100 divisions; any 10 division portion may be viewed by adjusting the Horizontal POSITION control to bring the desired portion onto the viewing area. The FINE position control is particularly useful when the magnifier is on, as it provides positioning in small increments for more precise control.

To use the magnified sweep, first move the portion of the display which is to be expanded to the center of the graticule. Then set the MAG switch to  $\times 10$ . The FINE position control can be adjusted to move the magnified portion to the desired position. The light located below the MAG switch is on whenever the switch is set to  $\times 10$ .

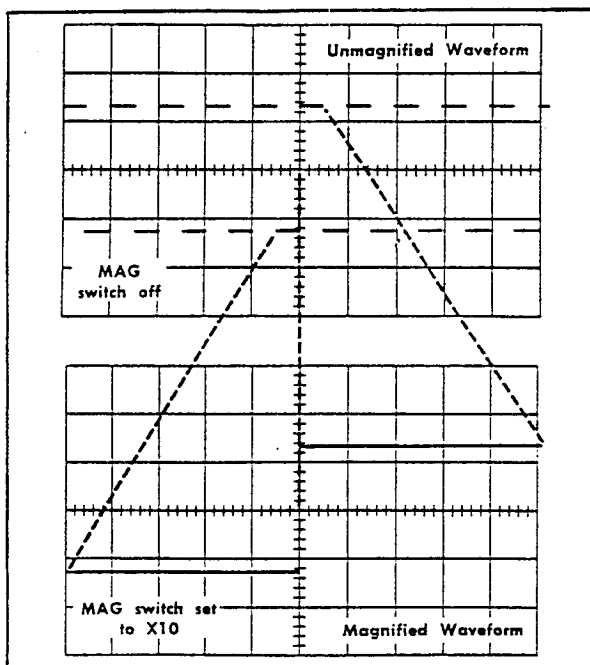

Fig. 2-10. Operation of sweep magnifier.

When the MAG switch is set to  $\times 10$ , the sweep rate is determined by dividing the TIME/DIV switch setting by 10. For example, if the TIME/DIV switch is set to  $.5 \mu\text{SEC}$ , the magnified sweep rate is 0.05 microsecond/division. The magnified sweep rate must be used for all time measurements when the MAG switch is set to  $\times 10$ . The magnified sweep rate is calibrated when the UNCAL A OR B light is off.

### Delayed Sweep

The delayed sweep (B Sweep) is operable in the A INTEN DURING B and DELAYED SWEEP (B) positions of the HORIZ

DISPLAY switch. The A Sweep determines the time that B Sweep is delayed. Sweep rate of the delayed portion is determined by the B TIME/DIV (DELAYED SWEEP) switch setting.

In the A INTEN DURING B position, the display will appear similar to Fig. 2-11a. The amount of delay time between the start of A Sweep and the intensified portion is determined by the setting of the A TIME/DIV switch and the DELAY-TIME MULTIPLIER dial. Fig. 2-12 shows the DELAY-TIME MULTIPLIER dial. The outer numbers are major dial divisions and the inner numbers, minor dial divisions. For example, the DELAY-TIME MULTIPLIER reading as shown in Fig. 2-12 is 3.55; 3 major divisions and 55 minor divisions. This reading multiplied by the setting of the A TIME/DIV switch gives the calibrated delay time of B Sweep.

For Service Manuals Contact  
**MAURITRON TECHNICAL SERVICES**  
 8 Cheney Tree Rd, Chinnor  
 Oxon OX9 3QY  
 Tel: 01844-351694 Fax: 01844-352554  
 Email: enquires@mauritron.co.uk

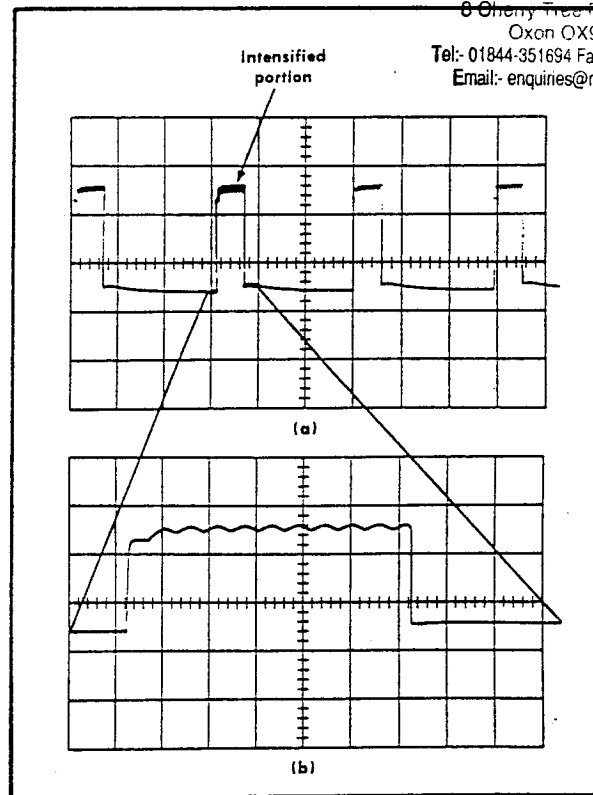

Fig. 2-11. (a) A INTEN DURING B display (A TIME/DIV,  $.5 \text{ mSEC}$ ; B TIME/DIV,  $50 \mu\text{SEC}$ ), (b) DELAYED SWEEP (B) display.

The intensified portion of the display is produced by B Sweep. The length of this portion is about 10 times the setting of B TIME/DIV switch. When the HORIZ DISPLAY switch is set to DELAYED SWEEP (B), only this intensified portion is displayed on the screen at the sweep rate indicated by the B TIME/DIV switch (see Fig. 2-11b).

**B SWEEP MODE.** The B SWEEP MODE switch provides two modes of delayed sweep. Fig. 2-13 illustrates the difference between these two modes. In the B STARTS AFTER DELAY TIME position, the B Sweep is presented immediately

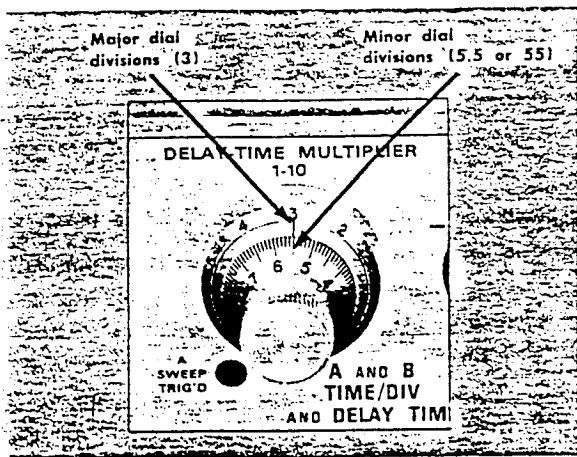

Fig. 2-12. DELAY-TIME MULTIPLIER dial. Reading shown: 3.55.

after the delay time (see Fig. 2-13a). The B Sweep is essentially free running. However, since the delay time is the same for each sweep, the display will appear stable. In the B TRIGGERABLE AFTER DELAY TIME position, the B Sweep operates only when triggered after the delay time (see Fig. 2-13b). The B Triggering controls operate as described in this section.

**A SWEEP LENGTH.** The A SWEEP LENGTH control is most useful when used with delayed sweep. As the control is rotated counterclockwise from the FULL position, the length of A Sweep decreases until it is about 4 divisions long in the counterclockwise position (not in B ENDS A detent). The B ENDS A position produces a display which ends immediately following B Sweep (B Sweep must end before the normal end of A Sweep). The A SWEEP LENGTH control is used to increase the repetition rate of delayed sweep displays.

To use the A SWEEP LENGTH control, set the HORIZ DISPLAY switch to A INTEN DURING B and set the delay time and delayed sweep rate in the normal manner. Turn the A SWEEP LENGTH control counterclockwise until the sweep ends immediately following the intensified portion on the display. Now set the HORIZ DISPLAY switch to DELAYED SWEEP (B). Using this procedure, the maximum repetition rate will be obtained. In the B ENDS A position, the maximum delayed sweep repetition rate is automatically maintained. However, care must be taken to avoid incorrect displays since A Sweep repetition rate is now a function of the DELAY-TIME MULTIPLIER dial and B TIME/DIV switch setting.

**Delayed Sweep Operation.** To obtain a delayed sweep display use the following procedure.

1. Set the HORIZ DISPLAY switch to A INTEN DURING B.
2. Set the B SWEEP MODE switch to the desired setting. If B TRIGGERABLE AFTER DELAY TIME is used, correct triggering is also necessary.
3. Set the delay time with the A TIME/DIV switch and the DELAY-TIME MULTIPLIER dial.
4. Pull the DELAYED SWEEP (B TIME/DIV) knob out and set to the desired sweep rate.

5. If the B TRIGGERABLE AFTER DELAY TIME position is used, check the display for an intensified portion. Absence of the intensified zone indicates that B Sweep is not correctly triggered.

6. Set the HORIZ DISPLAY switch to DELAYED SWEEP (B). The intensified zone shown in the A INTEN DURING B position is now displayed at the sweep rate selected by B TIME/DIV.

Several examples of the uses of the delayed sweep feature are given under 'Basic Applications' in this section.

### External Horizontal Deflection

In some applications, it is desirable to display one signal versus another (X-Y) rather than against time (internal sweep). The EXT HORIZ position of the HORIZ DISPLAY switch provides a means for applying an external signal to the horizontal amplifier for this type of display.

Two modes of external horizontal operation are provided. When the TRIGGER switch is set to CH 1 ONLY, the B Triggering SOURCE switch to INT and the COUPLING switch to DC, the horizontal deflection is provided by a signal applied to the Channel 1 INPUT connector. The CH 1 VOLTS/DIV setting indicates the calibrated horizontal deflection factor (Channel 1 VARIABLE control inoperative). Center the Horizontal POSITION control and use the Channel 1 POSITION control for horizontal positioning.

In the EXT and EXT  $\div 10$  positions of the B Triggering SOURCE switch, external horizontal deflection is provided by a signal applied to the EXT HORIZ input connector (B Triggering EXT TRIG INPUT). The signal coupling provided by the B Triggering COUPLING switch may be used to select or reject components of the external horizontal signal. Using this mode of operation, the horizontal deflection factor is uncalibrated.

### Intensity Modulation

Intensity (Z-axis) modulation can be used to relate further information to the displayed signal without changing the shape of the waveform. The modulating signal is applied to the crt through the rear-panel Z AXIS INPUT binding posts. The voltage amplitude required for visible trace modulation depends on the setting of the INTENSITY control. At normal intensity level, a 5-volt peak-to-peak signal will produce a visible change in brightness.

Time markers applied to the Z AXIS INPUT binding posts provide a direct time reference on the display. With uncalibrated horizontal sweep or external horizontal deflection, the time-markers provide a means of reading time directly from the display. If the markers are not time-related to the displayed waveform, a single-sweep display should be used (internal sweep only) to provide a stable display. The sharpest display will be provided by intensity modulation signals with a fast rise and fall. When the Z AXIS INPUT is not in use, keep the ground strap in place.

### Calibrator

The 1-kc square-wave calibrator of the Type 453 provides a convenient signal source for checking vertical gain and basic horizontal timing. However, to provide maximum

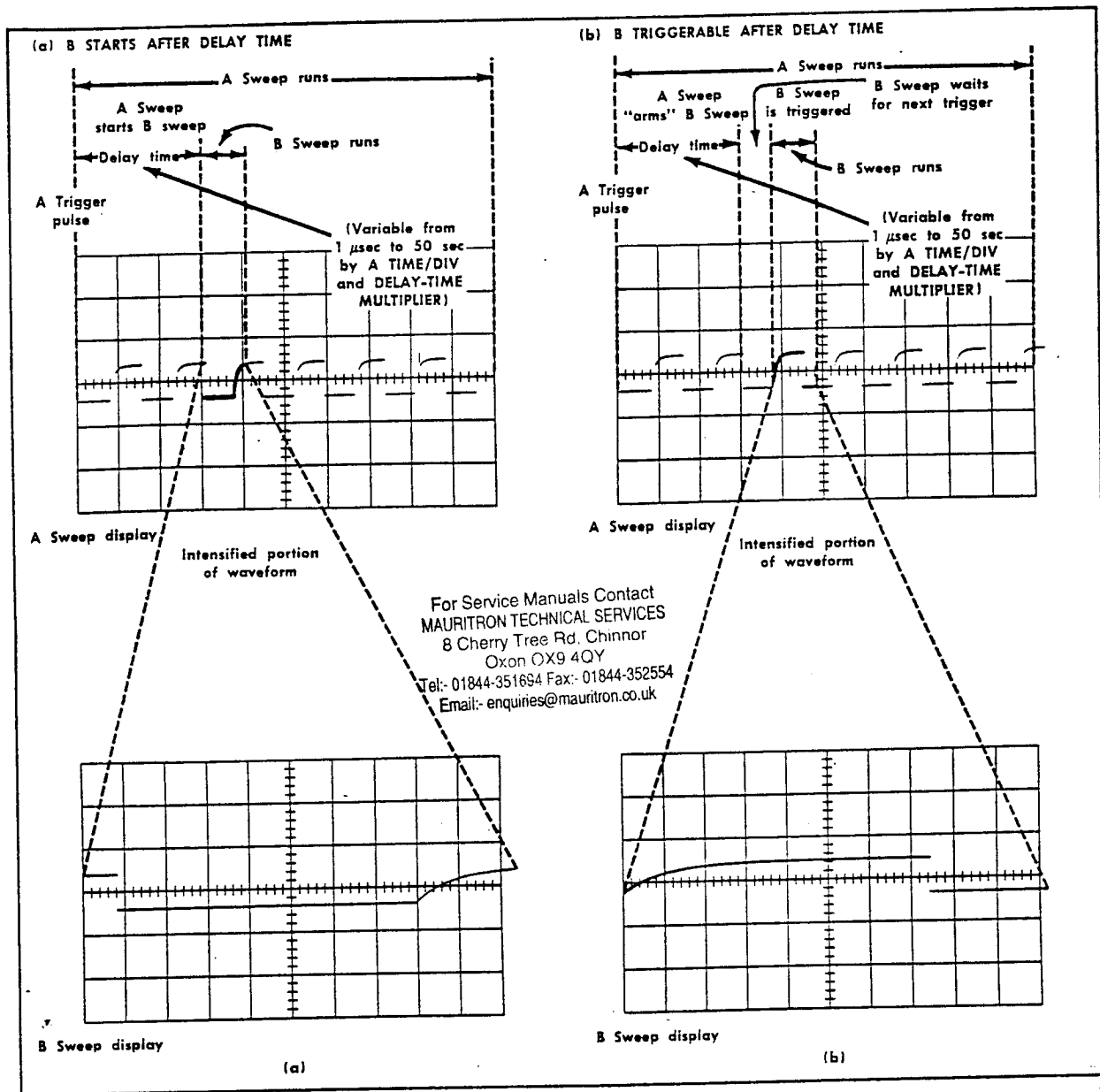

Fig. 2-13. Comparison of the delayed-sweep modes. (a) B STARTS AFTER DELAY TIME, (b) B TRIGGERABLE AFTER DELAY TIME. In each display the B Sweep is delayed a selected amount of time by A Sweep.

measurement accuracy, the adjustment procedure given in the Calibration section should be used. The Calibrator signal is also very useful for checking and adjusting probe compensation as described in the probe instruction manual. In addition, the calibrator can be used as a convenient signal source for application to external equipment.

**Voltage.** The Calibrator provides peak-to-peak square-wave voltages of 0.1 and 1 volt. Voltage range is selected by the CALIBRATOR switch on the side panel.

**Current.** The current loop, located on the side panel,

provides a 5 milliamp peak-to-peak square-wave current which can be used to check and calibrate current-probe systems. This current signal is obtained by clipping the probe around the current loop. Current is constant through the loop in either position of the CALIBRATOR switch. The arrow above the PROBE LOOP indicates conventional current flow; from + to -.

**Frequency.** The Calibrator circuit uses frequency stable components to maintain accurate frequency and constant duty cycle. Thus the Calibrator can be used for checking the basic horizontal timing as given above.

## BASIC APPLICATIONS

The following information describes the procedure and technique for making basic measurements with a Type 453 Oscilloscope. These applications are not described in detail since each application must be adapted to the requirements of the individual measurements. Familiarity with the Type 453 will permit these basic techniques to be applied to a wide variety of uses.

### Peak-to-Peak Voltage Measurements—AC

To make a peak-to-peak voltage measurement, use the following procedure:

1. Connect the signal to either INPUT connector.
2. Set the MODE switch to display the channel used.
3. Set the VOLTS/DIV switch to display about 5 divisions of the waveform.
4. Set the AC GND DC switch to AC.

#### NOTE

For low-frequency signals below about 16 cps, use the DC position.

5. Set the A Triggering controls to obtain a stable display. Set the TIME/DIV switch to a position that displays several cycles of the waveform.

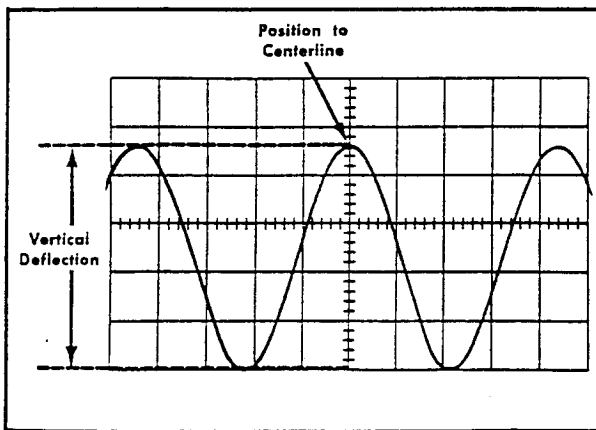

Fig. 2-14. Measuring peak-to-peak voltage of a waveform.

6. Turn the Vertical POSITION control so the lower portion of the waveform coincides with one of the graticule lines below the centerline, and the top of the waveform is on the viewing area. With the Horizontal POSITION control, move the display so one of the upper peaks lies near the vertical centerline (see Fig. 2-14).

7. Measure the divisions peak to peak of vertical deflection. Make sure the VARIABLE VOLTS/DIV control is in the CAL position.

#### NOTE

This technique may also be used to make measurements between two points on the waveform rather than peak to peak.

8. Multiply the distance measured in step 7 by the VOLTS/DIV switch setting. Also include the attenuation factor of the probe, if any.

**Example.** Assume a peak-to-peak vertical deflection of 4.6 divisions (see Fig. 2-14) using a 10X attenuator probe and a VOLTS/DIV switch setting of .5.

Using the formula:

$$\text{Volts Peak to Peak} = \frac{\text{vertical deflection (divisions)}}{\text{VOLTS/DIV setting}} \times \text{probe attenuation factor}$$

Substituting the given values:

$$\text{Volts Peak to Peak} = 4.6 \times 0.5 \times 10$$

The peak-to-peak voltage would be 23 volts.

### Instantaneous Voltage Measurements—DC

To measure the dc level at a given point on a waveform, use the following procedure:

1. Connect the signal to either INPUT connector.
2. Set the MODE switch to display the channel used.
3. Set the VOLTS/DIV switch to display about 5 divisions of the waveform.
4. Set the AC GND DC switch to GND.
5. Set the A SWEEP MODE switch to AUTO TRIG.
6. Position the trace to the bottom line of the graticule or other reference line. If the voltage is negative with respect to ground, position the trace to the top line of the graticule. Do not move the Vertical POSITION control after this reference line has been established.

#### NOTE

To measure a voltage level with respect to another voltage rather than ground, make the following changes in step 6. Set the AC GND DC switch to DC. Apply the reference voltage to the INPUT connector and position the trace to the reference line.

7. Set the AC GND DC switch to DC. The ground reference line can be checked at any time by switching to the GND position.

8. Set the A Triggering controls to obtain a stable display. Set the TIME/DIV switch to a setting that will display the desired waveform.

9. Measure the distance in divisions between the reference line and the point on the waveform at which the dc level is to be measured. For example, in Fig. 2-15 the measurement is made between the reference line and point A.

10. Establish the polarity of the signal. If the waveform is above the reference line, the voltage is positive; below the line, negative (INVERT switch pushed in if using Channel 2).

For Service Manuals Contact  
**MAURITRON TECHNICAL SERVICES**  
 8 Cherry Tree Rd. Chinnor  
 Oxon OX9 4QY  
 Tel:- 01844-351694 Fax:- 01844-352554  
 Email:- enquiries@mauritron.co.uk

## Operating Instructions—Type 453

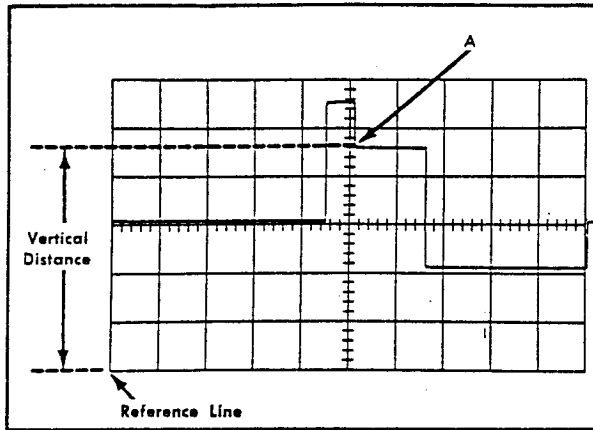

Fig. 2-15. Measuring instantaneous dc voltage with respect to a reference.

11. Multiply the distance measured in step 9 by the VOLTS/DIV switch setting. Include the attenuation factor of the probe, if any.

**Example.** Assume that the vertical distance measured is 4.6 divisions (see Fig. 2-15), the waveform is above the reference line, using a 10× attenuator probe and a VOLTS/DIV setting of 2.

Using the formula:

$$\text{Instantaneous Voltage} = \text{vertical distance (divisions)} \times \text{polarity} \times \text{VOLTS/DIV setting} \times \text{probe attenuation factor}$$

Substituting the given values:

$$\text{Instantaneous Voltage} = 4.6 \times +1 \times 2 \times 10$$

The instantaneous voltage would be +92 volts.

### Voltage Comparison Measurements

In some applications it may be necessary to establish a set of deflection factors other than those indicated by the VOLTS/DIV switch. This is useful for comparing signals to a reference voltage amplitude. To establish a new set of deflection factors based upon a specific reference amplitude, proceed as follows.

1. Apply the reference signal of known amplitude to either INPUT connector. Set the MODE switch to display the channel used. Using the VOLTS/DIV switch and the VARIABLE control, adjust the display for an exact number of divisions. Do not move the VARIABLE VOLTS/DIV control after obtaining the desired deflection.

2. Divide the amplitude of the reference signal (volts) by the product of the deflection in divisions (established in step 1) and the VOLTS/DIV switch setting. This is the Deflection Conversion Factor.

$$\text{Deflection Conversion Factor} = \frac{\text{reference signal amplitude (volts)}}{\text{deflection (divisions)} \times \text{VOLTS/DIV setting}}$$

3. To establish an Adjusted Deflection Factor at any setting of the VOLTS/DIV switch, multiply the VOLTS/DIV switch setting by the Deflection Conversion Factor established in step 2.

$$\text{Adjusted Deflection Factor} = \text{VOLTS/DIV setting} \times \text{Deflection Conversion Factor}$$

This Adjusted Deflection Factor applies only to the channel used and is correct only if the VARIABLE VOLTS/DIV control is not moved from the position set in step 1.

4. To determine the peak-to-peak amplitude of a signal compared to a reference, disconnect the reference and apply the signal to the INPUT connector.

5. Set the VOLTS/DIV switch to a setting that will provide sufficient deflection to make the measurement. Do not readjust the VARIABLE VOLTS/DIV control.

6. Measure the vertical deflection in divisions and determine the amplitude by the following formula:

$$\text{Signal Amplitude} = \frac{\text{Adjusted Deflection}}{\text{Factor}} \times \text{deflection (divisions)}$$

**Example.** Assume a reference signal amplitude of 30 volts, a VOLTS/DIV setting of 5 and a deflection of 4 divisions. Substituting these values in the Deflection Conversion Factor formula (step 2):

$$\text{Deflection Conversion Factor} = \frac{30}{4 \times 5} = 1.5$$

Then, with a VOLTS/DIV switch setting of 10, the Adjusted Deflection Factor (step 3) would be:

$$\text{Adjusted Deflection Factor} = 10 \times 1.5 = 15 \text{ volts/division}$$

To determine the peak-to-peak amplitude of an applied signal which produces a vertical deflection of 5 divisions, use the Signal Amplitude formula (step 6):

$$\text{Signal Amplitude} = 15 \times 5 = 75 \text{ volts}$$

### Time-Duration Measurements

To measure time between two points on a waveform, use the following procedure.

1. Connect the signal to either INPUT connector.
2. Set the MODE switch to display the channel used.
3. Set the VOLTS/DIV switch to display about 5 divisions of the waveform.
4. Set the A Triggering controls to obtain a stable display.



## Operating Instructions—Type 453

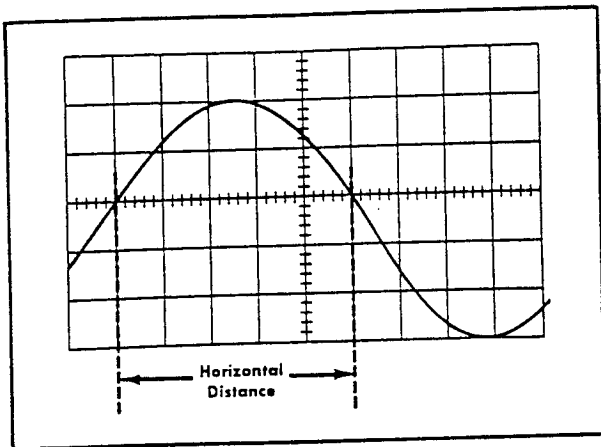

Fig. 2-16. Measuring the time duration between points on a waveform.

5. Set the TIME/DIV switch to the fastest sweep rate that will display less than eight divisions between the time measurement points (see Fig. 2-16). See the topic entitled 'Selecting Sweep Rate' in this section concerning non-linearity of first and last divisions of display.

6. Adjust the Vertical POSITION control to move the points between which the time measurement is made to the horizontal centerline.

7. Adjust the Horizontal POSITION control to move the starting point of the time measurement area to the first graticule line.

8. Measure the horizontal distance between the time measurement points. Be sure the A VARIABLE control is set to CAL.

9. Multiply the distance measured in step 8 by the setting of the TIME/DIV switch. If sweep magnification is used, divide this answer by 10.

**Example.** Assume that the distance between the time measurement points is 5 divisions (see Fig. 2-16) and the TIME/DIV switch is set to .1 mSEC with the magnifier off.

Using the formula:

$$\text{Time Duration} = \frac{\text{horizontal distance} \times \text{TIME/DIV setting}}{\text{magnification}} \text{ (divisions)}$$

Substituting the given values:

$$\text{Time Duration} = \frac{5 \times 0.1}{1}$$

The time duration would be 0.5 milliseconds.

### Frequency Measurements

The frequency of a periodically-recurrent waveform can be determined as follows.

1. Measure the time duration of one cycle of the waveform as described in the previous application.

2. Frequency of a signal is the reciprocal of the time duration of one cycle.

**Example.** The frequency of the signal shown in Fig. 2-16 which has a time duration of 0.5 milliseconds would be:

$$\text{Frequency} = \frac{1}{\text{time duration}} = \frac{1}{0.5} = 2 \text{ kc.}$$

### Risetime Measurements

Risetime measurements employ basically the same techniques as time-duration measurements. The main difference is the points between which the measurement is made. The following procedure gives the basic method of measuring risetime between the 10% and 90% points of the waveform. Falltime can be measured in the same manner on the trailing edge of the waveform.

1. Connect the signal to either INPUT connector.
2. Set the MODE switch to display the channel used.
3. Set the VOLTS/DIV switch and the VARIABLE control to produce a display an exact number of divisions in amplitude.
4. Center the display about the horizontal centerline.
5. Set the TIME/DIV switch to the fastest sweep rate that will display less than eight divisions between the 10% and 90% points on the waveform.
6. Determine the 10% and 90% points on the rising portion of the waveform. The figures given in Table 2-2 are for the points 10% up from the start of the rising portion and 10% down from the top of the rising portion (90% point).
7. Adjust the Horizontal POSITION control to move the 10% point of the waveform to the first graticule line. For example, with a 4-division display as shown in Fig. 2-17, the 10% point would be 0.4 division up from the start of the rising portion.

8. Measure the horizontal distance between the 10% and 90% points. Be sure the A VARIABLE control is set to CAL.

9. Multiply the distance measured in step 8 by the setting of the TIME/DIV switch. If sweep magnification is used, divide this answer by 10.

**Example.** Assume that the horizontal distance between the 10% and 90% points is 4 divisions (see Fig. 2-17) and the TIME/DIV switch is set to 1  $\mu$ SEC with the MAG switch set to  $\times 10$ .

Applying the time duration formula to risetime:

$$\text{Risetime (Time Duration)} = \frac{\text{horizontal distance} \times \text{TIME/DIV setting}}{\text{magnification}} \text{ (divisions)}$$

Substituting the given values:

$$\text{Risetime} = \frac{4 \times 1}{10}$$

The risetime would be 0.4 microsecond.

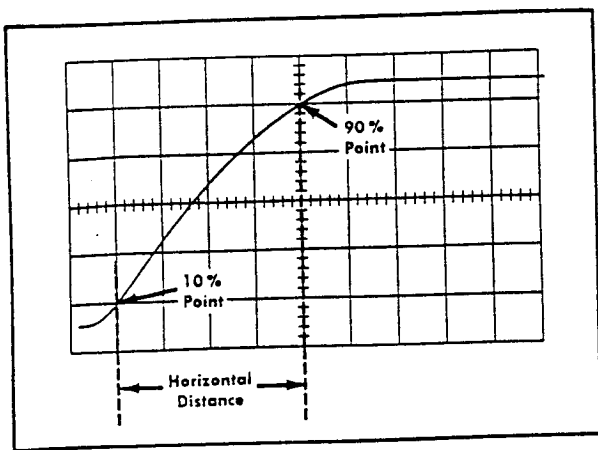

Fig. 2-17. Measuring risetime.

TABLE 2-2

Vertical Display (Divisions)	10% and 90% points
4	0.4 division
5	0.5 division
6	0.6 division

### Time-Difference Measurements

The calibrated sweep rate and dual-trace features of the Type 453 allow measurement of time difference between two separate events. To measure time difference, use the following procedure.

1. Set the AC GND DC switches to the desired coupling positions.
2. Set the MODE switch to either CHOP or ALT. In general, CHOP is more suitable for low-frequency signals and the ALT position is more suitable for high-frequency signals. More information on determining the mode is given under 'Dual-Trace Operation' in this section.
3. Set the TRIGGER switch to CH 1 ONLY.
4. Connect the reference signal to Channel 1 INPUT and the comparison signal to Channel 2 INPUT. The reference signal should precede the comparison signal in time. Use coaxial cables or probes which have equal time delay to connect the signals to the INPUT connectors.
5. If the signals are of opposite polarity, pull the INVERT switch out to invert the Channel 2 display.
6. Set the VOLTS/DIV switches to produce 4- or 5-division displays.
7. Set the Triggering LEVEL control for a stable display.
8. Set the TIME/DIV switch for a sweep rate which shows three or more divisions between the two waveforms.
9. Adjust the Vertical POSITION controls to center each waveform (or the points on the display between which the measurement is made) in relation to the horizontal centerline.

For Service Manuals Contact  
**MAURITRON TECHNICAL SERVICES**  
 8 Cherry Tree Rd, Chinnor  
 Oxon OX9 4QY  
 Tel: 01844-351694 Fax: 01844-352554  
 Email: enquiries@mauritron.co.uk

10. Adjust the Horizontal POSITION control so the Channel 1 (reference) waveform crosses the horizontal centerline at a vertical graticule line.

11. Measure the horizontal difference between the Channel 1 waveform and the Channel 2 waveform (see Fig. 2-18).

12. Multiply the measured difference by the setting of the TIME/DIV switch. If sweep magnification is used, divide this answer by 10.

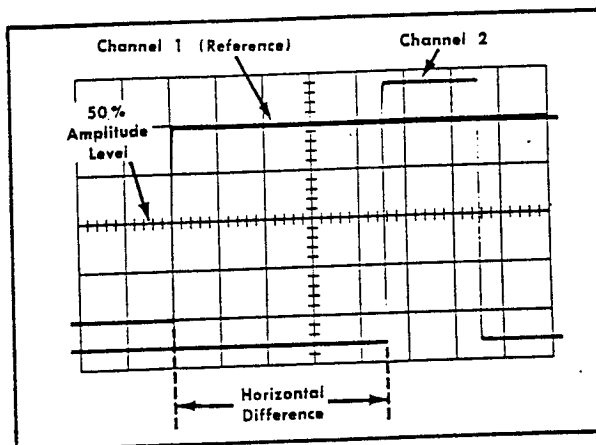

Fig. 2-18. Measuring time difference between two pulses.

**Example.** Assume that the TIME/DIV switch is set to 50  $\mu$ SEC, the MAG switch to  $\times 10$  and the horizontal difference between waveforms is 4.5 divisions (see Fig. 2-18).

Using the formula:

$$\text{Time Delay} = \frac{\text{TIME/DIV setting} \times \text{horizontal difference (divisions)}}{\text{magnification}}$$

Substituting the given values:

$$\text{Time Delay} = \frac{50 \times 4.5}{10}$$

The time delay would be 22.5 microseconds.

### Delayed Sweep Time Measurements

The delayed sweep mode can be used to make accurate time measurements. Overall accuracy of the time measurement will be affected by the following factors.

- a. Accuracy of the A Sweep Generator at the sweep rate used.
- b. DELAY-TIME MULTIPLIER dial incremental linearity.

The following measurement determines the time difference between two pulses displayed on the same trace. This application may also be used to measure time difference from two different sources (dual-trace) or to measure time duration of a single pulse.

1. Connect the signal to either INPUT connector. Set the MODE switch to display the channel used.

## Operating Instructions—Type 453

- Set the VOLTS/DIV switch to produce a display about 4 divisions in amplitude.
- Set the A TIME/DIV switch to a sweep rate which displays about 8 divisions between the pulses.
- Adjust the A Triggering controls for a stable display.
- Set the HORIZ DISPLAY switch to A INTEN DURING B and the B SWEEP MODE switch to B STARTS AFTER DELAY TIME.
- Set the B TIME/DIV switch to a setting 1/100 of the A TIME/DIV sweep rate. This will produce an intensified portion about 0.1 division in length.
- Turn the DELAY-TIME MULTIPLIER dial to move the intensified portion to the first pulse.
- Set the HORIZ DISPLAY switch to DELAYED SWEEP (B).
- Adjust the DELAY-TIME MULTIPLIER dial to move the pulse (or the rising portion) to the vertical centerline. Note the reading on the DELAY-TIME MULTIPLIER dial.
- Turn the DELAY-TIME MULTIPLIER dial clockwise until the second pulse is positioned to this same point (if several pulses are displayed, return to the A INTEN DURING B position to locate the correct pulse). Again note the dial reading.
- Subtract the first reading from the second and multiply by the setting of the A TIME/DIV switch. This is the time interval between the pulses.

**Example.** Assume the first dial reading is 1.31 and the second dial reading is 8.81 with the TIME/DIV switch set to 0.2 microsecond (see Fig. 2-19).

Using the formula:

$$\text{Time Difference (delayed sweep)} =$$

$$\frac{\text{second dial reading} - \text{first dial reading}}{\text{A TIME/DIV setting}} \times$$

Substituting the given values:

$$\text{Time Difference} = (8.81 - 1.31) \times 0.2.$$

The time difference would be 1.5 microseconds.

### Delayed Sweep Magnification

The delayed sweep feature of the Type 453 can be used to provide higher apparent magnification than is provided by the MAG switch. The sweep rate of the DELAYED SWEEP (B Sweep) is not actually increased; the apparent magnification is the result of delaying the B Sweep an amount of time selected by the A TIME/DIV switch and the DELAY-TIME MULTIPLIER dial before the display is presented at the sweep rate selected by the B TIME/DIV switch. At higher apparent magnification ranges, the 'Triggered Delayed Sweep Magnification' procedure should be used.

- Connect the signal to either INPUT connector. Set the MODE switch to display the channel used.
- Set the VOLTS/DIV switch to produce a display about 4 divisions in amplitude.

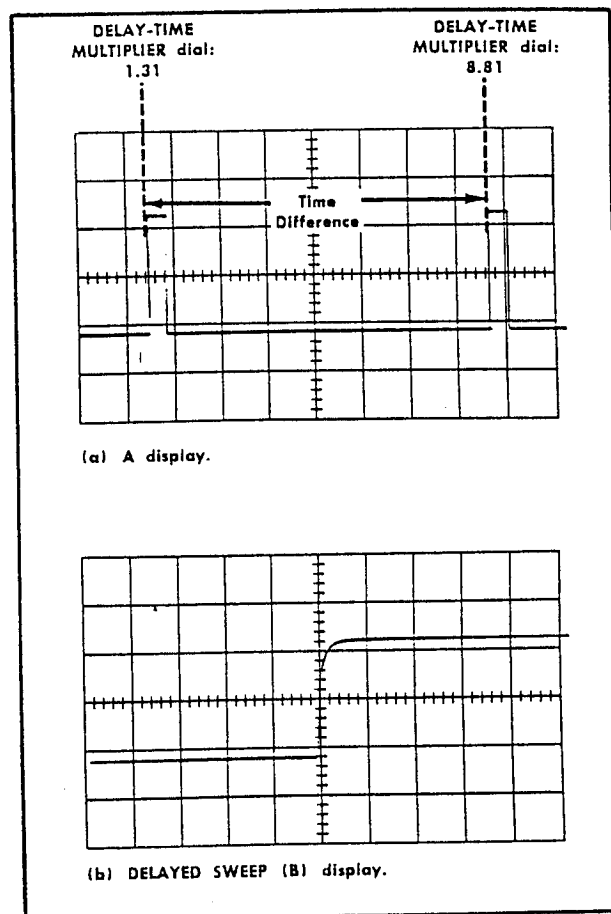

Fig. 2-19. Measuring time difference using delayed sweep.

- Set the A TIME/DIV switch to a sweep rate which displays the complete waveform.
- Adjust the A Triggering controls for a stable display.
- Set the HORIZ DISPLAY switch to A INTEN DURING B and the B SWEEP MODE switch to B STARTS AFTER DELAY TIME.
- Position the start of the intensified portion with the DELAY-TIME MULTIPLIER dial to the part of the display to be magnified.
- Set the B TIME/DIV switch to a setting which intensifies the full portion to be magnified. The start of the intensified trace will remain as positioned above.
- Set the HORIZ DISPLAY switch to DELAYED SWEEP (B).
- Time measurements can be made from the display in the conventional manner. Sweep rate is determined by the setting of the B TIME/DIV switch.
- The apparent sweep magnification can be calculated by dividing the A TIME/DIV setting by the B TIME/DIV setting.

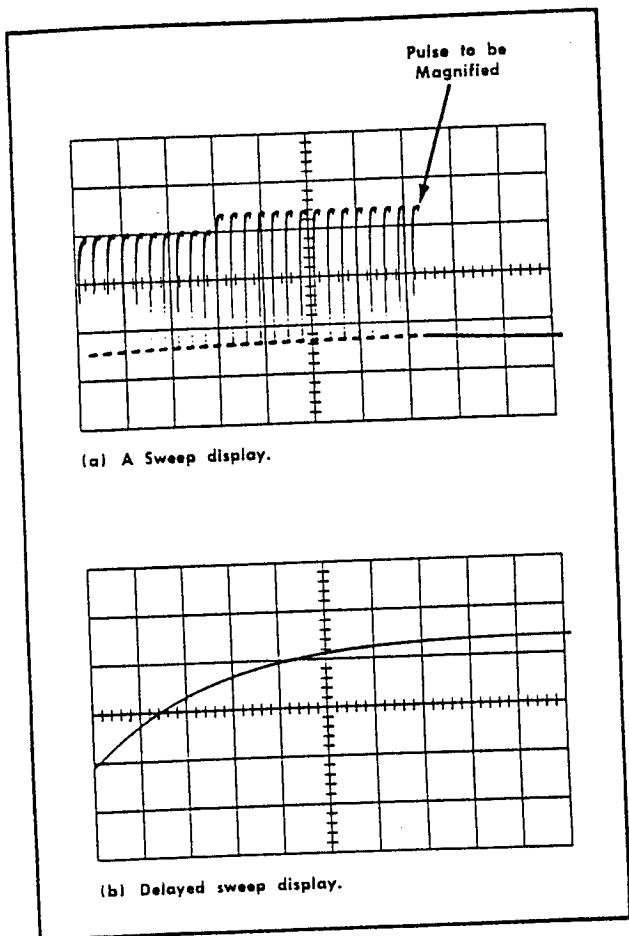

Fig. 2-20. Using delayed sweep for sweep magnification.

**Example.** The apparent magnification of the display shown in Fig. 2-20 with an A TIME/DIV setting of .1 mSEC and a B TIME/DIV setting of 1 μSEC would be:

$$\text{Apparent Magnification (Delayed Sweep)} = \frac{\text{A TIME/DIV setting}}{\text{B TIME/DIV setting}}$$

Substituting the given values:

$$\text{Apparent Magnification} = \frac{1 \times 10^{-4}}{1 \times 10^{-6}}$$

The apparent magnification would be 100 times.

**Triggered Delayed Sweep Magnification.** The delayed sweep magnification method just described may produce too much jitter at high apparent magnification ranges. The B TRIGGERABLE AFTER DELAY TIME position of the B SWEEP MODE switch provides a more stable display since the delayed display is triggered at the same point each time.

1. Set up the display as given in steps 1 through 7 described above.
2. Set the B SWEEP MODE switch to B TRIGGERABLE AFTER DELAY TIME.

3. Adjust the B Triggering LEVEL control so the intensified portion on the trace is stable. (If an intensified portion cannot be obtained, see step 4.)

4. Inability to intensify the desired portion indicates that the signal does not meet the triggering requirements. If the condition cannot be remedied with the B Triggering LEVEL control or by increasing the display amplitude (lower VOLTS/DIV setting), externally trigger B Sweep.

5. When the correct portion is intensified, set the HORIZ DISPLAY switch to DELAYED SWEEP (B). Slight readjustment of the B Triggering LEVEL control may be necessary for a stable display.

6. Measurement and magnification are as described above.

### Displaying Complex Signals Using Delayed Sweep

Complex signals often consist of a number of individual events of differing amplitudes. Since the trigger circuits are sensitive to changes in signal amplitude, a stable display can normally be obtained only when the sweep is triggered by the event(s) having the greatest amplitude. However, this may not produce the desired display of a lower amplitude event which follows the triggering event. The delayed sweep feature provides a means of delaying the start of the B Sweep by a selected amount following the start of the A Sweep Generator. Then, the part of the waveform which contains the information of interest can be displayed. Fig. 2-21 demonstrates this feature. Follow the operation under 'Delayed Sweep Magnification' or 'Triggered Delayed Sweep Magnification' to obtain a display in this mode.

### Delayed Trigger Generator

The B GATE output signal can be used to trigger an external device at a selected delay time after the start of A Sweep. The delay time of the B GATE output signal can be selected by the setting of the DELAY-TIME MULTIPLIER dial and A TIME/DIV switch.

**A Sweep Triggered Internally.** When A Sweep is triggered internally to produce a normal display, the delayed trigger may be obtained as follows.

1. Obtain a triggered display in the normal manner.
2. Set the HORIZ DISPLAY switch to A INTEN DURING B.
3. Select the amount of delay from the start of A Sweep with the DELAY-TIME MULTIPLIER dial. Delay time can be calculated in the normal manner.
4. Set the B SWEEP MODE switch to B STARTS AFTER DELAY TIME.
5. Connect the B GATE signal to the external equipment.
6. The duration of the B GATE pulse is determined by the setting of the B TIME/DIV switch.
7. The external equipment will be triggered at the start of the intensified portion if it responds to positive-going triggers, or at the end of the intensified portion if it responds to negative-going triggers.

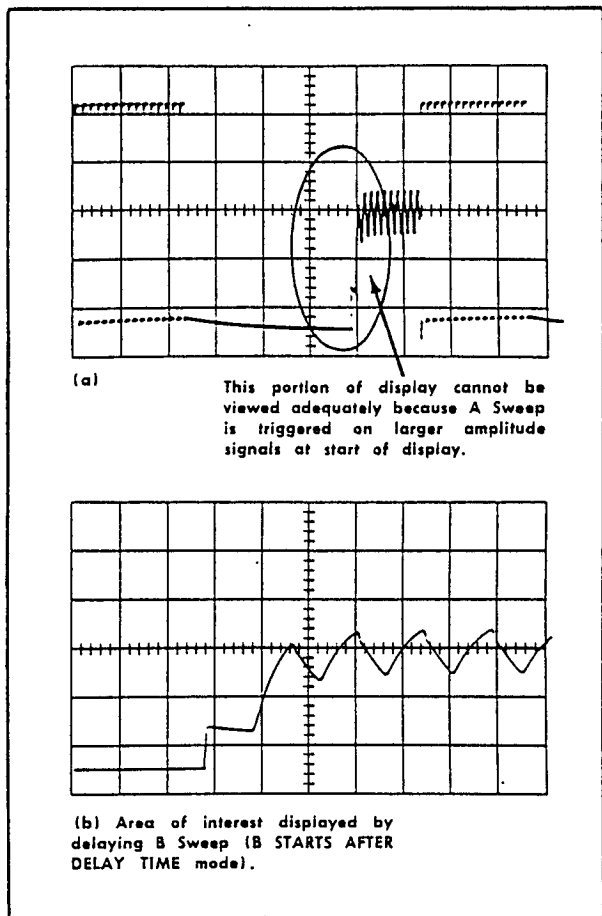

Fig. 2-21. Displaying a complex signal using delayed sweep.

**A Sweep Triggered Externally.** This mode of operation can be used to produce a delayed trigger with or without a corresponding display. Connect the external trigger signal to the A Triggering EXT TRIG INPUT connector and set the A Triggering SOURCE switch to EXT. Follow the operation given above to obtain the delayed trigger.

### Normal Trigger Generator

Ordinarily, the signal to be displayed also provides the trigger signal for the oscilloscope. In some instances, it may be desirable to reverse this situation and have the oscilloscope trigger the signal source. This can be done by connecting the A GATE signal to the input of the signal source. Set the A Triggering LEVEL control fully clockwise, A SWEEP MODE switch to AUTO TRIG and adjust the A TIME/DIV switch for the desired display. Since the signal source is triggered by a signal that has a fixed time relationship to the sweep, the output of the signal source can be displayed on the crt as though the Type 453 were triggered in the normal manner.

### Multi-Trace Phase Difference Measurements

Phase comparison between two signals of the same fre-

quency can be made using the dual-trace feature of the Type 453. This method of phase difference measurement can be used up to the frequency limit of the vertical system. To make the comparison, use the following procedure.

1. Set the AC GND DC switches to the same position, depending on the type of coupling desired.
2. Set the MODE switch to either CHOP or ALT. In general, CHOP is more suitable for low-frequency signals and the ALT position is more suitable for high-frequency signals. More information on determining the mode is given under 'Dual-Trace Operation' in this section.
3. Set the TRIGGER switch to CH 1 ONLY.
4. Connect the reference signal to Channel 1 INPUT and the comparison signal to Channel 2 INPUT. The reference signal should precede the comparison signal in time. Use coaxial cables or probes which have equal time delay to connect the signals to the INPUT connectors.
5. If the signals are of opposite polarity, pull the INVERT switch out to invert the Channel 2 display.
6. Set the VOLTS/DIV switches and the VARIABLE VOLTS/DIV controls so the displays are equal and about 5 divisions in amplitude.
7. Set the triggering controls to obtain a stable display.
8. Set the TIME/DIV switch to a sweep rate which displays about 1 cycle of the waveform.
9. Move the waveforms to the center of the graticule with the Vertical POSITION controls.
10. Turn the A VARIABLE control until 1 cycle of the reference signal (Channel 1) occupies exactly 9 divisions horizontally (see Fig. 2-22). Each division of the graticule represents  $40^\circ$  of the cycle ( $360^\circ \div 9 \text{ divisions} = 40^\circ / \text{division}$ ). This is the phase factor.

11. Measure the horizontal difference between corresponding points on the waveform.

12. Multiply the measured distance (in divisions) by  $40^\circ$  (phase factor) to obtain the exact amount of phase difference.

**Example.** Assume a horizontal difference of 0.6 divisions with a phase factor of  $40^\circ$  as shown in Fig. 2-22.

Using the formula:

$$\text{Phase Difference} = \frac{\text{horizontal difference}}{\text{divisions}} \times \text{phase factor}$$

Substituting the given values:

$$\text{Phase Difference} = 0.6 \times 40^\circ$$

The phase difference would be  $24^\circ$ .

**More Accurate Phase Measurements.** More accurate dual-trace phase measurements can be made by increasing the sweep rate (without changing the A VARIABLE control setting). One of the easiest ways to increase the sweep rate is with the MAG switch. Delayed sweep magnification may also be used. The adjusted phase factor is determined by dividing the phase factor obtained previously by the increase in sweep rate.

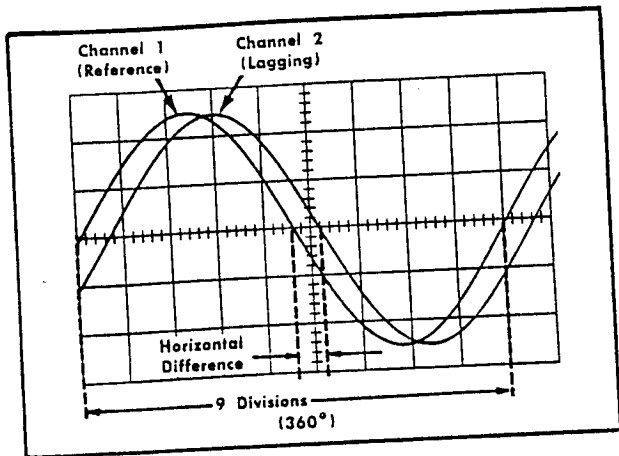

Fig. 2-22. Measuring phase difference.

**Example.** If the sweep rate were increased 10 times with the magnifier, the adjusted phase factor would be  $40^\circ \div 10 = 4^\circ/\text{division}$ . Fig. 2-23 shows the same signals as used in Fig. 2-22 but with the MAG switch set to  $\times 10$ . With a horizontal difference of 6 divisions, the phase difference would be:

$$\text{Phase Difference} = \frac{\text{horizontal difference}}{\text{division}} \times \text{adjusted phase factor}$$

Substituting the given values:

$$\text{Phase Difference} = 6 \times 4^\circ$$

The phase difference would be  $24^\circ$ .

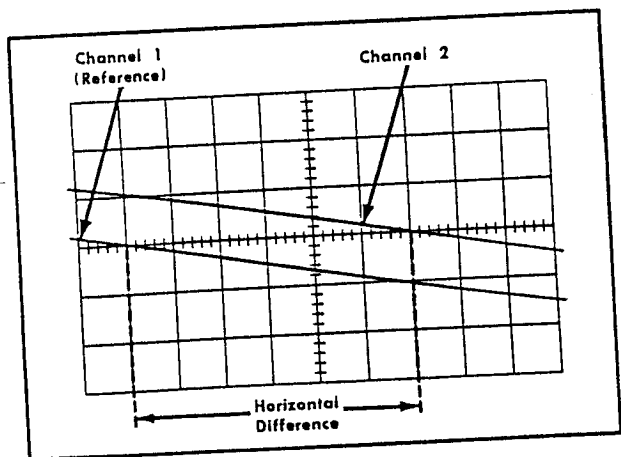

Fig. 2-23. Accurate phase-difference measurement with increased sweep rate.

### X-Y Phase Measurements

The X-Y phase measurement method can be used to measure the phase difference between two signals of the same frequency. This method provides a more precise method of measurement for signal frequencies up to about

100 kc than the multi-trace method discussed previously. However, above this frequency the inherent phase difference between the vertical and horizontal systems makes accurate phase measurement difficult. In this mode, one of the sine-wave signals provides horizontal deflection (X) while the other signal provides the vertical deflection (Y). The phase angle between the two signals can be determined from the lissajous pattern as follows.

1. Connect one of the sine-wave signals to both the Channel 1 INPUT and the Channel 2 INPUT connectors. (Note: steps 1 through 5 measure inherent phase difference between the X and Y amplifiers to provide more accurate X-Y phase measurements; not necessary below about 1 kc.)

2. Set the HORIZ DISPLAY switch to EXT HORIZ. Set the TRIGGER switch to CH 1 ONLY and the B Triggering SOURCE switch to INT.

3. Position the display to the center of the screen and adjust the VOLTS/DIV switches to produce about 4 divisions in each direction. The CH 1 VOLTS/DIV switch controls the horizontal deflection (X) and the CH 2 VOLTS/DIV switch controls the vertical deflection (Y).

4. Center the display in relation to the vertical graticule line. Measure the distances A and B as shown in Fig. 2-25. Distance A is the vertical measurement between the two points where the trace crosses the vertical centerline. Distance B is the maximum vertical height of the display.

5. Divide A by B to obtain the sine of the phase angle ( $\phi$ ) between the two signals. The angle can then be obtained from a trigonometric table. If the display appears as a diagonal straight line, the two signals are either in phase (tilted upper right to lower left) or  $180^\circ$  out of phase (tilted upper left to lower right). If the display is a circle, the signals are  $90^\circ$  out of phase. Fig. 2-24 shows the lissajous displays produced between  $0^\circ$  and  $360^\circ$ . Notice that above  $180^\circ$  phase shift, the resultant display will be the same as at some lower frequency.

6. Connect the Y signal to Channel 2 INPUT connector. Repeat steps 2 through 5 to measure phase angle.

7. Subtract the inherent phase difference from the phase angle  $\phi$  to obtain the actual phase difference.

**Example.** Assume an inherent phase difference of  $2^\circ$  with a display as shown in Fig. 2-25 where A is 2 divisions and B is 4 divisions.

Using the formula:

$$\text{Sine } \phi = \frac{A}{B}$$

Substituting the given values:

$$\text{Sine } \phi = \frac{2}{4} = 0.5$$

From the trigonometric tables:

$$\phi = 30^\circ$$

To adjust for the phase difference between X and Y amplifiers, subtract the inherent phase factor.

For Service Manuals Contact  
MAURITRON TECHNICAL SERVICES  
8 Cherry Tree Rd. Chinnor  
Oxon OX9 4QY  
Tel:- 01844-351694 Fax:- 01844-352554  
Email:- enquiries@mauritron.co.uk

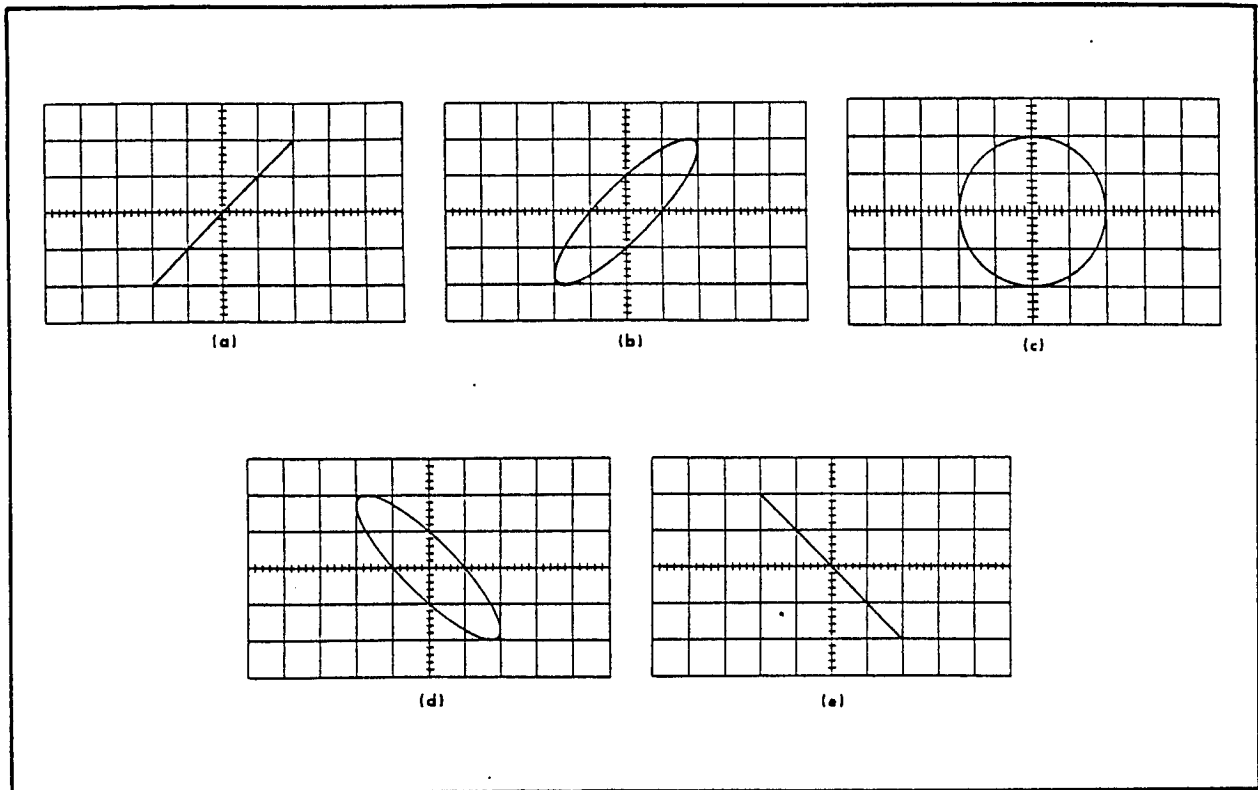

Fig. 2-24. Phase of Lissajous displays. (a) 0° or 360°, (b) 30° or 330°, (c) 90° or 270°, (d) 150° or 210° and (e) 180°.

$$\begin{array}{rcl} \text{Actual} & = & \text{Inherent} \\ \text{Phase} & = & \phi - \text{Phase} \\ \text{Factor} & & \text{Difference} \end{array}$$

Substituting the given values:

$$\begin{array}{rcl} \text{Actual} & & \\ \text{Phase} & = & 30^\circ - 2^\circ = 28^\circ \\ \text{Factor} & & \end{array}$$

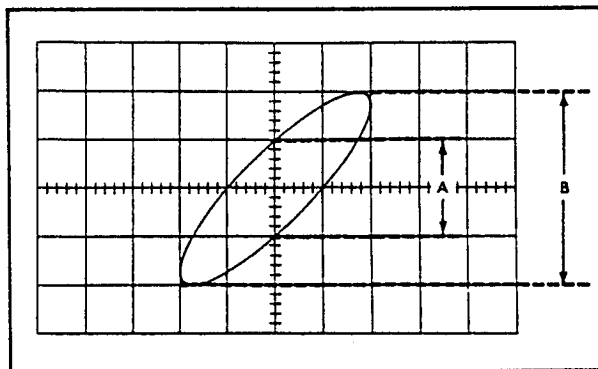

Fig. 2-25. Phase-difference measurement from an X-Y display.

### Common-Mode Rejection

The ADD feature of the Type 453 can be used to display signals which contain undesirable components. These undesirable components can be eliminated through common-mode rejection. The precautions given under 'Algebraic Addition' should be observed.

1. Connect the signal containing both the desired and undesired information to the Channel 1 INPUT connector.
2. Connect a signal similar to the unwanted portion of the Channel 1 signal to the Channel 2 INPUT connector. For example, in Fig. 2-26 a line-frequency signal is connected to Channel 2 to cancel out the line-frequency component of the Channel 1 signal.
3. Set both AC GND DC switches to DC (AC if dc component of input signal is too large).
4. Set the MODE switch to ALT. Set the VOLTS/DIV switches so the signals are about equal in amplitude.
5. Set the TRIGGER switch to NORM.
6. Set the MODE switch to ADD. Pull the INVERT switch so the common-mode signals are of opposite polarity.
7. Adjust the CH 2 VOLTS/DIV switch and VARIABLE control for maximum cancellation of the common-mode signal.

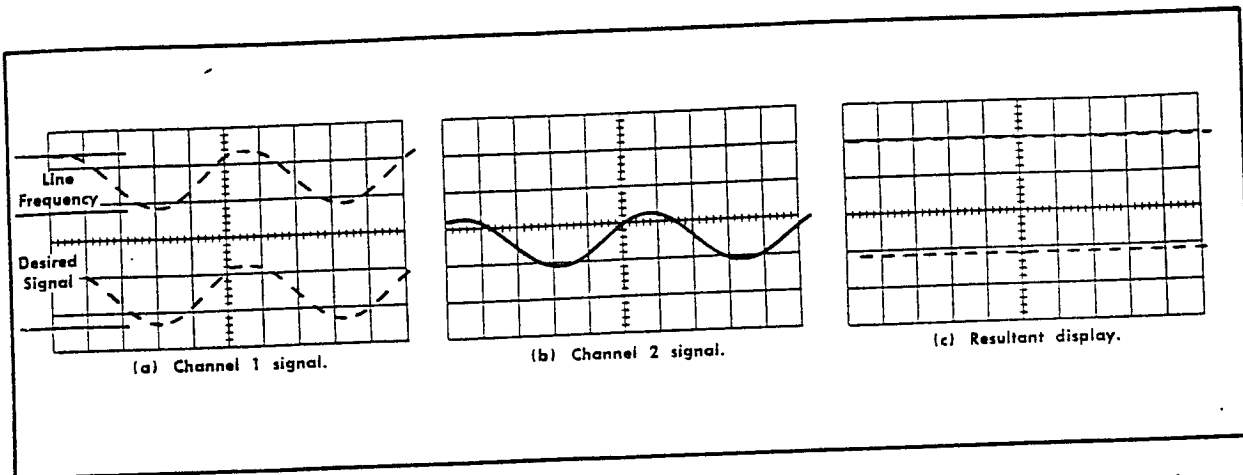

Fig. 2-26. Using the ADD feature for common-mode rejection. (a) Channel 1 signal contains desired information along with line-frequency component, (b) Channel 2 signal contains line-frequency only, (c) crt display using common-mode rejection.

8. The signal which remains should be only the desired portion of the Channel 1 signal. The undesired signal is cancelled out.

Example. An example of this mode of operation is

shown in Fig. 2-26. The signal applied to Channel 1 contains unwanted line-frequency components (Fig. 2-26a). A corresponding line-frequency signal is connected to Channel 2 (Fig. 2-26b). Fig. 2-26c shows the desired portion of the signal as displayed when common-mode rejection is used.

For Service Manuals Contact  
 MAURITRON TECHNICAL SERVICES  
 8 Cherry Tree Rd, Chinnor  
 Oxon OX9 4QY  
 Tel:- 01844-351694 Fax:- 01844-352554  
 Email:- enquiries@mauritron.co.uk



# SECTION 3

## CIRCUIT DESCRIPTION

### Introduction

This section of the manual contains an electrical description of each circuit in the Type 453 Oscilloscope. A detailed block diagram is given for each main section in the following description. A complete block diagram is located in the Diagrams section of this manual. The complete block diagram shows the relationship between the major circuits of the instrument.

Complete schematic diagrams are also given in the Diagrams section. These diagrams should be referred to for electrical values and relationship.

### VERTICAL PREAMP

#### NOTE

The following circuit description applies to both Ch 1 and 2 Vertical Preamps. Circuit numbers used in this description are from Channel 1. Circuit numbers for Channel 2 will be the same, except where circuit differences exist, only in the 100-series. Any differences between the two circuits is given under 'Ch 2 Vertical Preamp'.

### Input Coupling

Input signals applied to the INPUT connector can be ac-coupled, dc-coupled or internally disconnected. When the AC GND DC switch, SW1, is in the DC position, the input signal is coupled directly to the Input Attenuator. In the AC position, the input signal is passed through a blocking capacitor, C1. This prevents the dc component of the signal from passing to the amplifier. The GND position opens the signal path and the input to the amplifier is connected to ground. This provides a ground reference without the need to remove the applied signal from the INPUT connector.

### Input Attenuator

The effective overall deflection factor of the Type 453 is determined by the VOLTS/DIV switch and the VARIABLE control. In all positions of the VOLTS/DIV switch above 20 mV, the basic deflection factor of the vertical system is 20 millivolts per division of crt deflection. To increase this basic deflection factor to the values indicated on the front panel, various precision attenuators are switched into the circuit. In the 5 and 10 mV positions, input attenuation is not used. Instead, the gain of the Feedback Amplifier is changed to decrease the deflection factor (see 'Feedback Amplifier').

For the VOLTS/DIV switch positions above 20 mV, the attenuators are switched into the circuit singly or in pairs to produce the vertical deflection factor indicated on the front panel. These attenuators are frequency-compensated voltage dividers. For dc and low-frequency signals they are resistance dividers and the amount of voltage attenuation

is determined by the resistance in the circuit. The reactance of the capacitors in the circuit is so high at low frequencies that their effect is negligible. However, at higher frequencies, the reactance of the capacitors decreases and the attenuator becomes primarily a capacitance voltage divider.

In addition to providing correct attenuation, the Input Attenuators are designed to maintain the same input resistance (1 megohm) for each setting of the VOLTS/DIV switch. A variable capacitor is provided to set the input time constant of each attenuator to the same value (nominally  $20 \text{ pf} \times 1 \text{ megohm}$ ) for each setting of the VOLTS/DIV switch.

### Input Cathode Follower

The Input Cathode Follower, V23, provides a high input impedance with low impedance output drive to the following circuits. This stage also serves to isolate the input circuit and signal source from the remaining amplifier circuitry. R17 in the grid circuit of V23 is the input resistor. This resistor is part of the attenuation network at all VOLTS/DIV switch positions above 20 mV.

B18, D18 and D24 provide protection for V23. Neon bulb B18 prevents the grid-to-cathode voltage limit from being exceeded if a high amplitude negative signal is applied. Diode D18 limits the positive cathode excursion to about +12 volts. Diode D24 clamps the cathode of V23 near ground to protect V23 until the filament reaches operating temperature. It also provides limiting for negative signals at the cathode. Limiting by D18 and D24 prevents overdriving Q34B.

Transistor Q34A is a constant current source for V23. The STEP ATTEN BAL adjustment, R30, varies the base level of Q34A to provide a zero-volt level at the emitter of Q34B. With a zero-volt level at the emitter of Q34B, the trace position will not change when switching between the 5, 10 and 20 mV positions of the VOLTS/DIV switch.

R24 and R26 provide the correct operating bias for V23. C24 improves high-frequency response of the Input Cathode Follower.

### Feedback Amplifier

The Feedback Amplifier, Q34B and Q54, provides selectable gain to change the deflection factor in the 5 and 10 mV positions of the VOLTS/DIV switch. Gain of this stage is determined by the ratio of R49 to R43, R44 or R45 (see CH 1 Attenuators diagram). R45 is always in the circuit and provides basic gain of 2.5 times in the 20 mV and higher positions. When in the 10 mV position, R44 provides 5 times gain; R43 provides 10 times gain in the 5 mV position. As mentioned previously, the STEP ATTEN BAL adjustment is set to provide zero volts at the emitter of Q34B when the input is at zero volts. Since there is no voltage difference across the emitter resistors (R43, R44 and R45), changing the value of the resistance will not

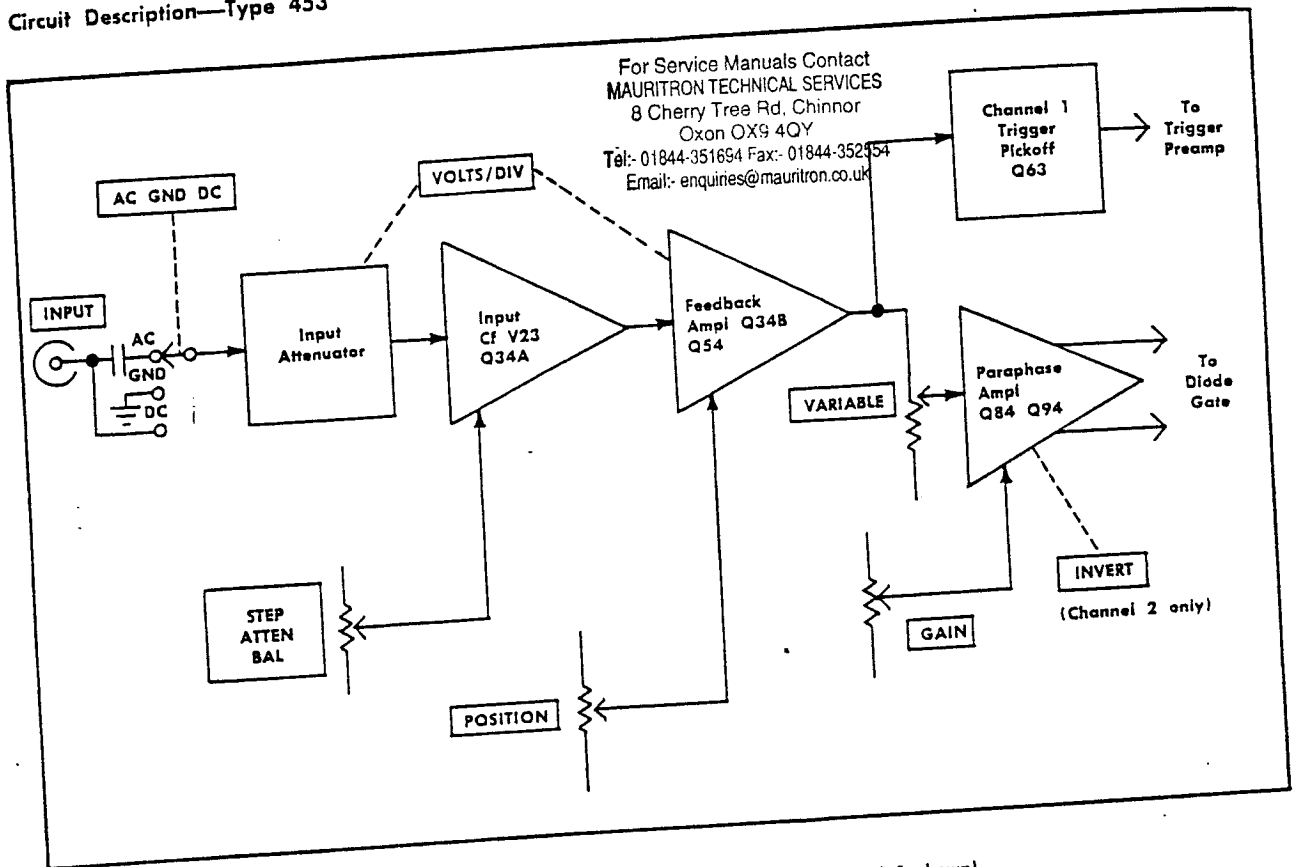

Fig. 3-1. Block diagram of Vertical Preamp circuit (Channel 1 shown).

change current in the circuit. Therefore, the trace position will not change when switching between the 5, 10 and 20 mV positions.

Vertical position of the trace is determined by the setting of the POSITION control, R40. The POSITION control changes the current into the emitter of Q34B, a low-impedance point, which results in negligible voltage change at this point. However, the output voltage of the stage changes to provide positioning.

Q34A and Q34B are mounted in a common case to provide temperature compensation for the stage. When a change in the characteristics occurs in one half of the dual transistor because of temperature change, the other half will be equally affected. The resultant effect is cancellation of temperature effects of Q34A and Q34B.

Zener diode D53 provides a low-impedance current source for the emitter of Q54. It also holds the voltage across R52 and R55 constant regardless of power-supply variations.

The Ch 1 Position Center adjustment, R55 is adjusted to bring the collector of Q54 to zero volts when the POSITION control is centered. This provides a zero-volt output level from the Feedback Amplifier.

Output signal voltage from the Feedback Amplifier is applied to the Paraphase Amplifier circuit and the Channel 1 Trigger Pickoff circuit.

### Paraphase Amplifier

The Paraphase Amplifier, Q84 and Q94, converts the single-ended input signal to a push-pull output signal to drive the next stage, the Delay-Line Driver. Gain of the Paraphase Amplifier is determined by emitter degeneration. As the impedance between the emitters of Q84 and Q94 increases, emitter degeneration also increases, resulting in less gain through the stage. The GAIN adjustment, R90, varies the resistance between the emitters to control overall gain of the Channel 1 Vertical Preamp.

When the VARIABLE control, R75, is moved from the CAL position, voltage drive to the Paraphase Amplifier is attenuated to provide variable deflection factors. SW75 is ganged with R75 to turn on B75 when the VARIABLE control is moved from the CAL position.

### Channel 1 Trigger Pickoff

The Channel 1 signal at the output of the Feedback Amplifier is connected to the Channel 1 Trigger Pickoff circuit to provide internal triggering only from the Channel 1 signal. The signal is coupled to emitter follower Q63 through D58. D58 provides thermal compensation for Q63. Use of an emitter follower for trigger pickoff provides very little loading on the Ch 1 Vertical Preamp and provides a low impedance output to the Trigger Preamp. Q63 also isolates the Trigger Preamp and Ch 1 Vertical Preamp circuits.

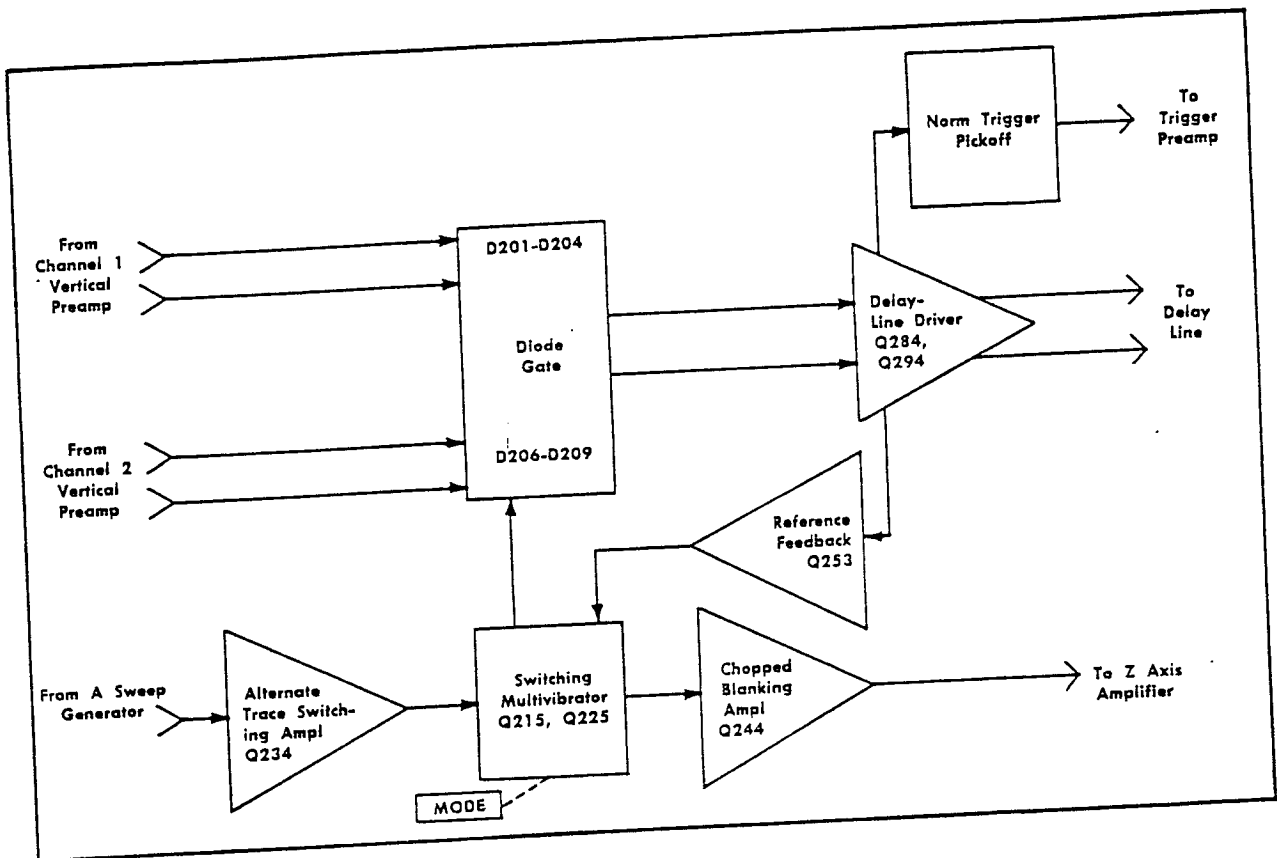

Fig. 3-2. Block diagram of Vertical Switching circuit.

The Ch 1 Trigger Dc Level adjustment, R60, adjusts the dc level at the emitter of Q63 to provide a zero-volt output from the Trigger Preamp circuit. Output from Q63 is connected to the Trigger Preamp in the CH 1 ONLY position of the TRIGGER switch, SW2308. When the TRIGGER switch is set to NORM, the output of the Channel 1 Trigger Pickoff is available at the CH 1 OUT connector.

### Ch 2 Vertical Preamp

The circuit differences between Ch 1 and 2 Vertical Preamps are: (1) No trigger pickoff circuit in Channel 2; (2) INVERT switch in Channel 2. R159 and C159 provide about the same loading for the Channel 2 Feedback Amplifier, Q134B and Q154, as the Channel 1 Trigger Pickoff stage provides for the Channel 1 Feedback Amplifier. This provides equal response from both channels.

The INVERT switch provides polarity inversion by applying the Ch 2 Vertical Preamp output signal to the opposite halves of the diode gate when pulled out.

## VERTICAL SWITCHING

### General

The Vertical Switching circuit determines which of the Vertical Preamp signals is connected to the Vertical Output Amplifier. In the ALT and CHOP positions of the MODE

switch, both channels are alternately displayed on a shared-time basis. The Vertical Switching circuit consists of a pair of Diode Gates, the Switching Multivibrator, and the Delay-Line Driver stages.

### Diode Gates

The two Diode Gates, consisting of four diodes each, can be thought of as switches which allow either of the Vertical Preamp signals to be coupled to the Vertical Output Amplifier. D201 through D204 control the Channel 1 output and D206 through D209 control the Channel 2 output. These diodes are in turn controlled by the Switching Multivibrator for dual-trace displays, or by the MODE switch for single-trace displays.

**CH 1.** In the CH 1 position of the MODE switch,  $-12$  volts is applied through R227 to the junction of D207-D208 in the Channel 2 Diode Gate (see Fig. 3-3). This forward biases D207-D208 and back biases D206-D209 since the input to the Delay-Line Driver is at about  $-5.9$  volts. D206-D209 block the Channel 2 signal so it cannot pass to the Delay-Line Driver stage.

In the Channel 1 Diode Gate, meanwhile, D202-D203 are connected to ground through R212. D202-D203 are held back biased while D201-D204 are forward biased. Therefore, the Channel 1 signal passes to the Delay-Line Driver.

**CH 2.** In the CH 2 position of the MODE switch, the above conditions are reversed. D202-D203 are connected

## Circuit Description—Type 453

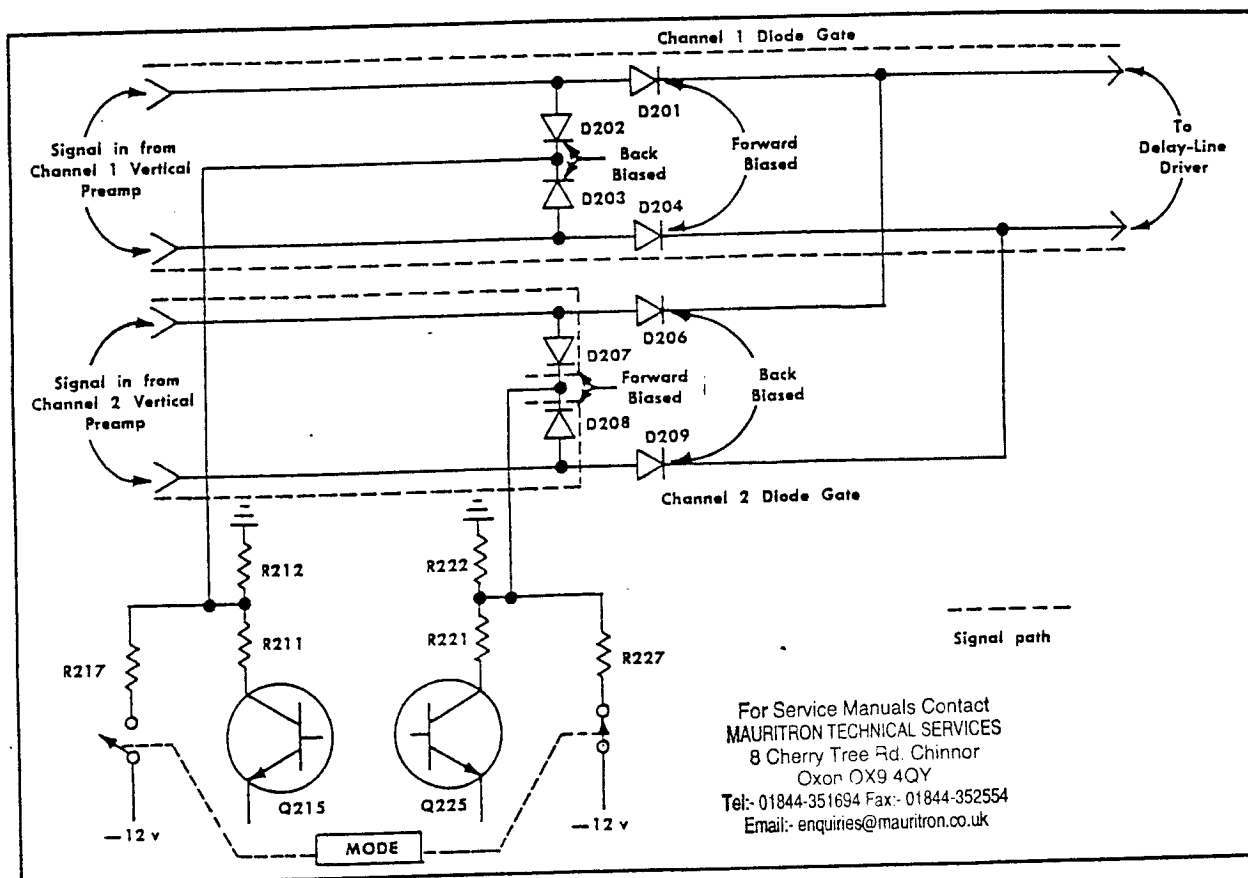

Fig. 3-3. Effect of diode gates on signal path. Shown in CH 1 position of MODE switch.

to  $-12$  volts through R217 and D207-D208 are connected to ground through R222. The Channel 1 Diode Gate will block the signal and the Channel 2 Diode Gate will allow it to pass.

### Switching Multivibrator

**ALT.** In the ALT position of the MODE switch,  $-12$  volts is applied to the emitter of the Alternate Trace Switching Amplifier, Q234. Q234 is conducting and supplies current to the 'on' Switching-Multivibrator transistor through D218 or D228. For example, if Q225 were conducting, current would flow through D228 to Q225. Current flow through the collector resistor drops the D207-D208 voltage level. Channel 2 Diode Gate will be blocked as for Channel 1 only operation and the signal will pass through the Channel 1 Diode Gate to the Output Amplifier.

The positive-going A Gate signal is applied to Q234 through R231 and C231. As the sweep ends, R231-C231 differentiate the negative-going portion of the gate waveform and this negative-going pulse is applied to the base of Q234. Current through Q234 is momentarily interrupted and both Q215 and Q225 turn off. When Q225 was conducting, C218 charged negative on the D218 side and positive on the D228 side. This charge is stored while Q234 is off and determines which transistor will conduct next. When current flow through Q234 is resumed, the anode of

D218 will be more negative than the anode of D228 because of the stored charge on C218. This causes Q215 to be turned on and Q225 turned off, switching the multivibrator. Channel 1 Diode Gate will be blocked and the Channel 2 signal will pass through the Channel 2 Diode Gate.

Q253 provides common-mode voltage feedback from the Delay-Line Driver stage to allow the diode gates to be switched with a minimum amplitude switching signal. The emitter of Q253 is connected to the anodes of D213-D223 and sets the voltage level to which these diodes are switched when turned on or off. The level at the emitter of Q253 follows the average voltage level at the emitters of the Delay-Line Driver stage.

**CHOP.** In the CHOP position of the MODE switch, the Switching Multivibrator free runs at about a 500-kc rate. The emitters of Q215 and Q225 are connected to  $-12$  volts through R218 and R228. At the time of turn-on, one of the transistors will begin to conduct, for example Q225. Q225 will conduct the Channel 2 current and prevent the Channel 2 signal from reaching the Delay-Line Driver stage. Meanwhile, the Channel 1 Diode Gate is passing the Channel 1 signal to the Delay-Line Driver.

The frequency-determining components in the CHOP mode are C218-R218-R228. Switching action will occur as follows: When Q225 is on, C218 will attempt to charge

toward  $-12$  volts through R218. The emitter of Q215 will slowly go toward  $-12$  volts as C218 charges. The base of Q215 is held at a negative point determined by voltage divider R215-R224 between  $-12$  volts and the collector of Q225. When the emitter voltage of Q215 reaches a level slightly more negative than the base, Q215 will conduct. The collector level of Q215 will go negative and pull the base of Q225 negative also, through divider R214-R225, cutting Q225 off. Again C218 begins to charge towards  $-12$  volts but this time through R228. The emitter of Q225 will slowly go negative as C218 again charges, until Q225 turns on. Q215 will be shut off and the cycle will begin again.

Diodes D218 and D228 are reverse biased through D235 and R235 to effectively remove them from the circuit in the CHOP mode. Q253 operates the same in CHOP as in ALT, allowing the Diode Gates to be switched with a minimum signal level.

Chopped Blanking Amplifier Q244 provides an output pulse to the Z Axis Amplifier which blanks out the transition from Channel 1 trace to Channel 2 trace. When the Switching Multivibrator changes states, the voltage across T241 momentarily increases. A negative pulse is applied to the base of Q244, turning it off. The width of the pulse at the base of Q244 is determined by R241 and C241. Q244 clips the signal applied at its base, and the positive-going output pulse, coincident with trace switching, is applied to the Z Axis Amplifier.

**ADD.** In the ADD position both Diode Gates allow signal to pass to the Delay-Line Driver stage. The Diode Gates are both held on by  $-12$  volts applied to the cathodes through R260 and R270. Since both signals are applied to the Delay-Line Driver stage, the output signal will be the algebraic sum of the signals on both Channel 1 and 2.

### Delay-Line Driver

Output of the Diode Gates is applied to Q284 and Q294, the Delay-Line Driver. Q284 and Q294 are connected as operational amplifiers with feedback provided by R268-R269 and R278-R279 and the delay-line compensation network. The delay-line compensation network, R261-R262-R264-R265-C261-C262-C263-C264-C265-C266, provides high-frequency

compensation for the Delay Line. R289-C289 in the collector circuit of Q284-Q294 improve the high-frequency reverse termination of the Delay Line. Output of the Delay-Line Driver stage is connected to the Vertical Output Amplifier through the Delay Line.

The trigger signal for NORM triggering is obtained from the collector of Q284. The Normal Trigger Dc Level adjustment, R285, sets the output of the Trigger Preamp to zero-volt dc level. The normal trigger signal is connected to the Trigger Preamp through SW230B. R294 and R295 provide the same dc load for Q294 as provided to Q284 by the Norm Trigger Pickoff.

### VERTICAL OUTPUT AMPLIFIER

Output of the Delay-Line Driver stage is applied to the emitters of Q304 and Q314 through the Delay Line. The Delay Line delays the signal approximately 140 nanoseconds to give the Sweep Generator circuit time to initiate a sweep before the vertical signal reaches the vertical deflection plates. R303-C303 and R313-C313 provide the forward termination for the Delay Line. L301-L302-L311-C301-C302-C311-C312 comprise a phase equalizer network for the Delay Line.

Output of Q304 and Q314 is applied to the bases of Q324 and Q334. R328-C326-C327-C328-C336 provide high-frequency peaking to compensate for the capacitive loading of the deflection plates on the output stage. The TRACE FINDER, SW330, reduces the quiescent current of Q324 and Q334 and restricts the collector voltage dynamic range of these transistors to limit the trace to the display area. This switch is used to locate a signal which has overscanned the display area. SW330 also performs a similar function in the Horizontal Amplifier.

Q344 and Q354 amplify the output of Q324 and Q334. The signal at the collectors of Q344 and Q354 is applied to the output transistors Q364 and Q374. D344 and D354 prevent saturation of Q344 and Q354 when large signals deflect the display off screen. This improves the recovery of the Vertical Output Amplifier. T357 provides high-frequency balance.

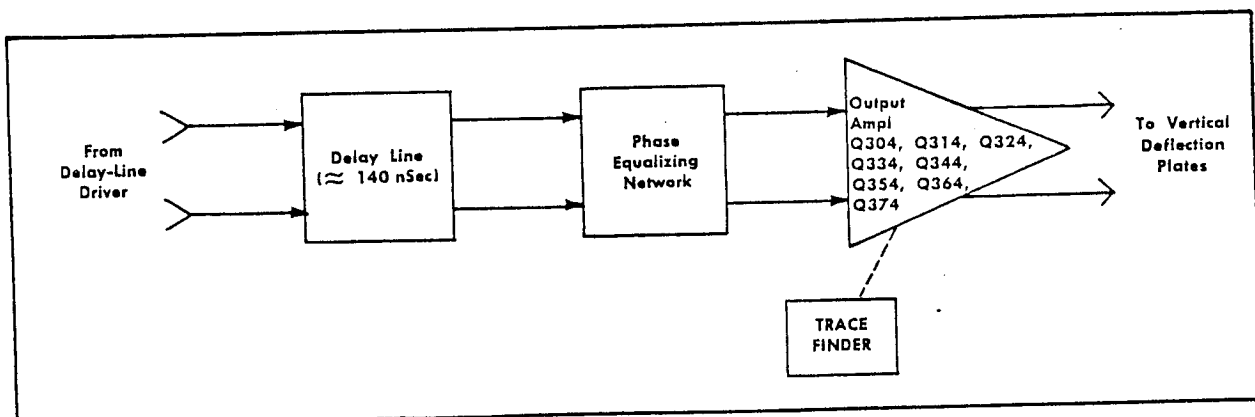

Fig. 3-4. Block diagram of Vertical Output Amplifier circuit.

## Circuit Description—Type 453

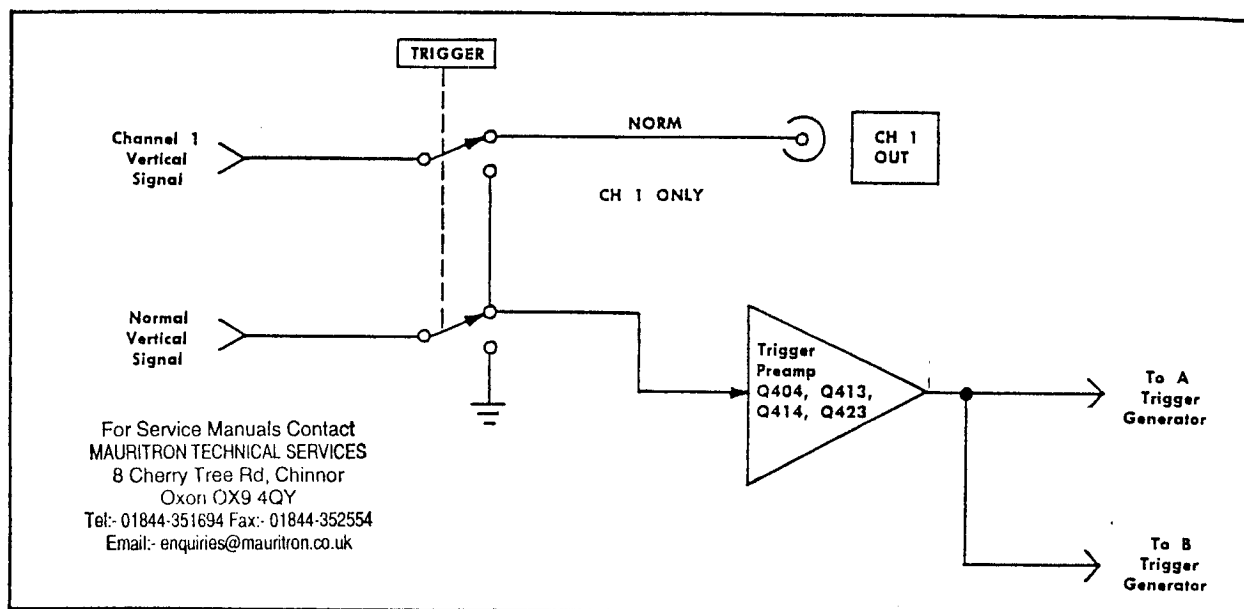

Fig. 3-5. Block diagram of Trigger Preamp circuit.

Q364 and Q374 provide the voltage to drive the crt vertical deflection plates. LR367 and LR377 provide damping for the leads connecting the output signal to the deflection plates.

### TRIGGER PREAMP

The Trigger Preamp amplifies the internal trigger signal to the level necessary to drive the Trigger Generator. Input to the Trigger Preamp circuit is selected from either the Channel 1 Vertical Preamp or the Output Amplifier by the TRIGGER switch.

When the TRIGGER switch is in the CH 1 ONLY position, the trigger signal is obtained from the emitter of Q63. The neons B400 and B401 indicate that the TRIGGER switch is in the CH 1 ONLY position. In this position of the TRIGGER switch, the CH 1 OUT connector, J402, is disconnected from the circuit.

The trigger signal in the NORM position is obtained from the collector of Q284. Since the signal is taken off following the dual-trace switching, this signal will be a sample of the composite vertical signal which is displayed on the crt. When the TRIGGER switch is in the NORM position, the CH 1 neons are disconnected. Also, the Channel 1 vertical signal is applied to the CH 1 OUT connector. This output connector can be used to monitor the signal applied to Channel 1 INPUT or, when used in conjunction with Channel 2, can be used to provide 1 millivolt/division minimum deflection factor.

The internal trigger signal selected by the TRIGGER switch is applied to Q404. The input signal amplitude will be greater than 25 millivolts/division of crt display. The dc level of the trigger signal is adjusted to zero volts by the Ch 1 Trigger Dc Level and the Normal Trigger Dc Level adjustments.

The trigger signal is amplified by Q404 and Q414. D408 in the emitter circuit of Q404 provides thermal compensation for the amplifier. The amplified signal at the collector of Q414 is applied to the base of Q423 through D421. This Zener diode provides a dc voltage drop while the signal is coupled without attenuation. The voltage level at the base of Q423 is about  $-0.7$  volt and the emitter-base forward voltage drop of the transistor provides an output signal which maintains the zero-volt dc level of the input signal. Feedback stabilization is provided from the emitter of Q423 to the base of Q414 by R419.

Q413 and Q423 are connected as emitter followers in the complementary amplifier configuration. This configuration overcomes the basic limitation of emitter followers; inability to provide equal response to both positive- and negative-going portions of a signal. This is accomplished by using an NPN, Q413, for one emitter follower and a PNP, Q423, for the other emitter follower. Since Q413 is an NPN transistor, it will respond best to positive-going signals and Q423, being a PNP transistor, will respond best to negative-going signals. The result is an amplifier which has equally fast response to both positive- and negative-going trigger signals as well as providing a low output impedance.

Total gain of the Trigger Preamp is about ten. The amplified internal trigger signal is available at both the A and B Triggering SOURCE switches.

### A TRIGGER GENERATOR

#### NOTE

The following circuit description describes the operation of both the A Trigger Generator and B Trigger Generator. Differences between the two circuits will be given under 'B Trigger Generator'.

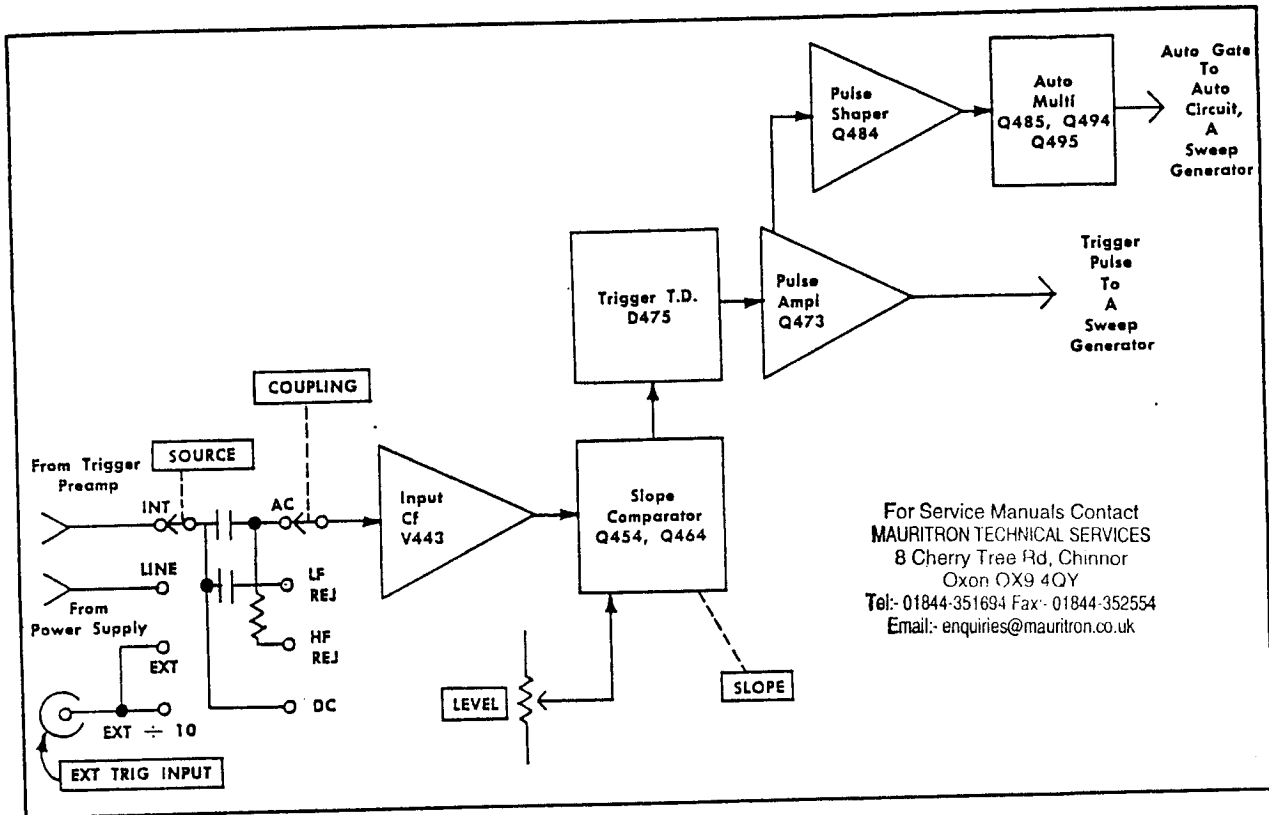

Fig. 3-6. Block diagram of A Trigger Generator circuit.

### Trigger Source

The trigger source is selected with the SOURCE switch. The trigger signal can be selected from three sources; internal, line and external. In addition, the external signal can be attenuated ten times.

The internal triggering signal is obtained from the Vertical Amplifier through the Trigger Preamp circuit. Amplitude of the internal signal at this point will be greater than 250 millivolts/division of crt display (25 millivolts/division input to Trigger Preamp amplified ten times in that circuit).

The line trigger is obtained from the voltage divider, R1104-R1105, in the Power-Supply circuit. This sample of the line frequency, about 1.5 volts in amplitude, is coupled to the Trigger Generator in the same way as the internal signal. The COUPLING switch should not be in the LF REJ position when using this trigger source.

External triggering signals applied to the EXT TRIG INPUT connector can be used to produce a trigger in the EXT and EXT  $\div 10$  positions of the SOURCE switch. Input resistance (dc) is about 1 megohm in both external positions. However, in the LF REJ position of the COUPLING switch, a 100-k resistor, R436, is switched in parallel with the 1-megohm input resistor to provide attenuation of low-frequency signals.

The EXT  $\div 10$  position provides 10 times attenuation of the input signal while maintaining the 1-megohm input resistance.

### Trigger Coupling

The COUPLING switch offers a means of accepting or rejecting certain frequency components of the trigger signal. In the AC and LF REJ positions, the dc component of the trigger signal is blocked by coupling capacitors, C435 or C436. In the AC position, frequency components below about 30 cps will be attenuated. In the LF REJ position, frequency components below about 30 kc will be attenuated.

The HF REJ position attenuates high-frequency components of the triggering signal. The trigger signal is ac coupled, attenuating signals below about 30 cps and above about 50 kc. The DC position provides equal coupling for all signals from dc to 50 Mc.

### Input Cathode Follower

The Input Cathode Follower, V443, provides high input impedance for signals applied to the EXT TRIG INPUT connector. This stage also isolates the input and preceding circuits from the Trigger Generator circuit. B444 protects V443 from excessive voltage between the grid and cathode.

### Slope Comparator

Q454 and Q464 provide selection of the slope of the trigger signal on which triggering occurs. Diodes D446 and D447 clamp the base of Q454 at about 1.4 volts negative. The dc level at the base of Q454 is quiescently about 2

## Circuit Description—Type 453

volts positive. Diode D448 and Zener diode D449 limit the positive swing of the signal to about 7 volts. This protects the Trigger Generator circuits which follow.

The Trigger Level Centering adjustment sets the level at the base of Q464 the same as the level on the base of Q454 (LEVEL control centered). The LEVEL control varies the base level of Q464 to select the point on the trigger signal where triggering occurs. As the LEVEL control is turned toward +, the voltage at the base of Q464 will become more positive. This will increase the current flow through R453, producing a more positive voltage on the emitters of both Q454 and Q464. The trigger signal must forward bias Q454 before it will conduct. Since the emitter is at a more positive voltage, Q454 will conduct at a more positive point on the trigger signal.

The slope of the input signal which triggers the sweep is determined by the SLOPE switch. When the SLOPE switch is set to +, D466 is forward biased connecting the collector of Q464 to the +12-volt supply through R467. The current path for Q454 to the +12-volt supply through D456 is open. The collector current path is now through D455, R459, L469, R469, R468 and R467 or through D475.

A trigger pulse is produced as follows. As a positive-going trigger signal is applied to the base of Q454, the collector current of Q454 increases. This increased current comes from the +12-volt supply through D455, R459 and tunnel diode D475. The current flows through D475 since inductor L469 does not respond instantaneously to the change in current. The increased current flow through D475 switches the tunnel diode to its high state producing a negative-going pulse with a very fast leading edge. As the current increases through L469, and C473 discharges, the current through tunnel diode D475 will decrease until the tunnel diode resets to its low state. The output pulse produced is a fast-rising pulse which occurs at the selected triggering point on the waveform.

When the SLOPE switch is set to —, the above situation is reversed and Q454 is connected to the +12-volt supply through D456 and Q464 through the parallel combination L469-D475. Now, a negative-going trigger signal at the base of Q454 will switch the tunnel diode as follows. A negative-going signal at the base of Q454 is also negative at the common emitters of Q454 and Q464. The signal is amplified by Q464 without polarity inversion since Q464 is connected as a grounded-base amplifier as far as the signal is concerned. The increased collector current of Q464 (negative-going signal) is supplied through D465, R459 and D475 since L469 does not respond instantaneously to the change in current. D475 switches state as described previously producing a negative-going trigger pulse with a fast leading edge.

### Pulse Amplifier

The negative-going, fast-rise pulse produced when D475 switches is applied to the base of Q473. Q473 amplifies and inverts the pulse. D474 limits the signal amplitude at the collector of Q473. T474 inverts the pulse and couples the negative-going pulse to the Sweep Generator circuit through R476 and C476.

The negative pulse at the emitter of Q473 is applied to the Auto Trigger stage through R481.

### Auto Trigger

**Pulse Shaper.** The negative pulse at the emitter of Q473 is applied to the base of Q484 at the same time as the collector pulse is applied to the Sweep Generator circuit. The Q484 stage differentiates and shapes the output pulse at its collector. The positive-going portion of the output pulse is coupled through D484 to the Auto Multi. D484 is back biased for any negative signals, blocking them from the remainder of the circuit.

**Auto Multi.** The Auto Multi produces the control pulse for the auto circuits located in the sweep generator. With no trigger signal, Q495 is conducting with its base at about -0.3 volt. The base of Q485 is held at about -0.7 volt by the forward voltage drop of D484. Since Q485 and Q495 share a common-emitter resistor, the conducting transistor establishes the emitter voltage. The emitter voltage established by Q495 is positive enough to prevent Q485 from conducting. The circuit will remain in this condition until a trigger pulse is received through Q484. Under triggered conditions, the positive-going pulse from Q484 is applied to the base of Q485 and is sufficient to turn it on. Q485 and Q495 become regenerative and switch to their opposite states. Q485 gains full control of the emitter current and Q495 shuts off until the multi recovers.

With no trigger signal applied, Q494 is off with about +12 volts applied to its base through D493. D486 is also conducting with its anode at about +12 volts. When Q485 switches, the voltage on its collector will drop to about -0.3 volt which back biases both D486 and D493 allowing Q494 to conduct. When Q494 conducts, its collector rises to about +12 volts producing an output pulse for auto operation.

When Q485 comes on, C485 will drop to about -0.3 volt and then begin to charge toward +75 volts. However, when it reaches about +12 volts, D486 will be biased on and will clamp the voltage at this point. Current flow through Q485 will cease and Q495 will again come into conduction. Q494 will also be turned off, ending the output pulse. Recovery time of the Auto Multi is about 85 milliseconds when only one trigger pulse is applied.

If the trigger signal is repetitive (above about 20 cps), Q485 will remain in conduction holding the output level at the collector of Q494 at about +12 volts. The voltage will be held at this level when a successive trigger pulse is received at the base of Q485 before the Auto Multi recovers.

## B TRIGGER GENERATOR

### General

The B Trigger Generator is similar to the A Trigger Generator in most respects. The differences between the two circuits will be given here. Parts of the circuit not mentioned here operate as described under 'A Trigger Generator.'

### Input Cathode Follower

The function of the Input Cathode Follower circuit is controlled by two switches in its cathode circuit; SW801A, HORIZ DISPLAY, and SW635, B SWEEP MODE. These switches affect the operation of V633 as follows.



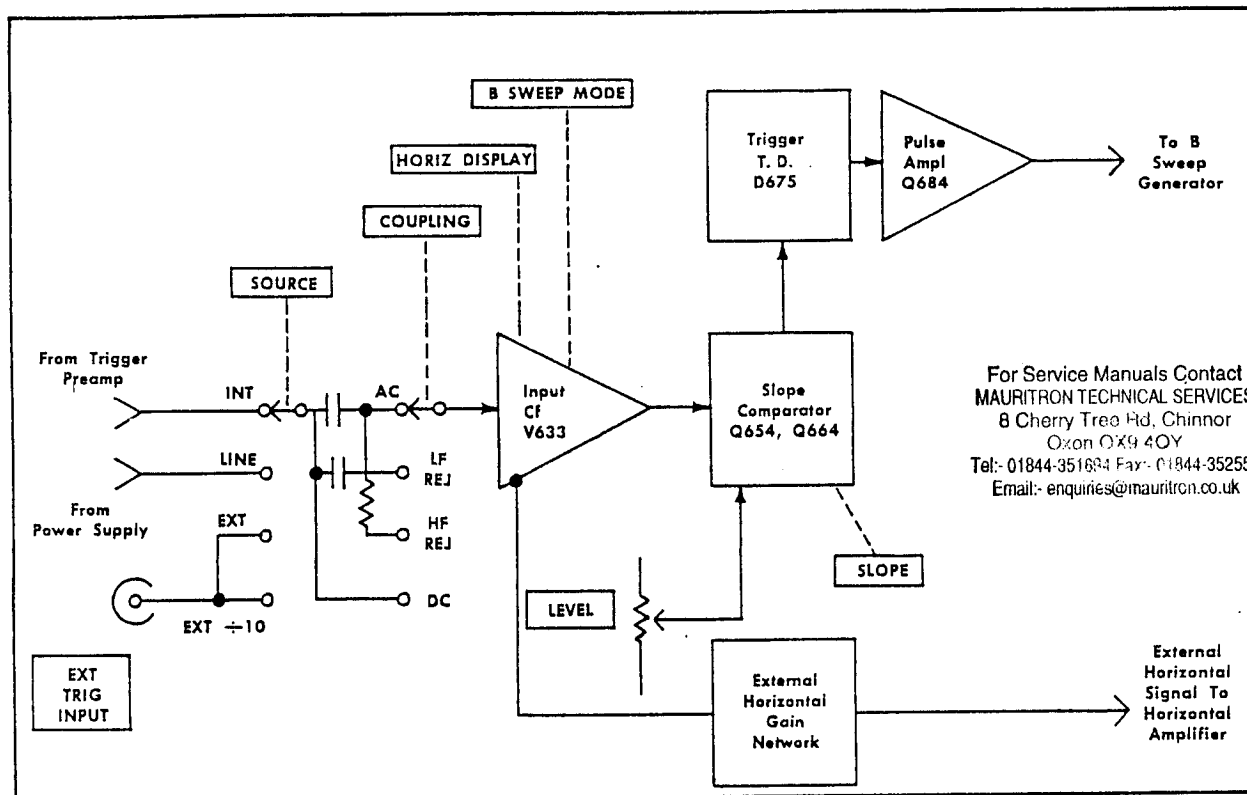

For Service Manuals Contact  
 MAURITRON TECHNICAL SERVICES  
 8 Cherry Tree Rd, Chinnor  
 Oxon OX9 4OY  
 Tel: 01844-351684 Fax: 01844-352554  
 Email: enquiries@mauritron.co.uk

Fig. 3-7. Block diagram of B Trigger Generator circuit.

In the A position of the HORIZ DISPLAY switch, the B trigger signal is disconnected by D638. The cathode of D638 is held positive with respect to its anode. This back biases D638, blocking the B trigger signal.

In the A INTEN DURING B and DELAYED SWEEP (B) positions, trigger signals will either be blocked or allowed to pass, depending on the position of the B SWEEP MODE switch. If the B SWEEP MODE switch is in the B STARTS AFTER DELAY TIME position, the trigger signal will be blocked as in the A position. However, when in the B TRIGGERABLE AFTER DELAY TIME position,  $-12$  volts is connected to the cathode of D638 through R639. The trigger signal will pass to the Slope Comparator circuit since D638 is forward biased. D635 is back biased because its anode is held more negative than its cathode.

In all positions of the HORIZ DISPLAY switch except EXT HORIZ, D641 is back biased since it is connected to  $+12$  volts through R641. In the EXT HORIZ position, D638 is reverse biased because its cathode is held positive by  $+12$  volts applied through R638. Therefore, trigger signals will not pass through D638. D641 is forward biased by  $-12$  volts connected to its cathode through R642. Signals at the cathode of V633 are connected to the Horizontal Amplifier through D641 and the External Horizontal Gain Network, R644, R645 and R646.

The external horizontal signal can be obtained either externally from the EXT TRIG INPUT or EXT HORIZ connector (B Triggering) when the B Triggering SOURCE switch is

set to EXT or EXT  $\div 10$ , or internally from Channel 1 when the TRIGGER switch is in the CH 1 ONLY position and the SOURCE switch is set to INT. Gain of the External Horizontal circuit is set by R645, Ext Horiz Gain, so a signal applied to Channel 1 INPUT produces the indicated horizontal deflection.

### Pulse Amplifier

The Pulse Amplifier in the B Trigger Generator operates much the same as in the A Trigger Generator. However, since there is no Auto circuit in the B Trigger Generator, a pulse is available only at the collector of Q684. The output pulse is applied to the B Sweep Generator through T686 and R688-C688.

## A SWEEP GENERATOR

### General

The A Sweep Generator produces five simultaneous output signals controlled by three input signals. The output signals are:

1. A negative-going sawtooth applied to the Horizontal Amplifier for time measurements.
2. A negative-going sawtooth applied to the Delay Pick-off Comparator to provide delayed sweep.

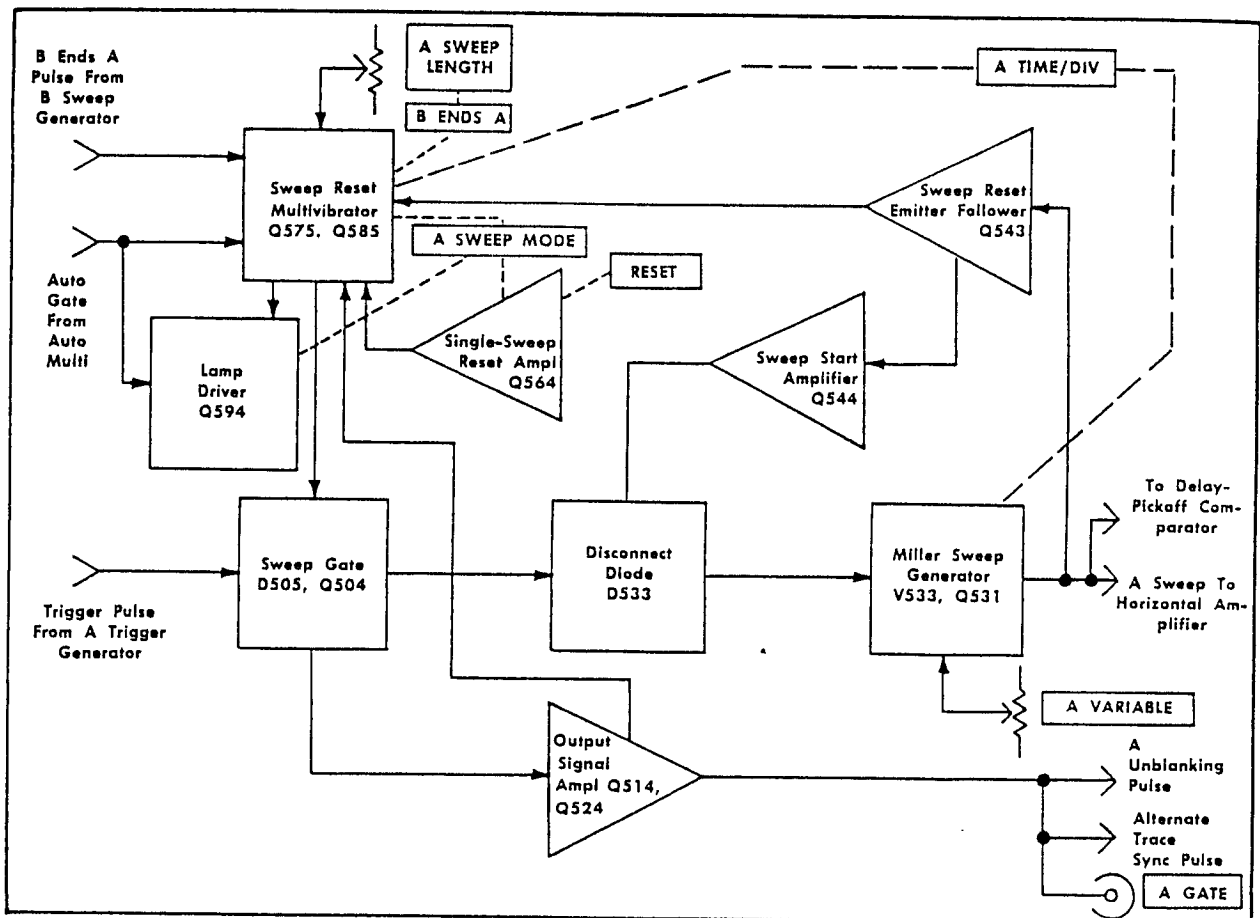

Fig. 3-8. Block diagram of A Sweep Generator circuit.

3. A negative-going unblanking pulse applied to the Z Axis Amplifier to unblank the crt for display.
4. A positive-going gate signal applied to the Vertical Switching circuit to produce an alternate-trace display.
5. A positive-going gate signal coupled to the side-panel A GATE OUT connector.

The input signals are:

1. Negative-going trigger pulse from A Trigger Generator.
2. Positive-going auto gate from the Auto Multi.
3. Negative-going B ENDS A reset pulse from B Sweep Generator.

The A SWEEP MODE switch allows three modes of operation. In the NORM TRIG position, a sweep is produced only when a trigger pulse is received from the A Trigger Generator circuit. Operation in the AUTO TRIG position is much the same as NORM TRIG except that a free-running trace will be displayed when a trigger pulse is not present. In the SINGLE SWEEP position, operation will also be similar to NORM TRIG except that the sweep will not be recurrent.

The following circuit description will be given with the A SWEEP MODE switch set to NORM TRIG. Differences in the other two modes will then follow.

### Normal Trigger Mode Operation

**Sweep Gate.** The trigger pulse generated by the A Trigger Generator is applied to the A Sweep Generator circuit through D501. This negative-going pulse switches D505 to its 'high state' where it remains until reset by the Sweep Reset Multivibrator at the end of the sweep. The negative-going signal at the base of Q504 turns it on and produces a positive signal at the collector. This signal is connected to the Disconnect Diode and the Output Signal Amplifier.

**Output Signal Amplifier.** The positive-going gate pulse from the Sweep Gate stage applied to the base of Q514 produces a negative-going pulse at the collector. This pulse is connected to the Z Axis Amplifier and is used to unblank the crt during sweep time. It is also connected to the Hold-off Capacitor to discharge it at the beginning of each sweep.

The positive-going gate pulse at the base of Q514 is also coupled from the emitter of Q514 to Q524. The resulting positive-going signal at the collector of Q524 is coupled to the Vertical Switching circuit to produce an alternate-trace display and to the side-panel A GATE connector.

**Disconnect Diode.** The Disconnect Diode, D533, is instantaneously conducting current through R506, R508, R509, R530 and R531. The gate signal from Q504 reverse biases D533

and interrupts this current flow allowing the sweep to be generated. D547 is also reverse biased, disconnecting Q544.

**Miller Sweep Generator.** When the current flow through D533 is interrupted by the Sweep Gate signal, the Timing Capacitor, C530, begins to charge through the Timing Resistor, R530, and the A Sweep Cal Adjustment, R531. The Timing Capacitor and Resistor are selected by the A TIME/DIV switch to change sweep rate. The A Sweep Cal adjustment allows calibration for correct sweep timing. The A VARIABLE control, R530Y (see Timing Switch diagram), provides variable sweep rates by changing the charge time of C530.

The positive-going voltage at the R530 side of C530 as C530 charges toward +75 volts is connected to the grid of V533. This positive-going voltage is connected to the base of Q531 through V533 producing a negative-going sweep output signal. To provide a linear charging rate for C530, the sweep output signal is connected to the negative side of C530. This feedback makes C530 appear to always be charging toward the same positive voltage, maintaining a constant charge rate and providing a linear sawtooth output signal. The output signal will continue to go negative until the circuit is reset through the Sweep Reset Multivibrator. The output signal from the collector of Q531 is connected to the Horizontal Amplifier and the B Delay Pickoff Comparator.

**Sweep Reset Emitter Follower.** The negative-going voltage at the collector of Q531 is connected to the Sweep Reset Emitter Follower, Q543. D542 provides warm-up protection for Q543. The negative-going signal at the emitter of Q543 is coupled to the Sweep Reset Multivibrator to determine sweep length. It is also coupled to the emitter of the Sweep Start Amplifier, Q544, through D543 and D545.

**Sweep Start Amplifier.** The negative-going voltage coupled to D545 from the emitter of Q543 blocks current flow through Q544. Q544 will remain off until the sweep retrace has been completed. When the voltage at the emitter of Q543 returns to its original dc level at the end of the sweep, D545 will again be forward biased and Q544 will conduct. The dc level at the collector of Q544 is connected to the Disconnect Diode through D547 to hold the cathode of D533 at a constant voltage and establish the correct starting point for the sweep. The Sweep Start adjustment, R758, in B Sweep Generator sets the starting point of both the A and B Sweep.

**Sweep Reset Multivibrator.** The negative-going voltage at the emitter of Q543 is coupled to D555 and D556. These diodes are reverse biased when the sweep starts. As the voltage on the cathode of D556 goes negative, this diode will become forward biased at a level determined by the A SWEEP LENGTH control, R555. When D556 conducts, the negative-going signal is connected to the base of Q575. Q575 will turn on and Q585 will turn off. The collector voltage of Q575 will go positive and switch D505 back to its original 'low state'. This ends the Sweep Gate pulse and the Disconnect Diode will be forward biased. The Timing Capacitor, C530, will rapidly discharge, returning the grid of V533 to the original starting level. The positive-going retrace signal from the Sweep Reset Emitter Follower is blocked by D555 and D556. When the voltage at the emitter of Q543 reaches the original level, Q544 will conduct and establish the starting level of the sweep.

As the A SWEEP LENGTH control is rotated counterclockwise, the Sweep Reset Multivibrator will switch at a less negative point on the Q543 signal. This means that the sweep will not complete the full cycle before resetting and the display will be shorter. In the B ENDS A position, fully counterclockwise, a negative-going pulse generated from the B unblanking pulse is connected to the emitters of Q575 and Q585 through D575. The negative-going pulse momentarily interrupts the emitter current of Q575 and Q585 and both transistors shut off. When the pulse ends, the stored charge on C572 will bring Q575 into conduction and end the A Sweep.

When Q575 conducts, it will remain in conduction for a period of time to establish a holdoff period and allow all circuits to return to their original conditions before the next sweep is produced. The holdoff time is determined by the charging rate of the Holdoff Capacitor, C550. C550 charges through R551 and R552 toward +75 volts. As the voltage at the emitter of Q575 rises positive because of the charging of C550, Q575 will turn off and Q585 will return to conduction. The level at the collector of Q575 will drop negative and D505 will be ready to receive the next trigger pulse. Holdoff time is changed for the various sweep rates by the TIME/DIV switch. To insure correct holdoff, C550 is discharged by the negative-going unblanking pulse at the collector of Q514 at the beginning of each sweep.

For fast sweep rates, the HF STAB control allows the holdoff to be varied about 10% to provide a stable display. This control has little effect on the display at low sweep rates.

**Lamp Driver.** The auto gate from the Auto Multi is connected to the Lamp Driver, Q594. This auto gate is coincident with the trigger pulse generated by the A Trigger Generator and is only present when a trigger signal is present. The positive-going auto gate saturates Q594 and the A SWEEP TRIG'D light will come on. This light will remain on as long as the auto gate is present.

### Auto Trigger Mode Operation

Operation of the Sweep Generator circuit in the AUTO TRIG position of the A SWEEP MODE switch, is the same as for NORM TRIG when a trigger pulse is applied. However, when a trigger pulse is not applied, a free-running reference trace is produced in the AUTO TRIG mode. This occurs as follows.

Q585 is turned on after sweep retrace and holdoff. Q575 will be turned off and current will flow through R574, R502 and D505. This current is not enough to trigger D505. In the AUTO TRIG position of the MODE switch, -12 volts is applied to the cathodes of D592 and D593 through R593. When the auto gate is present, the current through R593 flows through D592. However, when the gate is not present, current will flow through D593 and add to the current from R574. This additional current is enough to trigger D505 immediately after the holdoff period is complete. The sweep will be generated in the normal manner. Another sweep will begin at the end of each holdoff period, repeating the cycle.

### Single Sweep Operation

Operation of the Sweep Generator in the SINGLE SWEEP position of the A SWEEP MODE switch is similar to operation

②

For Service Manuals Contact  
**MAURITRON TECHNICAL SERVICES**  
 8 Cherry Tree Rd, Chinnor  
 Oxon OX9 4QY  
 Tel: 01844-351694 Fax: 01844-352554  
 Email: enquiries@mauritron.co.uk

Circuit Description—Type 453

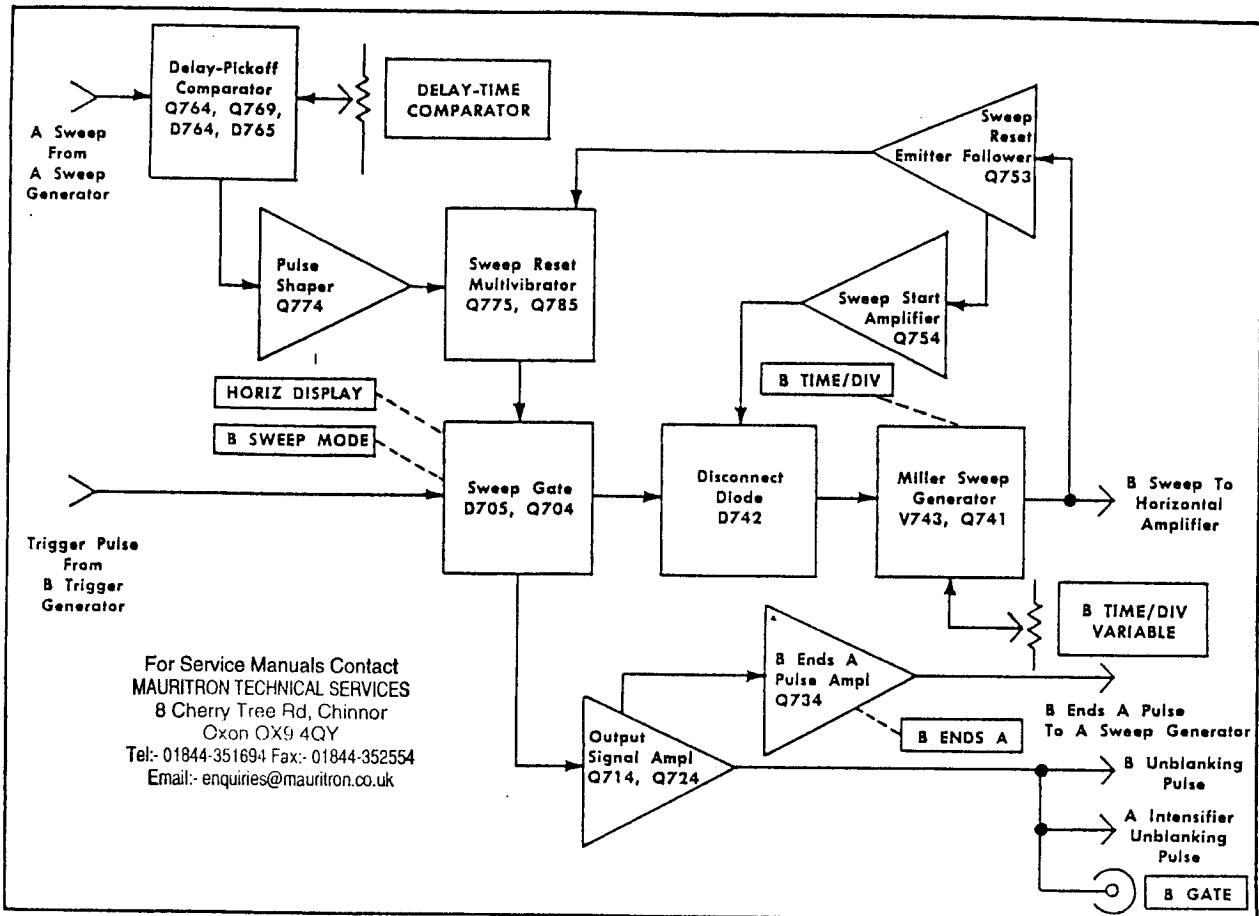

Fig. 3-9. Block diagram of B Sweep Generator circuit.

in the other modes. However, after one sweep has been produced, the Sweep Reset Multivibrator will not reset. All succeeding trigger pulses are 'locked out' until the RESET button is pressed.

In the SINGLE SWEEP position, the A SWEEP MODE switch disconnects reset current from the Holdoff Circuit. The base of Q575 is at a less positive level, allowing the stage to operate as a bistable multi. The auto gate signal is grounded at the cathode of D591.

The sweep cycle will occur as follows. When the sweep reaches the length selected by the A SWEEP LENGTH control, Q575 will turn on and return D505 to its 'low state'. Since the reset current is disconnected and the base of Q575 is negative enough to hold it on, it will remain in conduction and hold D505 'locked out'. This condition will remain until the circuit is reset.

**Single-Sweep Reset Amplifier.** The Single-Sweep Reset Amplifier, Q564, produces the reset pulse for the Sweep Reset Multivibrator in the SINGLE SWEEP mode. Normally, Q564 is biased off and the RESET switch is open. When the RESET button is pressed, B568 will ignite and the voltage at the base of Q564 will go negative. Q564 will saturate and produce a positive-going output pulse. This pulse has suf-

ficient amplitude to shut off Q575 and allow Q585 to conduct. Q585 will remain in conduction until the next sweep ends, keeping D505 in a triggerable state until the trigger arrives.

**Lamp Driver.** In the SINGLE SWEEP mode the anode of D595 is disconnected from ground and the diode is allowed to conduct. When Q585 returns to conduction its collector will go positive. This will pull the base of Q594 positive through D595. Q594 will conduct through the RESET light, indicating that the A Sweep Generator circuit is ready to produce a sweep when a trigger pulse arrives. Q594 will remain on until Q575 turns on again at the end of the sweep.

## B SWEEP GENERATOR

### General

Basic operation of the B Sweep Generator is the same as the A Sweep Generator. Only the differences between the two circuits will be discussed here. The following circuits operate as described for the corresponding circuits in the A Sweep Generator: Sweep Gate, D705 and Q704; Output Signal Amplifier, Q714 and Q724; Disconnect Diode, D742; Miller Sweep Generator, V743 and Q741; Sweep Reset

Emitter Follower, Q753; and the Sweep Start Amplifier, Q754. See the A Sweep Generator circuit description for the operation of these circuits.

### Delay Pickoff Comparator

The B Sweep Generator is 'locked out' at the end of each sweep by the Sweep Reset Multivibrator. The circuit will remain in this condition until a pulse from the Delay Pickoff Comparator, controlled by A Sweep, resets the Sweep Reset Multivibrator. The B Sweep Generator can produce a sweep only during A Sweep and is not reset until during the following A Sweep.

The output of the A Miller Sweep Generator is connected to the base of Q764A. Q764A and B are connected as a voltage comparator with Q769 providing a constant current to the emitters through diode D764A and B. Dual transistor Q764 used along with dual diode D764 provides temperature compensation for the comparator circuit.

Reference voltage for the comparator is established by the precision, ten-turn potentiometer R760, DELAY-TIME MULTIPLIER dial. The voltage to this potentiometer is filtered by C759 and held stable by R759. The instrument is calibrated so major dial markings correspond to graticule divisions by correct adjustment of the Sweep Start and A Sweep Cal adjustments.

Q764A is quiescently conducting, holding D765 in its 'high state'. When the sweep voltage applied to the base of Q764A goes more negative than the level at the base of Q764B established by the DELAY-TIME MULTIPLIER dial, Q764A will cutoff and Q764B will come into conduction. Since the voltage point on the sweep where Q764A cuts off represents time on the crt, the DELAY-TIME MULTIPLIER dial is used to select delay time.

When Q764A cuts off, the current flow through D765 decreases and it switches to its 'low state'. The positive-going step at the cathode of D765 when it switches, is connected to Q774. Q764A will regain control of the comparator when the sweep retrace rises positive enough to bias Q764A back into conduction. D765 will then return to its original state and the step connected to Q774 will go negative.

### Pulse Shaper

The step produced when D765 switches states is applied to the base of Q774 through C771. C773 and the emitter resistance of Q774 differentiate the rising and falling portions of the step. The differentiated pulses are amplified and connected to the Sweep Reset Multivibrator. Output from Q774 is a negative pulse to start the B Sweep and a positive pulse produced from the A Sweep retrace to end B Sweep.

### Sweep Reset Multivibrator

If the A Sweep does not end before B Sweep, the negative-going sweep produced by the Miller Sweep Generator, Q741, will reset the Sweep Reset Multivibrator through Q753 as described for A Sweep. The negative-going sweep is applied to the base of Q785 and will turn this transistor on

when the base goes more negative than the emitter. When Q785 turns on, it gains control of the circuit and will remain on until a reset pulse is received from the Pulse Shaper stage. The collector of Q785 will go positive and hold D705 in its 'low state', locking out the Sweep Gate stage.

The negative pulse produced by the Pulse Shaper stage when Q764A cuts off, turns Q775 on. Q785 will be turned off and D705 will be ready to trigger. When the B SWEEP MODE switch is in the B TRIGGERABLE AFTER DELAY TIME position the Sweep Gate, Disconnect Diode and the Miller Sweep Generator as described for A Sweep Generator in the NORM TRIG mode to produce a sweep upon receipt of a trigger.

However, in the A INTEN DURING B and DELAYED SWEEP (B) positions of the HORIZ DISPLAY switch, the B Sweep Generator will free run when the B Sweep Mode switch is set to B STARTS AFTER DELAY TIME. When Q785 is turned off, current flows through R787, R789 and D705. This current is not enough to switch D705. However, in the B STARTS AFTER DELAY TIME position, additional current is supplied through R786. The total current is sufficient to switch D705 and produce a trace immediately following turn-off of Q785. Although B Sweep is free running, it will appear stable on the screen because it is triggered at a definite point on the A Sweep waveform.

If A Sweep ends before B Sweep, the positive pulse produced by Q774 when A Sweep retraces will turn Q775 off. Q785 will turn on to end the B Sweep and hold D705 in its 'low state'.

### B Ends A Pulse Amplifier

The positive-going voltage as the B unblanking pulse ends is coupled to the B Ends A Pulse Amplifier, Q734, through D731 when the A SWEEP LENGTH control is in the B ENDS A position. This pulse saturates Q734 and produces a negative-going output pulse which is coupled to the A Sweep Generator Sweep Reset Multivibrator.

## HORIZONTAL AMPLIFIER

### Input Amplifier

The input signal for the Horizontal Amplifier is selected by the HORIZ DISPLAY switch. In the A, A INTEN DURING B and DELAYED SWEEP (B) positions, the negative-going sawtooth from either the A or B Sweep Generator is connected to the -Input Amplifier stage, Q814. In the EXT HORIZ position, the external horizontal signal is applied to the +Input Amplifier stage, Q824. The Input Amplifiers have a low input impedance and are current driven.

Input sensitivity of the Horizontal Amplifier is about 0.2 milliamp/division for normal gain or 0.02 milliamp/division for magnified gain (MAG switch set to X10).

In the EXT HORIZ position, the magnifier is automatically set to X10 (see 'Paraphase Amplifier' which follows). The signal for external horizontal deflection is obtained from the B Trigger Generator and is connected to the base of Q824. The B Triggering SOURCE switch can select either the internal signal from Channel 1 (TRIGGER switch set to CH 1 ONLY) or an external signal connected to the EXT HORIZ

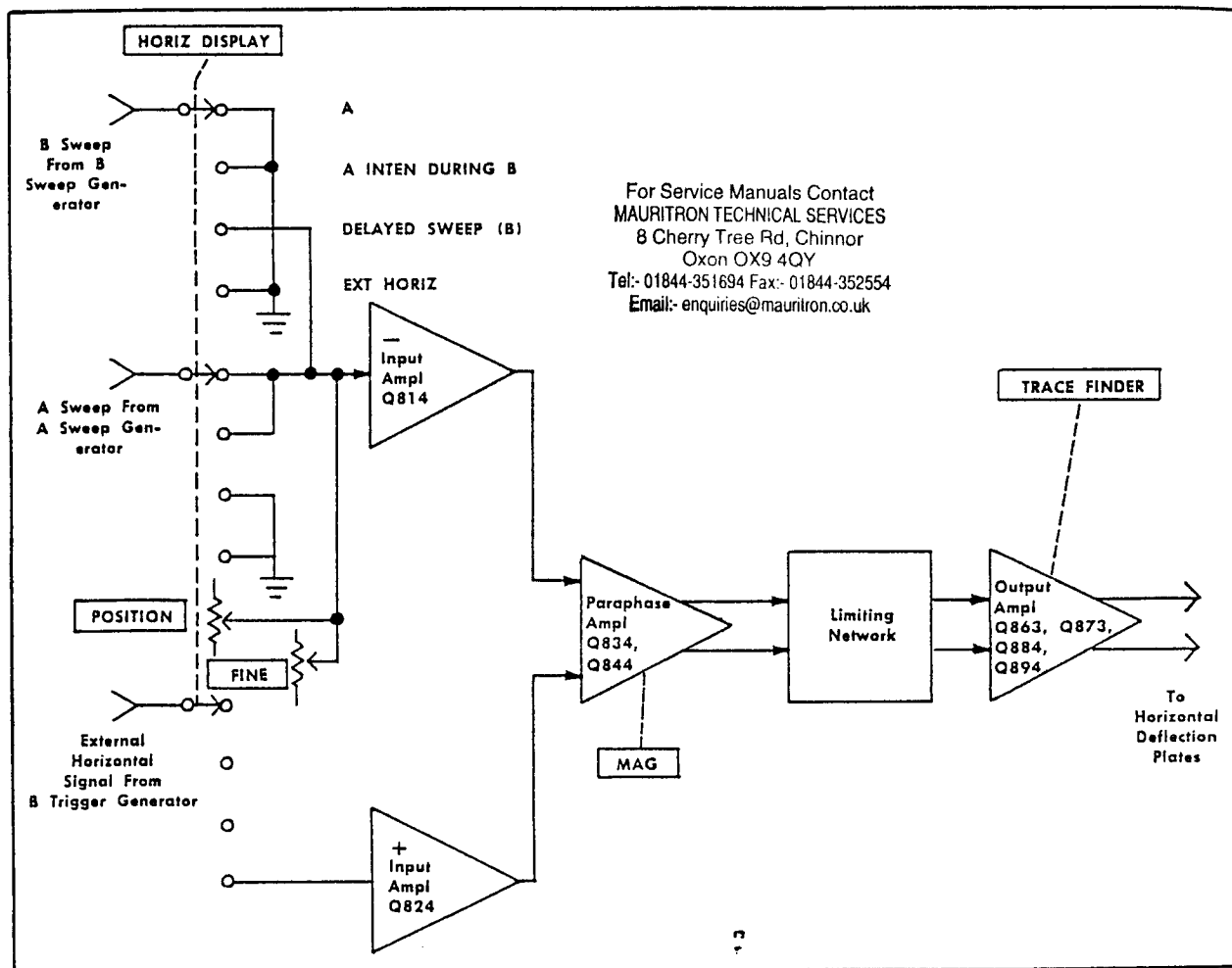

For Service Manuals Contact  
 MAURITRON TECHNICAL SERVICES  
 8 Cherry Tree Rd, Chinnor  
 Oxon OX9 4QY  
 Tel:- 01844-351694 Fax:- 01844-352554  
 Email:- enquiries@mauritron.co.uk

Fig. 3-10. Block diagram of Horizontal Amplifier circuit.

input connector. When the internal signal is selected, the Channel 1 deflection factor as indicated by the CH 1 VOLTS/DIVISION switch applies as Horizontal Volts/Division. More information on the external horizontal circuitry is contained in the 'B Trigger Generator' circuit description.

Horizontal positioning is provided by the POSITION control, R805A, and the FINE control, R805B. Horizontal trace position is changed by varying the dc current to the -Input Amplifier, Q814.

**Paraphase Amplifier**

The Paraphase Amplifier, Q834 and Q844, converts the single-ended input signal at either base to a push-pull output signal to drive the Output Amplifier. Gain of this stage is inversely proportional to the impedance between the emitters of Q834 and Q844. The MAG switch increases calibrated gain 10 times by switching in parallel emitter resistance (resistance between emitters decreases). Variable resistors R835, Norm Gain, and R845, Mag Gain, control the

overall gain of the Horizontal Amplifier for normal sweep (X1) and magnified sweep (X10) respectively.

When the HORIZ DISPLAY switch is set to EXT HORIZ, the magnifier is switched to X10 by the HORIZ DISPLAY switch. The Magnifier light will not come on however, since the indicated deflection factors apply directly.

**Output Amplifier**

The output of the Paraphase Amplifier is connected to the Output Amplifier, Q863-Q884 and Q873-Q894. Each side of the amplifier can be considered as a single-ended feedback amplifier which amplifies the current signal at the input to produce a voltage for horizontal deflection on the crt. As in the Input Amplifiers, the input impedance is low with very little voltage change due to the signal. Capacitors C882 and C892 adjust the transient response to provide correct high speed linearity.

The Mag Register adjustment, R855, adjusts the Output Amplifier input current for a center-screen display when the emitters of the Paraphase Amplifier are at equal voltage.

The Output Amplifier scan is limited by diodes D861, D871, D851 and D852. The series diodes D861 and D871 prevent saturation of the corresponding output transistor. When the output voltage drops below about five volts, the series diode will cut off allowing one of the shunt diodes to conduct. The input current will be shorted out, thereby also limiting the upper voltage swing of the opposite transistor.

The TRACE FINDER, SW330, reduces horizontal scan by restricting the current available to Q884 and Q894. When pressed in, power from the +150-volt unregulated supply is interrupted and power is supplied by the +75-volt supply through D884. Current supplied from the +75-volt supply will be lower, producing the desired scan limiting. R887 provides a load for the +150-volt supply when SW330 is pressed in.

### Z AXIS AMPLIFIER

#### General

The Z Axis Amplifier controls the crt intensity or unblanking through a series of input signals and currents. The effect of these various inputs is to either increase or decrease the trace intensity, or to completely blank the display or portions of the display from view.

All inputs to the Z Axis Amplifier are applied to the emitter of Q1014. Q1014 provides termination for all the input signals as well as isolation between the crt circuit and the input sources. D1015 and D1016 provide limiting protection at minimum intensity (discussed further under 'Intensity Control'). Amplification for the control signal is provided by

Q1023 and Q1034. C1036 provides high-frequency compensation adjustment. Output is provided through Q1043. D1046 and D1047 provide protection for the Z Axis Amplifier if the High-Voltage supply is shorted. D1045 improves response of Q1043 on negative-going signals.

Control signals for the Z Axis Amplifier can come from the following sources:

1. INTENSITY control.
2. Unblanking signal from A Sweep Generator during A Sweep.
3. Unblanking signal from B Sweep Generator to provide an intensified display in the A INTEN DURING B position of the HORIZ DISPLAY switch.
4. Unblanking signal from B Sweep Generator during B Sweep.
5. Blanking signal from Vertical Switching circuit.
6. External signal applied to the Z AXIS INPUT connector.

The effect of these inputs will be discussed in more detail in the following paragraphs.

#### Intensity Control

The INTENSITY control, R1005, connected between +12 volts and ground, varies the current through Q1014. When set to minimum intensity (counterclockwise), current through Q1014 will be reduced. The resultant output through Q1023, Q1034, Q1043 and the crt control grid supply will be a more negative crt bias which will blank the crt. When the collector of Q1014 starts to go positive (reduced current), D1015 will become reverse biased and D1016 forward

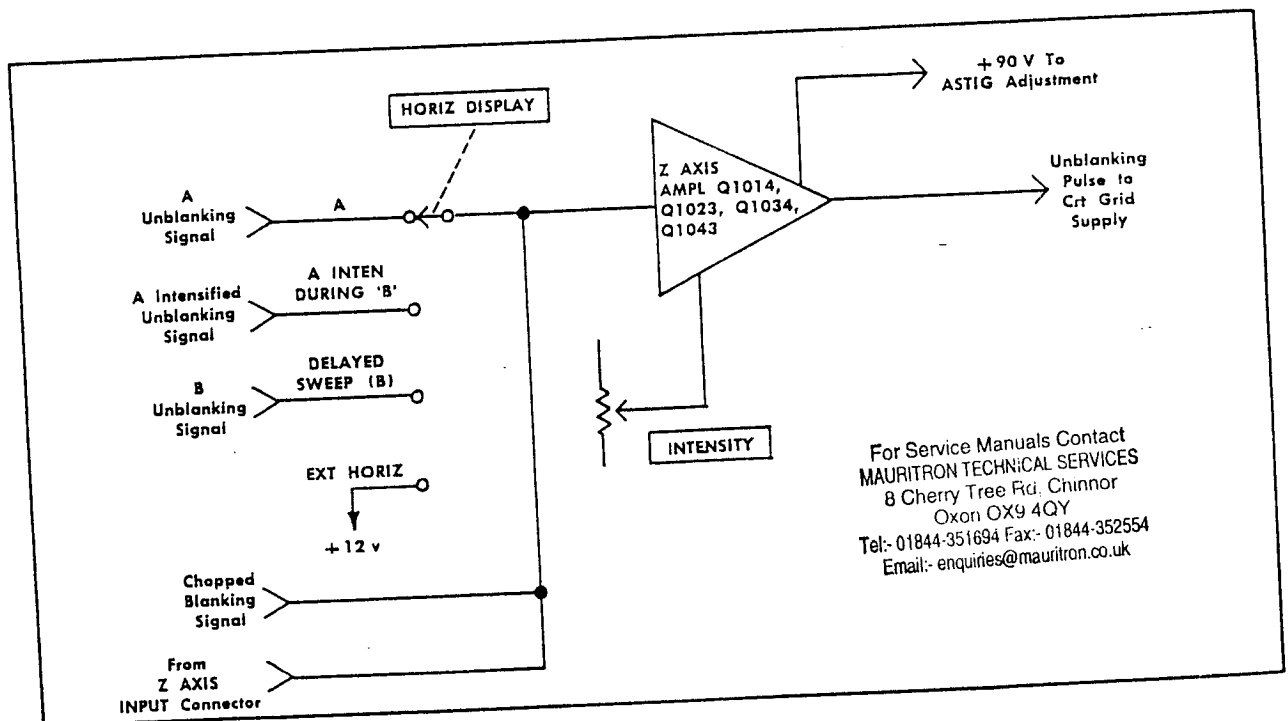

Fig. 3-11. Block diagram of Z Axis Amplifier circuit.

## Circuit Description—Type 453

biased to protect the circuit. At maximum intensity, maximum current flows through Q1014. This increases current flow through Q1043 producing a more positive crt grid bias and a higher intensity trace. Zener diode D1043 connected to the +75-volt supply clamps the collector voltage of Q1043 at +90 volts at high intensity. This voltage is also connected to the ASTIG adjustment.

R1006 from the +12-volt supply to the variable arm of the INTENSITY control produces a logarithmic change in trace intensity. To the eye, this appears as a smooth, gradual change in intensity level.

### Unblanking Inputs

The unblanking inputs operate in a similar manner and will be discussed as a group. More specific information relating the unblanking signals to the originating circuits is given in the A and B Sweep Generator circuit descriptions.

During retrace, the crt display is blanked and minimum current is flowing through Q1014. When the crt is to be unblanked to display a signal, Q1014 current is increased. This raises the Q1043 output level to the level established by the INTENSITY control, providing a visible trace on the crt. When in the A INTEN DURING B position of the HORIZ DISPLAY switch, the display will be partially unblanked during A Sweep time and further unblanked during B. This will make the portion of the sweep during which B Sweep Generator operates appear intensified.

In the EXT HORIZ position of the HORIZ DISPLAY switch, +12 volts is connected to the emitter of Q1014 through R1003. This raises the output level enough to unblank the crt so the external horizontal signal can be displayed.

### Blanking Input

The blanking input from the Vertical Switching circuit blanks the trace during trace switching. Normally, a constant current flows through R1011 and R245 (Vertical Switching circuit). During trace switching, this current is changed to reduce current through Q1014. Q1043 output level decreases temporarily, blanking the switching transient from the display.

### External Z Axis Input

A signal applied to the Z AXIS INPUT connector is applied both to the crt cathode through C979-C976-R976 and to the Z Axis Amplifier. Low frequency Z-axis signals are blocked from the crt cathode circuit by C976. They pass to the Z Axis Amplifier, producing an increase in intensity if negative going, or a decrease in intensity if positive going. C979 couples high-frequency signals directly to the crt cathode producing the same resultant display as the Z Axis Amplifier produces with low-frequency signals. This configuration operates as a crossover network to provide nearly constant intensity modulation from dc to 50 Mc.

## CRT CIRCUIT

### High Voltage Oscillator and Regulator

Q930 and associated circuitry comprise the high-voltage oscillator. Q923 is a shunt regulator and Q913 and Q914

are error amplifiers. Output of the High-Voltage Oscillator is through T930.

After the instrument is turned on, the current through the collector winding of T930 increases as the +12-volt supply comes into operation. This produces a corresponding current increase in the feedback winding of T930 which is connected to the base of Q930. The feedback current increases the voltage level on the base of Q930, forcing it to conduct even harder. The voltage level on the base of Q930 will increase until it goes into saturation. Saturation ends the current increase through the collector winding and feedback winding of T930. While current was being induced into the feedback winding of T930, C913 was being charged negative. When this current ceases and then reverses, the feedback winding pulls the base of Q930 negative. Q930 cuts off and the collector goes positive. When the dc level on C913 rises positive and brings the base of Q930 positive, Q930 will again conduct and the cycle will be repeated. C913 normally has a negative 5- to 6-volt dc level with respect to the emitter of Q930. Oscillation occurs at about a 40- to 50-kc rate.

Feedback from the secondary of T930 is applied to the base of Q914 through the voltage dropping network R903 to R910. This sample of the output voltage is amplified by Q914 and Q913 and applied to the base of Q923. Base current of Q930 is controlled by the average level on the emitter of Q923. The amplified sample of the output applied at the base of Q923 will produce a resultant current change in the collector winding of T930 to correct the original error.

For example, if the output voltage at the -1950 V test point starts to go positive, a sample of this positive-going voltage will be applied to the base of Q914. This positive-going signal increases current flow through Q914 resulting in increased current flow through Q913. An increase in current through Q913 means that the current flowing through the feedback winding of T930 increases, pulling the base level of Q930 more positive. A more positive level on the base of Q930 increases the collector current. Increased current in the collector winding of T930 produces increased current in the secondary which will appear as a more negative voltage at the -1950 V test point. This will correct the original positive-going voltage change. By sampling the output on the negative high-voltage supply, the total output of the high-voltage rectifier is held constant.

Output voltage level of the high-voltage supply is controlled by R900, High Voltage adjustment, in the base circuit of Q914. This adjustment sets the conduction level of Q914 which controls the current flow through Q913. In a similar manner to that described when correcting for an output error, Q923 sets the base level of Q930 to control the collector current swing and thereby control the rectified output voltages at the cathode-ray tube.

### High Voltage Rectifiers and Output

The high-voltage transformer has five output windings. Two of these windings provide filament voltage for the rectifier tubes V952 and V962. A third low-voltage winding provides filament voltage for the cathode-ray tube. The filament voltage can be supplied from the high-voltage supply since the cathode-ray tube has a very low filament



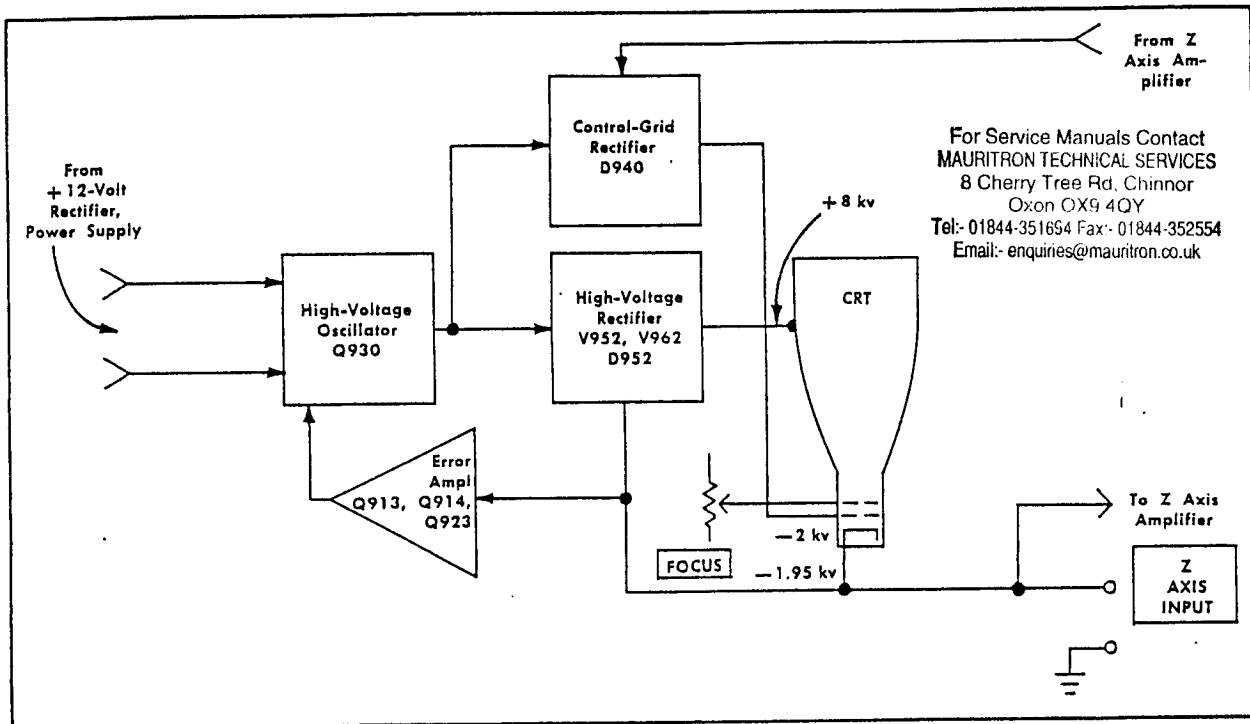

Fig. 3-12. Block diagram of Crt circuit.

current drain. Two high-voltage windings provide the negative and positive accelerating voltage and the crt grid bias voltage. All of these outputs are regulated by the high-voltage regulator circuit in the primary of T930 to hold the output voltage constant.

Positive accelerating potential is supplied by voltage doubler V952 and V962. Regulated voltage output is about +8 kilovolts. Ground return for this supply is through the resistive helix inside the cathode-ray tube to pin 7 and through R972.

The negative accelerating voltage for the crt cathode is supplied by the half-wave rectifier D952. Voltage output is about -1.95 kilovolts. A sample of this output voltage is connected to the voltage regulator to provide a regulated high-voltage output.

The half-wave rectifier D940 provides a negative voltage for the control grid of the crt. Output level is adjustable by R940, Crt Grid Bias adjustment. The neon bulbs B973, B974 and B975 provide protection if the voltage difference between the control grid and cathode exceeds about 165 volts. The unblanking pulse from the Z Axis Amplifier is applied to the positive side of this circuit.

### Crt Control Circuits

Focus of the crt display is controlled by the FOCUS control, R967. The divider R963 to R968 is connected between the crt cathode supply and D1142 (in Low-Voltage Power Supply) which is at about ground level. The voltage applied to the focus grid is more positive (closer to ground level) than the voltage on either the control grid or the crt

cathode. The ASTIG adjustment, R985, which is used in conjunction with the FOCUS control to provide a well-defined display, varies the positive level on the astigmatism grid.

Geometry adjustment, R982, varies the positive level on the horizontal deflection plate shields to control the overall geometry of the display.

Two adjustments control the trace alignment by varying the magnetic field around the crt. The Y Axis Align adjustment, R989, controls the current through L989, and the TRACE ROTATION control, R980, controls the current through L980.

### External Z Axis Input

The external Z Axis input signal is applied to both the crt cathode and the crt control grid through the Z Axis Amplifier circuit. Full operation of this circuit is explained under 'Z Axis Amplifier'.

## LOW VOLTAGE POWER SUPPLY

### General

The Low-Voltage Power Supply provides the operating power for the instrument from three regulated supplies and one unregulated supply. Electronic regulation is used to provide stable output voltages. Each supply contains a short protection circuit. The power-input circuit includes a switch to compensate for lower or higher than normal line voltages. A switch in the power receptacle automatically switches the instrument from 115-volt nominal to 230-volt nominal operation when the correct power cord is connected.

Circuit Description—Type 453

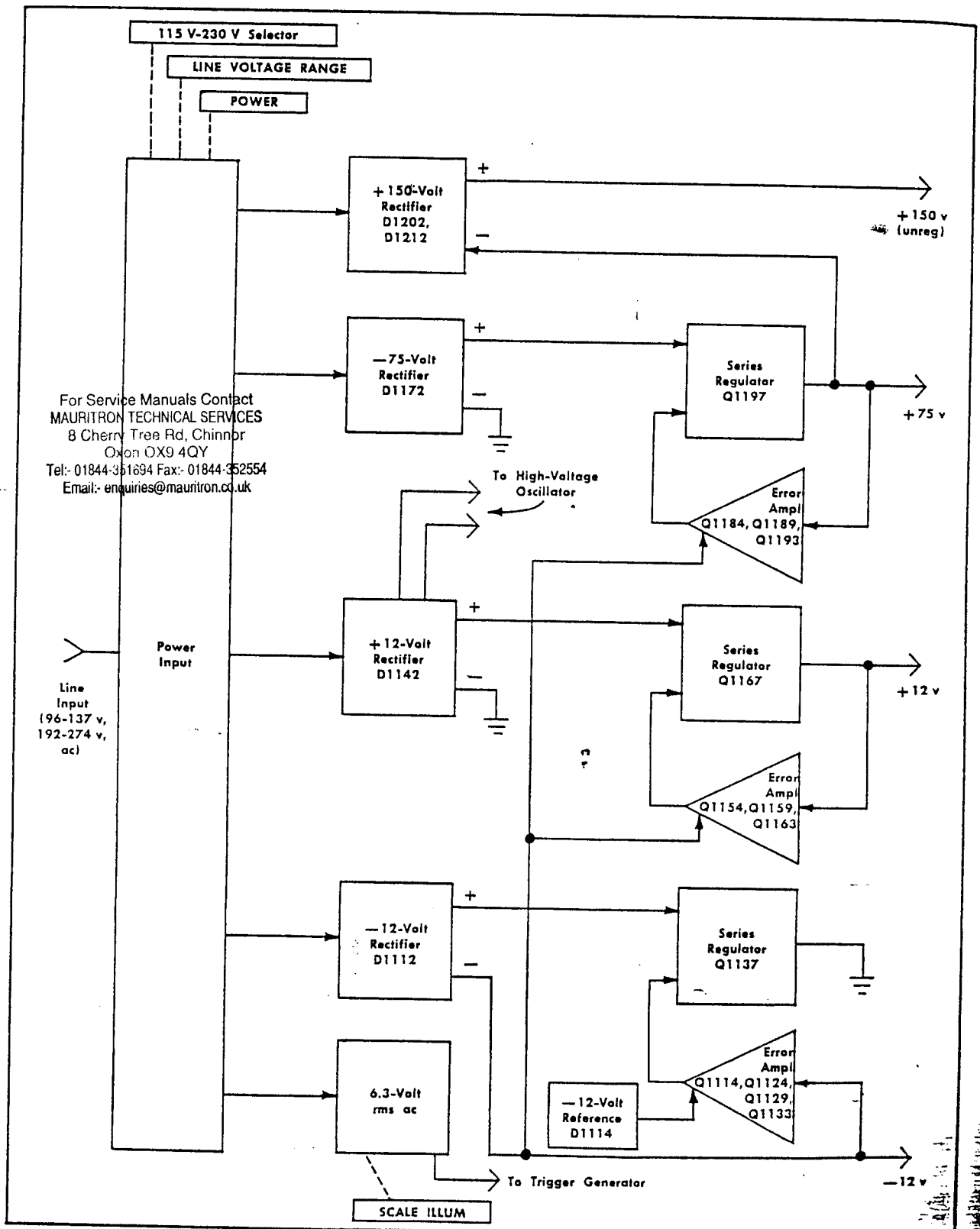

Fig. 3-13. Block diagram of Low-Voltage Power Supply circuit.

### Power Input

Power is applied to the instrument through P1101. The left part of the plug is used for 115-volt nominal line and the right part for 230-volt nominal line operation. As the correct power plug for the nominal line voltage used is connected to P1101, the 115V-230V Selector switch, SW1102, is automatically changed to the correct position. This switch connects the split primaries of T1101 in parallel for 115-volt nominal operation, or in series for 230-volt nominal operation. Fuses F1101 and F1102 are connected in series with the primary windings for 115-volt operation. For 230-volt operation, only F1101 is connected in series with the primary.

LINE VOLTAGE RANGE switch, SW1103, allows higher or lower than normal line voltages to be applied to the instrument. The instrument will operate at nominal line voltage (115 or 230 volts) in either range. This range selection is provided by an extra winding in series with the primary windings. For LOW range, the windings are not used; for HIGH range the extra windings are switched into the circuit.

TK1101 provides thermal protection by opening to interrupt power if the instrument overheats.

### —12-Volt Supply

The —12-Volt Supply provides the reference voltage for the remaining supplies. Reference for the —12-Volt Supply is provided by Zener diode D1114.

Output from the secondary of T1101 is rectified by bridge rectifier D1112A-D. The output of the bridge rectifier is regulated to provide a stable output voltage. Zener diode D1114 holds the base of Q1114 at about —9 volts. Q1114 and Q1124 are connected as a comparator. In this configuration, the emitter level will be established by D1114 with the emitter current dividing between Q1114 and Q1124, depending on the setting of R1122. Collector current of Q1114 controls conduction of Q1133 which in turn controls the conduction of Q1137 to provide the correct output voltage. The base level of Q1124 is set by the —12 Volts adjustment, R1122, to provide —12 volts output from the supply.

Ripple in the output voltage is held to a minimum by feeding a sample of the output back to the regulator transistor, Q1137. To understand this operation, assume that the ripple is in the negative half of its cycle. This negative signal at the output will be applied across the voltage divider R1121, R1122 and R1123 resulting in reduced current flow through Q1124. Reduced current flow through Q1124 allows Q1114 to conduct more. Increased current through Q1114 reduces the current through Q1133, resulting in reduced conduction of Q1137, the regulator transistor. Reduced current in Q1137 will oppose the original output change due to ripple and provide a stable output voltage. C1128 delays the current change at the base of Q1133 slightly, preventing the circuit from oscillating but allowing it to effectively remove line-frequency ripple from the output. In a similar manner, the regulator circuit compensates for changes in input voltage or changes in load current.

Q1129 protects the —12-volt Supply if the output is shorted. When the output is shorted, high current is de-

manded from Q1137. However, this current flows through R1129 and produces a voltage drop sufficient to bias Q1129 into operation. Current from Q1129 flows through R1117 and reduces the current through Q1133. Q1133 limits the conduction of Q1137 and, while not correcting the original shorted condition, it protects the regulator circuit from overload.

### +12-Volt Supply

Rectified voltage for operation of the +12-Volt Supply is provided by D1142A-D. This unregulated voltage is also applied to the high-voltage oscillator. Reference voltage for this supply is provided by voltage divider R1151-R1152-R1153 between —12 volts and the output of this supply. The —12 volts is held stable by the —12-Volt Supply as discussed previously. If the +12-volt output changes, this change is applied to Q1154 as an error signal. Regulation is controlled by regulator transistor Q1167 as described for the —12-Volt Supply. R1152, +12 Volts adjustment, sets the output level to +12 volts. D1152 provides thermal compensation for Q1154. C1156 prevents oscillation in the regulator circuit and C1164 improves low-frequency gain.

Shorting protection is provided by Q1159 and R1159. Q1159 limits the current of the regulator transistor, Q1167, if the output is shorted. Operation is the same as described in the —12-Volt Supply discussion. D1164 protects Q1154 when this supply is shorted. Zener diode D1167 clamps the collectors of Q1163 and Q1167 at about +30 volts if the high-voltage supply is shorted.

### +75-Volt Supply

Operation of the +75-Volt Supply is basically the same as the +12-Volt Supply. Only the differences in operation between the two supplies will be given in the following discussion.

Reference voltage for the +75-Volt Supply is provided by divider R1181-R1182-R1183 between —12 volts and the output of this supply. The regulator circuit and error amplifier operate as described for the —12-Volt Supply. C1184 and C1191 prevent oscillation of the regulator circuit. Low-ripple current for the regulator circuit is provided by D1209 from the +75-volt output. D1185 provides a voltage drop, without current limiting, to provide the correct operating level for Q1184.

Q1189 provides shorting current limiting through D1188. Under normal operating conditions, D1189 is conducting and D1188 is reverse biased. However, when the output is shorted, the collector of Q1189 goes more negative and D1188 is forward biased with D1189 reverse biased. This allows Q1189 to control the collector current of Q1197 through Q1193. F1172 also provides overload protection.

### +150-Volt Unregulated Supply

Rectifiers D1202 and D1212 provide the unregulated output for the +150-Volt Supply. D1198 provides protection for the +75-Volt Supply when the +150-Volt Supply is shorted. F1204 also provides overload protection.

## Circuit Description—Type 453

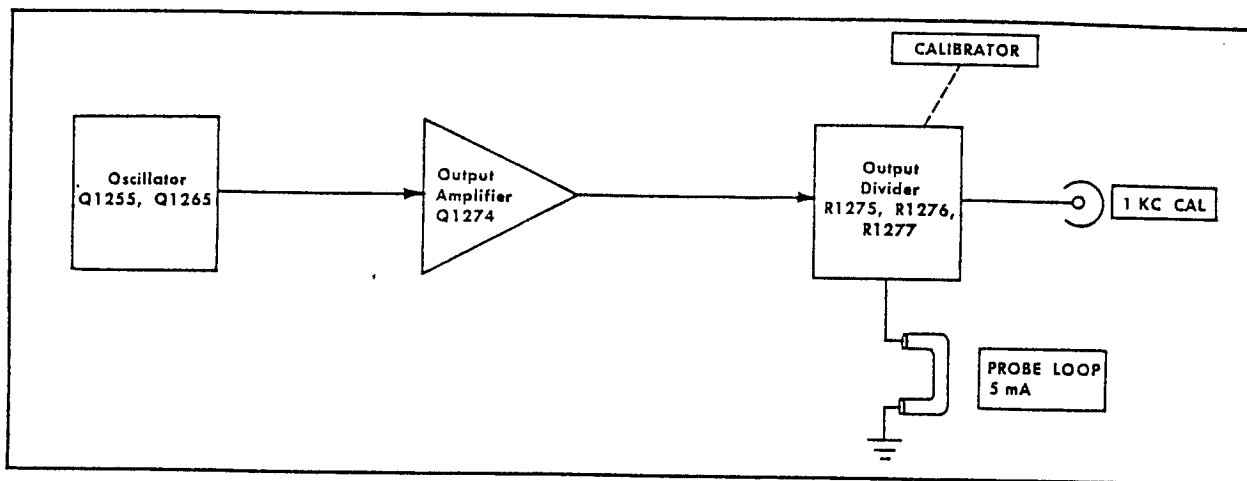

Fig. 3-14. Block diagram of Calibrator circuit.

### Other Outputs

A 6.3-volt rms winding provides power for the pilot light and scale illumination lights. A signal is also obtained from this winding through divider R1104-R1105 to provide line triggering for the Trigger Generators.

## CALIBRATOR

### Oscillator

Q1255 and Q1265 form the Oscillator stage for the Calibrator circuit. Frequency of the circuit is determined by T1255 and C1255 in the collector of Q1255. The frequency accuracy and stability of this circuit is obtained by using a high-quality capacitor, C1255, which has a temperature coefficient opposite to the temperature coefficient of T1255. Oscillation is sustained by the feedback winding of T1255 to the base of Q1255. C1266 provides regenerative feedback to Q1265 which, along with the base feedback of Q1255, provides fast changeover to quickly cut Q1255 off or turn it back on. The square-wave current output of Q1265 is connected to the Output Amplifier.

### Output Amplifier

The Output Amplifier, Q1274, is either saturated or turned off depending on the base signal. When Q1265 is conducting, Q1274 will saturate and the collector will rise to about +12 volts. The output of the +12-Volt Supply is adjusted for 1 volt at the 1 KC CAL connector when the CALIBRATOR switch is set to 1 V. When Q1265 is off, the voltage at the collector of Q1274 falls to zero. The output signal has a fast risetime due to the fast changeover between Q1255 and Q1265.

### Output Divider

The Output Divider, R1275-R1276-R1277, provides two output voltages from the Calibrator circuit. In the 1 V CALIBRATOR switch position, voltage is taken off the collector of Q1274 through R1274. In the .1 V CALIBRATOR switch position, the output is obtained at the junction of R1275 and R1276-R1277 to provide one-tenth of the previous output voltage.

Collector current of Q1274 flows through the PROBE LOOP on the side panel. Output current is a 5-milliamp square wave.

For Service Manuals Contact  
MAURITRON TECHNICAL SERVICES  
8 Cherry Tree Rd, Chinnor  
Oxon OX9 4QY  
Tel:- 01844-351694 Fax:- 01844-352554  
Email:- enquiries@mauritron.co.uk

# SECTION 4

## MAINTENANCE

### Introduction

This section of the manual contains maintenance information for use in preventive maintenance, corrective maintenance or troubleshooting of the Type 453.

### PREVENTIVE MAINTENANCE

#### General

Preventive maintenance consists of cleaning, visual inspection, lubrication, etc. Preventive maintenance performed on a regular basis will help prevent instrument failure and will improve reliability of this instrument. The severity of the environment to which the Type 453 is subjected will determine the frequency of maintenance.

#### Cleaning

The Type 453 should be cleaned as often as operating conditions require. Accumulation of dirt in the instrument can cause overheating and component breakdown. Dirt on components acts as an insulating blanket and prevents efficient heat dissipation. It also provides an electrical conduction path.

The top and bottom covers provide protection against dust in the interior of the instrument. Operation without the covers in place will require more frequent cleaning. The front cover provides dust protection for the front panel and crt face. The front cover should be installed for storage or transportation.

#### CAUTION

Avoid the use of chemical cleaning agents which might damage the plastics used in this instrument. Some chemicals to avoid are benzene, toluene, xylene, acetone or similar solvents.

**Air Filter.** The air filter should be visually checked every few weeks and cleaned if dirty. More frequent inspections and cleaning are required under severe operating conditions. Remove the filter by pulling it out of the plastic frame on the rear of the instrument. To clean the filter, wash it out in the same manner as a plastic sponge. Rinse the filter thoroughly and let it dry. Coat the dry filter with fresh air-filter adhesive (available from air conditioner suppliers or order Tektronix Part No. 006-0580-00). Let the adhesive dry thoroughly before reinstalling the filter.

**Exterior.** Loose dust accumulated on the outside of the Type 453 can be removed with a soft cloth or small paint brush. The paint brush is particularly useful for dislodging dirt on and around the front-panel controls. Dirt which remains can be removed with a soft cloth dampened in a mild solution of water and detergent. Abrasive cleaners should not be used.

Clean the light filter, faceplate protector and crt face with a soft, lint-free cloth dampened with denatured alcohol.

**Interior.** Dust in the interior of the instrument should be removed occasionally due to its electrical conductivity under high-humidity conditions. The best way to clean the interior is to blow off the accumulated dust with dry, low-velocity air. Remove any dirt which remains with a soft paint brush or a cloth dampened with a mild detergent and water solution. A cotton-tipped applicator is useful for cleaning in narrow spaces or for cleaning ceramic terminal strips and etched-wiring boards.

The high-voltage circuits, particularly parts located in the high-voltage compartment and the area surrounding the post-deflection anode connector, should receive special attention. Excessive dust or dirt in these areas may cause high-voltage arcing and result in improper instrument operation.

#### Lubrication

The reliability of potentiometers, rotary switches and other moving parts can be increased if they are kept properly lubricated. Use a cleaning-type lubricant (such as Tektronix Part No. 006-0218-00) on shaft bushings and switch contacts. Lubricate switch detents with a heavier grease (such as Tektronix Part No. 006-0219-00). Potentiometers should be lubricated with a lubricant which will not affect electrical characteristics (such as Tektronix Part No. 006-0220-00). Do not overlubricate. A lubrication kit containing the necessary lubricants and instructions is available from Tektronix. Order Tektronix Part No. 003-0342-00.

The fan bearings are sealed and do not require lubrication.

#### Visual Inspection

The Type 453 should be inspected occasionally for such defects as broken connections, broken or damaged ceramic strips, improperly seated transistors or nuvistors, damaged etched-wiring boards and heat-damaged parts.

The remedy for most visible defects is obvious; however, care must be taken if heat-damaged parts are located. Overheating is usually only a symptom of trouble. For this reason, it is essential to determine the actual cause of overheating before the heat-damaged part is replaced; otherwise, the damage may be repeated.

#### Transistor and Nuvistor Checks

Periodic checks of the transistors and nuvistors in the Type 453 are not recommended. The best check of transistor or nuvistor performance is its actual operation in the instrument. More details on checking transistor and nuvistor operation is given under 'Troubleshooting'.

#### Recalibration

To assure accurate measurements, check the calibration of this instrument after each 1000 hours of operation or

## Maintenance—Type 453

every six months if used infrequently. Complete instructions are given in the Calibration section.

The calibration procedure can also be helpful in localizing certain troubles in the instrument. In some cases minor troubles, not apparent during normal use, may be revealed and/or corrected by recalibration.

## CORRECTIVE MAINTENANCE

### General

Corrective maintenance consists of component replacement and instrument repair. Special techniques or procedures required to replace components in this instrument are described here.

### Obtaining Replacement Parts

**Standard Parts.** All electrical and mechanical part replacements for the Type 453 can be obtained through your local Tektronix Field Office or representative. However, many of the standard electronic components can be obtained locally in less time than is required to order them from Tektronix, Inc. Before purchasing or ordering replacement parts, consult the Parts List for value, tolerance and rating.

### NOTE

When selecting replacement parts, it is important to remember that the physical size and shape of a component may affect its performance at high frequencies. All replacement parts should be direct replacements unless it is known that a different component will not adversely affect instrument performance.

**Special Parts.** In addition to the standard electronic components, some special parts are used in the Type 453. These parts are manufactured or selected by Tektronix, Inc. to meet specific performance requirements, or are manufactured for Tektronix, Inc. in accordance with our specifications. These special parts are indicated in the Parts List by an asterisk preceding the part number. Most of the mechanical parts used in this instrument have been manufactured by Tektronix, Inc. Order all special parts directly from your Tektronix Field Office or representative.

**Ordering Parts.** When ordering replacement parts from Tektronix, include the following information:

1. Instrument Type.
2. A description of the part (if electrical, include circuit number).
3. Tektronix Part Number.
4. Instrument Serial Number.

### Soldering Techniques

#### WARNING

Disconnect the instrument from the power source before soldering.

**Etched-Wiring Boards.** Use ordinary 60/40 solder and a 35- to 40-watt pencil type soldering iron on the etched-wiring boards. The tip of the iron should be clean and properly tinned for best heat transfer to the solder joint. A higher wattage soldering iron may separate the etched wiring from the base material.

The following technique should be used to replace a component on an etched-wiring board. Most components can be replaced without removing the boards from the instrument.

1. Grip the component lead with long-nose pliers. Touch the soldering iron to the lead at the solder connection. Do not lay the iron directly on the board, as it may damage the board.

2. When the solder begins to melt, pull the lead out gently. This should leave a clean hole in the board. If not, the hole can be cleaned by reheating the solder and placing a sharp object such as a toothpick or pointed tool into the hole to clean it out.

3. Bend the leads of the new component to fit the holes in the board. If the component is replaced while the board is mounted in the instrument, cut the leads so they will just protrude through the board. Insert the leads into the board until the component is firmly seated against the board. If it does not seat properly, heat the solder and gently press the component into place.

4. Apply the iron and a small amount of solder to the connection to make a firm solder joint. To protect heat-sensitive components, hold the lead between the component body and the solder joint with a pair of long-nose pliers or other heat sink.

5. Clip the excess lead that protrudes through the board.

6. Clean the area around the soldered connection with a flux-remover solvent to maintain good environmental characteristics. Be careful not to remove information printed on the board.

**Ceramic Terminal Strips.** Solder used on the ceramic terminal strips should contain about 3% silver. Ordinary tin-lead solder can be used occasionally without damage to the ceramic terminal strips. Use a 40- to 75-watt soldering iron with a  $\frac{1}{8}$ " wide chisel-shaped tip. If ordinary solder is used repeatedly or if excessive heat is applied, the solder-to-ceramic bond may be broken.

A small roll of 3% silver solder is mounted on the rear subpanel. Additional silver solder should be available locally or it can be purchased directly from Tektronix; order by Tektronix Part No. 251-0514-00.

Observe the following precautions when soldering ceramic terminal strips:

1. Use a hot iron for a short time. Apply only enough heat to make the solder flow freely.

2. Maintain a clean, properly tinned tip.

3. Avoid putting pressure on the ceramic terminal strip.

4. Do not attempt to fill the terminal-strip notch with solder; use only enough solder to cover the wires adequately.

5. Clean the flux from the terminal strip with a flux-remover solvent to maintain good environmental characteristics.

**Metal Terminals.** When soldering metal terminals (e.g., switch terminals, potentiometers, etc.), ordinary 60/40 solder can be used. The soldering iron should have a 40- to 75-watt rating with a  $\frac{1}{8}$ " wide chisel-shaped tip.

Observe the following precautions when soldering metal terminals:

1. Apply only enough heat to make the solder flow freely.
2. Apply only enough solder to form a solid connection. Excess solder may impair the function of the part.
3. If a wire extends beyond the solder joint, clip off the excess.
4. Clean the flux from the solder joint with a flux-remover solvent to maintain good environmental characteristics.

## Component Replacement

### WARNING

Disconnect the instrument from the power source before replacing components.

**Removing Covers.** The top and bottom covers are held in place by thumb screws located on each side of the instrument. To remove the covers, loosen the thumb screws and slide the covers off of the instrument.

**Removing the Rear Panel.** The rear panel must be removed for access to the rear subpanel. This panel can be removed by removing the Z Axis ground strap and the four screws located near the feet.

**Ceramic Terminal Strip Replacement.** A complete ceramic terminal strip assembly is shown in Fig. 4-1. Replacement strips (including studs) and spacers are supplied under separate part numbers. The old spacers may be reused if they are not damaged.

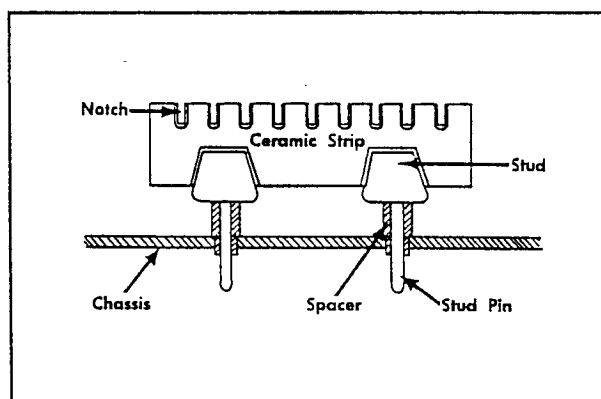

Fig. 4-1. Ceramic terminal strip assembly.

To replace a ceramic terminal strip, first unsolder all connections. Then, the damaged strip can be pried or pulled loose from the chassis. If the spacers come out with the strip, remove them from the stud pins to be used for installation of the new strip.

After the damaged strip has been removed, place the undamaged spacers in the chassis holes. Then, carefully press the studs into the spacers until completely seated. If necessary, use a soft mallet and tap lightly, directly over the stud area of the strip.

**Etched-Wiring Board Replacement.** If an etched-wiring board is damaged and cannot be repaired, the entire assembly including all soldered-on components should be replaced. The part number given in the Mechanical Parts list is for the completely-wired board.

Procedure for replacing etched-wiring boards follows:

**Etched-Wiring Board Removal.** All connections to the etched-wiring boards are made with pin connectors except the connections between the Vertical Preamp board and the attenuators. However, the attenuators and Vertical Preamp board can be removed from the instrument as a unit without unsoldering the interconnecting wires (see 'Vertical Preamp Unit Removal').

Most of the components mounted on the etched-wiring boards can be replaced without removing the boards from the instrument. Observe soldering precautions given under 'Soldering Techniques' in this section. However, if the underside of the board must be reached or if the board must be moved to gain access to other areas of the instrument, only the mounting screws need be removed. The interconnecting wires allow the board to be moved out of the way or turned over without disconnecting the pin connectors (except Vertical Preamp). The Vertical Preamp board can be reconnected to the instrument for troubleshooting after removal.

Use the following procedure to remove a board:

1. Disconnect all pin connectors which come through holes in the board.
2. Remove all screws holding the board to the chassis.
3. The board may now be lifted for maintenance or access to areas beneath the board.
4. To completely remove the board, disconnect the remaining pin connectors.
5. Lift the etched-wiring board out of the instrument. Do not force or bend the board.
6. To replace the board, reverse the order of removal. Correct location of the pin connectors is shown in Figs. 4-5 through 4-13. Replace the pin connectors carefully so they mate correctly with the pins. If forced into place incorrectly positioned, the pin connectors may be damaged.

**Vertical Preamp Unit Removal.** Use the following procedure to remove the Vertical Preamp unit.

1. Remove the screw (mounted with a washer) which holds the MODE-TRIGGER switch (rear of board) to the chassis. The other screw may be left in place.
2. Unsolder the connections on the MODE-TRIGGER switch which do not go to the Vertical Preamp board.
3. Disconnect all pin connectors which lead off of the Vertical Preamp board.
4. Remove the attenuator shield and remove the nuts (four) located under this shield at each side of the INPUT connectors.

## Maintenance—Type 453

5. Remove the VOLTS/DIV, VARIABLE, POSITION, AC GND DC, MODE and TRIGGER knobs.

6. Remove the securing nuts on the VOLTS/DIV switches and the STEP ATTEN BAL controls.

7. Remove the three screws at the rear of the board.

8. Lift up on the rear of the assembly and slide it out of the instrument.

9. The board may now be removed from the Vertical Preamp unit as follows:

a. Disconnect all pin connectors remaining on the board.

b. Unsolder all connections on the rear side of the board which connect between the attenuators and the board. Observe the soldering precautions given in this section.

c. Remove the remaining screw which holds the MODE TRIGGER switch to the board.

d. Remove the four screws holding the board to the attenuators.

10. To replace the unit, reverse the order of removal. Be sure the GAIN and INVERT extensions are positioned correctly in the corresponding front-panel holes.

**Cathode-Ray Tube Replacement.** Use care when handling a crt. Protective clothing and safety glasses should be worn. Avoid striking it on any object which might cause it to crack or implode. When storing a crt, place it face down on a smooth surface with a protective cover or soft mat under the faceplate to protect it from scratches.

The following procedure outlines the removal and replacement of the cathode-ray tube:

### A. Removal:

1. Remove the top and bottom covers and rear panel as described previously.

2. Remove the light filter or faceplate protector.

3. Disconnect the crt anode connector. Ground this lead and the anode connection to discharge any stored charge.

4. Unsolder the trace-rotation leads at the crt shield.

5. Unsolder the y-axis rotation leads at the Y Axis Align control.

6. Disconnect the deflection-plate connectors. Be careful not to bend the deflection-plate pins.

7. Remove the crt socket.

8. Remove the two nuts (by the graticule lights) which hold the front of the crt shield to the subpanel.

9. Remove the graticule lights from the studs and position them away from the shield.

10. Loosen the two hex-head screws inside the rear of the crt shield. Remove the shield angle clamps and mounting screws.

11. Slide the crt assembly to the rear of the instrument until the faceplate clears the mounting studs. Then, lift the front of the crt assembly up and slide it out of the instrument (see Fig. 4-2).

12. Loosen the three screws on the crt clamp inside the crt shield. Do not remove the screws.

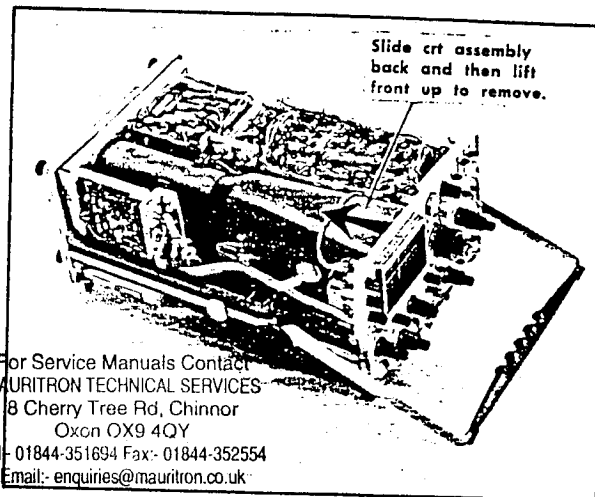

Fig. 4-2. Removing the cathode-ray tube.

13. Hold the left hand on the crt faceplate and push forward on the crt base with the right hand. As the crt starts out of the shield, grasp it firmly with the left hand. When the crt is free of the clamp, slide the shield completely off the crt. Be careful not to bend the neck pins.

### B. Replacement:

1. Insert the crt into the shield. Be careful not to bend the neck pins. Seat the crt firmly against the shield.

2. Tighten the bottom clamp screw—inside the crt shield. Recommended tightening torque: 4 to 7 in-lbs. Do not tighten the screws on the sides.

3. Place the light mask over the crt faceplate.

4. Using a method similar to that for removal (step 11) reinsert the crt assembly into the instrument. Be sure the crt faceplate seats properly in the subpanel.

5. Tighten the two remaining screws on the inside of the crt shield.

6. Replace the shield angle clamps and mounting screws on the rear subpanel. Tighten the two hex-head screws inside the rear of the crt shield.

7. Replace the graticule lights and securing nuts.

8. Replace the crt socket.

9. Reconnect the anode connector. Align the jack on the crt and the plug in the connector and press firmly on the insulated cover to snap the plug into place.

10. Reconnect the trace-rotation and y-axis leads.

11. Reconnect the deflection-plate connectors. Correct location is indicated on the crt shield.

12. Adjust the High Voltage, TRACE ROTATION, ASTIG, Y Axis Align and Geometry adjustments. Adjustment procedure is given in the Calibration section.

**Transistor and Nuistor Replacement.** Transistors and nuistors should not be replaced unless actually defective. If removed during routine maintenance, return them to their original sockets. Unnecessary replacement of transistors or nuistors may affect the calibration of this instrument. When transistors or nuistors are replaced, check the operation of that part of the circuit which may be affected.



Replacement transistors or nuvistors should be of the original type or a direct replacement. The transistors should be remounted in the same manner as the original. Some of the power-supply transistors and the vertical and horizontal output transistors use silicone grease to increase heat transfer. Replace the silicone grease when replacing these transistors.

#### WARNING

Handle silicone grease with care. Wash hands thoroughly after use. Avoid getting silicone grease in the eyes.

**Fuse Replacement.** The line fuses are located on the side panel. The +75-volt, +150-volt and high-voltage power-supply fuses are mounted on the rear subpanel. Remove the rear panel for access to these fuses. Table 4-1 gives the value of the fuses used in this instrument.

TABLE 4-1

Circuit Number	Rating	Location	Function
F937	2A Slow	Rear subpanel	High voltage
F1101	0.8A Slow	Side panel	Line
F1102	0.8A Slow	Side panel	Line
F1172	0.5A Slow	Rear subpanel	+75 volt
F1204	0.25A Fast	Rear subpanel	+150 volt

**Rotary Switches.** Individual wafers or mechanical parts of rotary switches are normally not replaced. If a switch is defective, replace the entire assembly. Replacement switches can be ordered either wired or unwired; refer to the Parts List for the applicable part numbers.

When replacing a switch, it is recommended that the leads and switch terminals be tagged with corresponding identification tags as the leads are disconnected. Then, use the old switch as a guide for installing the new one. An alternative method would be to draw a sketch of the switch layout and record the wire color at each terminal.

The swing-out side panel provides access to the side of the TIME/DIV and HORIZ DISPLAY switches. The top and bottom of these switches may be reached for easier repair or removal by removing the B Sweep board (top) or the A Sweep board (bottom).

**High-Voltage Compartment.** The components located in the high-voltage compartment can be reached for maintenance or replacement by using the following procedure.

1. Remove the bottom cover of the instrument as described in this section.
2. Remove the high-voltage shield.
3. Remove the three screws which hold the cover on the high-voltage compartment.
4. To remove the complete wiring assembly from the high-voltage compartment, unsolder the post-deflection anode lead (heavily insulated lead at the side of the compartment). The other leads are long enough to allow the assembly to be lifted out of the compartment to reach the parts on the under side.

5. To replace the high-voltage compartment, reverse the order of removal.

**Power Chassis.** The power transistors and other heat dissipating power-supply components are mounted below the Low-Voltage Regulator board. Remove the Low-Voltage Regulator board to reach these components. To reach the underside of the chassis, remove the fan through the rear subpanel.

## TROUBLESHOOTING

### Introduction

The following information is provided to facilitate troubleshooting of the Type 453, if trouble develops. Information contained in other sections of this manual should be used along with the following information to aid in locating the defective component.

### Troubleshooting Aids

**Diagrams.** Circuit diagrams are given on foldout pages in Section 7. The circuit number and electrical value of each component in this instrument are shown on the diagrams. Important voltages and waveforms are also shown on the diagrams.

**Component Numbering.** The circuit number of each electrical part is shown on the circuit diagram. Each main circuit is assigned a series of circuit numbers. Table 4-2 lists the main circuits in the Type 453 and the series of circuit numbers assigned to each. For example, using Table 4-2, a resistor numbered R550 is identified as being located in the A Sweep Generator.

TABLE 4-2

Circuit Numbers on Schematics	Circuit
1-99	Channel 1 Input Preamp
100-199	Channel 2 Input Preamp
200-299	Vertical Switching
300-399	Vertical Output Amplifier
400-429	Trigger Preamp
430-499	A Trigger Generator
500-599	A Sweep Generator
600-699	B Trigger Generator
700-799	B Sweep Generator
800-899	Horizontal Amplifier
900-999	Crt Circuit
1000-1099	Z Axis Amplifier
1100-1199	Power Supply
1200-1299	Calibrator

**Switch Wafer Identification.** Switch wafers shown on the diagrams are coded to indicate the position of the wafer in the complete switch assembly. The numbered portion of the code refers to the wafer number counting from the front, or mounting end of the switch, toward the rear. The letters 'F' and 'R' indicate whether the front or rear of the wafer performs the particular switching function. For example, a wafer designated 2R indicates that the rear of the second wafer is used for this particular switching function.

**Maintenance—Type 453**

**Etched-Wiring Boards.** Figs. 4-5 through 4-13 show the etched-wiring boards used in the Type 453. Fig. 4-4 shows the location of each board within the instrument. Each electrical component on the boards is identified by its circuit number. The circuit boards are also outlined on the diagrams with a blue line. These pictures used along with the diagrams will aid in locating the components mounted on the etched-wiring boards.

**Wiring Color-Code.** All insulated wire used in the Type 453 is color-coded according to the EIA standard color-code (as used for resistors) to facilitate circuit tracing. The widest color stripe identifies the first color of the code. Power-supply voltages can be identified by three color stripes and the following background color-code; white, positive voltage; tan, negative voltage. Table 4-3 shows the wiring color-code for the power-supply voltages used in the Type 453. The remainder of the wiring in the Type 453 is color-coded with two or less stripes or has a solid background with no stripes. The color-coding helps to trace a wire from one point in the instrument to another.

**TABLE 4-3**

Supply	Background Color	1st Stripe	2nd Stripe	3rd Stripe
-12 volt	Tan	Brown	Red	Black
+12 volt	White	Brown	Red	Black
+75 volt	White	Violet	Green	Black
+150 volt	White	Brown	Green	Brown

**Resistor Color-Code.** A number of precision metal-film resistors are used in this instrument. These resistors can be identified by their gray body color. If a metal-film resistor has a value indicated by three significant figures and a multiplier, it will be color-coded according to the EIA standard resistor color-code. If it has a value indicated by four significant figures and a multiplier, the value will be printed on the body of the resistor. For example, a 333 k resistor will be color-coded, but a 333.5 k resistor will have its value printed on the resistor body. The color-code sequence is shown in Fig. 4-3.

Composition resistors are color-coded according to the EIA standard resistor color-code.

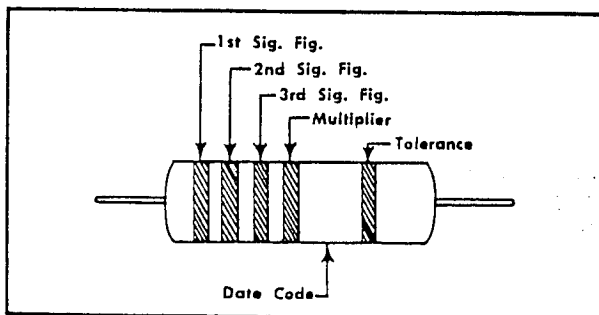

Fig. 4-3. Color-coding of metal-film resistors.

**Troubleshooting Techniques**

This troubleshooting procedure is arranged in an order which checks the simple trouble possibilities before proceeding with extensive troubleshooting. The first few checks assure proper connection, operation and calibration. If the trouble is not located by these checks, the remaining steps aid in locating the defective component. When the defective component is located, it should be replaced following the replacement procedures given in this section.

1. Check Associated Equipment. Before proceeding with troubleshooting of the Type 453, check that the equipment used with the Type 453 is operating correctly. Check that the signal is properly connected and that the interconnecting cables or probes are not defective. Also, check the power source.

2. Check Control Settings. Incorrect control settings can indicate a trouble that does not exist. For example, incorrect setting of the A VARIABLE or B TIME/DIV VARIABLE controls appears as an uncalibrated sweep; incorrect setting of the Triggering controls appears as defective sweep or trigger circuit; incorrect setting of the VARIABLE VOLTS/DIV controls appears as incorrect gain, etc. If there is any question about the correct function or operation of any control, see the Operating Instructions section of this manual.

3. Check Instrument Calibration. Check the calibration of the instrument, or the affected circuit if the trouble exists in one circuit. The indicated trouble may only be a result of misadjustment or may be corrected by calibration. Complete instructions are given in the Calibration section of this manual. Individual calibration steps can be performed out of sequence. However, if the circuit affects the calibration of other circuits in the instrument, a more complete calibration will be necessary. 'General Information' in the Calibration section describes how calibration steps which interact are noted.

4. Isolate Trouble to a Circuit. The Type 453 consists of 14 basic circuits. The normal interaction between these circuits is given in Table 4-4 to aid in isolating a trouble to an individual circuit. The left column of Table 4-4 lists the circuits in descending order as to their effect on other circuits in the Type 453. The circuits which interact with the most other circuits are at the top; those with least effect, at the bottom. This table may not list all interaction but is given as an aid in localizing a trouble in the Type 453.

To isolate a trouble to a circuit, note the trouble symptom. The symptom often identifies the circuit in which the trouble is located. For example, poor focus indicates that the CRT circuit (includes high voltage) is probably at fault. When trouble symptoms appear in more than one circuit, or if the trouble is not located in the circuit which indicates the trouble, Table 4-4 may aid in locating the cause of trouble. To use the table, find the horizontal line which shows the circuit(s) affected. Check first the circuit listed in the left column. If this circuit is not the source of the trouble, check the first circuit listed in the top line which interacts, etc. Methods of checking the circuits are given in steps 5 through 8.

The pin connectors used to connect the etched-wiring boards to the instrument provide a unique means of circuit isolation. For example, a short in a power supply can be isolated to the Low-Voltage Supply by disconnecting the connectors for that voltage at the boards.

TABLE 4-4

	Power Supply	Trigger Preamp.	A Sweep Generator	Horizontal Amplifier	B Sweep Generator	CRT Circuit	Vertical Switching	Vertical Output Amplifier	Z Axis Amplifier	A Trigger Generator	B Trigger Generator	Channel 1 Input Preamp	Channel 2 Input Preamp	Calibrator
Power Supply	X	X	X	X	X	X	X	X	X	X	X	X	X	X
Trigger Preamp	X	X	X	X	X	X		X		X	X			
A Sweep Generator	X	X	X	X	X	X			X	X				
Horizontal Amplifier	X	X	X	X	X	X			X		X			
B Sweep Generator	X	X	X	X	X	X	X	X	X					
CRT Circuit	X		X	X	X	X	X	X	X			X	X	
Vertical Switching	X					X	X	X	X			X	X	
Vertical Output Amplifier	X	X				X	X	X				X	X	
Z Axis Amplifier	X		X		X	X	X		X					
A Trigger Generator	X	X	X	X						X				
B Trigger Generator	X	X		X	X						X			
Channel 1 Input Preamp	X						X	X				X		
Channel 2 Input Preamp	X						X	X					X	
Calibrator	X													X

Incorrect operation of all circuits often indicates trouble in the Low-Voltage Power Supply. Check first for correct adjustment of the individual supplies. However, a defective component elsewhere in the instrument can appear as a power-supply trouble and may also affect the operation of other circuits.

Table 4-5 lists the tolerances of the power supplies in the Type 453. If a power-supply voltage is within the listed tolerance, the supply can be assumed to be working correctly. If outside the tolerance, the supply may be misadjusted or operating incorrectly. Use the procedure given in the Calibration section to adjust the power supplies.

TABLE 4-5

Power Supply	Tolerance
-12 volt	$\pm 0.12$ volt
+12 volt	12.1 volts, $\pm 0.21$ volt*
+75 volt	$\pm 0.75$ volt

\*Adjusted for correct output from the Calibrator circuit. See Calibration procedure.

After the defective circuit has been located, proceed with steps 5 through 8 to locate the defective component(s). If the trouble has not been isolated to a circuit using the procedure described here, check voltages and waveforms as explained in step 7 to locate the defective circuit.

5. Check Etched-Wiring Board Interconnections. After the trouble has been isolated to a particular circuit, check the pin connectors on the etched-wiring board for correct

connection. Figs. 4-5 through 4-13 show the correct connections for each board.

6. Visual Check. Visually check the circuit in which the trouble is located. Many troubles can be located by visual indications such as unsoldered connections, broken wires, damaged etched-wiring boards or damaged components.

7. Check Voltages and Waveforms. Often the defective component can be located by checking for the correct voltage or waveform in the circuit. Typical voltages and waveforms are given on the Schematic Diagrams.

## NOTE

Voltages and waveforms given on the diagrams are not absolute and may vary slightly between instruments. To obtain operating conditions similar to those used to take these readings, see the first schematic page.

**A. Voltages.** Voltage measurements should be taken with a 20,000 ohms/volt dc voltmeter. Accuracy of the voltmeter should be within 3% on all ranges. Be sure that the test prods are well insulated to prevent accidental shorting of components.

**B. Waveforms.** Use a test oscilloscope which has the following minimum specifications:

Bandwidth: Dc to at least 40 Mc.

Deflection factor: 0.05 volts/division minimum.

Input impedance: Approximately 10 megohms paralleled by about 10 pf when using a 10X probe.

**Maintenance—Type 453**

8. Check Individual Components. The following procedures describe methods of checking individual components in the Type 453. Components which are soldered in place can be checked most easily by disconnecting one end. This eliminates incorrect measurements due to the effects of surrounding circuitry.

**A. Transistors and Nuvistors.** The best check of transistor or nuvistor operation is actual performance under operating conditions. If a transistor or nuvistor is suspected of being defective, it can best be checked by substituting a new component or one which has been checked previously. However, be sure that circuit conditions are not such that a replacement transistor or nuvistor might also be damaged. If substitute transistors or nuvistors are not available, a dynamic tester may be used (such as Tektronix Type 570 or 575). Static-type testers are not recommended, however, since they do not check operation under simulated operating conditions.

**B. Diodes.** A diode can be checked for an open or shorted condition by measuring the resistance between terminals. With an ohmmeter scale having an internal source of about 1.5 volts, the resistance should be very high in one direction and very low when the leads are reversed.

**CAUTION**

Do not use an ohmmeter scale that has a high internal current. High currents may damage the diode. Do not measure tunnel diodes with an ohmmeter; use a dynamic tester (such as Tektronix Type 575 Transistor-Curve Tracer).

**C. Resistors.** Resistors can be checked with an ohmmeter. Check the Electrical Parts list for the tolerance of the resistors used in this instrument. Resistors normally do not need to be replaced unless the measured value varies widely from the specified value.

**D. Inductors.** Check for open inductors by checking continuity with an ohmmeter. Shorted or partially shorted inductors can usually be found by checking the waveform response when high-frequency signals are passed through the circuit. Partial shorting often reduces high-frequency response (roll-off).

**E. Capacitors.** A leaky or shorted capacitor can best be detected by checking resistance with an ohmmeter on the highest scale. Do not exceed the voltage rating of the capacitor. The resistance reading should be high after initial charge of the capacitor. An open capacitor can best be detected with a capacitance meter or by checking whether the capacitor passes ac signals.

**NOTES**

For Service Manuals Contact  
**MAURITRON TECHNICAL SERVICES**  
8 Cherry Tree Rd. Chinnor  
Oxon OX9 4QY  
Tel:- 01844-351634 Fax:- 01234-352554  
Email:- enquiries@mauritron.co.uk

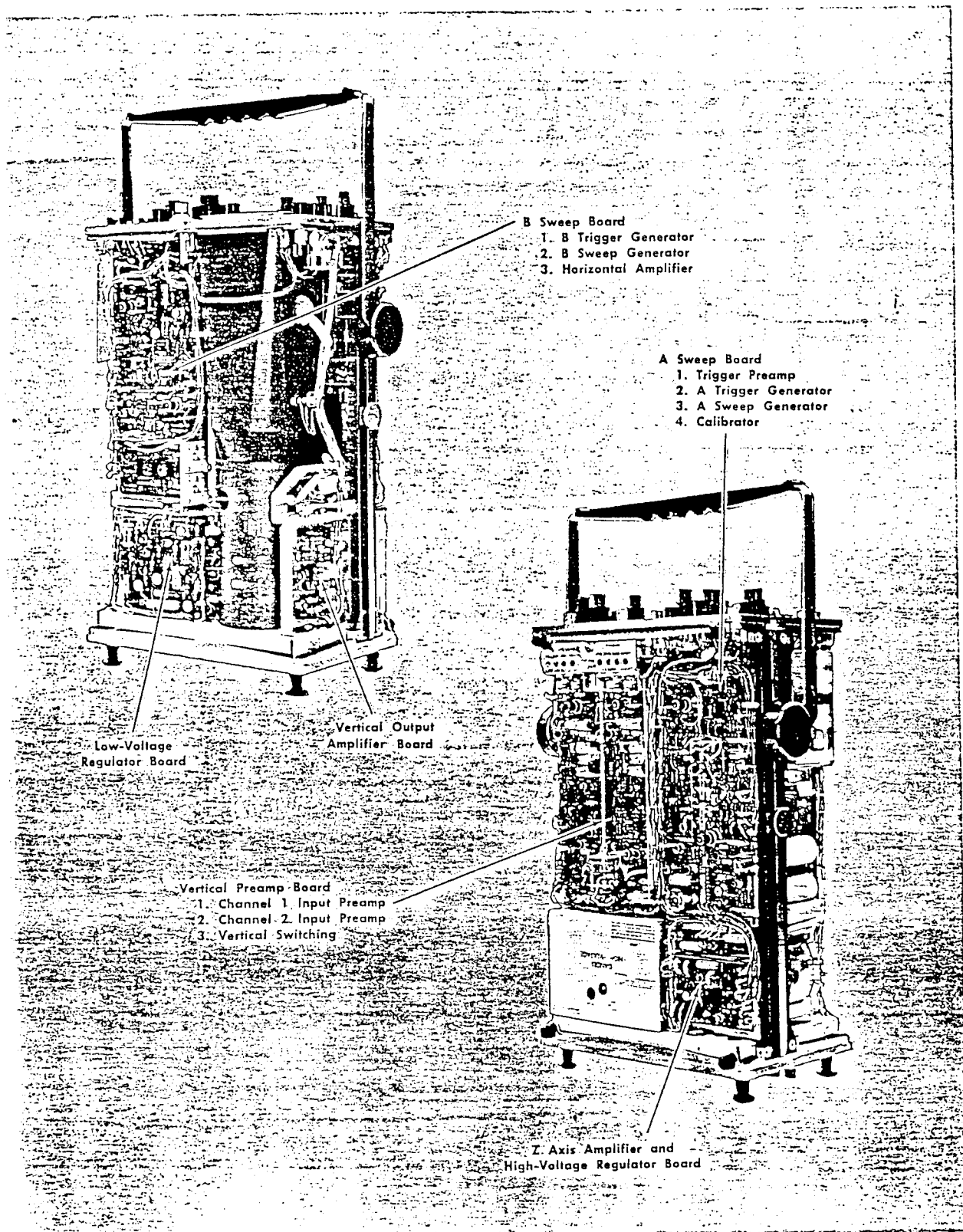
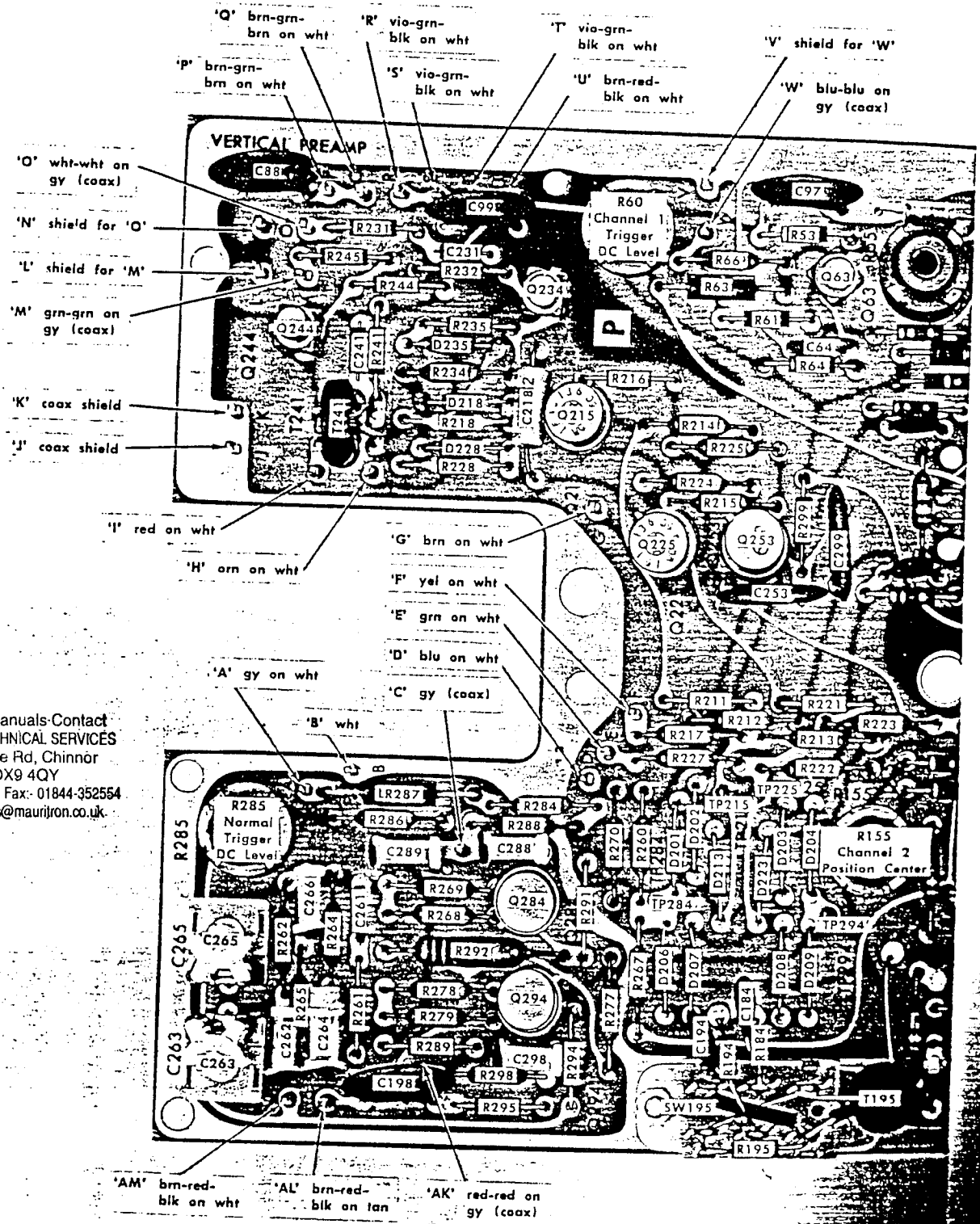

Fig. 4-4. Location of etched-wiring boards in Type 453.



For Service Manuals-Contact  
 MAURITRON TECHNICAL SERVICES  
 8 Cherry Tree Rd, Chinnor  
 Oxon OX9 4QY  
 Tel:- 01844-351694 Fax:- 01844-352554  
 Email:- enquiries@mauritron.co.uk

Fig. 4-5. Vertical Switching etched-wiring board (partial Vertical Preamp board).

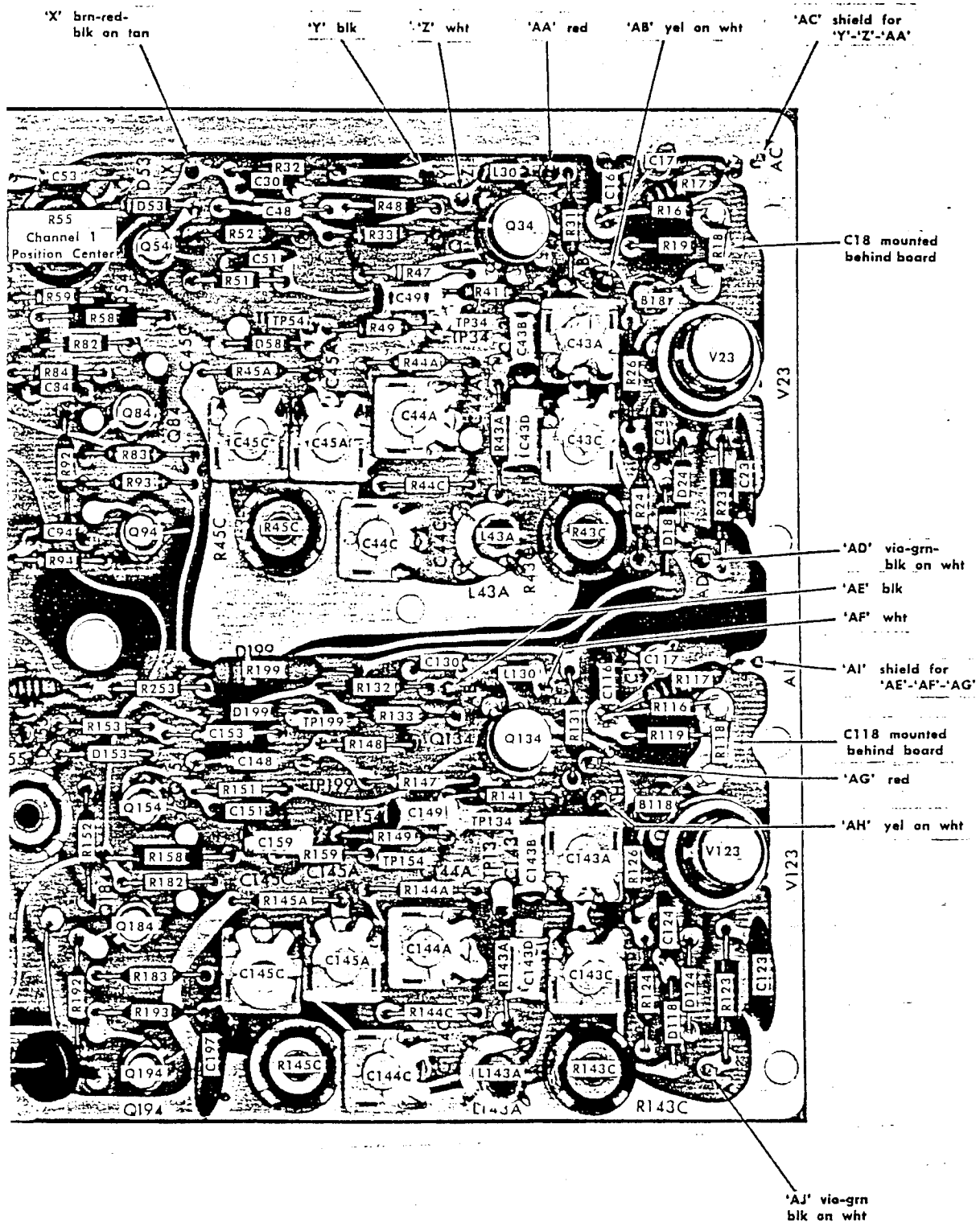

Fig. 4-6. Channel 1 and 2 Input Preamp etched-wiring board (partial Vertical Preamp board).

For Service Manuals Contact  
 MAURITRON TECHNICAL SERVICES  
 8 Cherry Tree Rd, Chinnor  
 Oxon OX9 4QY  
 Tel: 01844-351694 Fax: 01844-352554  
 Email: enquiries@mauritron.co.uk

A Sweep Generator

Calibrator

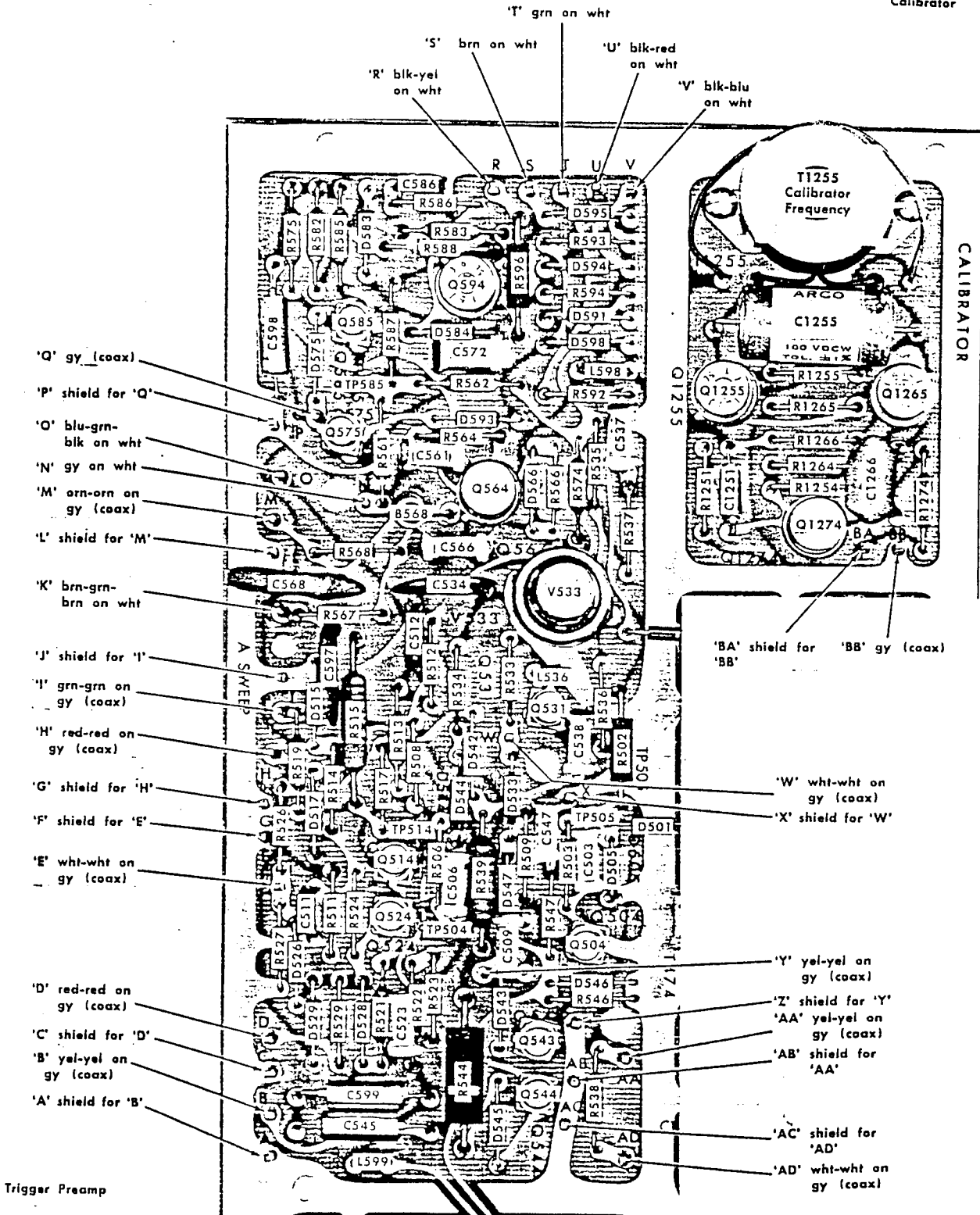

Fig. 4-7. A Sweep Generator and Calibrator etched-wiring board (partial A Sweep board).



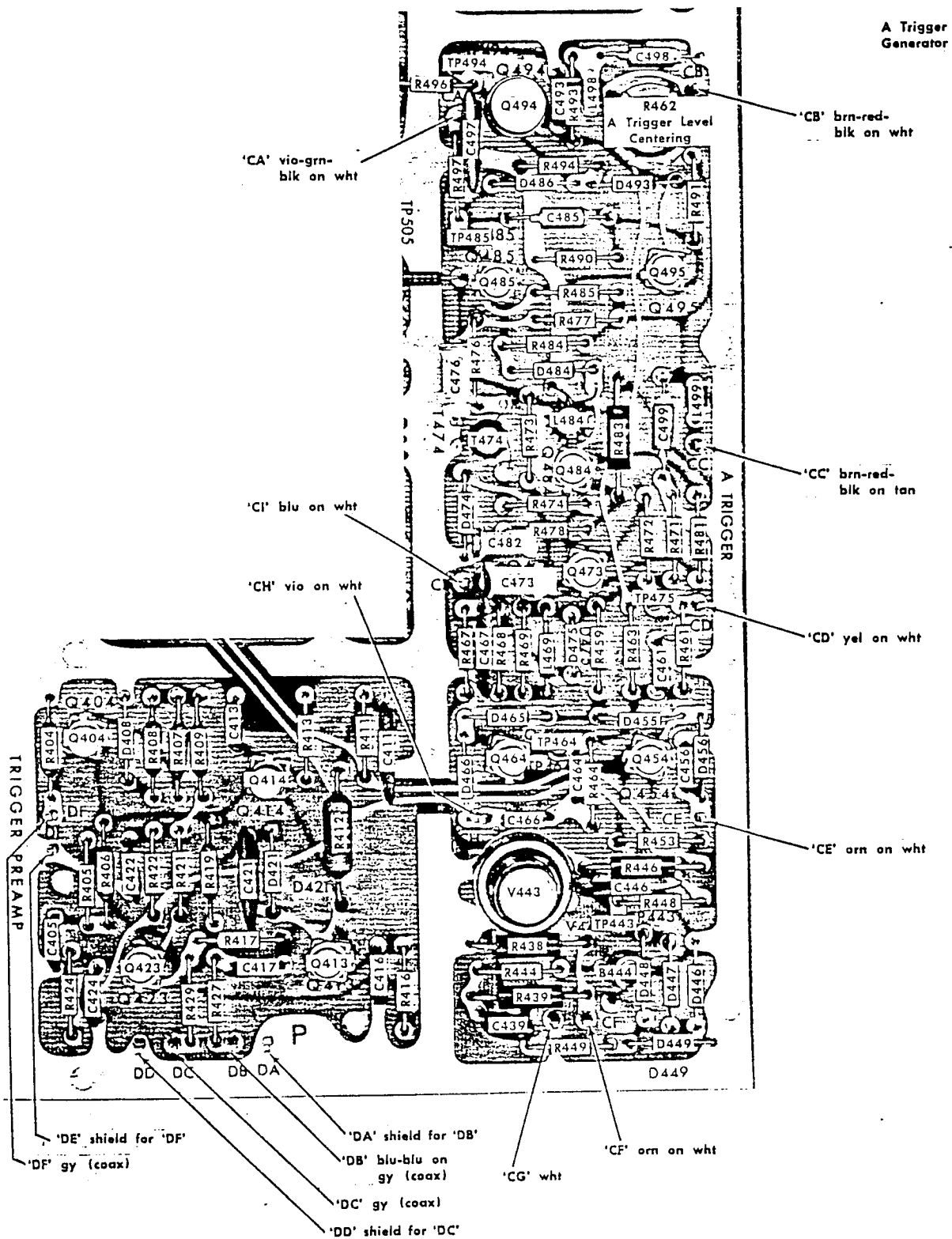
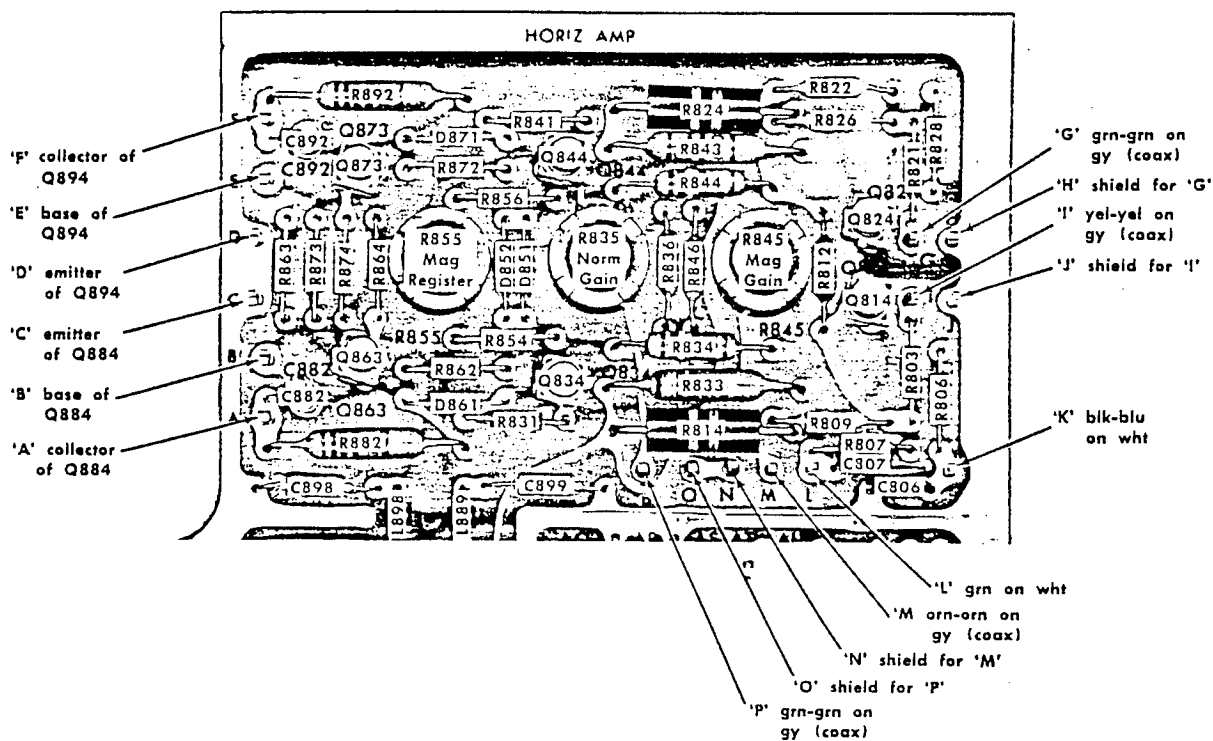

Fig. 4-8. Trigger Preamp and A Trigger Generator etched-wiring board (partial A Sweep Board).



For Service Manuals Contact  
 MAURITRON TECHNICAL SERVICES  
 8 Cherry Tree Rd, Chinnor  
 Oxon OX9 4QY  
 Tel: 01844-351694 Fax: 01844-352554  
 Email: enquiries@mauritron.co.uk

Fig. 4-9. Horizontal amplifier etched-wiring board (partial B Sweep board).

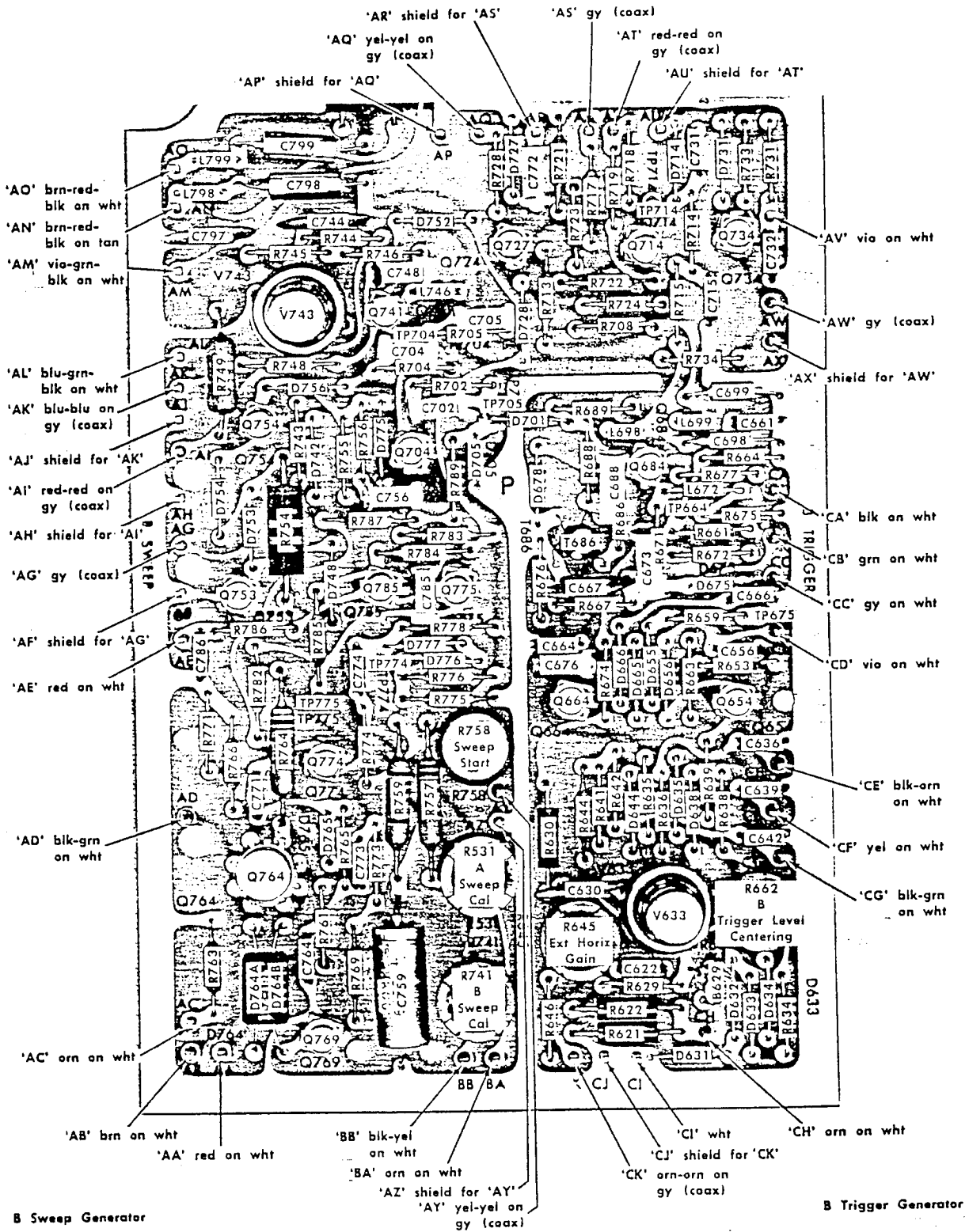
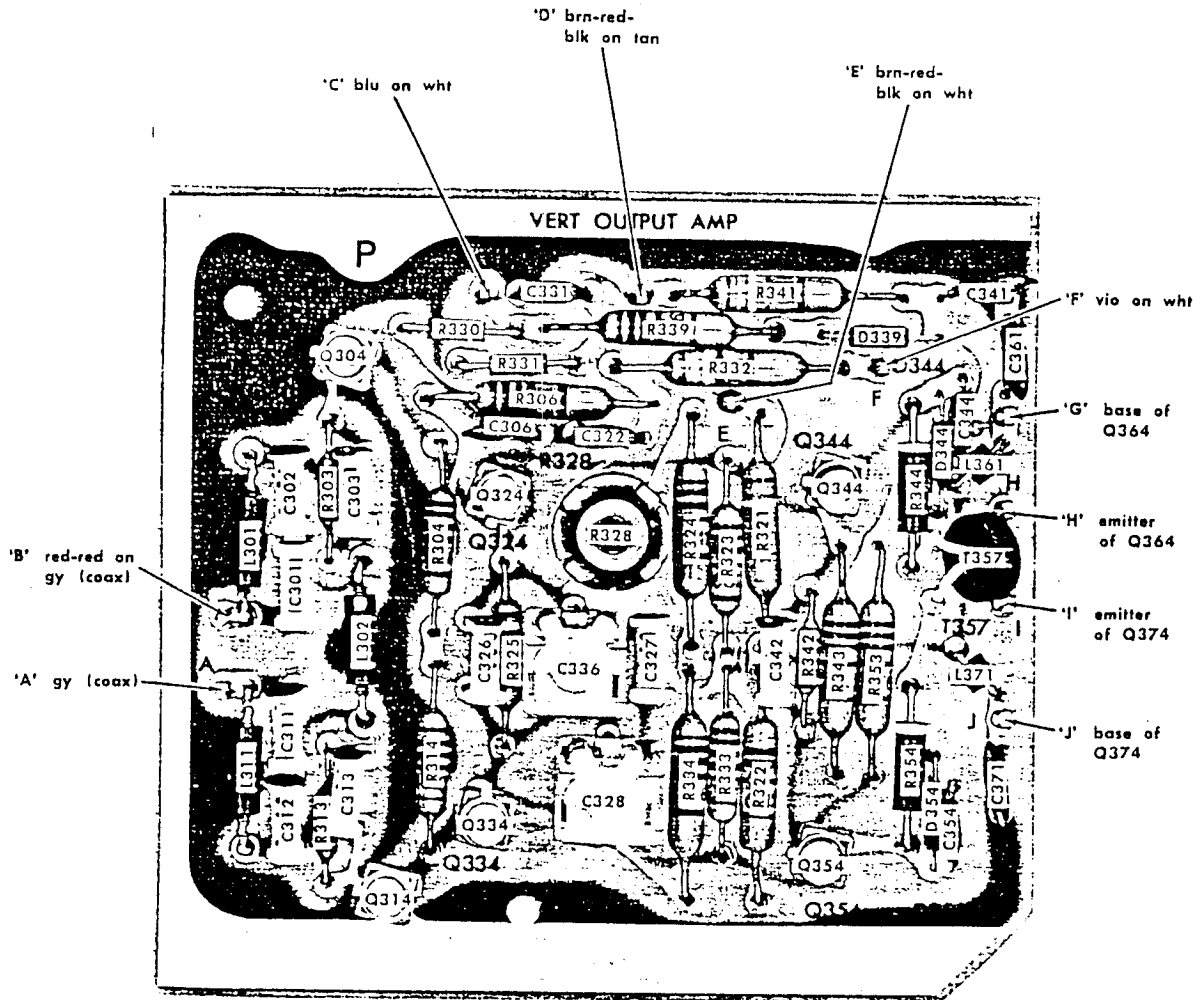

Fig. 4-10. B Trigger Generator and B Sweep Generator etched-wiring board (partial B Sweep board).



For Service Manuals Contact  
**MAURITRON TECHNICAL SERVICES**  
 8 Cherry Tree Rd, Chinnor  
 Oxon OX9 4QY  
 Tel:- 01844-351694 Fax:- 01844-352554  
 Email:- enquiries@mauritron.co.uk

Fig. 4-11. Vertical Output Amplifier etched-wiring board.

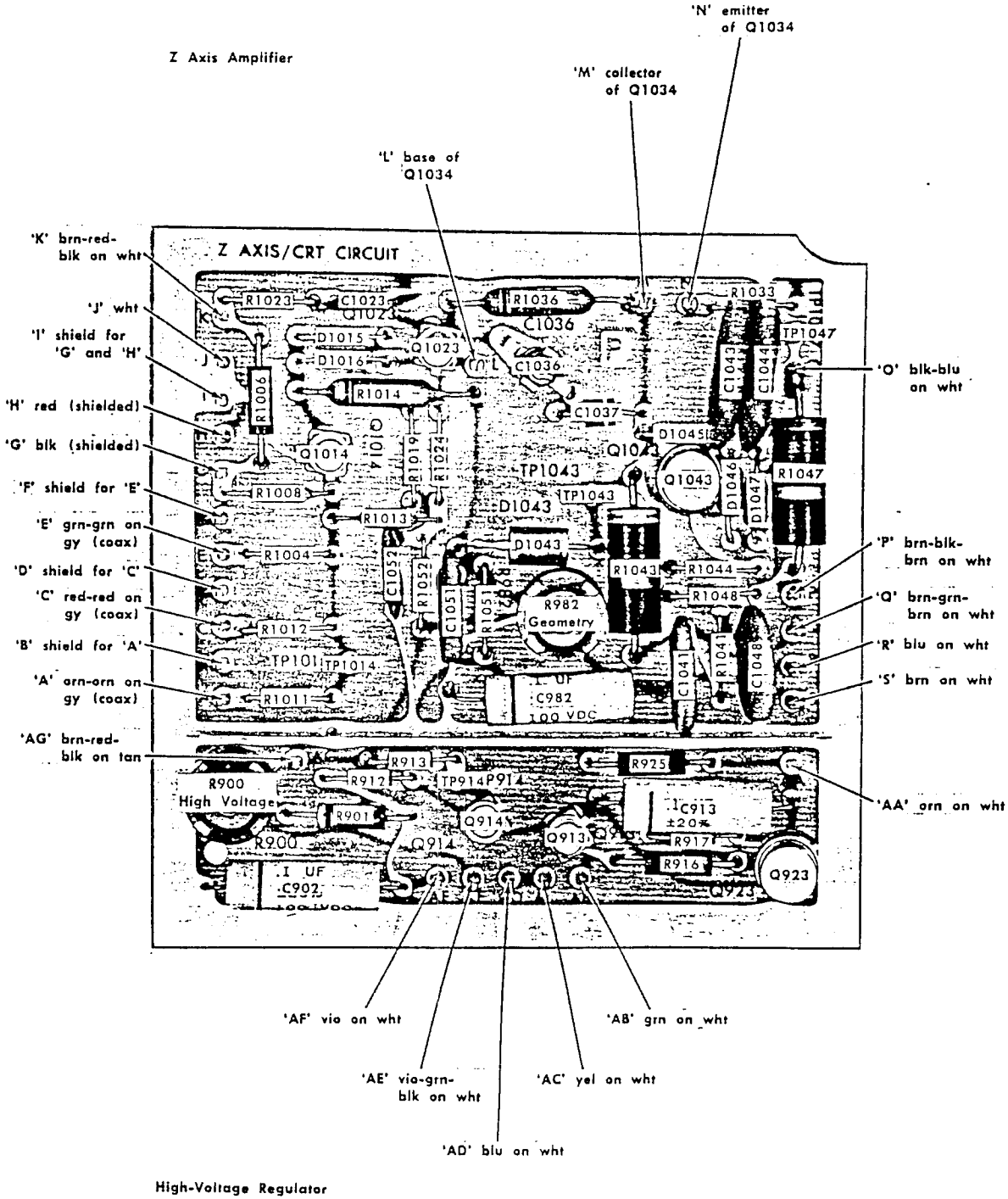

Fig. 4-12. Z Axis Amplifier and High-Voltage Regulator etched-wiring board.

For Service Manuals Contact  
MAURITRON TECHNICAL SERVICES  
8 Cherry Tree Rd, Chinnor  
Oxon OX9 4QY  
Tel: 01844-351694 Fax: 01844-352554  
Email: enquiries@mauritron.co.uk

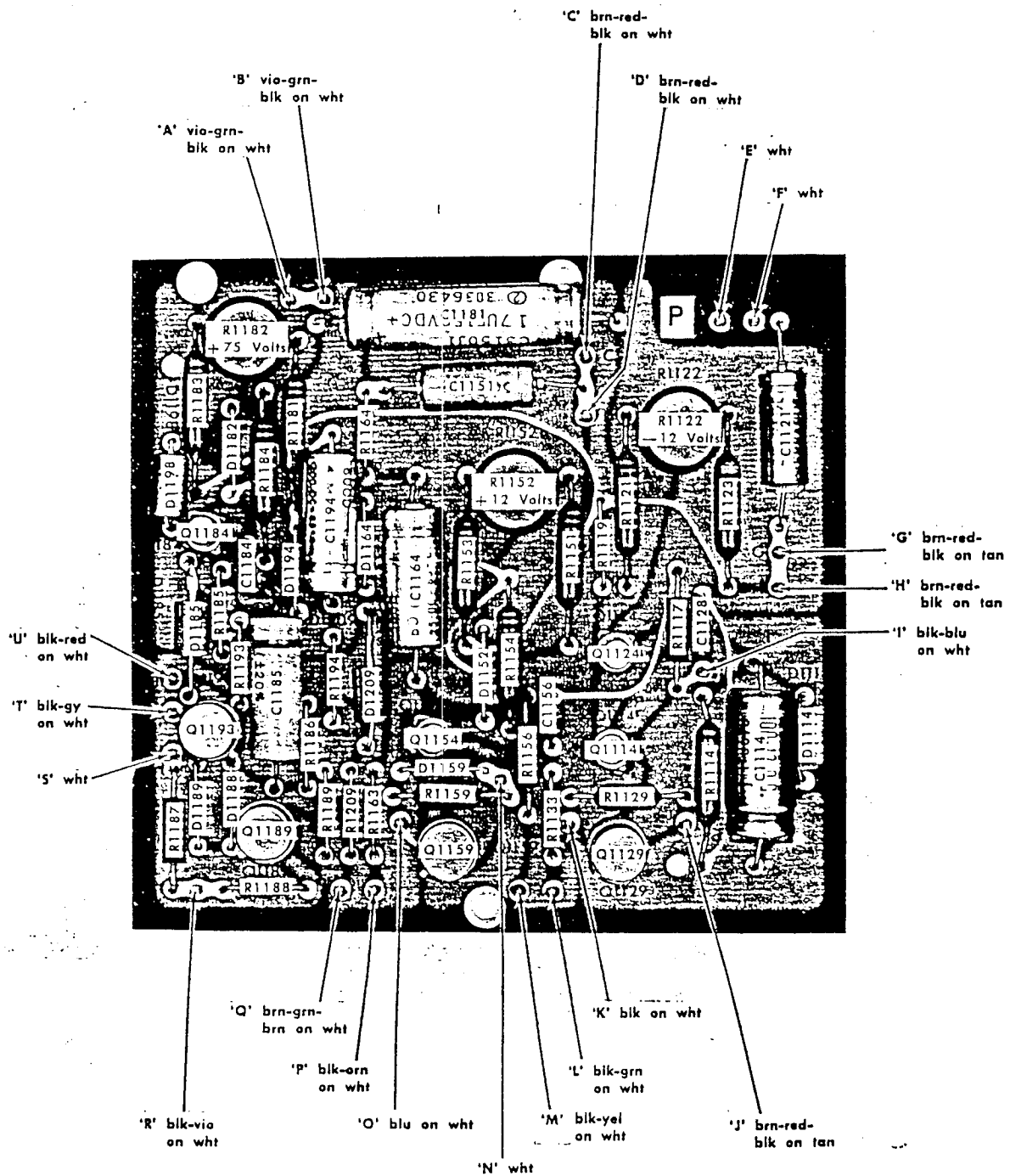

Fig. 4-13. Low Voltage Regulator etched-wiring board.

# SECTION 5

## PERFORMANCE CHECK

### Introduction

This performance check procedure is provided to check the operation of the Type 453 without removing the top or bottom covers. This procedure may be used for incoming inspection, instrument familiarization, reliability testing, calibration verification, etc.

Failure to meet the characteristics given in this procedure indicates that the instrument requires internal checks and/or adjustments. See the Calibration section of the Instruction Manual.

### Recommended Equipment

The following equipment is recommended for a complete performance check. Specifications given are the minimum necessary to perform this procedure. All equipment is assumed to be calibrated and operating within the original specifications. If equipment is substituted, it must meet or exceed the specifications of the recommended equipment.

For the most accurate and convenient performance check, special calibration fixtures are used in this procedure. These calibration fixtures are available from Tektronix, Inc. Order by part number through your local Tektronix Field Office or representative.

1. Time-mark generator. Marker outputs, 5 second to 1 microsecond; sine-wave output, 5 and 10 Mc; accuracy, 0.001%. Tektronix Type 180A Time-Mark Generator recommended.
2. Standard amplitude calibrator. Amplitude accuracy, 0.25%; signal amplitude, 5 millivolts to 50 volts; output signal, 1 kc, —DC and +DC; must have mixed display feature. Tektronix calibration fixture 067-0502-00 recommended.
3. Square-wave generator. Frequency, 1 kc and 100 kc; risetime, 20 nanoseconds maximum; output amplitude, about 8 volts into 50 ohms. Tektronix Type 105 Square-Wave Generator recommended.
4. Constant amplitude sine-wave generator. Frequency, 50 kc and 350 kc to above 52.5 Mc; output amplitude, 6 volts; amplitude accuracy,  $\pm 3\%$  from 50 kc to above 52.5 Mc. Tektronix calibration fixture 067-0506-00 recommended.
5. Test oscilloscope. Bandpass, dc to 300 kc; minimum deflection factor, 10 millivolts/division differential. Tektronix Type 540-Series oscilloscope with Type D Plug-in Unit recommended.
6. Tunnel-diode pulser. Output amplitude, 200 millivolts into 50 ohms; connectors, BNC. Tektronix TU-5 Pulser, Part No. 015-0038-00.
7. Adapter, TU-5/105. Allows TU-5 Pulser to be used with Type 105 Square-Wave Generator. Tektronix Part No. 013-0075-00.
8. Termination (two). Impedance, 50 ohm; accuracy,  $\pm 3\%$ ; connectors, BNC. Tektronix Part No. 011-0049-00.

9. 2X Attenuator. Impedance, 50 ohm; accuracy  $\pm 3\%$ ; connectors, BNC. Tektronix Part No. 011-0069-00.

10. 2.5X Attenuator. Impedance, 50 ohm; accuracy  $\pm 3\%$ ; connectors, BNC. Tektronix Part No. 011-0076-00.

11. 5X Attenuator. Impedance, 50-ohm; accuracy,  $\pm 3\%$ ; connectors, BNC. Tektronix Part No. 011-0060-00.

12. 10X Attenuator (two). Impedance, 50 ohm; accuracy,  $\pm 3\%$ ; connectors, BNC. Tektronix Part No. 011-0059-00.

13. Input rc standardizer. Time constant, 1 megohm X 20 pf; attenuation, 2X; connectors, BNC. Tektronix Part No. 011-0066-00.

14. BNC T connector. Tektronix Part No. 103-0030-00.

15. Adapter. Connectors, GR to BNC jack. Tektronix Part No. 017-0063-00.

16. Adapter. Connectors, BNC jack to BNC jack. Tektronix Part No. 103-0028-00.

17. Cable (two). Impedance, 50 ohm; type, RG58/AU; length, 42 inch; connectors, BNC. Tektronix Part No. 012-0057-00.

18. Cable (three). Impedance, 50 ohm; type, RG58/AU; length, 18 inch; connectors, BNC. Tektronix Part No. 012-0076-00.

19. 10X Probe with BNC connector. Tektronix P6010 recommended.

20. Adapter. Connectors, BNC jack to alligator clips. Tektronix Part No. 013-0076-00.

21. Dual-input coupler. Matched signal transfer to each input. Tektronix Part No. 067-0525-00.

### PERFORMANCE CHECK PROCEDURE

#### General

In the following procedure, test equipment connection or control settings should not be changed except as noted. If only a partial check is desired, refer to the preceding step(s) for setup information.

The following procedure uses the equipment listed under 'Recommended Equipment'. If substitute equipment is used, control settings or setup must be altered to meet the requirements of the equipment used.

#### Preliminary Procedure

1. Connect the Type 453 to a line voltage within the regulating range of the power supplies.
2. Set the Type 453 controls as follows:

## Performance Check—Type 453

### Crt controls

INTENSITY	Counterclockwise
FOCUS	Adjust for focused display
SCALE ILLUM	As desired

### Vertical controls (both channels if applicable)

VOLTS/DIV	20 mV
VARIABLE	CAL
POSITION	Midrange
AC GND DC	DC
MODE	CH 1
TRIGGER	NORM
INVERT	Pushed in

### Triggering controls (both A and B if applicable)

LEVEL	0
SLOPE	+
COUPLING	AC
SOURCE	INT

### Sweep controls

DELAY-TIME MULTIPLIER	0.50
A TIME/DIV	1 mSEC
B TIME/DIV	1 mSEC
A VARIABLE	CAL
A SWEEP MODE	AUTO TRIG
B SWEEP MODE	B TRIGGERABLE AFTER DELAY TIME
HORIZ DISPLAY	A
MAG	OFF
A SWEEP LENGTH	FULL
POSITION	Midrange
POWER	OFF

### Side-panel controls

B TIME/DIV VARIABLE CALIBRATOR
-----------------------------------

For Service Manuals Contact  
MAURITRON TECHNICAL SERVICES  
8 Cherry Tree Rd, Chinnor  
Oxon OX9 4QY  
Tel: 01844-351694 Fax: 01844-352554  
Email: enquiries@mauritron.co.uk

### Rear-panel controls

LINE VOLTAGE RANGE	HIGH*
--------------------	-------

3. Set the POWER switch to ON. Allow at least 20 minutes warm up at 25° C, ±5°, for checking the instrument to the given accuracy.

## 1. Check Crt Grid Bias

- Requirement—Spot must be visible at maximum intensity when sweep is inoperative.
- Set the INTENSITY control so the trace is visible.
- Position the start of the trace near the center of the graticule with the Horizontal POSITION control.

\* If line voltage is below 103 volts, set to LOW.

- Set the A SWEEP MODE switch to NORM TRIG.
- Set the INTENSITY control fully clockwise.
- Check—Spot visible near center screen.

## 2. Check Trace Rotation

- Requirement—Trace parallel to horizontal graticule lines.
- Change the following control settings:

INTENSITY	Midrange
A SWEEP MODE	AUTO TRIG
Horizontal POSITION	Midrange
- Position the trace to the horizontal centerline with the Channel 1 POSITION control.
- Check—Trace parallel to horizontal graticule lines.
- If necessary, adjust the TRACE ROTATION adjustment so trace is parallel to the horizontal graticule lines.

## 3. Check Z Axis Compensation

- Requirement—Equal intensity over entire trace.
- Set the TIME/DIV switch to .1 μSEC.
- Set the INTENSITY control for a low-intensity trace.
- Check—Display intensity equal over entire trace length.

## 4. Check Astigmatism

- Requirement—Sharp, well-defined display.
- Connect the time-mark generator to Channel 1 INPUT with a 42-inch 50-ohm cable.
- Set the time-mark generator for 1-millisecond and 100-microsecond markers.
- Set the TIME/DIV switch to 1 mSEC.
- Set the CH 1 VOLTS/DIV switch so the markers extend from the bottom to the top of the graticule area.
- Set the A Triggering LEVEL control for a stable display.
- Check—Well-defined markers with optimum setting of FOCUS control.
- If necessary, adjust ASTIGMATISM adjustment for a well-defined display.

## 5. Check Y Axis Alignment and Geometry

- Requirement—Linearity and alignment of markers with the vertical graticule lines within 0.15 division.
- Check—Bowing and tilt of markers over entire display area not to exceed 0.15 division (see Fig. 5-1).
- Disconnect all test equipment.



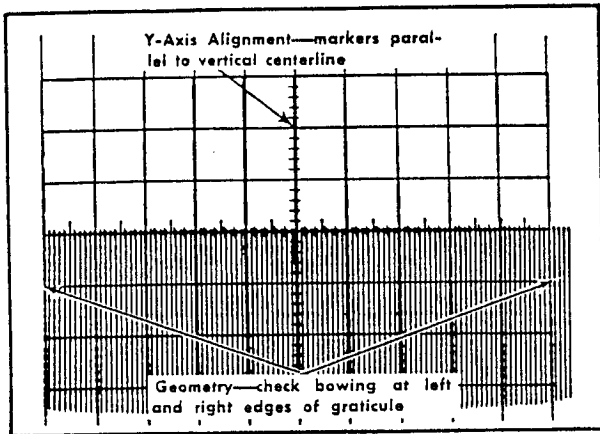

Fig. 5-1. Typical crt display showing good geometry and y axis alignment.

### 6. Check Channel 1 and 2 Step Attenuator Balance

- a. Requirement—No trace shift as VOLTS/DIV switch is changed from 20 mV to 5 mV.
- b. Set the CH 1 VOLTS/DIV switch to 20 mV.
- c. Position the trace to the graticule centerline with the Channel 1 POSITION control.
- d. Check—Change the CH 1 VOLTS/DIV switch from 20 mV to 5 mV and check for trace shift.
- e. If there is trace shift, adjust Channel 1 STEP ATTEN BAL adjustment for no trace shift as the CH 1 VOLTS/DIV switch is changed from 20 mV to 5 mV.
- f. Set the MODE switch to CH 2.
- g. Position the trace to the graticule centerline with the Channel 2 POSITION control.
- h. Check—Change the CH 2 VOLTS/DIV switch from 20 mV to 5 mV and check for trace shift.
- i. If there is trace shift, adjust Channel 2 STEP ATTEN BAL adjustment for no trace shift as the CH 2 VOLTS/DIV switch is changed from 20 mV to 5 mV.

### 7. Check Channel 1 and 2 Position Center

- a. Requirement—Trace within  $\pm 3$  divisions of graticule center with POSITION control centered.
- b. Set the Channel 2 POSITION control to the center of rotation (dot straight up).
- c. Check—Trace should be within  $\pm 3$  divisions of the horizontal centerline.
- d. Set the MODE switch to CH 1.
- e. Set the Channel 1 POSITION control to the center of rotation.
- f. Check—Trace should be within  $\pm 3$  divisions of the horizontal centerline.

### 8. Check Channel 1 and 2 Gain Adjustment

- a. Requirement—Vertical deflection within  $\pm 3\%$  of VOLTS/DIV switch indication.
- b. Connect the standard amplitude calibrator to both Channel 1 and 2 INPUT connectors using a BNC T connector and two 42-inch 50-ohm cables.
- c. Set the standard amplitude calibrator for a 0.1-volt square-wave output.
- d. Set both VOLTS/DIV switches to 20 mV.
- e. Check—Crt display for exactly five divisions of deflection (see Fig. 5-2).

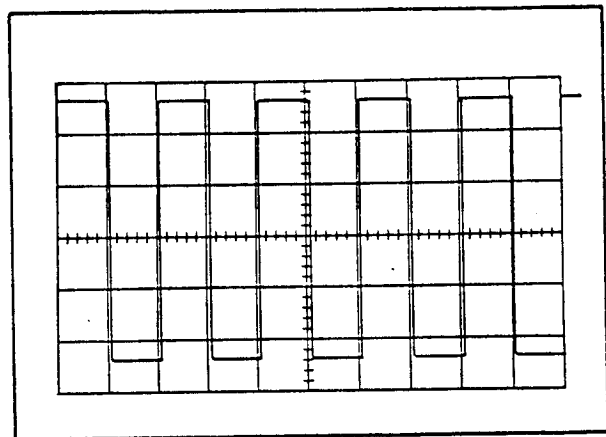

Fig. 5-2. Typical crt display showing correct vertical gain.

- f. If necessary, adjust Channel 1 GAIN adjustment for exactly five divisions of deflection.
- g. Set the MODE switch to ADD.
- h. Pull the INVERT switch out.
- i. Check—Crt display for straight line indicating identical gain for both channels.
- j. If necessary, adjust Channel 2 GAIN adjustment for straight line.

### 9. Check Added Mode Operation

- a. Requirement—Signal addition.
- b. Set standard amplitude calibrator for 50-millivolt square-wave output.
- c. Push the INVERT switch in.
- d. Check—Crt display 5 divisions in amplitude (see Fig. 5-2).

### 10. Check Channel 1 and 2 Variable Control Range

- a. Requirement—At least 2.5:1 reduction in deflection when fully counterclockwise.

**Performance Check—Type 453**

- b. Set standard amplitude calibrator for a 0.1-volt square-wave output.
- c. Set the MODE switch to CH 1.
- d. Turn the Channel 1 VARIABLE VOLTS/DIV control fully counterclockwise.
- e. Check—Maximum deflection of 2 divisions (2.5:1 range). See Fig. 5-3. UNCAL light must be on when VARIABLE control is not in CAL position.
- f. Set the MODE switch to CH 2.
- g. Turn the Channel 2 VARIABLE VOLTS/DIV control fully counterclockwise.
- h. Check—Maximum deflection of 2 divisions (2.5:1 range). See Fig. 5-3. UNCAL light must be on when VARIABLE control is not in CAL position.

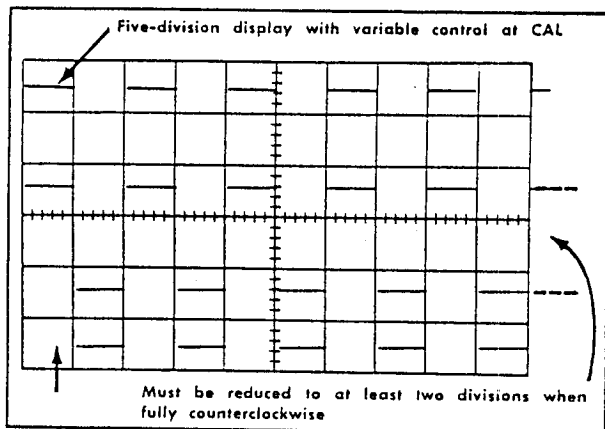

Fig. 5-3. Typical crt display showing correct VARIABLE VOLTS/DIV control range (double exposure).

**11. Check Channel 1 and 2 Deflection Accuracy**

- a. Requirement—Vertical deflection within  $\pm 3\%$  of VOLTS/DIV switch indication.
- b. Set both VARIABLE VOLTS/DIV controls to CAL.
- c. Set the Channel 1 AC GND DC switch to GND.
- d. Check—Using Table 5-1, check vertical deflection within  $\pm 3\%$  in each position of Channel 2 VOLTS/DIV switch.
- e. Set MODE switch to CH 1.
- f. Set the Channel 1 AC GND DC switch to DC and the Channel 2 AC GND DC switch to GND.
- g. Check—Using Table 5-1, check vertical deflection within  $\pm 3\%$  in each position of Channel 1 VOLTS/DIV switch.

**12. Check Vertical Linearity**

- a. Requirement—Less than 0.15 division compression or expansion at extremes of display area.

**TABLE 5-1**

VOLTS/DIV Switch Setting	Standard Amplitude Calibrator Output	Vertical Deflection In Divisions	Maximum Error For 3% Accuracy (divisions)
5mV	20 millivolts	4	$\pm 0.12$
10 mV	50 millivolts	5	$\pm 0.15$
20 mV	0.1 volt	5	Set exactly
50 mV	0.2 volt	4	$\pm 0.12$
.1	0.5 volt	5	$\pm 0.15$
.2	1 volt	5	$\pm 0.15$
.5	2 volts	4	$\pm 0.12$
1	5 volts	5	$\pm 0.15$
2	10 volts	5	$\pm 0.15$
5	20 volts	4	$\pm 0.12$
10	50 volts	5	$\pm 0.15$

- b. Set both VOLTS/DIV switches to 20 mV.
- c. Set the standard amplitude calibrator for a 50-millivolt square-wave output.
- d. Adjust the Channel 1 VARIABLE VOLTS/DIV control for exactly two divisions of deflection, positioned to graticule center.
- e. Position top of display to the top graticule line.
- f. Check—Compression or expansion less than 0.15 division (see Fig. 5-4).
- g. Position bottom of display to bottom graticule line.
- h. Check—Compression or expansion less than 0.15 division (see Fig. 5-4).
- i. Set MODE switch to CH 2.
- j. Set the Channel 2 AC GND DC switch to DC.
- k. Adjust the Channel 2 VARIABLE VOLTS/DIV control for exactly two divisions of deflection, positioned to graticule center.
- l. Position top of display to the top graticule line.
- m. Check—Compression or expansion less than 0.15 division (see Fig. 5-4).
- n. Position bottom of display to bottom graticule line.
- o. Check—Compression or expansion less than 0.15 division (see Fig. 5-4).

**13. Check Channel 1 and 2 AC GND DC Switch Operation**

- a. Requirement—Correct signal coupling in each position.
- b. Return both VARIABLE VOLTS/DIV switches to CAL.
- c. Position display so bottom of the square wave is at the graticule centerline.
- d. Set the Channel 2 AC GND DC switch to AC.

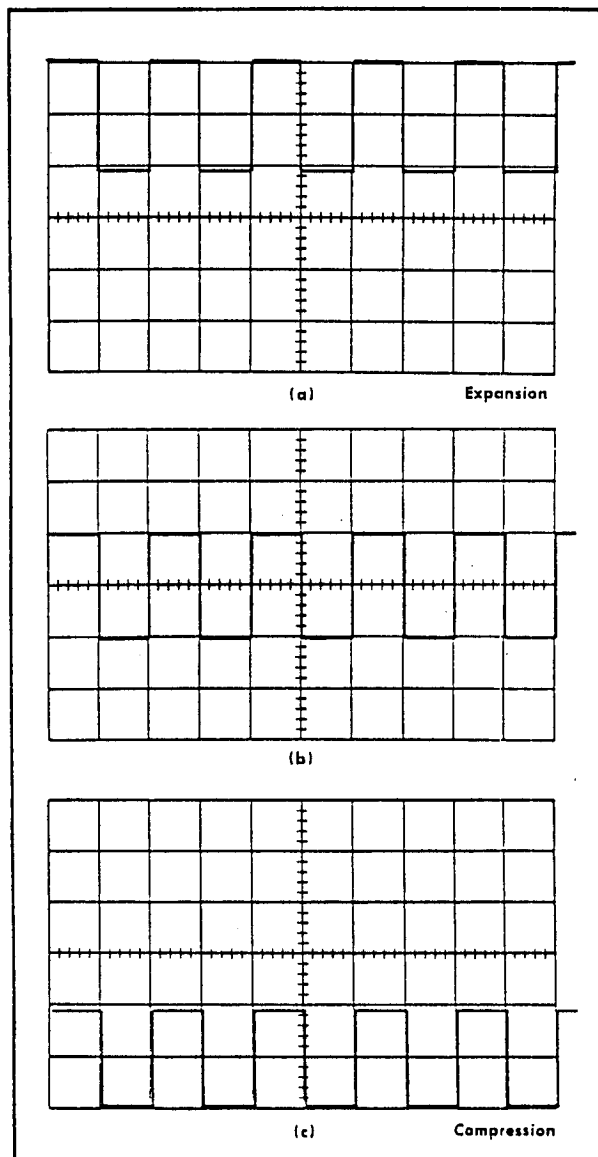

Fig. 5-4. Typical crt display showing acceptable compression and expansion. Waveform (a) shows expansion; waveform (c) shows compression.

- e. Check—Crt display should be centered about centerline.
- f. Set the Channel 2 AC GND DC switch to GND.
- g. Check—Crt display should be a straight line near the graticule centerline.
- h. Set the MODE switch to CH 1.
- i. Position display so bottom of the square wave is at the graticule centerline.
- j. Set the Channel 1 AC GND DC switch to AC.
- k. Check—Crt display should be centered about centerline.

- l. Set the Channel 1 AC GND DC switch to GND.
- m. Check—Crt display should be a straight line near the graticule centerline.
- n. Disconnect all test equipment.

#### 14. Check Channel 1 Output Operation

- a. Requirement—Deflection factor less than 1 millivolt/division when cascaded with Channel 2.
- b. Set both AC GND DC switches to DC.
- c. Set both VOLTS/DIV switches to 5 mV.
- d. Connect the standard amplitude calibrator signal to Channel 1 INPUT with a 42-inch 50-ohm cable.
- e. Set the standard amplitude calibrator for a 5-millivolt square-wave output.
- f. Connect the CH 1 OUT connector to Channel 2 INPUT with an 18-inch 50-ohm cable.
- g. Set the MODE switch to CH 2.
- h. Check—Deflection greater than 5 divisions in amplitude (less than 1 millivolt/division deflection factor).

#### 15. Check External Horizontal Gain

- a. Requirement—Horizontal deflection within  $\pm 5\%$  of Channel 1 VOLTS/DIV switch indication.
- b. Set the standard amplitude calibrator for a 0.1-volt square-wave output.
- c. Change the following control settings:
 

VOLTS/DIV	20 mV
MODE	CH 1
TRIGGER	CH 1 ONLY
B Triggering COUPLING	DC
HORIZ DISPLAY	EXT HORIZ
- d. Increase the INTENSITY control setting so the display is visible.
- e. Check—Crt display 5 divisions horizontally (see Fig. 5-5),  $\pm 0.25$  divisions ( $\pm 5\%$ ).
- f. Disconnect all test equipment.

#### 16. Check Trace Shift Due to Input Grid Current

- a. Requirement—Trace shift due to input grid current not to exceed 0.4 division at 5 mV.
- b. Return the INTENSITY control to normal.
- c. Change the following control settings:
 

VOLTS/DIV	5 mV
TRIGGER	NORM
B Triggering COUPLING	DC
HORIZ DISPLAY	A

For Service Manuals Contact  
**MAURITRON TECHNICAL SERVICES**  
 8 Cherry Tree Rd, Chinnor  
 Oxon OX9 4QY  
 Tel:- 01844-351694 Fax:- 01844-352554  
 Email:- enquiries@mauriton.co.uk

### Performance Check—Type 453

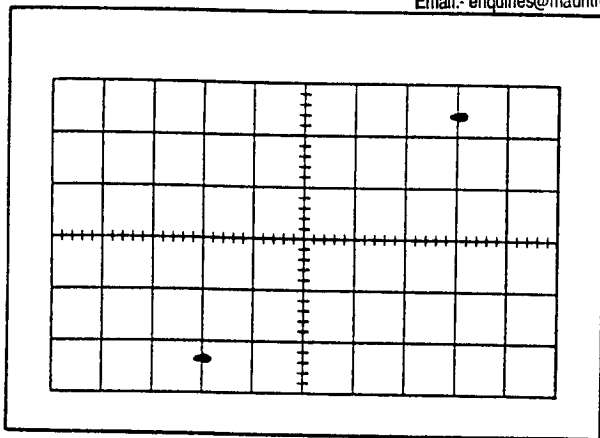

Fig. 5-5. Typical crt display showing correct external horizontal gain.

- d. Position the trace to the graticule centerline.
- e. Change the Channel 1 AC GND DC switch from DC to GND.
- f. Check—Trace shift not to exceed 0.4 division.
- g. Set the MODE switch to CH 2.
- h. Position the trace to the graticule centerline.
- i. Change the Channel 2 AC GND DC switch from DC to GND.
- j. Check—Trace shift not to exceed 0.4 division.

### 17. Check Alternate Mode Operation

- a. Requirement—Trace alternation at all sweep rates.
- b. Set the MODE switch to ALT.
- c. Position the traces about 2 divisions apart.
- d. Turn the TIME/DIV switch throughout its range.
- e. Check—The display should alternate between traces at all positions of the TIME/DIV switch. At faster sweep rates, alternation will not be apparent; display will appear as two traces on the screen.

### 18. Check Chopped Mode Operation

- a. Requirement—Chopped repetition rate, 500 kc,  $\pm 20\%$ . Blanking of switching transients.
- b. Set the MODE switch to CHOP.
- c. Set the TIME/DIV switch to  $.5 \mu\text{SEC}$ .
- d. Adjust the A Triggering LEVEL control to produce a stable display.
- e. Check—Duration of one complete cycle between 3.4 and 5 divisions ( $500 \text{ kc}$ ,  $\pm 20\%$ ).
- f. Check—Switching transients between segments completely blanked.

### 19. Check Channel 1 and 2 Volts/Division Compensation

- a. Requirement—Optimum square-wave response with minimum rolloff, overshoot or tilt.
- b. Change the following control settings:
 

VOLTS/DIV	20 mV
MODE	CH 1
AC GND DC	DC
TIME/DIV	.2 mSEC
- c. Connect the square-wave generator to Channel 1 INPUT through a 42-inch 50-ohm cable, 10X attenuator, 50-ohm termination and 20-pf input rc standardizer, in given order.

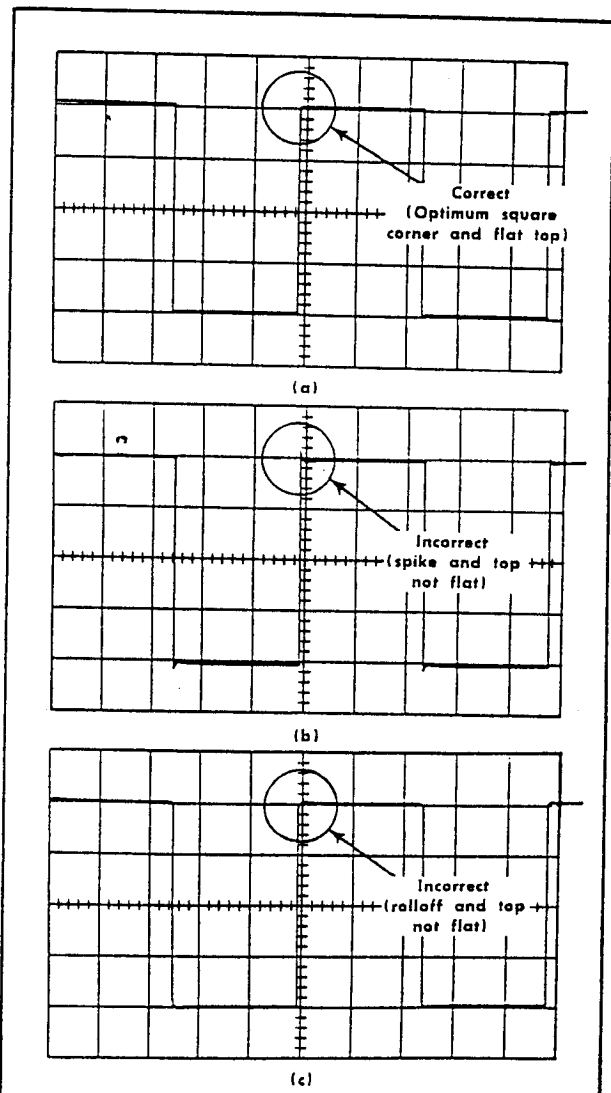

Fig. 5-6. (a) Typical crt display showing correct VOLTS/DIV switch compensation; (b) and (c) incorrect compensation.

- d. Set the square-wave generator for 4 divisions of 1-kc signal.
- e. Check—Top of square wave for minimum rolloff, overshoot or tilt (see Fig. 5-6). Repeat check at each CH 1 VOLTS/DIV switch position between 20 mV and 2 volts. Adjust the square-wave generator output or remove attenuation as needed to maintain 4-division display.
- f. Set the MODE switch to CH 2.
- g. Connect the square-wave generator to Channel 2 INPUT as in step c.
- h. Set the square-wave generator for 4 divisions of 1-kc signal.
- i. Check—Top of square wave for minimum rolloff, overshoot or tilt (see Fig. 5-6). Repeat check at each CH 2 VOLTS/DIV switch position between 20 mV and 2 volts. Adjust the square-wave generator output or remove attenuation as needed to maintain a 4-division display.

## 20. Check High-Frequency Compensation

- a. Requirement—Optimum square-wave response at high frequency.
- b. Change the following control settings:
- |           |              |
|-----------|--------------|
| VOLTS/DIV | 20 mV        |
| TIME/DIV  | .2 $\mu$ SEC |
| MAG       | $\times 10$  |
- c. Connect the square-wave generator to Channel 2 INPUT through the TU5/105 adapter, 42-inch 50-ohm cable, TU-5 Pulser, 2.5 $\times$  attenuator and a 50-ohm termination, in given order.
- d. Set the square-wave generator output frequency to 100 kc. Adjust the output amplitude and the TU-5 bias control to produce a pulse.
- e. Turn the Horizontal POSITION control so the rising portion of the pulse is displayed.
- f. Check—Crt display for optimum square-wave response (see Fig. 5-7).

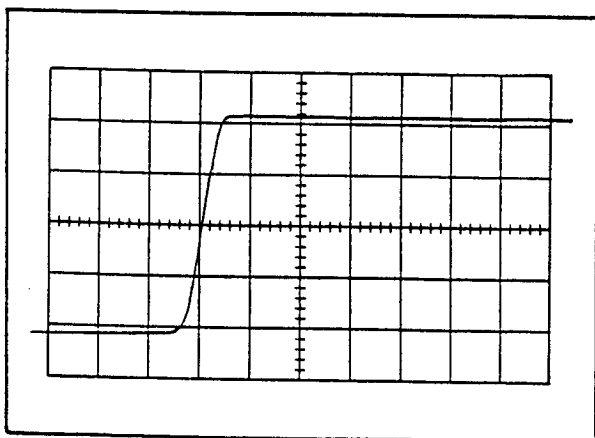

Fig. 5-7. Typical crt display showing correct high-frequency compensation.

- g. Set the CH 2 VOLTS/DIV switch to 10 mV.
- h. Replace the 2.5 $\times$  attenuator with a 5 $\times$  attenuator.
- i. Check—Crt display for optimum square-wave response (see Fig. 5-7).
- j. Set the CH 2 VOLTS/DIV switch to 5 mV.
- k. Replace the 5 $\times$  attenuator with a 10 $\times$  attenuator.
- l. Check—Crt display for optimum square-wave response (see Fig. 5-7).
- m. Set the MODE switch to CH 1.
- n. Connect the signal to Channel 1 INPUT as in step k.
- o. Set the CH 1 VOLTS/DIV switch to 5 mV.
- p. Check—Crt display for optimum square-wave response (see Fig. 5-7).
- q. Set the CH 1 VOLTS/DIV switch to 10 mV.
- r. Replace the 10 $\times$  attenuator with a 5 $\times$  attenuator.
- s. Check—Crt display for optimum square-wave response (see Fig. 5-7).
- t. Set the CH 1 VOLTS/DIV switch to 20 mV.
- u. Replace the 5 $\times$  attenuator with a 2.5 $\times$  attenuator.
- v. Check—Crt display for optimum square-wave response (see Fig. 5-7).

## 21. Check Vertical System Frequency Response

- a. Requirement—20 mV to 10 VOLTS/DIV, not more than 30% down at 52.5 Mc; 10 mV, not more than 30% down at 46.5 Mc; 5 mV, not more than 30% down at 41 Mc.
- b. Change the following control settings:
- |           |              |
|-----------|--------------|
| VOLTS/DIV | 20 mV        |
| TIME/DIV  | 20 $\mu$ SEC |
| MAG       | OFF          |
- c. Connect the constant-amplitude sine-wave generator to Channel 1 INPUT through the GR to BNC adapter, 18-inch 50-ohm cable, 5 $\times$  attenuator, 10 $\times$  attenuator and 50-ohm termination, in given order.
- d. Set the constant-amplitude generator for 4 divisions at 50 kc.
- e. Without changing the output amplitude, increase the output frequency until the deflection is reduced to 2.8 divisions (see Fig. 5-8).
- f. Check—Output frequency 52.5 Mc or higher. Actual response, \_\_\_\_\_ Mc.
- g. Set the CH 1 VOLTS/DIV switch to 10 mV.
- h. Replace the 5 $\times$  attenuator with a 10 $\times$  attenuator.
- i. Set the constant-amplitude generator for 4 divisions at 50 kc.
- j. Without changing the output amplitude, increase the output frequency until the deflection is reduced to 2.8 divisions (see Fig. 5-8).
- k. Check—Output frequency 46.5 Mc or higher. Actual response, \_\_\_\_\_ Mc.

**Performance Check—Type 453**

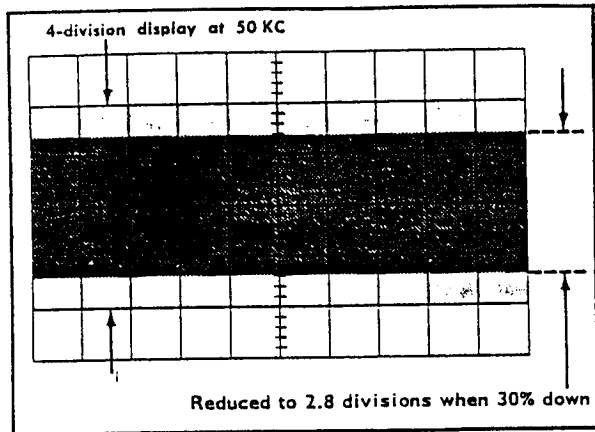

Fig. 5-8. Typical crt display when checking vertical frequency response.

- l. Set the CH 1 VOLTS/DIV switch to 5 mV.
- m. Add a 2X attenuator.
- n. Set the constant-amplitude generator for 4 divisions at 50 kc.
- o. Without changing the output amplitude, increase the output frequency until the deflection is reduced to 2.8 divisions (see Fig. 5-8).
- p. Check—Output frequency 41 Mc or higher. Actual response, \_\_\_\_\_ Mc.
- q. Set the MODE switch to CH 2.
- r. Connect the constant-amplitude generator to the Channel 2 INPUT connector as in step c.
- s. Set the constant-amplitude generator for 4 divisions at 50 kc.
- t. Without changing the output amplitude, increase the output frequency until the deflection is reduced to 2.8 divisions (see Fig. 5-8).
- u. Check—Output frequency 52.5 Mc or higher. Actual response, \_\_\_\_\_ Mc.
- v. Set the CH 2 VOLTS/DIV switch to 10 mV.
- w. Replace the 5X attenuator with a 10X attenuator.
- x. Set the constant-amplitude generator for 4 divisions at 50 kc.
- y. Without changing the output amplitude, increase the output frequency until the deflection is reduced to 2.8 divisions (see Fig. 5-8).
- z. Check—Output frequency 46.5 Mc or higher. Actual response, \_\_\_\_\_ Mc.
- aa. Set the CH 2 VOLTS/DIV switch to 5 mV.
- ab. Add a 2X attenuator.
- ac. Set the constant-amplitude generator for 4 divisions at 50 kc.

ad. Without changing the output amplitude, increase the output frequency until the deflection is reduced to 2.8 divisions (see Fig. 5-8).

ae. Check—Output frequency 41 Mc or higher. Actual response, \_\_\_\_\_ Mc.

**22. Check Channel 1 and 2 Cascaded Frequency Response**

- a. Requirement—Not more than 30% down at 25 Mc.
- b. Connect the constant-amplitude generator to Channel 1 INPUT through the GR to BNC adapter, 18-inch 50-ohm cable, 2X attenuator, 5X attenuator, 10X attenuator, 10X attenuator and 50-ohm termination, in given order.
- c. Connect the CH 1 OUT connector to the Channel 2 INPUT connector with an 18-inch 50-ohm cable.
- d. Set the constant-amplitude generator for 4 divisions at 50 kc.
- e. Without changing the output amplitude, increase the output frequency until the deflection is reduced to 2.8 divisions (see Fig. 5-8).
- f. Check—Output frequency 25 Mc or higher. Actual response, \_\_\_\_\_ Mc.

**23. Check Added Mode Frequency Response**

- a. Requirement—Not more than 30% down at 52.5 Mc.
- b. Connect the constant-amplitude generator to Channel 2 INPUT through the GR to BNC adapter, 18-inch 50-ohm cable, 5X attenuator, 10X attenuator and 50-ohm termination, in given order.
- c. Change the following control settings:
 

VOLTS/DIV	20 mV
Channel 1 AC GND DC	GND
MODE	ADD
- d. Set the constant-amplitude generator for 4 divisions at 50 kc.
- e. Without changing the output amplitude, increase the output frequency until the deflection is reduced to 2.8 divisions (see Fig. 5-8).
- f. Check—Output frequency 52.5 Mc or higher. Actual response, \_\_\_\_\_ Mc.
- g. Set the Channel 1 AC GND DC switch to DC and the Channel 2 AC GND DC switch to GND.
- h. Connect the constant-amplitude generator to Channel 1 INPUT connector as in step b.
- i. Set the constant-amplitude generator for 4 divisions at 50 kc.
- j. Without changing the output amplitude, increase the output frequency until the deflection is reduced to 2.8 divisions (see Fig. 5-8).
- k. Check—Output frequency 52.5 Mc or higher. Actual response, \_\_\_\_\_ Mc.

## 24. Check External Horizontal Frequency Response

- Requirement—Not more than 30% down at 5 Mc.
- Change the following control settings:
 

MODE	CH 2
TRIGGER	CH 1 ONLY
AC GND DC	DC
HORIZ DISPLAY	EXT HORIZ
B Triggering COUPLING	DC
- Increase the INTENSITY setting until a spot is visible.
- Connect the constant-amplitude generator to Channel 1 INPUT through the GR to BNC adapter, 18-inch-50-ohm cable, 5X attenuator, 10X attenuator and 50-ohm termination, in given order.
- Set the constant-amplitude generator for 6 divisions of horizontal deflection.
- Without changing the output amplitude, increase the output frequency until the horizontal deflection is reduced to 4.2 divisions (see Fig. 5-9).
- Check—Output frequency 5 Mc or higher. Actual response, \_\_\_\_\_ Mc.

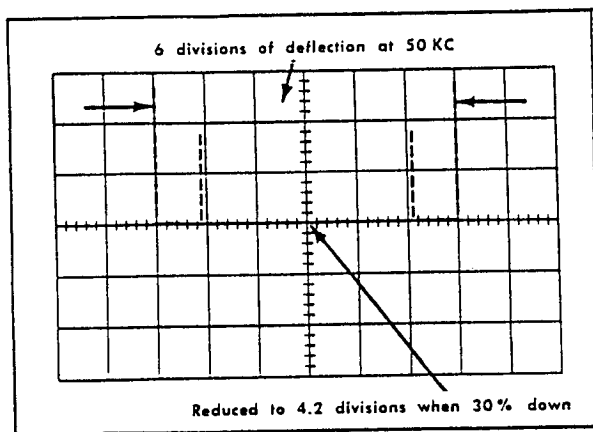

Fig. 5-9. Typical crt display when checking external horizontal frequency response.

## 25. Check Phase Shift

- Requirement—Less than 3° at 50 kc.
- Connect the constant-amplitude generator through the GR to BNC adapter, 18-inch 50-ohm cable, 2X attenuator, 2.5X attenuator, 10X attenuator, 50-ohm termination and the dual-input coupler to both INPUT connectors.
- Set the constant-amplitude generator for 4 divisions of vertical deflection at 50 kc.
- Check—Separation of displayed waveform along vertical centerline (see Fig. 5-10) not to exceed 0.2 division (3° phase shift).

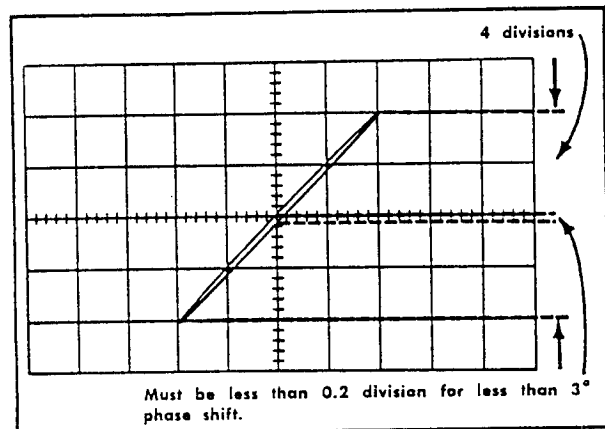

Fig. 5-10. Typical crt display when checking phase shift.

## 26. Check Common Mode Rejection Ratio

- Requirement—At least 20:1 at 20 Mc.
- Set the HORIZ DISPLAY switch to A.
- Leave the constant-amplitude generator connected as in step 25b.
- Set the constant-amplitude generator for 4 divisions at 20 Mc.
- Remove the 2X attenuator.
- Set the MODE switch to ADD.
- Pull the INVERT switch out.
- Check—Crt display less than 0.4 division (20:1 rejection).

## 27. Check Attenuator Isolation

- Requirement—Greater than 10,000:1.
- Change the following control settings:
 

CH 1 VOLTS/DIV	5 Volts
CH 2 VOLTS/DIV	5 mV
MODE	CH 1
Channel 2 AC GND DC	GND
INVERT	Pushed in
- Connect the constant-amplitude generator to Channel 1 INPUT through the GR to BNC adapter and the 18-inch 50-ohm cable.
- Set the constant-amplitude generator for 2 divisions at 20 Mc.
- Set the MODE switch to CH 2.
- Check—Crt display less than 0.2 division (10,000:1).
- Change the following control settings:
 

CH 1 VOLTS/DIV	5 mV
CH 2 VOLTS/DIV	5 Volts
MODE	CH 1

For Service Manuals Contact  
 MAURITRON TECHNICAL SERVICES  
 8 Cherry Tree Rd, Chinnor  
 Oxon OX9 4QY  
 Tel: 01844-351694 Fax: 01844-352554  
 Email: enquiries@mauritron.co.uk

### Performance Check—Type 453

Channel 1 AC GND DC GND  
 Channel 2 AC GND DC DC

h. Connect the constant-amplitude generator to Channel 2 INPUT connector as in step c.

i. Check—Crt display less than 0.2 division (10,000:1).

### 28. Check Trigger Level Centering

a. Requirement—Stable display within  $\pm 2$  divisions of graticule center with LEVEL control centered.

b. Change the following control settings:

VOLTS/DIV	20 mV
TRIGGER	NORM
AC GND DC	DC
COUPLING	DC
LEVEL	0
A SWEEP MODE	NORM TRIG

c. Connect the constant-amplitude generator to Channel 1 INPUT through the GR to BNC adapter, 18-inch 50-ohm cable, 2.5X attenuator, 5X attenuator, 10X attenuator, 10X attenuator and 50-ohm termination, in given order.

d. Set the constant-amplitude generator for a 0.2-division display at 50 kc.

e. Turn the Channel 1 POSITION control so the display is stable.

f. Check—Display within  $\pm 2$  divisions of graticule center.

g. Set the TRIGGER switch to CH 1 ONLY.

h. Turn the Channel 1 POSITION control so the display is stable.

i. Check—Display within  $\pm 2$  divisions of graticule center. CH 1 light in both A and B Triggering must be on.

j. Set the HORIZ DISPLAY switch to DELAYED SWEEP (B).

k. Turn the Channel 1 POSITION control so the display is stable.

l. Check—Display within  $\pm 2$  divisions of graticule center.

### 29. Check Internal Trigger Sensitivity

a. Requirement—Triggered display in AC, LF REJ and DC positions of the A and B Triggering COUPLING switch with 0.2-division deflection at 10 Mc and 1 division at 50 Mc.

b. Change the following control settings:

TRIGGER	NORM
TIME/DIV	.1 $\mu$ SEC
HORIZ DISPLAY	A

c. Connect the constant-amplitude generator as in step 28c.

d. Set the constant-amplitude generator for a 0.2-division display at 10 Mc.

e. Check—Stable display with A Triggering COUPLING switch set to AC, LF REJ and DC (LEVEL control may be adjusted as necessary for correct triggering). The A SWEEP TRIG'D light should be on when the display is stable.

f. Set the constant-amplitude generator for a 1-division display at 50 Mc (remove attenuation as necessary to obtain 1-division display).

g. Check—Stable display with A Triggering COUPLING switch set to AC, LF REJ and DC (LEVEL and HF STAB control may be adjusted as necessary for correct triggering).

h. Set the A SWEEP MODE switch to AUTO TRIG.

i. Set the HORIZ DISPLAY switch to DELAYED SWEEP (B).

j. Set the constant-amplitude generator for a 0.2-division display at 10 Mc (replace attenuation removed in step f).

k. Check—Stable display with B Triggering COUPLING switch set to AC, LF REJ and DC (LEVEL control may be adjusted as necessary for correct triggering).

l. Set the constant-amplitude generator for a 1-division display at 50 Mc (remove attenuation as necessary to obtain 1-division display).

m. Check—Stable display with B Triggering COUPLING switch set to AC, LF REJ and DC (LEVEL control may be adjusted as necessary for correct triggering).

### 30. Check External Trigger Sensitivity

a. Requirement—Triggered display in AC, LF REJ and DC positions of the A and B Triggering COUPLING switches with 50-millivolt input signal at 10 Mc, and 200-millivolt at 50 Mc.

b. Connect the constant-amplitude generator through the GR to BNC adapter, 18-inch 50-ohm cable, 2X attenuator, 5X attenuator, 10X attenuator, BNC to BNC adapter, BNC T connector and an 18-inch 50-ohm cable and a 50-ohm termination to both the CH 1 INPUT and the B Triggering EXT TRIG INPUT connectors, in given order.

c. Set the CH 1 VOLTS/DIV switch to 50 mV.

d. Set the constant-amplitude generator for a 1-division display (50 millivolts) at 10 Mc.

e. Set the B Triggering SOURCE switch to EXT.

f. Check—Stable display with B Triggering COUPLING switch set to AC, LF REJ and DC (LEVEL control may be adjusted as necessary for stable display).

g. Set the constant-amplitude generator for a 4-division display (200 millivolts) at 10 Mc (remove 5X attenuator).

h. Without changing the output amplitude, set the constant-amplitude generator to 50 Mc.

i. Check—Stable display with B Triggering COUPLING switch set to AC, LF REJ and DC (LEVEL control may be adjusted as necessary for stable display).

j. Change the following control settings:

HORIZ DISPLAY	A
A SWEEP MODE	NORM TRIG
SOURCE	EXT



k. Change the signal from the B Triggering EXT TRIG INPUT to the A Triggering EXT TRIG INPUT connector.

l. Set the constant-amplitude generator for a 1-division display (50 millivolts) at 10 Mc (replace 5X attenuator).

m. Check—Stable display with A Triggering COUPLING switch set to AC, LF REJ and DC (LEVEL control may be adjusted as necessary for stable display).

n. Set the constant-amplitude generator for a 4-division display (200 millivolts) at 10 Mc (remove 5X attenuator).

o. Without changing the output amplitude, set the constant-amplitude generator to 50 Mc.

p. Check—Stable display with A Triggering COUPLING switch set to AC, LF REJ and DC (LEVEL control may be adjusted as necessary for stable display).

### 31. Check High-Frequency Reject Operation

a. Requirement—Stable triggering with 0.2-division deflection at 50 kc; does not trigger at 1 Mc.

b. Change the following control settings:

VOLTS/DIV	20 mV
SOURCE	INT
COUPLING	HF REJ
TIME/DIV	5 $\mu$ SEC

c. Connect the constant-amplitude generator to Channel 1 INPUT through the GR to BNC adapter, 18-inch 50-ohm cable, 2.5X attenuator, 5X attenuator, 10X attenuator, 10X attenuator and 50-ohm termination, in given order.

d. Set the constant-amplitude generator for a 0.2-division display at 50 kc.

e. Check—Stable display (LEVEL control may be adjusted as necessary for stable display).

f. Without changing output amplitude, set the constant-amplitude generator to 1 Mc.

g. Check—Display not triggered at any setting of the A Triggering LEVEL control.

h. Change the following control settings:

HORIZ DISPLAY	DELAYED SWEEP (B)
A SWEEP MODE	AUTO TRIG
A Triggering COUPLING	AC

i. Set the constant-amplitude generator for a 0.2-division display at 50 kc.

j. Check—Stable display (LEVEL control may be adjusted as necessary for stable display).

k. Without changing output amplitude, set the constant-amplitude generator to 1 Mc.

l. Check—Display not triggered at any setting of B Triggering LEVEL control.

### 32. Check Single Sweep Operation

a. Requirement—Sweep triggers with same A Triggering LEVEL control setting as in AUTO TRIG; sweep locks out until reset.

b. Leave the constant-amplitude generator connected as in step 31c.

c. Set the constant-amplitude generator for a 0.2-division display at 50 kc.

d. Set the HORIZ DISPLAY switch to A.

e. Set the TIME/DIV switch to 20  $\mu$ SEC.

f. Adjust the A Triggering LEVEL control for a stable display.

g. Disconnect the signal.

h. Set the A SWEEP MODE switch to SINGLE SWEEP.

i. Push the RESET button.

j. Check—RESET light comes on when button is pressed and remains on until signal is reapplied.

k. Reconnect the signal to Channel 1 INPUT connector.

l. Check—A single, stable display should be presented. RESET light must go off and remain off until the RESET button is pressed again.

m. Disconnect all test equipment.

### 33. Check Line Triggering, Slope Switch Operation and Low-Frequency Reject Operation

a. Requirement—Line triggering, must produce stable display of correct polarity; Slope, changes display polarity when switched; Low-frequency reject operation, does not trigger at line frequency.

b. Connect the 10X probe to Channel 1 INPUT connector.

c. Change the following control settings:

VOLTS/DIV	10 Volts
TIME/DIV	2 mSEC
SOURCE	LINE
A SWEEP MODE	NORM TRIG

d. Connect the probe tip to a line-voltage source.

e. Check—Stable display starts on positive slope (see Fig. 5-11a).

#### NOTE

When connected to a 230-volt nominal line, display may start on opposite slope because of line phasing.

f. Set the A Triggering SLOPE switch to —.

g. Check—Stable display starts on negative slope (see Fig. 5-11b).

h. Set the A Triggering SOURCE switch to INT.

i. Set the A Triggering COUPLING switch to LF REJ.

j. Check—Stable display cannot be obtained.

k. Change the following control settings:

HORIZ DISPLAY	DELAYED SWEEP (B)
A Triggering COUPLING	AC
A SWEEP MODE	AUTO TRIG

For Service Manuals Contact  
**MAURITRON TECHNICAL SERVICES**  
 8 Cherry Tree Rd, Chinnor  
 Oxon OX9 4QY  
 Tel: 01844-351654 Fax: 01844-352554  
 Email: enquiries@mauritron.co.uk

**Performance Check—Type 453**

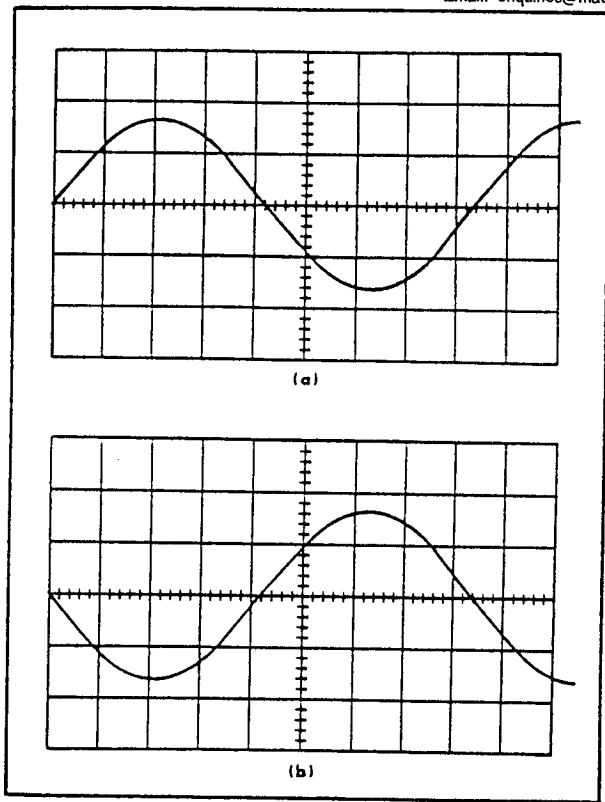

Fig. 5-11. Typical crt display showing correct operation of the SLOPE switch. (a) SLOPE switch set to +, (b) SLOPE switch set to -.

- l. Check—Stable display starts on positive slope (see Fig. 5-11a).
- m. Set the B Triggering SLOPE switch to —.
- n. Check—Stable display starts on negative slope (see Fig. 5-11b).
- o. Set the B Triggering SOURCE switch to INT.
- p. Set the B Triggering COUPLING switch to LF REJ.
- q. Check—Stable display cannot be obtained.
- r. Disconnect all test equipment.

**34. Check Triggering Level Control Range**

- a. Requirement—EXT, at least  $\pm 2$  volts; EXT  $\div 10$ , at least  $\pm 20$  volts.
- b. Change the following control settings:
 

VOLTS/DIV	5 Volts
SLOPE	+
COUPLING	DC
SOURCE	EXT

c. Connect the standard amplitude calibrator to the Channel 1 INPUT connector and the B Triggering EXT TRIG INPUT connector through the BNC T connector and two 42-inch 50-ohm cables.

d. Set the standard amplitude calibrator for 2-volts +dc in the mixed output mode.

e. Turn the B Triggering LEVEL control fully clockwise.

f. Check—Display not triggered, demonstrating that the control has moved the dc level of the Triggering circuit beyond the positive 2-volt signal amplitude.

g. Set the standard amplitude calibrator for -dc output.

h. Set the B Triggering SLOPE switch to —.

i. Set the B Triggering LEVEL control fully counterclockwise.

j. Check—Display not triggered, demonstrating that the control has moved the level of the triggering circuit beyond the amplitude of the negative 2-volt input signal.

k. Set the standard amplitude calibrator for 20 volts output.

l. Set both SOURCE switches to EXT  $\div 10$ .

m. Check—Display not triggered.

n. Set the standard amplitude calibrator for +dc output.

o. Set the B Triggering SLOPE switch to +.

p. Turn the B Triggering LEVEL control fully clockwise.

q. Check—Display not triggered.

r. Set the HORIZ DISPLAY switch to A.

s. Change the signal from the B Triggering EXT TRIG INPUT to the A Triggering EXT TRIG INPUT connector.

t. Set the A SWEEP MODE switch to NORM TRIG.

u. Set the A Triggering LEVEL control fully clockwise.

v. Check—Display not triggered.

w. Set the standard amplitude calibrator for -dc output.

x. Set the A Triggering SLOPE switch to —.

y. Turn the A Triggering LEVEL control fully counterclockwise.

z. Check—Display not triggered.

aa. Set the standard amplitude calibrator for 2 volts output.

ab. Set the A Triggering SOURCE switch to EXT.

ac. Check—Display not triggered.

- ad. Set the standard amplitude calibrator for +dc output.
- ae. Set the A Triggering SLOPE switch to +.
- af. Turn the A Triggering LEVEL control fully clockwise.
- ag. Check—Display not triggered.
- ah. Disconnect all test equipment.

### 35. Check Auto Recovery Time and Operation

- a. Requirement—Stable display above 20 cps repetition rate.
- b. Connect the time-mark generator to Channel 1 INPUT connector with a 42-inch 50-ohm cable.
- c. Set the time-mark generator for 50-millisecond markers.

#### CAUTION

To prevent permanent damage to the crt phosphor at slow sweep rates, position the baseline of the marker display below the viewing area.

- d. Change the following control settings:

VOLTS/DIV	2 VOLTS
TIME/DIV	50 mSEC
A SWEEP MODE	AUTO TRIG
LEVEL	Stable display
SLOPE	+
COUPLING	AC
SOURCE	INT

- e. Check—Stable display (LEVEL control may be adjusted as necessary for stable display). A SWEEP TRIG'D light on when display is stable.
- f. Set the time-mark generator for 100-millisecond markers.
- g. Check—Sweep free runs and stable display cannot be obtained.

### 36. Check Normal Gain

- a. Requirement—Timing within  $\pm 3\%$  of TIME/DIV switch indication.

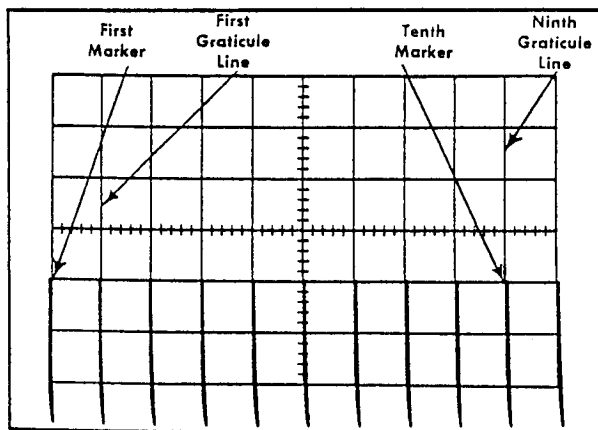

Fig. 5-12. Typical crt display showing correct normal gain adjustment.

- b. Set the time-mark generator for 1 millisecond markers.
- c. Set the TIME/DIV switch to 1 mSEC.
- d. Check—Crt display for one marker each division between the first and ninth graticule lines (see Fig. 5-12)  $\pm 0.24$  division ( $\pm 3\%$ ).

#### NOTE

Unless otherwise noted, use the middle eight horizontal divisions when checking timing (see Fig. 2-9, Operating Instructions).

### 37. Check Magnified Gain

- a. Requirement—Timing within  $\pm 4\%$  of magnified sweep rate.
- b. Set the time-mark generator for 100-microsecond markers.
- c. Set the MAG switch to  $\times 10$ .
- d. Check—Crt display for one marker each division between the first and ninth graticule lines (see Fig. 5-13)  $\pm 0.32$  division ( $\pm 4\%$ ).

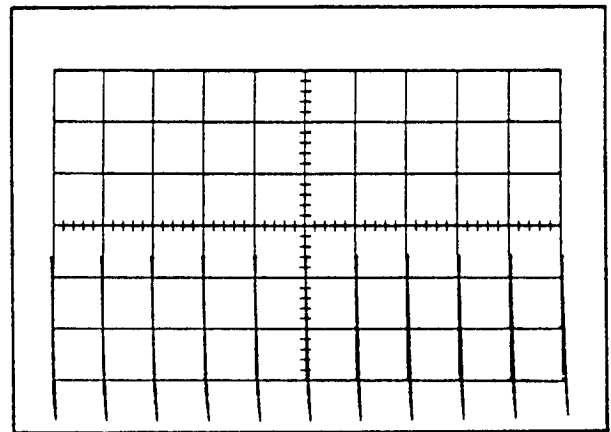

Fig. 5-13. Typical crt display showing correct magnified gain adjustment.

### 38. Check Magnified Linearity

- a. Requirement—Linearity within  $\pm 1.5\%$  for any eight-division portion of the magnified sweep.
- b. Position the first marker to the first graticule line. Check that the ninth marker is aligned with the ninth graticule line. If the ninth marker and graticule line do not coincide, change the TIME/DIV switch to .5 mSEC and adjust the A VARIABLE control for accurate alignment of the first and ninth markers with their respective graticule lines.
- c. Check—Displacement of each marker from its respective graticule line not to exceed  $\pm 0.12$  division ( $\pm 1.5\%$ ); see Fig. 5-14.
- d. Repeat check for each eight-division portion of the total display.

### 39. Check Fine Position Range

- a. Requirement—Range between 5 and 8 divisions with MAG switch set to  $\times 10$ .
- b. Center the FINE position control.

## Performance Check—Type 453

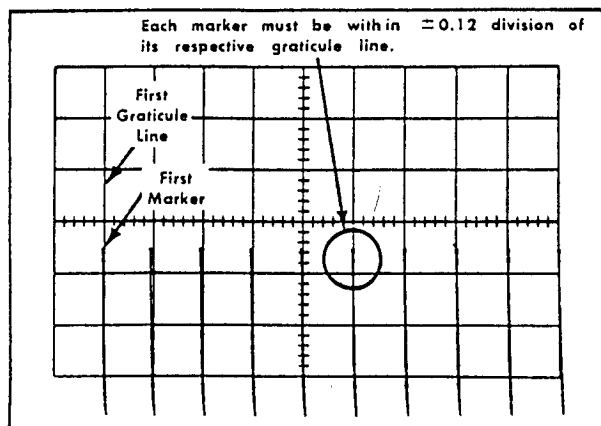

Fig. 5-14. Typical crt display when checking magnified linearity.

c. Position the start of the trace to the center of the graticule with the Horizontal POSITION control.

d. Check—FINE control will move the start of the trace horizontally over a range of 5 to 8 graticule divisions.

### 40. Check Normal/Magnified Registration

a. Requirement—Less than 0.2-division shift when switching MAG switch from  $\times 10$  to OFF.

b. Set the time-mark generator for 500-microsecond markers.

c. Position middle marker to the graticule centerline.

d. Set the MAG switch to OFF.

e. Check—Trace shift less than 0.2 division.

### 41. Check A Sweep Length

a. Requirement—A sweep length variable from 11,  $\pm 0.5$  division, maximum, to less than 4 divisions, minimum.

b. Set the time-mark generator for 1-millisecond and 100-microsecond markers.

c. Return the TIME/DIV switch to 1 mSEC and the A VARIABLE control to CAL.

d. Position start of trace to the left graticule edge.

e. Check—A Sweep length between 10.5 and 11.5 divisions. Large markers indicate divisions, and small markers indicate 0.1 division.

f. Turn the A SWEEP LENGTH control fully counterclockwise (not in detent).

g. Check—A Sweep length less than 4 divisions.

### 42. Check A Variable Control Range

a. Requirement—At least 2.5:1 reduction in A Sweep rate.

b. Set the time-mark generator for 10-millisecond markers.

c. Set the A SWEEP LENGTH control to FULL.

d. Position the markers to the far left and far right graticule lines with the Horizontal POSITION control.

e. Turn the A VARIABLE control fully counterclockwise.

f. Check—4 divisions or less between markers (2.5:1 range); see Fig. 5-15. UNCAL A or B light must be on when A VARIABLE control is not in CAL position.

### 43. Check B Variable Control Range

a. Requirement—At least 2.5:1 reduction in B Sweep rate.

b. Change the following control settings:

A TIME/DIV	2 mSEC
B TIME/DIV	1 mSEC
A VARIABLE	CAL
B SWEEP MODE	B TRIGGERABLE AFTER DELAY TIME
HORIZ DISPLAY	DELAYED SWEEP (B)

c. Position the markers to the far left and far right graticule lines with the Horizontal POSITION control.

d. Turn the B TIME/DIV VARIABLE control fully counterclockwise.

e. Check—4 divisions or less between markers (2.5:1 range); see Fig. 5-15. UNCAL A or B light must be on when B VARIABLE control is not in CAL position.

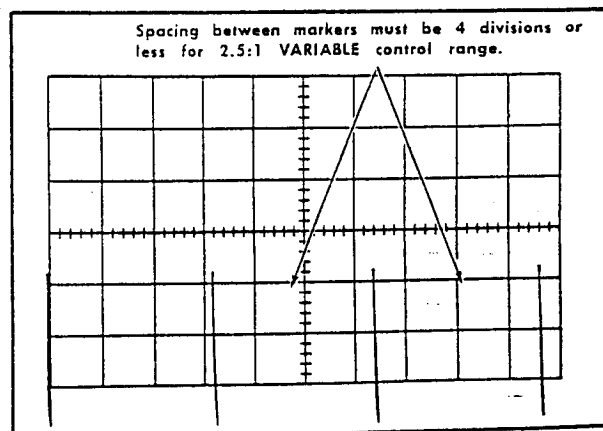

Fig. 5-15. Typical crt display when checking VARIABLE TIME/DIV control range.

#### 44. Check B Sweep Length

- Requirement—B Sweep length 11 divisions,  $\pm 0.5$  division.
- Set the B TIME/DIV VARIABLE control to CAL.
- Set the time-mark generator for 1-millisecond and 100-microsecond markers.
- Set the DELAY-TIME MULTIPLIER dial to 0.50.
- Position start of trace to the left graticule edge.
- Check—B Sweep length between 10.5 and 11.5 divisions. Large markers indicate divisions, and small markers indicate 0.1 division.

#### 45. Check B Sweep Timing Accuracy

- Requirement—Timing within  $\pm 3\%$  of 8 TIME/DIV switch setting.
- Check—Using Table 5-2, check B Sweep timing within  $\pm 3\%$  ( $\pm 0.24$  division for middle 8 divisions) in each position of the B TIME/DIV switch.

TABLE 5-2

A and B TIME/DIV Switch Setting	Time-Mark Generator Output	Crt Display (Markers/Division)
.1 $\mu$ SEC	10 Megacycle	1 cycle
.2 $\mu$ SEC	5 Megacycle	1 cycle
.5 $\mu$ SEC	1 Microsecond	1 marker/2 divisions
1 $\mu$ SEC	1 Microsecond	1
2 $\mu$ SEC	1 Microsecond	2
5 $\mu$ SEC	5 Microsecond	1
10 $\mu$ SEC	10 Microsecond	1
20 $\mu$ SEC	10 Microsecond	2
50 $\mu$ SEC	50 Microsecond	1
.1 mSEC	100 Microsecond	1
.2 mSEC	100 Microsecond	2
.5 mSEC	500 Microsecond	1
1 mSEC	1 Millisecond	1
2 mSEC	1 Millisecond	2
5 mSEC	5 Millisecond	1
10 mSEC	10 Millisecond	1
20 mSEC	10 Millisecond	2
50 mSEC	50 Millisecond	1
.1 SEC	100 Millisecond	1
.2 SEC	100 Millisecond	2
.5 SEC	500 Millisecond	1
A Sweep ONLY		
1 SEC	1 Second	1
2 SEC	1 Second	2
5 SEC	5 Second	1

#### 46. Check A Sweep Timing Accuracy

- Requirement—Timing within  $\pm 3\%$  of A TIME/DIV switch setting.
- Set the HORIZ DISPLAY switch to A.
- Check—Using Table 5-2, check A Sweep timing within  $\pm 3\%$  ( $\pm 0.24$  division for middle 8 divisions) in each position of the A TIME/DIV switch.

#### 47. Check High Speed Timing Linearity

- Requirement—Within  $\pm 4\%$  of magnified sweep rate.
- Set the A TIME/DIV switch to .1  $\mu$ SEC.
- Set the MAG switch to  $\times 10$ .
- Set the time-mark generator for 50 Mc output.
- Check—Timing over entire sweep length, excluding first and last 3 cycles of the total sweep, within  $\pm 4\%$  ( $\pm 0.32$  division for middle eight divisions); see Fig. 5-16.

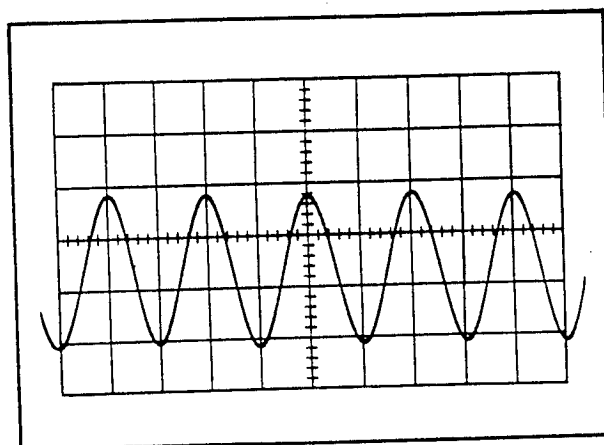

Fig. 5-16. Typical crt display when checking high speed timing linearity.

#### 48. Check Delay-Time Multiplier Operation and B Ends A Operation

- Requirement—Correct operation of intensified zone, eight major dial divisions,  $\pm 1.5\%$ , between markers at 1.00 and 9.00; B ENDS A, A Sweep ends after intensified zone.
- Change the following control settings:
 

A TIME/DIV	1 mSEC
B TIME/DIV	5 $\mu$ SEC
HORIZ DISPLAY	A INTEN DURING B
B SWEEP MODE	B STARTS AFTER DELAY TIME
MAG	OFF
- Set the time-mark generator for 1-millisecond markers.
- Position the first marker to the left graticule line.
- Check—Turn the DELAY-TIME MULTIPLIER dial to 1.00 and check that the intensified portion is at the first grati-

For Service Manuals Contact  
**MAURITRON TECHNICAL SERVICES**  
 8 Cherry Tree Rd, Chinnor  
 Oxon OX9 4QY  
 Tel: 01844-351694 Fax: 01844-352554  
 Email: enquiries@mauritron.co.uk

**Performance Check—Type 453**

cule line (second marker). Then turn the DELAY-TIME MULTIPLIER dial to 9.00 and check that the intensified portion is at the ninth graticule line (tenth marker).

- f. Set the HORIZ DISPLAY switch to DELAYED SWEEP (B).
- g. Turn the DELAY-TIME MULTIPLIER dial to about 1.00 so a marker is displayed at the start of the sweep. Note dial reading.
- h. Turn the DELAY-TIME MULTIPLIER dial to about 9.00 so a marker is displayed at the start of the sweep. Note dial reading.
- i. Check—Difference between dial readings in steps g and h must not exceed 8 major dial divisions,  $\pm 12$  minor divisions ( $\pm 1.5\%$ ).
- j. Set the A SWEEP LENGTH control to the B ENDS A position.
- k. Set the HORIZ DISPLAY switch to A INTEN DURING (B).
- l. Turn the DELAY-TIME MULTIPLIER dial throughout its range.
- m. Check—Crt display ends after the intensified portion at all DELAY-TIME MULTIPLIER dial positions.

**49. Check Delay-Time Multiplier Incremental Linearity**

- a. Requirement—Incremental linearity within tolerance of  $\pm 0.2\%$ .
- b. Set the HORIZ DISPLAY switch to DELAYED SWEEP (B).
- c. Set the A SWEEP LENGTH control to FULL (clockwise).
- d. If the difference between the DELAY-TIME MULTIPLIER dial reading at about 1.00 and 9.00 as measured in step 48 was not exactly 8 major dial divisions, use steps e through m to compensate for this error so the incremental linearity may be read directly from the DELAY-TIME MULTIPLIER dial. If the difference was exactly 8 dial divisions, proceed to steps n and o.
- e. Set the A TIME/DIV switch to .5mSEC and return the B TIME/DIV switch to 5  $\mu$ SEC.
- f. Set the HORIZ DISPLAY switch to A INTEN DURING B.
- g. Set the A VARIABLE control for one marker each division.
- h. Return the HORIZ DISPLAY switch to DELAYED SWEEP (B).
- i. Turn the DELAY-TIME MULTIPLIER dial to about 1.00 so a marker is displayed at the start of the sweep.
- j. Turn the DELAY-TIME MULTIPLIER dial to exactly 8 major dial divisions higher than the reading in step i.
- k. Turn the A VARIABLE control so a marker is displayed at the start of the sweep.

l. Set the HORIZ DISPLAY switch to A INTEN DURING B and check for nine markers between 1.00 and 9.00.

m. Return the HORIZ DISPLAY switch to DELAYED SWEEP (B) and repeat steps i through k until the difference between the markers at about 1.00 and 9.00 is exactly 8 major dial divisions.

n. Set the DELAY-TIME MULTIPLIER dial to each major dial division, taking into account the basic error, and adjust so a marker is displayed at the start of the sweep. For example, if the basic error at 1.00 is 8 minor divisions (actual dial reading 0.92), set the dial to 1.92 for checking error at 2.00, etc.

o. Check—Dial reading at each major dial division must be within 2 minor divisions ( $\pm 0.2\%$ ) of the reading at 1.00 (take into account basic dial error).

**50. Check Delay-Time Jitter**

- a. Requirement—Jitter not to exceed 1 part in 20,000.
- b. Change the following control settings:
 

A TIME/DIV	1 mSEC
B TIME/DIV	1 $\mu$ SEC
A VARIABLE	CAL
- c. Set the DELAY-TIME MULTIPLIER dial to about 1.00 so a marker is displayed at center screen.
- d. Check—Jitter on leading edge of marker not to exceed 0.5 division (1 part in 20,000); see Fig. 5-17. Ignore slow drift.
- e. Set the DELAY-TIME MULTIPLIER dial to 9.00.
- f. Check—Jitter on leading edge of marker not to exceed 0.5 division (1 part in 20,000); see Fig. 5-17. Ignore slow drift.

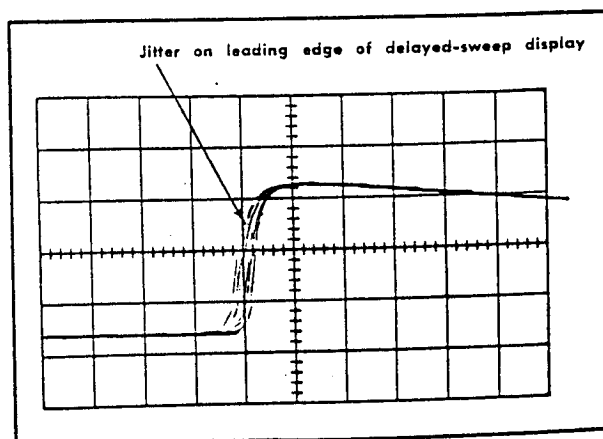

Fig. 5-17. Typical crt display showing acceptable delay-time jitter.

### 51. Check Calibrator Operation

- a. Requirement—Repetition rate, 1 kc,  $\pm 0.5\%$ ; duty cycle, 49 to 51%; risetime, less than 1 microsecond; voltage accuracy,  $\pm 1\%$ .
- b. Change the following control settings:
 

CH 1 VOLTS/DIV	50 mV
CH 2 VOLTS/DIV	2 Volts
MODE	ALT
TIME/DIV	.1 mSEC
HORIZ DISPLAY	A
- c. Connect the 1 KC CAL connector to Channel 1 INPUT with an 18-inch 50-ohm cable.
- d. Connect the time-mark generator to Channel 2 INPUT with a 42-inch 50-ohm cable.
- e. Position both waveforms to the graticule centerline.
- f. Set the A Triggering LEVEL control so both waveforms start at the same point.
- g. Position the rising portion of the second Calibrator cycle to the vertical centerline.
- h. Set the MAG switch to  $\times 10$ .
- i. Check—Separation between Calibrator waveform leading edge and the marker leading edge not to exceed 0.5 division (0.5% frequency accuracy).
- j. Disconnect the time-mark generator.
- k. Change the following control settings:
 

MODE	CH 1
TIME/DIV	50 $\mu$ SEC
MAG	OFF
- l. Set the A Triggering LEVEL control so the display starts at the 50% point on the rising portion.
- m. Set the MAG switch to  $\times 10$ .
- n. Position the 50% point on the falling edge of the Calibrator waveform to the vertical centerline.

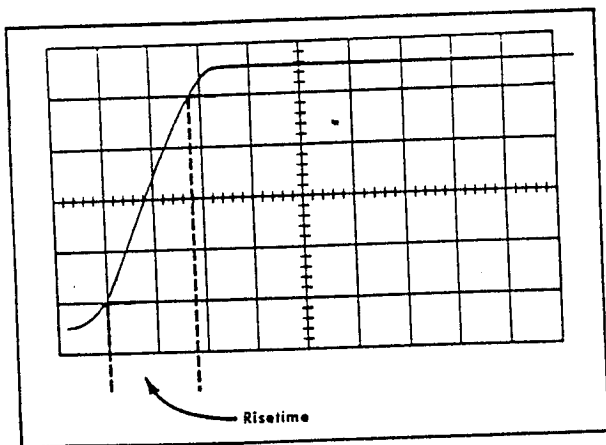

Fig. 5-18. Typical crt display when checking Calibrator risetime. Indicated risetime is 0.36 microsecond.

- o. Set the A Triggering SLOPE switch to —.
- p. Check—50% point on rising edge, now displayed, not displaced more than 4 divisions from the vertical centerline (duty cycle 49% to 51%).
- q. Change the following control settings:
 

CH 1 VOLTS/DIV	20 mV
A Triggering SLOPE	+
TIME/DIV	.2 $\mu$ SEC
MAG	OFF
- r. Adjust the A Triggering LEVEL control so all of the rising portion of the Calibrator waveform is visible.
- s. Check—Risetime between 10% and 90% points on waveform less than 5 divisions (1 microsecond); see Fig. 5-18.
- t. Connect the 1 KC CAL connector to Input A of the Type D Plug-In unit with a 42-inch 50-ohm cable.
- u. Connect the standard amplitude calibrator to Input B of the Type D Plug-In unit with a 42-inch 50-ohm cable.
- v. Set the standard amplitude calibrator for a 1-volt square-wave output.
- w. Set the Type D unit Millivolts/Cm switch to 1, Mv/Cm Multiplier switch to 10 and the input selector to A — B, DC.
- x. Check—Difference between Calibrator output and standard amplitude calibrator output less than 1 division ( $\pm 1\%$ ); see Fig. 5-19.
- y. Set the CALIBRATOR switch to .IV.
- z. Set the standard amplitude calibrator for a 0.1-volt square-wave output.

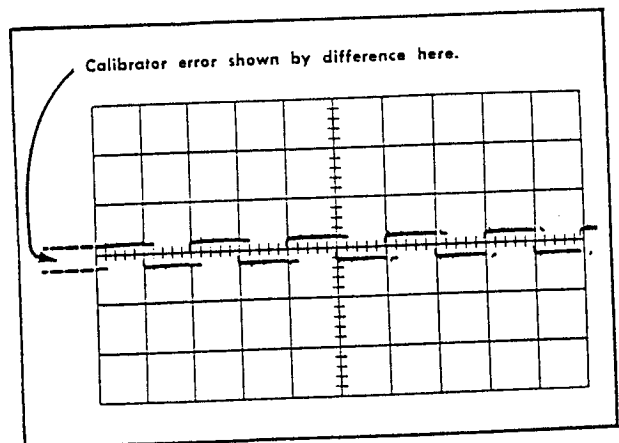

Fig. 5-19. Typical test oscilloscope display when checking amplitude accuracy of Calibrator (sweep rate, 0.5 millisecond/division).

- aa. Set the Type D unit Mv/Cm Multiplier switch to 1.
- ab. Check—Difference between Type 453 Calibrator output and standard amplitude calibrator output less than 1 division ( $\pm 1\%$ ); see Fig. 5-19.
- ac. Disconnect all test equipment.

**Performance Check—Type 453**

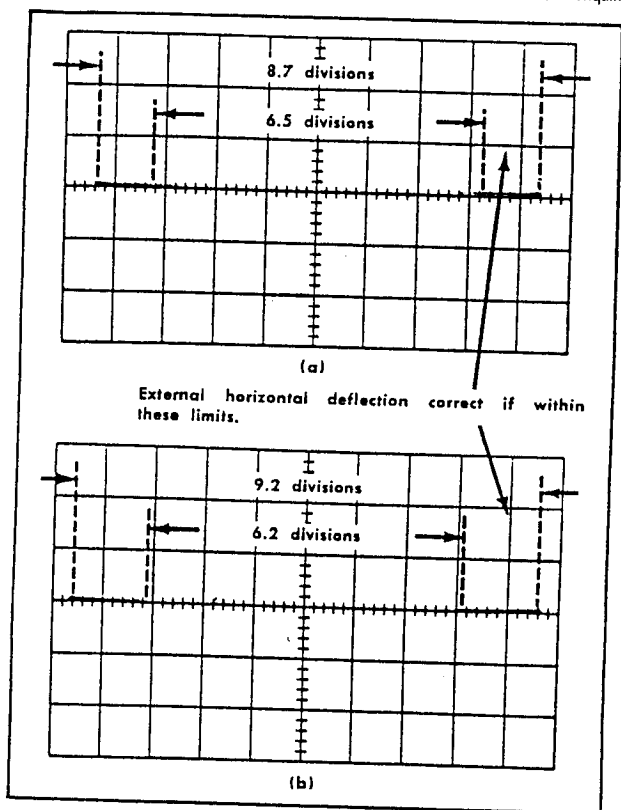

Fig. 5-20. Typical crt display when checking external horizontal deflection factor at EXT HORIZ input connector. (a) B Triggering SOURCE switch set to EXT; (b) B Triggering SOURCE switch set to EXT ÷10.

**52. Check External Horizontal Deflection Factor**

- Requirement—B Triggering SOURCE switch in EXT, 270 millivolts/division  $\pm 15\%$ ; EXT ÷10, 2.7 volts/division  $\pm 20\%$ .
- Connect the standard amplitude calibrator to the EXT HORIZ connector with a 42-inch 50-ohm cable.
- Set the standard amplitude calibrator for a 2-volt square-wave output.
- Set the HORIZ DISPLAY switch to EXT HORIZ.
- Increase the INTENSITY control setting until the display is visible.
- Set the B Triggering SOURCE switch to EXT.
- Check—Horizontal deflection 6.5 to 8.7 divisions (270 millivolts/division,  $\pm 15\%$ ); see Fig. 5-20a.
- Set the B Triggering SOURCE switch to EXT ÷10.
- Set the standard amplitude calibrator for a 20-volt square-wave output.
- Check—Horizontal deflection 6.2 to 9.2 divisions (2.7 volts/division,  $\pm 20\%$ ); see Fig. 5-20b.
- Disconnect all test equipment.

**53. Check Z Axis Sensitivity**

- Requirement—Noticeable intensity modulation with 5-volt signal.
- Change the following control settings:
 

INTENSITY	Normal
TIME/DIV	1 mSEC
HORIZ DISPLAY	A
- Connect the standard amplitude calibrator to the Z AXIS INPUT binding posts using a 42-inch 50-ohm cable and the BNC to alligator clips adapter.
- Remove the ground strap from between the binding posts.
- Set the standard amplitude calibrator for a 5-volt square-wave output.

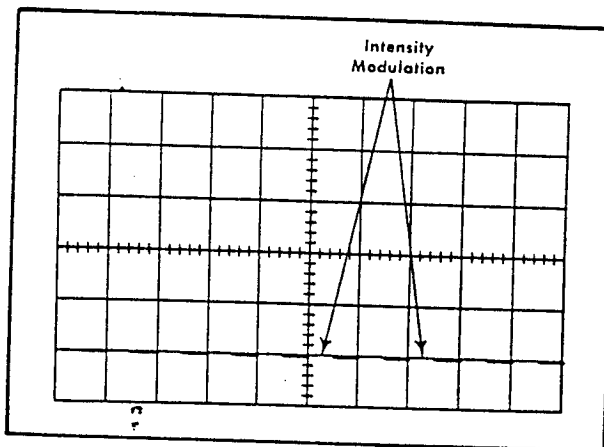

Fig. 5-21. Typical crt display showing intensity modulation (A Sweep externally triggered for stable display).

- Check—Crt display for noticeable intensity modulation (see Fig. 5-21).
  - Replace ground strap.
  - Disconnect all test equipment.
- 54. Check Trace Finder Operation**
- Requirement—Overscanned display returns to display area when TRACE FINDER is pressed.
  - Connect the standard amplitude calibrator to Channel 1 INPUT connector through the 42-inch 50-ohm cable.
  - Set the standard amplitude calibrator for a 10-volt square-wave output.
  - Press the TRACE FINDER button.
  - Check—Display reduced to about 4 divisions vertically and 7 divisions horizontally.
  - While holding the TRACE FINDER button depressed, increase the CH 1 VOLTS/DIV setting until the display is reduced in amplitude (at about 5 VOLTS/DIV).



g. Position the display to the center of the graticule with the Channel 1 POSITION control.

h. Check—Release TRACE FINDER button; display must remain on screen.

### 55. Check A and B Gate Output

a. Requirement—Polarity, positive going; amplitude, 12 volts,  $\pm 10\%$ ; duration, approximately same length as sweep.

b. Set the TIME/DIV switch to 1 mSEC.

c. Connect the A GATE connector to the Type D unit Input A connector with a 42-inch 50-ohm cable.

d. Set the Type D unit Millivolts/Cm switch to 1000, Mv/Cm Multiplier to 5 and Input Selector to A, DC.

e. Check—Test oscilloscope deflection between 2.16 and 2.64 divisions (12 volts  $\pm 10\%$ ); see Fig. 5-22.

f. Check—Gate signal duration about 11 milliseconds.

g. Set the HORIZ DISPLAY switch to DELAYED SWEEP (B).

h. Set the DELAY-TIME MULTIPLIER dial to 0.50.

i. Connect the B GATE connector to the Type D unit Input A connector with a 42-inch 50-ohm cable.

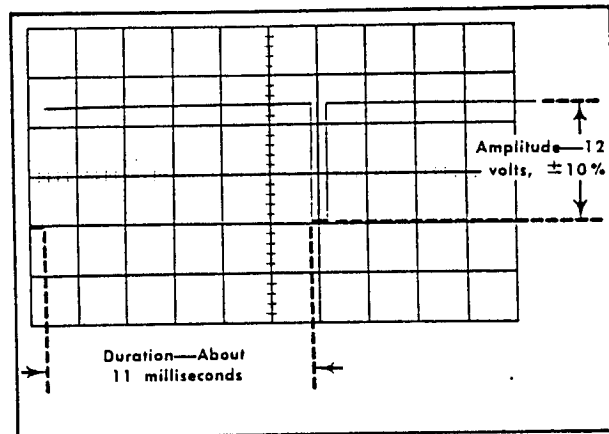

Fig. 5-22. Typical test oscilloscope display showing correct operation of A and B GATE circuit. Vertical deflection, 5 volts/division; sweep rate, 2 milliseconds/division.

j. Check—Test oscilloscope deflection between 2.16 and 2.64 divisions (12 volts,  $\pm 10\%$ ); see Fig. 5-22.

k. Check—Gate signal duration about 11 milliseconds.

This completes the performance check procedure for the Type 453. Disconnect all test equipment. If the instrument has met all performance requirements given in this procedure, it is correctly calibrated and within the specified tolerances.

For Service Manuals Contact  
 MAURITRON TECHNICAL SERVICES  
 8 Cherry Tree Rd, Chinnor  
 Oxon OX9 4QY  
 Tel:- 01844-351694 Fax:- 01844-352554  
 Email:- enquiries@mauritron.co.uk

# SECTION 6

## CALIBRATION

For Service Manuals Contact  
MAURITRON TECHNICAL SERVICES  
8 Cherry Tree Rd, Chinnor  
Oxon OX9 4QY  
Tel: 01844-351694 Fax: 01844-352554  
Email: enquiries@mauritron.co.uk

### Introduction

This calibration procedure can be used either for complete calibration of the Type 453 to return it to original performance, or as an operational check of instrument performance. Completion of every step in this procedure returns the Type 453 to original factory performance standards. If it is desired to merely 'touch up' the calibration, perform only those steps entitled 'Adjust . . . '.

### NOTE

The 'Adjust . . . ' steps provide a check of instrument performance before the adjustment is made. To prevent recalibration of other circuits when performing a partial calibration, readjust only if the listed tolerance is not met.

### General Information

Any needed maintenance should be performed before proceeding with calibration. Troubles which become apparent during calibration should be corrected using the techniques given in the Maintenance section of the Instruction Manual.

This procedure is arranged in a sequence which allows this instrument to be calibrated with the least interaction of adjustments and reconnection of equipment. If desired, the steps may be performed out of sequence or a step may be done individually. However, some adjustments affect the calibration of other circuits within the instrument. In this case, it will be necessary to check the operation of other parts of the instrument. When a step interacts with others, the steps which need to be checked will be noted.

The location of test points and adjustments is shown in each step. Waveforms which are helpful in determining the correct adjustment or operation are also shown.

Where references are made to divisions of deflection, the indication will be major divisions.

### EQUIPMENT REQUIRED (see Figs. 6-1 and 6-2)

#### General

The following equipment, or its equivalent, is required for complete calibration of the Type 453. Specifications given are the minimum necessary for accurate calibration of this instrument. All test equipment is assumed to be correctly calibrated and operating within the original specifications. If equipment is substituted, it must meet or exceed the specifications of the recommended equipment.

#### Special Test Equipment

For the quickest and most accurate calibration, special

calibration fixtures are used where necessary. All calibration fixtures listed under 'Equipment Required' can be obtained from Tektronix, Inc. Order by part number through your local Tektronix Field Office or representative.

1. Precision dc voltmeter. Accuracy, within  $\pm 0.05\%$ ; meter resolution,  $50 \mu\text{V}$ ; range, 0.1 to 75 volts. For example, Fluke Model 801B.

2.<sup>1</sup> Dc voltmeter. Minimum sensitivity, 20,000 ohms/volt; accuracy, checked to within 1% at  $-1950$  volts. For example, Simpson Model 262.

3. Test oscilloscope. Bandpass, dc to 50 Mc; minimum deflection factor, 0.005 volts/division. Tektronix Type 544 Oscilloscope with Type 1A1 Plug-In Unit and Tektronix P6008 Probe, or Tektronix Type 453 Oscilloscope with Tektronix P6010 Probe recommended.

4. Current probe. Sensitivity, 1 milliamp/division; accuracy, within 3%. Tektronix P6016 Current Probe with Type 131 Amplifier recommended.

5.<sup>2</sup>  $1\times$  probe with BNC connector. Tektronix P6028 Probe recommended.

6.<sup>2</sup> Variable autotransformer. Must be capable of supplying at least 200 volt-amperes over a voltage range of 96 to 137 volts (192 to 274 volts for 230-volt nominal line). If autotransformer does not have an ac voltmeter to indicate output voltage, monitor output with an ac voltmeter (rms) with range of at least 137 (or 274) volts. For example, General Radio W10MT3W Metered Variac Autotransformer.

7. Time-mark generator. Marker outputs, 5 seconds to 1 microsecond; sine-wave output, 5 and 10 Mc; accuracy, 0.001%. Tektronix Type 180A Time-Mark Generator recommended.

8. Standard amplitude calibrator. Amplitude accuracy, within 0.25%; signal amplitude, 5 millivolts to 50 volts; output signal, 1-kc,  $-DC$  and  $+DC$ ; must have mixed display feature. Tektronix calibration fixture 067-0502-00 recommended.

9. Square-wave generator. Frequency, 1 kc and 100 kc; risetime, 20 nanoseconds maximum; output amplitude, about 8 volts into 50 ohms. Tektronix Type 105 Square-Wave Generator recommended.

10. Constant amplitude sine-wave generator. Frequency, 50 kc and 350 kc to above 52.5 Mc; output amplitude, 6 volts; amplitude accuracy,  $\pm 3\%$  from 50 kc to above 52.5 Mc. Tektronix calibration fixture 067-0506-00 recommended.

<sup>1</sup> If a precision voltage divider (such as a Fluke 80A-2) is available for use with the precision dc voltmeter, it is recommended for more accurate adjustment of the High-Voltage Supply.

<sup>2</sup> Used only to check power-supply ripple in step 4. May be deleted if this check is not made.

Calibration—Type 453

For Service Manuals Contact  
MAURITRON TECHNICAL SERVICES  
8 Cherry Tree Rd, Chinnor  
Oxon OX9 4QY  
Tel:- 01844-351694 Fax:- 01844-352554  
Email:- enquiries@mauritron.co.uk

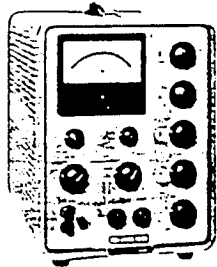

(1)

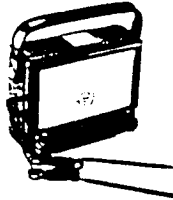

(2)

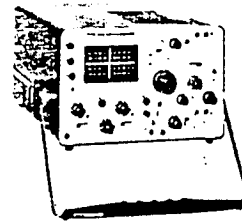

(3)

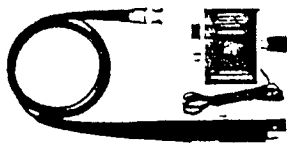

(4)

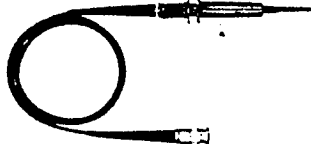

(5)

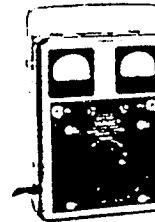

(6)

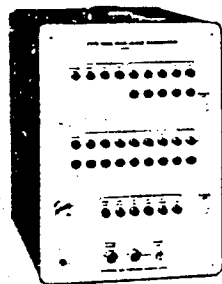

(7)

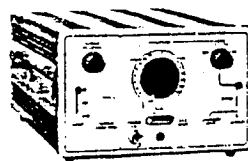

(8)

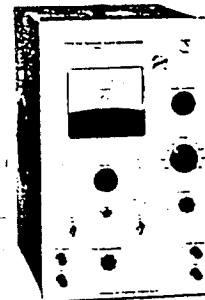

(9)



(10)

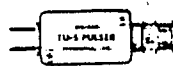

(11)

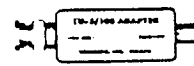

(12)

Fig. 6-1. Recommended calibration equipment. Items 1 through 12.

Calibration—Type 453



(13)

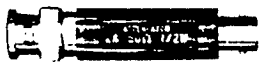

(14)

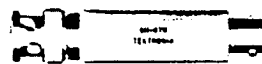

(15)



(16)



(17)

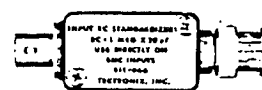

(18)



(19)



(20)



(21)



(22)

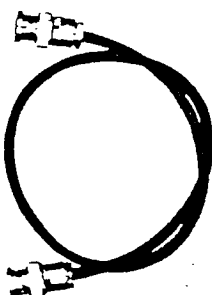

(23)

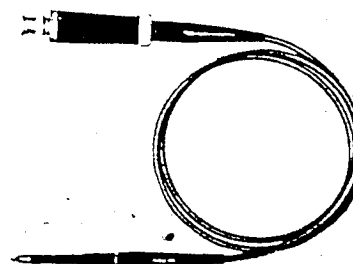

(24)



(25)



(26)

Fig. 6-2. Recommended calibration equipment. Items 13 through 26.

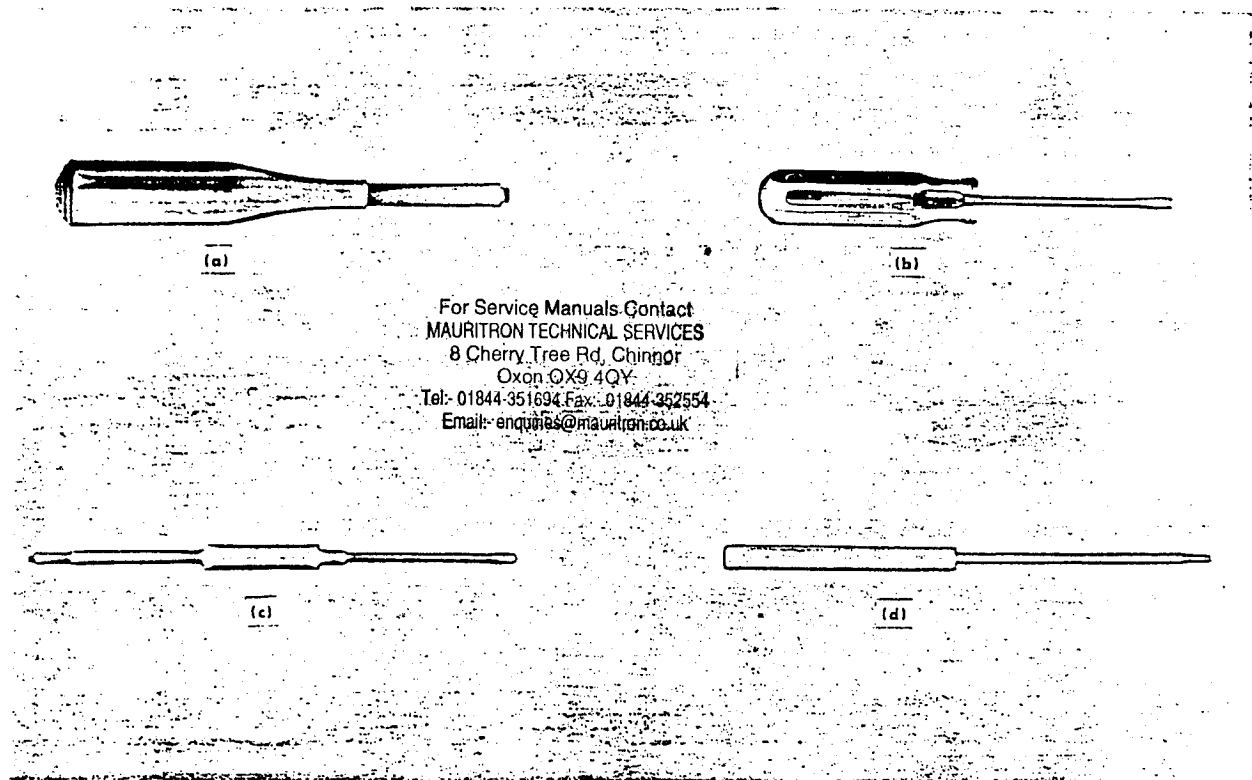

For Service Manuals Contact  
 MAURITRON TECHNICAL SERVICES  
 8 Cherry Tree Rd, Chingor  
 Oxon OX9 4QY  
 Tel: 01844 351694 Fax: 01844 352554  
 Email: enquiries@mauratron.co.uk

Fig. 6-3. Adjustment tools.

11. Tunnel-diode pulser. Output amplitude, about 200 millivolts into 50 ohms; connectors, BNC. Tektronix TU-5 Pulser, Part No. 015-0038-00, recommended.

12. Adapter, TU-5/105. Allows TU-5 Pulser to be used with Type 105 Square-Wave Generator. Tektronix Part No. 013-0075-00. (When using Tektronix 540-series test oscilloscope, the oscilloscope calibrator may be used to drive the TU-5.)

13. Termination (two). Impedance, 50 ohm; accuracy,  $\pm 3\%$ ; connectors, BNC. Tektronix Part No. 011-0049-00.

14. 2X attenuator. Impedance, 50 ohm; accuracy,  $\pm 3\%$ ; connectors, BNC. Tektronix Part No. 011-0069-00.

15. 2.5X attenuator. Impedance, 50 ohm; accuracy,  $\pm 3\%$ ; connectors, BNC. Tektronix Part No. 011-0076-00.

16. 5X attenuator. Impedance, 50 ohm; accuracy,  $\pm 3\%$ ; connectors, BNC. Tektronix Part No. 011-0060-00.

17. 10X attenuator (two). Impedance, 50 ohm; accuracy,  $\pm 3\%$ ; connectors, BNC. Tektronix Part No. 011-0059-00.

18. Input rc standardizer. Time constant, 1 megohm X 20 pf; attenuation, 2X; connectors, BNC. Tektronix Part No. 011-0066-00.

19. BNC T connector. Tektronix Part No. 103-0030-00.

20. Adapter. Connectors, GR to BNC jack. Tektronix Part No. 017-0063-00.

21. Adapter. Connectors, BNC jack to BNC jack. Tektronix Part No. 103-0028-00.

22. Cable (two). Impedance, 50 ohm; type, RG58/AU; length, 42 inch; connectors, BNC. Tektronix Part No. 012-0057-00.

23. Cable (three). Impedance, 50 ohm; type, RG58/AU; length, 18 inch; connectors, BNC. Tektronix Part No. 012-0076-00.

24. 10X probe with BNC connector. Tektronix P6010 Probe recommended.

25. Adapter. Connectors, BNC jack to alligator clips. Tektronix Part No. 013-0076-00.

26. Dual-input coupler. Matched signal transfer to each input. Tektronix calibration fixture 067-0525-00.

27. Adjustment tools (see Fig. 6-3).

Description	Tektronix Part No.
a. Insulated screwdriver, 1 1/2" shaft, non-metallic	003-0000-00
b. Screwdriver, 3" shaft	003-0192-00
c. Tuning rod, 5"	003-0301-00
d. Tuning tool Handle	003-0307-00
Insert, for 5/64" (ID) hex cores	003-0310-00

### ABRIDGED CALIBRATION PROCEDURE AND INDEX

This Abridged Calibration Procedure is provided to aid in checking the operation of the Type 453. It may be used as a calibration guide by the experienced calibrator, or it may be used as a calibration record. Since the step numbers and titles used here correspond to those used in the complete Calibration Procedure, the following procedure serves as an index to locate a step in the complete Calibration Procedure. Characteristics are those listed in the Characteristics section of the Instruction Manual.

Type 453, Serial No. \_\_\_\_\_

Calibration Date \_\_\_\_\_

- 1. Adjust -12-Volt Power Supply (page 6-8)  
-12 volts,  $\pm 0.012$  volt.
- 2. Adjust +12-Volt Power Supply (page 6-9)  
Adjust for +1 volt,  $\pm 0.002$  volt.  
Check for +12.1 volts,  $\pm 0.12$  volt.
- 3. Adjust +75-Volt Power Supply (page 6-9)  
+75 volts,  $\pm 0.075$  volt.
- 4. Check Low-Voltage Power-Supply Ripple (page 6-10)  
2 millivolts maximum.
- 5. Adjust High-Voltage Supply (page 6-13)  
-1950 volts,  $\pm 60$  volts.
- 6. Adjust Crt Grid Bias (page 6-13)  
Correct operation; see Calibration Procedure.
- 7. Adjust Z Axis Compensation (page 6-15)  
Optimum square wave.
- 8. Adjust Trace Alignment (page 6-15)  
Trace parallel to horizontal graticule lines.
- 9. Adjust Astigmatism (page 6-16)  
Sharp, well-defined display.
- 10. Adjust Y Axis Alignment (page 6-17)  
Markers parallel to vertical graticule centerline.
- 11. Adjust Crt Geometry (page 6-17)  
Best overall geometry.
- 12. Adjust Channel 1 and 2 Step Attenuator Balance (page 6-17)  
No trace shift as VOLTS/DIV switch is changed from 20 mV to 5 mV.
- 13. Adjust Channel 1 and 2 Position Center (page 6-18)  
Trace at horizontal centerline with POSITION control centered.
- 14. Adjust Channel 1 and 2 Gain (page 6-20)  
Correct vertical deflection as indicated by VOLTS/DIV switch.
- 15. Check Added Mode Operation (page 6-21)  
Signal addition.
- 16. Check Channel 1 and 2 Deflection Accuracy (page 6-21)  
Vertical deflection within  $\pm 3\%$  of VOLTS/DIV switch indication.
- 17. Check Channel 1 and 2 Variable Volts/Division Range (page 6-22)  
VARIABLE VOLTS/DIV control range of at least 2.5:1.
- 18. Check Compression and Expansion (page 6-22)  
Less than 0.15 division compression or expansion at extremes of display area.
- 19. Check Trace Shift Due to Input Grid Current (page 6-23)  
Less than 0.4 division at 5 mV.
- 20. Check Alternate Operation (page 6-23)  
Trace alternation at all sweep rates.
- 21. Adjust Channel 1 Volts/Division Compensation (page 6-24)  
Optimum square-wave response in all CH 1 VOLTS/DIV switch positions.
- 22. Adjust Channel 2 Volts/Division Compensation (page 6-25)  
Optimum square-wave response in all CH 2 VOLTS/DIV switch positions.
- 23. Adjust High-Frequency Compensation (page 6-27)  
Optimum square-wave response at high frequency.
- 24. Check Vertical Frequency Response (page 6-30)  
20 mV to 10 Volts      50 Mc minimum  
10 mV                      45 Mc minimum  
5 mV                        40 Mc minimum
- 25. Check Channel 1 and 2 Cascaded Frequency Response (page 6-31)  
25 Mc minimum.
- 26. Check Added Mode Frequency Response (page 6-32)  
50 Mc minimum.
- 27. Check External Horizontal Frequency Response (page 6-32)  
5 Mc minimum.

## Calibration—Type 453

- 28. Check Common-Mode Rejection Ratio (page 6-33)  
At least 20:1 at 20 Mc.
- 29. Adjust Trigger Level Centering (page 6-36)  
Correct operation; see Calibration Procedure.
- 30. Check Internal Triggering Operation (page 6-36)  
Stable triggering with minimum deflection in all positions of the COUPLING switches except HF REJ.
- 31. Check External Triggering Operation (page 6-38)  
Stable triggering with minimum signal in all positions of the COUPLING switches except HF REJ.
- 32. Check High-Frequency Reject Operation (page 6-39)  
Display not triggered at 1 Mc.
- 33. Check Single Sweep Operation (page 6-40)  
Sweep triggers with same A Triggering LEVEL control setting as in AUTO TRIG; sweep locks out until reset.
- 34. Check Line Triggering, Slope Switch Operation and Low-Frequency Reject Operation (page 6-41)  
Correct triggering operation.
- 35. Check Triggering Level Control Range (page 6-43)
 

EXT	±2 volts
EXT +10	±20 volts
- 36. Check Auto Recovery Time and Operation (page 6-44)  
Stable triggering at 20 cps.
- 37. Adjust Sweep Start and A Sweep Calibration (page 6-45)  
Correct operation; see Calibration Procedure.
- 38. Check Delay-Time Multiplier Incremental Linearity (page 6-46)  
Within ±0.2%.
- 39. Adjust Normal Gain (page 6-46)  
Correct timing as indicated by A TIME/DIV switch.
- 40. Adjust Magnified Gain (page 6-46)  
Correct timing with MAG switch set to X10.
- 41. Check Magnified Linearity (page 6-46)  
Within ±1.5% over any 3-division portion of the total sweep.
- 42. Adjust Magnifier Register (page 6-47)  
Less than 0.2 division shift when switching from magnified to normal sweep.
- 43. Adjust B Sweep Calibration (page 6-47)  
Correct timing as indicated by B TIME/DIV switch.
- 44. Check B Sweep Length (page 6-47)  
11 divisions, ±0.5 division.
- 45. Check A Sweep Length (page 6-48)  
Variable from 11, ±0.5, to less than 4 divisions.
- 46. Check A Variable Control Range (page 6-48)  
At least 2.5:1.
- 47. Check B Variable Control Range (page 6-49)  
At least 2.5:1.
- 48. Check Fine Position Range (page 6-49)  
Between 5 and 8 divisions with MAG switch set to X10.
- 49. Adjust 1 Microsecond Timing (page 6-49)  
Correct timing.
- 50. Adjust High-Speed Linearity (page 6-50)  
Equal linearity on left and right sides of graticule.
- 51. Check B Sweep Timing Accuracy (page 6-50)  
B Sweep timing within ±3% of indicated sweep rate.
- 52. Check A Sweep Timing Accuracy (page 6-51)  
A Sweep timing within ±3% of indicated sweep rate.
- 53. Check Delay-Time Jitter (page 6-51)  
Not to exceed 1 part in 20,000.
- 54. Check B Ends A Operation (page 6-51)  
Sweep ends after intensified portion.
- 55. Adjust External Horizontal Gain and Check Operation (page 6-52)  
Input to Channel 1, correct horizontal deflection as indicated by CH 1 VOLTS/DIV switch. Input to EXT HORIZ connector, see Calibration Procedure.
- 56. Check Z Axis Operation (page 6-53)  
Noticeable modulation with 5-volt input.
- 57. Check Trace Finder Operation (page 6-53)  
Overscanned display returned to viewing area.
- 58. Check Channel 1 Output Operation (page 6-53)  
At least 1 millivolt/division minimum deflection factor.
- 59. Check Chopped Operation (page 6-54)  
1.7- to 2.5-microsecond duration of each cycle and chopped blanking of switching transients.
- 60. Adjust Calibrator Repetition Rate (page 6-55)  
1 kc, ±0.5%.
- 61. Check Calibrator Duty Cycle and Rise Time (page 6-56)  
Duty cycle, 49% to 51%. Rise time, less than 1 microsecond.
- 62. Check Calibrator Current Through Probe Loop (page 6-57)  
5 milliamperes.
- 63. Check Gate Output Signals (page 6-59)  
12 volts in amplitude, ±10% with same duration as sweep.

## CALIBRATION PROCEDURE

### General

In the following calibration procedure, a test equipment setup is shown for each major setup change. Complete control settings are listed beneath the picture. To aid in locating individual controls which have been changed during complete calibration, these control names are printed in bold type. If only a partial calibration is performed, start with the nearest setup preceding the desired portion.

#### NOTE

When performing a complete recalibration, best performance will be provided if each adjustment is made to the exact setting, even if the Check is within the allowable tolerance.

The following procedure uses the equipment listed under 'Equipment Required'. If substitute equipment is used, control settings or setup must be altered to meet the requirements of the equipment used.

### Preliminary Procedure

1. Remove the top and bottom covers from the Type 453.
2. Connect the autotransformer (if used) to a suitable power source.
3. Connect the Type 453 power cord to the autotransformer output (or directly to the power source).
4. Set the autotransformer to 115 (or 230) volts.
5. Set the Type 453 POWER switch to ON. Allow at least 20 minutes warm up at 25° C, ±5°, for checking the instrument to the given accuracy.

### NOTES

For Service Manuals Contact  
MAURITRON TECHNICAL SERVICES  
8 Cherry Tree Rd, Chinnor  
Oxon OX9 4QY  
Tel: 01844-351694 Fax: 01844-352554  
Email: enquiries@mauritron.co.uk



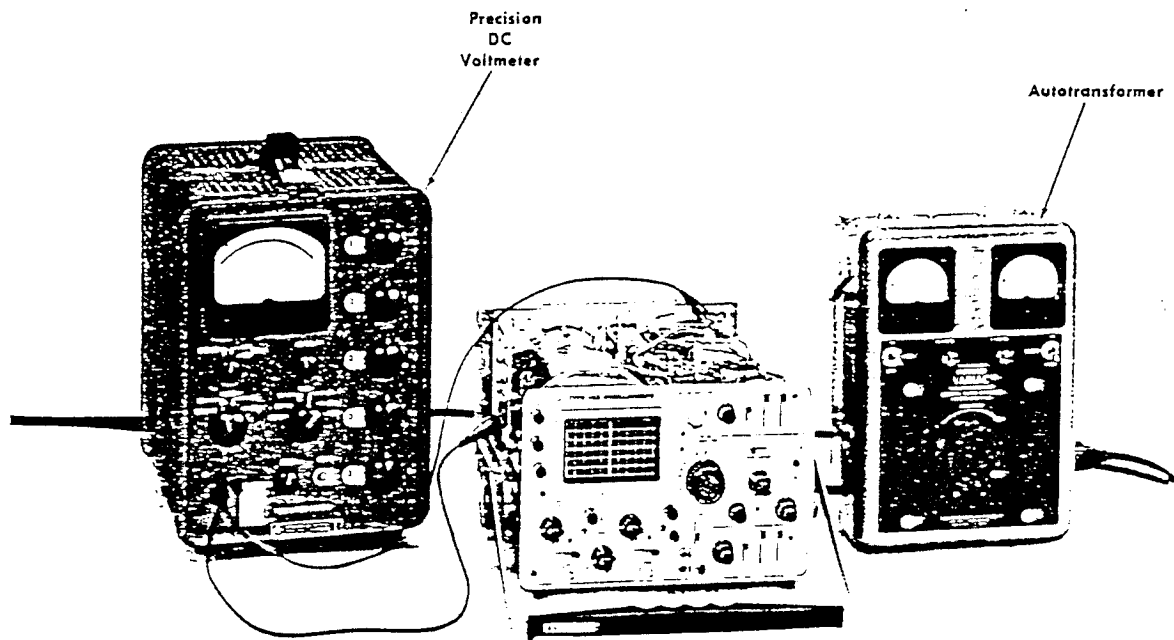

Fig. 6-4. Initial test equipment setup for steps 1 through 3.

**Crt controls**

INTENSITY Counterclockwise  
 FOCUS Adjust for focused display  
 SCALE ILLUM As desired

**Vertical controls (both channels if applicable)**

VOLTS/DIV 20 mV  
 VARIABLE CAL  
 POSITION Midrange  
 AC GND DC AC  
 MODE CH 1  
 TRIGGER NORM  
 INVERT Pushed in

**Triggering controls (both A and B if applicable)**

LEVEL 0  
 SLOPE +  
 COUPLING AC  
 SOURCE INT

**Sweep controls**

DELAY-TIME MULTIPLIER 0.50  
 A TIME/DIV 1 mSEC  
 B TIME/DIV 1 mSEC  
 A VARIABLE CAL  
 A SWEEP MODE NORM TRIG  
 B SWEEP MODE B TRIGGERABLE AFTER DELAY TIME

HORIZ DISPLAY A  
 MAG OFF  
 A SWEEP LENGTH FULL  
 POSITION Midrange  
 POWER ON

**Side-panel controls**

B TIME/DIV VARIABLE CAL  
 CALIBRATOR 1V

**Rear-panel controls**

LINE VOLTAGE RANGE HIGH

**1. Adjust —12-Volt Power Supply**

- a. Test equipment setup is shown in Fig. 6-4.
- b. Connect the precision dc voltmeter from the —12-volt test point (pin connector 'G', Low-Voltage Regulator board; see Fig. 6-5) to chassis ground.
- c. Check—Meter reading; —12 volts,  $\pm 0.012$  volt.
- d. Adjust— —12 Volts adjustment, R1122 (see Fig. 6-5), for —12 volts.
- e. Interaction—May affect operation of all circuits within the Type 453.

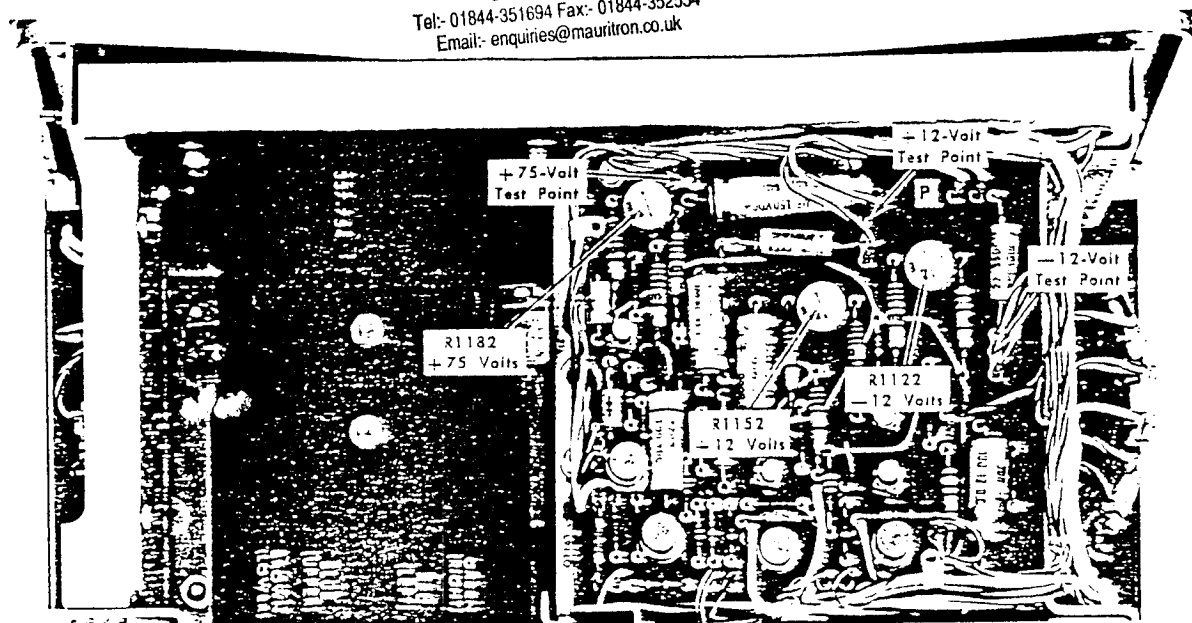

Fig. 6-5. Low-voltage test points and adjustment (Low-Voltage Regulator board).

## 2. Adjust +12-Volt Power Supply

- a. Test equipment setup is shown in Fig. 6-4.
- b. Connect the precision dc voltmeter from the center contact of the 1 KC CAL connector to chassis ground.
- c. Remove Q1255 (see Fig. 6-6) from the Calibrator board.
- d. Check—Meter reading;  $\pm 1$  volt,  $\pm 0.002$  volt.
- e. Adjust— $-12$  Volts adjustment, R1152 (see Fig. 6-5), for  $-1$  volt.
- f. Set the CALIBRATOR switch to .1V.
- g. Check—Meter reading;  $\pm 0.1$  volt,  $\pm 0.001$  volt.
- h. Replace Q1255.
- i. Connect the precision dc voltmeter from the  $-12$ -volt test point (pin connector 'C', Low-Voltage Regulator board; see Fig. 6-5) to chassis ground.
- j. Check—Meter reading;  $\pm 12.1$  volts,  $\pm 0.12$  volt.
- k. Interaction—May affect operation of all circuits within the Type 453.

## 3. Adjust +75-Volt Power Supply

- a. Test equipment setup is shown in Fig. 6-4.
- b. Connect the precision dc voltmeter from the  $+75$ -volt test point (pin connector 'B', Low-Voltage Regulator board; see Fig. 6-5) to chassis ground.

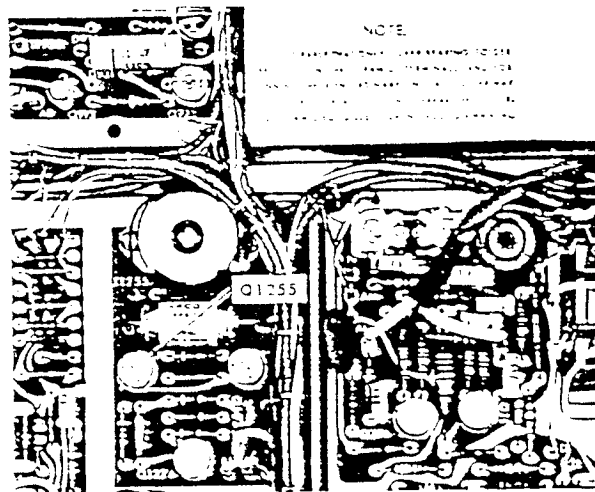

Fig. 6-6. Location of Q1255 (Calibrator section of A Sweep board).

- a. Check—Meter reading;  $-75$  volts,  $\pm 0.075$  volt.
- b. Adjust— $+75$  Volts adjustment, R1182 (see Fig. 6-5), for  $-75$  volts.
- c. Recheck all supplies and readjust if necessary.
- d. Interaction—May affect operation of all circuits within the Type 453.
- e. Disconnect all test equipment.

For Service Manuals Contact  
 MAURITRON TECHNICAL SERVICES  
 78 Cherry Tree Rd; Chinnor  
 Oxon OX9 4QY  
 Tel:- 01844-351694 Fax:- 01844-352554  
 Email:- enquiries@mauritron.co.uk

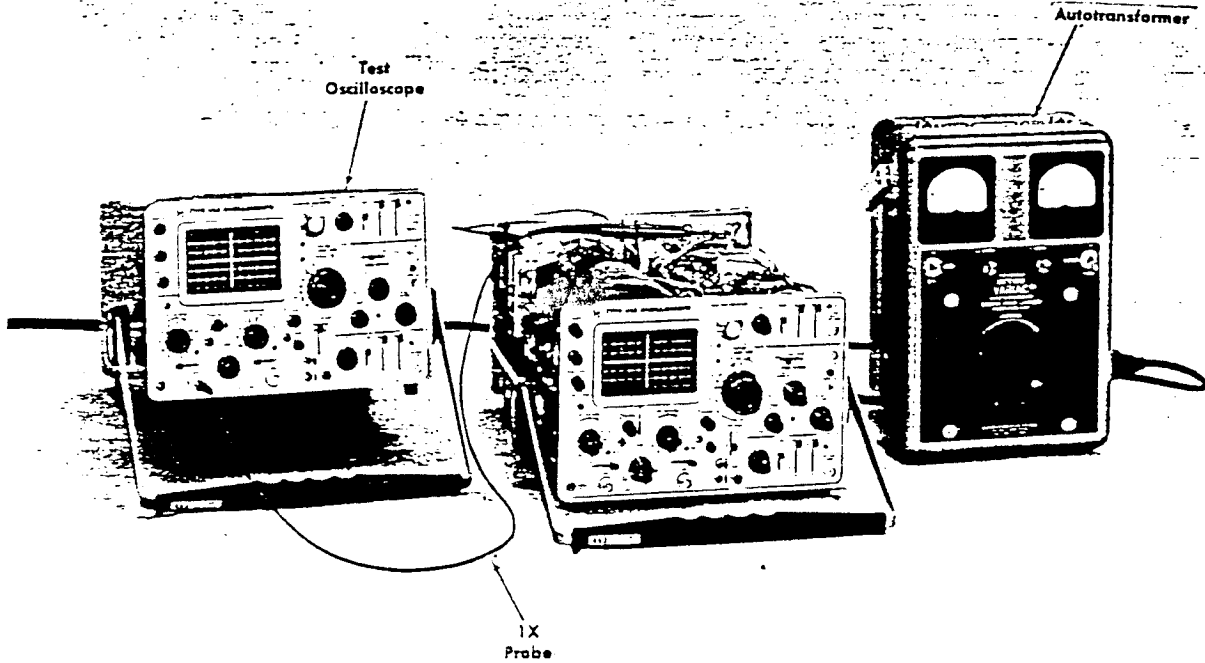

Fig. 6-7. Test equipment setup for step 4.

<b>Crt controls</b>	
INTENSITY	Counterclockwise
FOCUS	Adjust for focused display
SCALE ILLUM	As desired
<b>Vertical controls (both channels if applicable)</b>	
VOLTS/DIV	20 mV
VARIABLE	CAL
POSITION	Midrange
AC GND DC	AC
MODE	CH 1
TRIGGER	NORM
INVERT	Pushed in
<b>Triggering controls (both A and B if applicable)</b>	
LEVEL	0
SLOPE	—
COUPLING	AC
SOURCE	INT
<b>Sweep controls</b>	
DELAY-TIME MULTIPLIER	0.50
A TIME/DIV	1 mSEC
B TIME/DIV	1 mSEC
A VARIABLE	CAL
A SWEEP MODE	NORM TRIG
B SWEEP MODE	B TRIGGERABLE AFTER DELAY TIME

HORIZ DISPLAY	A
MAG	OFF
A SWEEP LENGTH	FULL
POSITION	Midrange
POWER	ON

<b>Side-panel controls</b>	
B TIME/DIV VARIABLE	CAL
CALIBRATOR	.1V

<b>Rear-panel controls</b>	
LINE VOLTAGE RANGE	HIGH

#### 4. Check Low-Voltage Power-Supply Ripple

- a. Test equipment setup is shown in Fig. 6-7.
- b. Connect the 1X probe to the test oscilloscope input.
- c. Set the test oscilloscope for a vertical deflection of 0.005 volts/division, ac coupled, at a sweep rate of 5 milliseconds/division.
- d. Check—2 millivolts peak-to-peak maximum line-frequency ripple on the -12-volt, +12-volt and +75-volt supplies while changing the autotransformer output voltage between 103, 115 and 137 volts (206, 230 and 274 volts for

230-volts nominal). Power-supply test points are shown in Fig. 6-5. Fig. 6-8 shows typical test oscilloscope display of ripple.

e. Set the LINE VOLTAGE RANGE switch to LOW.

f. Check—Power-supply ripple as in step d while changing the autotransformer output voltage between 96, 115 and 127 volts (192, 230 and 254 volts for 230-volts nominal).

g. Return autotransformer output voltage to 115 (230) volts. (If the line voltage is about 115 (230) volts, the Type 453 may be connected directly to the line; otherwise, leave the instrument connected to the autotransformer for the remainder of the procedure.)

h. Disconnect all test equipment.

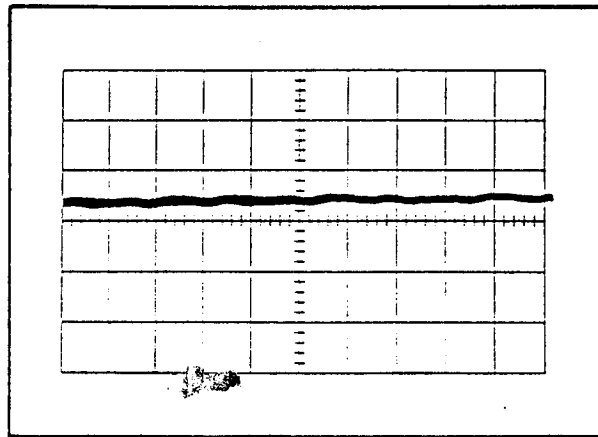

Fig. 6-8. Typical test oscilloscope display of power-supply ripple (60-cycle line). Vertical deflection, 0.005 volts/division; sweep rate, 5 milliseconds/division.

### NOTES

For Service Manuals Contact  
MAURITRON TECHNICAL SERVICES  
8 Cherry Tree Rd, Chinnor  
Oxon OX9 4QY  
Tel: 01844-351694 Fax: 01844-352554  
Email: enquiries@mauritron.co.uk

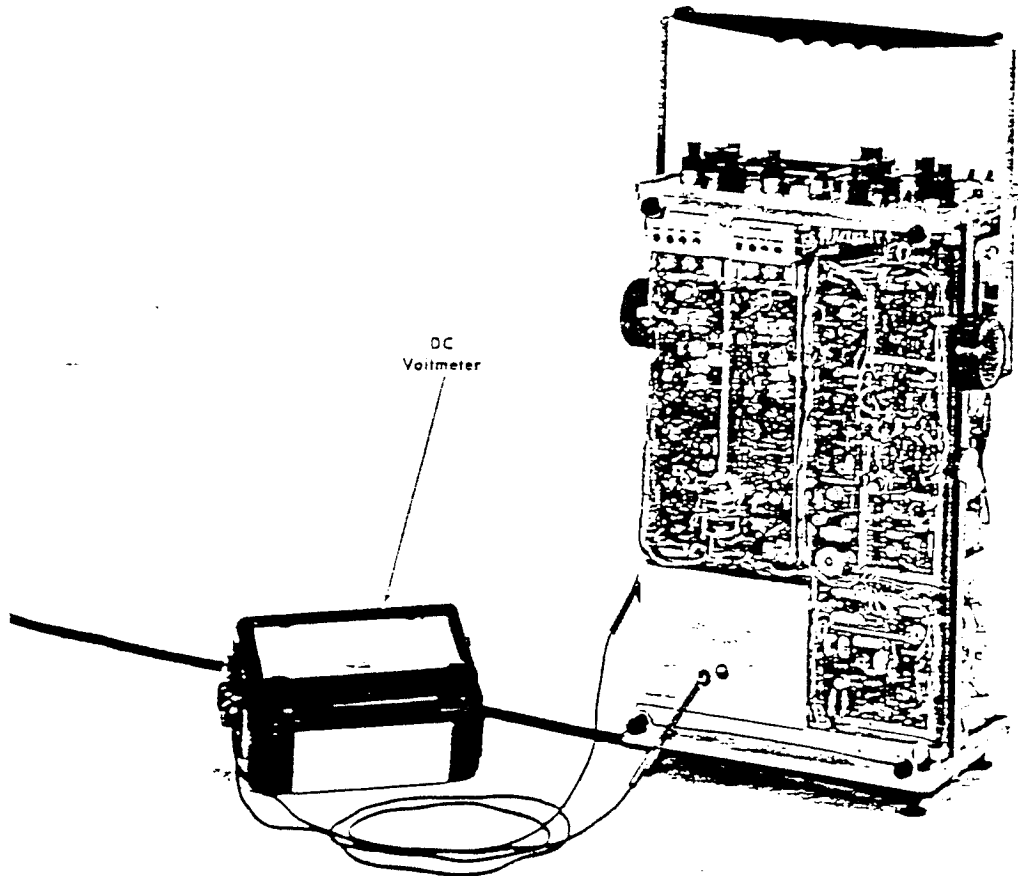

Fig. 6-9. Test equipment setup for steps 5 and 6.

**Crt controls**

INTENSITY                      Counterclockwise  
 FOCUS                              Adjust for focused display  
 SCALE ILLUM                      As desired

**Vertical controls (both channels if applicable)**

VOLTS/DIV                      20 mV  
 VARIABLE                        CAL  
 POSITION                          Midrange  
 AC GND DC                      AC  
 MODE                              CH 1  
 TRIGGER                         NORM  
 INVERT                          Pushed in

**Triggering controls (both A and B if applicable)**

LEVEL                              0  
 SLOPE                              +  
 COUPLING                        AC  
 SOURCE                            INT

**Sweep controls**

DELAY-TIME MULTIPLIER      0.50  
 A TIME/DIV                      1 mSEC  
 B TIME/DIV                      1 mSEC  
 A VARIABLE                      CAL  
 A SWEEP MODE                      NORM TRIG  
 B SWEEP MODE                      B TRIGGERABLE AFTER  
    DELAY TIME  
 HORIZ DISPLAY                      A  
 MAG                                OFF  
 A SWEEP LENGTH                      FULL  
 POSITION                          Midrange  
 POWER                            ON

**Side-panel controls**

B TIME/DIV VARIABLE      CAL  
 CALIBRATOR                      .1V

**Rear-panel controls**

LINE VOLTAGE RANGE      HIGH

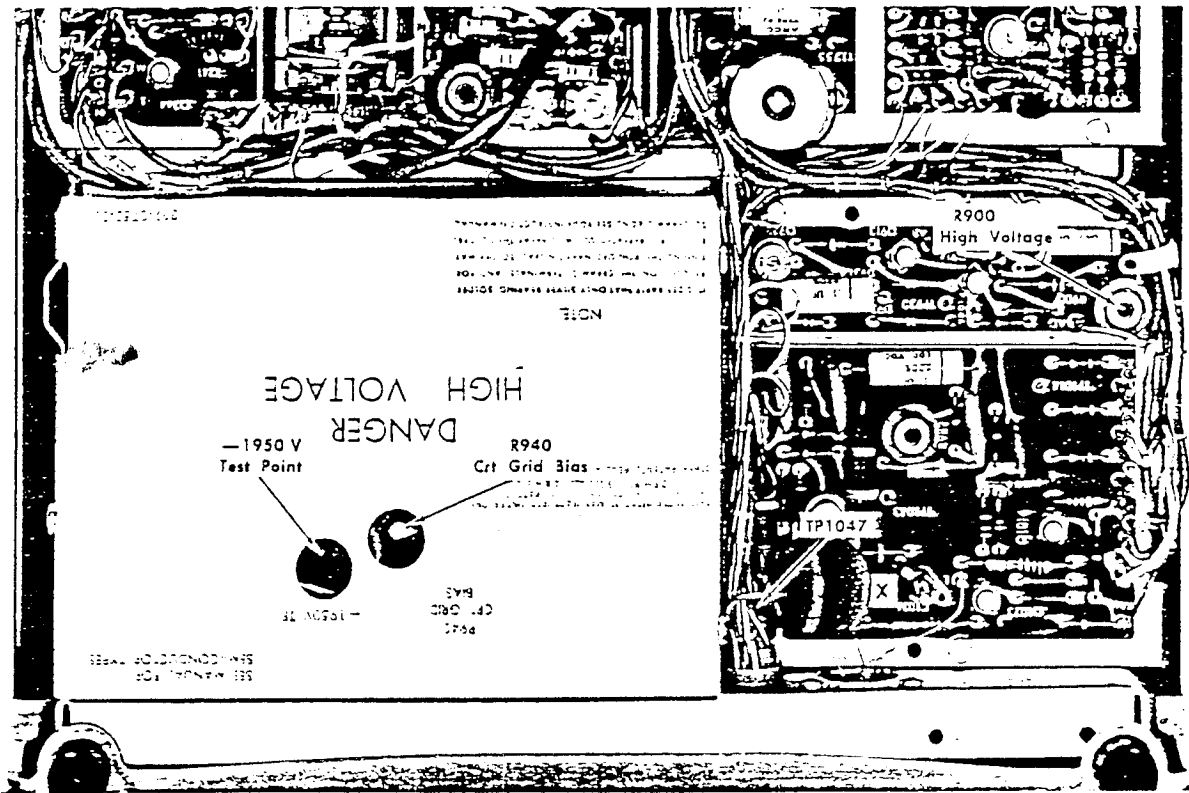

Fig. 6-10. Location of adjustments and test points on Z Axis Amplifier board.

5. Adjust High-Voltage Supply



- a. Test equipment setup is shown in Fig. 6-9.
- b. Connect the dc voltmeter from the -1950 V test point (see Fig. 6-10) to chassis ground.
- c. Check—Meter reading; -1950 volts,  $\pm 60$  volts.<sup>2</sup>
- d. Adjust—High-Voltage adjustment, R900 (see Fig. 6-10), for -1950 volts.
- e. Interaction—May affect operation of all circuits within the Type 453.

<sup>2</sup>If the precision dc voltmeter and precision divider are used for this step, meter reading should be -1950 volts,  $\pm 20$  volts.

6. Adjust Crt Grid Bias



- a. Test equipment setup is shown in Fig. 6-9.
- b. Connect the dc voltmeter from TP1047 (Z Axis Amplifier board; see Fig. 6-10) to chassis ground.
- c. Set the A SWEEP MODE switch to SINGLE SWEEP.
- d. Set the INTENSITY control for a meter reading of -12 volts.
- e. Adjust—Crt Grid Bias adjustment, R940 (see Fig. 6-10), so the spot just disappears.
- f. Interaction—Check steps 7, 56 and 59.
- g. Disconnect all test equipment.

For Service Manuals Contact  
 MAURITRON TECHNICAL SERVICES  
 8 Cherry Tree Rd, Chinnor  
 Oxon OX9 4QY  
 Tel:- 01844-351694 Fax:- 01844-352554  
 Email:- enquiries@mauritron.co.uk

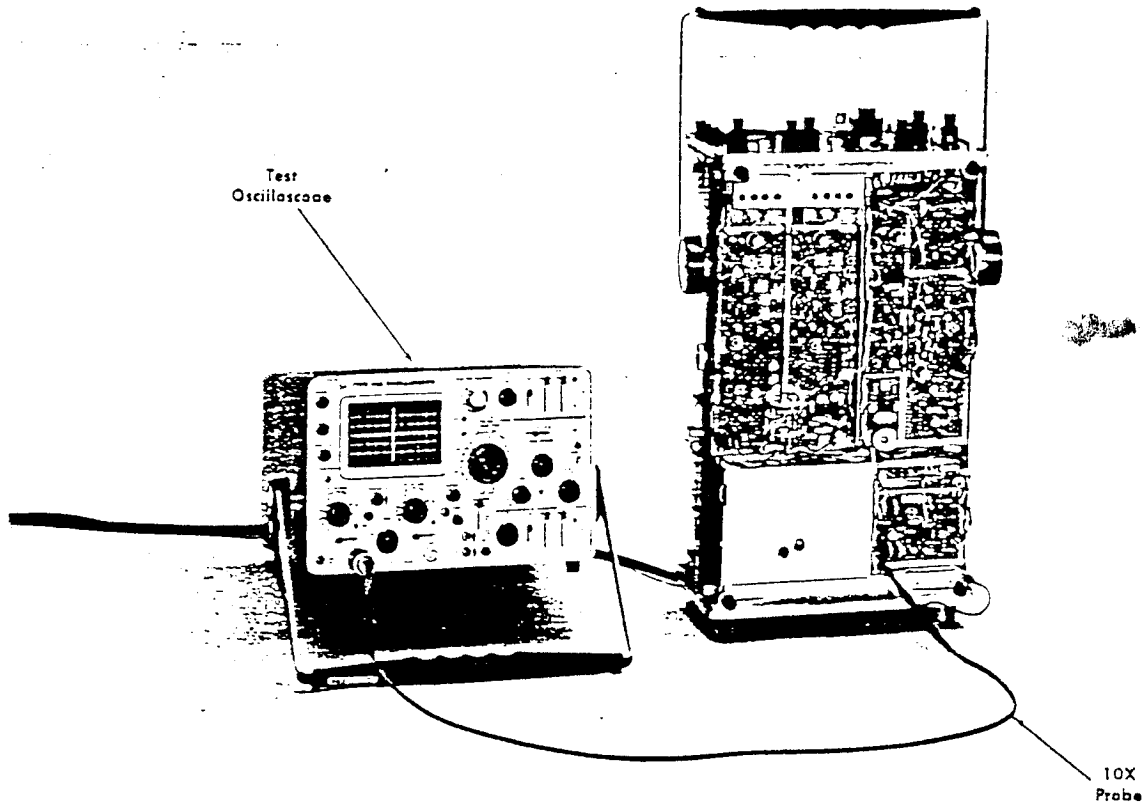

Fig. 6-11. Initial test equipment setup for Steps 7 and 8.

Crt controls

INTENSITY  
FOCUS  
SCALE ILLUM

Midrange

Adjust for focused display  
As desired

Sweep controls

DELAY-TIME MULTIPLIER	0.50
A TIME/DIV	.1 $\mu$ SEC
B TIME/DIV	.1 $\mu$ SEC
A VARIABLE	CAL
A SWEEP MODE	AUTO TRIG
B SWEEP MODE	B TRIGGERABLE AFTER DELAY TIME
HORIZ DISPLAY	A
MAG	OFF
A SWEEP LENGTH	FULL
POSITION	Midrange
POWER	ON

Vertical controls (both channels if applicable)

VOLTS/DIV	20 mV
VARIABLE	CAL
POSITION	Midrange
AC GND DC	AC
MODE	CH 1
TRIGGER	NORM
INVERT	Pushed in

Triggering controls (both A and B if applicable)

LEVEL	J
SLOPE	—
COUPLING	AC
SOURCE	INT

Side-panel controls

B TIME/DIV VARIABLE	CAL
CALIBRATOR	.1V

Rear-panel controls

LINE VOLTAGE RANGE	HIGH
--------------------	------

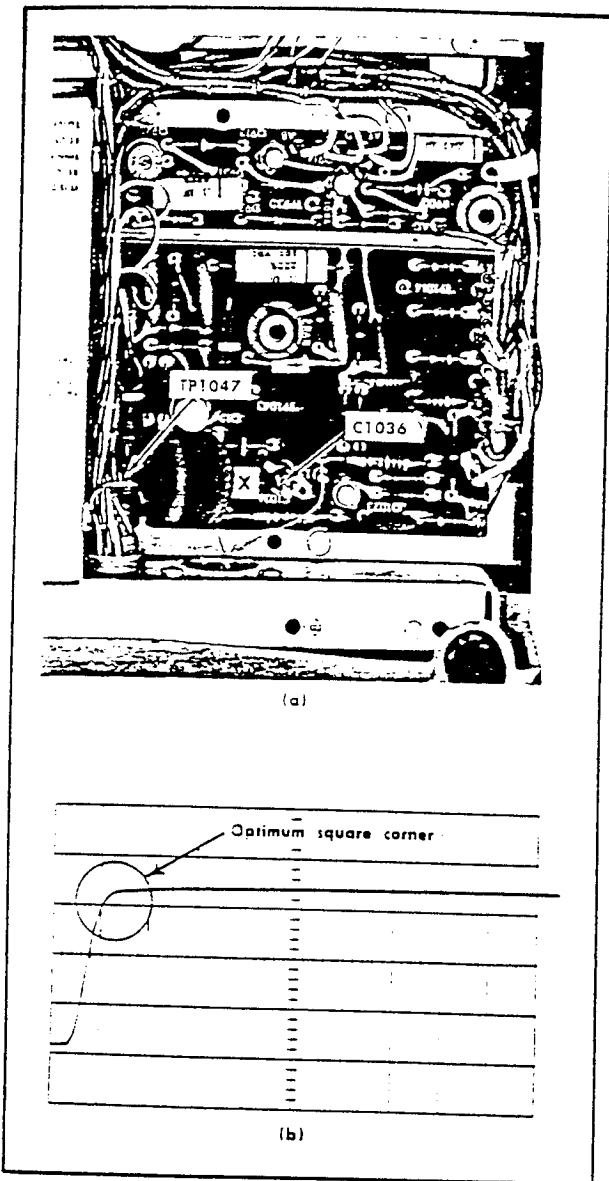

Fig. 6-12. (a) Location of TP1047 and C1036; (b) Typical test oscilloscope display showing correct adjustment of C1036 (vertical deflection, 0.5 volt/division; sweep rate, 0.1 microsecond/division).

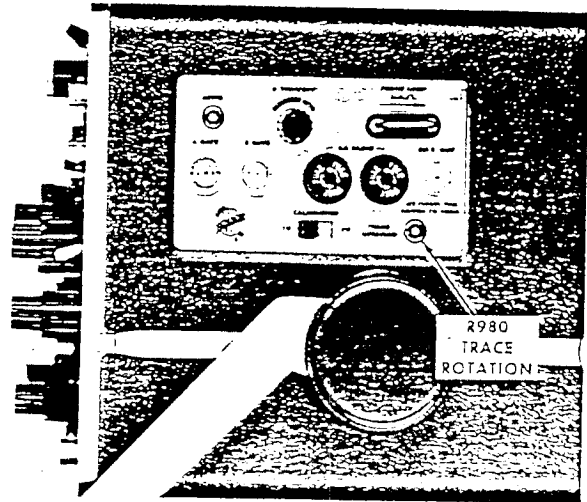

Fig. 6-13. Location of Trace Rotation adjustment (side panel).

### 7. Adjust Z Axis Compensation 0

- a. Test equipment setup is shown in Fig. 6-11.
- b. Connect the test oscilloscope 10X probe to TP1047 (see Fig. 6-12a).
- c. Check—Test oscilloscope display for optimum square corner on square-wave display (see Fig. 6-12b).
- d. Adjust—C1036 (see Fig. 6-12a) for best square corner on the square-wave display.
- e. Disconnect all test equipment.

### 8. Adjust Trace Alignment 0

- a. Turn the Channel 1 POSITION control to move the trace to the horizontal centerline.
- b. Check—The trace should be parallel with the centerline.
- c. Adjust—TRACE ROTATION adjustment, R980 (see Fig. 6-13), so the trace is parallel to the horizontal graticule lines.

### NOTES

For Service Manuals Contact  
**MAURITRON TECHNICAL SERVICES**  
 8 Cherry Tree Rd. Chipper  
 Oxon OX9 4OY  
 Tel: 01844-351694 Fax: 01844-352554  
 Email: enquiries@mauritron.co.uk



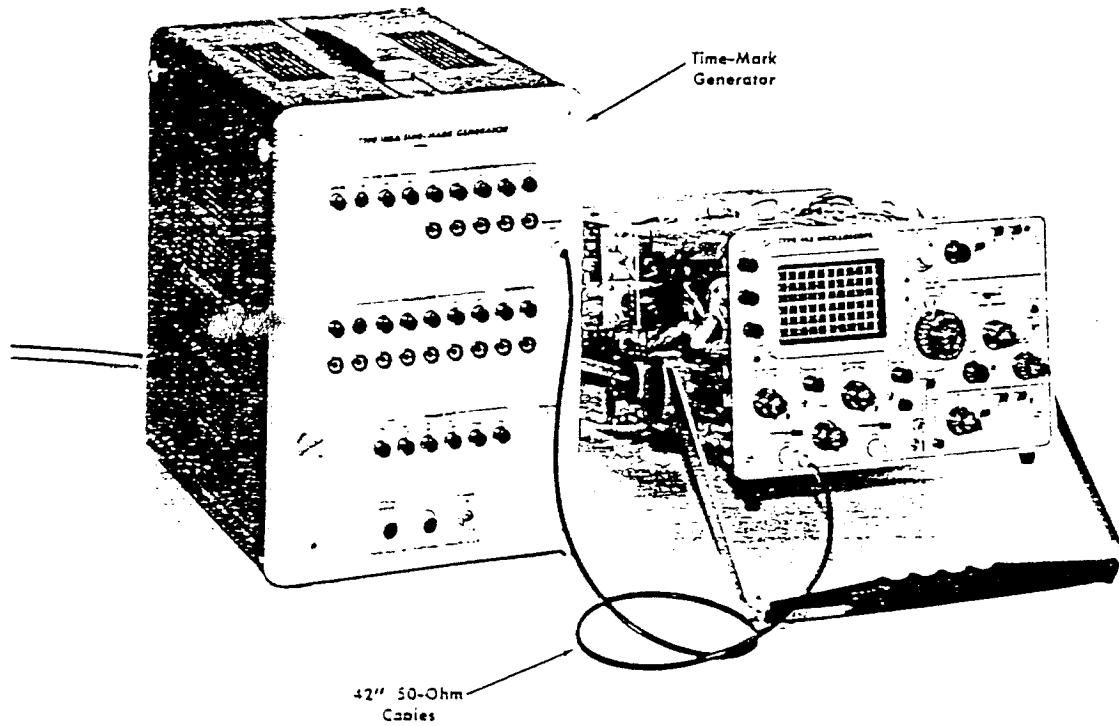

Fig. 6-14. Initial test equipment setup for steps 9 through 13.

<b>Crt controls</b>		<b>B SWEEP MODE</b>	<b>B TRIGGERABLE AFTER DELAY TIME</b>
INTENSITY	Midrange	HORIZ <sup>2</sup> DISPLAY	A
FOCUS	Adjust for focused display	MAG	OFF
SCALE ILLUM	As desired	A SWEEP LENGTH	FULL
<b>Vertical controls (both channels if applicable)</b>		POSITION	Midrange
VOLTS/DIV	20 mV	POWER	ON
VARIABLE	CAL	<b>Side-panel controls</b>	
POSITION	Midrange	B TIME/DIV VARIABLE	CAL
AC GND DC	AC	CALIBRATOR	1V
MODE	CH 1	<b>Rear-panel controls</b>	
TRIGGER	NORM	LINE VOLTAGE RANGE	HIGH
INVERT	Pushed in		
<b>Triggering controls (both A and B if applicable)</b>			
LEVEL	0		
SLOPE	+		
COUPLING	AC		
SOURCE	INT		
<b>Sweep controls</b>			
DELAY-TIME MULTIPLIER	0.50		
A TIME/DIV	1 mSEC		
B TIME/DIV	1 mSEC		
A VARIABLE	CAL		
A SWEEP MODE	AUTO TRIG		

### 9. Adjust Astigmatism ①

- a. Test equipment setup is shown in Fig. 6-14.
- b. Connect the time-mark generator (Type 180A) to Channel 1 INPUT through a 42-inch 50-ohm cable.
- c. Set the time-mark generator for output markers of 1 millisecond and 100 microsecond.
- d. Set the CH 1 VOLTS/DIV switch so the markers extend from the bottom to the top of the graticule area.

- e. Set the A Triggering LEVEL control for a stable display.
- f. Check—Markers should be well defined with optimum setting of FOCUS control.
- g. Adjust—FOCUS control and ASTIG adjustment, R985 (see Fig. 6-15), for best definition of markers.

### 10. Adjust Y Axis Alignment 0

- a. Test setup is given in step 9.
- b. Check—The markers should be parallel to the vertical centerline.
- c. Adjust—Y Axis Align adjustment, R989 (see Fig. 6-16), to align the markers with the centerline.

### 11. Adjust Crt Geometry 0

- a. Test setup is given in step 9.
- b. Check—Geometry at left and right edges of the graticule. Fig. 6-17 shows typical display of good geometry as well as examples of poor geometry.

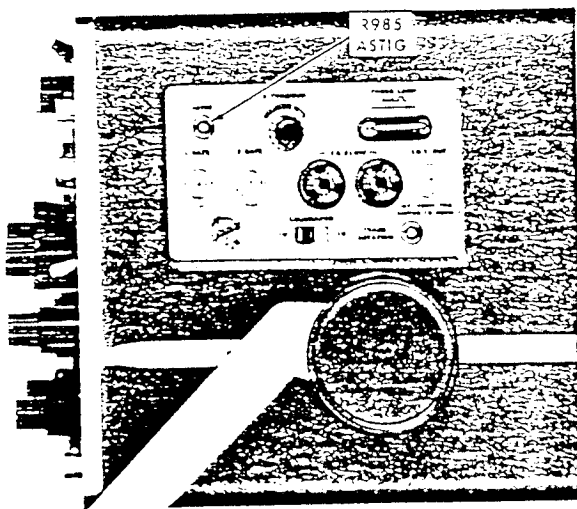

Fig. 6-15. Location of Astigmatism adjustment (side panel).

- c. Adjust—Geometry adjustment, R982 (see Fig. 6-17d), for minimum bowing of the trace at the left and right edges of the graticule.
- d. Interaction—Recheck step 10.
- e. Disconnect the time-mark generator.
- f. Position the trace to the top of the graticule area.

- g. Check—Deviation from straight line should not exceed 0.1 division.
- h. Position the trace to the bottom of the graticule area.
- i. Check—Deviation from straight line should not exceed 0.1 division.

### 12. Adjust Channel 1 and 2 Step Attenuator 0 Balance

- a. Position the trace to the horizontal centerline with the Channel 1 POSITION control.
- b. Set both AC GND DC switches to GND.

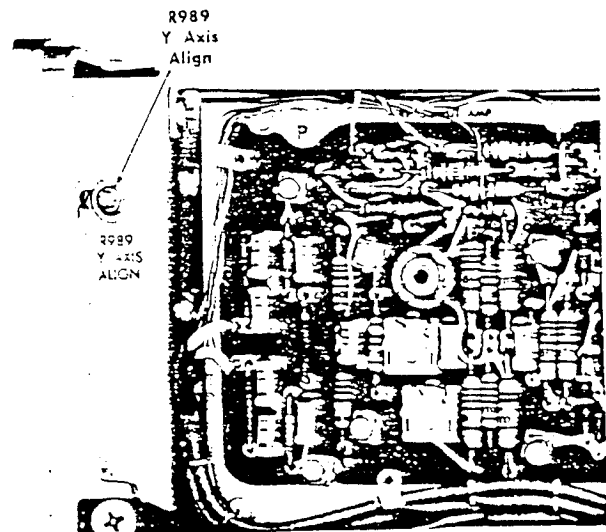

Fig. 6-16. Location of Y Axis Alignment adjustment (left side).

- c. Check—Change the CH 1 VOLTS/DIV switch from 20 mV to 5 mV. Trace should not move vertically.
- d. Adjust—Channel 1 STEP ATTEN BAL adjustment, R30 (see Fig. 6-18), for no trace shift as the CH 1 VOLTS/DIV switch is changed from 20 mV to 5 mV.
- e. Set the MODE switch to CH 2.
- f. Position the trace to the horizontal centerline with the Channel 2 POSITION control.
- g. Check—Change the CH 2 VOLTS/DIV switch from 20 mV to 5 mV. Trace should not move vertically.
- h. Adjust—Channel 2 STEP ATTEN BAL adjustment, R130 (see Fig. 6-18), for no trace shift as the CH 2 VOLTS/DIV switch is changed from 20 mV to 5 mV.

For Service Manuals Contact  
 MAURITRON TECHNICAL SERVICES  
 8 Cherry Tree Rd, Chinnor  
 Oxon OX9 4OY  
 Tel: 01844-351694 Fax: 01844-352554  
 Email: enquiries@mauritron.co.uk

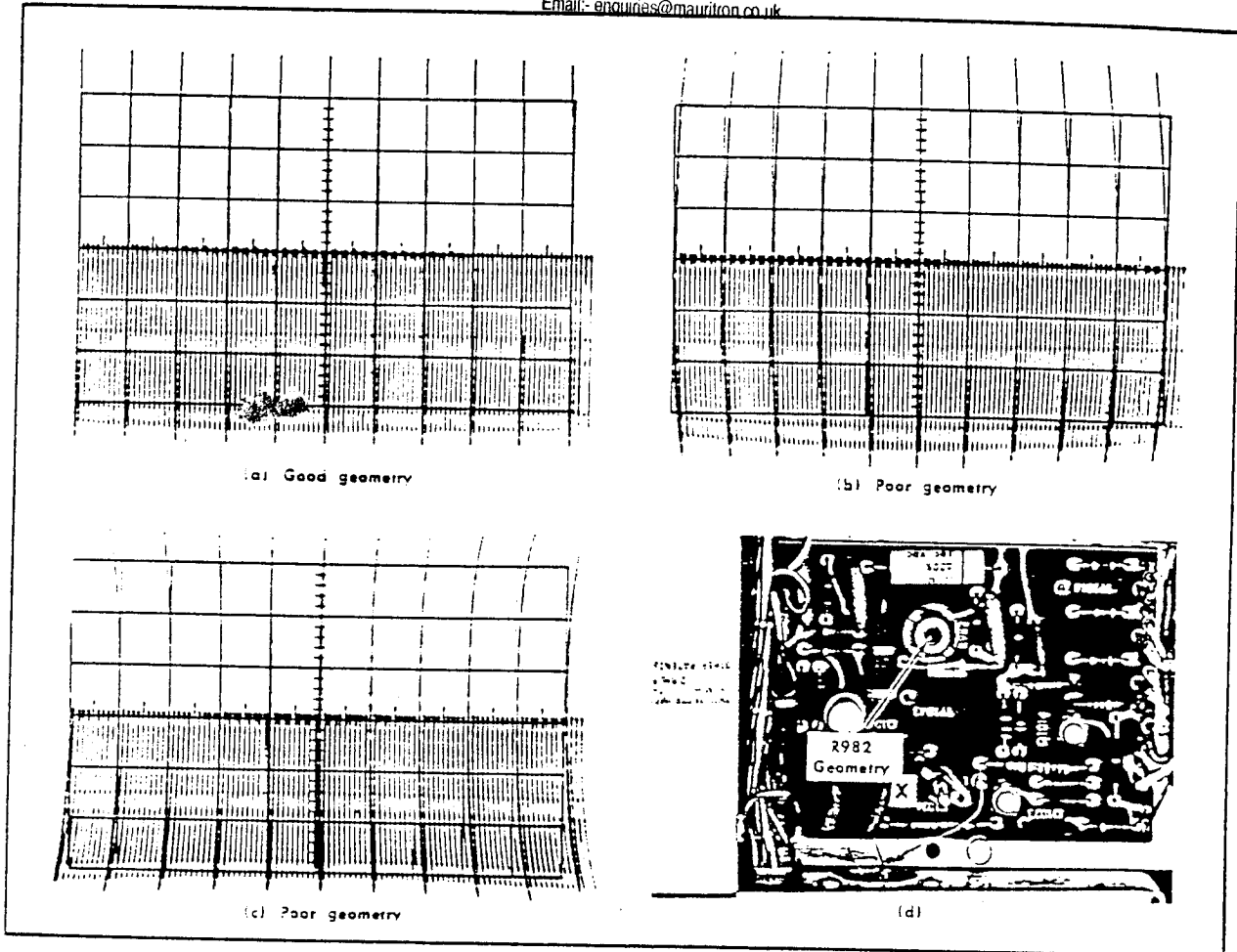

Fig. 6-17. (a) Typical crt display showing good geometry; (b) and (c) Poor geometry; (d) Location of Geometry adjustment (Z Axis Amplifier board).

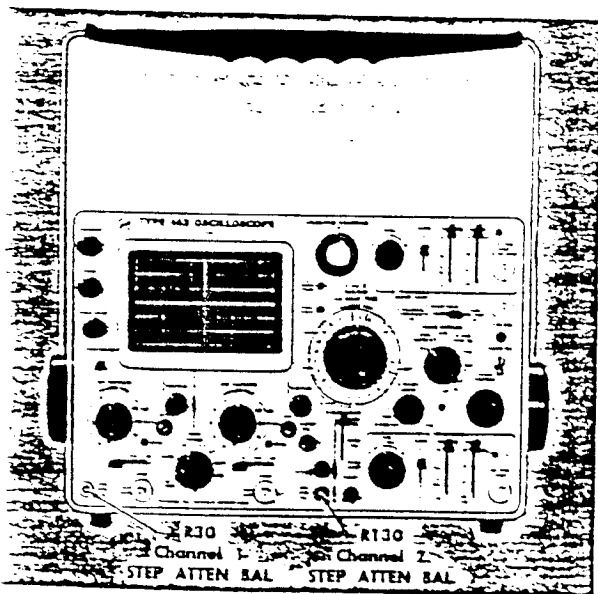

Fig. 6-18. Location of Channel 1 and 2 Step Attenuator Balance adjustments (front panel).

### 13. Adjust Channel 1 and 2 Position Center 0

- a. Connect the dc voltmeter to the Ch 2 position center test point (pin connector 'AH') on the Vertical Preamp board (see Fig. 6-19).
- b. Set the Channel 2 POSITION control to electrical center by adjusting for 0 volts on the meter.
- c. Check—Trace should be at the horizontal centerline.
- d. Adjust—Ch 2 Position Center adjustment, R155 (see Fig. 6-19), to position the trace to the centerline.
- e. Set the MODE switch to CH 1.
- f. Connect the dc voltmeter to the Ch 1 position center test point (pin connector 'AB') on the Vertical Preamp board (see Fig. 6-19).
- g. Set the Channel 1 POSITION control to electrical center by adjusting for 0 volts on the meter.
- h. Check—Trace should be at the horizontal centerline.
- i. Adjust—Ch 1 Position Center adjustment, R55 (see Fig. 6-19), to position the trace to the centerline.
- j. Interaction—Recheck step 12.
- k. Disconnect all test equipment.

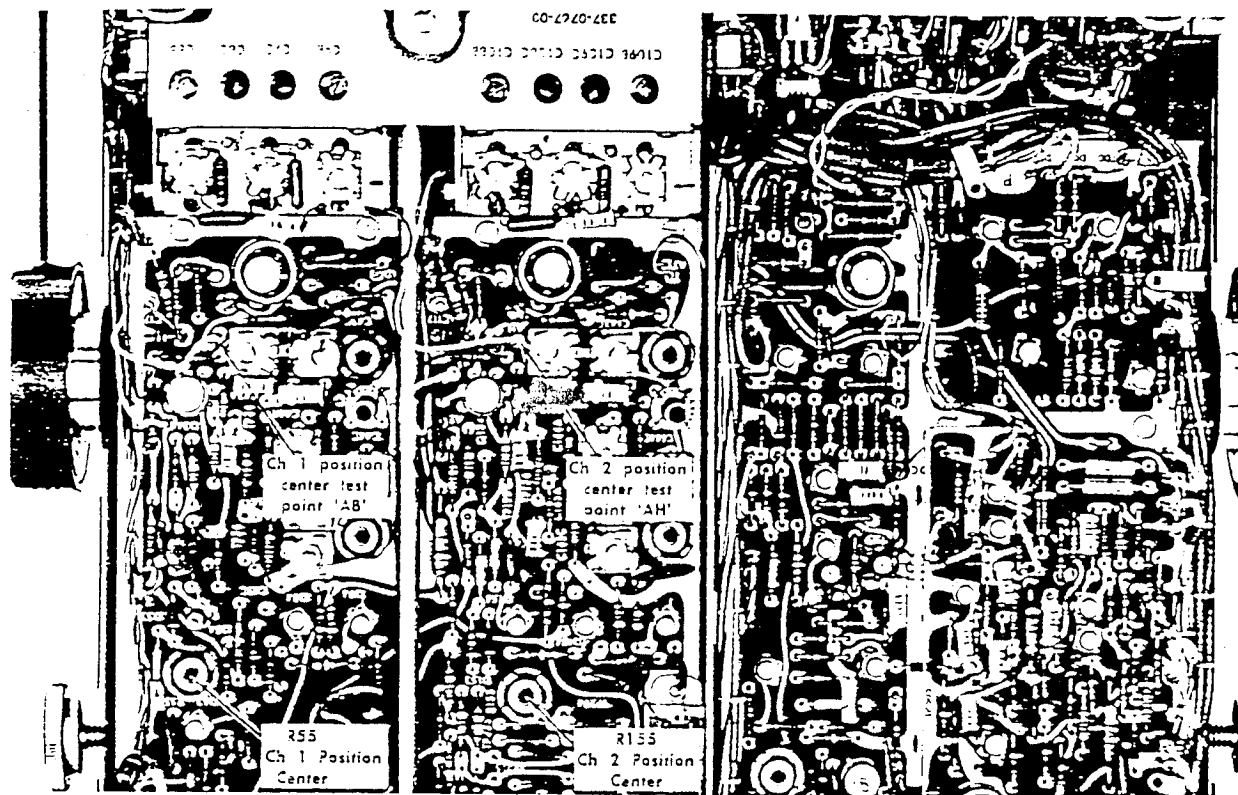

Fig. 6-19. Location of Channel 1 and 2 position center test points and adjustments (Vertical Preamp board).

### NOTES

For Service Manuals Contact  
MAURITRON TECHNICAL SERVICES  
8 Cherry Tree Rd, Chinnor  
Oxon OX9 4QY  
Tel: 01844-351694 Fax: 01844-352554  
Email: enquires@mauritron.co.uk

Calibration—Type 453

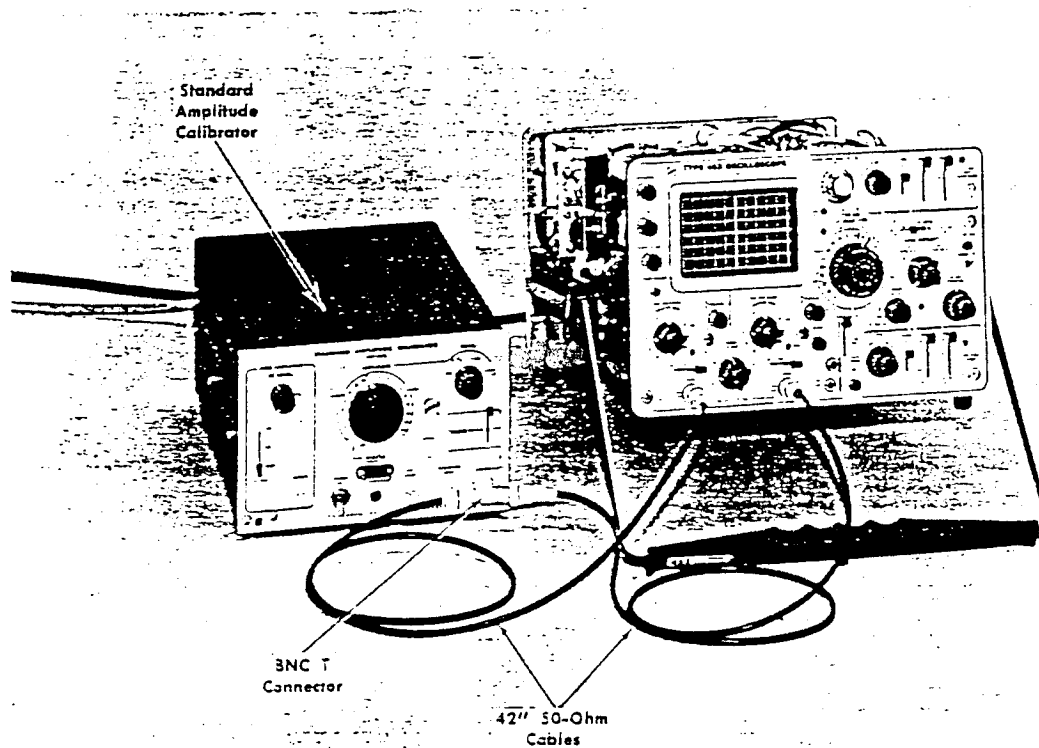

Fig. 6-20. Initial test equipment setup for steps 14 through 20.

<b>Crt controls</b>		A VARIABLE	CAL
INTENSITY	Midrange	A SWEEP MODE	AUTO TRIG
FOCUS	Adjust for focused display	B SWEEP MODE	B TRIGGERABLE AFTER DELAY TIME
SCALE ILLUM	As desired	HORIZ DISPLAY	A
		MAG	OFF
<b>Vertical controls (both channels if applicable)</b>		A SWEEP LENGTH	FULL
VOLTS/DIV	20 mV	POSITION	Midrange
VARIABLE	CAL	POWER	ON
POSITION	Midrange	<b>Side-panel controls</b>	
AC GND DC	DC	B TIME/DIV VARIABLE	CAL
MODE	CH 1	CALIBRATOR	.1V
TRIGGER	NORM	<b>Rear-panel controls</b>	
INVERT	Pushed in	LINE VOLTAGE RANGE	HIGH
<b>Triggering controls (both A and B if applicable)</b>			
LEVEL	0		
SLOPE	+		
COUPLING	AC		
SOURCE	INT		
<b>Sweep controls</b>			
DELAY-TIME MULTIPLIER	0.50		
A TIME/DIV	.5 mSEC		
B TIME/DIV	.5 mSEC		

14. Adjust Channel 1 and 2 Gain ①

a. Test equipment setup is shown in Fig. 6-20.

b. Connect the standard amplitude calibrator (067-0502-00) output connector to both INPUT 1 and 2 through a BNC T connector and two 42-inch 50-ohm cables.

c. Set the standard amplitude calibrator for a 0.1-volt square-wave output.

- d. Position the display to the center of the graticule with the Channel 1 POSITION control.
- e. Check—Crt display exactly five divisions in amplitude (see Fig. 6-21a).
- f. Adjust—Channel 1 GAIN adjustment, R90 (see Fig. 6-21b), for exactly five divisions of deflection.
- g. Set the MODE switch to ADD.
- h. Pull the INVERT switch out.
- i. Check—Crt display for straight line.
- j. Adjust—Channel 2 GAIN adjustment, R190 (see Fig. 6-21b), for straight line display.

### 15. Check Added Mode Operation

- a. Test setup is given in step 14.
- b. Push the INVERT switch in.

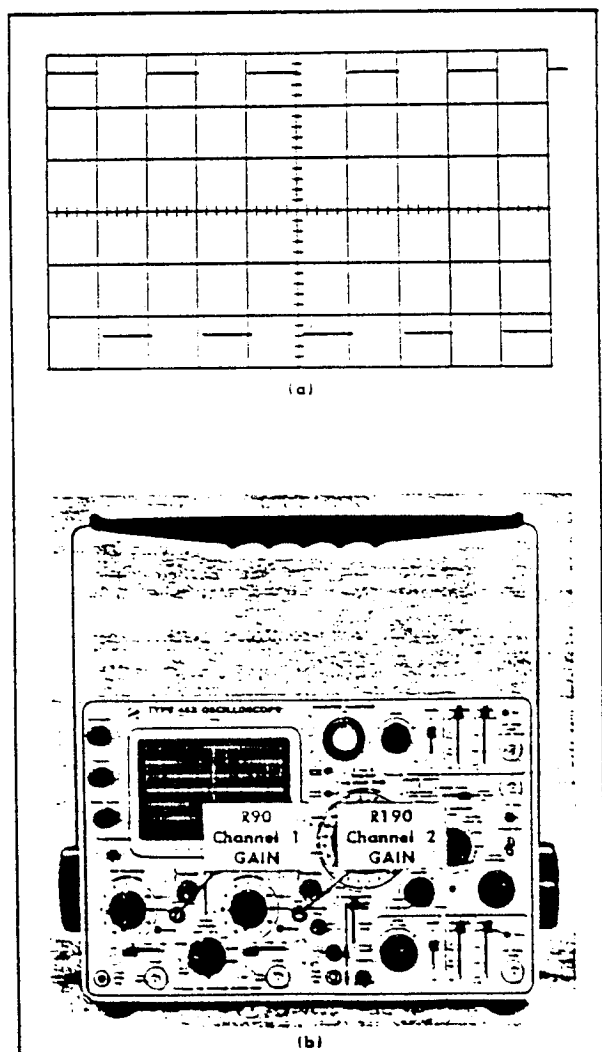

Fig. 6-21. (a) Typical crt display showing correct gain adjustments. (b) Location of Channel 1 and 2 GAIN adjustments (front panel).

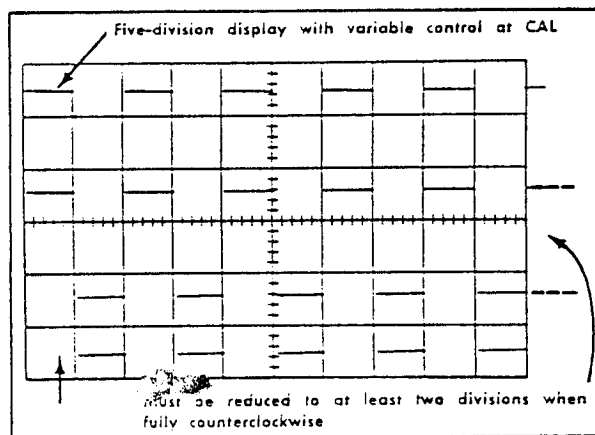

Fig. 6-22. Typical crt display showing correct VARIABLE VOLTS/DIV control range (double exposure).

- c. Set the standard amplitude calibrator for a 0.05-volt square-wave output.

- a. Check—Crt display five divisions in amplitude.

### 16. Check Channel 1 and 2 Deflection Accuracy

- a. Test setup is given in step 15.
- b. Set the MODE switch to CH 1.
- c. Set the Channel 2 AC GND DC switch to GND.
- d. Check—Using the CH 1 VOLTS/DIV switch and standard amplitude calibrator settings given in Table 6-1, check vertical deflection within  $\pm 3\%$  in each position of the CH 1 VOLTS/DIV switch.
- e. Set the MODE switch to CH 2.
- f. Set the Channel 1 AC GND DC switch to GND and Channel 2 AC GND DC switch to DC.
- g. Check—Using the CH 2 VOLTS/DIV switch and standard amplitude calibrator settings given in Table 6-1, check vertical deflection within  $\pm 3\%$  in each position of the CH 2 VOLTS/DIV switch.

TABLE 6-1

VOLTS/DIV Switch Setting	Standard Amplitude Calibrator Output	Vertical Deflection In Divisions	Maximum Error For $\pm 3\%$ Accuracy (divisions)
5 mV	20 millivolts	4	$\pm 0.12$
10 mV	50 millivolts	5	$\pm 0.15$
20 mV	0.1 volt	5	Set exactly
50 mV	0.2 volt	4	$\pm 0.12$
.1	0.5 volt	5	$\pm 0.15$
.2	1 volt	5	$\pm 0.15$
.5	2 volts	4	$\pm 0.12$
1	5 volts	5	$\pm 0.15$
2	10 volts	5	$\pm 0.15$
5	20 volts	4	$\pm 0.12$
10	50 volts	5	$\pm 0.15$

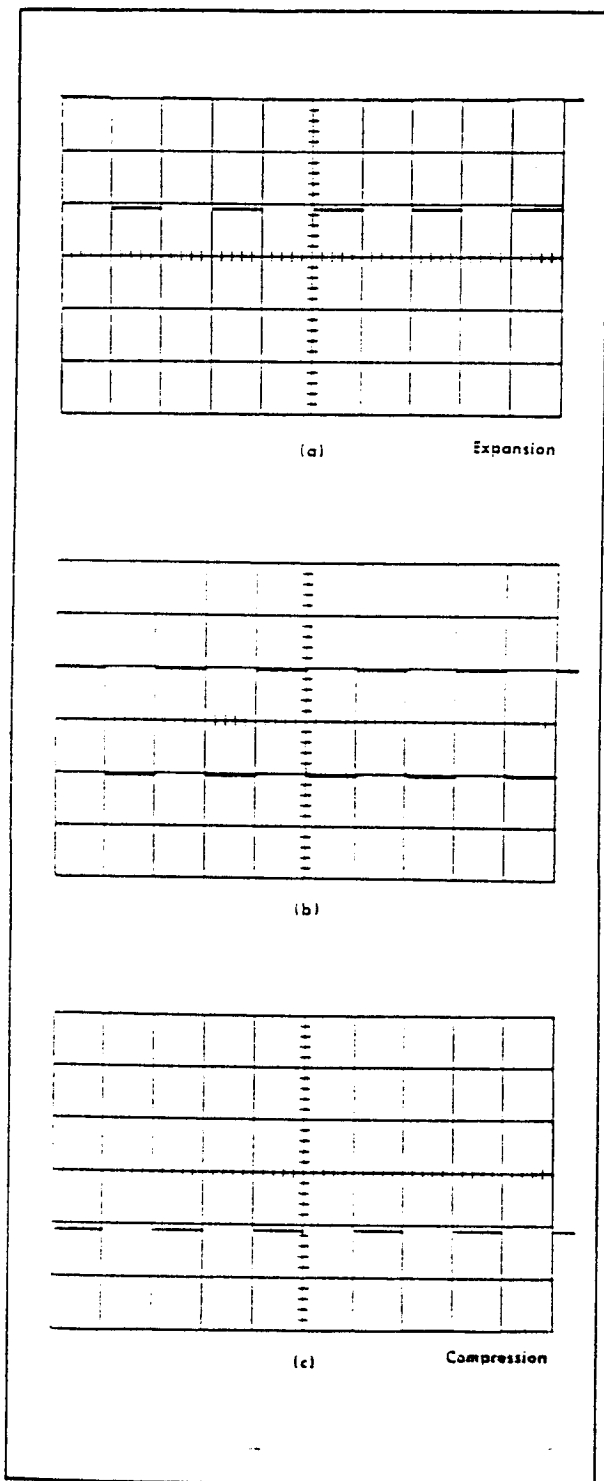

Fig. 6-23. Typical CRT display showing acceptable compression and expansion. Waveform (a) shows expansion; waveform (c) shows compression.

### 17. Check Channel 1 and 2 Variable Volts/Division Range

- a. Test setup is given in step 16.
- b. Set the standard amplitude calibrator for a 0.1-volt square-wave output.
- c. Change the following control settings:
 

VOLTS/DIV	20 mV
MODE	CH 1
AC GND DC	AC
- f. Check—Turn the Channel 1 VARIABLE VOLTS/DIV control fully counterclockwise. Display should be reduced to 2 divisions or less (see Fig. 6-22). UNCAL light must be on when VARIABLE control is not in CAL position.

g. Set the MODE switch to CH 2.

h. Check—Turn the Channel 2 VARIABLE VOLTS/DIV control fully counterclockwise. Display should be reduced to 2 divisions or less (see Fig. 6-22). UNCAL light must be on when VARIABLE control is not in CAL position.

### 18. Check Compression and Expansion

- a. Test setup is given in step 17.
- b. Set the standard amplitude calibrator for a 50-millivolt square-wave output.
- c. Position the display to the center of the graticule with the Channel 2 POSITION control.
- d. Set the Channel 2 VARIABLE VOLTS/DIV control for exactly 2 divisions of deflection.
- e. Position the top of the display to the top graticule line.
- f. Check—Compression or expansion should not exceed 0.15 division (see Fig. 6-23).
- g. Position the bottom of the display to the bottom graticule line.
- h. Check—Compression or expansion should not exceed 0.15 division (see Fig. 6-23).
- i. Set the MODE switch to CH 1.
- j. Position the display to the center of the graticule with the Channel 1 POSITION control.
- k. Set the Channel 1 VARIABLE VOLTS/DIV control for exactly 2 divisions of deflection.
- l. Position the top of the display to the top graticule line.

m. Check—Compression or expansion should not exceed 0.15 division (see Fig. 6-23).

n. Position the bottom of the display to the bottom graticule line.

o. Check—Compression or expansion should not exceed 0.15 division (see Fig. 6-23).

p. Disconnect all test equipment.

**19. Check Trace Shift Due to Input Grid Current**

a. Change the following control settings:

VOLTS/DIV	5 mV
VARIABLE	CAL
AC GND DC	GND

b. Position the trace to the horizontal centerline with the Channel 1 POSITION control.

c. Check—Set the AC GND DC switch to DC and note trace shift; should not exceed 0.4 division.

d. Set the MODE switch to CH 2.

e. Position the trace to the horizontal centerline with the Channel 2 POSITION control.

f. Check—Set the AC GND DC switch to DC and note trace shift; should not exceed 0.4 division.

**20. Check Alternate Operation**

a. Set the MODE switch to ALT.

b. Position the traces about 2 divisions apart.

c. Turn the TIME/DIV switch throughout its range.

d. Check—Trace alternation between Channel 1 and 2 at all sweep rates. At faster sweep rates, alternation will not be apparent; display will appear as two traces on the screen.

**NOTES**

---

---

---

---

---

---

---

---

---

---

---

---

---

---

---

---

---

---

---

---

---

---

---

---

For Service Manuals Contact  
MAURITRON TECHNICAL SERVICES  
8 Cherry Tree Rd, Chinnor  
Oxon OX9 4QY  
Tel: 01844 351694 Fax: 01844-352554  
Email: enquiries@mauritron.co.uk



Calibration—Type 453

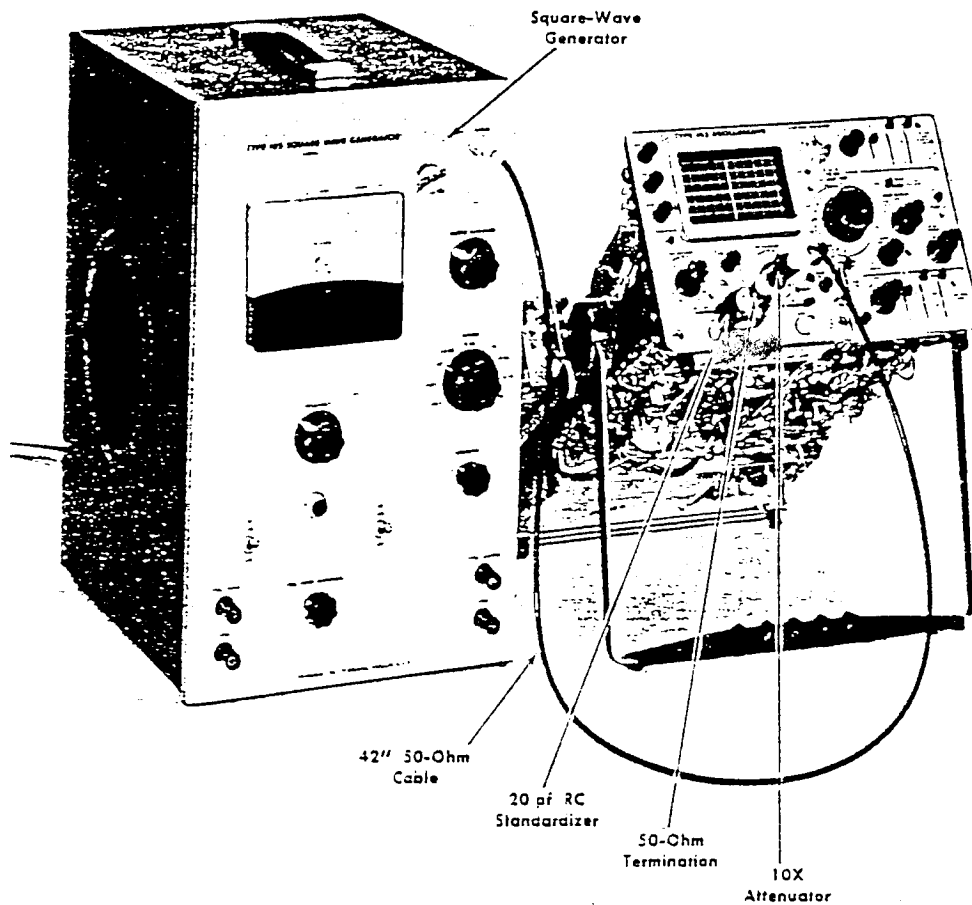

Fig. 6-24. Initial test equipment setup for steps 21 and 22.

<b>Crt controls</b>		<b>B TIME/DIV</b>	.2 mSEC
INTENSITY	Midrange	A VARIABLE	CAL
FOCUS	Adjust for focused display	A SWEEP MODE	AUTO TRIG
SCALE ILLUM	As desired	B SWEEP MODE	B TRIGGERABLE AFTER DELAY TIME
<b>Vertical controls (both channels if applicable)</b>		HORIZ DISPLAY	A
VOLTS/DIV	20 mV	MAG	OFF
VARIABLE	CAL	A SWEEP LENGTH	FULL
POSITION	Midrange	POSITION	Midrange
AC GND DC	DC	POWER	ON
MODE	CH 1	<b>Side-panel controls</b>	
TRIGGER	NORM	B TIME/DIV VARIABLE	CAL
INVERT	Pushed in	CALIBRATOR	.1V
<b>Triggering controls (both A and B if applicable)</b>		<b>Rear-panel controls</b>	
LEVEL	Adjust for stable display	LINE VOLTAGE RANGE	HIGH
SLOPE	+		
COUPLING	AC		
SOURCE	INT		
<b>Sweep controls</b>		<b>21. Adjust Channel 1 Volts/Division Compensation</b>	①
DELAY-TIME MULTIPLIER	0.50	a. Test equipment setup is shown in Fig. 6-24.	
A TIME/DIV	.2 mSEC	b. Connect the square-wave generator (Type 105) to Channel 1 INPUT through a 42-inch 50-ohm cable, 10X atten-	

uator, 50-ohm termination and 20 pf input rc standardizer, in given order.

c. Set the square-wave generator for 4 divisions of 1-kc signal.

d. Check—Crt display at each CH 1 VOLTS/DIV setting listed in Table 6-2 for optimum square corner and flat top (see Fig. 6-25a, b and c).

e. Adjust—CH 1 VOLTS/DIV compensation as shown in Table 6-2. First adjust for optimum square corner on the display and then for optimum flat top. Readjust the generator output with each setting of the CH 1 VOLTS/DIV switch to provide 4 divisions of deflection (remove 10X attenuator when necessary). Fig. 6-25d shows the location of the variable capacitors.

b. Set the MODE switch to CH 2.

c. Connect the square-wave generator to Channel 2 INPUT through a 42-inch 50-ohm cable, 10X attenuator, 50-ohm termination and 20 pf input rc standardizer, in given order.

TABLE 6-2

CH 1 VOLTS/DIV Switch Setting	Adjust For Optimum	
	Square Corner	Flat Top
20 mV		C17
50 mV	C6C	C6B
.1	C7C	C7B
.2	C3C	C3B
.5		Adjust C11 for best compromise
1		
2	C9C	C9B

## 22. Adjust Channel 2 Volts/Division Compensation

0

a. Test equipment setup is shown in Fig. 6-24.

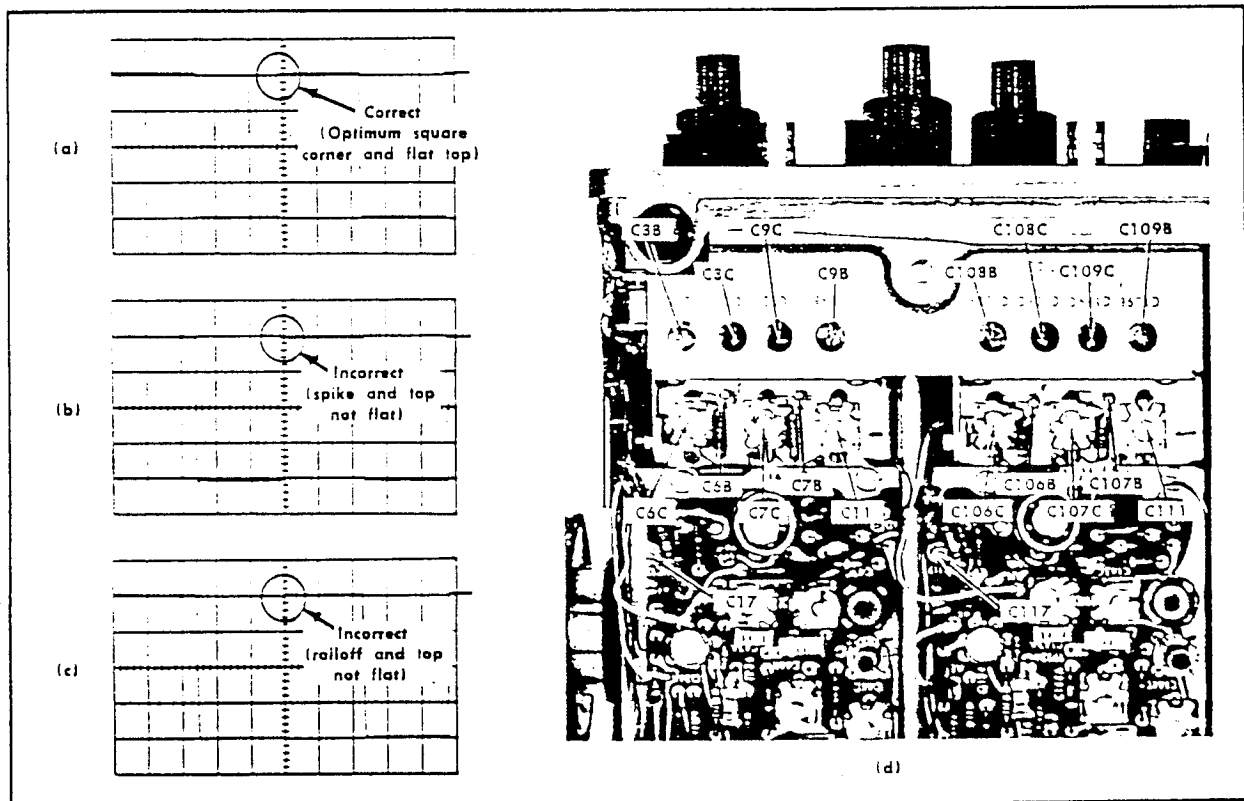

Fig. 6-25. (a) Typical crt display showing correct compensation; (b) and (c) incorrect compensation; (d) Location of variable capacitors (bottom view).

For Service Manuals Contact  
 MAURITRON TECHNICAL SERVICES  
 8 Cherry Tree Rd, Chinnor  
 Oxon OX9 4QY  
 Tel:- 01844-351694 Fax:- 01844-352554  
 Email:- enquires@mauritron.co.uk

Calibration—Type 453

d. Set the square-wave generator for 4 divisions of 1-kc signal.

e. Check—Crt display at each CH 2 VOLTS/DIV setting listed in Table 6-3 for optimum square corner and flat top (see Fig. 6-25a, b and c).

f. Adjust CH 2 VOLTS/DIV compensation as shown in Table 6-3. First adjust for optimum square corner on the display and then for optimum flat top. Readjust the generator output with each setting of the CH 2 VOLTS/DIV switch to provide 4 divisions of deflection (remove 10X attenuator when necessary). Fig. 6-25c shows the location of the variable capacitors.

g. Disconnect all test equipment.

TABLE 6-3

CH 2 VOLTS/DIV Switch Setting	Adjust For Optimum Square Corner	Flat Top
20 mV		C117
50 mV	C106C	C106B
.1	C107C	C107B
.2	C108C	C108B
.5		Adjust C111 for best compromise
1		
2	C109C	C109B

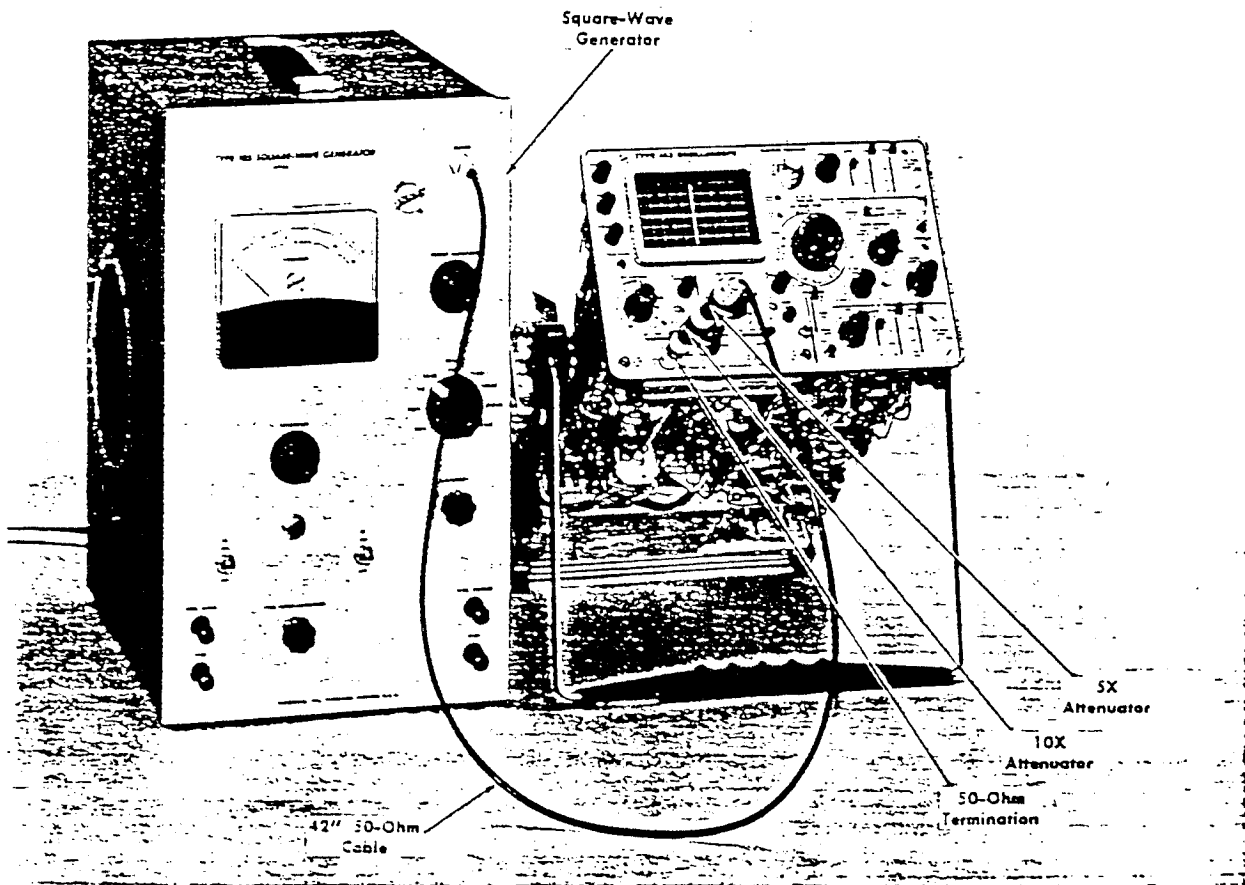

Fig. 6-26. Test equipment setup for step 23.

For Service Manuals Contact  
**MAURITRON TECHNICAL SERVICES**  
 8 Cherry Tree Rd, Chinnor  
 Oxon OX9 4QY  
 Tel: 01844-351694 Fax: 01844-352554  
 Email: enquiries@mauritron.co.uk

**Calibration—Type 453**

**Crt controls**

INTENSITY	Midrange
FOCUS	Adjust for focused display
SCALE ILLUM	As desired

**Vertical controls (both channels if applicable)**

VOLTS/DIV	20 mV
VARIABLE	CAL
POSITION	Midrange
AC GND DC	DC
MODE	CH 1
TRIGGER	NORM
INVERT	Pushed in

**Triggering controls (both A and B if applicable)**

LEVEL	Stable display
SLOPE	+
COUPLING	AC
SOURCE	INT

**Sweep controls**

DELAY-TIME MULTIPLIER	0.50
A TIME/DIV	.5 $\mu$ SEC
B TIME/DIV	.5 $\mu$ SEC
A VARIABLE	CAL
A SWEEP MODE	AUTO TRIG
B SWEEP MODE	B TRIGGERABLE AFTER DELAY TIME
HORIZ DISPLAY	A
MAG	OFF
A SWEEP LENGTH	FULL
POSITION	Midrange
POWER	ON

**Side-panel controls**

B TIME/DIV VARIABLE	CAL
CALIBRATOR	.1V

**Rear-panel controls**

LINE VOLTAGE RANGE	HIGH
--------------------	------

**23. Adjust High-Frequency Compensation** 

- a. Test equipment setup is shown in Fig. 6-26.
- b. Connect the square-wave generator to Channel 1 INPUT through the 42-inch 50-ohm cable, 5X attenuator, 10X attenuator and 50-ohm termination, in given order.
- c. Set the square-wave generator for 5 divisions of 100-kc signal.

d. Check—Crt display for optimum flat top (see Fig. 6-27a).

e. Adjust—C263 and C265 (see Fig. 6-27c) for optimum flat top.

f. Connect the square-wave generator to Channel 1 INPUT through the TU-5/105 Adapter, 42-inch 50-ohm cable, TU-5 Pulser, 2.5X attenuator and 50-ohm termination, in given order.

g. Set the square-wave generator output amplitude and the TU-5 bias control to produce a pulse.

h. Set the TIME/DIV switch to .1  $\mu$ SEC.

i. Set the MAG switch to X10.

j. Check—Crt display for optimum square corner and flat top (see Fig. 6-27b).

k. Adjust—R328, C328, C336, R45C, C45A and C45C (see Fig. 6-27d and e) for optimum square corner and flat top. To adjust R328 and R45C, advance them until ringing is apparent on the display. Then reverse the direction of adjustment until the ringing is just damped out. If the high-frequency response appears similar to Fig. 6-27b, only minor compensation of the given adjustments will be necessary. However, if the crt display indicates that the circuit is seriously misadjusted, first set the capacitors to midrange. Then adjust the resistors for correct response before attempting to obtain correct square corner and flat top with capacitors. Table 6-4 indicates the effect of each adjustment.

**TABLE 6-4**

Adjustment	Area of Waveform Affected or Interaction With Other Adjustments
C328	Adjusts amplitude of longest time constant.
R328	Adjusts damping of slowest ringing component. Readjust each time C328 is adjusted.
C336	Adjusts amplitude of intermediate time constant.
C45C	Adjusts amplitude of intermediate time constant.
R45C	Adjusts damping of fastest ringing component. Readjust each time C45C is adjusted.
C45A	Adjusts amplitude of shortest time constant.

l. After good response is obtained in step k, set the MAG switch to OFF and make minor readjustments of longer time constants (C328 and R328) to optimize response.

m. Set the MODE switch to CH 2.

n. Connect the signal to the Channel 2 INPUT connector as in step f.

o. Set the MAG switch to X10.

p. Check—Crt display for optimum square-wave response similar to Channel 1 response (see Fig. 6-27b).

q. Adjust—C145C, R145C and C145A (see Fig. 6-27d) for optimum square-wave response similar to Channel 1 response.

r. Set the MODE switch to CH 1 and recheck Channel 1 response as given in steps b through e, and readjust if necessary.

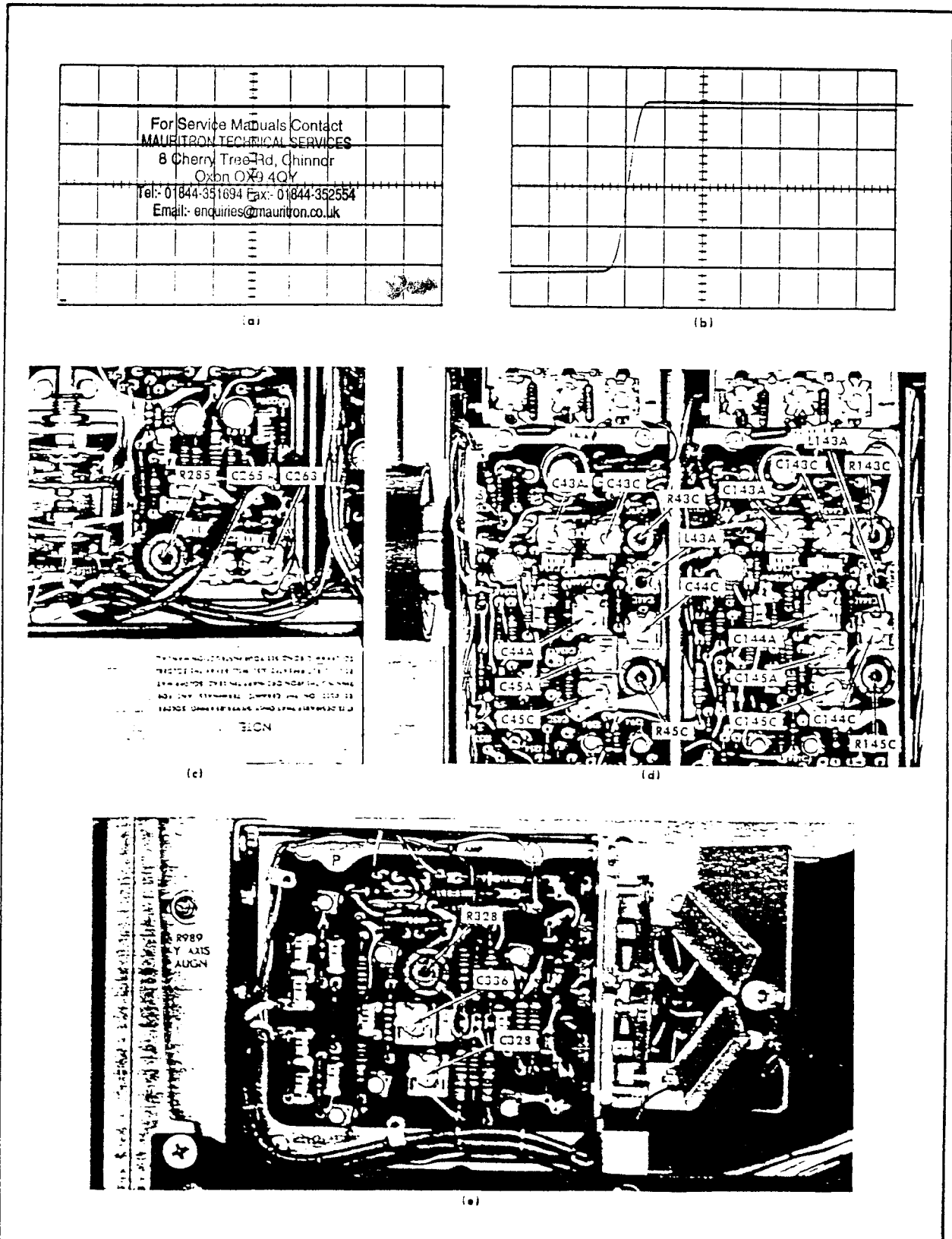

Fig. 5-27. (a) Typical crt display showing correct high-frequency compensation (10.5 microseconds/division); (b) Typical crt display showing correct high-frequency compensation (10 nanoseconds/division); (c) Location of R283, C265 and C263 (Vertical Preamp board); (d) Location of high-frequency compensation adjustments (Vertical Preamp board); (e) Location of R328, C328 and C336 (Vertical Output Amplifier board).

- s. Connect the square-wave generator to Channel 2 INPUT through the 42-inch 50-ohm cable, 5X attenuator, 10X attenuator and 50-ohm termination, in given order.
- t. Set the MODE switch to CH 2.
- u. Be sure the MAG switch is off and the TIME/DIV switch is set to .5 μSEC as for step r.
- v. Check—Channel 2 response matches response of Channel 1 checked in step r (also see Fig. 6-27a).

NOTE

If response of Channel 1 and 2 is not matched as measured in steps r and v, the selected resistor R195 may have to be changed (normally necessary only if Q84, Q94, Q184 or Q194 have been changed). Table 6-5 lists typical values of R195 as determined by the amount of increase or decrease of Channel 2 front corner with respect to that obtained with nominal resistance value. For example, if 0.5% overshoot was observed with R195 having a value of 33 k, using Table 6-5 R195 should be changed to 43 k (0.5% lower) to obtain correct response.

TABLE 6-5

Percent Variation of Front Corner With Respect to That Obtained With Nominal Resistance Value.	R195 (5%, 1/4 w)
+1.35%	24 k
+1.05%	27 k
+0.8%	30 k
+0.6%	33 k
+0.45%	36 k
+0.3%	39 k
+0.1%	43 k
0	47 k (nom. value)
-0.3%	56 k
-0.45%	58 k
-0.6%	82 k
-0.75%	100 k
-0.95%	150 k
-1.25%	300 k
-1.4%	open

- w. Change the following control settings:

CH 2 VOLTS/DIV	10 mV
TIME/DIV	.1 μSEC
MAG	X10

- x. Connect the square-wave generator to Channel 2 INPUT through the TU-5/105 Adapter, 42-inch 50-ohm cable, TU-5 Pulser, 5X attenuator and a 50-ohm termination, in given order.

- y. Check—Crt display for optimum square-wave response (see Fig. 6-27b).

- z. Adjust—C144A and C144C (see Fig. 6-27d) for optimum square-wave response.

- aa. Set the CH 2 VOLTS/DIV switch to 5 mV.

- ab. Replace the 5X attenuator with a 10X attenuator.

- ac. Check—Crt display for optimum square-wave response (see Fig. 6-27b).

- ad. Adjust—C143A, C143A, C143C and R143C (see Fig. 6-27a) for optimum square-wave response.

- ae. Set the MODE switch to CH 1.

- af. Set the CH 1 VOLTS/DIV switch to 5 mV.

- ag. Connect the signal to the Channel 1 INPUT connector as in step ab.

- ah. Check—Crt display for optimum square-wave response (see Fig. 6-27b).

- ai. Adjust—C43A, C43A, C43C and R43C (see Fig. 6-27d) for optimum square-wave response

- aj. Set the CH 1 VOLTS/DIV switch to 10 mV.

- ak. Replace the 10X attenuator with a 5X attenuator.

- al. Check—Crt display for optimum square-wave response (see Fig. 6-27b).

- am. Adjust—C44A and C44C (see Fig. 6-27d) for optimum square-wave response.

- an. Disconnect all test equipment.

NOTES

---



---



---



---



---

Calibration—Type 453

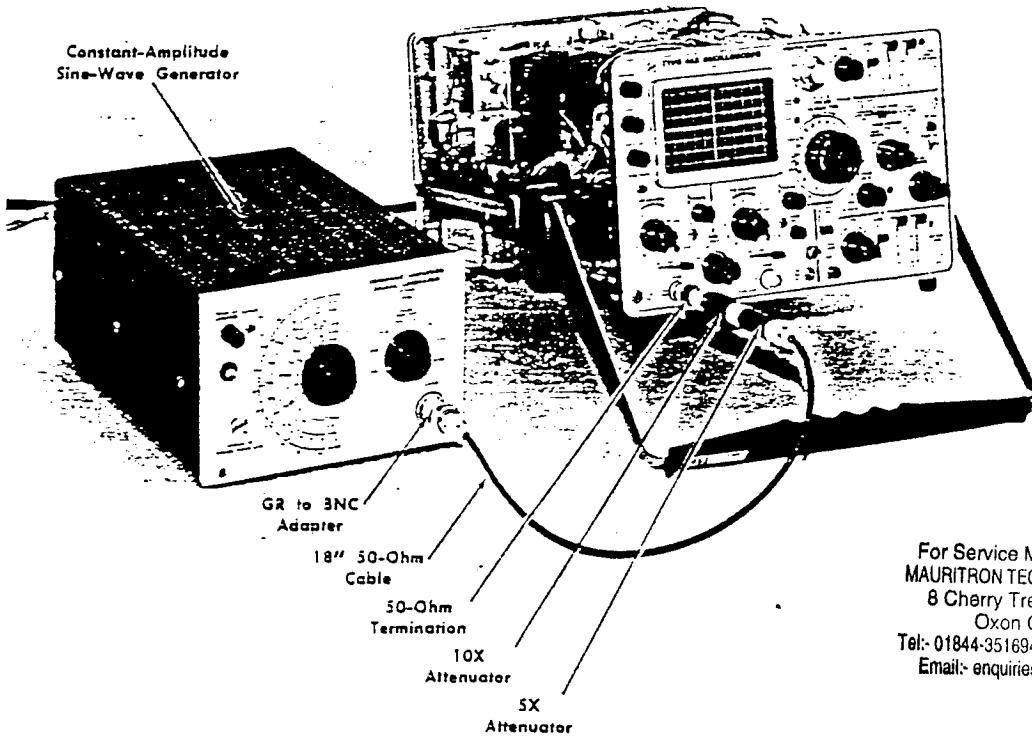

For Service Manuals Contact  
 MAURITRON TECHNICAL SERVICES  
 8 Cherry Tree Rd, Chinnor  
 Oxon OX9 4QY  
 Tel:- 01844-351694 Fax:- 01844-352554  
 Email:- enquiries@mauritron.co.uk

Fig. 6-28. Initial test equipment setup for steps 24 through 27.

<b>Crt Controls</b>		<b>B TIME/DIV</b>	20 $\mu$ SEC
INTENSITY	Midrange	A VARIABLE	CAL
FOCUS	Adjust for focused display	A SWEEP MODE	AUTO TRIG
SCALE ILLUM	As desired	B SWEEP MODE	B TRIGGERABLE AFTER DELAY TIME
<b>Vertical controls (both channels if applicable)</b>		<b>HORIZ DISPLAY</b>	A
VOLTS/DIV	20 mV	<b>MAG</b>	OFF
VARIABLE	CAL	A SWEEP LENGTH	FULL
POSITION	Midrange	POSITION	Midrange
AC GND DC	DC	POWER	ON
MODE	CH 1	<b>Side-panel controls</b>	
TRIGGER	NORM	B TIME/DIV VARIABLE	CAL
INVERT	Pushed in	CALIBRATOR	1V
<b>Triggering controls (both A and B if applicable)</b>		<b>Rear-panel controls</b>	
LEVEL	Any position	LINE VOLTAGE RANGE	HIGH
SLOPE	+		
COUPLING	AC		
SOURCE	INT		
<b>Sweep Controls</b>		<b>24. Check Vertical Frequency Response</b>	
DELAY-TIME MULTIPLIER	0.50	a. Test equipment setup is shown in Fig. 6-28.	
A TIME/DIV	20 $\mu$ SEC	b. Connect the constant-amplitude sine-wave generator (067-0506-00) to the Channel 1 INPUT through the GR to	

BNC adapter, 18-inch 50-ohm cable, 5X attenuator, 10X attenuator and 50-ohm termination, in given order.

c. Set the constant-amplitude generator for 4 divisions at 50 kc.

d. Without changing the output amplitude, increase the output frequency until the display is reduced to 2.8 divisions (see Fig. 6-29).

e. Check—Output frequency must be 52.5 Mc or higher.

f. Set the CH 1 VOLTS/DIV switch to 10 mV.

g. Replace the 5X attenuator with a 10X attenuator.

h. Set the constant-amplitude generator for 4 divisions at 50 kc.

i. Without changing the output amplitude, increase the output frequency until the deflection is reduced to 2.8 divisions (see Fig. 6-29).

j. Check—Output frequency must be 46.5 Mc or higher.

k. Set the CH 1 VOLTS/DIV switch to 5 mV.

l. Add a 2X attenuator.

m. Set the constant-amplitude generator for 4 divisions at 50 kc.

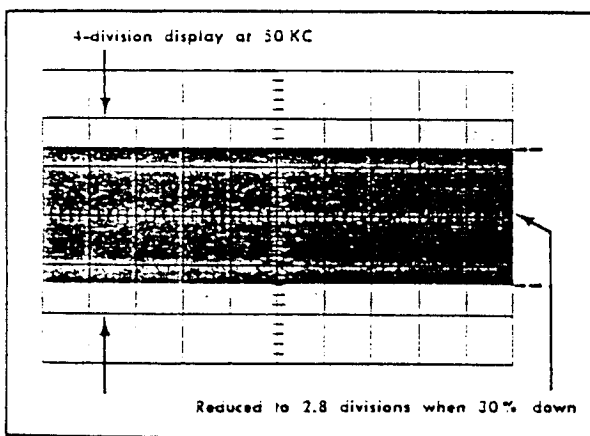

Fig. 6-29. Typical crt display when checking vertical frequency response.

n. Without changing the output amplitude, increase the output frequency until the deflection is reduced to 2.8 divisions (see Fig. 6-29).

o. Check—Output frequency must be 41 Mc or higher.

p. Set the MODE switch to CH 2.

q. Connect the constant-amplitude generator to the Channel 2 INPUT through the GR to BNC adapter, 18-inch 50-ohm cable, 5X attenuator, 10X attenuator and 50-ohm termination, in given order.

r. Set the constant-amplitude generator for 4 divisions at 50 kc.

s. Without changing the output amplitude, increase the output frequency until the deflection is reduced to 2.8 divisions (see Fig. 6-29).

t. Check—Output frequency must be 52.5 Mc or higher.

u. Set the CH 2 VOLTS/DIV switch to 10 mV.

v. Replace the 5X attenuator with a 10X attenuator.

w. Set the constant-amplitude generator for 4 divisions at 50 kc.

x. Without changing the output amplitude, increase the output frequency until the deflection is reduced to 2.8 divisions (see Fig. 6-29).

y. Check—Output frequency must be 46.5 Mc or higher.

z. Set the CH 2 VOLTS/DIV switch to 5 mV.

aa. Add a 2X attenuator.

ab. Set the constant-amplitude generator for 4 divisions at 50 kc.

ac. Without changing the output amplitude, increase the output frequency until the deflection is reduced to 2.8 divisions (see Fig. 6-29).

ad. Check—Output frequency must be 41 Mc or higher.

## 25. Check Channel 1 and 2 Cascaded Frequency Response

a. Test setup is given in step 24.

b. Connect the constant-amplitude generator to Channel 1 INPUT through the GR to BNC adapter, 18-inch 50-ohm cable, 2X attenuator, 5X attenuator, 10X attenuator, 10X attenuator and 50-ohm termination, in given order.

c. Connect the CH 1 OUT connector to the Channel 2 INPUT connector with an 18-inch 50-ohm cable.

d. Set the constant-amplitude generator for 4 divisions at 50 kc.

e. Without changing the output amplitude, increase the output frequency until the deflection is reduced to 2.8 divisions (see Fig. 6-29).

f. Check—Output frequency must be 25 Mc or higher.

g. Disconnect the 18-inch 50-ohm cable from between the CH 1 OUT and Channel 2 INPUT connectors.

## 26. Check Added Mode Frequency Response

a. Test setup is given in step 25.

b. Connect the constant-amplitude generator to Channel 2 INPUT through the GR to BNC adapter, 18-inch 50-ohm cable, 5X attenuator, 10X attenuator and 50-ohm termination, in given order.



### Calibration—Type 453

c. Change the following control settings:

VOLTS/DIV	20 mV
Channel 1 AC GND DC	GND
MODE	ADD

d. Set the constant-amplitude generator for 4 divisions at 50 kc.

e. Without changing the output amplitude, increase the output frequency until the deflection is reduced to 2.8 divisions (see Fig. 6-29).

f. Check—Output frequency must be 52.5 Mc or higher.

g. Set the Channel 1 AC GND DC switch to DC and the Channel 2 AC GND DC switch to GND.

h. Connect the signal to Channel 1 INPUT connector.

i. Set the constant-amplitude generator for 4 divisions at 50 kc.

j. Without changing the output amplitude, increase the output frequency until the deflection is reduced to 2.8 divisions (see Fig. 6-29).

k. Check—Output frequency must be 52.5 Mc or higher.

### 27. Check External Horizontal Frequency Response

a. Test setup is given in step 26.

b. Change the following control settings:

MODE	CH 2
TRIGGER	CH 1 ONLY
HORIZ DISPLAY	EXT HORIZ
COUPLING	DC

c. Connect the constant-amplitude generator to Channel 1 INPUT through the GR to BNC adapter, 18-inch 50-ohm cable, 5X attenuator, 10X attenuator and 50-ohm termination, in given order.

d. Increase the INTENSITY setting until the display is visible.

e. Set the constant-amplitude generator for 6 divisions of horizontal deflection.

f. Without changing the output amplitude, increase the output frequency until the horizontal deflection is reduced to 4.2 divisions (see Fig. 6-30).

g. Check—Output frequency must be 5 Mc or higher.

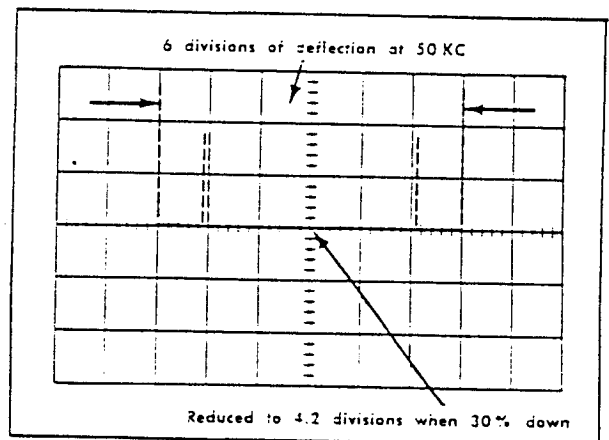

Fig. 6-30. Typical crt display when checking external horizontal bandpass.

### NOTES

For Service Manuals Contact  
 MAURITRON TECHNICAL SERVICES  
 8 Cherry Tree Rd, Chinnor  
 Oxon OX9 4QY  
 Tel: 01844-351694 Fax: 01844-352554  
 Email: enquiries@mauritron.co.uk

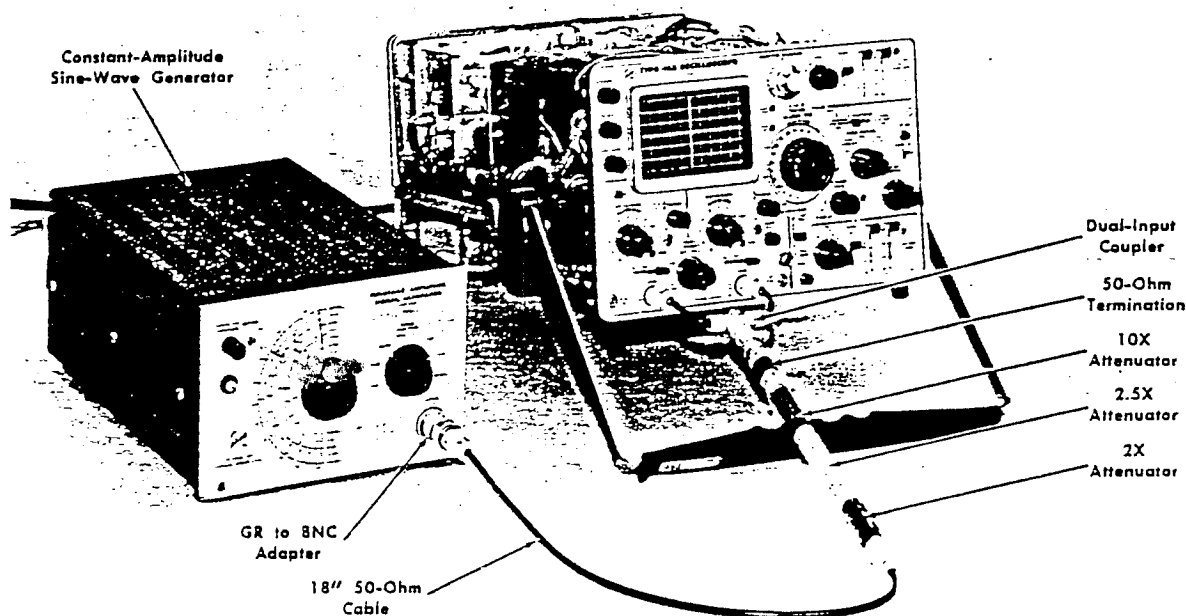

Fig. 6-31. Test equipment setup for step 28.

<b>Crt Controls</b>	
INTENSITY	Midrange
FOCUS	Adjust for focused display
SCALE ILLUM	As desired
<b>Vertical controls (both channels if applicable)</b>	
VOLTS/DIV	20 mV
VARIABLE	CAL
POSITION	Midrange
AC GND DC	DC
MODE	CH 1
TRIGGER	NORM
INVERT	Pushed in
<b>Triggering controls (both A and B if applicable)</b>	
LEVEL	Any position
SLOPE	+
COUPLING	AC
SOURCE	INT
<b>Sweep controls</b>	
DELAY-TIME MULTIPLIER	0.50
A TIME/DIV	.1 mSEC
B TIME/DIV	.1 mSEC
A VARIABLE	CAL

A SWEEP MODE	AUTO TRIG
B SWEEP MODE	B TRIGGERABLE AFTER DELAY TIME
HORIZ DISPLAY	A
MAG	OFF
A SWEEP LENGTH	FULL
POSITION	Midrange
POWER	ON
<b>Side-panel controls</b>	
B TIME/DIV VARIABLE	CAL
CALIBRATOR	.1 V
<b>Rear-panel controls</b>	
LINE VOLTAGE RANGE	HIGH

**28. Check Common-Mode Rejection Ratio**

a. Test equipment setup is shown in Fig. 6-31.

b. Connect the constant-amplitude generator through the GR to BNC adapter, 18-inch 50-ohm cable, 2X attenuator, 2.5X attenuator, 10X attenuator, 50-ohm termination and the dual-input coupler to both INPUT connectors.

c. Set the constant-amplitude generator for 4 divisions at 50 kc.

Calibration—Type 453

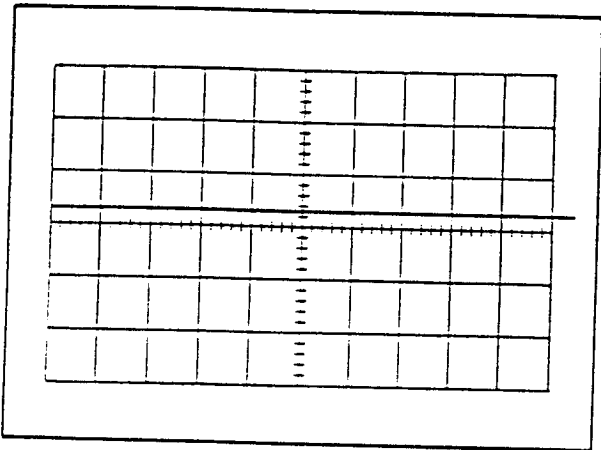

Fig. 6-32. Typical crt display showing correct common-mode rejection.

- d. Remove the 2X attenuator.
- e. Set the MODE switch to ADD.
- f. Pull the INVERT switch out.
- g. Adjust the Channel 2 GAIN adjustment for minimum amplitude.
- h. Without changing the output amplitude, set the constant-amplitude generator to 20 Mc.
- i. Check—Crt display should be 0.4 division or less in amplitude (20:1; see Fig. 6-32).
- j. Interaction—Recheck step 14 if GAIN adjustment was changed in step g.

NOTES

For Service Manuals Contact  
MAURITRON TECHNICAL SERVICES  
8 Cherry Tree Rd, Chinnor  
Oxon OX9 4QY  
Tel: 01844 351634 Fax: 01844 352554  
Email: enquiries@mauritron.co.uk

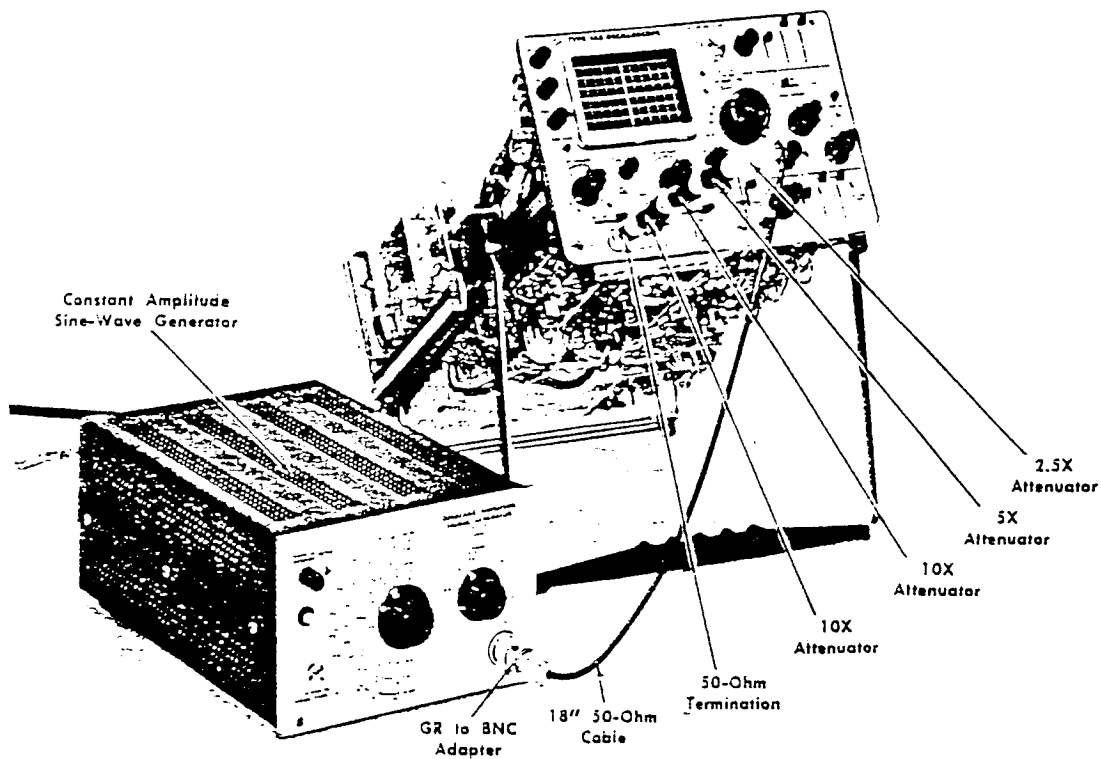

Fig. 6-33. Initial test equipment setup for steps 29 and 30.

<b>Crt controls</b>		<b>MODE</b>	<b>CH 1</b>
INTENSITY	Midrange	TRIGGER	NORM
FOCUS	Adjust for focused display	INVERT	Pushed in
SCALE ILLUM	As desired	<b>Triggering controls (both A and B if applicable)</b>	
<b>Vertical controls (both channels if applicable)</b>		LEVEL	0
VOLTS/DIV	20 mV	SLOPE	+
VARIABLE	CAL	COUPLING	AC
POSITION	Midrange	SOURCE	INT
AC GND DC	DC	MAG	OFF
<b>Sweep controls</b>		A SWEEP LENGTH	FULL
DELAY-TIME MULTIPLIER	0.50	POSITION	Midrange
A TIME/DIV	20 $\mu$ SEC	POWER	ON
B TIME/DIV	20 $\mu$ SEC	<b>Side-panel controls</b>	
A VARIABLE	CAL	B TIME/DIV VARIABLE	CAL
A SWEEP MODE	NORM TRIG	CALIBRATOR	.1V
B SWEEP MODE	B TRIGGERABLE AFTER DELAY TIME	<b>Rear-panel controls</b>	
HORIZ DISPLAY	A	LINE VOLTAGE RANGE	HIGH

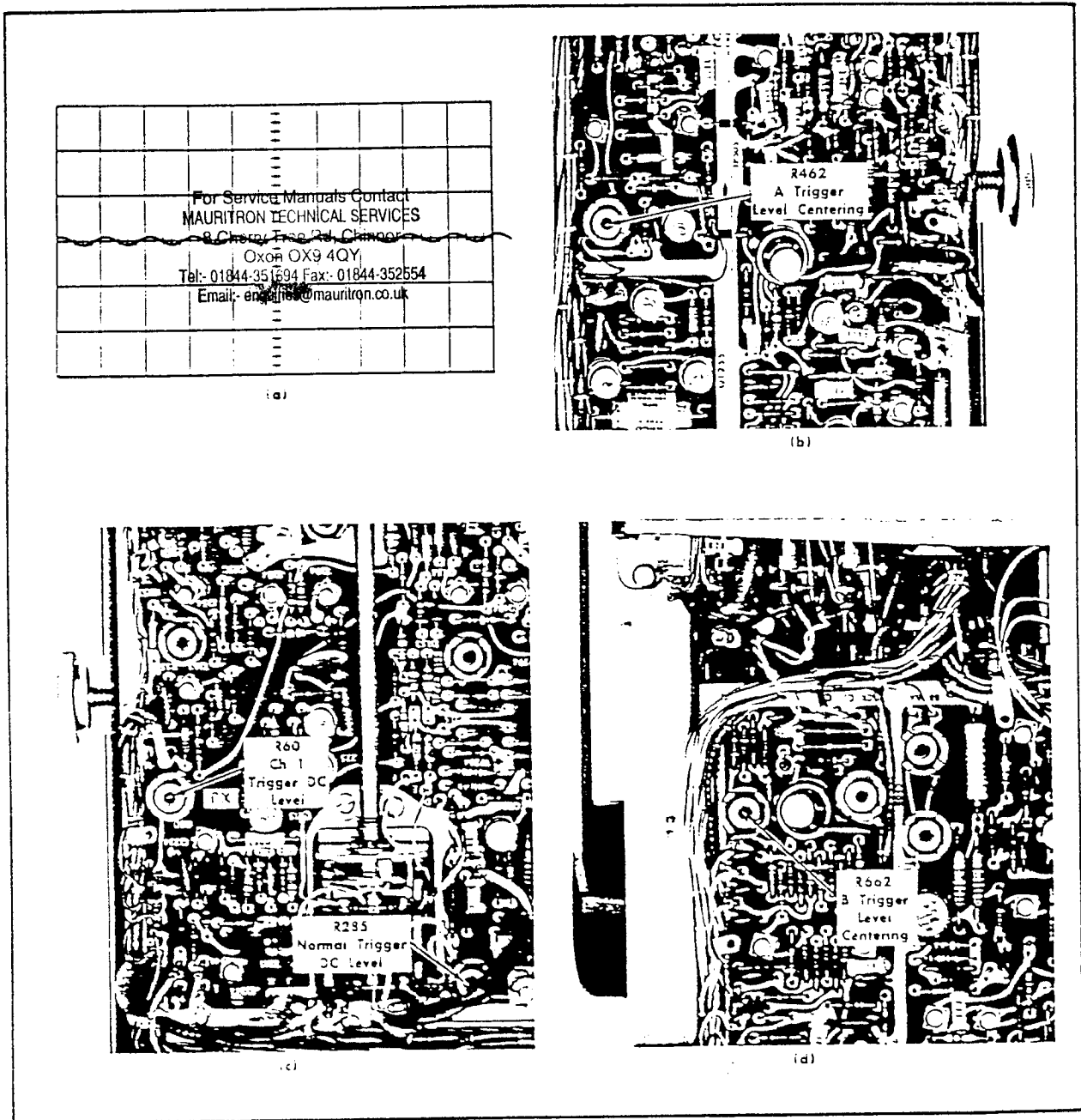

Fig. 6-34. (a) Typical crt display when checking trigger level centering; (b) Location of the A Trigger Level Centering adjustment (A Sweep board); (c) Location of the Normal Trigger DC Level and Ch 1 Trigger DC Level Adjustment (Vertical Preamp board); (d) Location of B Trigger Level Centering adjustment (B Sweep board).

## 29. Adjust Trigger Level Centering

- a. Test equipment setup is shown in Fig. 6-33.
- b. Connect the constant-amplitude generator to Channel 1 INPUT through the GR to BNC adapter, 18-inch 50-ohm cable, 2.5X attenuator, 5X attenuator, 10X attenuator, 10X attenuator and 50-ohm termination, in given order.
- c. Set the constant-amplitude generator for a 0.2-division display at 50 kc.

- d. Position the display to the horizontal centerline.
- e. Be sure the A Triggering LEVEL control is set to 0.
- f. Check—Stable crt display (see Fig. 6-34a).
- g. Adjust—A Trigger Level Centering adjustment, R462 (see Fig. 6-34b), for a stable display.
- h. Set the A Triggering COUPLING switch to DC.
- i. Check—Stable crt display (see Fig. 6-34a).

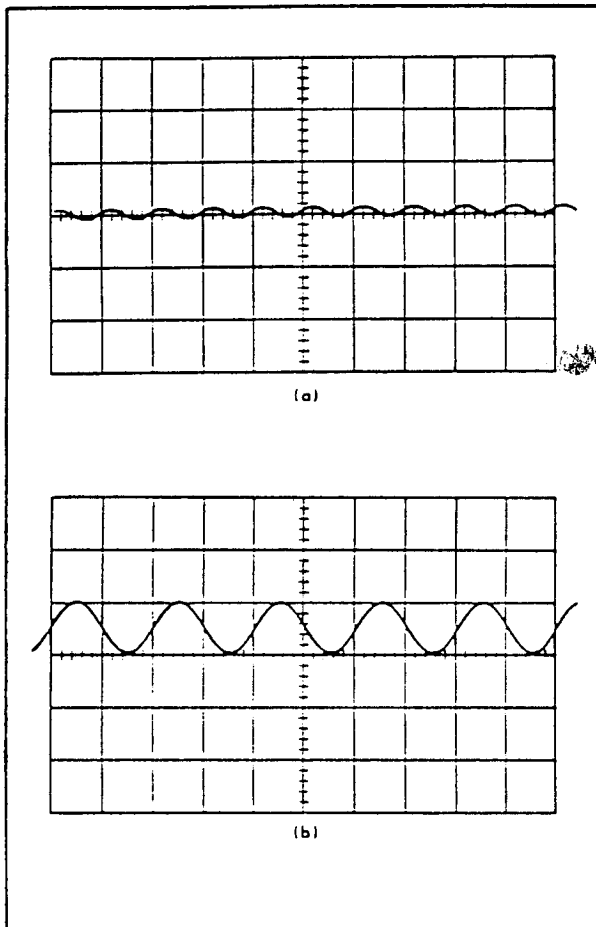

Fig. 6-35. (a) Typical crt display when checking internal triggering operations at 10 Mc; (b) Typical crt display when checking internal triggering operation at 50 Mc.

j. Adjust—Normal Trigger Dc Level adjustment, R285 (see Fig. 6-34c), for a stable display.

k. Set the TRIGGER switch to CH 1 ONLY.

l. Check—Stable crt display (see Fig. 6-34a). CH 1 light in both A and B Triggering must be on.

m. Adjust—Channel 1 Trigger Dc Level adjustment, R60 (see Fig. 6-34c), for a stable display.

n. Change the following control settings:

TRIGGER	NORM
B Triggering COUPLING	DC
A SWEEP MODE	AUTO TRIG
HORIZ DISPLAY	DELAYED SWEEP (B)

- o. Be sure the B Triggering LEVEL control is set to 0.
- p. Check—Stable crt display (see Fig. 6-34a).
- q. Adjust—B Trigger Level Centering adjustment, R662 (see Fig. 6-34d), for a stable display.

### 30. Check Internal Triggering Operation

- a. Test setup is given in step 29.
- b. Set the constant-amplitude generator for 0.2 division at 10 Mc.
- c. Set the HORIZ DISPLAY switch to A.
- d. Set the TIME/DIV switch to .1  $\mu$ SEC.
- e. Set the A SWEEP MODE switch to NORM TRIG.
- f. Check—Stable display (see Fig. 6-35a) can be obtained with the A Triggering COUPLING switch set to AC, LF REJ and DC (LEVEL control may be adjusted as necessary to obtain stable display). The A SWEEP TRIG'D light should be on when the display is stable.
- g. Set the constant-amplitude generator for 1 division at 50 Mc (remove 10X attenuator).
- h. Set the MAG switch to X10.
- i. Check—Stable display (see Fig. 6-35b) can be obtained with the A Triggering COUPLING switch set to AC, LF REJ and DC (LEVEL and HF STAB control may be adjusted as necessary to obtain stable display). Display jitter should not exceed 0.1 division.
- j. Set the A SWEEP MODE switch to AUTO TRIG.
- k. Set the HORIZ DISPLAY switch to DELAYED SWEEP (B).
- l. Set the MAG switch to OFF.
- m. Set the constant-amplitude generator for a 0.2-division display at 10 Mc (replace 10X attenuator removed in step g).
- n. Check—Stable display (see Fig. 6-35a) can be obtained with the B Triggering COUPLING switch set to AC, LF REJ and DC (LEVEL control may be adjusted as necessary to obtain stable display).
- o. Set the constant-amplitude generator for a 1-division display at 50 Mc (remove 10X attenuator).
- p. Set the MAG switch to X10.
- q. Check—Stable display (see Fig. 6-35b) can be obtained with the B Triggering COUPLING switch set to AC, LF REJ and DC (LEVEL control may be adjusted as necessary to obtain a stable display; A Sweep must also be triggered). Display jitter should not exceed 0.1 division.

Calibration—Type 453

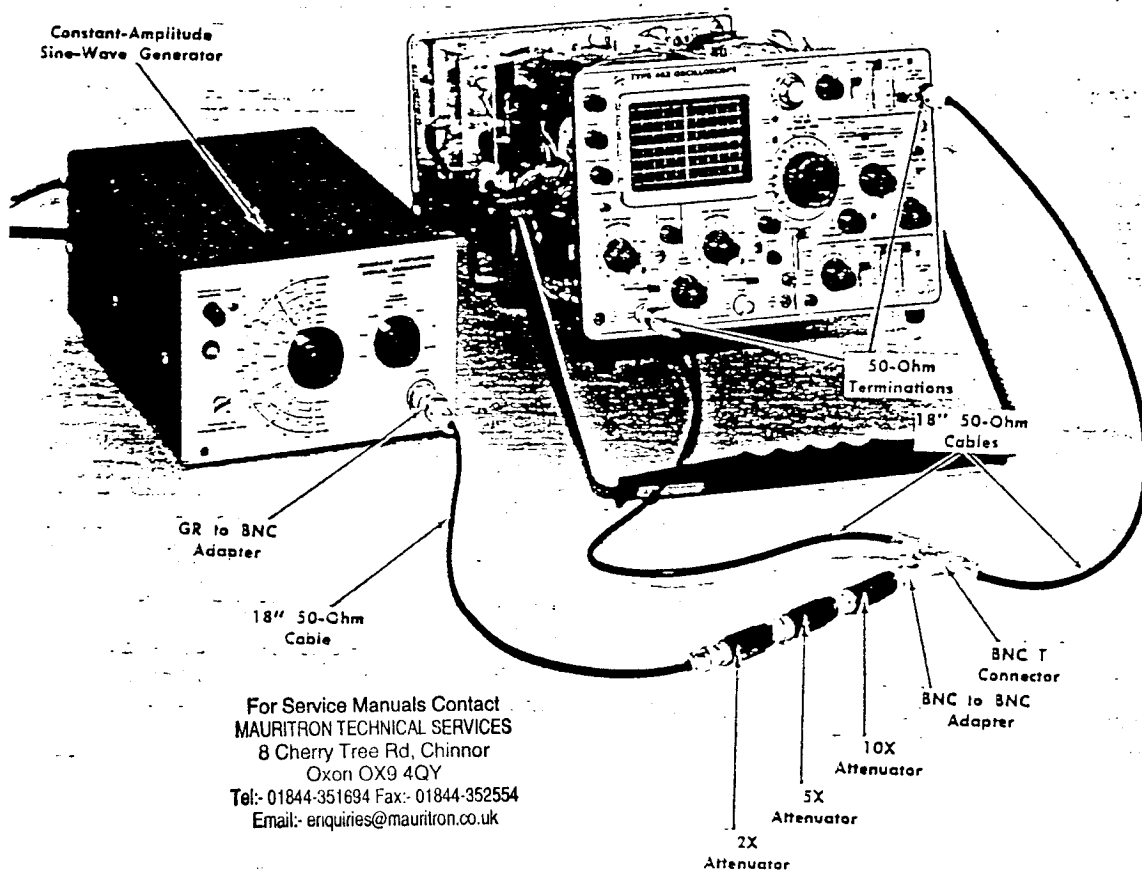

Fig. 6-36. Initial test equipment setup for steps 31 through 33.

<b>Ctrl controls</b>			
INTENSITY	Midrange	B TIME/DIV	.1 μSEC
FOCUS	Adjust for focused display	A VARIABLE	CAL
SCALE ILLUM	As desired	A SWEEP MODE	AUTO TRIG
<b>Vertical controls (both channels if applicable)</b>		B SWEEP MODE	B TRIGGERABLE AFTER DELAY TIME
VOLTS/DIV	50 mV	HORIZ DISPLAY	DELAYED SWEEP (B)
VARIABLE	CAL	MAG	OFF
POSITION	Midrange	A SWEEP LENGTH	FULL
AC GND DC	DC	POSITION	Midrange
MODE	CH 1	POWER	ON
TRIGGER	NORM	<b>Side-panel controls</b>	
INVERT	Pushed in	B TIME/DIV VARIABLE	CAL
<b>Triggering controls (both A and B if applicable)</b>		CALIBRATOR	.1V
LEVEL	Stable display	<b>Rear-panel controls</b>	
SLOPE	+	LINE VOLTAGE RANGE	HIGH
COUPLING	AC		
A SOURCE	INT		
B SOURCE	EXT		
<b>Sweep controls</b>			
DELAY TIME MULTIPLIER	0.50		
A TIME/DIV	.1 μSEC		

31. Check External Triggering Operation

- a. Test equipment setup is shown in Fig. 6-36.
- b. Connect the constant-amplitude generator through the GR to BNC adapter, 18-inch 50-ohm cable, 2X attenuator,

5X attenuator, 10X attenuator, BNC to BNC adapter, BNC T connector and two 18-inch 50-ohm cables and 50-ohm terminations to the Channel 1 INPUT and B Triggering EXT TRIG INPUT connectors, in given order.

c. Set the constant-amplitude generator for a 1-division display (50 millivolts) at 10 Mc.

d. Check—Stable display (see Fig. 6-37a) can be obtained with the B Triggering COUPLING switch set to AC, LF REJ and DC (LEVEL control may be adjusted as necessary to obtain stable display).

e. Set the constant-amplitude generator for a 4-division display (200 millivolts) at 10 Mc (remove 5X attenuator).

f. Without changing the output amplitude, set the constant-amplitude generator to 50 Mc.

g. Set the MAG switch to X10.

h. Check—Stable display (see Fig. 6-37b) can be obtained with the B Triggering COUPLING switch set to AC, LF REJ and DC (LEVEL control may be adjusted as necessary to obtain stable display).

i. Change signal from B Triggering EXT TRIG INPUT to A Triggering EXT TRIG INPUT connector.

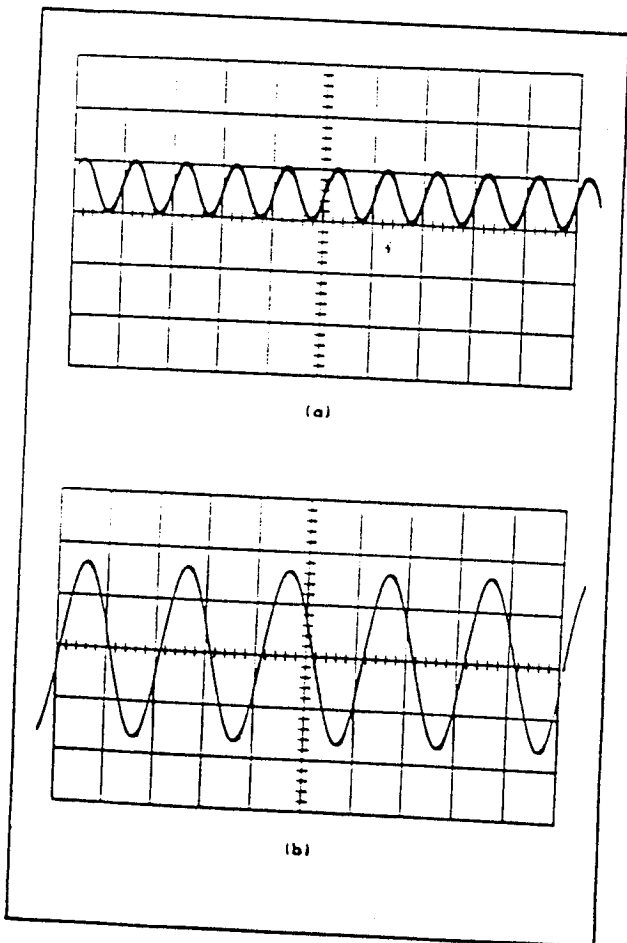

Fig. 6-37. (a) Typical crt display when checking external triggering at 10 Mc; (b) Typical crt display when checking external triggering at 50 Mc.

j. Change the following control settings:

MAG	OFF
HORIZ DISPLAY	A
A SWEEP MODE	NORM TRIG
A Triggering SOURCE	EXT

k. Set the constant-amplitude generator for a 1-division display at 10 Mc (replace 5X attenuator).

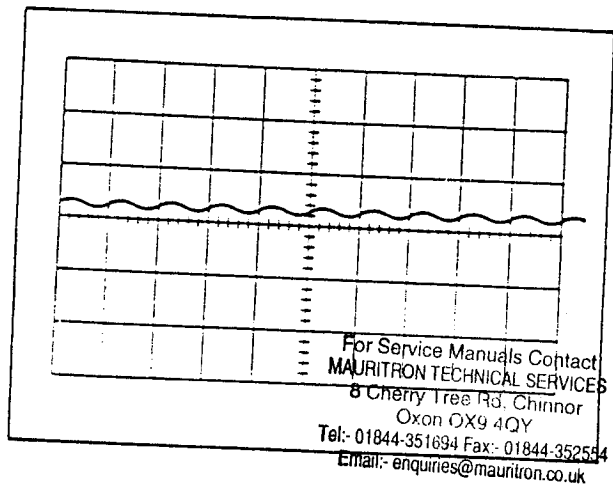

Fig. 6-38. Typical crt display when checking high-frequency reject operation at 50 kc.

l. Check—Stable display (see Fig. 6-37a) can be obtained with the A Triggering COUPLING switch set to AC, LF REJ and DC (LEVEL control may be adjusted as necessary to obtain stable display).

m. Set the constant-amplitude generator for a 4-division display at 10 Mc (remove 5X attenuator).

n. Without changing the output amplitude, set the constant-amplitude generator to 50 Mc.

o. Set the MAG switch to X10.

p. Check—Stable display (see Fig. 6-37b) can be obtained with the A Triggering COUPLING switch set to AC, LF REJ and DC (LEVEL and HF STAB controls may be adjusted as necessary to obtain stable display).

### 32. Check High-Frequency Reject Operation

a. Test setup is given in step 31.

b. Change the following control settings:

VOLTS/DIV	20 mV
TIME/DIV	20 μSEC
MAG	OFF
SOURCE	INT



### Calibration—Type 453

c. Set the constant-amplitude generator for a 0.2-division display at 50 kc (replace 5X attenuator and add 10X attenuator).

d. Set the A Triggering COUPLING switch to HF REJ.

e. Check—Stable display can be obtained (see Fig. 6-38).

f. Without changing the output amplitude, set the constant-amplitude generator to 1 Mc.

g. Check—Stable display cannot be obtained.

h. Change the following control settings:

A SWEEP MODE	AUTO TRIG
A Triggering COUPLING	AC
HORIZ DISPLAY	DELAYED SWEEP (B)

i. Set the constant-amplitude generator for 0.2 division at 50 kc.

j. Set the B Triggering COUPLING switch to HF REJ.

k. Check—Stable display can be obtained (see Fig. 6-38).

l. Without changing the output amplitude, set the constant-amplitude generator to 1 Mc.

m. Check—Stable display cannot be obtained.

### 33. Check Single Sweep Operation

a. Test setup is given in step 32.

b. Set HORIZ DISPLAY switch to A.

c. Set the TIME/DIV switch to 20  $\mu$ SEC.

d. Set the constant-amplitude generator for a 0.2-division display at 50 kc.

e. Adjust the A Triggering LEVEL control for a stable display.

f. Disconnect the signal from the Channel 1 INPUT connector.

g. Set the A SWEEP MODE switch to SINGLE SWEEP.

h. Push the RESET button.

i. Check—RESET light must come on when button is pressed and remain on until signal is applied.

j. Reconnect the signal to the Channel 1 INPUT connector.

k. Check—A single display (one sweep only) should be presented. RESET light must go off and remain off until the RESET button is pressed again.

l. Disconnect all test equipment.

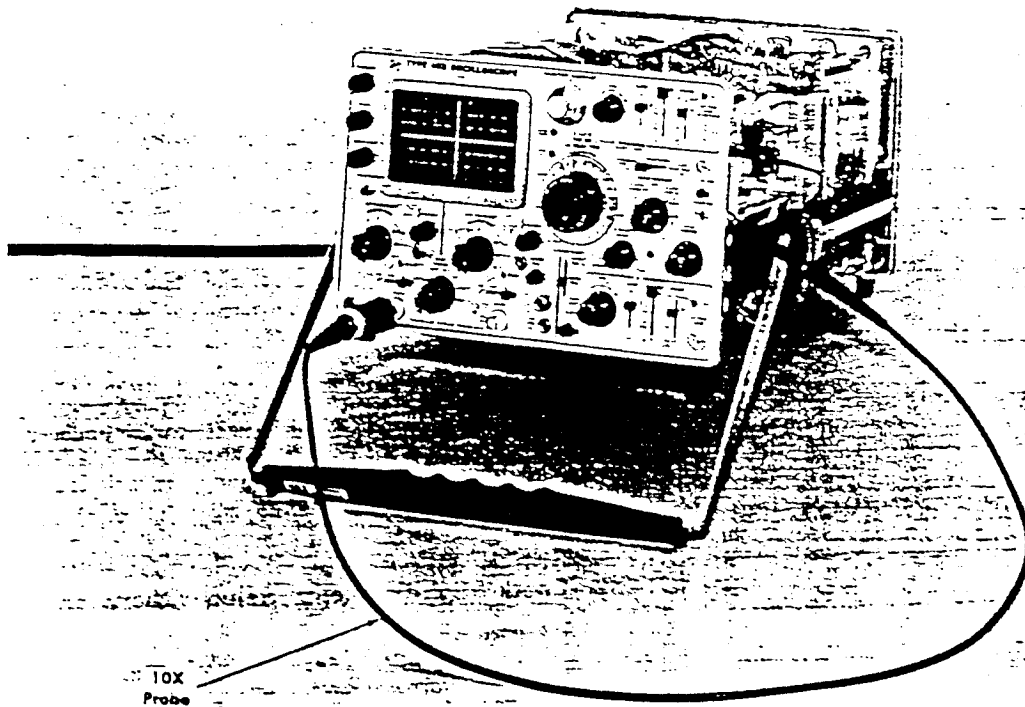

Fig. 6-39. Test equipment setup for step 34.

**Crt controls**

INTENSITY	Midrange
FOCUS	Adjust for focused display
SCALE ILLUM	As desired

**Vertical controls (both channels if applicable)**

VOLTS/DIV	10 Volts
VARIABLE	CAL
POSITION	Midrange
AC GND DC	DC
MODE	CH 1
TRIGGER	NORM
INVERT	Pushed in

**Triggering controls (both A and B if applicable)**

LEVEL	Stable display
SLOPE	+
COUPLING	AC
SOURCE	LINE

**Sweep controls**

DELAY-TIME MULTIPLIER	0.50
A TIME/DIV	2 mSEC
B TIME/DIV	2 mSEC
A VARIABLE	CAL
A SWEEP MODE	NORM TRIG
B SWEEP MODE	B TRIGGERABLE AFTER DELAY TIME
HORIZ DISPLAY	A
MAG	OFF
A SWEEP LENGTH	FULL
POSITION	Midrange
POWER	ON

**Side-panel controls**

B TIME/DIV VARIABLE	CAL
CALIBRATOR	.1V

**Rear-panel controls**

LINE VOLTAGE RANGE	HIGH
--------------------	------

**34. Check Line Triggering, Slope Switch Operation and Low-Frequency Reject Operation**

- a. Test equipment setup is shown in Fig. 6-39.
- b. Connect the 10X probe to Channel 1 INPUT connector.
- c. Connect the probe tip to a line-voltage source (such as the rear of the POWER switch).
- d. Check—Display must be stable and start on the positive slope (see Fig. 6-40a).
- e. Set the A Triggering SLOPE switch to —.
- f. Check—Display must be stable and start on the negative slope (see Fig. 6-40b).

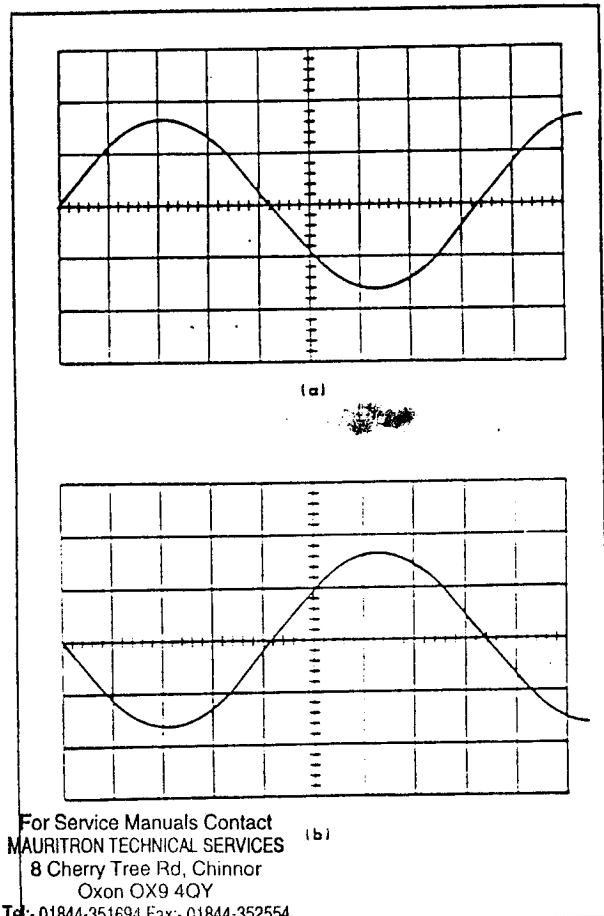

Fig. 6-40. Typical crt display when checking SLOPE switch operation. (a) SLOPE switch set to +; (b) SLOPE switch set to —.

- g. Set the A Triggering SOURCE switch to INT.
- h. Set the A Triggering COUPLING switch to LF REJ.
- i. Check—Stable display cannot be obtained.
- j. Change the following control settings:  
 HORIZ DISPLAY                      DELAYED SWEEP (B)  
 A Triggering COUPLING          AC  
 A SWEEP MODE                      AUTO TRIG
- k. Check—Display must be stable and start on the positive slope (see Fig. 6-40a).
  - l. Set the B Triggering SLOPE switch to —.
- m. Check—Display must be stable and start on the negative slope (see Fig. 6-40b).
  - n. Set the B Triggering SOURCE switch to INT.
  - o. Set the B Triggering COUPLING switch to LF REJ.
  - p. Check—Stable display cannot be obtained.
  - q. Disconnect all test equipment.

Calibration—Type 453

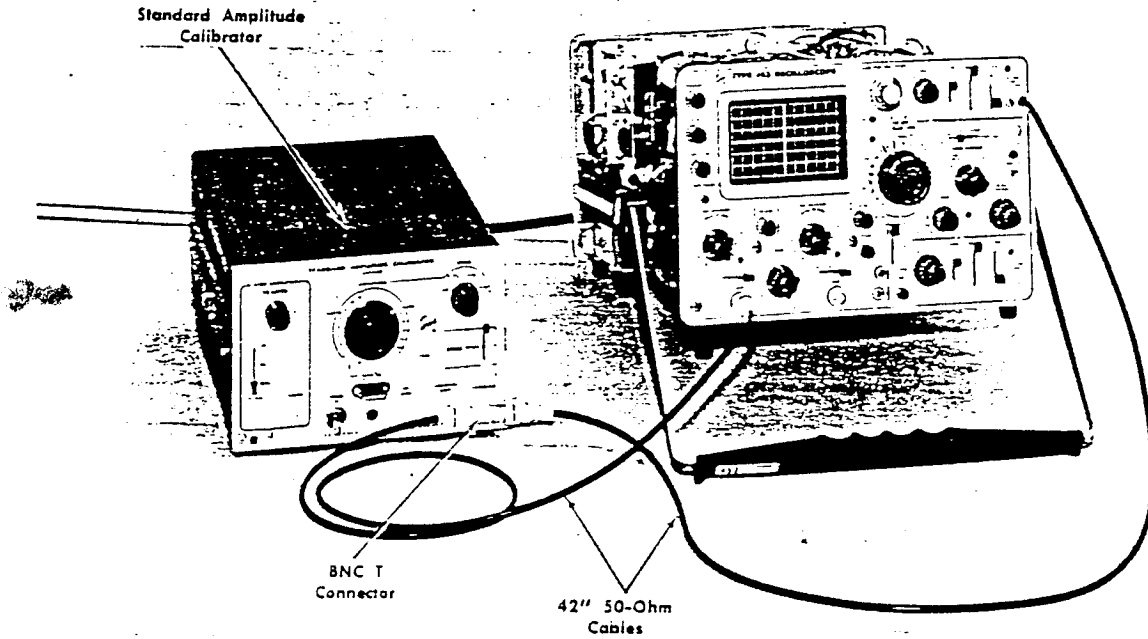

Fig. 6-41. Test equipment setup for step 35.

For Service Manuals Contact  
**MAURITRON TECHNICAL SERVICES**  
 8 Cherry Tree Rd, Chinnor  
 Oxon OX9 4QY  
 Tel: 01844-351694 Fax: 01844-352554  
 Email: enquiries@maurtron.co.uk

**Crt controls**

INTENSITY	Midrange
FOCUS	Adjust for focused display
SCALE ILLUM	As desired

**Vertical controls (both channels if applicable)**

VOLTS/DIV	5 Volts
VARIABLE	CAL
POSITION	Midrange
AC GND DC	DC
MODE	CH 1
TRIGGER	NORM
INVERT	Pushed in

**Triggering controls (both A and B if applicable)**

LEVEL	0
SLOPE	+
COUPLING	DC
SOURCE	EXT

**Sweep controls**

DELAY-TIME MULTIPLIER	0.50
A TIME/DIV	2 mSEC
B TIME/DIV	2 mSEC
A VARIABLE	CAL
A SWEEP MODE	AUTO TRIG
B SWEEP MODE	B TRIGGERABLE AFTER DELAY TIME
HORIZ DISPLAY	DELAYED SWEEP (B)
MAG	OFF
A SWEEP LENGTH	FULL
POSITION	Midrange
POWER	ON

**Side-panel controls**

B TIME/DIV VARIABLE	CAL
CALIBRATOR	.1 V

**Rear-panel controls**

LINE VOLTAGE RANGE	HIGH
--------------------	------

**35. Check Triggering Level Control Range**

- a. Test equipment setup is shown in Fig. 6-41.
- b. Connect the standard amplitude calibrator output to Channel 1 INPUT connector and B Triggering EXT TRIG INPUT connector through the BNC T connector and two 42-inch 50-ohm cables.
- c. Set the standard amplitude calibrator for 2 volts +dc in the mixed output mode.
- d. Turn the B Triggering LEVEL control fully clockwise.
- e. Check—Display is not triggered, indicating that the control has moved the ac level of the triggering circuit beyond the positive 2-volt signal amplitude.
- f. Set the standard amplitude calibrator for -dc output.
- g. Set the B Triggering SLOPE switch to —.
- h. Turn the B Triggering LEVEL control fully counterclockwise.
- i. Check—Display is not triggered, indicating that the control has moved the ac level of the triggering circuit beyond the negative 2-volt signal amplitude.
- j. Set the standard amplitude calibrator for 20-volts output.
- k. Set both Triggering SOURCE switches to EXT +10.
- l. Check—Display is not triggered.
- m. Set the standard amplitude calibrator for +dc output.
- n. Set the B Triggering SLOPE switch to +.

- o. Turn the B Triggering LEVEL control fully clockwise.
- p. Check—Display is not triggered.
- q. Set the HORIZ DISPLAY switch to A.
- r. Change the signal from the B Triggering EXT TRIG INPUT to A Triggering EXT TRIG INPUT connector.
- s. Set the A SWEEP MODE switch to NORM TRIG.
- t. Set the A Triggering LEVEL control fully clockwise.
- u. Check—Display is not triggered.
- v. Set the standard amplitude calibrator for -dc output.
- w. Set the A Triggering SLOPE switch to —.
- x. Turn the A Triggering LEVEL control fully counterclockwise.
- y. Check—Display is not triggered.
- z. Set the standard amplitude calibrator for 2-volts output.
- aa. Set the A Triggering SOURCE switch to EXT.
- ab. Check—Display is not triggered.
- ac. Set the standard amplitude calibrator for +dc output.
- ad. Set the A Triggering SLOPE switch to +.
- ae. Turn the A Triggering LEVEL control fully clockwise.
- af. Check—Display is not triggered.
- ag. Disconnect all test equipment.

**NOTES**

---

---

---

---

---

---

---

---

---

---

---

---

---

---

---

---

---

---

---

---

---

---

---

For Service Manuals Contact  
 MAURITRON TECHNICAL SERVICES  
 8 Cherry Tree Rd, Chinnor  
 Oxon OX9 4QY  
 Tel: 01844-351694 Fax: 01844-352554  
 Email: enquiries@mauritron.co.uk

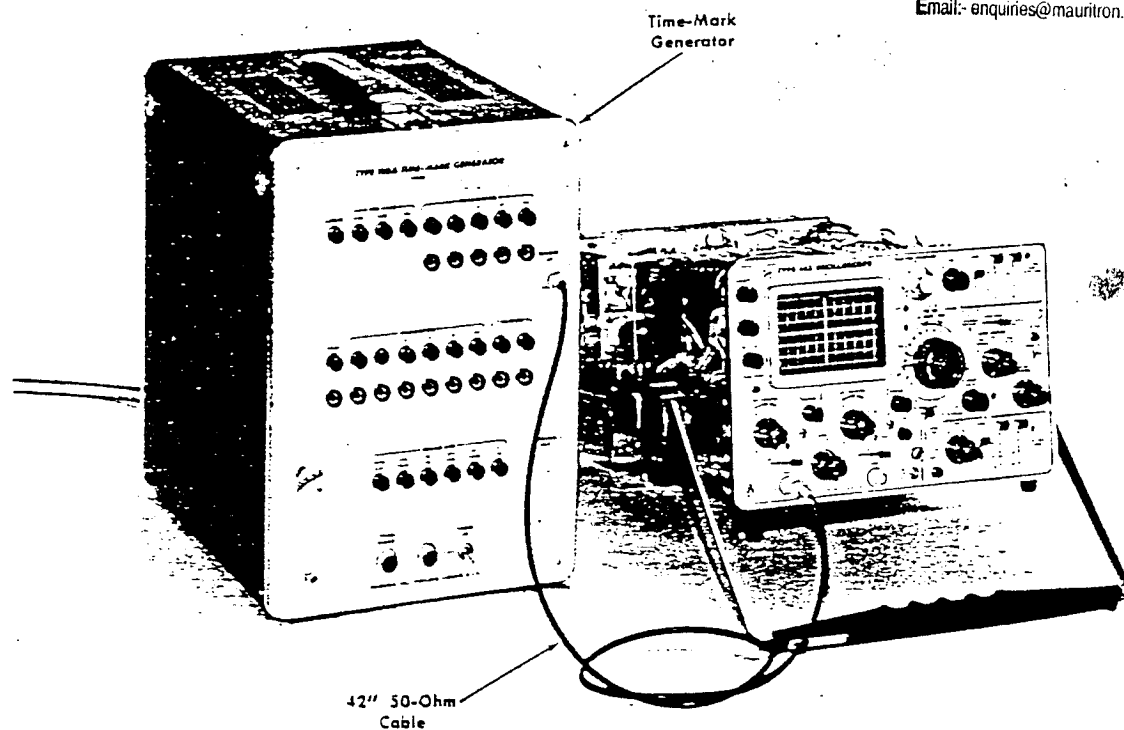

Fig. 6-42. Initial test equipment setup for steps 36 through 53.

**Crt controls**  
 INTENSITY Midrange  
 FOCUS Adjust for focused display  
 SCALE ILLUM As desired

**Vertical controls (both channels if applicable)**

VOLTS/DIV 2 Volts  
 VARIABLE CAL  
 POSITION Midrange  
 AC GND DC DC  
 MODE CH 1  
 TRIGGER NORM  
 INVERT Pushed in

**Triggering controls (both A and B if applicable)**

LEVEL Stable display  
 SLOPE  $\pm$   
 COUPLING AC  
 SOURCE INT

**Sweep controls**

DELAY-TIME MULTIPLIER 1.00  
 A TIME/DIV 50 mSEC  
 B TIME/DIV 50 mSEC  
 A VARIABLE CAL  
 A SWEEP MODE AUTO TRIG  
 B SWEEP MODE B STARTS AFTER DELAY-TIME

HORIZ DISPLAY A  
 MAG OFF  
 A SWEEP LENGTH FULL  
 POSITION Midrange  
 POWER ON

**Side-panel controls**

B TIME/DIV VARIABLE CAL  
 CALIBRATOR .1V

**Rear-panel controls**

LINE VOLTAGE RANGE HIGH

**36. Check Auto Recovery Time and Operation**

- a. Test equipment setup is shown in Fig. 6-42.
- b. Connect the time-mark generator to Channel 1 INPUT connector with a 42-inch 50-ohm cable.
- c. Set the time-mark generator for 50 millisecond markers.

**CAUTION**

- To prevent permanent damage to the crt phosphor at slow sweep rates, position the baseline of the marker display below the viewing area.
- d. Check—Stable display can be obtained with the A Triggering LEVEL control.
  - e. Set the time-mark generator for 100-millisecond markers.
  - f. Check—Sweep free runs and stable display cannot be obtained.

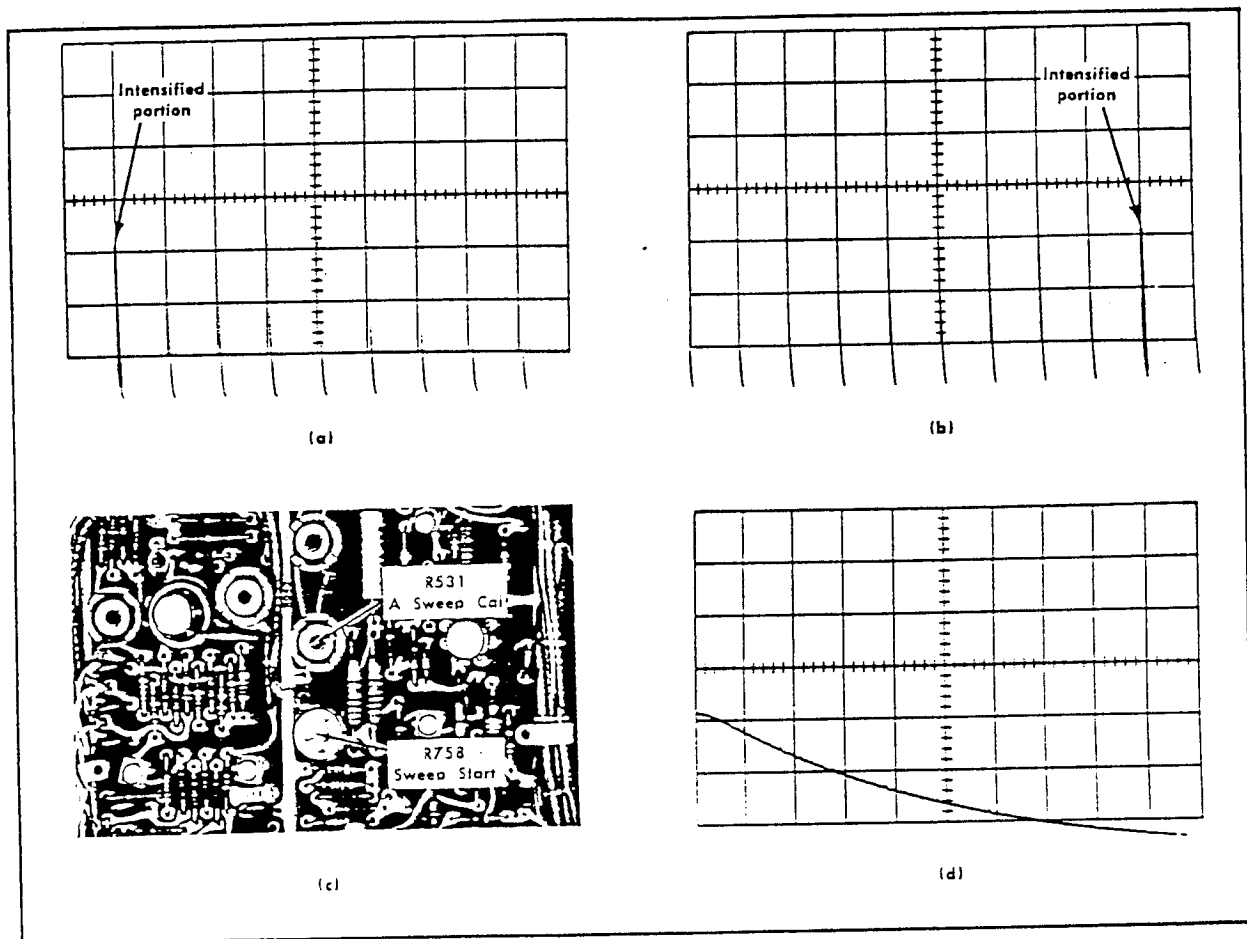

Fig. 6-43. (a) Typical crt display showing intensified portion correctly located at the 2nd marker; (b) Typical crt display showing intensified portion correctly located at the 10th marker; (c) Location of Sweep Start and A Sweep Cal adjustments (B Sweep board); (d) Typical crt display showing correct final adjustment of Sweep Start and A Sweep Cal adjustments.

### 37. Adjust Sweep Start and A Sweep Calibration

- a. Test setup is given in step 36.
- b. Change the following control settings:
 

A TIME/DIV	1 mSEC
B TIME/DIV	5 $\mu$ SEC
HORIZ DISPLAY	A INTEN DURING B
- c. Set the time-mark generator for 1-millisecond markers.
- d. Check—Intensified portion of display starts at 2nd marker (see Fig. 6-43a).
- e. Adjust—Sweep Start adjustment, R758 (see Fig. 6-43c), so intensified portion starts at 2nd marker (preliminary adjustment).
- f. Set DELAY-TIME MULTIPLIER dial to 9.00.
- g. Check—Intensified portion of display starts at 10th marker (see Fig. 6-43b).

- h. Adjust—A Sweep Cal adjustment, R531 (see Fig. 6-43c), so intensified portion starts at 10th marker (preliminary adjustment).
- i. Set the HORIZ DISPLAY switch to DELAYED SWEEP (B).
- j. Set the DELAY-TIME MULTIPLIER dial to 2.00.
- k. Check—Displayed pulse starts at the beginning of the sweep (see Fig. 6-43d).
- l. Adjust—Sweep Start adjustment, R758 (see Fig. 6-43c), so displayed pulse starts at the beginning of the sweep (final adjustment).
- m. Set DELAY-TIME MULTIPLIER dial to 8.00.
- n. Check—Displayed pulse starts at the beginning of the sweep (see Fig. 6-43d).
- o. Adjust—A Sweep Cal adjustment, R531 (see Fig. 6-43c), so displayed pulse starts at the beginning of the sweep (final adjustment).
- p. Recheck steps j through n and readjust if necessary.

## Calibration—Type 453

### 38. Check Delay-Time Multiplier Incremental Linearity

- Test setup is given in step 37.
- Set the DELAY-TIME MULTIPLIER dial to 9.00.
- Rotate the dial as necessary to position the start of the pulse to the beginning of the sweep (see Fig. 6-44).
- Check—Deviation of dial reading from 9.00 should be within 2 minor dial divisions ( $\pm 0.2\%$ ).
- Repeat check at each major dial division between 9.00 and 1.00.

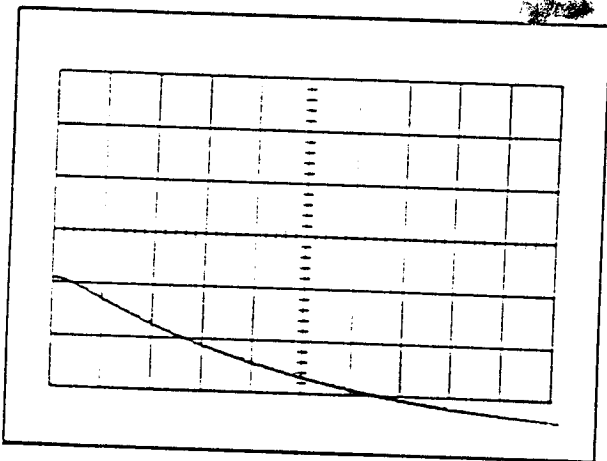

Fig. 6-44. Typical crt display when checking DELAY-TIME MULTIPLIER incremental linearity.

### 39. Adjust Normal Gain

- Test setup is given in step 33.
- Set the HORIZ DISPLAY switch to A.
- Check—Crt display for one marker each division between the first and ninth graticule lines (see Fig. 6-45a).

#### NOTE

Unless otherwise noted, use the middle eight horizontal divisions when checking or adjusting timing (see Fig. 2-9, Operating Instructions).

- Adjust—Norm Gain adjustment, R835 (see Fig. 6-45b), for one marker each division.
- Interaction—Check steps 40-54.

### 40. Adjust Magnified Gain

- Test setup is given in step 39.

- Set the time-mark generator for 100-microsecond markers.
- Set the MAG switch to  $\times 10$ .
- Check—Crt display for one marker each division between the first and ninth graticule lines (see Fig. 6-46a).
- Adjust—Mag Gain adjustment, R845 (see Fig. 6-46b), for one marker each division.
- Interaction—Check steps 41, 42 and 50.

### 41. Check Magnified Linearity

- Test setup is given in step 40.
- Position the first marker to the first graticule line.

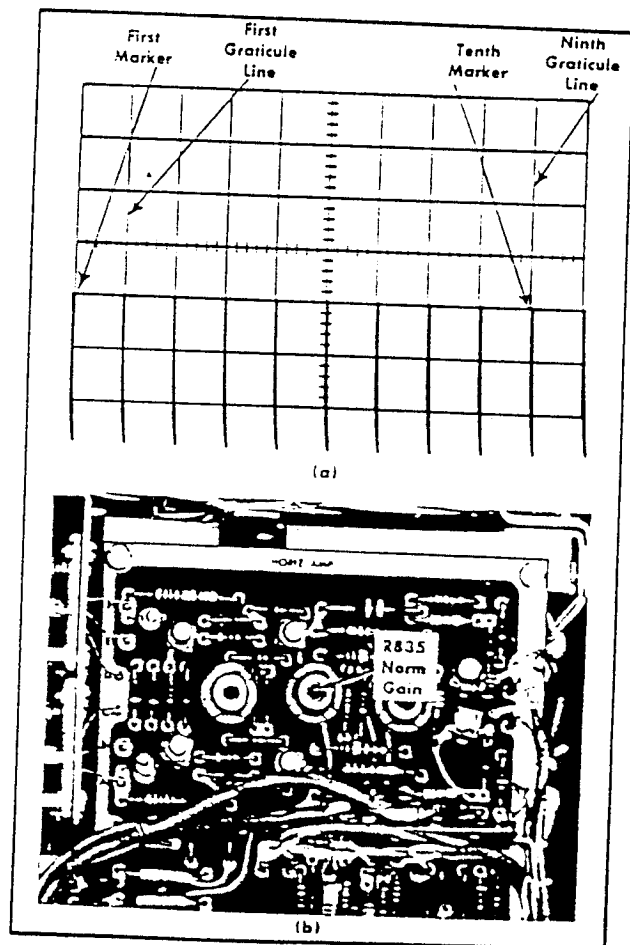

Fig. 6-45. (a) Typical crt display showing correct normal gain; (b) Location of Norm Gain adjustment (R835) on the Sweep board.

For Service Manuals Contact  
MAURITRON TECHNICAL SERVICES  
8 Cherry Tree Rd, Chinnor  
Oxon OX9 4QY  
Tel: 01844-351694 Fax: 01844-352554  
Email: enquiries@mauritron.co.uk

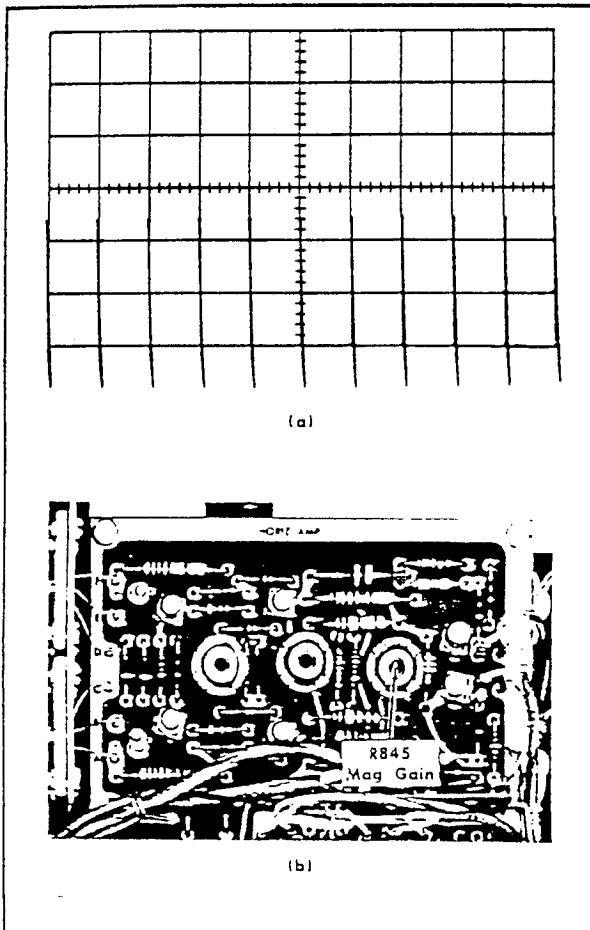

Fig. 6-46. (a) Typical crt display showing correct magnified gain; (b) Location of Mag Gain adjustment (B Sweep board).

c. Check—Linearity of crt display between the first and ninth graticule lines is within tolerance of  $\pm 1.5\%$  ( $\pm 0.12$  division); see Fig. 6-47.

d. Repeat check for each eight-division portion of the magnified sweep.

#### 42. Adjust Magnifier Register

- Test setup is given in step 40.
- Set the time-mark generator for 5-millisecond markers.
- Position the middle marker (three markers on total sweep) to the graticule centerline (see Fig. 6-48a).
- Set the MAG switch to OFF.
- Check—Middle marker should be at the graticule centerline (see Fig. 6-48b).
- Adjust—Mag Register adjustment, R855 (see Fig. 6-48c), to position the middle marker to the graticule centerline.

- Set the MAG switch to  $\times 10$ .
- Repeat steps c through f until no shift occurs when MAG switch is set to OFF.

#### 43. Adjust B Sweep Calibration

- Test setup is given in step 42.
- Change the following control settings:
 

DELAY-TIME MULTIPLIER	0.50
B SWEEP MODE	B TRIGGERABLE AFTER DELAY TIME
TIME/DIV	1 mSEC
HORIZ DISPLAY	DELAYED SWEEP (B)
MAG	OFF

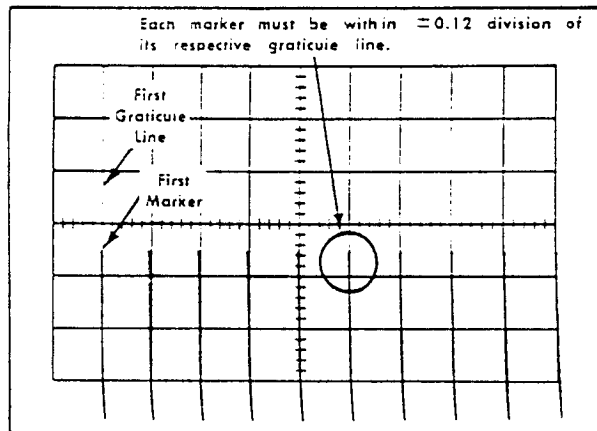

Fig. 6-47. Typical crt display when checking magnified linearity.

- Set the time-mark generator for 1-millisecond markers.
- Set the B Triggering LEVEL control for a stable display.
- Check—Crt display for one marker each division between the first and ninth graticule lines (see Fig. 6-49a).
- Adjust—B Sweep Cal adjustment, R741 (see Fig. 6-49b), for one marker each division.
- Interaction—Check step 51.

#### 44. Check B Sweep Length

- Test setup is given in step 43.
- Set the A TIME/DIV switch to 2 mSEC.
- Set the B TIME/DIV switch to 1 mSEC.
- Set the time-mark generator for 1-millisecond and 100-microsecond markers.



## Calibration—Type 453

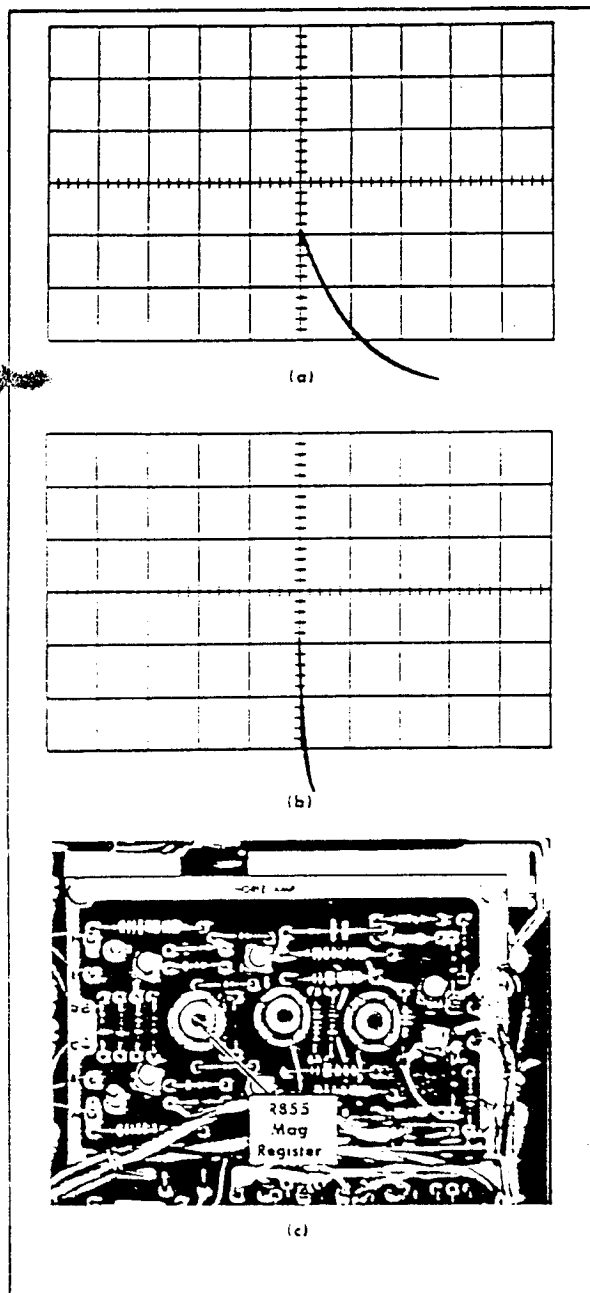

Fig. 5-48. Typical crt display showing correct magnifier register. (a) MAG switch set to X10; (b) MAG switch set to OFF; (c) location of Mag Register adjustment (B Sweep board).

e. Check—B Sweep length must be between 10.5 and 11.5 divisions (large markers indicate divisions and small markers indicate 0.1 division).

### 45. Check A Sweep Length

- Test setup is given in step 44.
- Set the HORIZ DISPLAY switch to A.
- Set the A TIME/DIV switch to 1 mSEC.

d. Check—A Sweep length must be between 10.5 and 11.5 divisions with the A SWEEP LENGTH control set to FULL.

e. Turn the A SWEEP LENGTH control to 4 DIV (not in derent).

f. Check—A Sweep length must be 4 divisions or less.

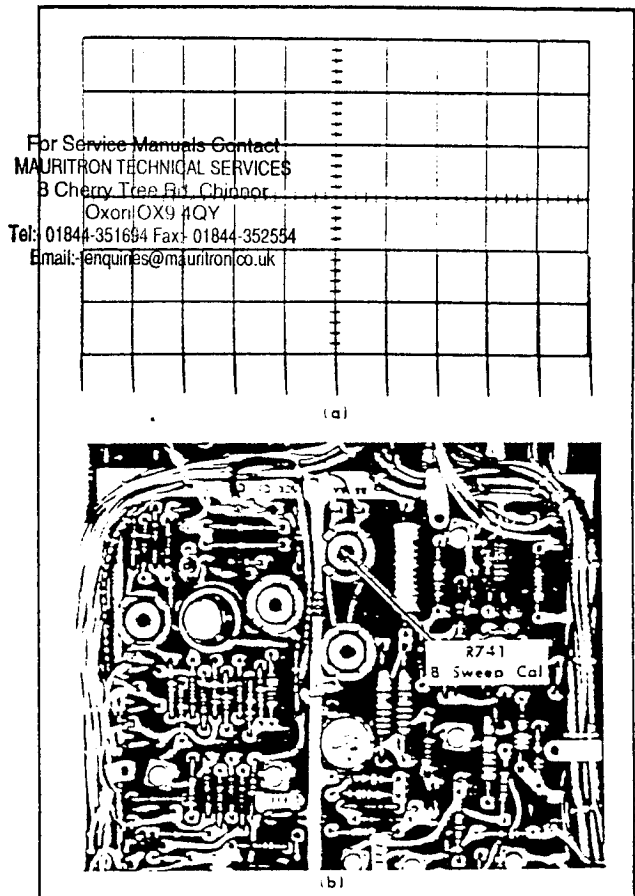

Fig. 5-49. (a) Typical crt display showing correct B Sweep calibration. (b) Location of the B Sweep Cal adjustment (B Sweep board).

### 46. Check A Variable Control Range

- Test setup is given in step 45.
- Set the A SWEEP LENGTH control to FULL.
- Set the time-mark generator for 10 millisecond markers.
- Position the markers to the far left and right graticule lines with the Horizontal POSITION control.
- Turn the A VARIABLE control fully counterclockwise.
- Check—Crt display for 4-division maximum spacing between markers (see Fig. 5-50). UNCAL A OR B light must be on when A VARIABLE control is not in CAL position.

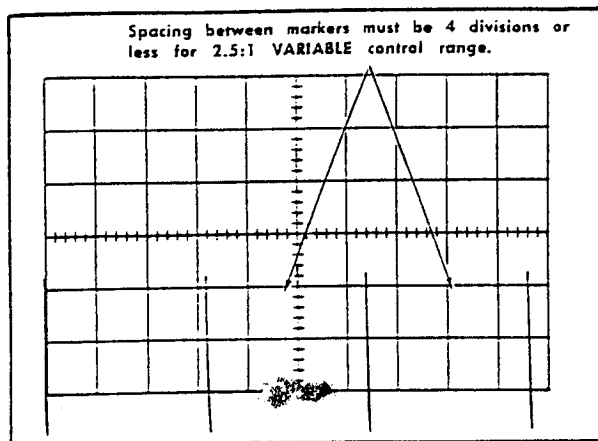

Fig. 6-50. Typical crt display when checking VARIABLE control range.

#### 47. Check B Variable Control Range

- a. Test setup is given in step 46.
- b. Change the following control settings:
 

A TIME/DIV	5 mSEC
B TIME/DIV	1 mSEC
A VARIABLE	CAL
HORIZ DISPLAY	DELAYED SWEEP (B)
- c. Position markers to the far left and right graticule lines with the Horizontal POSITION control.
- d. Turn the B TIME/DIV VARIABLE control fully counter-clockwise.
- e. Check—Crt display for 4-division maximum spacing between markers (see Fig. 6-50). UNCAL A OR B light must be on when B VARIABLE control is not in CAL position.

#### 48. Check Fine Position Range

- a. Test setup is given in step 47.
- b. Change the following control settings:
 

HORIZ DISPLAY	A
TIME/DIV	1 mSEC
B TIME/DIV VARIABLE	CAL
MAG	X10
- c. Center the FINE control and position a marker to the graticule center with the Horizontal POSITION control.
- d. Check—Range of FINE position control must be between 5 and 8 divisions.

ⓐ

#### 49. Adjust 1 Microsecond Timing

ⓐ

- a. Test setup is given in step 48.
- b. Return the Horizontal POSITION control to midrange.
- c. Set the time-mark generator for 1-microsecond markers.

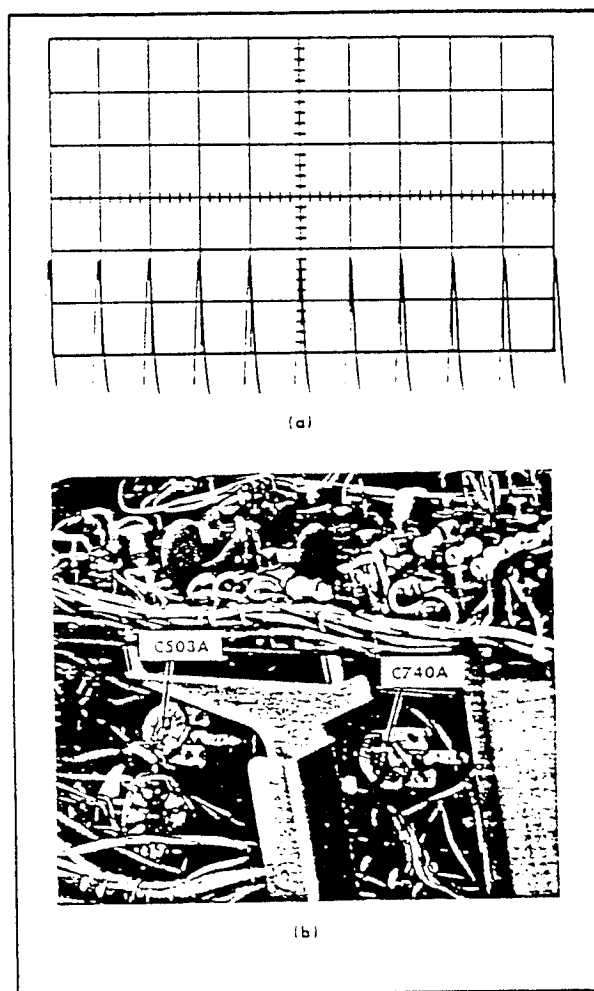

Fig. 6-51. (a) Typical crt display showing correct 1 microsecond timing; (b) Location of C530A and C740A (behind side panel).

- d. Set the MAG switch to OFF.
- e. Set the TIME/DIV switch to 1 μSEC.
- f. Check—Crt display for one marker each division between the first and ninth graticule lines (see Fig. 6-51a).
- g. Adjust—C530A (see Fig. 6-51b) for one marker each division.
- h. Set the HORIZ DISPLAY switch to DELAYED SWEEP (B).
- i. Check—Crt display for one marker each division between the first and ninth graticule lines (see Fig. 6-51a).
- j. Adjust—C740A (see Fig. 6-51b) for one marker each division.

### 50. Adjust High-Speed Linearity

- a. Test setup is given in step 49.
- b. Set the TIME/DIV switch to .1  $\mu$ SEC.
- c. Set the HORIZ DISPLAY switch to A.
- d. Set the time-mark generator for 50-Mc output.
- e. Position display so sweep starts at left edge of graticule.
- f. Set the MAG switch to X10.
- g. Check—Equal linearity for the two cycles to the left and the two cycles to the right of graticule center (see Fig. 6-52a).

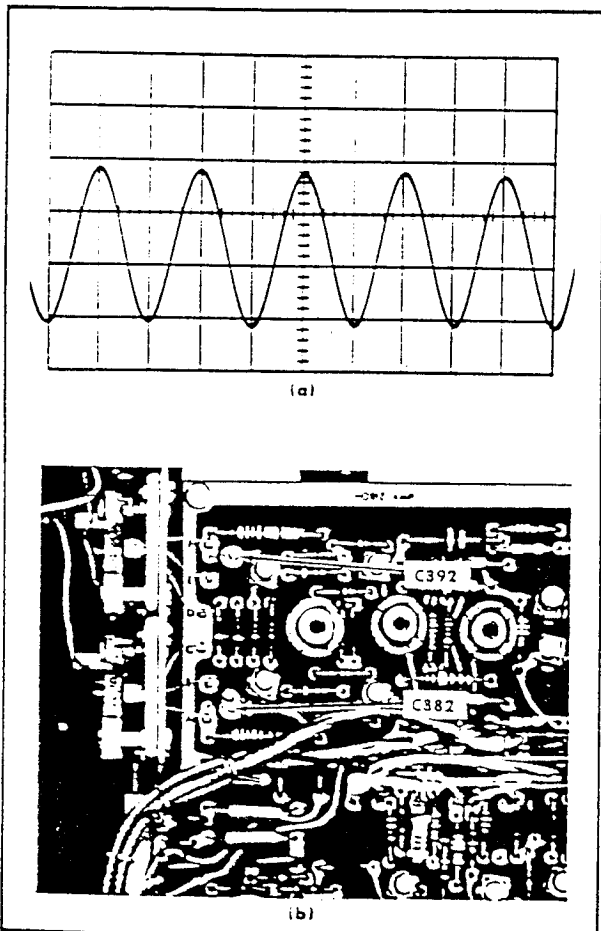

Fig. 6-52. (a) Typical crt display showing correct high speed linearity; (b) location of C382 and C392 (B Sweep board).

h. Adjust—C882 and C892 (see Fig. 6-52b) for equal spacing (linearity) for two cycles to the left and right of graticule center; that is, equal rate between the first and fifth graticule line and the fifth and ninth graticule line.

i. Check—Timing within  $\pm 4\%$  over full sweep length (excluding first and last three cycles of total sweep).

### 51. Check B Sweep Timing Accuracy

- a. Test setup is given in step 50.
- b. Set the MAG switch to OFF.
- c. Set the HORIZ DISPLAY switch to DELAYED SWEEP (B).
- d. Check—Using the A AND B TIME/DIV switch and time-mark generator settings given in Table 6-6, check B Sweep timing within  $\pm 3\%$ .

TABLE 6-6

A AND B TIME/ DIV Switch Setting	Time-Mark Generator Output	Crt Display (Markers/ Division)
.1 $\mu$ SEC	10 Megacyclic	1 cycle
.2 $\mu$ SEC	5 Megacyclic	1 cycle
.5 $\mu$ SEC	1 Microsecond	1 marker/2 division
1 $\mu$ SEC	1 Microsecond	1
2 $\mu$ SEC	1 Microsecond	2
5 $\mu$ SEC	5 Microsecond	1
10 $\mu$ SEC	10 Microsecond	1
20 $\mu$ SEC	10 Microsecond	2
50 $\mu$ SEC	50 Microsecond	1
.1 mSEC	100 Microsecond	1
.2 mSEC	100 Microsecond	2
.5 mSEC	500 Microsecond	1
1 mSEC	1 Millisecond	1
2 mSEC	1 Millisecond	2
5 mSEC	5 Millisecond	1
10 mSEC	10 Millisecond	1
20 mSEC	10 Millisecond	2
50 mSEC	50 Millisecond	1
.1 SEC	100 Millisecond	1
.2 SEC	100 Millisecond	2
.5 SEC	500 Millisecond	1
A Sweep ONLY		
1 SEC	1 Second	1
2 SEC	1 Second	2
5 SEC	5 Second	1

For Service Manuals Contact  
**MAURITRON TECHNICAL SERVICES**  
 8 Cherry Tree Rd, Chinnor  
 Oxon OX9 4QY  
 Tel: 01844-351694 Fax: 01844-352554  
 Email: enquiries@mauritron.co.uk

**52. Check A Sweep Timing Accuracy**

- a. Test setup is given in step 51.
- b. Set the HORIZ DISPLAY switch to A.
- c. Check—Using the A TIME/DIV switch and time-mark generator settings given in Table 6-6, check A Sweep timing within  $\pm 3\%$ .

**53. Check Delay-Time Jitter**

- a. Test setup is given in step 52.
- b. Change the following control settings:
 

DELAY-TIME MULTIPLIER	1.00
A TIME/DIV	1 mSEC
B TIME/DIV	1 $\mu$ SEC
HORIZ DISPLAY	DELAYED SWEEP (B)
B SWEEP MODE	B STARTS AFTER DELAY TIME
- c. Set the time-mark generator for 1-millisecond markers.
- d. Position the pulse near the center of the display area with the DELAY-TIME MULTIPLIER dial.
- e. Check—Jitter on the leading edge of the pulse should not exceed 0.5 division (1 part in 20,000); see Fig. 6-53. Ignore slow drift.
- f. Turn the DELAY-TIME MULTIPLIER dial to 9.00 and adjust so the pulse is displayed near the center of the display area.

- g. Check—Jitter on leading edge of the pulse should not exceed 0.5 division; see Fig. 6-53. Ignore slow drift.
- h. Disconnect all test equipment.

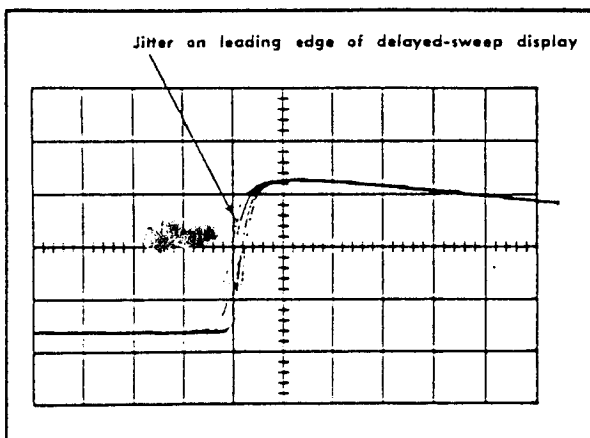

Fig. 6-53. Typical crt display when checking delay-time jitter.

**54. Check B Ends A Operation**

- a. Test setup is given in step 53.
- b. Set the B TIME/DIV switch to 5  $\mu$ SEC.
- c. Set the A SWEEP LENGTH control to B ENDS A.
- d. Turn the DELAY-TIME MULTIPLIER dial throughout its range.
- e. Check—The sweep ends after the intensified portion at all DELAY-TIME MULTIPLIER dial settings.

**NOTES**

For Service Manuals Contact  
**MAURITRON TECHNICAL SERVICES**  
 8 Cherry Tree Rd, Chinnor  
 Oxon OX9 4QY  
 Tel: 01844-351694 Fax: 01844-352554  
 Email: enquiries@mauritron.co.uk

---

---

---

---

---

---

---

---

---

---

---

---

---

---

---

---

---

---

---

---

---

---

---

---

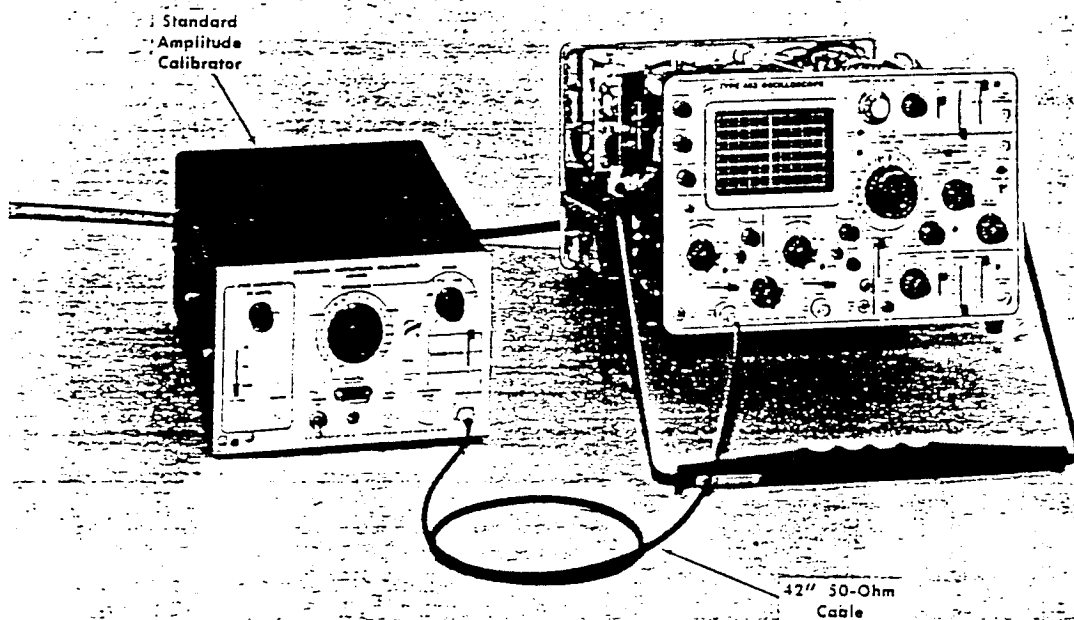

Fig. 6-54. Initial test equipment setup for steps 55 through 59.

Crt controls  
 INTENSITY Midrange  
 FOCUS Adjust for focused display  
 SCALE ILLUM As desired

Vertical controls (both channels if applicable)

VOLTS/DIV 20 mV  
 VARIABLE CAL  
 POSITION Midrange  
 AC GND DC DC  
 MODE CH 1  
 TRIGGER CH 1 ONLY  
 INVERT Pushed in

Triggering controls (both A and B if applicable)

LEVEL Any position  
 SLOPE —  
 COUPLING DC  
 SOURCE INT

Sweep controls

DELAY TIME MULTIPLIER 9.00  
 A TIME/DIV 1 mSEC  
 B TIME/DIV 1 mSEC  
 A VARIABLE CAL  
 A SWEEP MODE AUTO TRIG  
 B SWEEP MODE B STARTS AFTER DELAY  
 TIME  
 HORIZ DISPLAY EXT HORIZ  
 MAG OFF

A SWEEP LENGTH FULL  
 POSITION Midrange  
 POWER ON

Side-panel controls

B TIME/DIV VARIABLE CAL  
 CALIBRATOR DIV

Rear-panel controls

LINE VOLTAGE RANGE HIGH

55. Adjust External Horizontal Gain and Check Operation

- a. Test setup is shown in Fig. 6-54.
- b. Connect the standard amplitude calibrator to the Channel 1 INPUT connector through the 42-inch 50-ohm cable.
- c. Set the standard amplitude calibrator for a 0.1-volt square-wave output.
- d. Increase the INTENSITY setting until the display is visible.
- e. Check—Crt display for 5 divisions horizontal deflection,  $\pm 0.25$  division ( $\pm 5\%$ ); see Fig. 6-55a.
- f. Adjust—Ext Horiz Gain adjustment, R645 (see Fig. 6-55b), for 5 divisions horizontal deflection.
- g. Set the B Triggering SOURCE switch to EXT.

- h. Connect the standard amplitude calibrator to the EXT HORIZ input connector (B Triggering EXT TRIG INPUT).
- i. Set the standard amplitude calibrator for a 2-volt square-wave output.
- j. Check—Crt display for horizontal deflection between 6.5 and 8.7 divisions (similar to Fig. 6-55c).

- k. Set standard amplitude calibrator for a 20-volt square-wave output.
- l. Set the B Triggering SOURCE switch to EXT  $\div$  10.
- m. Check—Crt display for horizontal deflection between 6.2 and 9.2 divisions (similar to Fig. 6-55c).

**56. Check Z Axis Operation**

- a. Test setup is given in step 55.
- b. Set the INTENSITY control to a normal setting.

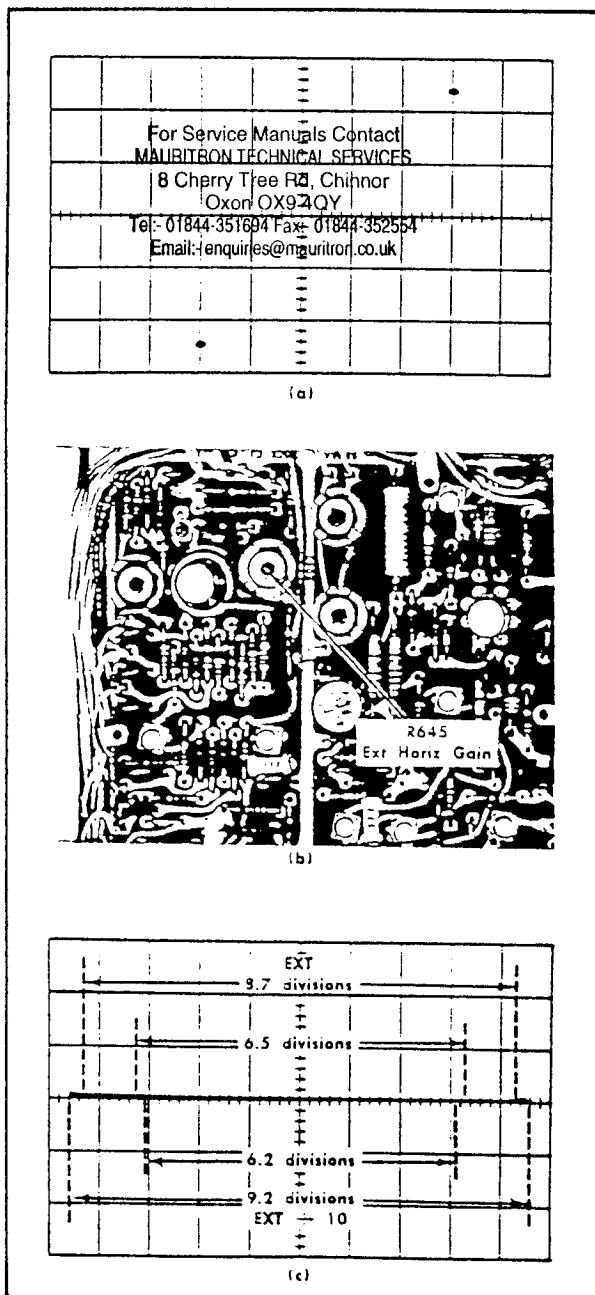

Fig. 6-55. (a) Typical crt display showing correct external horizontal gain; (b) Location of Ext Horiz Gain adjustment (B Sweep board); (c) Typical crt display when checking external horizontal deflection at EXT HORIZ input connector.

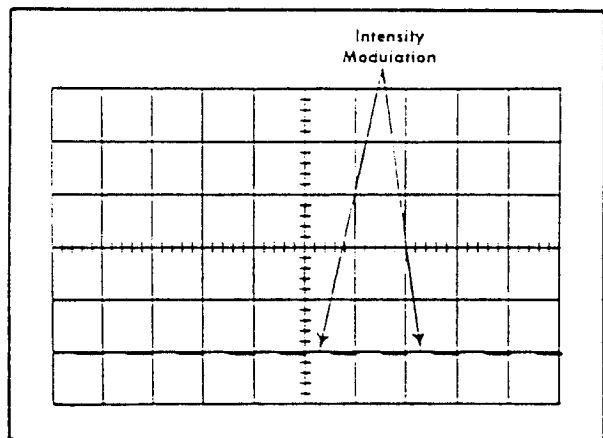

Fig. 6-56. Typical crt display showing intensity modulation (A Sweep externally triggered for stable display).

- a. Set the HORIZ DISPLAY switch to A.
- b. Connect the standard amplitude calibrator to the Z AXIS INPUT binding posts using a 42-inch 50-ohm cable and the BNC to alligator clips adapter.
- c. Remove the ground strap from between the binding posts.
- d. Set the standard amplitude calibrator for a 5-volt square-wave output.
- e. Check—Crt display for noticeable intensity modulation (see Fig. 6-56). (INTENSITY setting may have to be reduced to view trace modulation.)
- f. Replace ground strap.

**57. Check Trace Finder Operation**

- a. Test setup is given in step 56.
- b. Connect the standard amplitude calibrator to Channel 1 INPUT through the 42-inch 50-ohm cable.
- c. Set the standard amplitude calibrator for 10-volt square-wave output.
- d. Press the TRACE FINDER button.



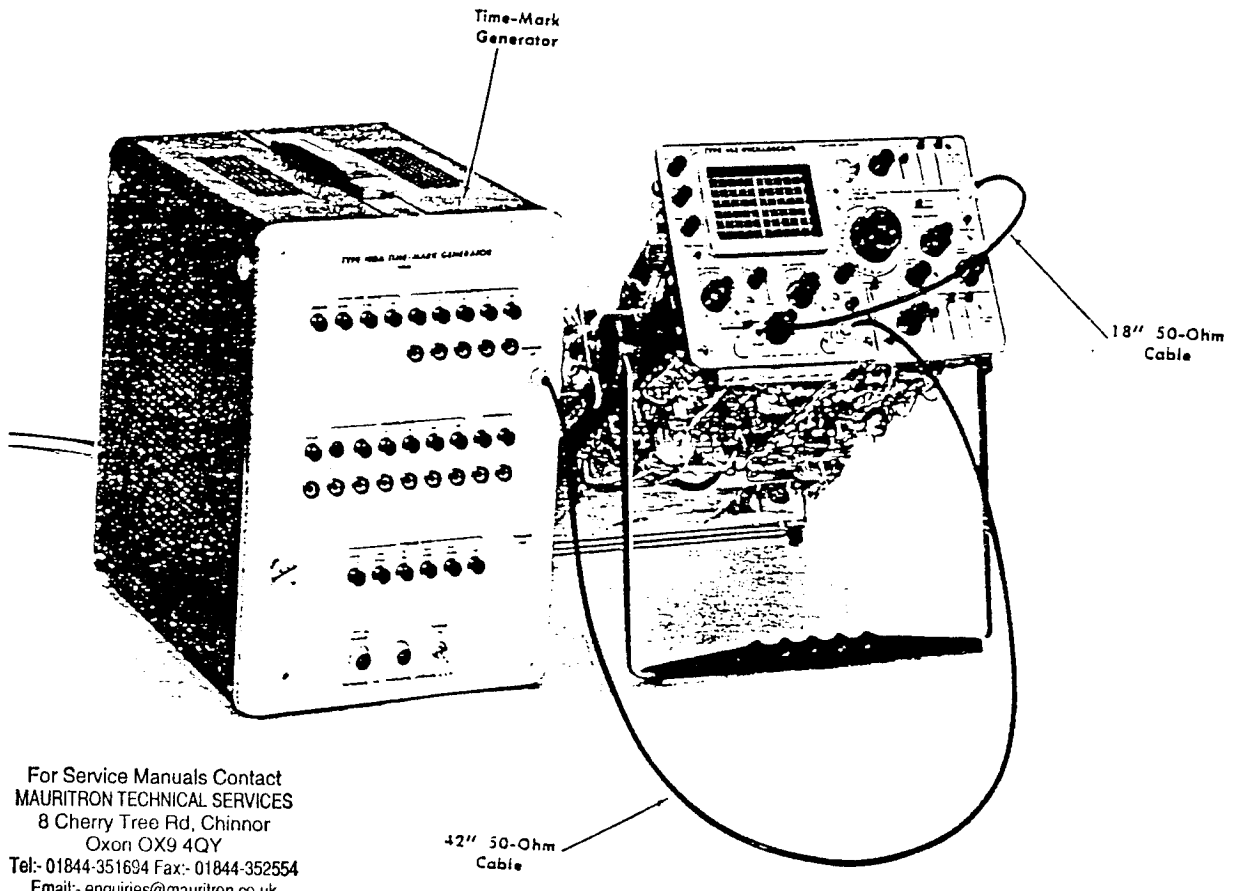

For Service Manuals Contact  
 MAURITRON TECHNICAL SERVICES  
 8 Cherry Tree Rd, Chinnor  
 Oxon OX9 4QY  
 Tel:- 01844-351694 Fax:- 01844-352554  
 Email:- enquiries@mauritron.co.uk

Fig. 6-58. Initial test equipment setup for steps 60 and 61.

- |   |                            |                            |                           |
|---|----------------------------|----------------------------|---------------------------|
| <b>Crt controls</b>                                     |                            |                            |                           |
| INTENSITY   | Midrange                   | A VARIABLE                 | CAL                       |
| FOCUS   | Adjust for focused display | A SWEEP MODE               | AUTO TRIG                 |
| SCALE ILLUM   | As desired                 | B SWEEP MODE               | B STARTS AFTER DELAY TIME |
| <b>Vertical controls (both channels if applicable)</b>  |                            |                            |                           |
| CH 1 VOLTS/DIV  | 50 mV                      | HORIZ DISPLAY              | A                         |
| CH 2 VOLTS/DIV  | 2 Volts                    | MAG                        | OFF                       |
| VARIABLE  | CAL                        | A SWEEP LENGTH             | FULL                      |
| POSITION  | Midrange                   | POSITION                   | Midrange                  |
| AC GND DC   | DC                         | POWER                      | ON                        |
| MODE  | ALT                        | <b>Side-panel controls</b> |                           |
| TRIGGER   | NORM                       | B TIME/DIV VARIABLE        | CAL                       |
| INVERT  | Pushed in                  | CALIBRATOR                 | .1V                       |
| <b>Triggering controls (both A and B if applicable)</b> |                            | <b>Rear-panel controls</b> |                           |
| LEVEL   | Stable display             | LINE VOLTAGE RANGE         | HIGH                      |
| SLOPE   | +                          |                            |                           |
| COUPLING  | AC                         |                            |                           |
| SOURCE  | INT                        |                            |                           |
| <b>Sweep controls</b>                                   |                            |                            |                           |
| DELAY-TIME MULTIPLIER                                   | 9.00                       |                            |                           |
| A TIME/DIV  | 1 mSEC                     |                            |                           |
| B TIME/DIV  | 1 mSEC                     |                            |                           |

- 60. Adjust Calibrator Repetition Rate** ①
- Test equipment setup is shown in Fig. 6-58.
  - Connect the 1 KC CAL connector to Channel 1 INPUT with a 18-inch 50-ohm cable.
  - Connect the time-mark generator to Channel 2 INPUT with a 42-inch 50-ohm cable.



## Calibration—Type 453

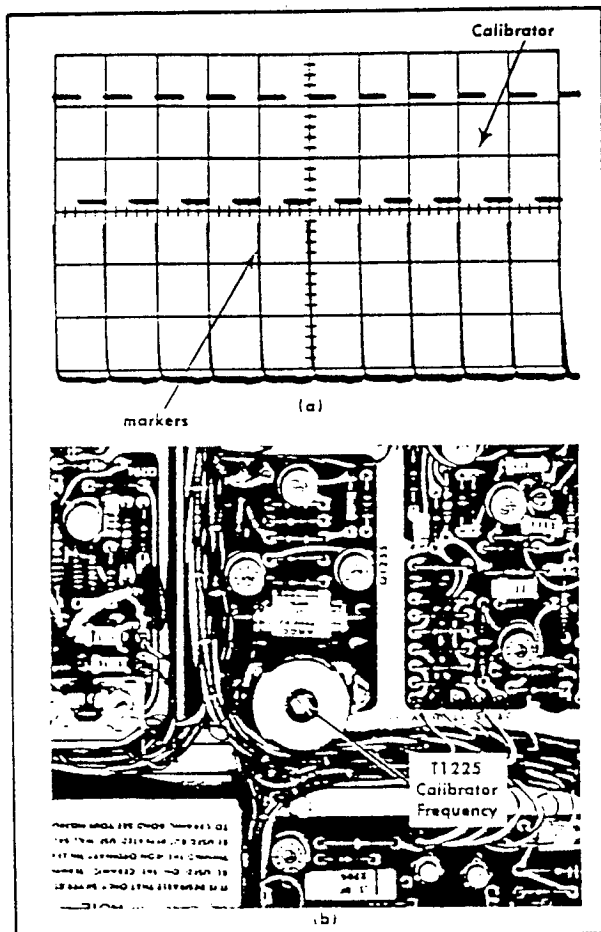

Fig. 6-59. (a) Typical CRT display showing correct calibrator repetition rate; (b) Location of Calibrator Frequency adjustment.

- d. Set the time-mark generator for 1-millisecond markers.
- e. Position the display so the tips of the markers fall just below the rising portions of the square wave (see Fig. 6-59a).
- f. Check—For one cycle of calibrator waveform for each marker (see Fig. 6-59a).
- g. Adjust—Calibrator Frequency adjustment, T1225 (see Fig. 6-59b), for one cycle of calibrator waveform for each marker.
- h. Set the TRIGGER switch to CH 1 ONLY.
- i. Check—Minimum drift of time markers.
- j. Adjust—T1225 for minimum drift of time markers.
- k. Disconnect all test equipment.

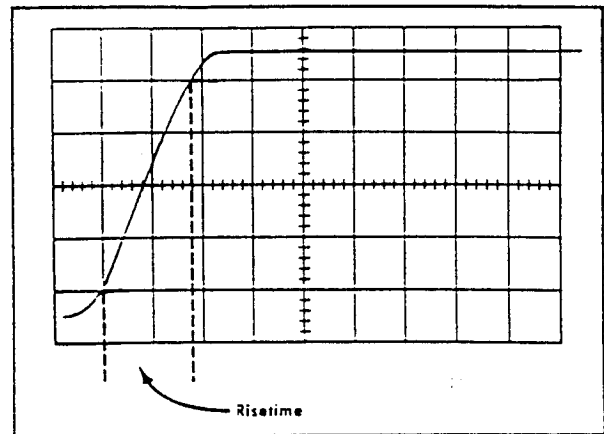

Fig. 6-60. Typical CRT display when checking Calibrator risetime. Indicated risetime is 0.36 microsecond.

### 61. Check Calibrator Duty Cycle and Risetime

- a. Change the following control settings:

VOLTS/DIV	20 mV
MCDE	CH 1
TIME/DIV	50 $\mu$ SEC

- b. Connect the 1 KC CAL connector to Channel 1 INPUT with an 18-inch 50-ohm cable.
- c. Set the A Triggering LEVEL control so the display starts at the 50% point on the rising portion of the waveform.
- d. Set the MAG switch to X10.
- e. Position the 50% point on the falling edge of the Calibrator waveform to the vertical centerline.
- f. Set the A Triggering SLOPE switch to —.

g. Check—50% point on rising edge now displayed not displaced more than 4 divisions from the vertical centerline (duty cycle 49% to 51%).

- h. Change the following control settings:

A Triggering SLOPE	+
TIME/DIV	2 $\mu$ SEC
MAG	OFF

i. Set the A Triggering LEVEL control so all of the rising portion of the Calibrator waveform is visible.

j. Check—Risetime between 10% and 90% points on the waveform less than 1 microsecond as shown by less than 5 divisions horizontally (see Fig. 6-60).

For Service Manuals Contact  
**MAURITRON TECHNICAL SERVICES**  
 8 Cherry Tree Rd, Chinnor  
 Oxon OX9 4QY  
 Tel: 01844-351694 Fax: 01844-352554  
 Email: enquiries@mauritron.co.uk

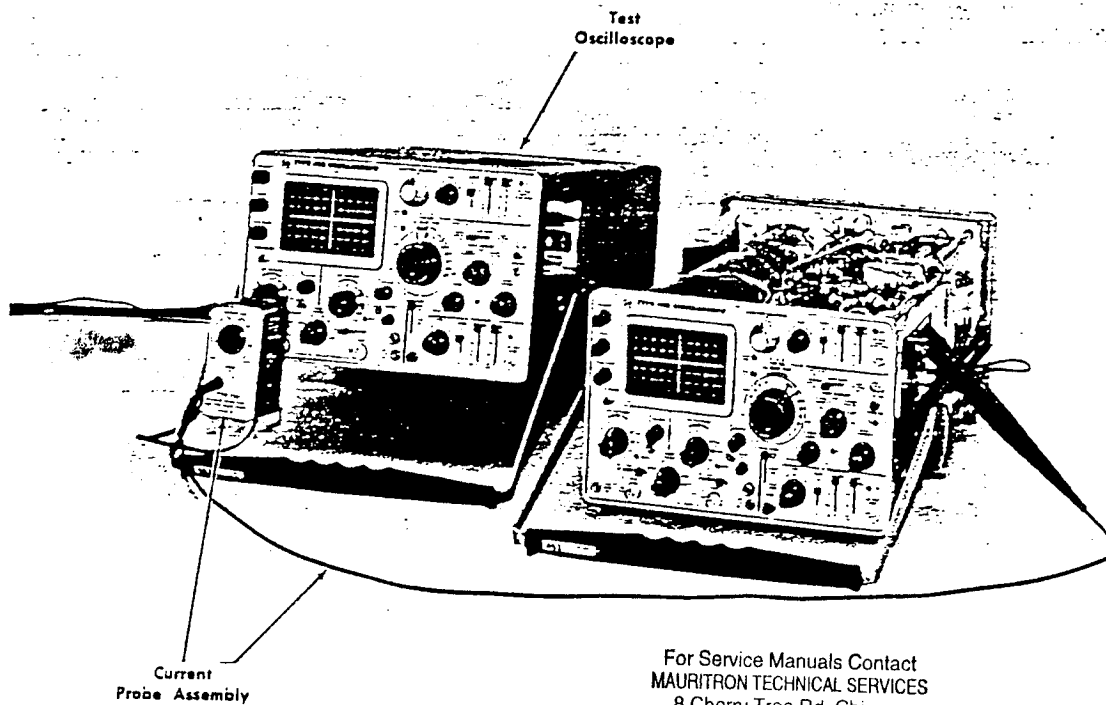

For Service Manuals Contact  
 MAURITRON TECHNICAL SERVICES  
 8 Cherry Tree Rd, Chinnor  
 Oxon OX9 4QY  
 Tel:- 01844-351694 Fax:- 01844-352554  
 Email:- enquiries@mauritron.co.uk

Fig. 6-61. Initial test equipment setup for step 62.

<b>Crt controls</b>	
INTENSITY	Midrange
FOCUS	Adjust for focused display
SCALE ILLUM	As desired
<b>Vertical controls (both channels if applicable)</b>	
Volts/div	50 mV
VARIABLE	CAL
POSITION	Midrange
AC GND DC	DC
MODE	CH 1
TRIGGER	CH 1 ONLY
INVERT	Pushed in
<b>Triggering controls (both A and B if applicable)</b>	
LEVEL	Stable display
SLOPE	+
COUPLING	AC
SOURCE	INT
<b>Sweep controls</b>	
DELAY-TIME MULTIPLIER	9.00
A TIME/DIV	.2 μSEC
B TIME/DIV	.2 μSEC
A VARIABLE	CAL
A SWEEP MODE	AUTO TRIG
B SWEEP MODE	B STARTS AFTER DELAY TIME
HORIZ DISPLAY	A
MAG	OFF
A SWEEP LENGTH	FULL

POSITION	Midrange
POWER	ON
<b>Side-panel controls</b>	
3 TIME/DIV VARIABLE CALIBRATOR	CAL 1 V
<b>Rear-panel controls</b>	
LINE VOLTAGE RANGE	HIGH

**62. Check Calibrator Current Through Probe Loop**

- a. Test equipment setup is shown in Fig. 6-61.
- b. Connect the current probe assembly to the input of the test oscilloscope.
- c. Clip the current probe around the PROBE LOOP.
- d. Check—5-milliamp current through PROBE LOOP.
- e. Set the CALIBRATOR switch to 1 V.
- f. Check—Current should be 5 milliamps.
- g. Disconnect all test equipment.

**NOTE**

Calibrator output voltage is checked and adjusted in step 2 of this procedure.

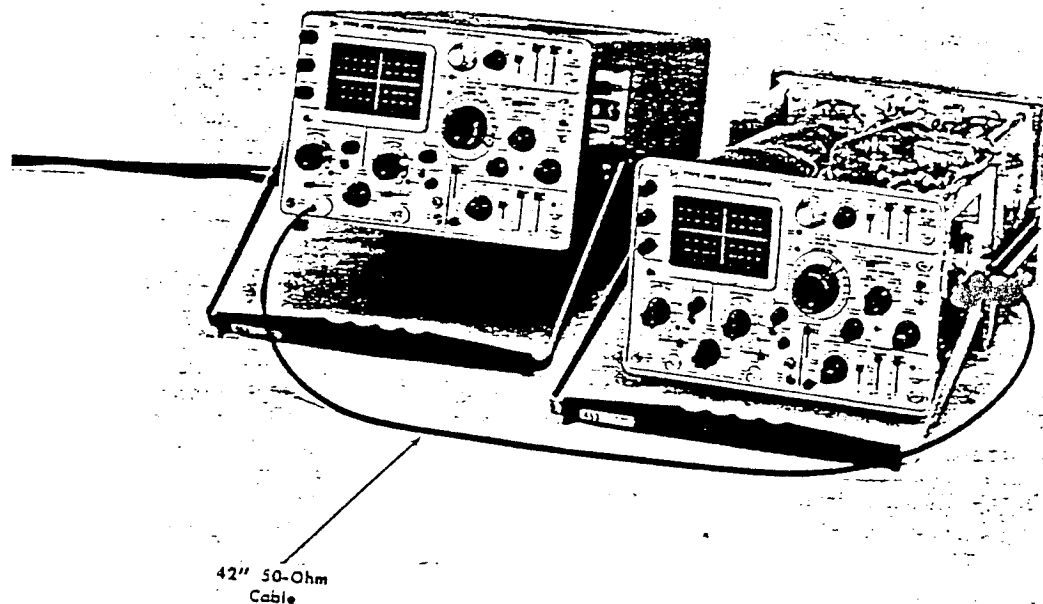

Fig. 6-62. Initial test equipment setup for step 63.

<b>Crt controls</b>		<b>Sweep controls</b>	
INTENSITY	Midrange	DELAY-TIME MULTIPLIER	0.05
FOCUS	Adjust for focused display	A TIME/DIV	1 mSEC
SCALE ILLUM	As desired	B TIME/DIV	1 mSEC
<b>Vertical controls (both channels if applicable)</b>		A VARIABLE	CAL
Volts/div	20 mV	A SWEEP MODE	AUTO TRIG
VARIABLE	CAL	B SWEEP MODE	B STARTS AFTER DELAY TIME
POSITION	Midrange	HORIZ DISPLAY	A
AC GND DC	DC	MAG	OFF
MODE	CH 1	A SWEEP LENGTH	FULL
TRIGGER	CH 1 ONLY	POSITION	Midrange
INVERT	Pushed in	POWER	ON
<b>Triggering controls (both A and B if applicable)</b>		<b>Side-panel controls</b>	
LEVEL	Clockwise	B TIME/DIV VARIABLE	CAL
SLOPE	+	CALIBRATOR	1 V
COUPLING	AC	<b>Rear-panel controls</b>	
SOURCE	INT	LINE VOLTAGE RANGE	HIGH

### 63. Check Gate Output Signals

- a. Test equipment setup is shown in Fig. 6-62.
- b. Connect the A GATE connector to the input of the test oscilloscope with a 42-inch 50-ohm cable.
- c. Check—A GATE output signal +12 volts in amplitude,  $\pm 10\%$  (see Fig. 6-63). Gate duration same as A Sweep.
- d. Set the HORIZ DISPLAY switch to DELAYED SWEEP (B).
- e. Connect the B GATE connector to the input of the test oscilloscope with a 42-inch 50-ohm cable.
- f. Check—B GATE output signal +12 volts in amplitude,  $\pm 10\%$  (see Fig. 6-63). Gate duration same as B Sweep.

This completes the calibration of the Type 453. Disconnect all test equipment and replace the top and bottom covers. If the instrument has been completely calibrated to the tolerances given in this procedure, it will perform to the limits given in the Characteristics section of the Instruction Manual.

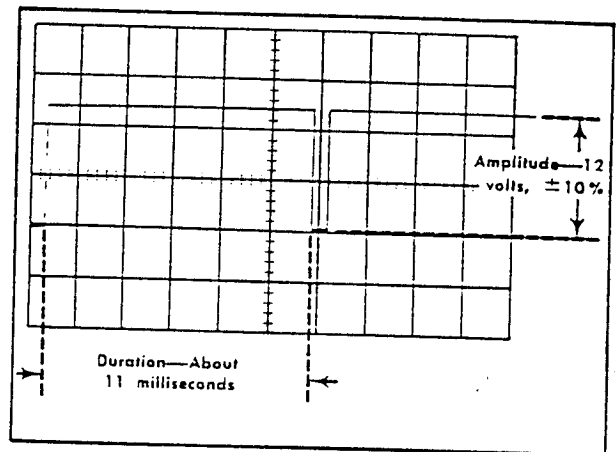

Fig. 6-63. Typical crt display when checking gate amplitude and duration (vertical deflection, 5 volts/division; sweep rate, 2 milliseconds/division).

### NOTES

For Service Manuals Contact  
 MAURITRON TECHNICAL SERVICES  
 8 Cherry Tree Rd, Chinnor  
 Oxon OX9 4QY  
 Tel: 01844-351694 Fax: 01844-352554  
 Email: enquires@mauritron.co.uk

# SECTION 7

## PARTS LIST and DIAGRAMS

### PARTS ORDERING INFORMATION

Replacement parts are available from or through your local Tektronix Field Office.



Changes to Tektronix instruments are sometimes made to accommodate improved components as they become available, and to give you the benefit of the latest circuit improvements developed in our engineering department. It is therefore important, when ordering parts, to include the following information in your order: Part number including any suffix, instrument type, serial number, and modification number if applicable.

If a part you have ordered has been replaced with a new or improved part, your local Tektronix Field Office will contact you concerning any change in part number.

### ABBREVIATIONS AND SYMBOLS

a or amp	amperes	mm	millimeter
BHS	binding head steel	meg or M	megohms or mega ( $10^6$ )
C	carbon	met.	metal
cer	ceramic	$\mu$	micro, or $10^{-6}$
cm	centimeter	n	nano, or $10^{-9}$
comp	composition	$\Omega$	ohm
cps	cycles per second	OD	outside diameter
cr	cathode-ray tube	OHS	oval head steel
CSK	counter sunk	p	pico, or $10^{-12}$
dia	diameter	PHS	pan head steel
div	division	piv	peak inverse voltage
EMC	electrolytic, metal cased	plstc	plastic
EMT	electrolytic, metal tubular	PMC	paper, metal cased
ext	external	poly	polystyrene
f	farad	Prec	precision
F & I	focus and intensity	PT	paper tubular
FHS	flat head steel	PTM	paper or plastic, tubular, molded
Fl HS	flattener head steel	RHS	round head steel
g or G	giga, or $10^9$	rms	root mean square
Ge	germanium	sec	second
GMV	guaranteed minimum value	Si	silicon
h	henry	S/N	serial number
hex	hexagonal	t or T	tera, or $10^{12}$
HHS	hex head steel	TD	toroid
HSS	hex socket steel	THS	truss head steel
HV	high voltage	tub.	tubular
ID	inside diameter	v or V	volt
incd	incandescent	Var	variable
int	internal	w	watt
k or K	kilohms or kilo ( $10^3$ )	w/	with
kc	kilocycle	w/o	without
m	milli, or $10^{-3}$	WW	wire-wound
mc	megacycle		

### SPECIAL NOTES AND SYMBOLS

X000	Part first added at this serial number.
000X	Part removed after this serial number.
*000-000	Asterisk preceding Tektronix Part Number indicates manufactured by or for Tektronix, or reworked or checked components.
Use 000-000	Part number indicated is direct replacement.
	Internal screwdriver adjustment.
	Front-panel adjustment or connector.

FRONT

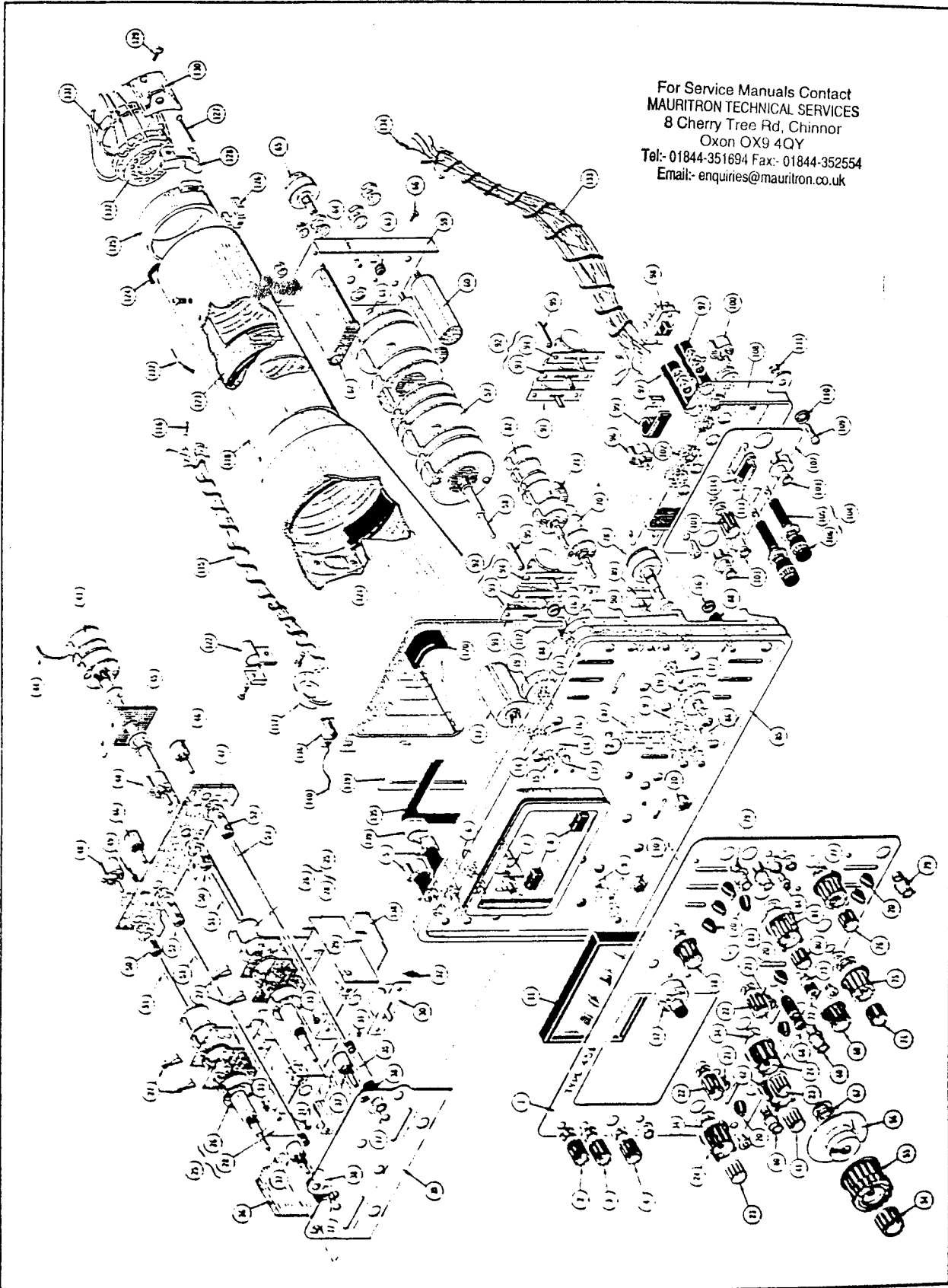

For Service Manuals Contact  
MAURITRON TECHNICAL SERVICES  
8 Cherry Tree Rd, Chinnor  
Oxon OX9 4QY  
Tel: 01844-351694 Fax: 01844-352554  
Email: enquiries@mauritron.co.uk

## FRONT

REF. NO.	PART NO.	SERIAL/MODEL NO.		QTY.	DESCRIPTION
		EFF.	DISC.		
1	333-0891-00			1	PANEL, front
2	366-0153-00			1	KNOB, small charcoal—INTENSITY
				-	knob includes:
	213-0004-00			1	SCREW, ser. 6-32 x 3/16 inch, HSS
3	366-0153-00			1	KNOB, small charcoal—FOCUS
				-	knob includes:
	213-0004-00			1	SCREW, ser. 6-32 x 3/16 inch, HSS
4	366-0153-00			1	KNOB, small charcoal—SCALE ILLUM
				-	knob includes:
	213-0004-00			1	SCREW, ser. 6-32 x 3/16 inch, HSS
5				2	POT
				-	mounting hardware for each: (not included w/pot)
	210-0046-00			1	LOCKWASHER, internal, .400 OD x .261 inch ID
	210-0940-00			1	WASHER, 1/4 ID x 3/8 inch OD
	210-0583-00			2	NUT, hex, 1/4-32 x 5/16 inch
6				1	POT
				-	mounting hardware: (not included w/pot)
	210-0046-00			1	LOCKWASHER, internal, .400 OD x .261 inch ID
	210-0940-00			1	WASHER, 1/4 ID x 3/8 inch OD
	210-0583-00			3	NUT, hex, 1/4-32 x 5/16 inch
7	260-0688-00			1	SWITCH, push—TRACE FINDER
				-	mounting hardware: (not included w/switch)
	210-0046-00			1	LOCKWASHER, internal, .400 OD x .261 inch ID
	210-0940-00			1	WASHER, 1/4 ID x 3/8 inch OD
	210-0583-00			2	NUT, hex, 1/4-32 x 5/16 inch
8	214-0654-00			1	SPRING, filter
9				2	POT
				-	mounting hardware for each: (not included w/pot)
	210-0223-00			1	LUG, solder, 1/4 inch
	220-0437-00			1	NUT, hex, 1/4-32 x 3/8 x .594 inch
	210-0046-00			1	LOCKWASHER, internal, .400 OD x .261 inch ID
	358-0054-00			1	BUSHING, banana jack
10	166-0402-00			2	SPACER, BNC connector
11				-	See Filter, mesh on Standard Accessories Page
12	331-0139-00			1	DIAL—TIME-DELAY MULTIPLIER
				-	dial includes:
	213-0048-00			1	SCREW, ser. 4-40 x 1/8 inch, HSS
13				1	POT
				-	mounting hardware: (not included w/pot)
	210-0012-00			1	LOCKWASHER, internal, 3/8 x 1/2 inch
14	352-0084-00			2	HOLDER, neon, black
15	378-0541-01			1	FILTER, lens, neon, green
16	200-0609-00			5	CAP, neon holder
17	378-0541-00			6	FILTER, lens, neon
18	366-0220-00			1	KNOB, small charcoal—LEVEL
				-	knob includes:
	213-0020-00			1	SCREW, ser. 6-32 x 1/8 inch, HSS

For Service Manuals Contact  
**MAURITRON TECHNICAL SERVICES**  
 8 Cherry Tree Rd, Chinnor  
 Oxon OX9 4QY  
 Tel: 01844-351694 Fax: 01844-352554  
 Email: enquiries@mauratron.co.uk

Parts List—Type 453

FRONT (Cont'd)

REF. NO.	PART NO.	SERIAL/MODEL NO.		QTY.	DESCRIPTION
		EFF.	DISC.		
19	----- 210-0012-00 210-0978-00 210-0590-00			2 - 1 1 1	POT - mounting hardware for each: (not included w/pot) LOCKWASHER, internal, 3/8 x 1/2 inch WASHER, 3/8 ID x 1/2 inch OD NUT, hex, 3/8-32 x 7/16 inch
20	366-0215-01			10	KNOB, lever
21	358-0216-00			2	BUSHING, front panel
22	366-0153-00 ----- 213-0004-00			2 - 1	KNOB, small charcoal—POSITION - each knob includes: SCREW, ser, 6-32 x 3/16 inch, HSS
23	366-0189-00 ----- 213-0020-00			2 - 1	KNOB, small rec—VARIABLE - each knob includes: SCREW, ser, 6-32 x 1/4 inch, HSS
24	366-0322-00 ----- 213-0004-00			2 - 1	KNOB, charcoal—VOLTS/DIV - each knob includes: SCREW, ser, 6-32 x 3/16 inch, HSS
25	644-0412-00 ----- 262-0728-00			2 - 1	ASSEMBLY, attenuator switch & chassis (See Ref. #33) - each assembly includes: SWITCH, wired—VOLTS/DIV
26	260-0720-00 ----- 214-0599-00			1 - 2	SWITCH, unwired—VOLTS/DIV - switch includes SPRING, switch shaft ground
27	441-0639-00			1	CHASSIS, attenuator
28	337-0769-00			1	SHIELD, attenuator chassis
29	260-0621-00 ----- 220-0413-00			1 - 2	SWITCH, lever—AC-GND-DC - mounting hardware: (not included w/switch alone) NUT, switch, 4-40 x 3/16 x .562 inch
	210-0004-00	X3150		2	LOCKWASHER, internal, #4
31	214-0456-00			5	FASTENER, deirin
32	131-0180-00 ----- 358-0135-00			1 - 1	CONNECTOR, terminal stand-off - mounting hardware: (not included w/connector alone) BUSHING, ferron
33	----- 210-0006-00 210-0407-00 210-0457-00	100 100 1890	1889 1889	2 2 2	- mounting hardware for each: (not included w/assembly) LOCKWASHER, internal, #6 NUT, hex, 6-32 x 1/4 inch NUT, keps, 6-32 x 3/16 inch
34	210-0012-00 210-0978-00 210-0590-00			1 1 1	LOCKWASHER, internal, 3/8 x 1/2 inch WASHER, 3/8 ID x 1/2 inch OD NUT, hex, 3/8-32 x 7/16 inch
35	337-0768-00 ----- 210-0586-00			1 - 3	SHIELD, attenuator, center - mounting hardware: (not included w/shield) NUT, keps, 4-40 x 1/4 inch
36	337-0774-00 ----- 210-0586-00			1 - 2	SHIELD, attenuator, side - mounting hardware: (not included w/shield) NUT, keps, 4-40 x 1/4 inch
37	----- 210-0046-00 210-0583-00			2 - 1 1	POT - mounting hardware for each: (not included w/pot) LOCKWASHER, internal, .400 OD x .261 inch ID NUT, hex, 1/4-32 x 3/16 inch



## FRONT (Cont'd)

REF. NO.	PART NO.	SERIAL/MODEL NO.		QTY.	DESCRIPTION
		EFF.	DISC.		
38	352-0067-00			2	HOLDER, neon, single
	-----			-	mounting hardware for each: (not included w/holder)
	211-0109-00			1	SCREW, 4-40 x 7/8 inch, FHS phillips
	210-0406-00			2	NUT, hex, 4-40 x 3/16 inch
39	386-0225-00			1	PLATE, attenuator
40	131-0352-00			2	CONNECTOR, BNC (hardware included)
41	366-0189-00			1	KNOB, small red—TRIGGER
	-----			-	knob includes:
	213-0020-00			1	SCREW, set 6-32 x 1/8 inch, HSS
42	366-0322-00			1	KNOB, charcoal—MODE
	-----			-	knob includes:
	213-0004-00			1	SCREW, set, 6-32 x 3/16 inch, HSS
43	262-0727-00			1	SWITCH, wired—MODE
	-----			-	switch includes:
	260-0695-00			1	SWITCH, unwired—MODE
44	131-0371-00			8	CONNECTOR, single contact
45	407-0157-00			1	BRACKET, MODE switch
	-----			-	mounting hardware: (not included w/bracket alone)
	210-0012-00			2	LOCKWASHER, internal, 3/8 x 1/2 inch
	210-0413-00			1	NUT, hex, 3/8-32 x 1/2 inch
46	-----			2	POT
	-----			-	mounting hardware for each: (not included w/pot)
	210-0940-00			1	WASHER, 1/4 ID x 3/8 inch OD
	210-0533-00			1	NUT, hex, 1/4-32 x 5/16 inch
47	407-0173-00			1	BRACKET, pot mounting
48	-----			2	POT
	-----			-	mounting hardware for each: (not included w/pot)
	210-0223-00			1	LUG, solder, 1/4 inch
	210-0853-00	X2776		1	WASHER, flat, 17/64 ID x 1/2 inch OD
	210-0940-00			1	WASHER, 1/4 ID x 3/8 inch OD
	210-0533-00			1	NUT, hex, 1/4-32 x 5/16 inch
49	131-0180-00			2	CONNECTOR, terminal stand-off
	-----			-	mounting hardware for each: (not included w/connector)
	358-0135-00			1	BUSHING, tetlon
50	376-0039-00	100	2775	2	COUPLING, shaft
	376-0059-00	2776		2	ASSEMBLY, coupling
	-----			-	each coupling includes:
	213-0075-00	100	2775	2	SCREW, set, 4-40 x 3/32 inch, HSS
	213-0075-00	2776		3	SCREW, set, 4-40 x 3/32 inch, HSS
	376-0014-00	X2776		1	COUPLING, wire
51	384-0368-00	100	2775	2	ROD, pot shaft
	384-0410-00	2776		2	ROD, pot shaft
52	376-0053-00			2	COUPLING, shaft
	-----			-	each coupling includes:
	213-0048-00			2	SCREW, set, 4-40 x 1/8 inch, HSS
53	384-0360-00			2	ROD, pot shaft
54	366-0038-00			1	KNOB, small red—A VARIABLE
	-----			-	knob includes:
	213-0004-00			1	SCREW, set, 6-32 x 3/16 inch, HSS
55	366-0194-00			1	KNOB, large charcoal—B TIME/DIV
	-----			-	knob includes:
	213-0022-00			2	SCREW, set, 4-40 x 3/16 inch, HSS

For Service Manuals Contact  
**MAURITRON TECHNICAL SERVICES**  
 8 Cherry Tree Rd, Chinnor  
 Oxon OX9 4QY  
 Tel: 01844-351694 Fax: 01844-352554  
 Email: enquiries@mauritron.co.uk

X2776

Parts List—Type 453

FRONT (Cont'd)

REF. NO.	PART NO.	SERIAL/ MODEL NO.		QTY.	DESCRIPTION
		EFF.	DISC.		
56	331-0092-00			1	DIAL, window knob—A TIME/DIV
	-----			-	dial includes:
	213-0022-00			2	SCREW, ser, 4-40 x 3/16 inch, HSS
57	262-0724-00			1	SWITCH, wired—A AND B TIME/DIV (See Ref. #66 & #67)
	-----			-	switch includes:
	260-0694-00			1	SWITCH, unwired—A AND B TIME/DIV
58	384-0262-00			1	ROD, extension
59	407-0148-00			1	BRACKET, switch
	-----			-	mounting hardware: (not included w/bracket alone)
	210-0006-00			1	LOCKWASHER, internal, #6
	210-0202-00			1	LUG, solder, SE #6
	210-0449-00			2	NUT, hex, 6-40 x 1/4 inch
60	-----			2	CAPACITOR
	-----			-	mounting hardware for each: (not included w/capacitor alone)
	210-0018-00			1	LOCKWASHER, internal, 3/16 inch
	210-0524-00			1	NUT, hex, 3/8-24 x 1/2 inch
61	376-0014-00			1	COUPLING, pot
62	-----			1	CAPACITOR -
	-----			-	mounting hardware: (not included w/capacitor alone)
	210-0457-00			2	NUT, keps, 6-32 x 3/8 inch
63	348-0055-00			2	GROMMET, plastic, 1/4 inch
64	131-0181-00			2	CONNECTOR, terminal
	-----			-	mounting hardware for each: (not included w/connector alone)
	353-0136-00			1	BUSHING, teflon
65	-----			1	POT
	-----			-	mounting hardware: (not included w/pot alone)
	210-0413-00			2	NUT, hex, 3/8-32 x 1/2 inch
	210-0012-00			1	LOCKWASHER, internal, 3/8 x 1/2 inch
66	-----			-	mounting hardware: (not included w/switch)
	211-0507-00			2	SCREW, 6-32 x 3/16 inch, PHS phillips
	210-0803-00			2	WASHER, 6L x 3/8 inch
67	210-0049-00			1	LOCKWASHER, internal, 3/8 inch
	210-0579-00			1	NUT, hex, 3/8-24 x 3/4 inch
68	384-0357-00			1	RCD, slide switch
69	356-0220-00	100	2099	1	KNOB, small charcoal—A SWEEP LENGTH
	356-0148-00	2100		1	KNOB, small charcoal—A SWEEP LENGTH
	-----			-	knob includes:
	213-0020-00	100	2099	1	SCREW, ser, 6-32 x 1/8 inch, HSS
	213-0004-00	2100		1	SCREW, ser, 6-32 x 3/16 inch, HSS
70	262-0726-00			1	SWITCH, wired—A SWEEP LENGTH
	-----			-	switch includes:
	260-0697-00			1	SWITCH, unwired—A SWEEP LENGTH
71	-----			1	POT
	-----			-	mounting hardware: (not included w/pot alone)
	376-0014-00			1	COUPLING, pot
	210-0012-00			1	LOCKWASHER, internal, 3/8 x 1/2 inch
	210-0590-00			2	NUT, hex, 3/8-32 x 3/16 inch
	-----			-	mounting hardware: (not included w/switch)
	210-0978-00			1	WASHER, 3/8 ID x 1/2 inch OD
	210-0590-00			1	NUT, hex, 3/8-32 x 3/16 inch

## FRONT (Cont'd)

REF. NO.	PART NO.	SERIAL/MODEL NO.		QTY.	DESCRIPTION
		EFF.	DISC.		
72	200-0103-00			1	CAP, binding post
73	129-0077-00			1	POST, binding, stud
	210-0046-00			-	mounting hardware: (not included w/post)
	210-0455-00			1	LOCKWASHER, internal, .400 OD x .261 inch ID
				1	NUT, hex, 1/4-28 x 3/8 inch
74	366-0319-00			1	KNOB, small red—HF STAB
	213-0020-00			-	knob includes:
	366-0138-00			1	SCREW, ser. 6-32 x 1/8 inch, HSS
				1	KNOB, charcoal—LEVEL
	213-0004-00			-	knob includes:
76	366-0189-00	100	1889	1	SCREW, ser. 6-32 x 3/16 inch, HSS
	366-0319-00	1890		1	KNOB, small red—FINE
				1	KNOB, small red—FINE
	213-0020-00			-	knob includes:
77	366-0175-00	100	1889	1	SCREW, ser. 6-32 x 1/8 inch, HSS
	366-0138-00	1890		1	KNOB, charcoal—POSITION
				1	KNOB, charcoal—POSITION
	213-0004-00			-	knob includes:
78				1	SCREW, ser. 6-32 x 3/16 inch, HSS
				1	POT
	210-0012-00			-	mounting hardware: (not included w/post)
	210-0494-00			2	LOCKWASHER, internal, 3/8 x 1/2 inch
	210-0840-00			1	NUT, hex, 3/8-32 x 1/2 x 1 1/16 inch
	358-0029-01	100	1889	1	WASHER, .390 ID x 3/16 inch OD
	358-0029-05	1890		1	BUSHING, hex, panel
				1	BUSHING, hex, panel
79	131-0106-00			3	CONNECTOR, coaxial, BNC (hardware included)
80	366-0189-00			1	KNOB, small red—MAG
	213-0020-00			-	knob includes:
81	366-0322-00			1	SCREW, ser. 6-32 x 1/8 inch, HSS
				1	KNOB, charcoal—HORIZ DISPLAY
	213-0004-00			-	knob includes:
82	262-0725-00	100	2499	1	SCREW, ser. 6-32 x 3/16 inch, HSS
	262-0725-01	2500		1	SWITCH, wired—HORIZ DISPLAY (See Ref. #83)
				1	SWITCH, wired—HORIZ DISPLAY (see ref. #83)
	260-0696-00			-	switch includes:
83				1	SWITCH, unwired—HORIZ DISPLAY
	210-0012-00			-	mounting hardware: (not included w/switch)
	210-0978-00			1	LOCKWASHER, internal, 3/8 x 1/2 inch
	210-0590-00			1	WASHER, 3/8 ID x 1/2 inch OD
				1	NUT, hex, 3/8-32 x 7/16 inch
84	136-0223-00			1	SOCKET, light
	210-0940-00			-	mounting hardware: (not included w/socket)
	210-0223-00			1	WASHER, 3/8 ID x 3/8 inch OD
	210-0562-00			1	LUG, solder, 1/4 inch
				1	NUT, hex, 1/4-40 x 3/16 inch
85	386-0208-00			1	PLATE, front
86	260-0717-00			1	SWITCH, push, w/bulb—RESET
	210-0012-00			-	mounting hardware: (not included w/switch)
	210-0978-00			1	LOCKWASHER, internal, 3/8 x 1/2 inch
	210-0590-00			1	WASHER, 3/8 ID x 1/2 inch OD
				1	NUT, hex, 3/8-32 x 7/16 inch

For Service Manuals Contact  
**MAURITRON TECHNICAL SERVICES**  
 8 Cherry Tree Rd, Chinnor  
 Oxon OX9 4QY  
 Tel: 01844-351694 Fax: 01844-352554  
 Email: enquiries@mauritron.co.uk

Parts List—Type 453

FRONT (Cont'd)

REF. NO.	PART NO.	SERIAL/MODEL NO.		QTY.	DESCRIPTION
		EFF.	DISC.		
87	260-0699-00			1	SWITCH lever—A SWEEP MODE
	220-0413-00			2	mounting hardware: (not included w/switch) NUT, switch, 4-40 x 3/16 x .562 inch
88	352-0084-01			3	HOLDER, neon, white
89	260-0716-00			1	SWITCH, toggle—POWER
	210-0046-00			-	mounting hardware: (not included w/switch)
	210-0940-00			1	LOCKWASHER, internal, .400 OD x .261 inch ID
	210-0562-00			1	WASHER, 1/4 ID x 3/8 inch OD
				2	NUT, hex, 1/4-40 x 3/16 inch
90	260-0587-00			1	SWITCH, lever—B SWEEP MODE
	220-0413-00			2	mounting hardware: (not included w/switch) NUT, switch, 4-40 x 3/16 x .562 inch
91	260-0472-00			2	SWITCH, lever—SLOPE
	220-0413-00			2	mounting hardware for each: (not included w/switch) NUT, switch, 4-40 x 3/16 x .562 inch
92	262-0723-00			2	SWITCH, wired—SOURCE-COUPLING (See Ref. #95)
	131-0371-00			-	each switch includes:
93	260-0700-00			2	CONNECTOR, single contact
	260-0698-00			1	SWITCH, lever—COUPLING
94	260-0698-00			1	SWITCH, lever—SOURCE
	220-0413-00			4	mounting hardware for each: (not included w/switch) NUT, switch, 4-40 x 3/16 x .562 inch
96				1	POT
	210-0223-00			-	mounting hardware: (not included w/pot)
	358-0075-00			1	LUG, solder, 1/4 inch
97	200-0237-00			1	BUSHING, pot mounting
	260-0447-00			2	COVER, insulating, fuse holder
98	210-0406-00			1	SWITCH, slide—CALIBRATOR
				-	mounting hardware: (not included w/switch)
				2	NUT, hex, 4-40 x 3/16 inch
99	343-0005-00			1	CLAMP, cable, 7/16 inch
	210-0863-00			-	mounting hardware: (not included w/clamp)
	210-0457-00			1	WASHER, "D" type
100				1	NUT, keps, 6-32 x 3/16 inch
	358-0075-00			1	POT
				-	mounting hardware: (not included w/pot)
				1	BUSHING, pot mounting

## FRONT (Cont'd)

REF. NO.	PART NO.	SERIAL/ MODEL NO.		QTY.	DESCRIPTION
		EFF.	DISC.		
101	366-0236-00			1	KNOB, small charcoal—8 TIME/DIV VARIABLE knob includes:
	213-0020-00			1	SCREW, set, 6-32 x 1/8 inch, HSS
102				1	POT (not shown)
	210-0012-00			1	mounting hardware: (not included w/pot)
	210-0590-00			1	LOCKWASHER, internal, 3/8 x 1/2 inch
				1	NUT, hex, 3/8-32 x 7/16 inch
103	131-0274-00			3	CONNECTOR, coaxial, BNC (hardware included)
104	352-0002-00			2	ASSEMBLY, fuse holder
				-	each assembly includes:
105	352-0010-00			1	HOLDER, fuse
	210-0873-00			1	WASHER, rubber, 1/2 ID x 1 1/16 inch OD
				1	NUT, fuse holder
				1	CAP, fuse
106	200-0582-00			1	PANEL, side plate
107	333-0909-00			1	FRAME, calibrator
108	426-0267-00			-	mounting hardware (not included w/frame)
109	211-0598-00			1	SCREW, captive, 6-32 x .375 inch, Fil HS
110	210-0869-00			1	WASHER, nylon, 5/32 ID x 3/8 inch OD
111	354-0163-00			1	RING, retaining
112	214-0573-00			1	PIN, hinge
	354-0163-00			1	RING, retaining
113	214-0335-00			1	BOLT, current loop
				-	mounting hardware: (not included w/bolt)
	210-0593-00			2	NUT, hex, current loop, 3-48 x 1/4 inch
	210-0849-00			2	WASHER, fiber, #4
	210-0994-00			2	WASHER, .125 ID x .250 inch OD
	210-0201-00			2	LUG, solder, SE #4
	210-0442-00			2	NUT, hex, 3-48 x 3/16 inch
114	361-0059-00			1	SPACER, current loop
115	179-0997-00			1	CABLE HARNESS, anode
				-	cable harness includes:
116	131-0371-00			6	CONNECTOR, single contact
117	131-0406-00			1	CONNECTOR, anode
				-	connector includes:
	131-0026-00			1	CONNECTOR, anode clip
	175-0012-00			1	CABLE, high voltage (15 1/4 inches)
	200-0544-00			1	COVER, anode connector

For Service Manuals Contact  
**MAURITRON TECHNICAL SERVICES**  
 8 Cherry Tree Rd, Chinnor  
 Oxon OX9 4QY  
 Tel: 01844-351634 Fax: 01844-352554  
 Email: enquiries@mauritron.co.uk

Parts List—Type 453

FRONT (Cont'd)

REF. NO.	PART NO.	SERIAL/MODEL NO.		QTY.	DESCRIPTION
		EFF.	DISC.		
118	337-0754-00			1	SHIELD, crt
119	354-0258-00			1	RING, reflector light
120	348-0070-00	100	749	4	CUSHION, crt
	348-0070-01	750		4	CUSHION, crt
121	-----			1	COIL
	211-0590-00			-	mounting hardware (not included w/coil)
				2	SCREW, 6-32 x 1/4 inch, PHB phillips
122	343-0042-00			1	CLAMP, cable, 5/16 inch (half)
	211-0539-00			-	mounting hardware: (not included w/clamp)
	210-0863-00			1	SCREW, 6-32 x 5/16 inch, PHB phillips
				1	WASHER, "D" type
123	343-0110-00			1	CLAMP, coil form
	211-0590-00			-	mounting hardware: (not included w/clamp)
	210-0006-00			2	SCREW, 6-32 x 1/4 inch, PHB phillips
	210-0407-00			2	LOCKWASHER, internal, #6
				2	NUT, hex, 6-32 x 1/4 inch
124	358-0231-00			1	BUSHING, crt cable
125	343-0124-00			1	CLAMP, crt
	211-0599-00			-	mounting hardware: (not included w/clamp)
	220-0444-00			2	SCREW, 6-32 x 3/4 inch, Fil HS
				2	NUT, square, 6-32 x 1/4 inch
126	343-0123-01			2	CLAMP, retainer
127	211-0600-00			1	SCREW, 6-32 x 2 inches, Fil HS
	220-0444-00			1	NUT, square, 6-32 x 1/4 inch
128	352-0091-01			2	HOLDER, crt clamp
	211-0590-00			-	mounting hardware for each: (not included w/holder)
129	213-0049-00			2	SCREW, 6-32 x 1/4 inch, PHB phillips
	210-0949-00			2	SCREW, 6-32 x 5/16 inch, HHS
				2	WASHER, 3/64 ID x 1/2 inch OD
130	343-0122-01			2	CLAMP, crt shield
	211-0510-00			-	mounting hardware for each: (not included w/clamp)
	210-0949-00			1	SCREW, 6-32 x 3/4 inch, PHB phillips
				1	WASHER, 3/64 ID x 1/2 inch OD
131	200-0616-00			1	COVER, crt socket
132	36-0227-00			1	ASSEMBLY, crt socket
	36-0202-00			-	assembly includes:
	214-0464-00			1	SOCKET, crt
133	79-0996-00			14	CONTACT, crt
				1	CABLE HARNESS, main
				-	cable harness includes:
134	131-0371-00			-	CONNECTOR, single contact
135	331-0141-00			1	MASK, graticule

## FRONT (Cont'd)

REF. NO.	PART NO.	SERIAL/MODEL NO.		QTY.	DESCRIPTION
		EFF.	DISC.		
136	136-0205-00 ----- 210-0586-00			2 - 1	SOCKET, graticule lamp - mounting hardware for each: (not included w/socket) NUT, keps, 4-40 x 1/4 inch
137	175-0582-00 175-0583-00 175-0584-00 175-0596-00			1 1 1 1	WIRE, art lead, .458 foot, striped brown, w/connector WIRE, art lead, 11 1/2 inches, striped red, w/connector WIRE, art lead, 11 1/2 inches, striped green, w/connector WIRE, art lead, .417 foot, striped blue, w/connector
138	227-0767-00 ----- 211-0007-00			1 - 5	SHIELD, attenuator - mounting hardware: (not included w/shield) SCREW, 4-40 x 3/16 inch, PHS phillips
139	200-0608-00			1	COVER, por
140	179-1001-00			1	CABLE HARNESS, graticule light

For Service Manuals Contact  
**MAURITRON TECHNICAL SERVICES**  
 8 Cherry Tree Rd, Chinnor  
 Oxon OX9 4QY  
 Tel: 01844-351694 Fax: 01844-352554  
 Email: enquiries@mauritron.co.uk

CHASSIS

THE QUALITY OF  
THIS PAGE IS  
THE BEST THAT  
IS AVAILABLE

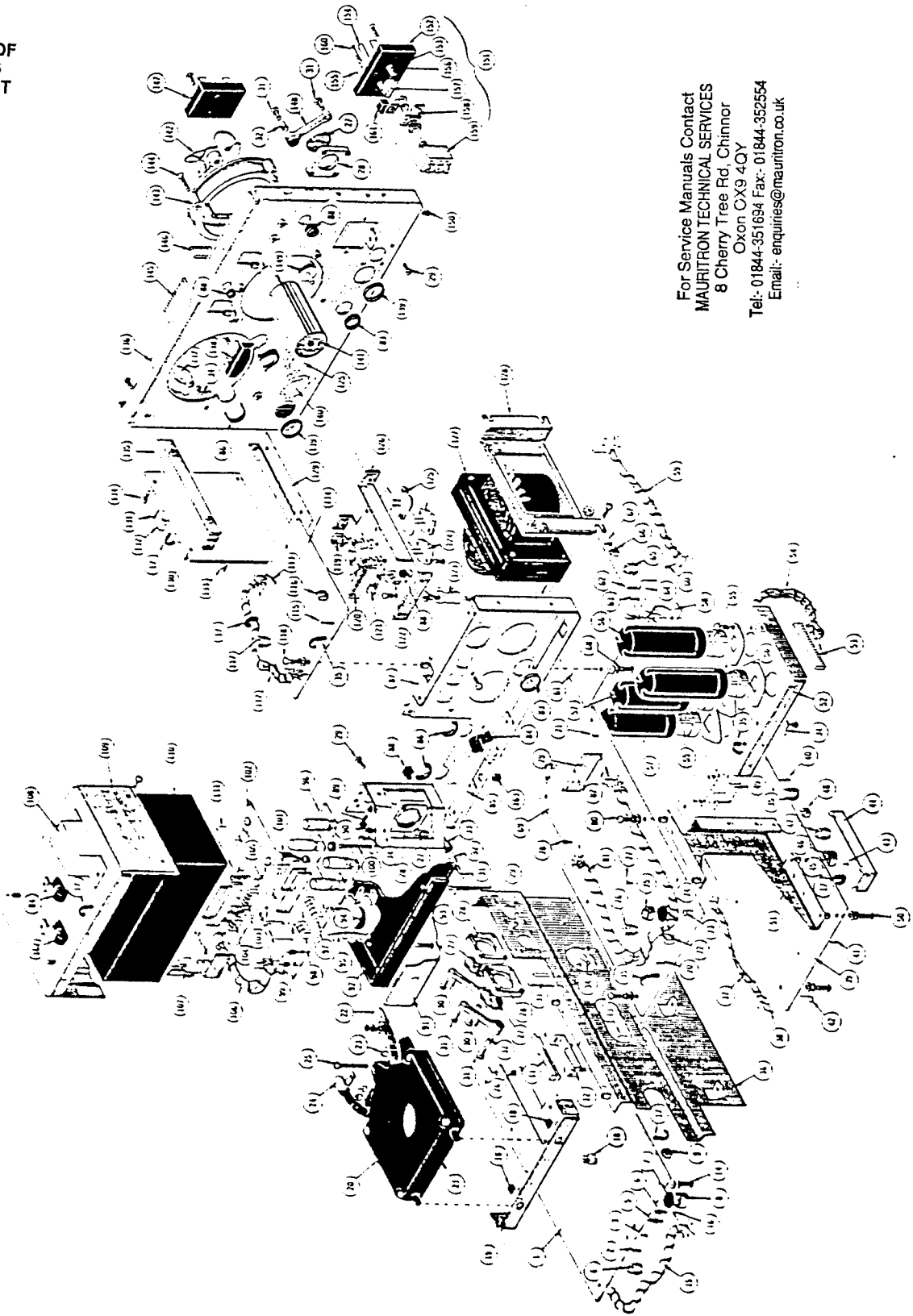

For Service Manuals Contact  
MAURITRON TECHNICAL SERVICES  
8 Cherry Tree Rd, Chinnor  
Oxon OX9 4QY  
Tel: 01844-351634 Fax: 01844-352554  
Email: enquiries@mauritron.co.uk



## CHASSIS

REF. NO.	PART NO.	SERIAL/MODEL NO.		QTY.	DESCRIPTION
		EFF.	DISC.		
1	670-0419-00			1	ASSEMBLY, Vertical Preamp board (See Ref. #14)
	388-0646-00			1	assembly includes: BOARD, etched circuit (wiring)
					board includes:
2	214-0506-00			38	PIN, connector, straight
3	214-0579-00			9	PIN, test point
4	136-0183-00			5	SOCKET, 3 pin transistor
5	131-0182-00			4	CONNECTOR, terminal feed-thru
	358-0135-00			1	mounting hardware for each: (not included w/connector alone) BUSHING, teflon
6	131-0235-00			2	CONNECTOR, terminal stand-off
	358-0135-00			1	mounting hardware for each: (not included w/connector alone) BUSHING, teflon
7	387-0603-00	100	499X	2	PLATE, insulator
8	136-0224-00			2	SOCKET, 5 pin
9	136-0220-00			9	SOCKET, 3 pin transistor
10	136-0186-00			2	SOCKET, 3 pin
11	214-0563-00			1	ACTUATOR, slide switch
12	406-0949-00			1	BRACKET, slide switch
13	260-0447-00			1	SWITCH, slide—INVERT
	210-0054-00				mounting hardware: (not included w/switch alone)
	210-0406-00			2	LOCKWASHER, #4 split
14	211-0116-00			2	NUT, hex, 4-40 x 3/16 inch
					mounting hardware: (not included w/assembly)
				9	SCREW, 4-40 x 3/16 inch, PHB phillips w/washers
15	179-0992-00			1	CABLE HARNESS, vertical preamp
					cable harness includes:
16	131-0371-00				CONNECTOR, single contact
17	343-0038-00			6	CLAMP, cable, deirin
18	348-0055-00			3	GRWMMET, plastic, 1/4 inch
19	407-0145-00			1	BRACKET, delay line
	358-0282-00				bracket includes:
				1	BUSHING, insulating, black deirin
					mounting hardware: (not included w/bracket)
	211-0097-00			3	SCREW, 4-40 x 3/16 inch, PHS phillips
	210-0851-00			1	WASHER, .119 ID x 3/8 inch OD
	210-0935-00			1	WASHER, fiber, .140 ID x .375 inch OD
	211-0507-00			1	SCREW, 6-32 x 3/16 inch, PHS phillips
	213-0049-00			1	SCREW, 6-32 x 3/16 inch, HHS

For Service Manuals Contact  
MAURITRON TECHNICAL SERVICES  
8 Cherry Tree Rd, Chinnor  
Oxon OX9 4QY  
Tel: 01844-351694 Fax: 01844-352554  
Email: enquiries@mauritron.co.uk

Parts List—Type 453

CHASSIS (Cont'd)

REF. NO.	PART NO.	SERIAL/MODEL NO.		QTY.	DESCRIPTION
		EFF.	DISC.		
20	119-0029-00			1	ASSEMBLY, delay line (See Ref. #26)
	380-0049-00			-	assembly includes:
21	200-0482-00			1	HOUSING, delay line
	211-0513-00			1	COVER, delay line housing
	210-0407-00			-	mounting hardware: (not included w/cover alone)
				4	SCREW, 6-32 x 3/8 inch, PHS phillips
				4	NUT, hex, 6-32 x 1/4 inch
22	131-0272-00			1	CONNECTOR, left-hand mounting
	211-0097-00			-	mounting hardware: (not included w/connector alone)
	210-0004-00			1	SCREW, 4-40 x 3/16 inch, PHS phillips
	210-0406-00			1	LOCKWASHER, internal, #4
				1	NUT, hex, 4-40 x 3/16 inch
23	131-0157-00			2	CONNECTOR, terminal stand-off
	131-0158-00			2	CONNECTOR, terminal feed-thru
24	131-0271-00			1	CONNECTOR, right-hand mounting
	211-0097-00			-	mounting hardware: (not included w/connector alone)
	210-0004-00			1	SCREW, 4-40 x 3/16 inch, PHS phillips
	210-0406-00			1	LOCKWASHER, internal, #4
				1	NUT, hex, 4-40 x 3/16 inch
25	211-0517-00			1	SCREW, 6-32 x 1 inch, PHS phillips
	210-0407-00			1	NUT, hex, 6-32 x 1/4 inch
26				-	mounting hardware: (not included w/assembly)
	210-0457-00			1	NUT, kecs. 6-32 x 3/16 inch
27	214-0317-00			5	HEAT SINK, insulator disc
28	352-0062-00			5	HOLDER, transistor heat sink
				-	mounting hardware for each: (not included w/holder)
29	211-0003-00	100	2049	2	SCREW, 4-40 x 1/4 inch, PHS phillips
	211-0033-00	2050		2	SCREW, 4-40 x 3/16 inch, PHS, w/lockwasher
	211-0097-00	100	2049	2	SCREW, 4-40 x 3/16 inch, PHS phillips
	211-0012-00	2050		2	SCREW, 4-40 x 3/16 inch PHS
	210-0004-00	X2050		4	LOCKWASHER, internal, #4
	210-0406-00			4	NUT, hex, 4-40 x 3/16 inch
30	343-0097-00			4	CLAMP, transistor heat sink
	210-0627-00			4	RIVET, brass
31	210-0599-00			10	NUT, sleeve
32	214-0268-00			5	SPRING, transistor heat sink holder
33	124-0143-00			2	STRIP, ceramic, 7/16 inch x 9 notches
	355-0046-00			-	each strip includes:
				2	STUD, nylon
	361-0007-00			-	mounting hardware for each: (not included w/strip)
				2	SPACER, nylon, 1/16 inch
34	210-0201-00			5	LUG, solder, SE #4
	213-0044-00			-	mounting hardware for each: (not included w/lug)
				1	SCREW, thread cutting, 5-32 x 3/16 inch, PHS phillips
35	343-0069-00			7	CLAMP, cable, dextrin

## CHASSIS (Cont'd)

REF. NO.	PART NO.	SERIAL/MODEL NO.		QTY.	DESCRIPTION
		EFF.	DISC.		
36	386-0203-00			1	PLATE, center support
	212-0001-00			-	mounting hardware: (not included w/plate)
	211-0504-00			1	SCREW, 6-32 x 1/4 inch, PHS phillips
	210-0457-00			1	SCREW, 6-32 x 1/4 inch, PHS phillips
				1	NUT, keps, 6-32 x 5/16 inch
37	179-0993-00			1	CABLE HARNESS, horizontal display A
				-	cable harness includes:
38	131-0371-00			1	CONNECTOR, single contact
39	670-0417-00			1	ASSEMBLY, A Sweep board (See Ref. #50)
				-	assembly includes:
	388-0644-00			1	BOARD, etched circuit (wiring)
				-	board includes:
40	214-0506-00			42	PIN, connector, straight
41	214-0579-00			9	PIN, test point
42	343-0043-00			2	CLAMP, wire, neon bulb
43	214-0565-00			2	FASTENER, pin press
44	337-0762-00			1	SHIELD, A sweep
45	136-0125-00			2	SOCKET, 5 pin
46	387-0603-00	100	499X	2	PLATE, insulator
47	136-0183-00			6	SOCKET, 3 pin transistor
48	136-0220-00			18	SOCKET, 3 pin transistor
49				1	TRANSFORMER (not shown)
				-	mounting hardware: (not included w/transformer alone)
	211-0010-00	100	1489X	2	SCREW, 4-40 x 1/4 inch, RHB phillips
	210-0406-00			2	NUT, hex, 4-40 x 3/16 inch
50				-	mounting hardware: (not included w/assembly)
	211-0116-00			6	SCREW, 4-40 x 5/16 inch, PHB phillips w/washer
51	407-0150-00			1	BRACKET, outer support
				-	mounting hardware: (not included w/bracket)
	211-0510-00			2	SCREW, 6-32 x 3/8 inch, PHS phillips
	210-0803-00			2	WASHER, 6L x 3/8 inch
52	407-0144-00			1	BRACKET, capacitor mounting
				-	mounting hardware: (not included w/bracket)
	211-0510-00			4	SCREW, 6-32 x 3/8 inch, PHS phillips
	210-0803-00			1	WASHER, 6L x 3/8 inch
53	124-0146-00			4	STRIP, ceramic, 7/16 inch x 16 notches
				-	each strip includes:
	355-0046-00			2	STUD, nylon
				-	mounting hardware for each: (not included w/strip)
	361-0007-00			2	SPACER, nylon, 1/16 inch
54	179-0990-00			1	CABLE HARNESS, capacitor mounting bracket
55				4	CAPACITOR
				-	mounting hardware for each: (not included w/capacitor)
	386-0252-00			1	PLATE, fiber, small capacitor
	211-0534-00			2	SCREW, 6-32 x 5/16 inch, PHS w/lockwasher
	210-0006-00			2	LOCKWASHER, internal, #6
	210-0407-00			2	NUT, hex, 6-32 x 1/4 inch

For Service Manuals Contact  
**MAURITRON TECHNICAL SERVICES**  
 8 Cherry Tree Rd, Chinnor  
 Oxon OX9 4QY  
 Tel: 01844-351694 Fax: 01844-352554  
 Email: enquiries@mauritron.co.uk

Parts List—Type 453

CHASSIS (Cont'd)

REF. NO.	PART NO.	SERIAL/MODEL NO.		QTY.	DESCRIPTION
		EFF.	DISC.		
56	200-0255-00			2	COVER, capacitor, 3 <sup>1</sup> / <sub>32</sub> inches
57	200-0257-00			2	COVER, capacitor, 2 <sup>1</sup> / <sub>32</sub> inches
58	344-0116-00			1	CLIP, capacitor mounting
	211-0007-00			-	mounting hardware: (not included w/clip)
	210-0004-00	100	2869	1	SCREW, 4-40 x 3 <sup>1</sup> / <sub>16</sub> inch, PHB phillips
	210-0201-00	2870		1	LOCKWASHER, internal, #4
	210-0406-00			1	LUG, solder, SE #4
				1	NUT, hex, 4-40 x 3 <sup>1</sup> / <sub>16</sub> inch
59	179-0995-00	100	3439	1	CABLE HARNESS, A Sweep
	179-0995-01	3440		1	CABLE HARNESS, A Sweep
				-	cable harness includes:
60	131-0371-00			37	CONNECTOR, single contact
61	670-0414-00	100	3439	1	ASSEMBLY, Z Axis/Crt board (See Ref. #68)
	670-0414-03	3440		1	ASSEMBLY, Z Axis/Crt board (See Ref. #68)
				-	assembly includes:
	338-0641-00	100	3439	1	BOARD, arched circuit (wiring)
	338-0641-01	3440		1	BOARD, arched circuit (wiring)
				-	board includes:
62	214-0506-00			23	PIN, connector, straight
63	214-0579-00			4	PIN, test point
64	337-0764-00			1	SHIELD, Z axis/crt
65	136-0183-00			2	SOCKET, 3 pin transistor
66	136-0220-00			4	SOCKET, 3 pin transistor
67	344-0119-00			3	CLIP, electrical
68				-	mounting hardware: (not included w/assembly)
	211-0116-00			3	SCREW, 4-40 x 3 <sup>1</sup> / <sub>16</sub> inch, PHB phillips w/washer
69	670-0418-00			1	ASSEMBLY, B Sweep board (See Ref. #80)
				-	assembly includes:
	338-0645-00			1	BOARD, arched circuit (wiring)
				-	board includes:
70	214-0506-00			53	PIN, connector, straight
71	214-0579-00			7	PIN, test point
72	136-0220-00			20	SOCKET, 3 pin transistor
73	343-0043-00			1	CLAMP, wire, neon bulb
74	337-0603-00	100	499X	2	PLATE, insulator
75	136-0125-00			2	SOCKET, 5 pin
76	136-0186-00			1	SOCKET, 3 pin
77	214-0565-00			1	FASTENER, pin press
78	344-0119-00			6	CLIP, electrical
79	337-0763-00			1	SHIELD, B Sweep
80				-	mounting hardware: (not included w/assembly)
	211-0116-00			6	SCREW, 4-40 x 3 <sup>1</sup> / <sub>16</sub> inch, PHB phillips w/washers
81	179-0994-00			1	CABLE HARNESS, horizontal display B
				-	cable harness includes:
82	131-0371-00			-	CONNECTOR, single contact
83	348-0063-00			2	GRGMMET, plastic, 1/2 inch
84	343-0002-00			2	CLAMP, cable 3/16 inch
				-	mounting hardware for each: (not included w/clamp)
	210-0863-00			1	WASHER, "D" type
	210-0457-00			1	NUT, keas, 6-32 x 3/16 inch

For Service Manuals Contact  
**MAURITRON TECHNICAL SERVICES**  
 8 Cherry Tree Rd, Chinnor  
 Oxon OX9 4QY  
 Tel: 01844-351694 Fax: 01844-352554  
 Email: enquiries@mauritron.co.uk

## CHASSIS (Cont'd)

REF. NO.	PART NO.	SERIAL/MODEL NO.		QTY.	DESCRIPTION
		EFF.	DISC.		
85	407-0158-00			1	BRACKET, vertical preamp mounting
	-----			-	mounting hardware: (not included w/bracket)
	211-0008-00			1	SCREW, 4-40 x 1/4 inch, PHS phillips
86	358-0215-00			4	BUSHING, plastic
87	386-0202-00			1	PLATE, center bulkhead
	-----			-	mounting hardware: (not included w/plate)
	212-0078-00			4	SCREW, 3-32 x 3/8 inch, Fil HS phillips
88	348-0056-00			6	GROMMET, plastic, 3/8 inch
89	129-0069-00			3	POST, terminal, tie-off
	-----			-	mounting hardware for each: (not included w/post)
	361-0007-00			1	SPACER, nylon, 1/16 inch
90	131-0181-00			1	CONNECTOR, terminal stand-off
	-----			-	mounting hardware: (not included w/connector)
	358-0136-00			1	BUSHING, teflon
91	337-0752-00			1	SHIELD, high-voltage
	-----			-	mounting hardware: (not included w/shield)
	211-0503-00			3	SCREW, 6-32 x 3/16 inch, PHS phillips
92	200-0620-00			1	COVER, high-voltage
	-----			-	mounting hardware: (not included w/cover)
93	211-0516-00			1	SCREW, 6-32 x 7/8 inch, PHS phillips
	211-0552-00			2	SCREW, 6-32 x 2 inches, PHS phillips
94	210-0966-00			3	WASHER, insulating, 7/8 OD x 3/16 inch ID
95	346-0032-00			4	STRAP, mouse tail, rubber
96	392-0170-00			1	BOARD, high-voltage (See Ref. #100)
	-----			-	board includes:
97	124-0164-00			4	STRIP, ceramic, 4 notches
98	124-0163-00			8	STRIP, ceramic, 2 notches
99	131-0227-00			1	CONNECTOR, terminal stand-off
	131-0359-00			1	CONNECTOR, terminal feed-thru
	358-0176-00			2	BUSHING, teflon
100	-----			-	mounting hardware: (not included w/board)
	211-0530-00			2	SCREW, 6-32 x 1 3/4 inches, PHS phillips
	210-0869-00			2	WASHER, nylon, 5/32 ID x 3/8 inch OD
	358-0231-00			4	BUSHING, rubber
101	-----			1	POT
	-----			-	mounting hardware: (not included w/pot)
	210-0046-00			1	LOCKWASHER, internal, .400 OD x .261 inch ID
	210-0583-00			1	NUT, hex, 1/4-32 x 3/16 inch

CHASSIS (Cont'd)

REF. NO.	PART NO.	SERIAL/MODEL NO.		QTY.	DESCRIPTION
		EFF.	DISC.		
102	392-0169-00			1	BOARD, high-voltage (See Ref. #105)
103	124-0176-00			-	board includes:
104	124-0175-00			2	STRIP, ceramic, 4 notches
105	211-2036-00			5	STRIP, ceramic, 2 notches
				-	mounting hardware: (not included w/board)
				1	SCREW, 4-40 x 1/2 inch, BH nylon
106	179-0988-00			1	CABLE HARNESS, high-voltage
107	166-0368-00			1	SLEEVE, anode
108				1	CAPACITOR
				-	mounting hardware: (not included w/capacitor)
	210-0006-00			2	LOCKWASHER, internal, #6
	210-0407-00			2	NUT, hex. 6-32 x 1/4 inch
109	202-0142-00			1	BOX, high-voltage
				-	mounting hardware: (not included w/box)
	211-0504-00			6	SCREW, 6-32 x 1/4 inch, PHS philips
110	380-0077-00			1	HOUSING, high-voltage
				-	mounting hardware: (not included w/housing)
	211-0504-00			3	SCREW, 6-32 x 1/4 inch, PHS philips
111	381-0243-00			1	BAR, heat sink, high-voltage box
112	179-0987-00			1	CABLE HARNESS, low-voltage regulator
				-	cable harness includes:
113	131-0371-00			-	CONNECTOR, single contact
114	570-0415-00			1	ASSEMBLY, Low-voltage Regulator board (See Ref. #118)
				-	assembly includes:
	338-0642-00			1	BOARD, archea circuit (wiring)
				-	board includes:
115	214-0506-00			21	PIN, connector, straight
116	136-0220-00			4	SOCKET, 3 pin transistor
117	136-0183-00			4	SOCKET, 3 pin transistor
118				-	mounting hardware: (not included w/assembly)
	211-0116-00			3	SCREW, 4-40 x 5/16 inch, PHB philips w/washer
119	214-0239-00			2	HEAT SINK, transistor
				-	mounting hardware for each: (not included w/heat sink)
	220-0410-00			1	NUT, kecs. 10-32 x 3/4 inch
120	124-0147-00			1	STRIP, ceramic, 7/16 inch x 13 notches
				-	strip includes:
	355-0046-00			2	STUD, nylon
				-	mounting hardware: (not included w/strip)
	351-0009-00			2	SPACER, nylon, 1/32 inch
121	179-0991-00			1	CABLE HARNESS, regulator bracket
122	124-0119-00			1	STRIP, ceramic, 7/16 inch x 2 notches
				-	strip includes:
	355-0046-00			1	STUD, nylon
				-	mounting hardware: (not included w/strip)
	351-0007-00			1	SPACER, nylon, 1/16 inch

For Service Manuals Contact  
 MAURITRON TECHNICAL SERVICES  
 8 Cherry Tree Rd, Chinnor  
 Oxon OX9 4QY  
 Tel: 01844-351694 Fax: 01844-352554  
 Email: enquiries@mauritron.co.uk

CHASSIS (Cont'd)

REF. NO.	PART NO.	SERIAL/MODEL NO.		QTY.	DESCRIPTION
		EFF.	DISC.		
123	- - - - -			4	RESISTOR
	- - - - -			-	mounting hardware for each: (not included w/resistor)
	211-0553-00			1	SCREW, 6-32 x 1 1/2 inches, RHS phillips
	210-0601-00			1	EYELET
	210-0478-00			1	NUT, hex, resistor mounting
	211-0507-00			1	SCREW, 6-32 x 5/16 inch, PHS phillips
124	- - - - -			1	TRANSISTOR
	- - - - -			-	mounting hardware: (not included w/transistor)
	386-0143-00			1	PLATE, mica insulator
	211-0510-00			2	SCREW, 6-32 x 3/8 inch, PHS phillips
	210-0983-00			2	WASHER, shoulder
	210-0802-00			2	WASHER, 6S x 5/16 inch
	210-0006-00			1	LOCKWASHER, internal, #6
	210-0202-00			1	LUG, solder, SE #6
	210-0407-00			2	NUT, hex, 6-32 x 1/4 inch
125	- - - - -			3	TRANSISTOR
	- - - - -			-	mounting hardware for each: (not included w/transistor)
	387-0345-00			1	PLATE, insulator
	211-0510-00			2	SCREW, 6-32 x 3/8 inch, PHS phillips
	210-0983-00			2	WASHER, shoulder
	210-0802-00			2	WASHER, 6S x 5/16 inch
	210-0006-00			1	LOCKWASHER, internal, #6
	210-0202-00			1	LUG, solder, SE #6
	210-0407-00			2	NUT, hex, 6-32 x 1/4 inch
126	407-0143-00			1	BRACKET, regulator
	- - - - -			-	mounting hardware: (not included w/bracket)
	211-0504-00			4	SCREW, 6-32 x 1/4 inch, PHS phillips
127	- - - - -			1	TRANSFORMER
	- - - - -			-	mounting hardware: (not included w/transformer)
	212-0520-00	100	3239	4	SCREW, 10-32 x 1 1/4 inches, HHS
	212-0576-00	3240		4	SCREW, 10-32 x 1 3/8 inches, HHS
	220-0410-00			4	NUT, keps. 10-32 x 3/8 inch
128	407-0149-00			1	BRACKET, transformer
	- - - - -			-	mounting hardware: (not included w/bracket)
	212-0004-00			4	SCREW, 8-32 x 5/16 inch, PHS phillips
129	407-0146-00			1	BRACKET, lower, vertical board
	- - - - -			-	mounting hardware: (not included w/bracket)
	210-0457-00			2	NUT, keps, 6-32 x 5/16 inch
130	670-0416-00			1	ASSEMBLY, Vertical Output Amplifier board (See Ref. #134)
	- - - - -			-	assembly includes:
	388-0643-00			1	BOARD, erched circuit (wiring)
	- - - - -			-	board includes:
131	214-0506-00			6	PIN, connector, straight
132	136-0220-00			6	SOCKET, 3 pin transistor
133	344-0119-00			4	CLIP, electrical
134	- - - - -			-	mounting hardware: (not included w/assembly)
	211-0116-00			4	SCREW, 4-40 x 5/16 inch, PHB phillips w/washers

Parts List—Type 453

CHASSIS (Cont'd)

REF. NO.	PART NO.	SERIAL/MODEL NO.		QTY.	DESCRIPTION
		EFF.	DISC.		
135	407-0147-00			1	BRACKET, upper, vertical preamp board
	211-0008-00			-	mounting hardware: (not included w/bracket)
	211-0504-00			2	SCREW, 4-40 x 1/4 inch, PHS phillips
136	386-0201-00			1	SCREW, 6-32 x 1/4 inch, PHS phillips
	212-0078-00			1	PLATE, rear bulkhead
137	210-0223-00			-	mounting hardware: (not included w/plate)
	210-0046-00			4	SCREW, 3-32 x 3/8 inch, Fil HS phillips
	210-0940-00			1	POT
	210-0583-00			-	mounting hardware: (not included w/pot)
				1	LUG, solder, 1/4 inch
				1	LOCKWASHER, internal, .400 OD x .261 inch ID
138	352-0031-00			1	WASHER, 1/4 ID x 3/8 inch OD
	211-0507-00			1	NUT, hex, 1/4-32 x 5/16 inch
139	348-0064-00			1	HOLDER, fuse, single
	260-0724-00			-	mounting hardware: (not included w/holder)
140	213-0044-00			1	SCREW, 6-32 x 5/16 inch, PHS phillips
				2	GROMMET, plastic, 5/8 inch
				1	SWITCH, thermal cutout
141	635-0426-00			-	mounting hardware: (not included w/switch)
	147-0027-00			2	SCREW, thread cutting, 5-32 x 3/16 inch, PHS phillips
142	369-0021-00			1	ASSEMBLY, fan motor (See Ref. #144)
	213-0007-00			-	assembly includes:
143	354-0260-00			1	MOTOR, fan
	211-0033-00			1	BLADE, fan
144	211-0523-00			-	blade includes:
				1	SCREW, ser, 10-32 x 1/4 inch, HSS
145	124-0147-00			1	RING, fan
	355-0046-00			-	mounting hardware: (not included w/ring alone)
	361-0007-00			3	SCREW, 4-40 x 5/16 inch, PHS w/lockwasher
146	124-0149-00			-	mounting hardware: (not included w/assembly)
	361-0007-00			3	SCREW, 6-32 x 3/8 inch, PHS phillips
147	352-0025-00			2	STRIP, ceramic, 7/16 inch x 13 notches
	211-0507-00			-	each strip includes:
				2	STUD, nylon
			-	mounting hardware for each: (not included w/strip)	
			2	SPACER, nylon, 1/16 inch	
			2	STRIP, ceramic, 7/16 inch x 7 notches	
			-	each strip includes:	
			2	STUD, nylon	
			-	mounting hardware for each: (not included w/strip)	
			2	SPACER, nylon, 1/16 inch	
			1	HOLDER, fuse, dual	
			-	mounting hardware: (not included w/holder)	
			2	SCREW, 6-32 x 5/16 inch, PHS phillips	

For Service Manuals Contact  
 MAURITRON TECHNICAL SERVICES  
 8 Cherry Tree Rd, Chinnor  
 Oxon OX9 4QY  
 Tel: 01844-351654 Fax: 01844-352554  
 Email: enquiries@mauritron.co.uk



## CHASSIS (Cont'd)

REF. NO.	PART NO.	SERIAL/MODEL NO.		QTY.	DESCRIPTION
		EFF.	DISC.		
148	343-0120-00			1	CLAMP, transistor heat sink
	210-0627-00			1	RIVET, brass
149	214-0210-00			1	ASSEMBLY, solder spool
	-----			-	assembly includes:
	214-0209-00			1	SPOOL, solder
	-----			-	mounting hardware: (not included w/assembly)
	361-0007-00			1	SPACER, nylon, 1/16 inch
150	131-0157-00			2	CONNECTOR, terminal stand-off
151	131-0402-00	100	488	1	CONNECTOR, 5 pin (See Ref. #160 & #161)
	131-0402-01	489		1	CONNECTOR, 5 pin (see ref. #160 & 161)
	-----			-	connector includes:
152	432-0056-00	100	488	1	BASE, 5 pin connector
	432-0056-01	489		1	BASE, 5 pin connector
	346-0041-00			1	STRAP, ground (not shown)
153	432-0055-00			1	BASE, sub, 5 pin connector
154	129-0078-00	100	488	1	POST, ground
	129-0078-01	489		1	POST, ground
	-----			-	mounting hardware: (not included w/post alone)
	210-0004-00			1	LOCKWASHER, internal, #4
	210-0406-00	100	488X	1	NUT, hex, 4-40 x 3/16 inch
	211-0008-00	X489		1	SCREW, 4-40 x 1/4 inch PHS phillips
155	214-0584-00			4	PIN, connecting
156	385-0187-00			2	RCD, switch actuator
157	214-0591-00			1	ACTUATOR, toggle switch
158	407-0172-00			1	BRACKET, switch
	-----			-	mounting hardware: (not included w/bracket alone)
	211-0114-00			2	SCREW, 4-40 x 7/16 inch, FHS
159	260-0715-00			1	SWITCH, toggle—115 v-230 v Selector
	-----			-	mounting hardware: (not included w/switch alone)
	210-0046-00			1	LOCKWASHER, internal, .400 OD x .261 inch ID
	210-0583-00			2	NUT, hex, 1/4-32 x 5/16 inch
160	-----			-	mounting hardware: (not included w/connector)
	211-0017-00			2	SCREW, 4-40 x 3/4 inch, RHS phillips
	210-0054-00			1	LOCKWASHER, #4 split
	210-0994-00			1	WASHER, .125 ID x .250 inch OD
161	214-0582-00			2	SPACER, 5 pin plug
162	343-0004-00			1	CLAMP, cable, 3/16 inch
	-----			-	mounting hardware: (not included w/clamp)
	210-0863-00			1	WASHER, "D" type
	210-0457-00			1	NUT, keps, 6-32 x 3/16 inch
163	348-0055-00	100	1758	2	GROMMET, plastic, 1/4 inch
	348-0056-00	1759		1	GROMMET, plastic, 3/8 inch

FRAME & CABINET

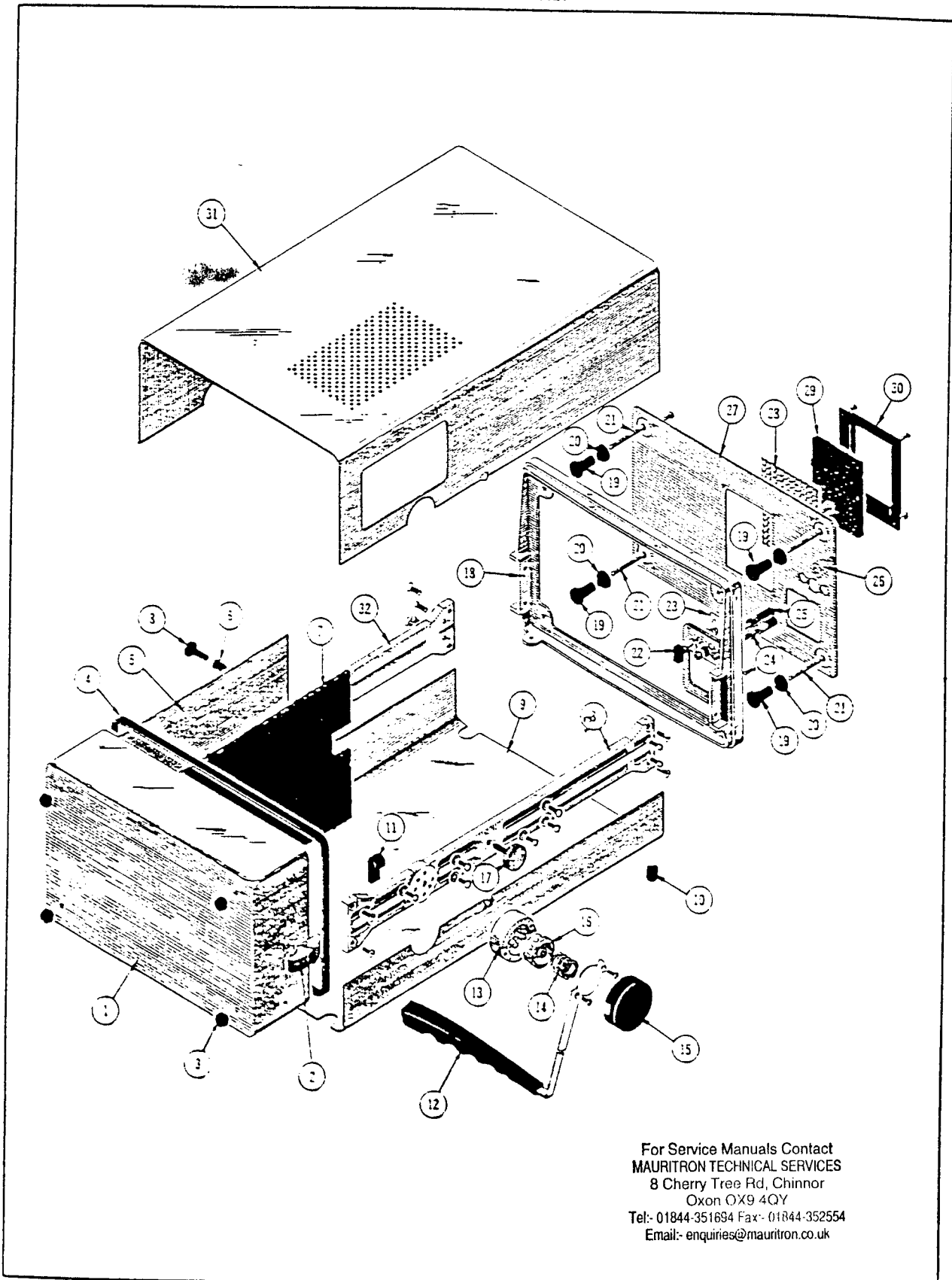

For Service Manuals Contact  
MAURITRON TECHNICAL SERVICES  
8 Cherry Tree Rd, Chinnor  
Oxon OX9 4QY  
Tel:- 01844-351694 Fax:- 01844-352554  
Email:- enquiries@mauritron.co.uk

## FRAME &amp; CABINET

REF. NO.	PART NO.	SERIAL/MODEL NO.		QTY.	DESCRIPTION
		EFF.	DISC.		
1	200-0633-01			1	ASSEMBLY, front cover
	348-0081-00			-	assembly includes:
	214-0631-00			1	CUSHION, cover bottom
	214-0531-01			2	PIN, hinge
2	214-0531-01			2	LATCH, chrome
3	348-0013-00			4	FOOT, rubber
4	252-0571-00			FT	EXTRUSION, neoprene (3 feet)
5	200-0641-00			1	COVER, accessory lid
				-	cover includes:
6	214-0530-00			1	LATCH, grommer
7	348-0082-00			1	CUSHION, accessory box lid
8	214-0529-00			1	LATCH, plunger
9	386-0210-00			1	PLATE, bottom
				-	plate includes:
10	348-0080-00			4	FOOT, plastic
				-	mounting hardware for each: (not included w/foot alone)
	211-0504-00	100	3259	1	SCREW, 6-32 x 1/4 inch, PHS
	211-0507-00	3260		1	SCREW, 6-32 x 5/16 inch, PHS
	210-0055-00	X3260		1	LOCKWASHER, split, #6
11	343-0005-00			1	CLAMP, cable, 7/16 inch
				-	mounting hardware: (not included w/clamp)
	211-0511-00			1	SCREW, 6-32 x 1/2 inch, PHS
	210-0863-00			1	WASHER, "D" type
	210-0457-00			1	NUT, keps. 6-32 x 5/16 inch
12	367-0058-00			1	HANDLE, carrying
				-	mounting hardware: (not included w/handle)
	211-0512-00			4	SCREW, 6-32 x 1/2 inch, PHS phillips
13	214-0513-00			2	INDEX, handle ring
14	214-0516-00			2	SPRING, handle index
15	200-0602-00			2	COVER, handle
16	214-0578-00			2	HUB, handle index
				-	mounting hardware for each: (not included w/hub)
	213-0129-00			1	SCREW, socket head, 1/4-20 x 3/4 inch
17	214-0598-01			2	SCREW, cabinet latch
	354-0175-00			2	RING, retaining
18	426-0258-00			1	FRAME, rear
19	348-0078-00			4	FOOT, body and cord holder
20	348-0079-00			4	FOOT, cap
21	212-0082-00			4	SCREW, 8-32 x 1 1/4 inches, PHS phillips
22	260-0642-00			1	SWITCH, toggle—LINE VOLTAGE RANGE
				-	mounting hardware: (not included w/switch)
	210-0046-00			1	LOCKWASHER, internal, .400 OD x .261 inch ID
	210-0940-00			1	WASHER, 1/4 ID x 3/8 inch OD
	210-0562-00			2	NUT, hex, 1/4-40 x 3/16 inch
23	346-0043-00			1	STRAP, ground

For Service Manuals Contact  
**MAURITRON TECHNICAL SERVICES**  
 8 Cherry Tree Rd, Chinnor  
 Oxon OX9 4QY  
 Tel: 01844-351694 Fax: 01844-352554  
 Email: enquiries@mauritron.co.uk

Parts List—Type 453

FRAME & CABINET (Cont'd)

REF. NO.	PART NO.	SERIAL/MODEL NO.		QTY.	DESCRIPTION
		EFF.	DISC.		
24	129-0020-00			1	POST, binding
	-----			-	post includes:
	355-0503-00			1	STEM, adapter
	200-0072-00			1	CAP, binding post
	-----			-	mounting hardware: (not included w/post)
	220-0410-00			1	NUT, keps, 10-32 x 3/8 inch
25	129-0064-00			1	POST, binding
	-----			-	mounting hardware: (not included w/post)
	358-0181-00			1	BUSHING, nylon
	210-0457-00			1	NUT, keps, 6-32 x 5/16 inch
26	214-0634-00			1	GUARD, switch
27	386-0211-00			1	PLATE, rear overlay
	-----			-	mounting hardware: (not included w/plate)
	211-0565-00			4	SCREW, 6-32 x 1/4 inch, THS phillips
28	378-0766-00			1	SCREEN, filter
29	378-0033-00			1	FILTER, air
30	330-0082-00			1	HOUSING, fan filter
	-----			-	mounting hardware: (not included w/housing)
	213-0107-00			4	SCREW, thread forming, 4-40 x 1/4 inch, FHS phillips
31	386-0209-00			1	PLATE, top
32	426-0260-00			2	FRAME, rail
	-----			-	mounting hardware for each: (not included w/frame)
	212-0560-00			4	SCREW, 10-32 x 5/16 inch, FHS phillips

For Service Manuals Contact  
 MAURITRON TECHNICAL SERVICES  
 8 Cherry Tree Rd, Chinnor  
 Oxon OX9 4QY  
 Tel: 01844-351694 Fax: 01844-352554  
 Email: enquiries@mauritron.co.uk

STANDARD ACCESSORIES

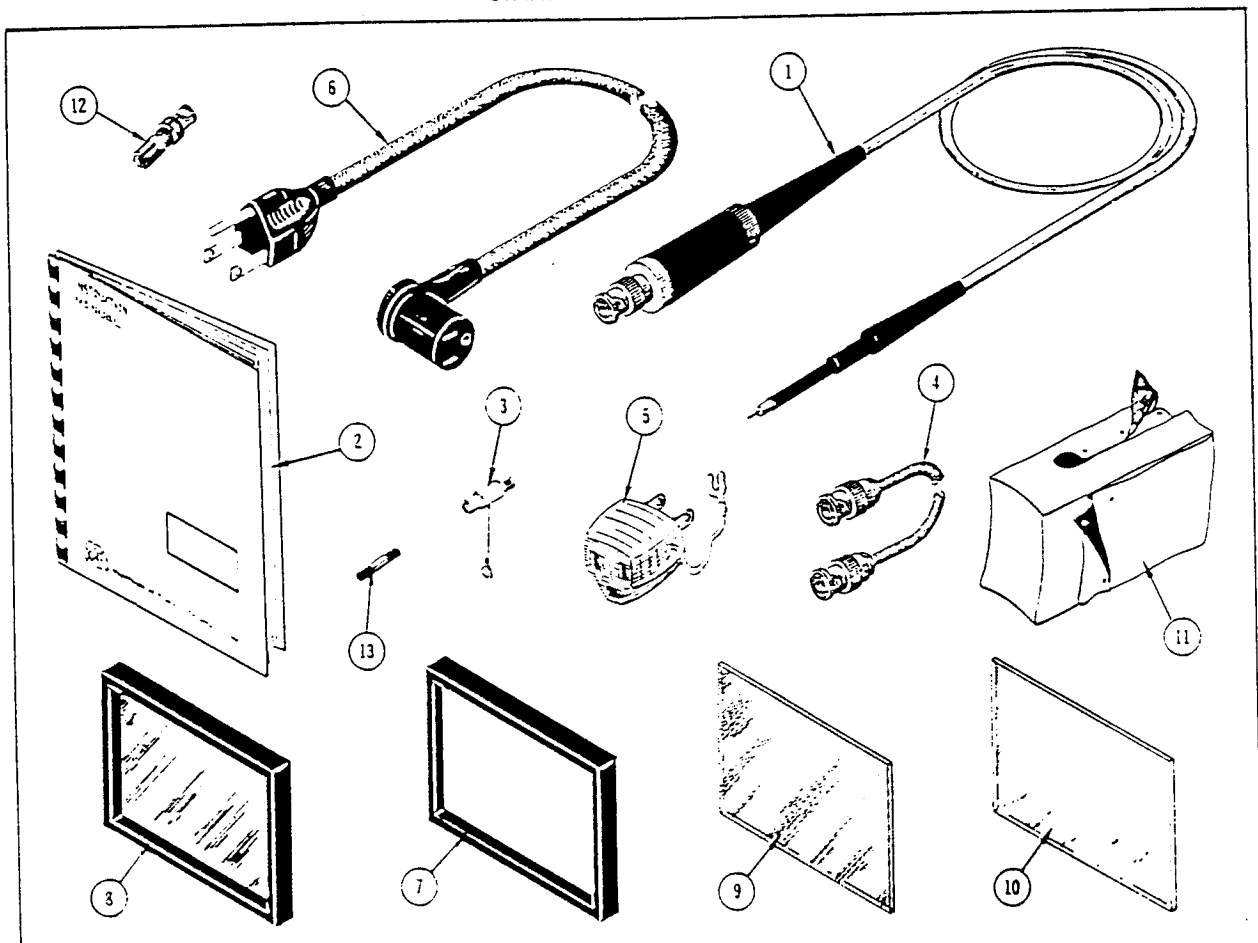

REF. NO.	PART NO.	SERIAL/MODEL NO.		QTY.	DESCRIPTION
		EFF.	DISC.		
1	010-0188-00			2	PRC3E, package, P6010, 10X, 42 inches, BNC
2	070-0478-00			2	MANUAL, instruction
3	012-0092-00			1	JACK BNC — Post
4	012-0076-00			1	CABLE, 50 Ω, BNC both ends
5	103-0013-00			1	ADAPTER, power card
6	161-0024-00	100	1878	1	CCRD, power, 115 volt
	161-0024-01	1879		1	CCRD, power, 115 volt
	214-0698-00	X1879		-	card includes: SPRING, power cord ground
	161-0027-00	X950	1878	1	CCRD, power, 230 volt
	161-0027-01	1879		1	CCRD, power, 230 volt
	214-0698-00	X1879		-	card includes: SPRING, power cord ground
7	354-0269-00			1	RING, ornamental
8	378-0573-00			1	FILTER, mesh, (installed)
9	378-0576-00			1	FILTER, light, smoke gray
10	386-0218-00			1	PLATE, protector, clear
11	016-0074-00			1	COVER, rain
12	103-0033-00			2	ADAPTER, BNC to binding post
13	159-0023-00	X1800		1	FUSE, slow-blow, 2 amps, 3AG
	159-0025-00	X1800		1	FUSE, fast-blow, 1/2 amp, 3AG
	159-0028-00	X1800		1	FUSE, fast-blow, 1/4 amp, 3AG
	159-0018-00	X1800		2	FUSE, slow-blow, 4/5 amp, 3AG



## ELECTRICAL PARTS

Values are fixed unless marked Variable.

Ckt. No.	Tektronix Part No.	Description	S/N Range
		Bulbs	
818	150-0035-00	Neon, A1D	
875	150-0030-00	Neon, NE-2V	CH 1 UNCAL
8118	150-0035-00	Neon, A1D	
8175	150-0030-00	Neon, NE-2V	CH 2 UNCAL
8400	150-0035-00	Neon, A1D	CH 1-A Triggering
8401	150-0035-00	Neon, A1D	CH 1-B Triggering
8444	150-0035-00	Neon, A1D	
8530W	150-0035-00	Neon, A1D	A OR B UNCAL
8568	150-0035-00	Neon, A1D	
8596	150-0046-00	Incandescent	A SWEEP TRIGGER
8597†	260-0717-00		
8629	150-0035-00	Neon, A1D	
8849	150-0035-00	Neon, A1D	Mag on
8973	150-0030-00	Neon, NE-2V	
8974	150-0030-00	Neon, NE-2V	
8975	150-0030-00	Neon, NE-2V	
81107	150-0045-00	Incandescent	POWER
81108	150-0047-00	Incandescent	Graticule Light
81109	150-0047-00	Incandescent	Graticule Light

## Capacitors

Tolerance = 20% unless otherwise indicated.

C1	*285-0697-00	0.1 $\mu$ f	PTM		600 v	
C3	281-0617-00	15 pf	Cer		200 v	
C5B	281-0064-00	0.2-1.5 pf	Tub.	Var		
C5C	281-0102-00	1.7-11 pf	Air	Var		
C7B	281-0064-00	0.2-1.5 pf	Tub.	Var		
C7C	281-0100-00	1.4-7.3 pf	Air	Var		
C7E	281-0577-00	14 pf	Cer		500 v	5%
C8B	281-0099-00	1.3-5.4 pf	Air	Var		
C8C	281-0083-00	0.2-1.5 pf		Var		
C8E		50 pf	Mica			10%
C8D	281-0544-00	5.6 pf	Cer		500 v	10%
C9B	281-0099-00	1.3-5.4 pf	Air	Var		
C9C	281-0086-00	0.2-1.5 pf		Var		
C9E		500 pf	Mica			
C9D		281-0593-00	3.9 pf	Cer		

†Furnished as a unit with SW569.

Parts List—Type 453

Capacitors (Cont'd)

Ckt. No.	Tektronix Part No.		Description			S/N Range
C11	281-0098-00	1.2-3.5 pf	Air	Var		
C13	281-0617-00	15 pf	Cer		200 v	
C16	281-0537-00	0.68 pf	Cer		500 v	
C17	281-0064-00	0.2-1.5 pf	Tub.	Var		
C18	283-0068-00	0.01 $\mu$ f	Cer		500 v	
C23	283-0092-00	0.03 $\mu$ f	Cer		200 v	-20% $\pm$ 80%
C24	283-0078-00	0.001 $\mu$ f	Cer		500 v	
C30	283-0080-00	0.022 $\mu$ f	Cer		25 v	-20% $\pm$ 80%
C43A	281-0081-00	1.3-13 pf	Air	Var		
C43B	281-0577-00	14 pf	Cer		500 v	5% 100-3659
C43B	281-0578-00	18 pf	Cer		500 v	5% 3660-up
C43C	281-0081-00	1.3-13 pf	Air	Var		
C43D	281-0603-00	39 pf	Cer		500 v	5%
C44A	281-0078-00	1.4-7.3 pf	Air	Var		
C44C	281-0078-00	1.4-7.3 pf	Air	Var		
C45A	281-0078-00	1.4-7.3 pf	Air	Var		
C45C	281-0081-00	1.3-13 pf	Air	Var		
C48	290-0267-00	1 $\mu$ f	EMT		35 v	
C49	281-0604-00	2.2 pf	Cer		500 v	$\pm$ 0.25 pf
C51	283-0078-00	0.001 $\mu$ f	Cer		500 v	
C53	290-0267-00	1 $\mu$ f	EMT		35 v	
C64	283-0078-00	0.001 $\mu$ f	Cer		500 v	
C73	281-0534-00	3.3 pf	Cer			$\pm$ 0.25 pf
C84	283-0032-00	470 pf	Cer		500 v	5%
C94	283-0032-00	470 pf	Cer		500 v	5%
C97	283-0081-00	0.1 $\mu$ f	Cer		25 v	-20% $\pm$ 80%
C98	283-0092-00	0.03 $\mu$ f	Cer		200 v	-20% $\pm$ 80%
C99	283-0092-00	0.03 $\mu$ f	Cer		200 v	-20% $\pm$ 80%
C101	285-0697-00	0.1 $\mu$ f	PTM		600 v	
C103	281-0617-00	15 pf	Cer		200 v	
C103B	281-0064-00	0.2-1.5 pf	Tub.	Var		
C105C	281-0102-00	1.7-11 pf	Air	Var		
C107B	281-0064-00	0.2-1.5 pf	Tub.	Var		
C107C	281-0100-00	1.4-7.3 pf	Air	Var		
C107E	281-0577-00	14 pf	Cer		500 v	5%
C108B	281-0099-00	1.3-5.4 pf	Air	Var		
C108C } C108E }	281-0083-00	0.2-1.5 pf 50 pf	Mica	Var		10%
C108D	281-0544-00	5.6 pf	Cer		500 v	10%
C109B	281-0099-00	1.3-5.4 pf	Air	Var		
C109C } C109E }	281-0086-00	0.2-1.5 pf 500 pf	Mica	Var		
C109D	281-0593-00	3.9 pf	Cer			10%
C111	281-0098-00	1.2-3.5 pf	Air	Var		
C113	281-0617-00	15 pf	Cer		200 v	
C116	281-0537-00	0.68 pf	Cer		500 v	
C117	281-0064-00	0.2-1.5 pf	Tub.	Var		



CHASSIS (Cont'd)

REF. NO.	PART NO.	SERIAL/MODEL NO.		QTY.	DESCRIPTION
		EFF.	DISC.		
123	- - - - - 211-0553-00 210-0601-00 210-0478-00 211-0507-00			4 - 1 1 1 1	RESISTOR - mounting hardware for each: (not included w/resistor) SCREW, 6-32 x 1 1/2 inches, RHS phillips EYELET NUT, hex, resistor mounting SCREW, 6-32 x 5/16 inch, PHS phillips
124	- - - - - 386-0143-00 211-0510-00 210-0983-00 210-0802-00 210-0006-00 210-0202-00 210-0407-00			1 - 1 2 2 1 1 2	TRANSISTOR - mounting hardware: (not included w/transistor) PLATE, mica insulator SCREW, 6-32 x 3/8 inch, PHS phillips WASHER, shoulder WASHER, 6S x 5/16 inch LOCKWASHER, internal, #6 LUG, solder, SE #6 NUT, hex, 6-32 x 1/4 inch
125	- - - - - 387-0345-00 211-0510-00 210-0983-00 210-0802-00 210-0006-00 210-0202-00 210-0407-00			3 - 1 2 2 1 1 2	TRANSISTOR - mounting hardware for each: (not included w/transistor) PLATE, insulator SCREW, 6-32 x 3/8 inch, PHS phillips WASHER, shoulder WASHER, 6S x 5/16 inch LOCKWASHER, internal, #6 LUG, solder, SE #6 NUT, hex, 6-32 x 1/4 inch
126	407-0143-00 211-0504-00			1 - 4	BRACKET, regulator - mounting hardware: (not included w/bracket) SCREW, 6-32 x 1/4 inch, PHS phillips
127	- - - - - 212-0520-00 212-0576-00 220-0410-00	100 3240	3239	1 - 4 4 4	TRANSFORMER - mounting hardware: (not included w/transformer) SCREW, 10-32 x 1 1/4 inches, HHS SCREW, 10-32 x 1 3/8 inches, HHS NUT, keps. 10-32 x 3/8 inch
128	407-0149-00 212-0004-00			1 - 4	BRACKET, transformer - mounting hardware: (not included w/bracket) SCREW, 8-32 x 5/16 inch, PHS phillips
129	407-0146-00 210-0457-00			1 - 2	BRACKET, lower, vertical board - mounting hardware: (not included w/bracket) NUT, keps, 6-32 x 5/16 inch
130	670-0416-00 388-0643-00			1 - 1 - - 6 6 4 - 4	ASSEMBLY, Vertical Output Amplifier board (See Ref. #134) - assembly includes: BOARD, erched circuit (wiring) - board includes: PIN, connector, straight SOCKET, 3 pin transistor CLIP, electrical - mounting hardware: (not included w/assembly) SCREW, 4-40 x 5/16 inch, PHB phillips w/washers
131	214-0506-00			6	PIN, connector, straight
132	136-0220-00			6	SOCKET, 3 pin transistor
133	344-0119-00			4	CLIP, electrical
134	- - - - - 211-0116-00			- 4	- mounting hardware: (not included w/assembly) SCREW, 4-40 x 5/16 inch, PHB phillips w/washers

Parts List—Type 453

CHASSIS (Cont'd)

REF. NO.	PART NO.	SERIAL/MODEL NO.		QTY.	DESCRIPTION
		EFF.	DISC.		
135	407-0147-00			1	BRACKET, upper, vertical preamp board
	211-0008-00			-	mounting hardware: (not included w/bracket)
	211-0504-00			2	SCREW, 4-40 x 1/4 inch, PHS phillips
136	386-0201-00			1	SCREW, 6-32 x 1/4 inch, PHS phillips
	212-0078-00			1	PLATE, rear bulkhead
				-	mounting hardware: (not included w/plate)
137				4	SCREW, 3-32 x 3/8 inch, Fil HS phillips
				1	POT
	210-0223-00			-	mounting hardware: (not included w/pot)
	210-0046-00			1	LUG, solder, 1/4 inch
	210-0940-00			1	LOCKWASHER, internal, .400 OD x .261 inch ID
	210-0583-00			1	WASHER, 1/4 ID x 3/8 inch OD
138	352-0031-00			1	NUT, hex, 1/4-32 x 5/16 inch
	211-0507-00			1	HOLDER, fuse, single
				-	mounting hardware: (not included w/holder)
139	348-0064-00			1	SCREW, 6-32 x 5/16 inch, PHS phillips
	260-0724-00			2	GROMMET, plastic, 5/8 inch
	213-0044-00			1	SWITCH, thermal cutout
				-	mounting hardware: (not included w/switch)
141	635-0426-00			2	SCREW, thread cutting, 5-32 x 3/16 inch, PHS phillips
	147-0027-00			1	ASSEMBLY, fan motor (See Ref. #144)
	369-0021-00			-	assembly includes:
142	213-0007-00			1	MOTOR, fan
	354-0260-00			1	BLADE, fan
	211-0033-00			-	blade includes:
143	211-0523-00			1	SCREW, ser, 10-32 x 1/4 inch, HSS
				1	RING, fan
				-	mounting hardware: (not included w/ring alone)
144	124-0147-00			3	SCREW, 4-40 x 5/16 inch, PHS w/lockwasher
	355-0046-00			-	mounting hardware: (not included w/assembly)
	361-0007-00			3	SCREW, 6-32 x 3/8 inch, PHS phillips
145	124-0147-00			2	STRIP, ceramic, 7/16 inch x 13 notches
	355-0046-00			-	each strip includes:
	361-0007-00			2	STUD, nylon
				-	mounting hardware for each: (not included w/strip)
146	124-0149-00			2	SPACER, nylon, 1/16 inch
	355-0046-00			-	each strip includes:
	361-0007-00			2	STUD, nylon
				-	mounting hardware for each: (not included w/strip)
147	352-0025-00			2	SPACER, nylon, 1/16 inch
	211-0507-00			1	HOLDER, fuse, dual
				-	mounting hardware: (not included w/holder)
			2	SCREW, 6-32 x 5/16 inch, PHS phillips	

For Service Manuals Contact  
 MAURITRON TECHNICAL SERVICES  
 8 Cherry Tree Rd, Chinnor  
 Oxon OX9 4QY  
 Tel: 01844-351654 Fax: 01844-352554  
 Email: enquiries@mauritron.co.uk

## CHASSIS (Cont'd)

REF. NO.	PART NO.	SERIAL/MODEL NO.		QTY.	DESCRIPTION
		EFF.	DISC.		
148	343-0120-00			1	CLAMP, transistor heat sink
	210-0627-00			1	RIVET, brass
149	214-0210-00			1	ASSEMBLY, solder spool
	-----			-	assembly includes:
	214-0209-00			1	SPOOL, solder
	-----			-	mounting hardware: (not included w/assembly)
	361-0007-00			1	SPACER, nylon, 1/16 inch
150	131-0157-00			2	CONNECTOR, terminal stand-off
151	131-0402-00	100	488	1	CONNECTOR, 5 pin (See Ref. #160 & #161)
	131-0402-01	489		1	CONNECTOR, 5 pin (see ref. #160 & 161)
	-----			-	connector includes:
152	432-0056-00	100	488	1	BASE, 5 pin connector
	432-0056-01	489		1	BASE, 5 pin connector
	346-0041-00			1	STRAP, ground (not shown)
153	432-0055-00			1	BASE, sub, 5 pin connector
154	129-0078-00	100	488	1	POST, ground
	129-0078-01	489		1	POST, ground
	-----			-	mounting hardware: (not included w/post alone)
	210-0004-00			1	LOCKWASHER, internal, #4
	210-0406-00	100	488X	1	NUT, hex, 4-40 x 3/16 inch
	211-0008-00	X489		1	SCREW, 4-40 x 1/4 inch PHS phillips
155	214-0584-00			4	PIN, connecting
156	385-0187-00			2	RCD, switch actuator
157	214-0591-00			1	ACTUATOR, toggle switch
158	407-0172-00			1	BRACKET, switch
	-----			-	mounting hardware: (not included w/bracket alone)
	211-0114-00			2	SCREW, 4-40 x 7/16 inch, FHS
159	260-0715-00			1	SWITCH, toggle—115 v-230 v Selector
	-----			-	mounting hardware: (not included w/switch alone)
	210-0046-00			1	LOCKWASHER, internal, .400 OD x .261 inch ID
	210-0583-00			2	NUT, hex, 1/4-32 x 5/16 inch
160	-----			-	mounting hardware: (not included w/connector)
	211-0017-00			2	SCREW, 4-40 x 3/4 inch, RHS phillips
	210-0054-00			1	LOCKWASHER, #4 split
	210-0994-00			1	WASHER, .125 ID x .250 inch OD
161	214-0582-00			2	SPACER, 5 pin plug
162	343-0004-00			1	CLAMP, cable, 3/16 inch
	-----			-	mounting hardware: (not included w/clamp)
	210-0863-00			1	WASHER, "D" type
	210-0457-00			1	NUT, keps, 6-32 x 3/16 inch
163	348-0055-00	100	1758	2	GROMMET, plastic, 1/4 inch
	348-0056-00	1759		1	GROMMET, plastic, 3/8 inch

FRAME & CABINET

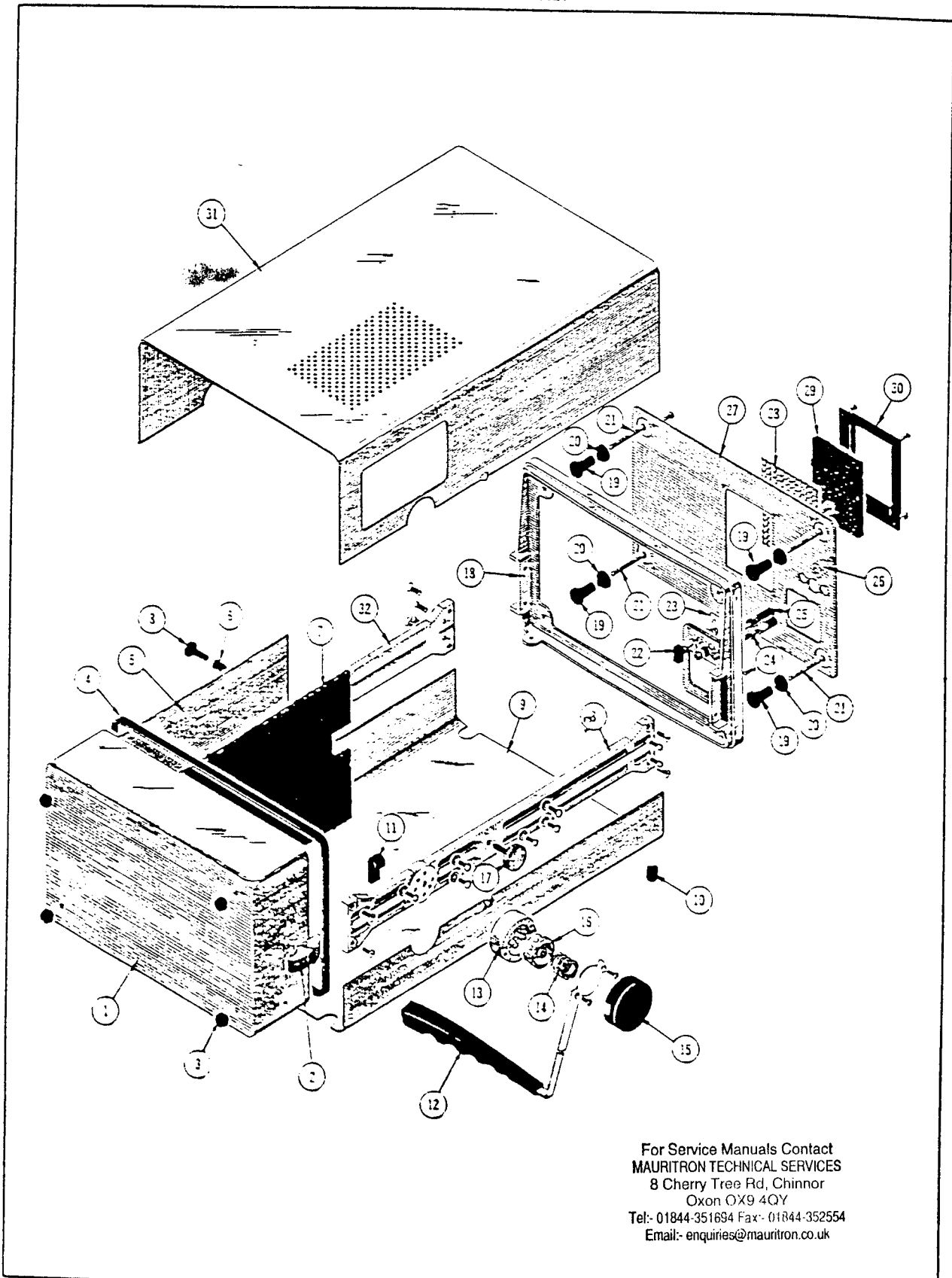

For Service Manuals Contact  
MAURITRON TECHNICAL SERVICES  
8 Cherry Tree Rd, Chinnor  
Oxon OX9 4QY  
Tel:- 01844-351694 Fax:- 01844-352554  
Email:- enquiries@mauritron.co.uk

## FRAME &amp; CABINET

REF. NO.	PART NO.	SERIAL/MODEL NO.		QTY.	DESCRIPTION
		EFF.	DISC.		
1	200-0633-01			1	ASSEMBLY, front cover
	348-0081-00			-	assembly includes:
	214-0631-00			1	CUSHION, cover bottom
	214-0531-01			2	PIN, hinge
2	214-0531-01			2	LATCH, chrome
3	348-0013-00			4	FOOT, rubber
4	252-0571-00			FT	EXTRUSION, neoprene (3 feet)
5	200-0641-00			1	COVER, accessory lid
				-	cover includes:
6	214-0530-00			1	LATCH, grommer
7	348-0082-00			1	CUSHION, accessory box lid
8	214-0529-00			1	LATCH, plunger
9	386-0210-00			1	PLATE, bottom
				-	plate includes:
10	348-0080-00			4	FOOT, plastic
				-	mounting hardware for each: (not included w/foot alone)
	211-0504-00	100	3259	1	SCREW, 6-32 x 1/4 inch, PHS
	211-0507-00	3260		1	SCREW, 6-32 x 5/16 inch, PHS
	210-0055-00	X3260		1	LOCKWASHER, split, #6
11	343-0005-00			1	CLAMP, cable, 7/16 inch
				-	mounting hardware: (not included w/clamp)
	211-0511-00			1	SCREW, 6-32 x 1/2 inch, PHS
	210-0863-00			1	WASHER, "D" type
	210-0457-00			1	NUT, keps. 6-32 x 5/16 inch
12	367-0058-00			1	HANDLE, carrying
				-	mounting hardware: (not included w/handle)
	211-0512-00			4	SCREW, 6-32 x 1/2 inch, PHS phillips
13	214-0513-00			2	INDEX, handle ring
14	214-0516-00			2	SPRING, handle index
15	200-0602-00			2	COVER, handle
16	214-0578-00			2	HUB, handle index
				-	mounting hardware for each: (not included w/hub)
	213-0129-00			1	SCREW, socket head, 1/4-20 x 3/4 inch
17	214-0598-01			2	SCREW, cabinet latch
	354-0175-00			2	RING, retaining
18	426-0258-00			1	FRAME, rear
19	348-0078-00			4	FOOT, body and cord holder
20	348-0079-00			4	FOOT, cap
21	212-0082-00			4	SCREW, 8-32 x 1 1/4 inches, PHS phillips
22	260-0642-00			1	SWITCH, toggle—LINE VOLTAGE RANGE
				-	mounting hardware: (not included w/switch)
	210-0046-00			1	LOCKWASHER, internal, .400 OD x .261 inch ID
	210-0940-00			1	WASHER, 1/4 ID x 3/8 inch OD
	210-0562-00			2	NUT, hex, 1/4-40 x 3/16 inch
23	346-0043-00			1	STRAP, ground

For Service Manuals Contact  
**MAURITRON TECHNICAL SERVICES**  
 8 Cherry Tree Rd, Chinnor  
 Oxon OX9 4QY  
 Tel: 01844-351694 Fax: 01844-352554  
 Email: enquiries@mauritron.co.uk

Parts List—Type 453

FRAME & CABINET (Cont'd)

REF. NO.	PART NO.	SERIAL/MODEL NO.		QTY.	DESCRIPTION
		EFF.	DISC.		
24	129-0020-00			1	POST, binding
	-----			-	post includes:
	355-0503-00			1	STEM, adapter
	200-0072-00			1	CAP, binding post
	-----			-	mounting hardware: (not included w/post)
	220-0410-00			1	NUT, keps, 10-32 x 3/8 inch
25	129-0064-00			1	POST, binding
	-----			-	mounting hardware: (not included w/post)
	358-0181-00			1	BUSHING, nylon
	210-0457-00			1	NUT, keps, 6-32 x 5/16 inch
26	214-0634-00			1	GUARD, switch
27	386-0211-00			1	PLATE, rear overlay
	-----			-	mounting hardware: (not included w/plate)
	211-0565-00			4	SCREW, 6-32 x 1/4 inch, THS phillips
28	378-0766-00			1	SCREEN, filter
29	378-0033-00			1	FILTER, air
30	330-0082-00			1	HOUSING, fan filter
	-----			-	mounting hardware: (not included w/housing)
	213-0107-00			4	SCREW, thread forming, 4-40 x 1/4 inch, FHS phillips
31	386-0209-00			1	PLATE, top
32	426-0260-00			2	FRAME, rail
	-----			-	mounting hardware for each: (not included w/frame)
	212-0560-00			4	SCREW, 10-32 x 5/16 inch, FHS phillips

For Service Manuals Contact  
 MAURITRON TECHNICAL SERVICES  
 8 Cherry Tree Rd, Chinnor  
 Oxon OX9 4QY  
 Tel: 01844-351694 Fax: 01844-352554  
 Email: enquiries@mauritron.co.uk

STANDARD ACCESSORIES

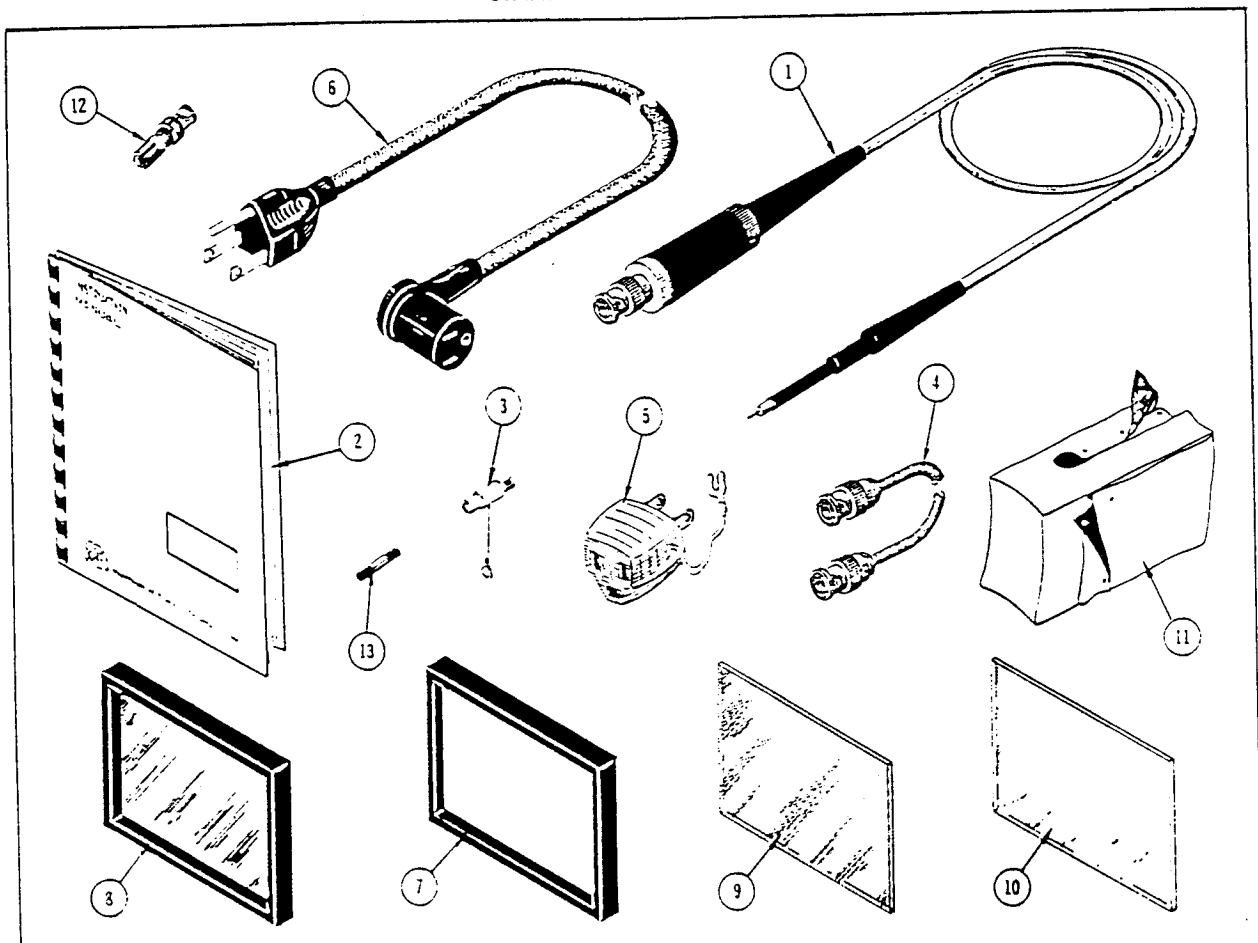

REF. NO.	PART NO.	SERIAL/MODEL NO.		QTY.	DESCRIPTION
		EFF.	DISC.		
1	010-0188-00			2	PRC3E, package, P6010, 10X, 42 inches, BNC
2	070-0478-00			2	MANUAL, instruction
3	012-0092-00			1	JACK BNC — Post
4	012-0076-00			1	CABLE, 50 Ω, BNC both ends
5	103-0013-00			1	ADAPTER, power card
6	161-0024-00	100	1878	1	CCRD, power, 115 volt
	161-0024-01	1879		1	CCRD, power, 115 volt
				-	card includes:
	214-0698-00	X1879		1	SPRING, power cord ground
	161-0027-00	X950	1878	1	CCRD, power, 230 volt
	161-0027-01	1879		1	CCRD, power, 230 volt
				-	card includes:
	214-0698-00	X1879		1	SPRING, power cord ground
7	354-0269-00			1	RING, ornamental
8	378-0573-00			1	FILTER, mesh, (installed)
9	378-0576-00			1	FILTER, light, smoke gray
10	386-0218-00			1	PLATE, protector, clear
11	016-0074-00			1	COVER, rain
12	103-0033-00			2	ADAPTER, BNC to binding post
13	159-0023-00	X1800		1	FUSE, slow-blow, 2 amps, 3AG
	159-0025-00	X1800		1	FUSE, fast-blow, 1/2 amp, 3AG
	159-0028-00	X1800		1	FUSE, fast-blow, 1/4 amp, 3AG
	159-0018-00	X1800		2	FUSE, slow-blow, 4/5 amp, 3AG





## ELECTRICAL PARTS

Values are fixed unless marked Variable.

Ckt. No.	Tektronix Part No.	Description	S/N Range
		Bulbs	
818	150-0035-00	Neon, A1D	
875	150-0030-00	Neon, NE-2V	CH 1 UNCAL
8118	150-0035-00	Neon, A1D	
8175	150-0030-00	Neon, NE-2V	CH 2 UNCAL
8400	150-0035-00	Neon, A1D	CH 1-A Triggering
8401	150-0035-00	Neon, A1D	CH 1-B Triggering
8444	150-0035-00	Neon, A1D	
8530W	150-0035-00	Neon, A1D	A OR B UNCAL
8568	150-0035-00	Neon, A1D	
8596	150-0046-00	Incandescent	A SWEEP TRIGGER
8597†	260-0717-00		
8629	150-0035-00	Neon, A1D	
8849	150-0035-00	Neon, A1D	Mag on
8973	150-0030-00	Neon, NE-2V	
8974	150-0030-00	Neon, NE-2V	
8975	150-0030-00	Neon, NE-2V	
81107	150-0045-00	Incandescent	POWER
81108	150-0047-00	Incandescent	Graticule Light
81109	150-0047-00	Incandescent	Graticule Light

## Capacitors

Tolerance = 20% unless otherwise indicated.

C1	*285-0697-00	0.1 $\mu$ f	PTM		600 v	
C3	281-0617-00	15 pf	Cer		200 v	
C5B	281-0064-00	0.2-1.5 pf	Tub.	Var		
C5C	281-0102-00	1.7-11 pf	Air	Var		
C7B	281-0064-00	0.2-1.5 pf	Tub.	Var		
C7C	281-0100-00	1.4-7.3 pf	Air	Var		
C7E	281-0577-00	14 pf	Cer		500 v	5%
C8B	281-0099-00	1.3-5.4 pf	Air	Var		
C8C	281-0083-00	0.2-1.5 pf		Var		
C8E		50 pf	Mica			10%
C8D	281-0544-00	5.6 pf	Cer		500 v	10%
C9B	281-0099-00	1.3-5.4 pf	Air	Var		
C9C	281-0086-00	0.2-1.5 pf		Var		
C9E		500 pf	Mica			
C9D		281-0593-00	3.9 pf	Cer		

†Furnished as a unit with SW569.

Parts List—Type 453

Capacitors (Cont'd)

Ckt. No.	Tektronix Part No.		Description			S/N Range
C11	281-0098-00	1.2-3.5 pf	Air	Var		
C13	281-0617-00	15 pf	Cer		200 v	
C16	281-0537-00	0.68 pf	Cer		500 v	
C17	281-0064-00	0.2-1.5 pf	Tub.	Var		
C18	283-0068-00	0.01 $\mu$ f	Cer		500 v	
C23	283-0092-00	0.03 $\mu$ f	Cer		200 v	-20% $\pm$ 80%
C24	283-0078-00	0.001 $\mu$ f	Cer		500 v	
C30	283-0080-00	0.022 $\mu$ f	Cer		25 v	-20% $\pm$ 80%
C43A	281-0081-00	1.3-13 pf	Air	Var		
C43B	281-0577-00	14 pf	Cer		500 v	5% 100-3659
C43B	281-0578-00	18 pf	Cer		500 v	5% 3660-up
C43C	281-0081-00	1.3-13 pf	Air	Var		
C43D	281-0603-00	39 pf	Cer		500 v	5%
C44A	281-0078-00	1.4-7.3 pf	Air	Var		
C44C	281-0078-00	1.4-7.3 pf	Air	Var		
C45A	281-0078-00	1.4-7.3 pf	Air	Var		
C45C	281-0081-00	1.3-13 pf	Air	Var		
C48	290-0267-00	1 $\mu$ f	EMT		35 v	
C49	281-0604-00	2.2 pf	Cer		500 v	$\pm$ 0.25 pf
C51	283-0078-00	0.001 $\mu$ f	Cer		500 v	
C53	290-0267-00	1 $\mu$ f	EMT		35 v	
C64	283-0078-00	0.001 $\mu$ f	Cer		500 v	
C73	281-0534-00	3.3 pf	Cer			$\pm$ 0.25 pf
C84	283-0032-00	470 pf	Cer		500 v	5%
C94	283-0032-00	470 pf	Cer		500 v	5%
C97	283-0081-00	0.1 $\mu$ f	Cer		25 v	-20% $\pm$ 80%
C98	283-0092-00	0.03 $\mu$ f	Cer		200 v	-20% $\pm$ 80%
C99	283-0092-00	0.03 $\mu$ f	Cer		200 v	-20% $\pm$ 80%
C101	285-0697-00	0.1 $\mu$ f	PTM		600 v	
C103	281-0617-00	15 pf	Cer		200 v	
C106B	281-0064-00	0.2-1.5 pf	Tub.	Var		
C106C	281-0102-00	1.7-11 pf	Air	Var		
C107B	281-0064-00	0.2-1.5 pf	Tub.	Var		
C107C	281-0100-00	1.4-7.3 pf	Air	Var		
C107E	281-0577-00	14 pf	Cer		500 v	5%
C108B	281-0099-00	1.3-5.4 pf	Air	Var		
C108C } C108E }	281-0083-00	0.2-1.5 pf 50 pf	Mica	Var		10%
C108D	281-0544-00	5.6 pf	Cer		500 v	10%
C109B	281-0099-00	1.3-5.4 pf	Air	Var		
C109C } C109E }	281-0086-00	0.2-1.5 pf 500 pf	Mica	Var		
C109D	281-0593-00	3.9 pf	Cer			10%
C111	281-0098-00	1.2-3.5 pf	Air	Var		
C113	281-0617-00	15 pf	Cer		200 v	
C116	281-0537-00	0.68 pf	Cer		500 v	
C117	281-0064-00	0.2-1.5 pf	Tub.	Var		

## Capacitors (Cont'd)

Ckt. No.	Tektronix Part No.		Description		S/N Range
C118	283-0068-00	0.01 $\mu$ f	Cer	500 v	
C123	283-0092-00	0.03 $\mu$ f	Cer	200 v	-20% +80%
C124	283-0078-00	0.001 $\mu$ f	Cer	500 v	
C130	283-0080-00	0.022 $\mu$ f	Cer	25 v	-20% +80%
C143A	281-0081-00	1.8-13 pf	Air	Var	
C143B	281-0577-00	14 pf	Cer	500 v	5%
C143B	281-0578-00	18 pf	Cer	500 v	5%
C143C	281-0081-00	1.8-13 pf	Air	Var	100-3659
C143D	281-0603-00	39 pf	Cer	500 v	5%
C144A	281-0078-00	1.4-7.3 pf	Air	Var	3660-up
C144C	281-0078-00	1.4-7.3 pf	Air	Var	
C145A	281-0078-00	1.4-7.3 pf	Air	Var	
C145C	281-0081-00	1.8-13 pf	Air	Var	
C148	290-0267-00	1 $\mu$ f	EMT	35 v	
C149	281-0604-00	2.2 pf	Cer	500 v	$\pm$ 0.25 pf
C151	283-0078-00	0.001 $\mu$ f	Cer	500 v	
C153	290-0267-00	1 $\mu$ f	EMT	35 v	
C159	281-0504-00	10 pf	Cer	500 v	10%
C173	281-0534-00	3.3 pf	Cer		$\pm$ 0.25 pf
C186	283-0032-00	470 pf	Cer	500 v	5%
C196	283-0032-00	470 pf	Cer	500 v	5%
C197	283-0081-00	0.1 $\mu$ f	Cer	25 v	-20% +80%
C198	283-0081-00	0.1 $\mu$ f	Cer	25 v	-20% +80%
C218	285-0698-00	0.0082 $\mu$ f	PTM	100 v	5%
C231	283-0047-00	270 pf	Cer	500 v	5%
C241	283-0060-00	100 pf	Cer	200 v	5%
C253	283-0081-00	0.1 $\mu$ f	Cer	25 v	-20% +80%
C261	283-0060-00	100 pf	Cer	200 v	5%
C262	281-0577-00	14 pf	Cer	500 v	5%
C263	281-0081-00	1.8-13 pf	Air	Var	
C264	281-0603-00	39 pf	Cer	500 v	5%
C265	281-0081-00	1.8-13 pf	Air	Var	
C266	281-0592-00	4.7 pf	Cer		$\pm$ 0.5 pf
C288	281-0505-00	12 pf	Cer	200 v	10%
C289	281-0593-00	3.9 pf	Cer		10%
C298	281-0505-00	12 pf	Cer	500 v	10%
C299	283-0081-00	0.1 $\mu$ f	Cer	25 v	-20% +80%
C301	281-0503-00	8 pf	Cer	500 v	$\pm$ 0.5 pf
C302	281-0503-00	8 pf	Cer	500 v	$\pm$ 0.5 pf
C303	281-0572-00	6.8 pf	Cer	500 v	10%
C306	283-0080-00	0.022 $\mu$ f	Cer	25 v	-20% +80%
C311	281-0503-00	8 pf	Cer	500 v	$\pm$ 0.5 pf
C312	281-0503-00	8 pf	Cer	500 v	$\pm$ 0.5 pf
C313	281-0572-00	6.8 pf	Cer	500 v	10%
C322	283-0080-00	0.022 $\mu$ f	Cer	25 v	-20% +80%
C326	281-0504-00	10 pf	Cer	500 v	10%
C327	281-0572-00	6.8 pf	Cer	500 v	10%

Parts List—Type 453

Capacitors (Cont'd)

Ckt. No.	Tektronix Part No.	Description	S/N Range
C328	281-0081-00	1.8-13 pf	
C331	283-0080-00	0.022 $\mu$ f	
C336	281-0081-00	1.8-13 pf	
C341	283-0080-00	0.022 $\mu$ f	
C342	281-0572-00	6.8 pf	
		Air	Var
		Cer	25 v
		Air	Var
		Cer	25 v
		Cer	500 v
			-20% +80%
			-20% +80% 100-2499X
			10%
C344	283-0077-00	330 pf	
C354	283-0077-00	330 pf	
C361	283-0073-00	0.001 $\mu$ f	
C365	283-0092-00	0.03 $\mu$ f	
C371	283-0073-00	0.001 $\mu$ f	
		Cer	500 v
		Cer	500 v
		Cer	500 v
		Cer	500 v
		Cer	200 v
			-20% +80%
C405	283-0080-00	0.002 $\mu$ f	
C411	283-0092-00	0.03 $\mu$ f	
C413	283-0065-00	0.001 $\mu$ f	
C416	283-0080-00	0.022 $\mu$ f	
C417	283-0090-00	0.022 $\mu$ f	
		Cer	25 v
		Cer	200 v
		Cer	100 v
		Cer	25 v
		Cer	25 v
			-20% +80%
			-20% +80%
			-20% +80%
C421	283-0081-00	0.1 $\mu$ f	
C422	283-0080-00	0.022 $\mu$ f	
C424	283-0080-00	0.022 $\mu$ f	
C432	281-0510-00	22 pf	
C433A	281-0505-00	12 pf	
		Cer	25 v
		Cer	25 v
		Cer	25 v
		Cer	500 v
		Cer	500 v
			10%
C433B	281-0557-00	1.8 pf	
C435	283-0013-00	0.01 $\mu$ f	
C436	281-0523-00	100 pf	
C439	283-0068-00	0.01 $\mu$ f	
C446	283-0092-00	0.03 $\mu$ f	
		Cer	500 v
		Cer	1000 v
		Cer	350 v
		Cer	500 v
		Cer	200 v
			-20% +80%
C456	283-0080-00	0.022 $\mu$ f	
C461	283-0023-00	0.0022 $\mu$ f	
C464	283-0029-00	0.0022 $\mu$ f	
C466	283-0080-00	0.022 $\mu$ f	
C467	283-0081-00	0.1 $\mu$ f	
		Cer	25 v
		Cer	50 v
		Cer	50 v
		Cer	25 v
		Cer	25 v
			-20% +80%
			-20% +80%
C473	281-0622-00	47 pf	
C476	281-0602-00	68 pf	
C482	281-0523-00	100 pf	
C485	290-0246-00	3.3 $\mu$ f	
C493	283-0080-00	0.022 $\mu$ f	
		Cer	500 v
		Cer	500 v
		Cer	500 v
		EMT	350 v
		Cer	15 v
			10%
			-20% +80%
C497	283-0092-00	0.03 $\mu$ f	
C498	290-0267-00	1 $\mu$ f	
C499	290-0267-00	1 $\mu$ f	
C503	281-0525-00	470 pf	
C506	281-0525-00	470 pf	
		Cer	200 v
		EMT	35 v
		EMT	35 v
		Cer	500 v
		Cer	500 v
			-20% +80%
C509	281-0628-00	15 pf	
C511	283-0080-00	0.022 $\mu$ f	
C512	283-0080-00	0.022 $\mu$ f	
C523	281-0525-00	470 pf	
C530A	281-0010-00	4.5-25 pf	
		Cer	600 v
		Cer	25 v
		Cer	25 v
		Cer	500 v
			5%
			-20% +80%
			-20% +80%
		Var	500 v

For Service Manuals Contact  
 MAURITRON TECHNICAL SERVICES  
 8 Cherry Tree Rd, Chinnor  
 Oxon OX9 4QY

Parts List—Type 453

Tel: 01844-351694 Fax: 01844-352554

Capacitors (Cont'd) Email: enquiries@mauritron.co.uk

Ckt. No.	Tektronix Part No.	Description	S/N Range
C530B	283-0097-00	84 pf	
C530C		0.001 $\mu$ f	
C530D		0.01 $\mu$ f	
C530E	*295-0089-00	0.1 $\mu$ f	
C530F		1 $\mu$ f	
C530G		10 $\mu$ f	
		Cer	1000 v 2%
		Timing Capacitor	
C530H	281-0523-00	100 pf	
C530J	281-0523-00	100 pf	
C530K	283-0032-00	470 pf	
C534	283-0092-00	0.03 $\mu$ f	
C537	281-0572-00	6.8 pf	
		Cer	350 v
		Cer	350 v
		Cer	500 v
		Cer	200 v 5% -20% +80%
		Cer	500 v 10%
C538	281-0558-00	18 pf	
C545	290-0135-00	15 $\mu$ f	
C547	281-0523-00	100 pf	
C550C	281-0525-00	470 pf	
C550D	285-0699-00	0.0047 $\mu$ f	
		Cer	500 v
		EMT	20 v
		Cer	350 v
		Cer	500 v
		PTM	100 v 10%
C550E	290-0282-00	0.047 $\mu$ f	
C550F	290-0283-00	0.47 $\mu$ f	
C550G	290-0284-00	4.7 $\mu$ f	
C550H	281-0519-00	47 pf	
C559	283-0081-00	0.1 $\mu$ f	
C561	283-0060-00	100 pf	
		EMT	35 v 10%
		EMT	35 v 10%
		EMT	35 v 10%
		Cer	35 v 10%
		Cer	500 v 10%
		Cer	25 v -20% +80% X3450-up
		Cer	200 v 5%
C566	281-0525-00	470 pf	
C568	283-0057-00	0.1 $\mu$ f	
C569	Use 283-0078-00	0.001 $\mu$ f	
C572	281-0519-00	47 pf	
C586	283-0080-00	0.022 $\mu$ f	
C597	283-0092-00	0.03 $\mu$ f	
		Cer	500 v
		Cer	200 v -20% +80%
		Cer	500 v
		Cer	500 v 10%
		Cer	25 v -20% +80%
		Cer	200 v -20% +80%
C598	290-0135-00	15 $\mu$ f	
C599	290-0135-00	15 $\mu$ f	
C602	281-0510-00	22 pf	
C613A	281-0505-00	12 pf	
C613B	281-0557-00	1.8 pf	
		EMT	20 v
		EMT	20 v
		Cer	500 v
		Cer	500 v 10%
		Cer	500 v
C615	283-0013-00	0.01 $\mu$ f	
C616	281-0523-00	100 pf	
C622	283-0068-00	0.01 $\mu$ f	
C630	283-0092-00	0.03 $\mu$ f	
C636	283-0080-00	0.022 $\mu$ f	
		Cer	1000 v
		Cer	350 v
		Cer	500 v
		Cer	200 v -20% +80%
		Cer	25 v -20% +80%
C639	283-0080-00	0.022 $\mu$ f	
C642	283-0080-00	0.022 $\mu$ f	
C656	283-0080-00	0.022 $\mu$ f	
C661	283-0028-00	0.0022 $\mu$ f	
C664	283-0028-00	0.0022 $\mu$ f	
		Cer	25 v -20% +80%
		Cer	25 v -20% +80%
		Cer	25 v -20% +80%
		Cer	25 v -20% +80%
		Cer	50 v -20% +80%
		Cer	50 v
C666	283-0080-00	0.022 $\mu$ f	
C667	283-0081-00	0.1 $\mu$ f	
C673	281-0622-00	47 pf	
C676	281-0540-00	51 pf	
C688	281-0602-00	68 pf	
		Cer	25 v -20% +80%
		Cer	25 v -20% +80%
		Cer	500 v 1%
		Cer	500 v 5%
		Cer	500 v 5%

Parts List—Type 453

Capacitors (Cont'd)

Ckt. No.	Tektronix Part No.	Description	S/N Range
C698	290-0267-00	1 $\mu$ f	
C699	290-0267-00	1 $\mu$ f	
C702	281-0580-00	470 pf	
C704	281-0628-00	15 pf	
C705	281-0580-00	470 pf	
C715	283-0080-00	0.022 $\mu$ f	
C722	281-0580-00	470 pf	
C731	283-0060-00	100 pf	
C732	283-0080-00	0.022 $\mu$ f	
C740A	281-0010-00	4.5-25 pf	
C740B	283-0097-00	84 pf	
C740C		0.001 $\mu$ f	
C740D		0.01 $\mu$ f	
C740E	*295-0079-00	0.1 $\mu$ f	
C740F		1 $\mu$ f	
C740H	281-0523-00	100 pf	
C744	283-0092-00	0.03 $\mu$ f	
C748	281-0626-00	3.3 pf	
C756	281-0523-00	100 pf	
C759	290-0248-01	150 pf	
C764	283-0080-00	0.022 $\mu$ f	
C771	283-0080-00	0.022 $\mu$ f	
C773	283-0114-00	0.0015 $\mu$ f	
C774	283-0080-00	0.022 $\mu$ f	
C785	281-0518-00	47 pf	
C786	283-0080-00	0.022 $\mu$ f	
C797	283-0092-00	0.03 $\mu$ f	
C798	290-0135-00	15 $\mu$ f	
C799	290-0135-00	15 $\mu$ f	
C804	283-0059-00	1 $\mu$ f	
C806	283-0080-00	0.022 $\mu$ f	
C807	283-0080-00	0.022 $\mu$ f	
C808	283-0059-00	1 $\mu$ f	
C882	281-0064-00	0.2-1.5 pf	
C886	285-0572-00	0.1 $\mu$ f	
C892	281-0064-00	0.2-1.5 pf	
C898	290-0267-00	1 $\mu$ f	
C899	290-0267-00	1 $\mu$ f	
C902	285-0622-00	0.1 $\mu$ f	
C906	283-0044-00	0.001 $\mu$ f	
C913	285-0622-00	0.1 $\mu$ f	
C937	290-0209-00	50 $\mu$ f	
C940	283-0120-00	0.015 $\mu$ f	
C945	283-0120-00	0.015 $\mu$ f	
C946	283-0120-00	0.015 $\mu$ f	
C952	283-0120-00	0.015 $\mu$ f	
C953	281-0556-00	500 pf	



For Service Manuals Contact  
**MAURITRON TECHNICAL SERVICES** Parts List—Type 453  
 8 Cherry Tree Rd, Chinnor  
 Oxon OX9 4QY

Capacitors (Cont'd) Tel: 01844-351694 Fax: 01844-352554  
 Email: enquiries@mauritron.co.uk

Ckt. No.	Tektronix Part No.		Description		S/N Range
C954	283-0021-00	0.001 $\mu$ f	Cer	5000 v	
C961	281-0556-00	500 pf	Cer	10,000 v	
C966	283-0120-00	0.015 $\mu$ f	Cer	2500 v	
C972	283-0079-00	0.01 $\mu$ f	Cer	250 v	
C976	283-0044-00	0.001 $\mu$ f	Cer	3000 v	
C979	283-0060-00	100 pf	Cer	200 v	5%
C994	285-0622-00	0.1 $\mu$ f	PTM	100 v	
Cy23	285-0572-00	0.1 $\mu$ f	PTM	200 v	
C1023	283-0079-00	0.01 $\mu$ f	Cer	250 v	
C1036	281-0043-00	0.7-3 pf	Tub.	Var	
C1037	281-0538-00	1 pf	Cer	500 v	
C1041	283-0092-00	0.03 $\mu$ f	Cer	200 v	
C1043	283-0057-00	0.1 $\mu$ f	Cer	200 v	-20% $\pm$ 80%
C1044	283-0057-00	0.1 $\mu$ f	Cer	200 v	-20% $\pm$ 80%
C1048	283-0092-00	0.03 $\mu$ f	Cer	200 v	
C1051	283-0092-00	0.03 $\mu$ f	Cer	200 v	
C1052	283-0079-00	0.01 $\mu$ f	Cer	250 v	
C1102	285-0696-00	0.5 $\mu$ f	PTM	600 v	10%
C1105	283-0080-00	0.022 $\mu$ f	Cer	25 v	-20% $\pm$ 80%
C1111	285-0566-00	0.022 $\mu$ f	PTM	200 v	10%
C1112	290-0281-00	1500 $\mu$ f	EMC	25 v	
C1114	290-0171-00	100 $\mu$ f	EMT	12 v	
C1121	290-0162-00	22 $\mu$ f	EMT	35 v	
C1128	283-0078-00	0.001 $\mu$ f	Cer	500 v	
C1141	285-0566-00	0.022 $\mu$ f	PTM	200 v	10%
C1142	290-0281-00	1500 $\mu$ f	EMC	25 v	
C1151	290-0162-00	22 $\mu$ f	EMT	35 v	
C1156	283-0078-00	0.001 $\mu$ f	Cer	500 v	
C1164	290-0286-00	50 $\mu$ f	EMT	25 v	-10% $\pm$ 75%
C1171	285-0566-00	0.022 $\mu$ f	PTM	200 v	10%
C1172	290-0280-00	200 $\mu$ f	EMC	150 v	
C1181	290-0198-00	17 $\mu$ f	EMT	150 v	-15% $\pm$ 30%
C1184	283-0078-00	0.001 $\mu$ f	Cer	500 v	
C1185	285-0622-00	0.1 $\mu$ f	PTM	100 v	
C1191	283-0006-00	0.02 $\mu$ f	Cer	500 v	
C1194	290-0285-00	4 $\mu$ f	EMT	200 v	-10% $\pm$ 50%
C1201	285-0566-00	0.022 $\mu$ f	PTM	200 v	10%
C1202	290-0280-00	200 $\mu$ f	EMC	150 v	
C1204	290-0214-00	10 $\mu$ f	EMT	250 v	
C1211	285-0566-00	0.022 $\mu$ f	PTM	200 v	10%
C1251	290-0267-00	1 $\mu$ f	EMT	35 v	
C1255	285-0595-00	0.1 $\mu$ f	PTM	100 v	1%
C1266	283-0010-00	0.05 $\mu$ f	Cer	50 v	

Parts List—Type 453

Diodes

Ckt. No.	Tektronix Part No.		Description	S/N Range
D18	*152-0185-00	Silicon	Replaceable by 1N3605	
D24	*152-0185-00	Silicon	Replaceable by 1N3605	
D53	152-0166-00	Zener	1N753A 6.2 v, 0.4 w, 5%	
D58	*152-0185-00	Silicon	Replaceable by 1N3605	
D118	*152-0185-00	Silicon	Replaceable by 1N3605	
D124	*152-0185-00	Silicon	Replaceable by 1N3605	
D153	152-0166-00	Zener	1N753A 6.2 v, 0.4 w, 5%	
D199	152-0212-00	Zener	1N936 9 v, 5% T.C.	
D201	152-0141-00	Silicon	1N3605	
D202	152-0141-00	Silicon	1N3605	
D203	152-0141-00	Silicon	1N3605	
D204	152-0141-00	Silicon	1N3605	
D206	152-0141-00	Silicon	1N3605	
D207	152-0141-00	Silicon	1N3605	
D208	152-0141-00	Silicon	1N3605	
D209	152-0141-00	Silicon	1N3605	
D213	*152-0185-00	Silicon	Replaceable by 1N3605	
D218	152-0141-00	Silicon	1N3605	
D223	*152-0185-00	Silicon	Replaceable by 1N3605	
D228	152-0141-00	Silicon	1N3605	
D235	*152-0185-00	Silicon	Replaceable by 1N3605	
D339	*152-0185-00	Silicon	Replaceable by 1N3605	
D344	152-0076-00	Zener	1N4372 3 v, 0.4 w, 10%	
D354	152-0076-00	Zener	1N4372 3 v, 0.4 w, 10%	
D408	152-0141-00	Silicon	1N3605	
D421	152-0166-00	Zener	1N753A 6.2 v, 0.4 w, 5%	
D446	*152-0185-00	Silicon	Replaceable by 1N3605	
D447	*152-0185-00	Silicon	Replaceable by 1N3605	
D448	*152-0185-00	Silicon	Replaceable by 1N3605	
D449	152-0166-00	Zener	1N753A 6.2 v, 0.4 w, 5%	
D455	*152-0185-00	Silicon	Replaceable by 1N3605	
D456	*152-0185-00	Silicon	Replaceable by 1N3605	
D465	*152-0185-00	Silicon	Replaceable by 1N3605	
D466	*152-0185-00	Silicon	Replaceable by 1N3605	
D474	*152-0153-00	Silicon	Replaceable by 1N4244	
D475	*152-0125-00	Tunnel	Selected TD3A 4.7 MA	
D484	*152-0153-00	Silicon	Replaceable by 1N4244	
D486	*152-0185-00	Silicon	Replaceable by 1N3605	
D493	*152-0185-00	Silicon	Replaceable by 1N3605	
D501	*152-0153-00	Silicon	Replaceable by 1N4244	
D505	*152-0125-00	Tunnel	Selected TD3A 4.7 MA	
D515	*152-0185-00	Silicon	Replaceable by 1N3605	
D517	*152-0185-00	Silicon	Replaceable by 1N3605	
D526	*152-0185-00	Silicon	Replaceable by 1N3605	
D528	*152-0185-00	Silicon	Replaceable by 1N3605	



## Diodes (Cont'd)

Ckt. No.	Tektronix Part No.		Description	S/N Range
D529	*152-0185-00	Silicon	Replaceable by 1N3605	
D533	Use *050-0290-00		Replacement kit	100-2589
D533	*152-0249-00	Silicon	Assembly	2590-up
D542	*152-0185-00	Silicon	Replaceable by 1N3605	
D543	*152-0185-00	Silicon	Replaceable by 1N3605	
D544	152-0064-00	Zener	1N761 10 v, 0.4 w, 5%	
D546	*152-0185-00	Silicon	Replaceable by 1N3605	
D547	*152-0185-00	Silicon	Replaceable by 1N3605	
D552	*152-0185-00	Silicon	Replaceable by 1N3605	
D555	*152-0185-00	Silicon	Replaceable by 1N3605	
D556	*152-0185-00	Silicon	Replaceable by 1N3605	
D559	152-0217-00	Zener	1N756A 8.2 v, 0.4 w, 5%	
D566	*152-0185-00	Silicon	Replaceable by 1N3605	
D575	*152-0185-00	Silicon	Replaceable by 1N3605	
D583	*152-0185-00	Silicon	Replaceable by 1N3605	
D584	*152-0185-00	Silicon	Replaceable by 1N3605	
D591	*152-0185-00	Silicon	Replaceable by 1N3605	
D592	*152-0185-00	Silicon	Replaceable by 1N3605	
D593	*152-0185-00	Silicon	Replaceable by 1N3605	
D594	*152-0185-00	Silicon	Replaceable by 1N3605	
D595	*152-0185-00	Silicon	Replaceable by 1N3605	
D631	*152-0185-00	Silicon	Replaceable by 1N3605	
D632	*152-0185-00	Silicon	Replaceable by 1N3605	
D633	*152-0185-00	Silicon	Replaceable by 1N3605	
D634	152-0166-00	Silicon	1N753A 6.2 v, 0.4 w, 5%	
D635	*152-0185-00	Silicon	Replaceable by 1N3605	
D638	*152-0185-00	Silicon	Replaceable by 1N3605	
D641	*152-0185-00	Silicon	Replaceable by 1N3605	
D655	*152-0185-00	Silicon	Replaceable by 1N3605	
D656	*152-0185-00	Silicon	Replaceable by 1N3605	
D665	*152-0185-00	Silicon	Replaceable by 1N3605	
D666	*152-0185-00	Silicon	Replaceable by 1N3605	
D675	*152-0125-00	Tunnel	Selected TD3A 4.7 MA	
D678	*152-0153-00	Silicon	Replaceable by 1N4244	
D701	*152-0153-00	Silicon	Replaceable by 1N4244	
D705	*152-0125-00	Tunnel	Selected TD3A 4.7 MA	
D714	*152-0185-00	Silicon	Replaceable by 1N3605	
D727	*152-0185-00	Silicon	Replaceable by 1N3605	
D728	*152-0185-00	Silicon	Replaceable by 1N3605	
D731	*152-0185-00	Silicon	Replaceable by 1N3605	
D742	Use *150-0290-00		Replacement kit	100-2589
D742	*152-0249-00	Silicon	Assembly	2590-up
D748	*152-0185-00	Silicon	Replaceable by 1N3605	
D752	*152-0185-00	Silicon	Replaceable by 1N3605	
D753	*152-0185-00	Silicon	Replaceable by 1N3605	
D754	*152-0185-00	Silicon	Replaceable by 1N3605	

For Service Manuals Contact  
**MAURITRON TECHNICAL SERVICES**  
 8 Cherry Tree Rd. Chinnor  
 Oxon OX9 4OY  
 Tel: 01844-351694 Fax: 01844-352554  
 Email: enquiries@mauritron.co.uk

Parts List—Type 453

Diodes (Cont'd)

Ckt. No.	Tektronix Part No.		Description	S/N Range
D755	*152-0185-00	Silicon	Replaceable by 1N3605 Replaceable by 1N3605 Assy, Matched pair of 1N3605 Selected TD3A 4.7 MA Replaceable by 1N3605	
D756	*152-0185-00	Silicon		
D764A,B	*152-0151-00	Silicon		
D765	*152-0125-00	Tunnel		
D776	*152-0185-00	Silicon		
D777	*152-0185-00	Silicon	Replaceable by 1N3605 Replaceable by 1N4244 Replaceable by 1N4244 1N3605 1N3605	
D851	*152-0153-00	Silicon		
D852	*152-0153-00	Silicon		
D861	152-0141-00	Silicon		
D871	152-0141-00	Silicon		
D884	*152-0061-00	Silicon	Tek Spec Varo 7701-5X Varo 7701-5X Replaceable by 1N3605 Replaceable by 1N3605	
D940	152-0192-00	Rectifier		
D952	152-0192-00	Rectifier		
D1015	*152-0185-00	Silicon		
D1016	*152-0185-00	Silicon		
D1043	152-0126-00	Zener	1N3024A 15 v, 1 w, 10% Replaceable by 1N3605 1N1329 1N1329 MR1032A (Motorola)	
D1045	*152-0185-00	Silicon		
D1046	152-0002-00	Silicon		
D1047	152-0002-00	Silicon		
D1112A,B,C,D	152-0198-00	Silicon		
D1114	152-0212-00	Zener	1N936 9 v, 5% T.C. MR1032A (Motorola) Replaceable by 1N3605 Replaceable by 1N3605 Replaceable by 1N3605	
D1142A,B,C,D	152-0198-00	Silicon		
D1152	*152-0185-00	Silicon		
D1159	*152-0185-00	Silicon		
D1164	*152-0185-00	Silicon		
D1167	152-0142-00	Zener	1N972 30 v, 0.4 w, 10% 1N3194 Replaceable by 1N3605 1N3037B 51 v, 1 w, 5% Replaceable by 1N3605	
D1172A,B,C,D	152-0066-00	Silicon		
D1182	*152-0185-00	Silicon		
D1185	152-0150-00	Zener		
D1188	*152-0185-00	Silicon		
D1189	*152-0185-00	Silicon	Replaceable by 1N3605 Replaceable by 1N3605 1N3194 1N3194 1N3032 33 v, 1 w, 20% 1N3194	
D1194	*152-0185-00	Silicon		
D1198	152-0066-00	Silicon		
D1202	152-0066-00	Silicon		
D1209	152-0213-00	Zener		
D1212	152-0066-00	Silicon		

Fuses

F107	159-0023-00	2 Amp	3AG	Slow-Blow
F101	159-0018-00	0.8 Amp	3AG	Slow-Blow
F102	159-0018-00	0.8 Amp	3AG	Slow-Blow
F172	159-0025-00	0.5 Amp	3AG	Fast-Blow
F104	159-0028-00	0.25 Amp	3AG	Fast-Blow

Connectors			
Ckt. No.	Tektronix Part No.	Description	S/N Range
J1	131-0352-00	Connector, BNC	
J101	131-0352-00	Connector, BNC	
J402	131-0274-00	Connector, BNC, chassis mtd.	
J529	131-0274-00	Connector, BNC, chassis mtd.	
J729	131-0274-00	Connector, BNC, chassis mtd.	
P1101†	Use 131-0402-01	Connector, Assy., 5 pin	

Inductors			
Ckt. No.	Tektronix Part No.	Description	S/N Range
LR6F	*108-0365-00	80 nh (wound on a 36 Ω resistor)	X1130-up
L30	276-0507-00	Core, Ferramic Suppressor	
L43A	*114-0170-00	0.15-0.25 μh Var	Core 276-0506-00
LR106F	*108-0365-00	80 nh (wound on a 36 Ω resistor)	X1130-up
L130	276-0507-00	Core, Ferramic Suppressor	
L143A	*114-0170-00	0.15-0.25 μh Var	Core 276-0506-00
LR287	*108-0329-00	2.5 μh (wound on a 75 Ω resistor)	
L300	*119-0029-00	Delay Line Assembly	
L301	*108-0220-00	0.15 μh	
L302	*108-0277-00	0.07 μh	
L311	*108-0220-00	0.15 μh	
L361	276-0507-00	Core, Ferramic Suppressor	
LR367	*108-0328-00	0.3 μh (wound on a 220 Ω resistor)	
L371	276-0507-00	Core, Ferramic Suppressor	
LR377	*108-0328-00	0.3 μh (wound on a 220 Ω resistor)	
L469	Use *108-0181-01	0.2 μh	
L484	*120-0382-00	Toroid, 18T single	
L498	276-0507-00	Core, Ferramic Suppressor	
L499	276-0507-00	Core, Ferramic Suppressor	
L536	276-0507-00	Core, Ferramic Suppressor	
L598	276-0507-00	Core, Ferramic Suppressor	
L599	276-0507-00	Core, Ferramic Suppressor	
L672	*108-0181-00	0.2 μh	
L698	276-0507-00	Core, Ferramic Suppressor	
L699	276-0507-00	Core, Ferramic Suppressor	
L746	276-0507-00	Core, Ferramic Suppressor	
L798	276-0507-00	Core, Ferramic Suppressor	
L799	276-0507-00	Core, Ferramic Suppressor	
L884	108-0254-00	600 μh	
L898	276-0507-00	Core, Ferramic Suppressor	
L899	276-0507-00	Core, Ferramic Suppressor	
L980	*108-0321-00	Trace Rotation	
L989	*108-0295-00	Y Axis Alignment	

For Service Manuals Contact  
**MAURITRON TECHNICAL SERVICES**  
 8 Cherry Tree Rd, Chinnor  
 Oxon OX9 4QY  
 Tel: 01844-351684 Fax: 01844-352554  
 Email: enquiries@mauritron.co.uk

Transistors		
Ckt. No.	Tektronix Part No.	Description
Q34	*151-0139-00	Dual, Selected 2N918
Q54	*151-0167-00	Selected from XF737
Q63	*151-0133-00	Selected from 2N3251
Q84	*151-0167-00	Selected from XF737
Q94	*151-0167-00	Selected from XF737

†Furnished as a unit with SW1102.

Parts List—Type 453

Transistors (Cont'd)

Ckt. No.	Tektronix Part No.	Description	S/N Range
Q134	*151-0139-00	Dual, Selected 2N918	
Q154	*151-0167-00	Selected from XF737	
Q184	*151-0167-00	Selected from XF737	
Q194	*151-0167-00	Selected from XF737	
Q215	*151-0136-00	Replacable by 2N3053	
Q225	*151-0136-00	Replacable by 2N3053	
Q224	*151-0108-00	Replacable by 2N2501	
Q244	*151-0108-00	Replacable by 2N2501	
Q253	*151-0087-00	Selected from 2N1131	
Q224	*151-0160-00	Selected from 2N3137	
Q294	*151-0160-00	Selected from 2N3137	
Q304	*151-0108-00	Replacable by 2N2501	
Q314	*151-0108-00	Replacable by 2N2501	
Q324	*151-0120-00	Selected from 2N2475	
Q334	*151-0120-00	Selected from 2N2475	
Q344	*151-0127-00	Selected from 2N2369	
Q354	*151-0127-00	Selected from 2N2369	
Q364	*153-0524-00	Checked pair, Tek Spec	
Q374			
Q404	*151-0120-00	Selected from 2N2475	
Q413	*151-0108-00	Replacable by 2N2501	
Q414	*151-0127-00	Selected from 2N2369	
Q423	*151-0133-00	Selected from 2N3251	
Q454	*151-0108-00	Replacable by 2N2501	
Q464	*151-0108-00	Replacable by 2N2501	
Q473	151-0131-00	2N964	
Q484	151-0131-00	2N964	
Q485	*151-0108-00	Replacable by 2N2501	
Q494	*151-0087-00	Selected from 2N1131	
Q495	*151-0108-00	Replacable by 2N2501	
Q504	151-0131-00	2N964	
Q514	*151-0108-00	Replacable by 2N2501	
Q524	*151-0108-00	Replacable by 2N2501	
Q531	*151-0127-00	Selected from 2N2369	
Q543	*151-0133-00	Selected from 2N3251	
Q544	*151-0133-00	Selected from 2N3251	
Q564	Use *151-0188-01	Replacable by 2N3251	
Q575	*151-0133-00	Selected from 2N3251	
Q585	*151-0133-00	Selected from 2N3251	
Q594	*151-0136-00	Replacable by 2N3053	
Q654	*151-0108-00	Replacable by 2N2501	
Q664	*151-0108-00	Replacable by 2N2501	
Q684	151-0131-00	2N964	
Q704	151-0131-00	2N964	
Q714	*151-0108-00	Replacable by 2N2501	

## Transistors (Cont'd)

Ckt. No.	Tektronix Part No.	Description	S/N Range
Q724	*151-0108-00	Replaceable by 2N2501	
Q734	*151-0108-00	Replaceable by 2N2501	
Q741	*151-0127-00	Selected from 2N2369	
Q753	*151-0133-00	Selected from 2N3251	
Q754	*151-0133-00	Selected from 2N3251	
Q764A,B	*151-0104-00	Replaceable by 2N2913	
Q769	*151-0108-00	Replaceable by 2N2501	
Q774	*151-0108-00	Replaceable by 2N2501	
Q775	*151-0133-00	Selected from 2N3251	
Q785	*151-0133-00	Selected from 2N3251	
Q814	*151-0127-00	Selected from 2N2369	
Q824	*151-0127-00	Selected from 2N2369	
Q834	*151-0133-00	Selected from 2N3251	
Q844	*151-0133-00	Selected from 2N3251	
Q863	*151-0133-00	Selected from 2N3251	
Q873	*151-0133-00	Selected from 2N3251	
Q884	*151-0124-00	Selected from TA1938	
Q894	*151-0124-00	Selected from TA1938	
Q913	*151-0133-00	Selected from 2N3251	
Q914	*151-0126-00	Replaceable by 2N2484	
Q923	*151-0136-00	Replaceable by 2N3053	
Q930	*151-0140-00	Selected from 2N3055	
Q1014	*151-0108-00	Replaceable by 2N2501	
Q1023	*151-0108-00	Replaceable by 2N2501	
Q1034	*151-0124-00	Selected from TA1938	
Q1043	*151-0124-00	Selected from TA1938	
Q1114	*151-0151-00	Replaceable by 2N930	
Q1124	*151-0151-00	Replaceable by 2N930	
Q1129	*151-0136-00	Replaceable by 2N3053	
Q1133	*151-0136-00	Replaceable by 2N3053	
Q1137	*151-0140-00	Selected from 2N3055	
Q1154	*151-0151-00	Replaceable by 2N930	
Q1159	*151-0136-00	Replaceable by 2N3053	
Q1163	*151-0136-00	Replaceable by 2N3053	
Q1167	*151-0140-00	Selected from 2N3055	
Q1184	*151-0151-00	Replaceable by 2N930	
Q1189	*151-0096-00	Selected from 2N1893	
Q1193	*151-0136-00	Replaceable by 2N3053	
Q1197	151-0149-00	2N3441	
Q1255	*151-0136-00	Replaceable by 2N3053	
Q1265	*151-0136-00	Replaceable by 2N3053	
Q1274	*151-0087-00	Selected from 2N1131	

For Service Manuals Contact  
**MAURITRON TECHNICAL SERVICES**  
 8 Cherry Tree Rd. Chinnor  
 Oxon OX9 4QY  
 Tel:- 01844-351694 Fax:- 01844-352554  
 Email:- enquiries@mauritron.co.uk

Parts List—Type 453

		Resistors					
Ckt. No.	Tektronix Part No.		Description			S/N Range	
Resistors are fixed, composition, $\pm 10\%$ unless otherwise indicated.							
R3	317-0620-00	62 $\Omega$	1/10 w			5%	
R6C	322-0643-00	600 k	1/4 w		Prec	1%	
R6E	322-0644-00	666.6 k	1/4 w		Prec	1%	
R6F	315-0220-00	22 $\Omega$	1/4 w			5%	
R7C	322-0620-00	800 k	1/4 w		Prec	1%	100-1129X
R7E	321-0618-00	250 k	1/8 w		Prec	1%	
R7F	315-0470-00	47 $\Omega$	1/4 w			5%	
R8C	322-0659-00	900 k	1/4 w		Prec	0.5%	
R8E	Use 321-1389-01	111 k	1/8 w		Prec	0.5%	
R8F	315-0560-00	56 $\Omega$	1/4 w			5%	
R9C	322-0659-00	990 k	1/4 w		Prec	0.5%	
R9E	Use 321-1239-01	10.1 k	1/8 w		Prec	0.5%	
R9F	315-0620-00	62 $\Omega$	1/4 w			5%	
R13	317-0220-00	22 $\Omega$	1/10 w			5%	
R15	317-0100-00	10 $\Omega$	1/10 w			5%	
R16	315-0102-00	1 k	1/4 w			5%	
R17	322-0481-00	1 meg	1/4 w		Prec	1%	
R18	315-0105-00	1 meg	1/4 w			5%	
R19	315-0122-00	1.2 k	1/4 w			5%	
R23	301-0102-00	1 k	1/2 w			5%	
R24	321-0119-00	169 $\Omega$	1/8 w		Prec	1%	
R26	321-0081-00	68.1 $\Omega$	1/8 w		Prec	1%	
R30	311-0169-00	100 $\Omega$		Var			
R31	321-0185-00	325 $\Omega$	1/8 w		Prec	1%	Ch 1 STEP ATTEN BAL
R32	321-0133-00	237 $\Omega$	1/8 w		Prec	1%	
R33	321-0157-00	422 $\Omega$	1/8 w		Prec	1%	
R40	311-0546-00	10 k		Var			
R41	321-0281-00	8.25 k	1/8 w		Prec	1%	Ch 1 POSITION
R43A	321-0078-00	63.4 $\Omega$	1/8 w		Prec	1%	
R43C	311-0442-00	250 $\Omega$		Var			
R44A	321-0124-00	191 $\Omega$	1/8 w		Prec	1%	
R44C	315-0511-00	510 $\Omega$	1/4 w			5%	
R44C	315-0681-00	680 $\Omega$	1/4 w			5%	100-3659
R45A	321-0151-00	365 $\Omega$	1/8 w		Prec	1%	3660-up
R45C	311-0462-00	1 k		Var			
R47	321-0237-00	2.37 k	1/8 w		Prec	1%	
R48	315-0100-00	10 $\Omega$	1/4 w			5%	
R49	321-0165-00	511 $\Omega$	1/8 w		Prec	1%	
R51	315-0151-00	150 $\Omega$	1/4 w			5%	
R52	321-0211-00	1.54 k	1/8 w		Prec	1%	
R53	307-0106-00	4.7 $\Omega$	1/4 w			5%	
R55	311-0480-00	500 $\Omega$		Var			Ch 1 Position Center
R58	301-0112-00	1.1 k	1/2 w			5%	
R59	315-0331-00	330 $\Omega$	1/4 w			5%	
R60	311-0465-00	100 k		Var			Ch 1 Trigger DC Level
R61	315-0153-00	15 k	1/4 w			5%	

For Service Manuals Contact  
MAURITRON TECHNICAL SERVICES  
8 Cherry Tree Rd, Chinnor  
Oxon OX9 4QY

Parts List—Type 453

Resistors (Cont'd) Tel: 01844-351694 Fax: 01844-352554  
Email: enquiries@mauritron.co.uk

Ckt. No.	Tektronix Part No.	Description	S/N Range
R63	301-0122-00	1.2 k 1/2 w	5%
R64	315-0331-00	330 Ω 1/4 w	5%
R66	321-0083-00	71.5 Ω 1/8 w	Prec 1%
R71	321-0111-00	140 Ω 1/8 w	Prec 1%
R73	315-0102-00	1 k 1/4 w	5%
R75†	311-0385-00	250 Ω	Var Ch 1 VARIABLE
R76	321-0114-00	150 Ω 1/8 w	Prec 1%
R77	316-0154-00	150 k 1/4 w	
R81	321-0055-00	36.5 Ω 1/8 w	Prec 1%
R82	315-0124-00	120 k 1/4 w	5%
R83	321-0207-00	1.4 k 1/8 w	Prec 1%
R84	315-0331-00	330 Ω 1/4 w	5%
R90	311-0169-00	100 Ω	Var Ch 1 GAIN
R91	321-0041-00	26.1 Ω 1/8 w	Prec 1%
R91	321-0017-00	14.7 Ω 1/8 w	Prec 1%
R92	321-0103-00	115 Ω 1/8 w	Prec 1%
R92	321-0121-00	178 Ω 1/8 w	Prec 1%
R93	321-0207-00	1.4 k 1/8 w	Prec 1%
R94	315-0331-00	330 Ω 1/4 w	5%
R103	317-0620-00	62 Ω 1/10 w	5%
R106C	322-0643-00	600 k 1/4 w	Prec 1%
R106E	322-0644-00	666.6 k 1/4 w	Prec 1%
R106F	315-0220-00	22 Ω 1/4 w	5%
R107C	322-0620-00	800 k 1/4 w	Prec 1%
R107E	321-0618-00	250 k 1/4 w	Prec 1%
R107F	315-0470-00	47 Ω 1/4 w	5%
R108C	322-0658-00	900 k 1/4 w	Prec 0.5%
R108E	Use 321-1289-01	111 k 1/8 w	Prec 0.5%
R108F	315-0560-00	56 Ω 1/4 w	5%
R109C	322-0659-00	990 k 1/4 w	Prec 0.5%
R109E	Use 321-1289-01	10.1 k 1/8 w	Prec 0.5%
R109F	315-0620-00	62 Ω 1/4 w	5%
R113	317-0220-00	22 Ω 1/10 w	5%
R115	317-0100-00	10 Ω 1/10 w	5%
R116	315-0102-00	1 k 1/4 w	5%
R117	322-0481-00	1 meg 1/4 w	Prec 1%
R118	315-0105-00	1 meg 1/4 w	5%
R119	315-0122-00	1.2 k 1/4 w	5%
R123	301-0102-00	1 k 1/2 w	5%
R124	321-0119-00	169 Ω 1/8 w	Prec 1%
R126	321-0081-00	68.1 Ω 1/8 w	Prec 1%
R130	311-0169-00	100 Ω	Var Ch 2 STEP ATTEN BAL
R131	321-0185-00	825 Ω 1/8 w	Prec 1%
R132	321-0133-00	237 Ω 1/8 w	Prec 1%
R133	321-0157-00	422 Ω 1/8 w	Prec 1%
R140	311-0546-00	10 k	Var Ch 2 POSITION
R141	321-0281-00	8.25 k 1/8 w	Prec 1%

†Furnished as a unit with SW75.

Parts List—Type 453

Resistors (Cont'd)

Ckt. No.	Tektronix Part No.	Description	S/N Range
R143A	321-0078-00	63.4 Ω	
R143C	311-0442-00	250 Ω	
R144A	321-0124-00	191 Ω	
R144C	315-0511-00	510 Ω	
R144C	315-0681-00	680 Ω	
R145A	321-0151-00	365 Ω	100-3659 3660-up
R145C	311-0462-00	1 k	
R147	321-0237-00	2.97 k	
R148	315-0100-00	10 Ω	
R149	321-0165-00	511 Ω	
R151	315-0151-00	150 Ω	
R152	321-0211-00	1.54 k	
R153	307-0106-00	4.7 Ω	
R155	311-0480-00	500 Ω	
R158	301-0122-00	1.2 k	
R159	315-0331-00	330 Ω	Ch 2 Position Center
R171	321-0111-00	140 Ω	
R173	315-0102-00	1 k	
R175†	311-0385-00	250 Ω	
R176	321-0114-00	150 Ω	
R177	316-0154-00	150 k	Ch 2 VARIABLE
R181	321-0055-00	36.5 Ω	
R182	315-0124-00	120 k	
R183	321-0207-00	1.4 k	
R186	315-0331-00	330 Ω	
R190	311-0169-00	100 Ω	Ch 2 GAIN
R191	321-0041-00	26.1 Ω	
R191	321-0017-00	14.7 Ω	
R192	321-0103-00	115 Ω	
R192	321-0121-00	178 Ω	
R193	321-0207-00	1.4 k	
R195	315-0473-00	47 k (nominal value)	
R196	315-0331-00	330 Ω	
R199	323-0175-00	649 Ω	
R211	315-0200-00	20 Ω	
R212	321-0175-00	649 Ω	
R213	321-0123-00	187 Ω	
R214	321-0193-00	1 k	
R215	321-0229-00	2.37 k	
R216	315-0332-00	3.3 k	
R217	321-0113-00	147 Ω	
R218	321-0125-00	196 Ω	
R221	315-0200-00	20 Ω	
R223	321-0175-00	649 Ω	
R224	321-0123-00	187 Ω	
R225	321-0193-00	1 k	
R227	321-0229-00	2.37 k	
R227	321-0113-00	147 Ω	

\*Furnished as a unit with SW175.



For Service Manuals Contact  
**MAURITRON TECHNICAL SERVICES**  
 8 Cherry Tree Rd, Chinnor  
 Oxon OX9 4QY  
 Tel: 01844-351694 Fax: 01844-352554  
 Email: enquiries@mauritron.co.uk

Parts List—Type 453

Resistors (Cont'd)

Ckt. No.	Tektronix Part No.		Description		S/N Range
R228	321-0125-00	196 Ω	1/8 w		
R231	315-0681-00	680 Ω	1/4 w	Prec	1%
R232	315-0153-00	15 k	1/4 w		5%
R234	321-0081-00	68.1 k	1/8 w	Prec	5%
R235	315-0102-00	1 k	1/4 w		1%
R241	315-0753-00	75 Ω	1/4 w		5%
R244	315-0392-00	3.9 k	1/4 w		5%
R245	315-0222-00	2.2 k	1/4 w		5%
R253	315-0102-00	1 k	1/4 w		5%
R260	321-0179-00	715 Ω	1/8 w	Prec	1%
R261	315-0363-00	36 k	1/4 w		5%
R262	321-0235-00	2.74 k	1/8 w	Prec	1%
R264	321-0267-00	5.9 k	1/8 w	Prec	1%
R265	321-0205-00	1.33 k	1/8 w	Prec	1%
R267	321-0164-00	499 Ω	1/8 w	Prec	1%
R268	321-0117-00	162 Ω	1/8 w	Prec	1%
R269	321-0117-00	162 Ω	1/8 w	Prec	1%
R270	321-0179-00	715 Ω	1/8 w	Prec	1%
R277	321-0164-00	499 Ω	1/8 w	Prec	1%
R278	321-0117-00	162 Ω	1/8 w	Prec	1%
R279	321-0117-00	162 Ω	1/8 w	Prec	1%
R284	321-0161-00	464 Ω	1/8 w	Prec	1%
R285	311-0480-00	500 Ω			
R286	321-0197-00	1.1 k	1/8 w	Var	Normal Trigger DC Level
R288	321-0087-00	78.7 Ω	1/8 w	Prec	1%
R289	315-0331-00	330 Ω	1/4 w		5%
R291	315-0221-00	220 Ω	1/4 w		5%
R292	323-0099-00	105 Ω	1/2 w	Prec	1%
R294	315-0752-00	7.5 k	1/4 w		5%
R295	315-0621-00	620 Ω	1/4 w		5%
R298	321-0087-00	78.7 Ω	1/8 w	Prec	1%
R299	315-0120-00	12 Ω	1/4 w		5%
R303	321-0091-00	86.6 Ω	1/8 w	Prec	1%
R304	322-0097-00	100 Ω	1/4 w	Prec	1%
R306	323-0054-00	35.7 Ω	1/2 w	Prec	1%
R313	321-0091-00	86.6 Ω	1/8 w	Prec	1%
R314	322-0097-00	100 Ω	1/4 w	Prec	1%
R321	323-0072-00	54.9 Ω	1/2 w	Prec	1%
R322	323-0060-00	41.2 Ω	1/2 w	Prec	1%
R323	322-0097-00	100 Ω	1/4 w	Prec	1%
R324	323-0181-00	750 Ω	1/2 w	Prec	1%
R325	322-0124-00	191 Ω	1/4 w	Prec	1%
R328	311-0480-00	500 Ω			
R330	315-0390-00	39 Ω	1/4 w	Var	Damping
R331	315-0332-00	3.3 k	1/4 w		5%

Parts List—Type 453

Resistors (Cont'd)

Ckt. No.	Tektronix Part No.		Description			S/N Range
R332	323-0175-00	649 $\Omega$	$\frac{1}{2}$ w	Prec	1%	
R333	322-0097-00	100 $\Omega$	$\frac{1}{4}$ w	Prec	1%	
R334	323-0181-00	750 $\Omega$	$\frac{1}{2}$ w	Prec	1%	
R339	323-0116-00	153 $\Omega$	$\frac{1}{2}$ w	Prec	1%	
R341	323-0079-00	64.9 $\Omega$	$\frac{1}{2}$ w	Prec	1%	
R342	321-0069-00	51.1 $\Omega$	$\frac{1}{8}$ w	Prec	1%	
R343	323-0138-00	267 $\Omega$	$\frac{1}{2}$ w	Prec	1%	
R344	301-0470-00	47 $\Omega$	$\frac{1}{2}$ w		5%	
R353	323-0138-00	267 $\Omega$	$\frac{1}{2}$ w	Prec	1%	
R354	301-0470-00	47 $\Omega$	$\frac{1}{2}$ w		5%	
R364	*310-0623-00	650 $\Omega$	4 w	WW	1%	
R365	316-0100-00	10 $\Omega$	$\frac{1}{4}$ w			
R374	*310-0623-00	650 $\Omega$	4 w	WW	1%	
R400	316-0154-00	150 k	$\frac{1}{4}$ w			
R401	316-0154-00	150 k	$\frac{1}{4}$ w			
R402	321-0097-00	100 $\Omega$	$\frac{1}{8}$ w	Prec	1%	
R403	321-0097-00	100 $\Omega$	$\frac{1}{8}$ w	Prec	1%	
R404	321-0097-00	100 $\Omega$	$\frac{1}{8}$ w	Prec	1%	
R405	316-0101-00	100 $\Omega$	$\frac{1}{4}$ w			
R406	321-0227-00	2.26 k	$\frac{1}{8}$ w	Prec	1%	
R407	321-0064-00	45.3 $\Omega$	$\frac{1}{8}$ w	Prec	1%	
R408	321-0077-00	61.9 $\Omega$	$\frac{1}{8}$ w	Prec	1%	
R409	321-0212-00	1.58 k	$\frac{1}{8}$ w	Prec	1%	
R411	316-0471-00	470 $\Omega$	$\frac{1}{4}$ w			
R412	308-0286-00	8.2 k	3 w	WW	5%	
R413	316-0101-00	100 $\Omega$	$\frac{1}{4}$ w			
R416	316-0101-00	100 $\Omega$	$\frac{1}{4}$ w			
R417	315-0471-00	470 $\Omega$	$\frac{1}{4}$ w		5%	
R419	321-0210-00	1.5 k	$\frac{1}{4}$ w	Prec	1%	
R421	315-0103-00	10 k	$\frac{1}{4}$ w		5%	
R422	316-0100-00	10 $\Omega$	$\frac{1}{4}$ w			
R424	315-0221-00	220 $\Omega$	$\frac{1}{4}$ w		5%	
R427	315-0910-00	91 $\Omega$	$\frac{1}{4}$ w		5%	
R429	315-0910-00	91 $\Omega$	$\frac{1}{4}$ w		5%	
R430	316-0100-00	10 $\Omega$	$\frac{1}{4}$ w		5%	
R433B	301-0914-00	910 k	$\frac{1}{2}$ w		5%	
R433C	301-0114-00	110 k	$\frac{1}{2}$ w		5%	
R435	315-0104-00	100 k	$\frac{1}{4}$ w		5%	
R436	315-0104-00	100 k	$\frac{1}{4}$ w		5%	
R438	301-0105-00	1 meg	$\frac{1}{2}$ w		5%	
R439	301-0105-00	1 meg	$\frac{1}{2}$ w		5%	
R444	316-0470-00	47 $\Omega$	$\frac{1}{4}$ w			
R446	302-0102-00	1 k	$\frac{1}{2}$ w			
R448	315-0392-00	3.9 k	$\frac{1}{4}$ w		5%	
R449	315-0472-00	4.7 k	$\frac{1}{4}$ w		5%	

Parts List—Type 453

Resistors (Cont'd)

Ckt. No.	Tektronix Part No.		Description		S/N Range
R453	315-0162-00	1.6 k	1/4 w		5%
R459	315-0820-00	82 Ω	1/4 w		5%
R460†	311-0553-00	10 k		Var	A Triggering LEVEL
R461	315-0122-00	1.2 k	1/4 w		5%
R462	311-0463-00	5 k		Var	A Trigger Level Centering
R463	315-0122-00	1.2 k	1/4 w		5%
R464	315-0391-00	390 Ω	1/4 w		5%
R467	315-0431-00	430 Ω	1/4 w		5%
R468	315-0510-00	51 Ω	1/4 w		5%
R469	315-0271-00	270 Ω	1/4 w		5%
R471	315-0472-00	4.7 k	1/4 w		5%
R472	316-0470-00	47 Ω	1/4 w		
R473	315-0243-00	24 k	1/4 w		5%
R474	315-0220-00	22 Ω	1/4 w		5%
R476	315-0201-00	200 Ω	1/4 w		5%
<p>For Service Manuals Contact  <b>MAURITRON TECHNICAL SERVICES</b>              8 Cherry Tree Rd, Chinnor              Oxon OX9 4QY              Tel:- 01844-351694 Fax:- 01844-352554              Email:- enquiries@mauritron.co.uk</p>					
R477	315-0392-00	3.9 k	1/4 w		5%
R481	316-0101-00	100 Ω	1/4 w		
R482	315-0270-00	27 Ω	1/4 w		5%
R483	301-0183-00	18 k	1/2 w		5%
R484	315-0273-00	27 k	1/4 w		5%
R485	315-0152-00	1.5 k	1/4 w		5%
R490	315-0271-00	270 Ω	1/4 w		5%
R491	315-0103-00	10 k	1/4 w		5%
R493	316-0470-00	47 Ω	1/4 w		
R494	315-0104-00	100 k	1/4 w		5%
R496	315-0272-00	2.7 k	1/4 w		5%
R497	315-0104-00	100 k	1/4 w		5%
R502	302-0101-00	100 Ω	1/2 w		
R503	315-0201-00	200 Ω	1/4 w		5%
R506	315-0391-00	390 Ω	1/4 w		5%
R508	315-0202-00	2 k	1/4 w		5%
R509	315-0102-00	1 k	1/4 w		5%
R509	315-0431-00	430 Ω	1/4 w		5%
R511	315-0620-00	62 Ω	1/4 w		5%
R512	316-0470-00	47 Ω	1/4 w		
R513	321-0143-00	301 Ω	1/8 w	Prec	1%
R514	315-0122-00	1.2 k	1/4 w		5%
R515	323-0301-00	13.3 k	1/2 w	Prec	1%
R517	315-0222-00	2.2 k	1/4 w		5%
R519	321-0277-00	7.5 k	1/8 w	Prec	1%
R521	321-0184-00	806 Ω	1/8 w	Prec	1%
R522	321-0234-00	2.67 k	1/8 w	Prec	1%
R523	316-0470-00	47 Ω	1/4 w		
R524	315-0122-00	1.2 k	1/4 w		5%
R526	Use 315-0103-00	10 k	1/4 w		5%
R527	315-0472-00	4.7 k	1/4 w		5%

†Furnished as a unit with R551.

Parts List—Type 453

Resistors (Cont'd)

Ckt. No.	Tektronix Part No.		Description		S/N Range
R529	315-0331-00	330 Ω	1/4 w		5%
R530A	323-0400-00	143 k	1/2 w	Prec	1%
R530B	323-0371-00	71.5 k	1/2 w	Prec	1%
R530C	323-0371-00	71.5 k	1/2 w	Prec	1%
R530D	323-0371-00	71.5 k	1/2 w	Prec	1%
R530E	315-0335-00	3.3 meg	1/4 w		5%
R530F	309-0095-00	10 meg	1/2 w	Prec	1%
R530G	309-0454-00	11.5 meg	1/2 w	Prec	1%
R530H	309-0453-00	7.15 meg	1/2 w	Prec	1%
R530J	309-0452-00	3.57 meg	1/2 w	Prec	1%
R530K	323-0712-00	1.43 meg	1/2 w	Prec	0.5%
R530L	323-0710-00	715 k	1/2 w	Prec	0.5%
R530M	323-0710-00	715 k	1/2 w	Prec	0.5%
R530N	323-0711-00	715 k	1/2 w	Prec	0.1%
R530W	316-0154-00	150 k	1/4 w		
R530X	315-0272-00	27 k	1/4 w		5%
R530Y†	311-0554-00	20 k		Var	A VARIABLE
R531	311-0462-00	1 k		Var	A Sweep Cal
R532	301-0221-00	220 Ω	1/2 w		5%
R533	316-0101-00	100 Ω	1/4 w		
R534	316-0101-00	100 Ω	1/4 w		5%
R535	315-0622-00	6.2 k	1/4 w		
R536	316-0101-00	100 Ω	1/4 w		5%
R537	315-0301-00	300 Ω	1/4 w		1%
R538	321-0259-00	4.87 k	1/8 w	Prec	
R539	308-0307-00	5 k	3 w	WW	1%
R544	303-0822-00	8.2 k	1 w		5%
R546	315-0152-00	1.5 k	1/2 w		5%
R546	315-0152-00	1.5 k	1/4 w		5%
R547	315-0191-00	190 Ω	1/4 w		5%
R551†	311-0553-00	10 k		Var	HF STAB
R552	323-0391-00	30.9 k	1/2 w		1%
R555	311-0547-00	10 k		Var	A SWEEP LENGTH
R555	323-0353-00	46.4 k	1/2 w	Prec	1%
R551	321-0268-00	6.04 k	1/8 w	Prec	1%
R562	321-0192-00	7.68 Ω	1/8 w	Prec	1%
R564	316-0473-00	47 k	1/4 w		5%
R566	315-0223-00	22 k	1/4 w		
R567	316-0472-00	47 k	1/4 w		
R568	316-0106-00	10 meg	1/4 w		
R569	302-0104-00	100 k	1/2 w		
R574	321-0248-00	3.74 k	1/8 w	Prec	1%
R575	321-0198-00	987 Ω	1/8 w	Prec	1%
R582	321-0202-00	1.24 k	1/8 w	Prec	1%
R583	321-0114-00	150 Ω	1/8 w	Prec	1%
R585	321-0327-00	24.9 k	1/8 w	Prec	1%

†Furnished as a unit with SW530Y.

‡Furnished as a unit with R460.



Parts List—Type 453

Resistors (Cont'd)

Ckt. No.	Tektronix Part No.		Description		S/N Range
R705	315-0391-00	390 Ω	1/4 w		5%
R708	315-0202-00	2 k	1/4 w		5%
R713	321-0184-00	806 Ω	1/8 w	Prec	1%
R714	315-0122-00	1.2 k	1/4 w		5%
R715	315-0620-00	62 Ω	1/4 w		5%
R717	321-0260-00	4.99 k	1/8 w	Prec	1%
R718	315-0333-00	33 k	1/4 w		5%
R719	315-0823-00	82 k	1/4 w		5%
R721	321-0184-00	806 Ω	1/8 w	Prec	1%
R722	321-0234-00	2.67 k	1/8 w	Prec	1%
R723	316-0470-00	47 Ω	1/4 w		
R724	315-0122-00	1.2 k	1/4 w		5%
R728	315-0331-00	330 Ω	1/4 w		5%
R731	315-0153-00	15 k	1/4 w		5%
R733	315-0471-00	470 Ω	1/4 w		5%
R734	316-0103-00	10 k	1/4 w		
R740A	323-0400-00	143 k	1/2 w	Prec	1%
R740B	323-0371-00	71.5 k	1/2 w	Prec	1%
R740C	323-0371-00	71.5 k	1/2 w	Prec	1%
R740D	323-0371-00	71.5 k	1/2 w	Prec	1%
R740E	315-0335-00	3.3 meg	1/4 w		5%
R740F	309-0095-00	10 meg	1/2 w	Prec	1%
R740G	309-0454-00	11.5 meg	1/2 w	Prec	1%
R740H	309-0453-00	7.15 meg	1/2 w	Prec	1%
R740J	309-0452-00	3.57 meg	1/2 w	Prec	1%
R740K	323-0712-00	1.43 meg	1/2 w	Prec	0.5%
R740L	323-0710-00	71.5 k	1/2 w	Prec	0.5%
R740M	323-0710-00	71.5 k	1/2 w	Prec	0.5%
R740N	323-0711-00	71.5 k	1/2 w	Prec	0.1%
R740P	315-0332-00	3.3 k	1/4 w		5%
R740X	315-0272-00	2.7 k	1/4 w		5%
R740Y-	311-0554-00	20 k		Var	(Time/Div) B VARIABLE
R741	311-0462-00	1 k		Var	B Sweep Cal
R743	316-0101-00	100 Ω	1/4 w		
R744	316-0101-00	100 Ω	1/4 w		
R745	315-0622-00	6.2 k	1/4 w		5%
R746	316-0470-00	47 Ω	1/4 w		
R748	321-0259-00	4.87 k	1/8 w	Prec	1%
R749	308-0307-00	5 k	3 w	WW	1%
R754	304-0103-00	10 k	1 w		
R755	315-0152-00	1.5 k	1/4 w		5%
R755	315-0162-00	1.6 k	1/4 w		5%
R756	315-0181-00	180 Ω	1/4 w		5%
R757	323-0299-00	12.7 k	1/2 w	Prec	1%
R758	311-0514-00	100 Ω		Var	WW Sweep Start
R759	323-0126-00	200 Ω	1/2 w	Prec	1%

\*Furnished as a unit with SW740Y.

For Service Manuals Contact  
 MAURITRON TECHNICAL SERVICES  
 8 Cherry Tree Rd, Chinnor  
 Oxon OX9 4QY

Parts List—Type 453

Tel: 01844-351694 Fax: 01844-352554  
 Email: enquiries@mauritron.co.uk

Resistors (Cont'd)

Ckt. No.	Tektronix Part No.	Description	S/N Range
R760	311-0386-00	2 k	
R761	316-0101-00	100 Ω	
R763	321-0153-00	383 Ω	
R764	323-0280-00	8.06 k	
R765	315-0750-00	75 Ω	
R766	321-0260-00	4.99 k	
R769	321-0245-00	3.48 k	
R771	316-0332-00	3.3 k	
R773	316-0681-00	1.2 k	
R774	316-0681-00	680 Ω	
R775	321-0207-00	1.4 k	
R776	321-0320-00	21 k	
R778	321-0333-00	28.7 k	
R782	321-0179-00	715 Ω	
R783	321-0198-00	1.13 k	
R784	321-0231-00	2.49 k	
R785	321-0226-00	2.21 k	
R786	315-0392-00	3.9 k	
R787	321-0248-00	3.74 k	
R789	316-0101-00	100 Ω	
R801	321-0286-00	9.31 k	
R802	321-0286-00	9.31 k	
R803	315-0510-00	51 Ω	
R804	315-0822-00	8.2 k	
R805A } R805B } R805A } R805B }	Use *050-0270-00		
	311-0542-01	10 k 50 k	
R806	315-0184-00	180 k	
R807	315-0822-00	8.2 k	
R808	315-0822-00	8.2 k	
R809	321-0231-00	2.49 k	
R812	321-0260-00	4.99 k	
R814	304-0103-00	10 k	
R821	315-0510-00	51 Ω	
R822	321-0263-00	5.36 k	
R824	304-0103-00	10 k	
R826	321-0231-00	2.49 k	
R828	315-0272-00	2.7 k	
R831	315-0153-00	15 k	
R833	323-0305-00	14.7 k	
R834	322-0216-00	1.74 k	
R835	311-0480-00	500 Ω	
R836	321-0210-00	1.5 k	
R841	315-0153-00	15 k	
R843	323-0305-00	14.7 k	
R844	322-0216-00	1.74 k	
R845	311-0433-00	100 Ω	
R846	321-0105-00	121 Ω	

Var WW DELAY-TIME MULTIPLIER  
 Prec 1%  
 Prec 1%  
 5%

Prec 1%  
 Prec 1%  
 Prec 1%  
 Prec 1%  
 Prec 1%  
 Prec 1%

Prec 1%  
 Prec 5%  
 Prec 1%  
 Prec 1%  
 Prec 1%

5%  
 5% X2500-up  
 (HORIZONTAL) POSITION  
 (POSITION) FINE 100-1889  
 (HORIZONTAL) POSITION  
 (POSITION) FINE 1890-up

5%  
 5%  
 5%  
 Prec 1%  
 Prec 1%  
 X2500-up

Prec 5%  
 Prec 1%  
 Prec 1%  
 Prec 5%

Prec 5%  
 Prec 1%  
 Prec 1%  
 Var Norm Gain  
 Prec 1%

Prec 5%  
 Prec 1%  
 Prec 1%  
 Var Mag Gain  
 Prec 1%

Parts List—Type 453

Resistors (Cont'd)

Ckt. No.	Tektronix Part No.		Description		S/N Range
R849	316-0154-00	150 k	1/4 w		
R854	315-0103-00	10 k	1/4 w		5%
R855	311-0541-00	20 k		Var	Mag Register
R856	315-0103-00	10 k	1/4 w		5%
R862	315-0473-00	47 k	1/4 w		5%
R863	316-0122-00	1.2 k	1/4 w		
R864	315-0681-00	680 Ω	1/4 w		5%
R872	315-0473-00	47 k	1/4 w		5%
R873	316-0122-00	1.2 k	1/4 w		
R874	315-0681-00	680 Ω	1/4 w		5%
R882	323-0322-00	22.1 k	1/2 w		Prec 1%
R884	308-0363-00	3 k	8 w		WW 5%
R886	305-0471-00	470 Ω	2 w		5%
R887	308-0092-00	4.5 k	5 w		WW 5%
R892	323-0322-00	22.1 k	1/2 w		Prec 1%
R894	308-0363-00	3 k	8 w		WW 5%
R900	311-0465-00	100 k		Var	High Voltage
R901	301-0435-00	4.3 meg	1/2 w		5%
R902	301-0125-00	1.2 meg	1/2 w		5%
R903	301-0305-00	3 meg	1/2 w		5%
R904	301-0305-00	3 meg	1/2 w		5%
R905	301-0305-00	3 meg	1/2 w		5%
R906	301-0305-00	3 meg	1/2 w		5%
R907	301-0305-00	3 meg	1/2 w		5%
R908	301-0305-00	3 meg	1/2 w		5%
R909	301-0305-00	3 meg	1/2 w		5%
R910	301-0305-00	3 meg	1/2 w		5%
R912	316-0103-00	10 k	1/4 w		
R913	316-0102-00	1 k	1/4 w		
R916	302-0101-00	100 Ω	1/2 w		
R917	316-0104-00	100 k	1/4 w		
R925	301-0133-00	13 k	1/2 w		5%
R940	311-0549-00	1 meg		Var	Crt Grid Bias
R941	315-0154-00	150 k	1/4 w		5%
R942	315-0153-00	15 k	1/4 w		5%
R944	301-0565-00	5.6 meg	1/2 w		5%
R945	301-0565-00	5.6 meg	1/2 w		5%
R946	301-0565-00	5.6 meg	1/2 w		5%
R947	301-0565-00	5.6 meg	1/2 w		5%
R948	301-0565-00	5.6 meg	1/2 w		5%
R951	Use 307-0063-00	9.1 Ω	1/2 w		5%
R956	316-0103-00	10 k	1/4 w		
R961	316-0105-00	1 meg	1/4 w		
R962	316-0105-00	1 meg	1/4 w		
R963	301-0365-00	3.6 meg	1/2 w		5%



## Resistors (Cont'd)

Ckt. No.	Tektronix Part No.	Description			S/N Range
R964	301-0365-00	3.6 meg	1/2 w		5%
R965	301-0365-00	3.6 meg	1/2 w		5%
R966	301-0335-00	3.3 meg	1/2 w		5%
R967	311-0254-00	5 meg		Var	FOCUS
R968	302-0474-00	470 k	1/2 w		
R971	316-0223-00	22 k	1/4 w		100-1809
R971	315-0332-00	3.3 k	1/4 w		5% 1810-up
R972	316-0473-00	47 k	1/4 w		100-1809
R972	301-0682-00	6.8 k	1/2 w		5% 1810-up
R975	316-0223-00	22 k	1/4 w		
R976	316-0101-00	100 Ω	1/4 w		
R979	315-0471-00	470 Ω	1/4 w		5%
R980	311-0458-00	5 k		Var	WW TRACE ROTATION
R982	316-0465-00	100 k		Var	Geometry
R985	311-0157-00	100 k		Var	ASTIG
R989	311-0458-00	5 k		Var	WW Y Axis Align
R1003	316-0123-00	12 k	1/4 w		
R1004	316-0470-00	47 Ω	1/4 w		
R1005	311-0511-00	10 k		Var	INTENSITY
R1006	301-0202-00	2 k	1/2 w		5%
R1008	321-0242-00	3.24 k	1/8 w		Prec 1%
R1011	316-0470-00	47 Ω	1/4 w		
R1012	302-0473-00	47 k	1/2 w		
R1013	321-0213-00	1.62 k	1/8 w		Prec 1%
R1014	323-0318-00	20 k	1/2 w		Prec 1%
R1019	315-0753-00	75 k	1/4 w		5%
R1023	316-0102-00	1 k	1/4 w		
R1024	316-0332-00	3.3 k	1/4 w		
R1033	315-0680-00	68 Ω	1/4 w		5%
R1034	*310-0624-00	3.3 k	8 w		WW 5%
R1036	323-0335-00	30.1 k	1/2 w		Prec 1%
R1041	316-0470-00	47 Ω	1/4 w		
R1043	305-0302-00	3 k	2 w		5%
R1044	316-0101-00	100 Ω	1/4 w		
R1047	306-0822-00	8.2 k	2 w		
R1048	316-0101-00	100 Ω	1/4 w		
R1051	316-0100-00	10 Ω	1/4 w		
R1052	316-0100-00	10 Ω	1/4 w		
R1104	316-0153-00	15 k	1/4 w		
R1105	316-0472-00	4.7 k	1/4 w		
R1106	316-0102-00	1 k	1/4 w		
R1107	316-0330-00	33 Ω	1/4 w		
R1108	311-0548-00	25 Ω		Var	WW SCALE ILLUM
R1112	316-0103-00	10 k	1/4 w		
R1114	323-0154-00	392 Ω	1/2 w		Prec 1%
R1117	301-0273-00	27 k	1/2 w		5%
R1119	315-0561-00	560 Ω	1/4 w		5%

Parts List—Type 453

Resistors (Cont'd)

Ckt. No.	Tektronix Part No.		Description		S/N Range
R1121	323-0212-00	1.58 k	1/2 w		Prec 1%
R1122	311-0515-00	250 Ω		Var	WW -12 Volts
R1123	323-0160-00	453 Ω	1/2 w		Prec 1%
R1129	308-0244-00	0.3 Ω	2 w		WW
R1133	316-0121-00	120 Ω	1/4 w		
R1137	308-0362-00	50 Ω	10 w		WW 5%
R1142	316-0103-00	10 k	1/4 w		
R1151	323-0210-00	1.5 k	1/2 w		Prec 1%
R1152	311-0514-00	100 Ω		Var	WW +12 Volts
R1153	323-0205-00	1.33 k	1/2 w		Prec 1%
R1154	323-0373-00	75 k	1/2 w		Prec 1%
R1156	301-0243-00	24 k	1/2 w		5%
R1159	308-0244-00	0.3 Ω	2 w		WW
R1163	316-0121-00	120 Ω	1/4 w		
R1164	316-0123-00	12 k	1/4 w		
R1167	308-0362-00	50 Ω	10 w		WW 5%
R1172	316-0104-00	100 k	1/4 w		
R1181	323-0308-00	15.8 k	1/2 w		Prec 1%
R1182	311-0515-00	250 Ω		Var	WW +75 Volts
R1183	323-0222-00	2 k	1/2 w		Prec 1%
R1184	323-0373-00	75 k	1/2 w		Prec 1%
R1185	316-0103-00	10 k	1/4 w		
R1186	315-0333-00	33 k	1/4 w		5%
R1187	307-0093-00	1.2 Ω	1/2 w		5%
R1188	316-0470-00	47 Ω	1/4 w		
R1189	315-0683-00	68 k	1/4 w		5%
R1191	308-0153-00	100 Ω	10 w		WW 5%
R1193	316-0121-00	120 Ω	1/4 w		
R1194	316-0823-00	82 k	1/4 w		
R1197	308-0153-00	100 Ω	10 w		WW 5%
R1202	316-0104-00	100 k	1/4 w		
R1204	302-0270-00	27 Ω	1/2 w		
R1209	301-0123-00	12 k	1/2 w		5%
R1251	307-0106-00	47 Ω	1/4 w		5%
R1254	316-0471-00	470 Ω	1/4 w		
R1255	315-0472-00	47 k	1/4 w		5%
R1264	316-0222-00	2.2 k	1/4 w		
R1265	315-0682-00	6.8 k	1/4 w		5%
R1266	316-0471-00	470 Ω	1/4 w		
R1274	321-0649-00	2.19 k	1/8 w		Prec 0.25%
R1275	322-0655-00	180 Ω	1/4 w		Prec 0.25%
R1276	321-0702-00	30 Ω	1/8 w		Prec 0.25%
R1277	321-0704-00	60 Ω	1/8 w		Prec 0.5%

Switches

Ckt. No.	Tektronix Part No.		Description	S/N Range
	Unwired	Wired		
SW1	260-0621-00		Lever	AC GND DC
SW5	260-0720-00	*262-0728-00	Rotary	CH 1 VOLTS/DIV
SW75†	311-0385-00			Ch 1 CAL
SW101	260-0621-00		Lever	AC GND DC
SW105	260-0720-00	*262-0728-00	Rotary	CH 2 VOLTS/DIV
SW175††	311-0385-00			Ch 2 CAL
SW195	260-0447-00		Slide	INVERT
SW230A } SW230B }	260-0695-00	*262-0727-00	Rotary	MODE
SW330	260-0688-00		Push	TRIGGER
SW430 } SW435 } SW455 } SW530A,B } SW530Y†††	260-0698-00	*262-0723-00	Lever	A SOURCE
	260-0700-00		Lever	A COUPLING
	260-0472-00		Lever	A SLOPE
	260-0694-00	*262-0724-00	Rotary	A AND B TIME/DIV
	311-0554-00			A VARIABLE CAL
SW555	260-0697-00	*262-0726-00	Rotary	A SWEEP LENGTH
SW569††††	260-0717-00		Push	RESET
SW580	260-0699-00		Lever	A SWEEP MODE
SW610 } SW615 }	260-0698-00	*262-0723-00	Lever	3 SOURCE
	260-0700-00		Lever	3 COUPLING
SW635	260-0587-00		Lever	B SWEEP MODE
SW655	260-0472-00		Lever	B SLOPE
SW740Y†††††	311-0554-00			B VARIABLE CAL
SW801A } SW801B }	260-0696-00	use *050-0296-00	Rotary	HORIZ DISPLAY
				MAG
				100-2499
SW801A } SW801B }	260-0696-00	*262-0725-01	Rotary	HORIZ DISPLAY
				MAG
SW1101	260-0716-00		Toggle	POWER
SW1102	260-0715-00		Toggle	115 V-230 V SELECTOR
SW1103	260-0642-00		Toggle	LINE VOLTAGE RANGE
SW1275	260-0447-00		Slide	CALIBRATOR
TK1101	260-0724-00			Thermal Cut-Out 182° F

Test Points

TP34	*214-0579-00	Pin, Test Point
TP54	*214-0579-00	Pin, Test Point
TP134	*214-0579-00	Pin, Test Point
TP154	*214-0579-00	Pin, Test Point
TP199	*214-0579-00	Pin, Test Point

†Ganged with R75. Furnished as a unit.

††Ganged with R175. Furnished as a unit.

†††Furnished as a unit with R530Y.

††††Furnished as a unit with B597.

†††††Furnished as a unit with R740Y.

For Service Manuals Contact  
**MAURITRON TECHNICAL SERVICES**  
 8 Cherry Tree Rd, Chinnor  
 Oxon OX9 4QY  
 Tel:- 01844-351694 Fax:- 01844-352554  
 Email:- enquiries@mauritron.co.uk

Parts List—Type 453

Test Points (Cont'd)

Ckt. No.	Tektronix Part No.	Description	S/N Range
TP215	*214-0579-00	Pin, Test Point	
TP225	*214-0579-00	Pin, Test Point	
TP284	*214-0579-00	Pin, Test Point	
TP294	*214-0579-00	Pin, Test Point	
TP443	*214-0579-00	Pin, Test Point	
TP464	*214-0579-00	Pin, Test Point	
TP475	*214-0579-00	Pin, Test Point	
TP485	*214-0579-00	Pin, Test Point	
TP499	*214-0579-00	Pin, Test Point	
TP504	*214-0579-00	Pin, Test Point	
TP505	*214-0579-00	Pin, Test Point	
TP514	*214-0579-00	Pin, Test Point	
TP585	*214-0579-00	Pin, Test Point	
TP664	*214-0579-00	Pin, Test Point	
TP675	*214-0579-00	Pin, Test Point	
TP704	*214-0579-00	Pin, Test Point	
TP705	*214-0579-00	Pin, Test Point	
TP714	*214-0579-00	Pin, Test Point	
TP774	*214-0579-00	Pin, Test Point	
TP775	*214-0579-00	Pin, Test Point	
TP914	*214-0579-00	Pin, Test Point	
TP1014	*214-0579-00	Pin, Test Point	
TP1043	*214-0579-00	Pin, Test Point	
TP1047	*214-0579-00	Pin, Test Point	

For Service Manuals Contact  
**MAURITRON TECHNICAL SERVICES**  
 8 Cherry Tree Rd, Chinnor  
 Oxon OX9 4QY  
 Tel:- 01844-351694 Fax:- 01844-352554  
 Email:- enquiries@mauritron.co.uk

Transformers

T195	Use 276-0517-00	Core, Powder Iron (1 ea.)	100-2499 2500-up
T195	276-0517-00	Core, Powder Iron (2 ea.)	
T241	*120-0384-00	Toroid 10T-5T	
T357	Use 276-0517-00	Core, Powder Iron	
T474	*120-0361-00	Toroid 9T Bifilar	
T666	*120-0361-00	Toroid 9T Bifilar	
T930	*120-0360-00	H.V. Power	
T1101	*120-0359-00	L.V. Power	
T1255	*120-0381-00	Calibrator Frequency	

Electron Tubes

V23	*157-0107-00	8393	checked
V123	*157-0107-00	8393	checked
V443	154-0461-00	8393	
V533	154-0461-00	8393	
V633	154-0461-00	8393	
V743	154-0461-00	8393	
V952	154-0051-00	5642	
V962	154-0051-00	5642	
V979	*154-0492-04	T4530-31-1	Crt Standard Phosphor

TYPE 453      TENT SN 5230

PARTS LIST CORRECTION

CHANGE TO:

R951	321-0027-00	18.7 $\Omega$	1/8 W	1%
------	-------------	---------------	-------	----

ADD:

R950*	321-0027-00	18.7 $\Omega$	1/8 W	1%
-------	-------------	---------------	-------	----

\*R950 added in parallel with R951.

For Service Manuals Contact  
MAURITRON TECHNICAL SERVICES  
8 Cherry Tree Rd, Chinnor  
Oxon OX9 4QY  
Tel:- 01844-351694 Fax:- 01844-352554  
Email:- enquires@mauritron.co.uk

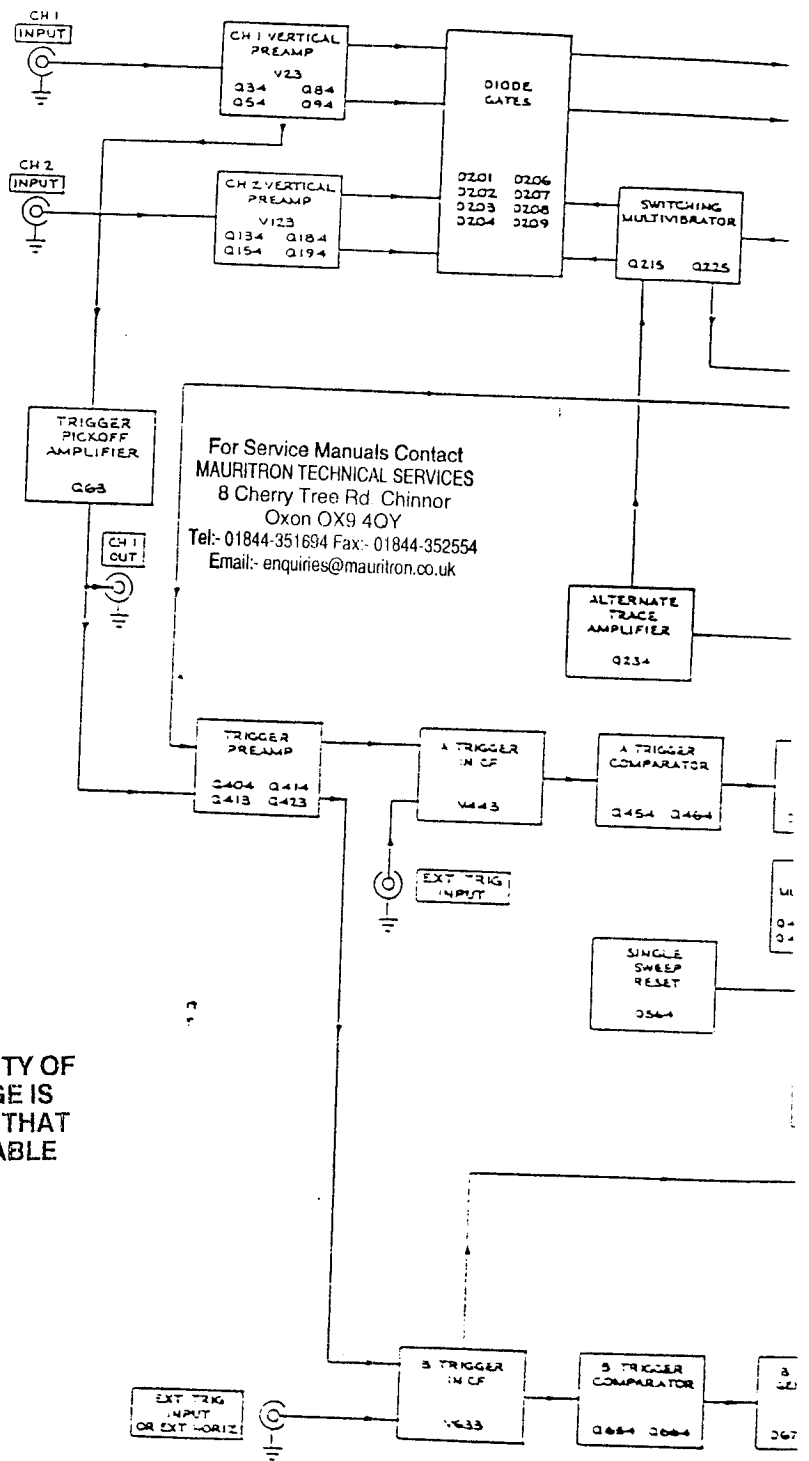

THE QUALITY OF  
THIS PAGE IS  
THE BEST THAT  
IS AVAILABLE

TYPE 453 OSCILLOSCOPE

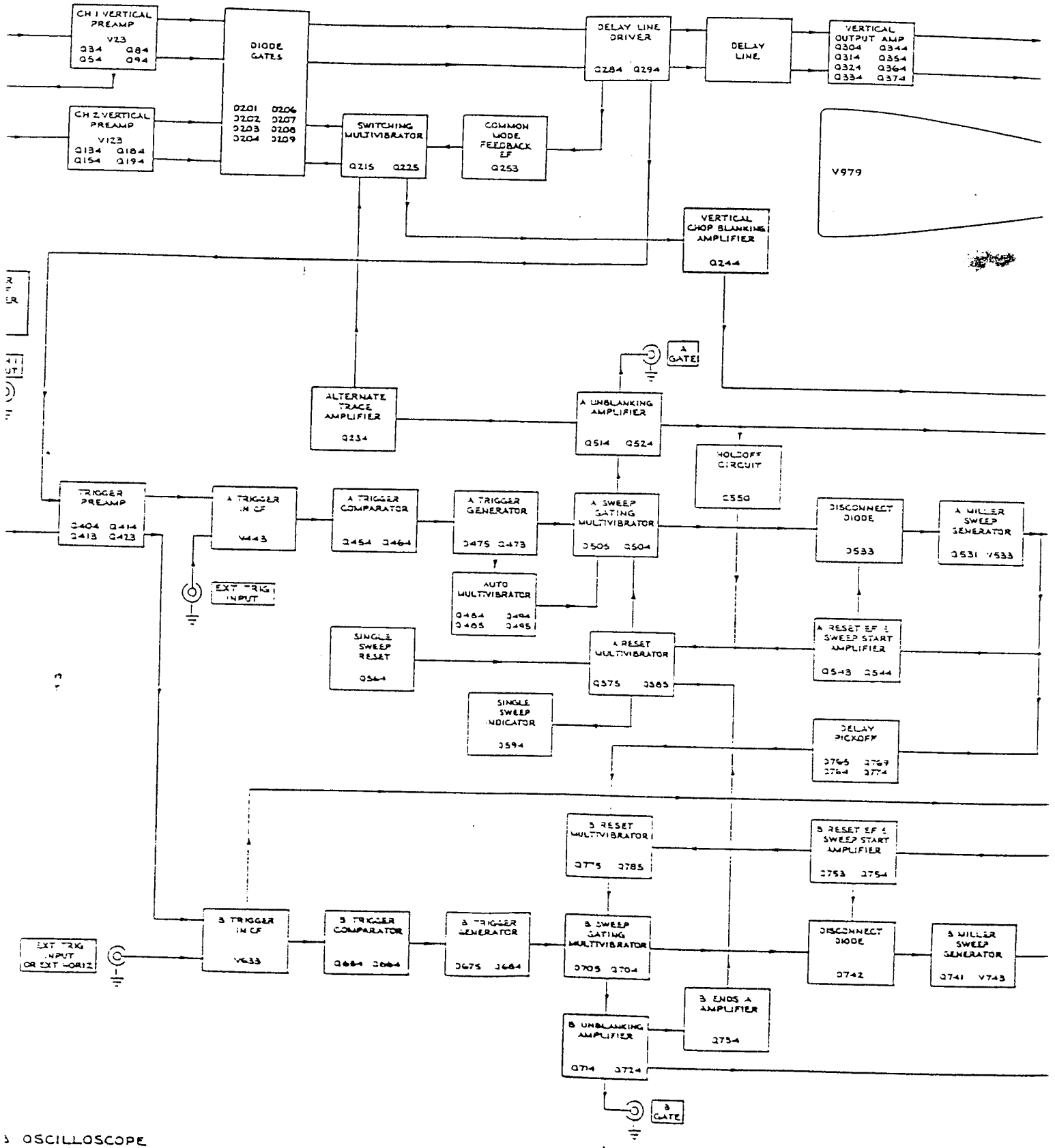

OSCILLOSCOPE

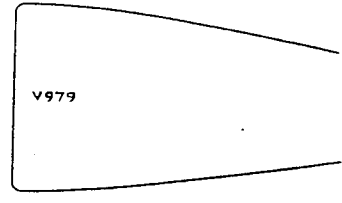

TRIGGER

10

A

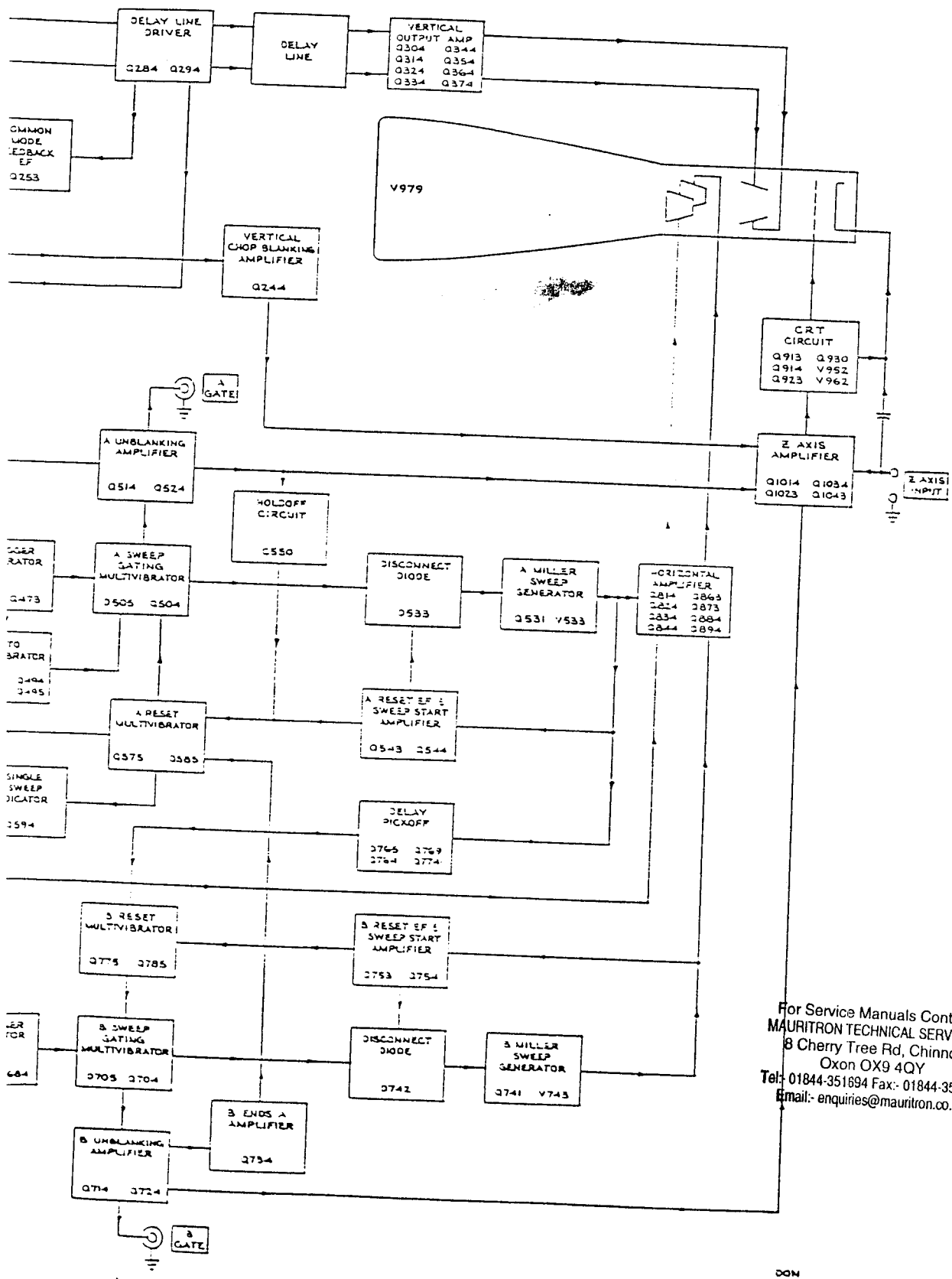

For Service Manuals Contact  
**MAURITRON TECHNICAL SERVICES**  
 8 Cherry Tree Rd, Chinnor  
 Oxon OX9 4QY  
 Tel: 01844-351694 Fax: 01844-352554  
 Email: enquiries@mauritron.co.uk

DOM  
 568  
**BLOCK DIAGRAM**



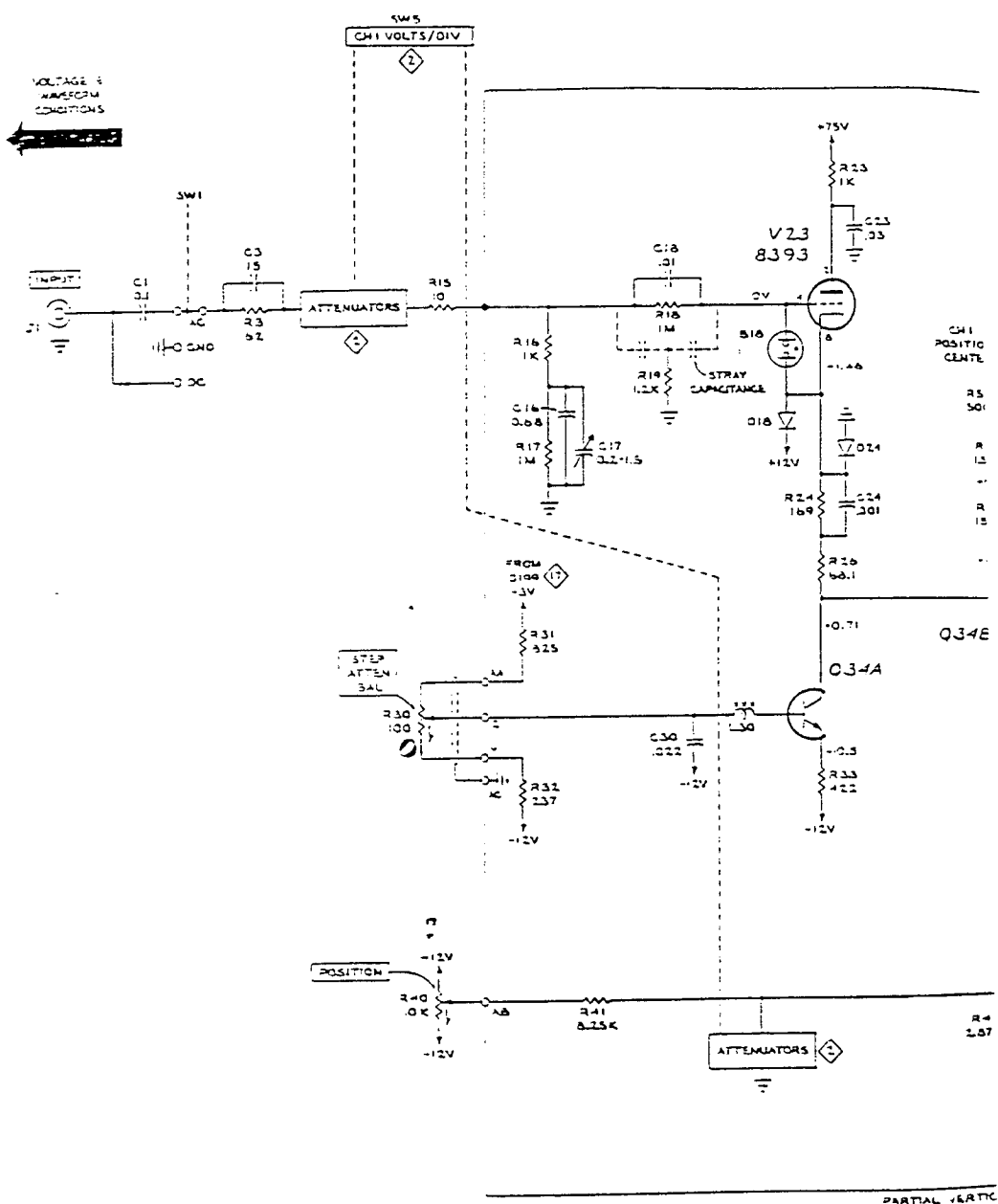

VOLTAGE & WAVEFORM CONDITIONS

REFERENCE DIAGRAM

- ① CH1 ATTENUATORS
- ② CH2 VERTICAL PREAMP
- ③ VERTICAL SWITCHING
- ④ TRIGGER PREAMP
- ⑤ POWER SUPPLY & DISTRIBUTION

SAA PARTS LIST FOR SEMICONDUCTOR TYPES

FOR DECOUPLING NETWORKS & VOLTAGE DISTRIBUTION SAA

VOLTAGES INDICATED ARE FOR THE TEST POINTS OF THIS DIAGRAM.

TYPE 453 OSCILLOSCOPE

For Service Manuals Contact  
**MAURITRON TECHNICAL SERVICES**  
 8 Cherry Tree Rd, Chinnor  
 Oxon OX9 4QY  
 Tel:- 01844-351694 Fax:- 01844-352554  
 Email:- enquiries@mauritron.co.uk

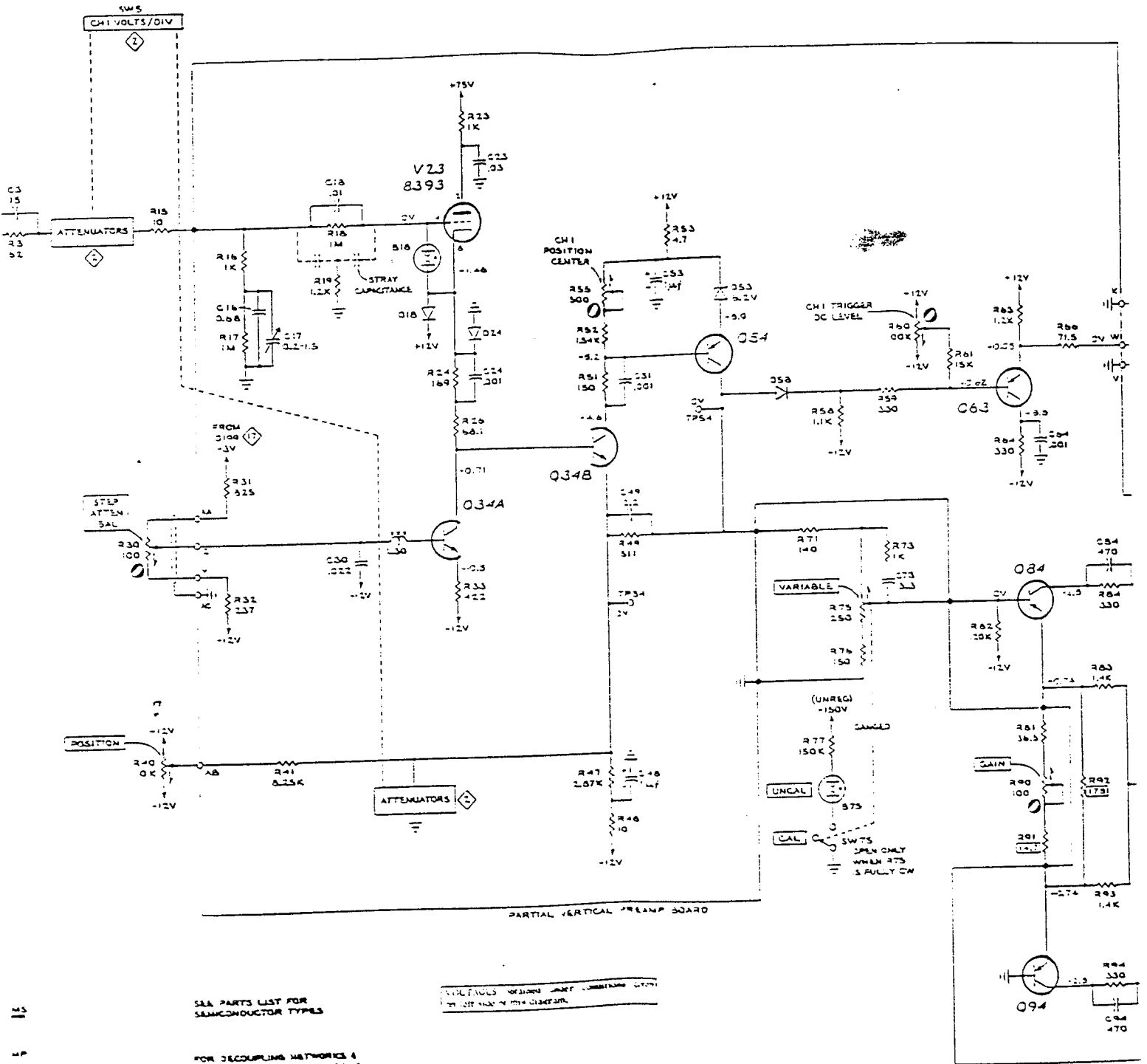

PARTIAL VERTICAL PREAMP BOARD

SEE PARTS LIST FOR SEMICONDUCTOR TYPES

RESISTORS UNLESS OTHERWISE SPECIFIED ARE 1% TOLERANCE

FOR DECOUPLING NETWORKS & VOLTAGE DISTRIBUTION SEE

MS  
MP  
G

DISTRIBUTION

OSCILLOSCOPE

CH1 VERT

THE QUALITY OF  
THIS PAGE IS  
THE BEST THAT  
IS AVAILABLE

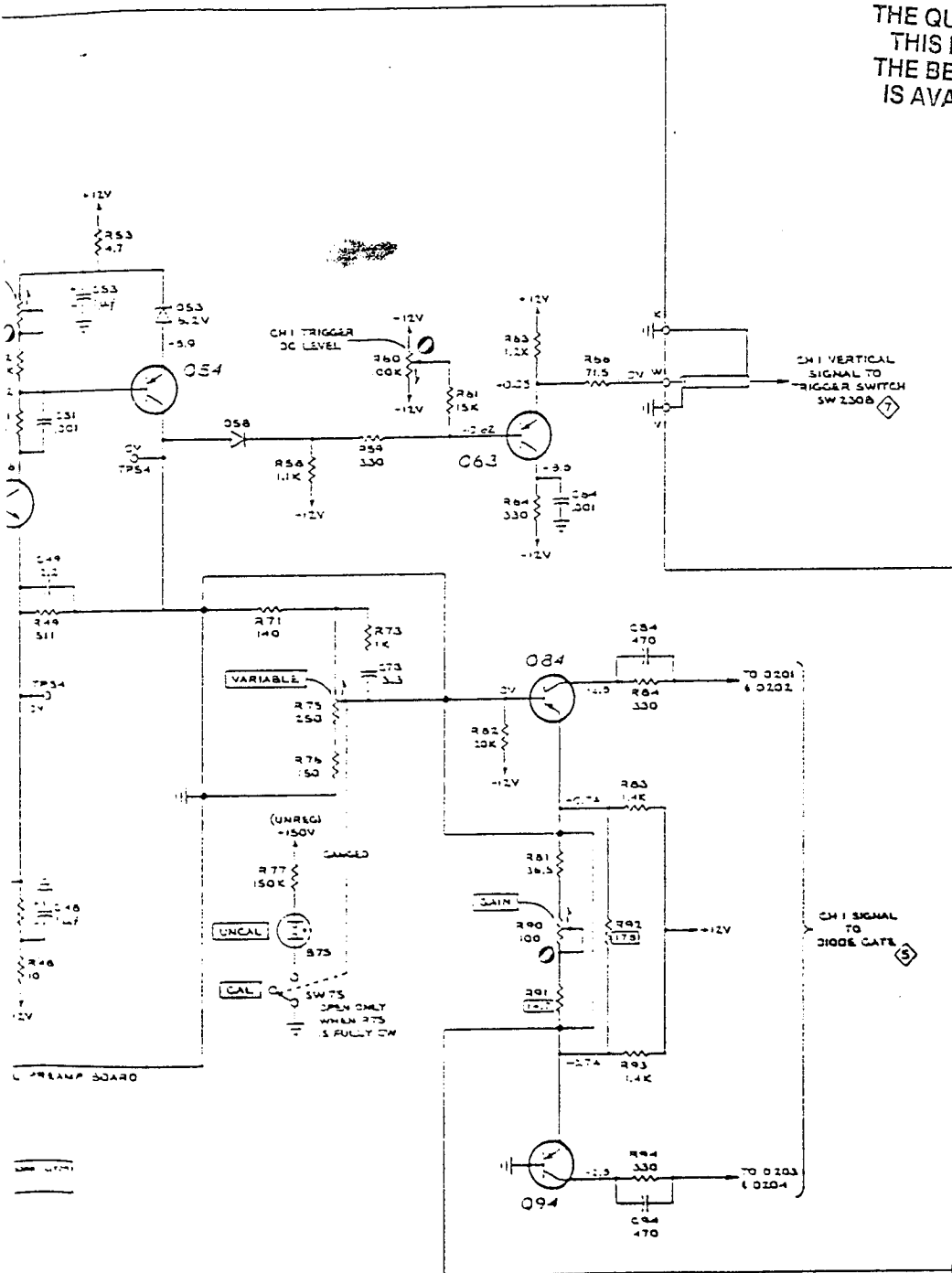

CH 1 VERTICAL PREAMP

ector.  
n  
ted  
ard.  
hed-  
ents  
ndi-

For Service Manuals Contact  
MAURITRON TECHNICAL SERVICES  
8 Cherry Tree Rd, Chinnor  
Oxon OX9 4QY  
Tel:- 01844-351694 Fax:- 01844-352554  
Email:- enquiries@mauritron.co.uk

CH 1 VERTICAL PREAMP

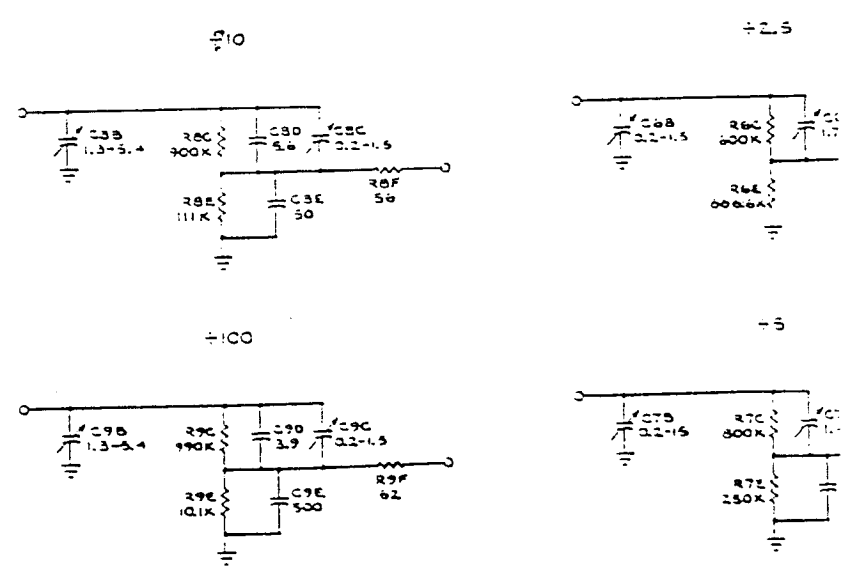
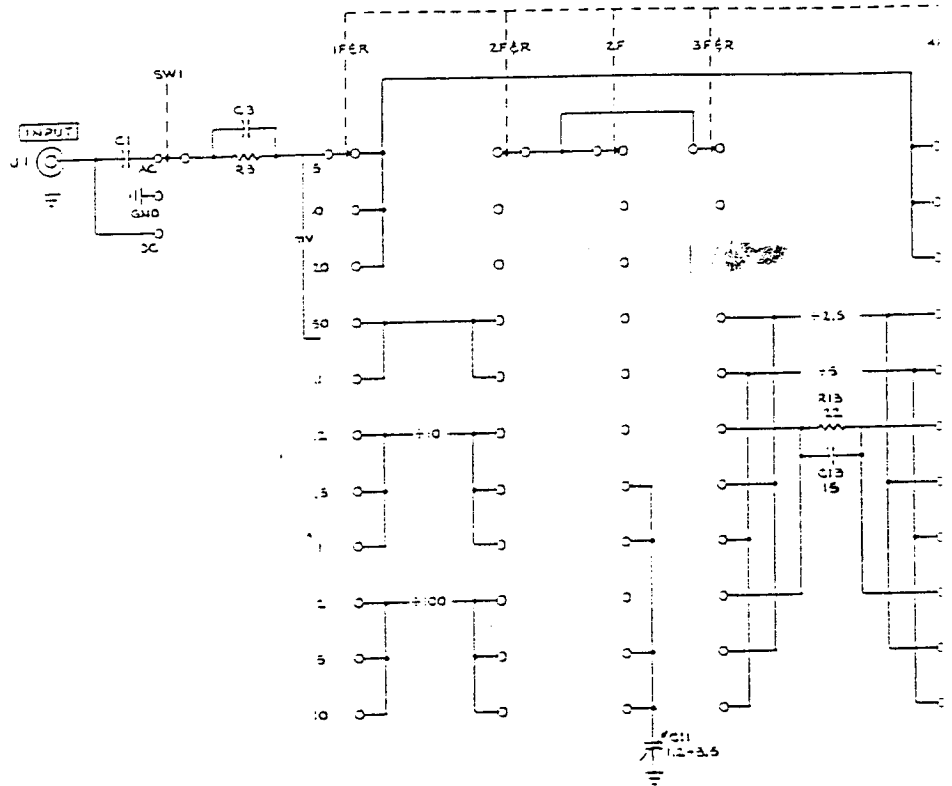

TYPE 453 OSCILLOSCOPE

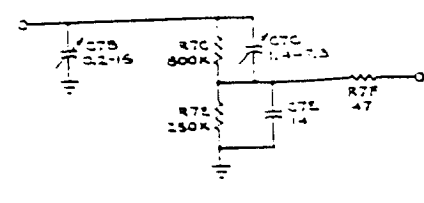
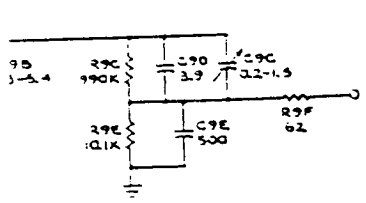
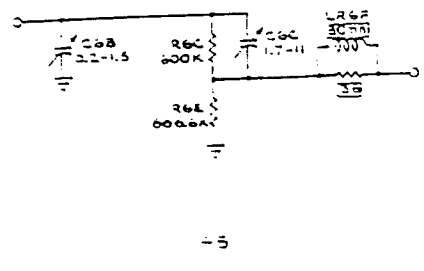
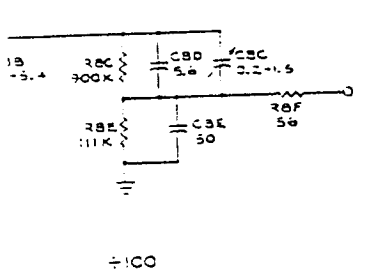
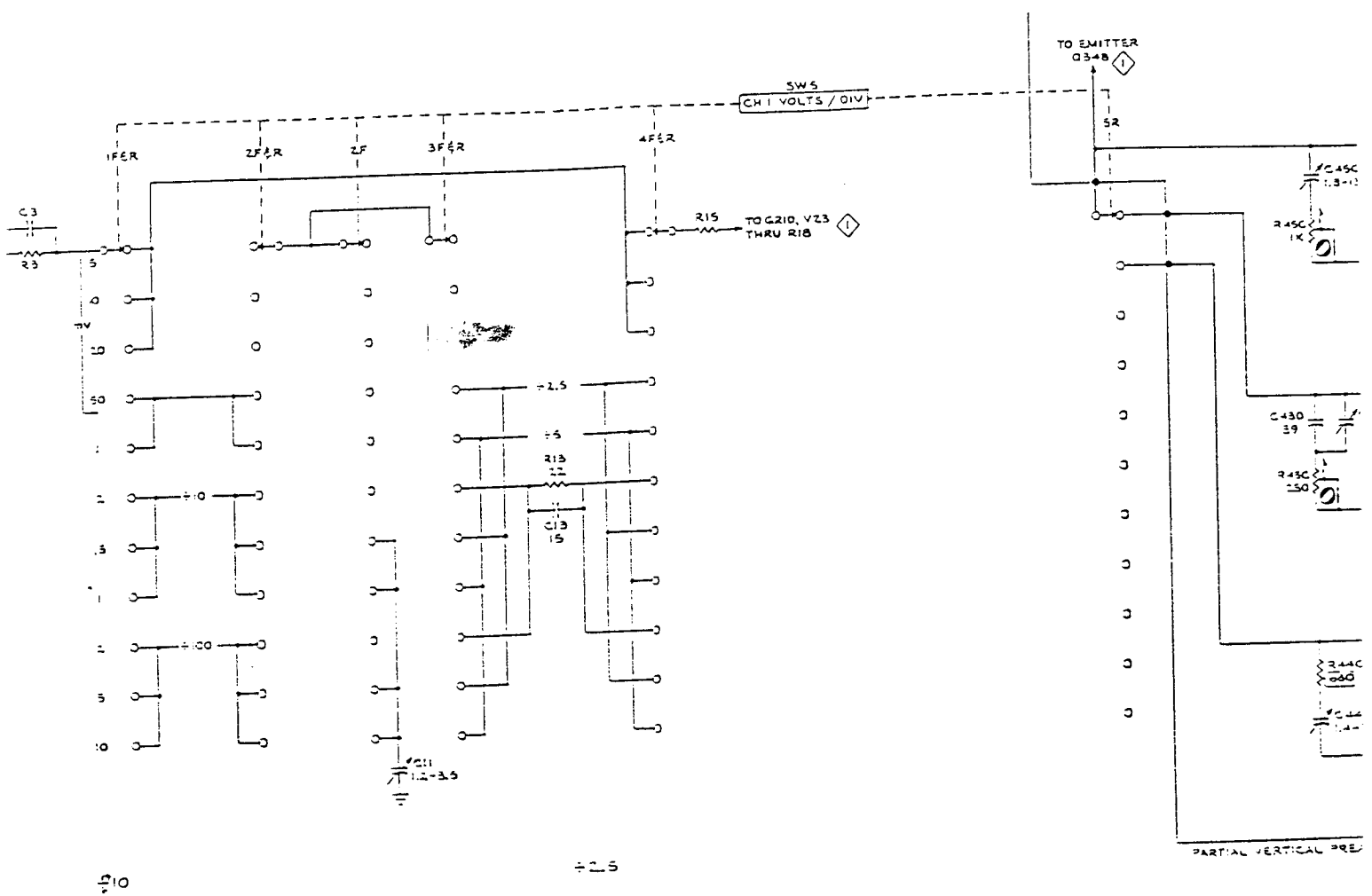

REFERENCE DIAGRAMS  
 CH1 VERTICAL PREAMP

SEE PARTS LIST FOR EARLIER VALUES AND SERIAL NUMBER RANGES OF PARTS MARKED WITH BLUE OUTLINE.

For Service Manuals Contact  
 MAURITRON TECHNICAL SERVICES  
 8 Cherry Tree Rd, Chinnor  
 Oxon OX9 4QY  
 Tel:- 01844-351694 Fax:- 01844-352554  
 Email:- enquiries@mauritron.co.uk

OSCILLOSCOPE

CH

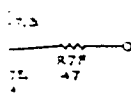
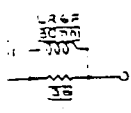
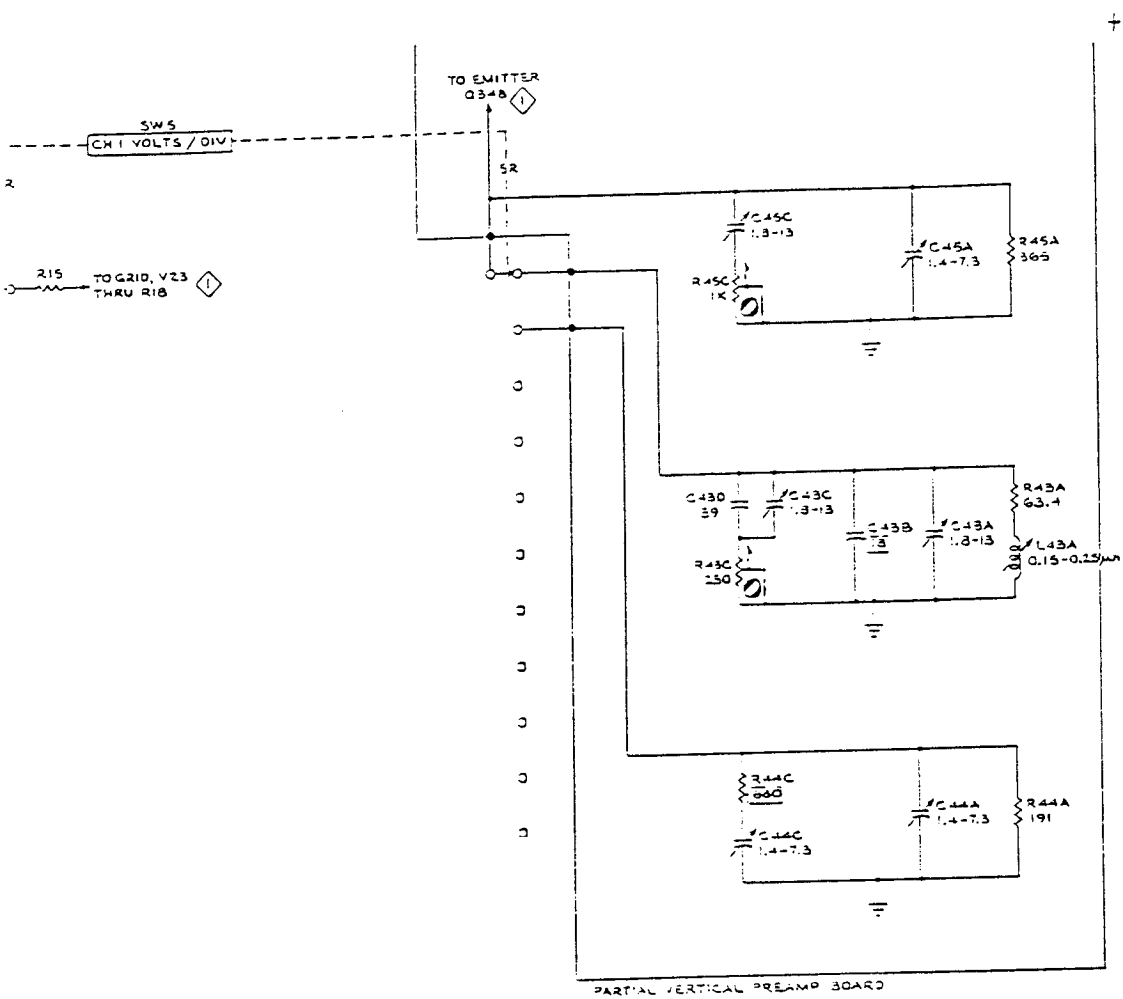

SEE PARTS LIST FOR EXACT VALUES AND LEGAL NUMBER RANGES OF PARTS MARKED WITH BLUE OUTLINE.

REFERENCE DIAGRAMS  
 CH 1 VERTICAL PREAMP

THE QUALITY OF THIS PAGE IS THE BEST THAT IS AVAILABLE

CH 1 ATTENUATORS 2

CH 1 ATTENUATORS

2

DOM  
366

c

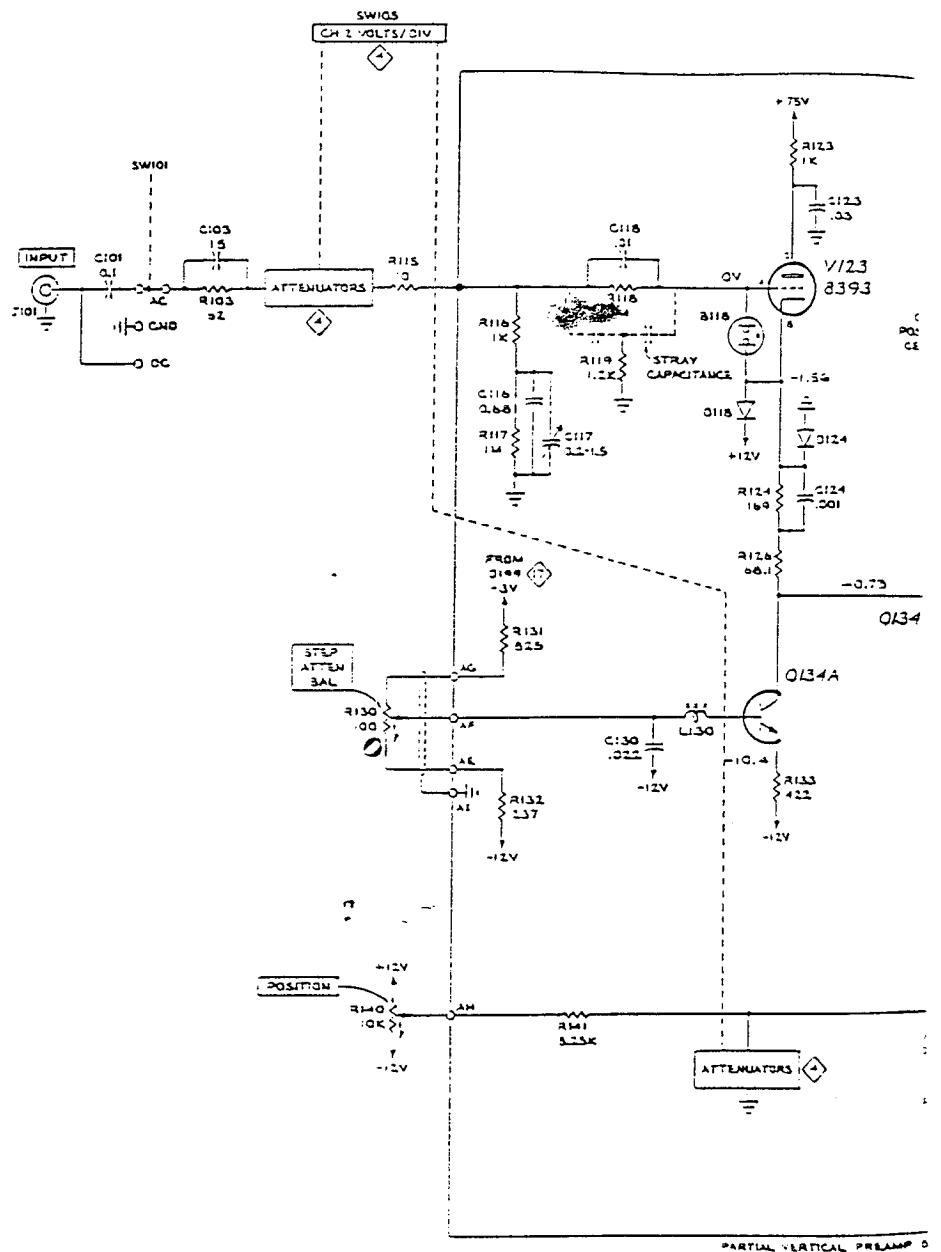

REFERENCE DIAGRAM

- ◇ CH 1 VERTICAL PREAMP
- ◇ CH 2 ATTENUATORS
- ◇ VERTICAL SWITCHING
- ◇ POWER SUPPLY & DISTRIBUTION

SEE PARTS LIST FOR SEMICONDUCTOR TYPES

FOR DECOUPLING NETWORKS & VOLTAGE DISTRIBUTION SEE ◇

+ TYPE 453 OSCILLOSCOPE

For Service Manuals Contact  
 MAURITRON TECHNICAL SERVICES  
 8 Cherry Tree Rd, Chinnor  
 Oxon OX9 4QY  
 Tel: 01844-351654 Fax: 01844-352554  
 Email: enquiries@mauritron.co.uk

THE  
TR  
THIS

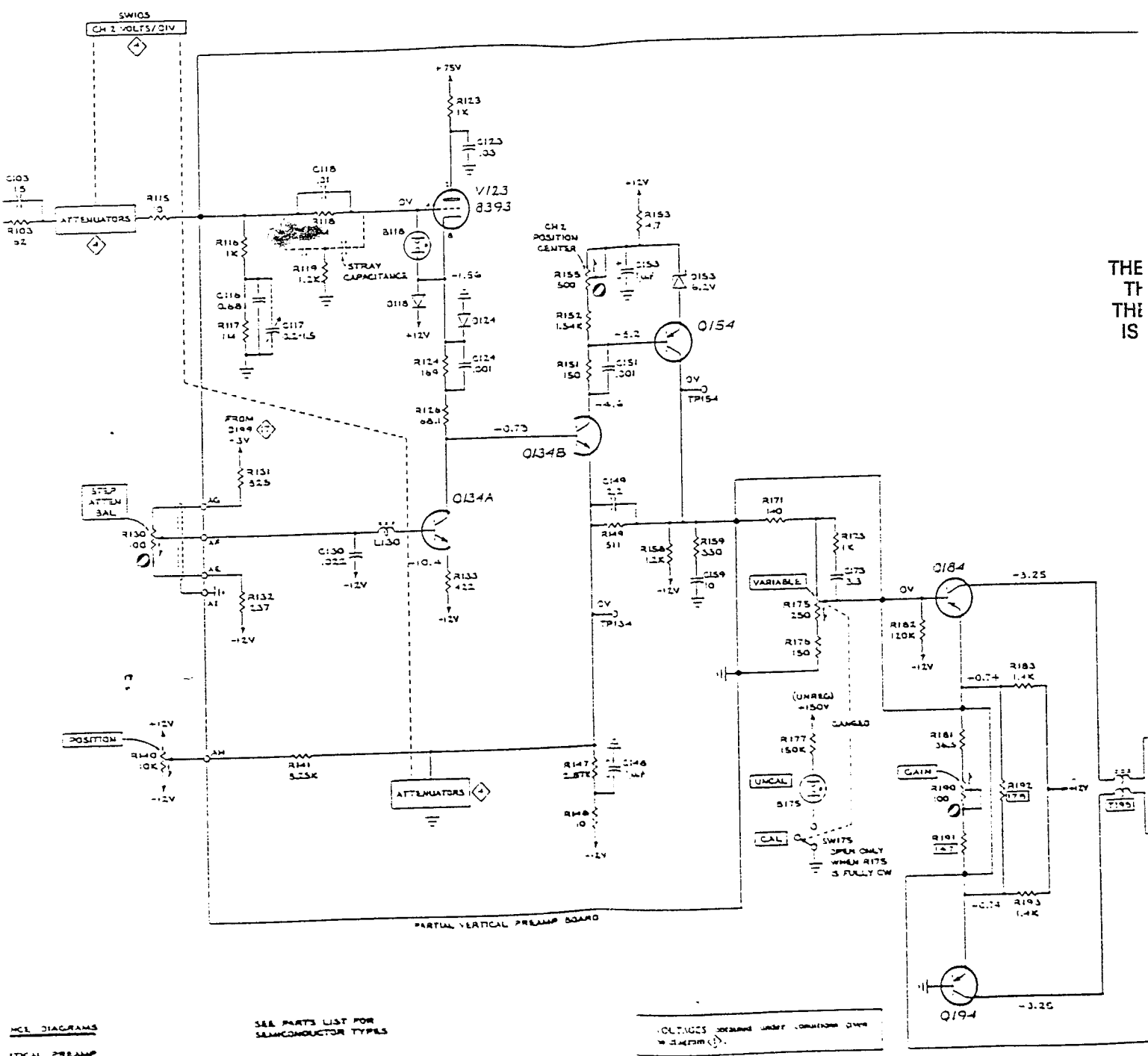

SEE DIAGRAMS  
VERTICAL PREAMP  
ATTENUATORS  
TUBE SWITCHING  
SUPPLY & DISTRIBUTION

SEE PARTS LIST FOR  
SEMICONDUCTOR TYPES

FOR DECOUPLING NETWORKS &  
VOLTAGE DISTRIBUTION SEE

VOLTAGES INDICATED UNDER COMPONENTS UNLESS  
OTHERWISE SPECIFIED

OSCILLOSCOPE

CH 2 V



+

THE QUALITY OF  
THIS PAGE IS  
THE BEST THAT  
IS AVAILABLE

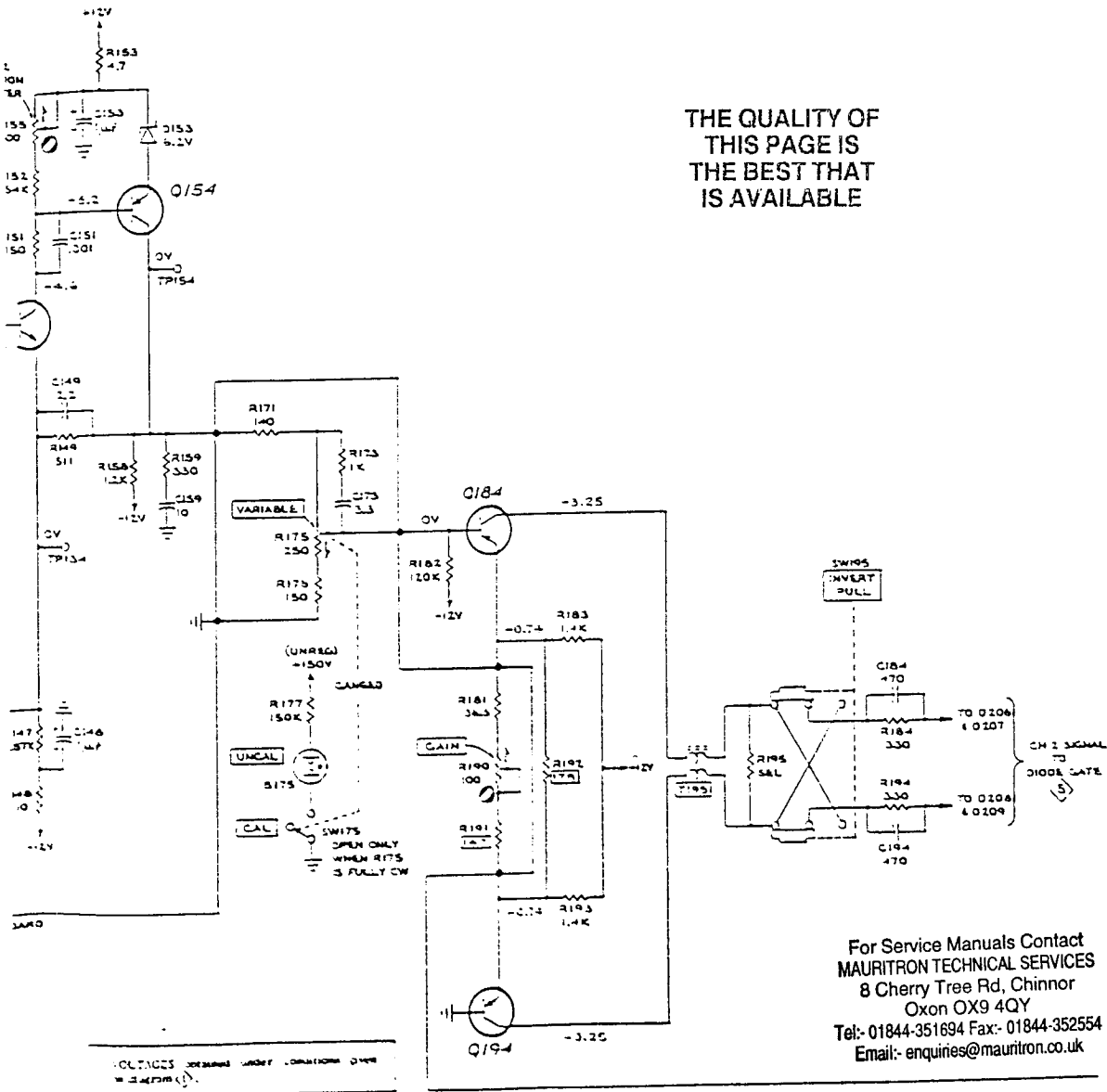

For Service Manuals Contact  
MAURITRON TECHNICAL SERVICES  
8 Cherry Tree Rd, Chinnor  
Oxon OX9 4QY  
Tel: 01844-351694 Fax: 01844-352554  
Email: enquiries@mauritron.co.uk

CH 2 VERTICAL PREAMP

CH 2 VERTICAL PREAMP

3

3

THE QUALITY OF  
THIS PAGE IS  
THE BEST THAT  
IS AVAILABLE

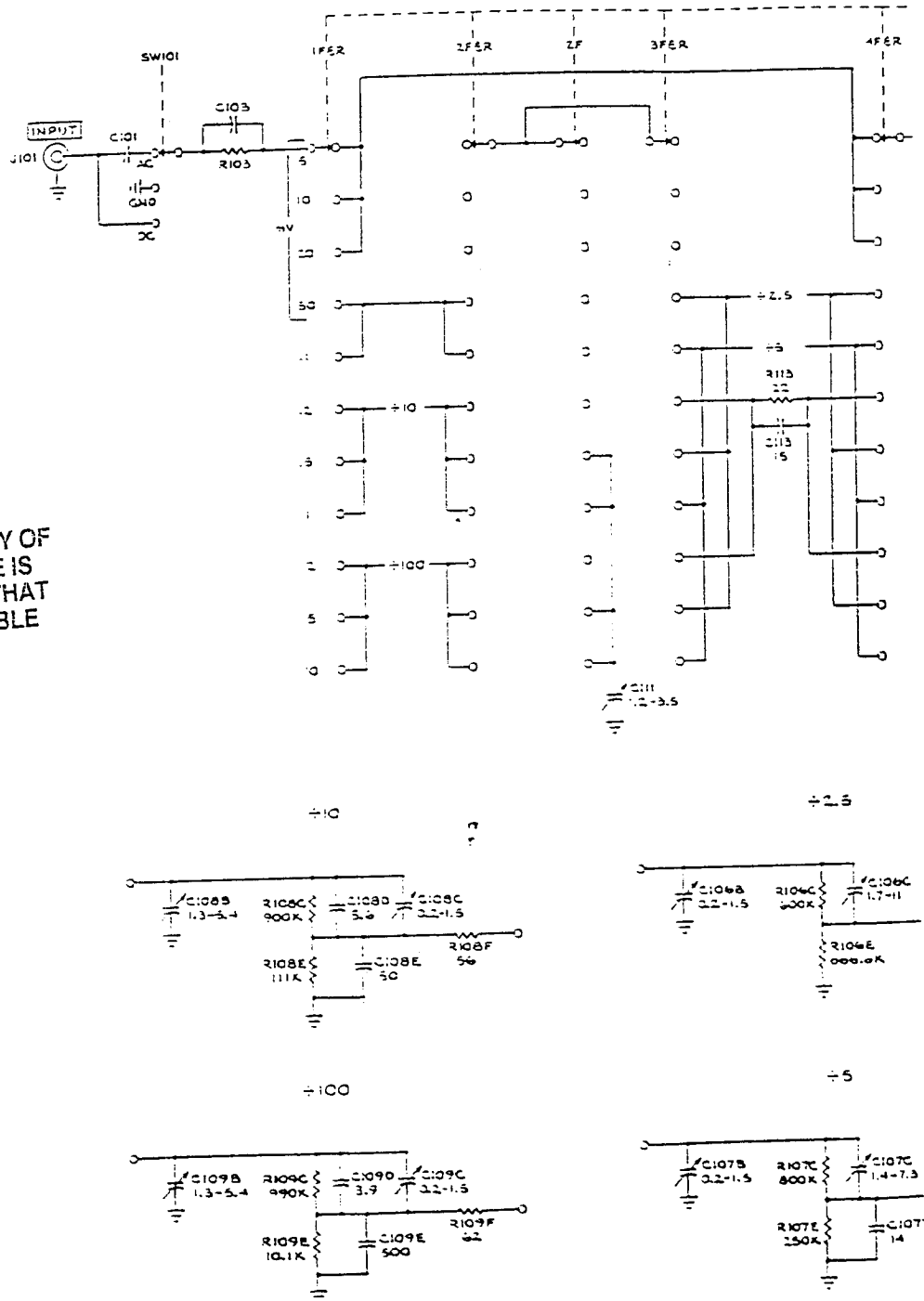

TYPE 453 OSCILLOSCOPE

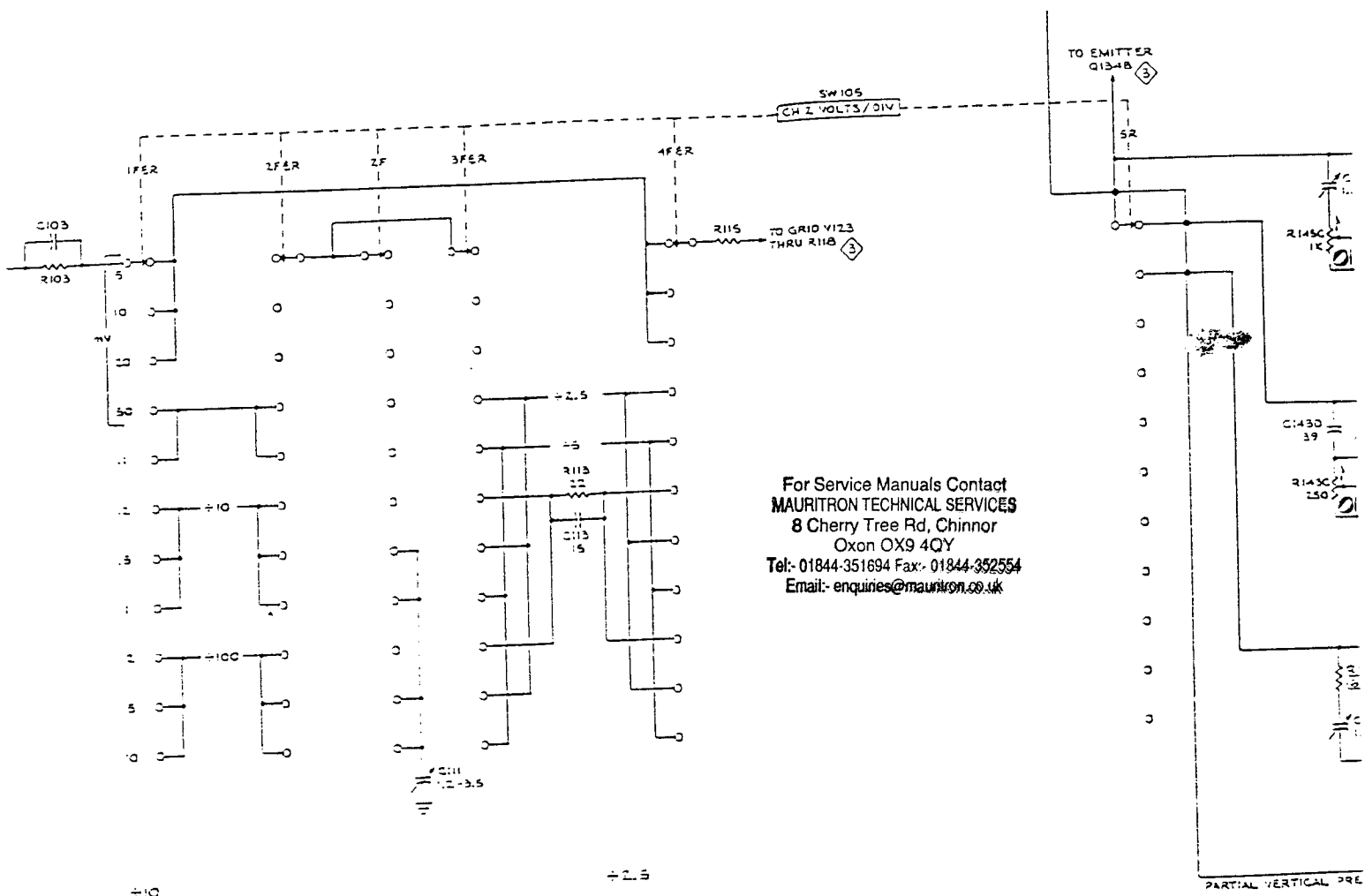

For Service Manuals Contact  
**MAURITRON TECHNICAL SERVICES**  
 8 Cherry Tree Rd, Chinnor  
 Oxon OX9 4QY  
 Tel: 01844-351694 Fax: 01844-352554  
 Email: enquiries@mauritron.co.uk

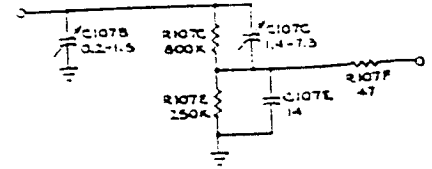
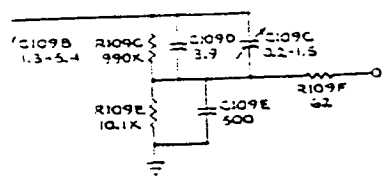
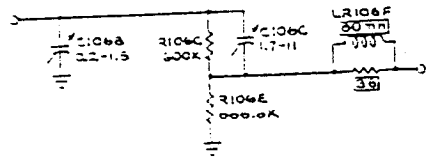
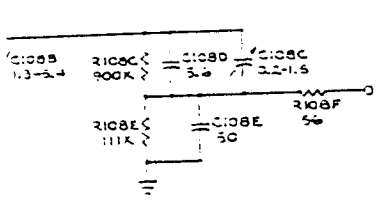

REFERENCE DIAG.  
 CH 2 VERTICAL

SEE PARTS LIST FOR EXACT VALUES AND SERIAL NUMBER RANGES OF PARTS MARKED WITH BLUE OUTLINE.

OSCILLOSCOPE

C

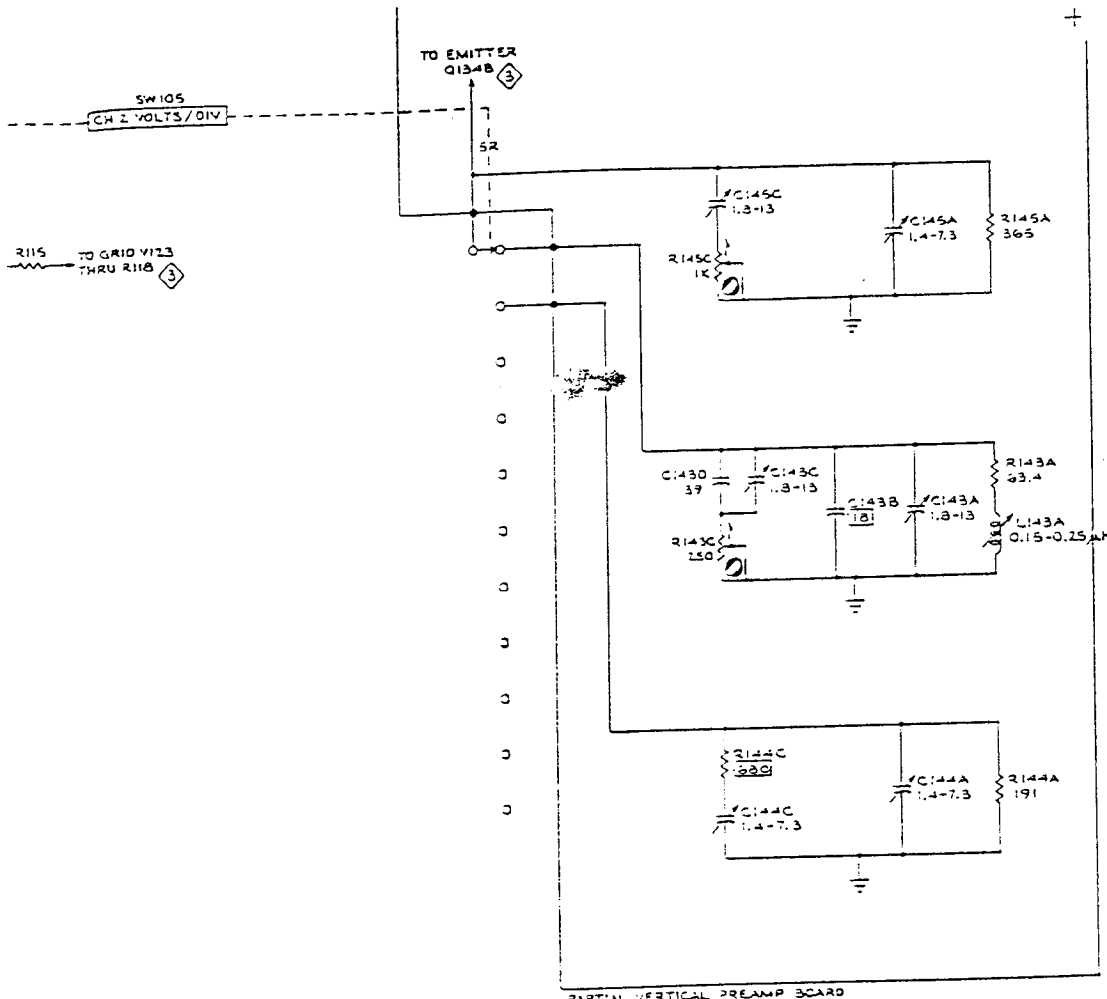

PARTIAL VERTICAL PREAMP BOARD

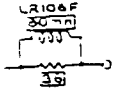

REFERENCE DIAGRAMS  
 3 CH 2 VERTICAL PREAMP

SEE PARTS LIST FOR LABELS, VALUES AND SERIAL NUMBER RANGES OF PARTS MARKED WITH BLUE OUTLINE.

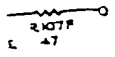

DDN  
 56

For Service Manuals Contact  
**MAURITRON TECHNICAL SERVICES**  
 8 Cherry Tree Rd, Chinnor  
 Oxon OX9 4QY  
 Tel: 01844-351694 Fax: 01844-352554  
 Email: enquiries@mauritron.co.uk

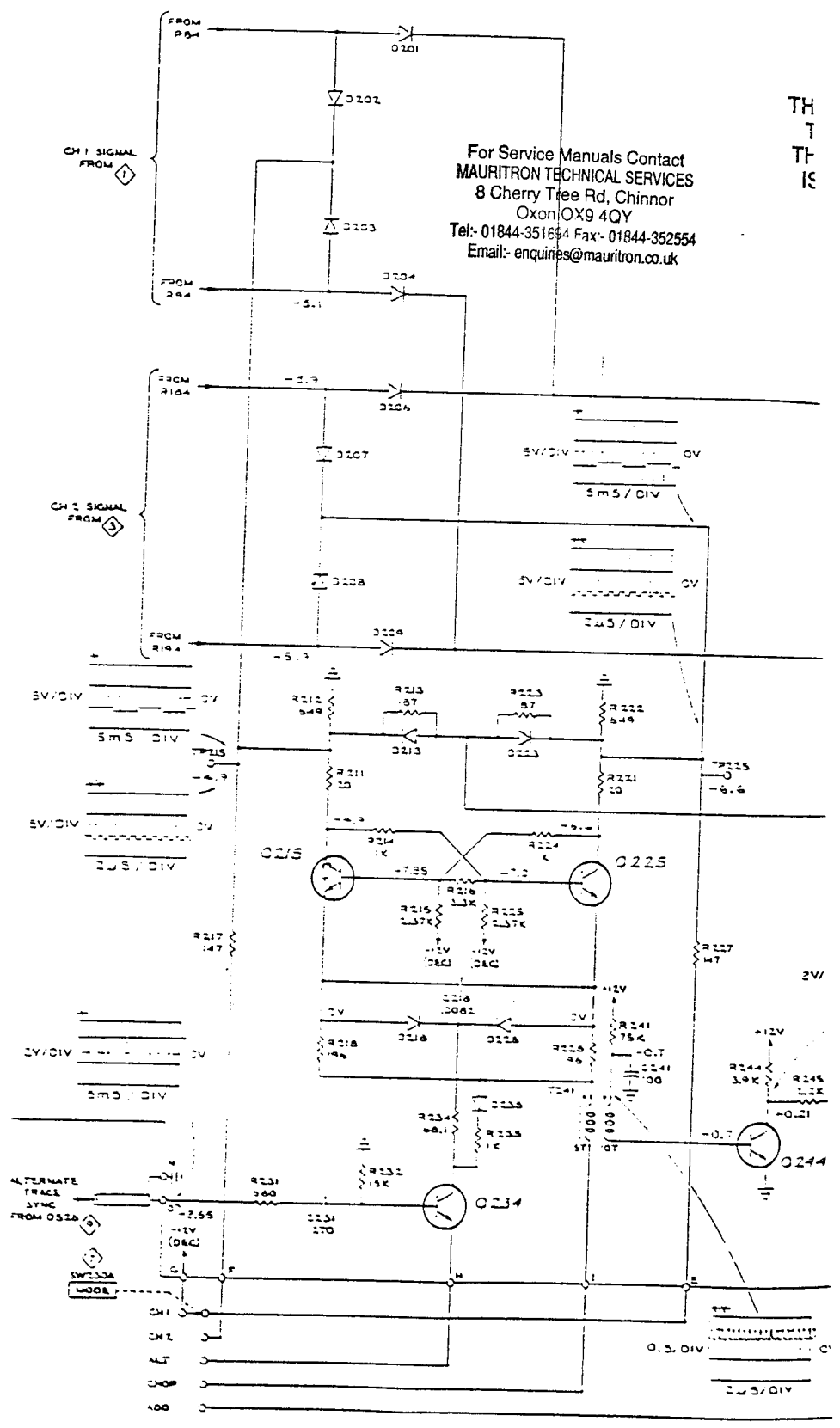

TYPE 453 OSCILLOSCOPE

THE QUALITY OF  
THIS PAGE IS  
THE BEST THAT  
IS AVAILABLE

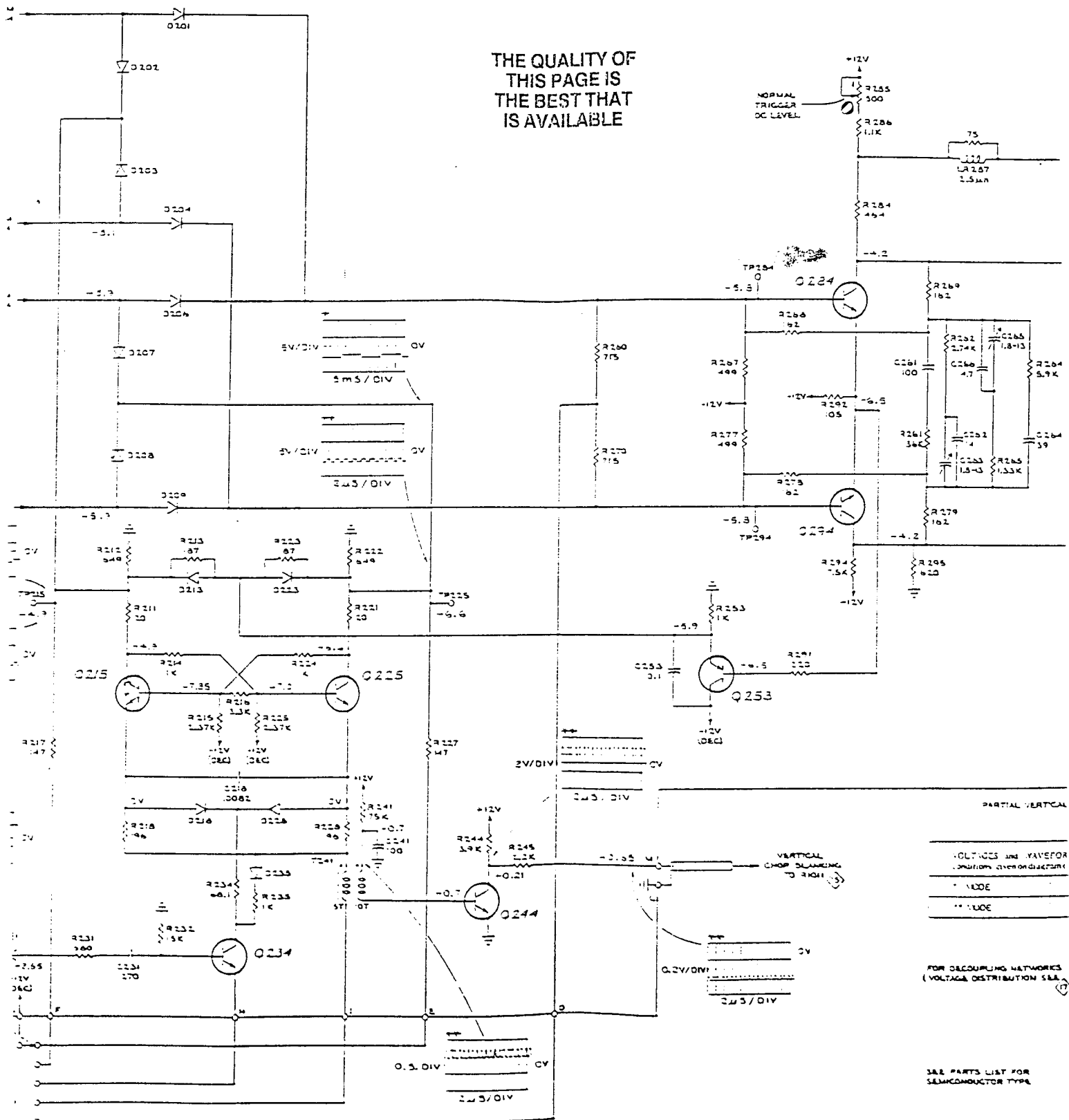

PARTIAL VERTICAL

VOLTAGES and WAVES FOR  
condition over structure

\* NODE

\*\* NODE

FOR DECOUPLING NETWORKS  
(VOLTAGE DISTRIBUTION SEE)

SEE PARTS LIST FOR  
SEMICONDUCTOR TYPE

SCILLOSCOPE

VERT

QUALITY OF  
THIS PAGE IS  
THE BEST THAT  
IS AVAILABLE

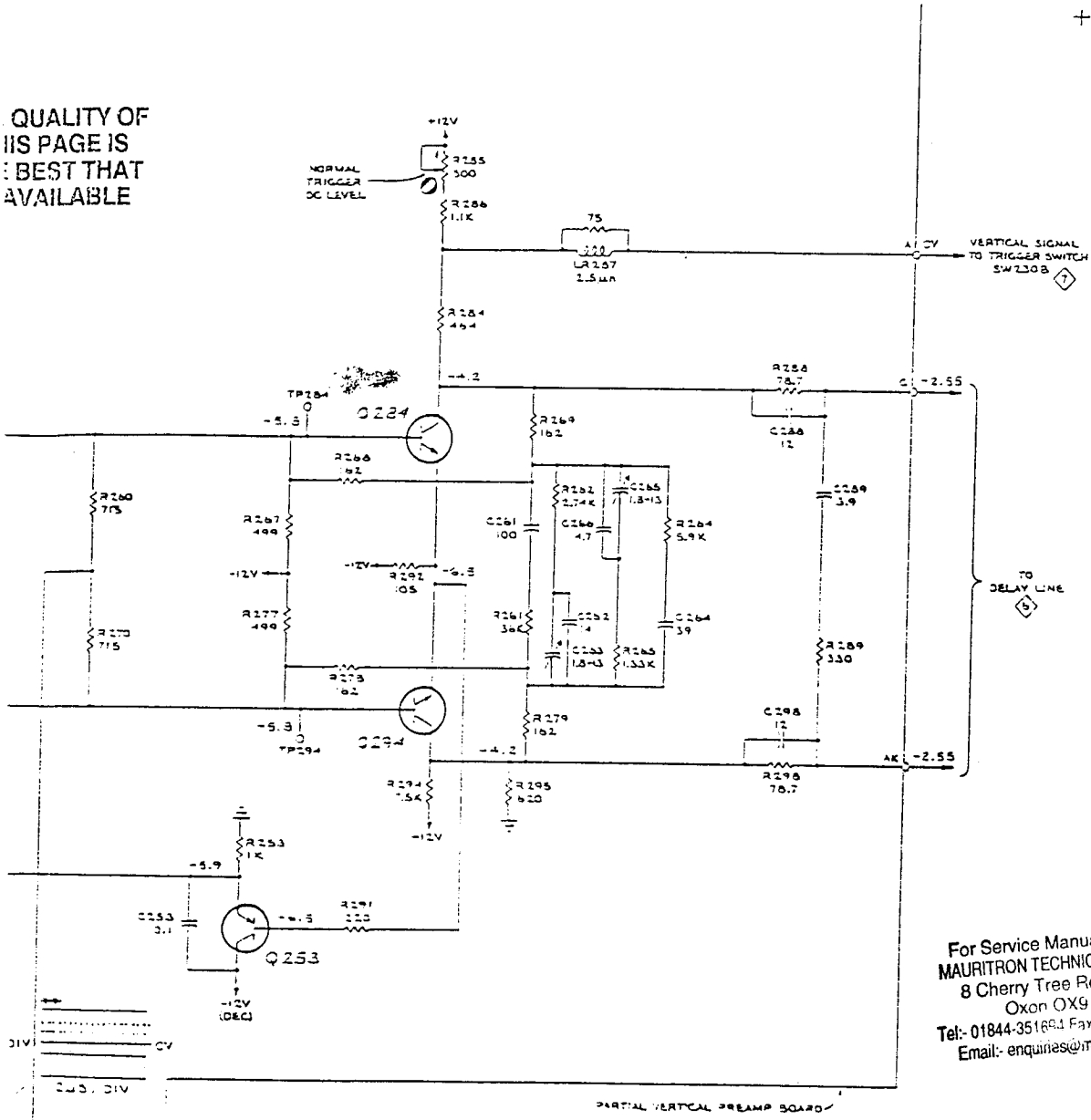

For Service Manuals Contact  
MAURITRON TECHNICAL SERVICES  
8 Cherry Tree Rd, Chinnor  
Oxon OX9 4QY  
Tel: 01844-351694 Fax: 01844-350554  
Email: enquiries@maurtron.com

VOLTAGES and WAVEFORMS obtained under conditions given on diagrams (except as indicated)

MODE	ALT
MODE	CHOP

FOR DECOUPLING NETWORKS (VOLTAGE DISTRIBUTION SEE 17)

- REFERENCE DIAGRAMS
- 1 CH1 VERTICAL PREAMP
  - 2 CH2 VERTICAL PREAMP
  - 3 VERTICAL OUTPUT AMPLIFIER
  - 4 TRIGGER PREAMP
  - 5 A SWEEP GENERATOR
  - 6 Z AXIS AMPLIFIER
  - 7 POWER SUPPLY DISTRIBUTION

SEE PARTS LIST FOR SEMICONDUCTOR TYPE

VERTICAL SWITCHING 5

VERTICAL SWITCHING 5

CMD 348

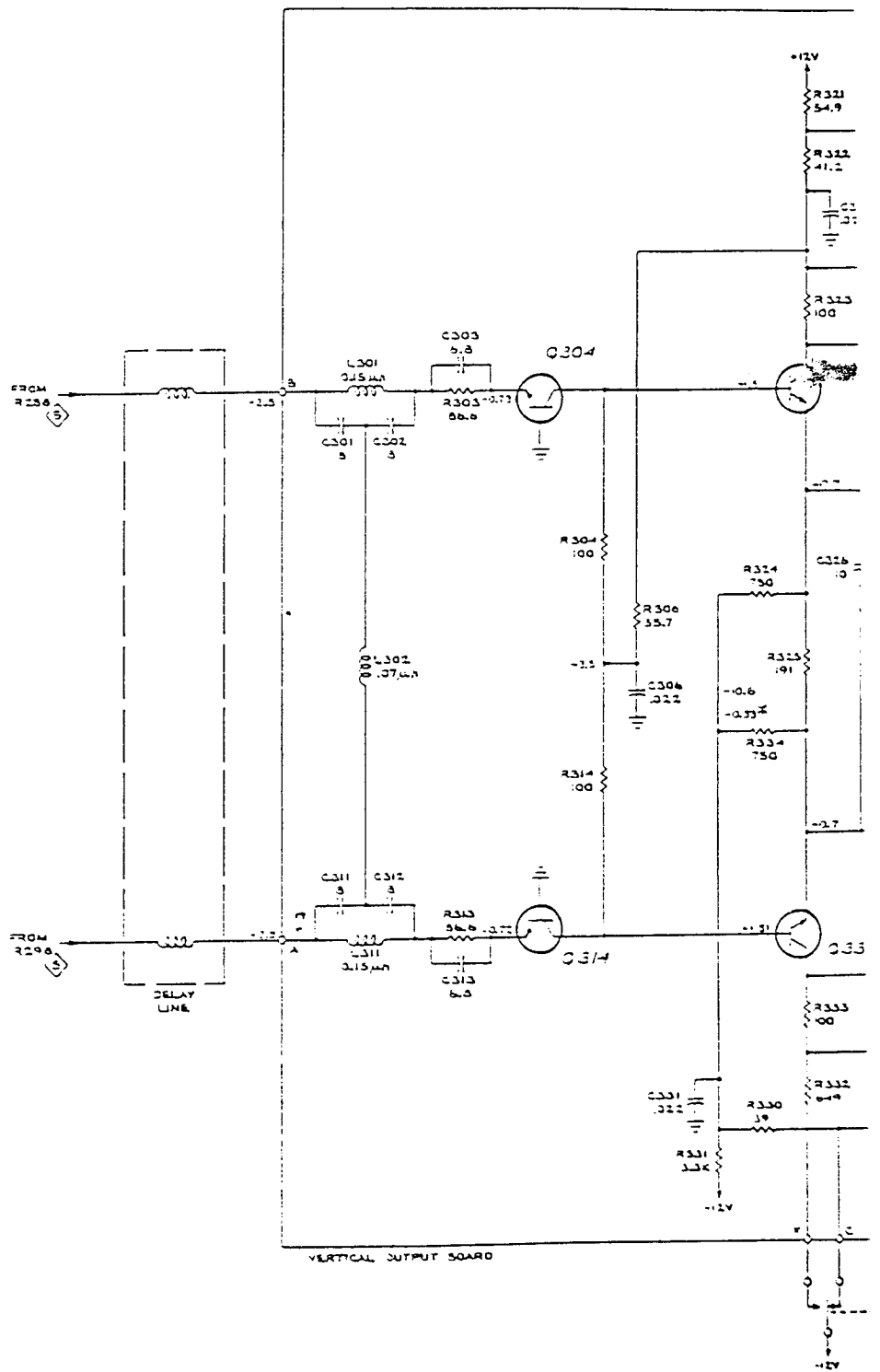

TYPE 453 OSCILLOSCOPE



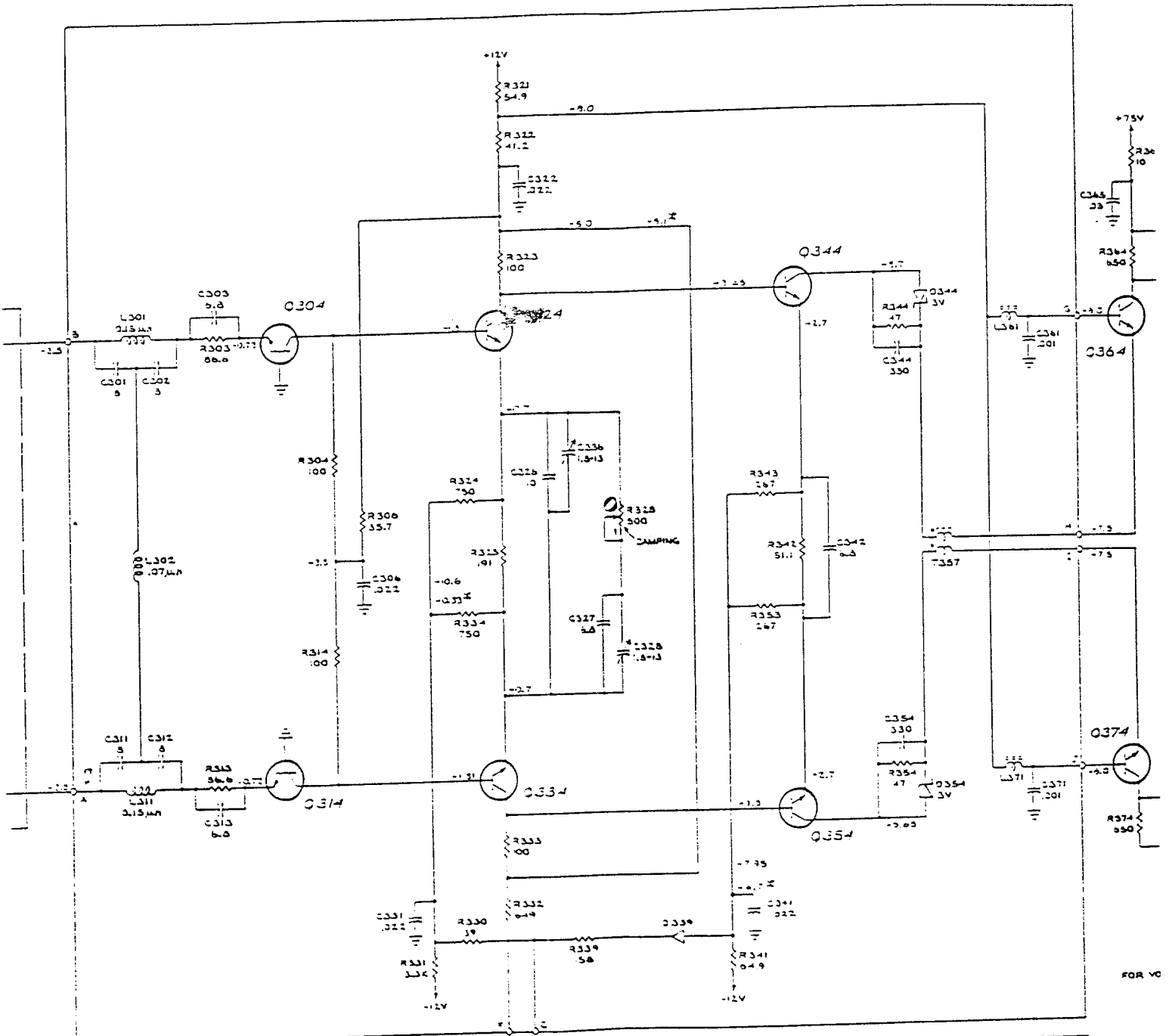

VOLTAGES and WAVEFORMS OBTAINED UNDER CONDITIONS GIVEN OR CAPTURED (SEE SCHEMATIC FOR FOLLOWING):

• TRACE FINDER Pressed

SEE PARTS LIST FOR SEMICONDUCTOR TYPES

REF: 5 VERT, 10 HORIZ, 100 VOLT

SW330  
TRACE FINDER  
SPRING RETURN TO POSITION SHOWN

VERTICAL OUTPUT BOARD

FOR VC

OSCOPE

VERTICAL OUTPUT AN

For Service Manuals Contact  
MAURITRON TECHNICAL SERVICES  
8 Cherry Tree Rd, Chinnor  
Oxon OX9 4QY  
Tel:- 01844-351694 Fax:- 01844-352554  
Email:- enquiries@mauritron.co.uk

+

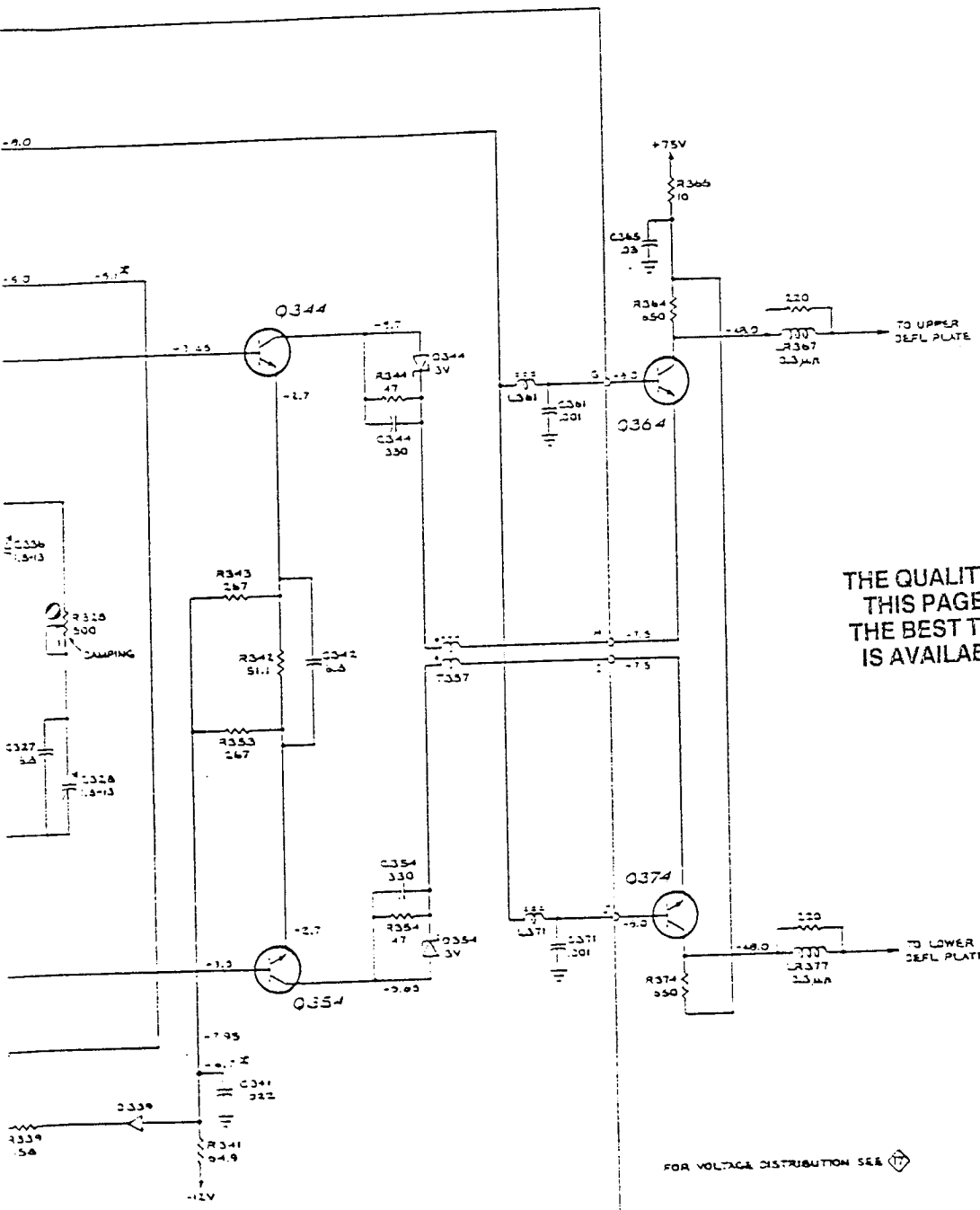

THE QUALITY OF  
THIS PAGE IS  
THE BEST THAT  
IS AVAILABLE

VERTICAL OUTPUT AMPLIFIER

6

FOR VOLTAGE DISTRIBUTION SEE 17

VOLTAGES AND WAVEFORMS OBTAINED WITH  
CONDENSER (1 MFD OR 20 MFD) IN CIRCUIT AS FOLLOWS:  
\* TRACE FINDER Pressed

SEE PARTS LIST FOR  
SEMICONDUCTOR TYPES

- REFERENCE DIAGRAM
- 5 VERTICAL SWITCHING
  - 6 HORIZONTAL AMPLIFIER
  - 7 POWER SUPPLY & DISTRIBUTION

SW 330  
TRACE FINDER  
SPRING RETURN TO  
POSITION SHOWN

CMD  
3-5-58

VERTICAL OUTPUT AMPLIFIER 6



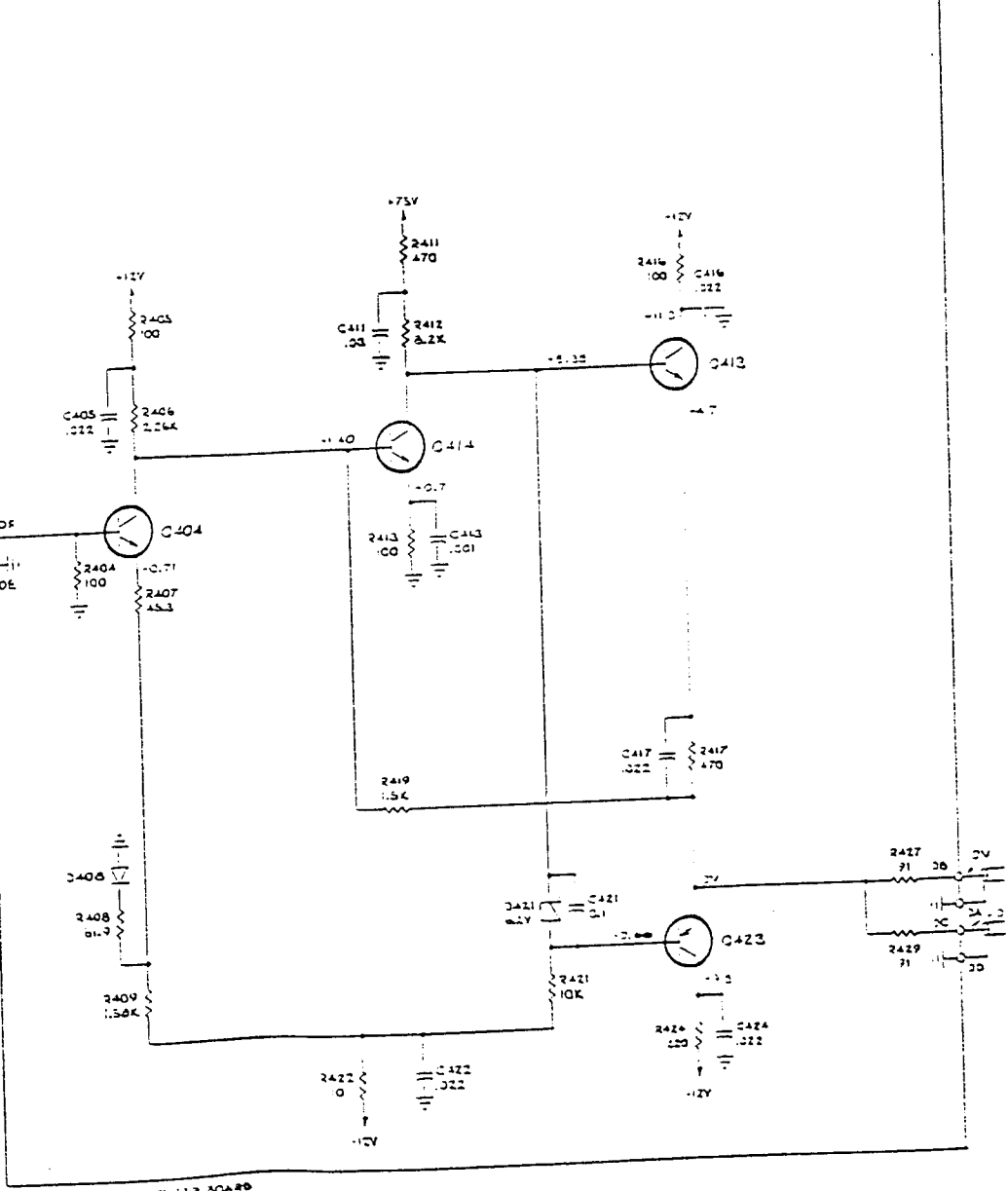
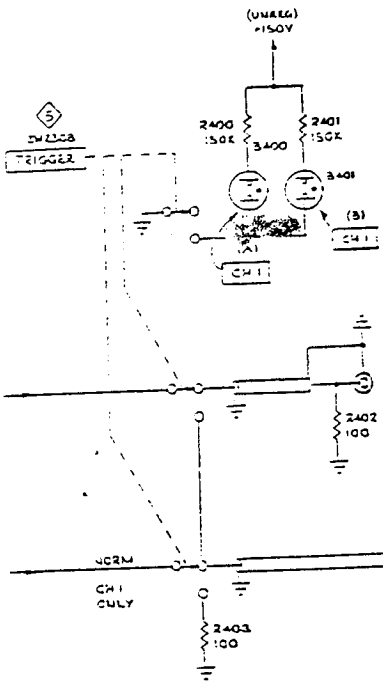

REFERENCE DIAGRAMS  
 (A) CH1 INPUT AMPLIFIER  
 (B) VERTICAL SWITCHING  
 (C) A TRIGGER GENERATOR  
 (D) B TRIGGER GENERATOR  
 (E) POWER SUPPLY & DISTRIBUTION  
 FOR VOLTAGE DISTRIBUTION SEE (F)  
 SEE PARTS LIST FOR SEMICONDUCTOR TYPES.

PLATE 1000 (PARTIAL A SWEEP BOARD)  
 W. 1000000

PARTIAL A SWEEP BOARD

For Service Manuals Contact  
**MAURITRON TECHNICAL SERVICES**  
 8 Cherry Tree Rd, Chinnor  
 Oxon OX9 4QY  
 Tel:- 01844-351694 Fax:- 01844-352554  
 Email:- enquiries@mauritron.co.uk

THE QUALITY OF  
 THIS PAGE IS  
 THE BEST THAT  
 IS AVAILABLE

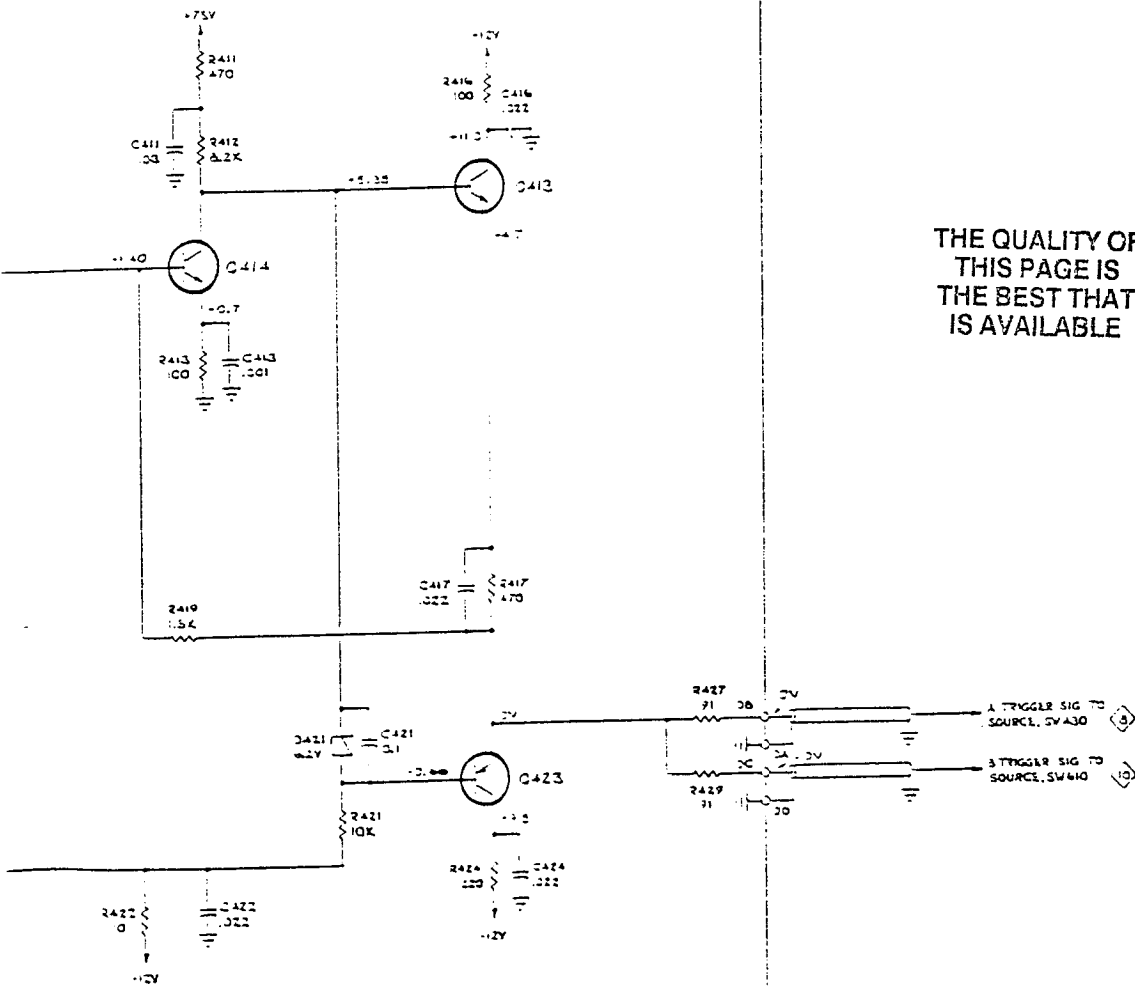

31  
 363  
 TRIGGER PREAMP

A

EMERSON ELECTRIC









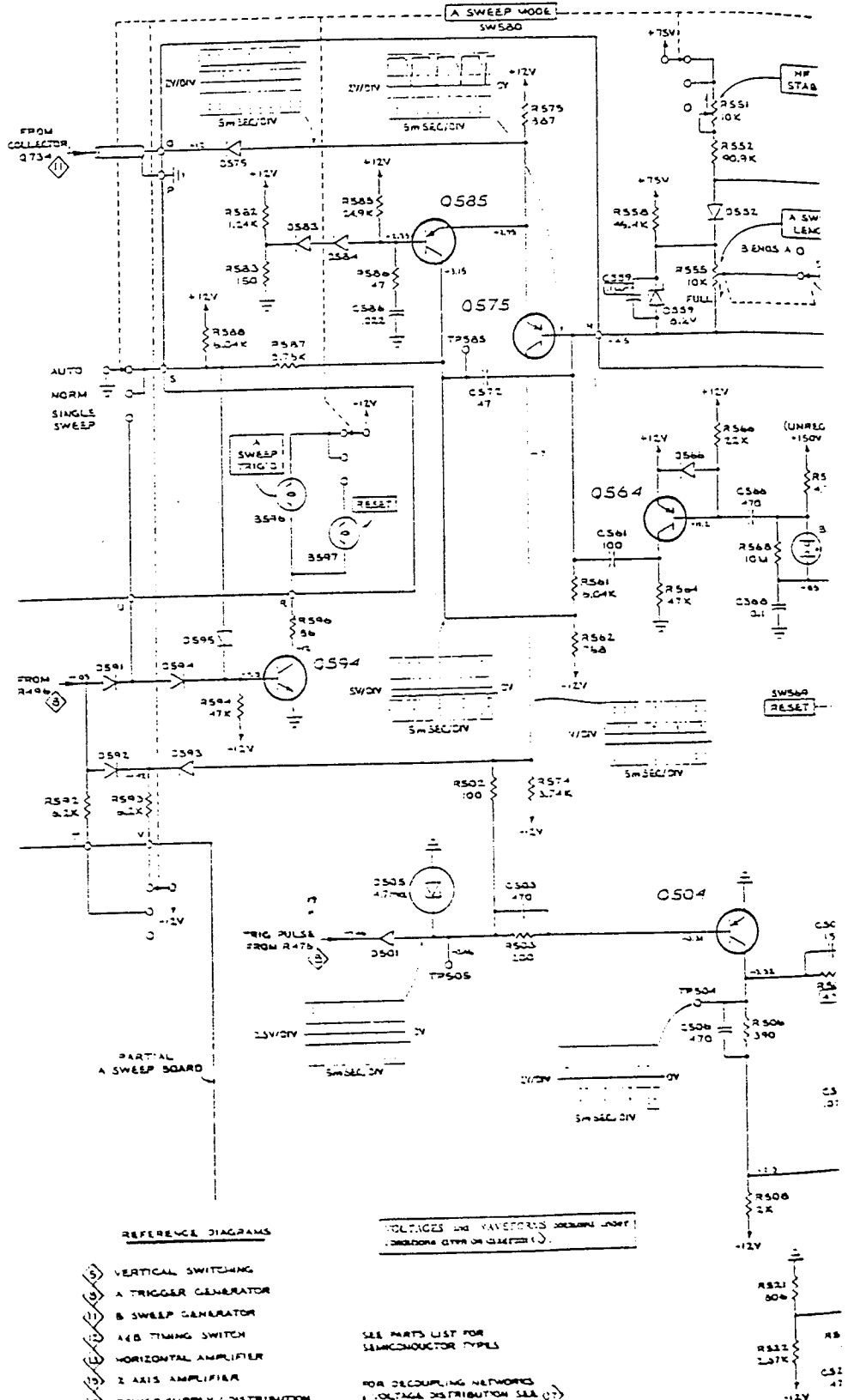

THE QUALITY OF THIS PAGE IS THE BEST THAT IS AVAILABLE

- REFERENCE DIAGRAM
- ① VERTICAL SWITCHING
  - ② A TRIGGER GENERATOR
  - ③ B SWEEP GENERATOR
  - ④ A/B TIMING SWITCH
  - ⑤ HORIZONTAL AMPLIFIER
  - ⑥ Z AXIS AMPLIFIER
  - ⑦ POWER SUPPLY & DISTRIBUTION

VOLTAGES AND WAVEFORMS (CONDITIONS GIVEN OR OTHERWISE)

SEE PARTS LIST FOR SEMICONDUCTOR TYPES  
FOR DECOUPLING NETWORKS & VOLTAGE DISTRIBUTION SEE

SEE PARTS LIST FOR LARGE VALUES AND SERIAL NUMBER RANGES OF PARTS MARKED WITH BLUE OUTLINE

TYPE 453 OSCILLOSCOPE

For Service Manuals Contact  
**MAURITRON TECHNICAL SERVICES**  
 8 Cherry Tree Rd, Chinnor  
 Oxon OX9 4QY  
 Tel: 01844-351694 Fax: 01844-352554  
 Email: enquiries@mauritron.co.uk

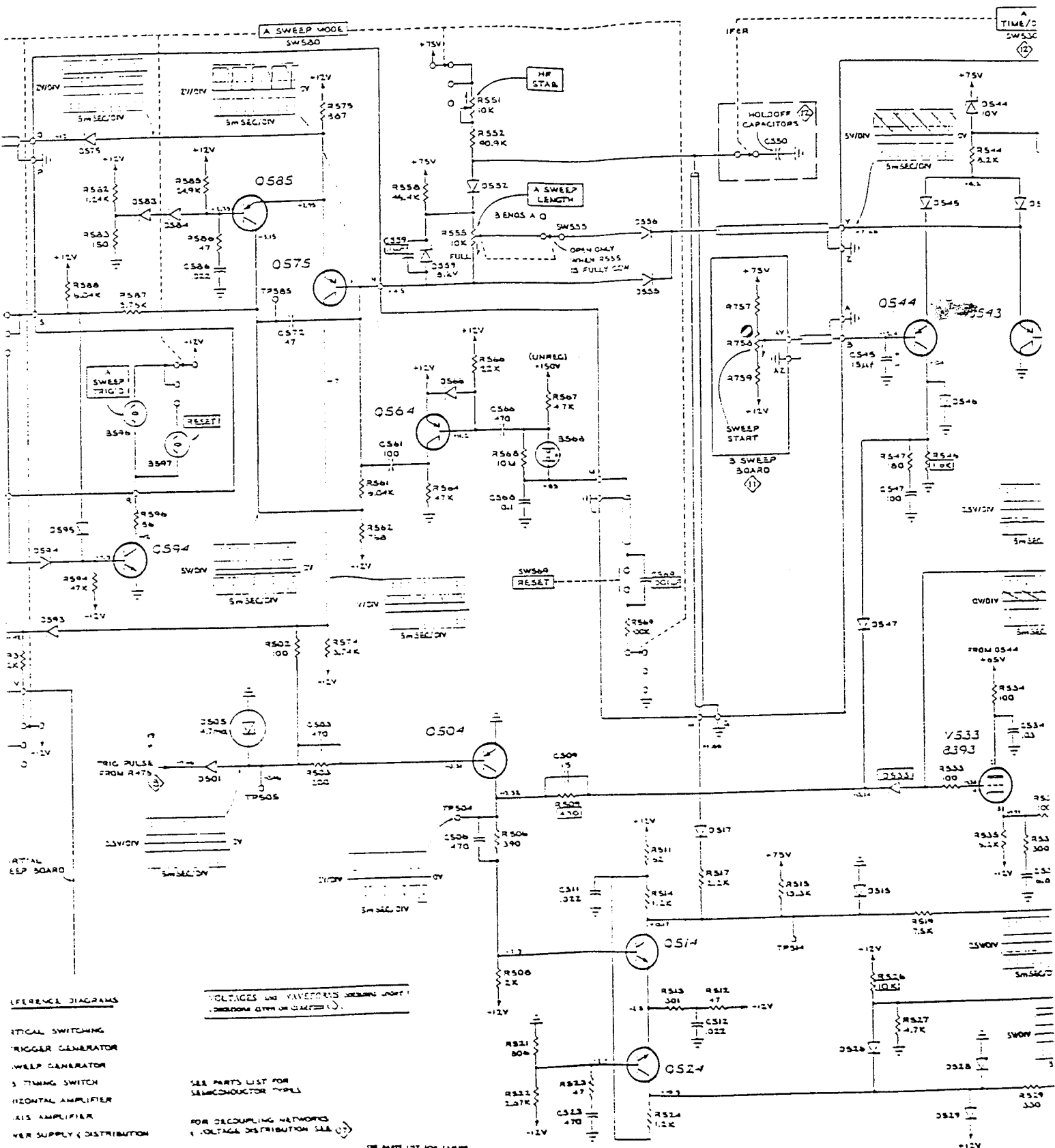

REFERENCE DIAGRAMS

- TRIGGER SWITCHING
- TRIGGER GENERATOR
- SWEEP GENERATOR
- TIME BASE SWITCH
- HORIZONTAL AMPLIFIER
- VIS. AMPLIFIER
- POWER SUPPLY DISTRIBUTION

VOLTAGES AND WAVEFORMS (SEE PARTS LIST FOR SEMICONDUCTOR TYPES)

SEE PARTS LIST FOR SEMICONDUCTOR TYPES

FOR DECOUPLING NETWORKS & VOLTAGE DISTRIBUTION SEE (2)

SEE PARTS LIST FOR LABELS, PARTS AND SERIAL NUMBER LABELS OF PARTS MARKED WITH BLUE OUTLINE

For Service Manuals Contact  
**MAURITRON TECHNICAL SERVICES**  
 8 Cherry Tree Rd, Chinnor  
 Oxon OX9 4QY  
 Tel: 01844-351694 Fax: 01844-352554  
 Email: equines@mauritron.co.uk

A SWEEP GENERATOR

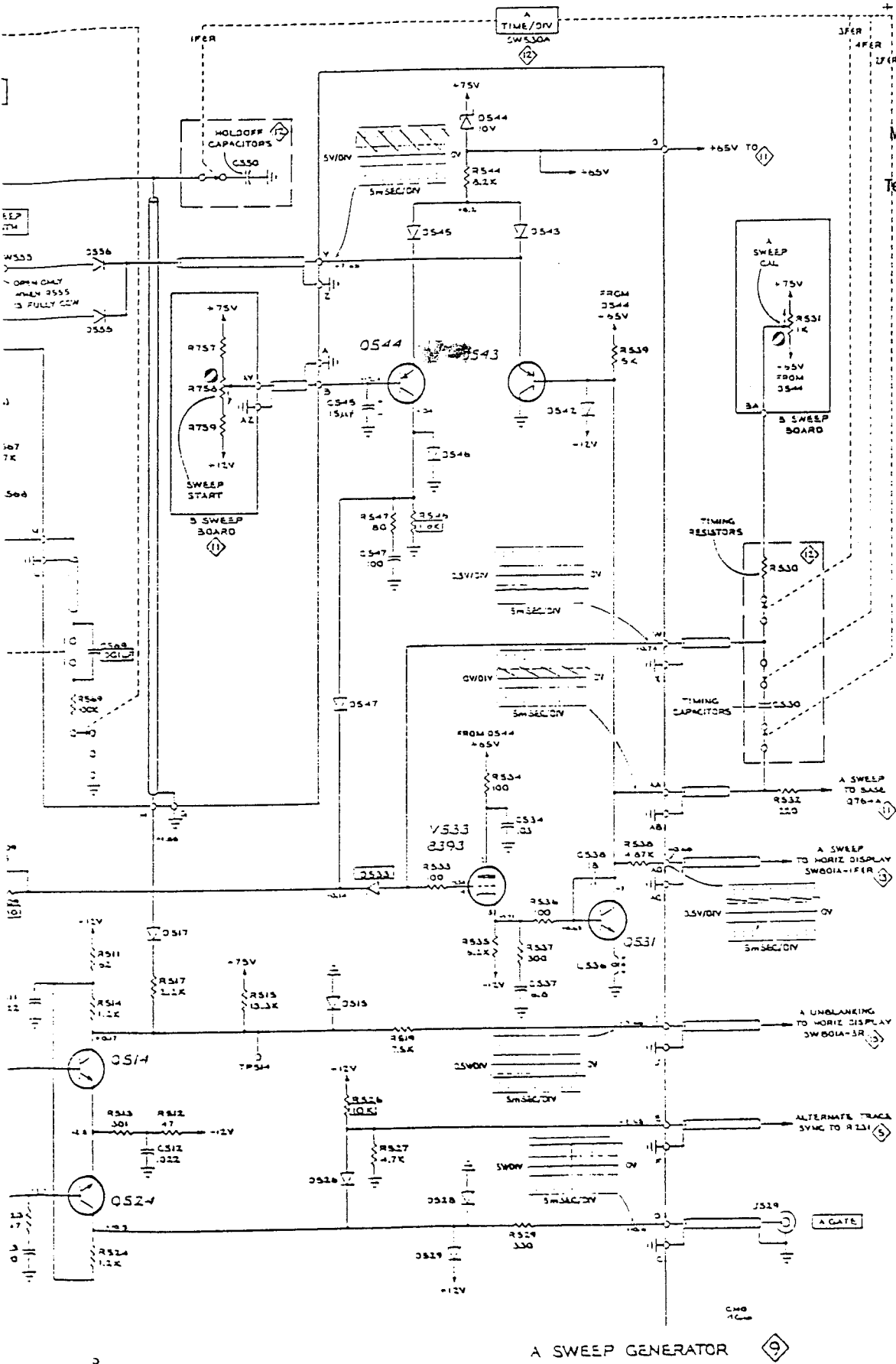

A SWEEP GENERATOR

THE QUALITY OF  
THIS PAGE IS  
THE BEST THAT  
IS AVAILABLE

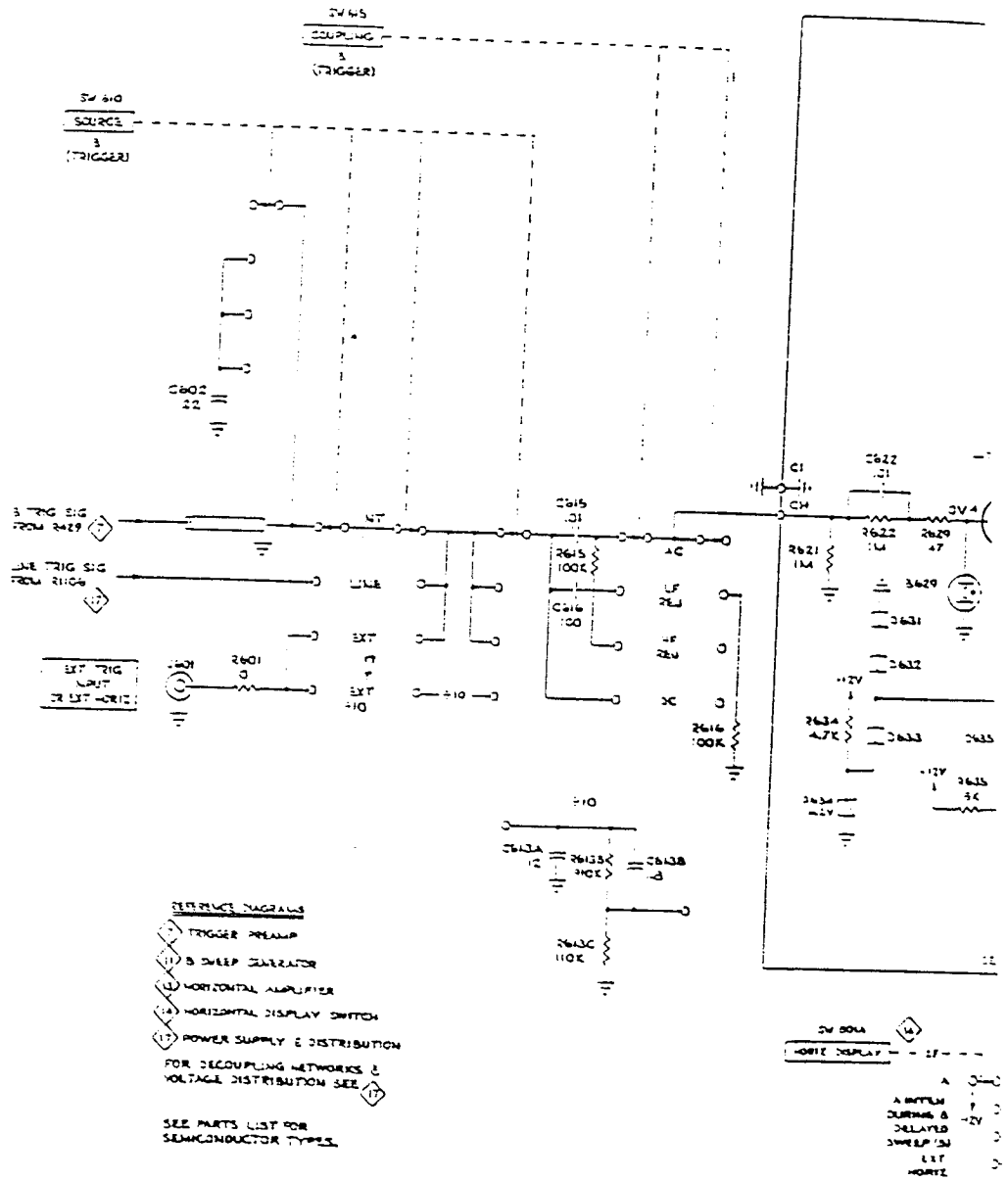

TYPE 433 OSCILLOSCOPE



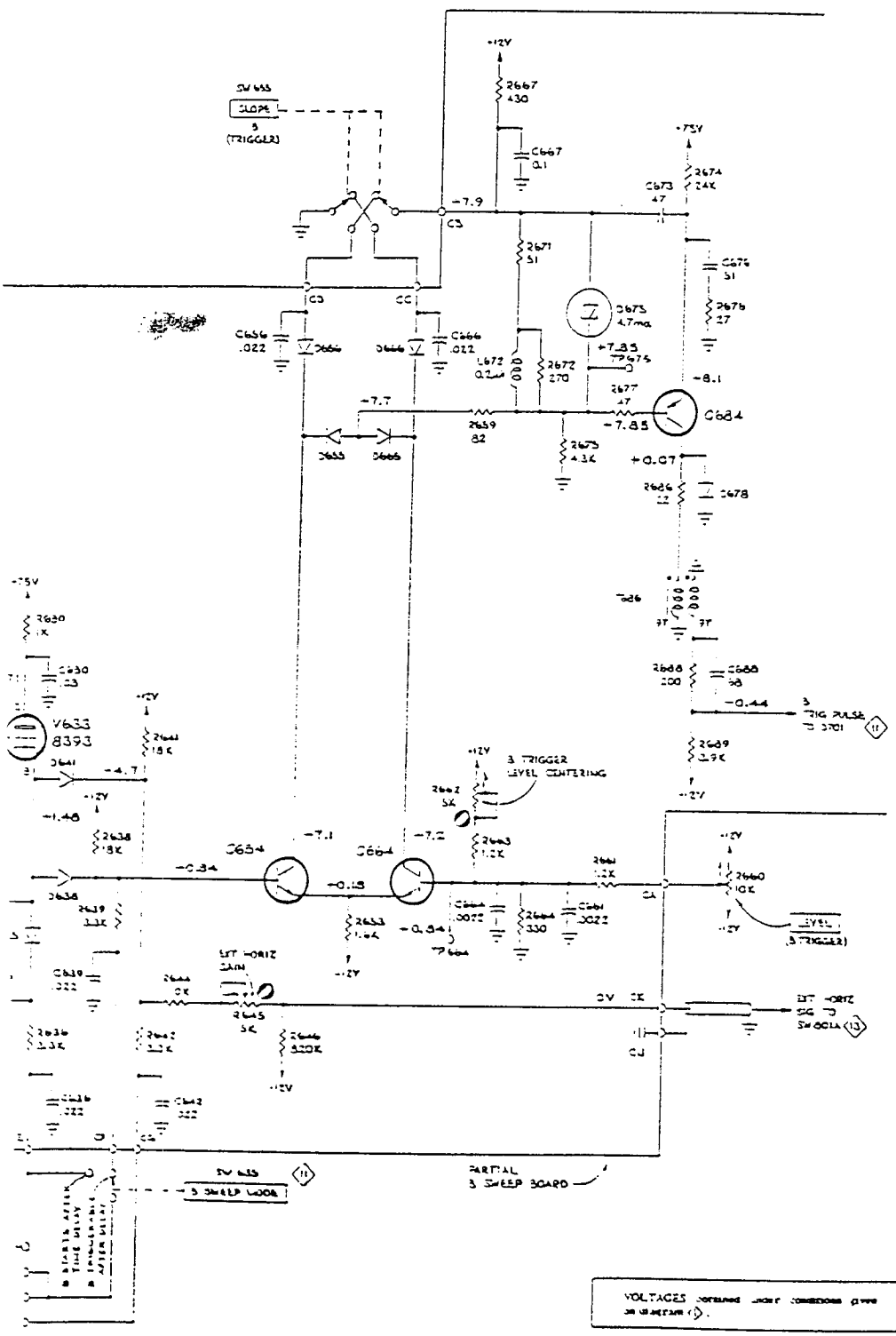

B TRIGGER GENERATOR

VOLTAGES OBTAINED UNDER CONDITIONS GIVEN IN DIAGRAM (V)

B TRIGGER GENERATOR

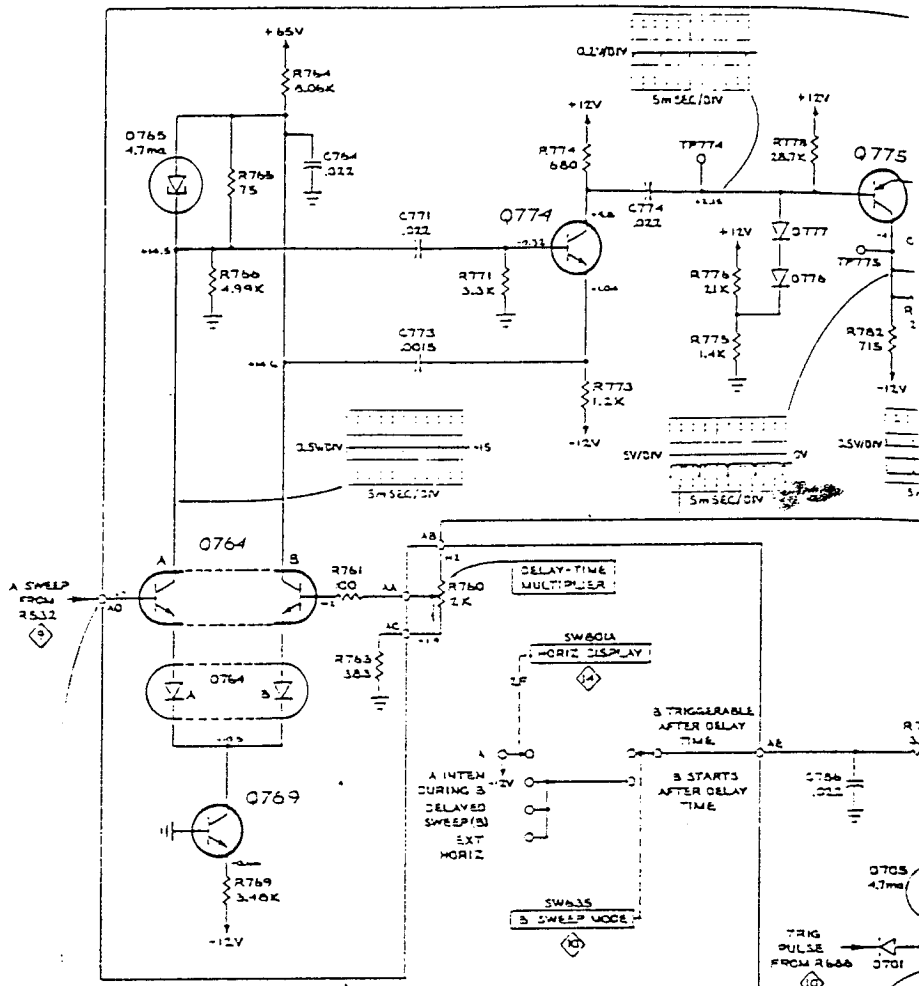

PARTIAL B SWEEP BOARD

THE QUALITY OF THIS PAGE IS THE BEST THAT IS AVAILABLE

FOR DECOUPLING NETWORKS (VOLTAGE DISTRIBUTION SEE 17)

For Service Manuals Contact  
**MAURITRON TECHNICAL SERVICES**  
 8 Cherry Tree Rd, Chinnor  
 Oxon OX9 4QY  
 Tel:- 01844-351694 Fax:- 01844-352554  
 Email:- enquiries@mauritron.co.uk

REFERENCE DIAGRAMS

- ① A SWEEP GENERATOR
- ② B TRIGGER GENERATOR
- ③ A&B TIMING SWITCH
- ④ HORIZONTAL AMPLIFIER
- ⑤ HORIZONTAL DISPLAY SWITCH
- ⑥ Z AXIS AMPLIFIER
- ⑦ POWER SUPPLY & DISTRIBUTION

SEE PARTS LIST FOR SEMICONDUCTOR TYPES

VOLTAGES AND WAVEFORMS SHOWN UNDER CONDITIONS OF OPERATION AS FOLLOWS:

Waveform	DELAYED SWEEP (S)
HORIZ DISPLAY	
Waveform	DELAYED SWEEP (S)
HORIZ DISPLAY	B STARTS AFTER DELAY TIME
B SWEEP MODE	

TYPE 453 OSCILLOSCOPE

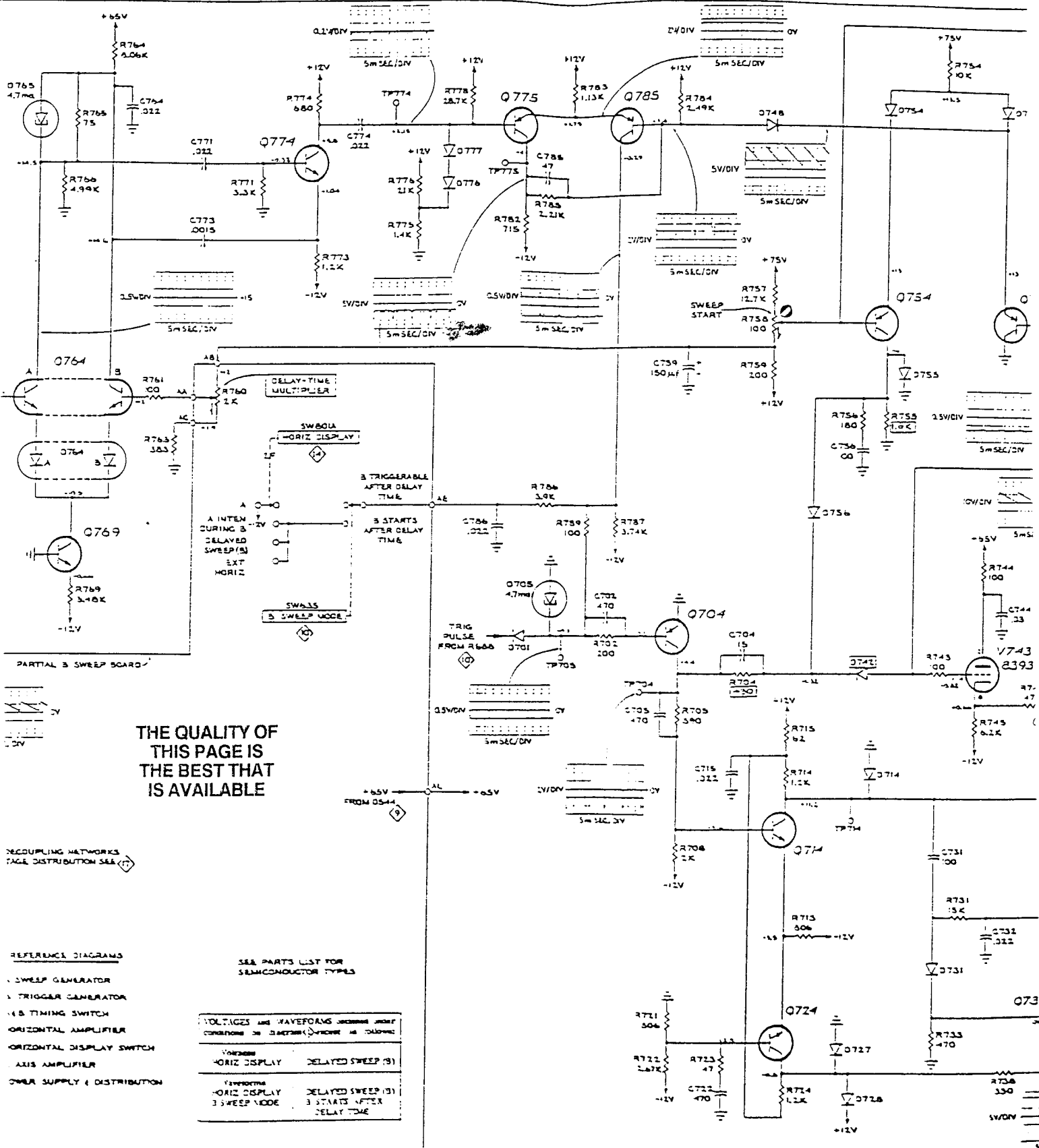

THE QUALITY OF THIS PAGE IS THE BEST THAT IS AVAILABLE

DECOUPLING NETWORKS PAGE DISTRIBUTION SEE (1)

- REFERENCE DIAGRAMS
- 1 SWEEP GENERATOR
  - 2 TRIGGER GENERATOR
  - 3 TIMING SWITCH
  - 4 HORIZONTAL AMPLIFIER
  - 5 HORIZONTAL DISPLAY SWITCH
  - 6 AXIS AMPLIFIER
  - 7 OVER SUPPLY & DISTRIBUTION

SEE PARTS LIST FOR SEMICONDUCTOR TYPES

VOLTAGES and WAVEFORMS measured under conditions of operation (1) unless as follows:	
Waveform	-HORIZ DISPLAY DELAYED SWEEP (S)
Voltages	-HORIZ DISPLAY DELAYED SWEEP (S) 3 SWEEP MODE 3 STARTS AFTER DELAY TIME



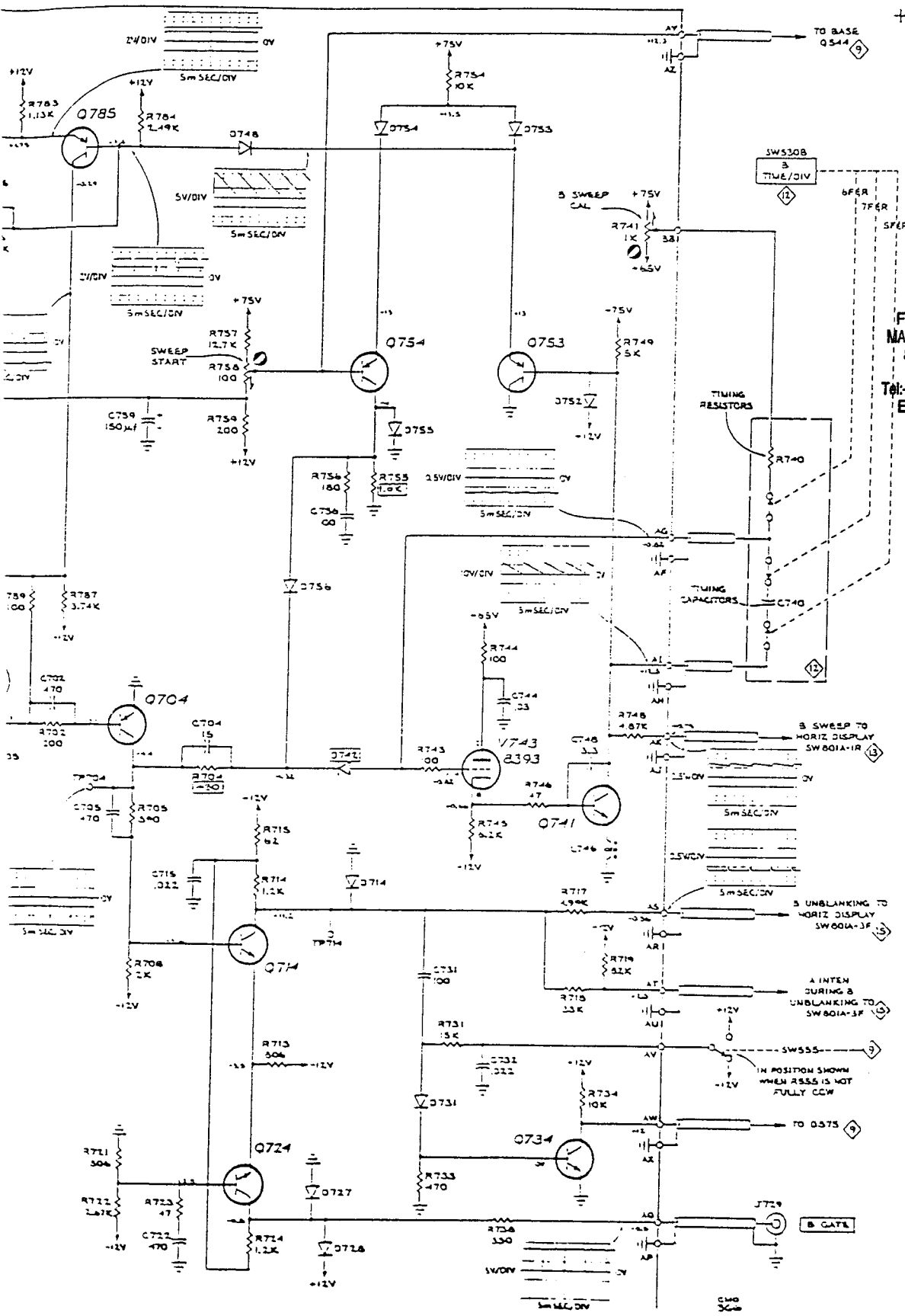

For Service Manuals Contact  
**MAURITRON TECHNICAL SERVICES**  
 8 Cherry Tree Rd, Chinnor  
 Oxon OX9 4QY  
 Tel: 01844-351694 Fax: 01844-352554  
 Email: enquiries@mauritron.co.uk

B SWEEP GENERATOR

B SWEEP GENERATOR



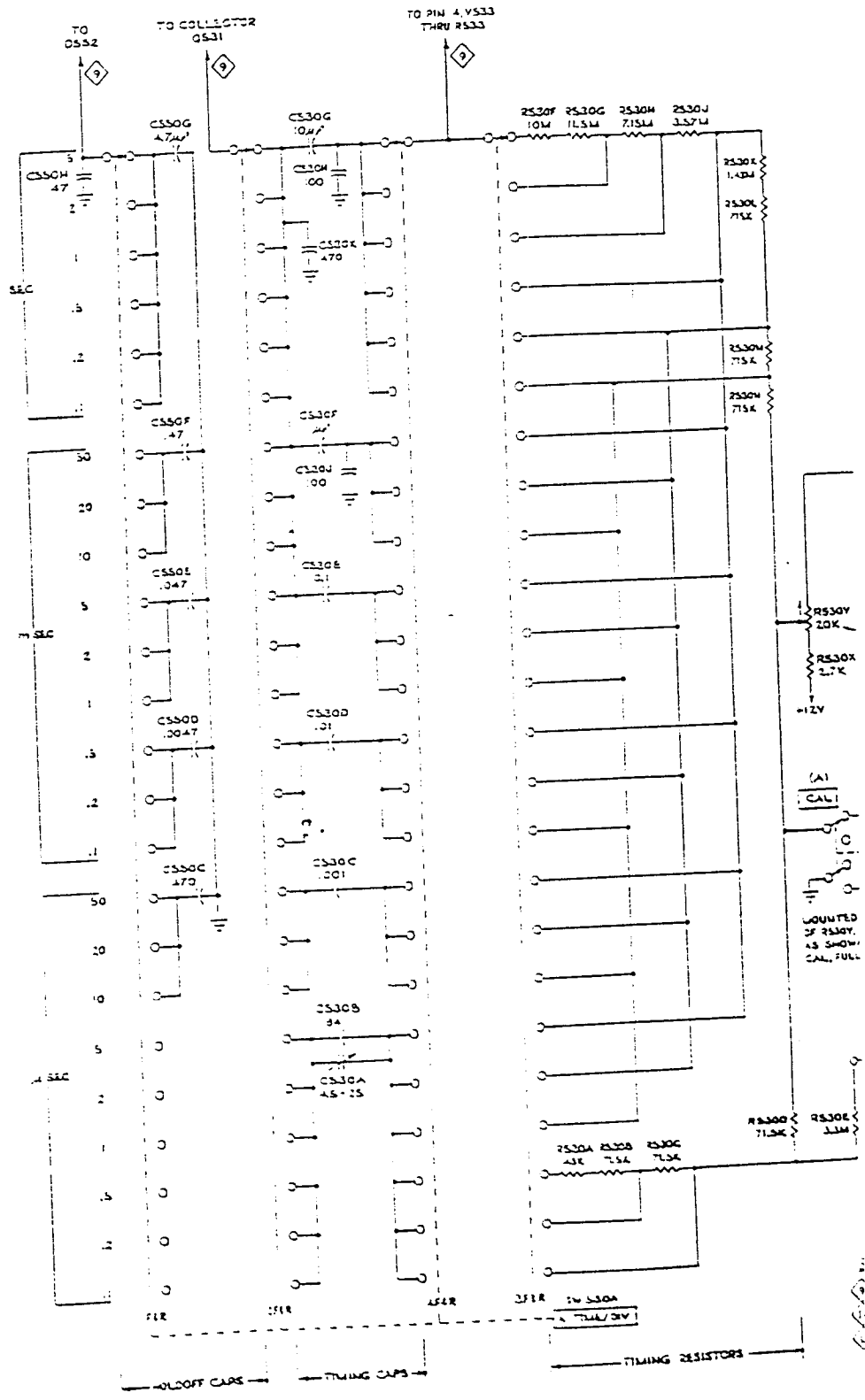

TYPE 452 OSCILLOSCOPE



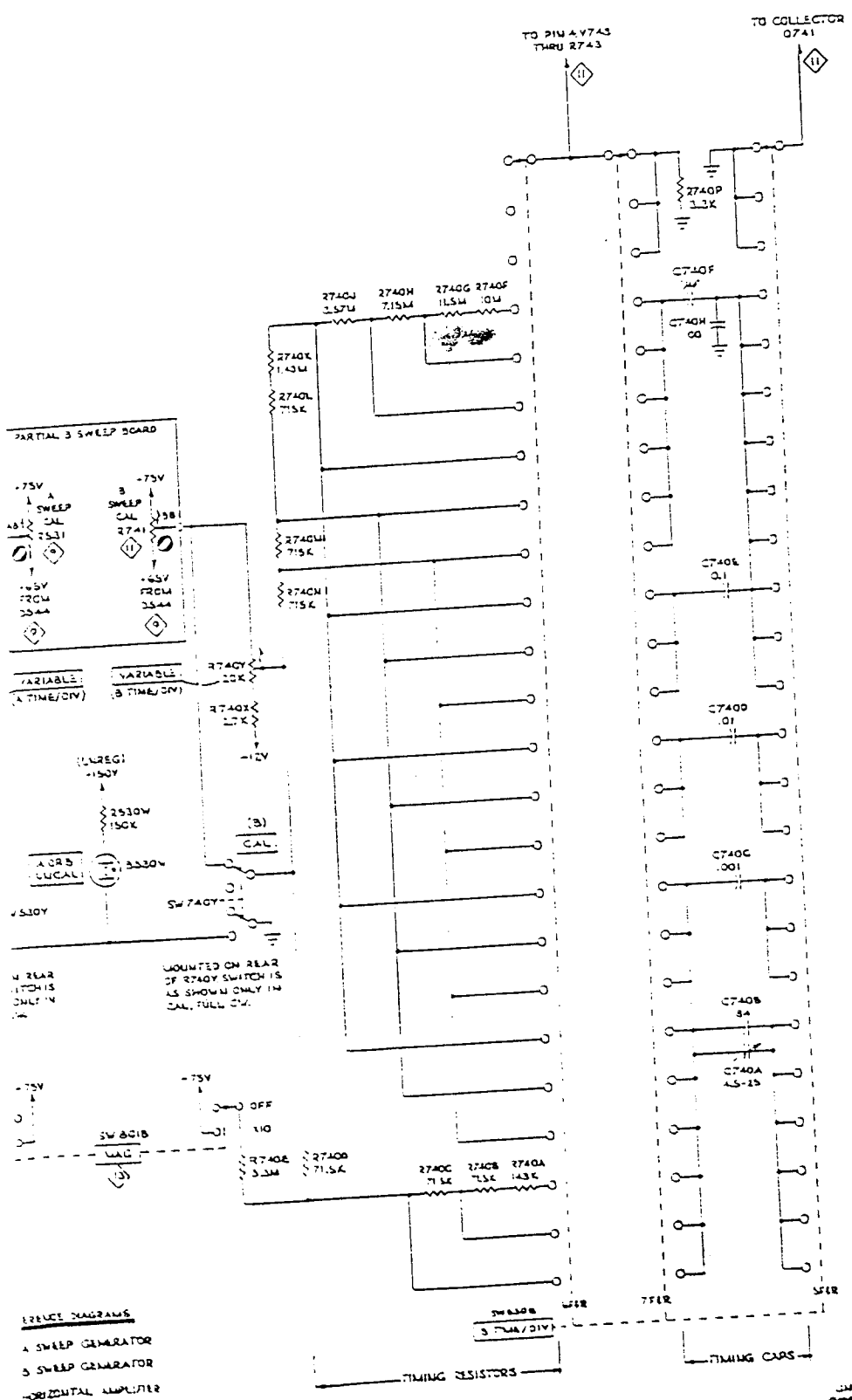

THE QUALITY OF THIS PAGE IS THE BEST THAT IS AVAILABLE

A AND B TIMING SWITCH 12

THE QUALITY OF  
THIS PAGE IS  
THE BEST THAT  
IS AVAILABLE

For Service Manuals Contact  
MAURITRON TECHNICAL SERVICES  
8 Cherry Tree Rd, Chinnor  
Oxon OX9 4OY  
Tel:- 01844-351694 Fax:- 01844-352554  
Email:- enquiries@mauritron.co.uk

TYPE 453 OSCILLOSCOPE

+

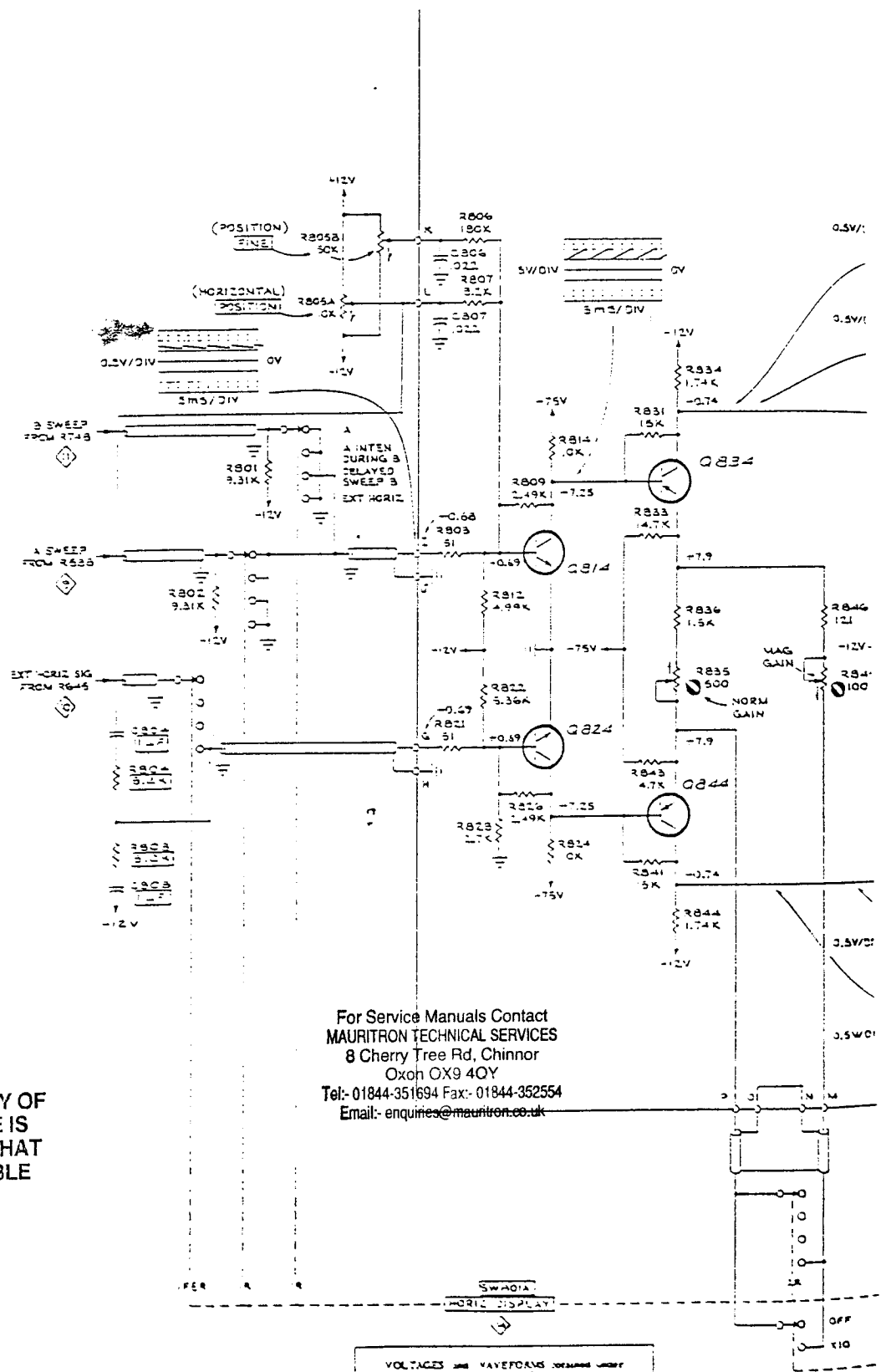

VOLTAGES and WAVEFORMS obtained under  
conditions given on circuit diagram or noted as follows:  
\* MAG 110

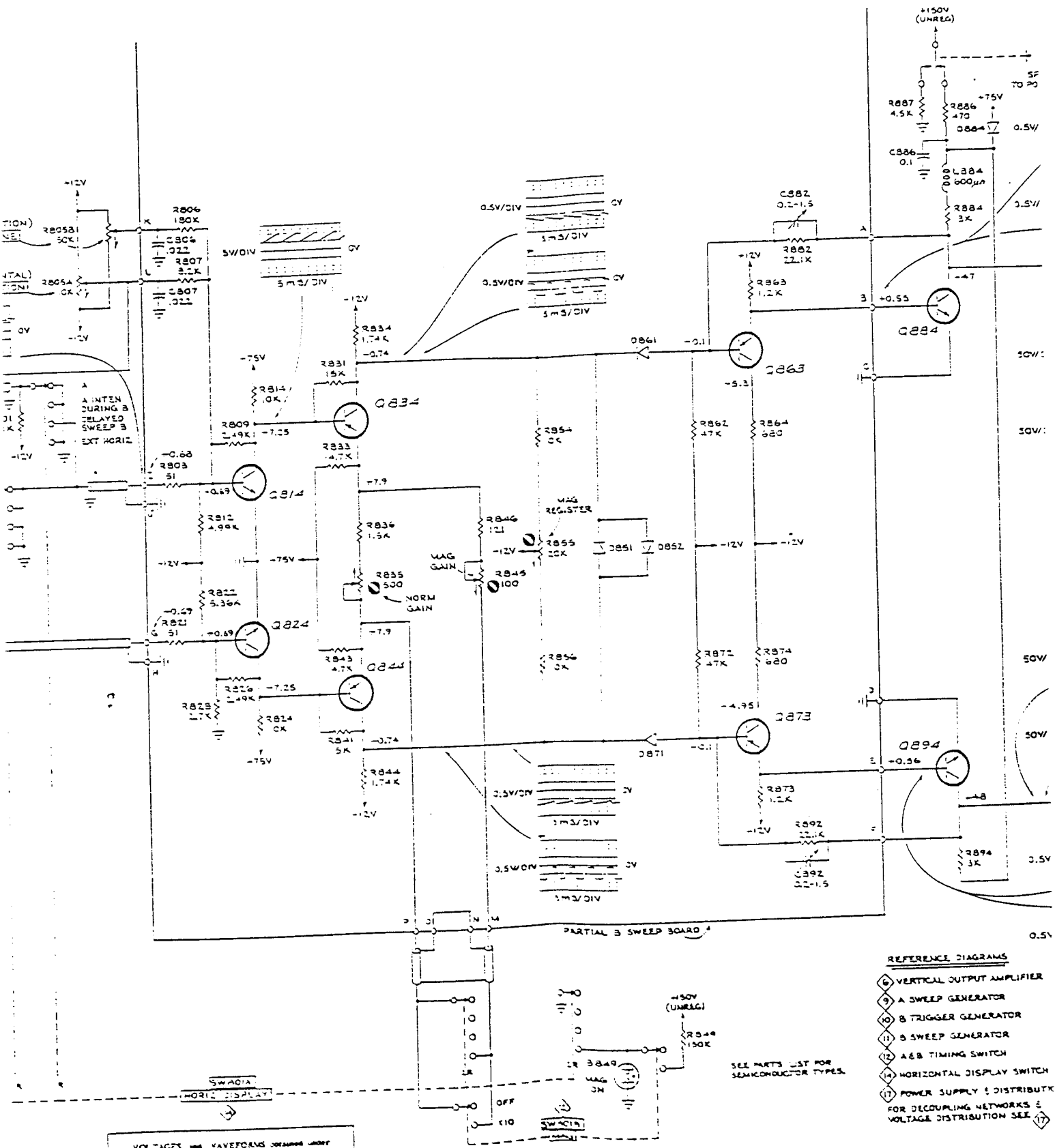

VOLTAGES and WAVEFORMS obtained under conditions shown on adjacent page are typical.

MAG	X10
-----	-----

- REFERENCE DIAGRAMS
- 6 VERTICAL OUTPUT AMPLIFIER
  - 9 A SWEEP GENERATOR
  - 10 B TRIGGER GENERATOR
  - 11 B SWEEP GENERATOR
  - 12 A&B TIMING SWITCH
  - 14 HORIZONTAL DISPLAY SWITCH
  - 17 POWER SUPPLY & DISTRIBUTION FOR DECOUPLING NETWORKS & VOLTAGE DISTRIBUTION SEE 17

SEE PARTS LIST FOR SEMICONDUCTOR TYPES.

HORIZONTAL AN

SCOPE

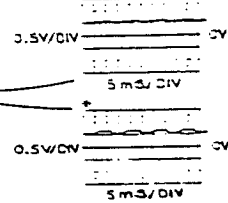
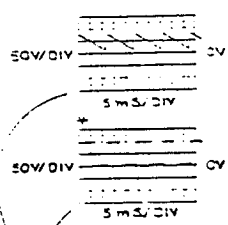
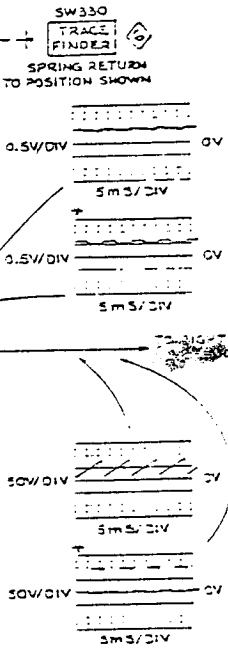
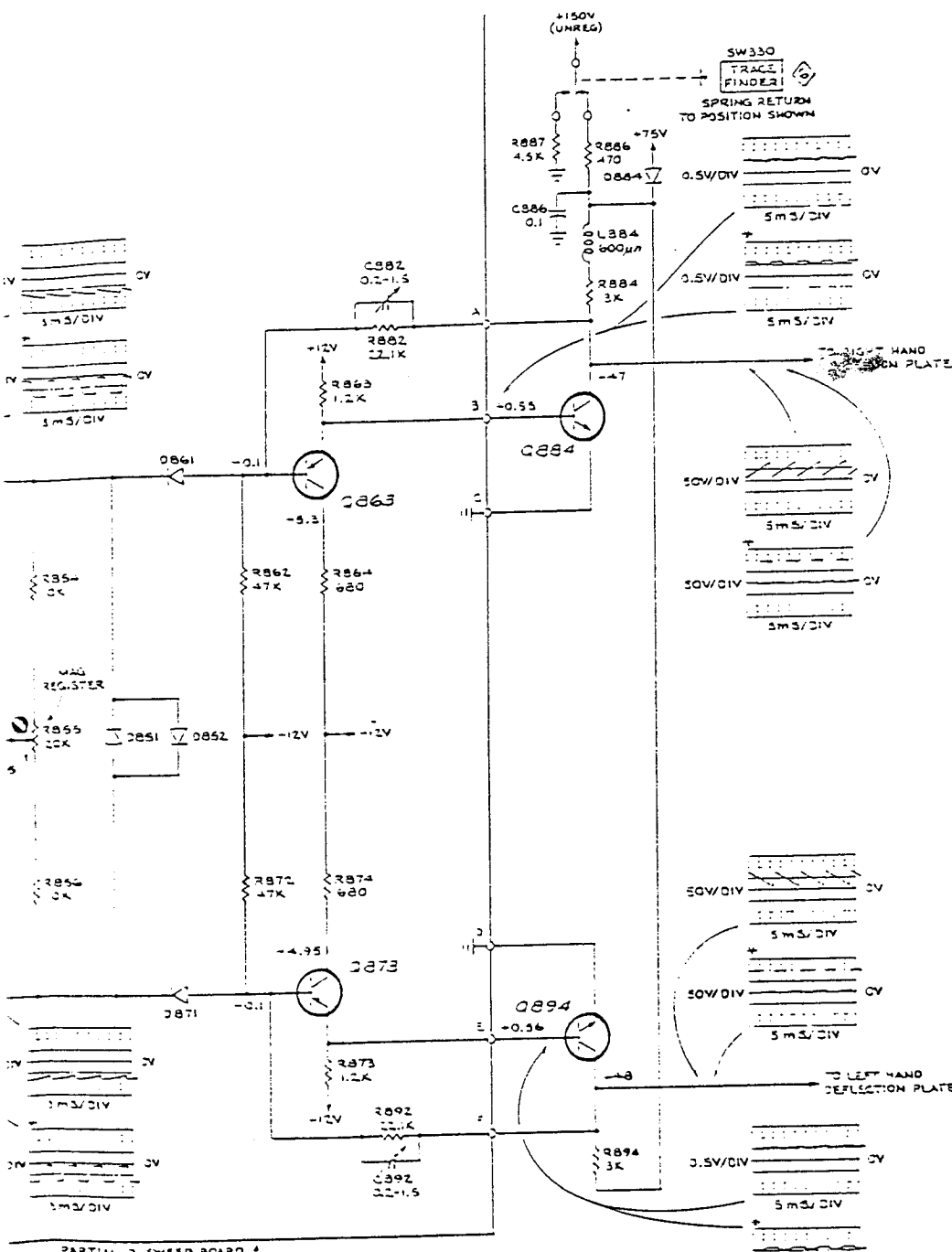

REFERENCE DIAGRAMS

- ① VERTICAL OUTPUT AMPLIFIER
- ② A SWEEP GENERATOR
- ③ B TRIGGER GENERATOR
- ④ B SWEEP GENERATOR
- ⑤ A & B TIMING SWITCH
- ⑥ HORIZONTAL DISPLAY SWITCH
- ⑦ POWER SUPPLY & DISTRIBUTION FOR DECOUPLING NETWORKS & VOLTAGE DISTRIBUTION SEE ⑦

HORIZONTAL AMPLIFIER ③

For Service Manuals Contact  
**MAURITRON TECHNICAL SERVICES**  
 8 Cherry Tree Rd, Chinnor  
 Oxon OX9 4QY  
 Tel:- 01844-351694 Fax:- 01844-352554  
 Email:- enquires@mauritron.co.uk

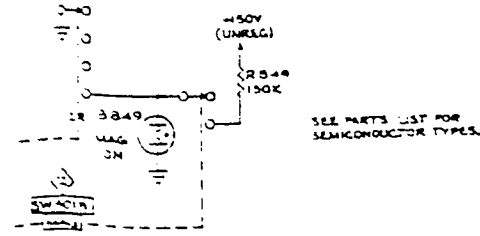

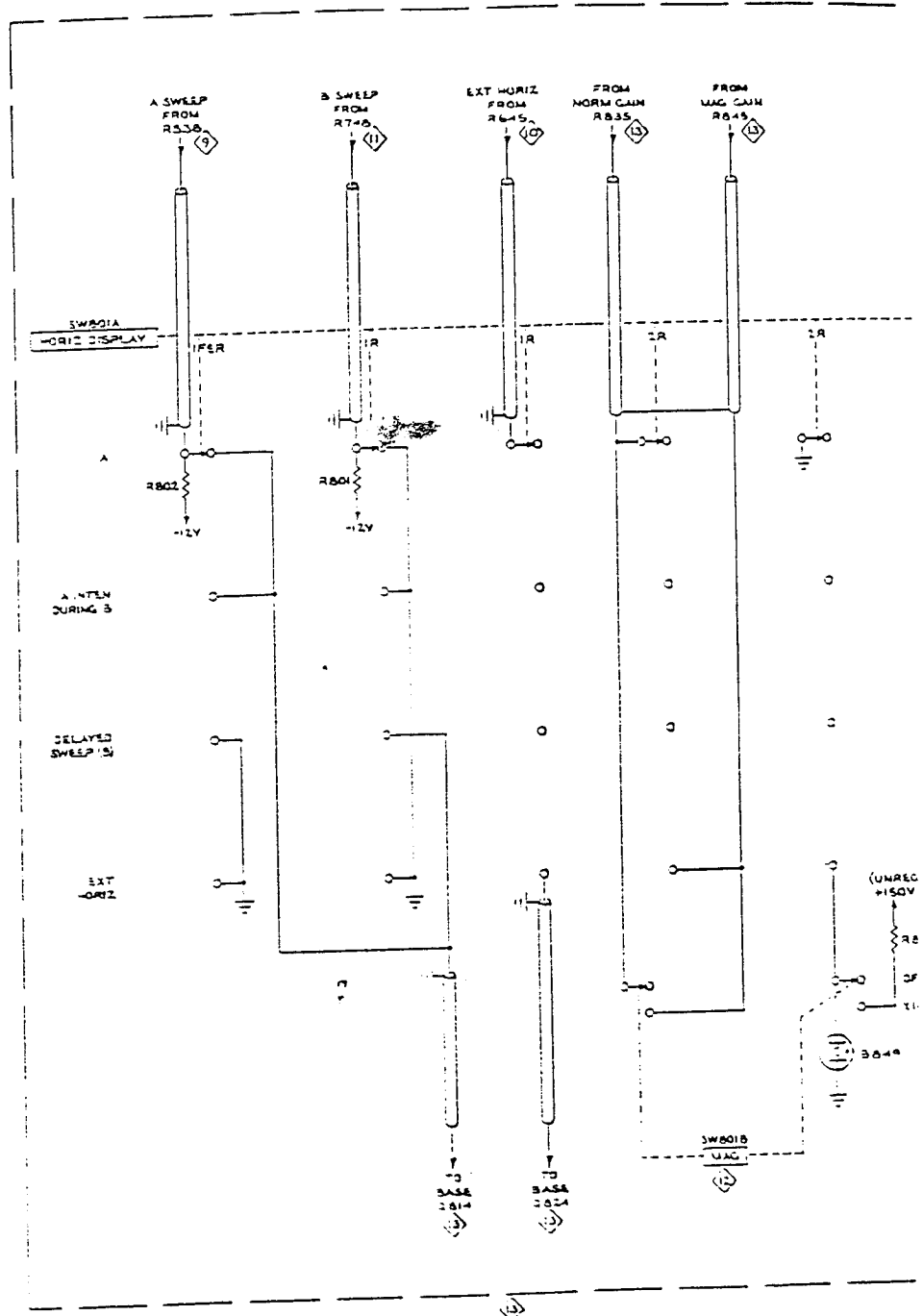

REFERENCE DIAGRAMS

- ① A SWEEP GENERATOR
- ② B TRIGGER GENERATOR
- ③ B SWEEP GENERATOR
- ④ HORIZONTAL AMPLIFIER
- ⑤ Z AXIS AMPLIFIER
- ⑥ A & B TIMING SWITCH

THE QUALITY OF  
THIS PAGE IS  
THE BEST THAT  
IS AVAILABLE

TYPE 453 OSCILLOSCOPE



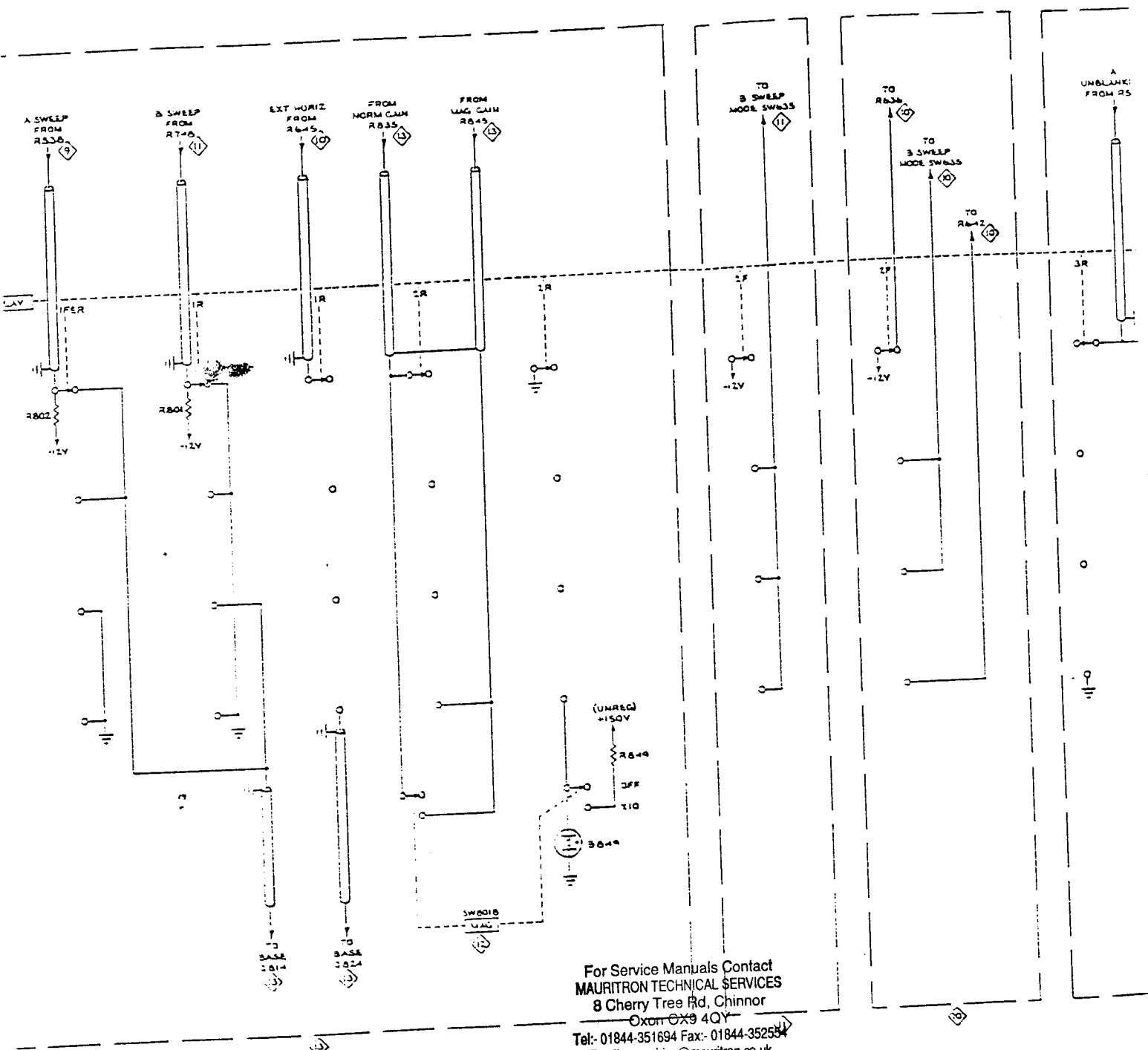

For Service Manuals Contact  
**MAURITRON TECHNICAL SERVICES**  
 8 Cherry Tree Rd, Chinnor  
 Oxon OX9 4QY  
 Tel: 01844-351694 Fax: 01844-352554  
 Email: enquiries@mauritron.co.uk

- REFERENCE DIAGRAMS**
- A SWEEP GENERATOR
  - B TRIGGER GENERATOR
  - B SWEEP GENERATOR
  - HORIZONTAL AMPLIFIER
  - Z AXIS AMPLIFIER
  - A & B TIMING SWITCH

THE QUALITY OF  
 THIS PAGE IS  
 THE BEST THAT  
 IS AVAILABLE

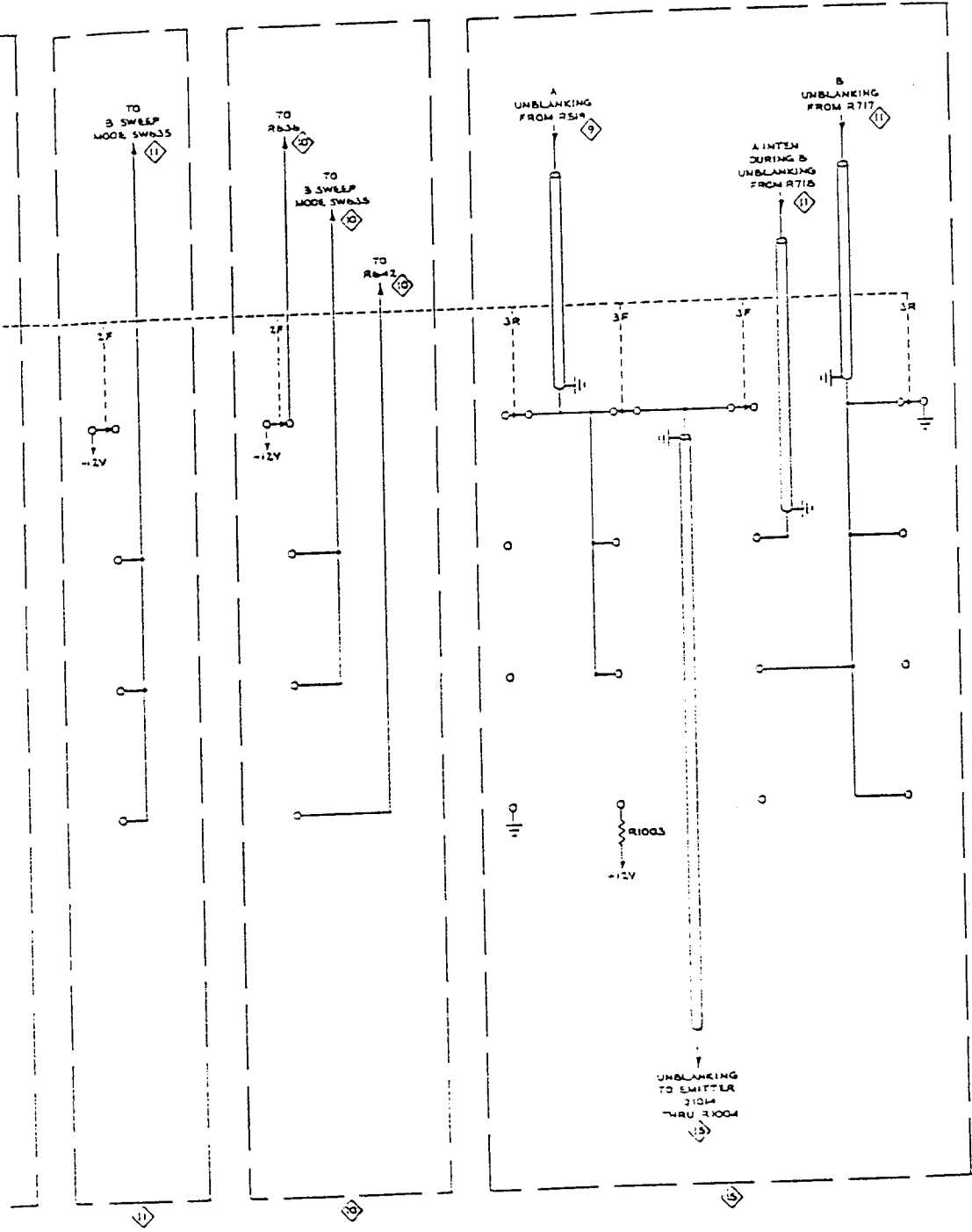

HORIZONTAL DISPLAY SWITCH



CMO  
310

HORIZONTAL DISPLAY SWITCH



1.

THE QUALITY OF  
THIS PAGE IS  
THE BEST THAT  
IS AVAILABLE

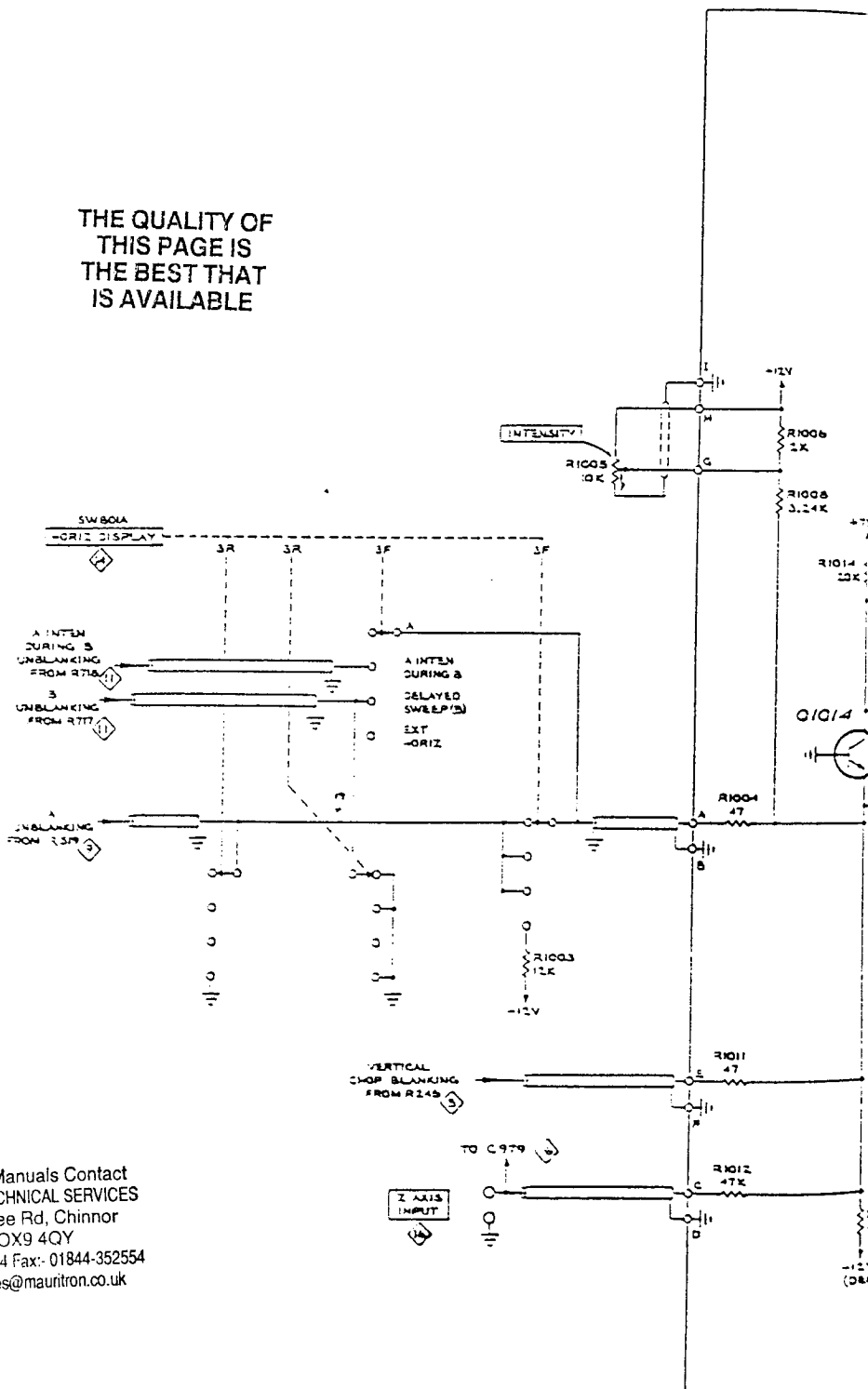

For Service Manuals Contact  
MAURITRON TECHNICAL SERVICES  
8 Cherry Tree Rd, Chinnor  
Oxon OX9 4QY  
Tel: 01844-351694 Fax: 01844-352554  
Email: enquiries@mauritron.co.uk

TYPE 453 OSCILLOSCOPE

QUALITY OF  
PAGE IS  
BEST THAT  
AVAILABLE

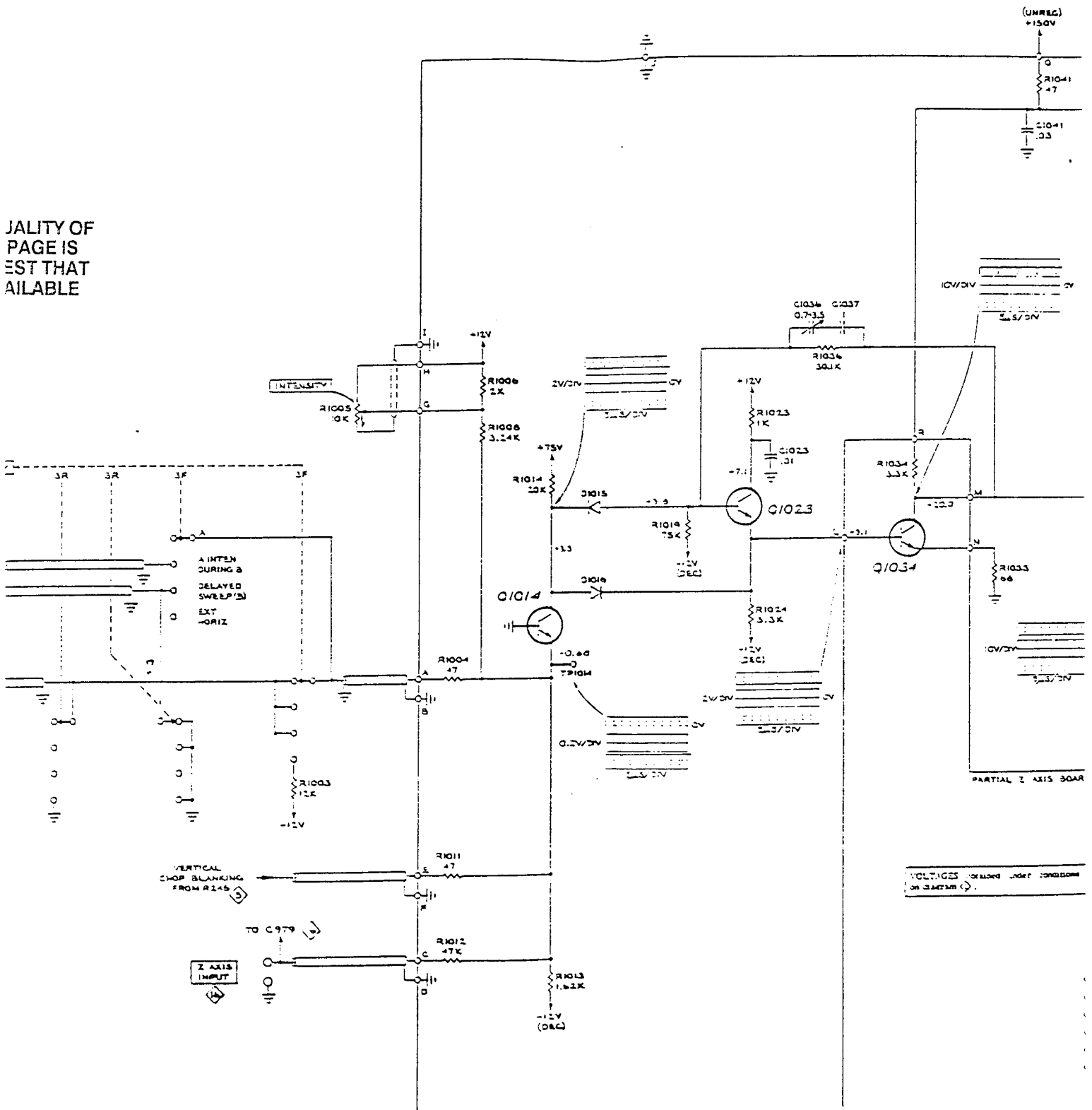

VOLTAGES MEASURED UNDER CONDITIONS  
OF OPERATION

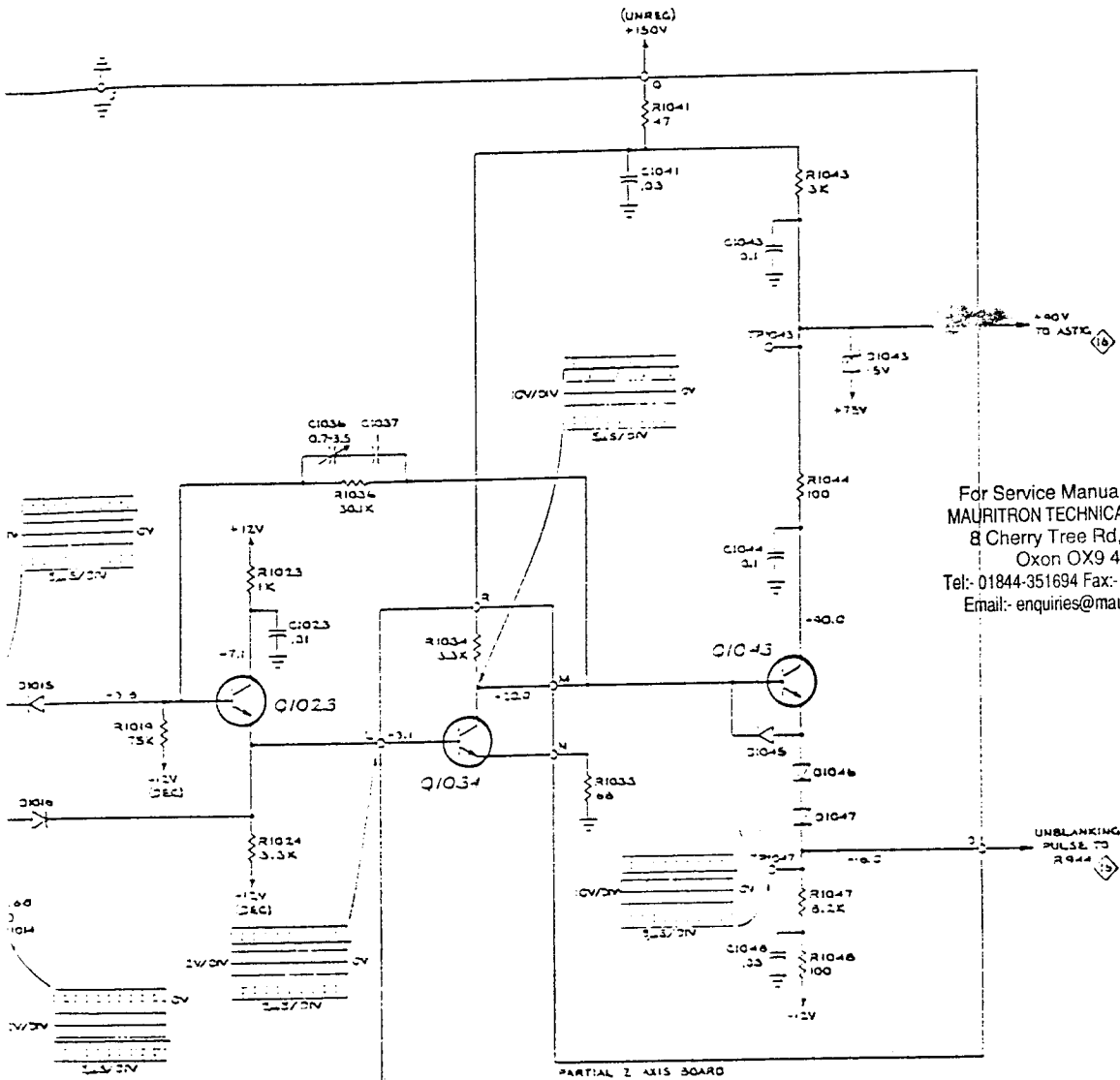

For Service Manuals Contact  
**MAURITRON TECHNICAL SERVICES**  
 8 Cherry Tree Rd, Chinnor  
 Oxon OX9 4QY  
 Tel: 01844-351694 Fax: 01844-352554  
 Email: enquiries@mauritron.co.uk

PARTIAL Z AXIS BOARD

SEE PARTS LIST FOR  
 SEMICONDUCTOR TYPES

VOLTAGES indicated under conditions given  
 on diagram (→)

FOR DECOUPLING NETWORKS &  
 VOLTAGE DISTRIBUTION SEE

REFERENCE DIAGRAM

- ◇ VERTICAL SWITCHING
- ◇ A SWEEP GENERATOR
- ◇ B SWEEP GENERATOR
- ◇ HORIZONTAL DISPLAY SWITCH
- ◇ CRT CIRCUIT
- ◇ POWER SUPPLY & DISTRIBUTION

CMS  
 363

Z AXIS AMPLIFIER ◇

Z AXIS AMPLIFIER

◇

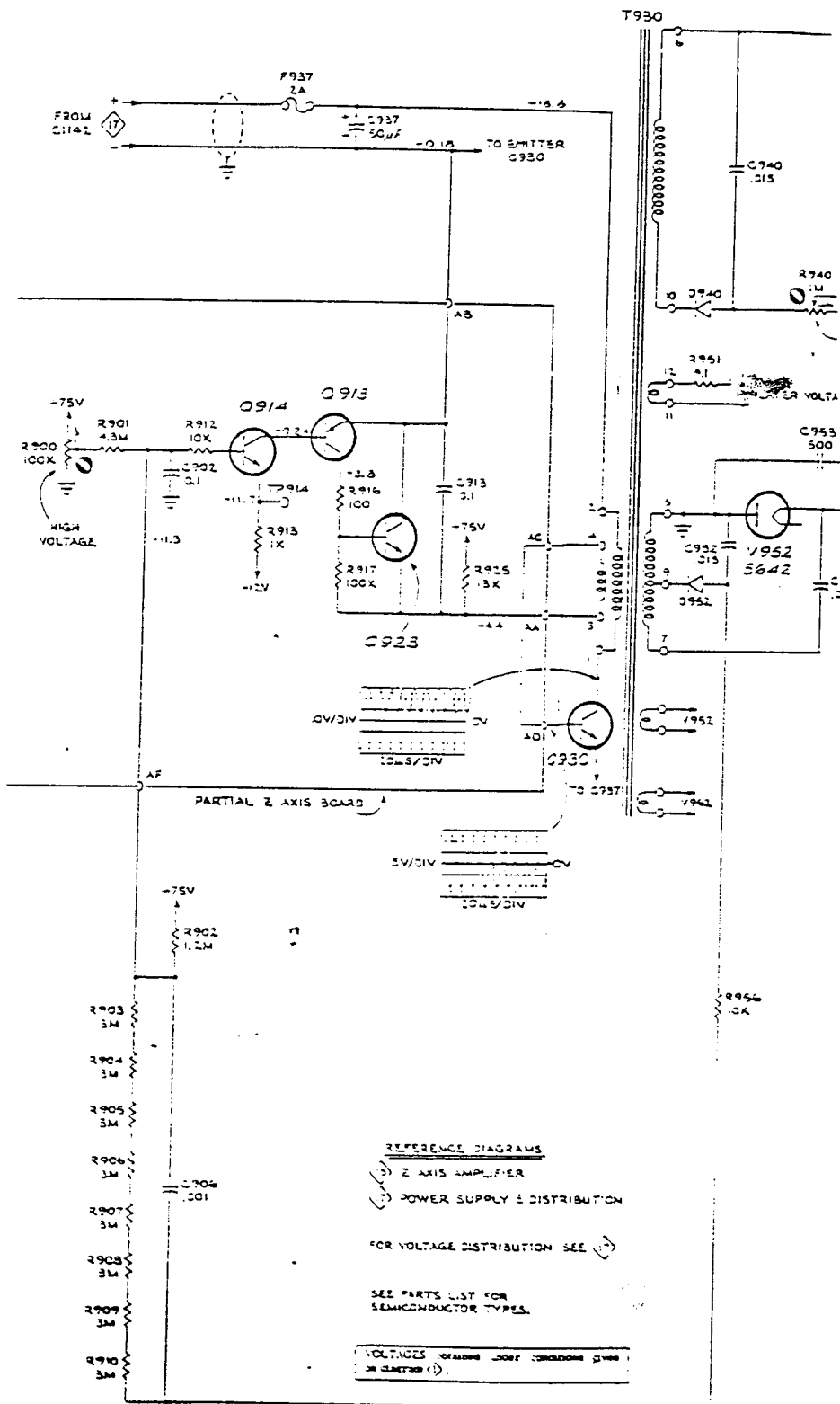

TYPE 453 OSCILLOSCOPE

SEE PARTS LIST FOR EARLIER VALUES AND SERIAL NUMBER RANGES OF PARTS MARKED WITH BLUE OUTLINE.

-1950V TP

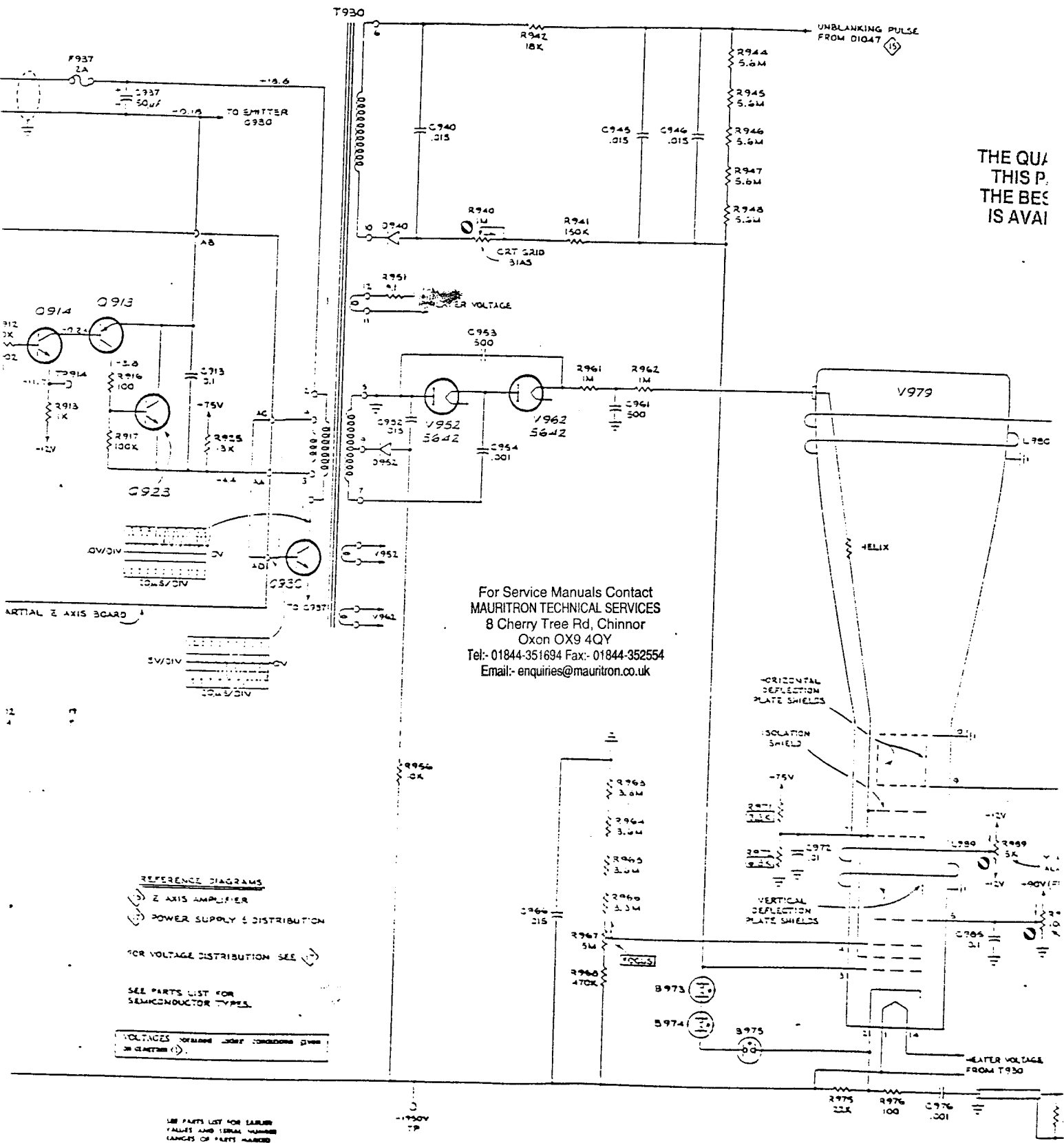

THE QUALITY  
THIS PRODUCT  
THE BEST  
IS AVAILABLE

For Service Manuals Contact  
MAURITRON TECHNICAL SERVICES  
8 Cherry Tree Rd, Chinnor  
Oxon OX9 4QY  
Tel: 01844-351694 Fax: 01844-352554  
Email: enquiries@mauritron.co.uk

REFERENCE DIAGRAMS  
 (1) Z AXIS AMPLIFIER  
 (2) POWER SUPPLY & DISTRIBUTION  
 FOR VOLTAGE DISTRIBUTION SEE (3)  
 SEE PARTS LIST FOR SEMICONDUCTOR TYPES  
 VOLTAGES OF TRANSISTORS AND CONDENSERS GIVEN IN CIRCLES (4)

SEE PARTS LIST FOR EARLIER  
VALUES AND SERIAL NUMBERS  
RANGES OF PARTS MARKED  
WITH BLUE OUTLINE

THE QUALITY OF THIS PAGE IS THE BEST THAT IS AVAILABLE

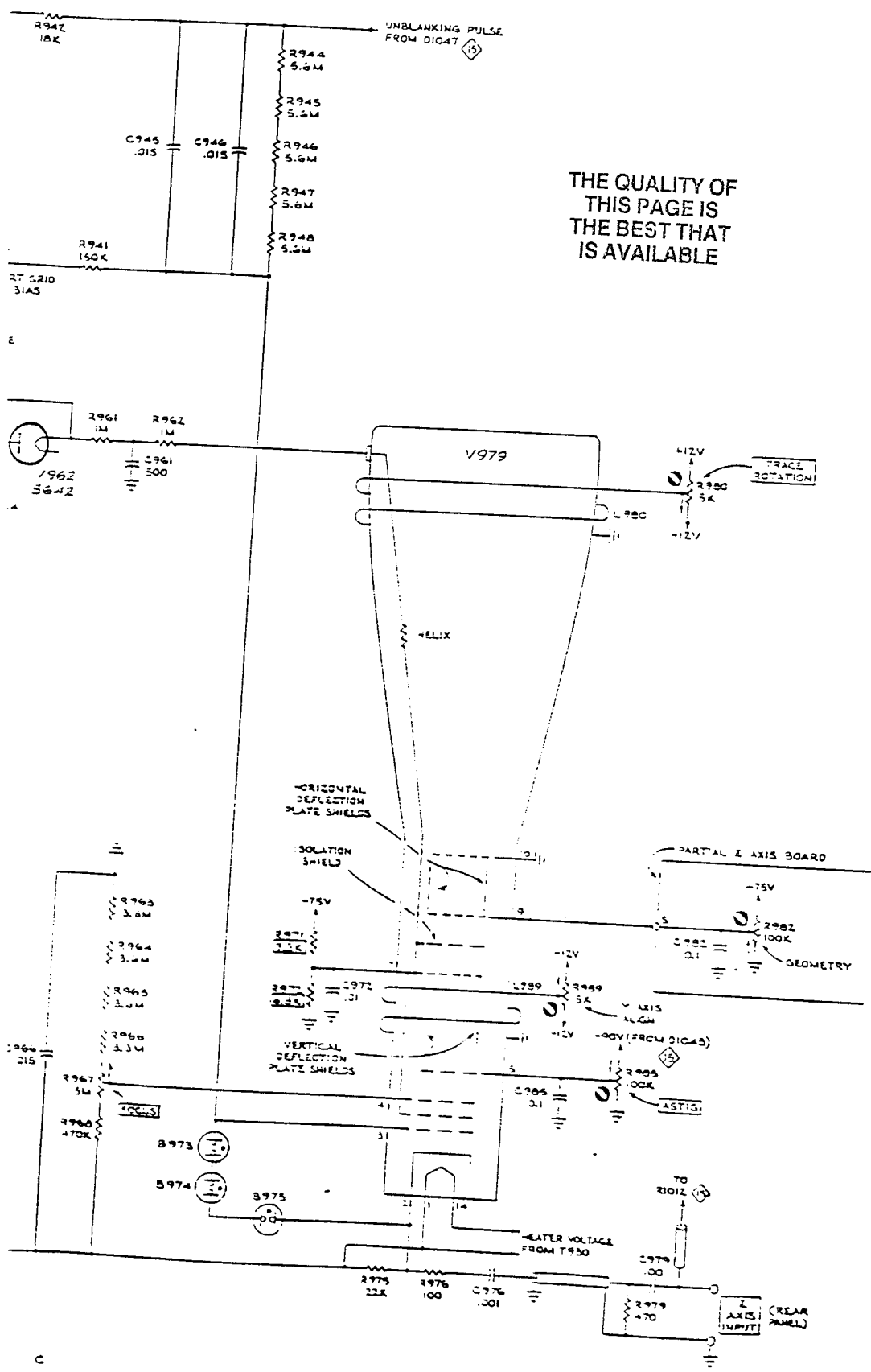

CRT CIRCUIT 16 DCM 466



THE QUALITY OF  
THIS PAGE IS  
THE BEST THAT  
IS AVAILABLE

For Service Manuals Contact  
MAURITRON TECHNICAL SERVICES  
8 Cherry Tree Rd, Chinnor  
Oxon OX9 4QY  
Tel: 01844-351694 Fax: 01844-352554  
Email: enquires@mauritron.co.uk

- REFERENCE DIAGRAMS
- 1. ELECTRICAL PREAMP
  - 2. ELECTRICAL PREAMP
  - 3. ELECTRICAL SWITCHING
  - 4. ELECTRICAL OUTPUT AMPLIFIER
  - 5. TRIGGER PREAMP
  - 6. TRIGGER GENERATOR
  - 7. SWEEP GENERATOR
  - 8. TRIGGER GENERATOR
  - 9. SWEEP GENERATOR
  - 10. HORIZONTAL AMPLIFIER
  - 11. X-Axis AMPLIFIER
  - 12. CRT CIRCUIT
  - 13. CALIBRATOR
  - 14. SEE PAGE 457 FOR SEMICONDUCTOR TYPES

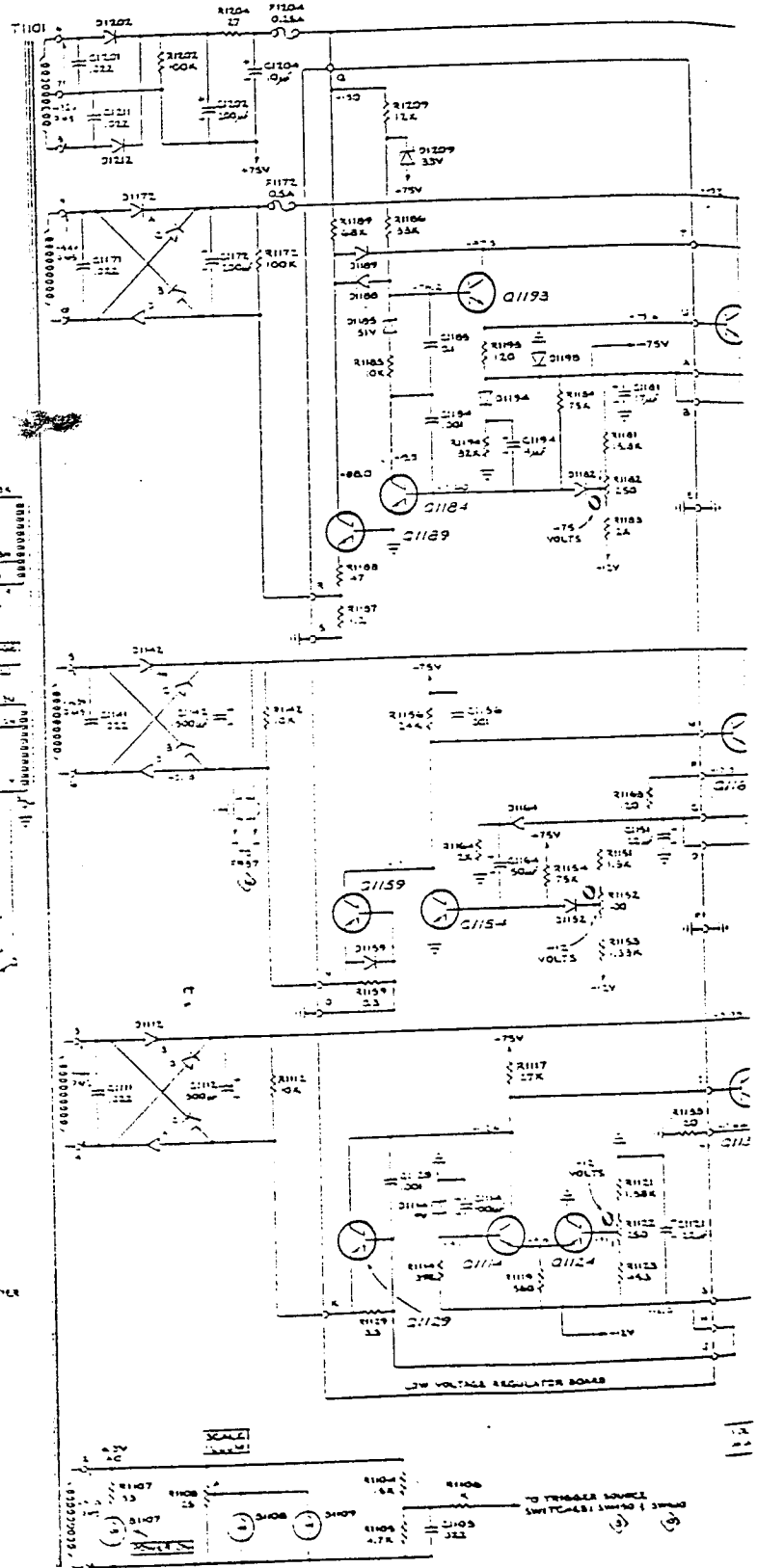

VOE 453 OSCILLOSCOPE

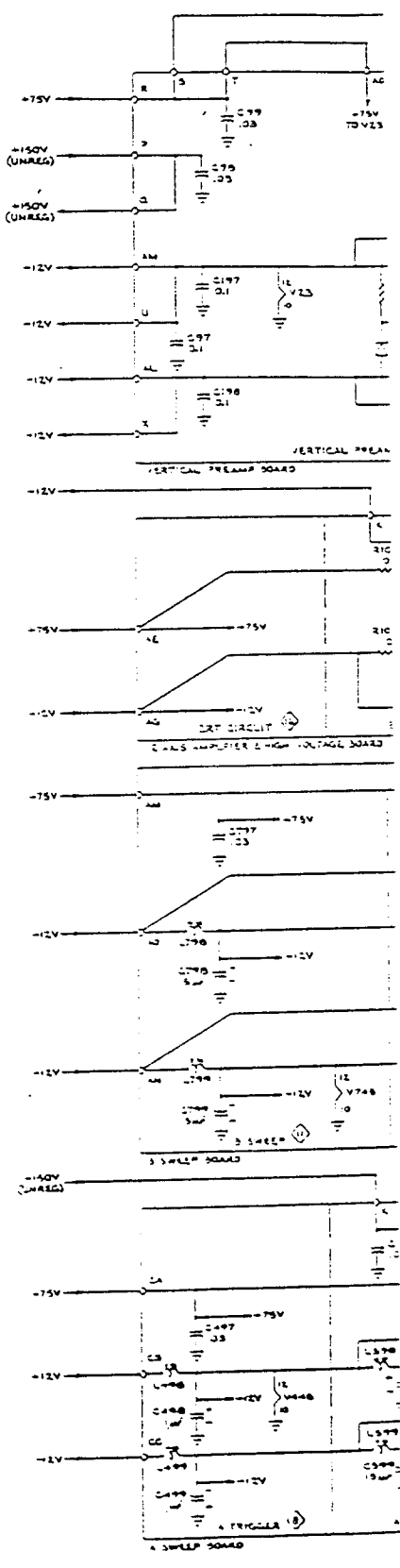
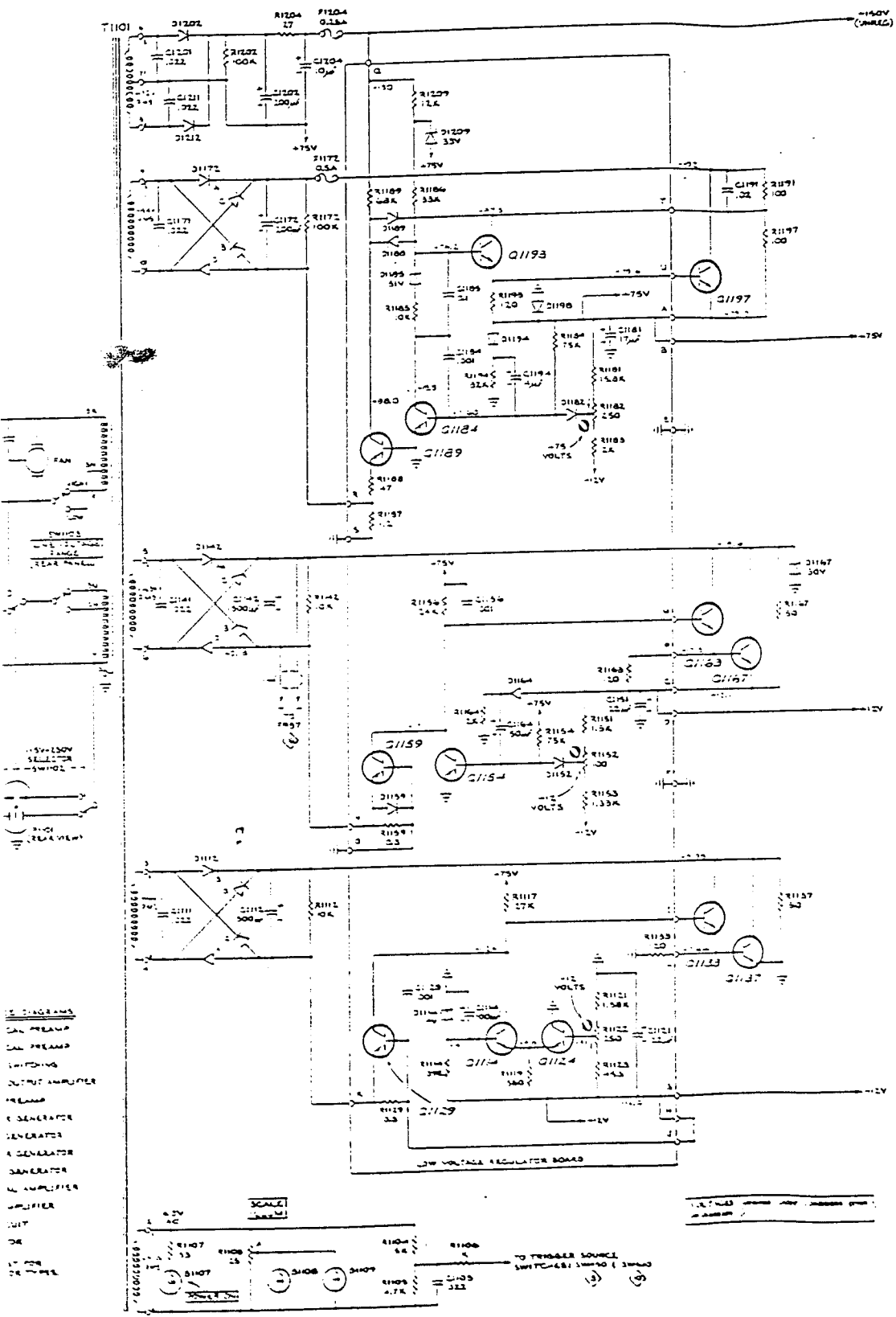

- 12 DIAGRAMS
- 13 CAL PREAMP
- 14 CAL PREAMP
- 15 SWITCHING
- 16 OUTPUT AMPLIFIER
- 17 PREAMP
- 18 GENERATOR
- 19 GENERATOR
- 20 GENERATOR
- 21 GENERATOR
- 22 AMPLIFIER
- 23 JUMPER
- 24
- 25
- 26
- 27
- 28
- 29
- 30

33 OSCILLOSCOPE



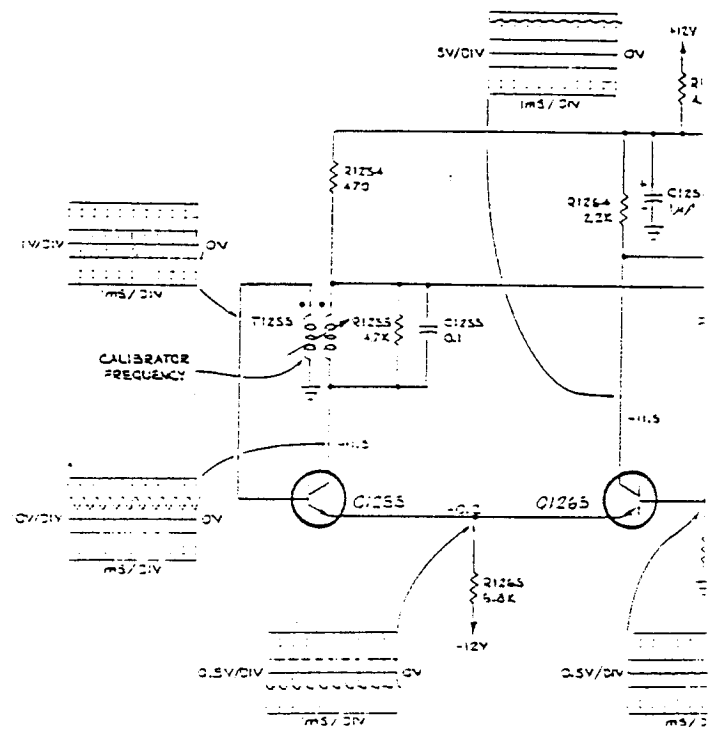

PARTIAL A SWEEP BOARD

FOR DECOUPLING NETWORKS & VOLTAGE DISTRIBUTION SEE 

THE QUALITY OF  
THIS PAGE IS  
THE BEST THAT  
IS AVAILABLE

TYPE 453 OSCILLOSCOPE

A.

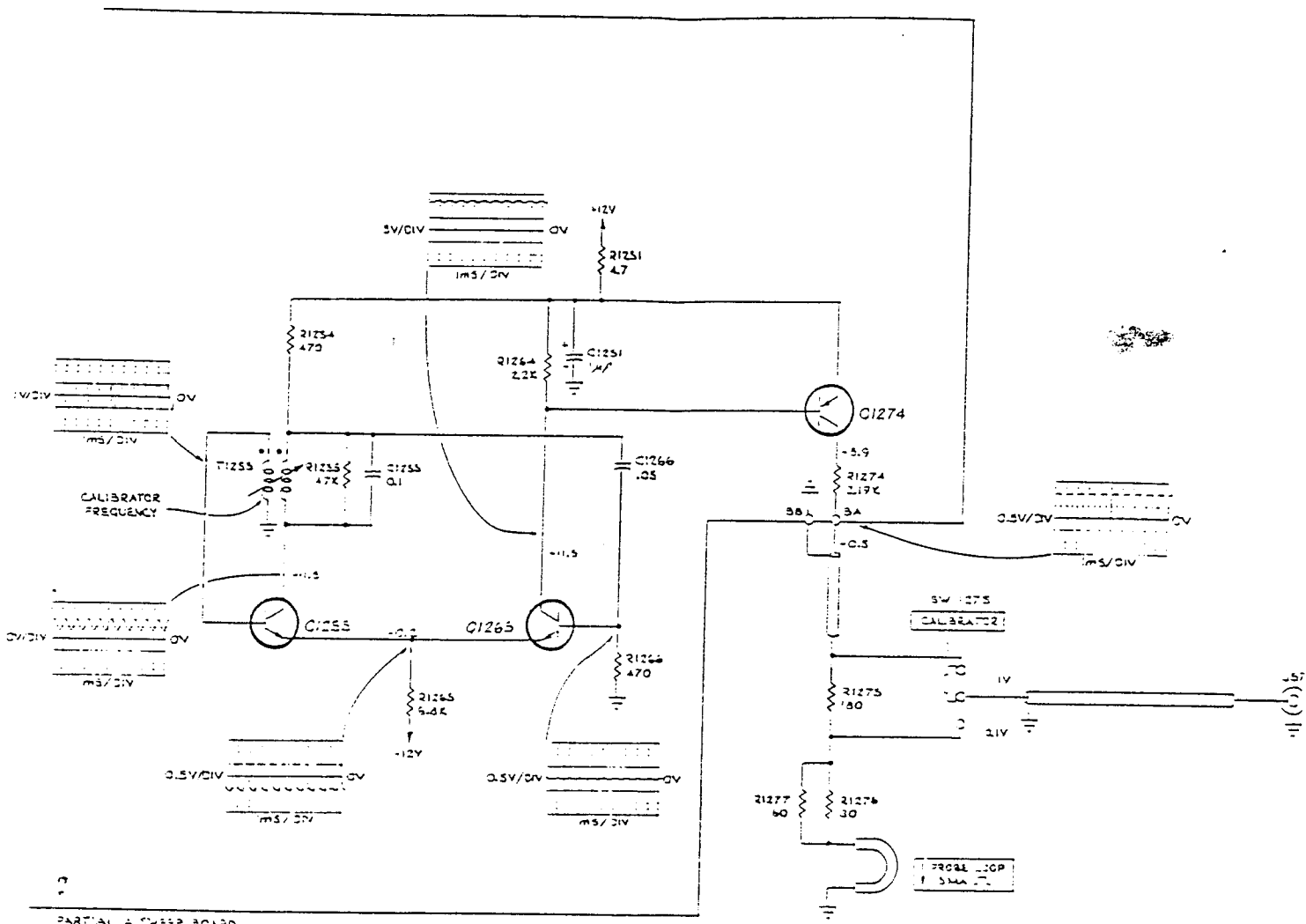

PARTIAL A SWEEP BOARD

FOR DECOUPLING NETWORKS & VOLTAGE DISTRIBUTION SEE (7)

SEE PARTS LIST FOR SEMICONDUCTOR TYPES

VOLTAGES and WAVEFORMS obtained under conditions given on diagram (8)

For Service Manuals Contact  
**MAURITRON TECHNICAL SERVICES**  
 8 Cherry Tree Rd, Chinnor  
 Oxon OX9 4QY  
 Tel:- 01844-351694 Fax:- 01844-352554  
 Email:- enquiries@mauritron.co.uk

TY OF  
 E IS  
 THAT  
 BLE

ILLOSCOPE

A,

C,

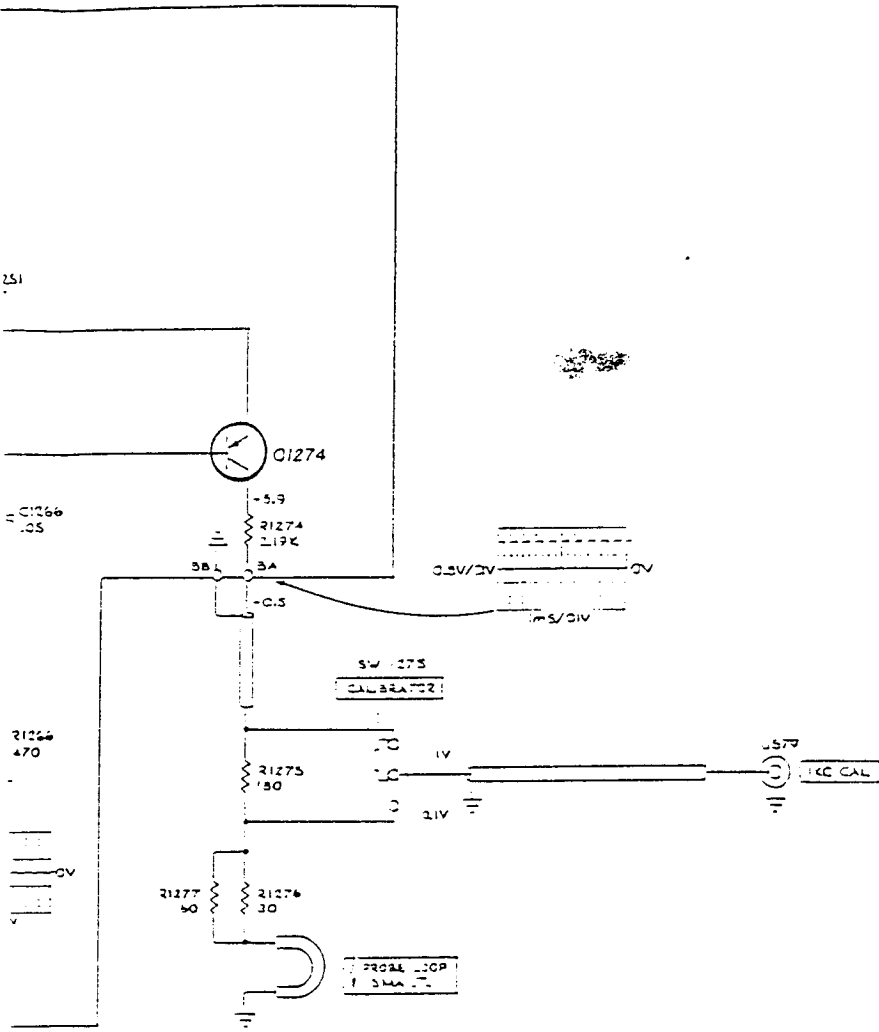

SEE PARTS LIST FOR SEMICONDUCTOR TYPES

VOLTAGES and WAVEFORMS obtained under conditions given on diagram (1)

CALIBRATOR



18  
CALIBRATOR