

TEK OPERATOR
MANUAL

Part No. 070-5614-00
Product Group 60

A6902B ISOLATOR

*Please Check for
CHANGE INFORMATION
at the Rear of This Manual*

First Printing JUL 1985
Revised JUN 1986

Tektronix[®]
COMMITTED TO EXCELLENCE

Copyright © 1985 Tektronix, Inc. All rights reserved.
Contents of this publication may not be reproduced in any
form without the written permission of Tektronix, Inc.

Products of Tektronix, Inc. and its subsidiaries are covered
by U.S. and foreign patents and/or pending patents.

TEKTRONIX, TEK, SCOPE-MOBILE, and  are
registered trademarks of Tektronix, Inc. TELEQUIPMENT
is a registered trademark of Tektronix U.K. Limited.

Printed in U.S.A. Specification and price change privileges
are reserved.

TABLE OF CONTENTS

LIST OF ILLUSTRATIONS	ii	BOTTOM PANEL	3-3
LIST OF TABLES	iii	INPUT PROBES	3-4
OPERATORS SAFETY SUMMARY	iv	Setting Probe-Tip Angles	3-4
 		Changing Input Probes	3-4
SECTION 1 SPECIFICATION		Replacing Common Leads	3-5
INTRODUCTION	1-1	Replacing the 3000-V Probe Tip	3-6
ACCESSORIES	1-2	Removing the Side Pouches	3-7
PERFORMANCE CONDITIONS	1-2	 	
 		SECTION 4	
SECTION 2 PREPARATION FOR USE		OPERATOR'S CHECKS AND ADJUSTMENTS	
INSTALLATION	2-1	INTRODUCTION	4-1
POWER CORDS	2-1	GAIN CHECK	4-1
POWER REQUIREMENTS	2-1	PROBE COMPENSATION	4-1
LINE VOLTAGE SELECTION	2-2	 	
CONNECTING THE A6902B ISOLATOR	2-4	SECTION 5 APPLICATION EXAMPLE	
 		INTRODUCTION	5-1
SECTION 3		EXAMPLE	5-1
CONTROLS, CONNECTORS AND INDICATORS		 	
FRONT PANEL	3-1	SECTION 6 OPTIONS AND ACCESSORIES	
REAR PANEL	3-2	OPTIONS	6-1
		STANDARD ACCESSORIES	6-1
		OPTIONAL POWER CORDS	6-1
		OPTIONAL ACCESSORIES	6-1

LIST OF ILLUSTRATIONS

Figure		Page
	The A6902B Isolator	vi
1-1	Maximum working voltage between probe input and probe common (all temperatures)	1-5
1-2	Maximum working voltage between probe common and earth ground	1-5
1-3	Common-lead feedthrough characteristics	1-9
1-4	A6902B dimensional drawing.....	1-14
2-1	Optional power cords and plugs	2-2
2-2	Fuse holder/line voltage selector.....	2-3
2-3	Example of connecting an input probe	2-5
2-4	Connecting the A6902B outputs to an oscilloscope	2-6
3-1	Front-panel controls and indicator	3-2
3-2	Rear- and bottom-panel controls, connectors, and labels	3-3
3-3	Setting the 3000-V probe tip angle and replacing the common lead.....	3-5
3-4	Replacing the 3000-V probe tip	3-6
5-1	Application example test circuit	5-1
5-2	Motor and gate waveforms at approximately 180° conduction	5-2
5-3	Motor and gate waveforms at approximately 360° conduction	5-2

LIST OF TABLES

Table		Page
1-1	Electrical Characteristics	1-3
1-2	Environmental Characteristics	1-12
1-3	Physical Characteristics	1-13
2-1	Line Voltage Ranges	2-4

OPERATORS SAFETY SUMMARY

The general safety information in this summary is for both operating personnel and servicing personnel. Specific warnings and cautions will be found throughout the manual where they apply and do not appear in this summary.

TERMS

In This Manual

CAUTION statements identify conditions or practices that could result in damage to the equipment or other property.

WARNING statements identify conditions or practices that could result in personal injury or loss of life.

As Marked on Equipment

CAUTION indicates either a personal injury hazard not immediately accessible as you read the marking or a hazard to property including the equipment itself.

DANGER or **WARNING—HIGH VOLTAGE** indicates a personal injury hazard immediately accessible as you read the marking.

SYMBOLS

As Marked on Equipment



DANGER – High voltage.



Protective ground (earth) terminal.

PRECAUTIONS

Power Source

This product is intended to operate from a power source that does not apply more than 250 volts rms between the supply conductors. A protective ground connection by way of the grounding conductor in the power cord is essential for safe operation.

Grounding the Product

This product is grounded through the grounding conductor of the power cord. To avoid electrical shock, plug the power cord into a properly wired receptacle before connecting to the product input or output terminals. A protective ground connection by way of the power cord is essential for safe operation. An earth-ground terminal is also provided on the rear panel.

Use the Proper Power Cord

Use only the power cord and connector specified for your product.

Use only a power cord that is in good condition.

For detailed information on power cords and connectors, see Figure 2-1 and "Accessories" (Section 6) in this manual.

Use the Proper Fuse

To avoid fire hazard, use only a fuse of the correct type, voltage rating, and current rating as specified in the parts list for your product.

Do Not Operate in Explosive Atmospheres

To avoid explosion, do not operate this product in an explosive atmosphere unless it has been specifically certified for such operation.

Do Not Remove Covers or Panels

To avoid personal injury, do not remove the product covers or panels. Do not operate the product without the covers and panels properly installed.

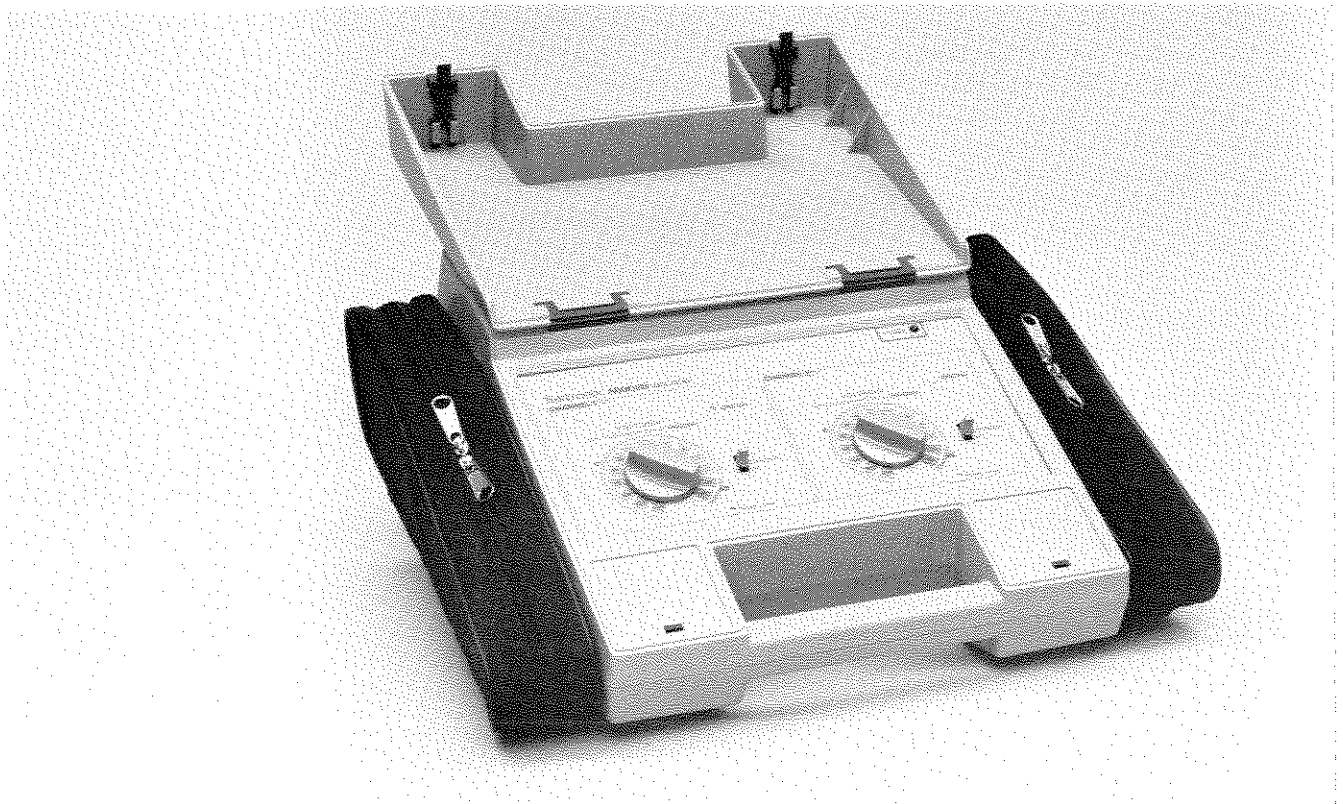

The A6902B.

5614-01

SPECIFICATION

INTRODUCTION

The TEKTRONIX A6902B Isolator is a two-channel instrument which will permit safe floating measurements of voltages up to 3000 V (dc + peak ac) above or below ground. It substitutes for the vertical amplifier of an oscilloscope when either high-voltage signals or small signals at a high voltage level are to be measured. These signals are isolated from the oscilloscope by a combination of optical and transformer coupling. This type of isolation, together with the all plastic construction of the external controls, protects the operator from exposure to high voltage levels when making control settings on the A6902B front panel.

Voltage to be measured is applied between the A6902B input probe tip and its common lead. When using the smaller probes (supplied as standard accessories with the instrument), the maximum differential voltage between channels is 1000 V (dc + peak ac). With the larger probes (supplied with Option 2), the maximum differential voltage between channels is 6000 V (dc + peak ac). All

measurements must be made with an oscilloscope having an input resistance of 1-M Ω , an input capacitance of up to 47 pF, and a vertical deflection factor of 100 mV per division (when necessary to use a connecting cable longer than that supplied, an oscilloscope with a deflection factor of 50 mV/division may be used in conjunction with a 50 Ω termination. An error in gain of up to $\pm 10\%$ may result from the use of this method).

The A6902B features include:

- Two isolated channels that may be used at the same time, either at different points in the same circuit or on separate circuits with different reference voltages.
- Dc to 20 MHz bandwidth.
- Plastic case and controls to provide a wide margin of operator safety.
- Two output cables.

- Two removable storage pouches for probes and cables.
- Floating inputs that meet the requirements of UL1244, IEC 348, and CSA Electronic Bulletin No. 556B.

ACCESSORIES

Standard accessories provided with the A6902B include two input probes and two 72-inch coaxial cables for connecting the Isolator output to oscilloscope and other instrument inputs. For more information on accessories

used with the A6902B, refer to the "Accessories" page at the rear of this manual.

PERFORMANCE CONDITIONS

The electrical specifications listed in Table 1-1 are valid under the following conditions: The A6902B Isolator was adjusted at an ambient temperature between +20°C and +30°C. The ambient operating temperature is between 0°C and +50°C with a warm-up period of at least 30 minutes.

Environmental characteristics are presented in Table 1-2, and the physical characteristics in Table 1-3.

**Table 1-1
Electrical Characteristics**

Characteristic	Performance Requirement	Supplemental Information
Deflection Factor		
Sensitivity	20 mV/div in a 1, 2, 5 sequence with oscilloscope set to 100 mV/div.	
Accuracy	≤ ±5% of indicated VOLTS/DIV switch setting.	
Maximum Working Voltage		
Large Probe (3000 V)		
Probe Center Tip to Earth Ground	3000 V (dc + peak ac). 1500 V (dc + peak ac), VDE.	
Probe Center Tip to Probe Common	3000 V (dc + peak ac) to 450 kHz. 1500 V (dc + peak ac), VDE.	For above 450 kHz, see Figure 1-1.
Probe Common to Earth Ground	3000 V (dc + peak ac) to 250 kHz. 1500 V (dc + peak ac), VDE.	For above 250 kHz, see Figure 1-2.

Table 1-1 (cont.)

Characteristic	Performance Requirement	Supplemental Information
Small Probe (500 V)		
Probe Center Tip to Earth Ground	500 V (dc + peak ac).	
Probe Center Tip to Probe Common	500 V (dc + peak ac) to 3 MHz.	For above 3 MHz, see Figure 1-1.
Probe Common to Earth Ground	500 V (dc + peak ac) to 6 MHz.	For above 6 MHz, see Figure 1-2.
Bandwidth (–3 dB)		
DC Coupled	DC to ≥ 20 MHz.	50 to 500 V/div. not specified.
AC Coupled	≤ 5 Hz to ≥ 20 MHz.	
Rise Time	≤ 17.5 ns.	50 to 500 Vdiv. not specified.

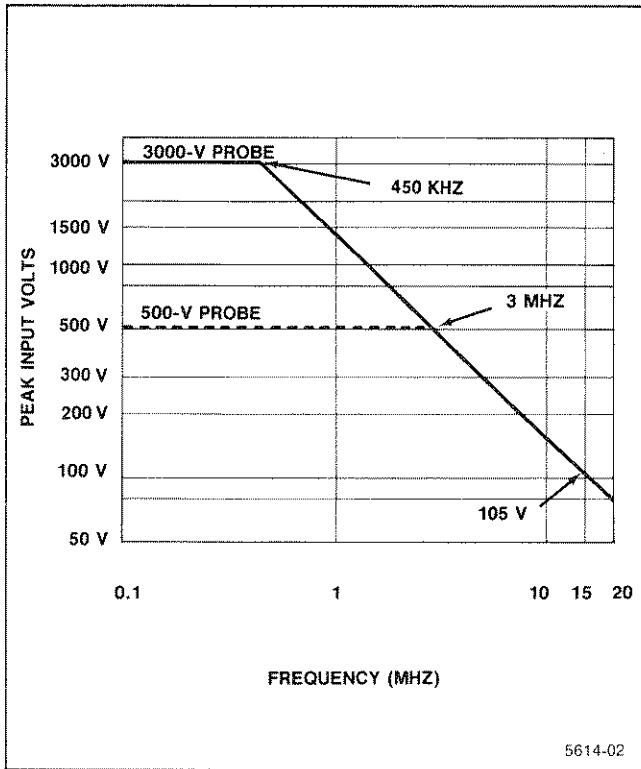

Figure 1-1. Maximum working voltage between probe input and probe common (all temperatures).

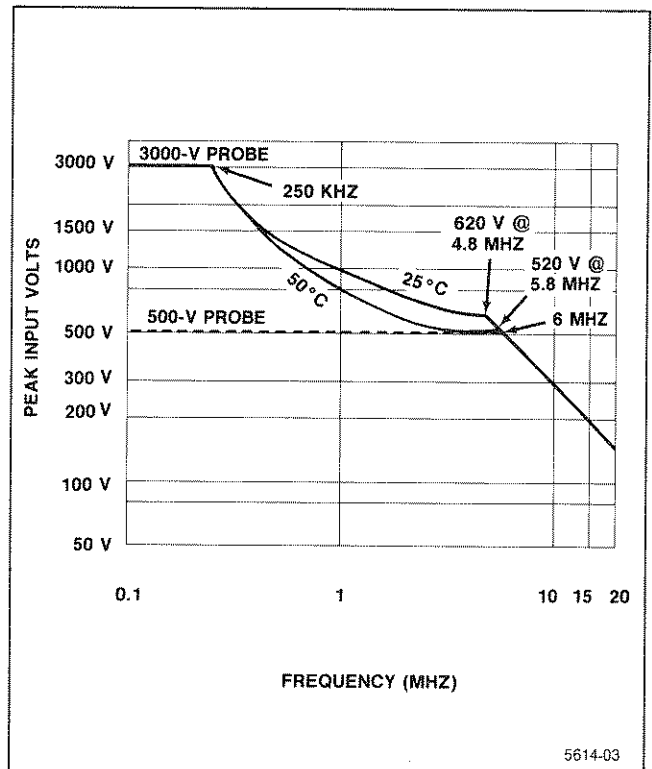

Figure 1-2. Maximum working voltage between probe common and earth ground.

Table 1-1 (cont.)

Characteristic	Performance Requirement	Supplemental Information
Aberrations		
20 mV/div. to 2 V/div.	$\pm 5\%$, 8% p-p. $\pm 0.3\%/^{\circ}\text{C}$ from 25°C.	Maximum dv/dt: 100 V/ns. 50 to 500 V/div. not specified.
5 V/div. to 10 V/div.	$\pm 8\%$, 12% p-p. $\pm 0.3\%/^{\circ}\text{C}$ from 25°C.	
20 V/div.	$\pm 10\%$, 14% p-p. $\pm 0.3\%/^{\circ}\text{C}$ from 25°C.	
Input Impedance (With Probe)		
Resistance	10 M Ω $\pm 3\%$.	
Nominal Capacitance		
Large Probe (3000 V)	19 pF	
Small Probe (500 V)	19 pF.	
Output Impedance	50 Ω $\pm 5\%$.	Output cable not 50- Ω terminated; calibrated on a 1-M Ω oscilloscope input.
Common-Mode Capacitance		100 pF nominal from probe common to earth ground.

Table 1-1 (cont.)

Characteristic	Performance Requirement	Supplemental Information
Tangential Sensitivity	≤ 20 mV.	
Output Noise		
Switching Power Supply	≤ 20 mV p-p, supply noise plus random noise.	Line voltage ≤ 115 V rms. (Add 0.6 mV p-p per volt above 115 V.)
60 Hz Ripple	≤ 20 mV p-p, ripple noise plus random noise.	
DC Drift Temperature Coefficient	≤ 10 mV/ $^{\circ}$ C or 0.1div/ $^{\circ}$ C at output.	
DC Balance	< 100 mV difference between any two VOLTS/DIV switch settings. Ambient temperature between 25 $^{\circ}$ C and 50 $^{\circ}$ C.	When operating at less than 25 $^{\circ}$ C, ZERO ADJ should be adjusted for the attenuator setting in use.
Range of ZERO ADJ Control	$\geq +$ and $-$ 5 divisions from center screen with oscilloscope set to 100 mV/div vertical deflection factor.	
Channel Isolation		
Maximum Voltage		
Using Two 3000 V Probes	6000 V (dc + peak ac). 3000 V (dc + peak ac), VDE.	
Using Two 500 V Probes	1000 V (dc + peak ac).	

Table 1-1 (cont)

Characteristic	Performance Requirement	Supplemental Information
Overdrive Recovery	$\leq 0.5 \mu\text{s}$ to recover to within 1 division of initial location after removing overdrive signal the equivalent of up to ± 25 divisions, regardless of the duration of the overdrive signal.	
Delay Difference Between Two Channels	$\leq 4 \text{ ns}$ from probe input to output BNC; when used with an oscilloscope having a $1\text{-M}\Omega$ input resistance and up to 47 pF input capacitance and when both probes are same type and properly compensated.	Typical delay from probe tip to output BNC is 52 ns .
Common-Lead Signal Feedthrough	-106 dB (dc to 500 Hz) from probe input to output BNC; when used with an oscilloscope having a $1\text{-M}\Omega$ input resistance and up to 47 pF input capacitance.	For above 500 Hz , see Figure 1-3. Measured with VOLTS/DIV switch set to 20 mV and AC-COMMON-DC switch set in common position.

NOTE

Common-lead signal feedthrough can be further optimized for a particular application. Refer the instrument to a qualified service technician.

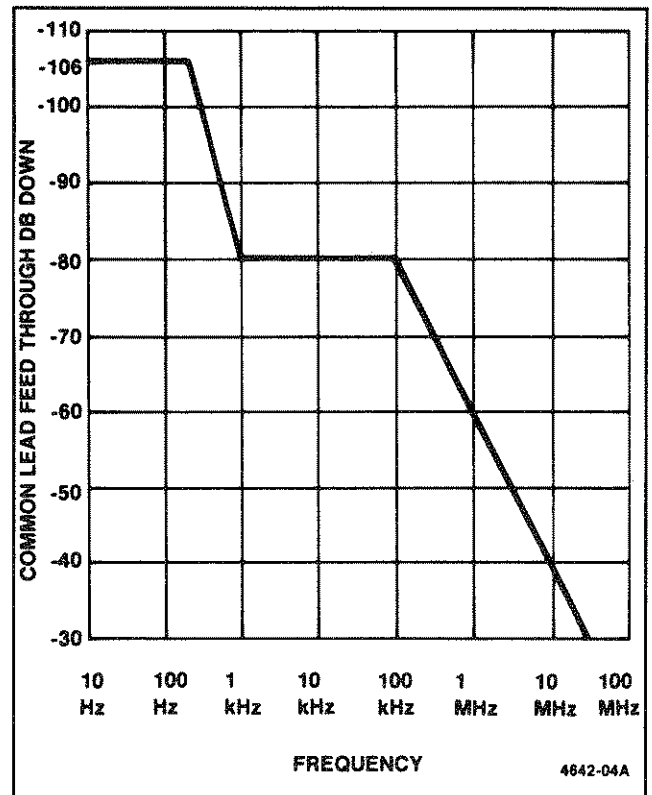

Figure 1-3. Common-lead feedthrough characteristics.

Table 1-1 (cont)

Characteristic	Performance Requirement	Supplemental Information
Line Voltage Ranges (rms)		
Low	90 to 132 V.	
High	180 to 250 V.	
Line Frequency Range	48 to 440 Hz.	
Power Consumption, Maximum	24 W at 115 V, 60 Hz.	Typical power consumption is 20 W.
Fuses for Line Voltage	0.30 A T/SB, 250 V, (90-132 V range). 0.15 A T/SB, 250 V, (180-250 V range).	
Internal Power Supply Voltages		
Ground Referenced Supply	+ 7 V \pm 0.5 V. - 7 V \pm 0.5 V.	Ripple \leq 10mV p-p.
Floating Supply	+ 5 V \pm 0.5 V. - 5 V \pm 0.5 V.	Ripple \leq 100 mV p-p.

Table 1-2
Environmental Characteristics

Characteristic	Description
Temperature	
Operating	0°C to +50°C.
Nonoperating (Storage)	-55°C to +75°C.
Altitude	
Operating	To 4.5 km (15,000 ft).
Nonoperating (Storage)	To 15 km (50,000 ft).
Humidity (Operating and Nonoperating)	Five cycles (120 hr total) with equipment tested nonoperating to MIL-STD-810C, Method 507.1, at 90% to 95% Relative Humidity and at 30°C to 60°C.
Vibration (Operating)	0.64 mm (0.025 in) p-p, 10 to 55 Hz sine wave. Total time of test, 75 minutes.
Shock	50 g, half-sine, 11-ms duration, for a total of 18 shocks.
Bench Handling	Instrument will withstand a drop from approximately 100 mm (3.9 in) at an angle of 45°.
Package Transportation	
Vibration	25 mm (1 in) at 270 vpm.
Drop	Package will withstand 10 drops from a height of 1 m (3.3 ft).

Table 1-3

Physical Characteristics

Characteristic	Description
Weight, With Accessories	6.2 kg (13.7 lb).
Shipping Weight	8.0 kg (17.7 lb).
Dimensions	See Figure 4.
Isolator	
Height	133 mm (5.2 in).
Width	394 mm (15.5 in).
Length	344 mm (13.5 in).
Large Probe (3000-V)	
Probe Cable Length	1.7 m (5.5 ft).
Probe Head Length	200 mm (7.9 in).
Probe Common Lead Length	300 mm (11.8 in).

Table 1-3 (cont)

Characteristic	Description
Dimensions (cont)	
Small Probe (500 V)	
Probe Cable Length	2 m (6.6 ft).
Probe Head Length	64 mm (2.5 in).
Probe Common Lead Length	300 mm (11.8 in).
Power Cable Length	3 m (9.8 ft).
Output Cable Length	1.8 m (6 ft).

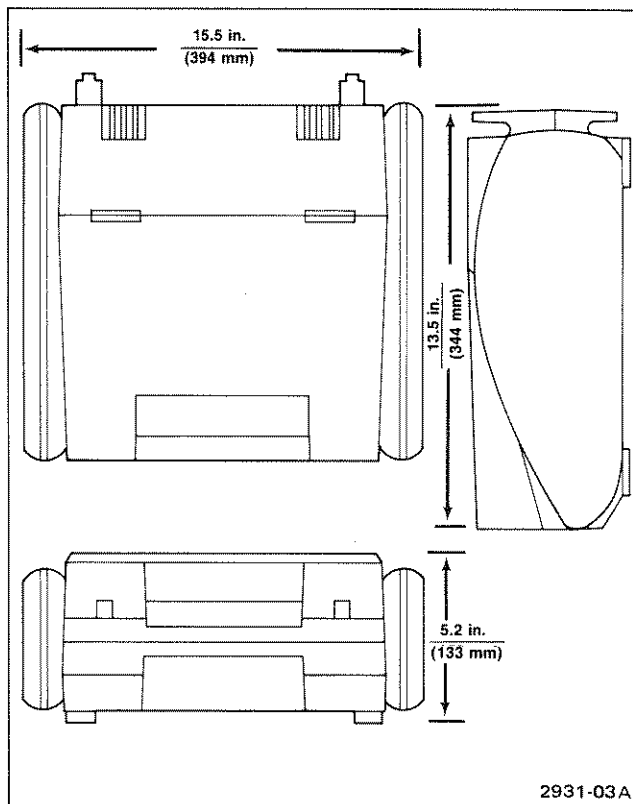
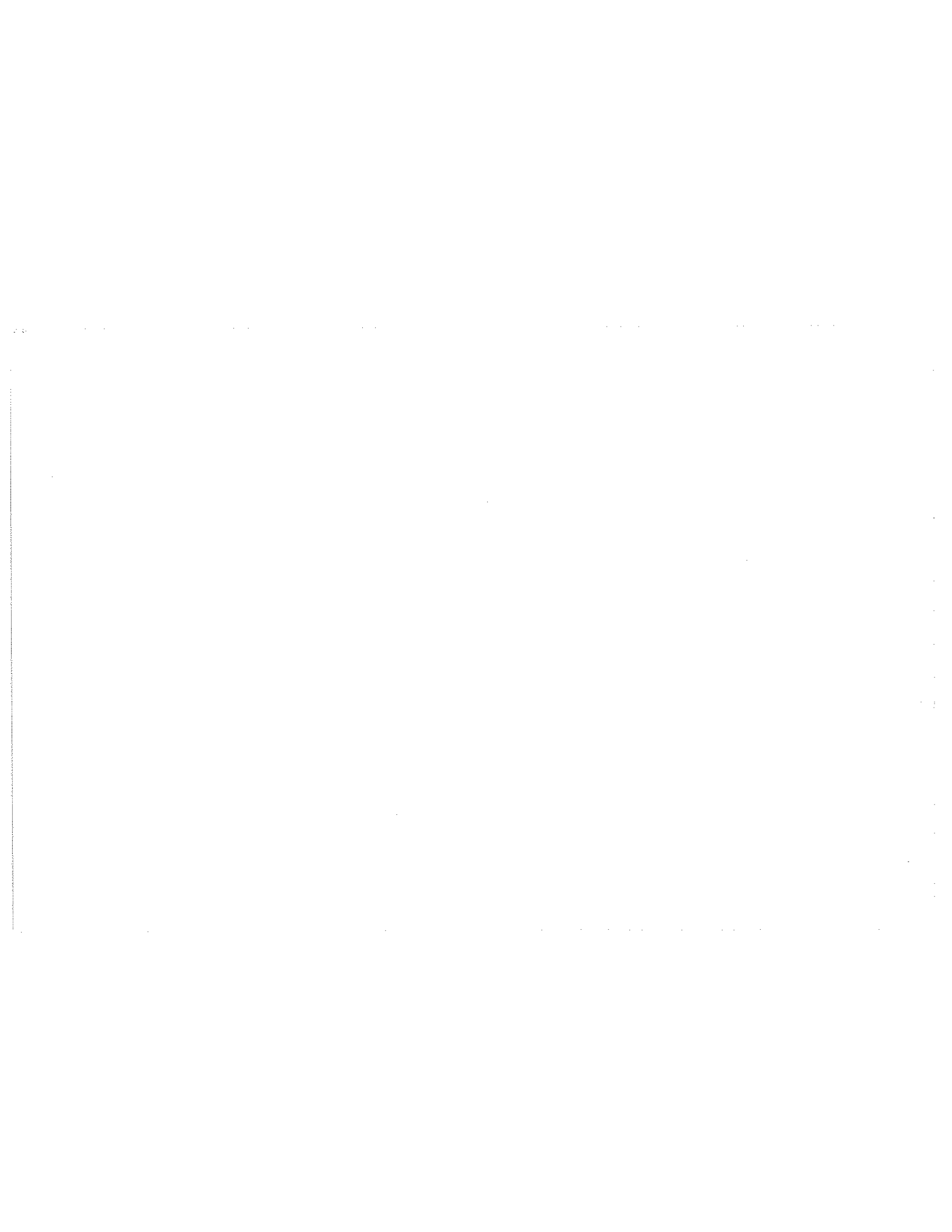

Figure 1-4. A6902B dimensional drawing.

Specification — A6902B



PREPARATION FOR USE

INSTALLATION

Installation of the A6902B consists of verifying the proper power cord, performing the "Line Voltage Selection" procedure, connecting the input probe(s) to the circuit under test, and connecting the output BNC connector(s) to an oscilloscope.

POWER CORDS





The A6902B has a detachable three-wire power cord with a three-terminal, polarized plug for connection to a power source. The grounding terminal of the plug is connected directly to the instrument frame as recommended by national and international safety codes. For electrical shock protection, this plug should only be inserted into a power-source socket that had a securely grounded protective ground contact. Qualified service personnel should verify the protective-ground system.

The power cord is detachable and when not in use should be wrapped around the cord storage lugs on the bottom of the A6902B. Instruments are factory equipped

with a standard 120-V power cord unless otherwise ordered. Other power cords that can be used with the A6902B are shown in Figure 2-1. Part numbers for the power cords are listed in "Accessories" (Section 6). For more information on power cords, contact your Tektronix representative or your local Tektronix Field Office.

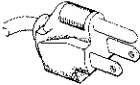
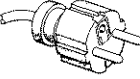
POWER REQUIREMENTS

The A6902B is designed to be used with a three-wire ac power system. It operates from either a 120-V or a 240-V nominal power source from 48 to 440 Hz. Before connecting the instrument to a power source, verify that the Line Voltage Selector is set for the line voltage being used, that the proper fuse is installed, and that the line cord matches the power source to be used. This procedure is described in the next paragraph and must be performed before operating the A6902B. Refer to the Safety Summary in the front of this manual for power source, grounding, and other safety considerations pertaining to the use of this instrument.

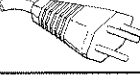
Plug Configuration	Usage	Line Voltage	Reference Standards	Option Number
	North American 120V/ 15A	120V	ANSI C73.11 NEMA 5-15-P IEC 83	Standard
	Universal Euro 240V/ 10-16A	240V	CEE (7),II,IV,VII IEC 83	A1
	UK 240V/ 13A	240V	BS 1363 IEC 83	A2
	Australian 240V/ 10A	240V	AS C112	A3
	North American 240V/ 15A	240V	ANSI C73.20 NEMA 6-15-P IEC 83	A4
	Switzerland 220V/ 6A	220V	SEV	A5
Abbreviations: ANSI — American National Standards Institute AS — Standards Association of Australia BS — British Standards Institution CEE — International Commission on Rules for the Approval of Electrical Equipment IEC — International Electrotechnical Commission NEMA — National Electrical Manufacturer's Association SEV — Schweizerischer Elektrotechnischer Verein				

2931-21

Figure 2-1. Optional power cords and plugs.

LINE VOLTAGE SELECTION

CAUTION

This instrument may be damaged if operated with the Line Voltage Selection switch set for the wrong voltage or if the wrong line fuse is used.

The power-input module located on the rear panel of the instrument houses a Line Voltage Selector, two line-fuses and a power cord connector. The present line voltage setting is indicated on the selector. The range in line voltage covered by each position is given in Table 2-1. If it is necessary to convert the instrument for operation with a different line voltage, perform the following procedure (refer to Figure 2-2).

1. Ensure that the power cord is disconnected from both the power source and the instrument and that both of the input probes and their common leads are disconnected from any electrical source.

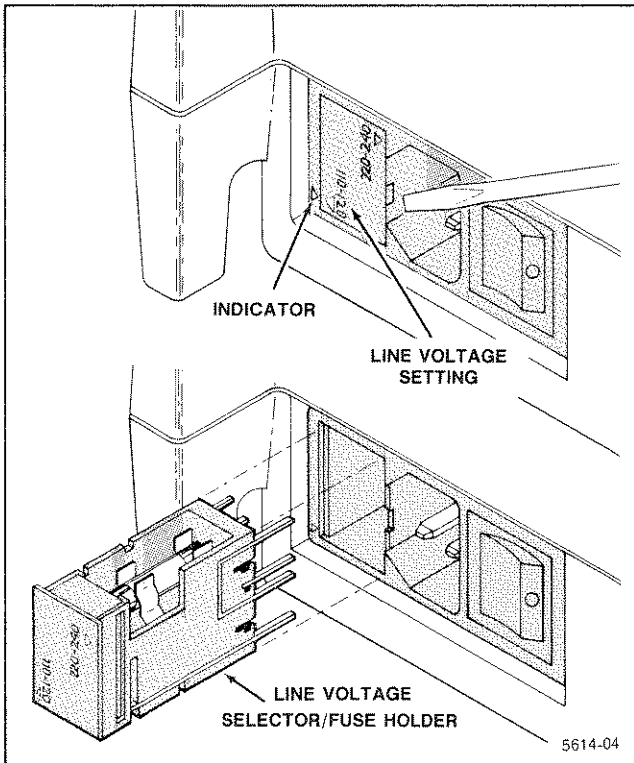

Figure 2-2. Fuse holder/line voltage selector.

2. Using a flat-bladed screwdriver, pry out the Line Voltage Selector. (Refer to Figure 2-2.)

3. From Table 2-1, determine the range for your average line voltage. Opposite that range, read the correct Line Voltage Selector position.

Table 2-1
Line Voltage Ranges

Line Voltage Range	Voltage Selector Switch Setting	Fuse Size
90 to 132 V	110 - 120	0.3A, 250V 3AG, SLOW
180 to 250 V	220 - 240	0.15A, 250V 3AG, SLOW

NOTE

Fuses for both line-voltage settings are installed in the Line Voltage Selector when the instrument is shipped. When the Selector is rotated to the desired setting, the proper fuse is automatically installed in the circuit. Confirm that both fuses are installed in the Selector.

4. Rotate the Line Voltage Selector so the proper range lines up with the indicator on the frame of the power-input module (refer to Figure 2-2), and insert it back into the module.

WARNING

This instrument is designed for operation from a power-input source with its neutral at or very near earth (ground) potential with a separate safety-earth conductor.

5. Verify that your power cord matches the power source being used (see Figure 2-1).
6. Confirm that the POWER switch is set to OFF and connect the receptacle end of the power cord to the power-input module.

CONNECTING THE A6902B ISOLATOR

WARNING

Before connecting any A6902B input probe(s) to a circuit under test, ensure that the Maximum Working Voltage limits and the Channel Isolation Maximum Voltage limits will not exceed those values listed in the Specification (Table 1-1).

Figure 2-3 shows an example of how to connect an A6902B input probe. Although this illustration shows the 3000-V probe, it is equally applicable for any A6902B probe.

The common lead of the probe should always be connected to the lowest impedance point (usually circuit common) in the circuit under test (relative to the probe tip) to obtain the most accurate waveform.

Whenever the type of input probe is changed (for example, changing from the 3000-V probe to the 500-V probe), a compensation adjustment must be made. Refer to the "Gain and Probe Compensation" procedure in "Operators Checks and Adjustments" (Section 4).

Figure 2-4 shows how the output BNC connectors are connected to an oscilloscope using the coaxial cables.

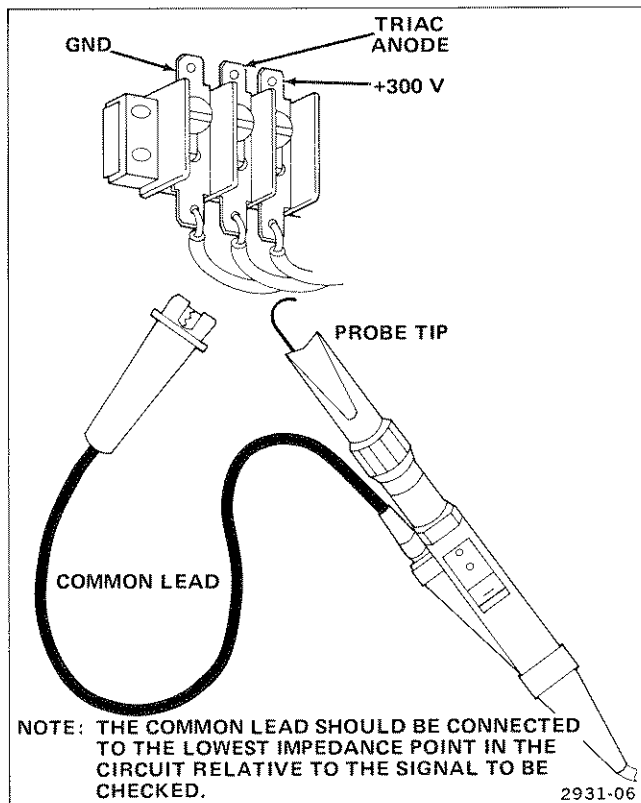

Figure 2-3. Example of connecting an input probe.

Whenever the type of input probe is changed (for example, changing from the 3000-V probe to the 500-V probe), a compensation adjustment must be made. Refer to the "Gain and Probe Compensation" procedure in "Operator's Checks and Adjustments" (Section 4).

Figure 2-4 shows how the output BNC connectors are connected to an oscilloscope using the coaxial cables.

NOTE

If both outputs of the A6902B are to be used at the same time, both cables should be the same length and impedance. Cable length should not exceed two meters and should be of 50-Ω impedance. Do not use any termination with the cables.

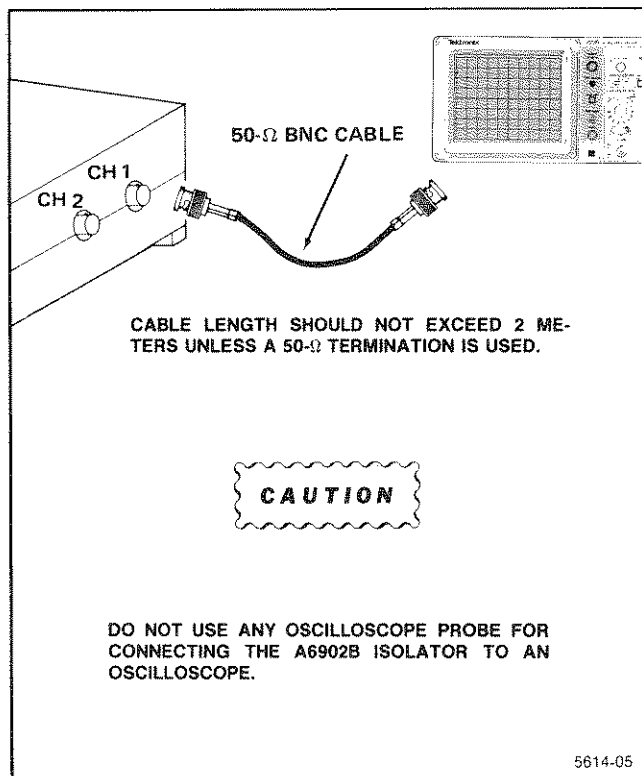

Figure 2-4. Connecting the A6902B outputs to an oscilloscope.

CONTROLS, CONNECTORS AND INDICATORS

FRONT PANEL

Refer to Figure 3-1 for the location of items 1 through 5.

NOTE

Only CHANNEL 2 controls (items 2 through 5) and the POWER indicator (item 1) are shown. CHANNEL 1 controls are identical to CHANNEL 2.

- ① **POWER** indicator is on whenever the Isolator is energized.
- ② **VOLTS/DIV** switches establish the sensitivity of the oscilloscope/Isolator system. The sensitivity is adjustable from 20 mV/division to 500 V/division in a 1, 2, and 5 sequence.
- ③ **ZERO ADJ** controls are used for adjusting the output DC level to zero volts with zero volts input to the A6902B.
- ④ **AC-COMMON-DC** switches select the coupling between the input probe and the input stage of the Isolator. In DC, the input is directly coupled; in AC the input is connected to the Isolator through a capacitor; and in COMMON the input is connected to the electronic circuitry Common terminal within the Isolator. (COMMON is comparable to the GND position on a conventional oscilloscope. It connects the input to a reference level so the operator can set the position control).
- ⑤ **PROBE COMP** controls are used to compensate the input stages of the Isolator when the input probes are changed.

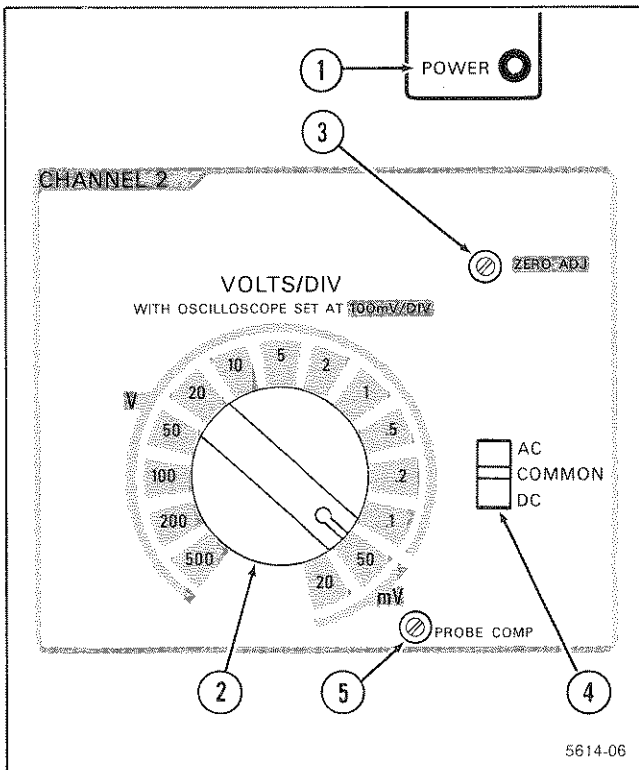

Figure 3-1. Front-panel controls and indicator.

REAR PANEL

Refer to Figure 3-2 for the location of items 6 through 10.

- ⑥ **POWER SWITCH** controls application of ac power to the Isolator. An indicator light on the front panel is actuated when the power switch is in its "on" position (1).
- ⑦ **POWER CONNECTOR/VOLTAGE SELECTOR** allows the connection of the ac power cord to the Isolator. The connector is an IEC connector, and includes the Voltage Selector/Indicator for alternative line voltage, (fully discussed in the "Preparation For Use" section of this manual.)
- ⑧ **OUTPUT VOLTAGE** connectors make available the output of Isolator Channels 1 and 2.
- ⑨ **CAUTION** label provides fuse replacement and line voltage information.

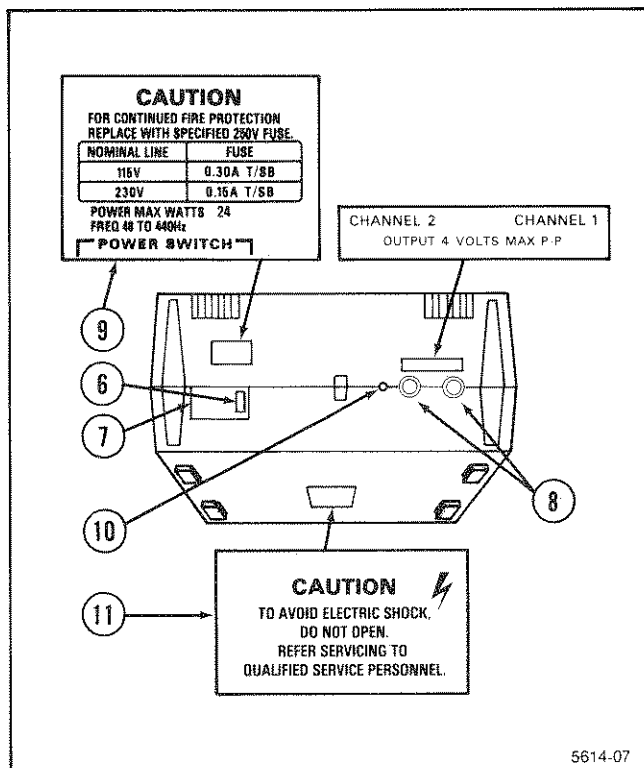

Figure 3-2. Rear- and bottom-panel controls, connectors, and labels.

- ⑩ **EARTH-GROUND CONNECTION** is a standard banana-plug connector attached to the Isolator chassis ground.

BOTTOM PANEL

Refer to Figure 3-2 for the location of item 11.

- ⑪ **CAUTION** label warns operators not to open the A6902B case.

INPUT PROBES

SETTING PROBE-TIP ANGLES

The angle of the 500-V probe tip is continuously variable and may be rotated to any desired position.

The angle of the 3000-V probe tip may be rotated in 90° increments, if necessary, to make it easier to attach the probe to the circuit under test. To change the probe tip angle, refer to Figure 3-3 and perform the following steps:

1. Hold the probe with one hand, placing your forefinger and thumb behind the slide to maintain the slide in the forward position.
2. Loosen the collar by rotating it in the direction shown until it disengages from the probe body.
3. While holding the probe tip, pull back on the slide until the indexing guides on the shaft of the probe tip disengage from the guide slots in the probe body (approximately one-fourth inch).

4. Rotate the probe tip to the desired position (0°, 90°, 180°, or 270°).
5. Match the indexing guides with the corresponding guide slots for the position chosen and push the slide forward until the indexing guides completely engage the probe slots.
6. Thread the collar onto the probe body until the collar is snugly seated.
7. The probe is now ready to be used.

CHANGING INPUT PROBES

The input probes are attached to the instrument via coaxial connectors located inside the zippered pouch. To remove an input probe, grasp each connector (one attached to the probe cable and one attached to the instrument cable) and carefully disconnect them by pulling apart. To

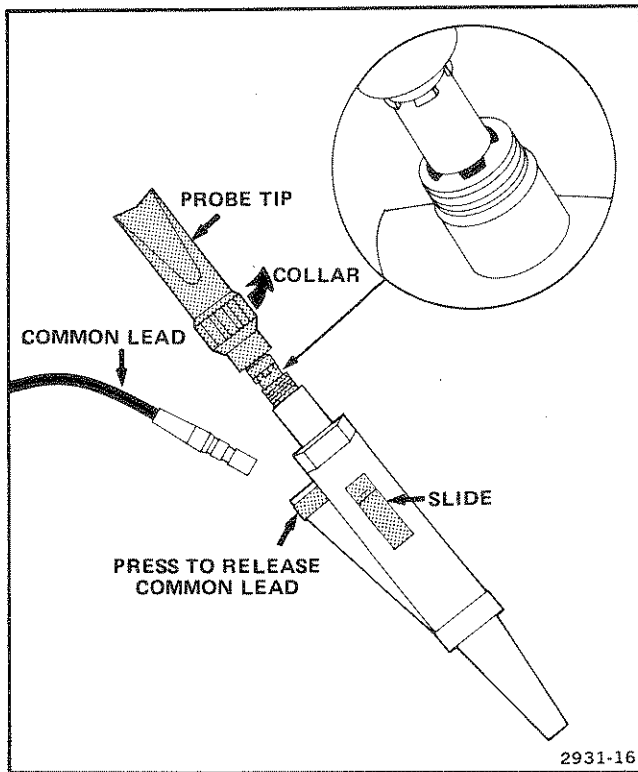

Figure 3-3. Setting the 3000-V probe tip angle and replacing the common lead.

install another input probe (either 500-V or 3000-V as required), align the two connectors and press them together until they snap into place and are firmly seated.

Whenever an input probe is changed, the PROBE COMP control must be adjusted. For these instructions, refer to the "Gain Check and Probe Compensation" procedure in the "Operator's Checks and Adjustments" part of this manual.

REPLACING COMMON LEADS

To replace the common lead on the 500-V Probe, grasp the end closest to the probe and pull straight away from the probe body. Install the new common lead by inserting the round end into the connector on the probe body.

To replace the common lead on the 3000-V Probe, press and hold the release point shown in Figure 3-3. Pull the lead out of the probe body and remove pressure from the release point. Install the new common lead by pushing the lead end into the probe body until an audible click is heard.

REPLACING THE 3000-V PROBE TIP

To replace the 3000-V Probe tip with a new one, refer to Figure 3-4 and perform the following steps:

1. Loosen the collar by rotating it in the direction shown until it disengages from the probe body.
2. Retract the slide to the position shown in Figure 3-4. The slide will stay in this position, and the spring inside the probe tip should cause the probe tip to return to its original position. If this does not occur, hold the slide in the retracted position and pull the probe tip away from the probe body until it reaches its original position.
3. Hold the probe body with one hand and rotate the probe tip in the direction shown until the probe tip completely disengages from the probe body.
4. To install a new probe tip, hold the probe body with the slide in the retracted position and insert the new probe tip into the probe body as far as it will easily go.

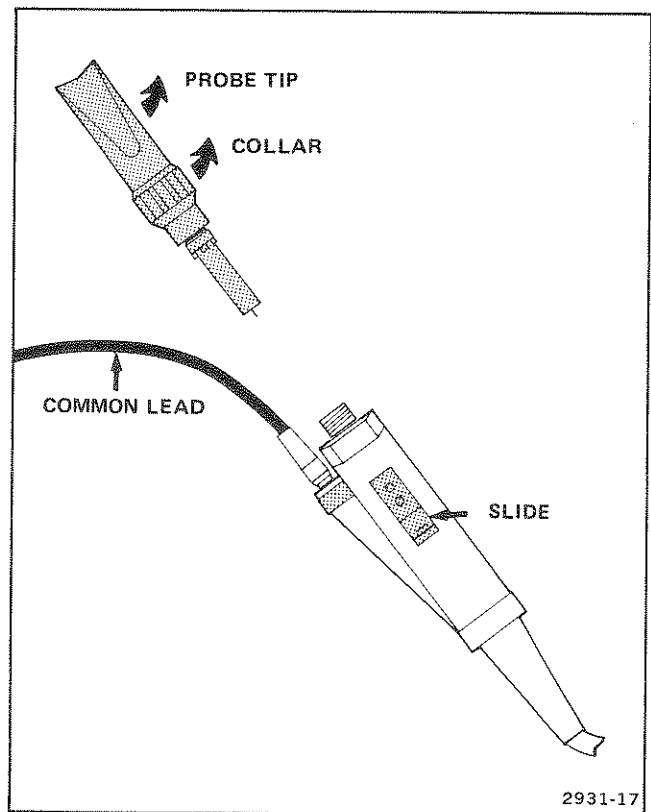

Figure 3-4. Replacing the 3000-V probe tip.

5. Thread the probe tip into the probe body until it seats snugly.

6. Move the slide forward to the position shown in Figure 3-3 and verify that there is approximately one-eighth inch clearance between the indexing guides on the shaft of the probe tip and the threaded portion of the probe body. If necessary, loosen the probe tip to achieve the correct clearance.

7. While holding the slide in the forward position, align the indexing guides with the guide slots in the probe body for the desired probe tip angle. Press the probe tip into the probe body until the indexing guides completely engage the guide slots.

8. Thread the collar onto the probe body until the collar is snugly seated.

9. The probe is now ready for use.

REMOVING THE SIDE POUCHES

Where space is a consideration, (such as installing the A6902B on a scope cart) the side pouches may be removed.

To remove the side pouches, first follow the procedure given in "Changing Input Probes" to remove the probes. The pouches may then be removed by unsnapping the four snaps holding them on the side of the instrument. The probes should then be reinstalled on their original channel inputs to avoid the need to readjust PROBE COMP.

OPERATOR'S CHECKS AND ADJUSTMENTS

INTRODUCTION

By using the calibrator of an oscilloscope, the gain and probe compensation of each channel can be checked, and the probe compensation may be adjusted if necessary.

Detailed instructions for operating test equipment are not provided in this procedure. Refer to the appropriate test equipment instruction manual if more information is needed.

EQUIPMENT REQUIRED

In addition to the Isolator and its standard accessories, the only other equipment necessary to make these checks is an oscilloscope with a vertical deflection of 100 mV/division, an input impedance of 1 M Ω , an input capacitance of less than 47 pF, and a frequency response from dc to 100 MHz (for example, the TEKTRONIX 2235).

NOTE

An oscilloscope with a deflection factor of 50 mV/division may also be used in conjunction with a 50- Ω termination.

GAIN CHECK AND PROBE COMPENSATION

1. Ensure that the "Line Voltage Selection" procedure has been performed.
2. Connect the A6902B to the power input source, press the POWER SWITCH to ON, and allow 30 minutes for the A6902B to stabilize.
3. Set the A6902B CHANNEL 1 AC-COMMON- DC switch to COMMON and the CHANNEL 1 VOLTS/DIV switch to 0.1 V.

4. Set the oscilloscope controls as follows:

VOLTS/DIV1 V
AC-GND-DC DC
Vertical Channel 1
Triggering Mode Auto
 Coupling DC
 Source Channel 1
 Slope +
 Level Midrange
POWER On

5. Connect the PROBE ADJUST output to the oscilloscope Channel 1 input and set the oscilloscope Channel 1 Volts/Division variable for exactly 5 divisions.
6. Remove the connection between the PROBE ADJUST output and Channel 1, and center the trace vertically using the Position control.
7. Connect the A6902B CHANNEL 1 output BNC connector to the oscilloscope Channel 1 input BNC connector using the 50- Ω cable.

8. Use the A6902B ZERO ADJ control to position the oscilloscope trace on the center graticule line.
9. Set the A6902B AC-COMMON-DC switch to DC.
10. Connect the A6902B CHANNEL 1 input to the oscilloscope PROBE ADJUST output and connect the common lead clip to the oscilloscope ground.
11. Adjust the PROBE COMP control for the best flat-top square-wave.
12. CHECK—That the oscilloscope display is 5 major divisions ± 2.5 minor divisions ($\pm 5\%$) at approximately 1 kHz.

NOTE

This display is based on the PROBE ADJUST output of the TEKTRONIX 2235 Oscilloscope (500 mV at approximately 1 kHz) with the A6902B VOLTS/DIV control set for 0.1 V/DIV. If a different calibrator output voltage is used, set the controls to maintain the same input/output ratio and measure for $\pm 5\%$ accuracy.

13. Repeat parts 3 through 12 for CHANNEL 2 of the A6902B .

APPLICATION EXAMPLE

INTRODUCTION

The following is an example of one of the ways the TEKTRONIX A6902B Isolator might be used to look at high-voltage signals or signals that are elevated to a high-voltage level.

EXAMPLE

The test circuit shown in Figure 5-1 is a simplified diagram of a motor controller. A variable RC network is used to trigger a diac which in turn triggers the gate of a triac. In this example, both channels of the A6902B may be used to compare the phase relationships of the gate signal to the motor-voltage waveform and to the triac waveform.

For best performance, the probe common leads should always be connected to the lowest possible impedance point relative to the probe tip. In this case, Channel 2 common would be connected to point A and Channel 2 input to point B to monitor the motor drive voltage. The Channel 1 common lead should be connected to point C and the input

to point D to monitor the triac gate waveform. A typical waveform comparison is illustrated in Figure 5-2.

Figures 5-2 and 5-3 show representative phase relationships of gate drive and motor conduction for various motor control settings. This type of measurement could not be made without the capability of floating the signal commons with the A6902B system.

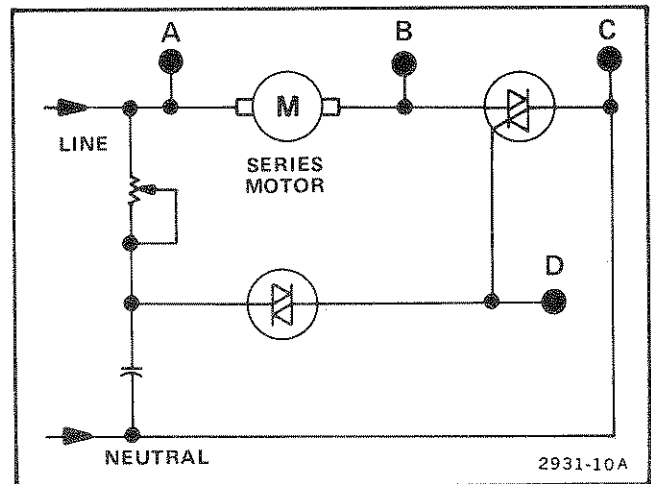

Figure 5-1. Application example test circuit.

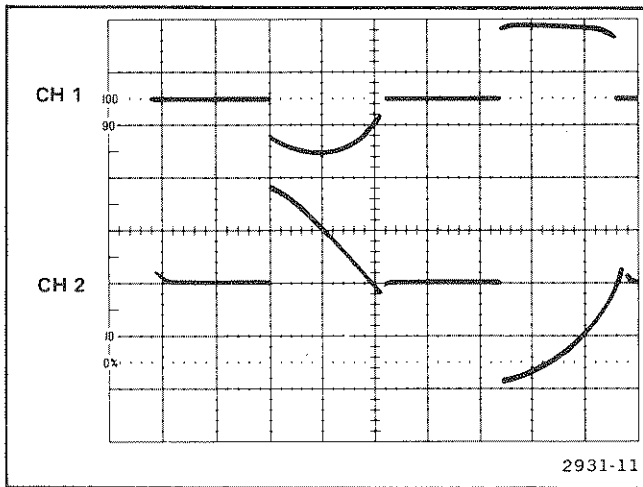

Figure 5-2. Motor and gate waveforms at approximately 180° conduction.

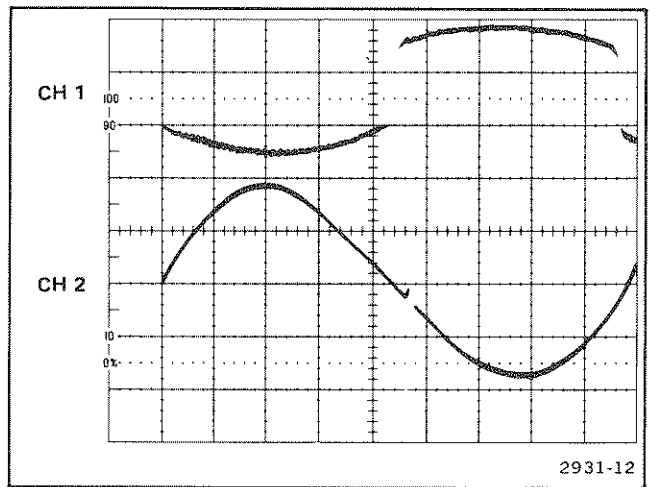

Figure 5-3. Motor and gate waveforms at approximately 360° conduction.

OPTIONS AND ACCESSORIES

STANDARD ACCESSORIES

2 Probes, input, 500 V (with accessories)	010-0411-15
2 Tips, hook	013-0107-05
2 Sleeve, ground cover	166-0404-01
2 Lead, ground	195-1870-00
1 Fuse 0.3 A T/SB (Standard)	159-0029-00
1 Fuse 0.15 A T/SB (Options A1 to A5)	159-0054-00
1 Operator Manual	070-5614-00
2 Cables, output, 50 Ω	012-0204-00
1 Cable assembly, power	161-0117-00

OPTIONAL ACCESSORIES

Service Manual	070-5615-00
2 Probes, input, 3000 V	010-0409-01
BNC-to-probe-tip Adapter (for 3000-V probe)	015-0405-00
BNC-to-probe-tip Adapter (for 500-V probe)	013-0084-02
Banana-to-probe-tip Adapter Kit	
(for 3000-V probe)	013-0224-00
Cable-Marker Band (White)	334-2794-01
Cable-Marker Band (Green)	334-2794-07

OPTIONAL POWER CORDS

Option A1, Universal European, 3 meters	161-0104-06
Option A2, United Kingdom, 3 meters	161-0133-00
Option A3, Australia, 3 meters	161-0135-00
Option A4, N. American, 3 meters	161-0134-00
Option A5, Switzerland, 3 meters	161-0154-00

OPTIONS

Includes (2) 3-kV Probes, (2) common leads	Option 2
Includes (2) 3-kV Probes, (2) common leads, (2) Banana-to-Probe-Tip Adapters	Option 9

