

PLEASE CHECK FOR CHANGE INFORMATION  
AT THE REAR OF THIS MANUAL.

**1503B METALLIC  
TIME DOMAIN  
REFLECTOMETER**

OPERATOR MANUAL

Tektronix, Inc.  
P.O. Box 500  
Beaverton, OR 97077

070-6268-01  
Product Group 22

First Printing OCT 1987  
REV JULY 1988

Copyright © 1987 and 1988 Tektronix, Inc. All rights reserved.  
Contents of this publication may not be reproduced in any form  
without the written permission of Tektronix, Inc.

Products of Tektronix, Inc. and its subsidiaries are covered by  
U.S. and foreign patents and/or pending patents.

TEKTRONIX, TEK, and  are registered trademarks of Tek-  
tronix, Inc.

Printed in U.S.A. Specification and price change privileges are  
reserved.

**Certificate of the Manufacturer/Importer**

We hereby certify that TDR Model 1503B complies with the RF Interference Suppression requirements of Amtsbl.-Vfg 1046/1984. The German Postal Service was notified that the equipment is being marketed. The German Postal Service has the right to re-test the series and to verify that it complies.

TEKTRONIX

**Bescheinigung des Herstellers/Importeurs**

Hiermit wird bescheinigt, daß das TDR Modell 1503B in Übereinstimmung mit den Bestimmungen der Amtsblatt-Verfügung 1046/1984 funkentstört ist. Der Deutschen Bundespost wurde das Inverkehrbringen dieses Gerätes angezeigt und die Berechtigung zur Überprüfung der Serie auf Einhalten der Bestimmungen eingeraäumt.

TEKTRONIX

**NOTICE to the user/operator:**

The German Postal Service requires that this equipment, when used in a test setup, may only be operated if the requirements of Postal Regulation, Vfg. 1046/1984, Par. 2, Sect. 1.7.1 are complied with.

**HINWEIS für den Benutzer/Betreiber:**

Dies Gerät darf in Meßaufbauten nur betrieben werden, wenn die Voraussetzungen des Par. 2, Ziff. 1.7.1 der Vfg. 1046/1984 eingehalten werden.



# TABLE OF CONTENTS

	Page
<b>SECTION 1 SAFETY AND INSTALLATION</b>	
Operator Safety Summary .....	1-1
Installation .....	1-3
Repacking for Shipment .....	1-3
 <b>SECTION 2 OPERATOR SECTION</b>	
<b>General Information</b> .....	2-1
Handling Information .....	2-1
Powering the 1503B .....	2-1
Care of the Optional Battery Pack .....	2-2
Battery Charging Information .....	2-2
Low Battery .....	2-3
Low Temperature Operation .....	2-3
<b>Operator Instructions</b> .....	2-4
Preparing to Use the 1503B .....	2-4
Front Panel Controls .....	2-4
Menu Selections .....	2-8
<b>Test Preparations</b> .....	2-11
Importance of $V_p$ .....	2-11
Impedance of Various Cables .....	2-11
$V_p$ of Various Dielectrics .....	2-11
Finding an Unknown $V_p$ .....	2-12
<b>Cable Test Procedures</b> .....	2-13
Distance to the Fault .....	2-13
Return Loss Measurement .....	2-15
Reflection Coefficient Measurement .....	2-15
Using VIEW INPUT .....	2-17
How to STORE the Waveform .....	2-17
Using VIEW STORE .....	2-17
Using VIEW DIFF .....	2-18
Using Vertical and Horizontal SET REF .....	2-21
HORZ SET REF .....	2-21
VERT SET REF .....	2-23
Additional Features .....	2-24
Max Hold .....	2-24
Pulse On/Off .....	2-25
Single Sweep .....	2-25

## Table of Contents (con't)

SECTION 2 OPERATOR SECTION (con't)	Page
<b>Operator Tutorial</b> .....	2-27
What is the Tektronix 1503B? .....	2-27
How Does it Do It? .....	2-27
YOU, the Operator .....	2-27
The MENU Screens .....	2-27
Getting Started .....	2-28
Waveform Up Close .....	2-30
A Longer Cable .....	2-31
Noise .....	2-33
Set Ref ( $\Delta$ Mode) .....	2-34
HORZ SET REF .....	2-34
VERT SET REF .....	2-36
VIEW INPUT .....	2-38
STORE and VIEW STORE .....	2-39
VIEW DIFF .....	2-40
Menu Accessed Functions .....	2-41
Max Hold .....	2-41
Pulse On/Off .....	2-43
Single Sweep .....	2-44
<b>TDR Questions and Answers</b> .....	2-45
<b>Glossary</b> .....	2-47
<b>Operator Maintenance</b> .....	2-52
Troubleshooting .....	2-52

## Table of Contents (con't)

SECTION 2 OPERATOR SECTION (con't)	Page
Option 06 (Ethernet®) .....	2-54
What is Ethernet®? .....	2-54
An Ethernet® System .....	2-55
Before Starting .....	2-56
Introduction to Test Procedures .....	2-56
Basic Test Procedure .....	2-57
Test Illustrations .....	2-58
Descriptions of Tests - Ethernet Menu .....	2-60
Introduction .....	2-60
"50Ω Termination is: Off/On" .....	2-60
"Single Sweep with Carrier is: Off/On" .....	2-60
"Carrier Test is: Off/On" .....	2-61
"Collision Test is: Off/On" .....	2-61
Description of Tests - Setup Menu .....	2-62
"50Ω DC Termination is: Off/On" .....	2-62
"Carrier (-1.05V) Output Signal is: Off/On" .....	2-62
"Collision (-1.7V) Output Signal is: Off/On" .....	2-62
Customizing Your Own Tests .....	2-63
Waveform Signatures .....	2-63
Test Examples of Two Ethernets® .....	2-64

## SECTION 3 SPECIFICATION

<b>General Information</b> .....	3-1
Product Description .....	3-1
Optional Battery Pack .....	3-1
Options .....	3-1
Standards and Documents .....	3-1
Change and History Information .....	3-1
<b>Specification</b> .....	3-1
Electrical Characteristics .....	3-2
Environmental Characteristics .....	3-5
Physical Characteristics .....	3-6
Option 06 (Ethernet®) .....	3-7
Product Description .....	3-7
Electrical Characteristics .....	3-7
Typical Frequency Response Curves .....	3-8

## Table of Contents (con't)

<b>SECTION 2 SPECIFICATION (con't)</b>	<b>Page</b>
<b>Operator Check Procedure</b> .....	3-9
Equipment Required .....	3-9
Getting Ready .....	3-9
POWER On .....	3-9
Set Up .....	3-9
Horizontal Scale (Timebase) Check .....	3-10
Vertical Position (Offset) Check .....	3-11
Noise Check .....	3-12
Offset/Gain Check .....	3-13
Impedance Check .....	3-13
Sampling Efficiency Check .....	3-13
Aberrations Check .....	3-14
Conclusions .....	3-16
 <b>SECTION 4 ACCESSORIES AND OPTIONS</b>	
<b>Accessories</b> .....	4-1
Standard Accessories .....	4-1
Optional Accessories .....	4-2
<b>Options</b> .....	4-3
Battery Pack (Option 03) .....	4-3
Battery Pack Removal .....	4-3
YT-1 Chart Recorder (Option 04) .....	4-3
Instructions for Use .....	4-3
Paper Replacement .....	4-3
Metric Default (Option 05) .....	4-4
Ethernet® (Option 06) .....	4-4
Power Cord Options .....	4-5



# OPERATOR SAFETY SUMMARY

The general safety information in this part of the summary is for both operating and servicing personnel. Specific warnings and cautions will be found throughout the manual where they apply, but may not appear in this summary.

## Terms

### In This Manual:

**CAUTION** statements identify conditions or practices which could result in damage to the equipment or other property.

**WARNING** statements identify conditions or practices which could result in personal injury or loss of life.

### As Marked on Equipment:

**CAUTION** indicates a personal injury hazard not immediately accessible as one reads the marking, or a hazard to property including the equipment itself.

**DANGER** indicates a personal injury hazard immediately accessible as one reads the marking.

## Symbols

### In This Manual:



This symbol indicates, where applicable, cautionary or other information is to be found.

### As Marked on Equipment:



**DANGER** High Voltage



**ATTENTION** refer to manual.



Protective ground (earth) terminal.

## Power Source

This product is intended to operate from a power source that will not apply more than 250 volts RMS between the supply conductors or between the supply conductor and ground. A protective ground connection by way of the grounding conductor in the power cord is essential for safe operation.

## Grounding the Product

This product is grounded through the grounding conductor of the power cord. To avoid electric shock, plug the power cord into a properly wired receptacle before connecting to the product input or output terminals. A protective ground connection by way of the grounding conductor in the power cord is essential for safe operation.

## Danger Arising From Loss of Ground

Upon loss of the protective-ground connection, all accessible conductive parts (including knobs and controls that appear to be insulating) can render an electric shock.

## Use the Proper Power Cord

Use only the power cord and connector specified for your product. Do not use instrument without a rated AC line cord.

The standard power cord (161-0228-00) is rated for outdoor use. *All other optional power cords are rated for indoor use only.*

Use only a power cord that is in good condition.

Refer cord and connector changes to qualified service personnel.

**Use the Proper Fuse**

To avoid fire hazard, use only the fuse of the correct type.

Refer fuse replacement to qualified service personnel.

**Do Not Operate In Explosive Atmospheres**

To avoid explosion, do not operate this product in an explosive atmosphere unless it has been specifically certified for such operation.

**Do Not Remove Covers or Panels**

To avoid personal injury, do not remove the product covers or panels. Do not operate the product without the covers and panels properly installed.

# INSTALLATION AND REPACKING

## Unpacking and Initial Inspection

Before unpacking the 1503B from its shipping container or carton, inspect for signs of external damage. If the carton is damaged, notify the carrier. The shipping carton contains the basic instrument and its standard accessories. Refer to the replaceable parts list in the Service Manual for a complete listing.

If the contents of the shipping container are incomplete, if there is mechanical damage or defect, or if the instrument does not meet operational check requirements, contact your local Tektronix Field Office or representative. If the shipping container is damaged, notify the carrier as well as Tektronix.

The instrument was inspected both mechanically and electrically before shipment. It should be free of mechanical damage and meet or exceed all electrical specifications. Procedures to check operational performance are in the Operator Performance Check in the *Specification* section. This check should satisfy the requirements for most receiving or incoming inspections. The electrical Performance Check Procedure is part of the *Service Manual*.

## Power Source and Power Requirements

The 1503B is intended to be operated from a power source that will not apply more than 250V RMS between the supply conductors or between either supply conductor and ground. A protective ground connection by way of the grounding conductor in the power cord is essential for safe operation.

The AC power connector is a three-way polarized plug with the ground (earth) lead connected directly to the instrument frame to provide electrical shock protection. If the unit is connected to any other power source, the unit frame must be connected to earth ground.

Power and voltage requirements are printed on the back panel. The 1503B can be operated from either 115 VAC or 230 VAC nominal line voltage, at 45 to 440 Hz, a 12 VDC supply, or a battery pack.

Further information on the 1503B power requirements can be found in the *Operator Safety Summary* in this section and in the *Operator* section.

## Repacking for Shipment

When the 1503B is to be shipped to a Tektronix Service Center for service or repair, attach a tag showing the name and address of the owner, name of the individual at your firm that can be contacted, complete serial number, and a description of the service required. If the original packaging is unfit for use or is not available, repackage the instrument as follows:

1. Obtain a carton of corrugated cardboard having inside dimensions that are at least six inches greater than the equipment dimensions to allow for cushioning. The test strength of the shipping carton should be 275 pounds (102.5 kg). Refer to the following table for test strength requirements.

SHIPPING CARTON TEST STRENGTH	
Gross Weight (lb)	Carton Test Strength (lb)
0-10	200
10-30	275
30-120	375
120-140	500
140-160	600

2. Install the front cover on the 1503B, and surround the instrument with polyethylene sheeting to protect the finish.
3. Cushion the instrument on all sides with packing material or urethane foam between the carton and the sides of the instrument.
4. Seal with shipping tape or an industrial stapler.

If you have any questions, contact your local Tektronix field office or representative.

### CAUTION

*The Option 03 battery pack should be removed from the instrument before shipping. If necessary to ship the battery, it should be wrapped and secured separately before being packed with the instrument.*



# OPERATOR SECTION

## This Section

- **General Information**
  - Handling Information*
  - Powering the 1503B*
  - Care of the Optional Battery Pack*
  - Battery Charging Information*
  - Low Battery*
  - Low Temperature Operation*
- **Operator Instructions**
- **Operator Tutorial**
- **Operator Maintenance**
- **Questions and Answers**
- **Glossary**

## General Information

### Handling Information

The 1503B front panel is protected by a watertight cover in which standard accessories are stored. Secure the front cover by snapping the side latches outward. If the instrument is inadvertently left on, installing the front cover will turn off the POWER switch automatically.

The carrying handle rotates 325° and serves as a stand when positioned beneath the instrument.

Inside the case at the back of the instrument is a moisture absorbing canister containing silica gel. In extremely wet environments it may be necessary to periodically remove and dry the canister. This procedure is explained in the *1503B Service Manual*.

The 1503B can be stored in temperatures ranging from  $-62^{\circ}\text{C}$  to  $+85^{\circ}\text{C}$ . However, if the temperature is below  $-40^{\circ}\text{C}$  or exceeds  $+55^{\circ}\text{C}$ , the battery pack should be removed and stored. Battery storage temperature should be between  $-40^{\circ}\text{C}$  to  $+55^{\circ}\text{C}$ .

### Powering the 1503B

In the field, the 1503B can be powered using the optional internal battery pack. For AC operation, check the rear panel for proper voltage setting. The voltage selector can be seen through the window of the protective cap. If the setting differs from the voltage available, it can be easily changed. Simply remove the protective cap on the rear panel and select the proper voltage range with a screwdriver.

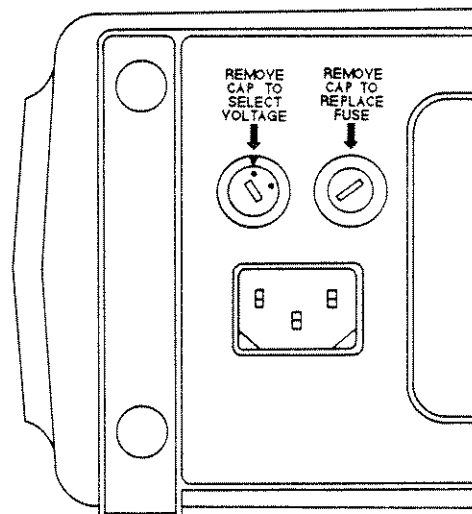

The 1503B is intended to be operated from a power source that will not apply more than 250V RMS between the supply conductors or between either supply conductor and ground. A protective ground connection by way of the grounding conductor in the power cord is essential for safe operation.

The AC power connector is a three-way polarized plug with the ground (earth) lead connected directly to the instrument frame to provide electrical shock protection. If the unit is connected to any other power source, the unit frame must be connected to an earth ground. See more information in the *Safety and Installation* section.

**CAUTION**

*If you change the voltage selector, you must change the line fuse to the appropriate value as listed near the fuse holder, and in the table below.*

FUSE RATING	VOLTAGE RATING	
250 V	NOMINAL RANGE	
0.3A T	115 VAC	90-132 VAC
0.15A T	230 VAC	180-250 VAC

**Care of the Optional Battery Pack**

**CAUTION**

*Read these instructions concerning the care of the optional battery pack. They contain instructions that reflect on your safety and the performance of the instrument.*

The 1503B can be powered by an optional rechargeable nickel-cadmium battery pack that is easily accessible from the back of the instrument without removing the case. When AC power is applied, the battery pack is charged at a continuous rate of approximately 150 mA.

The battery pack will operate the 1503B for a minimum of five continuous hours (including 20 chart recordings).

**Battery Charging Information**

The battery pack will charge fully in 16 hours when the instrument is connected, via the power cord, to an AC power source with the instrument turned off. The instrument may be turned on and operated while the batteries are charging, but this will increase the charging time. For longest battery life, a full charge is preferred over a partial charge.

For maximum capacity, the batteries should be charged within a temperature range of +20°C to +25°C. However, the batteries can be charged within a temperature range of 0°C to +40°C, and operated in temperatures ranging from -15°C to +55°C.

**CAUTION**

*Do not charge battery pack below 0° C or above 45° C. Do not discharge battery pack below -20° C or above 65° C. Do not use this instrument outside these parameters or the batteries may emit explosive gas (hydrogen). If removing the battery pack during or after exposure to these conditions, turn the instrument off and remove the AC power cord. Move the instrument to an ignition-free area before removing the battery pack.*

If the instrument is operated beyond the previously stated limits, turn off the instrument and either disconnect the AC power or remove the battery pack.

The battery pack should be stored within a temperature range of  $-40^{\circ}\text{C}$  to  $+55^{\circ}\text{C}$ . However, the self-discharge rate will increase as the temperature increases.

If the instrument is shipped, the battery pack should be removed. If the instrument is stored with the battery pack installed, the battery pack should be charged every thirty days, or the battery pack removed. A fully charged battery pack will lose about 50% of its capacity in three to four months if stored between  $+20^{\circ}\text{C}$  and  $+25^{\circ}\text{C}$ .

The batteries can be damaged by reverse charging. This can occur when an individual cell becomes discharged before the others, and current from the other cells flow in a reverse direction through the discharged cell. Reverse charging may develop because of individual cell aging, partial charging of the battery pack or if a single cell has been replaced rather than the entire pack.

### Low Battery

If the battery is low, it will be indicated on the LCD (*bat/low*). If this is the case, protective circuitry will shut down the 1503B within minutes. Either replace the battery pack, switch to AC power, or work fast. If the instrument is equipped with a chart recorder, using the recorder will further reduce the battery level, or the added load may shut down the instrument.

Protection circuits in the charger prevent deep discharge of the batteries during instrument operation. The circuits automatically shut down the instrument whenever battery voltage falls below approximately 10 V. If shutdown occurs, the batteries should be fully recharged before further use.

*NOTE: Turn the POWER switch off after instrument shutdown to prevent continued discharge of the batteries.*

*NOTE: Under low AC line voltage conditions, the AC fuse ratings may be exceeded if the battery is fully discharged and a chart recording is being made. Allow the battery to charge for about one hour before attempting to make a chart recording, or use AC only.*

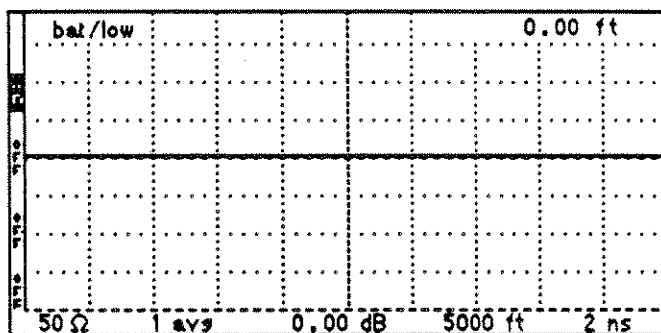

### Low Temperature Operation

When operating the 1503B in an environment below  $+10^{\circ}\text{C}$ ., a heater will activate. The element is built into the LCD module, and will heat the display to permit normal operations. Depending on the surrounding temperature, it may take up to 15 minutes to completely warm the crystals in the LCD. Once warmed, the display will operate normally.

# OPERATOR INSTRUCTIONS

## Preparing to Use the 1503B

Check the power requirements, remove the front cover, and you are ready to test cables. The following pages explain the front panel controls.

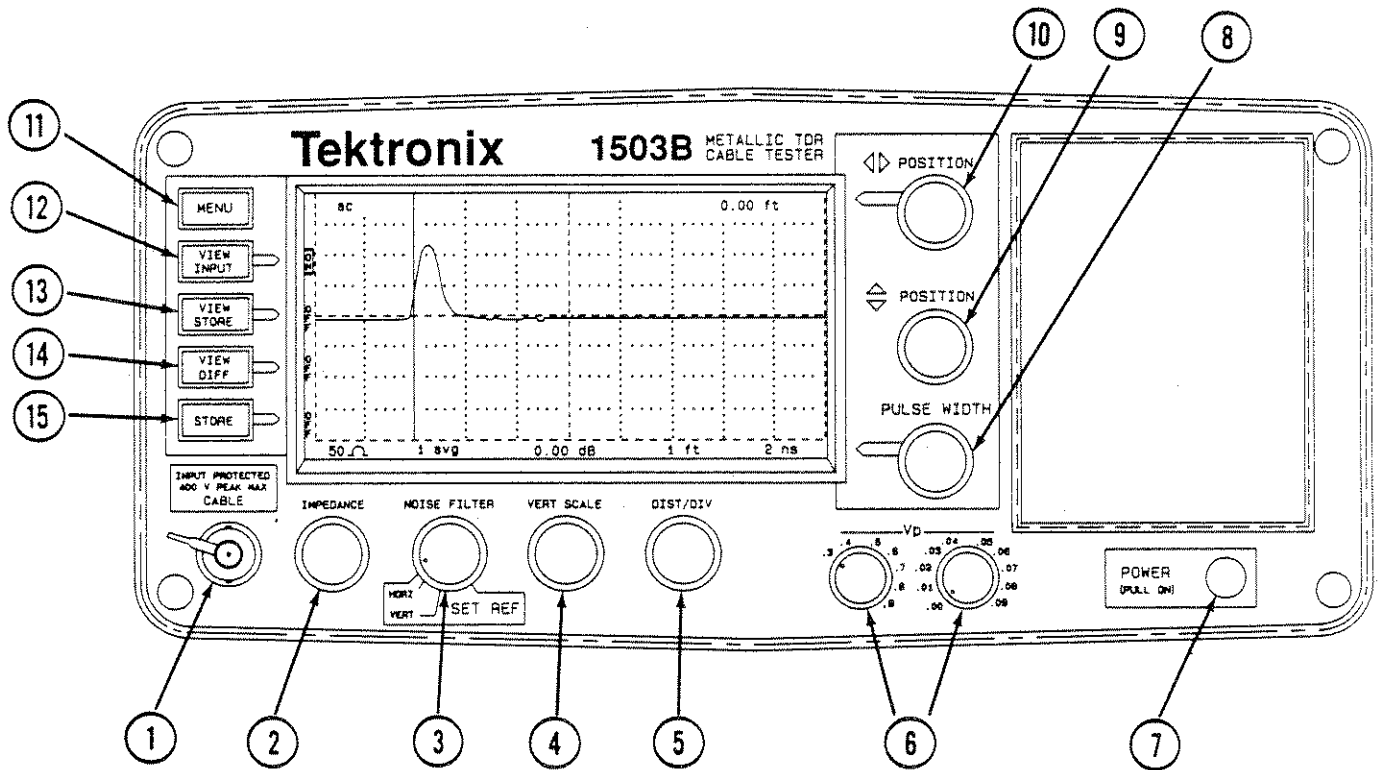

1503B Front Panel Controls



## Front Panel Controls

### 1 CABLE

A female BNC connector for attaching a cable to the 1503B for testing.

### 2 IMPEDANCE

A four position rotary switch which selects the output impedance of the cable test signal. Available settings are 50, 75, 93 and 125 ohms. Selected value is displayed above the control on the LCD.

IMPEDANCE

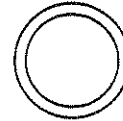

### 3 NOISE FILTER

If the displayed waveform is noisy, the apparent noise can be reduced by using noise averaging. Averaging settings are between 1 and 128. The time for averaging is directly proportional to the averaging setting chosen. A 128 setting may take the instrument up to 35 seconds to acquire and display. The first two positions on the NOISE FILTER control are used for setting the vertical and horizontal reference points. Selected value or function is displayed above the control on the LCD.

NOISE FILTER

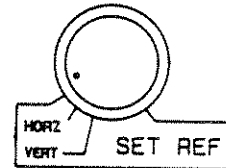

### 4 VERT SCALE

Sets the vertical gain displayed in dB or the vertical sensitivity displayed in mp per division. Although the instrument defaults to dB, the operator may choose which mode from the menu ("Set Up Menu"). Selected value is displayed above the control on the LCD.

VERT SCALE

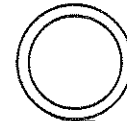

### 5 DIST/DIV

Determines the number of feet (or metres) per division across the display. Minimum setting is 1 ft/DIV (.25 metres); maximum setting is 5000 ft/DIV (1000 metres). Selected value is displayed above the control on the LCD. A standard instrument defaults to ft/DIV. A metric instrument (Option 5) defaults to m/DIV, but either metric or standard can be changed temporarily from the menu. The default can be changed by changing an internal jumper (See *Service Manual*).

DIST/DIV

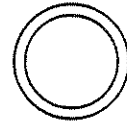

**6**  $V_p$  (Velocity of Propagation)

These controls are set according to the propagation velocity factor of the cable being tested. For example, solid polyethylene commonly has a  $V_p$  of 0.66. Solid polytetrafluoroethylene (Teflon®) is approximately 0.70. Air is 0.99. The controls are decoded: the left control is the first digit; the right control the second digit. For example, with a  $V_p$  of 0.30, the first knob would be set to .3, the second knob to .00.

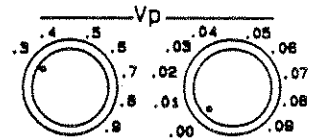

**7** POWER

Pull for power ON, push in for power OFF. When the front cover is installed, this switch is automatically pushed OFF.

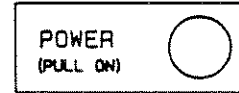

**8** PULSE WIDTH

A five position rotary switch selects the pulse width of the cable test signal. Available settings are 2, 10, 100, 1000 nanoseconds, and AUTO. Selected value is displayed on the LCD adjacent to the control. AUTO sets the pulse width according to the distance on the right side of the display. The selected value is displayed to the left of the control on the LCD.

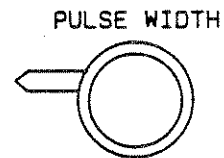

**9**  $\updownarrow$  POSITION

This is a continuously rotating control that positions the displayed waveform up or down the LCD.



**10**  $\leftarrow$  POSITION

This is a continuously rotating control that moves a vertical cursor completely across the LCD graticule. In addition, the waveform is also moved when the cursor reaches the extreme right or left side of the display. A readout (7-digit maximum) is displayed in the upper right hand corner of the LCD, displaying the distance from the front panel BNC to the cursor.

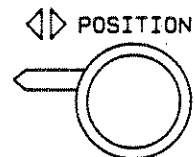

**11** MENU

Provides access to the menu, and also selects items chosen from the menu.



**12** VIEW INPUT

When pushed momentarily, this button toggles the display of the waveform acquired at the CABLE connector. This function is useful to stop displaying the current waveform to avoid confusion when looking at a stored waveform. Function defaults to ON when instrument is powered up.



**13 VIEW STORE**

When pushed momentarily, this button toggles the display of the stored waveform.

**14 VIEW DIFF**

When pushed momentarily, this button toggles the display of the CURRENT waveform minus the STORED waveform.

**15 STORE**

When pushed momentarily, the waveform currently displayed will be stored in the instrument memory. If a waveform is already stored, pushing **STORE** momentarily will erase it. The settings of the stored waveform are available from the first level menu under "View Stored Waveform Settings".



## Menu Selections

There are several "layers" of menu as explained below.

### Main Menu

**MAIN MENU** is entered by pushing the **MENU** button on the front panel.

1. **Return to Normal Operation** puts the instrument into Normal Operation mode.
2. **Help with Instrument Controls** explains the operation of each control. When a control or switch is adjusted or pushed, a brief explanation appears on the LCD.
3. **Cable Information** has three menu choices:
  - Help with Cables** gives a brief explanation of cable parameters.
  - Velocity of Propagation Values** displays a table of common dielectrics and their  $V_p$  values. These are nominal values. The manufacturers listed specifications should be used whenever possible.
  - Impedance Values** displays impedances for common cables. In some cases these values have been rounded off. Manufacturers specifications should be checked for precise values.
  - Finding unknown  $V_p$  values** describes a procedure for finding an unknown  $V_p$ .
4. **Setup Menu** controls the manner in which the instrument obtains and displays its test results.

**Acquisition Control Menu** has three choices.

**Max Hold is:** on or off. Set up by pushing **MENU**, then activated by pushing **STORE**. In this mode, waveforms are accumulated on the display. **MAX HOLD** can be deactivated by pushing **STORE** or the mode exited by using the **Setup** menu.

**Pulse is:** on or off. Turns the pulse generator off so the 1503B does not send out pulses.

**Single Sweep is:** on or off. This function is much like a still camera: it will acquire one waveform and hold it.

**Vertical Scale is:** offers a choice as to how the vertical gain of the instrument is displayed. You may choose decibels or millirho. When powered down, the instrument will default to decibels when powered back up.

**Distance/Div is:** offers a choice as to how the horizontal scale of the instrument is displayed. You may choose from feet per division, or metres per division. When powered up, the instrument will default to feet per division unless specified by an internal jumper. Instructions on changing this default to metres are contained in the *Service Manual*.

**Light is:** on or off. This control turns the electroluminescent backlight behind the LCD off and on.

5. **Diagnostics Menu** lists an extensive selection of diagnostics to test the operation of the instrument.

#### **Service Diagnostics Menu**

**Sampling Efficiency Diagnostic** displays a continuous efficiency diagnostic of the sampling circuits.

**Noise Diagnostic** measures the internal RMS noise levels of the instrument.

**Impedance Diagnostic** tests the output impedance circuits in the instrument.

**Offset/Gain Diagnostic** reports out of tolerance steps in the programmable gain stage. This can help a service technician quickly isolate the cause of waveform distortion problems.

**RAM/ROM Diagnostics Menu** performs tests on the RAM (Random Access Memory) and the ROM (Read Only Memory).

**Timebase is:** Normal - Auto Correction, or Diagnostic - No Correction. When in *Normal*, the instrument compensates for variations in temperature and voltage. This condition may not be desirable while calibrating the instrument. While in *Diagnostic - No Correction*, the circuits will not correct for these variations.

**Front Panel Diagnostic** aids in testing the front panel.

#### **LCD Diagnostics Menu**

**LCD Alignment Diagnostic** generates a dot pattern of every other pixel on the LCD. These pixels can be alternated to test the LCD.

**Response Time Diagnostic** generates alternate squares of dark and light, reversing their order. This tests the response time of the LCD, and can give an indication as to the effectiveness of the LCD heater in a cold environment.

**LCD Driver Test Diagnostic** generates a moving vertical bar pattern across the LCD.

**Contrast Adjust** allows you to adjust the contrast of the LCD. It generates an alternating four pixel pattern. The nominal contrast is set internally. When in *Contrast Adjust* mode, VERT SCALE is used as the contrast adjustment control. This value ranges from 0 to 255 units, and is used by the processor to evaluate and correct circuit variations caused by temperature changes in the environment.

**Chart Diagnostics Menu** offers various tests for the optional YT-1 chart recorder.

**LCD chart** allows adjusting the number of dots per segment and the number of prints (strikes) per segment.

**Head Alignment Chart** generates a pattern to allow mechanical alignment of the optional YT-1 chart recorder.

6. **View Stored Waveform Settings** displays the instrument settings for the stored waveform.
7. **Option Port Menu** contains three items. Two items allow configuration of the option port for communicating with devices other than the optional YT-1 chart recorder, and one item that tests the option port.

**Option Port Diagnostic** creates a repeating pattern of signals at the option port to allow service technicians to verify that all the signals are present and working correctly.

**Set Option Port Timing** allows adjustment of the data rate used to communicate with external devices. The timing rate between bytes can be set from about 0.05 to 12.8 milliseconds.

**Option Port Debugging is:** OFF - Quiet, or ON - Verbose, chooses how detailed the error message reporting will be when communicating with an external device.

It is possible to connect the instrument to a computer through a parallel interface with a unique software driver. Since different computers vary widely in processing speed, the instrument must be able to adapt to differing data rates while communicating with those computers. With user-developed software drivers, the ability to obtain detailed error messages during the development can be very useful. For more information, contact your Tektronix Customer Service Representatives. They have information describing the option port hardware and software protocol and custom development methods available.

## Test Preparations

### The Importance of $V_p$ (Velocity of Propagation)

$V_p$  is the speed of a signal down the cable given as a percentage of the speed of the signal in free space. It is sometimes expressed as a whole number (66), or a percentage (66%). On the 1503B it is the percentage expressed as a decimal number, e.g. 66% = .66. If you do not know the velocity of propagation, you can get a general idea from the following table, or use the *Help with Cables* section of the "Cable Information" menu. You can also find the  $V_p$  with the procedure that follows using a cable sample.

*NOTE: If you do not know the  $V_p$  of your cable, it will not prevent you from finding a fault in your cable. However, if  $V_p$  is set wrong, distance readings will be effected.*

### Impedance of Various Cable Types

50 $\Omega$	75 $\Omega$	93 $\Omega$	125 $\Omega$
RG-4	RG-6/U	RG-7/U	RG-23/U
RG-8/U	RG-11/U	RG-22/U	RG-63/U
RG-9/U	RG-12/U	RG-62/U	RG-79/U
RG-58/U	RG-13/U	RG-71/U	RG-89/U
RG-62/U	RG-59/U	RG-111/U	Flat Lead
RG-81	RG-124/U	Twisted Pair	Twisted Pair
RG-93	RG-140/U		
RG-142B/U	RG-179/U		
RG-225/U	75 $\Omega$ Video		
RG-303B/U			
RG-316/U			
RG-393/U			
Vertebrae Helix			

### $V_p$ of Various Dielectric Types

Dielectric	Probable $V_p$
Jelly Filled	.64
Polyethylene (PIC, PE, or SPE)	.66
PTFE (Teflon <sup>®</sup> ) or TFE	.70
Pulp Insulation	.72
Foam or Cellular PE (FPE)	.78
Semi-solid PE (SSPE)	.84
Air (Helical spacers)	.98

### Finding an Unknown $V_p$

1. Obtain a known length of cable of the exact type you wish to test. Attach the cable to the **CABLE** connector on the front panel.

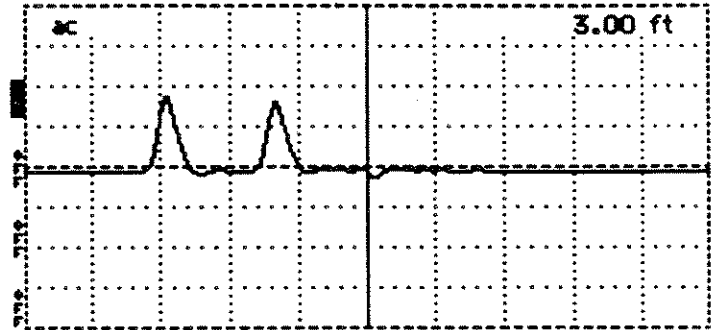

$V_p$  of .30 when it should have been .66 for 3 foot cable.

2. Pull **POWER** on.

3. Turn **DIST/DIV** to appropriate setting. For example, if trying to find the  $V_p$  of a 3 foot cable, turn **DIST/DIV** to 1 ft/DIV. Turn **POSITION** until the distance reading is the same as the known cable length.

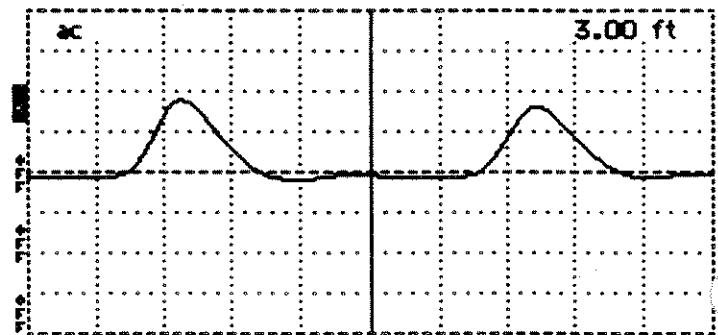

$V_p$  of .99 when it should have been .66 for 3 foot cable.

4. Turn the  $V_p$  controls until the cursor is resting on the rising portion of the reflected pulse. The  $V_p$  controls of the instrument are now set to the  $V_p$  of the cable.



$V_p$  set correctly at .66 for a 3 foot cable.



## Cable Test Procedures

### Distance to the Fault

Be sure to read the previous paragraphs on  $V_p$ .

1. Set the 1503B front panel:

POWER	On
CABLE	Cable to BNC
IMPEDANCE	50 $\Omega$
NOISE FILTER	1 avg
DIST/DIV	(see below)
$V_p$	(per cable)
PULSE WIDTH	(per cable)

2. If you know approximately how long the cable is, set DIST/DIV appropriately. e.g. A 20 foot cable would occupy 4 divisions on the LCD if 5 ft/DIV were used. The entire cable would be displayed.

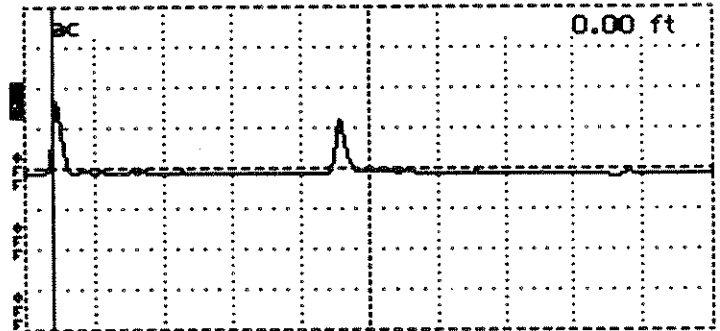

If the cable length is unknown, set DIST/DIV to 5000 ft/DIV, and continue to decrease the DIST/DIV setting until the reflected pulse is visible. Depending on cable length and the amount of pulse energy absorbed by the cable, it may be necessary to increase the VERT SCALE to provide more gain to see the reflected pulse.

The best pulse width is dependent on cable length. A short pulse can be completely dissipated in a long cable. Increasing pulse width will allow the reflected pulse to be more visible when testing long cables. AUTO will select the pulse width for you depending on the distance on the right side of the LCD.

CABLE LENGTH	SUGGESTED PULSE	SUGGESTED R/DIV
0 to 100 ft	2 ns	10 ft/DIV
51 to 500 ft	10 ns	50 ft/DIV
501 to 5000 ft	100 ns	500 ft/DIV
5001 to 50,000 ft	1000 ns	5000 ft/DIV

- Once the entire cable is displayed you can tell if there is an open or a short. Essentially, a drop in the pulse is a short, and a rise is the pulse is an open. Less catastrophic faults can be seen as hills and valleys in the waveform. Bend and kinks, frays, water, interweaving, all have distinctive signatures.

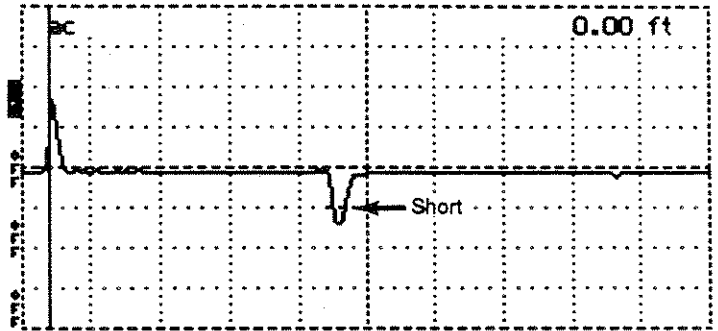

- To find the distance to the fault or end of the cable, turn  $\diamond$  POSITION until the cursor rests on the leading edge of the rising or falling reflected pulse. Read the distance in the distance window in the upper right corner of the display.

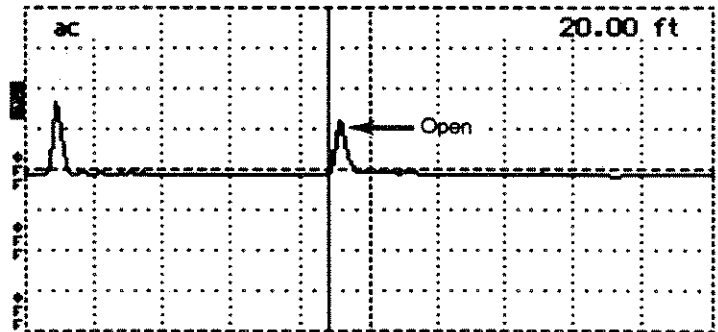

A more thorough inspection may be required. This example will use a longer cable:

- When inspecting a 455 foot cable, a setting of 100 ft/DIV would allow a relatively fast inspection. If needed, turn up VERT SCALE to increase the gain. The higher the gain, the smaller the faults that can be detected. If noise increases, increase the NOISE FILTER setting.

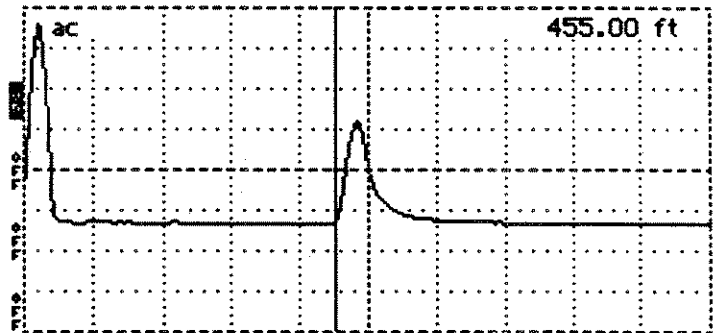

- Change DIST/DIV to 20 ft/DIV. The entire cable can now be inspected in detail on the LCD. Turn the  $\diamond$  POSITION control so the cursor travels to the far right side of the LCD. Keep turning, and the cable will be "dragged" across the display in either direction.

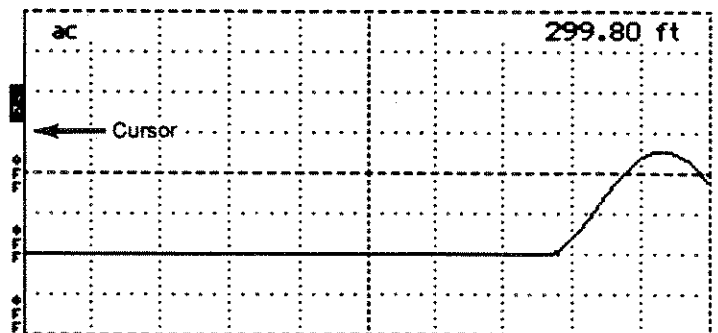

A "rise" or "fall" is a signature of an impedance mismatch, (fault). A dramatic rise in the pulse indicates an open. A dramatic lowering of the pulse indicates a short. Variations, such as inductive and capacitive effects on the cable, will appear as bumps and dips on the waveform. Capacitive faults will appear as a lowering of the pulse (water). Inductive faults will appear as a rising of the fault (kinks). Whenever an abnormality is found, set the cursor at beginning of the fault and read the distance to the fault on the distance window of the LCD. (See *Return Loss Measurement*).

## Return Loss Measurements

Return loss is another way of measuring impedance changes in a cable. Mathematically return loss is related to rho by the formula:

$$\text{return loss in dB} = -20 + \log \text{ base ten of the absolute value of rho}$$

To measure return loss with the 1503B, adjust the reflected pulse to be the same height as the incident pulse read the dB return loss directly off the LCD display. The incident pulse is set to be about two divisions high at zero dB automatically when the instrument is powered up.

A large return loss means that most of the pulse energy was "lost" instead of being "returned" as a reflection. The lost energy may have been sent down the cable or absorbed by a terminator or load on the cable. A terminator matched to the cable would absorb most of the pulse so its return loss would be large. An open or short would reflect or "return" all the energy so its return loss would be zero.

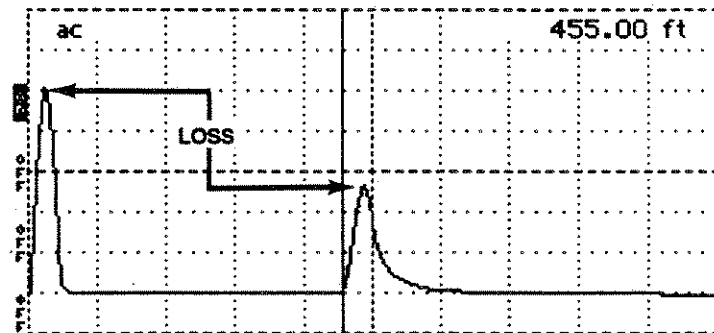

## Reflection Coefficient Measurements

The 1503B can be made to display in mp/DIV instead of dB through MENU.

1. Press **MENU**; and select "Setup Menu".
2. Press **MENU** and select Vertical Scale is: Decibels. Press **MENU** and the selection will change to Vertical Scale is: Millirho.

- Press **MENU** to exit from the Setup Menu and press it again to return to Normal Operation.

The reflection coefficient is a measure of the impedance change at a point in the cable. It is the ratio of the signal reflected back from a point divided by the signal going into that point. It is designated by the greek letter  $\rho$  and is written in this manual as "Rho". The 1503B measures reflection coefficient in millirho (rho times one thousand).

To measure a reflection, adjust **VERT SCALE** to make the reflection one division high. Read the reflection coefficient directly off the display above the **VERT SCALE** control. For reflections that are greater than 500 mp/DIV, adjust **VERT SCALE** for a reflection that is two division high and multiply the display **VERT SCALE** reading by two.

In a ideal transmission system with no changes in impedance, there will be no reflections, so rho is equal to zero. A good cable that is terminated in its characteristic impedance is close to ideal and will appear as a flat line on the 1503B display.

Small impedance changes, like those from a connector might have reflections from ten to one hundred millirho ( $\rho = .01$  to  $.1$ ). If rho is positive, it indicates an impedance higher than the impedance of the cable before the reflection. It will show as an upward bump or shift on the 1503B trace. If rho is negative, it indicates an impedance lower than the impedance of the cable before the reflection. It will show as a downward bump or shift on the 1503B trace.

If the cable has an open or short, all the energy sent out by the 1503B will be reflected. This is a reflection coefficient of  $\rho = 1$  or  $+1000$  mp for the open and  $-1000$  mp for a short.

Long cables have enough loss to affect the size of reflections. This loss will usually be apparent as an upward ramping of the trace along the length of the cable. In some cases the reflection coefficient measurement can be corrected for this loss. See **VERT SET REF** in this manual for details on making this correction.

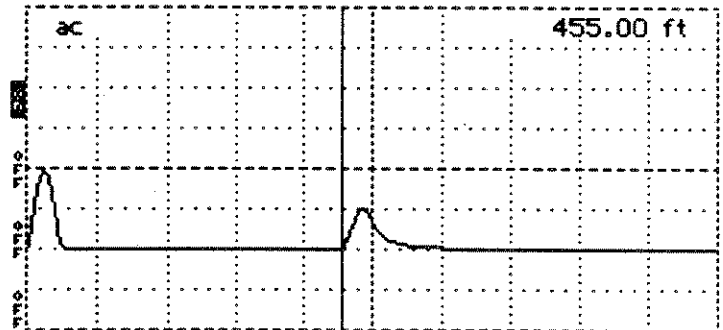

## Using VIEW INPUT

When pushed on, the VIEW INPUT button displays the input at the front panel **CABLE** connector. When this button is turned off, and no other buttons are pushed, the display will not have a waveform on it. VIEW INPUT is on when the instrument is powered up.

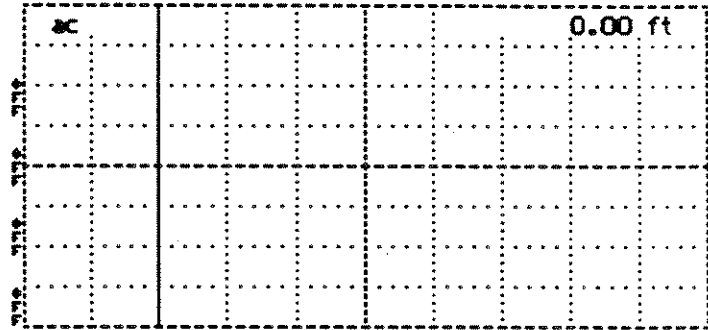

## How to STORE the Waveform

When pushed on, the STORE button puts the current waveform displayed into memory. If already stored, STORE will erase the stored waveform.

The front panel control settings and the menu accessed settings are also stored. They are accessed under "View Stored Waveform Settings" in the first level in the menu. Press MENU.

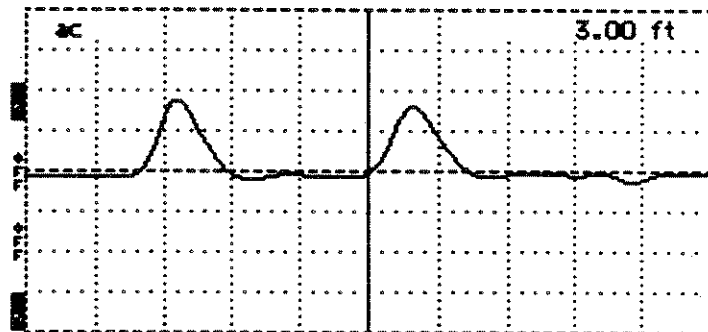

## Using VIEW STORE

The VIEW STORE button, when pushed on, displays the waveform stored in the memory as a dotted line. If no waveform is in the memory, an error message will appear.

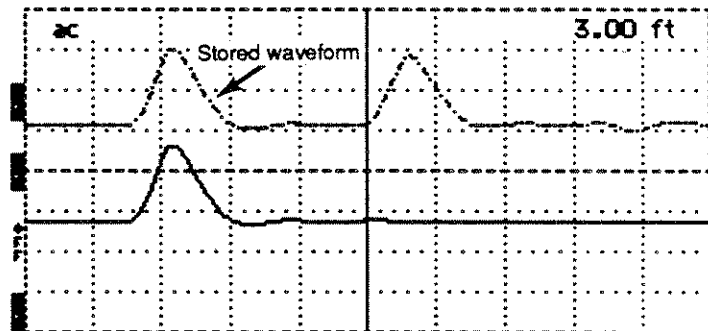

## Using VIEW DIFF

When pushed on, the **VIEW DIFF** button displays the difference between the current input and the stored waveform as a dotted line. If no waveform has been stored, an error message will appear. The "difference" waveform is made by subtracting each point in the stored waveform from each point in the current input waveform.

*NOTE: If the two waveforms are identical, i.e. if STORE is selected, and VIEW DIFF is immediately pushed, the waveforms would be identical, and the difference would be zero. A straight line would be displayed.*

The VIEW DIFF waveform will move up and down with the current input as you move the  $\phi$  POSITION control. Any of the waveforms may be turned on and off independently. You may wish to turn off some waveforms if the display becomes too "busy" or confusing.

*NOTE: Since the stored waveform is not effected by changes in the instrument controls, care should be taken or the results could be misleading.*

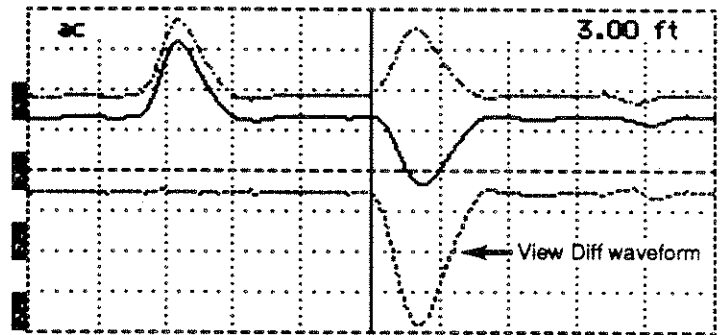

One method to minimize the overlapping of the waveforms in VIEW DIFF is:

1. Move the waveform to be stored into the top half of the display. Push **STORE** to capture the waveform. Remember, once it is stored this waveform cannot be moved on the display.

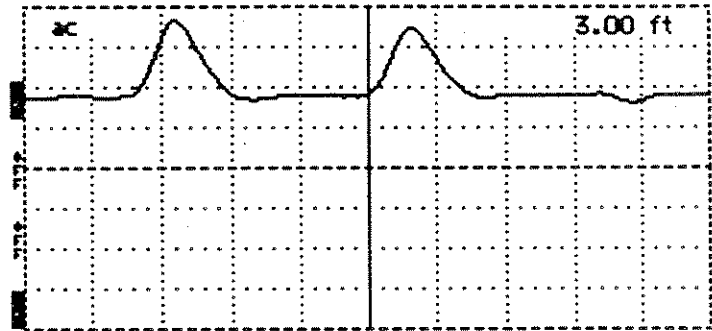

2. Move the current input waveform (the one you want to compare with the stored waveform) to the center of the display. Push **VIEW STORE** and the stored waveform will appear above the current input waveform.

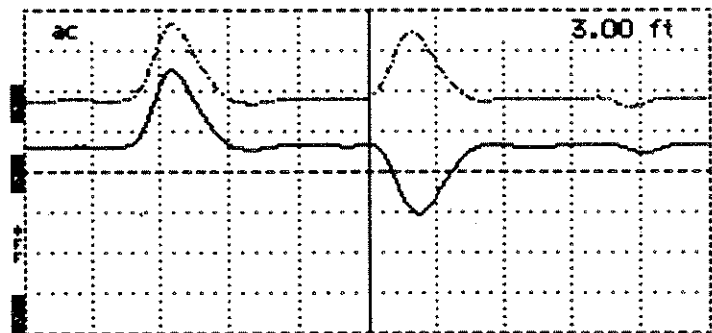

3. Push **VIEW DIFF** and the difference waveform will appear below the current input waveform.

Notice the VIEW INPUT waveform is solid, VIEW DIFF is dotted, and VIEW STORE is dot-dash.

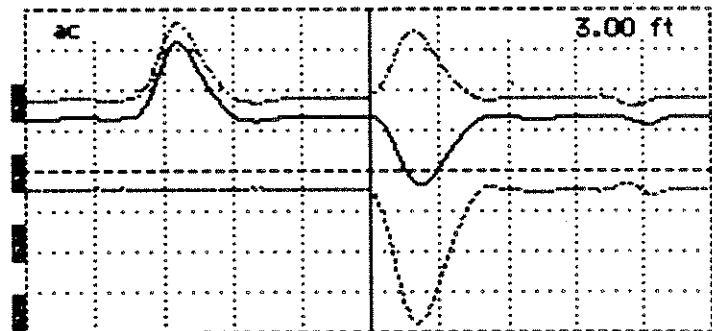

There are many situations where the VIEW DIFF function can be useful. One common situation is to store the waveform of a suspect cable, repair the cable, then compare the two waveforms after the repair. During repairs the VIEW INPUT, VIEW DIFF and VIEW STORE waveforms can be used to judge the effectiveness of the repairs. The optional YT-1 chart recorder can be used to make a chart of the three waveforms to document the repair.

Another valuable use for the VIEW DIFF function is for verifying cable integrity before and after servicing or periodic maintenance which requires moving or disconnecting the cable.

The VIEW DIFF function is useful when you want to see any changes in the cable. In some systems there may be several reflections coming back from each branch of the network. It may become necessary to disconnect branch lines from the cable under test to determine whether a waveform represents a physical fault or is simply an echo from one of the branches. The STORE and VIEW DIFF functions allow you to see and compare the network with and without branches.

Two important cautions should be observed when using the VIEW DIFF function. If you change either VERT SCALE or DIST/DIV you will no longer be comparing features that are the same distance apart or of the same magnitude on the display. It is possible to save a feature (e.g., a connector or tap) at one distance down the cable and compare it to a similar feature at a different distance by moving the  $\Phi$  POSITION and  $\Phi$  POSITION controls. When this is done great care should be taken to make sure the vertical and horizontal scales are identical for the two waveforms being compared. If either the stored or current waveform is clipped at the top or bottom of the display the difference waveform will be effected.



## Using Vertical and Horizontal SET REF

### HORZ SET REF ( $\Delta$ Mode)

HORZ SET REF mode allows you to offset the distance reading. For example, a lead-in cable to a switching network is 3 feet long, and it's desirable to start the measurement after the end of the lead-in cable. HORZ SET REF makes it simple.

1. Turn NOISE FILTER control to HORZ SET REF. The noise reading on the LCD will read "set  $\Delta$ ".

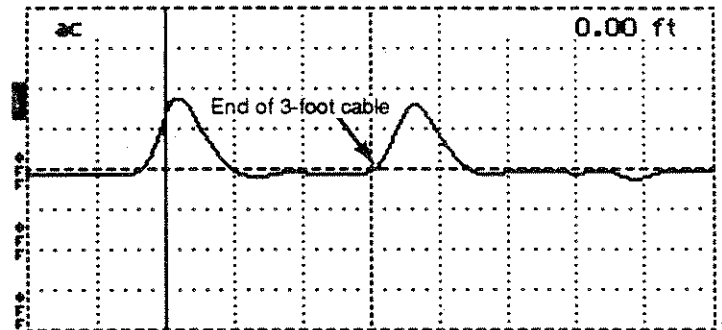

2. Turn  $\leftarrow$  POSITION to set the cursor where you want to start your distance reading. This is the "new" zero reference point. For a 3 foot lead-in cable the cursor would be set at 3 feet.

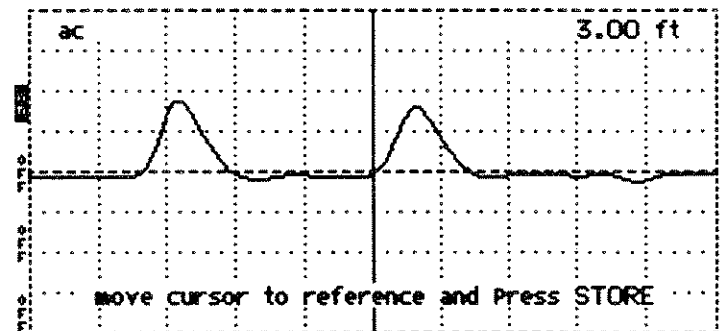

3. Push STORE.

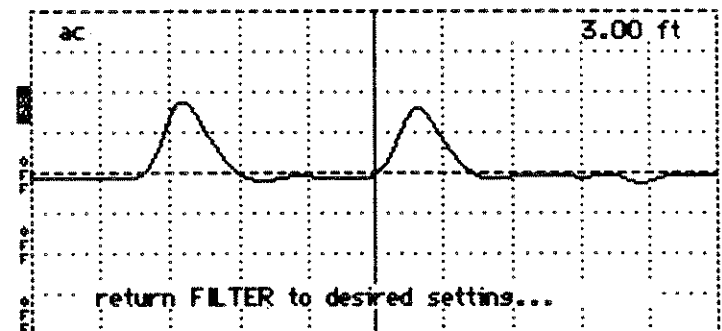

4. Turn NOISE FILTER control to 1 avg. The instrument is now in HORZ SET REF, or DELTA mode. The distance window reads 0.00 ft $\Delta$ . As the cursor is scrolled down the cable, the distance reading will be from the new zero reference point.

*NOTE:  $V_p$  changes will affect where the reference is set on the cable. Set  $V_p$ , then Set  $\Delta$  to the desired location.*

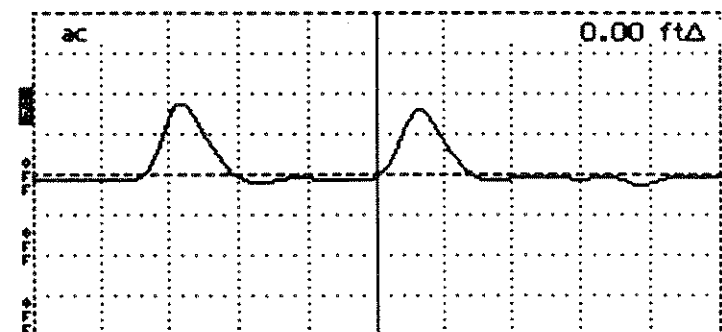

5. To exit HORZ SET REF, use the following procedure:

a. Turn NOISE FILTER control to HORZ SET REF.

b. Turn DIST/DIV to 1 ft/DIV. (If distance reading is extremely high, you may want to use a higher setting initially, then turn to 1 ft/DIV for the next adjustment).

c. Turn  $\diamond$  POSITION until the distance window reads 0.00 ft.

d. Push STORE.

e. Turn NOISE FILTER to desired setting.

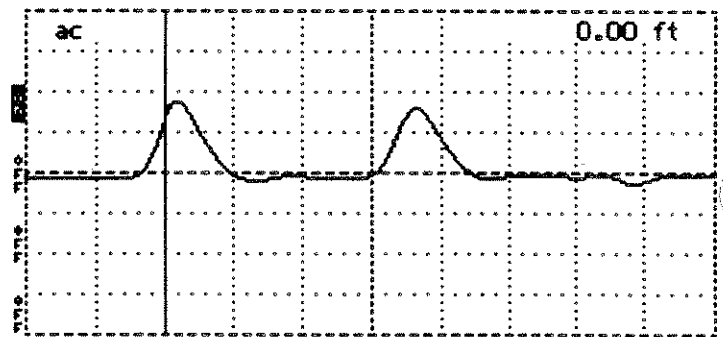
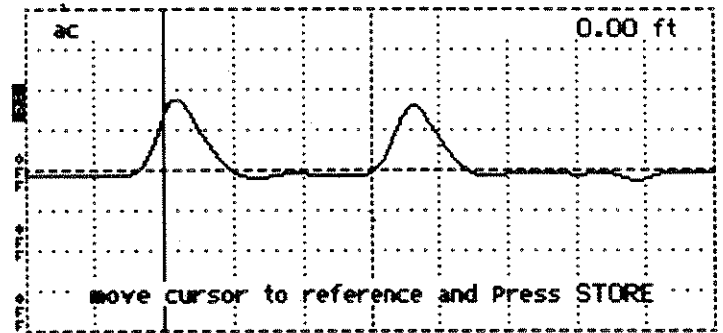

## VERT SET REF

VERT SET REF works similar to HORZ SET REF, except that it sets a reference for gain (pulse height) instead of distance. This feature allows zeroing the dB scale at whatever pulse height desired.

1. Turn **NOISE FILTER** fully counterclockwise. "Set Ref" will appear in the noise averaging window on the LCD. Adjust the incident pulse to the desired height (for example, four divisions). It may be necessary to adjust  $\Phi$  POSITION.
2. Push **STORE**. Return **NOISE FILTER** to desired setting.
3. Notice that the dB scale is set to 0.00 dB.
4. To exit **VERT SET REF**, use the following procedure:
  - a. Make sure vertical scale is in dB mode. Access Setup Menu if change is needed.
  - b. Turn **NOISE FILTER** to VERT SET REF.
  - c. Adjust **VERT SCALE** to obtain 0.00 dB.
  - d. Push **STORE**.
  - e. Turn **NOISE FILTER** to desired filter setting.

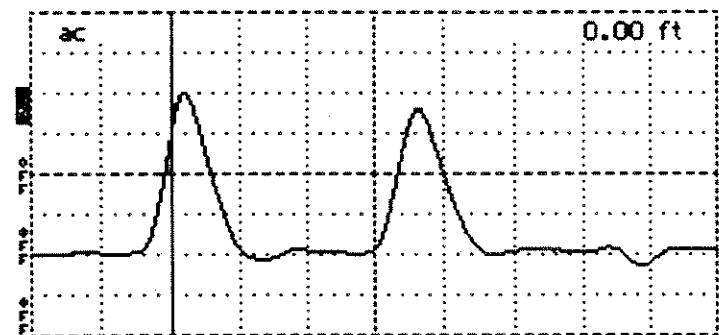
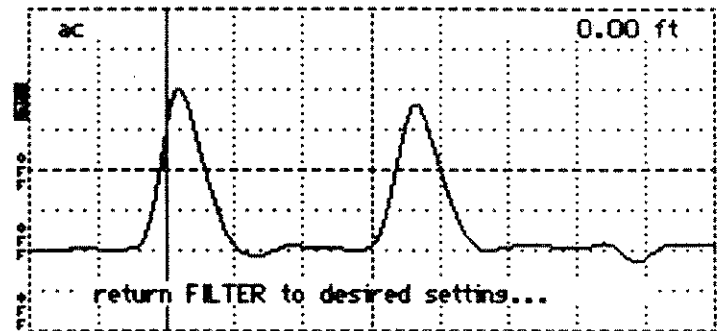

Since dB is actually a ratio between the energy sent out and the energy reflected back, using VERT SET REF does not affect the dB difference measured.

### IMPORTANT

*It is recommended that you DO NOT use Auto Pulse Width when making measurements in VERT SET REF. Auto Pulse Width changes the pulse width at 100, 500, and 5000 feet. If the pulse width changes while in VERT SET REF, it could result in an erroneous reading. Manually controlling the pulse width assures the pulse width remains the same for both the incident and reflective pulses.*

## Additional Features (Menu Selected)

### Max Hold

The 1503B will capture and store waveforms on an ongoing basis. This is useful when cable or wire is subjected to intermittent or periodic conditions. The 1503B will monitor the line and display any fluctuations on the LCD.

1. Attach cable to 1503B front panel. Push **MENU**. This will access the Main Menu.
2. Scroll to "Set Up Menu", and push **MENU**.
3. Scroll to "Acquisition Control Menu", and push **MENU**.
4. Scroll to "Max Hold is: Off", and push **MENU**. "Max Hold is: Off" will change to "On". The monitoring function is now ready to activate.
5. Repeatedly push **MENU** until the instrument is back in Normal Operation.
6. When ready to monitor, push **STORE**. The 1503B will now capture any changes in the cable.
7. Exit active monitor mode by pushing **STORE**.
8. Exit **Max Hold** by accessing the "Acquisition Control Menu", turn off **MAX HOLD**, and push **MENU** repeatedly until instrument returns to Normal Operation mode.

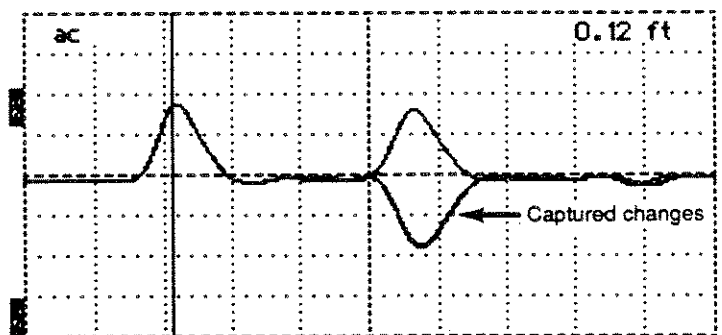
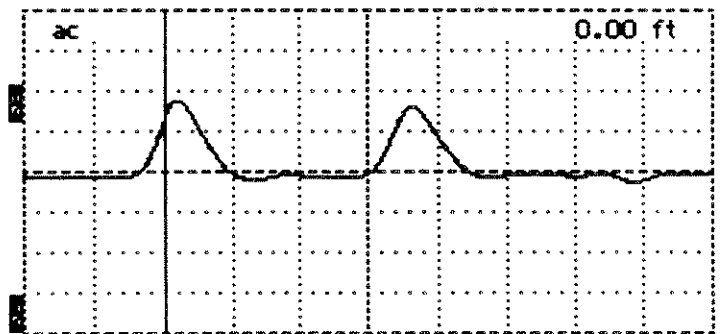
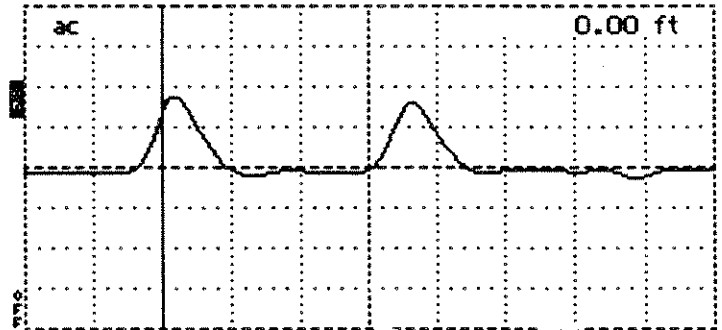

## Pulse On/Off

This feature puts the 1503B in a "listening mode" by turning off the pulse generator.

1. Attach cable to the 1503B front panel. Push **MENU**. That will access the Main Menu.
2. Scroll to "Set Up Menu", and push **MENU**.
3. Scroll to "Acquisition Control Menu", and push **MENU**.
4. Scroll to "Pulse is: On". Push **MENU**. "Pulse is: On" will change to "Off".
5. Repeatedly press **MENU** until instrument returns to Normal Operation mode.

ac					0.00 ft

This feature allows the 1503B to act much like a non-triggered oscilloscope. Caution should be taken, however. In this mode, the 1503B is acting as a detector only. Any pulses detected will not originate from the instrument, consequently distance readings will be invalid. If listening to a local area network, for example, it is possible to detect traffic, but not possible to measure the distance to their origin.

"Pulse is: On/Off" can be used in conjunction with "Max Hold is: On/Off".

6. To exit Pulse is: On/Off, access Acquisition Menu and turn function off. Then, repeatedly push **MENU** until the instrument returns to the Normal Operation mode.

## Single Sweep

The single sweep function will acquire one waveform and display it.

1. Attach cable to 1503B front panel. Push **MENU**. That will access the Main Menu.
2. Scroll to "Set Up Menu", and push **MENU**.
3. Scroll to "Acquisition Control Menu", and push **MENU**.
4. Scroll to "Single Sweep is: Off", and push **MENU**. "Single Sweep is: Off" will change to On.
5. Repeatedly push **MENU** until the instrument is back in the Normal Operation mode.
6. When ready to begin a sweep, push **VIEW INPUT**. A sweep will also be initiated when you change any of the front panel controls. This allows observing front panel changes without exiting the Single Sweep mode.

As in normal operation, averaged waveforms will take longer to acquire.

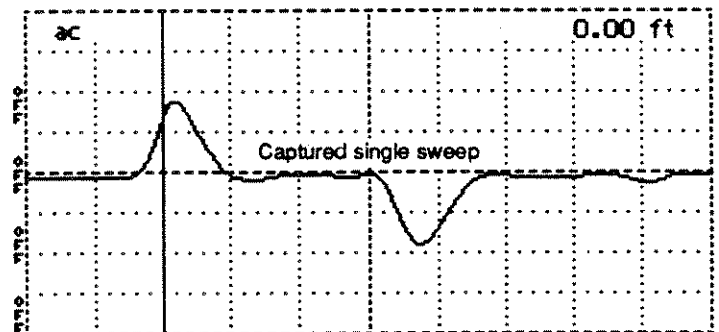

7. To exit Single Sweep mode, go into the Acquisition Menu and turn Single Sweep mode off. Then, repeatedly push **MENU** until the instrument returns to the Normal Operation mode.

## Operator Tutorial

The next few pages will show, step by step, the features and uses of the 1503B.

### What is the Tektronix 1503B?

The Tektronix 1503B Time Domain Reflectometer is a long range metallic cable tester capable of finding faults in metal cable. Tests can be made on coaxial, twisted pair, or parallel cable.

### How Does It Do It?

The 1503B sends an electrical pulse down the cable, and detects any reflections made by discontinuities. This is known as Time Domain Reflectometry. The 1503B is sensitive to impedance changes. Problems in the cable will be detected and displayed as changes in impedance along the cable. These will be displayed as hills and valleys in the reflected pulse. The 1503B is capable of finding shorts, opens, defects in the shield, foreign substances in the cable (water, etc.), kinks and more. Even though other instruments might show a cable as "good", the 1503B can show many previously "hidden" faults.

### YOU, the Operator

The 1503B is a highly accurate cable tester. It is easy to use, and will provide fast, accurate measurements. Because of electrical and environment differences in cables and their applications, each waveform will likely differ. The best way to learn these differences is experience with the instrument. You are the 1503B's most important feature. Experiment with different cables in known conditions and see how they compare. Subject cables to situations you might find in your application and learn their effects. We have included some examples of cable faults in this manual to help you gain familiarity. With practice, you will quickly become familiar with even the most subtle differences in waveforms.

### The MENU Screens

The 1503B is equipped with various help screens. Simply press **MENU** for assistance. The instrument will prompt you. More on MENU in the *Operator Instructions* located in this manual.

## Getting Started

Let's inspect a cable. For the next few examples, we'll be using the 3 foot precision test cable provided with the 1503B (Tek Part Number 012-0482-00).

1. Pull on the **POWER** switch. The instrument will initialize, give instructions for accessing the menu, and enter "Normal Operation" mode.

2. Set the 1503B front panel:

CABLE	Attach 3 ft cable
IMPEDANCE	50 $\Omega$
NOISE FILTER	1 avg
VERT SCALE	0.00 dB (default)
DIST/DIV	1 ft/DIV
<i>DIST/DIV (METRIC)</i>	<i>0.25 Metres</i>
$V_p$	.66
PULSE WIDTH	2 ns

### IMPORTANT

$V_p$  (Velocity of Propagation) of the test cable is important for making accurate distance measurements. If you do not know the  $V_p$  factor of a cable, distance readings will be directly affected. You can get a general idea from the table on page 2-11, find the  $V_p$  with a sample cable using the procedure on page 2-12, or use the Cable Information Menu. If it is impossible to obtain the  $V_p$  of a cable, the instrument will still show cable faults, but the distance readings may be erroneous. The test cable used in this tutorial has a  $V_p$  of .66.

**VERT SCALE** will already be set to 0.00 dB (called the "default setting"). The cursor will be near the leading edge of the incident pulse (at the point on the waveform representing the front panel). Other information displayed includes the type of power used ("AC or bat"), and the **DISTANCE WINDOW**, 0.00 ft. This data will be displayed when the instrument is turned on in this manner. Push button switch status and other instrument functions are also displayed.

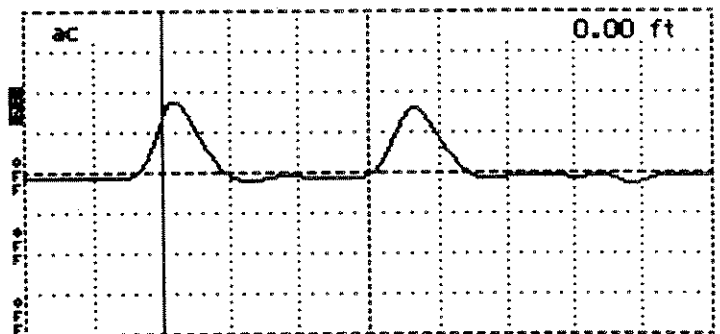



3. The pulse on the left is the test pulse (incident pulse) leaving the instrument. The reflected pulse on the right displays the echo coming back. Turn  $\Phi$  POSITION clockwise until the cursor rests on the rising edge of the reflected pulse. The upper right corner of the display (distance window) should read 3.00 feet. Note that the reflected pulse rises. This is the classic signature of an open cable, a point of higher impedance.

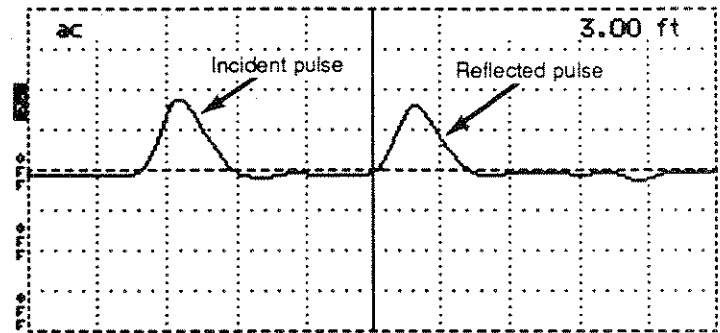

4. Adjust VERT SCALE control. This will increase or decrease the height of the pulse. For accurate measurements, the pulse should occupy most of the LCD. Note the LCD displays the VERT SCALE setting in dB. For now, set this control to 7 dB.

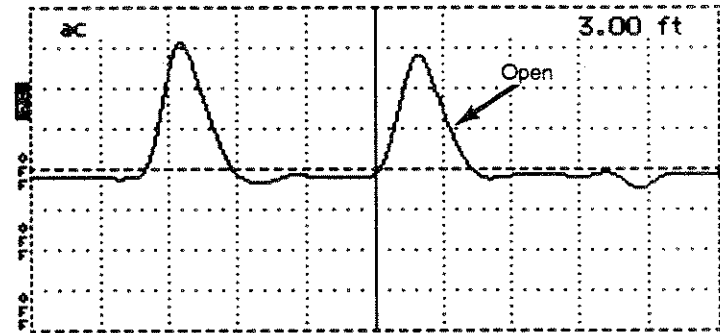

5.  $\Phi$  POSITION moves the trace up and down the display. Adjust for best viewing.

6. Short the end of the cable with an electrical clip or other suitable device. See the pulse take a dive? That's the classic signature of a short, a point of lower impedance. The distance window will still read 3.00 ft. If the short is not directly across the conductors of the BNC, e.g. needle nose pliers, the downward edge of the waveform may be slightly past the cursor indicating the length of the shorting device. Remove the short.

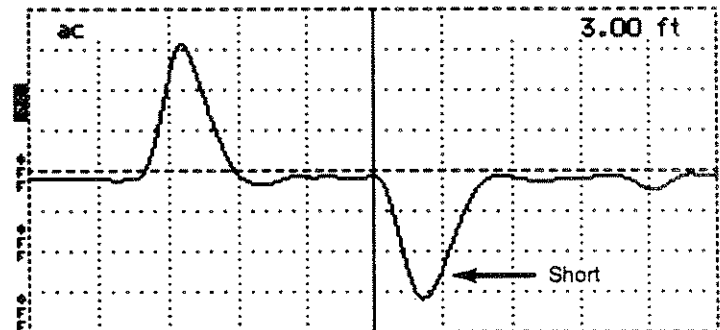

With a little practice, you can identify many kinds of cable faults.

## The Waveform Up Close

It helps to know the "ingredients" of the pulse. Here's the waveform anatomy using the 3 foot test cable as an example.

1. Turn  $\Phi$  POSITION counterclockwise until the distance window reads  $-2.00$  ft. The cursor will be on the far left side of the LCD, and the reflected pulse will be near center screen. Set the 1503B front panel:

CABLE	Attach 3 ft cable (no short)
IMPEDANCE	$50\Omega$
NOISE FILTER	1 avg
VERT SCALE	0.00 dB
DIST/DIV	1 ft
DIST/DIV (METRIC)	0.25 m
V <sub>p</sub>	.66
PULSE WIDTH	2 ns

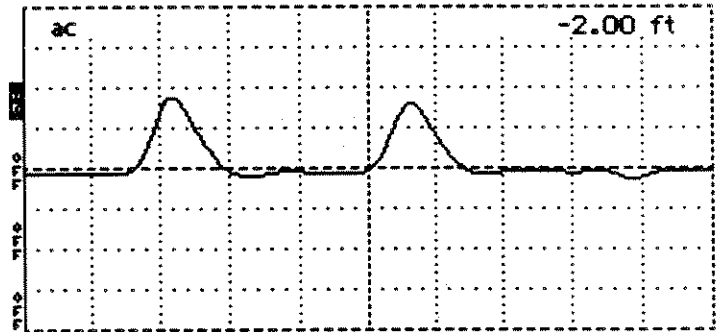

2. The first (left) pulse is the *incident pulse* as sent from the pulse generator. The second "bump" is the *reflected pulse* as it bounces back from the end of the cable. The reflected pulse and the distance (time) between pulses provides the information needed for calculating the distance between faults or the end of the cable.

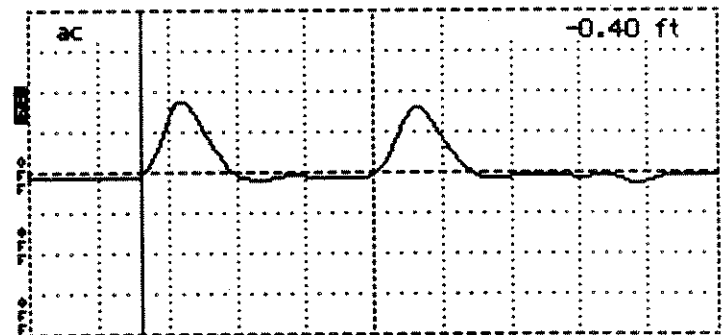

3. Adjust  $\Phi$  POSITION so the cursor rests on the rise of the incident pulse. Note the distance window reads approximately  $-0.40$  ft. This is the distance from the front panel BNC connector to the pulse generator circuit board (where the test pulse is generated).

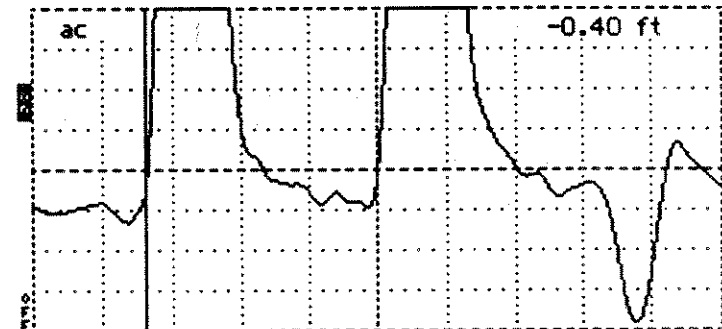

4. Adjust VERT SCALE to approximately 25 dB. Adjust  $\Phi$  POSITION to keep the middle portion of the pulse on the display. The bumps following the incident pulse are the aberrations from the internal circuitry, and reflections between the open end of the cable and the front panel.

## A Longer Cable

Longer cables may not fit in the display. Let's demonstrate with a longer cable.

Obtain a known length of cable, preferably 50 $\Omega$ . For this example, we're using a coaxial cable approximately 455 feet long. Your cable length likely will differ, but the following test procedure remains fundamentally correct for any cable length up to 50,000 feet.

1. Set the 1503B front panel:

CABLE	Connect available cable.
IMPEDANCE	50 $\Omega$
NOISE FILTER	1 avg
VERT SCALE	10 dB
DIST/DIV	100 ft
DIST/DIV (METRIC)	25 m
V <sub>p</sub>	Appropriate setting
PULSE WIDTH	Auto (Clockwise)

2. With the above settings, we can view our entire cable. By placing the cursor at the rise of the reflected pulse, we can see this particular cable is 456.00 feet.

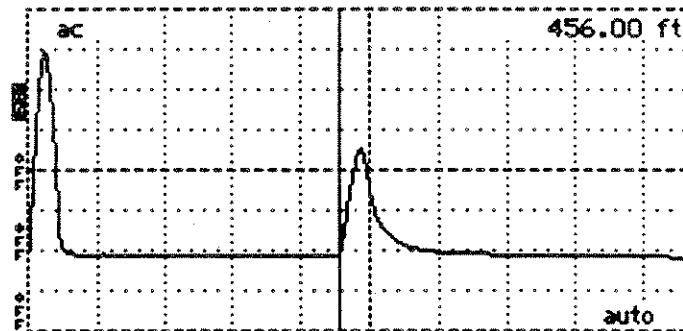

3. By decreasing the DIST/DIV control, the cable can be more closely inspected at the point of the cursor. Decrease the DIST/DIV to 10 FT/DIV. This has "expanded" the cable across the LCD. Turn  $\odot$  POSITION counterclockwise. Note that the distance window changes as we "scroll" down the cable. In reality, we are *electrically* inspecting the cable foot by foot.

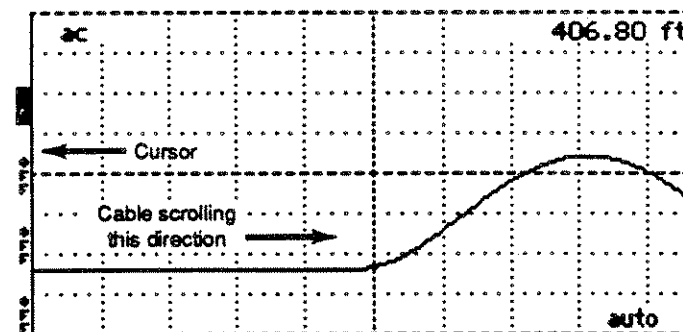

**NOTE:** When testing a long cable, it is helpful to set DIST/DIV to a higher setting when scrolling to either end of the cable. For example, if testing a 5,000 foot cable, it would be very tiring to scroll the cable from end to end with DIST/DIV at 1 FT/DIV!

4. Turn the  $\leftarrow$  POSITION control to return the cursor to the rise of the reflected pulse.
5. Increase DIST/DIV to 100 ft.
6. Set PULSE WIDTH to 2 ns. Notice that the pulse has nearly disappeared.
7. Set PULSE WIDTH to 10 ns. The pulse height increases because there is more energy being sent through the cable.
8. Set PULSE WIDTH to 100 ns. Now the pulse is quite large and easy to use.
9. Set PULSE WIDTH to 1000 ns. The pulse is now longer than our example cable. This would be an ideal pulse, however, for a very long cable.

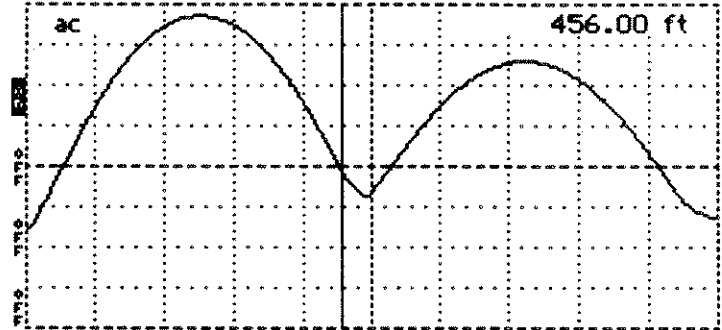
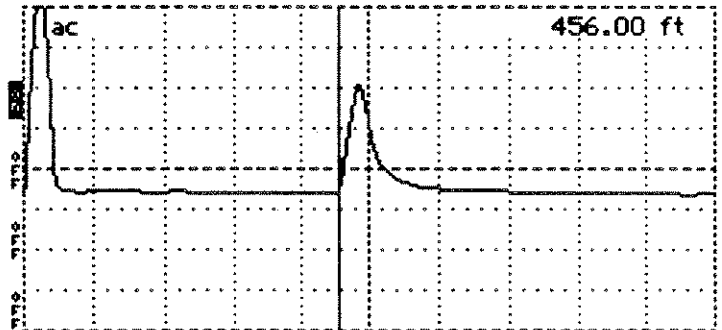
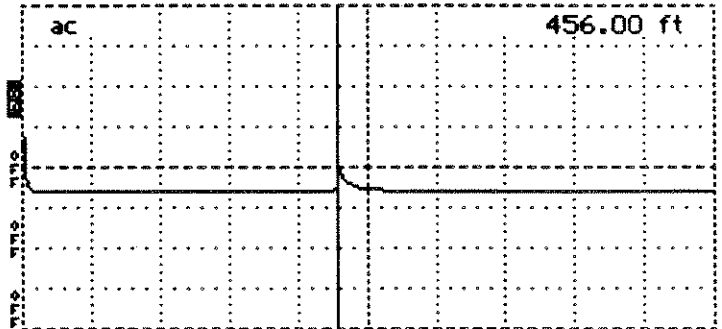
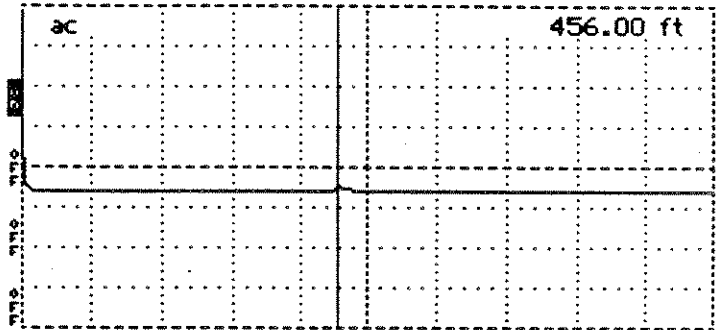

When the PULSE WIDTH control is set to "Auto", the instrument automatically sets the pulse width in relation to the distance on the right side of the display. The following table shows the relationship between the distance on the display and Auto PULSE WIDTH.

CABLE LENGTH	SUGGESTED PULSE	SUGGESTED ft/DIV
0 to 100 ft	2 ns	10 ft/DIV
51 to 500 ft	10 ns	50 ft/DIV
501 to 5000 ft	100 ns	500 ft/DIV
5001 to 50,000 ft	1000 ns	5000 ft/DIV

## Noise

- On a longer cable, "grass" may appear on the display pulse. This is primarily caused by the cable acting as an antenna, picking up nearby electrical noise. To show this, set the 1503B front panel:

CABLE	Attach 3 ft cable
IMPEDANCE	50 $\Omega$
NOISE FILTER	1 avg
VERT SCALE	0.00 dB
DIST/DIV	1 ft
DIST/DIV (METRIC)	0.25 m
V <sub>p</sub>	.66
PULSE WIDTH	2 ns
◄ POSITION	50.0 ft

- Attach the 50 $\Omega$  terminator to the test cable using the female-to-female BNC adaptor. (Both of these items are supplied with the instrument).
- Increase **VERT SCALE** to 50 dB. Use ◄ **POSITION** to keep the waveform on screen. As the **VERT SCALE** setting increases, there will be noise in the form of a moving, fuzz-like waveform with a few random spikes.

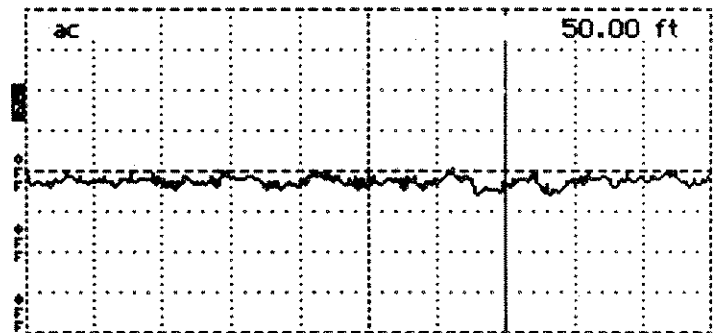

- Turn **NOISE FILTER** control clockwise to 8. This will "average out" much of the noise.

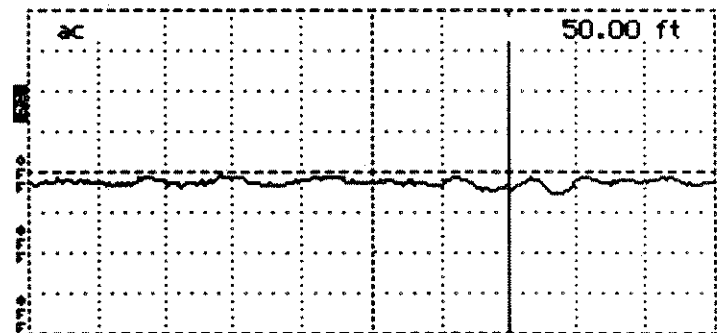

- Increase the **NOISE FILTER** setting to 128. *NOTE: The higher the setting, the more time the instrument takes to average the waveform.*

- Move ◄ **POSITION** and notice how averaging restarts at a low value to allow easy positioning.

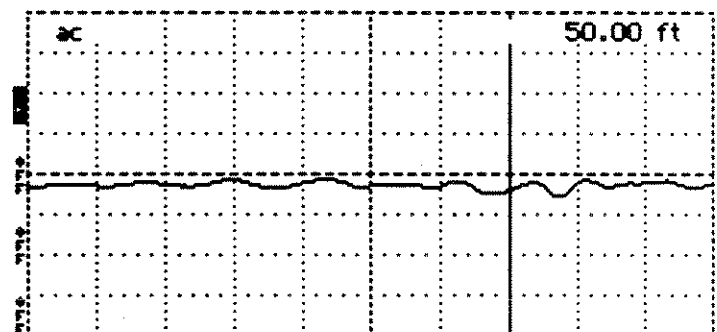

The 50 $\Omega$  terminator is used because it gives a good impedance match. Since there are no large discontinuities, it appears to the instrument as an "endless" cable. The noise seen in this demonstration is noise picked up on the cable, and some "internal" noise in the 1503B. When testing cables, the noise filter is extremely effective in reducing noise.

## Set Ref ( $\Delta$ Mode)

### HORZ SET REF

Horizontal Set Ref establishes the starting point at which the distance window begins reading the distance to the cursor. If, for example, you had a 3-foot cable leading to a patch panel, you could eliminate this jumper from your distance reading.

1. Set the 1503B front panel:

CABLE	Attach 3 ft cable
IMPEDANCE	50 $\Omega$
NOISE FILTER	1 avg
VERT SCALE	0.00 dB
DIST/DIV	1 ft
DIST/DIV (METRIC)	0.25 m
PULSE WIDTH	2 ns
	(No terminator)

2. If **POWER** has been left on from previous step, return distance window reading to 0.00 with  $\Leftarrow$  **POSITION** control.

There are the two familiar pulses of the test cable. Turn **NOISE FILTER** counterclockwise to **HORZ SET REF**. The noise filter reading says "set  $\Delta$ ". (The **NOISE FILTER** control has three functions: **NOISE FILTER**, **HORZ SET REF**, and **VERT SET REF**.)

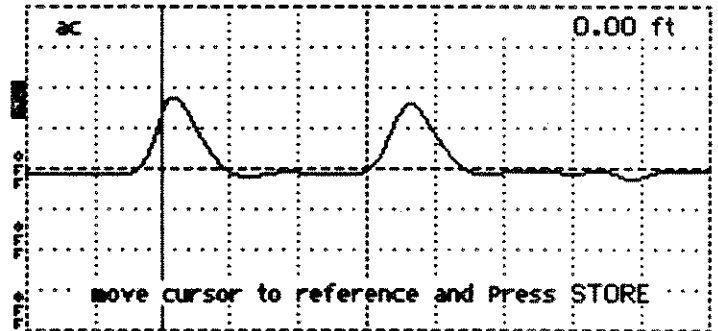

3. Adjust  $\Leftarrow$  **POSITION** so the cursor is on the rise of the reflected pulse. Distance window should read 3.0 ft. Press **STORE**.

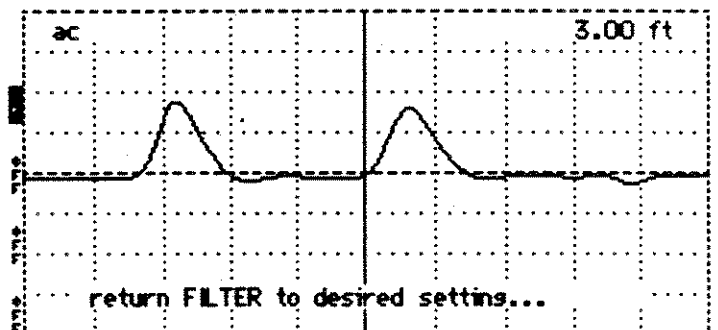

4. Turn **NOISE FILTER** control to 1 avg. Note that the distance window now reads "0.00 ft $\Delta$ ". This means everything from the front panel BNC to the end of the cable is subtracted from the distance calculations.

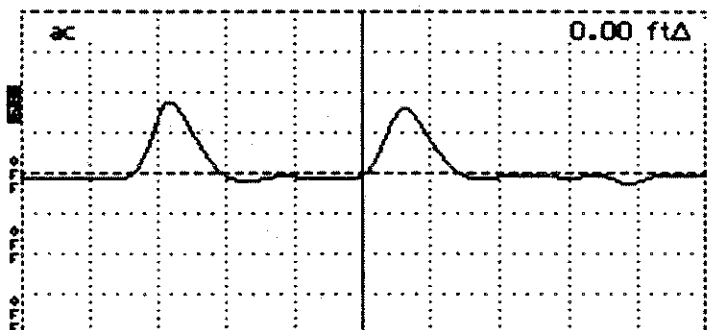

## 5. Changing or Exiting HORZ SET REF

Horz Set Ref can be changed by turning the **NOISE FILTER** back to HORZ SET REF and repeating the above procedure. If you wish to totally exit HORZ SET REF, do the following:

- a. Set **POSITION** to *exactly* 0.00 ft (you may have to set DIST/DIV to 1 ft).
- b. Push **STORE**.
- c. Turn **NOISE FILTER** to the desired noise setting.

**VERT SET REF**

This control is nearly the same as the HORZ SET REF except it sets the vertical zero reference. It would be helpful to read the section of VERT SET REF in the Operator Instructions. This will give you some technical background on VERT SET REF.

The VERT SET REF function allows manual control of the vertical calibration of the 1503B. This can be used to compensate for cable loss or to increase the resolution of the return loss measurements. The example below shows how to compensate for cable loss.

The reflection from an open or short at the far end of a long cable is often less than two divisions high at 0.00 dB. This is because of the energy lost in the cable. Here is how to correct for this loss and be able to make accurate measurements at the end of the cable.

1. To make this correction, open or short the cable (or another like cable in the bundle) at the far end.
2. Turn **NOISE FILTER** all the way counterclockwise to **VERT SET REF**. The display will prompt you and "Set Ref" will appear on the display above the **NOISE FILTER** control.
3. Adjust **VERT SCALE** until the reflection from the open (or short) is two divisions high. Press **STORE** and return **NOISE FILTER** to the desired setting.
4. The **VERT SCALE** will now read 0.00 dB.

Return loss measurements at the far end of the cable (or a similar cable in the bundle) can now be made using normal methods. To make measurements closer or farther from the instrument requires resetting the **VERT SET REF**.

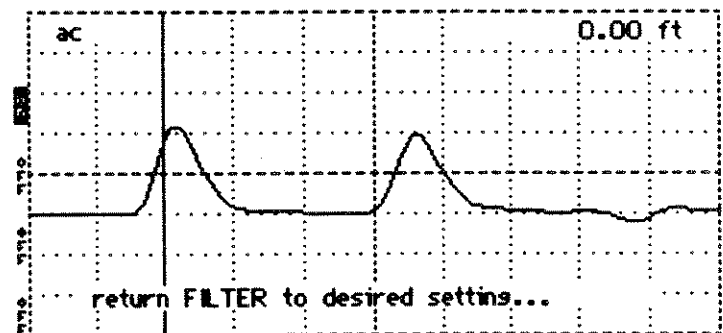
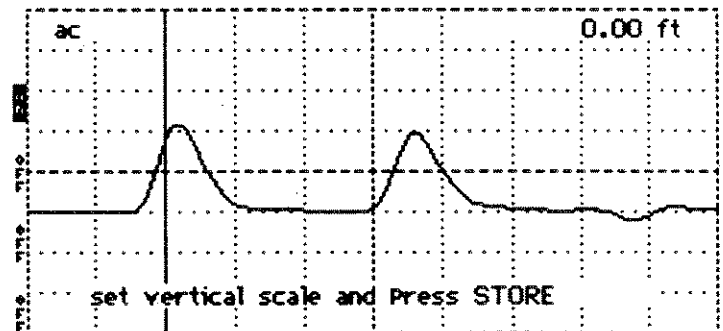
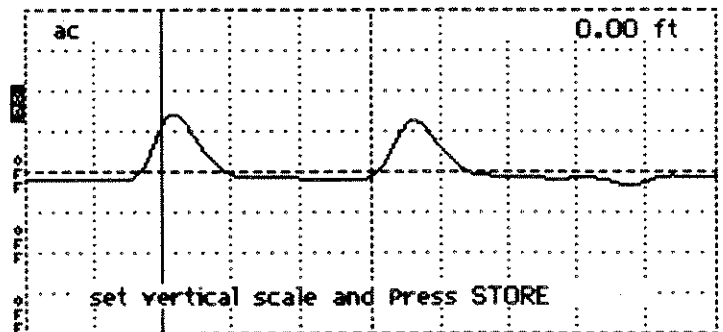



### 5. Changing or Exiting VERT SET REF

VERT SET REF can be changed by turning the **NOISE FILTER** back to VERT SET REF and repeating the above procedure. If you wish to totally exit VERT SET REF, do the following:

- a. Turn **NOISE FILTER** to VERT SET REF.
- b. Turn **VERT SCALE** for a display reading of 0.00 dB or 500 mp.
- c. Push **STORE**.
- d. Return **NOISE FILTER** to desired setting.

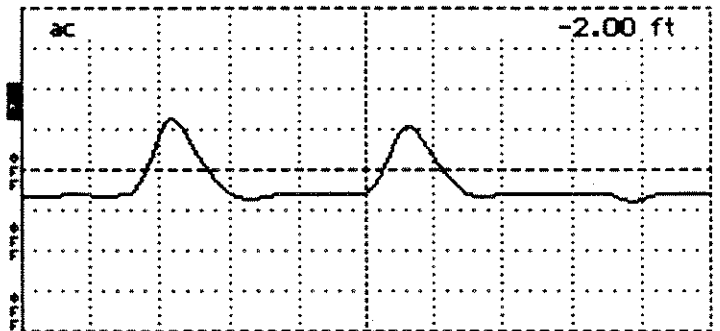
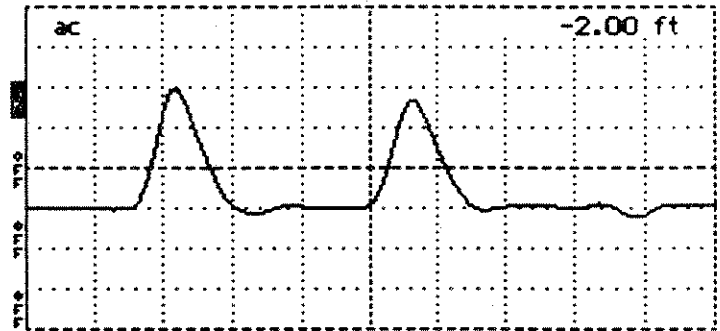

## VIEW INPUT

This push button allows you to view what's coming in the **CABLE** connector, or eliminate it from the display.

1. Set the 1503B front panel:

CABLE	Attach 3 ft cable
IMPEDANCE	50Ω
NOISE FILTER	1 avg
VERT SCALE	0.00 dB
DIST/DIV	1 ft
<i>DIST/DIV (METRIC)</i>	<i>0.25 m</i>
PULSE WIDTH	2 ns

2. Press **VIEW INPUT**. The indicator block on the LCD should read **OFF** and the waveform should disappear from the display.

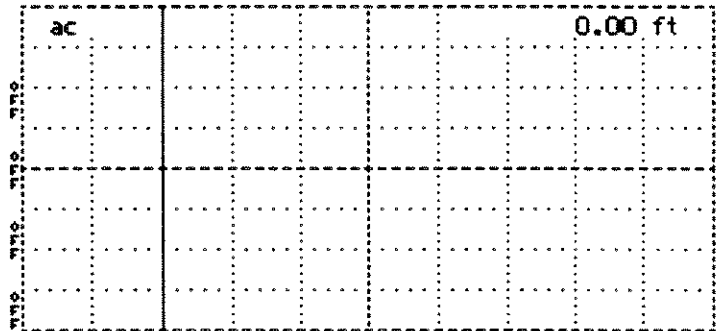

3. Press **VIEW INPUT**. The indicator block will re-appear as will the waveform.

This function can be used to make the display less "busy" when viewing stored waveforms.

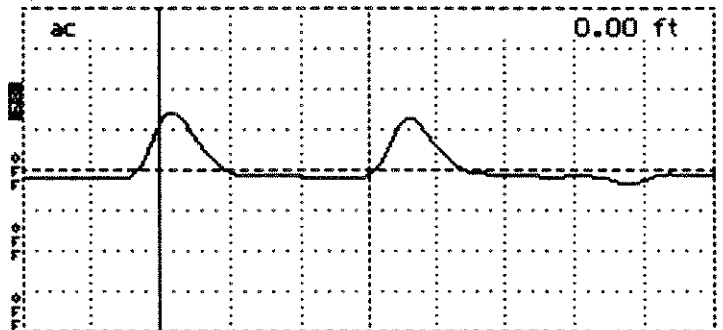

## STORE and VIEW STORE

These functions will allow you to store a waveform.

1. Set the 1503B front panel:

CABLE	Attach 3 ft cable
IMPEDANCE	50 $\Omega$
NOISE FILTER	1 avg
VERT SCALE	0.00 dB
DIST/DIV	1 ft
<i>DIST/DIV (METRIC)</i>	<i>0.25 m</i>
PULSE WIDTH	2 ns

2. Make sure you have a waveform on the LCD. Adjust  $\phi$  POSITION to place the waveform in the upper portion of the display. Press **STORE**. The STORE indicator block should turn black and read "ON". The waveform is now stored in a non-volatile (permanent) memory in the instrument.
3. Turn **POWER** off for a few seconds. Turn **POWER** on. Note that the STORE indicator block is "ON", showing that the waveform has been stored.
4. Short the inner conductor of the end of the test cable to the outer conductor of the test cable. The reflected pulse will drop below the baseline. Adjust  $\phi$  POSITION to place the trace in the middle portion of the LCD.
5. Press **VIEW STORE**. What you see on the display is the waveform you stored previously (VIEW STORE), and the current waveform (VIEW INPUT). The top waveform is an "open" (VIEW STORE), and the one on the bottom (VIEW INPUT) is a "short".

Comparing new cables with old cables, or repaired cables with damaged cables is easy using these two push buttons. Leave the instrument "as is" for the next step.

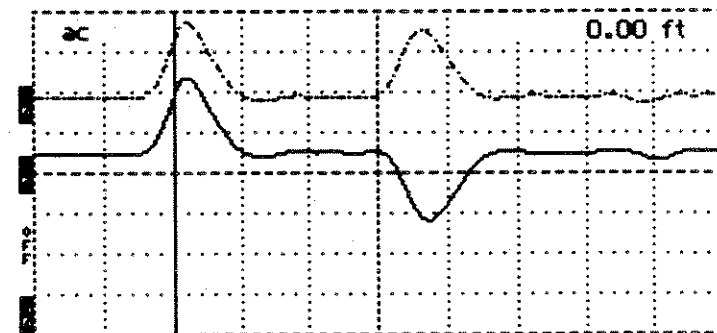
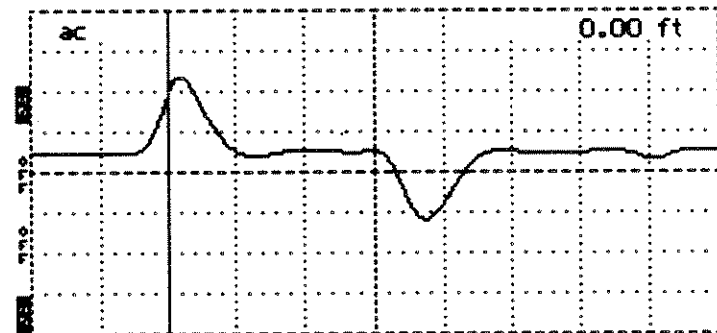
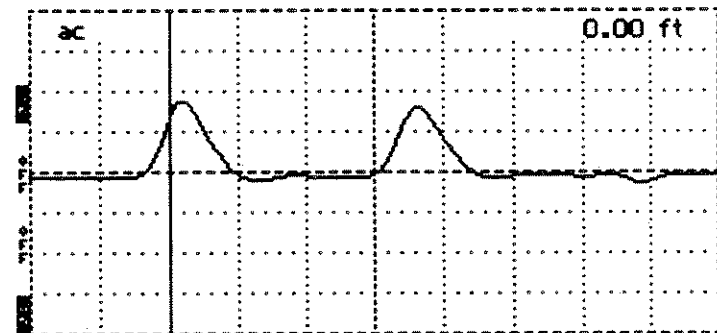
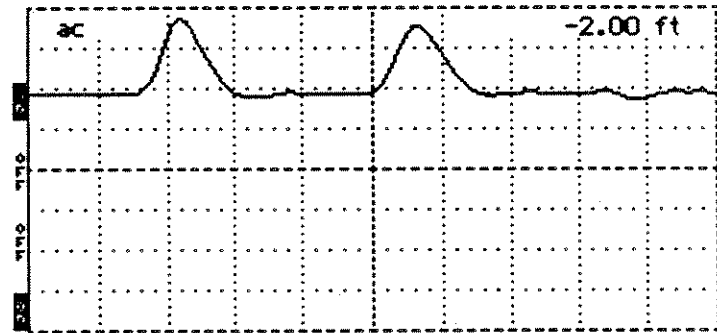

## VIEW DIFF

1. Press **VIEW DIFF**. This waveform is the difference between the **VIEW STORE** waveform and the **VIEW INPUT** waveform. If no waveform has been stored in the memory, an error message will be displayed.

*NOTE: There must be a waveform stored before it can be compared by the VIEW DIFF function.*

*NOTE: If the waveform STOREd and the VIEW INPUT waveform are identical, the difference will appear as a straight line.*

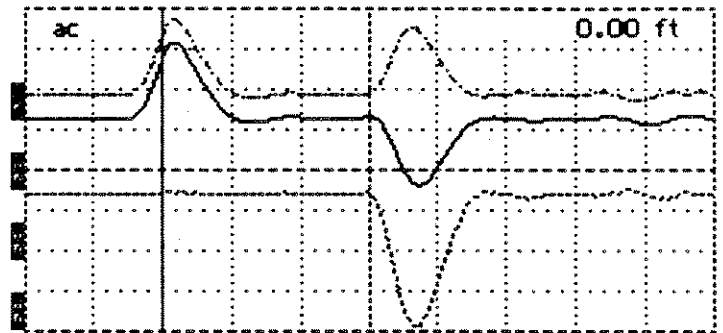

## Menu Accessed Functions

If you get confused or lost while in a MENU, repeatedly press MENU until the instrument returns to "Normal Operation" mode.

### Max Hold

1. Set the 1503B front panel:

CABLE	Attach 3 ft cable
IMPEDANCE	50 $\Omega$
NOISE FILTER	1 avg
VERT SCALE	0.00 dB
DIST/DIV	1 ft
DIST/DIV (METRIC)	0.25 m
PULSE WIDTH	2 ns

2. Pull POWER on. Press MENU to access the Main Menu. With the  $\theta$ POSITION control, scroll down to "Setup Menu" and press MENU.

3. Scroll down to "Acquisition Menu" and press MENU.

4. Scroll down to "Max Hold is:" and press MENU. The menu will change from "Max Hold is: Off", to "Max Hold is: On". The Max Hold function is now ready. Read the screen instructions. Press MENU.

5. Press MENU again to exit the Acquisition Control Menu.

6. Press MENU again to exit the Setup Menu.

7. Press MENU again to enter "Normal Operation" mode. Note that VIEW STORE and VIEW DIFF indicator blocks have disappeared. This tells you that both of these functions are inoperative.

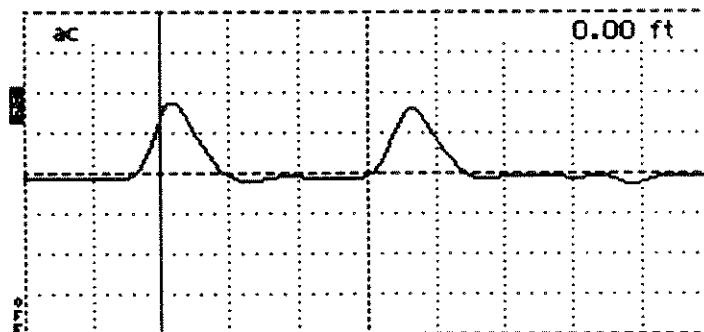

8. Press **STORE**. This activates the Max Hold function, and the STORE indicator block is dark. With a clip lead or other device, short the end of the test cable and remove. Note that the short has been left on the display.

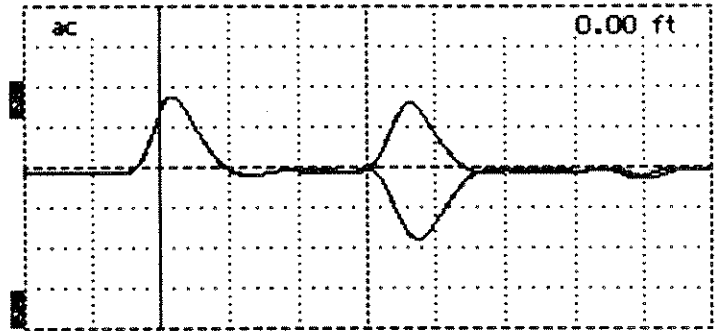

9. Turn  $\Phi$  **POSITION** control counterclockwise. The waveform will "strobe" down the display, leaving traces of its movements.
10. Press **STORE**. The display will clear, awaiting **STORE** to be pressed again, activating another Max Hold monitor cycle.

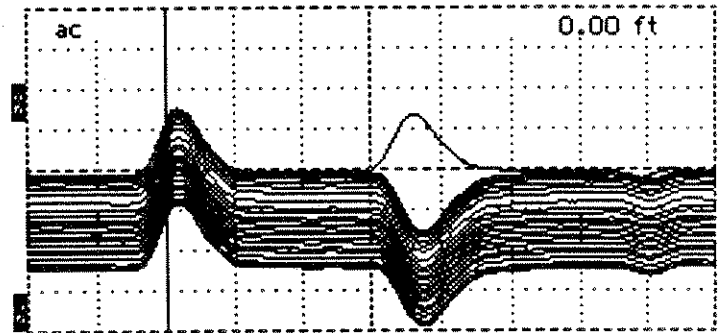

You can see how this function is useful for monitoring lines for changes over a period of time, or for intermittent conditions. For example:

- a) A coastal phone line only has problems during high tide. Overnight monitoring reveals water in the line during the high tide period.
- b) A data communications line is monitored for an intermittent short. Three days of monitoring reveals the shorts occur only during the hours of darkness. Rodents are found in the cable ducts.
- c) A cable becomes defective only during daytime hours. Monitoring reveals the line length increases (sags) during the heat of the day, shorting out on a tree limb. During the night the cable cools, tightens, and is no longer shorted on the tree limb.

## Pulse On/Off

Set the 1503B front panel:

CABLE	Attach 3 ft cable
IMPEDANCE	50Ω
NOISE FILTER	1 avg
VERT SCALE	0.00 dB
DIST/DIV	1 ft
<i>DIST/DIV (METRIC)</i>	<i>0.25 m</i>
PULSE WIDTH	2 ns

2. Pull **POWER** on. Press **MENU** to access the Main Menu. Scroll down to "Setup Menu" and press **MENU**.
3. Scroll down to "Acquisition Control Menu" and press **MENU**.
4. Scroll down to "Pulse is:" and press **MENU**. The menu will change from "Pulse is: On" to "Pulse is: Off".
5. Press **MENU** until instrument enters the "Normal Operation" mode.

*Note there is no pulse visible on the display. The 1503B is now functioning as a listening device, much like a non-triggered oscilloscope. Uses include monitoring the cable for pulses.*

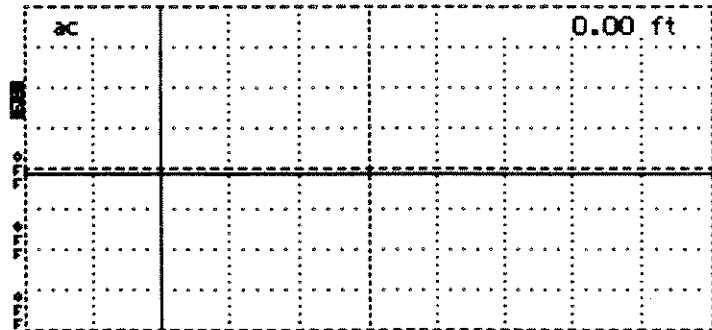

6. To turn the pulse back on, enter the "Acquisition Control Menu". Scroll to "Pulse is: On" and press **MENU**. Follow the usual procedure to return to enter "Normal Operation" mode.

## Single Sweep

1. Set the 1503B front panel:

CABLE	Attach 3 ft cable
IMPEDANCE	50
NOISE FILTER	1 avg
VERT SCALE	0.00 dB
DIST/DIV	1 ft
<i>DIST/DIV (METRIC)</i>	<i>0.25 m</i>
PULSE WIDTH	2 ns

2. Press **MENU** to access the Main Menu. Scroll down to "Setup Menu" and press **MENU**.
3. Scroll down to "Acquisition Control Menu" and press **MENU**.
4. Scroll down to "Single Sweep is:" and press **MENU**. The menu will change from "Single Sweep is: Off" to "Single Sweep is: On".
5. Press **MENU** to exit the Acquisition Control Menu.
6. Press **MENU** again to exit the Setup Menu.
7. Press **MENU** again to enter "Normal Operation" mode. The waveform now on the display is the familiar test cable.

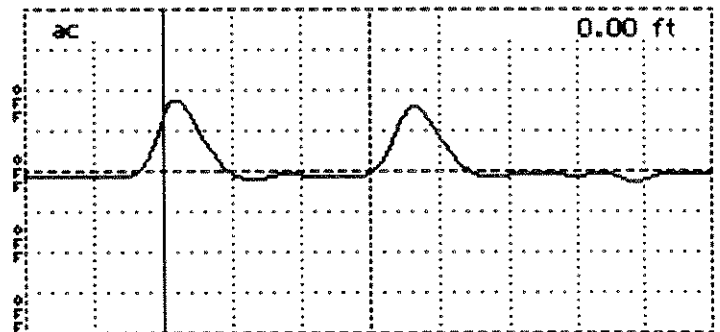

8. Now short the end of the test cable with a clip lead. Press **VIEW INPUT**. The 1503B has done a single sweep, capturing just one "frame". Remove the short and notice that the waveform does not change. Press **VIEW INPUT** again and a new sweep will be made and displayed showing the change in the cable.

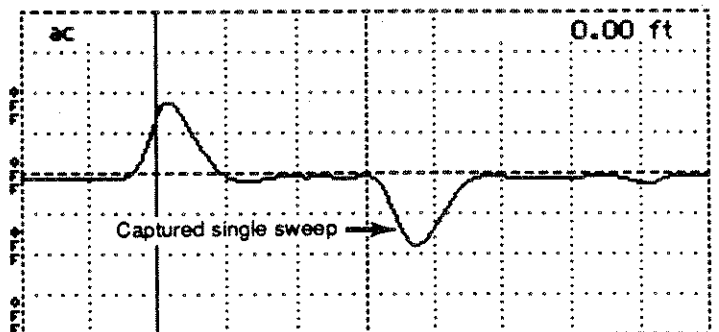

Single Sweep is useful for snap-shot tests of the cable, capturing just one waveform.

9. To exit Single Sweep, follow the above procedure, turning off Single Sweep after entering "Acquisition Control Menu".



## TDR Questions and Answers

1. *What does TDR stand for?*

Time Domain Reflectometer.

2. *What is the difference between time domain and frequency domain?*

Within the time domain, things are expressed in units of time, e.g. nanoseconds. In the frequency domain, things are expressed in cycles, or *frequency*, e.g. kilohertz.

3. *What does a TDR actually measure?*

Voltage over time.

4. *How does a TDR display this information?*

Voltage on the vertical axis (amplitude), and time (distance) on the horizontal axis.

5. *Does electricity travel the same speed (velocity) in all materials?*

No. Electricity is like light. Its velocity is affected by the material through which it passes.

6. *What is this difference called?*

The relative velocity of propagation ( $V_p$ ). The velocity of the cable is expressed in time/distance, e.g. feet per nanosecond. The velocity of electricity traveling in a vacuum is compared to the velocity of electricity traveling in a cable. This relationship is shown as a decimal. A relative propagation velocity of .5 would mean the electricity would travel half as fast as it would in a vacuum.

7. *If a reflection takes 30 nanoseconds to return in a cable with a  $V_p$  of .66, how far away is the point on the cable that caused the reflection?*

The time one way would be 30 divided by 2, or 15 nanoseconds. The velocity of 1 nanosecond per foot in a vacuum would mean a distance of 15 feet. Since the cable is slower, we multiply the distance by the  $V_p$  (.66), and arrive at a distance of 10 feet. Of course, the 1503B TDR does all this automatically and displays the information on the LCD.

8. *What is resistance?*

Resistance is the opposition of DC current, or the DC voltage divided by the DC current.

9. *What is impedance?*

Impedance is the total opposition (resistance plus reactance) a circuit offers to the flow of alternating current at a given frequency.

10. *What factors determine the resistance of a cable?*

The cross section, length and material of the conductive material (usually copper).

11. *What factors determine the impedance of a cable?*

Dielectric value of the insulation and geometry of the conductors.

12. *Why should cables of the same impedance be used?*

Because a mismatch of impedance means a loss of energy at the mismatch.

13. *Why is all this important to us?*

Because a TDR displays the energy reflected back from an impedance mismatch.

## GLOSSARY

### aberrations

Imperfections or variations from a desired signal. In TDRs a pulse of electrical energy is sent out over the cable. As the pulse generating circuitry is turned on and off the pulse is often distorted slightly and no longer a perfect step or sine shaped waveform.

### AC

Alternating current is a method of delivering electrical energy by periodically changing the direction of the flow of electrons in the circuit or cable. Even electrical signals designed to deliver direct current (DC) usually fluctuate enough to have an AC component.

### cable

Electrical conductors that are usually insulated and often shielded. Most cables are made of metal and are designed to deliver electrical energy from a source (such as a radio transmitter) across a distance to a load (such as an antenna) with minimal energy loss. Most cables consist of two conductors, one to deliver the electrical signal and another to act as a return path which keeps both ends of the circuit at nearly the same electrical potential. In early electrical systems and modern systems that over long distances the earth and/or air was used as the return path and the term ground or ground wire is often used to describe one of the wires in a cable pair.

### cable fault

Any condition that makes the cable less efficient at delivering electrical energy than it was designed to be. Water leaking through the insulation, poorly mated connectors and bad splices are typical kinds of cable faults.

### capacitance

(See reactance)

### characteristic impedance

Cables are designed to match the source and load for the electrical energy they carry. The designed impedance is often called the characteristic impedance of the cable. The arrangement of the conductors with respect to each other is the major factor in designing the impedance of cables.

### conductor

Any substance that will readily allow electricity to flow through it. Good conductors are metals such as silver, copper, gold, aluminum, and zinc (in that order).

**dB**

dB stands for decibel. Decibels are a method of expressing power or voltage ratios. The decibel scale is logarithmic. It is often used to express the efficiency of power distribution systems when the ratio consists of the energy put into the system divided by the energy delivered (or in some cases lost) by the system. The formula for decibels is:  $dB = 20 \log(V_r/V_i)$  where  $V_i$  is the voltage of the incident pulse,  $V_r$  is the voltage reflected back by the load, and  $\log$  is the decimal based logarithmic function. The dB vertical scale on our instrument refers to the amount of voltage gain (amplification) the instrument applies to the signal before displaying it. For example, when the instrument is amplifying the voltage by one hundred, the dB scale would read 40 dB which is  $20 * \log(100)$ .

**DC**

Direct current is a method of delivering electrical energy by maintaining a constant flow of electrons in one direction. Even circuits designed to generate only alternating current (AC) often have a DC component.

**dielectric**

(See insulation)

**domain**

Is a mathematical term that refers to the set of numbers that can be put into a function (the set of numbers that comes out of the function is called the range). A time domain instrument performs its function by measuring time.

**impedance**

Is the total opposition to flow of electrical energy in a cable or circuit. Impedance is made partly of resistance (opposition to DC) and partly of reactance (opposition to AC). Although impedance is expressed in units of ohms, it must not be confused with simple resistance which only applies to DC signals. Technically impedance is a function of the frequency of the electrical signal, so it should be specified at a frequency. As a practical matter, the impedance of most cables changes very little over the range of frequencies they were designed for.

**impedance mismatch**

Is a point in a cable or system where electrical energy is lost because of a significant change in the opposition to the flow of electrical energy.

**incident pulse**

The pulse of electrical energy sent out by the TDR. The waveform shown by the TDR consists of this pulse and the reflections of it coming back from the cable or circuit being tested.

**inductance**

(See reactance)

**insulation**

A protective coating on a electrical conductor that will not readily allow electrical energy to flow away from the conductive part of the cable or circuit. Insulation is also called dielectric. The kind of dielectric used in a cable determines how fast electricity can travel through that cable (*see velocity of propagation*).

**jitter**

Is the short term error or uncertainty in the clock (timebase) of a TDR. If the timing from sample to sample is not exact, the waveform will appear to move back and forth rapidly.

**LCD**

Stands for liquid crystal display. It is the kind of display used on this instrument, so the terms display and LCD are often used interchangeably in this manual.

**millirho**

rho ( $\rho$ ) is the reflection coefficient of a cable or power delivery system. It is the ratio of the voltage applied to the cable divided by the voltage reflected back from the cable or circuit due to cable faults or an impedance mismatch at the load. Millirho are thousandths of one rho. Rho measurements are often used to judge how well the cable is matched to the load at the other end of the cable. If there is a open circuit in the cable, nearly all the energy will be reflected back when a pulse is sent down the cable. The reflected voltage will equal the incident pulse voltage and rho will be +1. If there is a short circuit in the cable, nearly all the energy will be delivered back to the instrument through the ground or return conductor instead of being sent on to the load. The polarity of the reflected pulse will be the opposite of the incident pulse and rho will be -1. If there is no mismatch between the cable and the load, almost no energy will be reflected back and rho will be 0. In general, a load or fault with a higher impedance than the cable will return a rho measurement of 0 to +1 and a load or fault with a lower impedance will return a rho measurement of 0 to -1. The scale for rho measurements is determined by the height of the incident pulse. A pulse two divisions high means that each division is .5 rho or 500 millirho. A pulse set to be four divisions high would make each division .25 rho (250 millirho).

**noise**

Any unwanted electrical energy that interferes with a signal or measurement. Most noise is random with respect to the signals sent by the TDR to make a measurement and will appear as the waveform constantly moving up and down on the display. The NOISE FILTER control sets how many waveforms will be averaged together to make the waveform displayed. Noisy waveforms appear to fluctuate around the real signal. Since it is random, noise will sometimes add to the real signal and sometimes subtract energy from the real signal. By adding several noisy waveforms together the noise can be "averaged" out of the signal since the average amount of noise adding to the signal will be nearly the same as the average amount of noise subtracting from the signal. More waveforms in an average are more likely to approach the real signal (although it takes longer to acquire and add together more waveforms).

**open circuit**

In a cable, a broken conductor will not allow electrical energy to flow through it. These circuits are also called broken circuits. The circuit is "open" to the air (which looks like a very high impedance).

**reactance**

Is a conductor's opposition to the flow of AC electrical energy through it. All conductors have some reactance. Reactance is made up of capacitance and inductance. Capacitance is the ability of conductors separated by thin layers of insulation (dielectric) to store energy between them. Inductance is the ability of a conductor to produce induced voltage when the electrical current through it varies. All conductors have some capacitance and inductance, so all conductors have some reactance which means they all have impedance.

**reflectometer**

An instrument that uses reflections to make measurements. Our reflectometers use electrical energy that is reflected back from points along a cable.

**resistance**

Is a conductor's opposition to the flow of DC electrical energy through it. All conductors have a certain amount of resistance. Resistance is the low (or zero) frequency part of impedance.

**return loss**

The amount of energy reflected or returned from a cable indicates how much energy is lost or not available to the load at the other end. The ratio of the energy sent out by the TDR divided by the energy reflected back expressed in the logarithmic dB scale is called return loss.

**rho ( $\rho$ )**

(See millirho)

**risetime**

The length of time it takes a pulse signal to go from 10% to 90% of the change in voltage.

**RMS**

Stands for root mean squared. RMS is a way of measuring how much deviation there is from a known (or desired) waveform. It is also the method used to calculate how much DC power is contained in an AC waveform.

**sampling efficiency**

Our instruments make measurements by taking a succession of samples in time and displaying them as a waveform with voltage on the vertical scale (up and down) and time along the horizontal scale (across the display). The circuitry that captures and holds the samples can not instantly change from one voltage level to another. It may take the circuit several samples to "settle in" at the new voltage after a rapid change in the waveform. How efficiently the circuit moves from one sampled voltage level to the next is called sampling efficiency. If the efficiency is too low, the waveforms will be smoothed or rounded. If the efficiency is too high (above 100%) the circuit will actually move beyond the new voltage level in a phenomena known as overshoot which becomes an unwanted source of noise in the waveform.

**series loss**

Conductors all have some DC resistance to the flow of electrical energy through them. The amount of resistance per unit length is usually nearly constant for a cable. The energy lost overcoming this series of resistances is called series loss. The series loss must be compensated for when measuring the return loss or impedance mismatch at the far end of long cables.

**short circuit**

In a cable, a short circuit is a place where the signal conductor comes into electrical contact with a return path or ground conductor. The electrical circuit is actually "shorter" than was intended. Short circuits are caused by worn, leaky, or missing insulation.

**TDR**

Stands for *time domain reflectometer*. These instruments are also called cable radar. They send out pulses of energy and time the interval to reflections. If the velocity of the energy through the cable is known, distances to faults in the cable can be displayed or computed. Conversely, the speed that energy travels through a cable of known length can also be computed. The way in which the energy is reflected and the amount of the energy reflected indicate the condition of the cable.

**velocity of propagation ( $V_p$ )**

Electrical energy travels at the same speed as light in a vacuum. It travels slower than that everywhere else. The speed that it travels in a cable is often expressed as the relative velocity of propagation. This value is just the ratio of the speed in the cable to the speed of light (so it is always a number from 0 to 1). A velocity of propagation value of .50 indicates that the electrical energy moves through the cable at half the speed of light.

**waveform averaging**

(See noise)

## Troubleshooting

For assistance in troubleshooting, use the following flow chart to determine if you have a simple problem you can fix, or if the instrument needs to be sent to a Tektronix Service Center.

Use the process to determine whether the instrument should be repaired or is OK to use when you have a problem.

**CAUTION:** Any time the instrument smells hot, repeatedly blows fuses or repeats the same error message you should have the instrument serviced by qualified technicians using the procedures in the service manual.

These are the first checks you should perform when you think you might have a problem with the instrument.

The first step asks you to preset the instrument controls. Here is how to do that: Set Vp to .66, turn the Impedance knob all the way counter clockwise, turn the Filter knob all the way counter clockwise & then back two clicks, turn the Dist/Div knob all the way counter clockwise & then back three clicks, turn the Pulse Width knob all the way counter clockwise, remove any accessories that plug into the option port (chart printer, etc...) and disconnect any cable that may be attached to the front panel connector.

To complete the tests you may need a volt/ohmmeter (VOM), a flat bladed screwdriver (to set the line voltage switch) and possibly some spare fuses.

When you have completed these tests you will know that it is safe to use the instrument or that it needs repair or adjustment with the case removed (you will not have to remove the case for these tests).

**IMPORTANT:** It is possible for the instrument to continue to make some measurements even after reporting an error message. DO NOT IGNORE REPEATED ERROR MESSAGES!!!! They indicate something wrong & should be used with the Service manual troubleshooting procedures.

This procedure will give you good confidence that the instrument is functioning well. It is not an exhaustive set of tests that guarantee that the instrument meets all specifications & is in good calibration. The instrument calibration procedures in the Service manual are the best method for assuring all specifications.



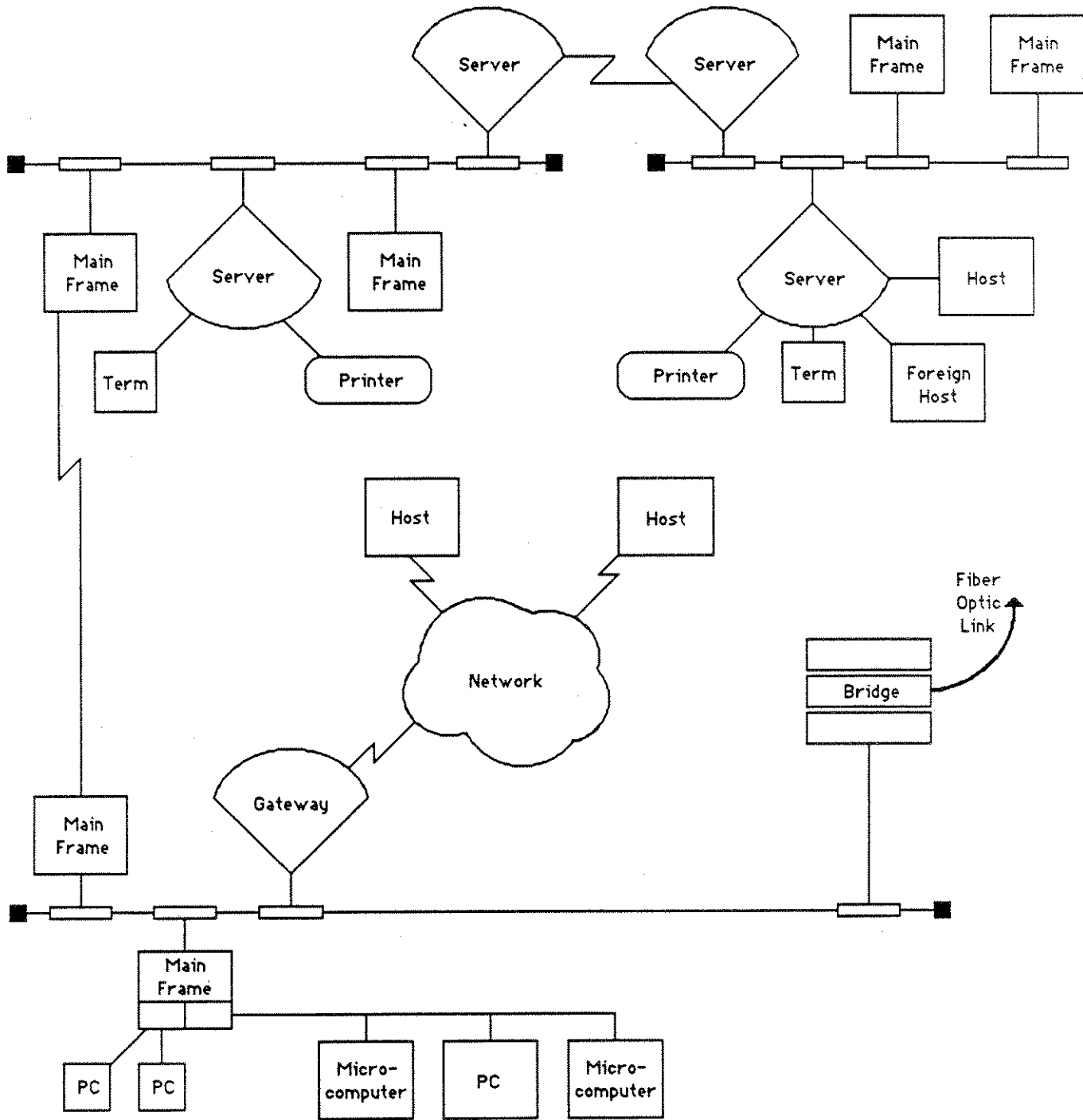

An Ethernet® System

## Before Starting

Here are some things you should know to make Ethernet® tests easier.

- *You need Option 06 for testing an active network.*
- Make measurements from an end of a segment.
- If possible, isolate the segment you plan to test.
- Use the shortest pulse width possible.
- Do not use the Auto pulse width mode. If it selects the 100 or 1000ns pulse, it may disrupt traffic on working networks.
- Use the simplest possible test first.
- Operate the 1503B on AC Power when using the optional YT-1 Chart Recorder.
- Changes made in the menus do not take effect until the instrument is returned to "Normal Operation". This prevents erroneous menu selections from creating disruptions.
- Have the network documentation ready. If available, have prior TDR profiles of the network that you will be comparing.
- If possible, turn off repeaters and bridges to other networks to minimize the extent of a possible disruption the 1503B may cause.

## Introduction to Test Procedures for a Working Network

*The IEEE 802.3 standard recommends only one earth ground per segment. When connected to AC power, the 1503B provides an earth ground to the coaxial shield. There is no connection to ground when the 1503B is used with the optional battery pack and the AC power cord is disconnected.*

The first test usually run on an active network is the normal sweep with the 2 or 10 ns pulse with the DC "50Ω termination is: ON" from the "Ethernet Menu". This test provides basic TDR tests with a 50Ω termination for the net. If the network traffic is low (3 to 4%), this test is very effective. The 2 and 10 ns pulses are narrower than the time occupied by a single bit, and usually will not cause any collisions. *All other tests in the "Ethernet Menu" have potentially destructive effects on working networks. See warning below.*

### WARNING

*The test just described should find most problems. Before going any further, KNOW WHAT YOU ARE DOING. Carrier and collision tests have the potential of causing problems on an active network. Read the warnings and instructions carefully. Try to limit tests to one segment during times of low traffic.*

The second test is the "Single Sweep with Carrier is: Off/On". This test asserts the carrier signal of -1.05 volts, then single sweeps the network and drops the carrier signal. This test occupies the network for 1 to 20 seconds, depending on the NOISE FILTER setting.

The third test "Carrier Test is: Off/On" helps track down transceivers suspected of ignoring the carrier sense signal. This test holds the carrier signal of -1.05 volts, turns off the pulse, and turns on MAX HOLD. The 1503B then acts as a traffic monitor. If spikes appear on the display, it is likely a transceiver is not responding to the carrier signal and is "babbling".

## Basic Test Procedure

This is the basic procedure for testing an Ethernet<sup>®</sup>. The following procedure describes the fundamental test with "50 $\Omega$  DC termination is: On". When performing other Ethernet<sup>®</sup> tests, use essentially the same procedure. A full description of individual tests (including custom tests) follows.

If you wish to disconnect and reconnect the 1503B to the cable segment, use a BNC tee between the instrument and a 50 $\Omega$  jumper cable (e.g. RG-58U). To one side of the tee connect a 50 $\Omega$  terminator (the double termination is about a 25 $\Omega$  mismatch, much less likely to cause problems than an open circuit.) The terminator can be removed during testing, allowing the 1503B to become the 50 $\Omega$  load. When removing the 1503B (or a power failure), the terminator can be reconnected, restoring the normal 50 $\Omega$  load for the network. The BNC tee also allows another point of access for an oscilloscope if you need to look for signal quality or noise levels.

Once the 1503B's 50 $\Omega$  termination has been turned ON, tests are similar to standard measurements on any coaxial 50 $\Omega$  cable. *Use only the 2 or 10 ns pulse widths.* The waveforms may be a little different due to traffic on the network. More on traffic in a few steps.

On the next page are suggestions on how to set up test fixtures that will provide flexibility, and provide network safety in case of power interruption to the 1503B.

Before Testing

During Testing

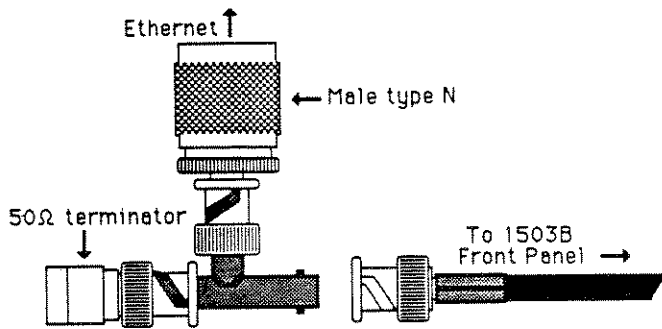

Type N Male

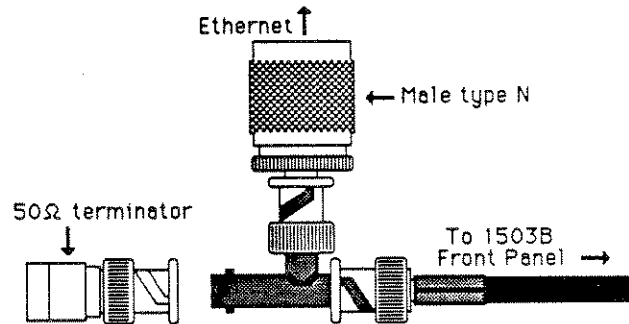

Type N Male

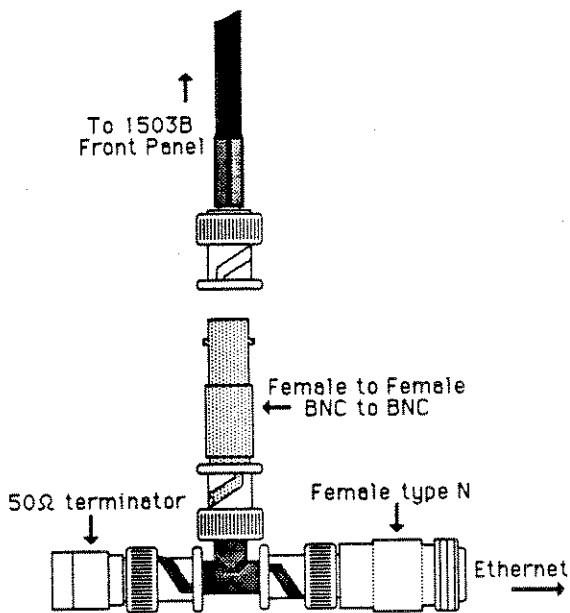

Type N Female

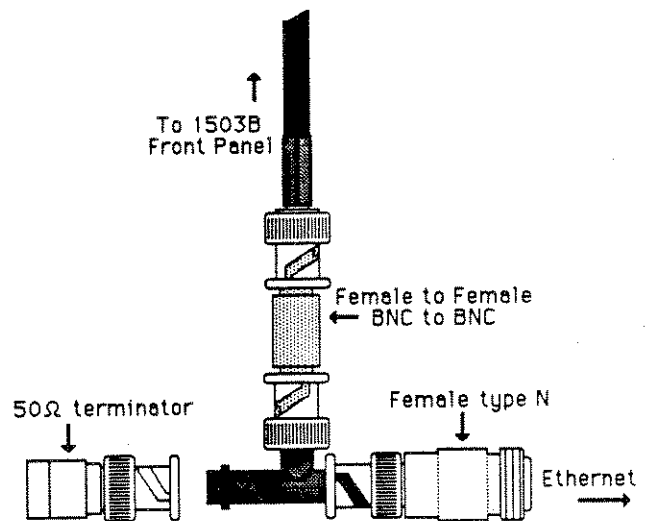

Type N Female

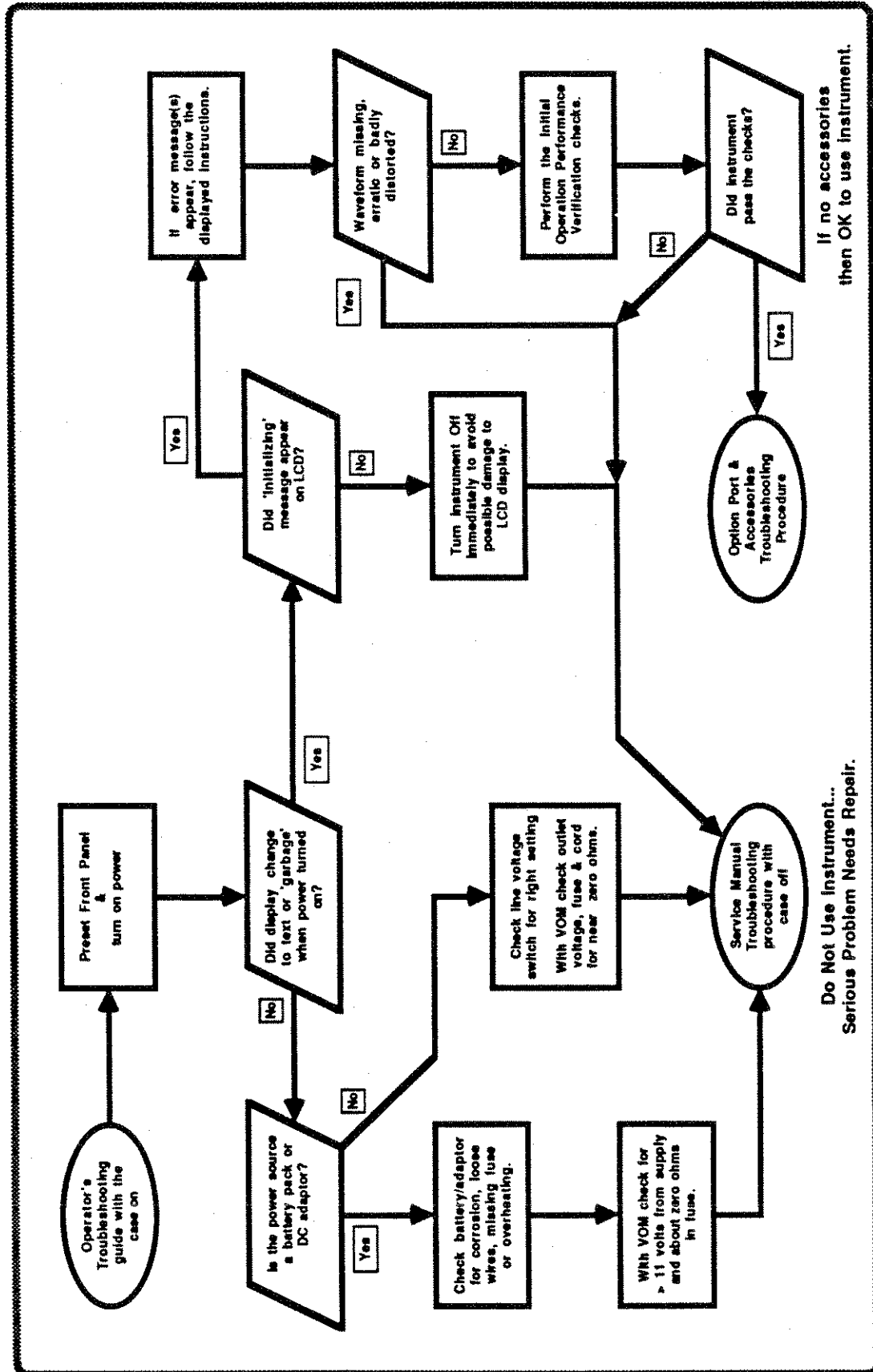

## 1503B Option 06 (Ethernet<sup>®</sup>)

### What is Ethernet<sup>®</sup>?

**Ethernet<sup>®</sup>** was invented by the Xerox Corporation<sup>®</sup> in 1973 to allow various data devices to use a common communication bus. In an Ethernet<sup>®</sup> system, signals flow in all directions and the transceivers attached to the Ethernet<sup>®</sup> receive all transmissions.

**Ethernet<sup>®</sup> cable** is typically 50 ohms with 50 $\Omega$  terminators at each end to prevent signal reflections. Reflections can interfere with transmissions sent out on the system.

**ThinWire<sup>®</sup>**, "**Cheapernet**", "**Thin Ethernet**" are variations of Ethernet<sup>®</sup>. It is usually used as a branch of the main network with a limited number of stations. It uses a more flexible cable, and is usually connected to each Media Access Unit with a tee connector instead of a tap.

**Segments** are the smaller "sub-networks" in an Ethernet<sup>®</sup> system. Each segment can be up to 500 meters long and have up to 100 transceiver taps. Each tap must have at least 2.5 meters of cable between itself and the next tap.

**Transceivers** transmit data to and from the stations on the Ethernet<sup>®</sup> bus. The typical Ethernet data rate is 10 million bits per second. At each tap is a transceiver (called Media Access Units or MAU's) sending and receiving this data. They also provide electrical isolation between the coaxial cable and the station, and house the electronics that detect carrier signals and recognize the collision of two signals.

**Taps** are what the transceivers are attached to.

A **bridge** connects several network segments. Depending on the hardware used, such as fiber optics, a network may extend up to 22,000 meters.

**Repeaters** are used to increase the effective length of a cable and to allow more transceivers. Due to distance limitations, two transceivers can have a maximum of two repeaters between them.

**Servers** let a network share resources such as terminals, disks, printers, etc.

The 1503B with Option 06 allows testing of an Ethernet<sup>®</sup> bus while the network is active. This is important because some installations may be interactive with other installations dependent on the Ethernet<sup>®</sup>. Physically, Option 06 is a piggyback board attached to the Sampler/Pulser board in the 1503B. A special EPROM replaces the standard EPROM on the main board. This allows Option 06 to be transparent to the standard instrument, but accessed through the "Ethernet Menu" and the "Setup/Acquisition Menu".

Option 06 performs three functions:

- A 50 $\Omega$  terminator for the network.
- Generates a DC signal that emulates the -1.05 volt carrier signal.
- Generates a DC signal that emulates the -1.7 volt collision signal.

Ethernet<sup>®</sup> is a registered trademark of the Xerox Corporation<sup>®</sup>. Thinwire<sup>®</sup> is a registered trademark of the Digital Equipment Corporation<sup>®</sup>.

1. Before removing the Ethernet<sup>®</sup> cable terminator, make sure you have the correct adaptors and cables ready.
2. Set front panel controls:
 

CABLE	See below
IMPEDANCE	50Ω
NOISE FILTER	1 avg
VERT SCALE	See below
DIST/DIV	Appropriate setting
PULSE WIDTH	2 or 10 ns (See below)
V <sub>p</sub>	To cable specification
POWER	ON (See below)

*Do not use the Auto pulse width mode. The longer pulses will cause problems on working networks.*

3. Notify network users of possible disruptions.
4. Using the  $\Phi$  POSITION control, access the "Ethernet Menu". Scroll to "50Ω DC termination is: Off" and turn it ON. Return to "Normal Operation".
5. As previously described, connect one end of a 50Ω jumper cable to the front panel CABLE connector. Connect the other end to one side of the BNC tee connector (see illustrations).
6. Connect the Ethernet<sup>®</sup> cable to the BNC tee.
7. Remove the 50Ω terminator.

*At this point you are testing on an active network.*

### WARNING

*The 50Ω termination of the 1503B is not maintained with the power off. In case of power failure, IMMEDIATELY replace the 50Ω terminator on the BNC tee.*

8. With the NOISE FILTER set at 1 avg, traffic will appear as large random "noise" spikes. If the traffic is severe enough to make measurements difficult, increase the NOISE FILTER setting.
9. A VERT SCALE setting of 30dB will normally allow you to see normal taps at the proximal (near) end of network. Greater distances may require more gain, depending on the loss of the cable and the pulse width.

Note that the location of traffic on the screen has no relationship to where it came from on the cable. In fact, traffic can appear on the display "beyond" the end of the cable.

## Descriptions of Tests in the Ethernet Menu

### Introduction

The following tests are composed of several functions found in the "Acquisition Control Menu". These combinations are displayed in the "Ethernet Menu" as a user convenience. Most of the tests in the "Ethernet Menu" can be recreated or modified. That is explained at the end of this section.

Changes made in the "Ethernet Menu" will effect some of the "Setup Menu" and "Acquisition Control Menu" functions. For example, if "Carrier Test is: Off/On" is turned on, the 50 $\Omega$  termination will also be turned on, since it is necessary for the Carrier Test to work.

### "50 $\Omega$ DC Termination is: Off/On"

*WARNING: This must be ON when testing on a working network, or reflections will cause collisions on the network.*

This entry is a duplicate of the entry in the "Setup Menu/Acquisition Control Menu". Its function is to allow direct control of the termination inside the 1503B. With the 50 $\Omega$  D.C. termination "ON", the 1503B will function normally as a cable tester. This is usually the only test needed to check a network cable.

Longer pulses are more likely to generate collisions than shorter pulses. On networks with traffic less than 3 or 4 percent, a 2ns pulse causes no measurable change in network statistics. Even on heavily tapped cables, the 2ns pulse can usually be used for distances to 700 feet. The 10ns pulse should be suitable for those longer segments that still fall within the 802.3 specifications (under 500 meters).

*WARNING: The 100ns and 1000ns pulses may cause collisions.*

### "Single Sweep With Carrier is: Off/On"

*WARNING: This can interrupt prior traffic and cause late collisions. It can also disrupt devices or applications that require periodic network traffic.*

When this test is selected, the 1503B will assert a -1.05 VDC signal on the net long enough to take a single waveform at the NOISE FILTER level selected. This is the equivalent to the average voltage level of a normal transmission and should cause the transceivers to assert Carrier Detect. This has the effect of causing most devices on the net to defer transmission until the 1503B is finished. This takes from about 1 to 20 seconds (depending on noise averaging) and reduces the traffic displayed on the trace.



**“Carrier Test is: Off/On”**

*WARNING: The carrier signal will stop traffic on the network. This may abort many application programs and may cause communications problems.*

This test asserts the -1.05 VDC signal on the network, turns off the normal 1503B pulse, and sets up the MAX HOLD mode. This is intended to help find transceivers that have a faulty Carrier Detect.

To use this test, have the network prepared for disruption and turn the test on via the “Ethernet Menu”. Any traffic observed is being transmitted in spite of a signal simulating a carrier. This may be due to a transceiver not asserting its carrier detect line, a host not reading its carrier detect line, or some other reason. This is not unusual with some equipment. One way to isolate which unit(s) are doing this is to disconnect them one at a time until it stops.

**“Collision Test is: Off/On”**

*WARNING: The collision signal will stop traffic on the network. This may abort many application programs and may cause communications problems.*

This test is similar to the “Carrier Test is: Off/On” except that it asserts a -1.7 VDC signal to simulate a collision on the net.

## Descriptions of Tests in the Setup Menu/Acquisition Menu

The entries in this menu allow a user to set up custom tests on networks in addition to the preset ones in the "Ethernet Menu". This is intended for users who are familiar enough with Ethernet<sup>®</sup> to anticipate the results. Changes in this menu can effect the state of the tests in the "Ethernet Menu". Changes in this menu can also effect the state of other entries that are mutually exclusive or necessary for the chosen entry. For example, turning on the "Collision Output Signal is: Off/On" will also turn off the Carrier Output Signal since only one voltage can be sent out.

Only the function of the entries unique to Option 06 will be explained, for the others refer to the standard part of this manual.

### "50Ω DC Termination is: Off/On"

*WARNING: This must be ON for use on a working network, or reflections will cause collisions on the network.*

This entry is a duplicate of the entry in the "Ethernet Menu". Its function is to allow direct control of the low frequency termination inside the 1503B. With the "50Ω DC Termination is: On", the 1503B will function normally to test cable. This is usually the only test needed to check a network cable.

### "Carrier (-1.05V) Output Signal is: Off/On"

*WARNING: The carrier signal will stop most traffic on the network. This may abort many application programs and may cause communications problems.*

When this test is ON the 1503B will assert a -1.05 VDC level on a 50Ω load (-2.1v open circuit). This signal is intended to be equivalent to the average of a standard Ethernet<sup>®</sup> transmission and so should trigger the carrier detect circuit on the transceivers. Since most applications will defer transmission when this signal is present, it can be used to test transceivers and systems, or to reduce traffic for 1503B testing.

### "Collision (-1.7V) Output Signal is: Off/On"

*WARNING: The collision signal will stop traffic on the network. This may abort many application programs and may cause communications problems.*

When this test is ON the 1503B will assert a -1.7 VDC level on a 50Ω load (-3.4v open circuit.) This signal is intended to be equivalent to the average of two colliding Ethernet<sup>®</sup> transmissions and so should trigger the collision detect circuit on the transceivers. This should cause applications to back off and retry then eventually abort as defined in the 802.3 standard, thus it can be used to test for units that do not respond to this signal or to stop traffic for TDR testing.

## Customizing Your Own Tests

Access the "Acquisition Control Menu" located under "Setup Menu". The various tests listed can be used in any combination. (Remember, the test combinations will not be activated until return to "Normal Operation", so any combination can be chosen, then activated).

## Waveform Signatures

By now you probably have a good idea what traffic looks like on the display and how you can use the NOISE FILTER to reduce it. Other signatures may also appear on the display.

**Terminators** are small reflections seen as stationary bumps and dips. A "perfect" terminator would not reflect any energy, and theoretically would be "invisible" on the 1503B display. Because of small impedance differences between the cable and the terminator, a small amount of energy will be reflected. The signature of a terminator tends to go either up or down. Because a terminator absorbs nearly all the energy of a pulse, the normal ripples in the waveform (small changes in impedance), will not be present after the terminator. At the point the waveform becomes flat is a clue to where the terminator is located.

**Taps** commonly have a characteristic down-then-up reflection. The TDR pulse will continue to travel past a tap because only part of the pulse's energy is reflected. This allows the 1503B to read signatures well beyond taps.

Following the Test Descriptions are examples of tests made on two Ethernet® systems.



1A - Tap hidden by traffic  
(1 avg, 50 ft/DIV, 35.00 dB gain)

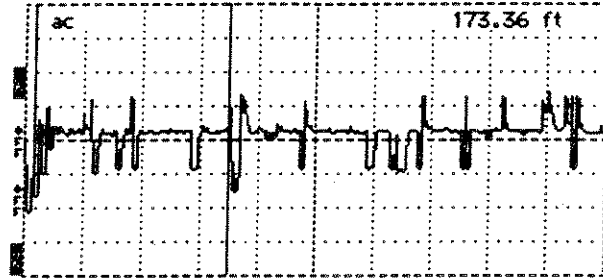

1B - Traffic and tap nearly identical  
(4 avg, 50 ft/DIV, 35.00 dB gain)

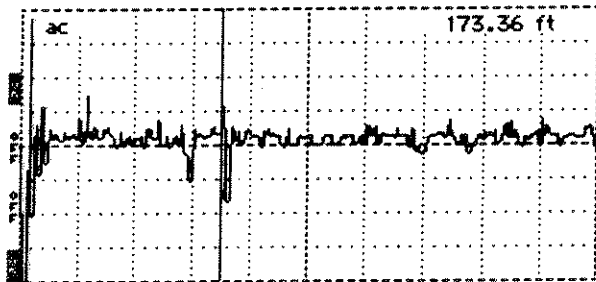

1C - Tap becoming visible  
(16 avg, 50 ft/DIV, 35.00 dB gain)

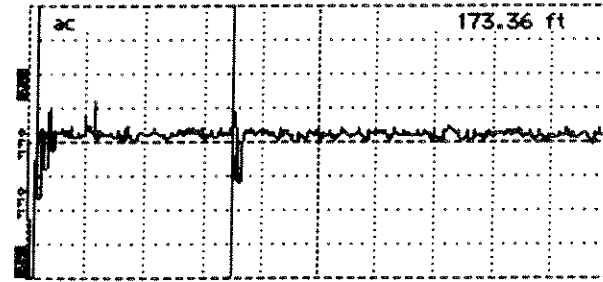

1D - Tap quite visible  
(128 avg, 50 ft/DIV, 35.00 gain)

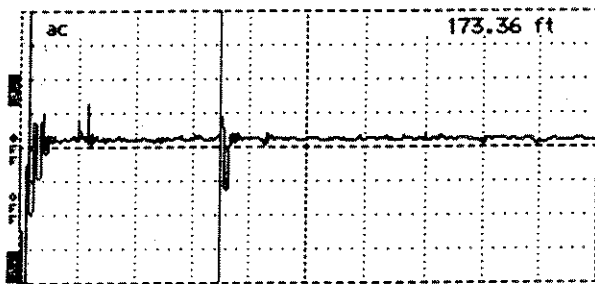

1E - No traffic  
(1 avg, 50 ft/DIV, 35.00 dB gain)

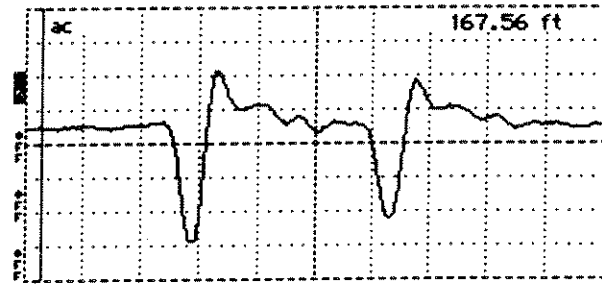

1F - Tap expanded, no traffic  
(1 avg, 2 ft/DIV, 35.00 gain)

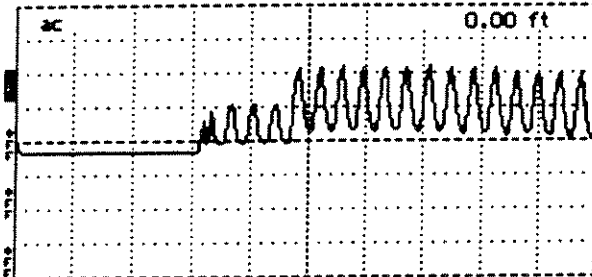

2A - Testing cable with revision one repeater\*  
(1 avg, 200 ft/DIV, 2.25 dB gain)

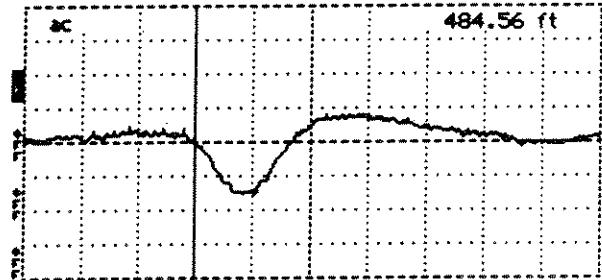

2B - First tap, no traffic  
(1 avg, 1 ft/DIV, 44.50 dB gain)



2C - Same tap with 5% Traffic  
(1 avg, 1 ft/DIV, 44.50 dB gain)

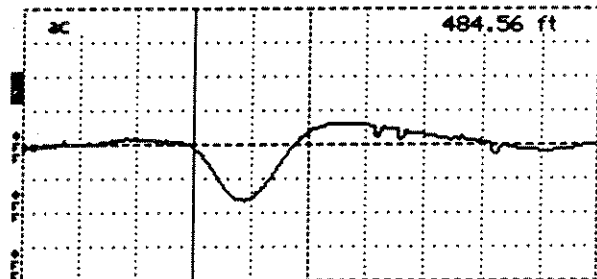

2D - Same tap, increased averaging  
(16 avg, 1 ft/DIV, 44.50 dB gain)

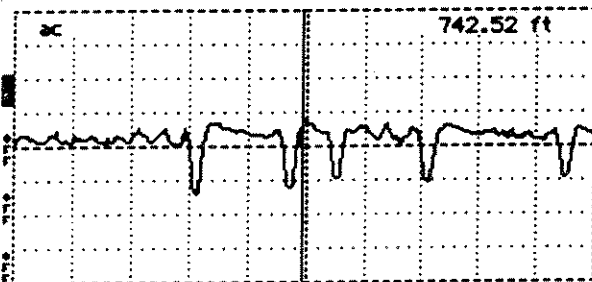

2E - Further out, more gain  
(128 avg, 10 ft/DIV, 53.50 dB)

\*Revision one repeaters must sense collisions and place a signal on both segments. When using the carrier sense volt level while sending out pulses (as in "Single Sweep with Carrier: On") the pulses may exceed the collision or traffic threshold of the repeater, causing it to send back jamming packets that synchronized with the 1503B. This creates an unusual waveform that looks similar to data. As a rule, repeaters should be down prior to testing an segment to prevent such an occurrence.

jam  
large  
rier  
oids  
are  
orm  
shut  
e.

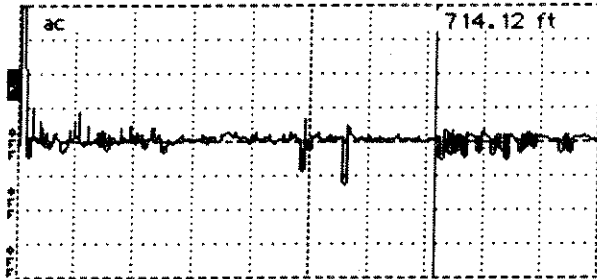

2F - 1000 feet of cable at 10 ns  
(128 avg, 100 ft/DIV, 43.75 dB gain)

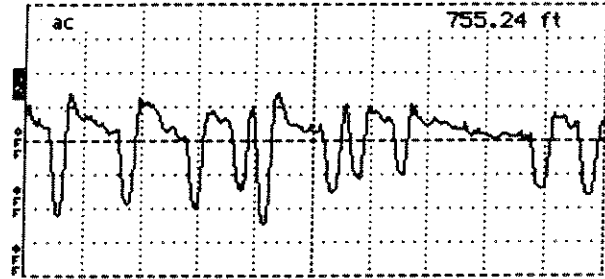

2G - Previous waveform expanded  
(128 avg, 20 Ft/DIV, 54.75 dB gain)

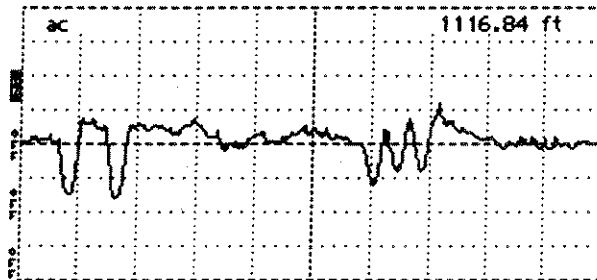

2H - Next group of taps  
(128 avg, 20 ft/DIV, 54.75 dB gain)

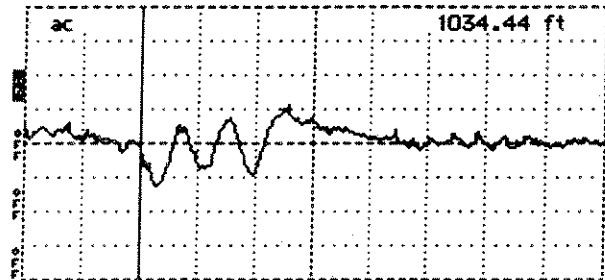

2I - Group of taps expanded  
(128 avg, 10 ft/DIV, 54.75 dB gain)

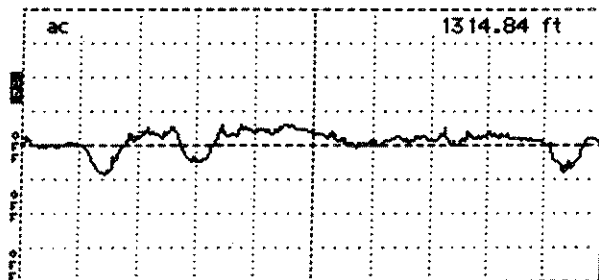

2J - Another group of taps  
(128 avg, 10 ft/DIV, 54.75 dB gain)

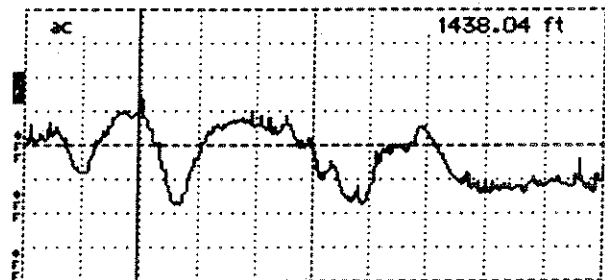

2K - End of cable  
(128 avg, 10 ft/DIV, 61.25 dB gain)

# GENERAL INFORMATION & SPECIFICATION

## General Information

### Product Description

The Tektronix 1503B Metallic Cable Time Domain Reflectometer is a cable test instrument that uses radar principles to determine the electrical characteristics of metallic cables.

The 1503B generates a  $\frac{1}{2}$  sine wave signal, applies it to the cable under test, and detects and processes the reflected voltage waveform from the cable. These reflections are displayed on the 1503B's liquid crystal display (LCD) where distance measurements may be made using a cursor technique. Impedance information may be obtained through interpreting waveform amplitude.

The waveform may be temporarily stored within the 1503B and recalled; or may be printed using the optional dot matrix strip chart recorder, which installs into the front panel Option Port.

### Battery Pack

The 1503B may be operated from AC power or a battery pack consisting of nine C-cells supplying a minimum of five hours operating time (see specification, *Table 1-1*).

### Options

Options available for the 1503B are explained in the *Accessories and Options* section of this manual.

## Standards, Documents, and References Used

Terminology used in this manual is in accordance with industry practice. Abbreviations are in accordance with ANSI Y1.1-1972, with exceptions and additions explained in parentheses in the text. Graphic symbology is based on ANSI Y32.2-1975. Logic symbology is based on ANSI Y32.14-1973 and manufacturer's data books or sheets. A copy of ANSI standards may be obtained from the Institute of Electrical and Electronic Engineers, 345 47th Street, New York, NY 10017.

## Change and History Information

Changes that involve manual corrections and/or additional data will be incorporated into the text and that page will show a revisions date (e.g. REV OCT 1988) on the inside bottom edge. History information is included in diagrams in grey.

## Specification

The tables on the following pages list the characteristics and features that apply to this instrument after the instrument has had a 20 minute warm-up time.

The Performance Requirement column describes the limits of the Characteristic. Supplemental Information describes features and typical values or other helpful information.

In this section is an *Operator Performance Check* that contains procedures that check many of the functions of the 1503B. This check is recommended for incoming inspections to verify that the instrument is performing properly. Procedures to verify the Performance Requirement are provided in the *Calibration* section of the Service Manual (070-6269-00).

Table 1-1  
**ELECTRICAL CHARACTERISTICS**

The following characteristics apply to the 1503B after a warm-up period of at least 5 minutes.

Characteristics	Performance Req'd	Supplemental Information
Test Pulse Width		Selected: 2ns, 10ns, 100ns, 1000ns. Measured at half amplitude point, with matching termination.
Accuracy	2ns $\pm$ 1ns; 10ns, 100ns, 1000ns, $\pm$ 10%	
Pulse Amplitude		
Terminated	-2.5V, $\pm$ 10% for 10ns, 100ns, 1000ns 2ns $\pm$ 20%	
Unterminated	-5.0V, $\pm$ 10% for 10ns, 100ns, 1000ns	Internal cable length prevents 2ns pulse from reaching full unterminated voltage
Pulse Shape		1/2 sine
Pulse Output Impedance Accuracy	1%	Selected: 50 $\Omega$ , 75 $\Omega$ , 93 $\Omega$ , 125 $\Omega$
Pulse Repetition Time		350 $\mu$ s nominal
Vertical Scales Accuracy Set Adjustment Vertical Position	0 dB to 63.75 dB gain $\pm$ 3%	256 values at 0.25 dB increments  Set incident pulse within $\pm$ 3%. Any waveform point movable to center screen. Combined with vertical scale control.
Displayed Noise		With matching terminator at panel. Beyond three test pulse widths after test pulse.
Random	$\leq \pm$ 1.0 division peak with 57 dB gain, filter set to 1 $\leq \pm$ 1.0 division peak with 63 dB gain, filter set to 8	
Aberrations	$\leq -30$ dB peak-to-peak for 10ns, 100ns, 1000ns test pulse  $\leq -25$ dB peak-to-peak for 2ns test pulse	Within three test pulse widths after test pulse. dB is relative to test pulse.



**Table 1-1  
ELECTRICAL CHARACTERISTICS (con't)**

<b>Characteristics</b>	<b>Performance Req'd</b>	<b>Supplemental Information</b>
Cable Connection Coupling Maximum Input Susceptibility	$\pm 400$ volts (DC + peak AC at maximum frequency of 440 Hz). No damage with application for up to 30 seconds (may affect measurement capability).	Capacitively coupled
Distance Cursor Resolution		1/25 of 1 major div.
Cursor Readout Range		-2 feet to $\geq 50,000$ ft
Resolution		0.04 ft
Accuracy	Within 2% $\pm 0.02$ ft at 1 FT/DIV	V <sub>p</sub> must be set $\pm 0.5\%$
Horizontal Scales		1 FV/Div to 5000 FV/Div <i>METRES: .25 M/Div to 1000 M/Div</i> 12 values; 1,2,5 sequence
Ranges		0 to 50,000 FV/Div <i>METRES: 25 metres to 10,000 metres</i>
Horizontal Position		Any distance to full scale may be moved on screen.
V <sub>p</sub> Range		0.30 to 0.99 Propagation Velocity relative to air.
Resolution		0.01
Accuracy		Within $\pm 1\%$

Table 1-1  
**ELECTRICAL CHARACTERISTICS (con't)**

Characteristic	Performance Requirement	Supplemental Information
Line Voltage	115 VAC (90 to 132 VAC), 45 to 440Hz 230 VAC (180 to 250 VAC), 45 to 440Hz 12 VDC through battery pack connector	Fused at 0.3A  Fused at 0.15A
Battery Pack Operation	5 hours minimum, 20 chart recordings maximum.	15° C to 25° C charge and discharge temp. LCD backlight turned off. Opera- tion of instrument with backlight on, or at temperatures below 10° C, will degrade battery operation specification.
Full Charge Time		20 hours maximum
Overcharge Protection		Limited to 10 days of continuous charge. Battery will charge whenever instrument is plugged in. Battery may be removed during AC operation.
Discharge protection		Operation terminates prior to cell rever- sal
Typical Charge Capacity		2 amp/hours
Battery Charge Indicator		"Bat/low" will be indicated on the LCD when capacity reaches approx 10%
Temperature Operating	-10° C to +55° C	Battery capacity reduced at other than 15° C to 25° C.
Non-operating	-62° C to +85° C.	With battery pack removed. Storage temp with battery pack is -20° C to +55° C. Contents on non-volatile memory (stored waveform) may be lost at tem- peratures below -40°C.

Table 1-2  
**ENVIRONMENTAL CHARACTERISTICS**

Characteristics	Performance Req'd	Supplemental Information
Humidity	To 100%	Internal desiccant with cover on and option port cover installed
Altitude Operating Non-operating	To 15,000 feet To 40,000 feet	Mil-T-28800C, Class 3
Vibration	5 to 15Hz, 0.06 inch peak-to-peak 15 to 25Hz, 0.04 inch peak-to-peak 25 to 55Hz, 0.013 inch peak-to-peak	Mil-T-28800C, Class 3
Shock, Mech Pulse	30g, 11ms 1/2 sine waveform. Total of 18 shocks	Mil-T-28800C, Class 3
Bench Handling		Mil-Std -810, Method 516 Procedure V
Operating	4 drops each face at 4 inches or 45° with opposite edge as pivot.	Cabinet off, front cover on
Non-operating	4 drops each face at 4 inches or 45° with opposite edge as pivot. Satisfactory operation after drops.	Cabinet off, front cover off.
Loose Cargo Bounce	1 inch double-amplitude orbital path at 5 Hz, 6 faces	Mil-Std-810 Method 514, Procedure XI, Part 2
Water Resistance		Mil-T-28800C, Style A
Operating	Splashproof and drip-proof	Front cover off.
Non-operating	Watertight with three feet of water above top of case.	Front cover on

**Table 1-2  
ENVIRONMENTAL CHARACTERISTICS**

<u>Characteristics</u>	<u>Performance Req'd</u>	<u>Supplemental Information</u>
Salt Atmosphere	Withstand 48 hours, 20% solution without corrosion	
Sand and Dust	Operates after test with cover on, non-operating	Mil-Std-810, Method 510 Procedure I
Washability	Capable of being washed	
Electromagnetic Comp	VDE 0871 Class B	
Fungus Inert	Materials are fungus inert	

**Table 1-3  
PHYSICAL CHARACTERISTICS**

<u>Characteristic</u>	<u>Description</u>
Weight	
Without cover	14.5 lb
With cover	16 lb
With cover, YT-1 Chart Recorder and Battery Pack	20 lb
Shipping Weight	
Domestic	25.5 lbs
Export	25.5 lbs
Height	5.0 inches
Width	
With handle	12.4 inches
Without handle	11.8 inches
Depth	
With cover	16.5 inches
With handle extended	18.7 inches

## OPTION 06 (Ethernet<sup>®</sup>)

### Product Description

The Tektronix 1503B with Option 06 is intended to provide a method for the 1503B to test an Ethernet<sup>®</sup> bus using Time Domain Reflectometry (TDR) with minimum disruptions to the IEEE 802.3 protocol. The method is to remove the 50Ω termination on the Ethernet<sup>®</sup> bus and replace it with a cable attached to the 1503B. The 1503B provides the function of the 50Ω termination while it is connected to the bus.

The option allows the operator to use the 1503B on a working network, but may cause network collisions or errors. It has the ability to assert a collision signal, a carrier signal or no signal on the bus. It allows the operator to use the 1503B on the bus or just passively sample for the presence of non-TDR generated signals.

Table 1-4  
ELECTRICAL CHARACTERISTICS

Characteristics	Performance Required	Supplemental Info
DC Termination	50Ω ±1Ω	See typical frequency response curve to estimate at other frequencies. Once the termination is turned ON it will remain ON until specifically turned OFF by the user and a warning to remove the 1503B from the network will be shown on the display. Leaving the TDR on the network with the termination turned OFF will cause traffic disruption and errors.
DC voltage offsets	0.0 volts ±0.02 volts, -1.05 volts, and -1.7 volts ±0.15 volts into 50Ω	AC pulse voltage is present on top of DC offsets while measuring. Voltages only asserted when 50Ω termination is ON.
Overvoltage protection		Circuit cuts out leaving standard 1503B protection for voltages greater than ±11 volts.
Floating ground		Only when used with battery pack. IEEE 802.3 specifies a single ground on the bus.

enet diplexed load

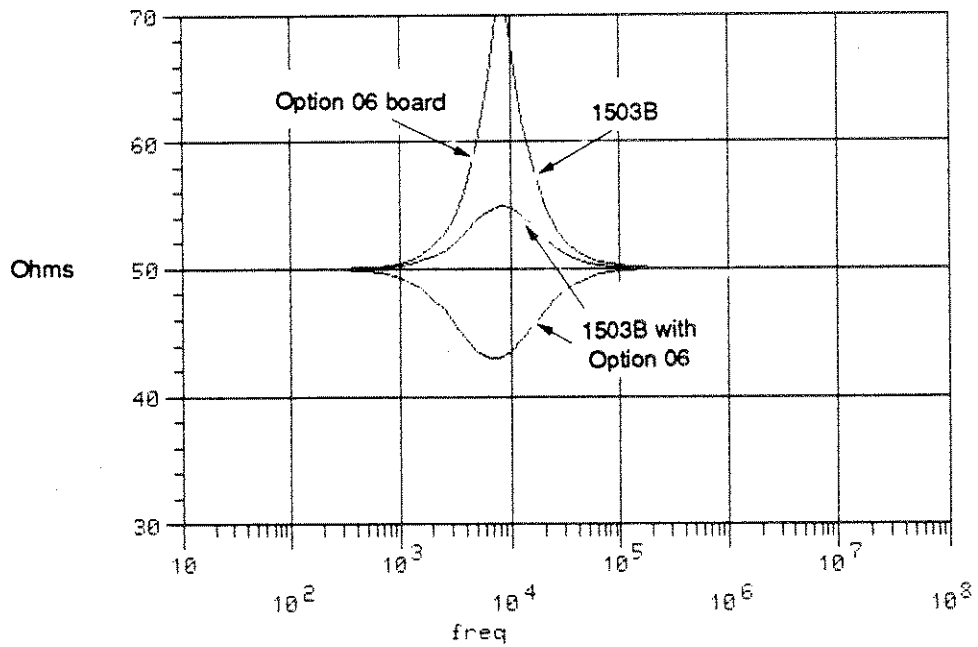

Typical Frequency Response Curves

## OPERATOR PERFORMANCE CHECK

The purpose of this procedure is make sure that the instrument is in good working condition and should be performed upon receipt of a new instrument or one that has been serviced or repaired. It does not test all portions of the instrument to Calibration specifications.

The purpose of this procedure is not to familiarize a new user with the instrument. If you are not experienced with the instrument you should read the *Operator* section of this manual before going on with these checks.

If the instrument fails any of these tests, it should be serviced. Many failure modes affect only some of the instruments functions.

Performance Check for Option 06 is located in the *Calibration* section of the Service Manual (070-6269-00).

### Equipment Required

ITEM	Tektronix P/N
50 $\Omega$ precision terminator	011-0123-00
3 foot precision coaxial cable	012-0482-00

### Getting Ready

Disconnect any cables from the front panel CABLE connector. Connect the instrument to a suitable power source (a fully charged optional battery pack or AC line source). If you are using AC power make sure the fuse and power switch are correct for the voltage you are using (115 volts requires a different fuse than used for 230 volts).

### POWER On

Pull POWER switch on the front panel. If a message does not appear on the display within a second or two, turn the instrument off. There are some failure modes that could permanently damage or ruin the LCD if the power is left on for more than a minute or so. Refer to the troubleshooting section of this manual (*1503B Operator - Maintenance*).

### Metric Instruments

On Option 5 (METRIC) instruments, you can change the ft/DIV scale to metric in the "Set Up" menu, or use the metric numbers provided. To change the readings to metric, press **MENU**. Using the  $\blacktriangle$  POSITION control, scroll down to "Setup Menu" and press **MENU**. Scroll down to "Distance/Div is: ft/div" and press **MENU**. Menu will change to "Distance/Div is: m/div". Exit by pressing **MENU** until instrument returns to Normal Operation. If the instrument power is turned off, this procedure must be repeated when the instrument is powered up.

### Set Up

Set the 1503B front panel:

IMPEDANCE	50 $\Omega$
NOISE FILTER	1 avg
VERT SCALE	0.00 dB
DIST/DIV	1 ft/DIV
<i>DIST/DIV (METRIC)</i>	0.25 m
V <sub>p</sub>	.66
PULSE WIDTH	2ns

**1. Horizontal Scale (Timebase) Check**

If the instrument fails this test it must be repaired before any distance measurements are made with it.

A. Turn on the instrument. The display should look very similar to the figure at right.

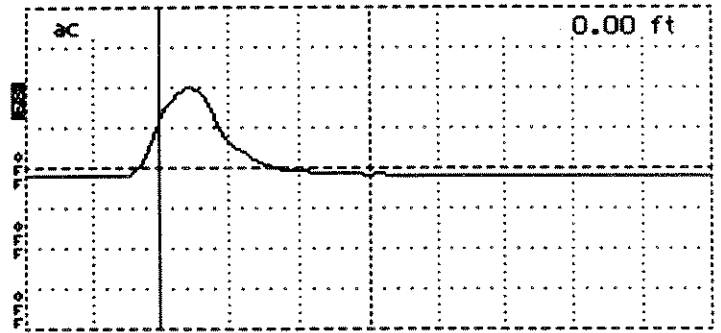

B. Connect the three foot precision cable to the front panel CABLE connector. The display should look like the figure at right.

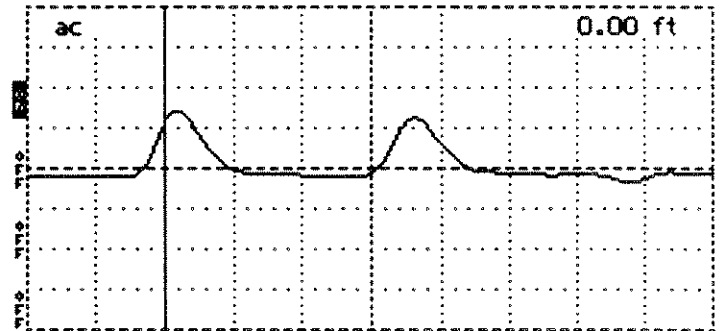

C. Using the  $\blacktriangleleft$  POSITION control measure the distance to the rising edge of the waveform at the open end of the cable. The distance shown on the display distance window should read from 2.96 to 3.04 feet (METRIC - 0.90 to 0.91 metres).

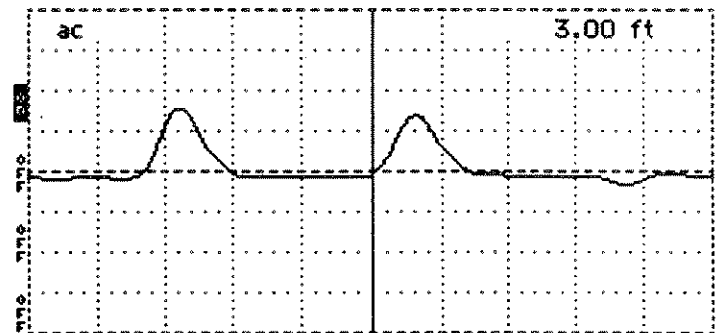

D. Change  $V_p$  to .30. Using the  $\blacktriangleleft$  POSITION control measure the distance to the rising edge of the waveform at the open end of the cable. The distance shown on the display distance window should read from 1.32 to 1.40 feet (METRIC - 0.40 to 0.41 metres).

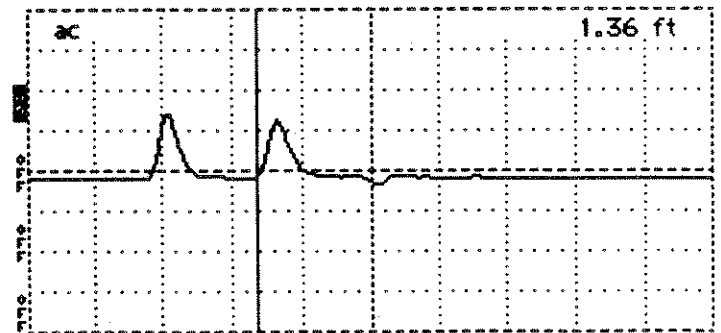



- E. Remove the three foot cable and connect the 50Ω terminator. Change the 1503B front panel:

DIST/DIV                      5000 ft/DIV  
 DIST/DIV (METRIC)        1000 m/DIV  
 PULSE WIDTH                1000 ns

- F. Turn the ◀ POSITION control clockwise until the display distance window reads a distance greater than 50000.00 ft (METRIC - 15250.00 metres). The waveform should remain a flat line from zero feet to this distance.

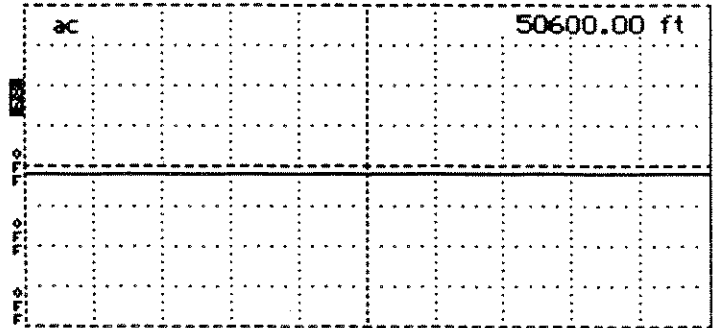

**2. Vertical Position (Offset) Check**

If the instrument fails only this test it can be used but should be serviced. Not all of the waveform will be viewable at all gain settings.

- A. Using the ◀ POSITION control, verify that the entire waveform can be moved to the very top of the display (off the graticule area).

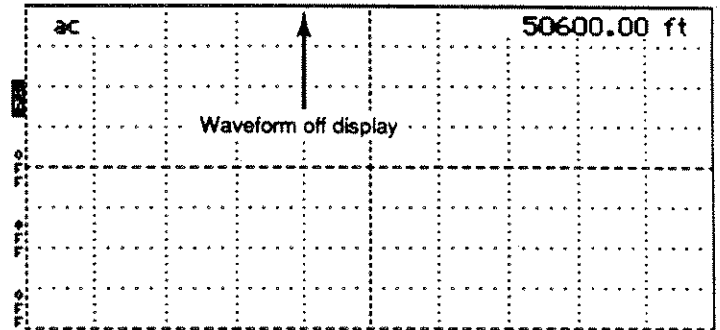

- B. Using the ◀ POSITION control, verify that the entire waveform can be moved to the very bottom of the display (to the bottom graticule line).

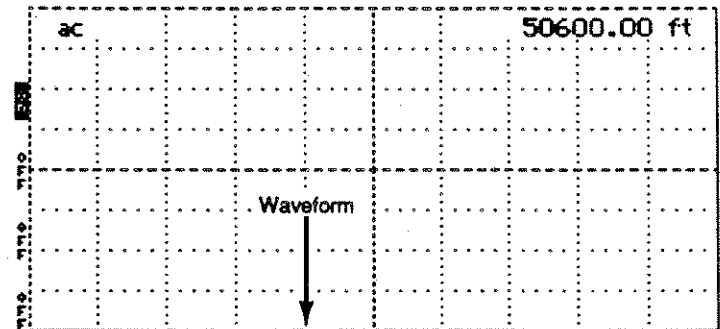

### 3. Noise Check

If the instrument fails this test it may still be usable for measurements of large faults that do not require a lot of gain. A great deal of noise reduction can be made using the NOISE FILTER control.

- A. Set the PULSE WIDTH to 2 ns. Using the  $\phi$  POSITION and VERT SCALE controls, set the gain to 57 dB with the the waveform centered vertically in the display.
  
- B. Press MENU and using the  $\phi$  POSITION control, select "Diagnostics Menu" and press MENU. Using the same procedure select "Service Diagnostic Menu", select "Noise Diagnostic" and follow the directions on the display.
  
- C. Exit from "Noise Diagnostic", but do not exit from the "Service Diagnostic Menu" yet!

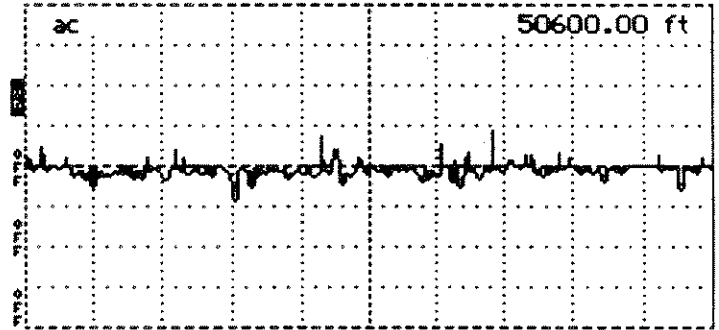

#### 4. Offset/Gain Check

If the instrument fails this test, it should not be used for loss or impedance measurements.

- A. In the "Service Diagnostic Menu" select the "Offset/Gain Diagnostic" and follow the directions on the display.
- B. There are three screens of data presented in this diagnostic. The Pass/Fail level is 3% for any single gain setting tested.
- C. Exit from "Offset/Gain Diagnostic", but do not leave the Service Diagnostic Menu yet!

#### 5. Impedance Check

If the instrument fails this test, it should not be used for loss or impedance measurements.

- A. In the "Service Diagnostic Menu" select the "Impedance Diagnostic" and follow the directions on the screen. The 50 $\Omega$  reading should be from 47.0 to 50.0 $\Omega$ . The 75 $\Omega$  reading should be from 71.0 to 75.0 $\Omega$ . The 93 $\Omega$  reading should be from 88 to 93 $\Omega$  and the 125 $\Omega$  reading should be from 118 to 125 $\Omega$ .
- B. Exit from the "Impedance Diagnostic", but do not leave the Service Diagnostic Menu yet!

#### 6. Sampling Efficiency Check

If the instrument fails this test, the waveforms may not look normal. If the efficiency is more than 100%, the waveforms will appear noisy. If the efficiency is below the lower limit, the waveform will take longer (more pixels) to move from the bottom to the top of a reflected pulse. This smoothing effect may completely hide some faults that would normally only be one or two pixels wide on the display.

- A. In the "Service Diagnostic Menu" select "Sampling Efficiency" test and follow the directions on the screen.
- B. When done with the test, press the **MENU** button to exit back to Normal Operation.

7. Aberrations Check

If the aberrations are too large, they can be confused with minor faults in the cable near the instrument.

A. Turn the  $\Phi$  POSITION control counterclockwise until the display distance window reads less than 20.00 ft (METRIC - 6.10 m). Set the DIST/DIV control to 1 ft/DIV (METRIC - 0.25 m/DIV).

B. Turn the  $\Phi$  POSITION control counterclockwise until the distance to the cursor is -2.00 ft (METRIC --0.62 metres).

C. Set the 1503B front panel:

IMPEDANCE	50 $\Omega$
NOISE FILTER	1 avg
VERT SCALE	0.00 dB
V <sub>p</sub>	.99
PULSE WIDTH	2 ns

D. Connect the 50 $\Omega$  precision terminator to the front panel. Turn NOISE FILTER control completely counterclockwise to the VERT SET REF position. Using VERT SCALE to increase the height of the pulse to 4 major divisions high and press STORE. Turn NOISE FILTER back to 1 avg.

E. Place the baseline of the waveform on the center graticule line with the  $\Phi$  POSITION control, and increase VERT SCALE to 25.00 dB.

F. Using the  $\Phi$  POSITION control, verify that the aberrations are less than four divisions high out to 10 ft (METRIC - 3.05 m).

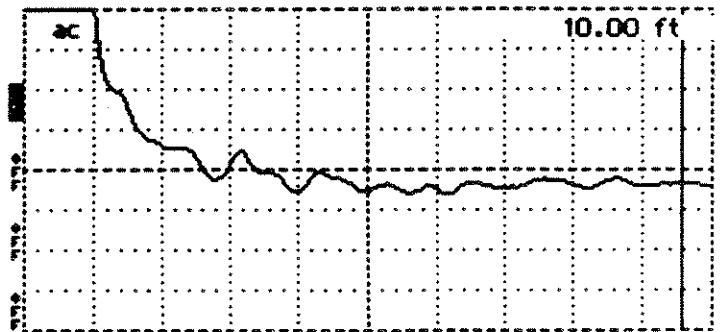
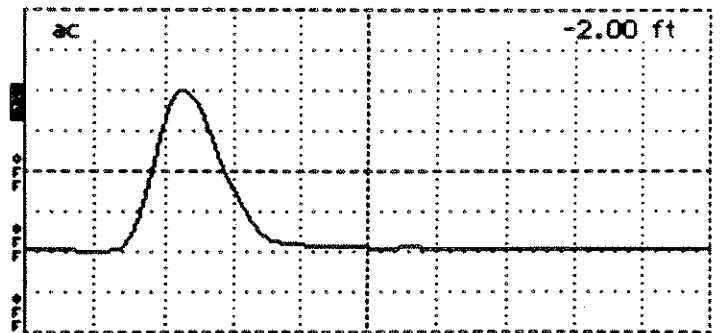
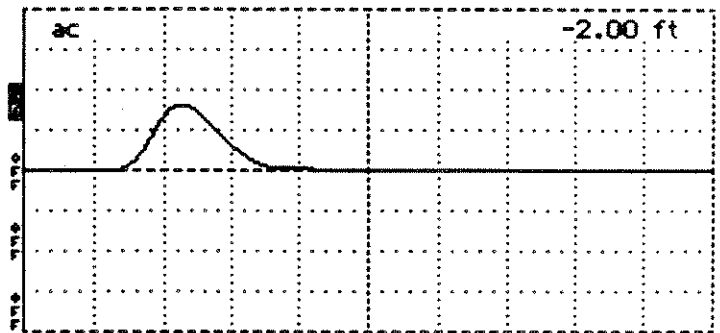

- G. Return the cursor to  $-2.00$  ft (*METRIC -  $-0.61$  m*). Turn **NOISE FILTER** back to **VERT SET REF** again. Set the **DIST/DIV** to  $2$  ft/DIV (*METRIC -  $0.5$  m/DIV*). Turn **PULSE WIDTH** to  $10$  ns. Adjust the pulse height to four major divisions, press **STORE** and return the **NOISE FILTER** control to  $1$  avg.

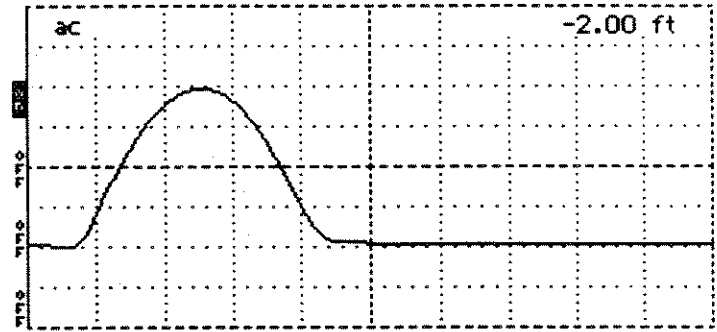

- H. Place the baseline of the waveform on the center graticule line with the  $\Phi$ **POSITION** control and increase **VERT SCALE** to  $30.00$  dB.
- I. Using the  $\Phi$ **POSITION** control, verify that the aberrations are less than four divisions high out to  $30$  feet.

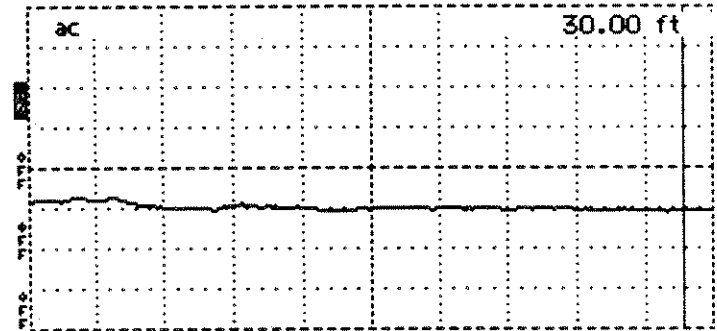

- J. Return the cursor to  $-2.00$  (*METRIC -  $-0.61$  m*). Turn **NOISE FILTER** back to **VERT SET REF**. Set **DIST/DIV** to  $50$  ft/DIV (*METRIC -  $10$  m/DIV*). Using **PULSE WIDTH**, select the  $100$  ns pulse. Adjust the pulse height to four major divisions, press **STORE** and return the **NOISE FILTER** to  $1$  avg.

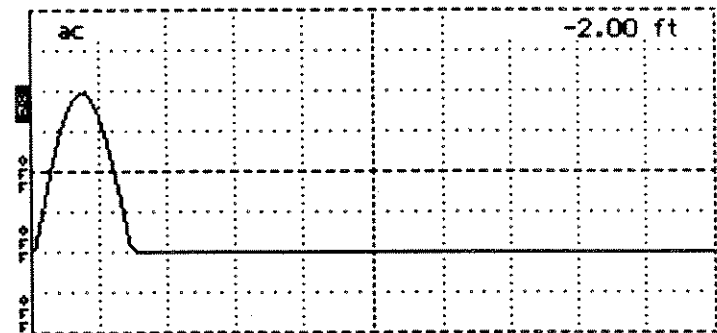

- K. Place the baseline of the waveform on the center graticule line with the  $\Phi$ **POSITION** control and increase **VERT SCALE** to  $30.00$  dB.

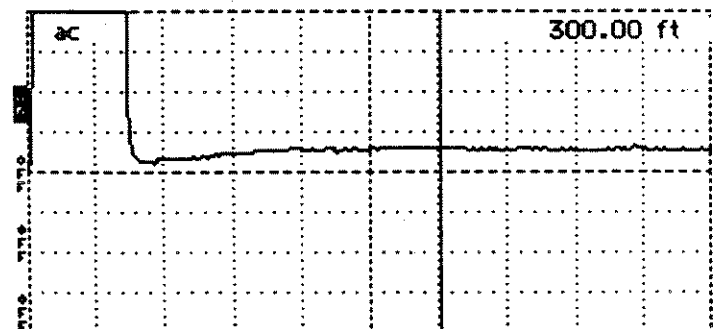

- L. Using the  $\Phi$ **POSITION** control, verify that the aberrations are less than four divisions high out to  $300$  ft (*METRIC -  $91.50$  m*).

- M. Return the cursor to  $-2.00$  ft (*METRIC - 0.50 m*). Turn **NOISE FILTER** back to **VERT SET REF.** Set **DIST/DIV** to  $500$  ft/DIV (*METRIC - 100m/DIV*). Using the **PULSE WIDTH** control, select the  $1000$  ns pulse. Adjust the pulse height to four major divisions, press **STORE** and return to 1 avg.

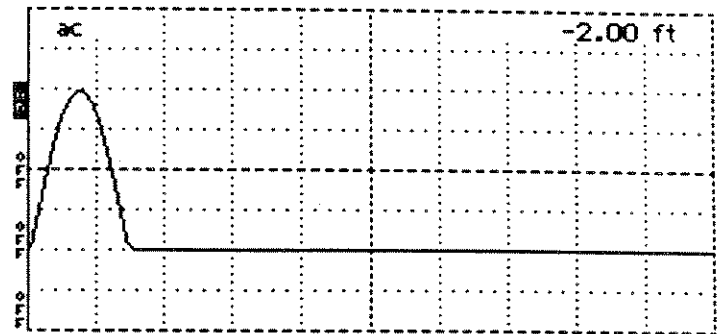

- N. Place the baseline of the waveform on the center graticule line with the  $\diamond$ **POSITION** control and increase **VERT SCALE** to  $30.00$  dB. The aberrations should be smaller than four divisions out to  $3000$  ft (*METRIC - 915.00 m*).

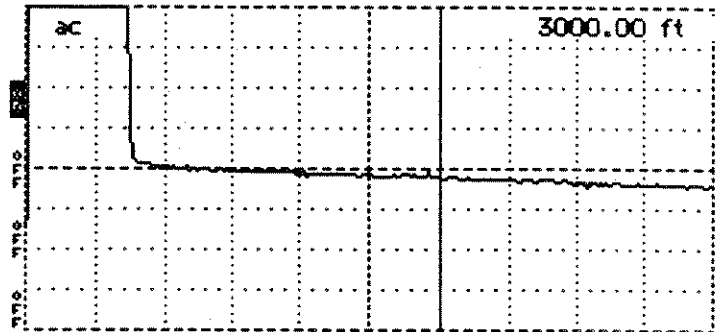

### Conclusions

If the instrument failed Aberrations or Sampling Efficiency tests, it is probably still adequate for all but extremely minor fault measurements. If it failed the Horizontal Scale test, you should not use the instrument until the cause of the failure has been identified and corrected.

All of the previous tests only verify the major functional blocks of the instrument that could prevent you from being able to make measurements. It is possible for the front panel controls or the LCD to have problems that would also interfere with controlling or displaying measurements. Most problems of this type would become evident as you perform the tests. If you suspect a problem of this nature, you should have the instrument serviced (or refer to the use of the diagnostics in the *Service Manual* that cover these portions of the instrument).

If the instrument passed all of the checks above, it is ready for use.

If your instrument is equipped with Option 06 (Ethernet), refer to the *Calibration* section in this manual.

# ACCESSORIES

## Standard Accessories (Included with instrument)

Fig.	Accessory	Tektronix Part Number
1	1 Replacement Fuse (for AC line)	159-0029-01 (for 115 VAC) or 159-0054-00 (for 230 VAC)
2	1 Power Cord (outdoor rated)	161-0228-00
3	1 Option Port Cover Assembly	200-3497-00
4	1 Battery Pack Port Cover	200-3452-00
5	1 Precision 50 $\Omega$ Cable	012-0482-00
6	1 50 $\Omega$ BNC Terminator	011-0123-00
7	1 BNC Connector, Female-to-Female	103-0028-00
8	1 Calculator Side Rule	003-1419-00
9	1 Interconnect cable, 108-inch	012-0671-02
	1 Operator Manual	070-6268-00
	1 Accessory Pouch	016-0814-00

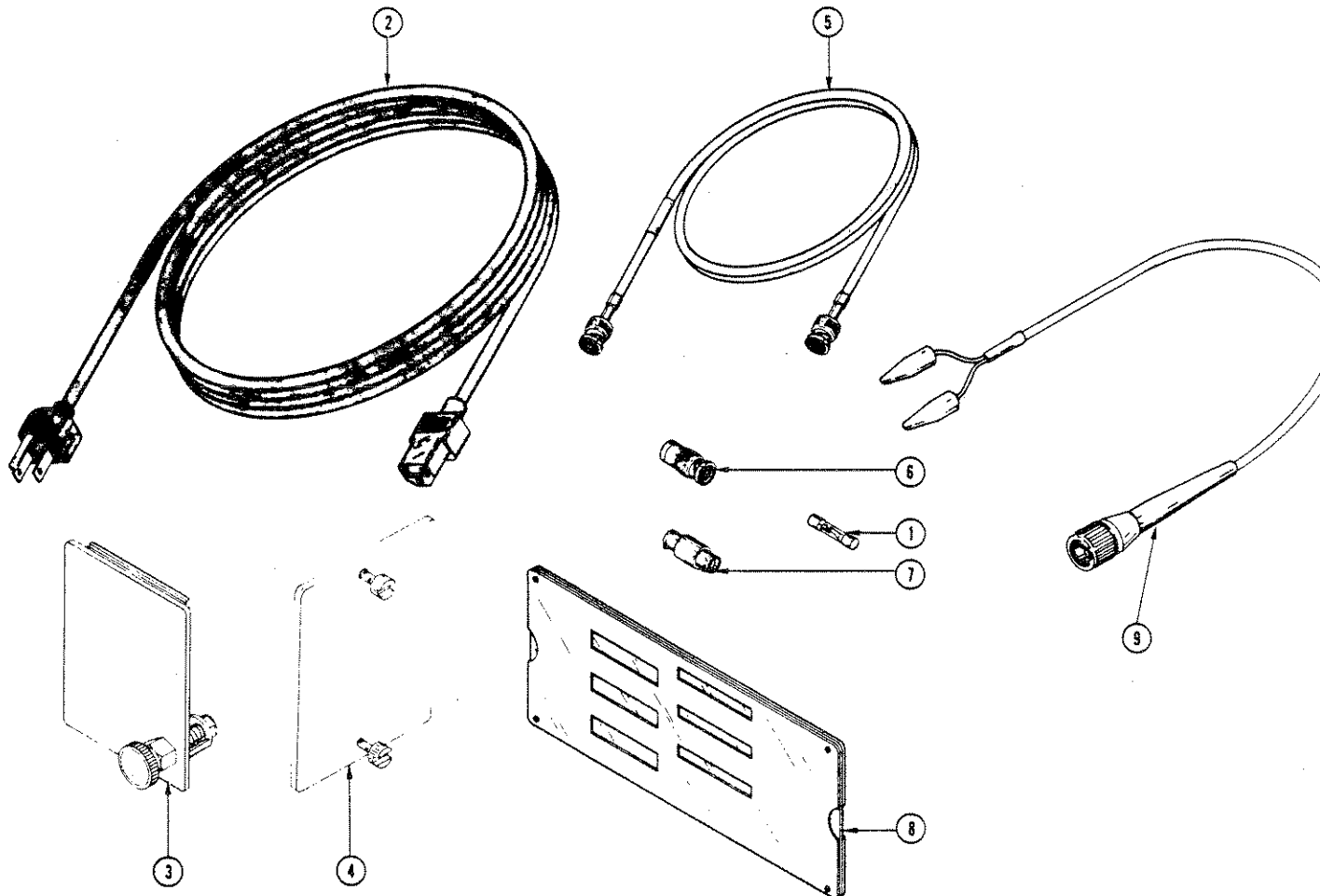

## OPTIONAL ACCESSORIES

Accessory	Tek Part No.
Instruction (Service) Manual	070-6269-00
Battery Pack	016-0813-00
Chart Recorder	YT-1
Chart paper, single roll	006-7647-00
Chart paper, 25-roll quantity	006-7677-00
Chart paper, 100-roll quantity	006-7681-00
Cable, Interconnect, 360-inches	012-0671-03
Connector, BNC Male to BNC Male	103-0029-00
Connector, BNC Female to Alligator Clips	013-0076-00
Connector, BNC Female to Hook-tip Leads	013-0076-01
Connector, BNC Female to Dual Banana Plug	103-0090-00
Connector, BNC Male to Dual Binding Post	103-0035-00
Connector, BNC Male to N Female	103-0058-00
Connector, BNC Female to N Male	103-0045-00
Connector, BNC Female to UHF Male	103-0015-00
Connector, BNC Female to UHF Female	103-0032-00
Connector, BNC Female to Type F Male	103-0158-00
Connector, BNC Male to Type F Female	013-0126-00
Connector, BNC Female to GR	017-0063-00
Connector, BNC Male to GR	017-0064-00
Terminator, 75 $\Omega$ BNC	011-0102-00
Adapter, Direct Current	015-0327-00
Isolation Network	013-0169-00
Pulse Inverter	015-0495-00



# OPTIONS

The following options are available for the 1503B TDR:

## OPTION 03 - Battery Pack

Instrument comes equipped with nickel-cadmium rechargeable battery pack.

### Battery Pack Removal



*Read the instructions in the front of this manual in the Operator Section concerning the safety precautions necessary when charging, removing, or servicing the battery pack.*

1. Loosen the two knurled screws on the battery pack and pull back to remove from the rear panel of the instrument.
2. Replace in the same manner. Check that the battery pack banana sockets are aligned correctly with the battery pack port banana plugs. Push the battery pack directly into the compartment and tighten the two screws finger tight.
3. If removing the battery for any length of time, seal the battery pack port with the battery port cover. This will help seal the instrument from dirt and moisture.

## OPTION 04 - YT-1 Chart Recorder

### Instructions for Use

Making permanent records with the 1503B is easy with the Tektronix YT-1 Digital Chart Recorder.

1. Make sure the desired waveform (or waveforms) is displayed on the LCD.
2. Slide back the protective cover on the recorder. Push **PRINT** on the front panel of the chart recorder.
3. When the chart recorder has finished, tear off the paper recording, pulling the paper to the left.

### YT-1 Chart Recorder Paper Replacement

1. Turn the knurled knob on the front panel of the chart recorder counterclockwise until it loosens. Pull the unit from the instrument. Set the instrument with the front panel to the right.
2. With your thumbs, push the frame surrounding the motor pulley. Push until the motor assembly latch locks the motor assembly to the side frame. This loosens the tension in the paper path, allowing any remaining paper to be removed.
3. Remove the paper retaining knob. Remove any paper and the empty paper core.
4. Following the diagram on the top of the recorder, place a fresh roll of paper in the recorder so the paper unwinds off the right side of the roll into the paper path (looking down on the recorder, the paper unrolls clockwise). Tearing the end of the paper roll on a slant will facilitate placing the paper in the slot.
5. Assure that the paper drops down into the paper path without binding, and the paper protrudes through the slot in the front of the instrument. Release the keeper from the frame, and the paper drive mechanism will return to the operating position.

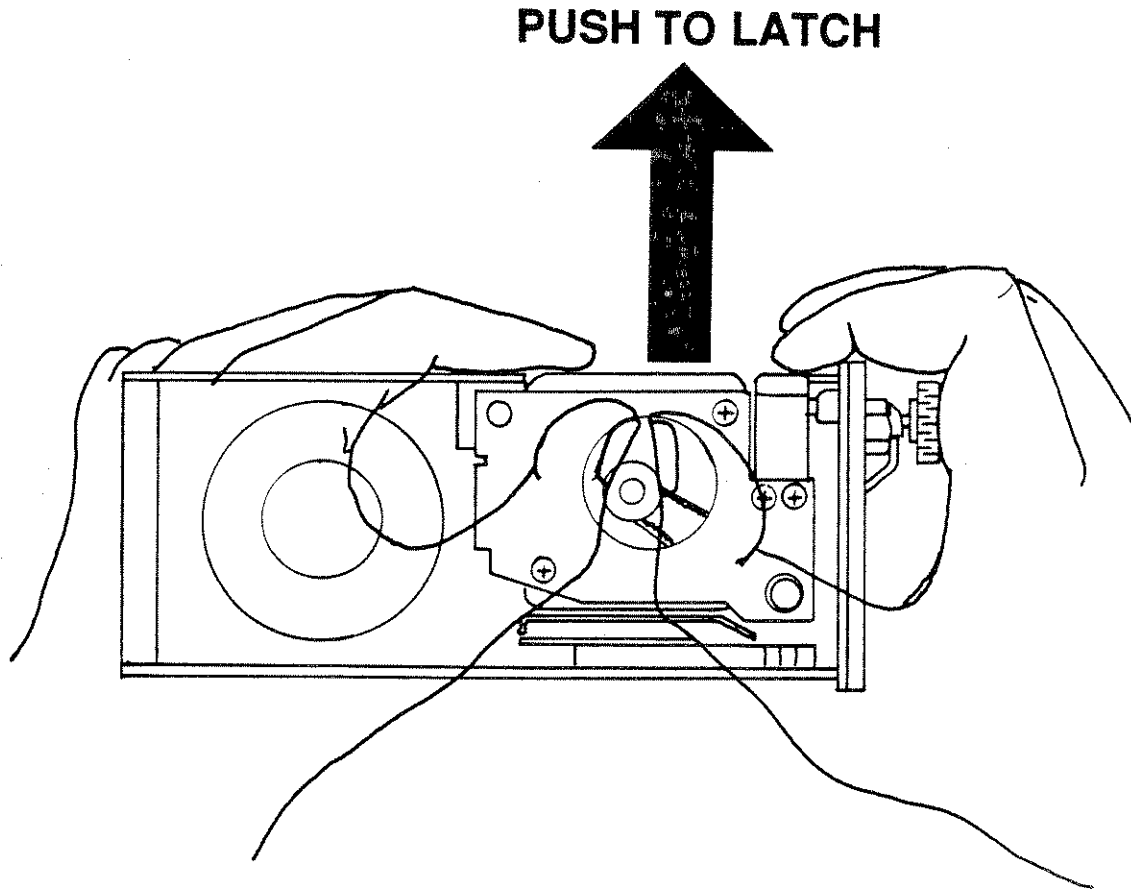

**Paper Replacement**

**OPTION 05 - Metric Default**

Instrument will power up in the metric mode. Standard measurements are then menu selected.

**OPTION 06 - Ethernet<sup>®</sup>**

Allows 1503B to test an Ethernet<sup>®</sup> bus using Time Domain Reflectometry with minimum disruption to the IEEE 802.3 protocol. For instructions, see the section in this manual corresponding to your needs.

Ethernet<sup>®</sup> is a registered trademark of the Xerox Corporation.

**POWER CORD OPTIONS**

The following power cords are available for the 1503B TDR. Options require inserting 0.15 A fuses in the rear panel fuse holder.

*NOTE: The only power cord rated for outdoor use is the standard cord (161-0228-00) included with instruments (if not otherwise specified). All other optional power cords are rated for indoor use only.*

<b>Option A1:</b>	220 V/16 A - Universal Europe	161-0066-09
<b>Option A2:</b>	240 V/13 A - United Kingdom	161-0066-10
<b>Option A3:</b>	240 V/10 A - Australia	161-0066-11
<b>Option A4:</b>	240 V/15 A - North America	161-0066-12
<b>Option A5:</b>	240 V/6 A - Switzerland	161-0154-00

