



PLEASE CHECK FOR CHANGE INFORMATION
AT THE REAR OF THIS MANUAL.

SG 505 OSCILLATOR

WITH OPTION 01

Francais Deutsch 日本語

INSTRUCTION MANUAL

Tektronix, Inc.
P.O. Box 500
Beaverton, Oregon 97077

070-2823-00
Product Group 75

Serial Number B.054481 8555WR
B.054466 8655WR
B.054493 8655WR

Scans by ARTEK MEDIA =>

First Printing OCT 1979
Revised DEC 1983

Scans By *Artek Media*

Artek Media
1042 Plummer Cir. SW
Rochester, MN 55902

www.artekmedia.com

“High resolution scans of obsolete technical manuals”

If you are looking for a quality scanned technical manual in PDF format please visit our WEB site at www.artekmedia.com or drop us an email at manuals@artekmedia.com and we will be happy to email you a current list of the manuals we have available.

If you don't see the manual you need on the list drop us a line anyway we may still be able to point you to other sources. If you have an existing manual you would like scanned please write for details, This can often be done very reasonably in consideration for adding your manual to our library.

Typically the scans in our manuals are done as follows;

- 1) Typed text pages are typically scanned in black and white at 300 dpi.
- 2) Photo pages are typically scanned in gray scale mode at 600 dpi
- 3) Schematic diagram pages are typically scanned in black and white at 600 dpi unless the original manual had colored high lighting (as is the case for some 70's vintage Tektronix manuals).

If you purchased this manual from us (typically through our Ebay name of ArtekMedia) thank you very much. If you received this from a well-meaning “friend” for free we would appreciate your treating this much like you would “share ware”. By that we mean a donation of at least \$5-10 per manual is appreciated in recognition of the time (a manual can take as much as 40 hours to reproduce, book, link etc.), energy and quality of effort that went into preserving this manual. Donations via PayPal go to: manuals@artekmedia.com or can be mailed to us the address above.

Thanks



Dave & Lynn Henderson
Artek Media

Copyright © 1979 Tektronix, Inc. All rights reserved.
Contents of this publication may not be reproduced in any
form without the written permission of Tektronix, Inc.

Products of Tektronix, Inc. and its subsidiaries are covered
by U.S. and foreign patents and/or pending patents.

TEKTRONIX, TEK, SCOPE-MOBILE, and  are reg-
istered trademarks of Tektronix, Inc.

Printed in U.S.A. Specification and price change privileges
are reserved.

Copyright © 1979 durch Tektronix, Inc. Alle Rechte vorbe-
halten. Der Inhalt dieser Publikation darf ohne Genehmigung
von Tektronix, Inc. nicht weitergegeben werden.

Produkte von Tektronix, Inc. und seinen Tochtergesellschaften
sind durch US- und Auslandspatente und/oder schwebende
Patente abgedeckt.

TEKTRONIX, TEK, SCOPE-MOBILE und  sind geschützte
Warenzeichen von Tektronix, Inc.

Gedruckt in U.S.A. Spezifikations- und Preisänderungen
bleiben vorbehalten.

Copyright © 1979 TEKTRONIX INC. Tous droits réservés.
Le contenu de ce manuel ne peut être reproduit sous quelque for-
me que ce soit sans l'accord de Tektronix Inc.

Tous les produits TEKTRONIX sont brevetés US et Etranger et
les logotypes TEKTRONIX, TEK SCOPE MOBILE,  sont
déposés.

Imprimé aux USA. TEKTRONIX se réserve le droit de modifier :
caractéristiques et prix dans le cadre de développements techno-
logiques.

© 1979 年版権所有テクトロニクス社。不許複製。

TEKTRONIX、TEK、SCOPE-MOBILE、
 はテクトロニクス社の登録商標です。

米国にて印刷。仕様及び価格は予告なく変更する場
合があります。

TABLE OF CONTENTS

| | Page | | Page |
|--|------|--|------|
| List of Illustrations | iii | Sélection du niveau de sortie | 2-2 |
| List of Tables | iv | Bornes de sortie | 2-2 |
| Operators Safety Summary | v | Utilisation de l'appareil | 2-2 |
| Servicing Safety Summary | vii | Informations générales d'utilisation .. | 2-2 |
| | | Connexions de sortie | 2-2 |
| | | Sélection de la fréquence | 2-4 |
| | | Sélection du niveau de sortie | 2-4 |
| | | Signal de test d'intermodulation (op- tion 01) | 2-4 |
| | | Signaux délivrés sur le connecteur de l'interface | 2-4 |
| OPERATORS PART | | | |
| Section 1 SPECIFICATION | | | |
| Introduction | 1-1 | | |
| Performance Conditions | 1-1 | | |
| Electrical Characteristics | 1-1 | | |
| Front Panel | 1-1 | | |
| Rear Interface | 1-3 | | |
| Miscellaneous | 1-3 | | |
| Environmental | 1-4 | | |
| Physical Characteristics | 1-4 | | |
| ENGLISH VERSION | | | |
| Section 2 OPERATING INSTRUCTIONS | | | |
| Installation Instructions | 2-1 | | |
| Preparation for Use | 2-1 | | |
| Repackaging Information | 2-2 | | |
| Controls and Connectors | 2-2 | | |
| Operators Familiarization | 2-4 | | |
| General Operating Information | 2-4 | | |
| Output Connections | 2-4 | | |
| Frequency Selection | 2-4 | | |
| Output Level Selection | 2-4 | | |
| Intermodulation Test Signal | 2-4 | | |
| Rear Interface Signals | 2-4 | | |
| FRENCH VERSION | | | |
| Chapitre 2 INSTRUCTIONS D'UTILISATION | | | |
| Mise en route | 2-1 | | |
| Opérations préliminaires | 2-1 | | |
| Instructions d'expédition | 2-1 | | |
| Commandes et connecteurs | 2-2 | | |
| Sélection de la fréquence | 2-2 | | |
| GERMAN VERSION | | | |
| Kapitel 2 BEDIENUNGSANLEITUNG | | | |
| Einbauanweisung | 2-1 | | |
| Bedienungselemente und Steckverbindungen | 2-2 | | |
| Allgemeine Bedienungsanleitung | 2-4 | | |
| Ausgangssignal | 2-4 | | |
| Frequenzwahl | 2-4 | | |
| Wahl des Ausgangspegels | 2-4 | | |
| Modulationstestsignal (Option 01) .. | 2-4 | | |
| Signale an der ruckseitigen Interfaceverbindung | 2-4 | | |
| Verpackungshinweise | 2-5 | | |
| JAPANESE VERSION | | | |
| 第 2 章 取扱説明 | | | |
| 取付け方法 | 2-1 | | |
| ご使用の前に | 2-1 | | |
| 梱包方法 | 2-2 | | |
| コントロールとコネクタ | 2-2 | | |
| 操作方法 | 2-2 | | |
| 操作の前に | 2-2 | | |
| 出力コネクタ | 2-2 | | |
| 周波数選択 | 2-4 | | |
| 出カレベル選択 | 2-4 | | |
| インターモジュレーション・テスト信号 .. | 2-4 | | |
| 後部インターフェイス信号 | 2-4 | | |

TABLE OF CONTENTS (cont)

SERVICE PART

WARNING

THE FOLLOWING SERVICING INSTRUCTIONS ARE FOR USE BY QUALIFIED PERSONNEL ONLY. TO AVOID PERSONAL INJURY, DO NOT PERFORM ANY SERVICING OTHER THAN THAT CONTAINED IN OPERATING INSTRUCTIONS UNLESS YOU ARE QUALIFIED TO DO SO.

| | | |
|------------------|---|-------------|
| Section 3 | THEORY OF OPERATION | Page |
| | Introduction | 3-1 |
| | Phase Shift Oscillator | 3-1 |
| | Amplitude Detector | 3-1 |
| | Peak Detector | 3-1 |
| | Amplitude Control | 3-1 |
| | Output Buffer Amplifier | 3-2 |
| | Output Attenuator and Buffer Amplifier | 3-2 |
| | Sync Driver and Sync Amplifier | 3-2 |
| | Power Supply | 3-2 |
| | Intermodulation Test Signal (Option 01) | 3-2 |
| Section 4 | CALIBRATION PROCEDURE | |
| | Introduction | 4-1 |
| | Test Equipment Requirements | 4-1 |
| | Performance Check | 4-3 |
| | Introduction | 4-3 |
| | Test Equipment Required | 4-3 |
| | Preparation | 4-3 |
| | Procedure | 4-3 |
| | Adjustments | 4-13 |
| | Introduction | 4-13 |
| | Test Equipment Required | 4-13 |
| | Preparation | 4-13 |
| | Procedure | 4-13 |

| | | |
|------------------|--|-------------|
| Section 5 | MAINTENANCE | Page |
| | Recalibration | 5-1 |
| | Obtaining Replacement Parts | 5-1 |
| | Cleaning Instructions | 5-1 |
| | Circuit Board Removal and Installation | 5-1 |
| | Low Frequency Selection (Option 01) | 5-2 |
| | Troubleshooting Aids | 5-2 |
| | Troubleshooting Equipment | 5-2 |
| | Static-Sensitive Components | 5-2 |

Section 6 OPTIONS

Section 7 REPLACEABLE ELECTRICAL PARTS

Section 8 DIAGRAMS AND CIRCUIT BOARD ILLUSTRATIONS

Section 9 REPLACEABLE MECHANICAL PARTS AND EXPLODED VIEW

Accessories

Change Information

LIST OF ILLUSTRATIONS

| Fig. No. | | Page |
|-------------|---|------|
| | SG 505 Oscillator (Option 01) | viii |
| 2-1 | SG 505 installation and removal | 2-1 |
| 2-2 | Front panel controls and connectors | 2-3 |
| 4-1 | 10 Hz null adjustment | 4-8 |
| 4-2 | 10 Hz harmonic distortion display | 4-8 |
| 4-3 | 20 Hz harmonic distortion display | 4-10 |
| 4-4 | 20 kHz harmonic distortion display | 4-10 |
| 4-5 | Left side view of SG 505 | 4-13 |

NOTE

The following illustrations are located in the diagrams foldout section at the rear of this manual.

| | |
|-----|---|
| 8-1 | SG 505 Simplified block diagram |
| 8-2 | Oscillator board (A10) |
| 8-3 | Troubleshooting flow chart—oscillator |
| 8-4 | Troubleshooting flow chart—power supply |
| 8-5 | IMD Option board (A11) |
| 8-6 | Adjustment locations |

LIST OF TABLES

| Table No. | | Page |
|-----------|--|------|
| 1-1 | Electrical Characteristics | 1-1 |
| 1-2 | Miscellaneous | 1-3 |
| 1-3 | Environmental | 1-4 |
| 1-4 | Physical Characteristics | 1-4 |
| 4-1 | List of test equipment requirements | 4-1 |
| 4-2 | Frequency accuracy check | 4-3 |
| 4-3 | Output level accuracy check | 4-5 |
| 4-4 | Output level step accuracy check | 4-6 |
| 4-5 | Level flatness check | 4-7 |
| 4-6 | Level flatness check | 4-7 |
| 4-7 | Harmonic correction factors | 4-9 |
| 4-8 | Factors for thd computation | 4-10 |
| 5-1 | Relative susceptibility to static discharge damage | 5-3 |

NOTE

The following tables are located in the diagrams foldout section at the rear of this manual.

| | |
|-----|--------------------------------------|
| 8-1 | Rear Interface Connector Assignments |
| 8-2 | Component reference chart |
| 8-3 | Component reference chart |
| 8-4 | Component reference chart |
| 8-5 | Component reference chart |

OPERATORS SAFETY SUMMARY

The general safety information in this part of the summary is for both operating and servicing personnel. Specific warnings and cautions will be found throughout the manual where they apply, but may not appear in this summary.

TERMS

In This Manual

CAUTION statements identify conditions or practices that could result in damage to the equipment or other property.

WARNING statements identify conditions or practices that could result in personal injury or loss of life.

As Marked on Equipment

CAUTION indicates a personal injury hazard not immediately accessible as one reads the marking, or a hazard to property including the equipment itself.

DANGER indicates a personal injury hazard immediately accessible as one reads the marking.

SYMBOLS

In This Manual



This symbol indicates where applicable cautionary or other information is to be found.

As Marked on Equipment



DANGER — High voltage.



Protective ground (earth) terminal.



ATTENTION — refer to manual.

Power Source

This product is intended to operate in a power module connected to a power source that will not apply more than 250 volts rms between the supply conductors or between either supply conductor and ground. A protective ground connection by way of the grounding conductor in the power cord is essential for safe operation.

Grounding the Product

This product is grounded through the grounding conductor of the power module power cord. To avoid electrical shock, plug the power cord into a properly wired receptacle before connecting to the product input or output terminals. A protective ground connection by way of the grounding conductor in the power cord is essential for safe operation.

Danger Arising From Loss of Ground

Upon loss of the protective-ground connection, all accessible conductive parts (including knobs and controls that may appear to be insulated) can render an electric shock.

Use the Proper Power Module Power Cord

Use only the power cord and connector specified for your product.

Use only a power cord that is in good condition.

Use the Proper Fuse

To avoid fire hazard, use only the fuse of correct type, voltage rating and current rating as specified in the parts list for your product.

Refer fuse replacement to qualified service personnel.

Do Not Operate in Explosive Atmospheres

To avoid explosion, do not operate this product in an explosive atmosphere unless it has been specifically certified for such operation.

Do Not Operate Without Covers

To avoid personal injury, do not operate this product without covers or panels installed. Do not apply power to the plug-in via a plug-in extender.

SERVICING SAFETY SUMMARY

FOR QUALIFIED SERVICE PERSONNEL ONLY

Refer also to the preceding Operators Safety Summary.

Do Not Service Alone

Do not perform internal service or adjustment of this product unless another person capable of rendering first aid and resuscitation is present.

Use Care When Servicing With Power On

Dangerous voltages exist at several points in this product. To avoid personal injury, do not touch exposed connections and components while power is on.

Disconnect power before removing protective panels, soldering, or replacing components.

Power Source

This product is intended to operate in a power module connected to a power source that will not apply more than 250 volts rms between the supply conductors or between either supply conductor and ground. A protective ground connection by way of the grounding conductor in the power cord is essential for safe operation.

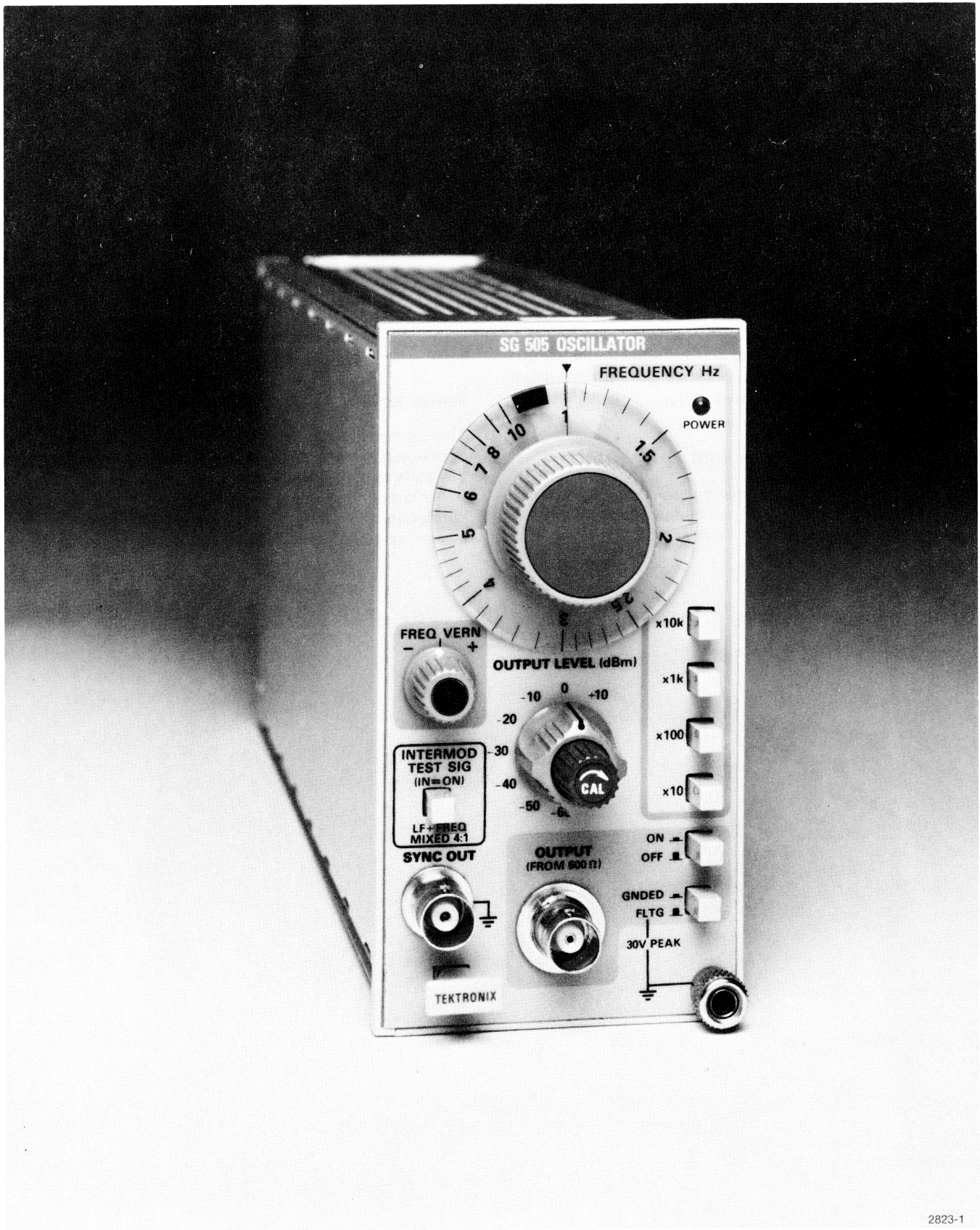

2823-1

The SG 505 Oscillator.

OPERATORS PART

SPECIFICATION

Introduction

The SG 505 Oscillator generates an ultra low distortion sine wave over the frequency range from 10 Hz to 100 kHz. This signal can be floated or referenced to chassis ground. The oscillator also provides a fixed amplitude ground referenced sine wave signal at the SYNC OUT connector that is identical in frequency to the signal from the OUTPUT connector. Versions of both output signals are available at the rear interface connector.

The Option 01 SG 505 adds an intermodulation test signal function. This signal consists of a lower frequency sine wave mixed with the selected frequency in a 4:1 amplitude ratio. The lower frequency sine wave is internally selectable for 60 Hz or 250 Hz. The SG 505 is designed to operate in one compartment of any TM 500 Series Power Module.

Performance Conditions

The electrical characteristics are valid only if the SG 505 has been calibrated at an ambient temperature of +20°C to +30°C and is operating at an ambient temperature of 0°C to +50°C, unless otherwise noted.

Items listed in the Performance Requirements column of the Electrical Characteristics are verified by completing the Performance Check in the Calibration section of this manual. Items listed in the Supplemental Information column are not verified in this manual. They are either explanatory notes or performance characteristics for which no limits are specified.

Table 1-1
ELECTRICAL CHARACTERISTICS (Front Panel)

| Characteristics | Performance Requirements | Supplemental Information |
|------------------|--|--|
| FREQUENCY | | |
| Range | 10 Hz to 100 kHz in four overlapping bands. | Typically 9 Hz to 110 kHz. Nominal range of each band is 0.90 to 11.0. |
| Vernier Range | $\geq \pm 1\%$ of frequency setting. | |
| Dial Accuracy | $\pm 3\%$ of setting with vernier at center. | |
| Drift | | Typically less than 0.01%/°C and 0.03%/hour. |
| OUTPUT LEVEL | | |
| Calibrated Steps | +10 dBm to -60dBm into 600 Ω in eight 10 dB steps, ± 0.2 dB at 0 dBm and 1 kHz. | |
| Step Accuracy | ± 0.1 dB/10 dB step. | |
| Stability | | Typically better than 0.01 dB/°C and 0.03 dB/hour. |
| Variable Range | $\geq +2.2$ dB to < -10 dB from calibrated position. | |

Table 1-1 (cont)
ELECTRICAL CHARACTERISTICS (Front Panel)

| Characteristics | Performance Requirements | Supplemental Information |
|--|--|--|
| OUTPUT LEVEL (cont) | | |
| Maximum Output | ≥ 10 dBV (+12.2 dBm) or 3.16 V rms into 600 Ω . | ≥ 6 V rms unloaded. |
| Settling Time | | ≤ 5 seconds to 0.2 dB of final value, 20 Hz—100 kHz, typically < 3 seconds above 100 Hz. Worst case transient overshoot is ≤ 3 dB. |
| LEVEL FLATNESS (1 kHz reference) | | |
| 10 Hz—20 kHz | ± 0.1 dB | |
| 20 kHz—100 kHz | ± 0.2 dB (exclude -60 dB OUTPUT LEVEL attenuator range) | |
| DISTORTION ($R_L \geq 600 \Omega$) | | Refer to Buffered Main Output load impedance limitation under Electrical Characteristics (Rear Interface) Typically $\leq 0.0003\%$. |
| 20 Hz—20 kHz | $\leq 0.0008\%$ (-102 dB) thd. | |
| 10 Hz—20 Hz, 20 kHz—50 kHz | $\leq 0.0018\%$ (-95 dB) thd. | |
| 50 kHz—100 kHz | $\leq 0.0032\%$ (-90 dB) thd. | |
| OUTPUT | | |
| Impedance | 600 $\Omega \pm 2\%$. | Floating or grounded through approximately 30 Ω . Output impedance does not change with OUTPUT ON/OFF selection. |
| Dc Offset | | $\leq 1\%$ of output ac rms voltage. |
| Maximum Floating Voltage | | ± 30 V peak. (0.01 μ F between output common and chassis ground in floating mode.) |
| Line Related Common Mode Output Voltage In Floating Mode | | Typically ≤ 50 mV rms into an open circuit. |
| SYNC OUTPUT | | |
| Signal | Sine wave with same frequency as output. 200 mVrms $\pm 20\%$ sine wave to 20KHz, at least 120 mv at 100 KHz. | Thd is typically $\leq 3\%$ and phase shift from OUTPUT is typically $\leq 5^\circ$, 20 Hz to 20 kHz. |
| Impedance | | 1 k Ω , $\pm 10\%$, ground referenced and isolated from main output. |

Table 1-1 (cont)
ELECTRICAL CHARACTERISTICS (Front Panel)

| Characteristics | Performance Requirements | Supplemental Information |
|------------------------------------|--|--|
| INTERMOD TEST SIGNAL (Optional) | | |
| Signal | Lf sine wave mixed with normal oscillator output in a 4 (± 0.1) to 1 amplitude ratio. | SYNC OUT signal is Lf component only. |
| Lf Frequency | Internally selectable 60 Hz ($\pm 2\%$) or 250 Hz ($\pm 2\%$). | |
| Level | Composite peak-to-peak output is within ± 0.2 dB of the normal oscillator mode sine wave output. | |
| Residual Imd | | Typically $\leq 0.0005\%$ from 2.5 kHz to 10 kHz and $\leq 0.001\%$ from 10 kHz to 20 kHz. |

ELECTRICAL CHARACTERISTICS (Rear Interface)

| Characteristics | Performance Requirements | Supplemental Information |
|----------------------|--------------------------|--|
| Buffered Main Output | | Pins 25A and 26A (common). Unity gain buffered version of the actual output signal from front panel connector. Pin 26A is electrically connected to front panel OUTPUT common. To prevent possible instrument damage, do not float output in excess of ± 30 V peak. Output impedance is approximately 600 Ω . To prevent degradation in oscillator distortion at the front panel, the rear interface load impedance must be ≥ 1 k Ω . This output is intended to provide an ac signal level reference for gain measurements. Thd is typically $\leq 0.03\%$. |
| Sync Output | | Pins 27B and 28B (ground). Approximately 200 mV rms sine wave identical to front panel SYNC output signal. Output impedance is approximately 50 Ω and always ground referenced. |

Table 1-2
MISCELLANEOUS

| Characteristics | Performance Requirements | Supplemental Information |
|----------------------|--------------------------|--------------------------|
| Power Consumption | | 6 VA or less. |
| Calibration Interval | | 1000 hours or 6 months. |
| Warm-up Time | | 30 minutes. |

Table 1-3
ENVIRONMENTAL^a

| Characteristics | Description | |
|-----------------------------|--|---|
| Temperature | Meets MIL-T-28800B, class 5. | |
| Operating | 0°C to +50°C | |
| Non-Operating | -55°C to +75°C | |
| Humidity | 90-95% RH for 5 days cycled to 50°C. | Exceeds MIL-T-28800B, class 5. |
| Altitude | Exceeds MIL-T-28800B, class 3. | |
| Operating | 4.6 km (15,000 ft). | |
| Non-operating | 15 km (50,000 ft). | |
| Vibration | 0.38 mm (0.015") 10 Hz to 55 Hz, 75 minutes. ^b | Meets or exceeds MIL-T-28800B, class 5, with exception in certain power modules. ^b |
| Shock | 30 g's (1/2 sine), 11 ms, 18 shocks. ^c | Meets or exceeds MIL-T-28800B, class 5, with exception in certain power modules. ^c |
| Bench Handling | 45° or 4" or equilibrium, whichever occurs first. | Meets MIL-T-28800B, class 3. |
| E.M.C. | MIL-STD 461A/462. | Meets MIL-T-28800B, class 3. |
| Electrical Discharge | 20 kV maximum. | Charge applied to each protruding area of the product under test except the output terminals. |
| Transportation ^d | Qualified under National Safe Transit Association Preshipment Test Procedures 1A-B-1 and 1A-B-2. | |
| Vibration | 25 mm (1") at 270 rpm for 1 hour. | |
| Package Drop | 10 drops from 91 cm (3 ft.). | |

^a With power module except where noted.

^b 0.26 mm (0.01"/) 10 Hz to 55 Hz in TM 501, TM 503, TM 504, TM 506.

^c 20 g's (1/2 sine), 11 ms, 18 shocks in TM 501, TM 503, TM 504, TM 506.

^d Without power module.

Table 1-4
PHYSICAL CHARACTERISTICS

| Characteristics | Description |
|--------------------|---|
| Finish | Plastic-aluminum laminate front panel. |
| Net Weight | 1.13 kg (2.49 lbs). |
| Overall Dimensions | 67.06 mm (2.640") W x 308.36 mm (12.140") D x 126.24 mm (4.970") H. |

OPERATING INSTRUCTIONS

INSTALLATION INSTRUCTIONS

Preparation for Use

The SG 505 Oscillator is calibrated and ready for use when received. It operates in any compartment of a TM 500 series power module. Refer to the power module instruction manual for line voltage requirements and power module operation. A list of standard accessories (and part numbers) is located in the back of this manual.

The SG 505 Option 01 instrument has an intermodulation test function that mixes a 60 Hz or 250 Hz sine wave with any selected frequency at the OUTPUT connector. The SG 505 contains an internal jumper that may be positioned to change the mixed 60 Hz sine wave to 250 Hz. The instrument is shipped with the jumper in the 60 Hz position. Refer internal jumper selection to qualified service personnel.

CAUTION

Turn the power module off before inserting or removing the plug-in; otherwise, damage may occur to the plug-in circuitry.

Check to see that the plastic barriers on the interconnecting jack of the selected power module compartment match the cutouts in the SG 505 circuit board edge connector. Align the SG 505 chassis with the upper and lower guides (see Fig. 2-1) of the selected compartment. Push the SG 505 chassis in and press firmly to seat the circuit board edge connector in the interconnecting jack. Pull out the power switch on the power module. The POWER indicator light on the front panel should light.

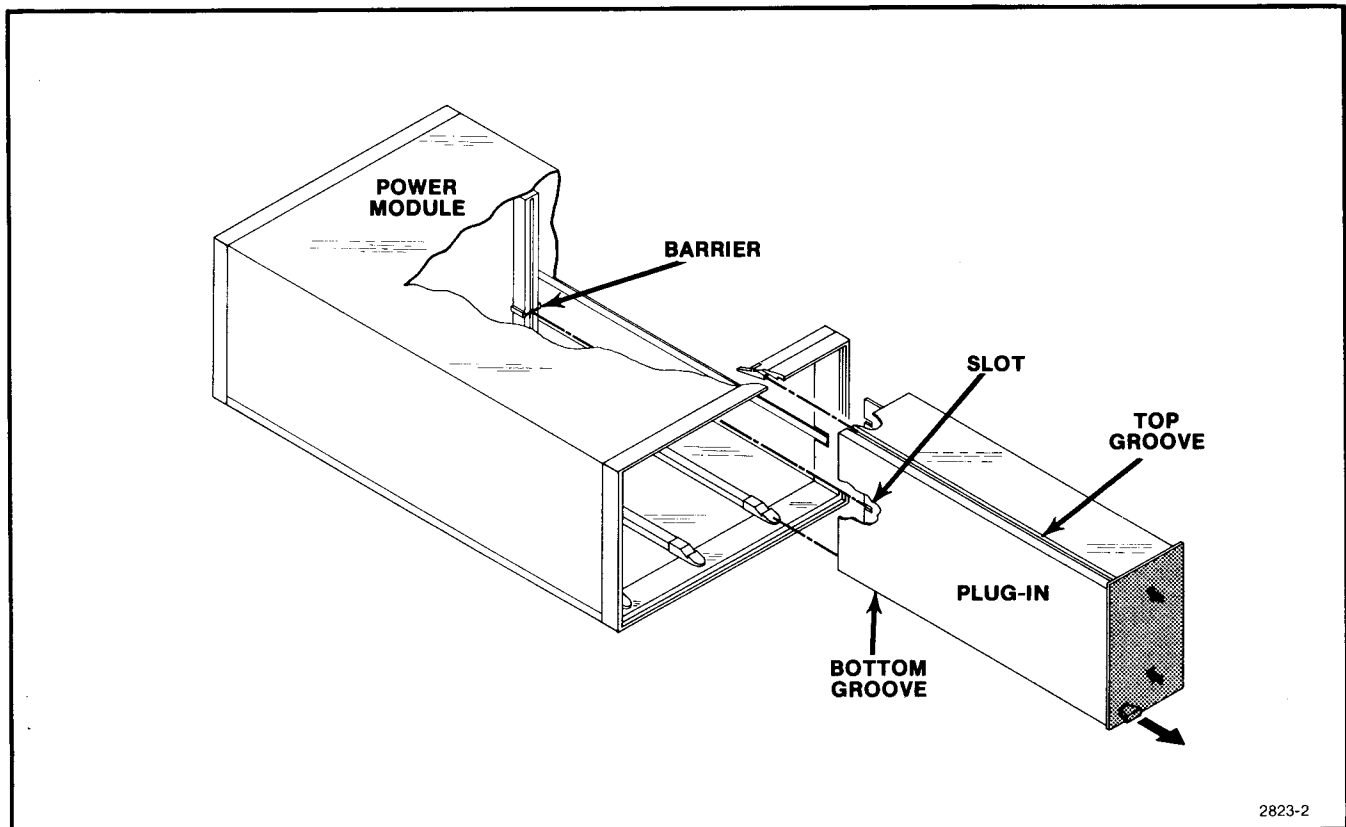

Fig. 2-1. SG 505 installation and removal.

2823-2

To remove the SG 505, pull on the release latch (located in the lower left corner) until the interconnecting jack disengages and the SG 505 slides out.

Repackaging Information

If the Tektronix instrument is shipped to a Tektronix Service Center for service or repair, attach a tag showing owner (with address) and the name of an individual at your firm to contact. Include the complete instrument serial number and a description of the service required.

Save and reuse the package in which your instrument was shipped. If the original packaging is unfit for use or not available, repackage the instrument as follows:

Surround the instrument with polyethylene sheeting to protect the instrument finish. Obtain a carton of corrugated cardboard of the correct carton strength having inside dimensions of no less than six inches more than the instrument dimensions. Cushion the instrument by tightly packing three inches of dunnage or urethane foam between carton and instrument on all sides. Seal the carton with shipping tape or an industrial stapler.

The carton test strength for this instrument is 200 pounds per square inch.

CONTROLS AND CONNECTORS

FREQUENCY SELECTION

- ① **FREQUENCY Hz Dial**
Provides continuous frequency selection within each pushbutton selected frequency range.
- ② **Multiplier Pushbuttons**
Select any one of four frequency ranges.
- ③ **FREQ VERNIER Dial**
Adjusts frequency $\pm 1\%$ from selected frequency.

OUTPUT LEVEL SELECTION

- ④ **OUTPUT LEVEL (dBm) Dial**
Selects one of eight amplitude level steps, calibrated in dBm, into a 600 Ω load.
- ⑤ **OUTPUT LEVEL (dBm) CAL Dial**
Provides continuous amplitude adjustment above and below the calibrated OUTPUT LEVEL (dBm) steps.
- ⑥ **INTERMOD TEST SIG Pushbutton (Option 01)**
Pushbutton in provides a 60 Hz or 250 Hz (see Preparation for Use) sine wave mixed with any selected output frequency in a 4:1 amplitude ratio. Also provides a 60 Hz or 250 Hz sine wave at the SYNC OUT connector.

- ⑦ **ON-OFF Pushbutton**
Connects or disconnects the signal to the OUTPUT connector.

⑧ GNDED-FLTG Pushbutton

GNDED connects the OUTPUT connector outer conductor (shield) to chassis ground through a low impedance.
FLTG connects the outer conductor to ground through a capacitor for floating operation.

OUTPUT CONNECTORS

⑨ OUTPUT Connector

Provides a sine wave signal at a frequency selected by the FREQUENCY Hz dial and multiplier pushbutton at an amplitude selected by the OUTPUT LEVEL (dBm) dial (Option 01, see INTERMOD TEST SIG Pushbutton (6)).

⑩ SYNC OUT Connector

Provides ≈ 200 mV rms fixed amplitude and ground referenced sinusoidal signal at the same frequency as the OUTPUT signal. (Option 01, see INTERMOD TEST SIG Pushbutton (6)).

⑪ Ground Binding Post

Chassis ground.

⑫ Release Latch

Pull to remove plug-in from the power module.

⑬ POWER Indicator

Indicator lights when power is applied to instrument from power module.

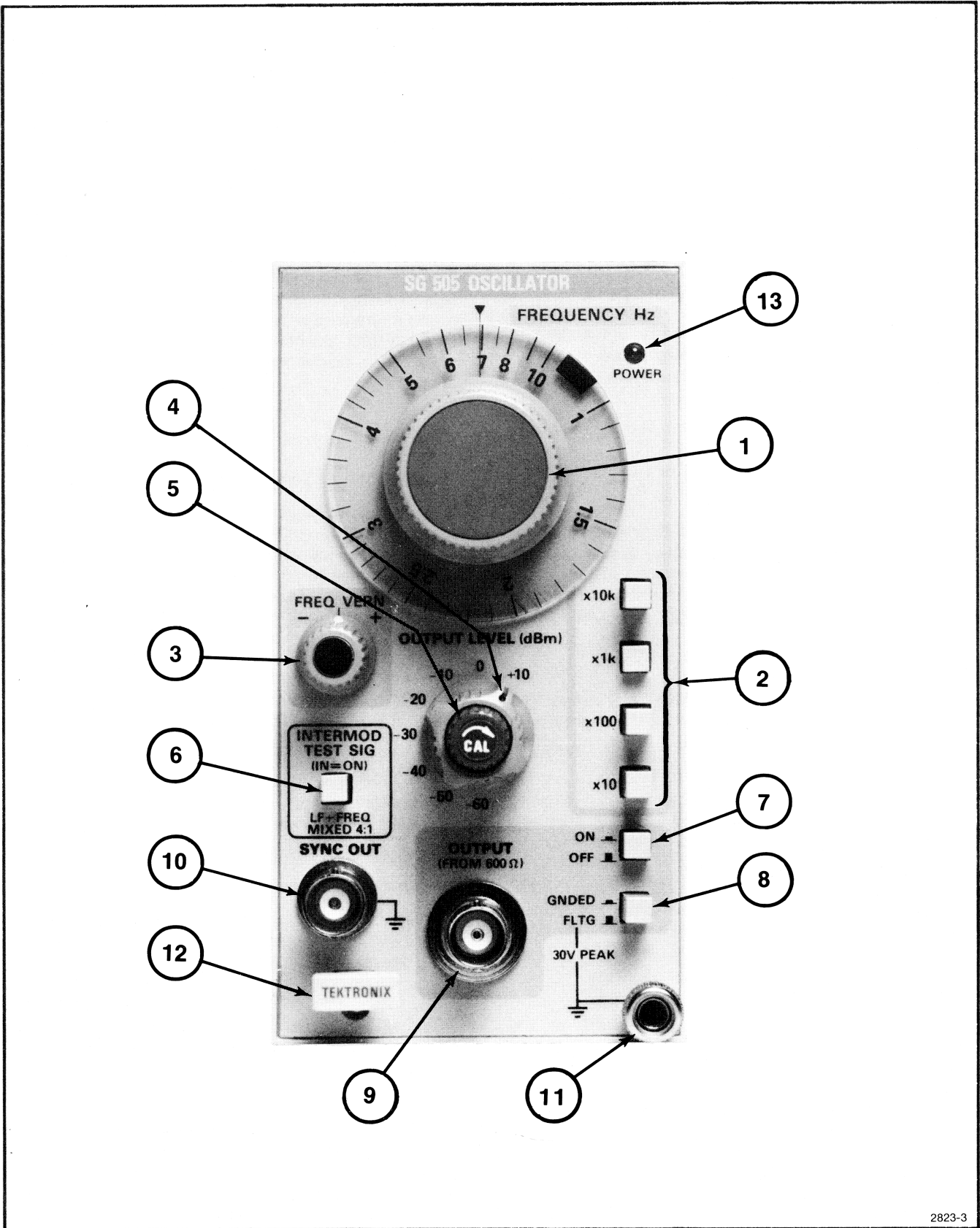

Fig. 2-2. Front panel controls and connectors.

OPERATORS FAMILIARIZATION

General Operating Information

With the SG 505 properly installed in the power module, allow thirty minutes warmup time for operation to specified accuracy.

Output Connections

The output of the SG 505 at the OUTPUT connector is designed to operate as a 600 Ω voltage source working into a 600 Ω load. At higher frequencies, an unterminated or improperly terminated output may reduce amplitude accuracy. Loads less than 600 Ω may cause waveform distortion. To ensure waveform purity, observe the following precautions:

1. Use good quality coaxial cables and connectors.
2. Make all connections tight and as short as possible.

The signal at the SYNC OUT connector is designed for use as an external trigger for a counter, oscilloscope, or other device. This output is approximately 200 mV rms with a source impedance of 1 k Ω , and is always referenced to chassis ground (even when the main OUTPUT is floating).

With the Option 01 INTERMOD TEST SIG pushbutton in, the OUTPUT signal at the SYNC OUT connector is replaced by either 60 Hz or 250 Hz (depending on the internal jumper setting).



To avoid damage to the SG 505 circuitry, do not apply a voltage exceeding 30 V peak, with respect to chassis ground, to any front panel connector or to rear interface connector pins 14A-28A and 14B-28B.

Frequency Selection

The SG 505 produces a sine wave signal at any frequency from 10 Hz to 100 kHz. To set the frequency, set the FREQUENCY Hz dial to the desired frequency and press the appropriate multiplier pushbutton. The FREQUENCY VERNIER dial may be used to adjust the OUTPUT frequency 1 percent above and below the frequency selected by the FREQUENCY Hz dial and multiplier pushbutton. With the FREQUENCY VERNIER dial at the center position, the output frequency produced is the FREQUENCY Hz dial setting multiplied by the active multiplier value. Signals at the OUTPUT and SYNC OUT connectors are of the same frequency. The SYNC OUT signal can be used as an external signal for monitoring the OUTPUT,

provided no more than approximately 200 mV is required from the SYNC OUT connector.

Output Level Selection

The OUTPUT LEVEL dial selects eight level steps from +10 dBm to -60 dBm. The CAL control, concentric within the OUTPUT LEVEL (dBm) dial, permits continuous adjustment above and below the calibrated output level steps. The signal at the OUTPUT connector may be ground referenced or floated up to ± 30 V peak, using the FLTG-GNDED pushbutton. The ON-OFF pushbutton connects or disconnects the signal at the OUTPUT connector.

Intermodulation Test Signal (Option 01)

With the INTERMOD TEST SIG pushbutton in, a 60 Hz or 250 Hz sine wave is mixed with any selected frequency at the OUTPUT connector in a 4:1 amplitude ratio. The composite peak-to-peak amplitude is set equal to the peak-to-peak amplitude of the unmodulated OUTPUT signal. The Intermod Test Sig LF frequency sine wave is selectable (60 Hz or 250 Hz) by means of an internal jumper. The SG 505 is shipped with the internal jumper in the 60 Hz position. Refer internal frequency selection to qualified service personnel. (Information for internal selection is provided in the Maintenance Section of this manual.)

In the INTERMOD TEST SIG mode, the SYNC OUT connector provides only the 60 Hz or 250 Hz sine wave.

Rear Interface Signals

A unity gain buffered OUTPUT signal is available at rear interface connector pins 25A and 26A (common). When the rear interface OUTPUT signal is used, the rear interface load impedance (pins 25A and 26A) must be ≥ 1 k Ω , to prevent OUTPUT amplitude distortion. The ON-OFF and FLTG-GNDED pushbuttons affect the rear interface output signal as previously described for the front panel OUTPUT signal.

The signal at the front panel SYNC OUT connector is also available at the rear interface connector, pins 27B and 28B (ground). The output impedance at these rear interface pins is approximately 50 Ω and the signal is always referenced to ground. In an Option 01 instrument, the INTERMOD TEST SIG pushbutton also affects the rear interface SYNC OUT signal as described for the front panel SYNC OUT signal.

SERVICE PART

THEORY OF OPERATION

Introduction

This section describes the SG 505 circuitry. The description is divided into parts that correspond to the circuit blocks shown on the block diagram in the Diagrams section of this manual. Each of these circuit blocks is also outlined in gray on the circuit diagram on which it is shown. The numbered diamond by each title of the following description refers to the corresponding circuit diagram number. The A10 or A11 number identifies the board assembly containing the circuit.

Phase Shift Oscillator A10

The phase shift or state variable oscillator consists of U1510, U1400, U1401, and associated components. Two integrators, U1400 and U1401, each having a 90° phase shift, are cascaded in a loop with inverter U1510. Combining the phase inversion of U1510 with the two 90° phase shifts of the integrators causes a 360° phase shift necessary for oscillation. Feedback occurs from pin 6 of U1401 to pin 2 of U1510 through R1517 and R510.

The output voltage rate of change of an integrator is proportional to the input voltage amplitude. The integrator timing capacitors and gain determine the oscillator frequency. The gain around the loop is unity at the oscillation frequency.

Multiplier pushbuttons S1410 select the timing capacitors across the integrators for each frequency range. The FREQUENCY Hz dial adjusts R520 and R530 to control the gain of the integrators. A small adjustment in the gain of U1510, through R510, providing a ±1% change in frequency, is accomplished by the frequency vernier dial.

The signal from U1401 is routed to a network consisting of Q1410, Q1411, and associated resistors and diodes. This network composes a clamp that limits the maximum output voltage from U1401 to no greater than 3 dB above the selected oscillator output level. Output voltage surges created at initial instrument turn on, or due to switching transients, are effectively eliminated.

Amplitude Detector A10

This circuitry provides an accurate relatively long time constant agc voltage. The output signal from U1401 is also fed to the amplitude detector circuit U1500 (an amplitude controlled integrator). U1500 compares the output of U1401 to the reference voltage (−15 V supply). The average current through R1504 equals the current through R1503 when the output of U1401 is 2 V rms. The output of U1500 sets the input offset voltage to the peak detector, Q1600 and Q1610.

Peak Detector A10

This circuitry provides a fast agc correction voltage. The offset voltage from U1500 and the ac signal from U1510 (coupled through C1603) are fed to a peak detector consisting of Q1600. This circuitry produces a negative dc output voltage on the agc line proportional to the negative peak voltage of the ac signal from U1510. Agc filter capacitors consist of combinations of C1611 and C1421, C1523, and C1420, depending on the frequency range selected. Between peaks, the agc filter capacitors charge from positive current source Q1611. Thus, the signal at the agc test point is a sawtooth waveform with a fast negative transition and a positive-going linear ramp. The network consisting of R1502 and C1502 provides cancellation of the fundamental frequency component of the agc signal.

Amplitude Control A10

The amplitude of the phase shift oscillator output is controlled by Q1501. Agc voltage generated by the peak detector and the amplitude detector controls the gate of Q1501. Components R1511, R1512, R1510, R1513, C1511, and C1510 form a voltage divider network. This voltage divider causes an ac signal that is one-half the amplitude of the signal appearing at the drain to drive the gate of Q1501. A more positive gate voltage at Q1501 causes an increase in oscillator amplitude by reducing the input signal at pin 3 of U1510.

Output Buffer Amplifier A10

The output signal from U1401 is fed through R1520, R1521, R1423, and R1518 to the output buffer amplifier U1520. The voltage gain of U1520 is set by R1518, the OUTPUT LEVEL (dBm) CAL control, and is variable from about 0.3 to 3. When this control is fully cw, the ganged switch is open and the buffer output amplitude is at the calibrated level set by R1423. Trimmer R1423 is internally adjusted to set the level at the OUTPUT connector to 0 dBm (with S1710 in the 0 dBm position).

Output Attenuator and Buffer Amplifier A10

The signal from the output buffer amplifier is fed through ON-OFF switch S1410E to output attenuator network R1720. This network has a constant output impedance of 600 Ω and provides eight output levels. Switch S1710 selects the output level tap for each of the eight output levels from +10 dBm to -60 dBm. From S1710, the signal passes to the front panel OUTPUT connector and to the main output buffer amplifier, U1700. Amplifier U1700 isolates the front panel OUTPUT connector from rear interface connector pin 25A.

Sync Driver and Sync Amplifier A10

An optical isolator is used in this circuitry because the SYNC OUT connector is connected to chassis ground. Output from U1401 also passes through U1300 to the base of Q1300. Transistor Q1300 produces a dc bias current (necessary to operate the LED in the linear region) which is combined with the ac current at the oscillator frequency. Sync Level Adjustment R1301 sets the gain of U1300 for an output of 200 mV rms at the SYNC OUT connector. The current through the LED section of optical isolator U1300 varies the intensity of emitted light. This light intensity controls the current through the transistor section of the optical isolator. The sync amplifier, consisting of Q1300, R1201, and R1200, converts the output current from U1300 to voltage. The output of Q1300 is coupled through R1204 to the front panel SYNC OUT connector and through R1202 to rear interface connector pin 27B.

Power Supply A10

Power is supplied to the SG 505 from the 25 V ac floating winding of the power module. The 25 V ac is applied to the primary winding of T1220. Each of the two secondary windings supplies 25 V ac, which is rectified by bridge rectifiers CR1113 and CR1114 and filtered by C1212 and C1211.

The two series pass transistors in the power module and U1101A and U1101B regulate the +15 V and -15 V

supply voltages. Resistors R1206 and R1205 divide the +15 V to +8.2 V at pin 5 of U1101B. Operational amplifier U1101B compares the voltage at pin 5 with the +8.2 V reference voltage at pin 6, supplied by VR1201. The output of U1101B drives the series pass transistor in the power module. If the voltage at pin 5 of U1101B moves below +8.2 V, the output of U1101B goes more negative, causing more base current flow in the PNP series pass transistor. This raises the +15 V to the level where U1101B can function. Resistor R1207 and C1200 decouple the +15 V used in the output amplifier.

The -15 V supply tracks the +15 V supply. Operational amplifier U1101A compares the voltage at pin 3 to the floating ground potential at pin 2. The voltage at the junction of the voltage divider R1102 and R1101 is 0 V if the +15 V and -15 V supply voltages are correct. If the -15 V supply voltage moves toward ground, the output of U1101A goes more positive, causing increased base current and conduction in the NPN series pass transistor which causes the -15 V to go more negative. FET Q1110 provides base current to the PNP series pass transistor at instrument turn on.

Current limit for the +15 V supply is provided by CR1111, CR1112, and R1120. The maximum output for each supply is 200 mA. At this current the series pass transistor base voltage is ≈ 1.4 V more negative than ground. If the output of U1101B attempts to drive the transistor base voltage more negative than -1.4 V, the current limiting diodes conduct, clamping the base at -1.4 V. The base to emitter voltage of the series pass transistor is limited by the voltage drop across R1120. The negative current limit operates in a similar manner.

Intermodulation Test Signal (Option 01) A11

Option 01 instruments include an intermodulation test signal that mixes a 60 Hz or 250 Hz sine wave with the selected frequency in a 4:1 amplitude ratio (four parts low frequency to one part selected frequency). The circuit contains a Wein-bridge oscillator composed of U1100 and associated components. To select a 60 Hz output at U1100, jumper P1100 is removed from the circuit. The oscillator frequency is set to 60 Hz by C1100, C1200, R1102, and R1103. With the jumper positioned across J1100, resistors R1101 and R1104 are added to the circuit changing the frequency to 250 Hz.

A peak detector consisting of CR1110 and Q1110 controls the gain of the oscillator by adjusting the voltage at the gate of Q1111. Resistor R1211 is an internal adjustment that sets the amplitude of the signal from U1100.

CALIBRATION PROCEDURE

Introduction

This section consists of a Performance Check and an Adjustments procedure. The Performance Check verifies the electrical specifications listed under Performance Requirements in the Specifications section of this manual. The Adjustments procedure describes a sequential adjustment of internal controls should it be necessary to restore the instrument performance to the electrical specifications listed in the Specifications section.

Tektronix, Inc. provides complete instrument repair and calibration at local Field Service Centers and at the

Factory Service Center. Contact your local Tektronix Field Office or representative for further information.

Test Equipment Requirements

Below is a list of equipment required to perform the Performance Check and Adjustments procedure. Other equipment may be substituted when suitable. Tolerances that are specified in the Performance Check and Adjustments procedure apply to the instrument under test and do not include test equipment error.

Table 4-1

LIST OF TEST EQUIPMENT REQUIREMENTS

| Description | Performance Requirements | Application | | Example |
|--------------------------------------|--|-------------------------|------------------|--|
| | | Performance Check Step | Adjustments Step | |
| TM 500 Series Power Module | | All steps | All steps | TEKTRONIX TM 503, TM 504, or TM 506 |
| Counter | 0.1 Hz resolution at 100 kHz. | 1, 2, 13 | 1 | TEKTRONIX DC 504 Digital Counter ^b |
| Calibration Fixture | 80 dB notch at 10 Hz, 20 Hz; 60 dB notch at 20 kHz, 50 kHz, 100 kHz. | 3, 4, 5, 6, 7, 8, 9, 10 | 2 | TEKTRONIX 067-0938-00 Calibration Fixture ^b |
| Wide Band Rms Voltmeter ^a | ±0.4% from 25 Hz to 100 kHz. ±0.6% from 10 Hz to 25 Hz. | 3, 4, 6, 7, 10, 11 | 2, 3 | Hewlett Packard 3403C True Rms Voltmeter |
| Rms Voltmeter ^a | ±0.2% at 1 kHz. | 3, 6, 10, 11 | 2, 3 | TEKTRONIX DM 501A Digital Multimeter ^b |
| Oscilloscope | | 5, 8, 9, 12 | 4 | TEKTRONIX 7704A or 7603 Oscilloscope |
| Vertical Amplifier | General purpose, Bandwidth; 10 MHz. | 12 | 4 | TEKTRONIX 7A15A Vertical Amplifier |
| Differential Comparator Amplifier | Comparison voltage; 6 V overload capability, 50 mV/div gain. | 5, 8 | | TEKTRONIX 7A13 Differential Comparator |
| Time Base | General purpose, 10 μ s/div sweep rate. | 5, 8, 12 | 4 | TEKTRONIX 7B50A Time Base |

Table 4-1 (cont)

| Description | Performance Requirements | Application | | Example |
|---|--|------------------------|------------------|--|
| | | Performance Check Step | Adjustments Step | |
| Spectrum Analyzer | 10 Hz resolution; 80 dB dynamic range; -60 dB reference level. | 9 | | TEKTRONIX 7L5/L3 Spectrum Analyzer |
| Differential Amplifier | Gain of 10, 100, 1000; output swing >10 V. | 4, 5, 9 | | TEKTRONIX AM 502 Differential Amplifier ^b |
| 4 ea. coaxial cables with male bnc connectors | 50 Ω | All steps | All steps | Tektronix Part No. 012-0057-01 |
| 1 ea. Extender Cable | | | All steps | Tektronix Part No. 067-0645-02 |
| Bnc T Adapter | | 10 | | Tektronix Part No. 103-0030-00 |
| Termination | 50 Ω | 9 | | Tektronix Part No. 011-0049-01 |
| 1 ea. coaxial cable | 50 Ω, 18 inch | 3, 4, 5, 6, 7, 8, 9 | 2 | Tektronix Part No. 012-0076-00 |

^a Either rms voltmeter may be used for those steps listed in common.

^b Requires a TM 500 Series Power Module.

The numbers in Table 4-1 columns refer to the Performance Check or Adjustment Step in which the equipment is used. The following list indexes the steps for each procedure.

Performance Check steps:

1. Check Frequency Accuracy
2. Check Frequency Vernier Range
3. Check Output Level Accuracy
4. Check Output Level Step Accuracy
5. Check Output Level Step Accuracy (alternative method)
6. Check Output Level Variable Range
7. Check Level Flatness
8. Check Level Flatness (alternative method)

9. Check Distortion
10. Check Output Impedance
11. Check Sync Out Amplitude
12. Check Intermodulation Test Signal Ratio (Option 01)
13. Check Intermodulation Test Signal Frequency (Option 01)

Adjustment Procedure steps:

1. Adjust Frequency Hz Dial
2. Adjust Output Level Amplitude
3. Adjust Sync Out Amplitude
4. Adjust Intermodulation Test Signal Ratio (Option 01)

PERFORMANCE CHECK

Introduction

This procedure checks the electrical characteristics of the SG 505 listed under Performance Requirements in the Specifications section of this manual. If the instrument fails to meet the requirements given in this Performance Check, the Adjustments procedure should be performed. Do the Performance Check with the instrument operating at an ambient temperature of 0°C to 50°C. For convenience, some steps in this procedure check the performance of this instrument at only one value in the specified performance range. Any value, with appropriate limits, within the specified range may be substituted.

Test Equipment Required

Test equipment used in the Performance Check is listed in Table 4-1 at the beginning of this section.

Preparation

1. Ensure that all power switches are off and that the power module and all test equipment are adapted for the line voltage available.
2. Install the SG 505 in the power module and connect the power module and test equipment to the line voltage source.
3. Turn on the power module and test equipment. Allow at least 30 minutes warm-up time for the SG 505 (60 minutes after storage in a high humidity environment).

b. Connect the SG 505 SYNC OUT through a coaxial cable to the counter input.

c. Set the counter resolution and the SG 505 controls as listed in Table 4-2.

Table 4-2
FREQUENCY ACCURACY CHECK

| Counter Resolution | SG 505 Frequency Hz | | Counter Reading Limits (kHz) |
|--------------------|---------------------|------------|------------------------------|
| | Dial | Pushbutton | |
| 0.1 Hz | 1 | x 10 | 0.0097 to 0.0103 |
| | 2 | | 0.0194 to 0.0206 |
| | 5 | | 0.0485 to 0.0515 |
| | 7 | | 0.0679 to 0.0721 |
| | 10 | | 0.0970 to 0.1030 |
| 1 Hz | 1 | x 100 | 0.097 to 0.103 |
| | 2 | | 0.194 to 0.206 |
| | 5 | | 0.485 to 0.515 |
| | 7 | | 0.679 to 0.721 |
| | 10 | | 0.970 to 1.030 |
| 1 Hz | 1 | x 1k | 0.970 to 1.030 |
| | 2 | | 1.940 to 2.060 |
| | 5 | | 4.850 to 5.150 |
| | 7 | | 6.790 to 7.210 |
| | 10 | | 9.700 to 10.300 |
| 10 Hz | 1 | x 10k | 9.70 to 10.30 |
| | 2 | | 19.40 to 20.60 |
| | 5 | | 48.50 to 51.50 |
| | 7 | | 67.90 to 72.10 |
| | 10 | | 97.00 to 103.00 |

d. CHECK—that the counter reads within the limits listed in Table 4-2.

e. Leave the connections and control settings and proceed to the next step.

PROCEDURE

1. Check Frequency Accuracy

a. Set the SG 505 controls as follows:

| | |
|--------------------|------------|
| FREQ VERNIER | centered |
| OUTPUT LEVEL (dBm) | 0 |
| OUTPUT LEVEL (dBm) | |
| CAL | fully cw |
| ON-OFF | ON (in) |
| GND-FLTG | FLTG (out) |
| INTERMOD TEST SIG | |
| Pushbutton (Opt.) | OFF (out) |

2. Check Frequency Vernier Range

a. Change the SG 505 controls as follows:

| | |
|-------------------|------|
| FREQUENCY Hz Dial | 1 |
| FREQUENCY Hz | |
| Pushbutton | x 1k |

**Calibration Procedure—SG 505
Performance Check**

- b. Set the counter resolution to 1 Hz.
- c. Adjust the FREQUENCY Hz dial for a counter reading of 1000 Hz.
- d. Rotate the FREQ VERNIER control fully ccw.
- e. CHECK—that the counter reading is ≤ 0.990 kHz.
- f. Rotate the FREQ VERNIER control fully cw.
- g. CHECK—that the counter reads ≥ 1.010 kHz.
- h. Remove all connections to the SG 505.

3. Check Output Level Accuracy

- a. Set the SG 505 controls as follows:

| | |
|--------------------|------------|
| FREQUENCY Hz Dial | 1 |
| FREQUENCY Hz | |
| Pushbutton | x 1k |
| FREQ VERNIER | centered |
| OUTPUT LEVEL (dBm) | 0 |
| OUTPUT LEVEL (dBm) | |
| CAL | fully cw |
| ON-OFF | ON (in) |
| GNDED-FLTG | FLTG (out) |
| INTERMOD TEST SIG | |
| Pushbutton (Opt.) | OFF (out) |
- b. Connect the SG 505 OUTPUT through a coaxial cable to the calibration fixture (067-0938-00) input.
- c. Connect the calibration fixture Output through an 18 inch coaxial cable to the rms voltmeter input.
- d. Set the calibration fixture Mode to Flat (out) and Atten to 0 dB (out).
- e. CHECK—that the rms voltmeter reads between 0.757 and 0.793 V rms.
- f. Remove all connections to the SG 505.

4. Check Output Level Step Accuracy

Step 5 is an alternative method for checking output level step accuracy. Either step 4 or step 5 may be performed.

- a. Set the SG 505 controls as follows:

| | |
|--------------------|------------|
| FREQUENCY Hz Dial | 1 |
| FREQUENCY Hz | |
| Pushbutton | x 1k |
| FREQ VERNIER | centered |
| OUTPUT LEVEL (dBm) | +10 |
| OUTPUT LEVEL (dBm) | |
| CAL | fully cw |
| ON-OFF | ON (in) |
| GNDED-FLTG | FLTG (out) |
| INTERMOD TEST SIG | |
| Pushbutton (Opt.) | OFF (out) |

b. Connect the SG 505 OUTPUT through a coaxial cable to the calibration fixture Input.

c. Connect the calibration fixture Output through an 18 inch coaxial cable to the differential amplifier + input.

d. Connect the differential amplifier output through a coaxial cable to the wide band rms voltmeter input. Set the differential amplifier inputs to dc coupled and not grounded. Set the high frequency 3 dB control to 1 MHz and the low frequency 3 dB control to 0.1 Hz.

e. Set the calibration fixture Mode to Flat (out) and Atten to 0 dB (out).

f. Set the differential amplifier gain to the first value shown in Table 4-3.

g. Set the SG 505 OUTPUT LEVEL (dBm) control to the first value listed in the table.

h. Adjust the differential amplifier variable gain for the first rms voltmeter reading shown in the table.

i. Set the SG 505 OUTPUT LEVEL (dBm) control to the second value listed in the table.

j. CHECK—that the rms voltmeter reads within the limits listed in Table 4-3.

k. Repeat step 4 parts f through j for each of the remaining lines in the table.

Table 4-3

OUTPUT LEVEL STEP ACCURACY CHECK

| Differential Amplifier Gain | SG 505 OUTPUT LEVEL | Adjust Gain for Rms Voltmeter Reading | SG 505 OUTPUT LEVEL | Rms Voltmeter Reading Limits |
|-----------------------------|---------------------|---------------------------------------|---------------------|------------------------------|
| x1 | +10 dBm | 1.800 V | 0 dBm | 0.562 to 0.576 V |
| x1 | 0 dBm | 0.700 V | -10 dBm | 0.218 to 0.224 V |
| x10 | -10 dBm | 1.800 V | -20 dBm | 0.562 to 0.576 V |
| x10 | -20 dBm | 0.700 V | -30 dBm | 0.218 to 0.224 V |
| x100 | -30 dBm | 1.800 V | -40 dBm | 0.562 to 0.576 V |
| x100 | -40 dBm | 0.700 V | -50 dBm | 0.218 to 0.224 V |
| x1000 | -50 dBm | 1.800 V | -60 dBm | 0.562 to 0.576 V |

I. Remove all connections to the SG 505.

5. Check Output Level Step Accuracy (alternative method)

a. Set the SG 505 controls as follows:

| | |
|-------------------------------------|-------------|
| FREQUENCY Hz Dial | 1 |
| FREQUENCY Hz Pushbutton | x 1k |
| FREQ VERNIER | centered |
| OUTPUT LEVEL (dBm) | +10 |
| OUTPUT LEVEL (dBm) | |
| CAL | fully cw |
| ON-OFF | ON (in) |
| GND-ED-FLT G | FLT G (out) |
| INTERMOD TEST SIG Pushbutton (opt.) | OFF (out) |

b. Connect the SG 505 OUTPUT through a coaxial cable to the calibration fixture Input.

c. Connect the calibration fixture Output through an 18 inch coaxial cable to the differential amplifier + input. Set the differential amplifier inputs to dc coupled and not grounded. Set the high frequency 3 dB control to 1 MHz and the low frequency 3 dB control to 0.1 Hz.

d. Connect the differential amplifier Output through a coaxial cable to the oscilloscope differential comparator + input.

e. Set the calibration fixture Mode to Flat (out) and set the Atten to -60 dB (in).

f. Set the vertical amplifier volts/div to 50 mV/div. Set the differential comparator input to gnd and adjust the vertical position control to place the trace on the center horizontal graticule line. Make certain the dc comparison voltage is connected to the - input of the differential comparator via front panel selection and the + input is dc coupled.

g. Set the differential amplifier gain control and pushbutton as listed in the first line of Table 4-4.

h. Set the differential comparator voltage to the first value shown in the table.

i. Adjust the differential comparator variable gain to position the waveform peaks on the oscilloscope display to the center horizontal graticule line.

j. Change the SG 505 OUTPUT LEVEL (dBm) control to the value shown in the table.

k. Adjust the differential comparator voltage to position the waveform peaks on the center horizontal graticule line.

l. CHECK—that the differential comparator voltage is within the limits shown in the table.

m. Repeat step 5 parts g through l for the remaining lines of the table.

Table 4-4

OUTPUT LEVEL STEP ACCURACY CHECK

| Differential Amplifier Gain | Differential Amplifier Mode | Differential Comparator Voltage | SG 505 OUTPUT LEVEL (dBm) Control | Differential Comparator Voltage Limits |
|-----------------------------|-----------------------------|---------------------------------|-----------------------------------|--|
| 100 | ÷ 100 | 3.200 V | 0 dBm | 1.000 to 1.024 V |
| 100 | ÷ 100 | 1.012 V | -10 dBm | 0.316 to 0.324 V |
| 1 K | ÷ 100 | 3.200 V | -20 dBm | 1.000 to 1.024 V |
| 1 K | ÷ 100 | 1.012 V | -30 dBm | 0.316 to 0.324 V |
| 100 | NORM | 3.200 V | -40 dBm | 1.000 to 1.024 V |
| 100 | NORM | 1.012 V | -50 dBm | 0.316 to 0.324 V |
| 1 K | NORM | 3.200 V | -60 dBm | 1.000 to 1.024 V |

n. Remove all connections to the SG 505.

h. CHECK—that the rms voltmeter reads ≤ 0.245 V rms.

6. Check Output Level Variable Range

a. Set the SG 505 controls as follows:

| | |
|-------------------------------------|-------------|
| FREQUENCY Hz Dial | 1 |
| FREQUENCY Hz Pushbutton | x 1k |
| FREQ VERNIER | centered |
| OUTPUT LEVEL (dBm) | 0 |
| OUTPUT LEVEL (dBm) CAL | fully cw |
| ON-OFF | ON (in) |
| GND-ED-FLTG | GND-ED (in) |
| INTERMOD TEST SIG Pushbutton (Opt.) | OFF (out) |

b. Connect the SG 505 OUTPUT through a coaxial cable to the calibration fixture Input.

c. Connect the calibration fixture Output through an 18 inch coaxial cable to the rms voltmeter input.

d. Set the calibration fixture Mode to Flat (out) and Atten to 0 dB (out).

e. Turn the SG 505 OUTPUT LEVEL (dBm) CAL control slightly ccw (just out of detent).

f. CHECK—that the rms voltmeter reads ≥ 1.000 V rms.

g. Turn the SG 505 OUTPUT LEVEL (dBm) CAL control fully ccw.

i. Leave the connections and control settings and proceed to the next step.

7. Check Level Flatness

Step 8 is an alternative method for checking level flatness. Either step 7 or step 8 may be performed.

a. Change the SG 505 controls as follows:

| | |
|--------------------|----------|
| OUTPUT LEVEL (dBm) | |
| CAL | fully cw |

b. Connect the calibration fixture Output through an 18 inch coaxial cable to the wide band rms voltmeter input.

c. Adjust the OUTPUT LEVEL (dBm) CAL control for a voltmeter reading of 0.775 V. Do not change this control position for the rest of step 7.

d. Set the SG 505 FREQUENCY Hz dial and FREQUENCY Hz pushbutton as listed in Table 4-5.

e. CHECK—that the rms voltmeter reading is within the limits listed in Table 4-5.

f. Repeat step 7 parts c through e for the remaining lines of the table.

Table 4-5
LEVEL FLATNESS CHECK

| SG 505 FREQUENCY Hz Dial | SG 505 FREQUENCY Hz Pushbutton | Rms Voltmeter Reading Limits |
|--------------------------------|--------------------------------------|---------------------------------|
| 1 | x 10 | 0.765 to 0.784 V rms |
| 2 | x 10K | |
| 5 | x 10K | 0.757 to 0.793 V rms |
| 10 | x 10K | |

g. Remove all connections to the SG 505.

8. Check Level Flatness (alternative method)

a. Set the SG 505 controls as follows:

- FREQUENCY Hz Dial 1
- FREQUENCY Hz
 Pushbutton x 1k
- FREQ VERNIER centered
- OUTPUT LEVEL (dBm) +10
- OUTPUT LEVEL (dBm)
- CAL fully cw
- ON-OFF ON (in)
- GNDED-FLTG FLTG (out)
- INTERMOD TEST SIG
 Pushbutton (Opt.) OFF (out)

b. Connect the SG 505 OUTPUT through a coaxial cable to the calibration fixture Input.

c. Connect the calibration fixture Output through an 18 inch coaxial cable to the oscilloscope differential comparator + input.

d. Set the calibration fixture Mode to Flat (out) and set the Atten to -60 dB (in).

e. Set the input coupling to ground and adjust vertical position to place the trace on the center horizontal graticule line. Make certain the dc comparison voltage is connected to the - input of the differential comparator via front panel selection and the + input is dc coupled.

f. Adjust the differential comparator voltage to 1.727 V. Adjust the SG 505 OUTPUT LEVEL (dBm) CAL control to position the waveform peaks on the center horizontal graticule line.

g. Change the SG 505 FREQUENCY Hz dial and pushbutton as listed in Table 4-6.

h. Adjust the differential comparator voltage to reposition the waveform peaks on the center horizontal graticule line.

i. CHECK—that the comparator voltage readout is within the limits listed in Table 4-6 for each frequency setting.

Table 4-6
LEVEL FLATNESS CHECK

| SG 505 FREQUENCY Hz | | Comparator Voltage Limits |
|---------------------|------------|------------------------------|
| Dial | Pushbutton | |
| 1 | x 10 | 1.707 to 1.747 V |
| 2 | x 10 | |
| 2 | x 10K | |
| 10 | x 10K | 1.687 to 1.767 V |

j. Remove all connections to the SG 505.

9. Check Distortion

NOTE

A complex and lengthy procedure is required to verify the SG 505 ultra-low distortion. Unless there is reason to suspect the SG 505 may not meet its distortion specification because of recent repair or accidental abuse, it is suggested that this procedure be omitted. Distortion can be easily and quickly checked to the residual limits of almost any commercially available distortion or spectrum analyzer.

**Calibration Procedure—SG 505
Performance Check**

a. Set the SG 505 controls as follows:

| | |
|--|--------------------|
| FREQUENCY Hz Dial | 1 |
| FREQUENCY Hz Pushbutton | x 10 |
| FREQ VERNIER | centered |
| OUTPUT LEVEL (dBm) | +10 |
| OUTPUT LEVEL (dBm) CAL | just out of detent |
| ON-OFF | ON (in) |
| GND-ED-FLTG | FLTG (out) |
| INTERMOD TEST SIG Pushbutton (Opt.) | OFF (out) |

b. Connect the SG 505 OUTPUT through a coaxial cable to the calibration fixture Input. Connect the calibration fixture Output through an 18 inch coaxial cable to the differential amplifier + input. Connect the differential amplifier output through a coaxial cable to L3 input. Connect a 50 Ω termination or short to the differential amplifier – input. Set the differential amplifier gain to 100. Set both input coupling to dc. Set the high frequency 3 dB control to 1 MHz and the low frequency 3 dB control to 0.1 Hz.

c. Set the calibration fixture controls as follows:

| | |
|-----------------|-------------|
| NOTCH FREQUENCY | 10 Hz |
| MODE | Flat (out) |
| ATTEN | -60 dB (in) |

d. Set the 7L5 controls as follows:

| | |
|-------------|------------------|
| FREQUENCY | 50 Hz/div |
| RESOLUTION | 10 Hz |
| TIME/DIV | 10 sec/div |
| LOG | 10 dB/div |
| SOURCE MODE | FREE RUN, NORMAL |

Set the L3 controls to 1 MΩ, dBv.

e. Set the 7L5 A & B to off and manual sweep. Adjust the 7L5 manual sweep dial to position the dot horizontally in line with the 10 Hz graticule mark (see Fig. 4-1). Adjust the 7L5 Reference level control to position the dot vertically on the top graticule line. This line is the -60 dB reference level

f. Set the calibration fixture Mode to Notch (in) position and the Atten to 0 dB (out). Adjust the SG 505 FREQ VERNIER dial and the calibration fixture Adj For Null controls to position the dot vertically to the most stable point below the -80 dB level on the display. (See Fig. 4-1.) Set the 7L5 A & B to the on position and normal sweep mode.

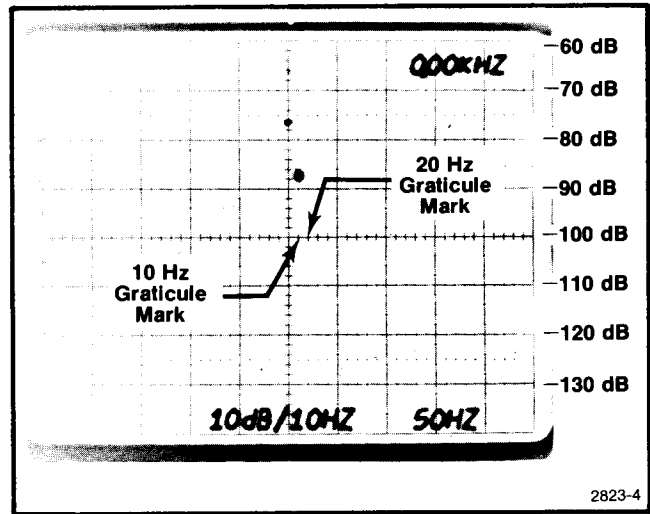

Fig. 4-1. 10 Hz null adjustment.

g. Note the 2nd, 3rd, 4th, and 5th harmonics on the displayed waveform (see Fig. 4-2). If the harmonic amplitudes on either side of the 0 Hz are slightly different, average the two readings for each harmonic.

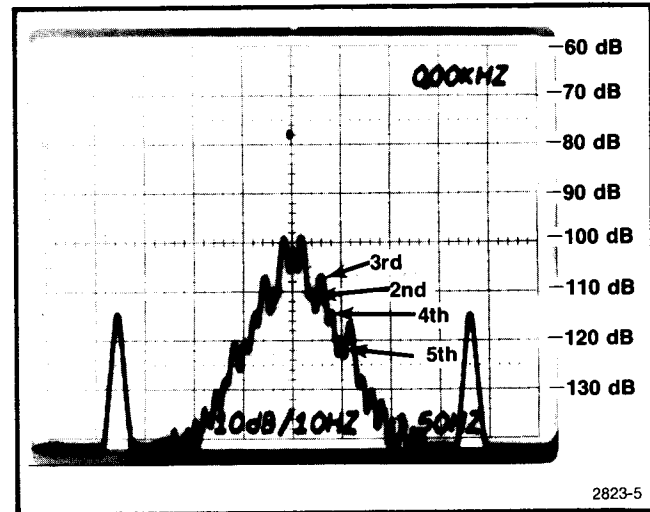

Fig. 4-2. 10 Hz harmonic distortion display.

NOTE

Due to the purely passive nature of the 067-0938-00 Calibration Fixture, the losses at the various harmonics must be taken into account to correct the harmonic values noted on the spectrum analyzer display. The following loss (correction) factors must be added to the displayed values to obtain corrected values.

Table 4-7

HARMONIC CORRECTION FACTORS

| Harmonic | Notch Frequency Setting | | |
|----------|-------------------------|--------|---------|
| | 10 Hz to 20 kHz | 50 kHz | 100 kHz |
| 2nd | 9.5 | 10 | 10.5 |
| 3rd | 6.0 | 6.5 | 7 |
| 4th | 4.5 | 5 | 5.5 |
| 5th | 3.5 | 4 | 4.5 |

h. Compute the total harmonic distortion (thd) using the harmonic values noted and either of the two following methods.

Formula Method for Computing thd:

Substitute the harmonic values (in dB), noted in step 9 part g, in the following formula:

$$\text{thd} = 20 \times \log_{10} A$$

$$\sqrt{10^{(2\text{nd} + 9.5)/10} + 10^{(3\text{rd} + 6)/10} + 10^{(4\text{th} + 4.5)/10} + 10^{(5\text{th} + 3.5)/10}}$$

The numbers added to the harmonic values in the formula are correction factors for the calibration fixture at 10 Hz Notch Frequency.

h. For example, using the harmonic distortion levels in Fig. 4-2 and the corrections factors in the previous formula:

$$\begin{aligned} 2\text{nd harmonic} &= -110 \text{ dB} + 9.5 = -100.5 \\ 3\text{rd harmonic} &= -107 \text{ dB} + 6 = -101 \\ 4\text{th harmonic} &= -115 \text{ dB} + 4.5 = -110.5 \\ 5\text{th harmonic} &= -121 \text{ dB} + 3.5 = -117.5 \end{aligned}$$

dividing by 10 and raising 10 to this power gives:

$$\begin{aligned} -100.5 \div 10 &= -10.05 \quad 10^{-10.05} = 89.12 \times 10^{-12} \\ -101 \div 10 &= -10.1 \quad 10^{-10.1} = 79.43 \times 10^{-12} \\ -110.5 \div 10 &= -11.05 \quad 10^{-11.05} = 8.91 \times 10^{-12} \\ -117.5 \div 10 &= -11.75 \quad 10^{-11.75} = \frac{1.77 \times 10^{-12}}{179.2 \times 10^{-12}} \end{aligned}$$

taking the square root results in:

$$\sqrt{179.2 \times 10^{-12}} = 1.34 \times 10^{-5}$$

taking the log:

$$\log_{10} 1.34 \times 10^{-5} = -4.87$$

multiplying by 20:

$$-4.87 \times 20 = -97.46 \text{ dB thd}$$

Table Method for Computing thd:

Add the calibration fixture correction factors to the harmonic distortion levels noted in step 9 part g. For example, using the harmonic distortion levels in Fig. 4-2 and the calibration fixture correction factors for 10 Hz Notch Frequency.

$$\begin{aligned} 2\text{nd harmonic} &= -110 \text{ dB} + 9.5 = -100.5 \\ 3\text{rd harmonic} &= -107 \text{ dB} + 6 = -101 \\ 4\text{th harmonic} &= -115 \text{ dB} + 4.5 = -110.5 \\ 5\text{th harmonic} &= -121 \text{ dB} + 3.5 = -117.5 \end{aligned}$$

Compute the arithmetic difference between the two numerically lower dB values—in this case, -100.5 and -101. Locate this difference value (0.5) in Table 4-8. If the difference value falls between two of the difference values in the table, interpolate the corresponding value in the Additive Factor column. Algebraically add the number in the Additive Factor column (2.77) to the numerically lower dB value:

$$\begin{array}{r} -100.50 \\ \quad 2.77 \\ \hline -97.73 \end{array}$$

Now repeat the process (find the arithmetic difference) using the resulting number (-97.73) and the next numerically lower dB value:

$$\begin{array}{r} -110.50 \\ \quad 9.77 \\ \hline -120.27 \end{array}$$

The value opposite 12.77 in Table 4-8 is approximately 0.23. Algebraically adding 0.23 to -97.73 = -97.50. Repeat the process using -97.50 and the remaining dB value to the combined, -117.5:

$$\begin{array}{r} -117.5 \\ \quad 9.50 \\ \hline -127.00 \end{array}$$

The value opposite 20.00 in the table is approximately 0.04.

$$\begin{array}{r} -97.50 \\ \quad 0.04 \\ \hline -97.46 = \text{thd} \end{array}$$

Table 4-8

FACTORS FOR THD COMPUTATION

| Difference Value | Additive Factor |
|------------------|-----------------|
| 0.0 | 3.01 |
| 0.5 | 2.77 |
| 1.0 | 2.54 |
| 2.0 | 2.12 |
| 3.0 | 1.76 |
| 4.0 | 1.46 |
| 5.0 | 1.19 |
| 6.0 | 0.97 |
| 7.0 | 0.79 |
| 8.0 | 0.64 |
| 9.0 | 0.51 |
| 10.0 | 0.41 |
| 11.0 | 0.33 |
| 12.0 | 0.27 |
| 13.0 | 0.21 |
| 14.0 | 0.17 |
| 15.0 | 0.14 |
| 16.0 | 0.11 |
| 17.0 | 0.09 |
| 18.0 | 0.07 |
| 19.0 | 0.05 |
| 20.0 | 0.04 |

- i. CHECK—that the calculated thd is less than -95 dB.
- j. Change the SG 505 FREQUENCY Hz dial to 2. Change the calibration fixture Notch Frequency to 20 Hz.

NOTE

Due to the microvolt nature of the SG 505's distortion products, their measurement is somewhat susceptible to interference from external magnetic fields. This is particularly true at the third harmonic of 20 Hz, where care should be exercised to avoid confusion with or interference from 60 Hz components. In particular, it may be necessary to move the calibration fixture (067-0938-00) away from stray magnetic fields (transformers).

- k. Repeat step 9 parts e through h using the 20 Hz graticule mark on the display for step 9 part e (see Fig. 4-1).

- l. CHECK—that the calculated thd is less than -102 dB (see Fig. 4-3 for harmonics at 20 Hz).

- m. Set the SG 505 FREQUENCY Hz pushbutton to 10 kHz (in). Change the calibration fixture Notch Frequency to 20-kHz.

- n. Set the calibration fixture Mode to Flat (out) and the Atten to -60 dB (in) position. Change the 7L5 to 10 kHz/div FREQ SPAN and 0.1 sec/div. Remove the differential amplifier and connect the calibration fixture output through the 18 inch coaxial cable to the 7L5/L3 input.

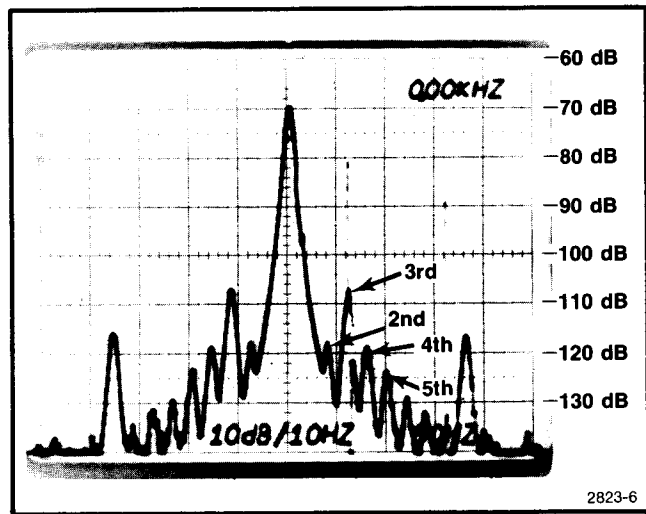

Fig. 4-3. 20 Hz harmonic distortion display.

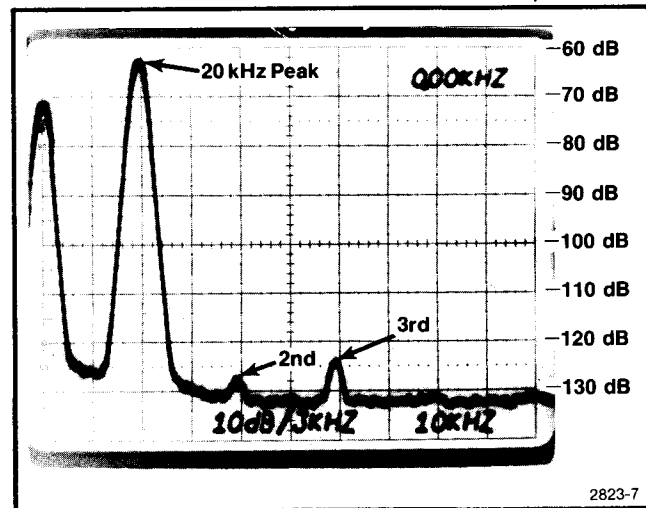

Fig. 4-4. 20 kHz harmonic distortion display.

- o. Adjust the 7L5 reference level control to position the 20 kHz peak on the top horizontal graticule line. This line is the -60 dB reference level (see Fig. 4-4).

- p. Set the calibration fixture Mode to Notch (in) and Atten to 0 dB (out). Adjust the SG 505 FREQ VERNIER control and the two calibration fixture Adjust For Null controls to position the 20 kHz peak below the top horizontal graticule line (see Fig. 4-4).

- q. Note the 2nd, 3rd, 4th, and 5th harmonics on the waveform, or as many of these harmonics as are visible. See Fig. 4-4 and compute the thd using the formula in step 9 part h.

- r. CHECK—that the calculated thd is less than -102 dB.
- s. Set the SG 505 FREQUENCY Hz dial to 5. Change the calibration fixture Notch Frequency to 50 kHz.
- t. Repeat step 9 parts n through q, except position the 50 kHz peak (2nd peak) of the waveform (see Fig. 4-4).

NOTE

The loss (correction) factors for the 067-0938-00 Calibration Fixture at the 50 kHz and 100 kHz frequencies are slightly different from the correction factors for the lower frequencies (see Table 4-7).

- u. CHECK—that the calculated thd is less than -95 dB.
- v. Set the SG 505 FREQUENCY Hz dial to 10. Change the calibration fixture Notch Frequency to 100 kHz.
- w. Repeat step 9 parts n through q, except position the 100 kHz peak (2nd peak) of the waveform. The waveform is similar to that in Fig. 4-4.
- x. CHECK—that the calculated thd is less than -90 dB.
- y. Remove all connections to the SG 505.

10. Check Output Impedance

- a. Set the SG 505 controls as follows:

| | |
|--------------------|------------|
| FREQUENCY Hz Dial | 1 |
| FREQUENCY Hz | |
| Pushbutton | x 1k |
| FREQ VERNIER | centered |
| OUTPUT LEVEL (dBm) | 0 |
| OUTPUT LEVEL (dBm) | |
| CAL | fully cw |
| ON-OFF | ON (in) |
| GNDED-FLTG | GNDED (in) |
| INTERMOD TEST SIG | |
| Pushbutton (Opt.) | OFF (out) |

- b. Connect the SG 505 OUTPUT through a T-adaptor and two coaxial cables to the rms voltmeter input.

- c. Adjust the SG 505 OUTPUT LEVEL (dBm) CAL control for a voltmeter reading of 1.800 V.
- d. Set the calibration fixture Mode to Flat (out) and Atten to 0 dB (out).
- e. Connect the T-adaptor to the calibration fixture Input.
- f. CHECK—that the voltmeter reading is between 0.891 and 0.909 V rms.
- g. Remove all connections to the SG 505.

11. Check Sync Out Amplitude

- a. Set the SG 505 controls as follows:

| | |
|--------------------|------------|
| FREQUENCY Hz Dial | 1 |
| FREQUENCY Hz | |
| Pushbutton | x 1k |
| FREQ VERNIER | centered |
| OUTPUT LEVEL (dBm) | 0 |
| OUTPUT LEVEL (dBm) | |
| CAL | fully cw |
| ON-OFF | ON (in) |
| GNDED-FLTG | GNDED (in) |
| INTERMOD TEST SIG | |
| Pushbutton (Opt.) | OFF (out) |

- b. Connect the SG 505 SYNC OUT through a coaxial cable to the rms voltmeter input.
- c. CHECK—that the voltmeter reads between 0.160 and 0.240 V rms.
- d. Remove all connections to the SG 505.

12. Check Intermodulation Test Signal Ratio (Option 01)

- a. Set the SG 505 controls as follows:

| | |
|--------------------|------------|
| FREQUENCY Hz Dial | 7 |
| FREQUENCY Hz | |
| Pushbutton | x 1k |
| FREQ VERNIER | centered |
| OUTPUT LEVEL (dBm) | 0 |
| OUTPUT LEVEL (dBm) | |
| CAL | fully cw |
| ON-OFF | ON (in) |
| GNDED-FLTG | FLTG (out) |
| INTERMOD TEST SIG | |
| Pushbutton (Opt.) | OFF (out) |

**Calibration Procedure—SG 505
Performance Check**

b. Connect the SG 505 OUTPUT through a coaxial cable to the oscilloscope vertical input.

c. Set the oscilloscope vertical sensitivity to 1 V/div.

d. Adjust the SG 505 OUTPUT LEVEL (dBm) CAL control and the oscilloscope vertical gain for a 5 V p-p display.

e. Set the SG 505 INTERMOD TEST SIG pushbutton on (in).

f. CHECK—that the amplitude of the composite signal on the display is between 4.89 and 5.12 divisions, peak-to-peak.

g. Adjust the SG 505 OUTPUT LEVEL (dBm) CAL control for a vertical trace width (high frequency portion of this waveform) one division in amplitude.

h. CHECK—that the vertical distance from the top of the lowest portion of the composite trace to the upper peak level of this trace is 3.9 to 4.1 divisions high. (4:1 Ratio).

i. Remove all connections to the SG 505.

13. Check Intermodulation Test Signal Frequency (Option 01)

a. Determine the low frequency of the intermodulation test signal.

b. Connect the SYNC OUT through a coaxial cable to the counter input.

c. Set the counter to 0.1 Hz resolution.

d. CHECK—that the counter reads between 58.8 and 61.2 Hz if the low frequency is 60 Hz or between 245 and 255 Hz if the low frequency is 250 Hz.

e. Remove all connections to the SG 505.

This completes the Performance Check procedure for the SG 505.

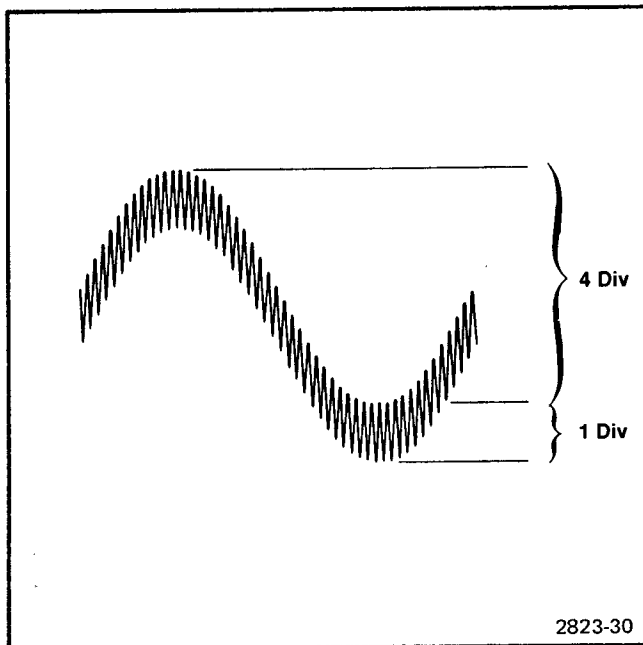

Fig. 4-4A. 4:1 Ratio.

ADJUSTMENTS

Introduction

This procedure need not be performed unless the instrument fails to meet the performance requirements of the electrical characteristics listed in the Specification section of this manual. To ensure instrument accuracy, perform the adjustment of the instrument every 1000 hours of operation or every six months if used infrequently. Adjustment may be required after a repair has been made. If adjustment of internal controls does not bring the instrument performance within the limits listed in the Specification section, troubleshooting is indicated. Adjustments should be made with the instrument operating at an ambient temperature of 20°C to 30°C.

Test Equipment Required

Test equipment used for adjustment of the SG 505 is listed at the beginning of the Calibration section of this manual.

Preparation

To gain access to the adjustable components, remove the left side cover of the SG 505 by pulling the rear of the side cover outward from the instrument. Adjustment locations are shown in the adjustment locations illustration located in the pullout pages in the rear of this manual.

Connect the SG 505 to the power module via the extender cable. Connect the test equipment and the power module to a suitable line voltage source. Turn on the power module and test equipment; allow at least 30 minutes warm-up time for the SG 505.

b. Connect the SG 505 SYNC OUT through a coaxial cable to the counter Input. Set the counter for 1 Hz resolution.

c. CHECK/ADJUST—the SG 505 frequency for 4.000 kHz as follows: Loosen internal set screw #1 located on the reduction drive shaft of the FREQUENCY Hz potentiometer assembly R530 and R520 (see Fig. 4-5). Position the FREQUENCY Hz dial to 4. Loosen set screw #2 and turn the potentiometer shaft with pliers until the counter reading is 4.000 kHz. Tighten set screw #2 without moving the FREQUENCY Hz dial. Turn the FREQUENCY Hz dial to gain access to set screw #1 and tighten.

d. Remove all connections to the SG 505.

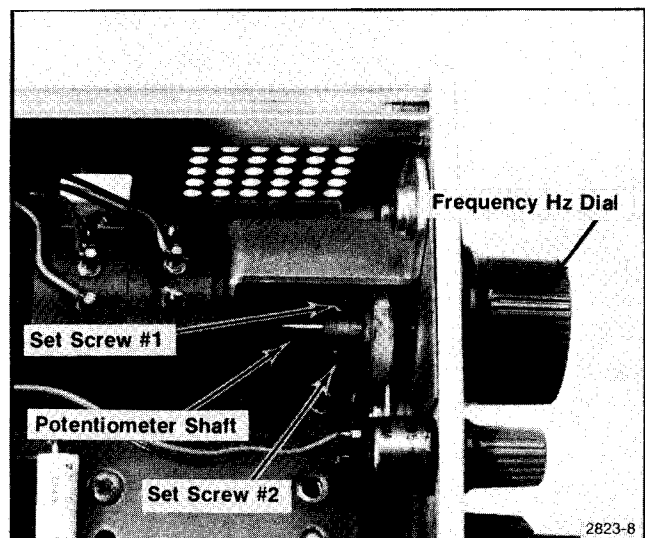

Fig. 4-5. Left side view of SG 505.

PROCEDURE

1. Adjust Frequency Hz Dial

a. Set the SG 505 controls as follows:

| | |
|--------------------|------------|
| FREQUENCY Hz Dial | 4 |
| FREQUENCY Hz | |
| Pushbutton | x 1k |
| FREQ VERNIER | centered |
| OUTPUT LEVEL (dBm) | 0 |
| OUTPUT LEVEL (dBm) | |
| CAL | fully cw |
| ON-OFF | ON (in) |
| GNDED-FLTG | FLTG (out) |
| INTERMOD TEST SIG | |
| Pushbutton (Opt.) | OFF (out) |

2. Adjust Output Level Amplitude

a. Set the SG 505 controls as follows:

| | |
|--------------------|------------|
| FREQUENCY Hz Dial | 1 |
| FREQUENCY Hz | |
| Pushbutton | x 1k |
| FREQ VERNIER | centered |
| OUTPUT LEVEL (dBm) | 0 |
| OUTPUT LEVEL (dBm) | |
| CAL | fully cw |
| ON-OFF | ON (in) |
| GNDED-FLTG | FLTG (out) |
| INTERMOD TEST SIG | |
| Pushbutton (Opt.) | OFF (out) |

Calibration Procedure—SG 505 Adjustments

- b. Connect the SG 505 OUTPUT through a coaxial cable to the calibration fixture Input.
- c. Connect the calibration fixture Output through an 18 inch coaxial cable to the rms voltmeter input.
- d. Set the calibration fixture Mode to Flat (out) and Atten to 0 dB (out).
- e. CHECK/ADJUST—A10 R1423, 0 dBm Adj, for a voltmeter reading of 0.775 V rms.
- f. Remove all connections to the SG 505.

3. Adjust Sync Out Amplitude

- a. Set the SG 505 controls as follows:

| | |
|--------------------|------------|
| FREQUENCY Hz Dial | 1 |
| FREQUENCY Hz | |
| Pushbutton | x 1k |
| FREQ VERNIER | centered |
| OUTPUT LEVEL (dBm) | 0 |
| OUTPUT LEVEL (dBm) | |
| CAL | fully cw |
| ON-OFF | ON (in) |
| GNDED-FLTG | FLTG (out) |
| INTERMOD TEST SIG | |
| Pushbutton (Opt.) | OFF (out) |

- b. Connect the SG 505 SYNC OUT through a coaxial cable to the rms voltmeter.
- c. CHECK/ADJUST—A10 R1301, Sync Level Adj, for a voltmeter reading of 0.2 V rms.
- d. Remove all connections to the SG 505.

4. Adjust Intermodulation Test Signal Ratio (Option 01)

- a. Set the SG 505 controls as follows:

| | |
|--------------------|------------|
| FREQUENCY Hz Dial | 7 |
| FREQUENCY Hz | |
| Pushbutton | x 1k |
| FREQ VERNIER | centered |
| OUTPUT LEVEL (dBm) | 0 |
| OUTPUT LEVEL (dBm) | |
| CAL | fully cw |
| ON-OFF | ON (in) |
| GNDED-FLTG | FLTG (out) |
| INTERMOD TEST SIG | |
| Pushbutton (Opt.) | OFF (out) |

- b. Connect the SG 505 OUTPUT through a coaxial cable to the oscilloscope vertical input.
- c. Set the oscilloscope vertical sensitivity to 1 V/div.
- d. Rotate the SG 505 OUTPUT LEVEL (dBm) CAL control and the oscilloscope vertical position for a 5 V p-p display.
- e. Set the SG 505 INTERMOD TEST SIG to ON (in).
- f. CHECK/ADJUST—A11 R1211, Imd Ratio Adj, so the composite signal amplitude is 5 divisions, peak-to-peak.
- g. Remove all connections to the SG 505.

This completes the Adjustments procedure for the SG 505.

MAINTENANCE

Recalibration

To ensure accurate measurements, check the calibration of this instrument after each 1000 hours of operation or every six months if used infrequently. In addition, replacement of components may necessitate recalibration of the affected circuits. Complete adjustment instructions are given in the Calibration section.

Tektronix, Inc. provides complete instrument repair and calibration at local Field Service Centers and at the Factory Service Center. Contact your local Tektronix Field Office or representative for further information.

Obtaining Replacement Parts

Most electrical and mechanical parts can be ordered through your local Tektronix Field Office or representative. However, you should be able to obtain many of the standard electronic components from a local commercial source in your area. Before you purchase or order a part from a source other than Tektronix, Inc., please check the electrical parts list for the proper value, rating, tolerance, and description.

Ordering Parts. When ordering replacement parts from Tektronix, Inc., it is important that all of the following information be included to ensure receiving the proper parts.

1. Instrument type (include modification or option numbers).
2. Instrument serial number.
3. A description of the part (if electrical, include circuit and assembly numbers).
4. Tektronix part number.

Cleaning Instructions

This instrument should be cleaned as often as operating conditions require. Accumulation of dirt on components acts as an insulating blanket and prevents efficient heat dissipation, which can cause overheating and component breakdown.

Exterior

Loose dust accumulated on the front panel can be removed with a soft cloth or a small brush. Dirt that remains can be removed with a soft cloth dampened with a mild detergent and water solution. Abrasive cleaners should not be used.

CAUTION

To prevent getting water inside the instrument during external cleaning, use only enough water to dampen the cloth or swab.

DO NOT use chemical cleaning agents as they may damage the plastics used in the instrument. In particular, avoid chemicals that contain benzene, toluene, xylene, acetone or similar solvents.

Interior

Dust in the interior of the instrument should be removed occasionally due to its electrical conductivity under high humidity conditions. The best way to clean the interior is to blow off the accumulated dust with dry, low pressure air. Then use a soft brush.

Isopropyl alcohol can be used to clean major repairs to the circuit board; however, flush the board well with clean, isopropyl alcohol. Make certain that resin or dirt is carefully removed from board areas of high impedance circuitry.

Circuit Board Removal and Installation

Remove the two snap-in side covers by pulling out on the rear of each side cover.

For an Option 01 SG 505, remove the IMD board (Assy A11) as follows:

Remove the INTERMOD TEST SIG pushbutton shaft by spreading the ends of the shaft attached to the pushbutton and pulling the shaft forward. Remove the two screws located to the left rear and to the right front on top of OUTPUT LEVEL switch S1710. Disconnect the two multi-pin connectors attached to the IMD board. Lift the board up and out.

Maintenance—SG 505

Remove the oscillator board (Assy A10) as follows:

1. Disconnect the multi-pin connector (P1500) from the FREQUENCY Hz potentiometer assembly (R520 and R530) to the oscillator board. Loosen the two set screws located on the reduction drive shaft. Using a 5/16" open end wrench, remove the nut that holds the potentiometer to the metal bracket.

2. Loosen the two set screws in the OUTPUT LEVEL (dBm) and OUTPUT LEVEL (dBm) CAL knobs and remove the knobs. Remove the nut and washer on the OUTPUT LEVEL shaft.

3. Disconnect the multi-pin connector (P1510) that connects the FREQ VERNIER potentiometer (R510) to the oscillator board.

4. Carefully unsolder, at the oscillator board, the two connections from OUTPUT connector J540. Also unsolder the connection from the SYNC OUT connector (J550) at the oscillator board.

5. On the back of the oscillator board, carefully pull out the socket holding the POWER LED (DS510).

6. Remove the two guide screws and the two Phillips screws on the rear metal frame and remove the frame.

7. Remove the four screws holding the oscillator board to the side panels.

8. Carefully slide the oscillator board toward the rear of the instrument.

To reassemble the instrument, reverse the above procedure. After placing the oscillator board within the chassis side panels, position the two plastic circuit board guides approximately midway on each side of the oscillator board. Make certain the circuit board guides do not contact components or component leads. After instrument reassembly, perform the Frequency Hz Dial adjustment (Step 1 in the Adjustments procedure), to calibrate the reduction drive and knob position to the FREQUENCY Hz potentiometer shaft position.

Low Frequency Selection (Option 01)

The SG 505 Option 01 instrument contains an internal jumper (P1100) that may be positioned to select either a 60 Hz or 250 Hz low frequency in the intermodulation test signal mode. The jumper is located toward the rear of the IMD Option board (Assy. A11). When the jumper is

positioned on the two pins marked 60 Hz (A11 J1102), the low frequency is 60 Hz. If the jumper is placed on the four pins marked 250 Hz (A11 J1100), the low frequency is 250 Hz.

Troubleshooting Aids

Troubleshooting Charts. As an aid in locating problem areas, troubleshooting charts are provided for the SG 505. These charts are located in the foldout pages in the Diagrams and Illustrations section. The numbered diamond by the troubleshooting chart title refers to the corresponding schematic diagram number.

Diagrams. Complete circuit diagrams are located in the foldout pages in the Diagrams and Illustrations section. The portions of the circuit mounted on circuit boards are enclosed by a solid line. The circuit number of each component in this instrument is shown on a diagram. See the first page of the Diagrams and Illustrations section for definitions of the symbols and reference designators used on the diagrams.

Circuit Board Illustrations. In conjunction with each circuit diagram is a circuit board illustration. Each component shown on a diagram is also identified on the circuit board illustration by its circuit number. A table is provided with each diagram listing components by assembly and circuit number. The table also lists the component grid locations on both the diagram and circuit board illustrations.

Adjustment Locations Illustration. To aid in locating test points and adjustable components, the adjustment locations pullout page (normally used with the Adjustment procedure) permits rapid location of test points and adjustments.

Troubleshooting Equipment

Before using any test equipment to make measurements on static sensitive components or assemblies, be certain that any voltage or current supplied by the test equipment does not exceed the limits of the component to be tested.

Static-Sensitive Components



Static discharge can damage any semiconductor component in this instrument.

This instrument contains electrical components that are susceptible to damage from static discharge. See

Table 5-1 for relative susceptibility of various classes of semiconductors. Static voltages of 1 kV to 30 kV are common in unprotected environments.

Observe the following precautions to avoid damage:

1. Minimize handling of static-sensitive components.
2. Transport and store static-sensitive components or assemblies in their original containers, on a metal rail, or on conductive foam. Label any package that contains static-sensitive assemblies or components.
3. Discharge the static voltage from your body by wearing a wrist strap while handling these components. Servicing static-sensitive assemblies or components should be performed only a static-free work station by qualified service personnel.
4. Nothing capable of generating or holding a static charge should be allowed on the work station surface.
5. Keep the component leads shorted together whenever possible.
6. Pick up components by the body, never by the leads.
7. Do not slide the components over any surface.
8. Avoid handling components in areas that have a floor or work-surface covering capable of generating a static charge.
9. Use a soldering iron that is connected to earth ground.

10. Use only special antistatic suction type or wick type desoldering tools.

Table 5-1
RELATIVE SUSCEPTIBILITY TO
STATIC DISCHARGE DAMAGE

| Semiconductor Classes | Relative Susceptibility Levels ^a |
|--|---|
| MOS or CMOS microcircuits or discretes, or linear microcircuits with MOS inputs. (Most Sensitive) | 1 |
| ECL | 2 |
| Schottky signal diodes | 3 |
| Schottky TTL | 4 |
| High-frequency bipolar transistors | 5 |
| JFETs | 6 |
| Linear microcircuits | 7 |
| Low-power Schottky TTL | 8 |
| TTL (Least Sensitive) | 9 |

^a Voltage equivalent for levels:

1 = 100 to 500 V 4 = 500 V 7 = 400 to 1000 V (est.)
 2 = 200 to 500 V 5 = 400 to 600 V 8 = 900 V
 3 = 250 V 6 = 600 to 800 V 9 = 1200 V
 (Voltage discharged from a 100 pF capacitor through a resistance of 100 ohms.)

OPTIONS

The information in this manual describes only the Option 01 version of the SG 505 Oscillator. A separate instruction manual is available which contains information for both the standard and Option 02 SG 505 Oscillator.

REPLACEABLE ELECTRICAL PARTS

PARTS ORDERING INFORMATION

Replacement parts are available from or through your local Tektronix, Inc. Field Office or representative.

Changes to Tektronix instruments are sometimes made to accommodate improved components as they become available, and to give you the benefit of the latest circuit improvements developed in our engineering department. It is therefore important, when ordering parts, to include the following information in your order: Part number, instrument type or number, serial number, and modification number if applicable.

If a part you have ordered has been replaced with a new or improved part, your local Tektronix, Inc. Field Office or representative will contact you concerning any change in part number.

Change information, if any, is located at the rear of this manual.

SPECIAL NOTES AND SYMBOLS

X000 Part first added at this serial number
00X Part removed after this serial number

ITEM NAME

In the Parts List, an Item Name is separated from the description by a colon (:). Because of space limitations, an Item Name may sometimes appear as incomplete. For further Item Name identification, the U.S. Federal Cataloging Handbook H6-1 can be utilized where possible.

ABBREVIATIONS

| | | | |
|--------|----------------------|----------|-----------------|
| ACTR | ACTUATOR | PLSTC | PLASTIC |
| ASSY | ASSEMBLY | QTZ | QUARTZ |
| CAP | CAPACITOR | RECP | RECEPTACLE |
| CER | CERAMIC | RES | RESISTOR |
| CKT | CIRCUIT | RF | RADIO FREQUENCY |
| COMP | COMPOSITION | SEL | SELECTED |
| CONN | CONNECTOR | SEMICOND | SEMICONDUCTOR |
| ELCTLT | ELECTROLYTIC | SENS | SENSITIVE |
| ELEC | ELECTRICAL | VAR | VARIABLE |
| INCAND | INCANDESCENT | WW | WIREWOUND |
| LED | LIGHT EMITTING DIODE | XFMR | TRANSFORMER |
| NONWIR | NON WIREWOUND | XTAL | CRYSTAL |

Replaceable Electrical Parts—SG 505

CROSS INDEX—MFR. CODE NUMBER TO MANUFACTURER

| Mfr. Code | Manufacturer | Address | City, State, Zip |
|-----------|--|---|---------------------------------------|
| 00853 | SANGAMO ELECTRIC CO., S. CAROLINA DIV. | P.O. BOX 128 | PICKENS, SC 29671 |
| 01121 | ALLEN-BRADLEY COMPANY | 1201 2ND STREET SOUTH | MILWAUKEE, WI 53204 |
| 01295 | TEXAS INSTRUMENTS, INC. SEMICONDUCTOR GROUP | P.O. BOX 5012 | DALLAS, TX 75222 |
| 02111 | SPECTROL ELECTRONICS CORPORATION | 17070 EAST GALE AVENUE | CITY OF INDUSTRY, CA 91745 |
| 04222 | AVX CERAMICS, DIVISION OF AVX CORP. | P O BOX 867 | MYRTLE BEACH, SC 29577 |
| 04713 | MOTOROLA, INC., SEMICONDUCTOR PROD. DIV. | 5005 E MCDOWELL RD, PO BOX 20923 | PHOENIX, AZ 85036 |
| 07263 | FAIRCHILD SEMICONDUCTOR, A DIV. OF FAIRCHILD CAMERA AND INSTRUMENT CORP. | 464 ELLIS STREET | MOUNTAIN VIEW, CA 94042 |
| 08806 | GENERAL ELECTRIC CO., MINIATURE LAMP PRODUCTS DEPARTMENT | NELA PARK | CLEVELAND, OH 44112 |
| 09019 | GENERAL ELECTRIC CO. SEMI-CONDUCTOR PRODUCTS DEPT. OPERATIONAL PLANNING AND CUSTOMER ENGINEERING | ELECTRONICS PARK LOWER WASHINGTON STREET | SYRACUSE, NY 13201 DOVER, NH 03820 |
| 12697 | CLAROSTAT MFG. CO., INC. | 580 PLEASANT STREET | WATERTOWN, MA 02172 |
| 12969 | UNITRODE CORPORATION | | LOS GATOS, CA 95030 |
| 13511 | AMPHENOL CARDRE DIV., BUNKER RAMO CORP. | | SANTA ANA, CA 92704 |
| 14552 | MICRO SEMICONDUCTOR CORP. | 2830 E FAIRVIEW ST. | SAN GABRIEL, CA 91776 |
| 14752 | ELECTRO CUBE INC. | 1710 S. DEL MAR AVE. | SANTA CLARA, CA 95054 |
| 17856 | SILICONIX, INC. | 2201 LAURELWOOD DRIVE | SUNNYVALE, CA 94086 |
| 18324 | SIGNETICS CORP. | 811 E. ARQUES | NEW CUMBERLAND, PA 17070 |
| 22526 | BERG ELECTRONICS, INC. | YOUK EXPRESSWAY | |
| 24546 | CORNING GLASS WORKS, ELECTRONIC COMPONENTS DIVISION | 550 HIGH STREET | BRADFORD, PA 16701 |
| 27014 | NATIONAL SEMICONDUCTOR CORP. | 2900 SEMICONDUCTOR DR. | SANTA CLARA, CA 95051 |
| 51642 | CENTRE ENGINEERING INC. | 2820 E COLLEGE AVENUE | STATE COLLEGE, PA 16801 |
| 53184 | XCITON CORPORATION | 5 HEMLOCK STREET | LATHAM, NY 12110 |
| 54473 | MATSUSHITA ELECTRIC, CORP. OF AMERICA | 1 PANASONIC WAY | SECAUCUS, NJ 07094 |
| 55680 | NICHICON/AMERICA/CORP. | 6435 N PROESEL AVENUE | CHICAGO, IL 60645 |
| 56289 | SPRAGUE ELECTRIC CO. | 87 MARSHALL ST. | NORTH ADAMS, MA 01247 |
| 57668 | R-OHM CORP. | 16931 MILLIKEN AVE. | IRVINE, CA 92713 |
| 71400 | BUSSMAN MFG., DIVISION OF MCGRAW- EDISON CO. | 2536 W. UNIVERSITY ST. | ST. LOUIS, MO 63107 |
| 73138 | BECKMAN INSTRUMENTS, INC., HELIPOT DIV. | 2500 HARBOR BLVD. | FULLERTON, CA 92634 |
| 80009 | TEKTRONIX, INC. | P O BOX 500 | BEAVERTON, OR 97077 |
| 90201 | MALLORY CAPACITOR CO., DIV. OF P. R. MALLORY AND CO., INC. | 3029 E. WASHINGTON STREET P. O. BOX 372 | INDIANAPOLIS, IN 46206 |
| 91637 | DALE ELECTRONICS, INC. | P. O. BOX 609 | COLUMBUS, NE 68601 |
| 91836 | KINGS ELECTRONICS CO., INC. | 40 MARBLEDALE ROAD | TUCKAHOE, NY 10707 |
| 96733 | SAN FERNANDO ELECTRIC MFG CO | 1501 FIRST ST | SAN FERNANDO, CA 91341 |

| Component No. | Tektronix Part No. | Serial/Model No. | | Name & Description | Mfr Code | Mfr Part Number |
|---------------|--------------------|------------------|---------|--|----------|-----------------|
| | | Eff | Dscont | | | |
| A10 | 672-0845-00 | B010100 | B029999 | CKT BOARD ASSY:OSCILLATOR (STANDARD ONLY) | 80009 | 672-0845-00 |
| A10 | ----- | | | | | |
| A10 | 672-0845-01 | B030000 | | CKT BOARD ASSY:OSCILLATOR (STANDARD ONLY) | 80009 | 672-0845-01 |
| A10 | ----- | | | | | |
| A10 | 672-0846-00 | B010100 | B029999 | CKT BOARD ASSY:OSCILLATOR (OPTION 01 ONLY) | 80009 | 672-0846-00 |
| A10 | ----- | | | | | |
| A10 | 672-0846-01 | B030000 | | CKT BOARD ASSY:OSCILLATOR (OPTION 01 ONLY) | 80009 | 672-0846-01 |
| A10 | ----- | | | | | |
| A11 | 670-6339-00 | | | CKT BOARD ASSY:IMD (OPTION 01 ONLY) | 80009 | 670-6339-00 |
| A11 | ----- | | | | | |
| A10 | ----- | | | CKT BOARD ASSY:OSCILLATOR,W/CAM SWITCH | | |
| A10C1100 | 281-0775-00 | | | CAP.,FXD,CER DI:0.1UF,20%,50V | 04222 | MA205E104MAA |
| A10C1101 | 290-0525-00 | | | CAP.,FXD,ELCTLT:4.7UF,20%,50V | 56289 | 196D475X0050KA1 |
| A10C1200 | 290-0721-00 | B010100 | B031979 | CAP.,FXD,ELCTLT:100UF,20%,20V (STANDARD ONLY) | 56289 | 196D107X0020TE3 |
| A10C1200 | ----- | | | | | |
| A10C1200 | 290-0770-00 | B031980 | | CAP.,FXD,ELCTLT:100UF,+50-10%,25V (STANDARD ONLY) | 56289 | 502D230 |
| A10C1200 | ----- | | | | | |
| A10C1200 | 290-0721-00 | B010100 | B032089 | CAP.,FXD,ELCTLT:100UF,20%,20V (OPTION 01 ONLY) | 56289 | 196D107X0020TE3 |
| A10C1200 | ----- | | | | | |
| A10C1200 | 290-0770-00 | B032090 | | CAP.,FXD,ELCTLT:100UF,+50-10%,25V (OPTION 01 ONLY) | 56289 | 502D230 |
| A10C1200 | ----- | | | | | |
| A10C1201 | 290-0721-00 | B010100 | B031979 | CAP.,FXD,ELCTLT:100UF,20%,20V (STANDARD ONLY) | 56289 | 196D107X0020TE3 |
| A10C1201 | ----- | | | | | |
| A10C1201 | 290-0770-00 | B031980 | | CAP.,FXD,ELCTLT:100UF,+50-10%,25V (STANDARD ONLY) | 56289 | 502D230 |
| A10C1201 | ----- | | | | | |
| A10C1201 | 290-0721-00 | B010100 | B032089 | CAP.,FXD,ELCTLT:100UF,20%,20V (OPTION 01 ONLY) | 56289 | 196D107X0020TE3 |
| A10C1201 | ----- | | | | | |
| A10C1201 | 290-0770-00 | B032090 | | CAP.,FXD,ELCTLT:100UF,+50-10%,25V (OPTION 01 ONLY) | 56289 | 502D230 |
| A10C1201 | ----- | | | | | |
| A10C1202 | 290-0724-00 | B010100 | B031979 | CAP.,FXD,ELCTLT:330UF,20%,6V (STANDARD ONLY) | 90201 | TDC337M006WSH |
| A10C1202 | ----- | | | | | |
| A10C1202 | 290-0771-00 | B031980 | | CAP.,FXD,ELCTLT:220UF,+50-10%,10VDC (STANDARD ONLY) | 56289 | 502D231 |
| A10C1202 | ----- | | | | | |
| A10C1202 | 290-0724-00 | B010100 | B032089 | CAP.,FXD,ELCTLT:330UF,20%,6V (OPTION 01 ONLY) | 90201 | TDC337M006WSH |
| A10C1202 | ----- | | | | | |
| A10C1202 | 290-0771-00 | B032090 | | CAP.,FXD,ELCTLT:220UF,+50-10%,10VDC (OPTION 01 ONLY) | 56289 | 502D231 |
| A10C1202 | ----- | | | | | |
| A10C1203 | 290-0534-00 | B010100 | B031979 | CAP.,FXD,ELCTLT:1UF,20%,35V (STANDARD ONLY) | 56289 | 196D105X0035HA1 |
| A10C1203 | ----- | | | | | |
| A10C1203 | 290-0920-00 | B031980 | | CAP.,FXD,ELCTLT:33UF,+50-10%,35V (STANDARD ONLY) | 55680 | ULB1V330TEAANA |
| A10C1203 | ----- | | | | | |
| A10C1203 | 290-0534-00 | B010100 | B032089 | CAP.,FXD,ELCTLT:1UF,20%,35V (OPTION 01 ONLY) | 56289 | 196D105X0035HA1 |
| A10C1203 | ----- | | | | | |
| A10C1203 | 290-0920-00 | B032090 | | CAP.,FXD,ELCTLT:33UF,+50-10%,35V (OPTION 01 ONLY) | 55680 | ULB1V330TEAANA |
| A10C1203 | ----- | | | | | |
| A10C1210 | 290-0721-00 | B010100 | B031979 | CAP.,FXD,ELCTLT:100UF,20%,20V (STANDARD ONLY) | 56289 | 196D107X0020TE3 |
| A10C1210 | ----- | | | | | |
| A10C1210 | 290-0770-00 | B031980 | | CAP.,FXD,ELCTLT:100UF,+50-10%,25V (STANDARD ONLY) | 56289 | 502D230 |
| A10C1210 | ----- | | | | | |
| A10C1210 | 290-0721-00 | B010100 | B032089 | CAP.,FXD,ELCTLT:100UF,20%,20V (OPTION 01 ONLY) | 56289 | 196D107X0020TE3 |
| A10C1210 | ----- | | | | | |
| A10C1210 | 290-0770-00 | B032089 | | CAP.,FXD,ELCTLT:100UF,+50-10%,25V (OPTION 01 ONLY) | 56289 | 502D230 |
| A10C1210 | ----- | | | | | |

Replaceable Electrical Parts—SG 505

| Component No. | Tektronix Part No. | Serial/Model No. Eff | Dscont | Name & Description | Mfr Code | Mfr Part Number |
|---------------|--------------------|----------------------|---------|---|----------|-----------------|
| A10C1211 | 290-0831-00 | | | CAP.,FXD,ELCTLT:470UF,+50-10%,50V | 55680 | ULB1E471TFANNA |
| A10C1212 | 290-0831-00 | | | CAP.,FXD,ELCTLT:470UF,+50-10%,50V | 55680 | ULB1E471TFANNA |
| A10C1300 | 295-0191-00 | | | CAP SET,MATCHED:2 EA 1.0UF/0.1UF/0.01UF | 80009 | 295-0191-00 |
| A10C1301 | 295-0191-00 | | | CAP SET,MATCHED:2 EA 1.0UF/0.1UF/0.01UF | 80009 | 295-0191-00 |
| A10C1310 | ----- | | | (PART OF A10C1300) | | |
| A10C1311 | ----- | | | (PART OF A10C1300) | | |
| A10C1312 | ----- | | | (PART OF A10C1301) | | |
| A10C1316 | 283-0766-00 | | | CAP.,FXD,MICA D:47PF,1%,500V | 00853 | D155E470D0 |
| A10C1320 | ----- | | | (PART OF A10C1301) | | |
| A10C1321 | ----- | | | (PART OF A10C1300) | | |
| A10C1322 | ----- | | | (PART OF A10C1301) | | |
| A10C1400 | 283-0603-00 | | | CAP.,FXD,MICA D:113PF,2%,300V | 00853 | D155F1130G0 |
| A10C1401 | 283-0603-00 | | | CAP.,FXD,MICA D:113PF,2%,300V | 00853 | D155F1130G0 |
| A10C1402 | 281-0763-00 | | | CAP.,FXD,CER DI:47PF,10%,100V | 04222 | GA101A470KAA |
| A10C1403 | 281-0775-00 | | | CAP.,FXD,CER DI:0.1UF,20%,50V | 04222 | MA205E104MAA |
| A10C1405 | 281-0763-00 | | | CAP.,FXD,CER DI:47PF,10%,100V | 04222 | GA101A470KAA |
| A10C1406 | 281-0763-00 | B030000 | | CAP.,FXD,CER DI:47PF,10%,100V | 04222 | GA101A470KAA |
| A10C1407 | 281-0775-00 | | | CAP.,FXD,CER DI:0.1UF,20%,50V | 04222 | MA205E104MAA |
| A10C1420 | 290-0671-00 | B010100 | B031979 | CAP.,FXD,ELCTLT:150UF,20%,15V | 90201 | TDC157M015WLH |
| A10C1420 | ----- | | | (STANDARD ONLY) | | |
| A10C1420 | 290-0987-00 | B031980 | | CAP.,FXD,ELCTLT:150UF,20%,16V | 56289 | 511D157M016CC4F |
| A10C1420 | ----- | | | (STANDARD ONLY) | | |
| A10C1420 | 290-0671-00 | B010100 | B032089 | CAP.,FXD,ELCTLT:150UF,20%,15V | 90201 | TDC157M015WLH |
| A10C1420 | ----- | | | (OPTION 01 ONLY) | | |
| A10C1420 | 290-0987-00 | B032090 | | CAP.,FXD,ELCTLT:150UF,20%,16V | 56289 | 511D157M016CC4F |
| A10C1420 | ----- | | | (OPTION 01 ONLY) | | |
| A10C1421 | 290-0527-00 | B010100 | B031979 | CAP.,FXD,ELCTLT:15UF,20%,20V | 90201 | TDC156M020FL |
| A10C1421 | ----- | | | (STANDARD ONLY) | | |
| A10C1421 | 290-0745-00 | B031980 | | CAP.,FXD,ELCTLT:22UF,+50-10%,25V | 54473 | ECE-A25V22L |
| A10C1421 | ----- | | | (STANDARD ONLY) | | |
| A10C1421 | 290-0527-00 | B010100 | B032089 | CAP.,FXD,ELCTLT:15UF,20%,20V | 90201 | TDC156M020FL |
| A10C1421 | ----- | | | (OPTION 01 ONLY) | | |
| A10C1421 | 290-0745-00 | B032090 | | CAP.,FXD,ELCTLT:22UF,+50-10%,25V | 54473 | ECE-A25V22L |
| A10C1421 | ----- | | | (OPTION 01 ONLY) | | |
| A10C1500 | 283-0597-00 | | | CAP.,FXD,MICA D:470PF,10%,300V | 00853 | D155F471K0 |
| A10C1501 | 283-0597-00 | | | CAP.,FXD,MICA D:470PF,10%,300V | 00853 | D155F471K0 |
| A10C1502 | 290-0574-00 | B010100 | B031979 | CAP.,FXD,ELCTLT:47UF,10%,20V | 90201 | TDC476K020CL |
| A10C1502 | ----- | | | (STANDARD ONLY) | | |
| A10C1502 | 290-0746-00 | B031980 | | CAP.,FXD,ELCTLT:47UF,+50-10%,16V | 55680 | ULA1C470TEA |
| A10C1502 | ----- | | | (STANDARD ONLY) | | |
| A10C1502 | 290-0574-00 | B010100 | B032089 | CAP.,FXD,ELCTLT:47UF,10%,20V | 90201 | TDC476K020CL |
| A10C1502 | ----- | | | (OPTION 01 ONLY) | | |
| A10C1502 | 290-0746-00 | B032090 | | CAP.,FXD,ELCTLT:47UF,+50-10%,16V | 55680 | ULA1C470TEA |
| A10C1502 | ----- | | | (OPTION 01 ONLY) | | |
| A10C1503 | 281-0775-00 | | | CAP.,FXD,CER DI:0.1UF,20%,50V | 04222 | MA205E104MAA |
| A10C1504 | 281-0775-00 | | | CAP.,FXD,CER DI:0.1UF,20%,50V | 04222 | MA205E104MAA |
| A10C1505 | 290-0523-00 | | | CAP.,FXD,ELCTLT:2.2UF,20%,20V | 56289 | 196D225X0020HA1 |
| A10C1510 | 290-0574-00 | B010100 | B031979 | CAP.,FXD,ELCTLT:47UF,10%,20V | 90201 | TDC476K020CL |
| A10C1510 | ----- | | | (STANDARD ONLY) | | |
| A10C1510 | 290-0746-00 | B031980 | | CAP.,FXD,ELCTLT:47UF,+50-10%,16V | 55680 | ULA1C470TEA |
| A10C1510 | ----- | | | (STANDARD ONLY) | | |
| A10C1510 | 290-0574-00 | B010100 | B032089 | CAP.,FXD,ELCTLT:47UF,10%,20V | 90201 | TDC476K020CL |
| A10C1510 | ----- | | | (OPTION 01 ONLY) | | |
| A10C1510 | 290-0746-00 | B032090 | | CAP.,FXD,ELCTLT:47UF,+50-10%,16V | 55680 | ULA1C470TEA |

| Component No. | Tektronix Part No. | Serial/Model No. Eff | Dscont | Name & Description | Mfr Code | Mfr Part Number |
|---------------|--------------------|----------------------|---------|--|----------|-----------------|
| A10C1510 | ----- | | | (OPTION 01 ONLY) | | |
| A10C1511 | 290-0574-00 | B010100 | B031979 | CAP.,FXD,ELCTLT:47UF,10%,20V | 90201 | TDC476K020CL |
| A10C1511 | ----- | | | (STANDARD ONLY) | | |
| A10C1511 | 290-0746-00 | B031980 | | CAP.,FXD,ELCTLT:47UF,+50-10%,16V | 55680 | ULA1C470TEA |
| A10C1511 | ----- | | | (STANDARD ONLY) | | |
| A10C1511 | 290-0574-00 | B010100 | B032089 | CAP.,FXD,ELCTLT:47UF,10%,20V | 90201 | TDC476K020CL |
| A10C1511 | ----- | | | (OPTION 01 ONLY) | | |
| A10C1511 | 290-0746-00 | B032090 | | CAP.,FXD,ELCTLT:47UF,+50-10%,16V | 55680 | ULA1C470TEA |
| A10C1511 | ----- | | | (OPTION 01 ONLY) | | |
| A10C1512 | 281-0811-00 | | | CAP.,FXD,CER DI:10PF,10%,100V | 96733 | R2911 |
| A10C1513 | 281-0775-00 | | | CAP.,FXD,CER DI:0.1UF,20%,50V | 04222 | MA205E104MAA |
| A10C1514 | 281-0763-00 | B030000 | | CAP.,FXD,CER DI:47PF,10%,100V | 04222 | GA101A470KAA |
| A10C1520 | 281-0767-00 | | | CAP.,FXD,CER DI:330PF,20%,100V | 12969 | CGB331MEN |
| A10C1521 | 281-0775-00 | | | CAP.,FXD,CER DI:0.1UF,20%,50V | 04222 | MA205E104MAA |
| A10C1522 | 290-0534-00 | B010100 | B031979 | CAP.,FXD,ELCTLT:1UF,20%,35V | 56289 | 196D105X0035HA1 |
| A10C1522 | ----- | | | (STANDARD ONLY) | | |
| A10C1522 | 290-0920-00 | B031980 | | CAP.,FXD,ELCTLT:33UF,+50-10%,35V | 55680 | ULB1V330TEAANA |
| A10C1522 | ----- | | | (STANDARD ONLY) | | |
| A10C1522 | 290-0534-00 | B010100 | B032089 | CAP.,FXD,ELCTLT:1UF,20%,35V | 56289 | 196D105X0035HA1 |
| A10C1522 | ----- | | | (OPTION 01 ONLY) | | |
| A10C1522 | 290-0920-00 | B032090 | | CAP.,FXD,ELCTLT:33UF,+50-10%,35V | 55680 | ULB1V330TEAANA |
| A10C1522 | ----- | | | (OPTION 01 ONLY) | | |
| A10C1523 | 290-0671-00 | B010100 | B031979 | CAP.,FXD,ELCTLT:150UF,20%,15V | 90201 | TDC157M015WLH |
| A10C1523 | ----- | | | (STANDARD ONLY) | | |
| A10C1523 | 290-0987-00 | B031980 | | CAP.,FXD,ELCTLT:150UF,20%,16V | 56289 | 511D157M016CC4F |
| A10C1523 | ----- | | | (STANDARD ONLY) | | |
| A10C1523 | 290-0671-00 | B010100 | B032089 | CAP.,FXD,ELCTLT:150UF,20%,15V | 90201 | TDC157M015WLH |
| A10C1523 | ----- | | | (OPTION 01 ONLY) | | |
| A10C1523 | 290-0987-00 | B032090 | | CAP.,FXD,ELCTLT:150UF,20%,16V | 56289 | 511D157M016CC4F |
| A10C1523 | ----- | | | (OPTION 01 ONLY) | | |
| A10C1524 | 281-0811-00 | | | CAP.,FXD,CER DI:10PF,10%,100V | 96733 | R2911 |
| A10C1600 | 290-0718-00 | B010100 | B031979 | CAP.,FXD,ELCTLT:22UF,20%,35V | 56289 | 196D226X0035PE4 |
| A10C1600 | ----- | | | (STANDARD ONLY) | | |
| A10C1600 | 290-0745-00 | B031980 | | CAP.,FXD,ELCTLT:22UF,+50-10%,25V | 54473 | ECE-A25V22L |
| A10C1600 | ----- | | | (STANDARD ONLY) | | |
| A10C1600 | 290-0718-00 | B010100 | B032089 | CAP.,FXD,ELCTLT:22UF,20%,35V | 56289 | 196D226X0035PE4 |
| A10C1600 | ----- | | | (OPTION 01 ONLY) | | |
| A10C1600 | 290-0745-00 | B032090 | | CAP.,FXD,ELCTLT:22UF,+50-10%,25V | 54473 | ECE-A25V22L |
| A10C1600 | ----- | | | (OPTION 01 ONLY) | | |
| A10C1601 | 290-0517-00 | | | CAP.,FXD,ELCTLT:6.8UF,20%,35V | 56289 | 196D685X0035KA1 |
| A10C1602 | 283-0212-00 | | | CAP.,FXD,CER DI:2UF,20%,50V | 51642 | 400-050-Z5U205M |
| A10C1603 | 283-0059-00 | | | CAP.,FXD,CER DI:1UF,+80-20%,50V | 51642 | 400050Z5U105Z |
| A10C1610 | 281-0775-00 | | | CAP.,FXD,CER DI:0.1UF,20%,50V | 04222 | MA205E104MAA |
| A10C1611 | 290-0523-00 | | | CAP.,FXD,ELCTLT:2.2UF,20%,20V | 56289 | 196D225X0020HA1 |
| A10C1620 | 281-0775-00 | | | CAP.,FXD,CER DI:0.1UF,20%,50V | 04222 | MA205E104MAA |
| A10C1621 | 281-0759-00 | | | CAP.,FXD,CER DI:22PF,10%,100V | 96733 | R2735 |
| A10C1622 | 281-0763-00 | B030000 | | CAP.,FXD,CER DI:47PF,10%,100V | 04222 | GA101A470KAA |
| A10C1720 | 281-0773-00 | | | CAP.,FXD,CER DI:0.01UF,10%,100V | 04222 | SA201C103KAA |
| A10CR1100 | 152-0141-02 | | | SEMICONV DEVICE:SILICON,30V,150MA | 01295 | 1N4152R |
| A10CR1110 | 152-0141-02 | | | SEMICONV DEVICE:SILICON,30V,150MA | 01295 | 1N4152R |
| A10CR1111 | 152-0141-02 | | | SEMICONV DEVICE:SILICON,30V,150MA | 01295 | 1N4152R |
| A10CR1112 | 152-0141-02 | | | SEMICONV DEVICE:SILICON,30V,150MA | 01295 | 1N4152R |
| A10CR1113 | 152-0585-00 | | | SEMICONV DEVICE:SILICON,BRIDGE,200V,1A | 80009 | 152-0585-00 |
| A10CR1114 | 152-0585-00 | | | SEMICONV DEVICE:SILICON,BRIDGE,200V,1A | 80009 | 152-0585-00 |

Replaceable Electrical Parts—SG 505

| Component No. | Tektronix Part No. | Serial/Model No. Eff Dscont | Name & Description | Mfr Code | Mfr Part Number |
|---------------|--------------------|-----------------------------|---|----------|-----------------|
| A10CR1200 | 152-0141-02 | | SEMICONV DEVICE:SILICON,30V,150MA | 01295 | 1N4152R |
| A10CR1412 | 152-0141-02 | | SEMICONV DEVICE:SILICON,30V,150MA | 01295 | 1N4152R |
| A10CR1413 | 152-0141-02 | | SEMICONV DEVICE:SILICON,30V,150MA | 01295 | 1N4152R |
| A10CR1501 | 152-0141-02 | | SEMICONV DEVICE:SILICON,30V,150MA | 01295 | 1N4152R |
| A10CR1502 | 152-0141-02 | | SEMICONV DEVICE:SILICON,30V,150MA | 01295 | 1N4152R |
| A10CR1510 | 152-0141-02 | | SEMICONV DEVICE:SILICON,30V,150MA | 01295 | 1N4152R |
| A10DS1424 | 150-0077-01 | | LAMP,INCAND:14V,0.08A | 08806 | 2182D |
| A10F1220 | 159-0025-00 | | FUSE,CARTRIDGE:3AG,0.5A,250V,FAST-BLOW | 71400 | AGC 1/2 |
| A10J1300 | 131-1857-00 | | TERM. SET,PIN:36/0.025 SQ PIN,ON 0.1 CTRS | 22526 | 65500136 |
| A10J1300 | ----- | | (OPTION 01 ONLY) | | |
| A10J1500 | 131-1857-00 | | TERM. SET,PIN:36/0.025 SQ PIN,ON 0.1 CTRS | 22526 | 65500136 |
| A10J1510 | 131-1857-00 | | TERM. SET,PIN:36/0.025 SQ PIN,ON 0.1 CTRS | 22526 | 65500136 |
| A10J1520 | 131-1857-00 | | TERM. SET,PIN:36/0.025 SQ PIN,ON 0.1 CTRS | 22526 | 65500136 |
| A10J1520 | ----- | | (OPTION 01 ONLY) | | |
| A10Q1110 | 151-1025-00 | | TRANSISTOR:SILICON,JFE,N-CHANNEL | 01295 | SFB8129 |
| A10Q1300 | 151-0301-00 | | TRANSISTOR:SILICON,PNP | 27014 | 2N2907A |
| A10Q1301 | 151-0302-00 | | TRANSISTOR:SILICON,NPN | 07263 | S038487 |
| A10Q1410 | 151-0301-00 | | TRANSISTOR:SILICON,PNP | 27014 | 2N2907A |
| A10Q1411 | 151-0302-00 | | TRANSISTOR:SILICON,NPN | 07263 | S038487 |
| A10Q1501 | 151-1021-00 | | TRANSISTOR:SILICON,JFE | 17856 | FN815 |
| A10Q1600 | 151-0301-00 | | TRANSISTOR:SILICON,PNP | 27014 | 2N2907A |
| A10Q1610 | 151-0302-00 | | TRANSISTOR:SILICON,NPN | 07263 | S038487 |
| A10Q1611 | 151-0301-00 | | TRANSISTOR:SILICON,PNP | 27014 | 2N2907A |
| A10Q1620 | 151-1025-00 | | TRANSISTOR:SILICON,JFE,N-CHANNEL | 01295 | SFB8129 |
| A10R1100 | 315-0301-00 | | RES.,FXD,CMPSN:300 OHM,5%,0.25W | 01121 | CB3015 |
| A10R1101 | 321-0356-00 | | RES.,FXD,FILM:49.9K OHM,1%,0.125W | 91637 | MFF1816G49901F |
| A10R1102 | 321-0356-00 | | RES.,FXD,FILM:49.9K OHM,1%,0.125W | 91637 | MFF1816G49901F |
| A10R1103 | 315-0751-00 | | RES.,FXD,CMPSN:750 OHM,5%,0.25W | 01121 | CB7515 |
| A10R1104 | 315-0301-00 | | RES.,FXD,CMPSN:300 OHM,5%,0.25W | 01121 | CB3015 |
| A10R1110 | 315-0751-00 | | RES.,FXD,CMPSN:750 OHM,5%,0.25W | 01121 | CB7515 |
| A10R1111 | 315-0751-00 | | RES.,FXD,CMPSN:750 OHM,5%,0.25W | 01121 | CB7515 |
| A10R1120 | 307-0103-00 | | RES.,FXD,CMPSN:2.7 OHM,5%,0.25W | 01121 | CB27G5 |
| A10R1121 | 307-0103-00 | | RES.,FXD,CMPSN:2.7 OHM,5%,0.25W | 01121 | CB27G5 |
| A10R1200 | 303-0202-00 | | RES.,FXD,CMPSN:2K OHM,5%,1W | 01121 | GB2025 |
| A10R1201 | 315-0471-00 | | RES.,FXD,CMPSN:470 OHM,5%,0.25W | 01121 | CB4715 |
| A10R1202 | 315-0470-00 | | RES.,FXD,CMPSN:47 OHM,5%,0.25W | 01121 | CB4705 |
| A10R1203 | 315-0103-00 | | RES.,FXD,CMPSN:10K OHM,5%,0.25W | 01121 | CB1035 |
| A10R1204 | 315-0102-00 | | RES.,FXD,CMPSN:1K OHM,5%,0.25W | 01121 | CB1025 |
| A10R1205 | 321-0336-00 | | RES.,FXD,FILM:30.9K OHM,1%,0.125W | 91637 | MFF1816G30901F |
| A10R1206 | 321-0333-00 | | RES.,FXD,FILM:28.7K OHM,1%,0.125W | 91637 | MFF1816G28701F |
| A10R1207 | 315-0560-00 | | RES.,FXD,CMPSN:56 OHM,5%,0.25W | 01121 | CB5605 |
| A10R1208 | 315-0100-00 | | RES.,FXD,CMPSN:10 OHM,5%,0.25W | 01121 | CB1005 |
| A10R1300 | 301-0821-00 | | RES.,FXD,CMPSN:820 OHM,5%,0.50W | 01121 | EB8215 |
| A10R1301 | 311-1560-00 | | RES.,VAR,NONWIR:5K OHM,20%,0.50W | 73138 | 91-82-0 |
| A10R1400 | 321-0222-07 | | RES.,FXD,FILM:2K OHM,0.1%,0.125W | 91637 | MFF1816C20000B |
| A10R1401 | 321-0222-07 | | RES.,FXD,FILM:2K OHM,0.1%,0.125W | 91637 | MFF1816C20000B |
| A10R1405 | 315-0471-00 | B030000 | RES.,FXD,CMPSN:470 OHM,5%,0.25W | 01121 | CB4715 |
| A10R1410 | 321-0300-00 | | RES.,FXD,FILM:13K OHM,1%,0.125W | 91637 | MFF1816G13001F |
| A10R1411 | 321-0236-00 | | RES.,FXD,FILM:2.8K OHM,1%,0.125W | 91637 | MFF1816G28000F |
| A10R1412 | 321-0236-00 | | RES.,FXD,FILM:2.8K OHM,1%,0.125W | 91637 | MFF1816G28000F |
| A10R1413 | 321-0300-00 | | RES.,FXD,FILM:13K OHM,1%,0.125W | 91637 | MFF1816G13001F |
| A10R1414 | 315-0104-00 | | RES.,FXD,CMPSN:100K OHM,5%,0.25W | 01121 | CB1045 |
| A10R1415 | 315-0104-00 | | RES.,FXD,CMPSN:100K OHM,5%,0.25W | 01121 | CB1045 |
| A10R1420 | 315-0104-00 | | RES.,FXD,CMPSN:100K OHM,5%,0.25W | 01121 | CB1045 |

| Component No. | Tektronix Part No. | Serial/Model No. Eff Dscnt | Name & Description | Mfr Code | Mfr Part Number |
|---------------|--------------------|----------------------------|--|----------|-----------------|
| A10R1421 | 315-0514-00 | | RES.,FXD,CMPSN:510K OHM,5%,0.25W | 01121 | CB5145 |
| A10R1422 | 315-0104-00 | | RES.,FXD,CMPSN:100K OHM,5%,0.25W | 01121 | CB1045 |
| A10R1423 | 311-1562-00 | | RES.,VAR,NONWIR:2K OHM,20%,0.50W | 73138 | 91-84-0 |
| A10R1500 | 321-0204-00 | | RES.,FXD,FILM:1.3K OHM,1%,0.125W | 91637 | MFF1816G13000F |
| A10R1501 | 321-0204-00 | | RES.,FXD,FILM:1.3K OHM,1%,0.125W | 91637 | MFF1816G13000F |
| A10R1502 | 321-0279-00 | | RES.,FXD,FILM:7.87K OHM,1%,0.125W | 91637 | MFF1816G78700F |
| A10R1503 | 321-0421-00 | | RES.,FXD,FILM:237K OHM,1%,0.125W | 91637 | MFF1816G23702F |
| A10R1504 | 321-0289-00 | | RES.,FXD,FILM:10K OHM,1%,0.125W | 91637 | MFF1816G10001F |
| A10R1505 | 315-0105-00 | | RES.,FXD,CMPSN:1M OHM,5%,0.25W | 01121 | CB1055 |
| A10R1506 | 315-0105-00 | | RES.,FXD,CMPSN:1M OHM,5%,0.25W | 01121 | CB1055 |
| A10R1507 | 315-0104-00 | B030000 | RES.,FXD,CMPSN:100K OHM,5%,0.25W | 01121 | CB1045 |
| A10R1510 | 321-0289-07 | | RES.,FXD,FILM:10K OHM,0.1%,0.125W | 91637 | MFF1816C10001B |
| A10R1511 | 321-0481-00 | | RES.,FXD,FILM:1M OHM,1%,0.125W | 24546 | NA4D1004F |
| A10R1512 | 321-0481-00 | | RES.,FXD,FILM:1M OHM,1%,0.125W | 24546 | NA4D1004F |
| A10R1513 | 321-0289-07 | | RES.,FXD,FILM:10K OHM,0.1%,0.125W | 91637 | MFF1816C10001B |
| A10R1514 | 321-0214-00 | | RES.,FXD,FILM:1.65K OHM,1%,0.125W | 91637 | MFF1816G16500F |
| A10R1515 | 321-0353-00 | | RES.,FXD,FILM:46.4K OHM,1%,0.125W | 91637 | MFF1816G46401F |
| A10R1516 | 315-0473-00 | | RES.,FXD,CMPSN:47K OHM,5%,0.25W | 01121 | CB4735 |
| A10R1517 | 321-0225-06 | | RES.,FXD,FILM:2.15K OHM,0.25%,0.125W | 91637 | MFF1816C21500C |
| A10R1518 | 311-1403-00 | | RES.,VAR,NONWIR:5K OHM,20%,0.50W | 01121 | 18M651 |
| A10R1519 | 315-0104-00 | | RES.,FXD,CMPSN:100K OHM,5%,0.25W | 01121 | CB1045 |
| A10R1520 | 321-0164-00 | | RES.,FXD,FILM:499 OHM,1%,0.125W | 91637 | MFF1816G499R0F |
| A10R1520 | ----- | | (STANDARD ONLY) | | |
| A10R1521 | 321-0230-00 | | RES.,FXD,FILM:2.43K OHM,1%,0.125W | 91637 | MFF1816G24300F |
| A10R1522 | 321-0276-00 | | RES.,FXD,FILM:7.32K OHM,1%,0.125W | 91637 | MFF1816G73200F |
| A10R1523 | 315-0512-00 | | RES.,FXD,CMPSN:5.1K OHM,5%,0.25W | 01121 | CB5125 |
| A10R1524 | 315-0103-00 | | RES.,FXD,CMPSN:10K OHM,5%,0.25W | 01121 | CB1035 |
| A10R1525 | 321-0256-00 | | RES.,FXD,FILM:4.53K OHM,1%,0.125W | 91637 | MFF1816G45300F |
| A10R1526 | 315-0331-00 | B030000 | RES.,FXD,CMPSN:330 OHM,5%,0.25W | 01121 | CB3315 |
| A10R1600 | 315-0683-00 | | RES.,FXD,CMPSN:68K OHM,5%,0.25W | 01121 | CB6835 |
| A10R1601 | 315-0752-00 | | RES.,FXD,CMPSN:7.5K OHM,5%,0.25W | 01121 | CB7525 |
| A10R1609 | 315-0123-00 | | RES.,FXD,CMPSN:12K OHM,5%,0.25W | 01121 | CB1235 |
| A10R1610 | 315-0182-00 | | RES.,FXD,CMPSN:1.8K OHM,5%,0.25W | 01121 | CB1825 |
| A10R1611 | 315-0102-00 | | RES.,FXD,CMPSN:1K OHM,5%,0.25W | 01121 | CB1025 |
| A10R1612 | 321-1263-02 | | RES.,FXD,FILM:5.42K OHM,0.5%,0.125W | 91637 | MFF1816D54200D |
| A10R1613 | 321-0361-00 | | RES.,FXD,FILM:56.2K OHM,1%,0.125W | 91637 | MFF1816G56201F |
| A10R1620 | 315-0511-00 | | RES.,FXD,CMPSN:510 OHM,5%,0.25W | 01121 | CB5115 |
| A10R1621 | 315-0680-00 | | RES.,FXD,CMPSN:68 OHM,5%,0.25W | 01121 | CB6805 |
| A10R1701 | 315-0102-00 | | RES.,FXD,CMPSN:1K OHM,5%,0.25W | 01121 | CB1025 |
| A10R1711 | 321-0680-03 | | RES.,FXD,FILM:35.3K OHM,0.25%,0.125W | 91637 | MFF1816D35301C |
| A10R1712 | 321-0680-03 | | RES.,FXD,FILM:35.3K OHM,0.25%,0.125W | 91637 | MFF1816D35301C |
| A10R1720 | 307-0669-00 | | RES,NTWK,FXD,FI:STEP ATTENUATOR | 80009 | 307-0669-00 |
| A10R1721 | 315-0100-00 | | RES.,FXD,CMPSN:10 OHM,5%,0.25W | 01121 | CB1005 |
| A10S1410 | 260-1985-00 | | SWITCH,PUSH:6 BUTTON,0/2/4 POLE | 80009 | 260-1985-00 |
| A10S1710 | 263-1182-00 | | SW CAM ACTR AS:ATTENUATOR | 80009 | 263-1182-00 |
| A10T1220 | 120-1284-00 | | XFMR PWR STN:LOW FREQUENCY | 80009 | 120-1284-00 |
| A10TP1510 | 214-0579-00 | | TERM,TEST POINT:BRS CD PL | 80009 | 214-0579-00 |
| A10U1101 | 156-0158-00 | | MICROCIRCUIT,LI:DUAL OPERATIONAL AMPLIFIER | 18324 | MC1458N |
| A10U1300 | 156-0109-00 | | CPLR,OPTOELECTR:LED & PHOTOTRANSISTOR | 09019 | H11AX881 |
| A10U1400 | 156-1338-00 | | MICROCIRCUIT,LI:OPERATIONAL AMPLIFIER | 18324 | NE5534N |
| A10U1401 | 156-1338-00 | | MICROCIRCUIT,LI:OPERATIONAL AMPLIFIER | 18324 | NE5534N |
| A10U1500 | 156-1149-00 | | MICROCIRCUIT,LI:OPERATIONAL AMP,JFET INPUT | 27014 | GLEA134 |
| A10U1510 | 156-1338-00 | | MICROCIRCUIT,LI:OPERATIONAL AMPLIFIER | 18324 | NE5534N |
| A10U1520 | 156-1338-00 | | MICROCIRCUIT,LI:OPERATIONAL AMPLIFIER | 18324 | NE5534N |

Replaceable Electrical Parts—SG 505

| Component No. | Tektronix Part No. | Serial/Model No. Eff Dscont | Name & Description | Mfr Code | Mfr Part Number |
|---------------|-----------------------|-------------------------------------|--|-------------|-----------------|
| A10U1700 | 156-1149-00 | | MICROCIRCUIT,LI:OPERATIONAL AMP,JFET INPUT | 27014 | GLEA134 |
| A10VR1201 | 152-0437-00 | | SEMICONV DEVICE:ZENER,SI,8.2V,2%,0.4W | 14552 | TD332679 |
| A10VR1600 | 152-0395-00 | | SEMICONV DEVICE:ZENER,0.4W,4.3V,5% | 14552 | TD332317 |
| A10W1300 | 131-0566-00 | | BUS CONDUCTOR:DUMMY RES,2.375,22 AWG | 57668 | JWW-0200E0 |
| A10W1300 | ----- | | (STANDARD ONLY) | | |

| Component No. | Tektronix Part No. | Serial/Model No. Eff Dscont | Name & Description | Mfr Code | Mfr Part Number |
|---------------|--------------------|-----------------------------|--|----------|-----------------|
| A11 | ----- | | CKT BOARD ASSY:IMD | | |
| A11 | ----- | | (OPTION 01 ONLY) | | |
| A11C1100 | 285-1050-00 | | CAP.,FXD,PLSTC:0.1UF,1%,200V | 14752 | 230B1C104F |
| A11C1101 | 281-0773-00 | | CAP.,FXD,CER DI:0.01UF,10%,100V | 04222 | SA201C103KAA |
| A11C1110 | 281-0775-00 | | CAP.,FXD,CER DI:0.1UF,20%,50V | 04222 | MA205E104MAA |
| A11C1111 | 281-0775-00 | | CAP.,FXD,CER DI:0.1UF,20%,50V | 04222 | MA205E104MAA |
| A11C1112 | 290-0846-00 | | CAP.,FXD,ELCTLT:47UF,-10+75%,35 WVDC | 54473 | ECE-A35V47LU |
| A11C1113 | 290-0846-00 | | CAP.,FXD,ELCTLT:47UF,-10+75%,35 WVDC | 54473 | ECE-A35V47LU |
| A11C1200 | 285-1050-00 | | CAP.,FXD,PLSTC:0.1UF,1%,200V | 14752 | 230B1C104F |
| A11CR1110 | 152-0141-02 | | SEMICONV DEVICE:SILICON,30V,150MA | 01295 | 1N4152R |
| A11J1100 | 131-0608-00 | | TERMINAL,PIN:0.365 L X 0.025 PH BRZ GOLD | 22526 | 47357 |
| A11J1100 | ----- | | (QUANTITY 4) | | |
| A11J1101 | 131-0608-00 | | TERMINAL,PIN:0.365 L X 0.025 PH BRZ GOLD | 22526 | 47357 |
| A11J1101 | ----- | | (QUANTITY 2) | | |
| A11J1102 | 131-0608-00 | | TERMINAL,PIN:0.365 L X 0.025 PH BRZ GOLD | 22526 | 47357 |
| A11J1102 | ----- | | (QUANTITY OF 2) | | |
| A11J1110 | 131-0608-00 | | TERMINAL,PIN:0.365 L X 0.025 PH BRZ GOLD | 22526 | 47357 |
| A11J1110 | ----- | | (QUANTITY 5) | | |
| A11Q1110 | 151-0188-00 | | TRANSISTOR:SILICON,PNP | 04713 | SPS6868K |
| A11Q1111 | 151-1025-00 | | TRANSISTOR:SILICON,JFE,N-CHANNEL | 01295 | SFB8129 |
| A11R1100 | 321-0748-06 | | RES.,FXD,FILM:4.95K OHM,0.25%,0.125W | 91637 | MFF1816C49500C |
| A11R1101 | 321-1619-07 | | RES.,FXD,FILM:8.334K OHM,0.1%,0.125W | 91637 | MFF1816C83340B |
| A11R1102 | 321-1329-03 | | RES.,FXD,FILM:26.4K OHM,0.25%,0.125W | 91637 | MFF1816D26401C |
| A11R1103 | 321-1329-03 | | RES.,FXD,FILM:26.4K OHM,0.25%,0.125W | 91637 | MFF1816D26401C |
| A11R1104 | 321-1619-07 | | RES.,FXD,FILM:8.334K OHM,0.1%,0.125W | 91637 | MFF1816C83340B |
| A11R1106 | 315-0103-00 | | RES.,FXD,CMPSN:10K OHM,5%,0.25W | 01121 | CB1035 |
| A11R1107 | 315-0103-00 | | RES.,FXD,CMPSN:10K OHM,5%,0.25W | 01121 | CB1035 |
| A11R1110 | 321-0164-00 | | RES.,FXD,FILM:499 OHM,1%,0.125W | 91637 | MFF1816G499R0F |
| A11R1111 | 321-0231-00 | | RES.,FXD,FILM:2.49K OHM,1%,0.125W | 91637 | MFF1816G24900F |
| A11R1112 | 321-0202-00 | | RES.,FXD,FILM:1.24K OHM,1%,0.125W | 91637 | MFF1816G12400F |
| A11R1113 | 321-0202-00 | | RES.,FXD,FILM:1.24K OHM,1%,0.125W | 91637 | MFF1816G12400F |
| A11R1115 | 315-0105-00 | | RES.,FXD,CMPSN:1M OHM,5%,0.25W | 01121 | CB1055 |
| A11R1116 | 315-0102-00 | | RES.,FXD,CMPSN:1K OHM,5%,0.25W | 01121 | CB1025 |
| A11R1210 | 321-0639-00 | | RES.,FXD,FILM:9.6K OHM,1%,0.125W | 91637 | MFF1816G96000F |
| A11R1211 | 311-1564-00 | | RES.,VAR,NONWIR:TRMR,500 OHM,0.5W | 73138 | 91-86-0 |
| A11R1212 | 321-0257-00 | | RES.,FXD,FILM:4.64K OHM,1%,0.125W | 91637 | MFF1816G46400F |
| A11R1213 | 321-0297-00 | | RES.,FXD,FILM:12.1K OHM,1%,0.125W | 91637 | MFF1816G12101F |
| A11S1110 | 260-1486-00 | | SWITCH,PUSH:1 BUTTON,PB1,4P,PUSH-PUSH | 80009 | 260-1486-00 |
| A11U1100 | 156-0742-00 | | MICROCIRCUIT,LI:OPERATIONAL AMPLIFIER | 27014 | LM318N |

Replaceable Electrical Parts—SG 505

| Component No. | Tektronix Part No. | Serial/Model No. Eff | Dscont | Name & Description | Mfr Code | Mfr Part Number |
|---------------|--------------------|----------------------|--------|--|----------|-----------------|
| CHASSIS PARTS | | | | | | |
| DS510 | 150-1029-00 | | | LT EMITTING DIO:GREEN,565NM,35MA | 53184 | XC209G |
| J540 | 131-0274-00 | | | CONNECTOR,RCPT.:BNC | 91836 | KC79-67 |
| J550 | 131-0955-00 | | | CONN,RCPT,ELEC:BNC,FEMALE | 13511 | 31-279 |
| P1500 | 175-2773-00 | | | CA ASSY,SP,ELEC:6,26 AWG,4.0L | 80009 | 175-2773-00 |
| P1500 | ----- | | | (FROM J1500 TO R520,R530) | | |
| P1510 | 175-2771-00 | | | CA ASSY,SP,ELEC:3.26 AWG,5.0L | 80009 | 175-2771-00 |
| P1510 | ----- | | | (FROM J1510 TO R510) | | |
| P1101 | 175-2772-00 | | | CA ASSY,SP,ELEC:2,26 AWG,5.0L | 80009 | 175-2772-00 |
| P1101 | ----- | | | (OPTION 01 ONLY - FROM A11J1101 TO A10J1300) | | |
| P1110 | 175-2774-00 | | | CA ASSY,SP,ELEC:5,26 AWG,3.0L | 80009 | 175-2774-00 |
| P1110 | ----- | | | (OPTION 01 ONLY - FROM A11J1110 TO A10J1520) | | |
| R510 | 311-1095-00 | | | RES.,VAR,NONWIR:10K OHM,20%,0.50W | 12697 | 382-CM40386 |
| R520 | 311-1502-00 | | | RES.,VAR,WW:PNL,2 X 10K OHM,2.75W | 02111 | 1009625 |
| R530 | ----- | | | (PART OF R520) | | |

DIAGRAMS AND CIRCUIT BOARD ILLUSTRATIONS

Symbols

Graphic symbols and class designation letters are based on ANSI Standard Y32.2-1975.

Logic symbology is based on ANSI Y32.14-1973 in terms of positive logic. Logic symbols depict the logic function performed and may differ from the manufacturer's data.

The overline on a signal name indicates that the signal performs its intended function when it is in the low state.

Abbreviations are based on ANSI Y1.1-1972.

Other ANSI standards that are used in the preparation of diagrams by Tektronix, Inc. are:

- Y14.15, 1966 Drafting Practices.
- Y14.2, 1973 Line Conventions and Lettering.
- Y10.5, 1968 Letter Symbols for Quantities Used in Electrical Science and Electrical Engineering.

American National Standard Institute
1430 Broadway
New York, New York 10018

Component Values

Electrical components shown on the diagrams are in the following units unless noted otherwise:

- Capacitors = Values one or greater are in picofarads (pF). Values less than one are in microfarads (μ F).
- Resistors = Ohms (Ω).

The following special symbols may appear on the diagrams:

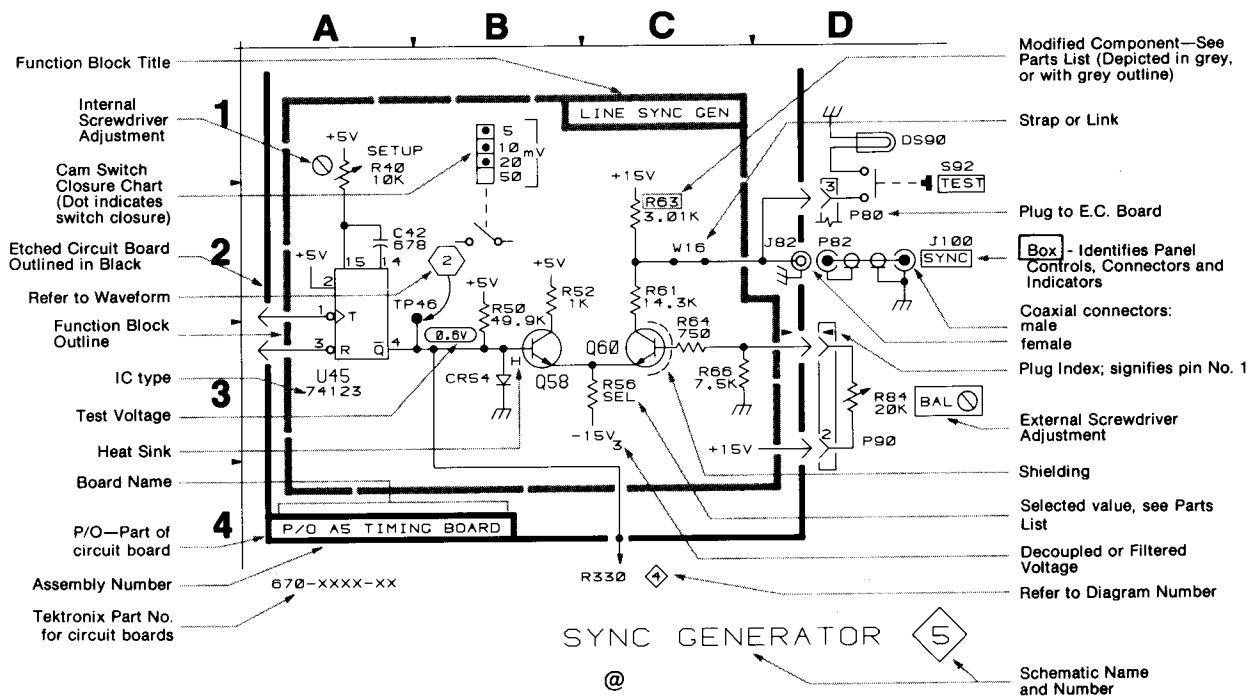

Assembly Numbers and Grid Coordinates

Each assembly in the instrument is assigned an assembly number (e.g., A20). The assembly number appears on the circuit board outline on the diagram, in the title for the circuit board component location illustration, and in the lookup table for the schematic diagram and corresponding component locator illustration. The Replaceable Electrical Parts list is arranged by assemblies in numerical sequence; the components are listed by component number (see following illustration for constructing a component number).

COMPONENT NUMBER EXAMPLE

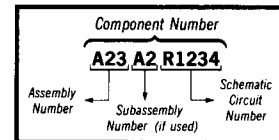

Chassis-mounted components have no Assembly Number prefix—see end of Replaceable Electrical Parts List.

The schematic diagram and circuit board component location illustration have grids. A lookup table with the grid coordinates is provided for ease of locating the component. Only the components illustrated on the facing diagram are listed in the lookup table. When more than one schematic diagram is used to illustrate the circuitry on a circuit board, the circuit board illustration may only appear opposite the first diagram on which it was illustrated; the lookup table will list the diagram number of other diagrams that the circuitry of the circuit board appears on.

TABLE 8-1 REAR INTERFACE CONNECTOR ASSIGNMENTS

| Output or Input | Pin B | | Pin A | Output or Input |
|------------------------------------|-------|---------------------------|---------------------------------|---------------------------------|
| Sync Common | 28 | SG Barrier Slot | 28 | MAIN OUT COMMON |
| Sync Output | 27 | | 27 | MAIN OUT |
| IMD INF - (SG50SWR ONLY) | 26 | | 26 | Buffered Main Output Common |
| IMD INPUT COMMON (SG50SWR ONLY) | 25 | | 25 | Buffered Main Output |
| | 24 | | 24 | |
| | 23 | TM 500 Barrier Slot | 23 | |
| | 22 | | 22 | |
| | 21 | | 21 | |
| | 20 | | 20 | |
| | 19 | | 19 | |
| | 18 | | 18 | |
| | 17 | | 17 | |
| | 16 | | 16 | |
| | 15 | | 15 | |
| | 14 | | 14 | |
| | 13 | | 13 | |
| | 12 | | 12 | |
| Collector lead of PNP Series-Pass | 11 | | 11 | Base lead of PNP Series-Pass |
| | 10 | | 10 | Emitter lead of PNP Series-Pass |
| 33.5 V Common | 9 | | 9 | -33.5 V Common |
| | 8 | 8 | -33.5 V dc | |
| Collector Lead of NPN Series-Pass | 7 | 7 | Emitter lead of NPN Series-Pass | |
| | 6 | 6 | Base lead of NPN Series-Pass | |
| | 5 | 5 | | |
| +11.5 V Common | 4 | 4 | +11.5 V Common | |
| +11.5 V Common | 3 | 3 | +11.5 V Common | |
| | 2 | 2 | +11.5 V filtered DC | |
| 25 V ac | 1 | 1 | 25 V ac | |
| | B | Rear View of Plug-in | A | |

@

SG 505 SIMPLIFIED BLOCK DIAGRAM

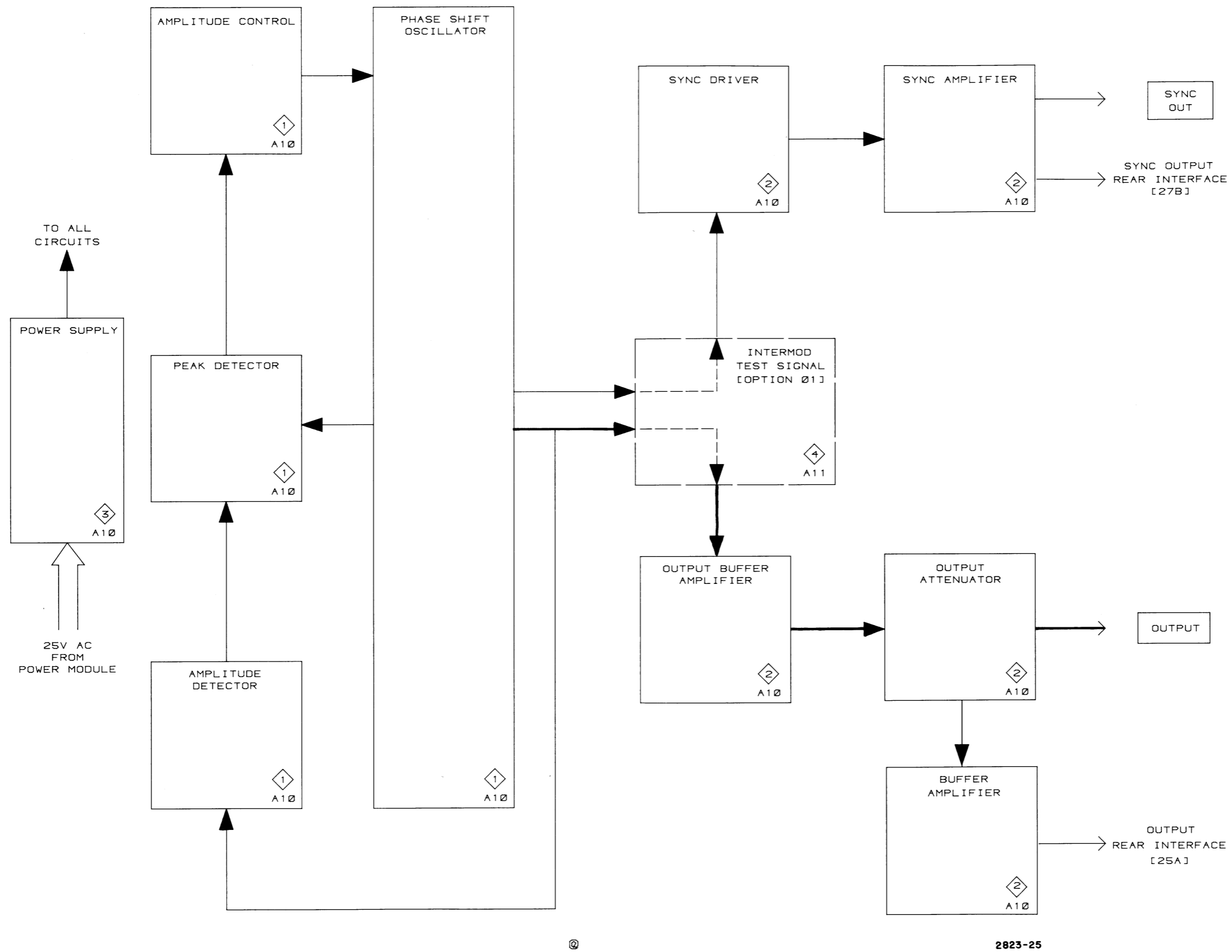
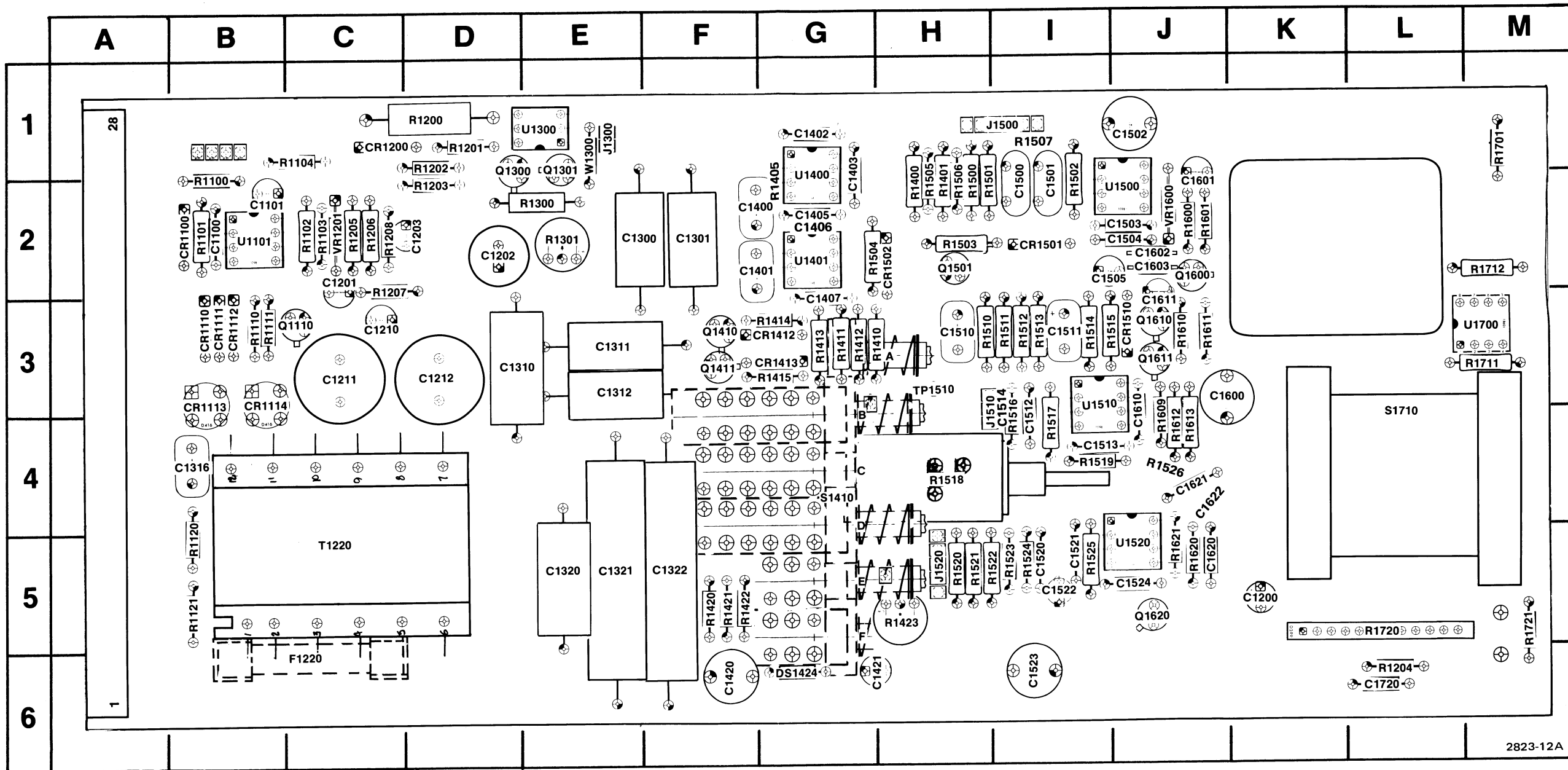

Fig. 8-1. SG 505 Simplified block diagram.

PARTS LOCATION GRID



2823-12A

Fig. 8-2. Oscillator board (A10).

COMPONENT NUMBER EXAMPLE

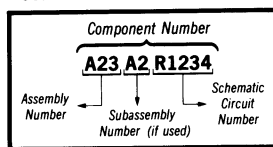

Chassis-mounted components have no Assembly Number prefix—see end of Replaceable Electrical Parts List.

Static Sensitive Devices
See Maintenance Section

Table 8-2 COMPONENT REFERENCE CHART

| P/O A10 ASSY | | | Oscillator 1 | | |
|----------------|--------------------|----------------|--|--------------------|----------------|
| Circuit Number | Schematic Location | Board Location | Circuit Number | Schematic Location | Board Location |
| C1300 | L3 | E2 | R520 | F3 | CHASSIS |
| C1301 | H2 | F2 | R530 | J4 | CHASSIS |
| C1310 | L2 | D3 | R1400 | K4 | H2 |
| C1311 | L2 | E3 | R1401 | F3 | H2 |
| C1312 | J2 | E3 | R1405*† | L5 | G2 |
| C1320 | J2 | E5 | R1410 | K5 | G3 |
| C1321 | L2 | E5 | R1411 | K5 | G3 |
| C1322 | J1 | F5 | R1412 | J6 | G3 |
| C1400 | H3 | F2 | R1413 | J6 | G3 |
| C1401 | L3 | F2 | R1414 | K4 | G3 |
| C1402 | H4 | G1 | R1415 | K6 | G3 |
| C1403 | H3 | G2 | R1420 | F1 | F5 |
| C1405 | L4 | G2 | R1421 | K2 | F5 |
| C1406*† | L4 | G2 | R1422 | K2 | F5 |
| C1407 | L4 | G3 | R1500 | J5 | H2 |
| C1420 | A6 | F6 | R1501 | F4 | H2 |
| C1421 | C6 | G6 | R1502 | A4 | I2 |
| C1500 | J5 | I2 | R1503 | H7 | H2 |
| C1501 | E4 | I2 | R1504 | J6 | G2 |
| C1502 | A4 | J1 | R1505 | J4 | H2 |
| C1503 | F7 | J2 | R1506 | F3 | H2 |
| C1504 | F6 | J2 | R1507*† | A5 | I1 |
| C1505 | H6 | J2 | R1510 | D5 | H3 |
| C1510 | D5 | H3 | R1511 | D4 | I3 |
| C1511 | D4 | I3 | R1512 | D5 | I3 |
| C1512 | D2 | I4 | R1513 | D4 | I3 |
| C1513 | D3 | I4 | R1514 | C3 | I3 |
| C1514*† | E2 | I4 | R1515 | C3 | I3 |
| C1523 | B6 | I6 | R1516 | C3 | I4 |
| C1600 | D7 | J3 | R1517 | D2 | I4 |
| C1601 | F5 | J2 | R1519 | D4 | I4 |
| C1602 | D7 | J2 | R1523 | H5 | I5 |
| C1603 | E5 | J2 | R1600 | E7 | J2 |
| C1610 | D3 | J4 | R1601 | F6 | J2 |
| C1611 | D6 | J3 | R1609 | E3 | J4 |
| CR1412 | K4 | G3 | R1610 | D7 | J3 |
| CR1413 | K6 | G3 | R1611 | D7 | J3 |
| CR1501 | H6 | I2 | R1612 | D2 | J4 |
| CR1502 | H6 | H2 | R1613 | D6 | J4 |
| CR1510 | D6 | J3 | S1410B | C6 | G4 |
| J1500 | J4 | I1 | S1410B | H2 | G4 |
| J1500 | F3 | I1 | S1410C | B6 | G4 |
| J1510 | B3 | H4 | S1410C | L2 | G4 |
| | | | S1410C | H2 | G4 |
| P1500 | J4 | CHASSIS | S1410D | A5 | G4 |
| P1500 | F3 | CHASSIS | S1410D | H1 | G4 |
| P1510 | B3 | CHASSIS | S1410D | H5 | G4 |
| | | | S1410D | K2 | G4 |
| Q1410 | K5 | F3 | TP1510 | A7 | H3 |
| Q1411 | K6 | F3 | U1400 | H3 | G2 |
| Q1501 | C4 | H2 | U1401 | L4 | G2 |
| Q1600 | E7 | J2 | U1500 | H6 | J2 |
| Q1610 | D7 | J3 | U1510 | D3 | I3 |
| Q1611 | D6 | J3 | VR1600 | F7 | J2 |
| R510 | B3 | CHASSIS | | | |

PO/ A10 ASSY also shown on 2 3

*SEE PARTS LIST FOR SERIAL NUMBER RANGES.

†LOCATED ON BACK OF BOARD

A | B | C | D | E | F | H | J | K | L | M

1
2
3
4
5
6
7
8

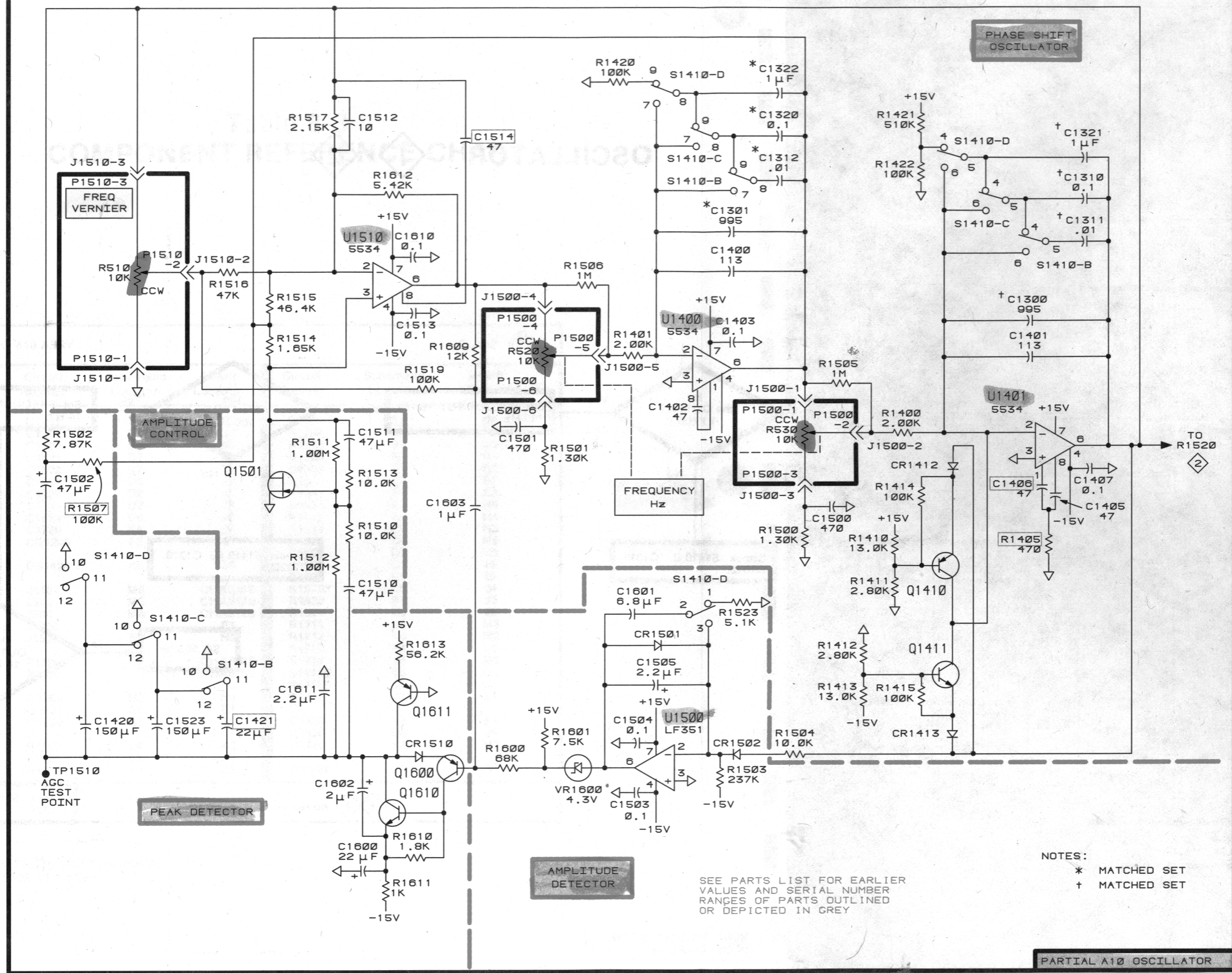

⚡ STATIC SENSITIVE DEVICES
SEE MAINTENANCE SECTION

COMPONENT NUMBER EXAMPLE

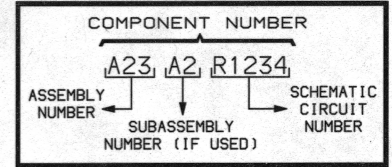

CHASSIS-MOUNTED COMPONENTS HAVE NO ASSEMBLY NUMBER PREFIX—SEE END OF REPLACEABLE ELECTRICAL PARTS LIST

NOTES:
* MATCHED SET
+ MATCHED SET

SEE PARTS LIST FOR EARLIER VALUES AND SERIAL NUMBER RANGES OF PARTS OUTLINED OR DEPICTED IN GREY

OSCILLATOR 1 2

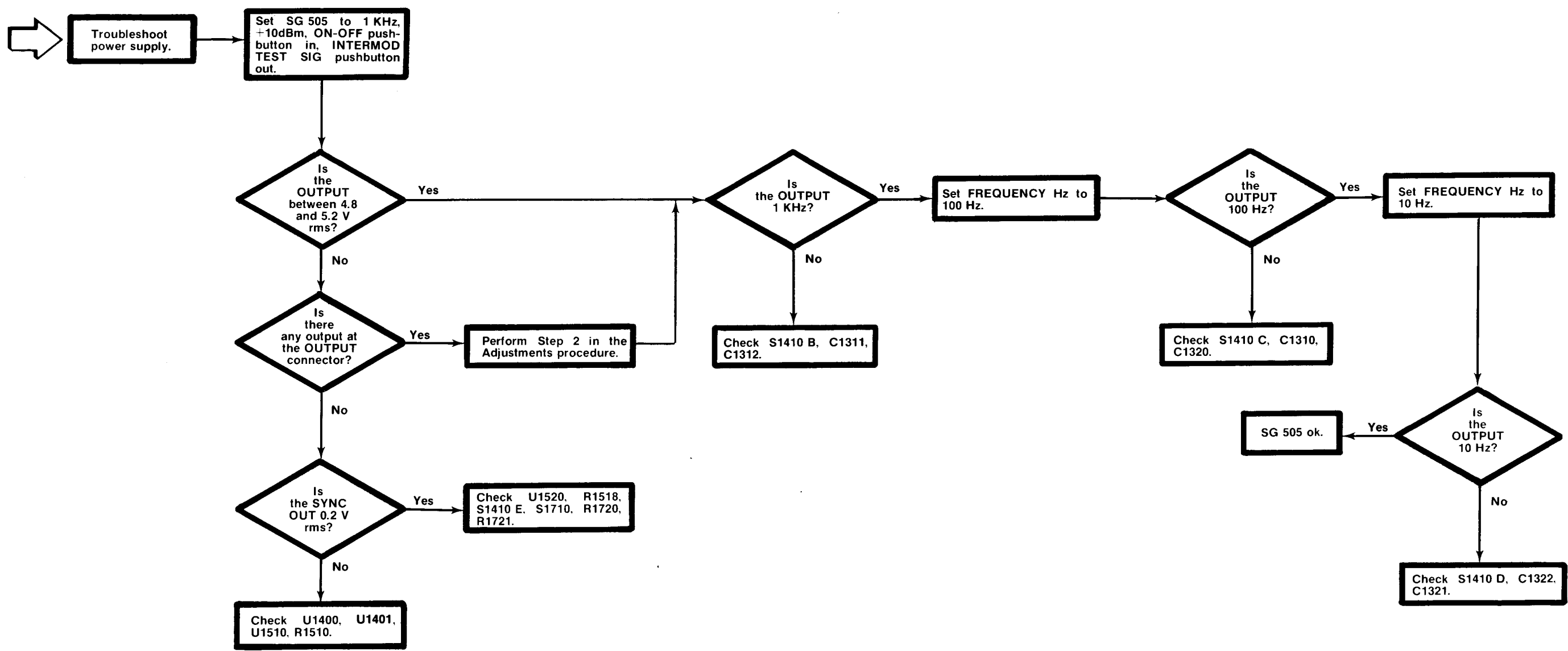



OSCILLATOR T/S FLOW CHART, COMPONENT REFERENCE CHART

Fig. 8-3. Troubleshooting flow chart—Oscillator

Table 8-3 COMPONENT REFERENCE CHART

| P/O A10 ASSY | | | Output  | | |
|----------------|--------------------|----------------|--|--------------------|----------------|
| Circuit Number | Schematic Location | Board Location | Circuit Number | Schematic Location | Board Location |
| C1202 | J3 | D2 | R1201 | E2 | D1 |
| C1203 | F1 | D2 | R1202 | K2 | D1 |
| C1520 | C7 | I5 | R1203 | J3 | D2 |
| C1521 | D7 | I5 | R1204 | K3 | C1 |
| C1522 | B7 | I5 | R1208 | E1 | C2 |
| C1524 | D6 | J5 | R1300 | E3 | E2 |
| C1620 | D6 | J5 | R1301 | E3 | E2 |
| C1621 | D7 | J4 | R1423 | E4 | H5 |
| C1622* | D6 | J4 | R1518 | E5 | H4 |
| C1720 | K6 | L6 | R1520 | C4 | H5 |
| CR1200 | F2 | C1 | R1521 | D4 | H5 |
| | | | R1522 | D5 | H5 |
| DS1424 | K6 | G6 | R1524 | C7 | I5 |
| | | | R1525 | E5 | I5 |
| J540 | M6 | CHASSIS | R1526* | C5 | J4 |
| J550 | M3 | CHASSIS | R1620 | B7 | J5 |
| J600 | M6 | CHASSIS | R1621 | D6 | J5 |
| J1300 | C2 | E1 | R1711 | J5 | M3 |
| J1520 | B3 | H5 | R1712 | K4 | M2 |
| | | | R1720 | F4 | L5 |
| P1300 | C2 | CHASSIS | R1721 | J6 | M5 |
| P1520 | B3 | CHASSIS | S1410E | E6 | G5 |
| | | | S1410F | L6 | G5 |
| Q1300 | H2 | D1 | S1710 | J8 | L4 |
| Q1301 | E2 | E1 | | | |
| Q1620 | B7 | J5 | U1300 | E2 | E1 |
| | | | U1520 | D6 | J5 |
| R1100 | L4 | B2 | U1700 | K4 | M3 |
| R1104 | L5 | C1 | | | |
| R1200 | E3 | D1 | W1300 | C3 | E1 |

P/O A10 ASSY also shown on  

*SEE PARTS LIST FOR SERIAL NUMBER RANGES

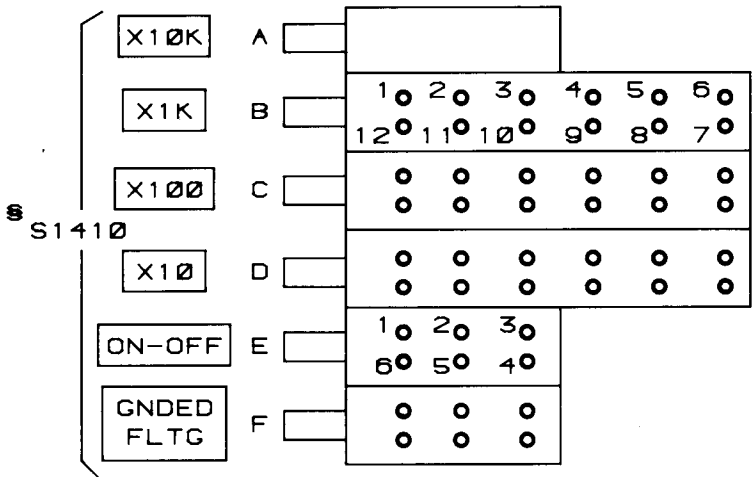

NOTES:

§ VIEWED FROM BACK OF BOARD

OUTPUT



A | B | C | D | E | F | H | J | K | L | M

1
2
3
4
5
6
7
8

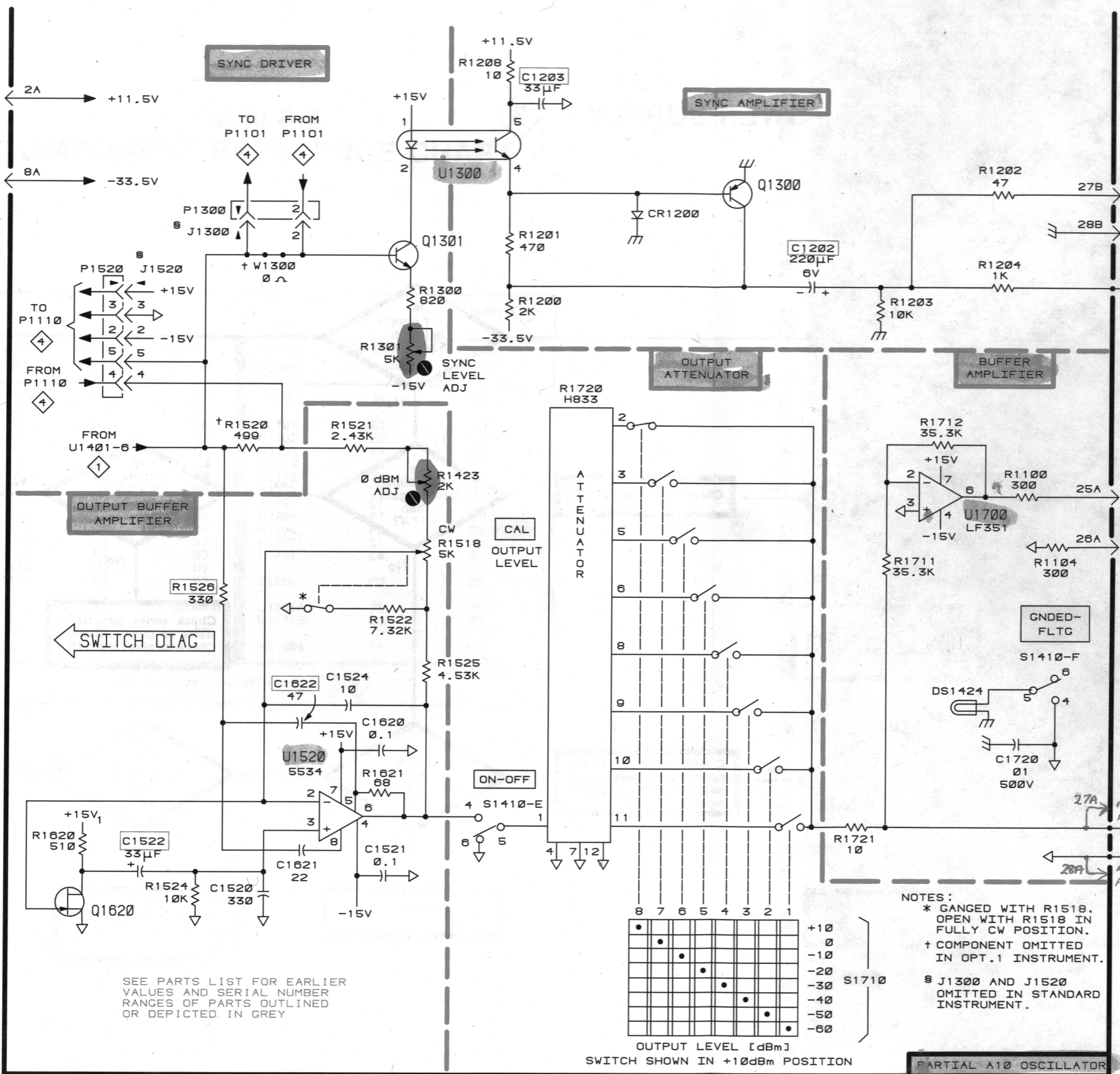

SG505WR (NOT 45Q)
U1700 is TL072 (dual opamp)
with both ops driving 300Ω to
25A : 26A.

SWITCH DIAG

SEE PARTS LIST FOR EARLIER VALUES AND SERIAL NUMBER RANGES OF PARTS OUTLINED OR DEPICTED IN GREY

| | | | | | | | | |
|---|---|---|---|---|---|---|---|-----|
| 8 | 7 | 6 | 5 | 4 | 3 | 2 | 1 | |
| | | | | | | | | +10 |
| | | | | | | | | 0 |
| | | | | | | | | -10 |
| | | | | | | | | -20 |
| | | | | | | | | -30 |
| | | | | | | | | -40 |
| | | | | | | | | -50 |
| | | | | | | | | -60 |

OUTPUT LEVEL [dBm]
SWITCH SHOWN IN +10dBm POSITION

- NOTES:
- * GANGED WITH R1518. OPEN WITH R1518 IN FULLY CW POSITION.
 - † COMPONENT OMITTED IN OPT.1 INSTRUMENT.
 - § J1300 AND J1520 OMITTED IN STANDARD INSTRUMENT.

⊗ STATIC SENSITIVE DEVICES SEE MAINTENANCE SECTION

COMPONENT NUMBER EXAMPLE

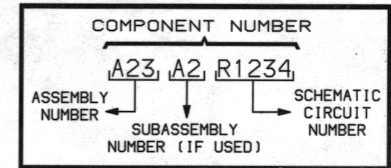

CHASSIS-MOUNTED COMPONENTS HAVE NO ASSEMBLY NUMBER PREFIX—SEE END OF REPLACEABLE ELECTRICAL PARTS LIST

SG 505

2823-27
REV NOV 1983

OUTPUT

OUTPUT

2

POWER SUPPLY

3

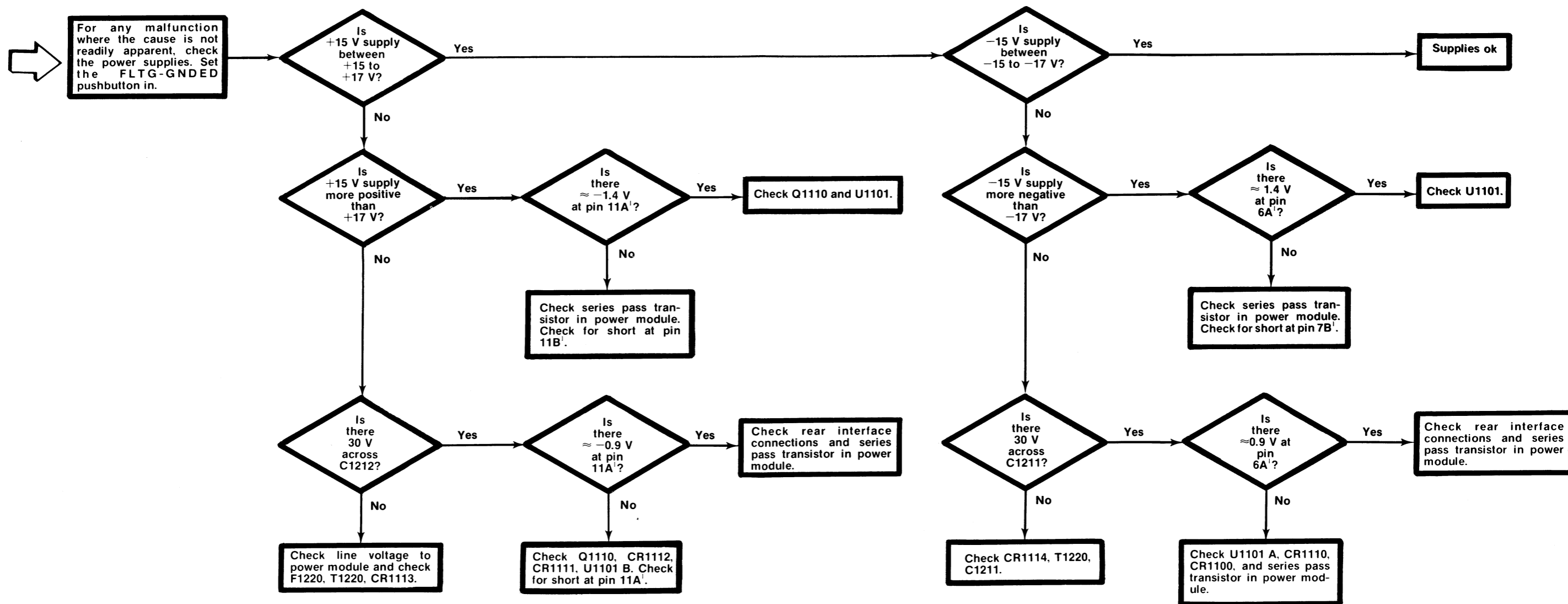

¹ On rear interface connector.

Fig. 8-4. Troubleshooting flow chart—power supply.

Table 8-4 COMPONENT REFERENCE CHART

| P/O A10 ASSY | | | Power Supply 3 | | |
|----------------|--------------------|----------------|--|--------------------|----------------|
| Circuit Number | Schematic Location | Board Location | Circuit Number | Schematic Location | Board Location |
| C1100 | F7 | B2 | Q1110 | J3 | C3 |
| C1101 | H2 | B2 | R1101 | E7 | B2 |
| C1200 | L2 | K5 | R1102 | E2 | C2 |
| C1201 | L1 | C2 | R1103 | F2 | C2 |
| C1210 | L8 | C3 | R1110 | J6 | B3 |
| C1211 | E6 | C3 | R1111 | J2 | B3 |
| C1212 | E2 | D3 | R1120 | L2 | B5 |
| C1316 | C7 | B4 | R1121 | L7 | B5 |
| CR1100 | K7 | B2 | R1205 | F2 | C2 |
| CR1110 | K7 | B3 | R1206 | F2 | C2 |
| CR1111 | K2 | B3 | R1207 | L1 | C2 |
| CR1112 | K2 | B3 | R1701 | L4 | M1 |
| CR1113 | D2 | B3 | T1220 | C2 | C5 |
| CR1114 | D6 | B3 | U1101A | J6 | B2 |
| DS510 | L4 | CHASSIS | U1101B | H3 | B2 |
| F1220 | B4 | C6 | VR1201 | F3 | C2 |

P/O A10 ASSY also shown on 1 2

T/S FLOW CHART—POWER SUPPLY COMPONENT REFERENCE CHART

A | B | C | D | E | F | H | J | K | L | M

1

2

3

4

5

6

7

8

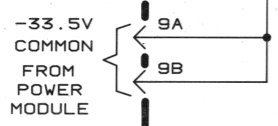
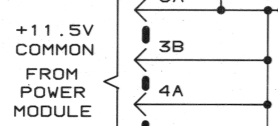
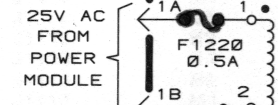
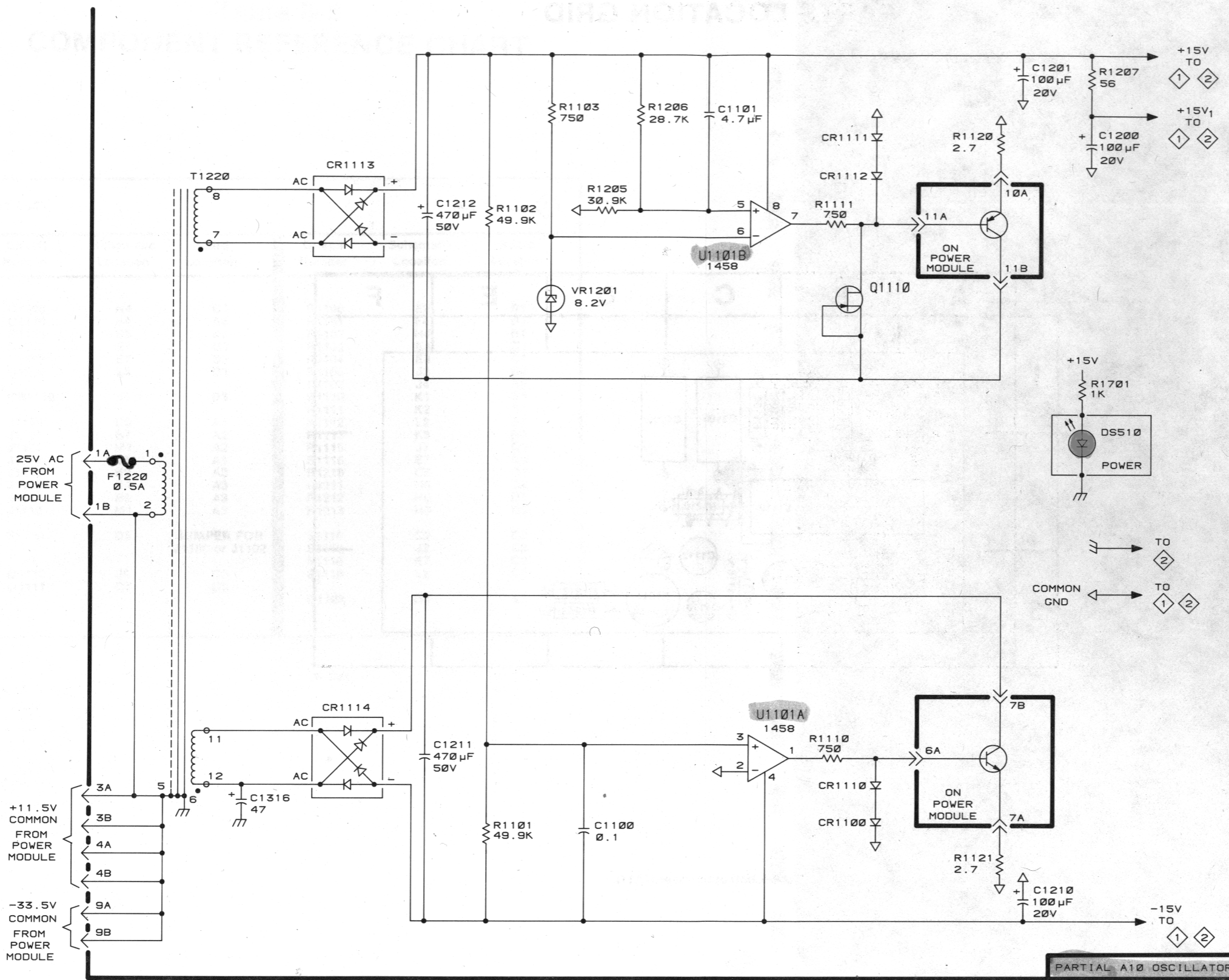

SG 505

2823-28
REV OCT 1981

POWER SUPPLY 3 JP

COMPONENT NUMBER EXAMPLE

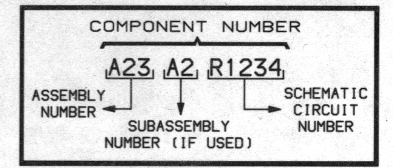

CHASSIS-MOUNTED COMPONENTS HAVE NO ASSEMBLY NUMBER PREFIX—SEE END OF REPLACEABLE ELECTRICAL PARTS LIST

⚡ STATIC SENSITIVE DEVICES
SEE MAINTENANCE SECTION

PARTIAL A10 OSCILLATOR

PARTS LOCATION GRID

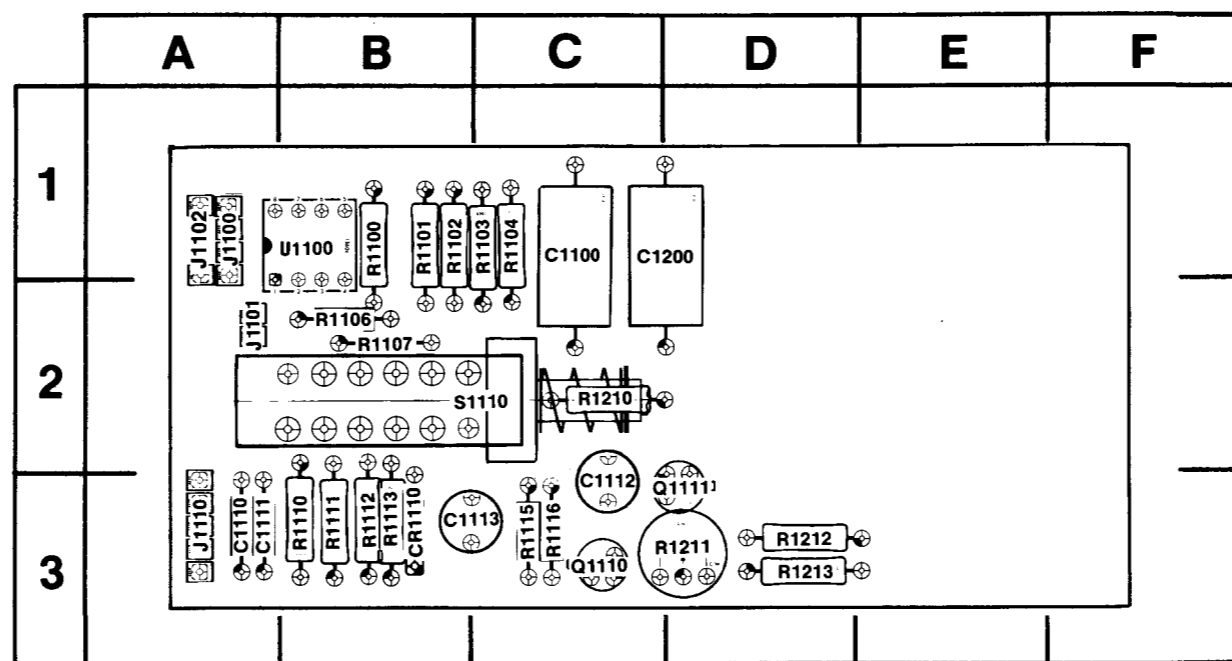

2823-17

Fig. 8-5. IMD option board (A11).

COMPONENT NUMBER EXAMPLE

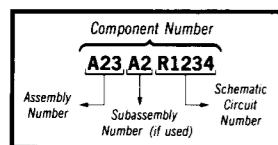

Chassis-mounted components have no Assembly Number prefix—see end of Replaceable Electrical Parts List.

Static Sensitive Devices
See Maintenance Section

Table 8-5 COMPONENT REFERENCE CHART

| A11 ASSY | | | IMD Option 4 | | |
|----------------|--------------------|------------------------------|--|--------------------|----------------|
| Circuit Number | Schematic Location | Board Location | Circuit Number | Schematic Location | Board Location |
| C1100 | H4 | C1 | R1100 | E2 | B1 |
| C1110 | B4 | A3 | R1101 | F4 | B1 |
| C1111 | B5 | A3 | R1102 | H4 | B1 |
| C1112 | E7 | C3 | R1103 | E4 | C1 |
| C1113 | E7 | B3 | R1104 | E3 | C1 |
| C1200 | E4 | D1 | R1106 | J3 | B2 |
| CR1110 | J4 | B3 | R1107 | J4 | B2 |
| J1100 | D5 | A1 | R1110 | K1 | B3 |
| J1101 | B7 | A2 | R1111 | K2 | B3 |
| J1101 | M7 | A2 | R1112 | L2 | B3 |
| J1102 | D5 | A1 | R1113 | K3 | B3 |
| J1110 | B2 | A3 | R1115 | J7 | C3 |
| J1110 | B4 | A3 | R1116 | E7 | C3 |
| J1110 | B5 | A3 | R1210 | C6 | C2 |
| J1110 | M1 | A3 | R1211 | H6 | D3 |
| P1100 | D5 | JUMPER FOR J1100 or J1102 | R1212 | H6 | D3 |
| Q1110 | J6 | C3 | R1213 | H5 | D3 |
| Q1111 | C7 | D3 | S1110 | C2 | C2 |
| | | | S1110 | J2 | C2 |
| | | | S1110 | K7 | C2 |
| | | | S1110 | L2 | C2 |
| | | | U1100 | H3 | B1 |

A | B | C | D | E | F | H | J | K | L | M

1

2

3

4

5

6

7

8

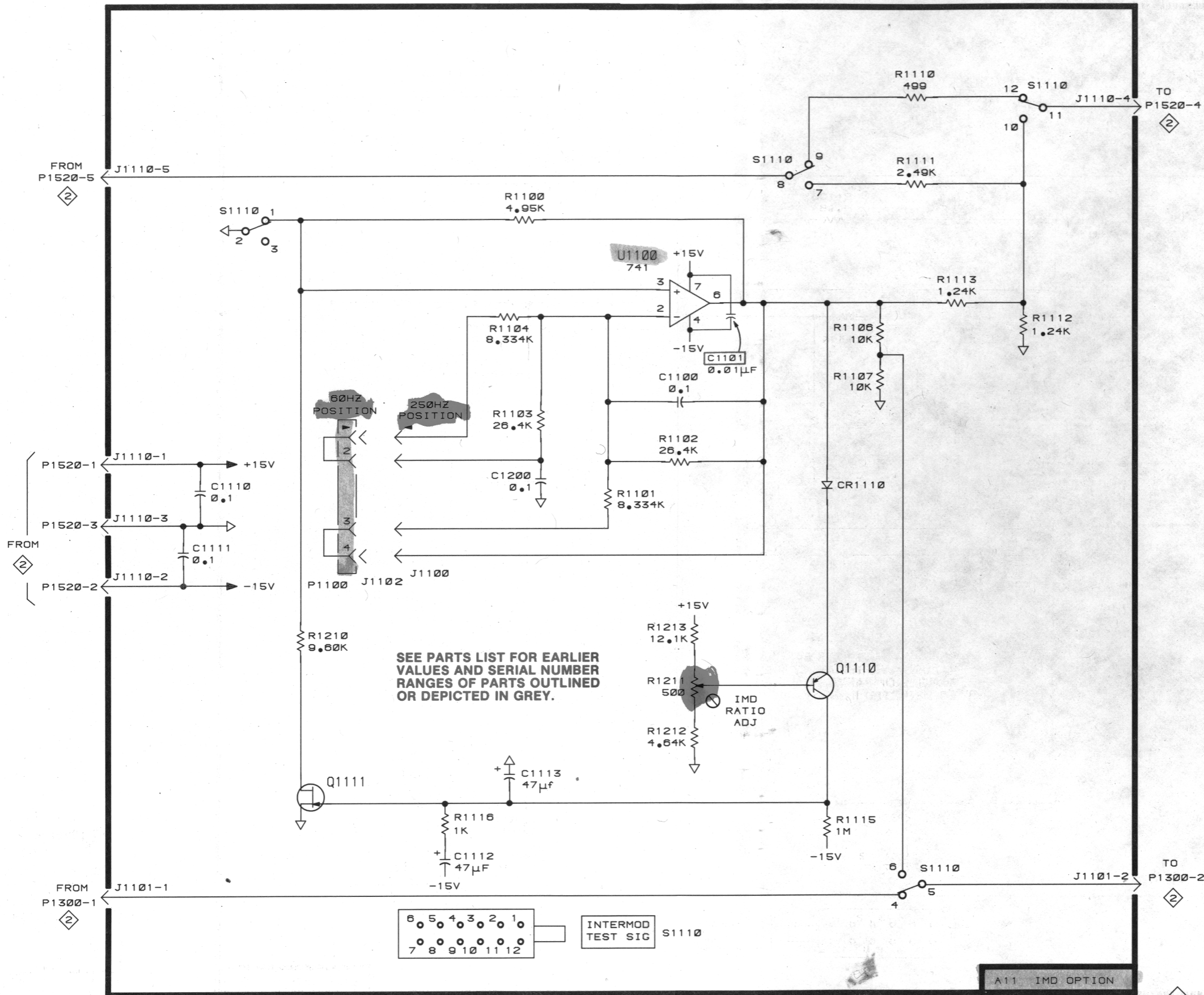

SEE PARTS LIST FOR EARLIER VALUES AND SERIAL NUMBER RANGES OF PARTS OUTLINED OR DEPICTED IN GREY.

⚡ Static Sensitive Devices
See Maintenance Section

COMPONENT NUMBER EXAMPLE

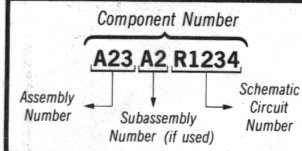

Chassis-mounted components have no Assembly Number prefix—see end of Replaceable Electrical Parts List.

IMD OPTION

4

ADJUSTMENT LOCATIONS

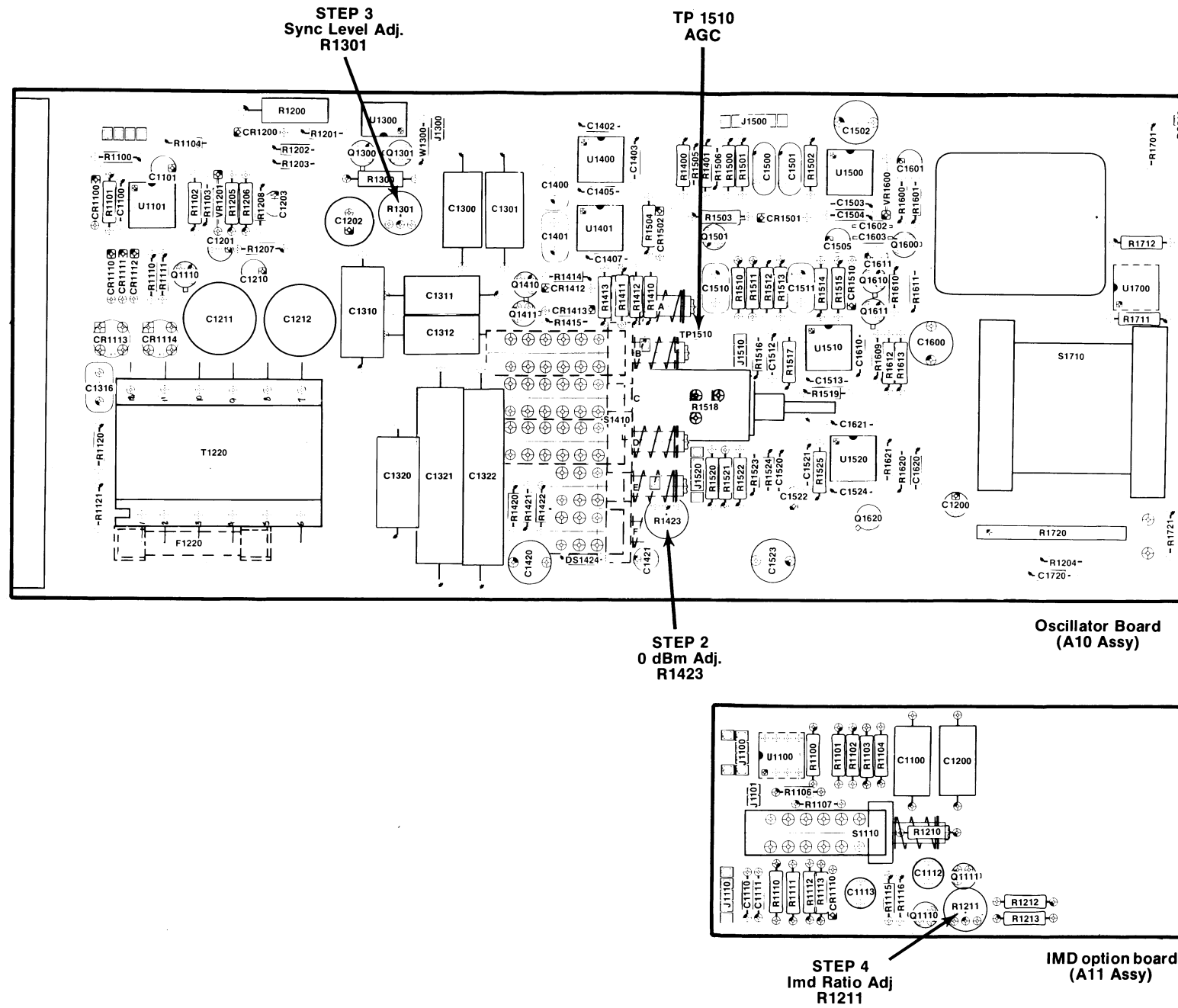

Fig. 8-6. Adjustment locations.

REPLACEABLE MECHANICAL PARTS

PARTS ORDERING INFORMATION

Replacement parts are available from or through your local Tektronix, Inc. Field Office or representative.

Changes to Tektronix instruments are sometimes made to accommodate improved components as they become available, and to give you the benefit of the latest circuit improvements developed in our engineering department. It is therefore important, when ordering parts, to include the following information in your order: Part number, instrument type or number, serial number, and modification number if applicable.

If a part you have ordered has been replaced with a new or improved part, your local Tektronix, Inc. Field Office or representative will contact you concerning any change in part number.

Change information, if any, is located at the rear of this manual.

SPECIAL NOTES AND SYMBOLS

X000 Part first added at this serial number
00X Part removed after this serial number

FIGURE AND INDEX NUMBERS

Items in this section are referenced by figure and index numbers to the illustrations.

INDENTATION SYSTEM

This mechanical parts list is indented to indicate item relationships. Following is an example of the indentation system used in the description column.

```

1 2 3 4 5           Name & Description
Assembly and/or Component
Attaching parts for Assembly and/or Component
-----
Detail Part of Assembly and/or Component
Attaching parts for Detail Part
-----
Parts of Detail Part
Attaching parts for Parts of Detail Part
-----

```

Attaching Parts always appear in the same indentation as the item it mounts, while the detail parts are indented to the right. Indented items are part of, and included with, the next higher indentation. The separation symbol --- * --- indicates the end of attaching parts.

Attaching parts must be purchased separately, unless otherwise specified.

ITEM NAME

In the Parts List, an Item Name is separated from the description by a colon (:). Because of space limitations, an Item Name may sometimes appear as incomplete. For further Item Name identification, the U.S. Federal Cataloging Handbook H6-1 can be utilized where possible.

ABBREVIATIONS

| | | | | | | | |
|-------|--------------------|---------|-----------------------|----------|----------------------|---------|-----------------|
| # | INCH | ELCTRN | ELECTRON | IN | INCH | SE | SINGLE END |
| ACTR | NUMBER SIZE | ELEC | ELECTRICAL | INCAND | INCANDESCENT | SECT | SECTION |
| ADPTR | ACTUATOR | ELCTLT | ELECTROLYTIC | INSUL | INSULATOR | SEMCOND | SEMICONDUCTOR |
| ALIGN | ADAPTER | ELEM | ELEMENT | INTL | INTERNAL | SHLD | SHIELD |
| AL | ALIGNMENT | EPL | ELECTRICAL PARTS LIST | LPHLDR | LAMPHOLDER | SHLDR | SHOULDERED |
| ASSEM | ALUMINUM | EOPT | EQUIPMENT | MACH | MACHINE | SKT | SOCKET |
| ASSY | ASSEMBLED | EXT | EXTERNAL | MECH | MECHANICAL | SL | SLIDE |
| ATTEN | ASSEMBLY | FIL | FILLISTER HEAD | MTG | MOUNTING | SFLKLG | SELF-LOCKING |
| AWG | ATTENUATOR | FLEX | FLEXIBLE | NIP | NIPPLE | SLVG | SLEEVEING |
| BD | AMERICAN WIRE GAGE | FLH | FLAT HEAD | NON WIRE | NOT WIRE WOUND | SPR | SPRING |
| BRKT | BOARD | FLTR | FILTER | OBD | ORDER BY DESCRIPTION | SQ | SQUARE |
| BRS | BRACKET | FR | FRAME or FRONT | OD | OUTSIDE DIAMETER | SST | STAINLESS STEEL |
| BRZ | BRASS | FSTNR | FASTENER | OVH | OVAL HEAD | STL | STEEL |
| BSHG | BRONZE | FT | FOOT | PH BRZ | PHOSPHOR BRONZE | SW | SWITCH |
| CAB | BUSHING | FXD | FIXED | PL | PLAIN or PLATE | T | TUBE |
| CAP | CABINET | GSKT | GASKET | PLSTC | PLASTIC | TERM | TERMINAL |
| CER | CAPACITOR | HDL | HANDLE | PN | PART NUMBER | THD | THREAD |
| CHAS | CERAMIC | HEX | HEXAGON | PNH | PAN HEAD | THK | THICK |
| CKT | CHASSIS | HEX HD | HEXAGONAL HEAD | PWR | POWER | TNSN | TENSION |
| COMP | CIRCUIT | HEX SOC | HEXAGONAL SOCKET | RCPT | RECEPTACLE | TPG | TAPPING |
| CONN | COMPOSITION | HLCPS | HELICAL COMPRESSION | RES | RESISTOR | TRH | TRUSS HEAD |
| COV | CONNECTOR | HLEXT | HELICAL EXTENSION | RGD | RIGID | V | VOLTAGE |
| CPLG | COVER | HV | HIGH VOLTAGE | RLF | RELIEF | VAR | VARIABLE |
| CRT | COUPLING | IC | INTEGRATED CIRCUIT | RTNR | RETAINER | W/ | WITH |
| DEG | CAATHODE RAY TUBE | ID | INSIDE DIAMETER | SCH | SOCKET HEAD | WSHR | WASHER |
| DWR | DEGREE | IDENT | IDENTIFICATION | SCOPE | OSCILLOSCOPE | XFMR | TRANSFORMER |
| | DRAWER | IMPLR | IMPELLER | SCR | SCREW | XSTR | TRANSISTOR |

Replaceable Mechanical Parts—SG 505

CROSS INDEX—MFR. CODE NUMBER TO MANUFACTURER

| Mfr. Code | Manufacturer | Address | City, State, Zip |
|-----------|--|------------------------------|----------------------------|
| 000CY | NORTHWEST FASTENER SALES, INC. | 7923 SW CIRBUS DRIVE | BEAVERTON, OR 97005 |
| 000EX | O'HARA METAL PRODUCT COMPANY | 542 BRANNAN STREET | SAN FRANCISCO, CA 94107 |
| 01536 | CAMCAR DIV OF TEXTRON INC. SEMS PRODUCTS UNIT | 1818 CHRISTINA ST. | ROCKFORD, IL 61108 |
| 06383 | PANDUIT CORPORATION | 17301 RIDGELAND | TINLEY PARK, IL 60477 |
| 09922 | BURNDY CORPORATION | RICHARDS AVENUE | NORWALK, CT 06852 |
| 22526 | BERG ELECTRONICS, INC. | YOUK EXPRESSWAY | NEW CUMBERLAND, PA 17070 |
| 70276 | ALLEN MFG. CO. | P. O. DRAWER 570 | HARTFORD, CT 06101 |
| 71159 | BRISTOL SOCKET SCREW, DIV. OF AMERICAN CHAIN AND CABLE CO., INC. | P O BOX 2244, 40 BRISTOL ST. | WATERBURY, CT 06720 |
| 71590 | CENTRALAB ELECTRONICS, DIV. OF GLOBE-UNION, INC. | P O BOX 858 | FORT DODGE, IA 50501 |
| 73743 | FISCHER SPECIAL MFG. CO. | 446 MORGAN ST. | CINCINNATI, OH 45206 |
| 73803 | TEXAS INSTRUMENTS, INC., METALLURGICAL MATERIALS DIV. | 34 FOREST STREET | ATTLEBORO, MA 02703 |
| 75915 | LITTELFUSE, INC. | 800 E. NORTHWEST HWY | DES PLAINES, IL 60016 |
| 78189 | ILLINOIS TOOL WORKS, INC. SHAKEPROOF DIVISION | ST. CHARLES ROAD | ELGIN, IL 60120 |
| 78471 | TILLEY MFG. CO. | 900 INDUSTRIAL RD. | SAN CARLOS, CA 94070 |
| 79136 | WALDES, KOHINOOR, INC. | 47-16 AUSTEL PLACE | LONG ISLAND CITY, NY 11101 |
| 79807 | WROUGHT WASHER MFG. CO. | 2100 S. O BAY ST. | MILWAUKEE, WI 53207 |
| 80009 | TEKTRONIX, INC. | P O BOX 500 | BEAVERTON, OR 97077 |
| 83385 | CENTRAL SCREW CO. | 2530 CRESCENT DR. | BROADVIEW, IL 60153 |
| 86928 | SEASTROM MFG. COMPANY, INC. | 701 SONORA AVENUE | GLENDALE, CA 91201 |
| 93907 | TEXTRON INC. CAMCAR DIV | 600 18TH AVE | ROCKFORD, IL 61101 |
| K0099 | JACKSON BROS (LONDON) LTD. | 258 BROADWAY | NEW YORK, NEW YORK 10007 |

| Fig. & Index No. | Tektronix Part No. | Serial/Model No. | | Qty | 1 2 3 4 5 | Name & Description | Mfr Code | Mfr Part Number |
|------------------|--------------------|------------------|---------|-----|-----------|--|----------|------------------|
| | | Eff | Dscont | | | | | |
| 1-1 | 337-1399-04 | | | 2 | | SHIELD,ELEC:SIDE | 80009 | 337-1399-04 |
| -2 | 366-1007-05 | | | 1 | | KNOB:GY,0.252 ID X 1.17 OD X 0.7 | 80009 | 366-1007-05 |
| | 213-0153-00 | | | 2 | | .SETSCREW:5-40 X 0.125,STL BK OXD,HEX | 000CY | OBD |
| -3 | 354-0557-04 | | | 1 | | RING,KNOB SKIRT:CLEAR,1.875 OD ***** (ATTACHING PARTS) ***** | 80009 | 354-0557-04 |
| -4 | 211-0030-00 | | | 2 | | SCREW,MACHINE:2-56 X 0.25"82 DEG,FLH STL ***** (END ATTACHING PARTS) ***** | 83385 | OBD |
| -5 | 210-0978-00 | B010100 | B010189 | 1 | | WASHER,FLAT:0.375 ID X 0.50 INCH OD,STL (STANDARD ONLY) | 78471 | OBD |
| | 210-0051-00 | B010190 | | 1 | | WASHER,LOCK:INTL,0.425" ID X 0.615 OD,S (STANDARD ONLY) | 78189 | 1220-08-00-0541C |
| | 210-0978-00 | B010100 | B010239 | 1 | | WASHER,FLAT:0.375 ID X 0.50 INCH OD,STL (OPTION 01 ONLY) | 78471 | OBD |
| | 210-0051-00 | B010240 | | 1 | | WASHER,LOCK:INTL,0.425" ID X 0.615 OD,S (OPTION 01 ONLY) | 78189 | 1220-08-00-0541C |
| -6 | 366-0494-05 | | | 1 | | KNOB:GRAY,0.127 ID X 0.5 OD,0.53 | 80009 | 366-0494-05 |
| | 213-0246-00 | | | 1 | | .SETSCREW:5-40 X 0.093 ITL BK OXD,HEX | 71159 | OBD |
| -7 | ----- | | | 1 | | RES.,VAR,NONWIR:(SEE R510 REPL) ***** (ATTACHING PARTS) ***** | | |
| -8 | 210-0583-00 | | | 1 | | NUT,PLAIN,HEX:0.25-32 X 0.312 INCH,BRS | 73743 | 2X20317-402 |
| -9 | 210-0940-00 | | | 1 | | WASHER,FLAT:0.25 ID X 0.375 INCH OD,STL ***** (END ATTACHING PARTS) ***** | 79807 | OBD |
| -10 | 366-1031-08 | | | 1 | | KNOB:GY,CAL/W/ARROW,0.127 ID,0.3 | 80009 | 366-1031-08 |
| | 213-0246-00 | | | 1 | | .SETSCREW:5-40 X 0.093 ITL BK OXD,HEX | 71159 | OBD |
| -11 | 366-1170-03 | | | 1 | | KNOB:GRAY,0.25 ID X 0.706 OD,0.6 | 80009 | 366-1170-03 |
| | 213-0153-00 | | | 2 | | .SETSCREW:5-40 X 0.125,STL BK OXD,HEX | 000CY | OBD |
| -12 | 358-0029-00 | | | 1 | | BSHG,MACH,THD:HEX,0.375-32 X 0.438"LONG ***** (ATTACHING PARTS) ***** | 80009 | 358-0029-00 |
| -13 | 210-0590-00 | | | 1 | | NUT,PLAIN,HEX.:0.375-32 X 0.438" BRS | 73743 | 2X28269-402 |
| -14 | 210-0978-00 | | | 1 | | WASHER,FLAT:0.375 ID X 0.50 INCH OD,STL ***** (END ATTACHING PARTS) ***** | 78471 | OBD |
| -15 | 344-0195-01 | | | 1 | | CLIP,ELECTRICAL:CAM SHAFT | 80009 | 344-0195-01 |
| -16 | ----- | | | 1 | | CONNECTOR,RCPT:(SEE J550 REPL) | | |
| -17 | 366-1690-00 | | | 1 | | KNOB:SIL GY,0.53 X 0.23 X 1.059 | 80009 | 366-1690-00 |
| -18 | ----- | | | 1 | | CONNECTOR,RCPT:(SEE J540 REPL) | | |
| -19 | 355-0170-00 | | | 1 | | STUD,SHOULDERED:6-32 X 0.40 INCH LONG ***** (ATTACHING PARTS) ***** | 80009 | 355-0170-00 |
| -20 | 220-0633-00 | | | 1 | | NUT,PLAIN,KNURL:0.25-28 X 0.25 INCH L,BRS ***** (END ATTACHING PARTS) ***** | 80009 | 220-0633-00 |
| -21 | 333-2599-00 | | | 1 | | PANEL,FRONT: | 80009 | 333-2599-00 |
| | 333-2599-01 | | | 1 | | PANEL,FRONT: (OPTION 01 ONLY) ***** (ATTACHING PARTS) ***** | 80009 | 333-2599-01 |
| -22 | 129-0510-00 | | | 2 | | POST,ELEC-MECH:0.156" LONG X 0.125 HEX BRS | 80009 | 129-0510-00 |
| -23 | 210-0053-00 | | | 2 | | WASHER,LOCK:INTL,0.092 ID X 0.175"OD,S ***** (END ATTACHING PARTS) ***** | 83385 | OBD |
| -24 | 105-0719-00 | | | 1 | | LATCH,RETAINING:PLUG-IN ***** (ATTACHING PARTS) ***** | 80009 | 105-0719-00 |
| -25 | 213-0113-00 | | | 1 | | SCR,TPG,THD FOR:2-32 X 0.312 INCH,PNH STL ***** (END ATTACHING PARTS) ***** | 93907 | OBD |
| -26 | 105-0718-01 | | | 1 | | BAR,LATCH RLSE: | 80009 | 105-0718-01 |
| -27 | 352-0157-00 | | | 1 | | LAMPHOLDER:WHITE PLASTIC | 80009 | 352-0157-00 |
| -28 | 200-0935-00 | | | 1 | | BASE,LAMPHOLDER:0.29 OD X 0.19 CASE | 80009 | 200-0935-00 |
| -29 | ----- | | | 1 | | RES.,VAR,WW:(SEE R520,R530 REPL) ***** (ATTACHING PARTS) ***** | | |
| -30 | 210-0413-00 | | | 1 | | NUT,PLAIN,HEX.:0.375-32 X 0.50 BRS | 73743 | 3145-402 |
| -31 | 210-0021-00 | B010100 | B010189 | 1 | | WASHER,LOCK:INTL,0.476 ID X 0.60"OD ST (STANDARD ONLY) | 78189 | 1222-01-00-0541C |
| | 210-0012-00 | B010190 | | 1 | | WASHER,LOCK:INTL,0.384 ID,INTL,0.022 TH (STANDARD ONLY) | 78189 | 1220-02-00-0541C |
| | 210-0021-00 | B010100 | B010239 | 1 | | WASHER,LOCK:INTL,0.476 ID X 0.60"OD ST (OPTION 01 ONLY) | 78189 | 1222-01-00-0541C |
| | 210-0012-00 | B010240 | | 1 | | WASHER,LOCK:INTL,0.384 ID,INTL,0.022 TH (OPTION 01 ONLY) ***** (END ATTACHING PARTS) ***** | 78189 | 1220-02-00-0541C |

Replaceable Mechanical Parts—SG 505

| Fig. & Index No. | Tektronix Part No. | Serial/Model No. | | Qty | Name & Description | | | | | Mfr Code | Mfr Part Number |
|------------------|--------------------|------------------|---------|-----|--|---|---|---|---|----------|-----------------|
| | | Eff | Dscont | | 1 | 2 | 3 | 4 | 5 | | |
| 1-32 | 407-1274-00 | | | 1 | BRACKET,VAR RES:ALUMINUM ***** (ATTACHING PARTS) ***** | | | | | 80009 | 407-1274-00 |
| -33 | 211-0559-00 | | | 1 | SCREW,MACHINE:6-32 X 0.375"100 DEG,FLH ST ***** (END ATTACHING PARTS) ***** | | | | | 83385 | OBD |
| -34 | 401-0161-00 | | | 1 | DRIVE,TURNS,RED:6 1 REDUCTION ***** (ATTACHING PARTS) ***** | | | | | K0099 | 4511/DAF |
| -35 | 213-0138-00 | | | 2 | SCR,TPG,TF:4-24 X 0.188 INCH,PNH STL ***** (END ATTACHING PARTS) ***** | | | | | 83385 | OBD |
| | 213-0020-00 | B010190 | | 2 | SETSCREW:6-32 X 0.125 INCH,HEX.SOC S (STANDARD ONLY) | | | | | 70276 | OBD |
| | 213-0020-00 | B020250 | | 2 | SETSCREW:6-32 X 0.125 INCH,HEX.SOC S (OPTION 01 ONLY) | | | | | 70276 | OBD |
| -36 | 386-4274-00 | | | 1 | SUBPANEL,FRONT: ***** (ATTACHING PARTS) ***** | | | | | 80009 | 386-4274-00 |
| -37 | 213-0123-00 | | | 3 | SCREW,TPG,TF:6-32 X 0.375,SPCL TYPE,FLH ***** (END ATTACHING PARTS) ***** | | | | | 93907 | OBD |
| -38 | 337-2706-00 | | | 1 | SHIELD,ELEC:REAR SUBPANEL,AL | | | | | 80009 | 337-2706-00 |
| -39 | 366-1512-00 | | | 6 | PUSH BUTTON:GRAY,0.18 SQ X 0.83 INCH LG | | | | | 80009 | 366-1512-00 |
| | 366-1512-00 | | | 7 | PUSH BUTTON:GRAY,0.18 SQ X 0.83 INCH LG (OPTION 01 ONLY) | | | | | 80009 | 366-1512-00 |
| -40 | 384-1370-00 | | | 6 | EXTENSION SHAFT:4.68" L,MOLDED PLSTC | | | | | 80009 | 384-1370-00 |
| -41 | 384-1292-00 | | | 1 | EXTENSION SHAFT:2.417 INCH LONG,PLASTIC (OPTION 01 ONLY) | | | | | 80009 | 384-1292-00 |
| | 672-0845-00 | B010100 | B030765 | 1 | CKT BOARD ASSY:OSCILLATOR (STANDARD ONLY) | | | | | 80009 | 672-0845-00 |
| | 672-0845-01 | B030766 | | 1 | CKT BOARD ASSY:OSCILLATOR (STANDARD ONLY) | | | | | 80009 | 672-0845-01 |
| | 672-0846-00 | B010100 | B030765 | 1 | CKT BOARD ASSY:OSCILLATOR (OPTION 01 ONLY) | | | | | 80009 | 672-0846-00 |
| | 672-0846-01 | B030766 | | 1 | CKT BOARD ASSY:OSCILLATOR (OPTION 01 ONLY) | | | | | 80009 | 672-0846-01 |
| -42 | 213-0146-00 | | | 4 | SCR,TPG,THD FOR:6-20 X 0.313 INCH,PNH STL ***** (END ATTACHING PARTS) ***** | | | | | 83385 | OBD |
| -43 | ----- | | | 1 | .CKT BOARD ASSY:IMD(SEE A11 REPL) (OPTION 01 ONLY) | | | | | | |
| | ----- | | | - | ***** (ATTACHING PARTS) ***** | | | | | | |
| -44 | 211-0097-00 | | | 2 | .SCREW,MACHINE:4-40 X 0.312 INCH,PNH STL (OPTION 01 ONLY) | | | | | 83385 | OBD |
| | ----- | | | - | ***** (END ATTACHING PARTS) ***** | | | | | | |
| | ----- | | | - | .CKT BOARD ASSY INCLUDES: | | | | | | |
| -45 | ----- | | | 13 | .TERMINAL,PIN:(SEE A11J1100,A11J1101, A11J1110 REPL) | | | | | | |
| -46 | 131-1207-00 | | | 1 | .LINK,TERM.CONNE:4 WIRE BLACK | | | | | 80009 | 131-1207-00 |
| -47 | ----- | | | 1 | .SWITCH,PUSH:(SEE A11S1110 REPL) | | | | | | |
| -48 | 361-0411-00 | | | 2 | .SPACER,PUSH SW:0.13 W X 0.375 INCH L,PLS | | | | | 71590 | J64285-00 |
| -49 | 136-0514-00 | B010100 | B031969 | 1 | .SKT,PL-IN ELEC:MICROCIRCUIT,8 DIP (STANDARD ONLY) | | | | | 73803 | CS9002-8 |
| | 136-0514-00 | B010100 | B031979 | 1 | .SKT,PL-IN ELEC:MICROCIRCUIT,8 DIP (OPTION 01 ONLY) | | | | | 73803 | CS9002-8 |
| -50 | 384-0496-00 | | | 1 | .EXTENSION SHAFT:4.82 L X 0.123 OD EPOXY-G | | | | | 80009 | 384-0496-00 |
| | ----- | | | 1 | .SW CAM ACTR ASSY:(SEE A10S1710 REPL) ***** (ATTACHING PARTS) ***** | | | | | | |
| -51 | 211-0678-00 | | | 4 | .SCR,ASSEM WSHR:4-40 X 0.281 L,PNH STEEL ***** (END ATTACHING PARTS) ***** | | | | | 01536 | OBD |
| | ----- | | | - | .ACTUATOR ASSY INCLUDES: | | | | | | |
| -52 | 200-2426-00 | | | 1 | .COVER,CAM SW:8 ELEMENTS,ALUMINUM ***** (ATTACHING PARTS) ***** | | | | | 80009 | 200-2426-00 |
| -53 | 211-0678-00 | | | 4 | .SCR,ASSEM WSHR:4-40 X 0.281 L,PNH STEEL ***** (END ATTACHING PARTS) ***** | | | | | 01536 | OBD |
| -54 | 354-0390-00 | | | 1 | .RING,RETAINING:0.338 ID X 0.025" THK,STL | | | | | 79136 | 5100-37MD |
| -55 | 210-0406-00 | | | 7 | .NUT,PLAIN,HEX.:4-40 X 0.188 INCH,BRS | | | | | 73743 | 12161-50 |
| -56 | 131-0963-00 | | | 1 | .CONTACT,ELEC:GROUNDING | | | | | 000EX | OBD |
| -57 | 214-1139-02 | | | 2 | .SPRING,FLAT:GREEN COLORED | | | | | 80009 | 214-1139-02 |

| Fig. & Index No. | Tektronix Part No. | Serial/Model No. | | Qty | 1 2 3 4 5 | Name & Description | Mfr Code | Mfr Part Number |
|------------------------|-----------------------|------------------|---------|-----|-----------|---|-------------|-----------------|
| | | Eff | Dscont | | | | | |
| 1-58 | 214-1752-00 | | | 2 | | ..ROLLER,DETENT: | 80009 | 214-1752-00 |
| -59 | 401-0180-00 | | | 1 | | ..BEARING,CAM SW:FRONT & REAR | 80009 | 401-0180-00 |
| -60 | 401-0178-01 | | | 1 | | ..BEARING,CAM SW:CENTER/REAR | 80009 | 401-0178-01 |
| -61 | 384-0878-18 | | | 1 | | ..SHAFT CAM SW:OUTER CNCTRC,W/DRVR,TIME/CM | 80009 | 384-0878-18 |
| -62 | 105-0836-00 | | | 1 | | ..ACTUATOR,CAM SW:ATTENUATOR | 80009 | 105-0836-00 |
| -63 | 376-0051-00 | | | 1 | | ..CPLG,SHAFT,FLEX:0.127 ID X 0.375 ID DELRI | 80009 | 376-0051-00 |
| | 131-0963-00 | | | 1 | | ..CONTACT,ELEC:GROUNDING | 000EX | OBD |
| -64 | ----- | | | 1 | | ..CKT BOARD ASSY:OSCILLATOR(SEE A10 REPL) | | |
| -65 | 136-0514-00 | B010100 | B031969 | 7 | | ..SKT,PL-IN ELEC:MICROCIRCUIT,8 DIP | 73803 | CS9002-8 |
| | ----- | | | - | | ..(STANDARD ONLY) | | |
| | 136-0727-00 | B031970 | | 4 | | ..SKT,PL-IN ELEC:MICROCKT,8 CONTACT | 09922 | DILB8P-108 |
| | ----- | | | - | | ..(STANDARD ONLY) | | |
| | 136-0514-00 | B010100 | B031979 | 7 | | ..SKT,PL-IN ELEC:MICROCIRCUIT,8 DIP | 73803 | CS9002-8 |
| | ----- | | | - | | ..(OPTION 01 ONLY) | | |
| | 136-0727-00 | B031980 | | 4 | | ..SKT,PL-IN ELEC:MICROCKT,8 CONTACT | 09922 | DILB8P-108 |
| | ----- | | | - | | ..(OPTION 01 ONLY) | | |
| -66 | 344-0326-00 | | | 2 | | ..CLIP,ELECTRICAL:FUSE,BRASS | 75915 | 102071 |
| -67 | ----- | | | 1 | | ..LINK,TERM.CONNE:(SEE A10W1300 REPL) | | |
| -68 | ----- | | | 1 | | ..RES.,VAR,NONWIR:(SEE A10R1518 REPL) | | |
| | | | | | | *****ATTACHING PARTS***** | | |
| -69 | 210-0583-00 | | | 1 | | ..NUT,PLAIN,HEX:0.25-32 X 0.312 INCH,BRS | 73743 | 2X20317-402 |
| -70 | 210-0223-00 | | | 1 | | ..TERMINAL,LUG:0.25 INCH DIA,SE | 86928 | A313-136 |
| -71 | 210-0905-00 | | | 1 | | ..WASHER,FLAT:0.256 ID X 0.05 THK,BRS | 83385 | OBD |
| | | | | | | *****END ATTACHING PARTS***** | | |
| -72 | 361-0515-00 | | | 1 | | ..SPACER,SWITCH:PLASTIC | 80009 | 361-0515-00 |
| -73 | ----- | | | 1 | | ..TERM.SET,PIN:(SEE A10J1500,A10J1510 REP | | |
| -74 | 136-0252-07 | | | 3 | | ..SOCKET,PIN CONN:W/O DIMPLE | 22526 | 75060-012 |
| -75 | 131-0604-00 | | | 8 | | ..CONTACT,ELEC:CKT BD SW,SPR,CU BE | 80009 | 131-0604-00 |
| -76 | ----- | | | 1 | | ..TERM,TEST POINT:(SEE A10TP1510 REPL) | | |
| -77 | 334-2990-00 | | | 1 | | ..MARKER,IDENT:CAUTION | 80009 | 334-2990-00 |
| -78 | ----- | | | 1 | | ..SWITCH,PUSH:(SEE A10S1410 REPL) | | |
| -79 | 361-0411-00 | | | 4 | | ..SPACER,PUSH SW:0.13 W X 0.375 INCH L,PLS | 71590 | J64285-00 |
| | 346-0120-00 | | | 1 | | ..STRAP,TIEDOWN:5.5 L MIN,PLASTIC | 06383 | SST 1.5M |
| -80 | 351-0612-00 | | | 2 | | GUIDE,CKT BOARD:NYLON,1.0 L | 80009 | 351-0612-00 |
| -81 | 386-4278-00 | | | 1 | | SUPPORT,FRAME:REAR,AL | 80009 | 386-4278-00 |
| | | | | | | *****ATTACHING PARTS***** | | |
| -82 | 213-0146-00 | | | 2 | | SCR,TPG,THD FOR:6-20 X 0.313 INCH,PNH STL | 83385 | OBD |
| -83 | 386-3657-01 | | | 2 | | SUPPORT,PLUG IN: | 93907 | OBD |
| | | | | | | *****END ATTACHING PARTS***** | | |
| -84 | 214-1061-00 | | | 1 | | SPRING,GROUND:FLAT | 80009 | 214-1061-00 |
| -85 | 426-0725-05 | | | 1 | | FR SECT,PLUG-IN:TOP | 80009 | 426-0725-05 |
| -86 | 426-0724-09 | | | 1 | | FR SECT,PLUG-IN:BOTTOM | 80009 | 426-0724-09 |
| -87 | ----- | | | 1 | | CA ASSY,SP,ELEC:(SEE P1510 REPL) | | |
| | 352-0161-03 | | | 1 | | ..CONN BODY,PL,EL:3 WIRE ORANGE | 80009 | 352-0161-03 |
| -88 | ----- | | | 1 | | CA ASSY,SP,ELEC:(SEE P1500 REPL) | | |
| | 352-0164-06 | | | 1 | | ..CONN BODY,PL,EL:6 WIRE BLUE | 80009 | 352-0164-06 |
| -89 | ----- | | | 1 | | CA ASSY,SP,ELEC:(SEE P1101 REPL) | | |
| | ----- | | | - | | (OPTION 01 ONLY) | | |
| | 352-0169-02 | | | 2 | | ..CONN BODY,PL,EL:2 WIRE RED | 80009 | 352-0169-00 |
| -90 | ----- | | | 1 | | CA ASSY,SP,ELEC:(SEE P1110 REPL) | | |
| | ----- | | | - | | (OPTION 01 ONLY) | | |
| | 352-0163-05 | | | 2 | | ..CONN BODY,PL,EL:5 WIRE GREEN | 80009 | 352-0163-05 |

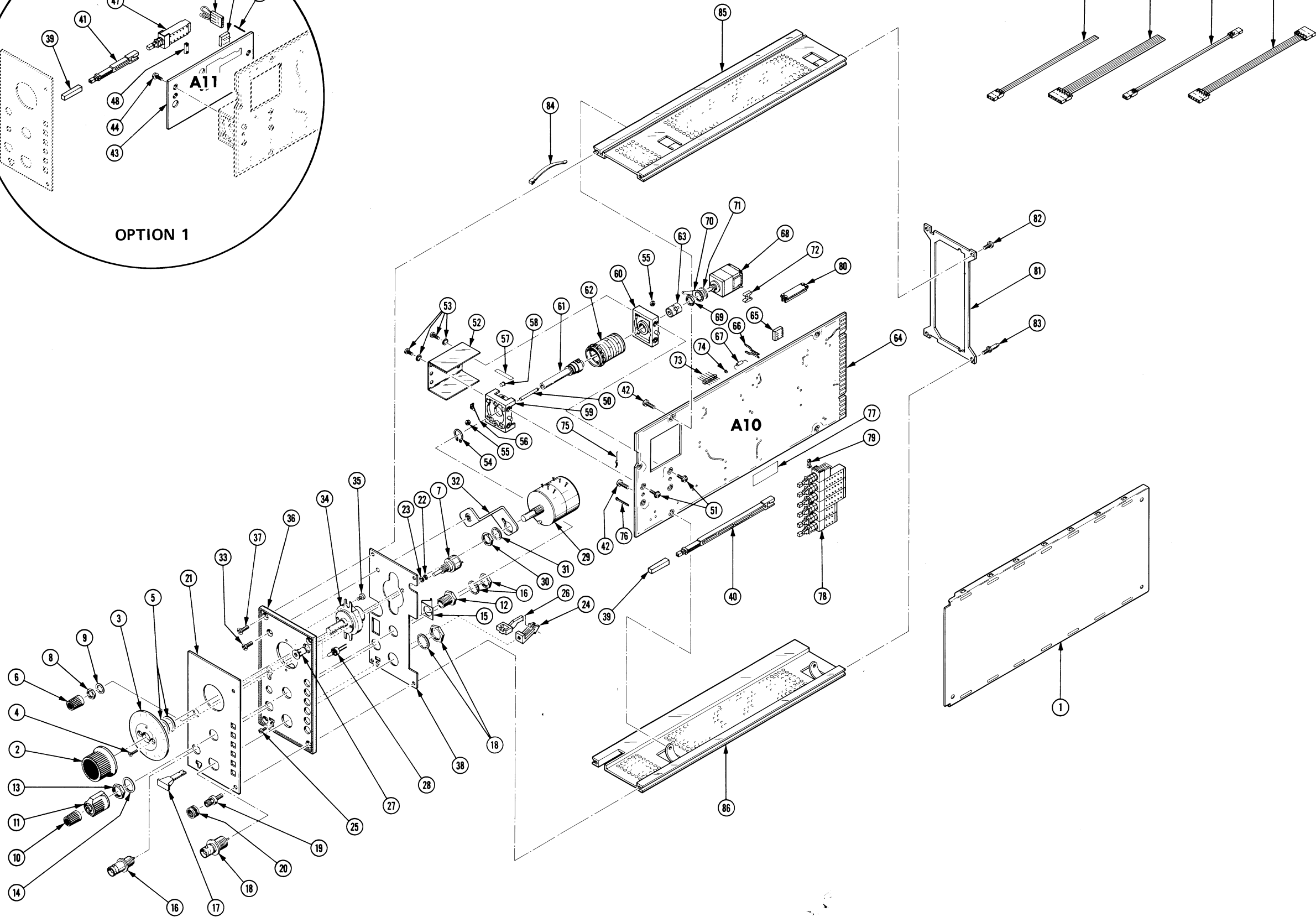
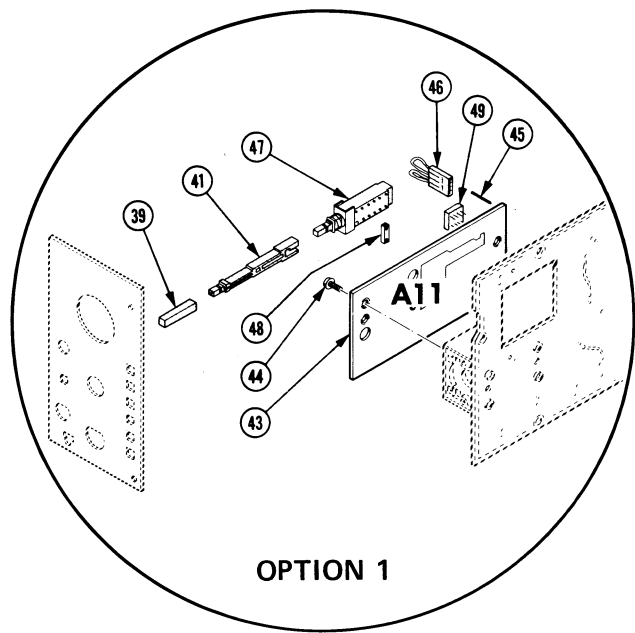

@

ACCESSORIES

| Fig. & Index No. | Tektronix Part No. | Serial/Model No. Eff | Dscont | Qty | 1 | 2 | 3 | 4 | 5 | Name & Description | Mfr Code | Mfr Part Number |
|------------------|--------------------|----------------------|--------|-----|---|---|---|---|---|---------------------------------------|----------|-----------------|
| | 070-2823-00 | | | 1 | | | | | | MANUAL, TECH: INSTR, SG505 OSCILLATOR | 80009 | 070-2823-00 |

ACCESSORIES

@

SG 505

MANUAL CHANGE INFORMATION

At Tektronix, we continually strive to keep up with latest electronic developments by adding circuit and component improvements to our instruments as soon as they are developed and tested.

Sometimes, due to printing and shipping requirements, we can't get these changes immediately into printed manuals. Hence, your manual may contain new change information on following pages.

A single change may affect several sections. Since the change information sheets are carried in the manual until all changes are permanently entered, some duplication may occur. If no such change pages appear following this page, your manual is correct as printed.

DESCRIPTION

PG 75

Effective Serial Number: B042240 (standard), B042190 (Option 01)

CHANGE TO:

| Figure | Quantity | Part No. | Description |
|--------|----------|-------------|-------------------------------|
| 1-1 | 2 | 337-3039-04 | Shield, Elec: Side |
| 1-17 | 1 | 366-1851-01 | Knob, Latch |
| 1-19 | 1 | 355-0239-00 | Stud, Shouldered |
| 1-24 | 1 | 105-0866-00 | Latch, Retaining: Plug-in |
| 1-26 | 1 | 105-0865-00 | Bar Latch, Release |
| 1-37 | 1 | 211-0025-00 | Screw, 4-40 x 0.375L |
| | 3 | 211-0101-00 | Screw, 4-40 x 0.250L |
| 1-32 | 1 | 407-2975-00 | Bracket, Var. Res. |
| 1-38 | 1 | 337-0210-00 | Shield, Elec: Front Sub Panel |
| 1-81 | 1 | 386-4866-00 | Support, Frame, Rear |
| 1-84 | 1 | 214-3406-00 | Spring, Ground: Flat |
| 1-85 | 1 | 426-0725-24 | Frame Sect: Top |
| 1-86 | 1 | 426-0724-25 | Frame Sect: Bottom |

REMOVE:

| | | | |
|------|---|-------------|-----------------------------------|
| 1-5 | 1 | 210-0051-00 | Washer, Lock: 0.425 ID x 0.615 OD |
| 1-14 | 1 | 210-0978-00 | Washer, Flat: 0.375 ID x 0.50 OD |
| 1-22 | 2 | 129-0510-00 | Post, Elec-Mech: 0.156L x 0.125 |
| 1-23 | 2 | 210-0053-00 | Washer, Lock: 0.092 ID x 0.175 OD |
| 1-25 | 1 | 213-0113-00 | Scr, Tpg, Thd For: 2.32 x 0.312 |
| 1-33 | 1 | 211-0559-00 | Screw, Mach: 6-32 x 0.375 100 Deg |
| 1-36 | 1 | 386-4274-00 | Subpanel, Front |

ADD:

| | | |
|---|-------------|------------------------------------|
| 2 | 105-0932-00 | Latch, Panel: Side |
| 1 | 210-1258-00 | Washer, Lamp |
| 1 | 211-0658-00 | Screw, 6-32 x 0.312 |
| 2 | 213-0793-00 | Screw, Tpg: 6-32 x 0.437 |
| 1 | 214-3143-00 | Spring, Latch |
| 2 | 214-3364-00 | Fastener Latch: Side |
| 1 | 333-1855-00 | Panel, Front, Assembly (Standard) |
| 1 | 333-1950-00 | Panel, Front, Assembly (Option 01) |

Figure Numbers refer to the numbers on the Figure 1 Exploded View.

DESCRIPTION

PG 75

EFF SN B050760

REPLACEABLE ELECTRICAL PARTS AND SCHEMATIC CHANGES

CHANGE TO:

A12 670-7755-01 CKT BOARD ASSY:OSCILLATOR

A12R1515 321-0360-00 RES., FXD, FILM: 54.9K OHM, 1%, 0.125W

R1515 is located on the Oscillator board and is

shown on diagram  OSCILLATOR.

DESCRIPTION

PG 75

EFF SN B052741

REPLACEABLE ELECTRICAL PARTS AND SCHEMATIC CHANGES

CHANGE TO:

A10 670-6337-04 CKT BOARD ASSY:OSCILLATOR
(STANDARD ONLY)

A10 670-6338-04 CKT BOARD ASSY:OSCILLATOR
(OPTION 1 ONLY)

A10R1515 321-0360-00 RES., FXD, FILM:54.9K OHM, 1%, 0.125W

R1515 is located on the Oscillator board and is
shown on diagram  OSCILLATOR.

Date: Jul 31, 1986 Change Reference: C4/0786
 Product: SG 505 Option 01 Manual Part No.: 070-2823-00

DESCRIPTION

For Manuals Revised MAR 1986:

Board dollie and component reference table 8-1 were omitted during printing of manual.

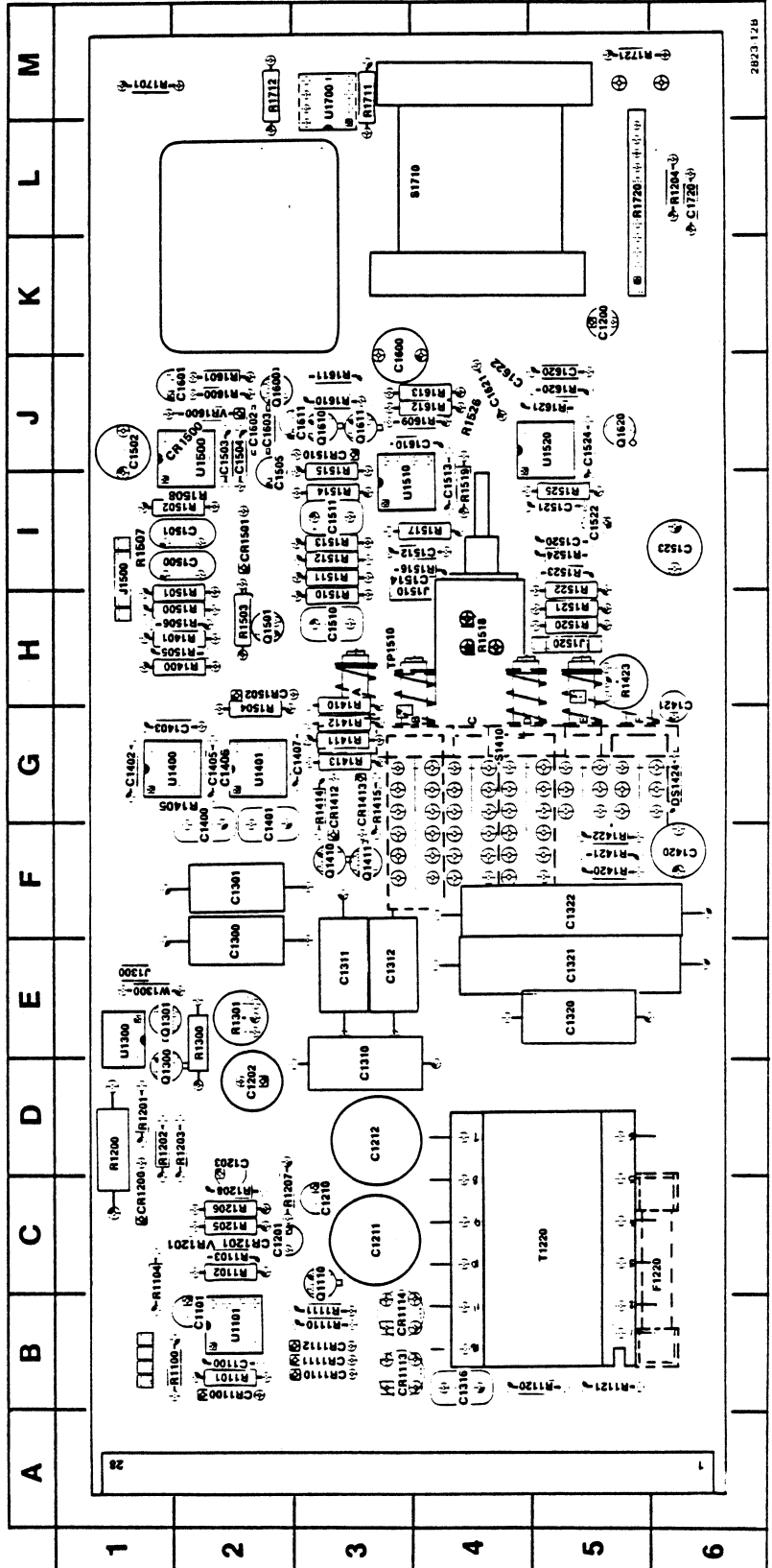
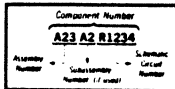

Fig. 8-2. Oscillator board (A10).

COMPONENT NUMBER EXAMPLE



Use Only Approved Components. Have the Assembly Number Marked on the end of the Component Part, Ltd.

⊗ Static Sensitive Devices See Maintenance Section

DESCRIPTION

**Table 8-2
COMPONENT REFERENCE CHART**

| P/O A10 ASSY | | | Oscillator  | | |
|----------------|--------------------|----------------|--|--------------------|----------------|
| Circuit Number | Schematic Location | Board Location | Circuit Number | Schematic Location | Board Location |
| C1300 | L3 | E2 | R520 | F3 | CHASSIS |
| C1301 | H2 | F2 | R530 | J4 | CHASSIS |
| C1310 | L2 | D3 | R1400 | K4 | H2 |
| C1311 | L2 | E3 | R1401 | F3 | H2 |
| C1312 | J2 | E3 | R1405*† | L5 | G2 |
| C1320 | J2 | E5 | R1410 | K5 | G3 |
| C1321 | L2 | E5 | R1411 | K5 | G3 |
| C1322 | J1 | F5 | R1412 | J6 | G3 |
| C1400 | H3 | F2 | R1413 | J6 | G3 |
| C1401 | L3 | F2 | R1414 | K4 | G3 |
| C1402 | H4 | G1 | R1415 | K6 | G3 |
| C1403 | H3 | G2 | R1420 | F1 | F5 |
| C1405 | L4 | G2 | R1421 | K2 | F5 |
| C1406*† | L4 | G2 | R1422 | K2 | F5 |
| C1407 | L4 | G3 | R1500 | J5 | H2 |
| C1420 | A6 | F6 | R1501 | F4 | H2 |
| C1421 | C6 | G6 | R1502 | A4 | I2 |
| C1500 | J5 | I2 | R1503 | H7 | H2 |
| C1501 | E4 | I2 | R1504 | J6 | G2 |
| C1502 | A4 | J1 | R1505 | J4 | H2 |
| C1503 | F7 | J2 | R1506 | F3 | H2 |
| C1504 | F6 | J2 | R1507*† | A5 | I1 |
| C1505 | H6 | J2 | R1508*† | H7 | I2 |
| C1510 | D5 | H3 | R1510 | D5 | H3 |
| C1511 | D4 | I3 | R1511 | D4 | I3 |
| C1512 | D2 | I4 | R1512 | D5 | I3 |
| C1513 | D3 | I4 | R1513 | D4 | I3 |
| C1514*† | E2 | I4 | R1514 | C3 | I3 |
| C1523 | B6 | I6 | R1515* | C3 | I3 |
| C1600 | D7 | J3 | R1516 | C3 | I4 |
| C1601 | F5 | J2 | R1517 | D2 | I4 |
| C1602 | D7 | J2 | R1519 | D4 | I4 |
| C1603 | E5 | J2 | R1523 | H5 | I5 |
| C1610 | D3 | J4 | R1600 | E7 | J2 |
| C1611 | D6 | J3 | R1601 | F6 | J2 |
| CR1412 | K4 | G3 | R1609 | E3 | J4 |
| CR1413 | K6 | G3 | R1610 | D7 | J3 |
| CR1500*† | F7 | J2 | R1611 | D7 | J3 |
| CR1501 | H6 | I2 | R1612 | D2 | J4 |
| CR1502 | H6 | H2 | R1613 | D6 | J4 |
| CR1510 | D6 | J3 | S1410B | C6 | G4 |
| J1500 | J4 | I1 | S1410B | H2 | G4 |
| J1500 | F3 | I1 | S1410C | B6 | G4 |
| J1510 | B3 | H4 | S1410C | L2 | G4 |
| P1500 | J4 | CHASSIS | S1410C | H2 | G4 |
| P1500 | F3 | CHASSIS | S1410D | A5 | G4 |
| P1510 | B3 | CHASSIS | S1410D | H1 | G4 |
| Q1410 | K5 | F3 | S1410D | H5 | G4 |
| Q1411 | K6 | F3 | S1410D | K2 | G4 |
| Q1501 | C4 | H2 | TP1510 | A7 | H3 |
| Q1600 | E7 | J2 | U1400 | H3 | G2 |
| Q1610 | D7 | J3 | U1401 | L4 | G2 |
| Q1611 | D6 | J3 | U1500 | H6 | J2 |
| R510 | B3 | CHASSIS | U1510 | D3 | I3 |
| | | | VR1600 | F7 | J2 |

PO/ A10 ASSY also shown on  

*SEE PARTS LIST FOR SERIAL NUMBER RANGES.

†LOCATED ON BACK OF BOARD