

TEKTRONIX®

**AF 501
BANDPASS
FILTER**

INSTRUCTION MANUAL

Tektronix, Inc.
P.O. Box 500
Beaverton, Oregon 97077

Serial Number _____



WARRANTY

All Tektronix instruments are warranted against defective materials and workmanship for one year. Any questions with respect to the warranty should be taken up with your Tektronix Field Engineer or representative.

All requests for repairs and replacement parts should be directed to the Tektronix Field Office or representative in your area. This will assure you the fastest possible service. Please include the instrument type number or part number and serial number with all requests for parts or service.

Specifications and price change privileges reserved.

Copyright © 1974, 1977 by Tektronix, Inc., Beaverton, Oregon. Printed in the United States of America. All rights reserved. Contents of this publication may not be reproduced in any form without permission of Tektronix, Inc.

U.S.A. and foreign Tektronix products covered by U.S. and foreign patents and/or patents pending.

TEKTRONIX is a registered trademark of Tektronix, Inc.



AF 501 Bandpass Filter plug-in unit.

1770

OPERATING INSTRUCTIONS

INTRODUCTION

The AF 501 is a bandpass-filter amplifier, ac-coupled amplifier, and sine-wave generator designed to operate in a single TM 500-series module. Used alone or in conjunction with other TM 500-series instruments, the AF 501 is a highly versatile and accurate signal analysis tool. When used as a bandpass filter, it has an effective Q of 5 in the BROAD position or 15 in the NARROW position. In both the BANDPASS FILTER and OSCILLATOR mode of operation, the tuning range is from 3 hertz to 35 kilohertz. As an ac-coupled, broadband amplifier the AF 501 range is from 0.5 hertz to 50 kilohertz.

Three front-panel bnc connectors are provided: an INPUT connector for amplifier and bandpass filter input signals; an OUTPUT connector for output signals from the amplifier, bandpass filter and oscillator; and a TRIG OUT connector for internally generated pulses. The Trig Out pulse, generated when the positive slope of an output signal greater than 500 millivolts peak-to-peak passes through zero, has an amplitude of at least 10 volts and a duration of 10 ± 5 microsecond. It can be used to trigger an oscilloscope sweep or strobe-light, or used as an input to a frequency counter.

A single knob with a frequency range from 3 hertz to 35 kilohertz is used for tuning the bandpass filter or oscillator. The dial readout, in Hz and CPM (cycles per minute), has a range from 3 to 40 Hz and 180 to 2400 CPM. Frequency multiplication of X1, X10, X100 and X1K is provided by front-panel, self-cancelling, pushbuttons.

Installation and Removal

CAUTION

Turn the power module off before inserting the plug-in; otherwise, damage may occur to the plug-in circuitry. It is also recommended that the power module be turned off before removing the AF 501. Refer to Fig. 1-1. Check to see that the plastic barriers on the interconnecting jack of the selected power module compartment match the cut-outs in the AF 501 circuit board edge connector.

Align the AF 501 chassis with the upper and lower guides of the selected compartment. Push the module in and press firmly to seat the circuit board in the interconnecting jack.

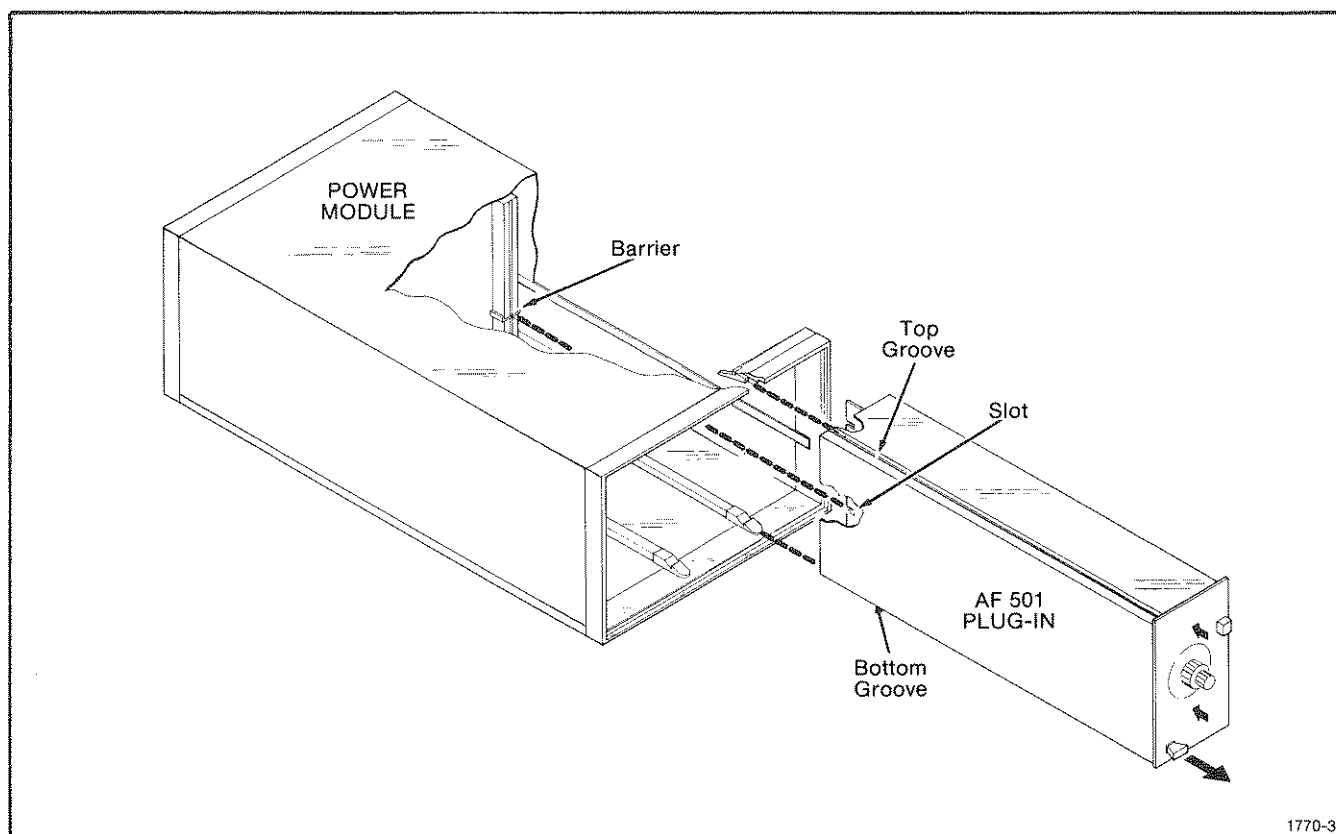

Fig. 1-1. Plug-in module installation/removal.

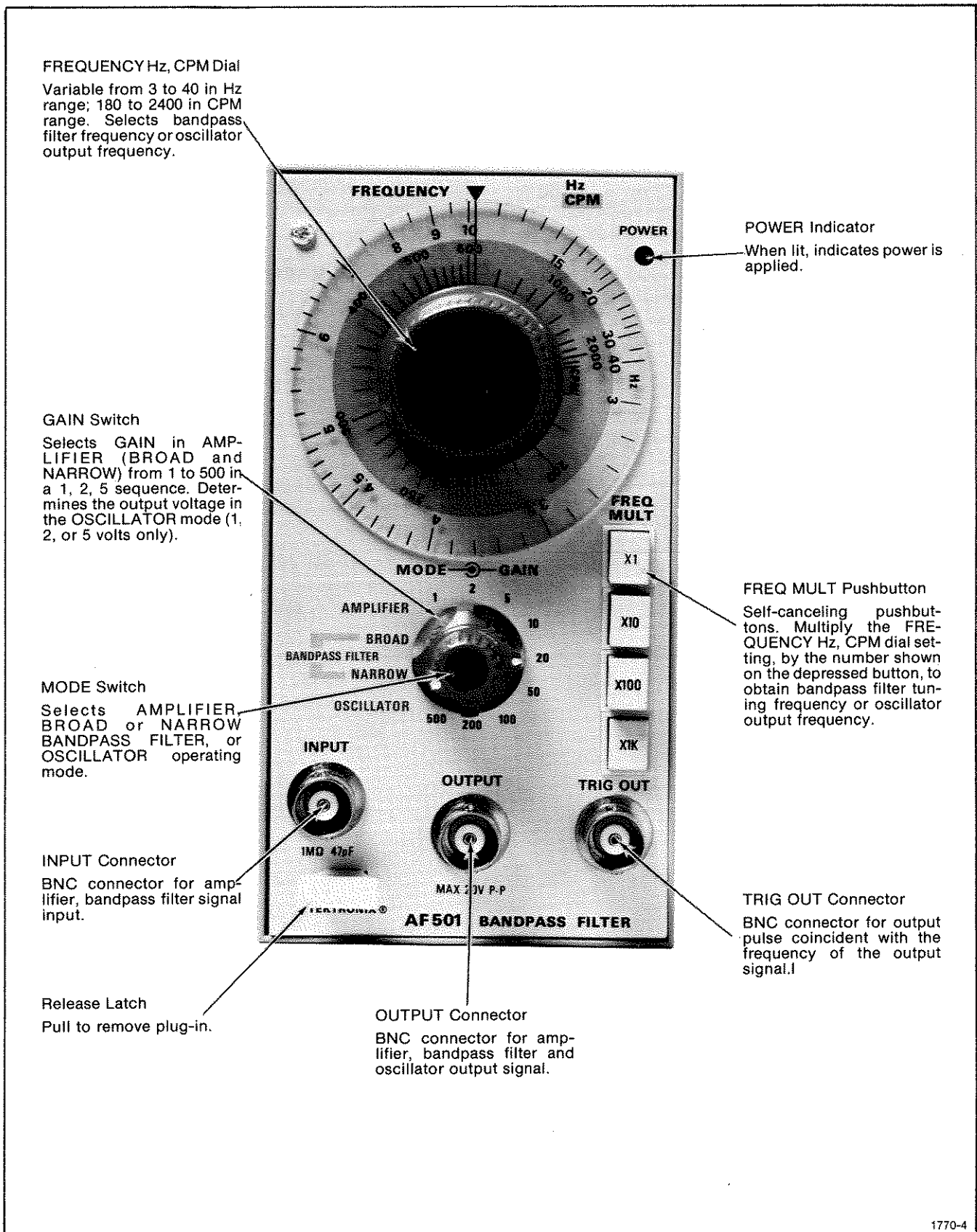

Fig. 1-2. AF 501 controls and connectors.

To remove the AF 501, pull on the release latch located in the lower left corner until the interconnecting jack disengages and the AF 501 will slide out.

Controls and Connectors

Refer to Fig. 1-2. Even though the AF 501 is fully calibrated and ready to use, the functions and actions of the controls and connectors should be reviewed before attempting to use it. Pull the Power switch on the power module to apply power to the AF 501. The POWER indicator light indicates when power is applied to the AF 501.

OPERATING CONSIDERATIONS

Overheating

The AF 501 is designed to operate at an ambient temperature from 0-degree Celsius to +50-degree Celsius. However, when operating several power supplies in a multi-plug-in power module, especially at low output voltages, or when operating close to other heat-producing equipment, internal temperature may exceed safe limits and actuate a thermal cutout in the power module. Refer to the power module instruction manual for more complete information.

OPERATING MODES

Amplifier

When the MODE switch is set to AMPLIFIER, the AF 501 functions as an ac-coupled, single-ended amplifier, with a bandwidth ranging from 0.5 hertz to 50 kilohertz, maximum 20 volts peak-to-peak output and X500 maximum amplification. The gain from 1 to 500 is controlled by the GAIN switch in a 1, 2, 5 sequence.

NOTE

The AF 501 may be used with a 10X voltage probe. Slew rate at the probe tip must not exceed 2.5 volts per microsecond. This is especially true when using a pulse for compensating the probe. If the slew rate limitation is exceeded, the input capacitance of the AF 501 is no longer constant making compensation impossible.

The amplifier (and bandpass filter) output signal of maximum 20 milliamperes peak-to-peak at 20 volts peak-to-peak, and 50 milliamperes peak-to-peak at 10 volts peak-to-peak, can be used to drive the majority of galvanometers or provide amplification of low-level signals for other subsequent instrumentation. By adding a resistor in series with the output, lower current limits can be obtained when needed.

Bandpass Filter, Narrow and Broad

When the MODE switch is set to one of the BANDPASS FILTER positions, the AF 501 functions as a tunable bandpass filter amplifier. The tuning range is from 3 hertz to 35 kilohertz. There are two bandpass filter switch positions. The effective Q of the filter is approximately 15 in the NARROW position or approximately 5 in the BROAD position. In the BROAD setting, tuning is not as critical, but the signal will not be cleaned-up as well as in the NARROW setting.

The FREQUENCY knob can be adjusted to tune the AF 501 to a single frequency of the input signal, which can be read from the FREQUENCY dial readout.

Oscillator

The AF 501 operates as an oscillator ranging from 3 hertz to 35 kilohertz when the MODE switch is set to that position. Output voltage of 1, 2, or 5 volts peak-to-peak sine-wave, controlled by the GAIN switch is available at the OUTPUT connector. The leading digit marking the GAIN switch position indicates the voltage output. In other words, switch positions 1, 10 and 100 all provide a 1-volt output; 2, 20 and 200 produce a 2-volt output; and switch positions 5, 50, and 500 provide a 5-volt output.

APPLICATIONS

Amplifier

The AMPLIFIER mode can be used to check the input signal to the AF 501. To examine the input signal from a transducer, for example, set the MODE switch to AMPLIFIER and observe the amplified output waveform on a monitor. To find the amplitude of the input signal, divide the amplitude displayed on the monitor by the gain setting of the AF 501.

If the waveform display of the input signal is "clipped" in the AMPLIFIER mode, it is an indication that the input signal or the AF 501 gain setting is too large.

Bandpass Filter, Narrow and Broad

With the MODE switch set to one of the BANDPASS FILTER positions, the AF 501 can be used for amplification, and accurate frequency and amplitude component analysis in complex vibration, sound and ultrasound signals. Using a monitor or oscilloscope, the AF 501 can be used to clean up noisy waveforms for dynamic balancing of rotating machines or to look at higher-order, shock-type disturbances. Such disturbances may occur in engines, compressors, ball bearings, etc. caused by valve action, looseness, wear, leaks or blowdry. See Fig. 1-3 for reference.

To tune the center frequency of the bandpass filter to one of the frequency components of an input signal, connect the signal source or transducer to the INPUT connector of the AF 501. The type of signal source used determines whether volts, amps or some other quantity is measured. Connect the OUTPUT connector of the AF 501 to an oscilloscope or other monitoring device.

Set the MODE switch to BANDPASS FILTER, NARROW or BROAD, depending on the requirements and set the GAIN switch high enough so there is sufficient signal to be detected at the OUTPUT. Make sure the input signal or gain is not so high that it overdrives the amplifier. (Check by switching the MODE switch to the AMPLIFIER position and verify that the signal displayed on a cathode-ray-tube monitor or oscilloscope is not "clipped".) Adjust the FREQUENCY knob to display maximum amplitude on the monitor. The AF 501 is now tuned to a single frequency on the input signal which can be read from the FREQUENCY dial readout. The amplitude can be read from the monitor.

The bandpass filter (as well as the amplifier) output signal can be used to drive a galvanometer up to 50 milliamperes peak-to-peak or amplify low-level signals.

The TRIG OUT pulse in BANDPASS FILTER mode can be used to accurately measure the frequency of a repetitive input signal with a counter. The TRIG OUT signal provides this same tuned frequency when the AF 501 is switched to the OSCILLATOR mode. Thus, with an appropriate input signal a counter can be used to calibrate the FREQUENCY dial in either the BANDPASS FILTER mode or the OSCILLATOR mode of operation.

With a dual channel counter having Ratio A/B capabilities, the order of frequency components can be read-out directly. To do this, connecting the signal from TRIG OUT (in BANDPASS FILTER mode) to Channel A and connect the basic reference signal, such as 1X rpm shaft pip mark, to Channel B. See Fig. 1-4 for reference.

Oscillator

The oscillator frequency, controlled by the FREQUENCY dial and FREQ MULT pushbuttons, is the same as the center frequency of the bandpass filter. Therefore, with the AF 501 used in the OSCILLATOR mode, the center frequency of the bandpass filter can be displayed on a frequency counter using the signal from TRIG OUT to trigger the counter.

In the OSCILLATOR mode of operation, a method of tuning the filter to the rotational speed of a shaft or rotor is to connect a stroboscope to TRIG OUT, which freezes the shaft motion. Another method is to compare the OSCILLATOR sine-wave frequency with the signal frequency of an electromagnetic pick-up on a dual-trace oscilloscope, or on a dual-channel counter.

Specific Applications

Figs. 1-3 through 1-5 show three specific applications using the AF 501, along with the waveform analysis of the performed measurement. These applications illustrate the many possible uses for the AF 501.

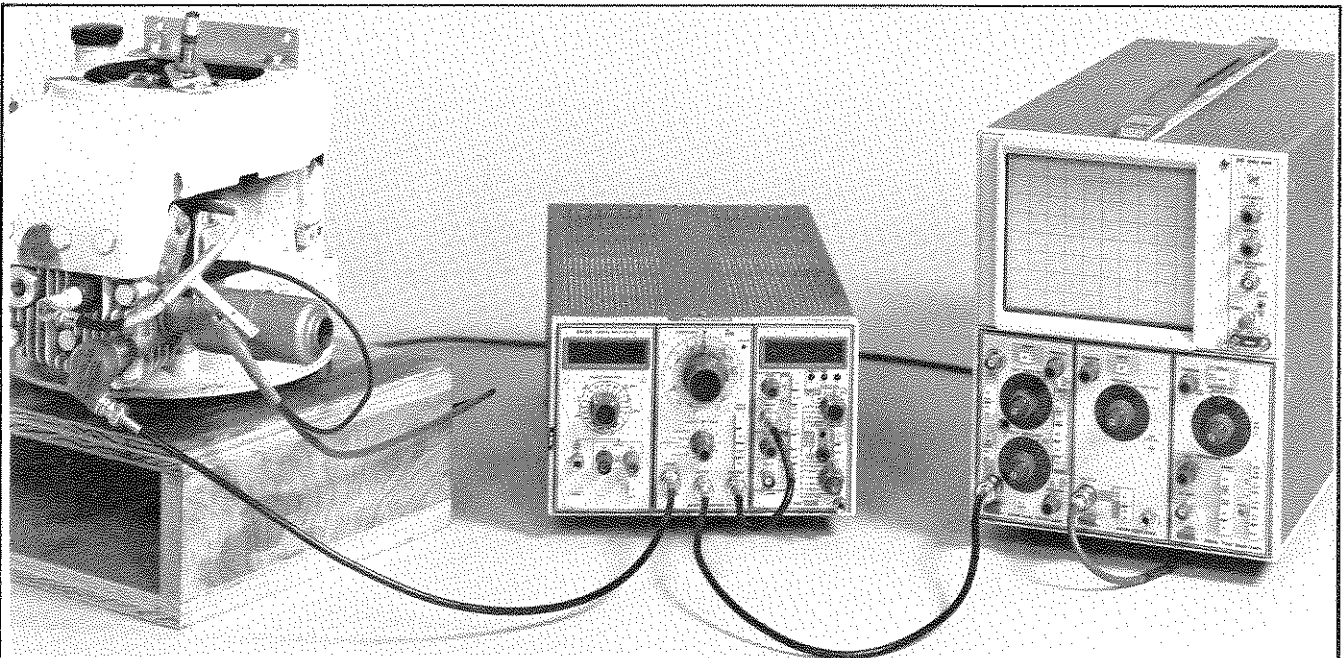

Instrumentation:

AF 501 Bandpass Filter installed in a TM 500-Series Power Module with DC 503 Universal Counter and DM 501 Digital Multimeter.

Unfiltered Vibration Pattern

5110 Oscilloscope with 5A18, 5A15 and 5B10 plug-ins

Sweep Rate: ≈ 15 ms/div
Vertical Sensitivity: 20 mV/div

Lawn Mower Test Engine (710 rpm)

Vibration Transducer (Accelerometer, 40 Hz to ≈ 11 kHz), Tektronix Part No. 015-0116-00

Ignition Pick-off, Tektronix Part No. 012-0139-00

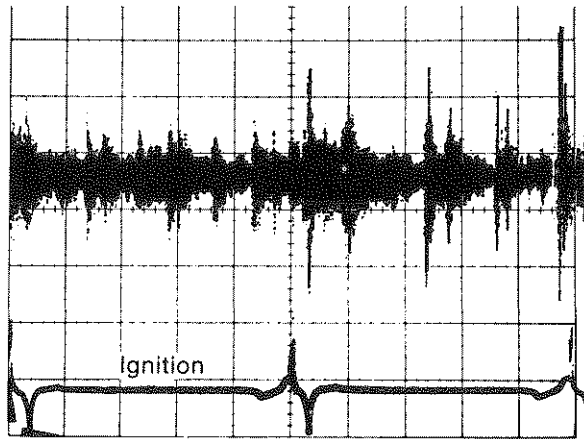

1770-5

AF 501 MODE switch set to BANDPASS FILTER
Oscilloscope Sweep Rate: ≈ 15 ms/div

Filtered Vibration Pattern

NARROW; FREQUENCY dial tuned to 11.8 Hz (1 X rpm)
Oscilloscope Vertical Sensitivity: 0.25 mV/div

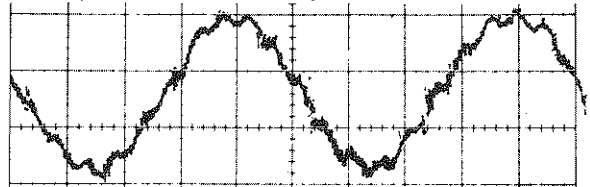

BROAD; FREQUENCY dial tuned to 2600 Hz
Oscilloscope Vertical Sensitivity: 15 mV/div

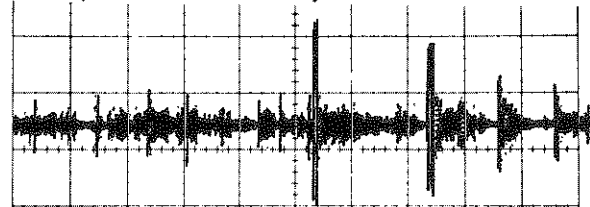

NARROW; FREQUENCY dial tuned to 10.1 kHz
Oscilloscope Vertical Sensitivity: 25 mV/div

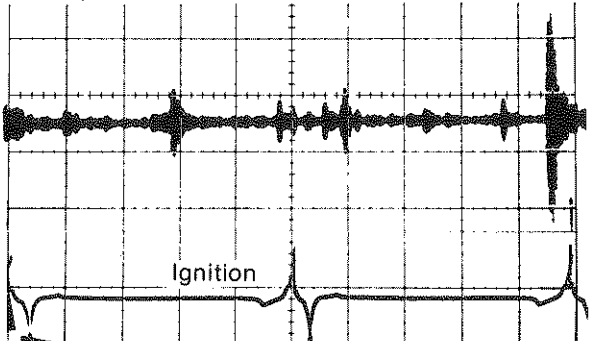
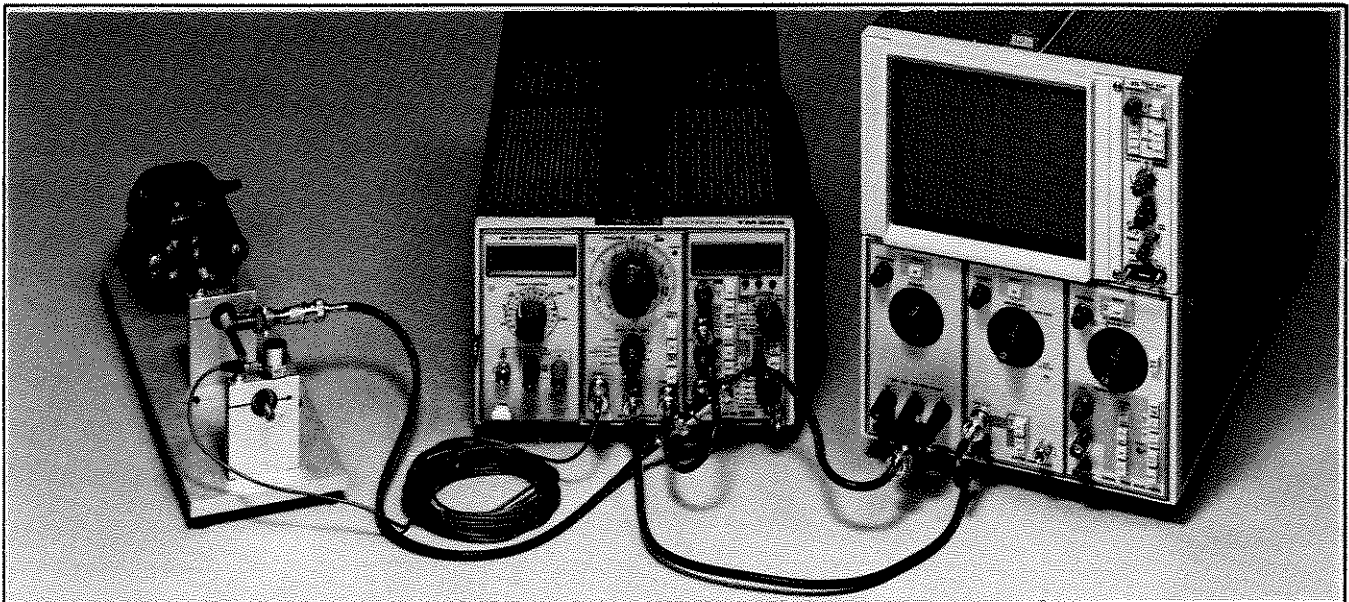

Fig. 1-3. Equipment setup required for performing engine vibration test.



Instrumentation:

AF 501 Bandpass Filter installed in a TM 500 Series Power Module with DC 503 Universal Counter (Dual channel, in Ratio A/B to indicate frequency of vibration as a multiple of shaft rpm), and DM 501 Digital Multimeter (to indicate rms signal out).

Unfiltered Vibration Pattern

5115 Oscilloscope with 5A24, 5A15 and 5B10 plug-ins.

Sweep Rate: ≈ 10 ms/div
Vertical Sensitivity: 100 g/div

Ball bearing with 6 balls (290 rpm), crack in outer race.

Accelerometer (15 Hz to ≈ 40 kHz), Tektronix Part No. 015-0165-00.

Electro-magnetic pick-up, Tektronix Part No. 015-0119-00.

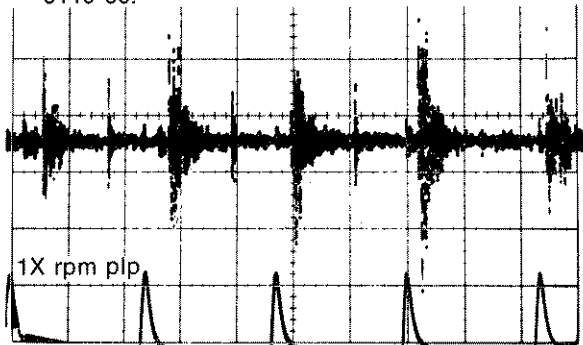

AF 501 MODE switch set to BANDPASS FILTER
Oscilloscope Sweep Rate: ≈ 10 ms/div

Filtered Vibration Pattern

NARROW; FREQUENCY dial turned to 2900 cpm (48 Hz)
Oscilloscope Vertical Sensitivity: .04 g/div

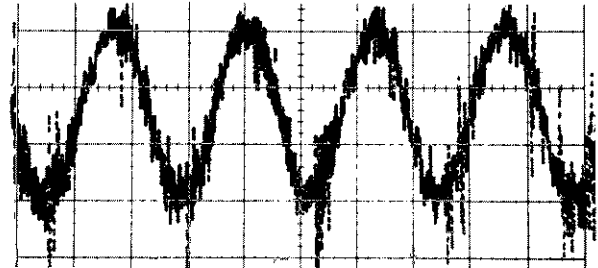

NARROW; FREQUENCY dial tuned to 24 kHz
Oscilloscope Vertical Sensitivity: 2.5 g/div

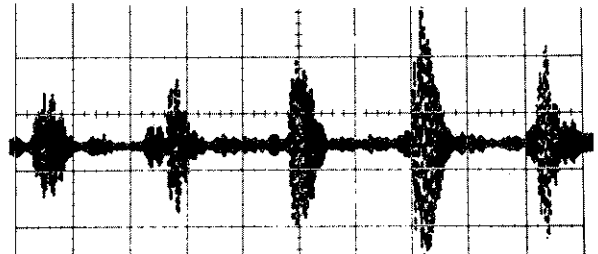

NARROW; FREQUENCY dial tuned to 3.35 kHz
Oscilloscope Vertical Sensitivity: 2.5 g/div

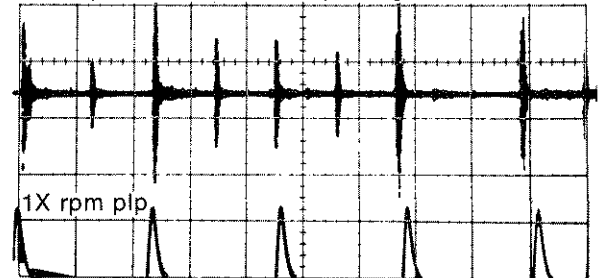

1770-6

Fig. 1-4. Equipment setup required for performing ball bearing vibration test.

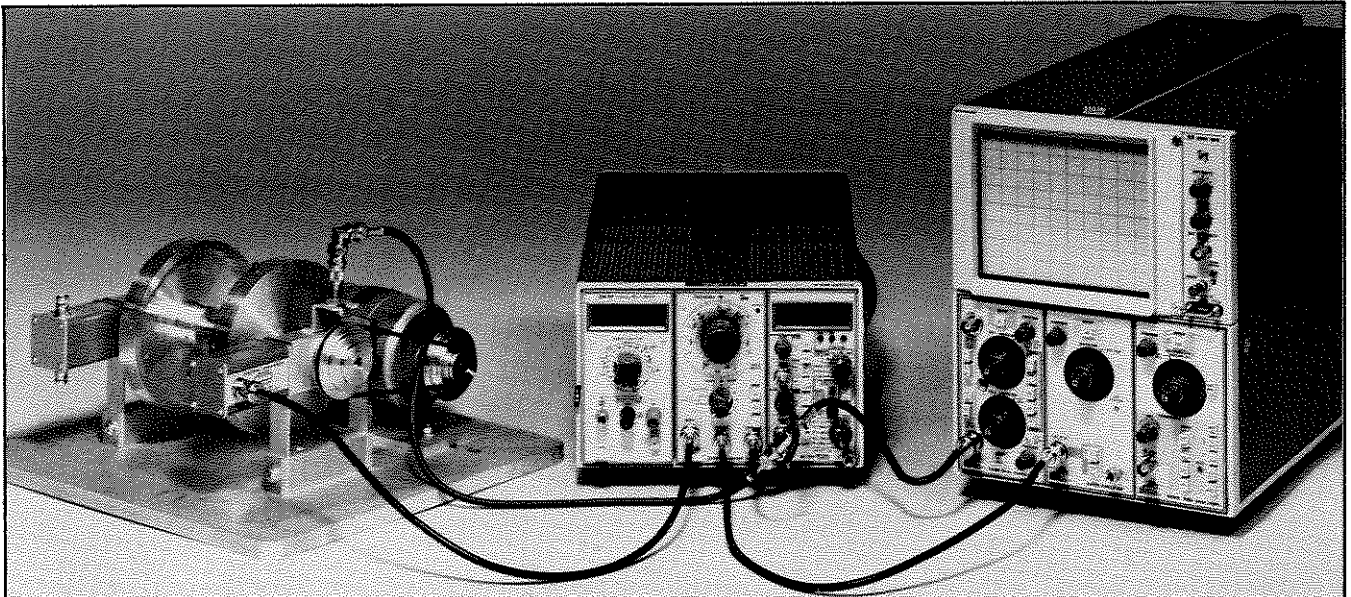

Instrumentation:

AF 501 Bandpass Filter installed in a TM 501-Series Power Module with DC 503 Universal Counter and DM 501 Digital Multimeter.

Balancing Demo

Horizontal Vibration Transducer, Tektronix Part No. 015-0167-00.

Electro-magnetic Pick-up, Tektronix Part No. 015-0119-00.

Unfiltered Vibration Pattern

5110 Oscilloscope with 5A18, 5A15 and 5B10 plug-ins.

Sweep Rate: ≈ 20 ms/div

Vertical Sensitivity: 0.1 mil (10^{-3} inch)/div

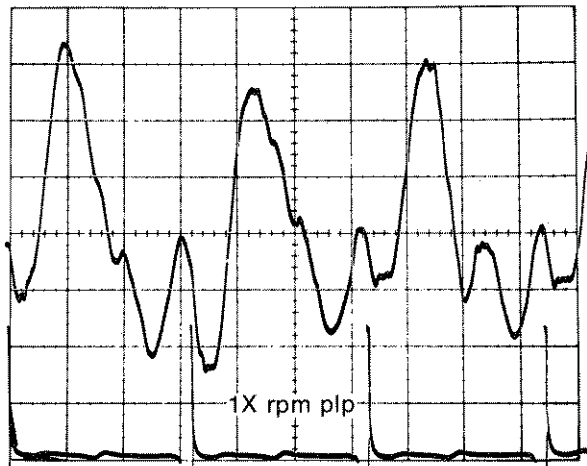

Filtered Vibration Pattern

AF 501 MODE switch set to BANDPASS FILTER, NARROW; FREQUENCY dial tuned to exactly 1 X rpm, 960 cpm (16 Hz)

Oscilloscope Sweep Rate: ≈ 20 ms/div
Vertical Sensitivity: 0.1 mil/div

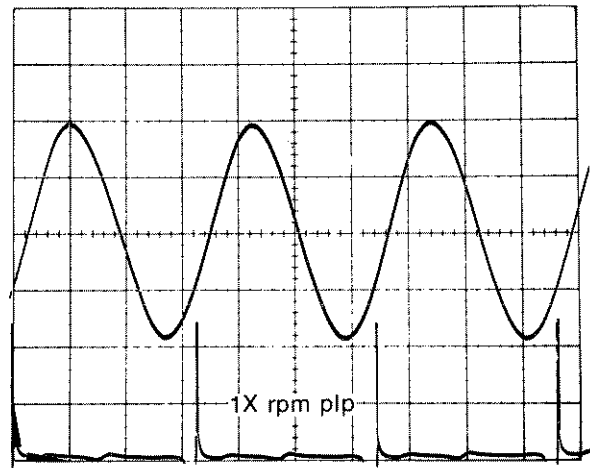

1770-7

Fig. 1-5. Equipment setup required for performing dynamic balancing test.



SPECIFICATION AND PERFORMANCE CHECK

SPECIFICATION

Performance Conditions

The electrical characteristics are valid only if the AF 501 has been calibrated at an ambient temperature between +20-degrees Celsius and +30-degree Celsius and is operating at an ambient temperature between 0-degree Celsius and +50-degree Celsius unless otherwise noted.

Items listed in the Performance Requirements column of the Electrical Characteristics are verified by completing the Performance Check in this manual. Items listed in the Supplemental Information column are not verified in this manual; they are either explanatory notes or performance characteristics for which no limits are specified.

Table 2-1
ELECTRICAL CHARACTERISTICS

Characteristics	Performance Requirements	Supplemental Information
BANDPASS FILTER		
Frequency Range		3 Hz to 35 Hz In 4 decade steps Single knob tuning
Frequency Dial Error	<5% dial between 3—20 <10% dial between 20—30	
Frequency Multiplier		X1, X10, X100, X1k
Phase Shift		<10° at tuned frequency Below 5 kHz
Dial Readout		Hz, and cycles per minute (cpm)
Dial Range		3 to 40 Hz, 180—2400 cpm
Dial Rotation		360°, no stops
Knob Rotation		≈6 turns per one dial turn
Max. Filter Attenuation		>70 dB
Filter Selectivity		Q ≈ 5 (BROAD) Q ≈ 15 (NARROW)

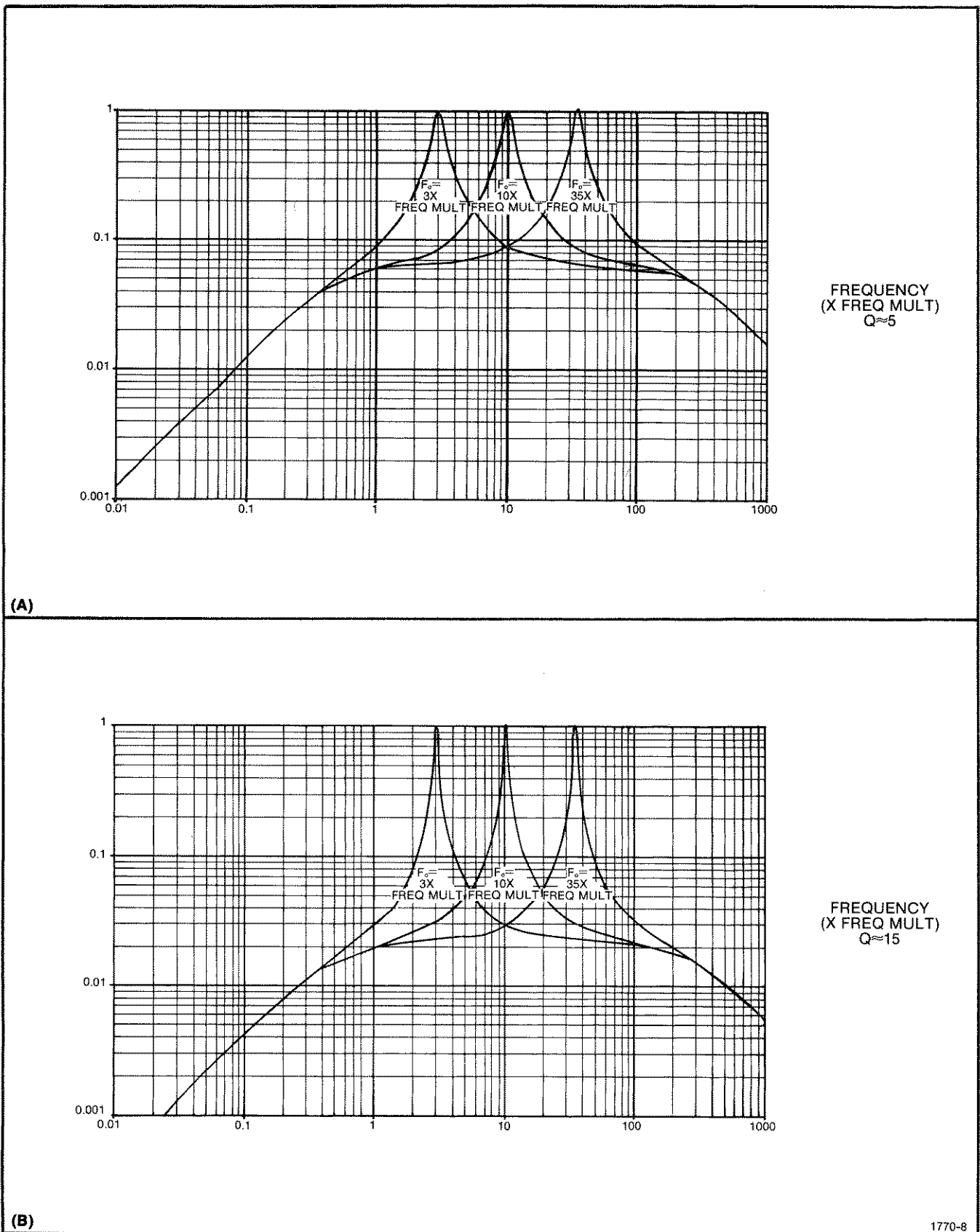

Fig. 2-1. Attenuation vs frequency (A) Q=5, (B) Q=15.

Table 2-1 (cont)

ELECTRICAL CHARACTERISTICS

Characteristics	Performance Requirements	Supplemental Information
Filter Roll-Off		See Fig. 2-1.
Gain Range		1—500, 1, 2, 5 Sequence
Gain Accuracy	± 3 dB (BROAD) ± 5 dB (NARROW)	
Input Impedance		≈ 1 M Ω paralleled by ≈ 47 pF
Max. Non-Destruct ac Input Voltage		130 volts rms
Max. Non-Destruct dc Input Voltage		± 100 volts
Output Voltage	20 V p-p (product of output amplitude in volts and frequency in kHz not to exceed 400)	
Output Current		20 mA p-p max. (at 20 V p-p). See graph Fig. 2-2
Output Impedance		< 1 Ω (with output voltage and current within limits of graph, Fig. 2-2).
	AMPLIFIER	
Single Ended		Ac coupled
Gain		1 to 500; 1, 2, 5 sequence
Gain Accuracy	$\pm 3\%$	
Bandwidth	< 0.5 Hz to > 50 kHz (at 3 dB point)	
Input Impedance		1 M Ω paralleled by ≈ 47 pF
Noise		< 25 mV rms (referred to Output)
Max. Non-Destruct ac Input Voltage		130 volts rms
Max. Non-Destruct dc Input Voltage		± 100 Volts
Output Voltage	20 V p-p (product of output amplitude in volts and frequency in kHz not to exceed 400)	
Output Current		20 mA p-p max. (at 20 V p-p). See Graph Fig. 2-2.
Output Impedance		< 1 Ω (with output voltage and current within limits of graph, Fig. 2-2).

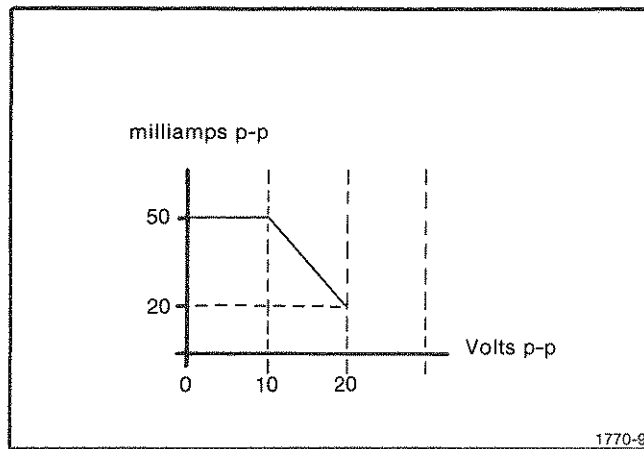

Fig. 2-2. Graph of output current vs volts.

Table 2-1 (cont)

ELECTRICAL CHARACTERISTICS

OSCILLATOR

Characteristics	Performance Requirements	Supplemental Information
Sine-Wave Output Range		3 Hz to 35 kHz
Dial Readout		Hz and cpm
Dial Range		3 to 40 Hz, 180—2400 cpm
Dial Rotation		360°, no stops
Knob Rotation		≈6 turns per one dial turn
Output Amplitude		1.2, or 5 V p-p ±20%. Depending on gain position.
Waveform Distortion		>3%
Output Current		Max. 50 mA p-p
Output Impedance		<1 Ω (within 50 mA output current limit).

TRIGGER OUT

Trigger Out		Positive pulse, triggered when positive slope of output signal goes through 0 (used for counter, strobe-light, etc.).
Pulse Amplitude	>10 volts	
Pulse Duration	10 ±5 μs	
Minimum Signal Out Required To Set Trigger		500 mV, p-p
Rise and Fall Time		<1 μs
Output Impedance		≈50 Ω

Table 2-2 (cont)

ENVIRONMENTAL

Characteristic	Information
Temperature	
Operating	0° C to +50°
Storage	-40° C to +75° C
Altitude	
Operating	To 15,000 feet, maximum operating temperature decreased by 1° C/1000 feet from 5000 to 15000 feet.
Storage	To 50,000 feet
Vibration	
Operating and Non-Operating	With the instrument complete and operating, vibration frequency swept from 10 to 55 to 10 Hz at 1 minute per sweep. Vibrate 15 minutes in each of the three major axes at 0.015" total displacement. Hold 10 minutes at any major resonance, or if none, at 55 Hz. Total time, 75 minutes.
Shock	
Operating and Non-Operating	30 g's, 1/2 sine, 11 ms duration, 3 shocks in each direction along 3 major axes, for a total of 18 shocks.
Transportation	Qualified under National Safe Transit Committee Test Procedure 1A, Category II.

Table 2-3

PHYSICAL

Characteristic	Information
Overall Dimensions (measured at maximum points)	
Height	5.0 inches (12.7 cm)
Width	2.6 inches (6.6 cm)
Length	12.20 inches (31.0 cm)
Net Weight (Instrument only)	1 lb 13 oz (821 grams)

PERFORMANCE CHECK

Introduction

This procedure checks the electrical characteristics of the AF 501 that appear in the Specification section of this manual. If the instrument fails to meet the requirements given in this performance check, the adjustment procedure should be performed. This procedure can also be used by an incoming inspection facility to determine acceptability of performance.

The electrical characteristics in Section 2 are valid only if the AF 501 is calibrated at an ambient temperature of +20-degree Celsius to +30-degree Celsius and operated at an ambient temperature of 0-degree Celsius to +50-degree Celsius. Forced air circulation is required for ambient temperatures above +40-degrees Celsius.

Table 2-4

LIST OF TEST EQUIPMENT REQUIREMENTS

Description	Performance Requirements	Application	Example
Oscilloscope	Bandwidth, dc to 1 MHz; minimum deflection factor, 100 mV/div; sweep rate to at least 1 μ s/div.	Used throughout procedure to provide display.	TEKTRONIX SC 501. ^a
Counter	Maximum frequency, 50 kHz; input sensitivity, 0.5 V; display accuracy, 1 count in 10 ³ .	Used for dial frequency check.	TEKTRONIX DC 501. ^a
Calibration Generator	Square-wave amplitude, 10 V, 1 V, and 0.1 V; amplitude accuracy, $\pm 0.25\%$.	Used for amplifier gain check.	TEKTRONIX PG 506. ^a
Sine-wave Generator	Frequency range, 0.5 Hz to 50 Hz; voltage amplitude 20 V p-p (open circuit); accuracy $\pm 3\%$.	Used throughout procedure to provide signal.	TEKTRONIX FG 503. ^a
Power module	Accepts TM 500-series plug-ins.	Used throughout procedure.	TEKTRONIX TM 504 or TM 506.
Coaxial cable (3 required)	Impedance, 50 Ω ; length, 42 inches; connectors, bnc.	Used throughout procedure for signal connection.	Tektronix Part 012-0057-01.
RC normalizer	Time constant, 1 M Ω X 47 pF; connectors, bnc; attenuation 2X.	Used for input compensation check.	Tektronix Part 011-0059-02.

^aRequires TM 500-Series Power Module.

Preliminary Procedure

1. Ensure that all test equipment and the AF 501 under test are suitably adapted to the line voltage to be applied. Refer to the installation section of the power module manual.

2. Ensure that all test equipment is suitably adapted to the applied line voltage.

3. Install the AF 501 into the power module, and if applicable, install the TM 500 series test equipment into the test equipment power module.

4. Connect the equipment under test and the test equipment to a suitable line voltage source. Turn all equipment on and allow at least 20 minutes for the equipment to stabilize.

Initial Control Settings

Set the following controls during warm-up time:

Oscilloscope

Intensity, Focus	set for well-defined trace and normal brightness
Vert Mode	left
Trig Source	vertical

Time Base Unit

Trig Source	left
Time/Div	1 ms
Variable	fully clockwise (cal)

Time Base Unit (cont)

Triggering	
Level/Slope	positive
Mode	vert
Coupling	ac
Source	int
Position	set so trace starts at left side of graticule
Magnifier	normal sweep

Vertical Amplifier

Volts/div	.2 V
Input	dc

Counter

Gate time	1 second
Display time	minimum
Trigger level	near zero setting
Trigger source external	

AF 501

MODE	OSCILLATOR
GAIN	1
FREQUENCY MULTIPLIER	X100
FREQUENCY Hz dial	20

PERFORMANCE CHECK PROCEDURE

1. Check Dial Accuracy. Dial accuracy is within 5% from 3 to 20; within 10% from 20 to 40.

a. Connect a 50 Ω cable from the AF 501 TRIG OUT connector to the counter input connector.

b. Check—dial settings and display using Table 2-5 as reference.

2. Check Frequency Multiplier Accuracy. Frequency Multiplier accuracy is within 5% from 3 to 20; within 10% from 20 to 40.

a. Check—multiplier settings and display using Table 2-6 as reference.

b. Disconnect the 50-ohm cable from the counter and AF 501 TRIG OUT connector.

3. Check Amplifier Gain Accuracy. Accuracy is within ±3% at given settings.

a. Connect a 50-Ω cable from the calibration generator amplitude output to the AF 501 connector.

b. Preset the following front-panel control settings:

AF 501 Bandpass Filter

MODE	AMPLIFIER
GAIN	1
FREQUENCY Hz	20
FREQUENCY MULTIPLIER	X1

Calibration Generator

Mode Switch	Standard Amplitude

Table 2-5

FREQUENCY DIAL ACCURACY

AF 501 FREQUENCY	AF 501 FREQ. MULT	Frequency	Maximum Error	Frequency Limit
3	X100	300 Hz	15 Hz	.285—315 kHz
5	X100	500 Hz	25 Hz	.475—.525 kHz
10	X100	1.0 kHz	50 Hz	.950—1.050 kHz
15	X100	1.5 kHz	75 Hz	1.425—1.575 kHz
20	X100	2.0 kHz	200 Hz	1.800—2.200 kHz
30	X100	3.0 kHz	300 Hz	2.700—3.300 kHz
40	X100	4.0 kHz	400 Hz	3.600—4.400 kHz

Table 2-6

FREQUENCY MULTIPLIER ACCURACY

Counter Gate Time	AF 501 FREQUENCY	AF 501 FREQ MULT	Frequency	Maximum Error	Frequency Limit
1 Sec	10	X1K	10 kHz	0.5 kHz	9.5—10.5 kHz
1 Sec	10	X100	1 kHz	.05 kHz	.95—1.05 kHz
1 Sec	10	X10	100 Hz	5 Hz	.095—.105 kHz
10 Sec	10	X1	10 Hz	0.5 Hz	.0095—.0105 kHz
10 Sec	30	X1	30 Hz	3 Hz	.027—.033 kHz
1 Sec	30	X10	300 Hz	30 Hz	.27—.33 kHz
1 Sec	30	X100	3 kHz	0.3 kHz	2.7—3.3 kHz
1 Sec	30	X1K	30 kHz	3 kHz	27—33 kHz

c. Set the time-base unit sweep rate for 1 ms/div.

d. Connect a 50 Ω cable from the AF 501 OUTPUT connector to the oscilloscope input connector.

e. Use Table 2-7 as reference to check the amplifier gain accuracy. The vertical amplifier deflection factor must be adjusted to maintain an appropriate display.

Table 2-7

AMPLIFIER GAIN ACCURACY

AF 501 GAIN switch setting	Calibration Generator amplitude switch setting	AF 501 Output peak-to-peak voltage
1	10 V	10 V
2	5 V	10 V
5	2 V	10 V
10	1 V	10 V
20	.5 V	10 V
50	.2 V	10 V
100	.1 V	10 V
200	50 mV	10 V
500	20 mV	10 V

f. Turn off the power module.

g. Disconnect the cable from the calibration generator amplitude output connector and remove the generator from the power module.

h. Install the sine-wave generator into the power module plug-in compartment.

i. Connect the 50 Ω cable from the AF 501 INPUT connector to the output connector of the sine-wave generator.

j. Set the AF 501 GAIN control to 1.

k. Turn on the power module and allow the required warmup time.

4. Check Amplifier Bandwidth. Bandwidth is less than 0.5 Hz to more than 50 kHz (at 3 dB point).

a. Connect a 50 Ω cable from the sine-wave generator trigger out connector to the counter input (the purpose of the counter is to monitor the sine-wave generator output frequency).

b. Set the time-base unit sweep rate for 5 ms/div and the triggering source switch to auto (sweep display will be present).

c. Set the sine-wave generator frequency for a 1 kHz output signal.

d. Set the sine-wave generator amplitude control and the oscilloscope controls to obtain a 5-division display on the oscilloscope. Do not disturb the sine-wave generator amplitude control or the oscilloscope amplitude control for the remainder of this step.

e. Set the sine-wave generator frequency control for a 0.5 Hz output signal. Change the time-base sweep rate to 2 s/div.

f. Check—amplitude of display signal is at least 3.5 divisions.

g. Set the sine-wave generator frequency control for a 50 kHz output signal. Change the time-base unit sweep rate to 1 ms/div.

h. Check—amplitude of display signal is at least 3.5 divisions.

i. Disconnect all cables.

5. Check Trigger Out. Amplitude is greater than 10 V; pulse duration, 10 μs ±5 μs; minimum signal out, 500 mV, peak-to-peak.

a. Preset the following front-panel control settings:

AF 501 Bandpass Filter

MODE	AMPLIFIER
GAIN	1

b. Set the vertical amplifier deflection factor for 5 V/div.

c. Set the time-base unit sweep rate for 10 μs/div.

d. Set the sine-wave generator frequency for a 0.5 V, 20 kHz output signal.

Specification and Performance Check—AF 501

e. Connect a 50 Ω cable from the AF 501 TRIG OUT connector to the oscilloscope input connector.

f. Check—pulse amplitude is greater than 10 V.

g. Check—pulse duration is 5 μ s to 15 μ s.

h. Disconnect all cables.

6. Check Input Compensation.

a. Connect the 1 M Ω , 47 pF input normalizer to the AF 501 INPUT connector.

b. Connect a 50 Ω cable from the calibration generator output to the normalizer input.

c. Connect a 50 Ω cable from the AF 501 OUTPUT connector to the oscilloscope vertical amplifier input.

d. Set the calibration generator for a 1 V square-wave signal, the vertical amplifier deflection factor for 0.1 V/div, and the time-base unit to 1 ms/div.

e. Adjust the time-base unit triggering controls for a stable display.

f. Check—the displayed square-wave for a flat top, with minimum front corner roll-off or overshoot.

g. Disconnect all cables.

This completes the Performance Check procedure of the AF 501.