

**Tektronix<sup>®</sup>**

**FG 504  
40 MHz  
FUNCTION  
GENERATOR**

(SN B0400000 & ABOVE)

**INSTRUCTION MANUAL**



**Tektronix**<sup>®</sup>  
COMMITTED TO EXCELLENCE

**PLEASE CHECK FOR CHANGE INFORMATION  
AT THE REAR OF THIS MANUAL.**

**FG 504  
40 MHz  
FUNCTION  
GENERATOR**

(SN B0400000 & ABOVE)

**INSTRUCTION MANUAL**

**Tektronix, Inc.  
P.O. Box 500  
Beaverton, Oregon 97077**

070-2655-00  
Product Group 75

Serial Number \_\_\_\_\_

First Printing NOV 1979  
Revised MAY 1982

Copyright © 1979 Tektronix, Inc. All rights reserved.  
Contents of this publication may not be reproduced in any  
form without the written permission of Tektronix, Inc.

Products of Tektronix, Inc. and its subsidiaries are covered  
by U.S. and foreign patents and/or pending patents.

TEKTRONIX, TEK, SCOPE-MOBILE, and  are reg-  
istered trademarks of Tektronix, Inc.

Printed in U.S.A. Specification and price change privileges  
are reserved.

Copyright © 1979 durch Tektronix, Inc. Alle Rechte vorbe-  
halten. Der Inhalt dieser Publikation darf ohne Genehmigung  
von Tektronix, Inc. nicht weitergegeben werden.

Produkte von Tektronix, Inc. und seinen Tochtergesellschaften  
sind durch US- und Auslandspatente und/oder schwebende  
Patente abgedeckt.

TEKTRONIX, TEK, SCOPE-MOBILE und  sind geschützte  
Warenzeichen von Tektronix, Inc.

Gedruckt in U.S.A. Spezifikations- und Preisänderungen  
bleiben vorbehalten.

Copyright © 1979 TEKTRONIX INC. Tous droits réservés.  
Le contenu de ce manuel ne peut être reproduit sous quelque for-  
me que ce soit sans l'accord de Tektronix Inc.

Tous les produits TEKTRONIX sont brevetés US et Etranger et  
les logotypes TEKTRONIX, TEK SCOPE MOBILE,  sont  
déposés.

Imprimé aux USA. TEKTRONIX se réserve le droit de modifier :  
caractéristiques et prix dans le cadre de développements techno-  
logiques.

©1979 年版權所有テクトロニクス社。不許複製。

TEKTRONIX、TEK、SCOPE-MOBILE、  
 はテクトロニクス社の登録商標です。

米国にて印刷。仕様及び価格は予告なく変更する場  
合があります。

# TABLE OF CONTENTS

	Page		Page
<b>LIST OF ILLUSTRATIONS</b> .....	ii	<b>Section 3 THEORY OF OPERATION</b> .....	3-1
<b>LIST OF TABLES</b> .....	iii	<b>Section 4 CALIBRATION PROCEDURE</b> .....	4-1
<b>Section 1 SPECIFICATION</b> .....	1-1	Performance Check .....	4-3
<b>Section 2 OPERATING INSTRUCTIONS</b> .....	2-1	Adjustment Procedure .....	4-8
English Version		<b>Section 5 MAINTENANCE</b> .....	5-1
French Version		<b>Section 6 OPTIONS</b> .....	6-1
German Version		<b>Section 7 REPLACEABLE ELECTRICAL PARTS</b>	7-1
Japanese Version		<b>Section 8 DIAGRAMS AND ILLUSTRATIONS</b> ..	8-1
		<b>Section 9 REPLACEABLE MECHANICAL PARTS</b>	9-1

**WARNING**

*THE FOLLOWING SERVICE INSTRUCTIONS ARE FOR USE BY QUALIFIED PERSONNEL ONLY. TO AVOID PERSONAL INJURY, DO NOT PERFORM ANY SERVICING OTHER THAN THAT CONTAINED IN OPERATING INSTRUCTIONS UNLESS YOU ARE QUALIFIED TO DO SO.*



# LIST OF ILLUSTRATIONS

Fig. No.	Page	Fig. No.	Page
	FG 504 Function Generator . . . . .	viii	
2-1	FG 504 Installation and Removal . . . . .	2-1	
2-2	FRONT Panel Controls and Connectors . . . . .	2-3	
2-3	Swept Frequency Ranges . . . . .	2-6	
2-4	Swept Frequency Range with 10 V applied to VCF IN connector . . . . .	2-4	
2-5	Trigger Signal Amplitude Requirements and Triggering Points . . . . .	2-8	
2-6	Phase Relationships between Output Waveforms and TRIG OUT Waveform . . . . .	2-8	
2-7	Basic Functions. Square, Triangle, and Sine Waveforms . . . . .	2-8	
2-8	Ramps and Pulses . . . . .	2-8	
2-9	Variable Rise and Fall Times . . . . .	2-9	
2-10	Linear Sweep . . . . .	2-9	
2-11	Logarithmic Sweep . . . . .	2-9	
2-12	Narrow Band Sweep . . . . .	2-9	
2-13	Gated Operation . . . . .	2-10	
2-14	Triggered Operation . . . . .	2-10	
2-15	Phase Control Operation . . . . .	2-10	
2-16	Phase Locked Loop Operation . . . . .	2-10	
2-17	Amplitude Modulation . . . . .	2-11	
2-18	Suppressed Carrier Operation . . . . .	2-11	
2-19	Low Frequency Hold Operation . . . . .	2-11	
2-20	Delayed Operation . . . . .	2-11	
2-21	Tone Burst Testing . . . . .	2-12	
2-22	Linear Sweep of Filters . . . . .	2-12	
2-23	Logarithmic Sweep of Filters . . . . .	2-12	
2-24	Pulse Shaping Capabilities . . . . .	2-24	
4-1	Amplitude Flatness Check . . . . .	4-11	
5-1	Semiconductor Basing . . . . .	5-4	
5-2	Rear Interface Connector Assignments . . . . .	5-5	
The following illustrations are located in the diagram pull-out section.			
8-1	Semiconductor Basing		
8-2	Adjustment Locations		
8-3	A3 Loop Board Component Locations		
8-4	A1 Main Board Component Locations (FRONT)		
8-5	A1 Main Board Component Locations (BACK)		
8-6	A2 Function Board Component Locations		
8-7	A4 Floating Interface Board Component Locations		

# LIST OF TABLES

<b>Table No</b>		<b>Page</b>
1-1	Electrical Characteristics .....	1-1
1-2	Environmental Characteristics.....	1-7
1-3	Physical Characteristics .....	1-7
4-1	Test Equipment Required .....	4-1
5-1	Relative Susceptibility to Static Discharge Damage .....	5-3
5-2	Maintenance Aids .....	5-9



# OPERATORS SAFETY SUMMARY

The general safety information in this part of the summary is for both operating and servicing personnel. Specific warnings and cautions will be found throughout the manual where they apply, but may not appear in this summary.

## TERMS

### In This Manual

CAUTION statements identify conditions or practices that could result in damage to the equipment or other property.

WARNING statements identify conditions or practices that could result in personal injury or loss of life.

### As Marked on Equipment

CAUTION indicates a personal injury hazard not immediately accessible as one reads the marking, or a hazard to property including the equipment itself.

DANGER indicates a personal injury hazard immediately accessible as one reads the marking.

## SYMBOLS

### In This Manual



This symbol indicates where applicable cautionary or other information is to be found.

### As Marked on Equipment



DANGER — High voltage.



Protective ground (earth) terminal.



ATTENTION — refer to manual.

### Power Source

This product is intended to operate from a power source that will not apply more than 250 volts rms between the supply conductors or between either supply conductor and ground. A protective ground connection by way of the grounding conductor in the power cord is essential for safe operation.

### **Grounding the Product**

This product is grounded through the grounding conductor of the power cord. To avoid electrical shock, plug the power cord into a properly wired receptacle before connecting to the product input or output terminals. A protective ground connection by way of the grounding conductor in the power cord is essential for safe operation.

### **Danger Arising From Loss of Ground**

Upon loss of the protective-ground connection, all accessible conductive parts (including knobs and controls that may appear to be insulating) can render an electric shock.

### **Use the Proper Power Cord**

Use only the power cord and connector specified for your product.

Use only a power cord that is in good condition.

For detailed information on power cords and connectors, see the power module manual.

Refer cord and connector changes to qualified service personnel.

### **Use the Proper Fuse**

To avoid fire hazard, use only the fuse of correct type, voltage rating and current rating as specified in the parts list for your product.

Refer fuse replacement to qualified service personnel.

### **Do Not Operate in Explosive Atmospheres**

To avoid explosion, do not operate this product in an explosive atmosphere unless it has been specifically certified for such operation.

### **Do Not Operate Without Covers**

To avoid personal injury, do not operate this product without covers or panels installed. Do not apply power to the plug-in via a plug-in extender.



# **SERVICING SAFETY SUMMARY**

## *FOR QUALIFIED SERVICE PERSONNEL ONLY*

*Refer also to the preceding Operators Safety Summary.*

### **Do Not Service Alone**

Do not perform internal service or adjustment of this product unless another person capable of rendering first aid and resuscitation is present.

### **Use Care When Servicing With Power On**

Dangerous voltages exist at several points in this product. To avoid personal injury, do not touch exposed connections and components while power is on.

Disconnect power before removing protective panels, soldering, or replacing components.

### **Power Source**

This product is intended to operate from a power source that will not apply more than 250 volts rms between the supply conductors or between either supply conductor and ground. A protective ground connection by way of the grounding conductor in the power cord is essential for safe operation.

# CONSIGNES DE SECURITE

Ce rappel des consignes générales de sécurité s'adresse à la fois aux utilisateurs et au personnel de maintenance. Avertissements et précautions à respecter sont annotés au long de ce manuel à chaque fois que l'utilisation du FG 504 l'exige. Il est à noter que ceux-ci peuvent ne pas figurer dans cette rubrique de rappel.

## TERMES

### Dans ce manuel

Les paragraphes intitulés ATTENTION identifient les circonstances ou opérations pouvant entraîner la détérioration de l'appareil ou de tout autre équipement.

Les paragraphes intitulés AVERTISSEMENT indiquent les circonstances dangereuses pour l'utilisateur (danger de mort ou risque de blessure).

### Repères gravés sur l'appareil

CAUTION (ATTENTION) : ce mot identifie les zones de risque non immédiatement perceptible ou un risque éventuel de détérioration de l'appareil.

DANGER (DANGER) : ce mot indique les zones de risque immédiat pouvant entraîner blessures ou mort.

## SYMBOLES

### Dans ce manuel



Ce symbole signifie «se reporter au manuel».

### Gravés sur l'appareil



DANGER – Haute tension



Borne de masse de protection (terre)



ATTENTION – se reporter au manuel

### Source d'alimentation

L'appareil est conçu pour fonctionner à partir d'une source d'alimentation maximale de 250 V efficaces entre les conducteurs d'alimentation ou entre chaque conducteur d'alimentation et la terre. Pour utiliser l'appareil en toute sécurité, une connexion à la masse, réalisée au moyen d'un conducteur prévu dans le cordon d'alimentation, est indispensable.

### Mise à la masse de l'appareil

Une fois installé dans le châssis d'alimentation, l'appareil est relié à la masse à l'aide d'un conducteur du cordon d'alimentation. Pour éviter tout choc électrique, insérer la prise du cordon d'alimentation dans une prise de distribution correspondante avant de connecter l'entrée ou les sorties de l'appareil. Pour utiliser l'appareil en toute sécurité, une connexion à la masse, réalisée au moyen d'un conducteur prévu dans le cordon d'alimentation, est indispensable.



**Danger provoqué par la coupure de connexion de masse**

En cas de coupure de la connexion de masse, tous les éléments conducteurs accessibles (y compris boutons et commandes apparaissant isolants) peuvent provoquer un choc électrique.

**Utiliser le cordon d'alimentation approprié**

N'utiliser que le cordon d'alimentation et la prise recommandés pour votre appareil. Utiliser un cordon d'alimentation en parfait état. Consulter le manuel du châssis d'alimentation pour une information plus complète sur les cordons et connecteurs d'alimentation. Seul, un personnel qualifié peut procéder à un changement de cordon et prises.

**Utiliser le fusible approprié**

Pour éviter tout risque d'accident (incendie...) n'utiliser que le fusible recommandé pour votre appareil. Le fusible de remplacement doit toujours correspondre au fusible remplacé : même type, même tension et même courant. Un remplacement de fusible ne doit être effectué que par un personnel qualifié.

**Ne pas utiliser l'appareil en atmosphère explosive**

Pour éviter toute explosion, ne pas utiliser cet appareil dans une atmosphère de gaz explosifs.

**Ne pas démonter les capots**

Pour éviter toute blessure, ne pas ôter les capots. N'utiliser l'appareil que si ceux-ci ont été correctement remis en place.

**Ne pas utiliser sans capots (pour les tiroirs TM 500 seulement)**

Pour éviter toute blessure, ne pas utiliser ce produit sans capots ou panneaux. Ne pas alimenter le tiroir à travers un prolongateur.

**CONSIGNES DE SECURITE**

**UNIQUEMENT DESTINEES AU PERSONNEL DE MAINTENANCE**

Ces consignes s'adressent exclusivement à un personnel qualifié. Il est également indispensable de se reporter aux consignes de sécurité précédentes.

Toute intervention interne ou réglage doit s'effectuer en présence d'une autre personne capable d'assurer les premiers secours en cas de danger.

**Agir avec précaution lorsque l'appareil est sous tension**

Des potentiels dangereux existent en différents points de l'appareil. Pour éviter toute blessure, ne pas intervenir sur les connexions et les composants alors que l'appareil est sous tension. Débrancher l'alimentation avant le démontage des panneaux, soudure ou remplacement de composants.

**Source d'alimentation**

Cet appareil est conçu pour fonctionner à partir d'une source d'alimentation qui n'applique pas plus de 250 V efficaces entre les conducteurs d'alimentation ou entre un conducteur et la masse. Pour utiliser l'appareil en toute sécurité, une connexion à la masse réalisée au moyen d'un conducteur prévu dans le cordon d'alimentation est indispensable.

# SICHERHEITSAANGABEN

Der folgende Text enthält in zwei Teilen Angaben über Sicherheitsvorkehrungen, die jederzeit bei Betrieb, Service und Reparatur des Gerätes beachtet werden müssen.

## SICHERHEITSAANGABEN FÜR DEN ANWENDER

Die allgemeinen Sicherheitsinformationen in diesem Teil der Angaben dienen dem Anwender- und Servicepersonal. Spezielle Warnungen und Hinweise sind überall im Handbuch zu finden, müssen jedoch in diesen Angaben nicht erscheinen.

### BEGRIFFE

In diesem Handbuch:

**VORSICHTSHINWEISE** erläutern Bedingungen, die zur Zerstörung des Gerätes oder anderer Gegenstände führen könnten.

**WARNUNGSHINWEISE** erläutern Bedingungen, die zu Personenschäden führen können oder lebensgefährlich sind.

Markierungen auf dem Gerät:

**CAUTION – VORSICHT** weist darauf hin, daß durch zufälliges Berühren an einer nicht unmittelbar zugänglichen Stelle Personenschaden entstehen kann, oder Schaden am Gerät selbst.

**DANGER – GEFAHR** weist darauf hin, daß durch zufälliges Berühren an einer zugänglichen Stelle Personenschaden entstehen kann.

### SYMBOLE

In diesem Handbuch:



Dieses Symbol zeigt an, wo Vorsicht walten zu lassen ist, oder wo Informationen zu finden sind.

Markierungen auf dem Gerät:



**GEFAHR – Hochspannung.**



Schutzerdungskontakt



**ACHTUNG – beziehen Sie sich auf das Handbuch**

### Masseanschluß des Gerätes

Dieses Gerät wird über den Schutzleiter der Versorgungseinheit mit Erdpotential verbunden.

Zur Vermeidung von elektrischen Schlägen ist vor der Beschaltung der Ein- und Ausgänge der Netzstecker in eine korrekt verdrahtete Steckdose einzustecken. Verwenden Sie den Schutzleiter nicht als einzige Verbindung zwischen zwei oder mehreren Geräten. Zur Vermeidung von elektrischen Schlägen sind die Geräte untereinander mit separaten Leitungen zu verbinden.



### **Verwendung eines richtigen Netzkabels**

Verwenden Sie nur Netzkabel, die für die Versorgungseinheit geeignet sind und die sich in gutem Zustand befinden.

Für detaillierte Informationen über Kabel und Stecker beziehen Sie sich auf Abbildungen innerhalb des Handbuches.

Ein Austausch von Kabeln und Steckern ist nur von geschultem Personal vorzunehmen.

### **Verwendung einer richtigen Sicherung**

Zur Vermeidung von Brandschäden sind nur Sicherungen zu verwenden, die in den Teilelisten dieses Gerätes aufgeführt sind und die in Spannungs- und Stromwert entsprechend sind. Ersatz von Sicherungen ist nur von geschultem Personal vorzunehmen.

### **Arbeiten Sie nicht in explosiver Umgebung**

Zur Vermeidung von Explosionen ist die Inbetriebnahme dieses Gerätes in explosiver Umgebung zu unterlassen, wenn das Gerät nicht dafür geeignet ist.

### **Entfernen Sie keine Gehäuseabdeckungen**

Zur Vermeidung von Personenschäden sind keine Gehäuseteile zu entfernen. Auch ist das Gerät ohne Gehäuse nicht in Betrieb zu nehmen.

### **Arbeiten Sie nicht ohne Gehäuseabdeckung**

Zur Vermeidung von Personenschäden ist das Gerät nicht ohne Gehäuse in Betrieb zu nehmen. Der Einschub sollte nicht über einen Verlängerungsadapter betrieben werden.

## **SICHERHEITSAANGABEN FÜR DEN SERVICE**

### **NUR FÜR GESCHULTES PERSONAL**

Beziehen Sie sich auch auf die vorangehenden Sicherheitsangaben für den Anwender.

### **Führen Sie keine Servicetätigkeiten alleine durch**

Nehmen Sie an dem Gerät keine Service- oder Einstellarbeiten vor, wenn nicht eine andere Person verfügbar ist, um im Bedarfsfall Erste Hilfe oder Wiederbelebungsversuche zu leisten.

### **Lassen Sie besondere Vorsicht walten, wenn Sie an einem unter Spannung stehenden Gerät arbeiten**

An verschiedenen Stellen im Gerät liegen hohe und damit gefährliche Spannungen. Zur Vermeidung von Personenschäden sind solche Stellen und Bauteile nicht zu berühren, während Betriebsspannung anliegt.

Vor dem Entfernen von Gehäuseteilen, Löten oder Ersetzen von Bauteilen ist immer die Betriebsspannung zu entfernen.

### **Netzspannungsversorgung**

Die Betriebsspannung für dieses Gerät darf  $250 V_{\text{eff}}$  nicht überschreiten und ist an die Versorgungsleitungen bzw. an eine Versorgungsleitung und Masse anzulegen. Innerhalb des Netzanschlußkabels muß ein Schutzleiter vorhanden sein, der mit Gerätemasse verbunden ist.

## ご使用の前に

FG 504型を安全にお使いいただくために、操作、点検、修理上の注意事項が、大きく2項目に分れて述べられています。

### 操作上の注意

操作上の注意は、オペレータの方にもサービス・エンジニアの方にも共通しています。このマニュアルの各所に特別の注意書きがありますが、これによく従ってください。

### 用語

#### マニュアル中の用語

**警告 (WARNING)** の項は人体に損傷を及ぼしたり危険を与える恐れのある場合の注意です。

**注意 (CAUTION)** の項は本機器または他の接続機器に損傷を及ぼす恐れのある場合の注意です。

#### 機器上の用語

CAUTIONと記されている部分は人体や本機器に損傷を及ぼす恐れがありますのでご注意ください。

DANGERと記されている部分は、人体に危険を及ぼしますので手を触れないでください。

### 記号

#### マニュアル中の記号



注意等が記述されています。

#### 機器上の記号



DANGER——高電圧



保護用接地ターミナル



ATTENTION——マニュアル参照

### 電源モジュールの接地

FG 504型は電源モジュールの接地線によって接地されます。電氣的ショックを防止するため、電源プラグを電源に接続するのは、入出力コネクタを接続する前に行ってください。

2台またはそれ以上の機器の間だけで接地線を接続するだけでなく、電氣的ショックを避けるため接地端子に接地してください。

**電源コード**

機器に適合する電源コード及びコネクタを使用して下さい。電源コードは損傷のないものをお使い下さい。

電源コードとコネクタに関する詳細は、**TM500**電源本体のマニュアルをご参照下さい。

コードとコネクタの交換の際は当社エンジニアにおたずね下さい。

**ヒューズ**

危険防止のため本機器のパーツ・リストに記載されている、形状、定格電圧、定格電流と同等のヒューズをご使用下さい。

ヒューズ交換の際は、当社エンジニアにおたずね下さい。

**爆発防止**

危険防止のため、爆発性のガスが周囲にあるような所では作動させないで下さい。

**カバー、パネル**

人体への損傷を避けるため、機器のカバーやパネルは取りはずさないで下さい。カバーやパネルをはずしたまま、機器を作動させないで下さい。

**カバーの扱いについて**

人体への損傷を避けるため、機器のカバーやパネルを取りはずしたまま作動させないで下さい。またプラグイン・エクステンダによって電源と接続しないで下さい。

**サービス上の注意****サービス・エンジニアの方へ**

“操作上の注意”を先にお読み下さい。

**1人でサービスを行わないで下さい。**

機器の内部点検または修理は、万一の場合に備えて応急処置のできる人がいる所で行って下さい。

**電源を入れた場合の注意**

機器内部には高電圧の部分があります。人体への危険を防止するため、電源がはいっている時は、露出している接続部分や部品には手を触れないで下さい。

パネルの取りはずし、ハンダ付、部品の交換を行う前には、電源を必ず切って下さい。

**電源**

**FG 504 型**は電源コードの線間あるいは電源コードとグラウンド間が250Vrms以内の範囲の電源で作動します。安全のために電源コードのアース線できちんと接地して下さい。

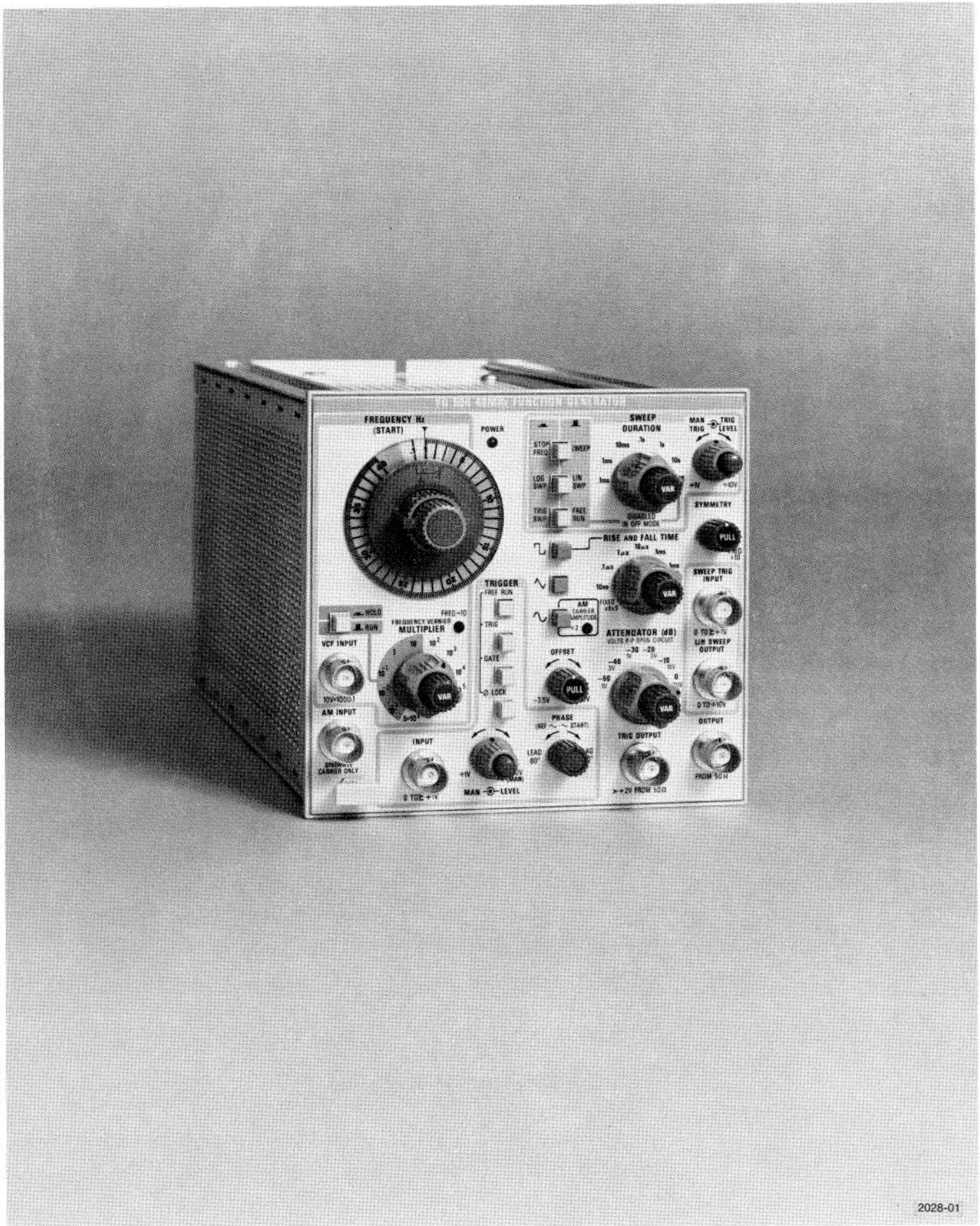

2028-01

The FG 504 Function Generator.

# SPECIFICATION

## Introduction

The FG 504 Function Generator provides low distortion sine, square, triangle, ramp, and pulse waveforms over the frequencies from 0.001 Hz to 40 MHz in ten decades. A user-definable custom frequency range is also available. The output amplitude is 10 mV to 30 V peak-to-peak into an open circuit and 5 mV to 15 V peak-to-peak into a 50  $\Omega$  load. The output impedance is 50  $\Omega$ . The FG 504 may be swept between the START and STOP FREQ dial settings with a linear or logarithmic sweep. The output may be phase locked, gated, or triggered for single cycle output. The output waveform may be shifted  $\pm 80^\circ$  from the triggering waveform. The symmetry of the output waveform may also be varied. For the slower frequencies, the output may be held at any level by pushing the front panel button labeled HOLD.

A voltage-controlled frequency (VCF) input controls the output frequency from an external voltage source. The output frequency can be swept above or below the selected frequency, to a maximum of 1000:1, depending on the polarity and amplitude of the VCF input and the selected output frequency. Provision is also made for amplitude modulating the sinewave output from an external source.

The variety of swept and modulated signals available from the FG 504 make it especially useful for such applications as testing amplifier or servo-system response, distortion, and stability. It is useful for fm generation, as a beat frequency oscillator, as a gated triggered or phase-locked logic interface, or as a source for various ramp or pulse waveforms. It is also useful as a source for amplitude modulated signals for various purposes.

## SPECIFICATION

### Performance Conditions

The following electrical characteristics are valid if the FG 504 is calibrated at an ambient temperature between  $+20^\circ\text{C}$  and  $+30^\circ\text{C}$  and is operated at an ambient temperature between  $0^\circ\text{C}$  and  $+50^\circ\text{C}$ , unless otherwise noted. Forced air circulation is required at temperatures above  $+40^\circ\text{C}$ . Allow a one-hour warm-up period before performing verification tests.

Table 1-1

### ELECTRICAL CHARACTERISTICS

Characteristic	Performance Requirement	Supplemental Information
Frequency		
Range		
Sine-wave, square-wave, and triangle	.001 Hz to 40 MHz calibrated in 10 overlapping steps	
Ramps, pulses, or waveforms requiring use of variable SYMMETRY control		.001 Hz to nominally 4 MHz.
Duty Cycle		$\leq 7\%$ to $\geq 93\%$ below 1 MHz $\leq 20\%$ to $\geq 80\%$ above 1 MHz
$.5 \times 10^3$ position of MULTIPLIER switch (User selected timing capacitor)		$\approx 400$ kHz maximum. A 5 $\mu\text{F}$ capacitor provides a full-scale frequency of $\approx 400$ Hz. The factory-installed capacitor gives a 20 Hz to 20 kHz range for the $.5 \times 10^3$ position of the MULTIPLIER switch.

Table 1-1 (cont)

Characteristic	Performance Requirement	Supplemental Information										
Frequency (cont) Resolution		1 part in 10 <sup>4</sup> of full-scale setting using the FREQUENCY VERNIER control, as measured with a frequency counter.										
Stability  Time	$\leq 0.05\%$ for 10 minutes $\leq 0.1\%$ for 1 hour $\leq 0.5\%$ for 24 hours	Applies to calibrated portion of the FREQUENCY Hz dial only.  The instrument must be at a constant ambient temperature between 0° C and +50° C and checked after a 1-hour warmup.										
Temperature		See Dial Accuracy										
Dial Calibration		1 to 40 Hz (X MULTIPLIER setting) calibrated; 0.1 to 1 Hz (X MULTIPLIER setting) uncalibrated.										
Dial Accuracy  FREQUENCY Hz (START) dial	Within 3% of full scale from 0.001 Hz to 4 MHz. Within 6% of full scale from 4 MHz to 40 MHz.	Measurements made at an ambient temperature between +15° CC and +35° C after 1 hour warmup.										
STOP FREQUENCY dial	Within 5% of the difference between the start and stop frequencies plus the FREQUENCY Hz (START) dial error.	STOP FREQUENCY dial is uncalibrated on the 10 <sup>6</sup> MULTIPLIER range.										
Maximum Frequency Ranges for Dial, Sweep Frequency, and Voltage Controlled Frequency (VCF) Modes	<table border="0"> <tr> <td>MULTIPLIER Setting</td> <td>Maximum to Minimum Frequency Ratios</td> </tr> <tr> <td>10<sup>6</sup></td> <td><math>\geq 500:1</math></td> </tr> <tr> <td>10<sup>5</sup>—10<sup>2</sup></td> <td><math>\geq 1000:1</math></td> </tr> <tr> <td>10<sup>1</sup>, 1, 10<sup>-1</sup>, 10<sup>-2</sup></td> <td><math>\geq 100:1</math></td> </tr> <tr> <td>10<sup>-3</sup></td> <td><math>\geq 40:1</math></td> </tr> </table>	MULTIPLIER Setting	Maximum to Minimum Frequency Ratios	10 <sup>6</sup>	$\geq 500:1$	10 <sup>5</sup> —10 <sup>2</sup>	$\geq 1000:1$	10 <sup>1</sup> , 1, 10 <sup>-1</sup> , 10 <sup>-2</sup>	$\geq 100:1$	10 <sup>-3</sup>	$\geq 40:1$	
MULTIPLIER Setting	Maximum to Minimum Frequency Ratios											
10 <sup>6</sup>	$\geq 500:1$											
10 <sup>5</sup> —10 <sup>2</sup>	$\geq 1000:1$											
10 <sup>1</sup> , 1, 10 <sup>-1</sup> , 10 <sup>-2</sup>	$\geq 100:1$											
10 <sup>-3</sup>	$\geq 40:1$											
Internal Sweep Accuracy		Linear or Logarithmic. Limited by Start and Stop Frequency Specifications; use external frequency counter if greater accuracy is required.										
Sweep Duration		100 s to 0.1 ms in six decades (selected by SWEEP DURATION switch). VARIABLE control overlaps decades.										
Stop Frequency to Swept Stop Frequency Error		Within 2% from 100 s to 1 ms sweep duration. Within 10% from 1 ms to 0.1 ms sweep duration.										
LINear SWEEP	0 V to +10 V.	Output impedance 1 k $\Omega$ .										



Table 1-1 (cont)

Characteristic	Performance Requirement	Supplemental Information
Internal Sweep (cont) OUTPUT Amplitude Accuracy	Within 5% from 100 s to 1 ms, Within 10% from 1 ms to 0.1 ms.	
SWEEP TRIGger INPUT		
Input sensitivity	1 V p-p.	
Level	1 V through 10 V.	
Maximum Input	+20 V.	
Manual Trigger		Front-panel control.
Voltage-controlled Frequency Input (VCF)		
Nominal Sensitivity (Hz/volt)		=4 X MULTIPLIER setting per volt. A positive-going voltage increases frequency.
Maximum Frequency		=40 X MULTIPLIER setting.
Minimum Frequency		Maximum frequency divided by VCF range (see Maximum Frequency Ranges for Dial, Sweep Frequency, and Voltage Controlled Frequency (VCF) Modes).
Slew Rate		0.3 V/ $\mu$ s maximum.
Input Impedance		10 k $\Omega$ .
OUTPUT Signal Amplitude	At least 30 V p-p into an open circuit, at least 15 V into 50 $\Omega$ .	
Flatness		
Sine-wave 0.001 Hz to 40 kHz 40 kHz to 40 MHz	Within $\pm 0.5$ dB. Within $\pm 2$ dB from 40 kHz to 40 MHz.	Typically within $\pm 0.5$ dB to 40 MHz. Reference at 10 kHz.
Triangle 0.001 Hz to 40 kHz 40 kHz to 40 MHz.	Within $\pm 0.5$ dB. Within $\pm 2$ dB.	Reference at 10 kHz.
Square-wave 0.001 Hz to 20 MHz 20 MHz to 40 MHz	Within $\pm 0.5$ dB. Within $\pm 2$ dB.	Reference at 10 kHz.
Sine-wave, Triangle, and Square-wave Amplitude Match	Within $\pm 1$ dB at 10 kHz.	

Table 1-1 (cont)

Characteristic	Performance Requirement	Supplemental Information														
Output ATTENUATOR           Accuracy	<table border="1"> <thead> <tr> <th data-bbox="561 331 808 428">Attenuator Step</th> <th data-bbox="813 331 1021 428">Maximum Open-circuit Output Voltage (p-p)</th> </tr> </thead> <tbody> <tr> <td data-bbox="561 434 808 470">0 dB</td> <td data-bbox="813 434 1021 470">30 V</td> </tr> <tr> <td data-bbox="561 476 808 512">-10 dB</td> <td data-bbox="813 476 1021 512">9.5 V</td> </tr> <tr> <td data-bbox="561 518 808 554">-20 dB</td> <td data-bbox="813 518 1021 554">3 V</td> </tr> <tr> <td data-bbox="561 560 808 596">-30 dB</td> <td data-bbox="813 560 1021 596">950 mV</td> </tr> <tr> <td data-bbox="561 602 808 638">-40 dB</td> <td data-bbox="813 602 1021 638">300 mV</td> </tr> <tr> <td data-bbox="561 644 808 680">-50 dB</td> <td data-bbox="813 644 1021 680">95 mV</td> </tr> </tbody> </table> Within $\pm 0.5$ dB/decade.	Attenuator Step	Maximum Open-circuit Output Voltage (p-p)	0 dB	30 V	-10 dB	9.5 V	-20 dB	3 V	-30 dB	950 mV	-40 dB	300 mV	-50 dB	95 mV	
Attenuator Step	Maximum Open-circuit Output Voltage (p-p)															
0 dB	30 V															
-10 dB	9.5 V															
-20 dB	3 V															
-30 dB	950 mV															
-40 dB	300 mV															
-50 dB	95 mV															
VARiable Control	Provides up to -20 dB additional attenuation to reduce the minimum output signal amplitude to 10 mV.															
OFFSET Range  Into Open Circuit Into 50 $\Omega$	$\pm 7.5$ V $\pm 3.75$ V	Maximum signal plus offset peak output amplitude of $\pm 20$ V into an open circuit and $\pm 11.25$ V into 50 $\Omega$ . Offset defeatable by front-panel control.														
Output Waveforms  Without Use of SYMMETRY (variable) control  With SYMMETRY (variable) Control  Triangle  Symmetry  10 Hz to 400 kHz 400 kHz to 40 MHz		Sine, Triangle, and Square  Ramps and Pulses. Duty cycle range is $\leq 7\%$ to $\geq 93\%$ for all variable symmetry waveforms below 1 MHz; limited to $\approx 20\%$ to $\approx 80\%$ for triangle and sine-waveforms above 1 MHz. Actuation of SYMMETRY control divides output frequency by approximately 10.  Typically within 2% from 0.001 Hz to 10 Hz.  On calibrated portion of FREQUENCY Hz dial.														
Linearity  10 Hz to 400 kHz 400 kHz to 4 MHz 4 MHz to 40 MHz		Measured from the 20% point to the 80% point of the waveform. Typically within 2% from 0.001 Hz to 10 Hz.  Within 1%. Within 2%. Within 10%.														

Table 1-1 (cont)

Characteristic	Performance Requirement	Supplemental Information
Output Waveforms (cont)		
Sine-Wave		
Total Harmonic Distortion		
20 Hz to 40 kHz	≤0.5%.	Typically ≤1% from 0.001 Hz to 20 Hz, measured under the following conditions: Temperature +10°C to +35°C ambient terminated into 50 Ω; zero offset; ≤30 dB attenuation, and with FREQUENCY Hz (START) dial set between 4 and 40.
40 kHz to 1 MHz	Greatest harmonic at least 30 dB down.	
1 MHz to 40 MHz	Greatest harmonic at least 20 dB down.	
Square-wave		
RISE AND FALL TIMES FIXED	≤6 ns 10 ns to 100 ms in 7 steps measured from 10% to 90%	Applies to pulse waveforms also.
Aberrations	≤5% p-p plus 30 mV into 50 Ω load.	
VARiable	10 ns to 100 ms in 7 steps. Measured between the 10% and 90% points of Amplitude; accuracy within 30%. VARiable control has ≥10X range.	Period of waveform must exceed combined rise and fall times by ≥20%.
AM INPUT		
Dc to 4 MHz	5 V p-p signal produces 100% modulation of a sine-wave carrier with ≤5% distortion at 70% modulation.	When driven from a source impedance ≤600 Ω.
4 MHz to 40 MHz	≤10% distortion at 65% modulation.	Modulating frequencies from 20 Hz to 20 kHz. Modulation frequency bandwidth is dc to 100 kHz. A modulating source impedance of ≤10 kΩ ensures proper modulation and divides the output amplitude by 2.
Input Impedance		≥1 MΩ.
External TRIG/GATE/ Φ LOCK Input		
Input Impedance		≥10 kΩ.
Sensitivity	≤1 V p-p.	
Maximum Input Amplitude		+20 V.
TRIG		
LEVEL	-1 V to +10 V.	For triggering a single cycle of generator waveform.
Minimum Period		75 ns.

Table 1-1 (cont)

Characteristic	Performance Requirement	Supplemental Information
External TRIG/GATE/ Φ LOCK Input (cont)		
Maximum Trigger Frequency	≥20 MHz.	
GATE		
Minimum Period		75 ns.
Maximum Gated Frequency	≥20 MHz.	For gating multiple-cycle burst of generator waveform.
Φ LOCK		
	100 Hz to 40 MHz. Adjust range ±80° from 0 100 Hz to 4 MHz.	Capture range: ±10 major dial divisions from 100 Hz to 4 MHz; ±8 major dial divisions from 4 MHz to 40 MHz (40 MHz may not capture, but will track.)
4 MHz to 40 MHz	±8 major dial divisions.	
Lock Range		Generator will lock to a changing external signal, without readjusting the PHASE control, within ±10 major dial divisions from 100 Hz to 4 MHz and within ±1 MHz from 4 MHz to 40 MHz.
PHASE		
Phase Adjustment Range		±80° from 0.001 Hz to 4 MHz.
MAN		Manual Trigger/Gate front-panel pushbutton.
TRIG OUTPUT	0 V to +2 V from 50 Ω.	
HOLD		
Drift		10% of p-p output amplitude/hour.
Range	0.001 Hz to 400 Hz.	

**Table 1-2**  
**ENVIRONMENTAL CHARACTERISTICS**

<b>Characteristics</b>	<b>Description</b>
Temperature	
Operating	0° C to +40° C (+40° C to +50° C; forced air required).
Storage	-40° C to +75° C.
Altitude	
Operating	To 15,000 feet (4,570 meters).
Storage	To 50,000 feet (15,250 meters).
Vibration	
Operating and non-operating	0.64 mm (0.025") displacement, 10-50-10 Hz sinewave, 54 minutes.
Shock	
Operating and non-operating	50 g's (half sine), 11 ms, 12 shocks.
Transportation	Qualified under National Safe Transit Association Test, Procedure 1A Category II.

**Table 1-3**  
**PHYSICAL CHARACTERISTICS**

<b>Characteristics</b>	<b>Description</b>
Finish	Anodized aluminum panel and chassis.
Weight	3.75 pounds (1.7 kg).
Overall Dimensions	Width 5.312" (13.49 cm), Length 12.125" (30.8 cm), Height 5.0" (12.7 cm).

# OPERATING INSTRUCTIONS

## INSTALLATION AND REMOVAL INSTRUCTIONS

The FG 504 is calibrated and ready to use when received. It operates in any two compartments of the TM 500 series power modules except the TM 501. Refer to the power module instruction manual for line voltage requirements and power module operation. Forced air cooling is required for operation between 40 and 50 degrees centigrade.

### CAUTION

*Turn the power module off before inserting or removing the FG 504; otherwise, arcing may occur at the rear interface connectors. Arcing reduces the useful life of the connectors and damage may be done to the plug-in circuitry.*

Check for plastic barriers on the interconnecting jacks of the power module in the selected compartments. If there are barriers present and they do not match the cut-outs in the FG 504 circuit board edge connectors, they may indicate special rear interface connections for another type of instrument. Do not insert the plug-in until this has been verified by qualified service personnel.

When the units are properly matched, align the FG 504 with the upper and lower guides (see Fig. 2-1) of the selected compartments. Insert the FG 504 into the compartment and press firmly to seat the circuit boards in the interconnecting jacks. The POWER light should be illuminated when the power module switch is turned on.

To remove the FG 504, pull the release latch, which is located on the lower left corner, until the circuit board edge connectors disconnect from the power module jacks. The FG 504 will now slide out of the power module.

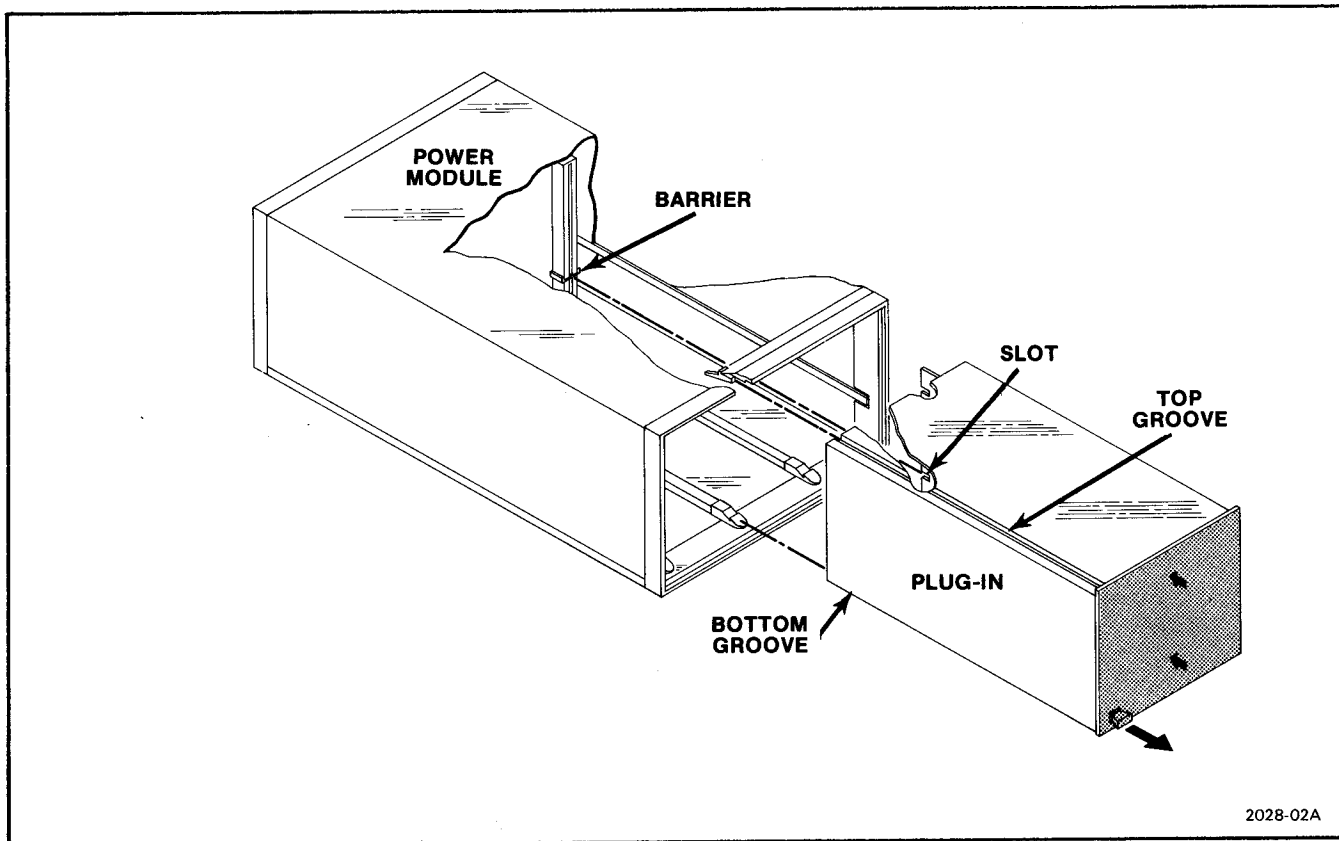

Fig. 2-1. FG 504 Installation and Removal.



## OPERATING CONSIDERATIONS

### Output Connections

The output of the FG 504 is designed to operate as a 50  $\Omega$  voltage source working into a 50  $\Omega$  load. At higher frequencies, an unterminated or improperly terminated output will cause excessive aberrations on the output waveform (see Impedance Matching discussion). Loads less than 50  $\Omega$  will reduce the waveform amplitude.

Excessive distortion or aberrations, due to improper termination, are less noticeable at the lower frequencies (especially with sine and triangle waveforms). To ensure waveform purity, observe the following precautions:

1. Use good quality 50  $\Omega$  coaxial cables and connectors.
2. Make all connections tight and as short as possible.
3. Use good quality attenuators if it is necessary to reduce waveform amplitude applied to sensitive circuits.
4. Use terminations or impedance-matching devices to avoid reflections when using long cable (6 feet or more).
5. Ensure that attenuators, terminations, etc., have adequate power handling capabilities for the output waveform.

If there is a dc voltage across the output load, use a coupling capacitor in series with the load. The time constant of the coupling capacitor and load must be long enough to maintain pulse flatness.

### NOTE

*If the FG 504 is used in early models of the TM 500 Series Power Modules, ripple on the output waveform can be excessive in some cases. The ripple results from Power Module transformer phasing that is incompatible with FG 504 operation; however, the problem is easily cured. Refer to qualified service personnel for checking transformer phasing.*

## CONTROLS AND CONNECTORS

- ① **FREQUENCY (Hz):** Selects frequency of operation, or lowest frequency in sweep mode.
- ② **STOP FREQUENCY (Hz):** Selects highest frequency in sweep mode.
- ③ **FREQ  $\div$ 10:** Lamp indicates when SYMMETRY knob is pulled out.
- ④ **RUN:** (Button out) for normal operation.  
**HOLD:** (Button in) Disables the generator and provides an output dc level equal to the level of the signal when the button was pushed. (5 lower frequency ranges only.)
- ⑤ **VCF INPUT:** Externally applied voltage varies output frequency.
- ⑥ **FREQUENCY VERNIER:** For fine frequency variations.
- ⑦ **MULTIPLIER:** Determines range of FREQUENCY dial.
- ⑧ **AM INPUT:** Externally applied signal modulates sine wave output.
- ⑨ **LATCH:** Pull to remove the plug-in.
- ⑩ **INPUT:** Apply external gating, triggering, or phase-locking signals to this connector.
- ⑪ **MAN:** Provides a manual trigger in TRIG operation or manual gate in GATE operation to control the output waveform.
- ⑫ **LEVEL:** Selects the beginning voltage level on INPUT waveform for triggered, gated, or phase-locked operation.
- ⑬  **$\Phi$  LOCK:** Button in locks output waveform frequency to signal applied to INPUT connector.
- ⑭ **GATE:** Button in causes generator to produce a waveform during a high level at the INPUT connector.
- ⑮ **TRIG:** Button in causes generator to produce one cycle of output waveform for each positive-going INPUT signal.
- ⑯ **FREE RUN:** Button in causes continuous output waveform.



## Operating Instructions—FG 504 (SN B040000 & UP)

- 28 **SWEEP DURATION:** Selects duration of frequency sweeping ramp.
- 29 **TRIG LEVEL:** Selects level on SWEEP TRIG INPUT that starts sweep ramp.
- 30 **MAN TRIG:** Provides manual sweep waveform start when pressed in.
- 31 **OFFSET:** Pull and rotate to offset the OUTPUT waveform from 0 V at the OUTPUT connector.
- 32 **AM CARRIER AMPLITUDE ÷2:** Lamp lights when impedance at AM INPUT  $\leq 10$  k $\Omega$ .
- 33 **(SINE WAVE):** Button in selects sine wave output.
- 34 **(TRIANGLE WAVE):** Button in selects triangle wave output.
- 35 **(SQUARE WAVE):** Button in selects square wave output.
- 36 **STOP FREQ:** Button in stops frequency sweep at highest (STOP) frequency. Button out sweeps frequency from START to STOP settings on FREQUENCY dial.
- 37 **LOG SWP/LIN SWP:** Button in produces logarithmic sweep. Button out produces a linear sweep.
- 38 **TRIG SWP/FREE RUN:** Button in causes sweep to start with trigger. Button out causes the sweep to free run.
- 39 **POWER:** Indicates when power is applied to FG 504.

## FIRST TIME OPERATION

The Controls and Connectors pages give a description of the front panel controls and connectors. The frequency determining controls are outlined in blue, the trigger function controls and inputs are outlined in green, and the internal sweep function controls and inputs are outlined in orange on the FG 504 front panel.

For first time operation, preset the controls as follows:

Blue section:

FREQUENCY Hz (Main Dial)	10
STOP	40
MULTIPLIER	10 <sup>2</sup>
HOLD/RUN	RUN (out)
VAR	Fully cw

Green section:

FREE RUN	In
----------	----

Orange section:

SWEEP DURATION	OFF
----------------	-----

Unmarked section:

Sine Wave	In
RISE and FALL TIME	FIXED
ATTENUATOR	-10
VAR	Fully cw

Connect a 50  $\Omega$  bnc cable terminated in 50  $\Omega$  to the vertical input of an oscilloscope. Set the oscilloscope to:

Vertical	1 V/Div DC coupled
Horizontal time base	1 millisecond/Div

Adjust the oscilloscope to display at least five full cycles of the sine wave. Now alternately push in the square wave, sine wave, and the triangle wave buttons in the unmarked section and observe the different waveshapes. Rotate the ATTENUATOR and VAR controls to verify that the output amplitude changes. Return them to the preset conditions. Pull out the OFFSET knob and rotate it. Notice the change in dc level of the output waveform. Return the OFFSET knob to the in position.

Press the square wave button in. Rotate the RISE and FALL TIME switch through its range. Note the change of square wave shape. Return the RISE and FALL TIME switch to the PRESET position. Pull the SYMMETRY knob to its out position and rotate it through its range. Note the change of waveshape for the square wave, the triangle wave, and the sine wave with the appropriate buttons pushed in. Return the SYMMETRY knob to its in position.

With the three buttons in the orange section in the out position, switch the SWEEP DURATION switch to 1 s. Note that the output frequency changes from a low frequency to a higher frequency once a second. Press the LOG SWP button in and note that the frequency change is slow at first and then more rapid. Press the STOP FREQ button and note that the sweep stops at the highest frequency of the sweep range. Rotate the STOP FREQ knob on the main dial in the blue section of the panel. Note

that the STOP FREQ is set by the STOP FREQ dial. Release the STOP FREQ button and press the TRIG SWP button. Note that the frequency no longer changes. Press the MAN TRIG button and note that the frequency changes once. Return the SWEEP DURATION knob to the OFF position.

Press the TRIG button in the green section of the panel in. Note that the OUTPUT signal stops. Press the MAN button in the green section in and note that there is one complete output cycle for each time the MAN switch is pressed. Press the GATE button in. Now press the MAN button. Note that the output waveform is continuous while the MAN button is pressed. Press the FREE RUN button in again for continuous output.

The output frequency controls are outlined in blue. Vary the FREQUENCY control to see the effect on the output frequency. The output frequency MULTIPLIER Knob selects the frequency range covered by the main dial. Switch the MULTIPLIER knob to the  $10^{-2}$  range. As the signal amplitude slowly varies on the oscilloscope, push the HOLD/RUN button in and release it several times to see that the oscillator stops at one point on the waveform and then begins at the same point when the button is released.

This completes the first time operation of the instrument.

### Risetime and Falltime

If the output pulse from the FG 504 is used to measure the rise or falltime of a device, consider the risetime characteristics of the associated equipment used. If the risetime of the device under test is at least ten times longer than the combined risetimes of the FG 504 plus the monitoring oscilloscope and associated cables, the error introduced will not exceed 1%. This error can generally be ignored. When the rise or falltime of the test device is less than ten times as long as the combined risetimes of the testing system, the actual risetime of the system must be determined. This is found from the risetime of each component making up the system. The total risetime equals the square root of the sum of the squares of the individual risetimes, or:

$$R_t = \sqrt{(R_1)^2 + (R_2)^2 + \dots}$$

Once the risetime of the system is known, the risetime of the device under test can be found by using the preceding method.

The physical and electrical characteristics of the pulse transmitting cable determine the characteristic im-

pedance, velocity of propagation, and amount of signal loss. Signal loss is related to frequency. A few feet of cable can attenuate high frequency information in a fast-rise pulse. It is therefore important to keep these cables as short as practical.

When signal comparison measurements or time difference determinations are made, the two signals from the test device should travel through coaxial cables with identical loss and time delay characteristics.

### Impedance Matching

As a pulse travels down a transmission line, each time it encounters a mismatch (or an impedance different than that of the transmission line), a reflection is generated and sent back along the line to the source. The amplitude and polarity of the reflections are determined by the impedance mismatch encountered. If the impedance mismatch is a higher value than the line impedance, the reflection will be of the same polarity as the applied signal. If it is a lower value than the line impedance, the reflection will be of opposite polarity.

If the reflected signal returns before the pulse is ended, it adds to or subtracts from the amplitude of the pulse. This distorts the pulse shape and amplitude.

If the FG 504 is driving a high impedance such as the 1 MΩ input impedance (paralleled by a stated capacitance) of the vertical input to an oscilloscope, connect the transmission line to a 50 Ω attenuator, 50 Ω termination, and then the oscilloscope input. The attenuator isolates the input capacitance of the device, and the FG 504 is properly terminated.

### Free Running Output

Select the desired waveform (square, triangle, or sine) by pushing the appropriate button marked with SQUAREWAVE, TRIANGLE, or SINEWAVE symbols. Push the FREE RUN button. Make certain the SWEEP DURATION switch is in the OFF position. Select the desired frequency with the MULTIPLIER and FREQUENCY Hz (START) dials. The FREQUENCY VERNIER control permits fine frequency adjustments. Connect the load to the OUTPUT terminal. Make certain the HOLD button is out. Set the ATTENUATOR control for the desired peak-to-peak output amplitude. Use the VAR knob to vary the amplitude between the steps.

The waveforms without offset center around 0 V. To offset the waveforms, pull and rotate the OFFSET control for the desired offset. If a square-wave output is selected, adjust the RISE and FALLTIME control for the desired values. The VAR knob varies these times between the

## Operating Instructions—FG 504 (SN B040000 & UP)

control steps. A trigger signal, one for each cycle of the selected waveform, is available at the TRIG OUTPUT connector.

When using the sine or triangle waveform output with the MULTIPLIER in the slowest five positions, the waveform output may be stopped by pushing the HOLD button. The waveform generator stops and the FG 504 outputs a dc voltage equal to the voltage the triangle or sine waveform reached when the button was pushed. This feature does not operate on the square waveform.

When pulled out, the SYMMETRY control divides the output frequency ( $FREQ \div 10$  indicator lit) by ten, and varies the time based symmetry of the selected waveform. Pull this control and turn for the desired symmetry using any of the three basic waveforms.

### Triggered or Gated Operation

With the FG 504 set for free running operation as described in the previous paragraphs, apply the triggering or gating signal to the INPUT connector. If only one cycle of the output waveform per trigger is desired, push the TRIG button and set the LEVEL control for the level on the triggering waveform at which the output waveform is to begin. If more than one cycle of the output waveform is desired, press the GATE pushbutton. The FG 504 output now begins at the triggering level and continues until the waveform at the input connector drops below the triggering level. The output duration is now the duration of the gating waveform. The number of cycles per burst may be approximated by dividing the gating signal duration by the period of the FG 504 output frequency. In the gated mode of operation, the FG 504 always completes the last cycle. If, at the termination of the gating waveform, less than approximately  $270^\circ$  of the last cycle remains, an additional cycle is completed.

In triggered or gated operation the PHASE control varies the start of the triangle or sine output waveform by  $\pm 80^\circ$ . This phase change is measured from the 0 V,  $0^\circ$  point on the output waveform.

To manually trigger or gate the FG 504, turn the LEVEL control fully clockwise and push the TRIG or GATE button as desired. In the TRIG mode, pushing the MAN button triggers one cycle of the output waveforms. In the GATE mode, the selected output waveform continues as long as the MAN button is pressed in.

### Voltage Controlled Frequency Operation

The output frequency of the FG 504 can be swept over a frequency range of 1000:1, depending on the MULTIPLIER setting, by applying a 0 V to 10 V signal to

the VCF INPUT connector. See Figure 2-3 for the maximum vcf range for each MULTIPLIER setting. It may be necessary to vary the FREQUENCY VERNIER control to obtain the full 1000:1 swept range or the lowest swept frequency desired.

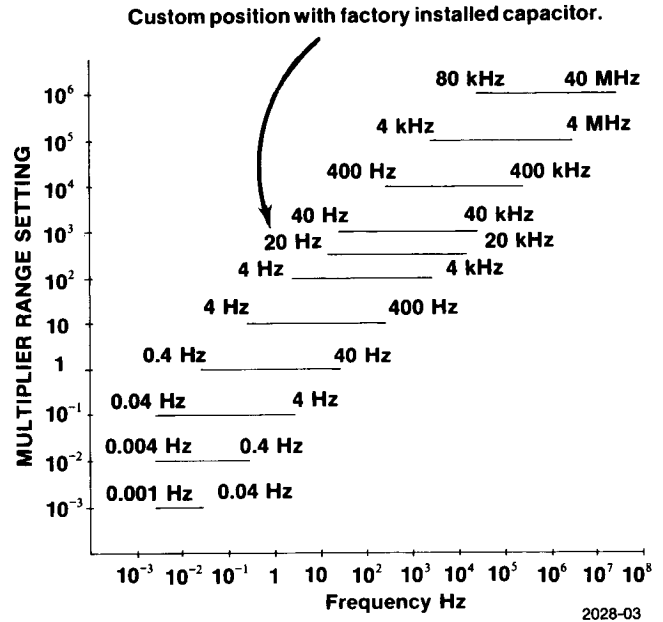

Fig. 2-3. Graph showing range of frequencies for each MULTIPLIER setting that can be swept with a 0 to 10 V signal applied to the VCF INPUT.

The polarity of the vcf input signal determines the direction the output frequency is swept from the frequency set by the MULTIPLIER, FREQUENCY Hz (START), and FREQUENCY VERNIER controls. A positive-going voltage raises the frequency while a negative-going voltage lowers the frequency. A voltage that varies symmetrically about 0 V sweeps the output frequency symmetrically about the center frequency determined by the frequency controls (see Figure 2-3).

Since the vcf input amplitude versus frequency is a linear relationship, the frequency output may be determined from the vcf input amplitude and the FREQUENCY Hz dial position. VCF sensitivity is the highest possible dial setting (40) times the MULTIPLIER range divided by the maximum VCF input voltage (10 V). In the FG 504, this is a nominal sensitivity (Hz per V) of 4 times the MULTIPLIER setting. For example, with a  $10^3$  MULTIPLIER setting, a two-volt change at the VCF INPUT will change the output frequency 8 kHz.

### Custom Timing Range

This feature permits the user to install a custom swept frequency range. The  $.5 \times 10^3$  position of the MUL-

TIPLIER switch is used for the custom range. The factory-installed capacitor (C248) for this position of the MULTIPLIER switch provides a swept range from 20 Hz to 20 kHz.

### Phase Locked Operation

The frequency of the output waveform may be synchronized with an externally-applied reference signal.

The output frequency of the FG 504 must be set to within  $\pm 10$  major dial divisions of the frequency of the externally applied signal (the "1" on the dial is the lowest major dial division). Connect the reference signal to the INPUT connector and push the  $\Phi$ LOCK pushbutton. The PHASE control varies the phase of the output waveform  $\pm 80^\circ$  with respect to the reference signal waveform. The LEVEL control adjusts the triggering point on the reference waveform.

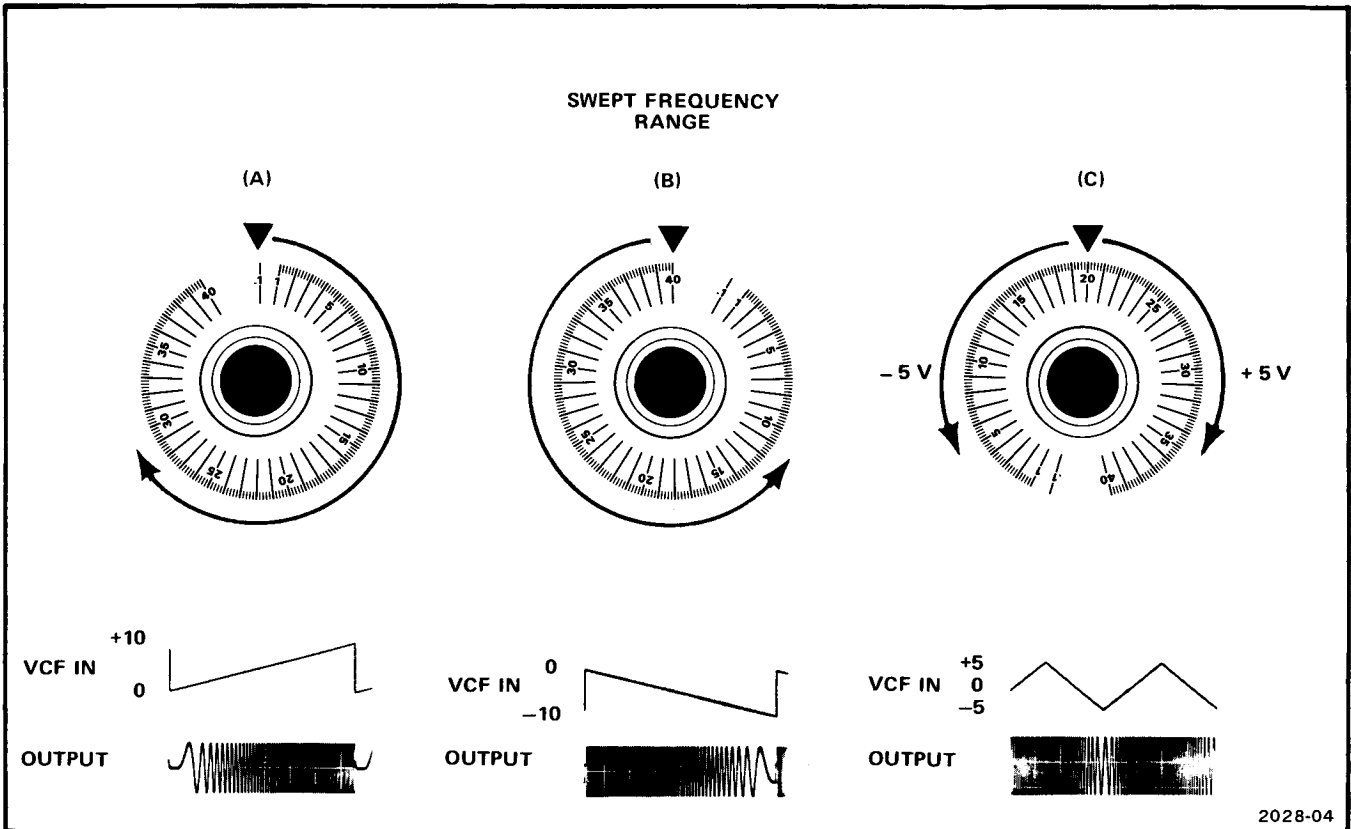

Fig. 2-4. Swept frequency range with 10 V signal applied to VCF IN connector.

Proper adjustment of the LEVEL and PHASE controls is easier if they are adjusted first in the TRIG mode. Set the FREE RUN frequency of the FG 504 somewhat higher than the frequency of the reference signal applied to the INPUT connector, and then select the TRIG mode. Adjust the LEVEL control for stable triggering and (if viewing on an oscilloscope) adjust the output frequency of the FG 504 until it is nearly the same as the frequency of the signal applied to the INPUT connector. Set the PHASE control at 12 o'clock (for  $0^\circ$  with sine wave selected) and press  $\Phi$ LOCK. Readjust the PHASE control, if necessary, to obtain a stable output at the desired phase. The PHASE control range decreases above 4 MHz.

A jumper allows the VCF INPUT to function as a phase modulating input when the FG 504 is operated in the

PHASE LOCK mode. The phase modulating input voltage limits are  $\pm 2.5$  V, with an upper frequency limit of 1 kHz. When phase locked, the phase modulating voltage varies the output phase by approximately  $5^\circ/V$ .

### Amplitude Modulating Input

To amplitude modulate the output waveform, connect the modulating signal to the AM INPUT connector. Push the SINEWAVE pushbutton and set the FREQUENCY Hz dial for the desired carrier frequency. Refer to the Amplitude Modulating Input specification for more information about this mode of operation.



### Internal Sweep Operation

Select the time for one complete sweep with the SWEEP DURATION control. Use the VAR knob to obtain sweep times between steps. Set the FREQUENCY Hz (START), STOP FREQ, and MULTIPLIER dials for the desired swept frequencies. Select either a logarithmic or linear sweep rate by pushing or releasing the LOG/LIN SWP pushbutton. Release the STOP FREQ pushbutton. Use the FREQUENCY VERNIER control to set the START frequency when sweeping from frequencies lower than the "1" calibration figure on the dial. If a triggered sweep is desired, push the TRIG SWP pushbutton and connect the trigger signal to the SWEEP TRIG INPUT connector. Adjust the LEVEL control so the sweep starts at the desired level on the triggering waveform. If free running operation is desired, release the TRIG SWP pushbutton.

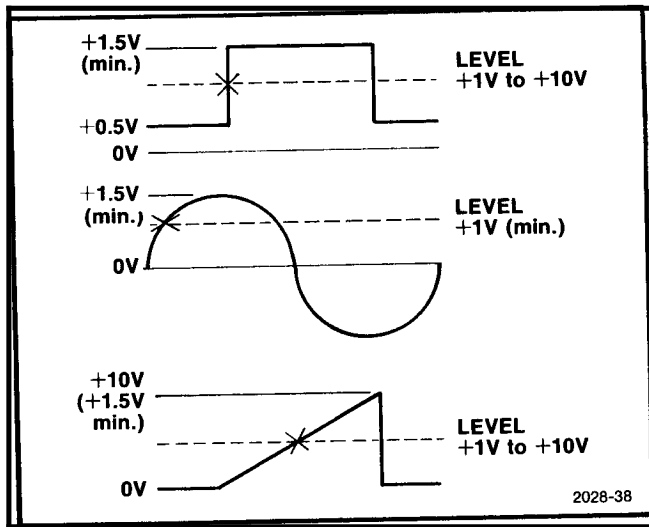

Fig. 2-5. Trigger Signal amplitude requirements and triggering points.

The sweep may be stopped and the output frequency held at any time by pushing the STOP FREQ pushbutton. The linear sweep voltage is available at the SWEEP OUTPUT connector.

### External Input Signals for Trigger, Gate, Phase Lock, and Sweep Trig Modes

External input signals for these modes must be at least 1 V p-p around the dc voltage set by the LEVEL control (+1 V to +10 V). With the LEVEL control at or near minimum, the external signal must, at least, pass through +0.5 V and +1.5 V. For example, an external signal whose amplitude is symmetrical about 0 V (such as a sine wave) must be at least 3 V p-p (+1.5 V to -1.5 V). Typical input signals are as shown in Figure 2-5.

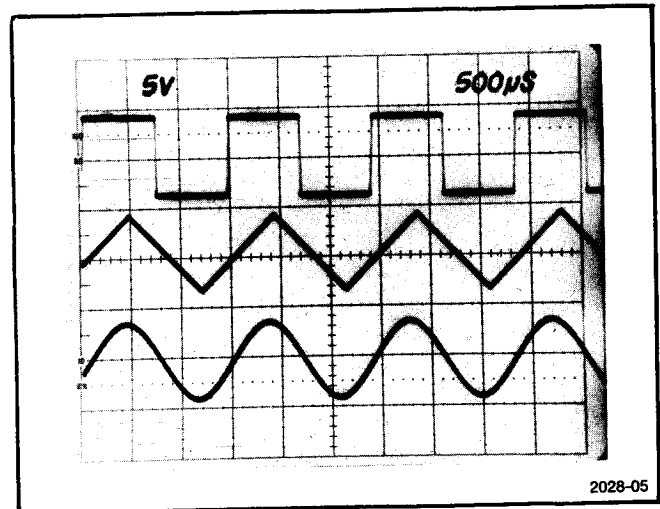

Fig. 2-7. BASIC FUNCTIONS. Square, triangle, and sine waveforms selected by front panel pushbuttons.

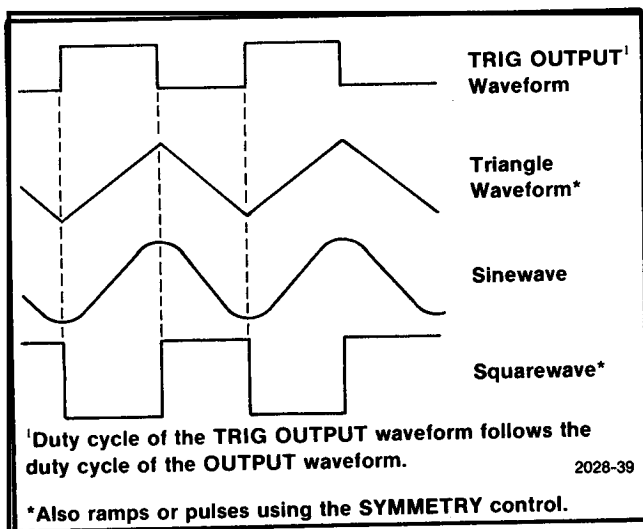

Fig. 2-6. Phase relationships between OUTPUT waveforms and the TRIG OUT waveform.

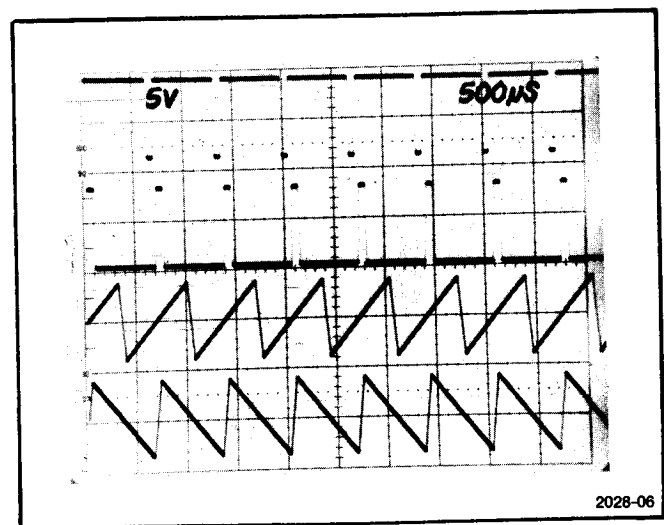

Fig. 2-8. RAMPS AND PULSES. These are obtained from the basic waveforms by using the SYMMETRY control.

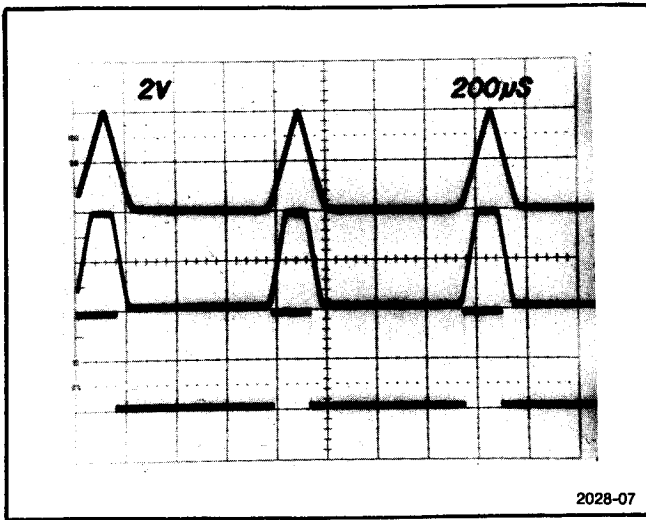

Fig. 2-9. VARIABLE RISE AND FALL TIMES. By varying the rise and fall times in the square wave mode various pulse shapes are formed.

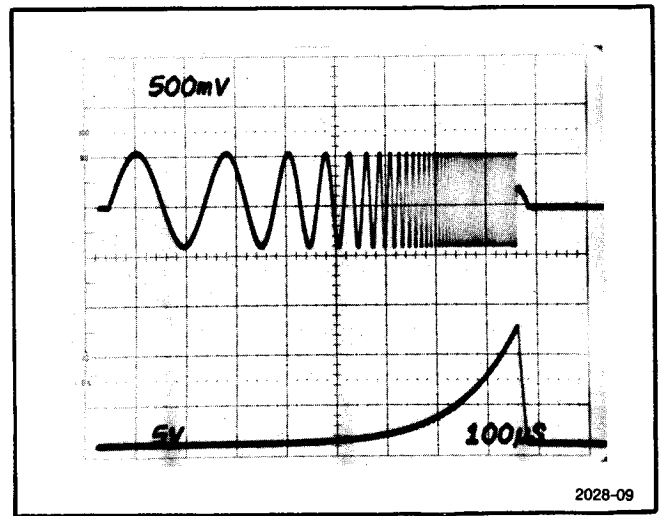

Fig. 2-11. LOGARITHMIC SWEEP. Use the same setup as in Fig. 2-10. Select the logarithmic ramp. The frequency is swept at a logarithmic rate. The logarithmic ramp voltage is not externally available.

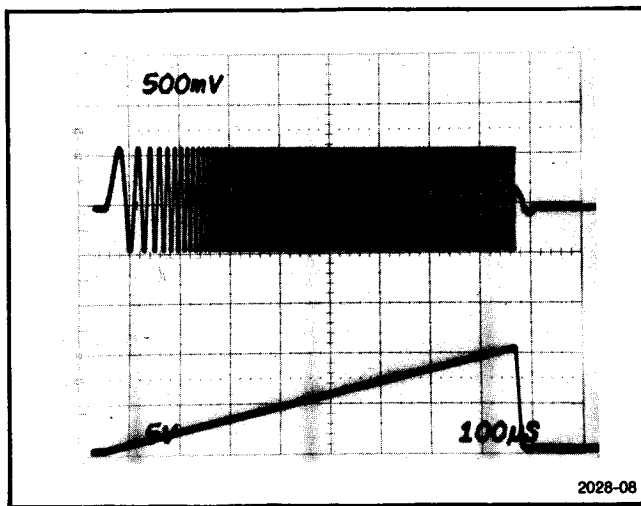

Fig. 2-10. LINEAR SWEEP. Select the start and stop frequencies and the internal linear ramp for a swept output from the start to stop frequencies in the selected time.

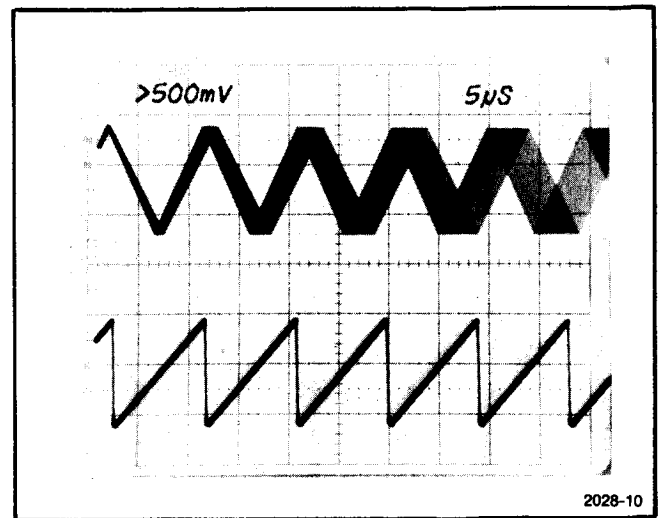

Fig. 2-12. NARROW BAND SWEEP. The top trace shows the triangle waveform swept by a linear ramp. The start frequency is 9.52 kHz and the stop frequency is 10.52 kHz. This function is useful for narrow band sweep testing. The bottom trace is the sweeping ramp.

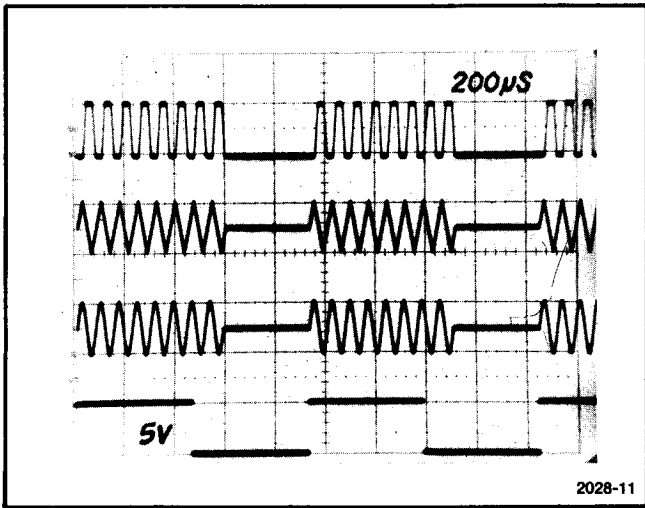

Fig. 2-13. GATED OPERATION. The top three traces are various output waveforms and the bottom trace is the gating waveform applied to the trigger INPUT connector with the GATE pushbutton pressed in. Note the additional cycle completed after the waveforms are gated off.

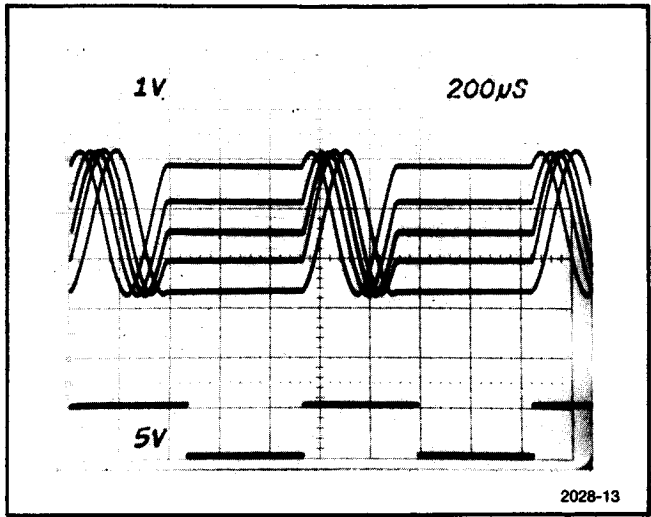

Fig. 2-15. PHASE CONTROL OPERATION. This photograph illustrates PHASE control usage in the triggered mode. The five super-imposed traces illustrate the effect of the phase control. This control provides approximately  $\pm 80^\circ$  of shift. The bottom trace is the triggering waveform.

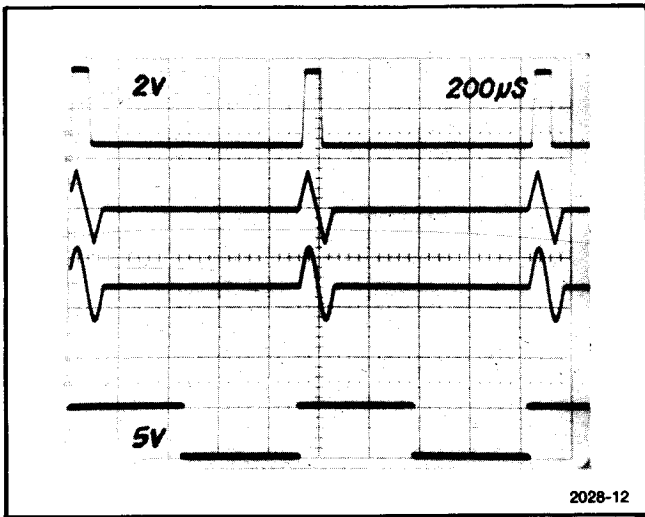

Fig. 2-14. TRIGGERED OPERATION. The top three traces are the various output traces selected. The bottom trace is the triggering waveform applied to the trigger INPUT connector with the TRIG mode selected. Note that only one cycle of the output waveforms is completed.

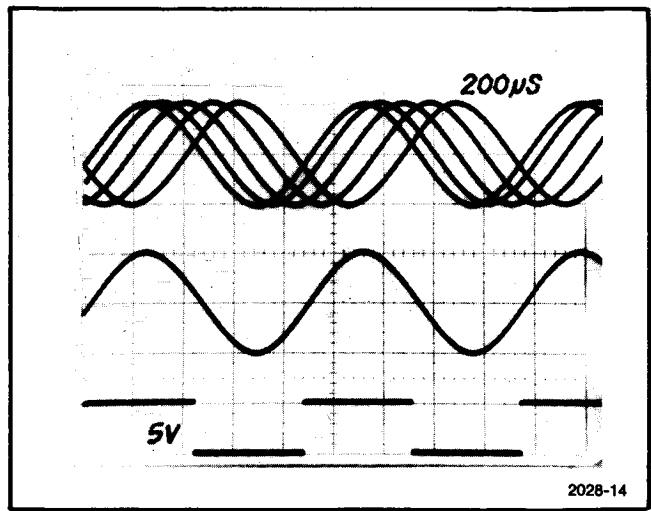

Fig. 2-16. PHASE LOCKED LOOP. The bottom trace is the signal applied to the INPUT connector in the  $\Phi$  LOCK mode of operation. The middle trace is the output phase locked to the input signal. The top traces show the effect of the PHASE control.

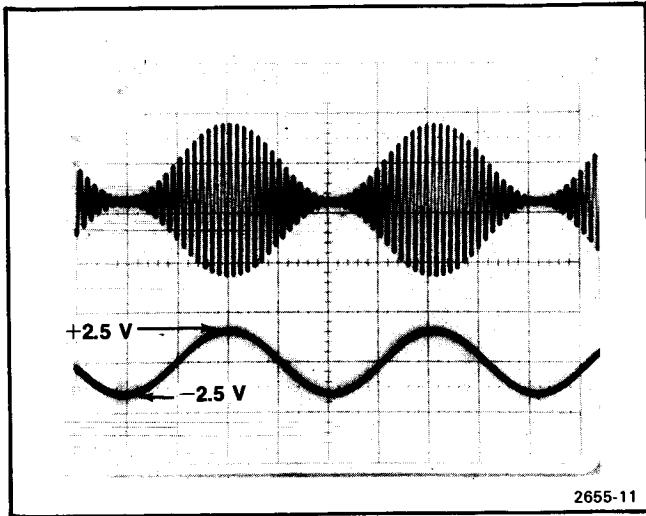

Fig. 2-17. **AMPLITUDE MODULATION.** The top trace shows the 100% modulated envelope and the bottom trace the modulating signal.  $\pm 2.5$  volts modulates the output 100%. (5 V P-P centered around 0 V).

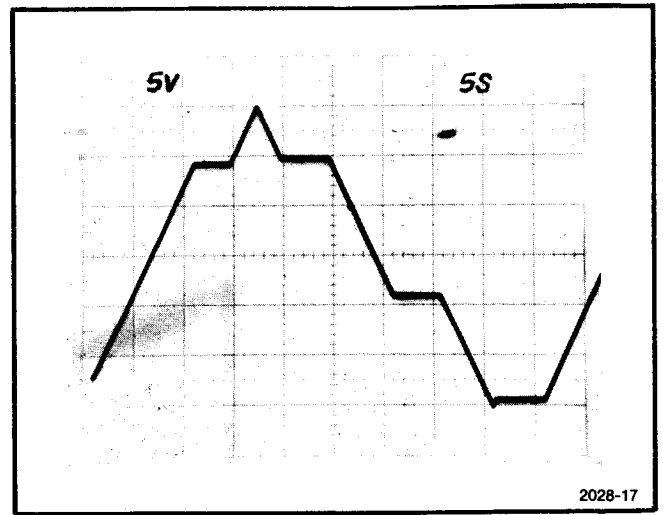

Fig. 2-19. **LOW FREQUENCY HOLD.** The output of the FG 504 in the lowest five MULTIPLIER settings can be held at any level by pushing the HOLD button. The steps on this time exposure were obtained in this manner.

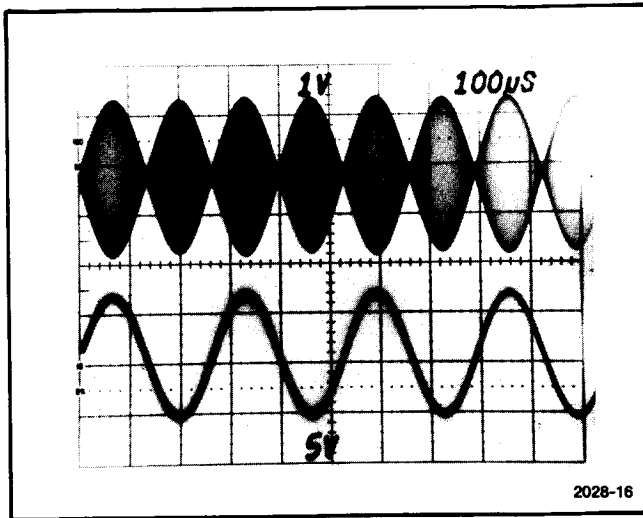

Fig. 2-18. **SUPPRESSED CARRIER MODULATION.** The top trace shows a double sideband suppressed carrier modulation envelope while the bottom trace displays the modulating waveform. The upper peak of the modulating waveform is at 0 V and the bottom peak is at -10 V. The overall level of the modulating waveform must be carefully adjusted for true suppressed carrier operation.

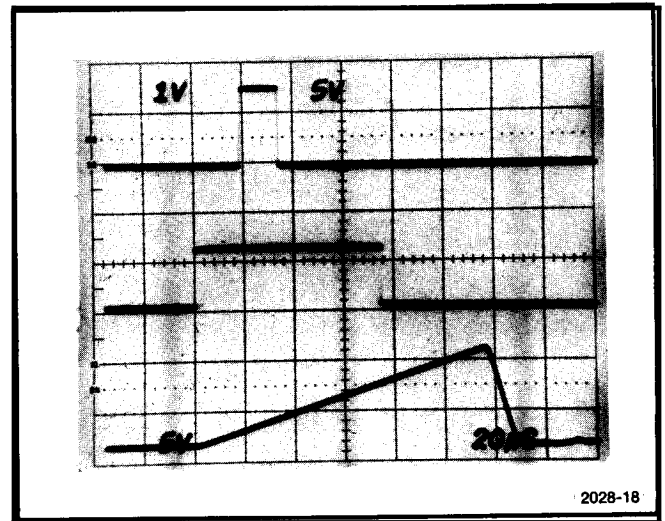

Fig. 2-20. **DELAYED OPERATION.** A wide range of delay times are available by using the internal sweep generator as a delay generator. The middle trace is the underlaid input signal applied to the SWEEP TRIG INPUT. The bottom trace is at the LIN SWP OUT connector. This ramp is applied to the external trigger INPUT connector. The top trace is the delayed output pulse. The amount of delay is proportional to the sweep duration and the setting of the TRIG LEVEL control. Be sure when using the sweep as a delay generator to set the STOP FREQ dial fully ccw.

### Tone Burst Testing

The FG 504, with an external pulse generator, may be used for tone burst testing. Connect the output of a TEKTRONIX PG 501 (or equivalent) pulse generator to the trigger INPUT connector. Select the GATE mode of operation. Set the external pulse generator for the desired pulse duration and repetition rates. Now select the desired sweep time for the FG 504. Select the start and stop frequencies. The output of the FG 504 will now be a series of tone bursts as shown in Figure 2-21.

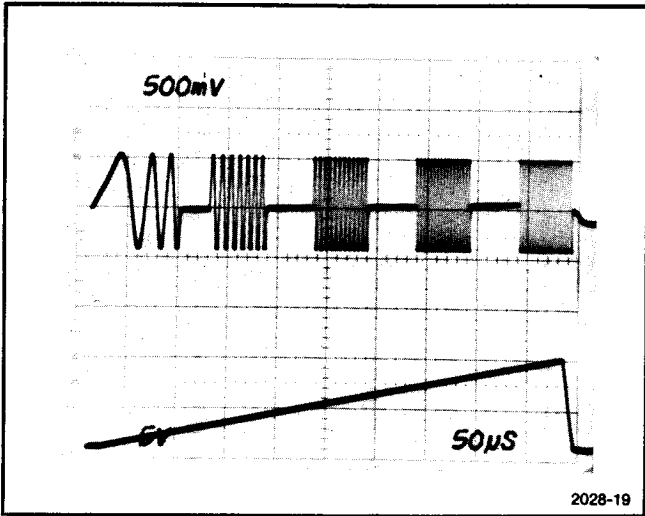

Fig. 2-21. TONE BURST TESTING. The lower trace is the linear ramp from the LIN SWEEP OUTPUT terminal.

### Filter Testing

The swept frequency capabilities of the FG 504 make it quite suitable for sweep testing filters. When using the FG 504 in this application, it is best to use the LOG SWP Mode. Figures 2-22 and 2-23 illustrate the advantages of using logarithmic sweeps.

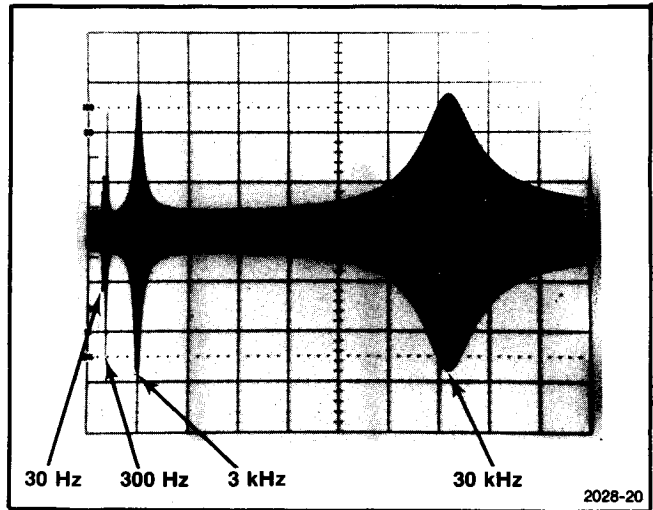

Fig. 2-22. Linear sweep showing skewed spacing of filter output frequencies.

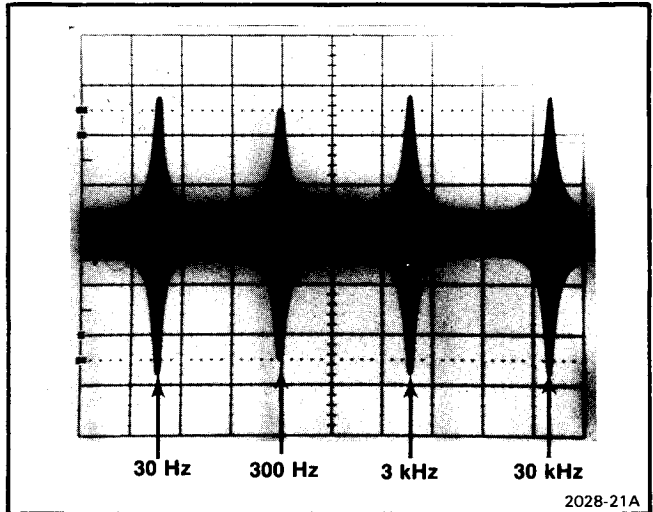

Fig. 2-23. Logarithmic sweep showing even spacings of filter output frequencies.

### Pulse Shaping

The external triggering feature of the FG 504 adapts for pulse shaping. Connect the pulse to be shaped to the trigger INPUT connector and place the FG 504 in the square-wave mode. The triggering level may be selected with the TRIG LEVEL control. The rise and fall times, levels, and symmetry of the clean output pulse may be changed as desired. Figure 2-24 illustrates this application.

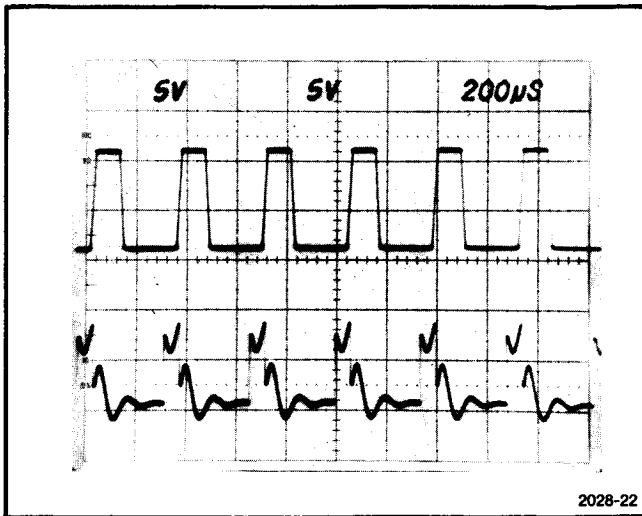

Fig. 2-24. PULSE SHAPING CAPABILITIES. The lower trace is the triggering signal.

### REPACKAGING FOR SHIPMENT

If the Tektronix instrument is to be shipped to a Tektronix Service Center for service or repair, attach a tag showing: owner (with address) and the name of an individual at your firm that can be contacted. Include complete instrument serial number and a description of the service required.

Save and re-use the package in which your instrument was shipped. If the original packaging is unfit for use or not available, repackage the instrument as follows:

Surround the instrument with polyethylene sheeting to protect the finish of the instrument. Obtain a carton of corrugated cardboard of the correct carton strength and having inside dimensions of no less than six inches more than the instrument dimensions. Cushion the instrument by tightly packing three inches of dunnage or urethane foam between carton and instrument, on all sides. Seal carton with shipping tape or industrial stapler.

The carton test strength for your instrument is 200 pounds.

# INSTRUCTIONS D'UTILISATION

## Introduction

Le FG 504 fournit des signaux sinusoïdaux à faible distorsion, carrés, triangulaires, des rampes ainsi que des impulsions sur une plage de fréquence comprise entre 0,001 Hz et 40 MHz, répartie en 10 décades. Le commutateur de décades comprend également une position libre. L'amplitude de sortie est de 10 mV à 30 V crête-à-crête en circuit ouvert et de 5 mV à 15 V crête-à-crête dans une charge de 50  $\Omega$ . L'impédance de sortie est de 50  $\Omega$ . Le FG 504 est pourvu d'un système interne de vobulation linéaire ou logarithmique. La sortie du signal peut être verrouillée en phase, validée ou déclenchée. Le déphasage entre la sortie «signal» et la sortie «déclenchement» peut être de  $\pm 80^\circ$ . La symétrie du signal de sortie peut également être modifiée. Pour les fréquences les plus basses, la sortie peut être maintenue à n'importe quel niveau en appuyant sur le bouton du panneau avant HOLD.

Une entrée de vobulation externe (VCF) permet de commander la fréquence du signal de sortie à partir d'une source de tension externe. La fréquence de sortie peut être vobulée de part et d'autre de la fréquence sélectionnée dans un rapport maximal de 1 000 : 1. Ce rapport est fonction de l'amplitude et de la polarité du signal de vobulation, ainsi que de la fréquence de sortie choisie. Le signal sinusoïdal peut également être modulé en amplitude par des signaux externes.

La grande diversité de signaux délivrés par le FG 504 le désigne tout particulièrement pour des applications telles que tests de systèmes d'asservissement, mesures de bande passante, de distorsion et de stabilité des amplificateurs. Il est appréciable pour la génération de modulation de fréquence, comme oscillateur à battements, comme interface logique validée, déclenchée ou verrouillée en phase, ou bien comme générateur de signaux de diverses formes : rampe ou impulsion. Il peut être également utilisé comme générateur de signal pour obtenir des signaux modulés en amplitude.

## INSTRUCTIONS DE MISE EN ROUTE

Le FG 504 est livré prêt à être utilisé. Il occupe deux compartiments de tout châssis de la série TM 500, à l'exclusion du TM 501. Consulter le manuel d'instruction du châssis d'alimentation pour obtenir toute information relative à la tension du réseau et à l'utilisation du châssis. Une ventilation à air forcé est indispensable pour une utilisation à une température comprise entre 40° et 50°C.

## ATTENTION

*Couper l'alimentation secteur du châssis avant d'installer ou d'extraire le FG 504 car il y a un risque d'amorçage sur les connecteurs de l'interface arrière. Ces amorçages réduisent la durée de vie des connecteurs et peuvent endommager les circuits du tiroir.*

Vérifier l'emplacement des détrompeurs en plastique dans les connecteurs du châssis d'alimentation. Si des détrompeurs ne correspondent pas aux fentes des circuits imprimés du FG 504, cela indique qu'un câblage spécial de l'interface est réalisé pour un autre tiroir. Ne pas introduire le FG 504 avant d'avoir fait vérifier l'ensemble par une personne qualifiée.

Lorsque les détrompeurs sont mis correctement, aligner les rainures supérieures et inférieures du FG 504 avec les guides du châssis d'alimentation (voir la Fig. 2-1). Pousser le FG 504 et presser fermement pour qu'il soit parfaitement engagé dans le châssis. Le voyant POWER doit s'allumer après la mise sous tension du module d'alimentation.

Pour sortir le FG 504, tirer sur le verrou (dans le coin inférieur gauche) jusqu'au dégageement du tiroir.

## CONSEILS D'UTILISATION

### Connexions de sortie

Le FG 504 étant conçu pour travailler comme source de tension d'impédance interne 50  $\Omega$  doit être chargé par 50  $\Omega$ . Aux fréquences élevées, une charge non ou mal adaptée provoquera des aberrations excessives sur le signal de sortie (se reporter au chapitre : Adaptation d'impédance). Les charges inférieures à 50  $\Omega$  réduiront l'amplitude du signal de sortie.

Les distorsions ou aberrations excessives, provoquées par des impédances mal adaptées, sont moins grandes aux fréquences basses (plus particulièrement avec des signaux sinusoïdaux ou triangulaires). Cependant, afin de s'assurer de la pureté du signal, observer les précautions suivantes :

1. Utiliser des câbles et connecteurs 50  $\Omega$  de bonne qualité.
2. Les connexions doivent être soigneusement réalisées et aussi courtes que possible.



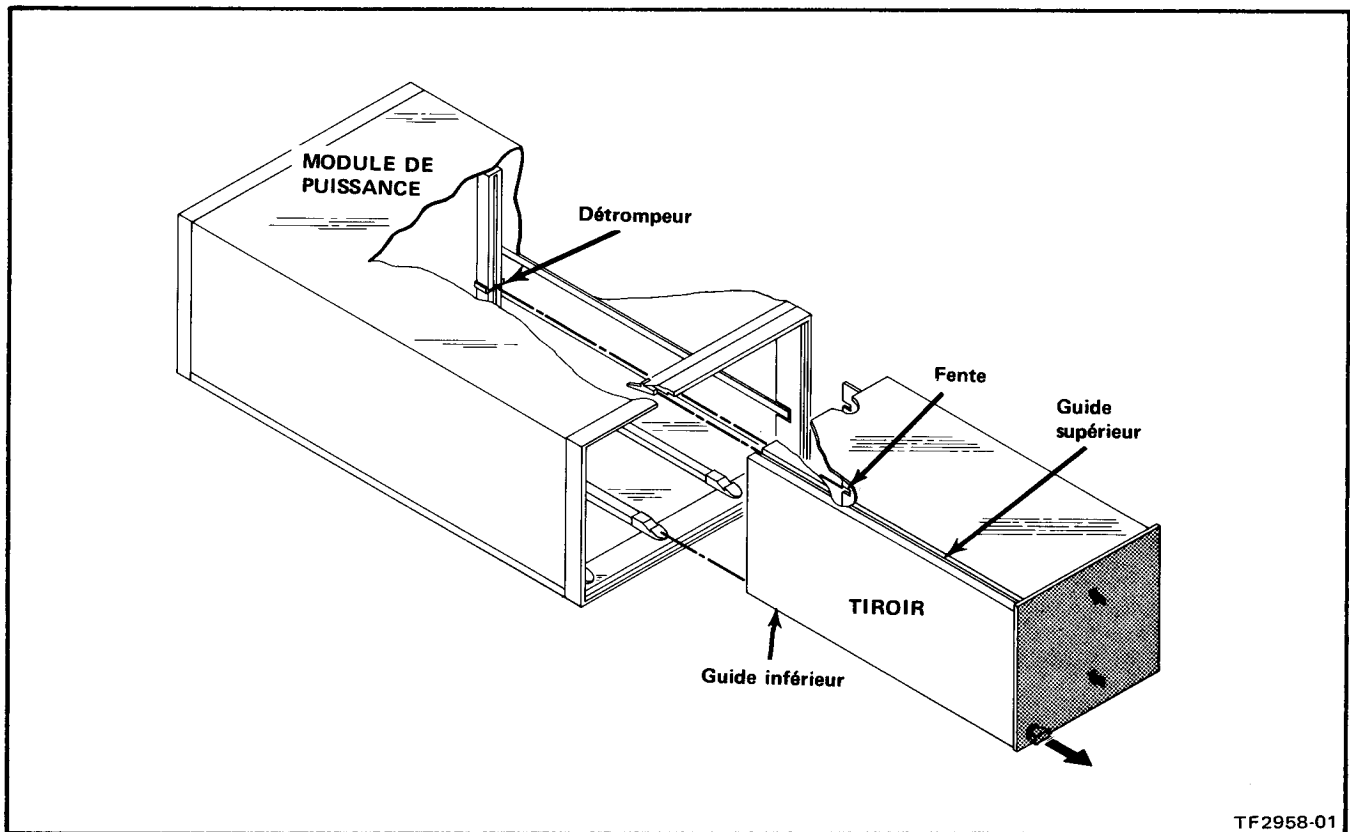

Fig. 2-1. Installation et extraction du FG 504.

3. Utiliser des atténuateurs de qualité, s'il s'avère nécessaire de réduire l'amplitude du signal.

4. Utiliser des résistances de terminaison ou des adaptateurs d'impédance, pour éviter les réflexions lorsque l'on emploie des câbles de grande longueur, c'est-à-dire égale ou supérieure à deux mètres.

5. S'assurer que les atténuateurs, terminaisons, etc... peuvent supporter la puissance maximale délivrée à la sortie du générateur.

Si le générateur doit débiter sur une charge comportant une tension continue, utiliser un condensateur couplé en série avec la charge. La constante de temps du condensateur de couplage et de la charge doit être suffisamment grande pour pouvoir maintenir l'impulsion correcte.

**NOTA**

*Si l'on utilise le FG 504 avec des châssis d'alimentation anciens modèles, les ondulations résiduelles se produisant sur le signal de sortie peuvent être excessives, dans certains cas. Ces ondulations résultent d'une mise en phase du transformateur du châssis d'alimentation incompatible avec le fonctionnement du FG 504.*

*Cependant, le problème peut aisément se résoudre. Pour cela, consulter une personne qualifiée pour régler le problème.*

**COMMANDES ET BORNES**

- ① **FREQUENCY (Hz)** : sélectionne la fréquence de fonctionnement ou la fréquence de départ (la plus basse) en mode vobulation.
- ② **STOP FREQUENCY (Hz)** : sélectionne la fréquence d'arrêt (la plus haute) en mode vobulation.
- ③ **FREQ ÷ 10** : s'allume lorsque la commande VARIABLE SYMMETRY est tirée.
- ④ **RUN** : bouton sorti pour un fonctionnement normal.  
**HOLD** : le bouton enfoncé maintient le générateur et la sortie au niveau continu atteint. Fonctionnement sur les cinq gammes les plus basses de la commande MULTIPLIER (zone grise).

- 5 **VCF INPUT** : la tension externe appliquée fait varier la fréquence de sortie.
- 6 **FREQUENCY VERNIER** : pour des variations précises de fréquence.
- 7 **MULTIPLIER** : détermine la fréquence de sortie en association avec la commande FREQUENCY Hz.
- 8 **AM INPUT** : la tension externe appliquée module le signal de sortie sinusoïdal.
- 9 **LATCH** : tirer pour extraire le tiroir.
- 10 **INPUT** : appliquer à cette entrée les signaux de validation externe, de déclenchement ou de verrouillage de phase.
- 11 **MAN** : permet un déclenchement manuel dans le mode TRIG, ou une validation du signal de sortie en mode GATE.
- 12 **LEVEL** : règle le niveau à partir duquel un signal de sortie sera déclenché, validé ou déphasé.
- 13  $\phi$  **LOCK** : en position enfoncée, verrouille la fréquence en sortie sur la fréquence du signal appliqué à la prise INPUT.
- 14 **GATE** : en position enfoncée, provoque le fonctionnement du générateur durant un niveau haut sur la prise d'entrée.
- 15 **TRIG** : en position enfoncée, provoque la sortie d'une seule période du signal sélectionné pour chaque fraction positive du signal de déclenchement appliqué à la prise INPUT.

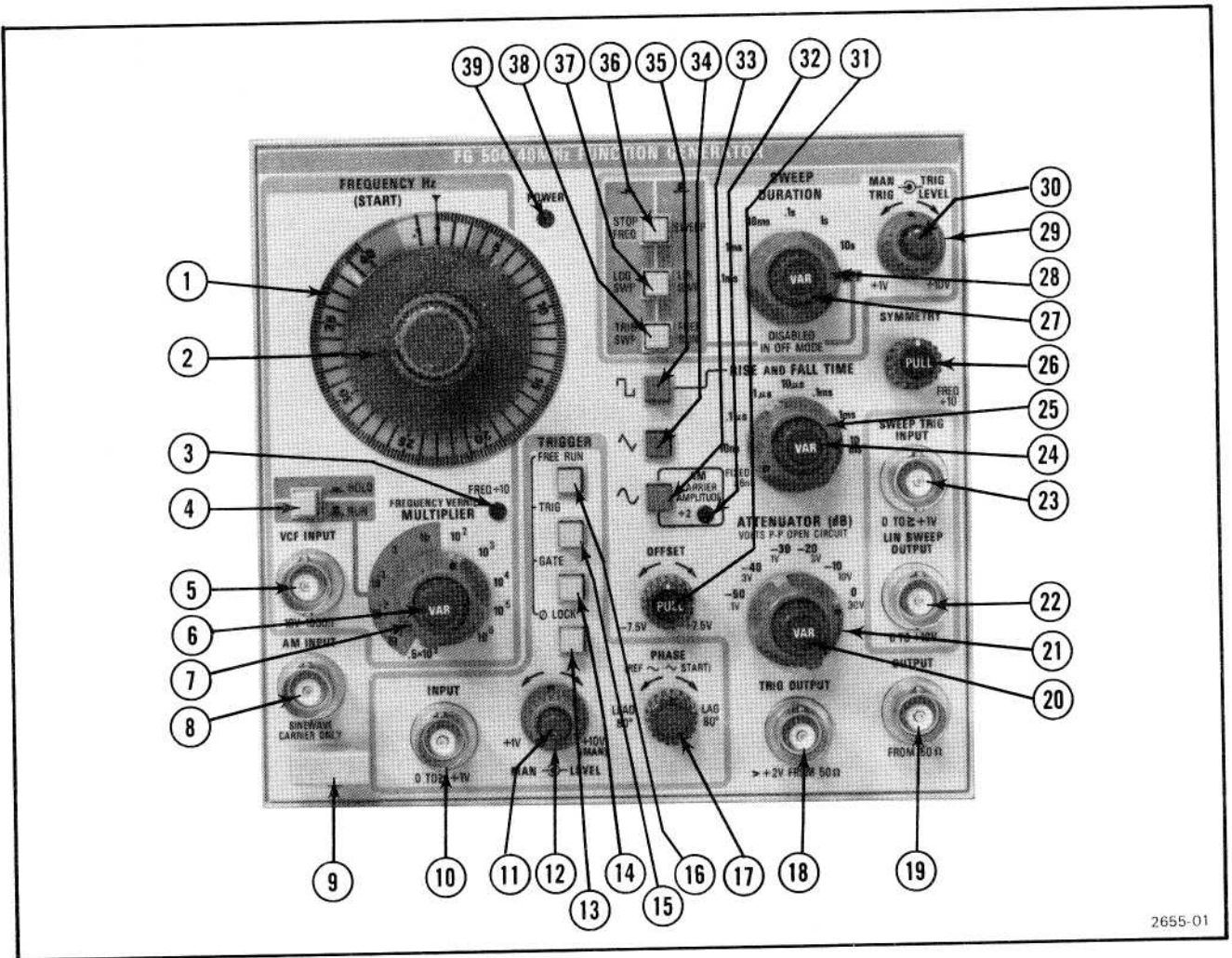

Fig. 2-2. Commandes et bornes du panneau avant.

## Instructions d'utilisation - FG 504 (à partir de B040000)

- 16 **FREE RUN** : la position enfoncée provoque un fonctionnement continu du générateur.
- 17 **PHASE** : sélectionne la phase du signal en sortie jusqu'à  $\pm 80^\circ$  par rapport au niveau de déclenchement sélectionné sur le signal d'entrée.
- 18 **TRIG OUTPUT** : sortie d'une impulsion positive pour chaque période positive du signal sélectionné, exception faite du mode « carré », où la fraction positive du signal de déclenchement TRIG OUTPUT correspond à la fraction négative du signal de sortie.
- 19 **OUTPUT** : prise de sortie du signal.
- 20 **VAR** : fait varier l'amplitude de la forme de sortie entre les positions étalonnées de la commande ATTENUATOR (dB).
- 21 **ATTENUATOR (dB)** : fait varier l'amplitude du signal de sortie par bonds de 10 dB.
- 22 **LIN SWEEP OUTPUT** : la sortie délivre une rampe linéaire entre 0 et +10 V à chaque cycle de balayage.
- 23 **SWEEP TRIG INPUT** : le signal appliqué déclenche la rampe de balayage en fréquence lorsque la commande TRIG SWEEP est utilisée.
- 24 **VAR** : fait varier les temps de montée et de descente entre les positions étalonnées.
- 25 **RISE and FALL TIME** : fait varier les temps de montée et de descente des signaux carrés entre les positions.
- 26 **SYMMETRY** : tirer et tourner pour régler la symétrie du signal de sortie. Divise par 10 la fréquence de sortie. Allume le voyant  $FREQ \div 10$ .
- 27 **VAR** : fait varier le temps de balayage entre les positions étalonnées de la commande SWEEP DURATION.
- 28 **SWEEP DURATION** : sélectionne la durée de la rampe de balayage.
- 29 **TRIG LEVEL** : sélectionne le niveau de déclenchement du balayage sur le signal appliqué à l'entrée SWEEP TRIG.
- 30 **MAN TRIG** : en position enfoncée, provoque le déclenchement d'un balayage.
- 31 **OFFSET** : tirer et faire tourner pour décaler le signal en sortie à partir de 0 V.
- 32 **AM CARRIER AMPLITUDE  $\div 2$**  : s'allume lorsque l'impédance de source sur l'entrée AM est  $\leq 10 \text{ k}\Omega$ .
- 33 **(SINE WAVE)** : bouton enfoncé, sélectionne un signal rectangulaire.
- 34 **(TRIANGLE WAVE)** : bouton enfoncé, sélectionne un signal triangulaire.
- 35 **(SQUARE WAVE)** : bouton enfoncé, sélectionne un signal sinusoïdal.
- 36 **STOP FREQ** : bouton enfoncé, bloque le vobulateur sur la fréquence d'arrêt de la vobulation. Bouton sorti, fonctionnement normal du vobulateur entre les fréquences de départ et d'arrêt.
- 37 **LOG SWP/LIN SWP** : bouton enfoncé, vobulation logarithmique. bouton sorti, vobulation linéaire.
- 38 **TRIG SWP/FREE RUN** : bouton enfoncé, le balayage de fréquence commence avec une impulsion positive appliquée sur la prise SWEEP TRIG. Bouton sorti, balayage relaxé.
- 39 **POWER** : voyant éclairé lorsque l'appareil est sous tension.

## PREMIERE UTILISATION

Sur la face avant un entourage de couleur permet d'identifier les diverses fonctions. Les commandes déterminant la fréquence du signal sont entourées de bleu, celles concernant le déclenchement de vert et celles commandant la vobulation d'orange.

Lors de la première mise en service positionner les commandes comme suit :

Section bleue :	
FREQUENCY Hz	10
(cadran principal)	
STOP	40

MULTIPLIER HOLD/RUN VAR	10 <sup>2</sup> RUN (bouton sorti) complètement à droite
Section verte : FREE RUN	bouton enfoncé
Section orange : SWEEP DURATION	position OFF
Section non repérée : bouton ~ RISE ET FALL TIME ATTENUATOR VAR	enfoncé position FIXED -10 complètement à droite

Connecter un câble BNC, terminé par une charge 50 Ω, à l'entrée verticale de l'oscilloscope. Régler l'oscilloscope comme suit :

Vertical	1 V/div, couplage DC
Base de temps	1 ms/div

Régler l'oscilloscope pour visualiser cinq périodes de la sinusoïde. Appuyer successivement sur le bouton «signal rectangulaire», «signal sinusoïdal» et enfin sur le bouton «signal triangulaire». Observer les différentes formes d'ondes. Tourner les commandes ATTENUATOR et VAR et vérifier que l'amplitude du signal de sortie varie. Revenir aux positions de départ. Tirer le bouton OFFSET et le tourner. Noter la variation du niveau continu du signal de sortie. Pousser le bouton OFFSET.

Enfoncer le bouton SQUARE WAVE. Tourner la commande RISE ET FALL TIME sur toutes ses positions et noter un changement du temps de montée du signal. Remettre cette commande sur la position de départ. Tirer le bouton SYMMETRY et parcourir sa plage de variation. Noter le changement de l'enveloppe du signal rectangulaire, du signal triangulaire et du signal sinusoïdal en pressant sur le bouton approprié. Appuyer sur le bouton SYMMETRY.

Les trois boutons de la partie orange étant sortis sélectionner la valeur 1 s du commutateur SWEEP DURATION. Noter que la fréquence du signal de sortie varie d'une fréquence basse (1 kHz) à une fréquence haute (4 kHz) en une seconde. Appuyer sur le bouton LOG SWP et noter que la variation de fréquence est lente au départ puis accélérée. Presser le bouton STOP FREQ et vérifier que le balayage s'arrête sur la plus haute fréquence de la gamme. Tourner le bouton STOP FREQ. Noter que la fréquence d'arrêt (STOP FREQ) est déterminée par la position du cadran STOP FREQ. Relâcher le bouton STOP FREQ et appuyer sur le bouton TRIG SWP. Noter que la fréquence ne varie plus. Presser le bouton MAN TRIG. Noter qu'un seul balayage est effectué. Mettre le bouton SWEEP DURATION sur la position OFF.

Appuyer sur le bouton TRIG, localisé dans la partie verte du panneau avant. Noter qu'il n'y a plus de signal. Presser le bouton MAN et vérifier qu'une seule période complète est générée à chaque pression. Appuyer sur le bouton GATE. Presser ensuite le bouton MAN. Noter que le signal de sortie est continuellement généré tant que le bouton MAN est maintenu enfoncé. Presser le bouton FREE RUN pour une sortie normale du générateur.

Les commandes de la fréquence du signal de sortie sont entourées de bleu. Tourner la commande de fréquence (FREQUENCY) pour voir son action sur le signal de sortie. Le bouton MULTIPLIER sélectionne la gamme de fréquence couverte par le cadran principal. Mettre le bouton MULTIPLIER sur 10<sup>-2</sup>. Le signal de sortie varie lentement sur l'oscilloscope, appuyer sur le bouton HOLD/RUN et le relâcher plusieurs fois pour voir que le signal s'arrête à un point du signal et redémarre au même point lorsque le bouton est relâché.

Ceci termine la mise en route du FG 504.

### Temps de montée et de descente

Si les impulsions de sortie du FG 504 sont utilisées pour mesurer le temps de montée ou de descente d'un appareil, il faut considérer les caractéristiques globales de l'équipement de mesure utilisé. Si le temps de montée de l'appareil sous test est dix fois supérieur au temps de montée résultant de celui du FG 504, de l'oscilloscope de mesure et des câbles de liaison, l'erreur introduite ne dépassera pas 1 % ; elle peut généralement être ignorée. Lorsque le temps de montée ou de descente de l'appareil sous test est inférieur à dix fois le temps de montée global du système de test le temps de montée réel du système se détermine à partir du temps de montée de chaque élément du système. Le temps de montée total est égal à la racine carrée de la somme des carrés des temps de montée individuels, à savoir :

$$T_t = \sqrt{(T_1)^2 + (T_2)^2 + \dots}$$

Une fois le temps de montée du système connu, il est possible de calculer le temps de montée de l'appareil sous test en utilisant la méthode précédente.

Les caractéristiques physiques du câble de transmission déterminent l'impédance caractéristique, la vitesse de propagation et l'importance des pertes. Les pertes sont fonction de la fréquence. Quelques mètres de câble peuvent modifier une impulsion ayant un temps de montée rapide. Il est, par conséquent, important de maintenir la longueur de ces câbles aussi courte que possible.

Lorsque l'on effectue des mesures par comparaison de signaux ou des mesures d'intervalles de temps, les deux

## Instructions d'utilisation - FG 504 (à partir de SN B040000)

signaux issus de l'appareil sous test doivent être acheminés au moyen de câbles coaxiaux identiques.

### Adaptation d'impédance

Chaque fois qu'une impulsion, se propageant le long d'une ligne de transmission rencontre une désadaptation (ou une impédance différente de celle de la ligne de transmission) une onde réfléchie se produit et est renvoyée le long de la ligne en direction de la source. L'amplitude et la polarité de ces réflexions dépendent de la variation d'impédance rencontrée. Si la valeur de cette impédance est supérieure à celle de la ligne, l'onde réfléchie sera de même polarité que le signal appliqué. Si elle est inférieure, la polarité sera inversée.

Si le signal réfléchi arrive avant la fin de l'impulsion, il s'additionne ou se soustrait de l'amplitude de l'impulsion, provoquant ainsi une distorsion de la forme et de l'amplitude de l'impulsion.

Si le FG 504 est chargé par une impédance élevée, par exemple  $1\text{ M}\Omega$  en parallèle sur une certaine capacité (entrée d'un oscilloscope), terminer la ligne de transmission par un atténuateur refermé sur une charge  $50\ \Omega$  et le connecter ensuite à l'entrée de l'oscilloscope.

### Fonctionnement en mode relaxé

Sélectionner la forme d'onde désirée (carrée, triangle ou sinusoïdale) en appuyant sur le bouton approprié indiqué CARRE, TRIANGULAIRE ou SINUSOIDAL. Appuyer sur le bouton FREE RUN (relaxation). S'assurer que le commutateur SWEEP DURATION (durée de balayage) est sur la position OFF (arrêt). Sélectionner la fréquence désirée au moyen des commandes MULTIPLIER (multiplicateur) et FREQUENCY Hz (fréquence en Hz). On obtient des réglages de fréquence précis au moyen de la commande FREQUENCY VERNIER. Relier la charge à la prise de sortie OUTPUT. S'assurer que le bouton HOLD est sorti. Régler la commande ATTENUATOR afin d'obtenir l'amplitude crête-à-crête désirée en sortie. Utiliser la commande VAR pour faire varier l'amplitude entre les positions étalonnées.

Les signaux sans tension continue de décalage se situent de part et d'autre du niveau zéro. Afin d'obtenir le décalage souhaité des signaux, tirer et tourner la commande OFFSET. Si l'on sélectionne le mode signaux carrés, régler la commande RISE AND FALL TIME afin d'obtenir les valeurs souhaitées pour les temps de transitions. Il est possible de faire varier ces durées entre les positions étalonnées à l'aide du bouton VAR. Un signal de déclenchement, un pour chaque période du signal sélectionné, est disponible sur la prise TRIG OUTPUT (sortie de déclenchement).

Lorsque l'on utilise les modes «sinusoïde» ou «triangle», la commande MULTIPLIER étant placée sur les cinq positions les plus basses (zone grise), l'évolution du signal peut être arrêtée en appuyant sur le bouton HOLD (maintien). Le générateur de signal s'arrête et le FG 504 sort une tension égale à la tension atteinte par la rampe ou la sinusoïde, lorsque le bouton a été enfoncé. Cette possibilité n'existe pas dans le mode «signal carré».

Lorsqu'elle est tirée, la commande SYMMETRY divise la fréquence de sortie par dix et permet de faire varier le rapport cyclique du signal sélectionné (symétrie du signal). Le voyant  $\text{FREQ} \div 10$  s'allume. Tirer cette commande et la tourner pour obtenir la symétrie voulue avec les trois formes d'ondes de base.

### Utilisation en déclenchement ou validation

Régler le FG 504 pour une utilisation en relaxation libre, selon les indications du paragraphe précédent, appliquer le signal de déclenchement ou de validation à la prise INPUT. Si l'on désire une seule période du signal de sortie par déclenchement, enfoncer le bouton TRIG. Régler la commande LEVEL pour que le signal débute au niveau souhaité. Si l'on désire plusieurs périodes du signal de sortie, appuyer sur le bouton poussoir GATE. La sortie du FG 504 commence au niveau de déclenchement choisi et se poursuit jusqu'à ce que le signal de validation sur la prise d'entrée redescende au-dessous du niveau de déclenchement. La durée du signal en sortie est alors égale à la durée du signal de validation. Le nombre de périodes par train est environ égal à la durée du signal de validation divisé par la période du signal de sortie du FG 504. En mode validation, la dernière période du signal est complétée s'il reste moins de  $270^\circ$  de la période à générer au moment où se termine le signal de validation.

En fonctionnement déclenchement ou validation, la commande PHASE fait varier le départ du signal de sortie sinusoïdal ou triangulaire d'environ  $\pm 80^\circ$ . Cette variation de phase se mesure à partir du niveau 0 V, point  $0^\circ$  sur le signal de sortie.

Pour déclencher ou valider manuellement le FG 504, tourner à fond dans le sens horaire la commande LEVEL et enfoncer le bouton TRIG ou le bouton GATE, selon le mode désiré. Dans le mode TRIG, si l'on appuie sur le bouton MAN, on obtient le déclenchement d'une période du signal en sortie. Dans le mode GATE (validation), le signal en sortie se poursuit aussi longtemps que le bouton MAN est enfoncé.

### Fonctionnement en vobulation de fréquence

La fréquence de sortie du FG 504 peut être vobulée dans un rapport maximal de 1 000 : 1, en fonction de la position

de la commande MULTIPLIER et en appliquant un signal de 0 à 10 V à la prise d'entrée VCF. La figure 2-3 indique la plage maximale de vobulation de fréquence pour chaque commande MULTIPLIER. Si l'on veut obtenir un rapport maximal de 1 000 : 1 ou la vobulation des plus basses fréquences de la plage, il peut s'avérer nécessaire de faire varier le réglage de la commande FREQUENCY VERNIER.

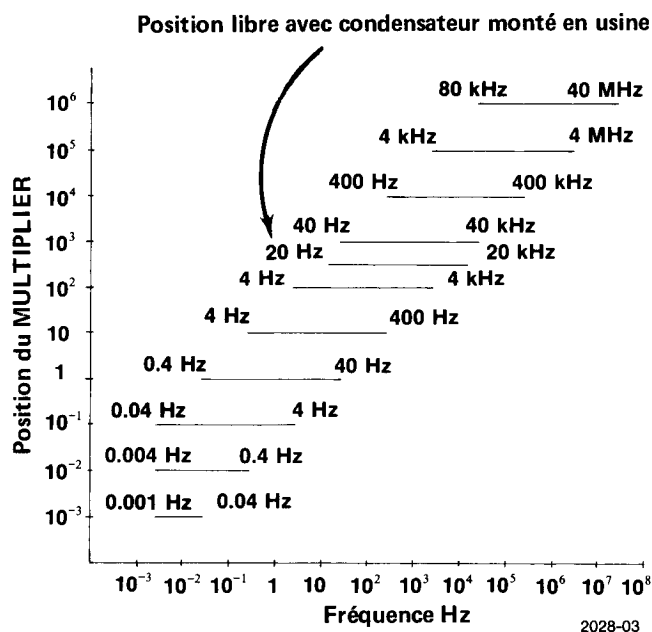

Fig. 2-3. Graphique indiquant la plage d'excursion en fréquence obtenue en appliquant un signal de 0 à 10 V à la prise VCF IN, en fonction de la commande MULTIPLIER.

La polarité du signal appliqué sur l'entrée de vobulation détermine la direction de l'excursion de fréquence à partir de la fréquence indiquée par les commandes MULTIPLIER, FREQUENCY Hz (START) et FREQUENCY VERNIER. Une tension positive augmente la fréquence alors qu'une tension négative abaisse la fréquence. Une tension qui varie symétriquement de part et d'autre du zéro provoque une excursion de la fréquence du signal symétrique de part et d'autre de la fréquence centrale indiquée par les commandes de fréquence (se reporter à la figure 2-4).

Etant donné que la variation de la fréquence suit une loi linéaire, la plage de fréquence du signal de sortie peut être déterminée à partir de l'amplitude du signal d'entrée VCF et de la position du cadran FREQUENCY Hz. La sensibilité de la vobulation externe est égale à la plus haute indication possible du cadran (40) que multiplie la gamme de la commande MULTIPLIER divisée par la tension d'entrée maximale VCF (10 V). Le FG 504 possède une sensibilité nominale (Hz/V) égale à quatre fois la gamme choisie par la commande MULTIPLIER. Par exemple, avec la gamme  $10^3$  de la commande

MULTIPLIER, une variation de deux volts à l'entrée VCF INPUT provoquera une excursion de la fréquence de sortie de 8 kHz.

### Plage de fréquence particulière

L'utilisateur peut sélectionner une plage de fréquence particulière au moyen du commutateur de gamme MULTIPLIER en utilisant la position  $0,5 \cdot 10^3$ . L'appareil est livré muni d'un condensateur (C248) qui produit une plage de vobulation comprise entre 20 Hz et 20 kHz, la commande MULTIPLIER étant positionnée sur  $.5 \times 10^3$ .

### Utilisation en verrouillage de phase

La fréquence du signal de sortie peut être synchronisée avec le signal de référence externe. La fréquence de sortie du FG 504 doit être réglée à  $\pm 10$  divisions principales du cadran de la fréquence par rapport à la fréquence du signal externe (le « 1 » apparaissant sur le cadran est la division principale la plus basse utilisable). Relier le signal de référence au connecteur INPUT et appuyer sur le bouton pousser  $\phi$  LOCK. La commande PHASE fait varier la phase du signal en sortie de  $\pm 80^\circ$  par rapport au signal de référence. La commande LEVEL règle le point de déclenchement sur la forme d'onde de référence.

Les commandes LEVEL et PHASE se règlent aisément si l'on procède d'abord à leur réglage en mode TRIG. Régler la fréquence de relaxation du FG 504 afin qu'elle soit légèrement supérieure à la fréquence du signal appliqué à la prise INPUT. Puis sélectionner le mode TRIG. Régler la commande LEVEL pour obtenir un déclenchement stable et (si l'on utilise un oscilloscope), régler la fréquence de sortie du FG 504 jusqu'à ce qu'elle soit à peu près identique à la fréquence du signal appliqué à la prise INPUT. Placer la commande PHASE à mi-course (position « 12 heures ») (pour  $0^\circ$  en mode sinusoïde) et enfoncer la commande  $\phi$  LOCK. Régler à nouveau la commande PHASE, si nécessaire, afin d'obtenir une sortie stable avec le déphasage désiré. La plage d'action de la commande PHASE décroît continûment au-dessus de 4 MHz.

Un cavalier situé sur le circuit d'asservissement permet de transformer l'entrée VCF INPUT en entrée de modulation de phase lorsque le FG 504 fonctionne en mode verrouillage de phase. Les tensions limites à l'entrée modulation de phase sont de  $\pm 2,5$  V, avec une fréquence maximale limitée à 1 kHz. Lorsque la phase est verrouillée, la tension de modulation de phase fait varier la phase en sortie d'environ  $5^\circ/V$ .

### Entrée de modulation d'amplitude

Pour moduler l'amplitude de signaux de sortie, relier le signal modulant à la prise AM INPUT. Enfoncer le bouton sinusoïde ( $\sim$ ) et régler la commande FREQUENCY Hz pour

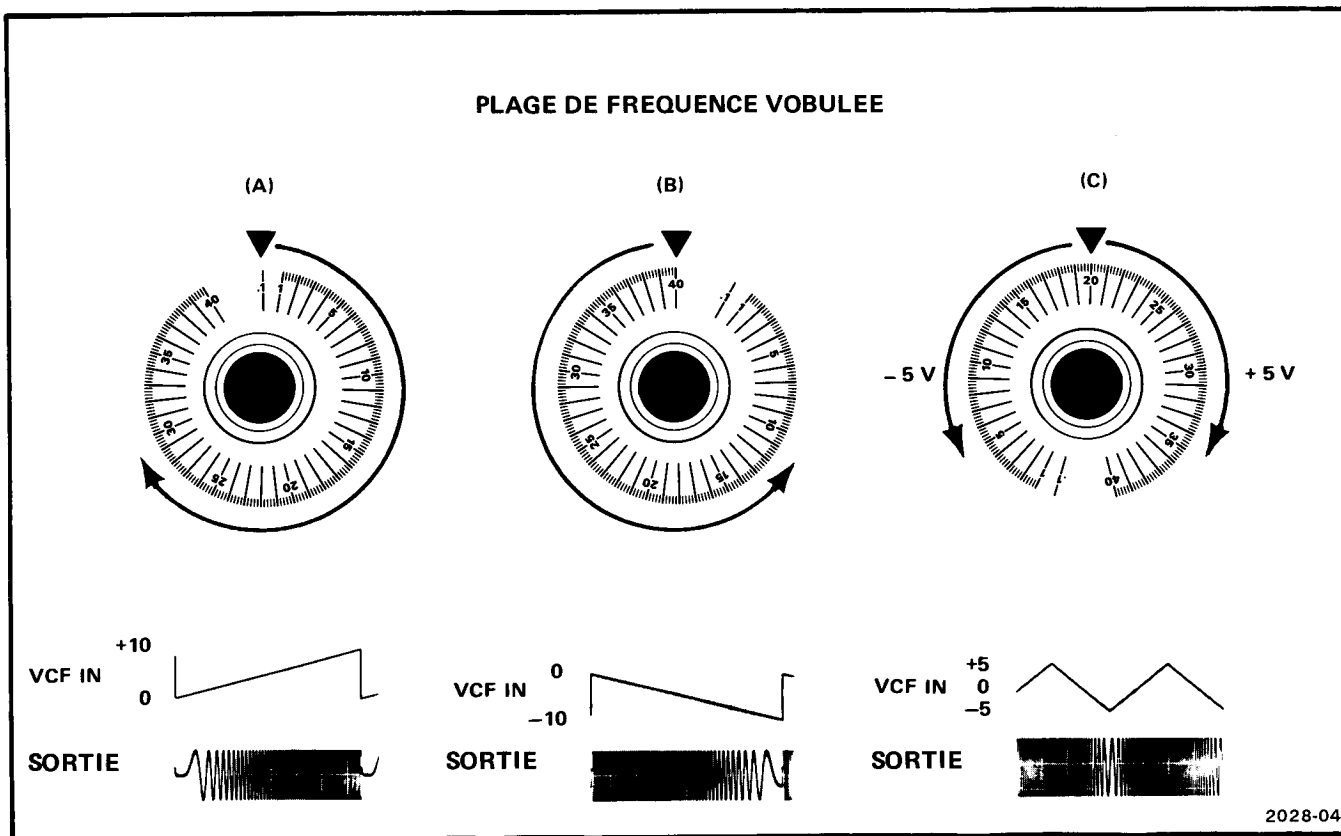

Fig. 2-4. Plage de fréquence vobulée obtenue avec un signal de 10 V appliqué à la prise VCF IN.

obtenir la fréquence de porteuse souhaitée. Se reporter aux caractéristiques de l'entrée de modulation d'amplitude pour de plus amples informations.

### Utilisation en vobulation interne

Sélectionner la durée d'un balayage complet au moyen de la commande SWEEP DURATION. Utiliser le bouton VAR pour obtenir les temps de balayage entre les positions étalonnées. Régler les commandes FREQUENCY Hz, START, STOP FREQ et MULTIPLIER, de façon à obtenir les fréquences de vobulation désirées. La sélection du balayage linéaire ou logarithmique s'effectue en enfonçant ou libérant le bouton poussoir LOG LIN SWP. Libérer le bouton poussoir STOP FREQ. Régler la fréquence de départ au moyen de la commande FREQUENCY VERNIER lorsque la valeur désirée est différente du chiffre « 1 » du cadran. Si l'on souhaite un balayage déclenché, appuyer sur le bouton poussoir TRIG SWP et relier le signal de déclenchement à l'entrée SWEEP TRIG INPUT. Régler la commande LEVEL de manière à ce que le balayage débute au niveau souhaité sur le signal de déclenchement. Si l'on souhaite un fonctionnement

en relaxation libre, libérer le bouton poussoir TRIG SWP. Il est possible d'arrêter le balayage et de maintenir la fréquence de sortie obtenue à n'importe quel moment en appuyant sur le bouton poussoir STOP FREQ. La dent de scie du balayage linéaire est disponible sur la prise SWEEP OUTPUT.

### Signaux d'entrée externe pour déclenchement, validation, verrouillage en phase et mode de balayage déclenché

Les signaux d'entrée externe, pour ces modes, doivent être d'au moins 1 V crête-à-crête de part et d'autre de la tension continue établie au moyen de la commande LEVEL (+1 V à +10 V). Lorsque la commande LEVEL se trouve réglée au minimum ou proche du minimum, le signal externe doit dépasser les niveaux +0,5 V et +1,5 V. Par exemple, un signal externe dont l'amplitude est symétrique de part et d'autre de 0 V (tel qu'une sinusoïde) doit être d'au moins 3 V crête-à-crête (+1,5 à -1,5 V). La figure 2-5 illustre les signaux d'entrée typiques.

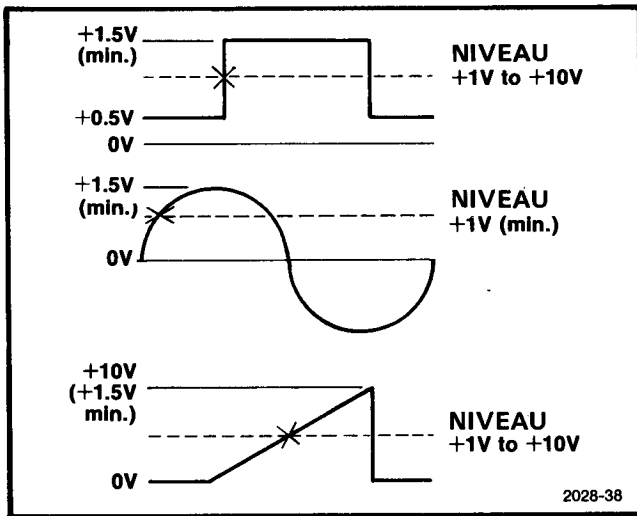

Fig. 2-5. Amplitude nécessaire et points de déclenchement.

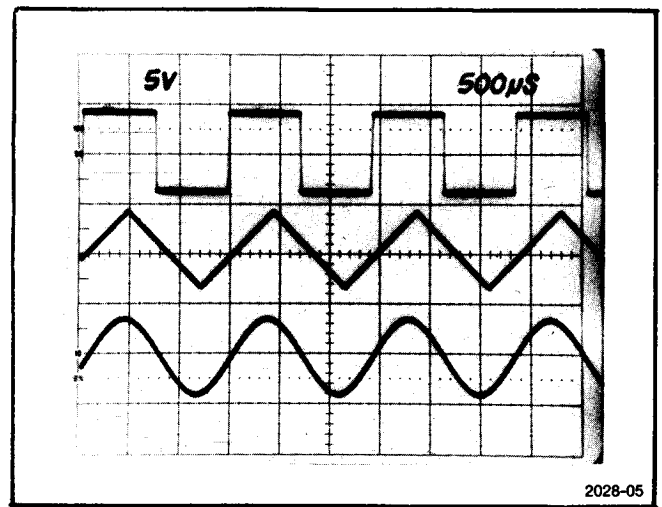

Fig. 2-7. FONCTIONS DE BASE : les formes d'ondes carrées, triangulaires, sinusoïdales sont sélectionnées au moyen des boutons poussoirs du panneau avant.

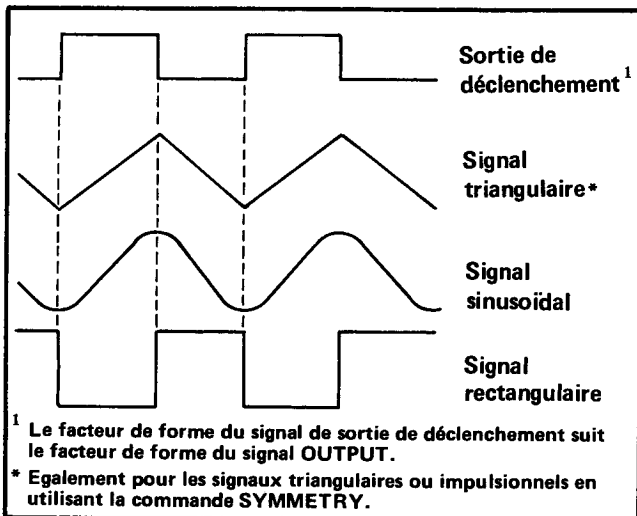

Fig. 2-6. Relations de phase entre les divers signaux en sortie et le signal TRIG OUT.

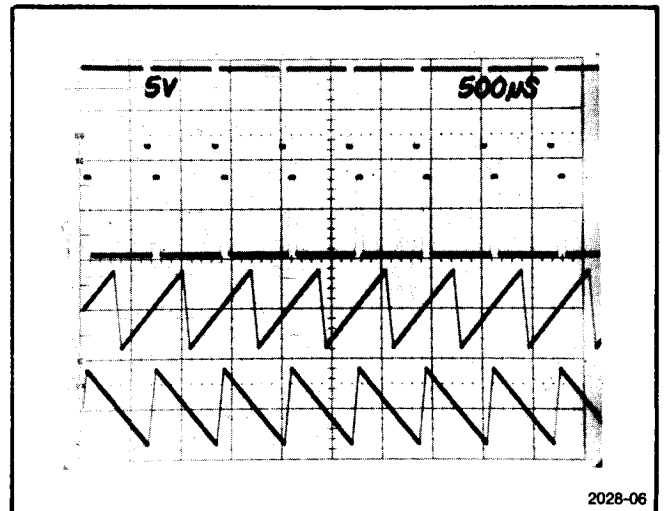
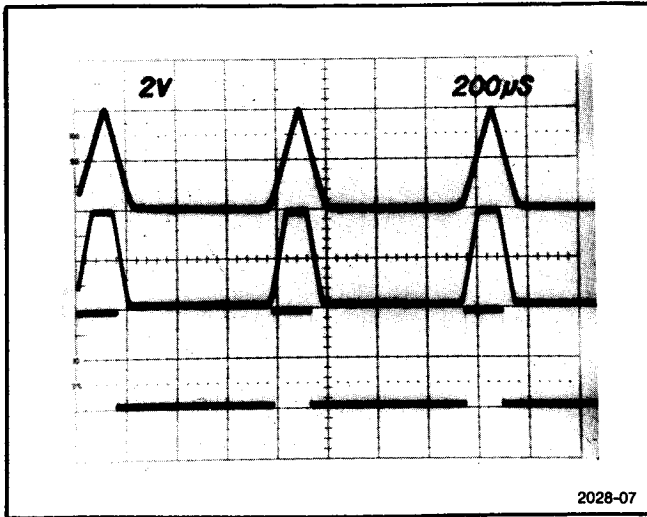
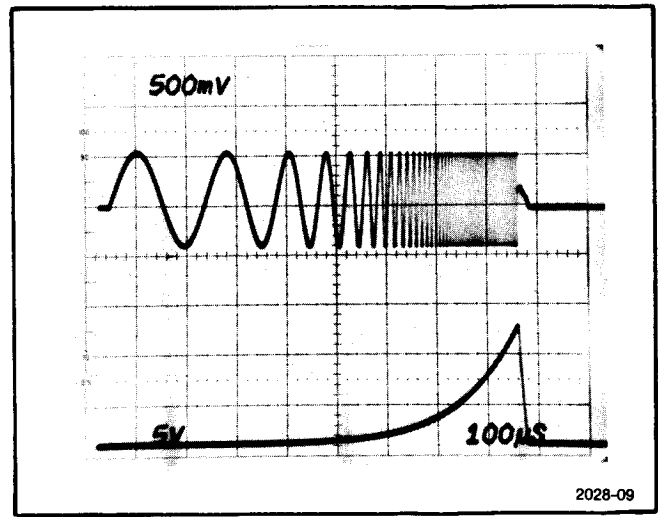

Fig. 2-8. RAMPES ET IMPULSIONS. Ces formes d'ondes s'obtiennent à partir des formes d'ondes de base en utilisant la commande SYMMETRY.

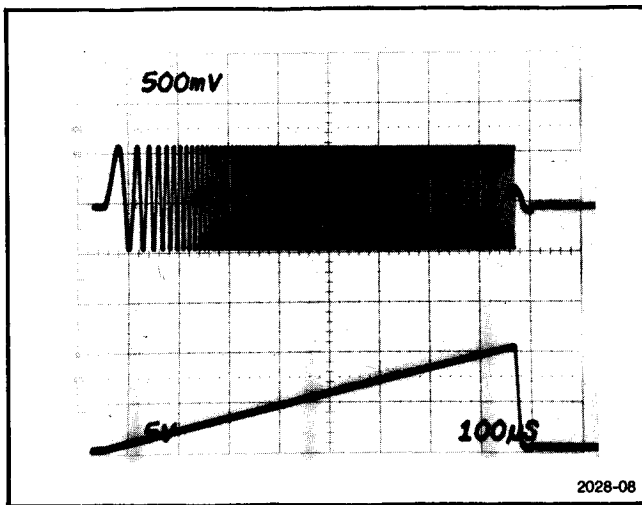



**Fig. 2-9. TEMPS DE MONTEE ET DE DESCENTE VARIABLES.** Dans l'utilisation de forme d'onde carrée, diverses formes d'impulsions peuvent être obtenues en faisant varier les temps de montée et de descente.



**Fig. 2-11. BALAYAGE LOGARITHMIQUE.** Procéder de manière identique que pour la figure 2-10. Sélectionner la rampe logarithmique. La fréquence est modulée de façon logarithmique. La tension de la rampe logarithmique n'est pas disponible extérieurement.



**Fig. 2-10. BALAYAGE LINEAIRE.** Sélectionner les fréquences de départ et d'arrêt ainsi que la rampe linéaire interne pour obtenir un balayage de la fréquence de sortie.

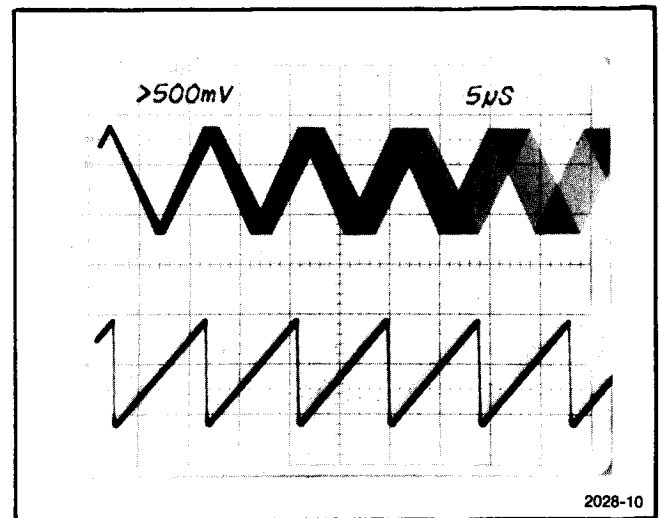

**Fig. 2-12. BALAYAGE A BANDE ETROITE.** La trace supérieure illustre un signal triangulaire balayé par une rampe linéaire. La fréquence de départ est de 9,52 kHz et la fréquence d'arrêt est de 10,52 kHz. Cette fonction est utile pour des tests par balayage à bande étroite. La trace inférieure correspond à la rampe de balayage.

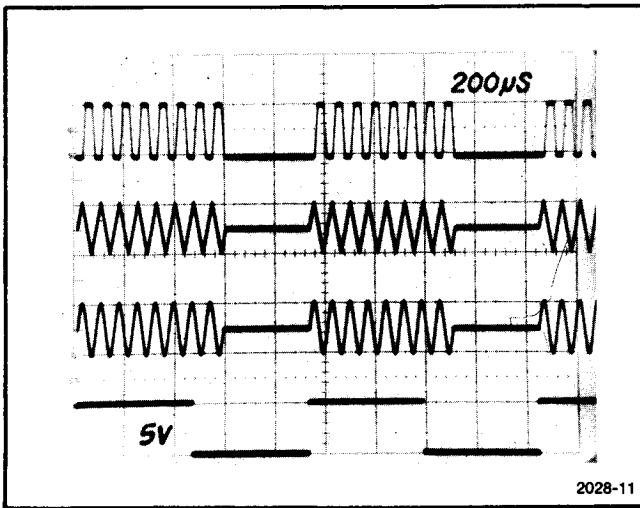

Fig. 2-13. FONCTIONNEMENT VALIDE. Les trois traces supérieures représentent les diverses formes de sortie et la trace inférieure est le signal de validation appliqué à la prise INPUT, le bouton poussoir GATE étant enfoncé. Noter qu'une période supplémentaire complète est générée après la fin du signal de validation.

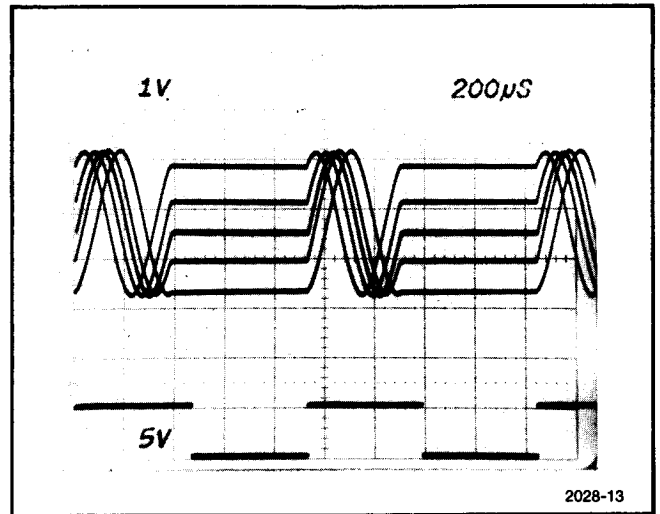

Fig. 2-15. FONCTIONNEMENT DECLENCHE AVEC CONTROLE DE PHASE. Cette figure illustre l'utilisation de la commande PHASE en mode déclenché. Les cinq traces superposées illustrent l'effet de la commande de phase. Cette commande fournit environ  $\pm 80^\circ$  de décalage. La trace inférieure est le signal de déclenchement.

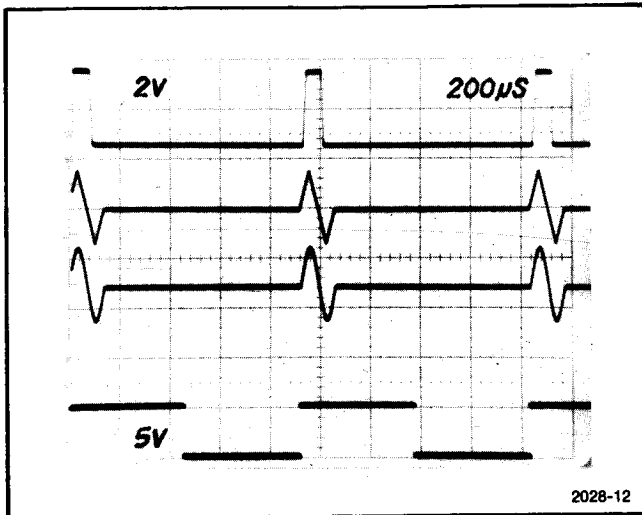

Fig. 2-14. FONCTIONNEMENT DECLENCHE. Les trois traces supérieures représentent les diverses formes de sortie et la trace inférieure est le signal de déclenchement appliqué à la prise de déclenchement INPUT. Le mode TRIG étant sélectionné. Noter qu'une seule période de signal est générée.

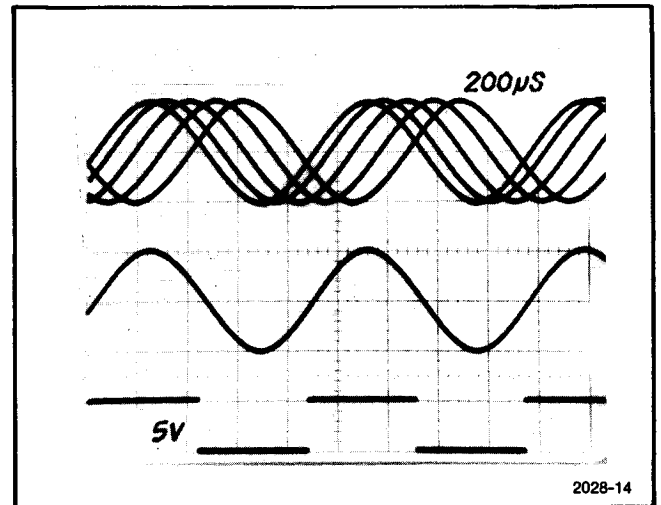

Fig. 2-16. FONCTIONNEMENT VERROUILLE EN PHASE. La trace inférieure représente le signal appliqué à la prise INPUT dans le mode  $\phi$  LOCK. La trace du milieu représente la sortie verrouillée en phase par rapport au signal d'entrée. Les traces supérieures illustrent l'action de la commande PHASE.

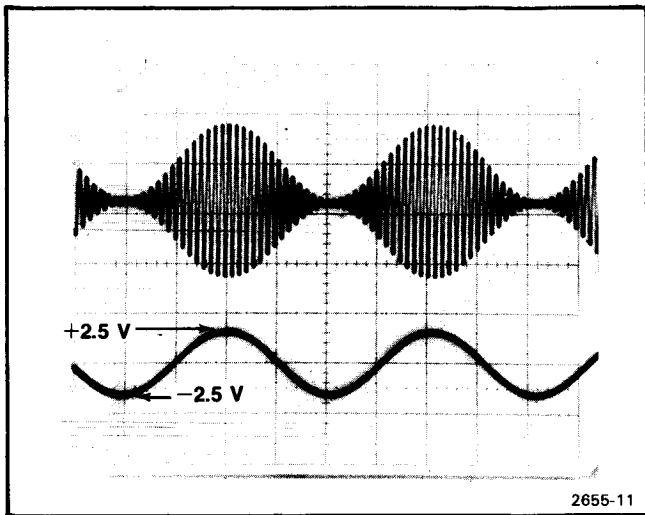

Fig. 2-17. MODULATION D'AMPLITUDE. La trace supérieure illustre l'enveloppe modulée à 100 % et la trace inférieure représente le signal modulant :  $\pm 2,5$  V modulent le signal à 100 % (5 V crête-à-crête centrés à 0 V).

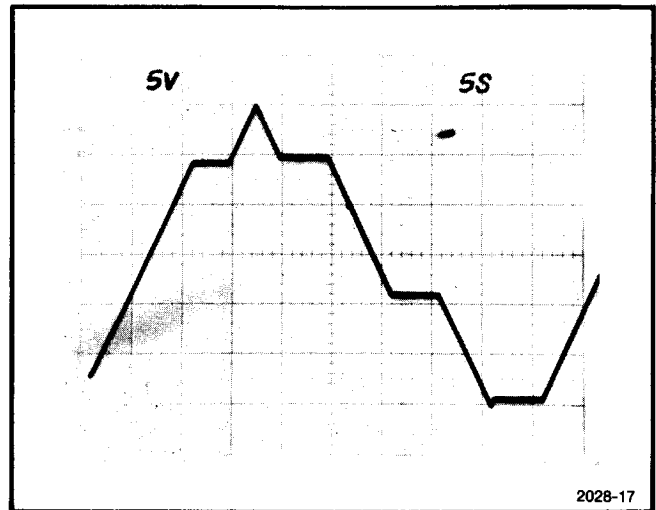

Fig. 2-19. FONCTION MAINTIEN EN BASSE FREQUENCE. La sortie du FG 504 dans les cinq positions les plus basses de la commande MULTIPLIEUR peut être maintenue à n'importe quel niveau en appuyant sur le bouton HOLD. Les paliers visibles sur la figure s'obtiennent de cette manière.

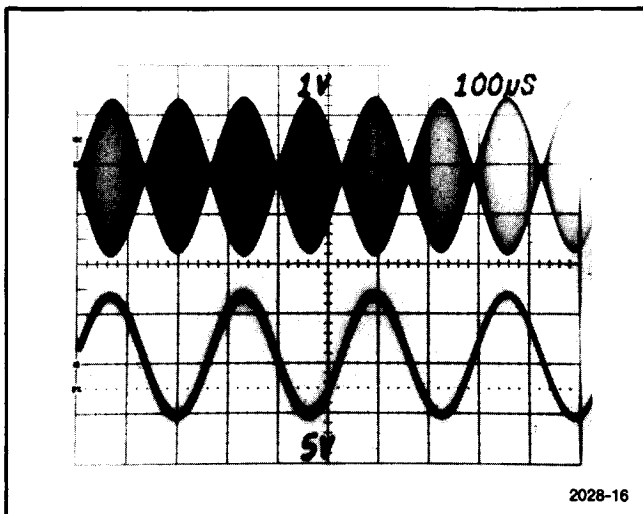

Fig. 2-18. MODULATION A PORTEUSE SUPPRIMEE. La trace supérieure illustre une modulation à porteuse supprimée alors que la trace inférieure représente le signal modulant. La crête supérieure du signal modulant est de 0 V et la crête inférieure est de -10 V. Le niveau total du signal modulant doit être réglé avec soin pour obtenir une véritable suppression de la porteuse.

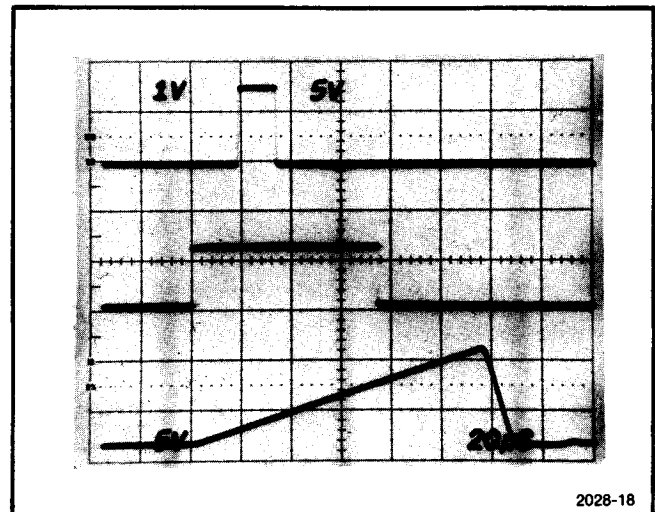

Fig. 2-20. FONCTIONNEMENT RETARDE. Une large gamme de retards est disponible en utilisant le générateur de balayage interne comme générateur de retard. La trace du milieu correspond au signal d'entrée non retardé à la borne SWEEP TRIG INPUT. La trace inférieure est le signal disponible sur la prise LIN SWP OUT. Cette rampe est appliquée à la prise de déclenchement externe INPUT. La trace supérieure correspond à l'impulsion de sortie retardée. Le retard dépend de la durée de balayage et de l'indication de la commande TRIG LEVEL. S'assurer qu'en utilisant le balayage comme un générateur de retard, le cadran de fréquence d'arrêt FREQ est placé à fond dans le sens anti-horaire.

### Tests par train de signaux

Le FG 504, associé à un générateur d'impulsions externe, peut être utilisé en générateur de trains de signaux. Relier la sortie d'un générateur PG 501 TEKTRONIX ou tout autre générateur d'impulsions à la prise de déclenchement INPUT. Sélectionner le mode de fonctionnement GATE. Régler le générateur d'impulsions externe pour obtenir la durée désirée des impulsions et le taux de répétition convenable. Puis sélectionner le temps de balayage souhaité du FG 504 et sélectionner les fréquences d'arrêt et de départ. Comme l'illustre la figure 2-21, la sortie du FG 504 devient alors une série de trains de signaux.

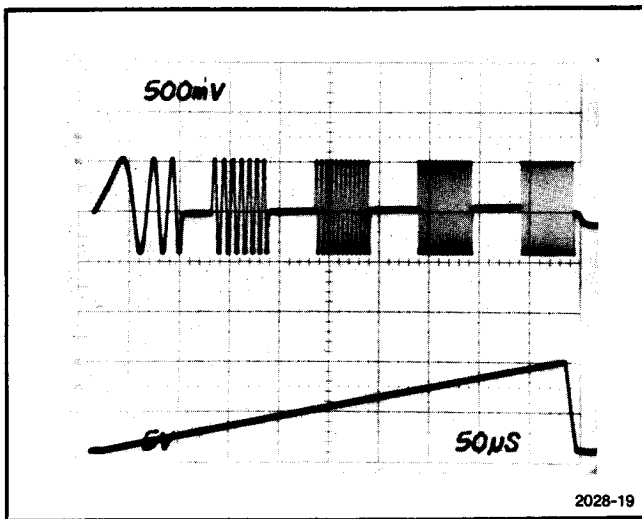

Fig. 2-21. TESTS PAR TRAIN DE SIGNAUX. La trace inférieure représente la rampe linéaire issue de la prise LIN SWEEP OUTPUT.

### Tests de filtre

Les caractéristiques de modulation de fréquence du FG 504 lui permettent d'être utilisé pour le test des filtres. Lorsque l'on utilise le FG 504 pour cette application, il est préférable d'utiliser le mode logarithmique. Les figures 2-22 et 2-23 illustrent les avantages qu'il y a à utiliser le balayage logarithmique (LOG SWP).

### Mise en forme d'impulsions

Les caractéristiques de déclenchement externe du FG 504 s'adaptent à la mise en forme d'impulsions. Relier le signal devant être mis en forme à la prise de déclenchement INPUT et placer le FG 504 dans le mode signal carré. Le niveau de déclenchement est réglé au moyen de la commande TRIG LEVEL. Les temps de montée et de descente, les niveaux et la symétrie de l'impulsion de sortie remise en forme peuvent être changés à volonté selon la nécessité. La figure 2-24 illustre cette application.

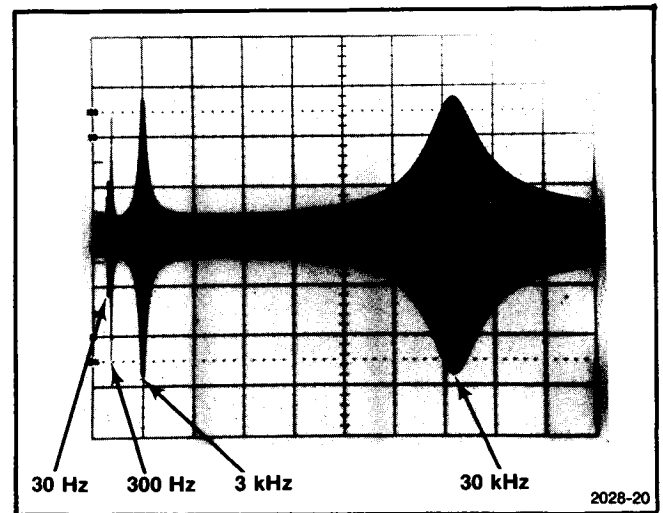

Fig. 2-22. Balayage linéaire montrant l'espacement progressif des fréquences de résonance du filtre.

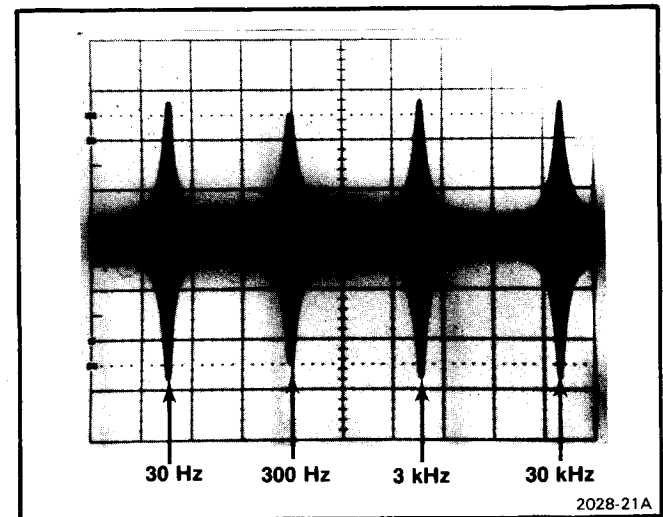

Fig. 2-23. Balayage logarithmique montrant un espacement régulier des fréquences de résonance du filtre.

## REEMBALLAGE

Si cet instrument doit être expédié dans un service de maintenance Tektronix pour étalonnage ou réparation, lui adjoindre une étiquette comportant : nom du propriétaire et son adresse, nom d'une personne de la société pouvant être contactée. Ajouter le numéro de série complet de l'appareil ainsi qu'une description du service désiré.

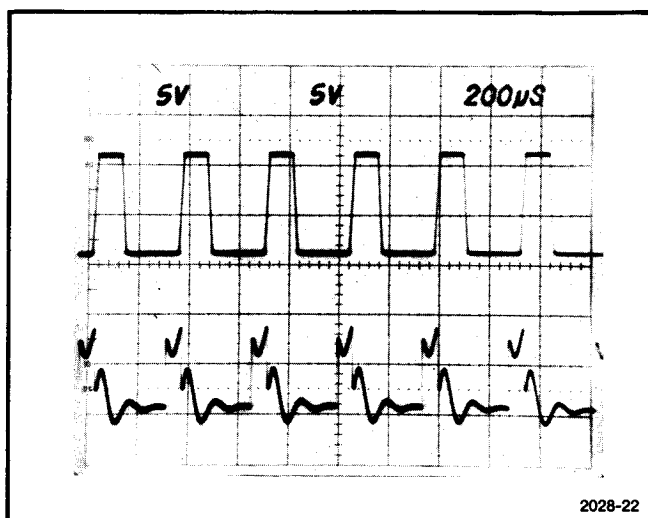

Fig. 2-24. MISE EN FORME D'IMPULSIONS. La trace inférieure est le signal de déclenchement.

Conserver et réutiliser l'emballage dans lequel votre appareil a été expédié. Si l'emballage d'origine est inutilisable, réemballer l'appareil comme suit :

Entourer l'instrument de feuilles de polyéthylène pour protéger son aspect extérieur. Utiliser un carton ondulé solide aux dimensions intérieures dépassant d'au moins 3 cm Celles du matériel. Remplir cet intervalle de flocons de polyéthylène, sur toutes les faces. Fermer le carton avec une bande de scotch.

Le carton doit avoir une résistance de 100 kg.

# BEDIENUNGSANLEITUNG

## ANLEITUNG FÜR DIE INSTALLATION UND DAS AUSWECHSELN

Der FG 504 ist bei Lieferung kalibriert und kann sofort verwendet werden. Er arbeitet in zwei Einschubfächern der Stromversorgungseinheiten der Serie TM 500 mit Ausnahme des Typs TM 501. Informationen hinsichtlich der Stromversorgung und des Betriebs der Stromversorgungseinheiten entnehmen Sie den entsprechenden Bedienungsanleitungen. Beim Betrieb zwischen 40 °C und 50 °C ist eine verstärkte Luftkühlung erforderlich.

### VORSICHT

*Um eine Zerstörung am Einschub FG 504 zu vermeiden, ist die Stromversorgungseinheit auszuschalten, bevor der Einschub ein- oder ausgeschoben wird. Funkenbildung kann die Lebensdauer der Kontakte verringern und die Schaltkreise des Einschubs beschädigen.*

Vergewissern Sie sich, daß die Kunststoffstege des Verbindungssockels der gewählten Stromversorgungseinheit mit der Aussparung des Verbindungssteckers des FG 504 übereinstimmen. Ist dies nicht der Fall, darf das Instrument nicht eingeschoben werden, bis die Ursache gefunden wurde. Nach dieser Überprüfung kann der FG 504 in die Führungsschiene gesetzt und eingeschoben werden. Durch vorsichtiges Drücken werden Sockel und Stecker verbunden. Der FG 504 wird über den Stromversorgungsschalter der Stromversorgungseinheit mit Betriebsstrom versorgt.

Zur Herausnahme des FG 504 wird die Verriegelungslasche (untere linke Ecke) gezogen, um die Verbindung von Sockel und Stecker zu lösen. Danach wird der FG 504 gerade herausgezogen.



Abb. 2-1. Installation und Auswechseln

## BEDIENUNG

### Ausgangsanschlüsse

Der Ausgang des FG 504 arbeitet als 50  $\Omega$ -Spannungsquelle an eine Last von 50  $\Omega$ . Bei höheren Frequenzen hat ein nicht abgeschlossener oder unkorrekt abgeschlossener Ausgang hohe Abweichungen des Ausgangssignal zur Folge. (Siehe hierzu auch Impedanzanpassung.) Lasten kleiner als 50  $\Omega$  reduzieren die Signalamplitude.

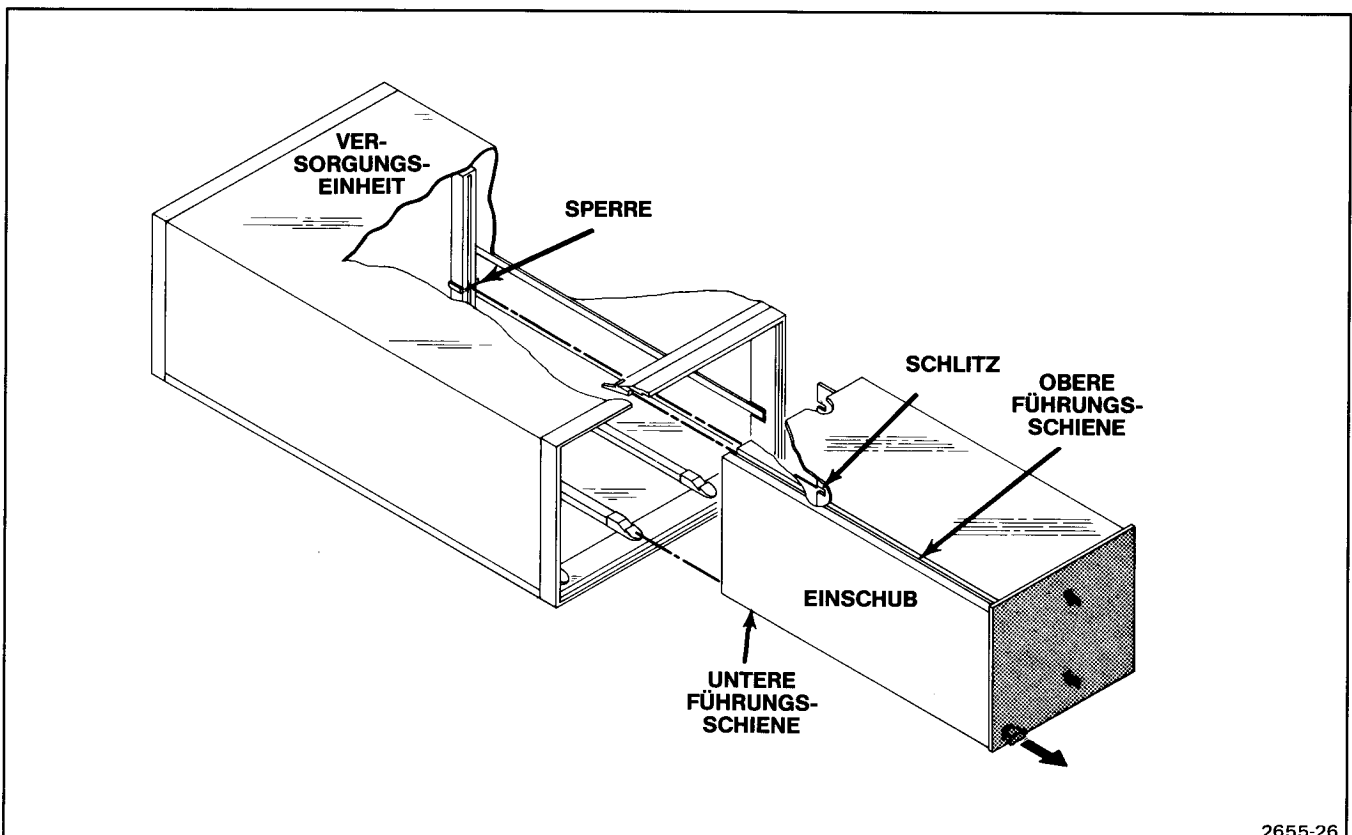
Hohe Verzerrungen oder Abweichungen, die infolge eines unkorrekten Abschlusses auftreten, machen sich bei niedrigeren Frequenzen weniger bemerkbar (insbesondere die Signalformen Sinus und Dreieck). Damit Sie ein sauberes Signal erhalten, beachten Sie bitte folgende Punkte:

1. Verwenden Sie nur 50  $\Omega$ -Koaxialkabel und Stecker von hoher Qualität.

2. Nehmen Sie die Verbindungen fest vor und halten Sie sie so kurz wie möglich.

3. Wenn es erforderlich ist, Signalamplituden zu reduzieren, verwenden Sie Abschwächer von hoher Qualität.

4. Verwenden Sie Abschlüsse oder Einrichtungen für Impedanzanpassung, damit bei der Verwendung von längeren Kabeln (2 Meter und mehr) keine Reflexionen auftreten.

5. Vergewissern Sie sich, daß die Abschwächer, Abschlüsse usw. die für das Ausgangssignal geeigneten Stromwerte aufweisen.

Liegt eine Gleichspannung an der Ausgangslast, schalten Sie einen Koppelkondensator in Serie zur Last. Die Zeitkonstante des Koppelkondensators und der Last muß so groß sein, daß die Dachschräge aufrechterhalten bleibt.

### BEACHTEN

*Wird der FG 504 in Verbindung mit alten Modellen der Stromversorgungseinheiten TM 500 benutzt, kann der Brumm auf dem Ausgangssignal in einigen Fällen zu hoch sein. Der Brumm resultiert aus einem Transformator-Phasenabgleich, der nicht zum Betrieb des FG 504 paßt. Das Problem kann durch den Service leicht gelöst werden.*

### BEDIENUNGSELEMENTE UND ANSCHLÜSSE

- ① **FREQUENCY (Hz)** – Frequenz (Hz): Wählt die Betriebsfrequenz oder die niedrigste Frequenz im Wobbelbetrieb.
- ② **STOP FREQUENCY (Hz)** – Stopfrequenz (Hz): Wählt die höchste Frequenz im Wobbelbetrieb.

③ **FREQ + 10** – Frequenz + 10: Die Anzeigelampe leuchtet, wenn der SYMMETRY-Knopf gezogen ist.

④ **RUN** – Freilaufend: (Gelöste Taste) für Normalbetrieb.

**HOLD** – Pegelhaltung: (Taste gedrückt) setzt den Generator außer Funktion und erzeugt einen Ausgangsgleichspannungspegel, der gleich dem Signalpegel bei gedrückter Taste ist. (Nur in den 5 unteren Bereichen).

⑤ **VCF INPUT** – Frequenzmodulationseingang: Externe Spannungen, die an diesen Eingang gelegt werden, erzeugen Frequenzveränderungen.

⑥ **FREQUENCY VERNIER** – Feineinsteller Frequenz: Dient zur Feineinstellung der Frequenz.

⑦ **MULTIPLIER** – Multiplizierer: Bestimmt den Bereich des FREQUENCY-Wählers.

⑧ **AM INPUT** – Eingang für Amplitudenmodulation: Ein externes Signal, das an diese Buchse angeschlossen wird, moduliert den Sinusausgang.

⑨ **KLINKE**: Durch Ziehen dieser Klinke kann der Einschub herausgezogen werden.

⑩ **INPUT** – Eingang: An diese Eingangsbuchse werden externe Torsignale, Triggersignale oder Signale für phasenstarrten Betrieb angeschlossen.

⑪ **MAN** – Manuell: Gestattet manuellen Trigger im TRIGGER-Betrieb oder manuelles Tor im GATE-Betrieb, um das Ausgangssignal zu steuern.

⑫ **LEVEL** – Pegel: Wählt den Startspannungspegel auf dem Eingangssignal für getriggerten, torgesteuerten oder phasenstarrten Betrieb.

⑬ **LOCK** – Phasenkopplung: Bei gedrückter Taste wird die Frequenz des Ausgangssignals mit dem an INPUT angeschlossenem Signal gekoppelt.

⑭ **GATE** – Tastung: Bei gedrückter Taste erzeugt der Generator ein Signal für die Zeit, an der ein HI-Signal an INPUT angeschlossen ist.

⑮ **TRIG** – Trigger: Bei gedrückter Taste erzeugt der Generator bei jedem positiven Eingangssignal einen Ausgangssignalzyklus.

⑯ **FREE RUN** – Freilaufend: Bei gedrückter Taste erfolgt ein kontinuierliches Ausgangssignal.

- ①⑦ **PHASE** – Phase: Wählt voreilende oder nacheilende Phase bis zu  $\pm 80^\circ$  vom gewählten Triggerpegel des an INPUT angeschlossenen Sinus- oder Sägezahnsignals.
- ①⑧ **TRIG OUT** – Triggerausgang: Liefert einen positiven Impuls für jeden positiven Zyklus der gewählten Signalform. (Außer Rechteckausgang, der einem negativen Zyklus entspricht).
- ①⑨ **OUTPUT** – Ausgang: An dieser BNC-Buchse steht das Ausgangssignal zur Verfügung.
- ①⑩ **VAR** – Variable Einstellung: Mit diesem Einsteller werden Ausgangsamplituden zwischen den Stufen des Schalters ATTENUATOR eingestellt.
- ①⑪ **ATTENUATOR** – Teiler: Dient zur Einstellung der Amplitude des Ausgangssignals in 10 dB-Schritten.
- ①⑫ **LIN SWEEP OUTPUT** – Ausgang des Wobbelsignals: An dieser BNC-Buchse wird, wenn die Wobbelung läuft, ein lineares Ablenksignal (Sägezahn) von 0 bis 10 V ausgegeben.
- ②③ **SWEEP TRIG INPUT** – Triggereingang: Triggersignale, die an diese BNC-Buchse angeschlossen werden, lösen den Sägezahn aus, wenn in der Betriebsart TRIG SWP gearbeitet wird.
- ②④ **VAR** – Variabler Einsteller: Dient zur variablen Einstellung der Anstiegs- und Abfallzeiten des Rechtecksignals.
- ②⑤ **RISE and FALL TIME** – Anstiegs- und Abfallzeit: Dient zur Einstellung der Anstiegs- und Abfallzeiten des Rechtecksignals in dekadischen Schritten.
- ②⑥ **SYMMETRY**: Wird der Knopf gezogen, kann durch Drehen die Symmetrie eingestellt werden. Die Ausgangsfrequenz wird durch 10 geteilt und die Anzeigelampe  $\pm 10$  (3) leuchtet.
- ②⑦ **VAR** – Variabler Einsteller: Gestattet stufenlose Einstellung der Wobbelzeiten zwischen den Stufen des Schalters SWEEP DURATION.



Abb. 2-2. Bedienungselemente und Anschlüsse der Frontplatte



- 28 **SWEEP DURATION** – Wobbelzeit: Wählt die Dauer des Sägezahnsignals.
- 29 **TRIG LEVEL** – Triggerpegel: Wählt den Pegel am Eingang SWEEP TRIG INPUT, bei dem die Wobbelzeit ausgelöst wird.
- 30 **MAN TRIG** – Manuelle Triggerung: Gestattet es, die Wobbelung durch Drücken der Taste von Hand zu starten.
- 31 **OFFSET** – Offset: Dem Ausgangssignal kann eine Offsetspannung unterlegt werden. Dazu wird der Knopf gezogen und gedreht.
- 32 **AM CARRIER AMPLITUDE** ÷ 2 – AM-Trägeramplitude ÷ 2: Diese Lampe leuchtet, wenn die Impedanz am AM INPUT  $\leq 10 \text{ k}\Omega$  ist.
- 33 **(SINE WAVE)** – Sinus: Gedrückte Taste wählt die Funktion Sinus als Ausgangssignal.
- 34 **(TRIANGLE WAVE)** – Dreieck: Gedrückte Taste wählt die Funktion Dreieck als Ausgangssignal.
- 35 **(SQUARE WAVE)** – Rechteck: Gedrückte Taste wählt die Funktion Rechteck als Ausgangssignal.
- 36 **STOP FREQ** – Stopfrequenz: Bei gedrückter Taste stoppt die Wobbelfrequenz bei der höchsten (STOP) Frequenz. Gelöste Taste wobbelt die Frequenz über den Bereich von START bis STOP, die mit FREQUENCY eingestellt sind.
- 37 **LOG SWP/LIN SWP** – Logarithmische/Lineare Wobbelung: Bei gedrückter Taste wird eine logarithmische Wobbelung erzeugt und bei gelöster Taste eine lineare.
- 38 **TRIG SWP/FREE RUN** – Getriggerte/Freilaufende Wobbelung: Bei gedrückter Taste startet die Wobbelung mit einem Triggersignal. Bei gelöster Taste läuft die Wobbelung frei.
- 39 **POWER** – Stromversorgung: Das Leuchten dieser Anzeigelampe zeigt an, daß der FG 504 mit Strom versorgt ist.

## INBETRIEBNAHME

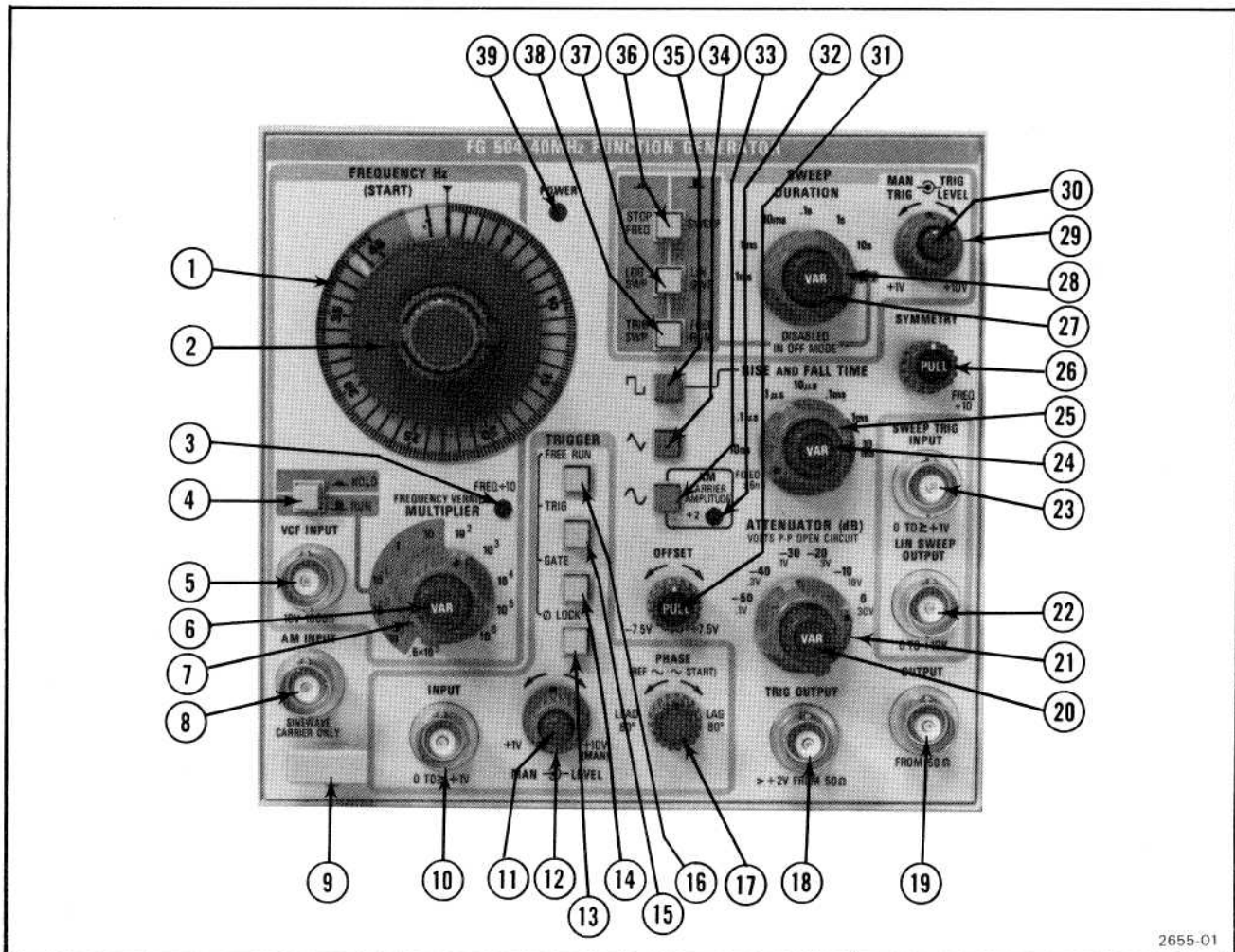
Vorgehend wurden die Bedienungselemente und Anschlüsse der Frontplatte beschrieben. Zur besseren Übersicht sind die Bedienungselemente nach Funktionsgruppen farblich gekennzeichnet. Die frequenzbestimmenden Elemente sind blau gekennzeichnet, die Elemente für Triggerfunktionen und Eingänge sind grün gekennzeichnet und die internen Ablenkfunktionen sind orange gekennzeichnet.

Bei Inbetriebnahme sollten die Bedienungselemente wie folgt eingestellt werden:

Blauer Bereich:

FREQUENCY Hz (Hauptwähler)	10
STOP	40
MULTIPLIER	10 <sup>2</sup>
HOLD/RUN	RUN (gelöst)
VAR	Rechtsanschlag

Grüner Bereich:

FREE RUN	gedrückt
----------	----------

Orange Bereich:

SWEEP DURATION	Aus
----------------	-----

Unmarkierter Bereich:

Sine Wave	gedrückt
RISE and FALLTIME	FIXED
ATTENUATOR	-10
VAR	Rechtsanschlag

Schließen Sie ein 50 $\Omega$ -BNC-Kabel, daß mit 50 $\Omega$  abgeschlossen ist, an den Vertikaleingang eines Oszilloskops an. Stellen sie das Oszilloskop wie folgt ein:

Vertikal	1 V/Teil DC-Kopplung
Horizontal	1 ms/Teil

Stellen Sie das Oszilloskop so ein, daß bis zu fünf komplette Signalzyklen des Sinussignals dargestellt werden. Jetzt betätigen Sie abwechselnd die Funktionstasten Rechteck, Sinus und Dreieck und beobachten auf dem Bildschirm des Oszilloskops die unterschiedlichen Signalformen. Drehen Sie die Bedienungselemente ATTENUATOR und VAR, um zu überprüfen, daß sich die Ausgangsamplituden verändern. Danach stellen Sie diese Elemente wieder auf ihre ursprünglichen Bedingungen zurück. Ziehen Sie den Knopf OFFSET und drehen Sie diesen. Sie können die Änderung des Gleichspannungspegels des Ausgangssignals beobachten. Stellen Sie den Knopf OFFSET wieder zurück. Drücken Sie nun die Taste Rechteck. Bewegen Sie die Einsteller RISE und FALL TIME durch ihre Bereiche. Beobachten Sie die Änderung der Signalform des Rechtecksignals. Ziehen Sie den Knopf SYMMETRY und drehen Sie ihn durch seinen Einstellbereich. Sie können beobachten, wie sich die Signalform der Funktionen Rechteck, Dreieck (bei entsprechend gedrückter Taste) und Sinus ändert. Stellen Sie den Knopf SYMMETRY wieder zurück.

Stellen Sie SWEEP DURATION auf 1 s ein, wobei die drei Tasten im orangefarbenen Bereich der Frontplatte gelöst sind. Sie können jetzt beobachten, wie sich die Ausgangsfrequenz einmal pro Sekunde von einer niedrigen Frequenz auf eine höhere Frequenz ändert. Wenn Sie die

Taste LOG SWP drücken, können Sie sehen, daß sich die Frequenz zunächst langsam und dann schnell verändert. Wenn Sie die Taste STOP FREQ drücken, bleibt die Wobbelung bei der höchsten Frequenz in dem Wobbelbereich stehen. Drehen Sie den Knopf STOP FREQ auf dem Hauptwähler im blauen Bereich der Frontplatte. Sie können feststellen, daß die Stopfrequenz (STOP FREQ) mit dem Wähler STOP FREQ eingestellt wird. Lösen Sie die Taste STOP FREQ und drücken Sie die Taste TRIG SWP. Sie können feststellen, daß sich die Frequenz nicht mehr verändert. Drücken Sie die Taste MAN TRIG und die Frequenz verändert sich einmal. Stellen Sie den Knopf SWEEP DURATION wieder auf die „Aus“-Stellung zurück.

Drücken Sie die Taste TRIG im grünen Bereich der Frontplatte. Beobachten Sie, daß das Ausgangssignal (OUTPUT) stoppt. Drücken Sie die Taste MAN im grünen Bereich und Sie werden feststellen, daß mit jedem Drücken von MAN ein kompletter Signalzyklus am Ausgang erfolgt. Drücken Sie die Taste GATE. Jetzt drücken Sie die Taste MAN. Sie können beobachten, daß das Ausgangssignal während des Drückens von MAN kontinuierlich ist. Drücken Sie nun die Taste FREE RUN, um wieder ein kontinuierliches Ausgangssignal einzustellen.

Die Bedienelemente für die Ausgangsfrequenz sind in Blau gekennzeichnet. Verändern Sie die Einstellung von FREQUENCY, um den Einfluß auf die Ausgangsfrequenz zu sehen. Der Knopf MULTIPLIER für die Ausgangsfrequenz wählt den Frequenzbereich, der durch den Hauptwähler abgedeckt wird. Schalten Sie den Knopf MULTIPLIER auf den Bereich  $10^{-2}$ . Sobald die Signalamplitude sich auf dem Oszilloskop langsam verändert, drücken Sie die Taste HOLD/RUN ein und lösen sie mehrere Male, um zu sehen, ob der Oszillator an einem Punkt des Signals stoppt und mit Lösen der Taste auf demselben Punkt wieder beginnt. Hiermit ist die Inbetriebnahme beendet.

### Anstiegs- und Abfallzeit

Wird das Ausgangssignal des FG 504 zur Messung von Anstiegs- und Abfallzeiten benutzt, sind die Anstiegscharakteristika der entsprechenden Einrichtung zu berücksichtigen. Ist die Anstiegszeit der zu testenden Einrichtung zehnmal länger als die kombinierten Anstiegszeiten des FG 504 zusammen mit dem Oszilloskop und den Kabeln, übersteigt der Fehler nicht 1 %. Dieser Fehler kann in der Regel ignoriert werden. Ist jedoch die Anstiegszeit der zu testenden Einheit kleiner als der zehnfache Wert der kombinierten Anstiegszeiten, muß die wirksame Anstiegszeit bestimmt werden. Diese wird aus den einzelnen Anstiegszeiten im System gebildet. Die Gesamtanstiegszeit ist die Wurzel aus der Summe der Quadrate der einzelnen Anstiegszeiten:

$$\sqrt{R_t = (R_1)^2 + (R_2)^2 + \dots}$$

Ist die Anstiegszeit des Systems bekannt, kann nach obiger Methode die Anstiegszeit der zu testenden Einrichtung bestimmt werden.

Die physikalischen und elektrischen Eigenschaften der Übertragungskabel bestimmen die charakteristische Impedanz, die Fortpflanzungsgeschwindigkeit und die Dämpfung. Die Dämpfung ist auf die Frequenz bezogen. Eine kurze Kabelstrecke kann eine Hochfrequenzinformation eines Pulses mit schnellem Anstieg abschwächen. Aus diesem Grunde sollten die Kabel so kurz wie möglich gehalten werden.

Bei der Durchführung von Vergleichsmessungen oder Bestimmung von Zeitdifferenzen sollten zur Übertragung der beiden Testsignale zwei identische Koaxialkabel (gleiche Dämpfung und Verzögerungseigenschaften) verwendet werden.

### Impedanzanpassung

Bei der Übertragung von Impulsen werden überall dort, wo Fehlanpassungen auftreten (oder Impedanzdifferenzen), Reflexionen erzeugt und zur Signalquelle zurückgesendet. Die Amplitude und die Polarität der Reflexionen hängt von der Art der Fehlanpassung (Stoßstelle) ab. Hat die Fehlanpassung einen höheren Wert als die Leitungsimpedanz, hat die Reflexion dieselbe Polarität. Bei geringeren Werten weist die Reflexion die umgekehrte Polarität auf.

Das reflektierte Signal trifft ein, bevor der Impuls beendet ist und addiert oder subtrahiert sich somit zur Impulsamplitude. Dadurch wird die Form und Amplitude des Impulses verzerrt.

Treibt der FG 504 eine hohe Impedanz, z.B.  $1 \text{ M}\Omega$  (parallel eine Kapazität) eines Oszilloskopeneingangs, ist die Übertragungsleitung mit einem  $50\Omega$ -Teiler zu verbinden oder der Eingang des Oszilloskops wird mit  $50\Omega$  abgeschlossen. Der Teiler trennt die Eingangskapazität des Gerätes, so daß der FG 504 korrekt abgeschlossen ist.

### Freilaufender Ausgang

Wählen Sie die gewünschte Signalf orm, indem Sie die entsprechende Taste (Rechteck, Dreieck oder Sinus) drücken. Jetzt drücken Sie die Taste FREE RUN. Vergewissern Sie sich, daß der Schalter SWEEP DURATION in die Position OFF (Aus) eingestellt ist. Mit den Wählern MULTIPLIER und FREQUENCY Hz (START) wählen Sie die gewünschte Frequenz. Der Feineinsteller für die Frequenz (FREQUENCY VERNIER) gestattet die Feineinstellung der Frequenz. Schließen Sie die Last an die Ausgangsklemme (OUTPUT). Vergewissern Sie sich, daß die Taste HOLD gelöst ist. Stellen Sie das Bedienelement ATTENUATOR auf die gewünschte Spitzenausgangsamplitude ein. Mit Hilfe von VAR können Sie die Amplitude zwischen den Schritten einstellen.

Zentrieren Sie das Signal ohne Offset um 0 V. Um eine Offsetspannung zu unterlegen, ziehen Sie den Knopf OFFSET und drehen diesen auf den gewünschten Wert. Falls Sie mit der Signalf orm Rechteck arbeiten, müssen die Anstiegs- und Abfallzeit (RISE and FALLTIME) auf die gewünschten Werte eingestellt werden. Mit Hilfe des

## Bedienungsanleitung – FG 504

VAR-Knopfes werden Einstellungen zwischen den Schritten vorgenommen. Am Triggerausgang TRIG OUTPUT steht ein Triggersignal (eines für jeden Signalzyklus) zur Verfügung.

Wird das Ausgangssignal Sinus oder Dreieck benutzt, wenn MULTIPLIER in den 5 langsamsten Positionen eingestellt ist, kann der Signalausgang durch Drücken der Taste HOLD gestoppt werden. In diesem Fall stoppt der Signalgenerator und der FG 504 gibt eine Gleichspannung aus, die gleich der Spannung des Dreiecks oder Sinus ist, die vor Drücken der HOLD-Taste erreicht wurde. Diese Einrichtung arbeitet nicht bei der Funktion Rechteck.

Durch Ziehen des Knopfes SYMMETRY wird die Ausgangsfrequenz 10fach geteilt (die Anzeigelampe FREQ – 10 leuchtet) und die zeitbezogene Symmetrie des gewählten Signals wird verändert. Wenn der Knopf gezogen ist, kann durch Drehen die gewünschte Symmetrie für jede der drei Signalformen eingestellt werden.

### Getriggter oder getasteter Betrieb

Wird der FG 504 in die freilaufende Betriebsart, wie vorgehend beschrieben, eingestellt, wird das Trigger- oder Tastsignal an die Eingangsbuchse INPUT angeschlossen.

Wird nur ein Signalzyklus des Ausgangssignals pro Trigger gewünscht, ist die Taste TRIG zu drücken und LEVEL auf den Pegel des Triggersignals einzustellen, auf dem das Ausgangssignal beginnen soll. Wird mehr als ein Ausgangssignalzyklus gewünscht, drücken Sie die Taste GATE. Der Ausgang des FG 504 beginnt nun mit dem Triggerpegel und bleibt so lange erhalten, bis das Signal am Eingang unter den Triggerpegel abfällt. Die Ausgangsdauer entspricht jetzt der Dauer des Tastsignals. Die Anzahl der Signalzyklen pro Brust können näherungsweise durch Division der Tastsignaldauer durch die Periode der Ausgangsfrequenz des FG 504 ermittelt werden. Im getasteten Betrieb beendet der FG 504 immer den letzten Zyklus. Falls bei Ende des Tastsignals weniger als  $270^\circ$  des letzten Zyklus verbleiben, wird ein zusätzlicher Zyklus beendet.

Im getriggerten oder getasteten Betrieb wird mit Hilfe des Bedienelementes PHASE der START eines Dreieck- oder Sinussignals um  $\pm 80^\circ$  verschoben. Diese Phasenänderung wird vom 0 V-,  $0^\circ$ -Punkt des Ausgangssignals gemessen.

Um die Triggerung oder Tastung von Hand vorzunehmen, drehen Sie LEVEL auf Rechtsanschlag und drücken entweder die Taste GATE. Im TRIG-Betrieb wird durch Drücken der Taste MAN ein Ausgangssignalzyklus getriggert. Im GATE-Betrieb bleibt das gewählte Ausgangssignal so lange erhalten, wie die Taste MAN gedrückt ist.

### Wobbelbetrieb

Die Ausgangsfrequenz des FG 504 kann über einen Frequenzbereich von 1000 : 1 (in Abhängigkeit der Ein-

stellung von MULTIPLIER) mit einem Signal von 0 V bis 10 V, das an den Eingang VCF INPUT angeschlossen wird, gewobbelt werden. Abb. 2-3 zeigt den max. VCF-Bereich für jede MULTIPLIER-Einstellung.



Abb. 2-3. Die Grafik zeigt die Frequenzbereiche für jede Einstellung von MULTIPLIER, die mit einem Signal von 0 V bis 10 V am VCF-Eingang gewobbelt werden kann.

Die Polarität des Frequenzmodulations-Eingangssignals (VCF) bestimmt die Richtung, in der die durch MULTIPLIER, FREQUENCY Hz (START) und FREQUENCY VERNIER eingestellte Frequenz gewobbelt wird. Durch ein positives Signal steigt die Frequenz an und durch ein negatives Signal fällt sie ab. Eine Spannung, symmetrisch um 0 V, wobbelt die Ausgangsfrequenz symmetrisch um die durch die Frequenzeinsteller gewählte Mittenfrequenz. (Siehe Abb. 2-3).

Da die VCF-Eingangsamplitude in einem linearen Bezug zur Frequenz steht, kann der Frequenzausgang durch die VCF-Eingangsamplitude und durch FREQUENCY Hz bestimmt werden. Die VCF-Empfindlichkeit ist der höchstmögliche Wählerwert (40) multipliziert mit dem MULTIPLIER-Bereich, dividiert durch die max. VCF-Eingangsspannung (10 V). Beim FG 504 ist dies eine nominelle Empfindlichkeit (Hz pro V) vom 4fachen Wert der MULTIPLIER-Einstellung. Zum Beispiel: wenn MULTIPLIER auf  $10^3$  eingestellt ist, bewirkt eine Spannungsänderung von 2 V am VCF-Eingang eine Ausgangsfrequenzänderung von 8 kHz.

### Anwenderbestimmbarer Zeitbereich

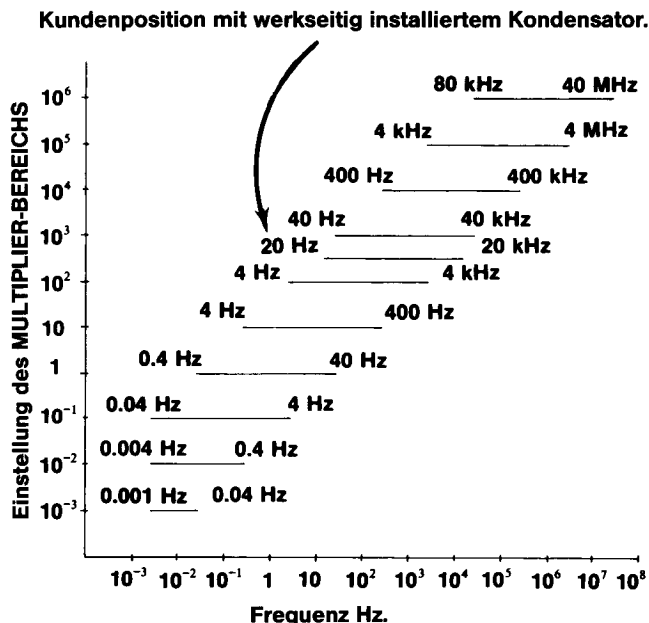
Diese Einrichtung gestattet es dem Anwender, einen eigenen Wobbelbereich zu installieren. Dieser Bereich wird durch die Position  $.5 \times 10^3$  des MULTIPLIER-

Schalters eingestellt. Der werkseitig eingebaute Kondensator (C248) für diese Position des Schalters MULTIPLIER liefert einen Wobbelbereich von 20 Hz bis 20 kHz.

### Phasenstarrer Betrieb

Die Frequenz des Ausgangssignals kann mit einem externen Referenzsignal synchronisiert werden. Die Ausgangsfrequenz des FG 504 muß innerhalb von  $\pm 10$

Hauptteilstrichen des Frequenzeinstellers in Bezug auf das extern angelegte Signal sein (die „1“ auf dem Einsteller ist der niedrigste Hauptteilstrich). Schließen Sie das Referenzsignal an die Eingangsbuchse INPUT und drücken Sie LOCK. Mit Hilfe von PHASE wird die Phase des Ausgangssignals um  $\pm 80^\circ$  mit Bezug auf das Referenzsignal verschoben. Das Bedienelement LEVEL stellt den Triggerpunkt auf dem Referenzsignal ein.



Abb. 2-4. Wobbelbereich, wenn ein Signal von 10 V an die VCF IN-Buchse angeschlossen ist.

Die Bedienelemente LEVEL und PHASE lassen sich einfacher und besser einstellen, wenn sie zunächst im TRIG-Betrieb einjustiert werden. Stellen Sie die FREE RUN-Frequenz des FG 504 etwas höher als die Frequenz des an INPUT angeschlossenen Referenzsignals ein und wählen Sie den TRIG-Betrieb. Stellen Sie LEVEL so ein, daß eine stabile Triggerung erhalten wird (falls das Signal auf einem Oszilloskop betrachtet wird) und stellen Sie die Ausgangsfrequenz des FG 504 so ein, daß sie fast denselben Wert hat wie die Frequenz des an INPUT angeschlossenen Signals. Stellen Sie PHASE in die Grundstellung ( $0^\circ$  bei Sinussignal) und drücken Sie LOCK. Stellen Sie, falls erforderlich, Phase nach, damit ein stabiler Ausgang bei der gewünschten Phase erhalten wird. Der PHASE-Bereich erhöht sich oberhalb 4 MHz.

Mit Hilfe einer internen Brücke kann VCF INPUT als Phasenmodulationseingang arbeiten, wenn der FG 504

im phasenstarken Betrieb PHASE LOCK betrieben wird. Die Eingangsspannung für den Phasenmodulationseingang ist auf  $\pm 2,5$  V begrenzt, wobei die obere Frequenzgrenze 1 kHz beträgt. Im phasenstarken Betrieb verändert die Phasenmodulationsspannung die Ausgangsphase um etwa  $5^\circ/V$ .

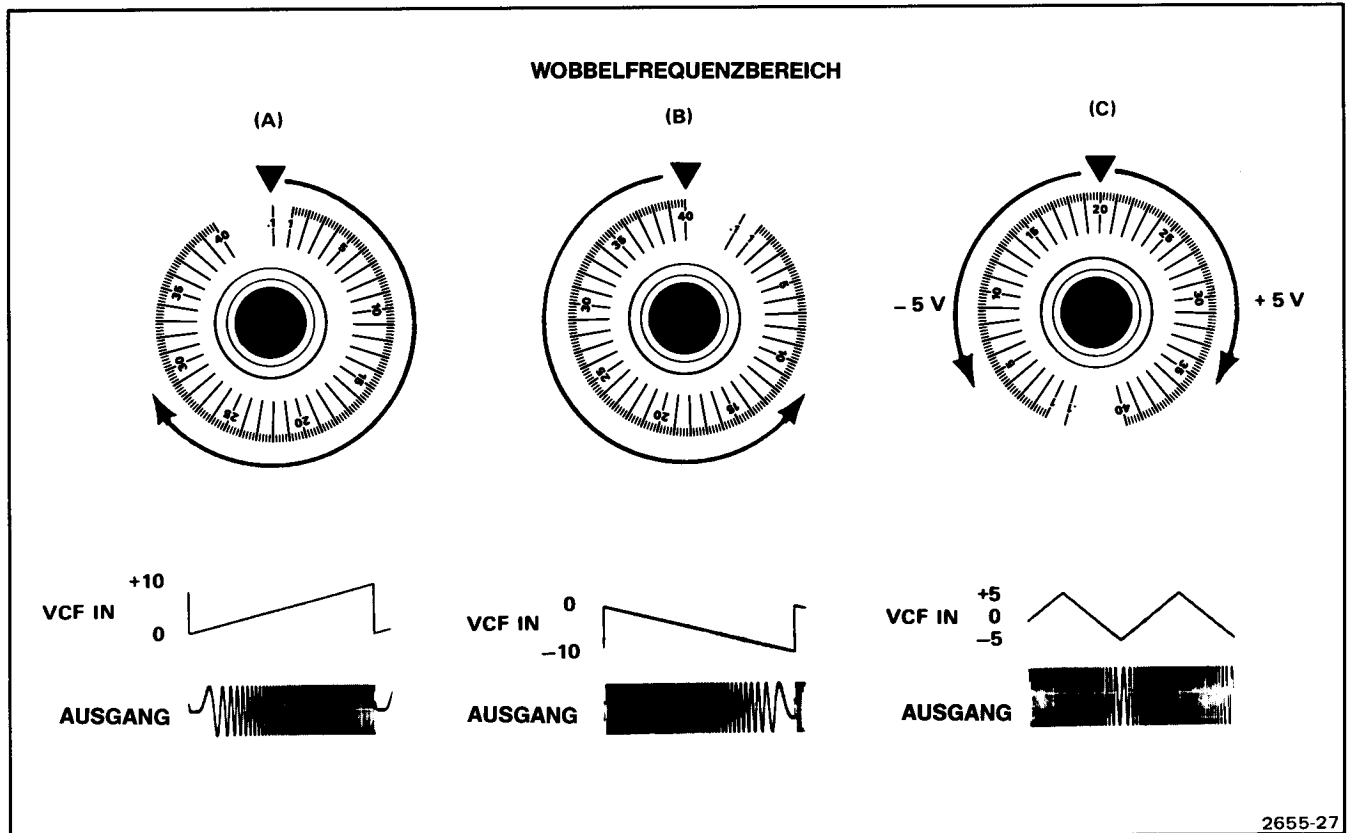
### Amplitudenmodulations-Eingang

Um eine Amplitudenmodulation des Ausgangssignals zu erhalten, wird das Modulationssignal an die Eingangsbuchse AM INPUT angeschlossen. Drücken Sie die Taste SINEWAVE und stellen Sie FREQUENCY Hz auf die gewünschte Trägerfrequenz ein. Weitere Informationen hierzu finden Sie im Spezifikationsteil dieses Handbuchs.

**Interne Wobbelung**

Eine komplette Wobbelung wird mit Hilfe des Bedienelementes SWEEP DURATION gewählt. Mit Hilfe des Knopfes VAR erhalten Sie Wobbelzeiten zwischen den festen Schritten. Stellen Sie FREQUENCY Hz (START), STOP FREQ und MULTIPLIER auf die gewünschte Wobbelfrequenz ein. Wählen Sie mit Hilfe von LOG/LIN SWP entweder logarithmische oder lineare Wobbelung. Lösen Sie die Taste STOP FREQ. Verwenden Sie das Bedienelement FREQUENCY VERNIER zur Einstellung der START-Frequenz, wenn die Ablenkung bei Frequenzen unterhalb von „1“ auf dem Wähler erfolgt. Ist eine getriggerte Wobbelung gewünscht, drücken Sie die Taste TRIG SWP und schließen das Triggersignal an den Eingang SWEEP TRIG INPUT an. Mit Hilfe von LEVEL stellen Sie den gewünschten Startpunkt auf dem Triggersignal ein. Ist freilaufender Betrieb gewünscht, lösen Sie die Taste TRIG SWP. Durch Drücken der Taste

STO- FREQ kann die Wobbelung gestoppt und die Ausgangsfrequenz gehalten werden. Die lineare Ablenkspannung (Sägezahn) steht an der Ausgangsbuchse SWEEP OUTPUT zur Verfügung.

**Externe Eingangssignale für Triggerng, Tastung, Phasenkopplung und getriggerte Wobbelung**

Die externen Eingangssignale für diese Betriebsarten müssen mindestens  $1 V_{SS}$  um das Gleichspannungssignal liegen, das über LEVEL eingestellt wurde (+1 V bis +10 V). Ist der Pegelinsteller LEVEL in Nähe seines Minimums eingestellt, muß das externe Signal zwischen +0,5 V und +1,5 V liegen. Zum Beispiel: ein externes Signal, dessen Amplitude symmetrisch um 0 V liegt (wie ein Sinussignal), muß mindestens  $3 V_{SS}$  (+1,5 V bis -1,5 V) betragen. Typische Eingangssignale zeigt Abb. 2-5.



Abb. 2-5. Triggersignalamplitude und Triggerpunkte.



Abb. 2-7. GRUNDFUNKTIONEN. Rechteck, Dreieck und Sinus, wählbar durch Tasten der Frontplatte.

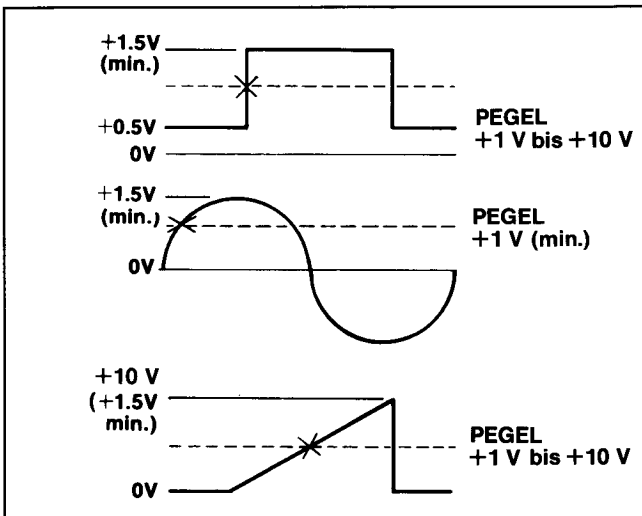

Abb. 2-6 Phasenbezug zwischen Ausgangssignalen und Triggersignalsignal.

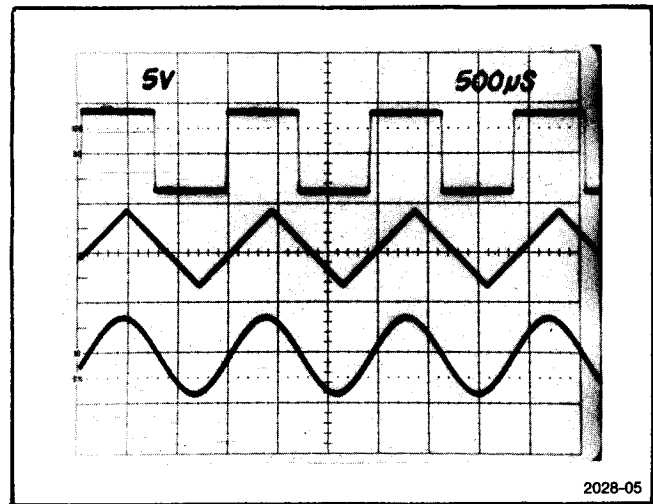

Abb. 2-8. SÄGEZÄHNE UND IMPULSE. Diese werden mit Hilfe von SYMMETRY aus den Grundfunktionen erhalten.

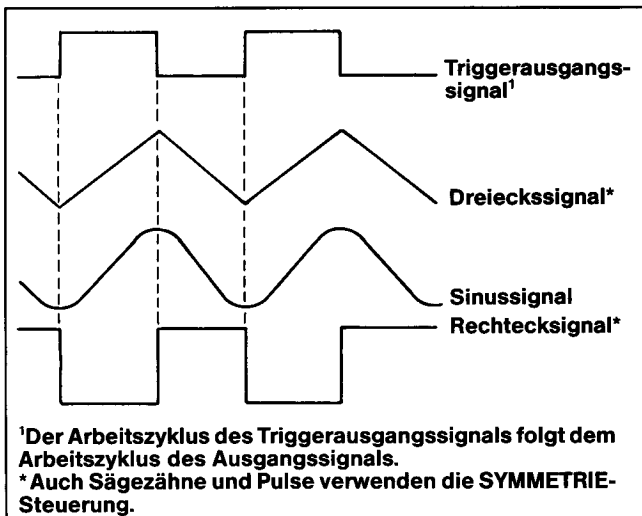

Abb. 2-9. VARIABLE ANSTIEGS- UND ABFALLZEITEN. Durch Veränderung der Anstiegs- und Abfallzeiten im Rechteckbetrieb können unterschiedliche Pulsformen erzeugt werden.

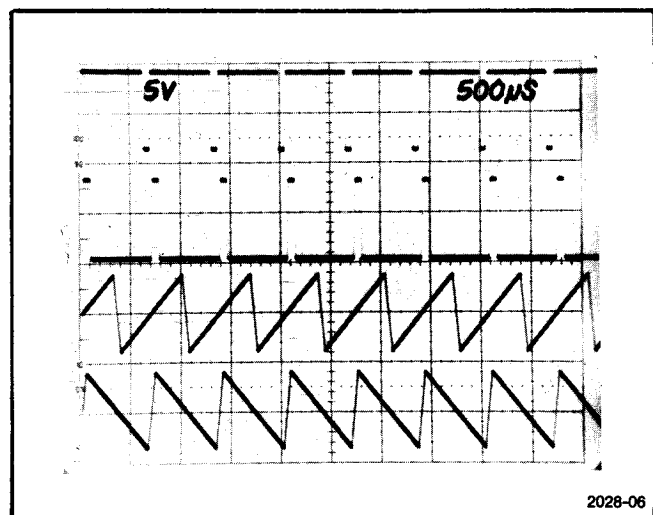

Abb. 2-11. LOGARITHMISCHE WOBBELUNG. Wird mit denselben Einstellungen wie in Abb. 2-10 benutzt. Wählen Sie den logarithmischen Sägezahn. Die Frequenz wird logarithmisch gewobbelt. Die logarithmische Sägezahnspannung steht nicht extern zur Verfügung.

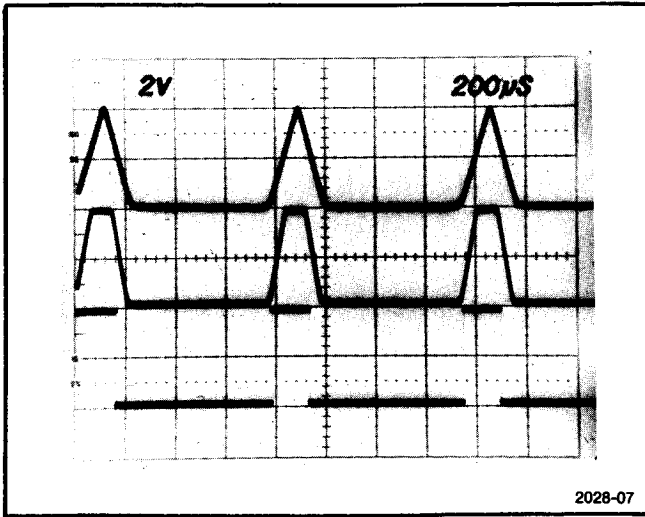

Abb. 2-10. LINEARE WOBBELUNG. Wählen Sie die Start- und Stopfrequenzen und den internen linearen Sägezahn für einen gewobbelten Ausgang von der Start- bis zur Stopfrequenz in der gewählten Zeit.

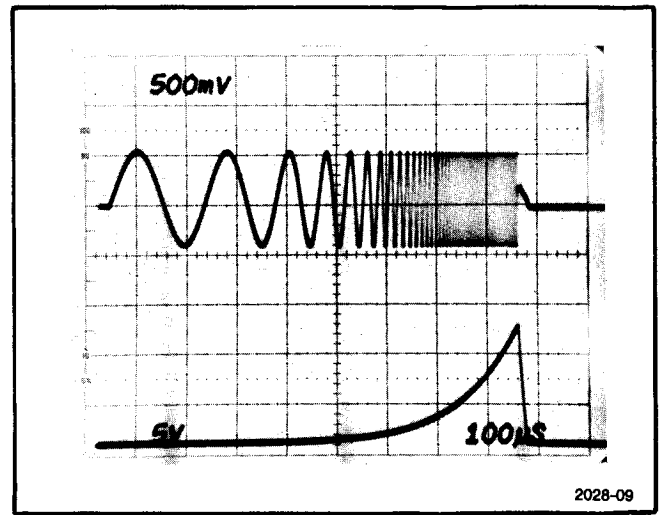

Abb. 2-12. SCHMALBANDWOBBELUNG. Der obere Ablenkstrahl zeigt ein Dreieckssignal, das durch den linearen Sägezahn gewobbelt wird. Die Startfrequenz beträgt 9,52 kHz und die Stopfrequenz 10,52 kHz. Diese Funktion eignet sich besonders für schmalbandiges Testen. Der untere Ablenkstrahl zeigt den Sägezahn.

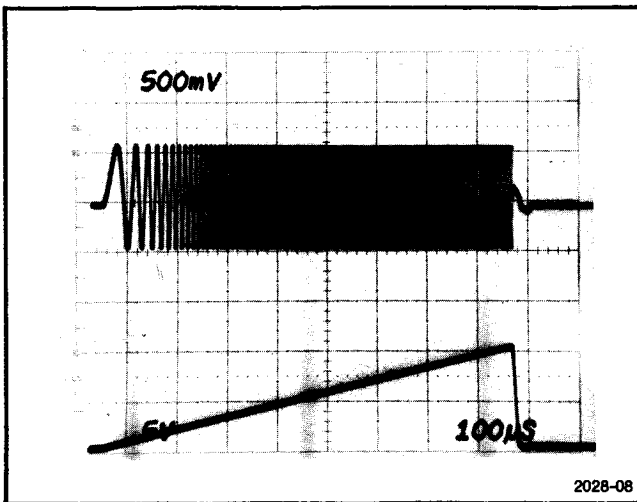

Abb. 2-13. GETASTETER BETRIEB. Die oberen drei Ablenkstrahle sind verschiedene Ausgangssignale und der untere Ablenkstrahl ist das Tastsignal, das an die Triggereingangsbuchse bei gedrückter GATE-Taste angeschlossen ist. Beachten Sie, daß ein zusätzlicher Zyklus nach Ende des Tastsignals beendet wird.

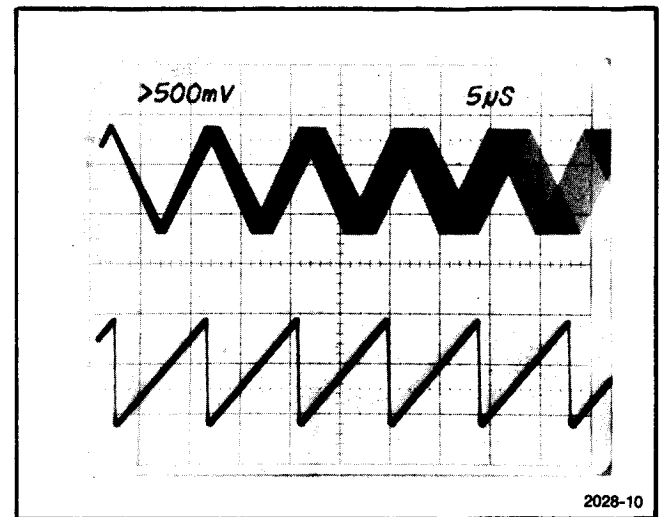

Abb. 2-15. PHASENGESTEUERTER BETRIEB. Das Bild zeigt die Funktion des Phaseinstellers bei getriggertem Betrieb. Die fünf überlagerten Strahle zeigen die Wirkung des Phaseinstellers. Dieser Einsteller bietet ca.  $\pm 80^\circ$  Phasenänderung. Das untere Signal ist das Triggersignal.

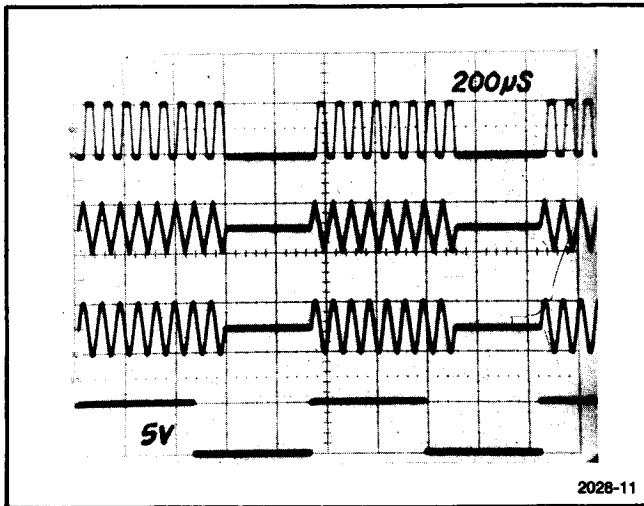

Abb. 2-14. GETRIGGERTER BETRIEB. Die oberen drei Ablenkstrahle zeigen verschiedene gewählte Ausgangssignale. Der untere Ablenkstrahl ist das an die Triggereingangsbuchse angeschlossene Triggersignal in der Betriebsart TRIG. Beachten Sie, daß nur ein Signalzyklus des Ausgangssignals beendet wird.

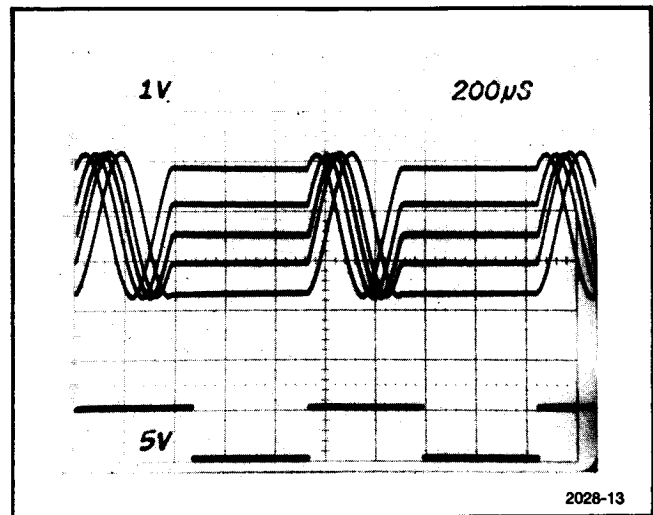

Abb. 2-16. PHASENSTARRER BETRIEB. Der untere Ablenkstrahl zeigt das an die Buchse INPUT angeschlossene Signal im LOCK-Betrieb. Der mittlere Ablenkstrahl ist das an das Eingangssignal phasengekoppelte Signal. Die oberen Ablenkstrahle zeigen die Wirkung des Bedienelementes PHASE.

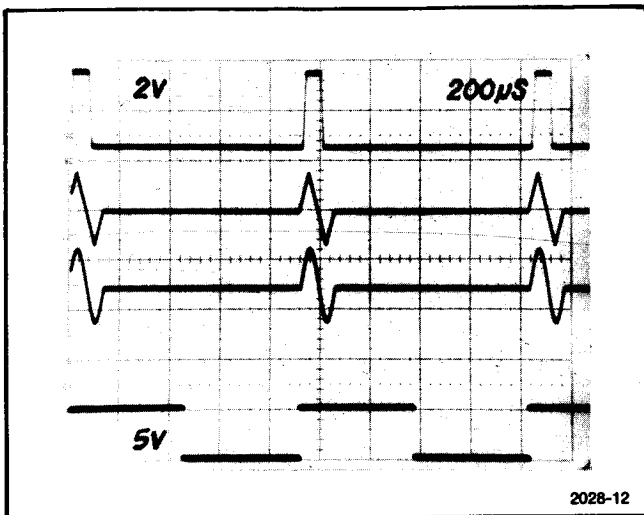

Abb. 2-17. AMPLITUDENMODULATION. Der obere Ablenkstrahl zeigt die 100 % modulierte Hüllkurve und der untere Ablenkstrahl das Modulationssignal.  $\pm 2,5$  V modulieren den Ausgang 100%. ( $5 V_{SS}$  zentrieren um 0 V).

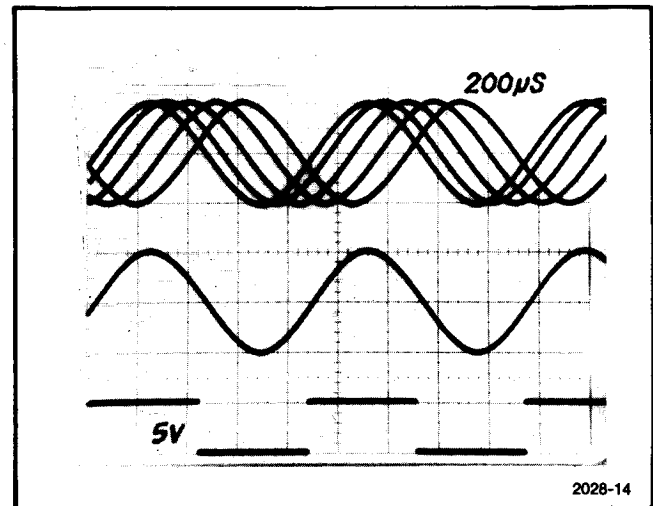

Abb. 2-19. NIEDERFREQUENZ HALTEN (HOLD). In den unteren fünf Positionen des Wählers MULTIPLIER kann der Ausgang bei beliebigem Pegel gehalten werden, indem die Taste HOLD gedrückt wird. Die Schritte in diesem Beispiel wurden auf diese Art erhalten.

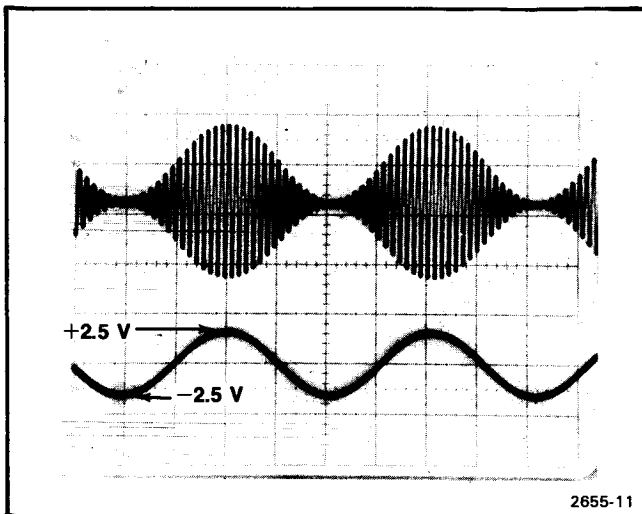

Abb. 2-18. UNTERDRÜCKTE TRÄGERMODULATION. Der obere Ablenkstrahl zeigt eine Zweiseitenband-Modulation mit unterdrücktem Träger und der untere Ablenkstrahl zeigt das Modulationssignal. Die obere Spitze des Modulationssignals ist 0 V und die untere Spitze ist  $-10$  V. Der Gesamtpegel des Modulationssignals muß vorsichtig eingestellt werden, um den echten unterdrückten Trägerbetrieb zu erreichen.

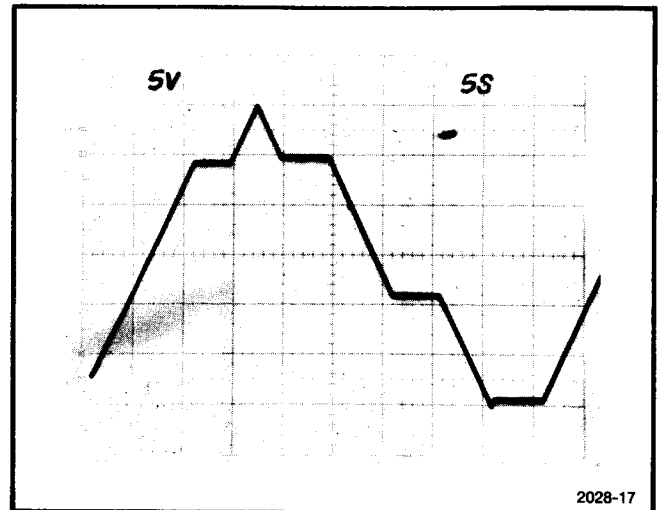

Abb. 2-20. VERZÖGERTER BETRIEB. Wird der interne Sägezahn-generator als Verzögerungsgenerator verwendet, steht ein großer Bereich von Verzögerungszeiten zur Verfügung. Der mittlere Ablenkstrahl ist ein unterlegtes Eingangssignal an SWEEP TRIG INPUT. Der untere Ablenkstrahl zeigt das Signal an LIN SWP OUT. Dieser Sägezahn wird an den externen Triggereingang angeschlossen. Der Verzögerungsbetrag ist proportional zur Dauer der Ablenkung (Sägezahn) und der Einstellung von TRIG LEVEL. Wird der Sägezahn-generator als Verzögerungsgenerator verwendet, muß STOP FREQ auf Linksschlag eingestellt sein.

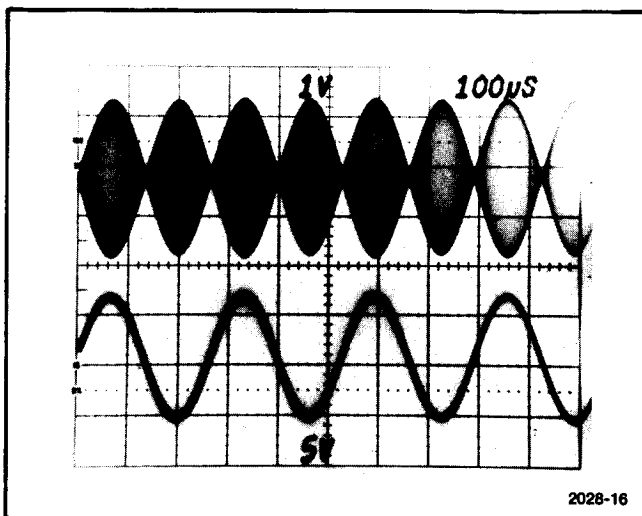

### Tonfrequenzburst-Test

Zusammen mit einem externen Pulsgenerator kann der FG 504 zum Tonfrequenzburst-Test verwendet werden. Schließen Sie den Ausgang des Pulsgenerators PG 501 von TEKTRONIX an die Triggereingangsbuchse. Wählen Sie GATE-Betrieb. Stellen Sie am externen Puls-generator die Pulsdauer und die Repetiergeschwindigkeit ein. Wählen Sie nun die Ablenkzeit für den FG 504. Wählen Sie die Start- und Stopfrequenzen. Am Ausgang des FG 504 liegen jetzt eine Serie von Tonfrequenzbursts, wie in Abb. 2-21 gezeigt.

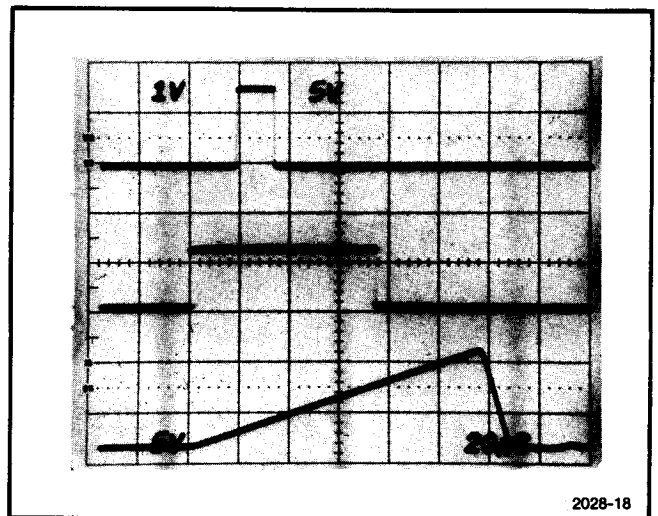

Abb. 2-21. TONFREQUENZBURST-TEST. Der untere Ablenkstrahl ist der lineare Sägezahn von dem Ausgang LIN SWEEP OUTPUT.

### Filtertest

Die Wobbelmöglichkeiten des FG 504 machen ihn auch für das Testen von Filtern geeignet. Für diesen Zweck arbeitet man am günstigsten in der Betriebsart LOG SWP (logarithmisch). Die Abbildungen 2-22 und 2-23 zeigen die Vorteile der logarithmischen Ablenkung.

### Pulsformung

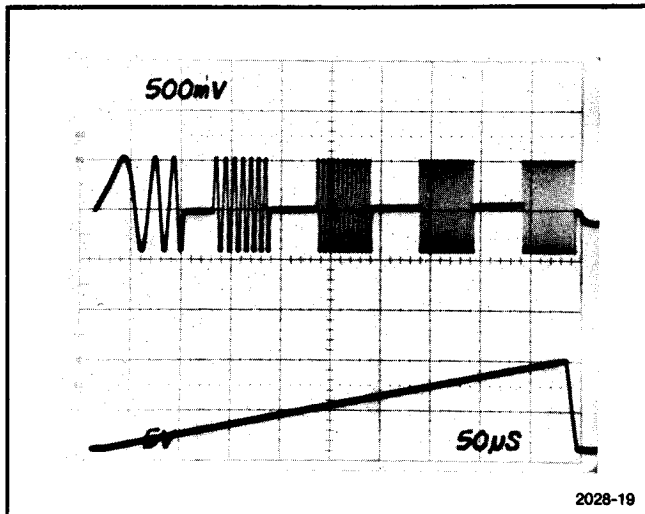
Durch die externe Triggerung ist der FG 504 auch für Pulsformung geeignet. Dazu schließen Sie den zu formenden Puls an die Triggereingangsbuchse und stellen den FG 504 in den Rechteckbetrieb ein. Mit Hilfe von LEVEL kann der Triggerpegel gewählt werden. Die Anstiegs- und Abfallzeiten, Pegel und Symmetrie eines sauberen Ausgangspulses kann nach Wunsch verändert werden. Abb. 2-24 zeigt eine solche Anwendung.



Abb. 2-22. Bei linearem Sägezahn erscheinen die Filterausgänge in unterschiedlichem Abstand.



Abb. 2-23. Bei logarithmischem Sägezahn erscheinen die Filterausgangsfrequenzen in gleichem Abstand.

## VERPACKUNG DES GERÄTES

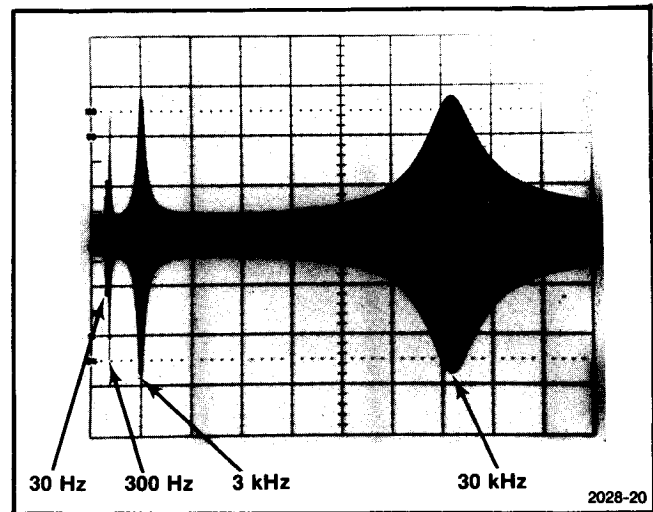
Für den Versand des Gerätes an den Tektronix-Service sollte ein Etikett mit folgenden Angaben beigelegt werden: Ihre Adresse mit Angabe der zuständigen Kontaktperson, die Seriennummer sowie die Serviceanleitung.

Für den Fall, daß die Originalverpackung nicht mehr zur Verfügung steht, wird das Gerät wie folgt verpackt:

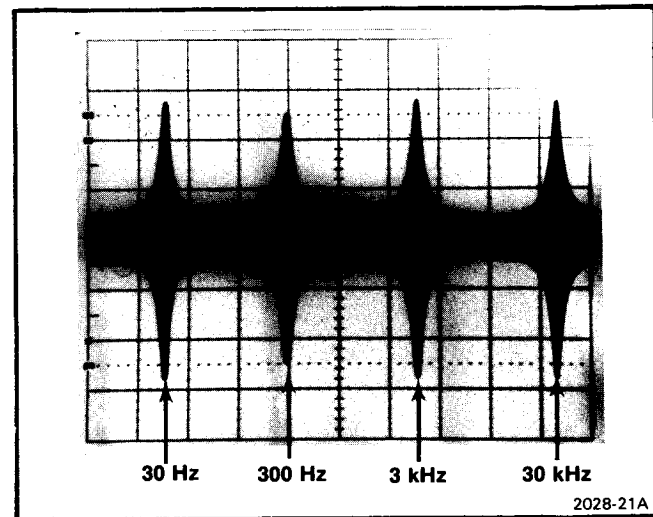
Schützen Sie das Gerät mit einer Kunststoffhülle oder ähnlichem. Verwenden Sie einen stabilen Karton, dessen Innenmaße die Geräteabmessungen nicht mehr als 15 cm überschreiten. Schützen Sie das Gerät, indem Sie den Raum zwischen Gerät und Karton von allen Seiten mit geeignetem Füllmaterial ausfüllen. Der Karton muß eine Testfestigkeit von 90 kg haben.



Abb. 2-24. PULSFORMUNG. Der untere Ablenkstrahl ist das Triggersignal.

# 取扱説明

## 概要

この章ではFG504型を最も有効にお使い頂くために必要な取扱いについて書かれています。さらに取付および取はずし方法、前面パネルのコントロールとコネクタの機能および動作モードと基本的な応用についても説明しています。

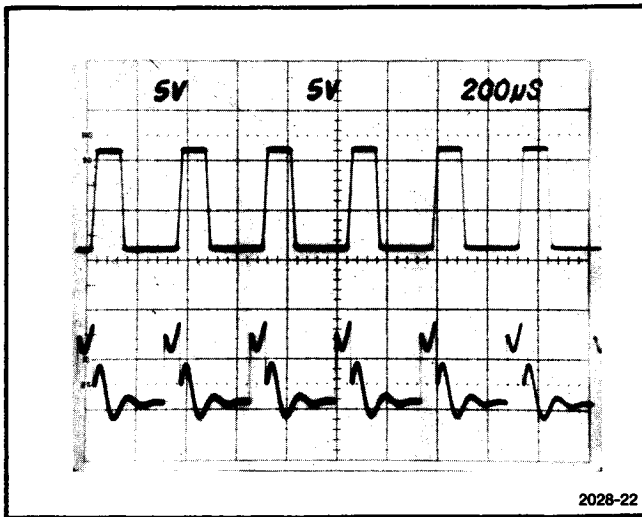
## 取付および取はずし方法

FG504型は2プラグイン幅ですからTM501型を除くTM500シリーズの本体に組込んで使用します。出荷時に校正されていますのですぐにご使用できます。電源電圧については本体の取扱説明書をご覧ください。

### 注意

FG504型を抜き差しする場合には必ず本体の電源を切ってから行なって下さい。また必要以上の力でプラグインを抜き差ししないように注意して下さい。

本体のコネクタ内に入っているプラスチックの位置決めスパーサとFG504型のエッジ・コネクタのカット部分とが一致していることを確認します。差し込もうとする本体のコンパートメントの上下のガイド（2-1図）に沿ってFG504型を押し込み、さらに本体のコネクタにFG504型のエッジ・コネクタがしっかりと固定されるまで押して下さい。本体の電源をオンにします。FG504型を取りはずす場合には、左下隅にあるつまみを引っぱりそのまま引き抜きます。

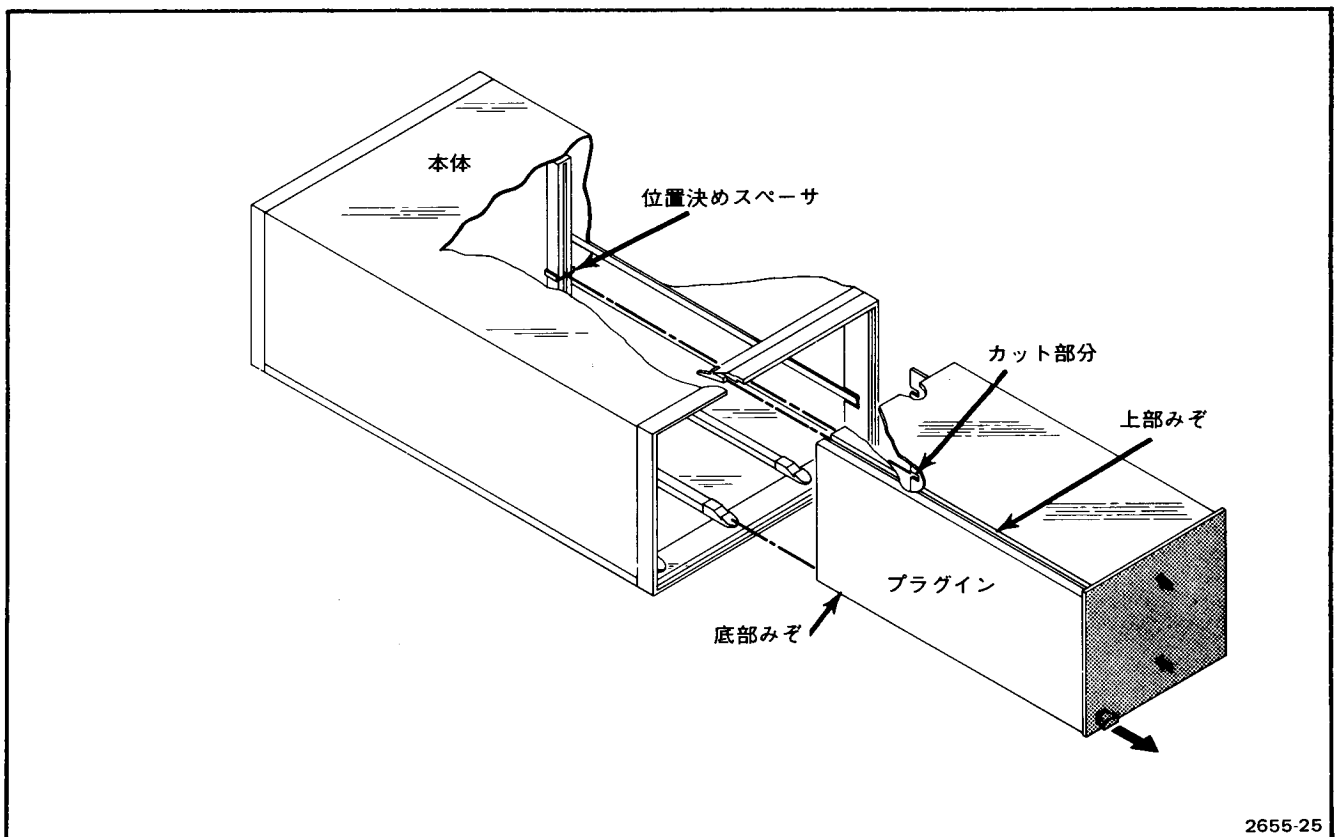

2655-25

2-1図 取付および取はずし方法

## 操作について

### 出力コネクタ

FG504型の出力は50Ωの電圧源として、50Ω負荷で動作するよう設計されています。より高い周波数において、終端されないか、もしくは不適當に終端された場合にはアブレーションの悪い波形が出力されます。50Ω以下の負荷では出力波形の振幅は減小します。

不適當な終端による過大なひずみやアブレーションは、低い周波数では余り目立ちません（特に正弦波および方形波）。真の出力波形を確認するための手順が次にあります。

1. 良質な50Ωの同軸ケーブルおよびコネクタをご使用下さい。
2. できるだけケーブルは短かくして、しっかりと接続します。
3. もし感度の良い回路に波形を入力する時は、振幅を減衰させるために良質のアテネータをご使用下さい。
4. 1.8m以上の長いケーブルを使用する時には反射を防ぐため、終端するかあるいはインピーダンス整合を行って下さい。
5. 出力波形に対して、アテネータやターミネーションなどは適切な定格電圧を持っているかお確かめ下さい。

もし出力にDC電圧が重畳している時は、負荷に直列にカップリング・キャパシタを挿入します。パルスの平坦度を維持するため、カップリング・キャパシタと負荷の時定数は十分長くする必要があります。

### 注

使用本体のTM500シリーズ電源が初期のモデルの場合、出力波形上にリップルがやや多くある場合があります。本体のトランスの位相がFG504型動作に適合しないためリップルが多くなります。これはトランス位相調整により簡単に取り除くことができます。手順についてはフィールド・エンジニアにお尋ね下さい。

### コントロールとコネクタ

- ① **FREQUENCY Hzダイヤル(スタート)**  
周波数を設定します。掃引モードの時にはスタート（下限）周波数の設定となります。
- ② **STOP FREQUENCY Hzダイヤル(ストップ)**  
掃引モードの時のストップ(上限)周波数の設定となります。

- ③ **FREQ÷10ランプ**  
SYMMETRYノブが引き出されている時に点灯します。
- ④ **RUN ボタン**：通常の操作にはボタンは出ている状態。  
**HOLD ボタン**：ボタンを押し込むと波形出力はストップして信号のレベル（5低周波数レンジのみ）に等しいDCレベルを出力します。
- ⑤ **VCF INPUTコネクタ**  
出力周波数をコントロールするための外部電圧を入力するコネクタです。正方向電圧により周波数は増加します。
- ⑥ **FREQUENCY VERNIERコントロール**  
出力周波数の微調整を行います。
- ⑦ **MULTIPLIERスイッチ**  
FREQUENCY Hzダイヤルの出力周波数レンジを設定します。
- ⑧ **AM INPUTコネクタ**  
正弦波出力をAM変調するための外部信号を入力するコネクタです。
- ⑨ **リリース・ラッチ**  
本体からFG504型を引き抜く時に使うつまみです。
- ⑩ **INPUTコネクタ**  
外部ゲート信号、トリガ信号、フェーズ・ロック信号を入力するコネクタです。
- ⑪ **MANボタン**  
トリガ操作又は出力波形コントロール用のゲート操作を手動で行える押しボタン・スイッチです。
- ⑫ **LEVELコントロール**  
トリガ、ゲート、フェーズ・ロック動作用へ入力波形のスタート電圧レベルを選択します。
- ⑬ **φLOCKボタン**  
このボタンが押された時にはINPUTコネクタへ入力された信号に出力波形周波数がロックします。
- ⑭ **GATEボタン**  
このボタンが押された時には、INPUTコネクタに入力された高レベルの期間のみ連続した波形が出力されます。
- ⑮ **TRIGボタン**  
このボタンが押された時には、INPUTコネクタに入力された各正方向信号ごとに1周期分の波形が出力されます。
- ⑯ **FREE RUNボタン**  
連続したフリーランの波形を出力させる時に押します。

⑰ PHASEコントロール

INPUTコネクタに入力された正弦波又はのこぎり波形上で選ばれたトリガ・レベルから±80°迄、位相の進み又は遅れを選びます。

⑱ TRIG OUTPUTコネクタ

選択された波形出力の各正方向サイクルで1個の正パルスを出します。(方形波出力の時には負方向サイクルでも出力します。)

⑲ OUTPUTコネクタ

波形を出力するコネクタです。

⑳ VARコントロール

アッテネータ・スイッチのステップ間の出力振幅を可変します。

㉑ ATTENUATOR (dB) スイッチ

10dB ステップで出力波形の振幅を変化させます。

㉒ LIN SWEEP OUTPUTコネクタ

掃引が行われている間は掃引モードには関係なく、0 から10Vののこぎり波がこのコネクタより出力されます。

㉓ SWEEP TRIG INPUTコネクタ

TRIG SWPモードの時に、このコネクタに入力された信号により掃引がトリガされスタートします。

㉔ VARコントロール

方形波の立上り及び立下り時間を変えます。

㉕ RISE AND FALL TIMEスイッチ

ステップで方形波の立上りと立下り時間を変えます。

㉖ SYMMETRYコントロール

引き出された時に動作します。出力波形のX軸方向の対称性を調整します。出力波形の周波数がおおよそ1/10に減少し同時にFREQ÷10ランプが点灯します。

㉗ VARコントロール

SWEEP DURATIONスイッチのステップ間の掃引時間を可変します。

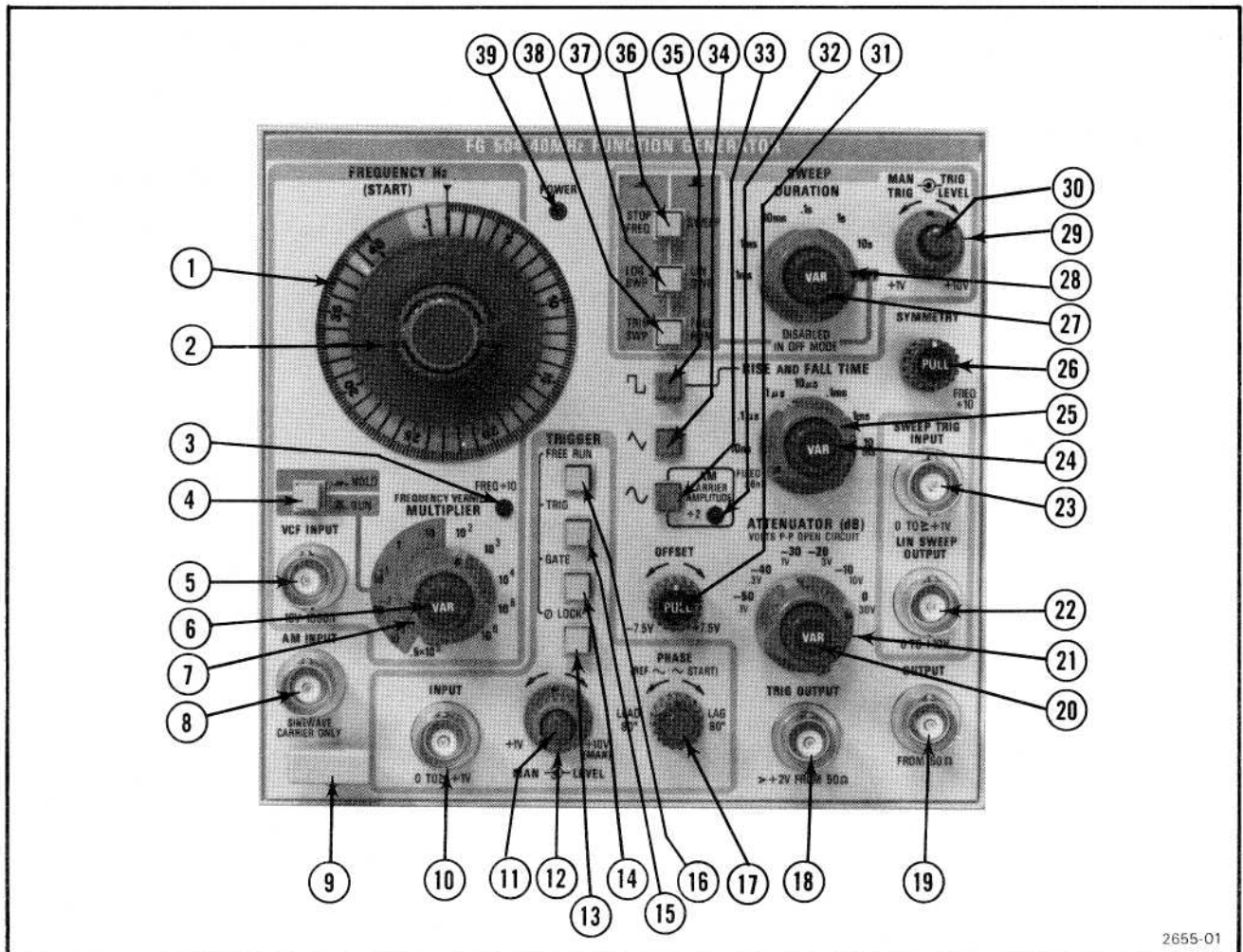

2-2 図 前面パネル コントロールとコネクタ

⑳ SWEEP DURATIONスイッチ

周波数掃引用のこぎり波の幅を選びます。

㉑ TRIG LEVELコントロール

掃引用のこぎり波をスタートさせるためにSWEEP TRIG INPUTコネクタに入力された信号のレベルを選びます。

㉒ MAN TRIGボタン

トリガ掃引モードが選択されている時は、このボタンを押すごとに1回の掃引が行われます。

㉓ OFFSETコントロール

このコントロールを手前に引いて回しますと出力波形に0VからのDCオフセット電圧を加えることができます。

㉔ AM CARRIER AMPLITUDE ÷ 2 ランプ

AM INPUTに入力された信号源インピーダンスが10kΩ以下の場合ランプが点灯します。

㉕ 正弦波ボタン

ボタンを押すと正弦波出力がえられます。

㉖ 三角波ボタン

ボタンを押すと三角波出力がえられます。

㉗ 方形波ボタン

ボタンを押すと方形波出力がえられます。

㉘ STOP FREQボタン

ボタンを押すと周波数掃引の最高(ストップ)周波数で掃引をストップします。ボタンが出ている状態ではFREQUENCYダイヤル上のスタートからストップ周波数設定値までを掃引します。

㉙ LOG SWP / LIN SWPボタン

ボタンを押した時には掃引は対数関数で行われ、ボタンが外に出ている時は、直線的に掃引が行われます。

㉚ TRIG SWP / FREE RUNボタン

ボタンを押した時トリガ信号で掃引がスタートします。ボタンが外に出ている時は、掃引はフリーランで連続的に行われます。

㉛ POWERランプ

本体からFG504型に電源が供給されている時に点灯します。

## 基本操作

前面パネルのコントロールの機能については、コントロールとコネクタの項で説明されています。

波形の選択および周波数を設定するためのコントロールは青色、トリガ機能と入力は緑色、掃引コントロールは橙色でそれぞれ色分けされています。

FG504型の各機能について慣れるために以下の手順で操作して下さい。

## 注

操作中に何んらかの支障が起きた際にはフィールド・エンジニアにお問い合わせ下さい。

操作する前に次のように設定します。

### 青色の部分

FREQUENCY Hz (START)	10
FREQUENCY Hz (STOP)	40
MULTIPLIER	10 <sup>2</sup>
HOLD/RUN	RUN(ボタン・オフ)
VAR	右回し一杯

### 緑色の部分

FREE RUN 押した状態

### 橙色の部分

SWEEP DURATION OFF位置

### 色のない部分

Sine Wave 押した状態

RISE及びFALL TIME FIXED位置

ATTENUATOR -10

VAR 右回し一杯

50Ωで終端された50Ω同軸ケーブルをオシロスコープの垂直軸入力に接続します。オシロスコープを次のように設定します。

垂直軸	1V/DIV、DC結合
水平軸(時間軸)	1ms/DIV

オシロスコープ管面全体に正弦波5サイクルが表示されるように調整して下さい。

1. 方形波、三角波および正弦波を順次選択して各々の波形を確認します。最初の設定にコントロールを戻します。
2. ATTENUATORとVARコントロールを回し、波形の振幅が変化するのを確かめます。最初の設定にコントロールを戻します。
3. OFFSETコントロールを引き、回転させます。表示された波形のDCレベルが変化します。OFFSETコントロールを押し込みます。
4. 方形波ボタンを押します。RISE AND FALL TIMEダイヤルを回します。方形波の変化に注意して下さい。次にRISE AND FALL TIMEダイヤルをPRESET位置に戻します。
5. SYMMコントロールを引き出した状態にします。FREQ ÷ 10ランプが点灯し表示波形が1周期になることを確認します。SYMMコントロールを回して方形波、三角波、正弦波の各波形が変化するのを確かめます。最初の設定にコントロールを戻します。
6. 橙色の部分の3つのボタンを押し出します。SWEEP DURATIONスイッチを1Sに合わせます。出力波形が1秒に1回づつ低周波数からより高い周波数に変化するのを確認して下さい。

7. LOG SWPボタンを押します。**FG504型**は、対数関数で掃引されます。掃引波形は、掃引の最初ではゆっくりと終りに向かって速くなることを確認します。
8. STOP FREQボタンを押して掃引レンジの最も高い周波数で掃引が止まるのを確認して下さい。
9. 青色部分のメイン・ダイヤル上のSTOP FREQダイヤルを回して下さい。ストップ周波数がSTOP FREQダイヤルで設定されることを確認します。STOP FREQボタンを押し出します。
10. TRIG SWPボタンを押します。周波数が変化しなくなったことを確認します。MAN TRIGボタンを押すごとに1度掃引が行なわれるのを確認します。SWEEP DURATIONスイッチをOFF位置にします。
11. 緑色部分のTRIGボタンを押します。波形が出力されなくなったことを確認して下さい。緑色部分のMANコントロールを押します。MANコントロールを押すごとに1周期の波形が出力されることを確認します。GATEボタンを押し、さらにMANコントロールを押します。MANコントロールを押している間は出力波形が連続しているのを確認して下さい。FREE RUNボタンを押して連続出力波形を得ます。
12. 青色部分のFREQUENCYダイヤルを変えて出力周波数の変化をみます。MULTIPLIERスイッチはFREQUENCYダイヤルと共に出力周波数を設定します。MULTIPLIERスイッチを $10^{-2}$ レンジに合わせます。オシロスコープ管面上で信号振幅がゆっくりと変化し、その時にHOLD/RUNボタンを押すと、その瞬間の波形上の振幅点で電圧がホールドされ、またボタンを押し出すと再びその振幅点から波形がスタートするのを確認します。

以上で基本操作を終わります。

### 立上りおよび立下り時間

**FG504型**を使用して立上りまたは立下り時間を測定する際には、他の機器の立上り時間も考慮に入れる必要があります。**FG504型**、オシロスコープおよびケーブルなどの合計の仕上り時間と、測定しようとする機器の立上り時間とを比較して、合計の立上り時間の方が10倍以上早い時には誤差は1%以下となりほとんど無視することができます。測定しようとする機器の立上りまたは立下り時間と、測定システムの立上り時間と比較して10倍以下の時には誤差が大きくなるため、実際の立上り時間は計算して求める必要があります。システムの立上り時間は各機器の立上り時間の2乗和の平方根となります。

$$R_t = \sqrt{(R_1)^2 + (R_2)^2 + \dots}$$

一度、システムの立上り時間が解れば測定しようとする機

器の立上り時間は容易に決めることができます。パルス伝送ケーブルの物理的電気的特性により、特性インピーダンス、伝搬速度および信号損失量が決まります。信号損失量は周波数に関係し、数フィートのケーブル長では速い立上り時間の高周波成分を減衰させてしまいます。ケーブルはできるだけ短かくします。

波形比較や時間差測定を行う場合は同じ損失量で同じ遅延時間を持つケーブルを使用します。

### インピーダンス整合

パルス信号が伝送線路を通過する時に不整合（伝送線路のインピーダンスと違うインピーダンス）が生じると、線路から信号源への反射が起こります。反射の振幅や極性はインピーダンス不整合の状態により決まります。線路インピーダンスよりも不整合インピーダンスが大きい値の時は、反射は入力信号と同じ極性になり、小さい値の時は逆の極性になります。

パルス波形が終わる前に反射信号が信号源に戻った時には、パルス振幅に反射信号が加わるかまたは差し引かれるかします。これによりパルスの形状と振幅にひずみを与えてしまいます。

**FG504型**を1MΩ入力インピーダンス（並列に容量を含む）を持つオシロスコープの垂直軸入力のような、高インピーダンス入力に接続する時は、伝送ライン、50Ωアテネータ、50Ωターミネーションを通してオシロスコープに入力します。アテネータは機器の入力容量をアイソレートしターミネーションは**FG504型**を適切に終端します。

### フリー・ラン出力

次は任意の周波数および振幅で連続したフリーラン出力を得る方法です。

任意の波形を選び、FREE RUNボタンを押します。

SWEEP DURATIONスイッチがオフになっていることを確認しFREQUENCY Hz (START)ダイヤルとMULTIPLIERスイッチにより任意の周波数を選びます。

FREQUENCY VERNIERコントロールで周波数の微調整を行います。**FG504型**のOUTPUTコネクタに負荷を接続します。HOLDボタンは出ている状態であることを確認した後、ATTENUATORスイッチを必要なp-p出力振幅に設定します。ステップ間の振幅はVARコントロールで調整します。

オフセットのかかっていない波形はOVが中心となります。オフセットをかけるにはDFSETコントロールをひっぱり必要なオフセットをかけます。方形波出力を選んだ場合はRISE AND FALL TIMEコントロールを必要な値に調整

します。ステップ間はVARコントロールで調整します。各波形の同期に対応したトリガ信号がTRIG OUTPUT コネクタから得られます。

正弦波や三角波出力をMULTIPLIERスイッチの最も低い方の5つの設定値で使用する際は、HOLDボタンを押すことで出力波形をホールドすることができます。このボタンを押すと同時に正弦波形または三角波形上のその時の振幅点のDC電圧が出力されます。このホールド機能は方形波出力では動作しません。

SYMMETRYコントロールを引き出すと出力波形の周波数は1/10になります(FREQ÷10ランプが点灯します) このコントロールにより出力波形の時間方向の対称性を変えられます。この機能は方形波三角波、正弦波のすべてに適用できます。

### トリガおよびゲート(バースト)モード動作

FG504型がフリーラン・モードになっていることを確認して、INPUTコネクタにトリガまたはゲート信号を入力します。

1個のトリガ信号で1周期のみの出力波形を得る場合にはTRIGボタンを押し、LEVELコントロールによりトリガ信号+のレベルを選びます。各トリガ信号に同期した出力波形が得られます。

1周期以上の出力波形が必要な場合にはGATEボタンを押します。ゲート信号のゲート幅(トリガ信号がトリガ・レベルを越し再び下がるまでの時間)の期間だけ連続した出力波形が得られます。バーストの繰返し数は、ほぼゲート幅をFG504型出力波形の周期で割った値となります。

ゲート・モード動作ではFG504型は常に最後の1サイクルを完了します。最後の1周期が270°以上の所でゲート波形がオフになった時にはもう1周期が追加されます。

トリガまたはゲート・モード動作では、PHASEコントロールにより±80°の範囲で正弦波または三角波形のスタート点を変えることができます。この位相を変えるコントロールは出力波形上の0V、0°を基準としています。

手動でトリガ又はゲート動作を行うには、LEVELコントロールを右に一杯回し、TRIG又はGATEボタンを押します。TRIGモードでMANボタンを押すと1周期の波形が得られ、GATEモードでは、MANボタンを押している間中、連続した波形出力が得られます。

### 外部周波数コントロール(VCF)動作

VCF INPUTコネクタに0V~10Vの外部電圧を入力しMULTIPLIERスイッチの設定により1000:1の範囲内で出力波形の周波数を掃引させることができます。

各MULTIPLIERスイッチの設定で最大VCFレンジについては図2-3をご参照下さい。この時FREQUENCY VERNIERコントロールを、1000:1の掃引レンジまたは最も低い周波数までの掃引が得られるよう調整する必要があります。



図2-3 VCF INPUTに0~10V信号を入力した際の各MULTIPLIERスイッチの設定レンジ毎の掃引可能範囲を示しています。

VCF入力信号の極性により、MULTIPLIERスイッチFREQUENCY Hz (START)ダイヤルとFREQUENCY VERNIERコントロールで設定された周波数からどちらの方向に周波数が掃引されるかが決まります。正(+)方向の信号により周波数は高くなり負(-)方向の信号で周波数は低くなります。

ほぼ0Vで対称的に変化するVCF入力電圧では、同波数コントロールにより設定された出力周波数を対称的に掃引します。(図2-3)

出力周波数とVCF入力電圧は直線的に比例していますので出力周波数はVCF入力振幅とFREQUENCY Hzダイヤル位置によって決定されます。VCF入力感度はダイヤル最高設定値(40)×MULTIPLIERレンジ/VCF最大入力電圧(10V)となります。FG504型ではMULTIPLIERスイッチの設定値の4倍が定格感度(Hz/V)です。例えばMULTIPLIERスイッチの設定を10<sup>3</sup>としVCF INPUTで2V変えると出力周波数は8kHz変化します。

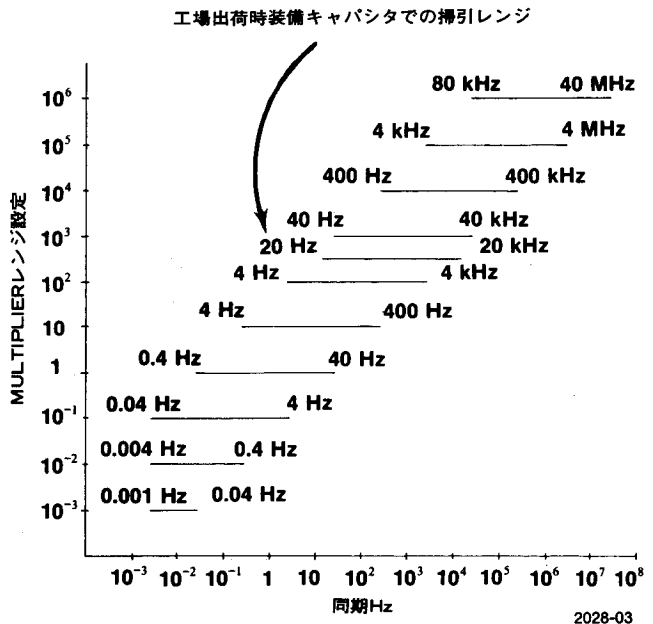
### カスタム・タイピング・レンジ

必要に応じてユーザが掃引周波数レンジを決めることができます。MULTIPLIERスイッチの0.5×10<sup>3</sup>位置がカス



タム・レンジとして使用されます。この位置には工場出荷時にキャパシタ (C248) が組み込まれていて20Hz~20kHz 掃引レンジとなっています。

### フェイズ・ロック動作

出力波形の周波数を外部の基準信号と同期させることが

可能です。**FG504型**の出力周波数は外部入力信号±10 FREQUENCYの主ダイヤル値(ダイヤルの1が主ダイヤルの最小値)内であればなりません。外部基準信号をINPUTコネクタに入力してφLOCKボタンを押して下さい。PHASEコントロールで外部基準信号に関して出力波形の位相を±80°変化することができます。LEVELコントロールで基準波形のトリガ点を調整します。



図2-4 VCF INコネクタに入力された10Vの信号による掃引周波数レンジ

最初にTRIGモードで調整すれば、LEVELとPHASEコントロールの正しい調整は簡単にできます。INPUTコネクタの基準入力信号の周波数よりやや高めにFREE RUN周波数を設定してからTRIGモードを選びます。オシロスコープ使用の際はLEVELコントロールを調整してトリガを安定させます。次いで出力波形の周波数を基準入力信号周波数に近づく様に調整します。PHASEコントロールを12時位置(正弦波選択時は0°)に合わせφLOCKボタンを押します。必要でしたら希望の位相で安定した出力が得られるようPHASEコントロールを再調整します。PHASEコントロール調整範囲は、4MHz以上では減少します。

PHASELOCKモードの際VCF INPUTを位相変調入力として機能させるジャンパ線切換えが内部にあります。位相

変調入力電圧制限は±2.5Vで上限周波数制限は1kHzです。フェイズ・ロックされた時に、位相変調電圧が出力位相を約5°/V変えます。

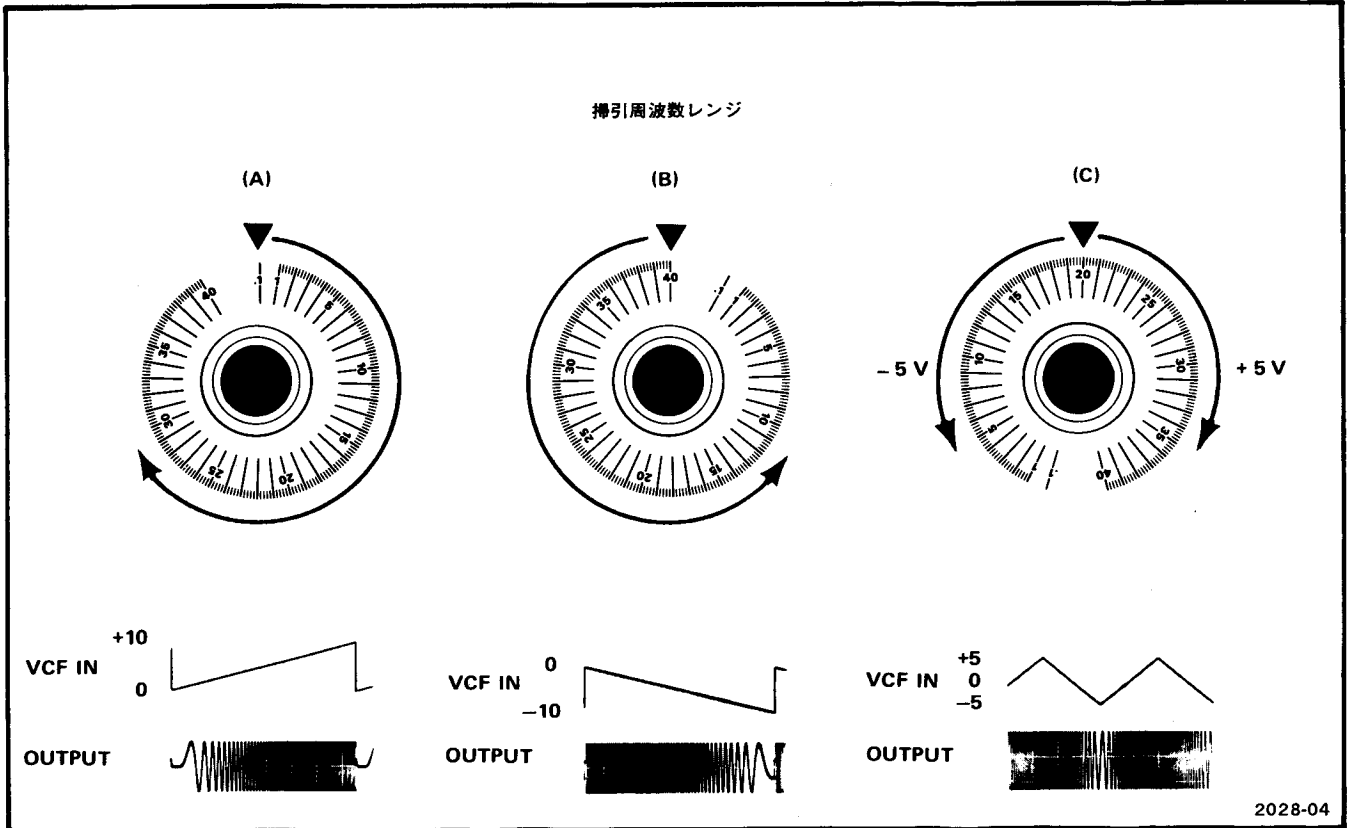
### 振幅変調入力

出力波形を振幅変調するにはAM INPUTコネクタに変調信号を入力します。SINEWAVEボタンを押し希望の搬送周波数にFREQUENCY Hzダイヤルを合せます。詳細については振幅変調入力の仕様の項をご参照下さい。

内部掃引動作

SWEEP DURATIONスイッチで丁度一掃引する時間を設定します。ステップ間の掃引時間設定にはVARダイヤルを使います。FREQUENCY Hz (START)、STOP FREQ、MULTIPLIERダイヤルを希望掃引周波数に合わせます。LOG/LIN SWPボタンで対数又は直線掃引のいずれかを選びます。STOP FREQボタンをはずします。ダイヤルの1より周波数を掃引する際はSTART周波数を設定するのにFREQUENCY VERNIERコントロールを使用します。トリガ掃引が必要な場合はTRIG SWPボタンを押してトリガ信号をSWEEP TRIG INPUTコネクタに入力します。トリガ波形の希望するレベルで掃引がスタートするようにLEVELコントロールを調整します。フリーランが必要な場合はTRIG SWPボタンをはずして下さい。

STOP FREQボタンを押すと掃引をストップし出力周波数を止めることができます。直線掃引電圧はSWEEP ON OUTPUT コネクタで得られます。

トリガ、ゲート、フェーズ・ロック、トリガ掃引モード用外部入力信号

上記モード用の外部入力信号はLEVELコントロールで決められた(+1V~+10V)のDC電圧で1V p-p以上の振幅を必要とします。外部信号はLEVELコントロールを最小又は最小近くにした状態で少くとも0.5V~+1.5Vの電圧変化が必要です。例えば、正弦波のようなOVで振幅が対称な外部信号は最低3V p-p (+1.5V~-1.5V) 必要とします。代表的な入力信号を図2-5に示しています。

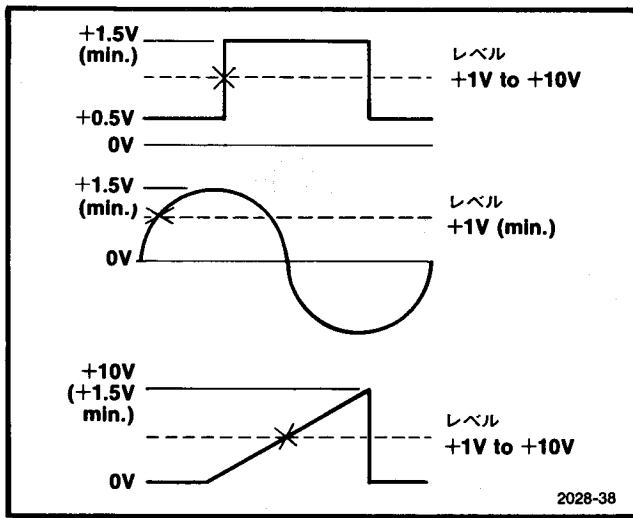

2-5図 トリガ信号として必要な振幅とそのトリガ点です。

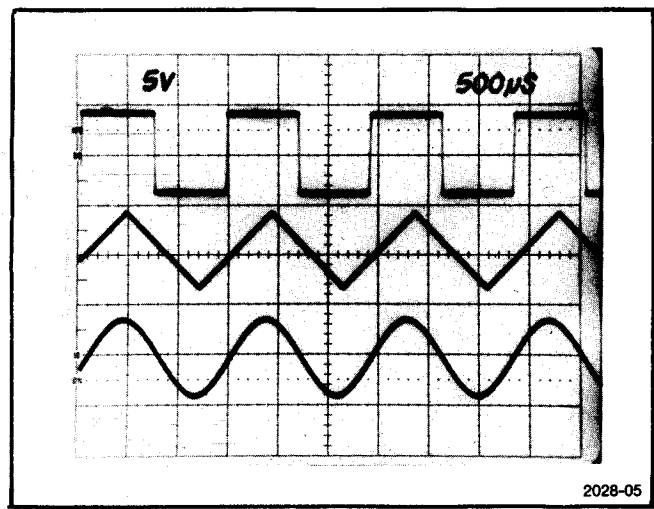

2-7図 前面パネルの押しボタンにより選ばれた方形波、三角波、正弦波の基準となる各波形を示しています。

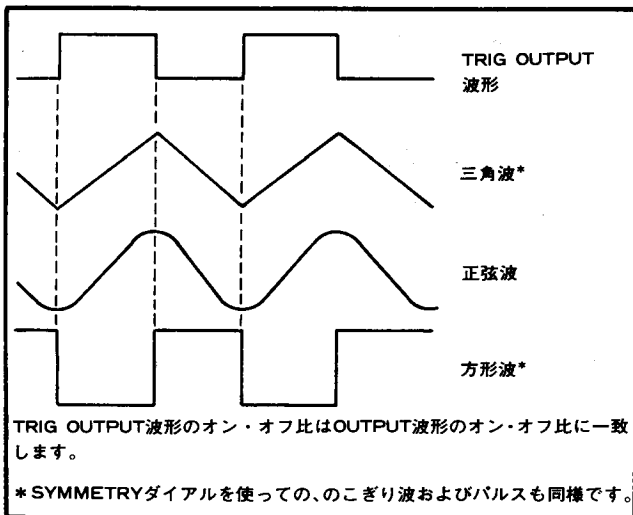

2-6図 OUTPUT波形とTRIG OUT波形との位相関係を示しています。

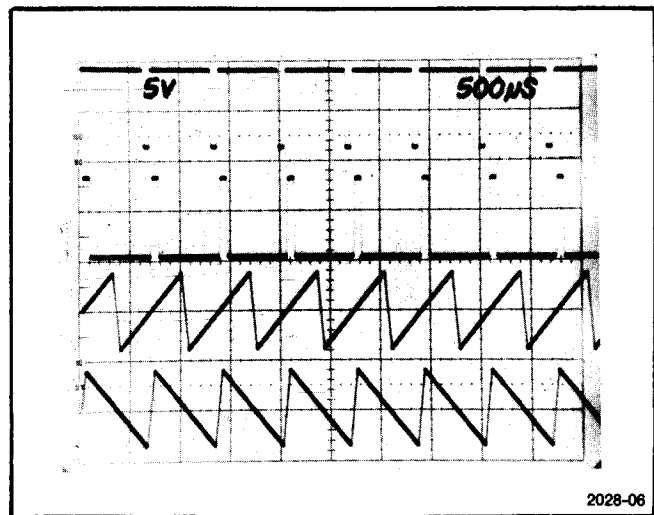

2-8図 のこぎり波とパルス。SYMMETRYコントロールを使ってこのような波形をつくることができます。

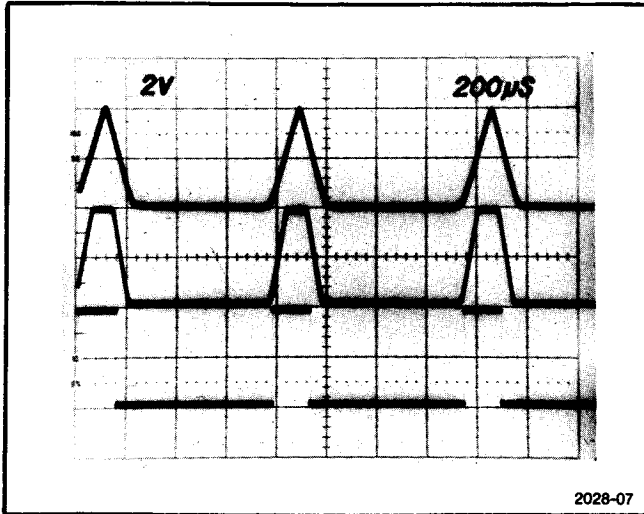

2-9図 可変立上り時間と立下り時間。方形波モードで立上り時間と立下り時間を変えることにより多様な形のパルスをつくれます。

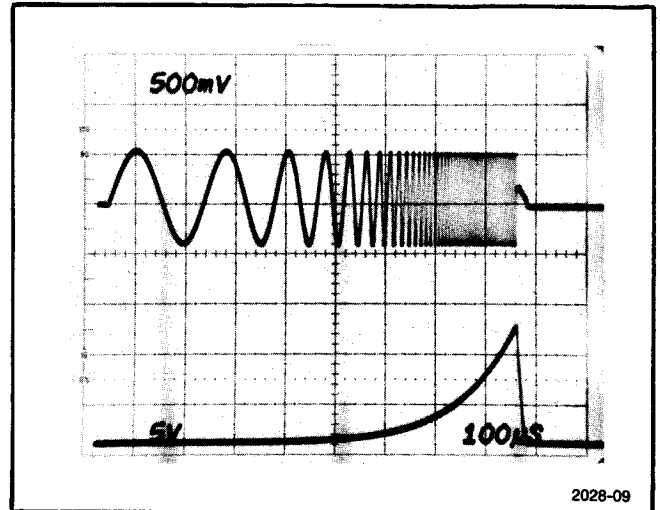

2-11図 対数掃引。LOG SWPモードを選ぶ以外は2-10図と同じ設定で得られます。スタートからストップ周波数までを対数関数的に掃引しています。外部にこの対数掃引のこぎり波を取り出すことはできません。

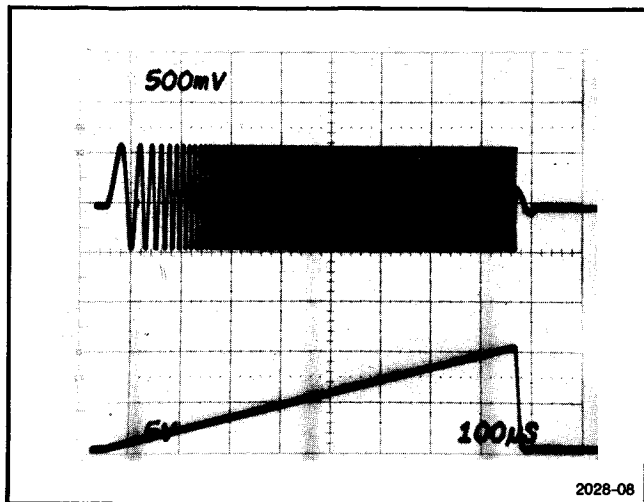

2-10図 直線掃引。上側はスタートからトップ周波数までを直線的に掃引している波形で、下側はLIN SWP OUTPUTコネクタから得られる掃引用内部のこぎり波です。

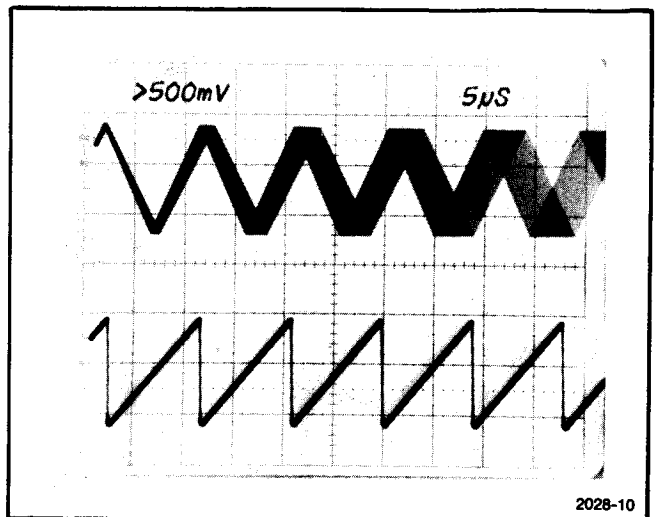

2-12図 狭い範囲の掃引。上側はスタート周波数が9.52kHz、ストップ周波数が10.52kHzのリニア掃引による三角波です。これは狭い帯域での掃引試験を行う時に有効です。下側の波形は掃引用のこぎり波です。

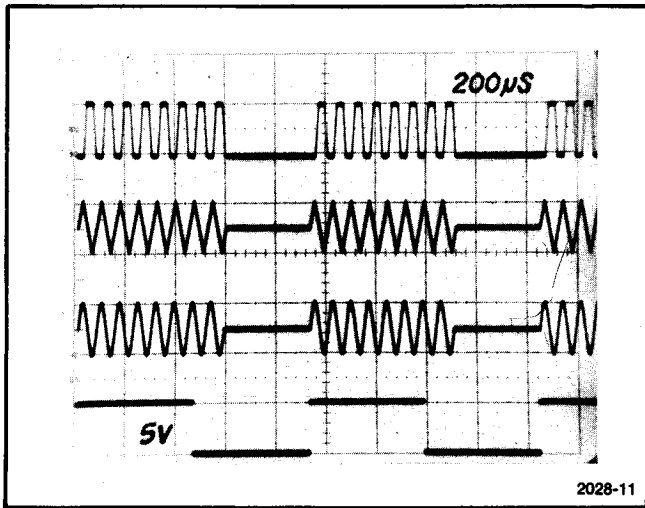

2-13図 ゲート動作。GATEボタンが押されて、トリガINPUTコネクタにゲート信号が入力された時の、上側3個が出力波形で、下側がゲート波形です。ゲート波形がオフになってもすぐにはバーストの繰返しが停止しないことに注意して下さい。

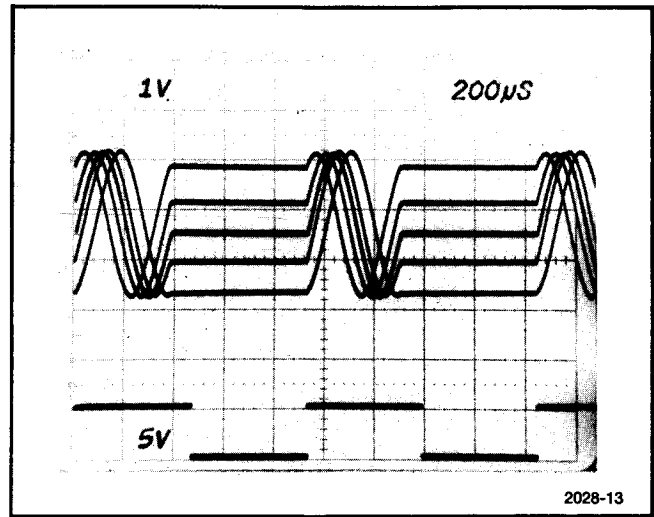

2-15図 位相調整。トリガ・モードでのPHASEダイヤルによる動作を示しています。5個の重ねられた波形は位相調整による結果です。このダイヤルにより $\pm 80^\circ$ の位相を変えられます。下側の波形はトリガ信号です。

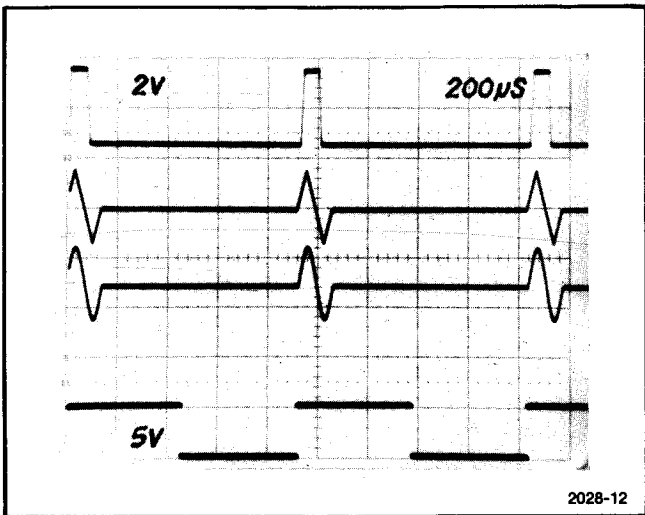

2-14図 トリガ動作。TRIGモードが選択され、トリガINPUTコネクタにトリガ信号が入力された時の、上側3個が出力波形で、下側がトリガ波形です。出力波形が1周期であることに注意して下さい。

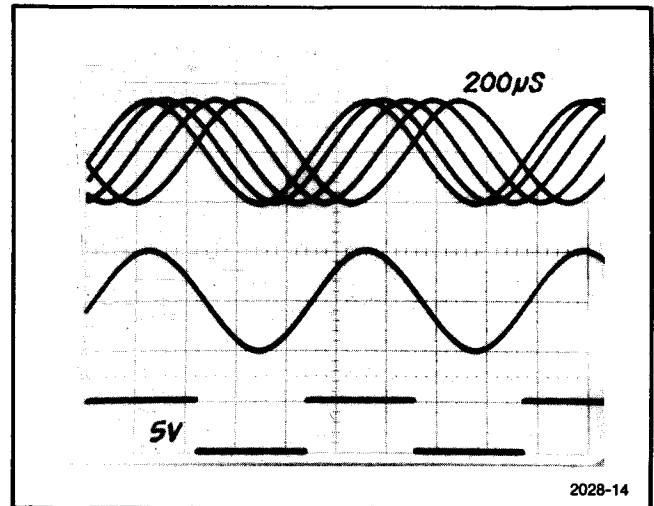

2-16図 フェイズ・ロック動作。下側の波形は $\phi$ LOCKモードでINPUTコネクタに入力した信号です。中段の波形は入力信号にロックした出力波形です。上側の波形はPHASEコントロールによる位相の変化を示しています。

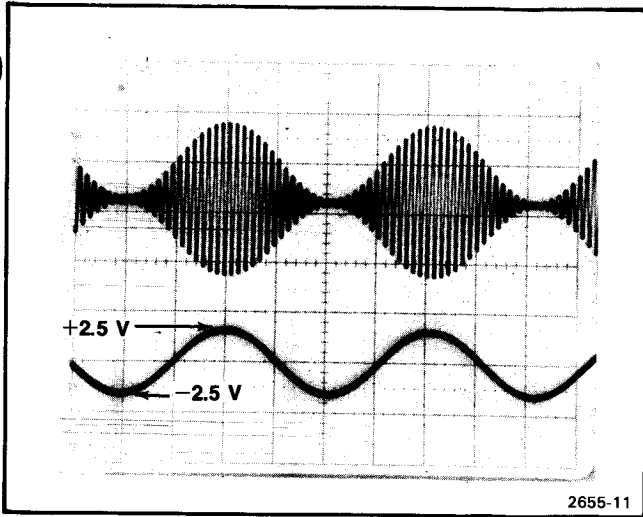

2-17図 振幅変調。上側の波形は100%変調のエンベロープをまじ、下側は変調信号を示しています。±2.5Vで出力を100%変調しています(0Vを中心に5V p-p)。

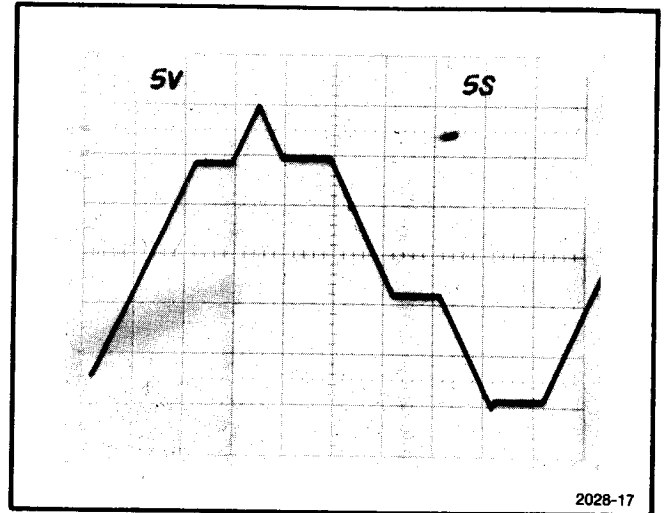

2-19図 低周波数ホールド。MULTIPLIERスイッチの最も低い方の5設定値ではHOLDボタンを押すだけでどのレベルにでもホールドすることができます。この図はホールド機能により得られた波形です。

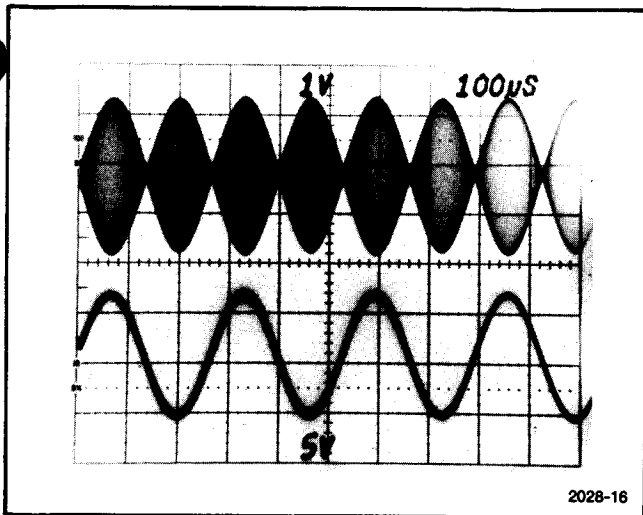

2-18図 搬送波抑圧変調。上側は両側波帯搬送波抑圧変調のエンベロープ波形で下側は変調波形を示しています。変調波形の上限ピークは0V、下限ピークは-10V。変調波形の全体レベルは、真の搬送波抑圧動作が行われるよう調整されなければなりません。

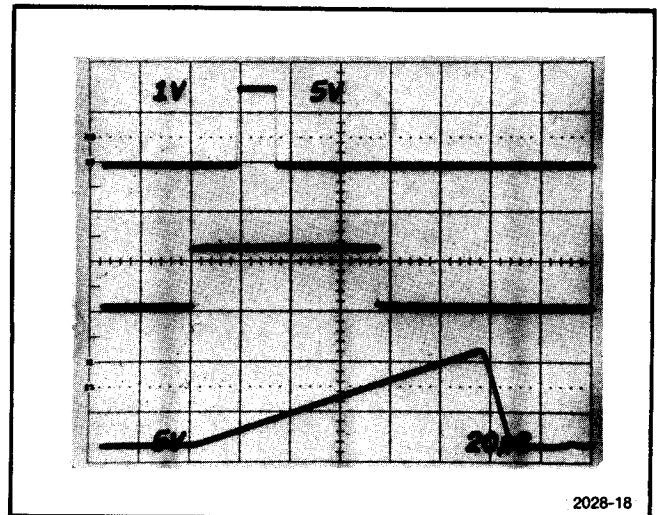

2-20図 遅延動作。遅延ゼネレータとして内部掃引ゼネレータを使用することにより広範囲な遅延時間が設定できます。中段はSWEEP TRIG INP UTに入力された基準信号波形です。下側の波形はLIN SWP OUTコネクタからのこぎり波です。このこぎり波を外部トリガ入力コネクタに入力します。上側の波形は遅延出力パルスです。遅延時間は掃引時間幅と TRIG LEVELコントロールの設定に比例します。掃引を遅延ゼネレータとして使用する際はSTOP FREQダイヤルを左回し一杯になっていることを確認して下さい。

## トーン・バーストの発生

FG504型を他のパルス・ゼネレータと組み合わせて使用できます。その方用ではFG504型の内部掃引機能とゲート信号源として当社のPG501型のようなパルス・ゼネレータを使用します。

まずPG501型(2は同当製品)パルス・ゼネレータの出力をトリガINPUTコネクタにつなぎます。次にGATEモードを選び、パルス・ゼネレータを希望するパルス幅と繰り返し率に設定し、スタート及びストップ周波数を選択します。こうしますとFG504型の出力は2-21図のようにトーン・バースト波形となります。

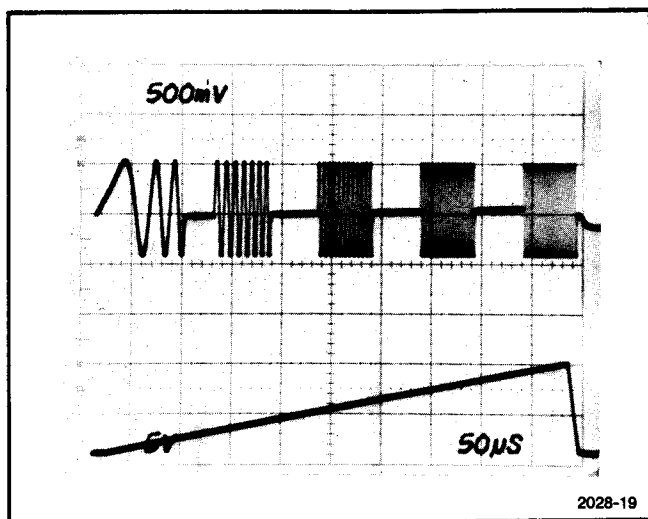

2-21図 トーン・バースト・テスト。下側はLIN SWEEP OUTPUT コネクタからの直線のこぎり波です。

## フィルタ試験

FG504型の周波数掃引機能はフィルタの掃引試験に最適です。この応用にFG504型を使用する時はLOG SWP モードが適しています。2-22図および2-23図は対数掃引を使用した時の特徴を示しています。

## パルス整形

FG504型の外部トリガ機能はパルス整形に利用できます。整形したいパルスをトリガINPUTコネクタに入力し、方形波モードのボタンを押します。トリガ・レベルはTRIG LEVELコントロールで選びます。出力パルスの立上り、立下り時間、レベル、対称性は任意に変えられます。2-24図は応用例です。

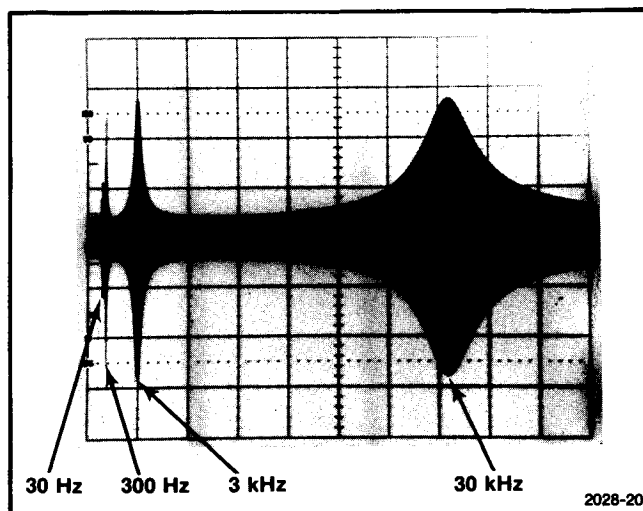

2-22図 各フィルタに入力された直線掃引信号表示

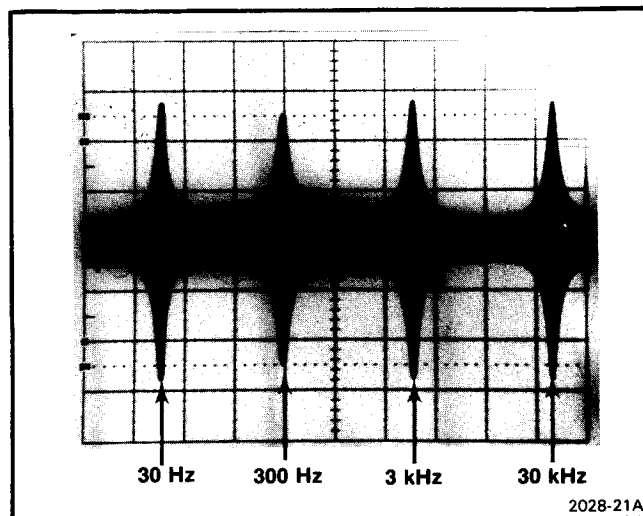

2-23図 各フィルタに入力された対数掃引信号による等間隔表示

## 梱包方法

修理のため機器を送り返す時には、連絡先および故障の内容、シリアル番号を記入したタグを付けて下さい。

納入時に機器が梱包されていた箱を使用すれば簡単に再梱包ができますが、もしその箱がない時には次のようになっています。

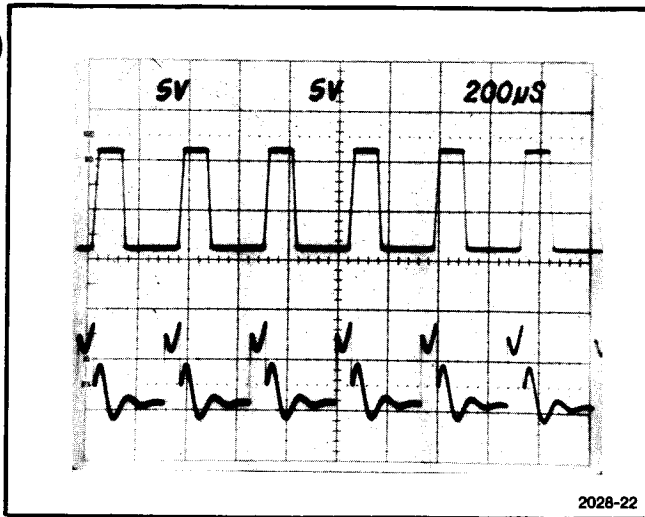

2-24図 パルス整形機能。下段波形は整形前の信号

機器の塗装を保護するためにポリエチレン・シートのような物でくるみます。機器の長さよりも15cm位長い丈夫なダンボール箱を用意し、その箱の中にウレタン・フォームのようなクッション材を、上下左右に均等に箱と機器のあいだに詰めます。箱をテープもしくは大型ホチキスでシールします。FG504型を梱包する箱はおよそ90kgの重量に耐えられる強度が必要です。

# THEORY OF OPERATION

## Introduction

The following is a description of the electrical circuits in the FG 504. Refer to the block diagram and the schematic diagrams on the foldout pages at the back of the manual to aid in the understanding of this description.

## Triangle Generator or Main Loop (Diagram 1)

This circuitry consists of a diode bridge, timing capacitors, positive and negative current sources, and the semiconductor switches necessary to generate the basic triangle waveform.

The current sources are controlled by the FREQUENCY Hz (START) and STOP controls, as well as the sweep, when operating in the swept frequency mode.

The calibration voltage for the FREQUENCY Hz (START) dial is supplied via operational amplifier U5B and potentiometer R145. On the highest MULTIPLIER setting ( $10^6$ ), R128 is switched into the circuit to improve the linearity of the FREQUENCY Hz (START) dial. This frequency control voltage is fed into operational amplifier U30A. When the FG 504 operates in the swept frequency mode, the sweep ramp is fed to operational amplifier U25B through STOP FREQ control R5 and buffer U5A. This control sets the maximum ramp voltage applied to the input of U25B. This action sets the maximum or upper limit in the swept frequency mode. The voltage controlled frequency input voltage, phase lock loop correction voltage, and the sweep ramp voltage, through the STOP FREQ dial, are summed at pin 6 of U25B. Operational amplifier U30B serves as a level shifter. These voltages and the voltage from the FREQUENCY Hz (START) dial are summed at pins 3 of U45 and U155. The voltage at pins 3 of U45 and U155 increases for a decrease in frequency and decreases for an increase in frequency. The output from U155 is fed to the base of Q165. The output from U45 controls positive current source transistor Q55.

The SYMMETRY control adjusts the current balance between the positive and negative current sources. The collector of Q165 connects to the base of Q175. A current mirror is formed by transistors Q170A, B, and Q175. The matched pair of transistors, Q170A and B, have equal emitter-to-base voltages. Therefore, their collector currents are equal. This ensures that the collector current of Q165 exactly matches the collector current of Q175.

To understand the operation of the triangle generator loop, assume that switch driver Q100 is conducting and Q90 is off. Current flows from the negative current source through CR180. Diodes CR182 and CR184 are back-biased with no current flowing. No current flows through CR190. Current from the positive current source flows through diodes CR188 and CR186, charging the timing capacitors. In the slowest five MULTIPLIER switch settings, a capacitance multiplier replaces the timing capacitors; switches S240-3 and 9 close and S240-16 opens. This capacitance multiplier consists of U215, Q230, Q225 and their associated resistors and capacitors. With switches S240-5, 6, and 7 closed, the positive timing current divides. Most of the current flows through R202, and the remaining current flows through R200, R204, and C210. One-tenth of the current flows through R200 and R204 to charge C210 because the combined resistance of R200 and R204 is ten times the resistance of R202. This has the effect of multiplying the value of C210 by a factor of ten. The multiplying factor is increased as additional resistances are added in series with C210. For this discussion, the voltage at pin 3 of U215 ramps up. The voltage between pins 2 and 3 of U215 remains at zero and the action of U215, Q225, and Q230 causes the current through R202 to remain constant.

The positive-going ramp is applied to the gate of fet Q255A. The other half of the fet buffer, Q255B, supplies constant current to Q255A. The ramp at the source of Q255A drives a set of two complementary Darlington amplifiers. Transistors Q270 and Q280 compose one set; Q285 and Q295 the other. The ramp output is taken from the emitters of Q280 and Q295.

The ramp is also fed to the base of Q310 to the negative input of comparator amplifier U375 through R322, and to the positive input of U375 through R336. The waveform at the emitter of Q310 serves to compensate the drive currents for high frequency components at the inputs of U375.

With the ramp rising in the positive direction, the voltage at pin 3 of U375 is about 0.4 V more positive than the voltage at pin 9. This makes U375 inoperative. As the ramp rises in the positive direction, pin 6 of U375 goes positive and pin 7 negative. Pin 7 of U375 connects to the base of switching transistor Q65 and pin 6 connects to the base of Q80. As the ramp continues in the positive direction, Q80 decreases conduction and Q65 increases



## Theory of Operation—FG 504 (SN B040000 & UP)

conduction until the pair switches. Pin 3 of U375 now goes from about  $-2.8$  V to about  $-3.2$  V and pin 9 goes to about  $-2.8$  V. This action disables the lower pair of transistors in U375 and enables the upper pair. When Q80 ceases conduction, Q90 comes into conduction and Q100 ceases conduction. Current now flows through Q90, diode CR190, and the positive current source, Q55. Bridge diodes CR188 and CR186 are back-biased. No current flows through CR180 as Q100 is off. Current from the negative current source now flows through diodes CR182 and CR184. This action charges the timing capacitors in the negative direction, causing a negative-going ramp at the output. As the ramp goes negative, the output of U375 at pin 14 gradually goes positive. Pin 13 of U375 gradually goes negative. When the ramp reaches a voltage sufficiently negative, Q65 turns off, Q80 comes into conduction, the positive current source is connected to the timing capacitors, and the previously described cycle repeats. The bases of emitter followers Q410 and Q395 are connected to the non-inverting outputs of U375. The outputs from these emitter followers drive the bases of common emitter amplifiers Q415 and Q406, which generate the TRIG OUT and synchronizing signals.

### Square Wave Generator

Switching transistor Q65 generates the square wave. When the ramp is rising in the positive direction, the collector of Q65 is in its most negative state. This signal is passed to the base of Q450. The emitter of Q450 drives the base of Q456. The emitter of Q456 drives Q462 and Q470. When Q456 is conducting, Q462 is off; Q470 is conducting with CR470 back-biased. Current flows through CR462 and the square wave moves in the positive direction. When the switching waveform changes state, Q462 comes into conduction, back-biasing CR462. The square wave now moves in the negative direction by current through CR470 as Q470 is not conducting.

### Variable Rise and Fall Circuitry (Diagram 2)

This circuitry consists of variable positive and negative sources, a current switch with integrating capacitors, and an output buffer. Transistor Q540 serves as the positive current source while Q580 serves as the negative current source. The rise and fall times are changed by varying the current through the constant current sources and by changing the values of the integrating capacitors.

The current available to charge the integrating capacitors, C592 through C598, is varied by switching R536, R538, R584, and R586 into the emitter circuit of Q540 and Q580 as necessary. The current is also varied by the VAR control through U530 and Q530. When the VAR control is in the calibrated position, the wiper is at the grounded end of the control. This action increases the current through the emitter resistances of the current source transistors. An increase in charging current for the integrating capacitors reduces the rise and fall times of the waveforms.

The current switch determines which current source is connected to the integrating capacitors. Transistors Q495, Q500, and Q510 form a clipping and speed-up circuit for the square wave coming from the Main Loop. When the square-wave driving this circuitry is negative with respect to ground, Q570 is conducting. Current from the negative current source passes through CR566, Q570, and VR570 to the  $+15$  V supply. Diodes CR562 and CR564 are back-biased, preventing current flow to the integrating capacitors. Transistor Q550 is off, causing current from the positive constant current source to pass through diodes CR558 and CR560. This current charges the integrating capacitor, causing the gate of fet Q600 to move at a controlled rate in the positive direction. In the FIXED position of the RISE and FALLTIME switch, the current switch and the integrating capacitors are bypassed through switch S590-7. Fet Q600 serves as a fet follower with Q610 supplying constant current. The source of Q600 drives the base of Q615, which forms a differential pair with Q620. Clipping takes place in this differential circuitry. A differentially driven amplifier, Q640, restores to the output signal the amplitude lost in the clipping process.

### Sine Shaper, Buffer, and Modulating Circuitry (Diagram 3)

This circuitry generates the sine wave from the basic triangle waveform by means of a four step approximation. The sine wave is also amplitude modulated, if desired, by this circuitry and buffered for delivery to the output amplifier.

The sine shaper consists of four diode bridges, CR745-CR748, CR750-CR753, CR755-CR758, and CR762-CR765. These bridges are connected between the  $+15$  V and  $-15$  V supplies. The voltages from the common anodes and cathodes of each bridge are equal in value. The resistance values for each bridge are, however, different from the other bridges. This causes equal positive and negative break points for an individual bridge, but different amplitude voltage break points for the different bridges. As the triangle voltage rises to  $+1$  V, it progressively exceeds the break point of each bridge. The non-linear characteristics of the diodes prevent sharp transitions at the break points. The opposite action occurs as the input triangle drives to  $-1$  V. The output currents from the bridges are summed at the input to U770, and the result is a close approximation of a pure sine wave.

The output from the sine shaper is fed into U770, a transconductance multiplier. This multiplier is used to amplitude modulate the sine wave. The output from the multiplier is taken at pins 8 and 9; the amplitude modulating signal inputs at pin 12. Gain adjustment R855 sets the sine wave gain for U770, and R870 shifts dc levels so that the sine wave is modulated equally in both positive and negative directions. Centering of the sine wave with respect to ground is accomplished with offset adjustment

R790. The differential output from the multiplier is applied to the input transistors Q825 and Q805 of the output buffer amplifier. This output amplifier provides gain as well as differential to single-ended output conversion. This is an operational amplifier. The collector of Q825 directly drives the base of output emitter follower Q830. The collector of Q805, with level shifting, drives the base of Q840. This transistor provides phase inversion. Its collector drives the base of emitter follower output transistor Q835. Feedback takes place through R822. The single-ended output goes to the function switch.

### Amplitude Modulating Input Circuitry

The amplitude modulating signal is applied to the input of operational amplifier U710. The output at pin 6 drives the transconductance multiplier and the base of Q720. This transistor drives the AM indicator lamp. With no modulating signal, the voltage at the output of U710 is about +15 V. The indicator lamp lights when the voltage is about +10 V and 100% modulation occurs when the voltage reaches about +5 V.

### Output Amplifier (Diagram 4)

This circuitry is an inverting operational amplifier. The input stage, driven by emitter followers Q906 and Q914, consists of pairs of differential amplifiers Q930 and Q940 complemented by Q1030 and Q1040. The configuration is such that for a positive-going input waveform, the collectors of Q930 and Q1030 both move in a negative direction. Under the same conditions, the collectors of Q940 and Q1040 both move in a positive direction. These pairs differentially drive transistor pairs Q950, Q952, Q1050, and Q1052 respectively. Voltage gain takes place in this stage. The output from pair Q950 and Q952 is taken at the collector of Q952, and for pair Q1050 and Q1052 at the collector of Q1052. For a negative-going input signal, the above mentioned collectors both move in a positive direction. Components R950, C950, C1050, R1050, C965 and R965 provide high frequency compensation and R1015 adjusts the dc balance for the entire amplifier.

The collector of Q952 drives the base of output emitter followers Q970 and Q980 while Q1052 drives Q1070 and Q1080. The feedback path is through R1090 and C1090 to the bases of Q930 and Q1030.

### Output Attenuator

The signal from the output amplifier is fed to the output attenuator circuitry. The variable amplitude control (R1100A and B), with resistors R1102 and R1104, form a bridged T attenuator with a maximum attenuation of approximately 20 dB. Thick film attenuator chips R1110, R1112, and R1114 provide a total of 50 dB of additional attenuation. These attenuators are compensated resistive dividers.

### Offset Circuitry

Output offset is adjusted by R1130, the OFFSET control. Should additional positive offset be desired, the OFFSET control is moved in the negative direction. This causes the output of U1145 to move in the negative direction. Through the action of Q1150 and Q1170, the bases of Q1160 and Q1180 move in a negative direction. This causes their common collector circuit to move in a positive direction, increasing current flow through R1122. The dc offset generated by the increased current flow is passed to the OUTPUT terminal through R1120 and L1120.

### Gating and Triggering Circuitry (Diagram 5)

In this circuitry, U1225B operates as an ECL line receiver. In the FREE RUN mode, the set input (pin 5) for D flip flop U1215A is connected to +5 V through CR1235. This places a high on the Q output at pin 2. This action lowers the combined collectors of Q1245 and Q1250 and reduces conduction in Q1254, turning Q1262 off and Q1260 on. No current flows through diodes CR1285 and CR1286. The triangle generator is now free to run. In the GATE mode of operation, the set input of U1215A is connected to the output of U1225B. When the input gate is high, the circuit functions as in the normal mode with Q1262 off and Q1260 on, allowing the triangle generator to run. When the input gate goes low, the next positive-going pulse at pin 6 (clock) from the triangle generator causes the Q terminal to go low. This action resets the flip flop for the next trigger. However, Q1262 does not conduct until the sync pulse at the base of Q1245 goes low at the peak of the triangle ramp. This action allows completion of the last cycle. With Q1262 on, the triangle generator is prevented from operating through CR1286. In the triggered mode, the output of the trigger shaper is connected to the clock input of U1215A. The triggering signal causes the clock terminal to go high. This transfers the level at the D input to the Q input. If the Q output is high (Q low), the triangle generator runs until a positive-going synchronizing signal, which occurs at the start of the up ramp, forces the Q output low. At the start of the down ramp, the synchronizing signal goes low, which causes Q1262 to conduct and turns Q1260 off. The triangle now ramps down until CR1286 comes into conduction. This point is determined by the setting of the phase control, which determines the voltage at the output of U25A and at the cathode of CR1285. The next positive-going trigger from U1225B causes pin 9 of U1215A to go positive. This transfers the high on the D input to the Q output, allowing the triangle generator to begin the next cycle.

### Phase Locked Loop Circuitry

This circuitry provides a dc output voltage proportional to the difference in frequency between an external triggering signal and a synchronizing signal from the voltage-controlled oscillator.

## Theory of Operation—FG 504 (SN B040000 & UP)

The trigger input signal is fed into inverter U1225B. This integrated circuit is an ECL line receiver. It is connected to operate as a Schmitt trigger for trigger shaping purposes. The inverted output is fed to the input of one of two D type flip flops (U1295B). The C input of the other D flip flop (U1295A) is connected to the sync signal from the oscillator. Both D inputs are always high. They are connected to +5 V through CR1312. On the positive-going transition of either, the sync signal for U1295A or the triggering signal for U1295B, the highs on the D inputs are transferred to the Q outputs. The Q outputs connect to the input of U1225A, which is also an ECL line receiver. The lows on the Q terminals create a high on pin 3 of U1225A, which is connected to the reset input of both flip flops. This action resets both flip flops. They are now ready to repeat the previously described cycle.

The Q outputs are connected through a low pass filter composed of R1324, R1320, and C1322 to the input of U1340. If the frequency of the synchronizing signal is higher than the triggering signal, the resulting current difference at the input of U1340 causes the output of U1340 to go negative. This action is reversed (+ input terminal positive) if the frequency of the triggering signal is lower than the sync signal. The phase control sets the voltage at the input of U1340 so that wide differences in frequency are within the capture range of the circuitry. The voltage at the output of U1340 adjusts the frequency of the voltage controlled oscillator to the triggering frequency. This voltage swings between  $\pm 12$  V.

### Sweep Circuitry (Diagram 6)

The sweep trigger is applied to pin 13 of U1225C. The TRIG LEVEL control adjusts the dc level at pin 13 of U1225C, an ECL line receiver. Protective diodes CR1370 and CR1372 are also connected to pin 13. When the voltage at pin 13 reaches about +3.5 V, pin 15 goes from about +3.5 V to about +4.0 V. This positive-going step is differentiated through C1392 to the base of Q1400. (The MAN TRIG button also creates a positive step at the base of Q1400.) Transistors Q1400 and Q1410 compose a Schmitt trigger. The base of Q1400 goes positive, causing the base of Q1410 to go negative. When operating in the TRIG SWEEP mode, the collector of Q1410 rises, turning Q1420 off. This action turns fet Q1430 off, allowing the integrator formed by U1445, Q1450, and their associated components to ramp up. The slope of the positive-going ramp is determined by the setting of the VAR control, the resistance in series with its wiper, and the value of the capacitor connected from pin 2 to the emitter of Q1450.

As the ramp rises, the voltage at pin 3 of U1470 also rises. When this voltage reaches the voltage at pin 2 of U1470, the output immediately switches positive. The positive step at the output of U1470 turns fet Q1430 on, discharging the timing capacitors and returning the sweep to the starting level. When pin 3 of U1470 goes lower than

pin 2, during the sweep fall, CR1470 turns on. This closes the positive feedback loop for U1470 and the output switches immediately to about  $-13$  V. If the sweep is running in the triggered mode, this negative transition is differentiated by C1394, which resets the Schmitt trigger circuit composed of Q1400 and Q1410. The cycle then repeats at the next trigger pulse. In the free running mode, when pin 6 of U1470 goes negative, Q1430 is turned off and the free running cycle repeats.

### Logarithmic Converter

In the bipolar transistor, the relationship between the collector current and the emitter-to-base voltage is precisely logarithmic over a wide current range.

The linear ramp is fed to pin 2 of U1480 through temperature compensating resistor RT1456. Operational amplifier U1480 is used as an attenuator (gain is considerably less than one) and as an inverter. Resistor RT1456 decreases in value with increasing temperature to compensate for the decreasing gain with temperature of U1495A. Transistors U1495A and B are on a common substrate so that their base-to-emitter voltages remain constant with temperature, assuming equal collector currents. The operation of this circuit can be easily understood if it is assumed pin 3 of U1490 is ground rather than returned to the output of U1480. Pin 3 of U1490 is actually connected to the output of U1480 to improve the temperature characteristics of the circuit without introducing significant error in the linear to logarithmic conversion.

As the ramp voltage at the base of U1495A changes linearly, the emitter voltage of U1495A changes through the action of U1490 to maintain a constant current through R1496. The linear emitter voltage change of U1495A drives the emitter of U1495B, causing the current drive for U1500 to become logarithmic. This logarithmic current is converted to a voltage change by U1500 and fed through the LOG LIN SWP switch to the frequency control circuitry. The output ramp changes from 0 V to 10 V. When operating in the STOP FREQ mode, the sweep output line connects to 10 V provided by U1495D and C operating as a simple voltage divider. This provides a fixed voltage to the stop frequency potentiometer and only the stop frequency is outputted.

### Power Supplies

There are five regulated power supplies: +5 V, +15 V,  $-15$  V, +25 V, and  $-25$  V. The  $-15$  V, +25 V, and  $-25$  V supplies reference to the +15 V supply. The +5 V supply obtains its unregulated voltage from the +11.5 V ac supply in the power module. The +5 V supply is series regulated by U1690 which contains its own internal reference and provides short circuit current limiting at approximately 750 mA.

**+15 V Supply.** The +15 V supply is series regulated and referenced to a 6.2 V zener connected in the emitter of Q1610. Potentiometer R1605 adjusts the +15 V output. Resistor R1602 provides a voltage correction feedback path. Should the load on the +15 V supply increase, the voltage at the base of Q1610 will drop slightly. This causes the base of Q1620 to go slightly positive, reducing conduction. The base of Q1622 now goes slightly negative, thus increasing conduction in the series pass transistor located in the power module. This supplies more current for the +15 V load and restores the voltage to the preset level. The power module supplies +33.5 V dc through rear interface contacts 12A and 12B for the operation of this supply. The 0.75  $\Omega$  resistor in the emitter circuit of the series pass transistor is for sensing an overload current. When enough current flows through this resistor to turn on Q1621, base drive to the series pass transistor is reduced. This sets an upper limit to the amount of current that can be drawn from this supply. If the +15 V supply is raised beyond about +19.5 V, for any reason, an scr crowbar circuit on the floating interface board shuts down all supplies except the +5 V.

**-15 V Supply.** The -15 V supply is referenced to the +15 V supply. Transistors Q1710 and Q1715 form a differential amplifier for this series regulating supply. Any change of output voltage level, due to a shift in load, is fed back to Q1710. Transistor Q1710 drives the series pass transistor through Q1720 and Q1722 so that the supply remains at -15 V over its range of current handling capability. The current sensing resistor for this supply is R1726. When the voltage across this resistor becomes high enough to turn on Q1721, base drive to the series pass transistor in the power module is reduced and the supply becomes current limited. Shutdown of the supply due to overvoltage, occurs at -18.7 V. The power module supplies -33.5 V dc through contacts 8A and 8B for this supply.

**+25 V Supply.** The two 25 V ac windings and the 17.5 V ac winding are each connected to full wave bridge rectifiers. The rectifier outputs are connected in series to provide approximately plus and minus 40 V. This dc output powers the +25 V and -25 V series regulator circuitry. Transistors Q1640 and Q1642 make up the differential amplifier for the +25 V supply. The +15 V reference is applied to the base of Q1640. The +25 V feedback for voltage sensing is connected through R1644 to the base of Q1642. The series pass transistor is driven by Q1642 through Q1650 and Q1660. The current limit sensing resistor is R1663. When the voltage across this resistor is high enough to turn on Q1652, base drive to the series pass transistor is reduced and current limiting occurs. If the output voltage drops approximately 27 V below the raw supply, VR1652 turns on Q1652, limiting the current. This is a foldback overload safety action. If the supply output voltage moves in a positive direction, the crowbar circuit Q1677, activates at +31.5 V disabling all positive supplies except the +5 V.

**-25 V Supply.** Transistors Q1742 and Q1740 form a differential amplifier for the -25 V supply. The -25 V is sensed through R1744 and referenced to the +15 V supply by R1742. The bases of the differential amplifier operate at a zero voltage level. Changes in the output level are amplified to drive Q1750 and Q1760 which control the power module series pass transistor. This provides -25 V supply regulation. Current limiting is achieved by the voltage drop across R1763. As the current increases beyond safe limits, Q1752 turns on, reducing drive to the series pass transistor. If the output voltage rises to approximately 27 V above the raw supply, VR1752 turns on Q1752, limiting the current. This provides foldback overload protection. Over voltage conditions occur at approximately -31.5 V when actuation of the crowbar circuit disables all negative supplies.

**+5 V Supply.** The +5 V dc is supplied from +11.5 V dc from the power module through regulator U1690. This regulator also provides short circuit limit at approximately 750 mA.

# CALIBRATION PROCEDURE

## PERFORMANCE CHECK PROCEDURE

### Introduction

The performance check procedure checks the electrical performance requirements listed in the Specification section in this manual. Perform the Adjustment procedure if the instrument fails to meet these checks. If recalibration does not correct the discrepancy, troubleshooting is indicated. This procedure may be used to determine acceptability of performance in an incoming inspection facility.

For convenience, many steps in the procedure check the performance of this instrument at only one value in the specified performance range. Performance requirements for various temperature ranges are listed in this procedure. When performing the procedure, use only the limits listed for the ambient temperature that the instrument is operating in.

### Calibration Interval

To ensure instrument accuracy, check the calibration every 2000 hours of operation or at a minimum of every six months if used infrequently.

### Services Available

Tektronix Inc. provides complete instrument repair and adjustment at local field service centers and at the factory service center. Contact your local Tektronix field office or representative for further information.

### Test Equipment Required

The following test equipment or equivalent is suggested to perform the Performance Check and Adjustment Procedure.

Table 4-1

TEST EQUIPMENT REQUIRED

Description	Performance Requirements	Applications	Example
Frequency Counter	150 Hz to 40 MHz Accuracy one part in $10^5$	Frequency measurements.	TEKTRONIX DC 504 <sup>a</sup>
Oscilloscope System	200 MHz bandpass (vertical) 1 mV/div at 60 Hz 5 mV/div to 5 V/div	Waveshape and amplitude measurements	TEKTRONIX 7704 TEKTRONIX 7A16A <sup>b</sup> TEKTRONIX 7A13 <sup>b</sup> TEKTRONIX 7B80 <sup>b</sup>
Power Module		All tests	Compartments for the FG 504 (2) and other TM 500-Series equipment used in this procedure.
Function Generator	Triangle, Sine, and Square wave output. 100 Hz to 10 MHz; 10 V p-p into 50 $\Omega$	Trigger signal and phase lock	TEKTRONIX FG 502 <sup>a</sup>
Digital Voltmeter	Ranges $\pm 25$ Vdc Accuracy $\pm 1\%$	Power supply measurements	TEKTRONIX DM 502 <sup>a</sup>
Power Supply	0—10 V	Sweep range	TEKTRONIX PS 501-1 <sup>a</sup>
Distortion Analyzer	20 Hz to 40 kHz 10 MHz	Sine wave and modulation distortion checks	HEWLETT PACKARD Model 334A

**Calibration Procedure—FG 504 (SN B040000 & UP)  
Performance Check**

**Table 4-1 (cont)**

Description	Performance Requirements	Applications	Example
Spectrum Analyzer (Optional)	1—40 MHz	Sine wave harmonic check	TEKTRONIX Model 7L12
10X probe	To match oscilloscope input.		TEKTRONIX P6106 Part No. 010-6106-01.
1X probes (2)	To match oscilloscope input		TEKTRONIX P6101 Part No. 010-6101-01.
50 Ω Termination	Bnc connectors		Tektronix Part No. 011-0049-01.
50 Ω Attenuator	10X, bnc connectors		Tektronix Part No. 011-0059-02.
Cable (3)	42", 50 Ω, bnc connectors		Tektronix Part No. 012-0057-01.
Adapter	Bnc female to bnc female		Tektronix Part No. 103-0028-00.
Extender Cables (2)	To match power module and FG 504 connectors		Tektronix Part No. 067-0645-02.

<sup>a</sup> Requires a TM 500-Series power module.

<sup>b</sup> Requires a TEKTRONIX 7000-Series Mainframe.



**Calibration Procedure—FG 504 (SN B040000 & UP)  
Performance Check**

**Preliminary Procedure**

1. Ensure that the correct nominal line selector block has been installed on the line selector pins on the power module interface board, and that the regulating range selected includes the applied line voltage. Refer to the Installation section of the power module manual.

2. Ensure that all test equipment is adapted to the applied line voltage.

3. Install the FG 504 into the power module and, if applicable, install the TM 500-Series test equipment into the test equipment power module.

4. Connect the equipment under test and the test equipment to a suitable line voltage source. Turn on all equipment and allow at least an hour for the equipment to stabilize.

b. Connect the OUTPUT connector through a 50 Ω coaxial cable and 50 Ω termination to the input of a frequency counter.

c. Check that the FG 504 output frequency as measured by the counter is 40 MHz ±6%.

d. Set the MULTIPLIER switch to 10<sup>5</sup> setting and check that the counter reads 4 MHz ±3%.

e. Check that the FREQUENCY Hz dial setting vs output frequency is within the specified accuracy at each of the remaining positions of the MULTIPLIER switch (±3% of full scale, .001 Hz to 4 MHz; ±6% of full scale, 4 MHz to 40 MHz).

f. Set the FREQUENCY Hz dial to 20 and check that the output frequency as indicated on the counter is within the specified accuracy on each range setting of the MULTIPLIER switch.

g. Set the FREQUENCY Hz dial to 1 and check that the output frequency as indicated on the counter is within the specified accuracy on each range setting of the MULTIPLIER switch.

**PROCEDURE**

**1. Dial Alignment, Accuracy, Resolution, and Frequency Range**

a. Set the FG 504 controls as follows:

HOLD/RUN pushbutton	Out
FREQUENCY Hz	
(START) dial	40
STOP dial	40
MULTIPLIER	10 <sup>6</sup>
FREQUENCY VERNIER	
(VAR)	Fully cw
TRIGGER—FREE RUN	
pushbutton	In
LEVEL control	Midrange
SWEEP pushbuttons	Out
Square-wave pushbutton	In
OFFSET control	Pushed in and midrange
PHASE control	Midrange
SWEEP DURATION	
rotary switch	OFF
VARIABLE	Fully ccw
RISE and FALL TIME	
switch	FIXED
VARIABLE	Fully ccw
ATTENUATOR (dB)	0
VARIABLE	Fully cw
TRIG LEVEL	Midrange
SYMMETRY	Pushed in and midrange

**2. Stability**

a. Set the FG 504 controls as follows:

HOLD/RUN pushbutton	Out
FREQUENCY Hz	
(START) dial	40
STOP dial	40
MULTIPLIER	10 <sup>3</sup>
FREQUENCY VERNIER	
(VAR)	Fully cw
TRIGGER/FREE RUN	
pushbutton	FREE RUN
LEVEL control	Midrange
SWEEP pushbuttons	Out
Waveshape pushbuttons	In
OFFSET control	In
PHASE control	Midrange
SWEEP DURATION	
switch	Off
VARIABLE	Fully cw
RISE and FALL TIME	
switch	FIXED
VARIABLE	Fully cw

## Calibration Procedure—FG 504 (SN B040000 & UP)

### Performance Check

ATTENUATOR (dB)	0 dB
VARIABLE	Fully cw
TRIG LEVEL	Midrange
SYMMETRY	Midrange

b. Connect the FG 504 output through a 50  $\Omega$  coaxial cable and a 50  $\Omega$  termination to the input of a frequency counter. Check that the output frequency of the FG 504 does not vary more than 0.05% in ten minutes and not more than 0.1% for one hour.

### 3. STOP FREQUENCY Dial Accuracy

a. Set the FG 504 controls as follows:

HOLD/RUN pushbutton	Out
FREQUENCY Hz	
(START) dial	20
STOP dial	40
MULTIPLIER	$10^3$
FREQUENCY VERNIER	
(VAR)	Fully cw
TRIGGER/FREE RUN	
pushbutton	FREE RUN
LEVEL control	Midrange
SWEEP pushbuttons	STOP FREQ in
Waveshape pushbuttons	Sine Wave in
OFFSET control	Pushed in
PHASE control	Midrange
SWEEP DURATION	
switch	10 s
VARIABLE	Fully ccw
RISE and FALL TIME	
switch	FIXED
VARIABLE	Fully ccw
ATTENUATOR (dB)	0
VARIABLE	Fully cw
TRIG LEVEL	Midrange
SYMMETRY	Pushed in and midrange

b. Connect the FG 504 OUTPUT through a 50  $\Omega$  cable and a 50  $\Omega$  termination to the input of a frequency counter. Check that the output frequency of the FG 504 is within 5% of the difference between the start and stop frequencies plus the FREQUENCY Hz (START) dial error.

### 4. Maximum Ranges for Sweep Frequency and VCF Modes

a. Set the FG 504 controls as follows:

HOLD/RUN pushbutton	RUN
FREQUENCY Hz	
(START) dial	40
STOP dial	40

MULTIPLIER	$10^6$
FREQUENCY VERNIER	
(VAR)	Fully cw
TRIGGER/FREE RUN	
pushbutton	FREE RUN
LEVEL control	Midrange
SWEEP pushbuttons	Out
Waveshape pushbuttons	Sine Wave In
OFFSET control	Midrange
PHASE control	Midrange
SWEEP DURATION	
switch	Off
VARIABLE	Fully ccw
RISE and FALL TIME	
switch	FIXED
VARIABLE	Fully ccw
ATTENUATOR (dB)	0 dB
VARIABLE	Fully cw
TRIG LEVEL	Midrange
SYMMETRY	Midrange

b. Connect the OUTPUT through a 50  $\Omega$  coaxial cable and a 50  $\Omega$  termination to the input of a frequency counter. Verify that the output frequency is over 40 MHz. Connect the output of the power supply to the VCF input and apply a negative voltage. Verify that the output frequency goes to less than 0.08 MHz before the applied voltage reaches  $-9.9$  V. Disconnect the power supply.

c. Set the FREQUENCY Hz (START) dial to the lowest frequency end of the dial. Set the MULTIPLIER to  $10^5$ . Using the FREQUENCY VERNIER, set the output frequency below 0.004 MHz. Set the SWEEP DURATION to 10 seconds, press the STOP FREQ button in and verify that the output frequency is equal to or over 4.0 MHz.

#### NOTE

*To verify the exact start and stop frequencies in the swept frequency mode, it will be necessary to use a spectrum analyzer.*

### 5. LINEAR SWEEP OUTPUT Amplitude Accuracy

a. Set the FG 504 controls as follows:

HOLD/RUN pushbutton	RUN
FREQUENCY Hz	
(START) dial	1.0
STOP dial	40
MULTIPLIER	$10^4$
FREQUENCY VERNIER	
(VAR)	Fully cw
TRIGGER/FREE RUN	
pushbutton	FREE RUN



**Calibration Procedure—FG 504 (SN B040000 & UP)**  
**Performance Check**

LEVEL control	Midrange
SWEEP pushbuttons	FREE RUN
Waveshape pushbuttons	Square wave
OFFSET control	Midrange
PHASE control	Midrange
SWEEP DURATION	
switch	0.1 ms
VARIABLE	Fully ccw
RISE and FALL TIME	
switch	FIXED
VARIABLE	Fully ccw
ATTENUATOR (dB)	0 dB
VARIABLE	Fully cw
TRIG LEVEL	Midrange
SYMMETRY	Midrange

ATTENUATOR (dB)	0
VARIABLE	Fully cw
TRIG LEVEL	Midrange
SYMMETRY	Midrange

b. Connect an unterminated coaxial cable from the LIN SWEEP OUTPUT jack to the oscilloscope vertical input. Verify that the output signal varies from 0 V to 10 V  $\pm 5\%$  from 100 seconds to 1 ms and  $\pm 10\%$  from 1 ms to 0.1 ms.

b. Connect the output of the FG 504 to the dc coupled vertical input of the oscilloscope through a 50  $\Omega$  unterminated cable. Check that the output is at least 30 V p-p on all MULTIPLIER ranges. Verify that the ATTENUATOR VARIABLE control will reduce the output to 3.0 V p-p. Return the VARIABLE control to fully cw. Connect a 50  $\Omega$  termination at the scope end of the 50  $\Omega$  output cable. Verify that the output amplitude varies less than  $\pm 6\%$  on all ranges for all three wave shapes. Verify that the output amplitude varies less than  $\pm 11\%$  from 40 kHz to 40 MHz ( $\pm 1$  dB). Verify that the three wave shapes have the same amplitudes,  $\pm 0.5$  dB at 10 kHz. Set the ATTENUATOR to each step and verify that the accuracy at each step is within  $\pm 0.5$  dB per decade. Remove the 550  $\Omega$  termination. With the ATTENUATOR at  $-50$  dB, pull out the OFFSET control and vary it from one end of rotation to the other. Verify that the output changes from  $+7.5$  V to  $-7.5$  V with the output unterminated.

c. Press the TRIG SWP button in. Check for one sweep each time the MAN button is pressed. Connect a 100 Hz sine wave signal from the function generator to the SWEEP TRIG INPUT jack and adjust the output signal to 1 V p-p. Verify that the FG 504 sweep generator can be triggered on this waveform by adjusting the TRIG LEVEL knob.

**6. Output Amplitude, Flatness, Offset, and Attenuator Accuracy**

a. Set the FG 504 controls as follows:

HOLD/RUN pushbutton	RUN
FREQUENCY Hz	
(START) dial	10
STOP dial	40
MULTIPLIER	$10^5$
FREQUENCY VERNIER	
(VAR)	Fully cw
TRIGGER/FREE RUN	
pushbutton	FREE RUN
LEVEL control	Midrange
SWEEP pushbuttons	Out
Waveshape pushbuttons	Square Wave
OFFSET control	Midrange
PHASE control	Midrange
SWEEP DURATION	
switch	OFF
VARIABLE	Fully ccw
RISE and FALL TIME	
switch	FIXED
VARIABLE	Fully ccw

**7. Output Waveforms (Triangle Symmetry, Sine Wave Distortion, Square Wave Rise and Fall Time)**

a. Set the FG 504 controls as follows:

HOLD/RUN pushbutton	RUN
FREQUENCY Hz	
(START) dial	10
STOP dial	40
MULTIPLIER	$10^4$
FREQUENCY VERNIER	
(VAR)	Fully cw
TRIGGER/FREE RUN	
pushbutton	FREE RUN
LEVEL control	Midrange
SWEEP pushbuttons	Out
Waveshape pushbuttons	Triangle In
OFFSET control	Midrange
PHASE control	Midrange
SWEEP DURATION	
switch	OFF
VARIABLE	Fully cw
RISE and FALL TIME	
switch	FIXED
VARIABLE	Fully ccw
ATTENUATOR (dB)	0 dB
VARIABLE	Fully cw
TRIG LEVEL	Midrange
SYMMETRY	Midrange

b. Set the oscilloscope controls to display two cycles of the waveform across the graticule. Using the delayed

## Calibration Procedure—FG 504 (SN B040000 & UP)

### Performance Check

sweep, measure the time difference between a positive peak and the next negative peak of the waveform. Next measure the time difference between the negative peak and the next positive peak ( $\pm 1\%$ ).

c. Push in the sine wave button. Connect the output through a 50  $\Omega$  cable and a 50  $\Omega$  termination to the sine wave distortion analyzer. Verify that the sine wave distortion is 0.5% or less. Remove the 50  $\Omega$  termination and move the cable from the scope input and connect it to the input of the spectrum analyzer. Set the MULTIPLIER to  $10^5$  and verify that the greatest harmonic is at least 30 dB down from the fundamental.

d. Press the square wave button in. Move the output cable from the spectrum analyzer, add a 50  $\Omega$  termination, and connect it to the vertical input of the oscilloscope. Set the MULTIPLIER switch to  $10^4$ . Set the oscilloscope controls as required and verify the rise and fall times of the square wave. (Accuracy within  $\pm 30\%$  of indicated time with Variable control fully ccw, 10% to 90% of the displayed waveform.) Verify that the aberrations on the waveform do not exceed 5% +30 mV. Change the RISE and FALL TIME switch to 10 ns and verify that the VARIABLE control has a ten to one range (10 ns to 100 ns).

### 8. AM Modulation and Distortion

a. Set the FG 504 controls as follows:

HOLD/RUN pushbutton	RUN
FREQUENCY Hz	
(START) dial	20
STOP dial	40
MULTIPLIER	$10^5$
FREQUENCY VERNIER	
(VAR)	Fully cw
TRIGGER/FREE RUN	
pushbutton	FREE RUN
LEVEL control	Midrange
SWEEP pushbuttons	Out
Waveshape pushbuttons	Sine Wave In
OFFSET control	Midrange
PHASE control	Midrange
SWEEP DURATION	
switch	Off
VARIABLE	Fully ccw
RISE and FALL TIME	
switch	FIXED
VARIABLE	Fully ccw
ATTENUATOR (dB)	0 dB
VARIABLE	Fully cw
TRIG LEVEL	Midrange
SYMMETRY	Midrange

b. Connect a 1 kHz, 5 V p-p sine wave from a function generator through a 50  $\Omega$  cable terminated in 50  $\Omega$  to the

FG 504 AM INPUT. Reduce the FG 504 output to 70% modulation. Connect the FG 504 output to the AM input of the distortion analyzer. The distortion should be 5% or less.

### 9. TRIGgered, GATEd, and PHASE LOCK Operation

a. Set the FG 504 controls as follows:

HOLD/RUN pushbutton	RUN
FREQUENCY Hz	
(START) dial	20
STOP dial	40
MULTIPLIER	$10^2$
FREQUENCY VERNIER	
(VAR)	Fully cw
TRIGGER/FREE RUN	
pushbutton	TRIGGER In
LEVEL control	Adjust for Triggered operation
SWEEP pushbuttons	Out
Waveshape pushbuttons	Sine wave
OFFSET control	Midrange
PHASE control	Midrange
SWEEP DURATION	
switch	Off
VARIABLE	Fully cw
RISE and FALL TIME	
switch	FIXED
VARIABLE	Fully ccw
ATTENUATOR (dB)	0 dB
VARIABLE	Fully cw
TRIG LEVEL	Midrange
SYMMETRY	Midrange

b. Connect the OUTPUT from the FG 504 through a 50  $\Omega$  coaxial cable to the vertical input of the oscilloscope. Connect a 1 V p-p 200 Hz sine wave to the TRIGGER section INPUT of the FG 504. Adjust the LEVEL control for a triggered output from the FG 504. Rotate the FG 504 LEVEL control clockwise to the MANUAL position. Verify that the FG 504 puts out one cycle of signal each time the MANUAL button is pressed.

c. Press the GATE button in. Verify that the FG 504 puts out a continuous signal when the MANUAL button is pushed. Rotate the LEVEL control counterclockwise until the FG 504 output signal is gated on and off at the 200 Hz rate.

d. Press the PHASE LOCK button in. Set the FREQUENCY Hz START knob to 20. Set the MULTIPLIER knob to  $10^3$ . Set the external signal generator to 20 kHz at 1 V p-p. Set the PHASE control to midrange and adjust the LEVEL control for a phase locked signal. Vary the

incoming signal from 10 to 30 kHz and verify that the signal from the FG 504 locks with the incoming signal over the entire range.

### 10. TRIGGER OUTPUT and HOLD Operation

a. Set the FG 504 controls as follows:

HOLD/RUN pushbutton	RUN
FREQUENCY Hz	
(START) dial	10
STOP dial	40
MULTIPLIER	10 <sup>2</sup>
FREQUENCY VERNIER	
(VAR)	Fully cw
TRIGGER/FREE RUN	
pushbutton	FREE RUN
LEVEL control	Midrange
SWEEP pushbuttons	Out
Waveshape pushbuttons	Sine wave
OFFSET control	Midrange
PHASE control	Midrange
SWEEP DURATION	

### Calibration Procedure—FG 504 (SN B040000 & UP) Performance Check

switch	Off
VARIABLE	Fully ccw
RISE and FALL TIME	
switch	FIXED
VARIABLE	Fully ccw
ATTENUATOR (dB)	0 dB
VARIABLE	Fully cw
TRIG LEVEL	Midrange
SYMMETRY	Midrange

b. Connect the TRIGGER OUTPUT through an unterminated cable to the vertical input of the oscilloscope. Verify that the signal varies from 0 V to 2.0 V or more.

c. Disconnect the 50 Ω cable from the TRIGGER OUTPUT and connect it to the OUTPUT connector. Set the MULTIPLIER switch to 10<sup>-2</sup>. When the output waveform reaches a maximum positive or negative peak, push in the HOLD button and note that the output signal stops at that point. Verify that the output voltage drifts less than 10% of the "stopped" voltage amplitude in one hour.

# ADJUSTMENT PROCEDURE

## Introduction

Use this Adjustment Procedure to restore the FG 504 to original performance requirements. This Adjustment Procedure need not be performed unless the instrument fails to meet the Performance Requirements of the electrical characteristics listed in the Specification section, or if the Performance Check procedure cannot be completed satisfactorily. If the instrument has undergone repairs, the Adjustment Procedure is recommended.

Satisfactory completion of all adjustment steps in this procedure ensures that the instrument will meet the Performance Requirements.

## Test Equipment Required

The test equipment (or equivalent) listed in Table 4-1 is required for adjustment of the FG 504. Specifications given for the test equipment are the minimum necessary for accurate adjustment. All test equipment is assumed to be correctly calibrated and operating within specifications.

If other test equipment is substituted, calibration setup may need to be altered to meet the requirements of the equipment used.

## ADJUSTMENT PROCEDURE

### Preparation

Disconnect the Power Module from the power input source. For access to all adjustments, connect the FG 504 through extender cables to a TM 500-Series power module (TM 503 or larger). Extender cable connectors must be oriented with the top of one connector toward the top of the FG 504 and the top of the other connector toward the top of the power module (do not attempt to operate the FG 504 with only one extender cable).

### NOTE

*One end of R14 should be disconnected from the circuitry to prevent jitter at low frequencies when the FG 504 is operated with extender cables.*

Install all required TM 500-Series test equipment in power modules. Connect power modules and other powered test equipment to an appropriate power input source; turn them on and allow at least 30 minutes warmup before starting the adjustment procedure. All adjustments must be made at an ambient temperature between +20°C and +30°C.

## Adjustment Locations

Refer to adjustment locations pullout in this manual for location of all adjustable components and test points mentioned in this procedure. Adjustable components are located at the top and both sides of the FG 504.

## Preliminary Control Settings

FREQUENCY Hz (START)	1
STOP FREQ	40
HOLD/RUN	HOLD (in)
MULTIPLIER	10
FREQUENCY VERNIER	Fully cw
TRIGGER	
FREE RUN	Out
TRIG	Out
GATE	Out
ΦLOCK	Out
MAN	Out
LEVEL	Midrange
STOP FREQ/SWEEP	SWEEP (out)
LOG SWP/LIN SWP	LIN SWP (out)
TRIG SWP/FREE RUN	TRIG SWP (out)
Square wave pushbutton	Off (out)
Triangle pushbutton	Off (out)
Sine wave pushbutton	Off (out)
OFFSET (PULL)	Off (in)
PHASE	Midrange
SWEEP DURATION	OFF
VAR	Fully ccw
RISE AND FALL TIME	FIXED ≤6 ns
VAR	Fully ccw
ATTENUATOR (dB)	0 dB
VAR	Fully cw
MAN TRIG	Out
TRIG LEVEL	Midrange
SYMMETRY (PULL)	Pushed in, variable at midrange

**Procedure**

**NOTE**

In the following procedure, the test oscilloscope vertical input requirements will be identified as *Differential* or *just Input*. *Differential* indicates a system providing differential operation with at least 1 mV/div sensitivity. When a test oscilloscope is mentioned, use a 60 MHz (or greater) system with 5 mV to 5 V/div sensitivity (200 MHz for steps 12 and 14).

**1. Set +15 V Supply (R1605)**

Set the digital voltmeter range to 20 Vdc. Connect the low level test lead to the ground test point on the A1 MAIN board. Connect the high input test lead to the +15 V test point on the A1 MAIN board. Check for a reading of +15 V ±30 mV. If outside of tolerance, adjust R1605 (+15 V Adj) for correct reading.

**NOTE**

If R1605 (step 1) or R1705 (step 2) settings require adjustment, the entire adjustment procedure must be performed.

**2. Set -15 V Supply (R1705)**

Move the high input test lead to the -15 V test point on the A1 MAIN board. Check for a reading within ±10 mV of the absolute value of the +15 V supply reading in step 1. If reading is out of tolerance, adjust R1705 (-15 V Adj).

**3. Check Power Supply Voltages**

Move the high input test lead to the test points on the A1 MAIN board and set the voltmeter range switch as necessary while measuring the following supplies for listed tolerance limits:

Supply	Tolerance
+25 V	±0.5 V
-25 V	+0.5 V, -1.5 V
+5 V	±0.2 V

**4. Check Power Supply Ripple and Noise**

Set the Differential oscilloscope Trigger to Line, Vertical Input Coupling to ac, and Vertical Sensitivity as required. Connect a 1X probe to each differential input. Connect the - (minus) input probe tip to the FG 504 chassis ground. Connect the + input probe tip to the appropriate test points on the A1 MAIN board. Check ripple and noise according to the following table.

**Supply**

**Adjustment Procedure**

**Tolerance**

+15 V	Less than 500 μV p-p
-15 V	Less than 500 μV p-p
+25 V	Less than 5 mV p-p
-25 V	Less than 5 mV p-p
+5 V	Less than 100 mV p-p

Disconnect the probes.

**5. Adjust Triangle DC Level (R360)**

Set the oscilloscope vertical input coupling to dc, volts/div to 20 mV, variable volts/div as required, time base to 0.5 ms/div, trigger source to external, and trigger mode to auto. Connect a 10X probe to the oscilloscope vertical input, the probe ground clip to the FG 504 chassis ground and the probe tip to TP1 on the FG 504 A3 LOOP board. Connect a 50 Ω coaxial cable from the FG 504 TRIG OUTPUT to the oscilloscope external trigger input connector. Push the TRIGGER FREE RUN and triangle pushbuttons in. Release the HOLD/RUN button to RUN (out) and set the MULTIPLIER to 10<sup>3</sup>. Adjust the oscilloscope for an externally triggered 6-division display. Set the oscilloscope vertical input coupling to ground and position the trace vertically to the exact graticule center. Set the vertical input coupling to dc and adjust R360 (Triangle dc Level) on the A3 LOOP board for triangle peaks equally spaced above and below graticule center. Disconnect the 10X probe.

**6. Adjust Top Dial Waveform Symmetry (R52)**

Connect a 50 Ω coaxial cable from the FG 504 OUTPUT terminal to a 50 Ω termination connected to the oscilloscope vertical input. Change the following FG 504 control settings: Push the square wave pushbutton in and set the FREQUENCY Hz (START) dial to 40 (40 kHz square wave). Set the oscilloscope vertical for a 5 V/div display; set time/div, variable, and triggering (source to Internal; level as required) so the negative-going half-cycle of the square wave just fills the graticule area horizontally. Switch the oscilloscope trigger slope from + to - while adjusting R52 (Top Dial Sym Cal) on the A3 LOOP board so the halves of the square wave are exactly equal in time (R52 only affects the positive half). Set the oscilloscope trigger slope to +.

**7. Adjust Minimum Dial Waveform Symmetry (R155)**

Change the FG 504 FREQUENCY Hz (START) dial setting to a position approximately half way between a .1 and 1 on the dial and set the MULTIPLIER to 10<sup>4</sup>. Adjust the oscilloscope sweep speed so the positive half of the waveform cycle just fills the graticule horizontally. Switch the oscilloscope trigger slope from + to - while adjusting R155 (Min Dial Sym Cal) on the A3 LOOP board so the halves of the square wave are exactly equal in time (R155 only affects the negative half of the waveform).

## Calibration Procedure—FG 504 (SN B040000 & UP)

### Adjustment Procedure

#### 8. Adjust Low Dial Waveform Symmetry (R215)

Set the FG 504 FREQUENCY Hz (START) dial to 1 and the MULTIPLIER to 10. Set the oscilloscope for dc coupled normal triggering and adjust sweep speed and trigger level so one waveform cycle just fills the graticule horizontally. Adjust R215 (LF Sym Cal) on the A3 LOOP board so that the halves of the square wave are exactly equal in time. Disconnect the 50  $\Omega$  cables and termination from the FG 504 and oscilloscope.

#### 9. Check Dial Calibration (R115, R145) and Adjust Mechanical Alignment

a. Connect the FG 504 TRIG OUTPUT through a 50  $\Omega$  coaxial cable to a 50  $\Omega$  termination at the frequency counter input. Set the FG 504 MULTIPLIER to  $10^3$  and the FREQUENCY Hz (START) dial to .1 (fully cw). Adjust R115 (Min Dial Cal) on A3 LOOP board for a reading of 150 Hz to 200 Hz on the counter. Set the FREQUENCY Hz (START) dial to 40 and adjust R145 (X40 Cal) on A3 LOOP board for a counter display of 40.0 kHz. Set the FREQUENCY Hz (START) dial to 1; the counter display should be 1.0 kHz. If the reading is correct, skip part b and proceed to part c; if not correct, perform part b.



*The mechanical dial adjustment in part b must be performed with the instrument operating. Exercise caution to avoid shorting out circuitry with Allen wrench or pliers.*

b. Mechanical dial adjustment: Use a 1/16" Allen wrench to loosen set screws on the dial coupling behind the front panel. Use long nose pliers to rotate R125 potentiometer shaft until the counter reads 1.00 kHz. With the FREQUENCY Hz (START) dial set to 1, tighten the coupling set screws.

c. Set the FREQUENCY Hz (START) dial to 30 and check that STOP FREQ dial will rotate fully ccw and stop with the index mark aligned with the index mark on the panel. If alignment is correct, proceed to part e; if not correct, perform part d.

d. Use a 0.050" Allen wrench to loosen the STOP FREQ knob set screws, then remove the knob. Turn the potentiometer shaft to the ccw end and re-install the STOP FREQ knob so index mark is aligned with front panel index mark. Tighten the set screws.

e. Set the STOP FREQ dial fully ccw and check that it stops with its index mark within approximately 5 degrees of 40 on the FREQUENCY Hz (START) dial.

f. Repeat step 9, parts a through e, as necessary for correct dial calibration. Disconnect the 50  $\Omega$  cable and termination from the FG 504 and counter.

#### 10. Adjust Residual Offset (R1140)

Set the FG 504 ATTENUATOR (dB) to  $-50$  dB. Set all front panel pushbuttons to the OUT position. Connect the FG 504 OUTPUT through a 50  $\Omega$  unterminated coaxial cable to either the oscilloscope vertical input or digital voltmeter input. Adjust R1140 (Offset Balance) on A1 MAIN board for a reading of zero volts  $\pm 100$  mV on the oscilloscope or voltmeter.

#### 11. Adjust Zero Input Offset (R1015)

Set the FG 504 ATTENUATOR (dB) to the 0 dB position. Adjust R1015 (Input Offset) on the A1 MAIN board for a reading of 0 V  $\pm 100$  mV on the oscilloscope or voltmeter. Disconnect the 50  $\Omega$  cable.

#### 12. Adjust Output Impedance (C1092)

Push the FG 504 square-wave pushbutton and the TRIGGER FREE RUN pushbutton in. Set the MULTIPLIER to  $10^5$  and the FREQUENCY Hz (START) dial to 40. Connect two unterminated 42-inch 50  $\Omega$  coaxial cables in series with a female-to-female bnc adapter; connect one end to the FG 504 OUTPUT and the other end to the oscilloscope vertical input. Adjust the oscilloscope vertical sensitivity, triggering (Mode to Auto) and sweep speed to display at least one complete square wave cycle approximately 6-divisions in amplitude. Adjust C1092 (Output Impedance) on the A1 MAIN board for minimum reflected aberration behind the rising and falling edges of the square wave. Disconnect the 50  $\Omega$  cables from the FG 504 OUTPUT and oscilloscope vertical input.

#### 13. Adjust Square Wave Amplitude and DC Level (R630, R641)

Connect the FG 504 OUTPUT through a 50  $\Omega$  coaxial cable to a 50  $\Omega$  termination at the oscilloscope vertical input. Set the MULTIPLIER to  $10^2$ . Adjust the oscilloscope vertical sensitivity, triggering, and sweep speed to display at least one cycle of the square wave at a calibrated 2 V/div amplitude. Adjust R630 (Sq Wave Ampl Adj) on the A1 MAIN board for a peak-to-peak amplitude of 15 V to 15.9 V. Set the oscilloscope vertical input coupling to ground and center the trace vertically. Return vertical input coupling to dc, and adjust R641 (Sq Wave Offset Adj) on the A1 MAIN board for square wave positive and negative peaks equally spaced above and below the graticule center. Disconnect the 50  $\Omega$  cable and termination from the FG 504 and oscilloscope.

#### 14. Adjust Output Amplifier Response (C922, C1090, R950, R1050)

Connect the FG 504 OUTPUT through a 50  $\Omega$  coaxial cable to a 50  $\Omega$  termination at the vertical input of the oscilloscope.

Set the FG 504 MULTIPLIER to  $10^5$ . Adjust the oscilloscope vertical sensitivity and sweep speed to display one or more complete cycles of the square wave at about 6-division amplitude. Adjust triggering to view the leading edge of the positive-going slope. Adjust C922 (Sq Comp Long Term) on the A1 MAIN board for optimum square corner in the first 100 ns from the rising and falling edges. Adjust C1090 (Sq Comp Short Term) on the A1 MAIN board for optimum square corner with aberrations less than 5% over the first 20 ns from the rising and falling edges. Adjust R950 (Sq Comp Leading Edge) on the A1 MAIN board for minimum rise time, optimum square corner, and minimum aberrations over the first 20 ns from the leading edge. Adjust R1050 (Sq Comp Trailing Edge) on the A1 MAIN board for minimum fall time, optimum square corner, and minimum aberrations over the first 20 ns from the trailing edge. Check that rise time and fall time of the square wave is equal to or less than 6 ns. Repeat step 14 as necessary to achieve minimum aberrations (equal or less than 5% +30 mV) and rise time of equal or less than 6 ns.

#### 15. Adjust Amplitude Flatness (R365, C325, C340)

Set FG 504 controls as follows:

SWEEP DURATION	1 ms
VAR	Fully ccw
Triangle pushbutton	In
FREQUENCY Hz (START)	1
STOP FREQ	40
MULTIPLIER	$10^3$
FREQUENCY VERNIER	Fully cw
RISE and FALL TIME	FIXED $\leq 6$ ns
VAR	Fully ccw
ATTENUATOR (dB)	0 dB
VAR	cw
TRIGGER	
FREE RUN	In
All other buttons	Out

Connect a 50  $\Omega$  coaxial cable from the FG 504 LINEAR SWEEP OUTPUT to the oscilloscope external trigger input. Set the time base sweep speed to 0.2 ms per division and trigger externally on the negative slope of the waveform. Adjust the oscilloscope vertical sensitivity for a 6-division display. Set the FG 504 MULTIPLIER to  $10^6$ . Adjust the SWEEP DURATION VARIABLE so only one envelope is visible across the entire horizontal graticule. Vertically center the left side of this envelope. Adjust R365 (HF Loop DC Level) on the A3 LOOP board so that the

#### Calibration Procedure—FG504 (SN B040000 & UP)

##### Adjustment Procedure

right side of the envelope is also vertically centered on the graticule. Adjust C325 and C340 (HF Loop Comp) on the A3 LOOP board so that the rest of the waveform is approximately symmetrical around the center horizontal graticule line with minimum amplitude in the center. (See Figure 4-1.) Considerable interaction exists between C325 and C340. Readjust as necessary to obtain the best symmetry and amplitude flatness. Check that the peak-to-peak amplitude of the envelope is between 4.5 divisions and 7.5 divisions at all points on the waveform. Set the FG 504 SWEEP DURATION to off.

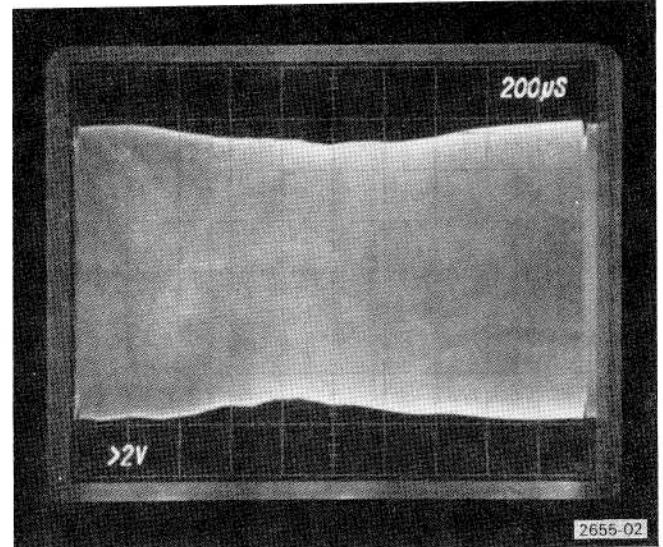

Fig. 4-1. Amplitude flatness check.

#### 16. Adjust Sine Flatness (C857)

Push the sine-wave pushbutton in. Set the FREQUENCY Hz (START) dial to 40. Adjust C857 (Sine Flatness) on the A2 FUNCTION board for a 5.5 division sine-wave amplitude. Disconnect the 50  $\Omega$  cables and termination.

#### 17. Adjust Top Dial Calibration (R145)

Set the FG 504 MULTIPLIER to  $10^3$ . Set the FREQUENCY Hz (START) dial to exactly 40. Connect TRIG OUTPUT through a coaxial cable and 50  $\Omega$  termination to a frequency counter. Adjust R145 (X40 Cal) on the A3 LOOP board for a reading of 40 kHz within  $\pm 3\%$  ( $\pm 1.2$  kHz). Change the MULTIPLIER setting to  $10^4$  and check for a reading of 400 kHz within  $\pm 3\%$  ( $\pm 12$  kHz).

#### 18. Adjust $10^6$ Range Timing (C195)

Change the MULTIPLIER to  $10^6$ . Adjust C195 (40 MHz Cal) on the A3 LOOP board for a readout of  $\geq 40$  MHz in all three functions—square, triangle, and sine wave.

**Calibration Procedure—FG 504 (SN B040000 & UP)  
Adjustment Procedure**

**19. Adjust  $10^5$  Range Timing (C242)**

Change the FG 504 MULTIPLIER setting to  $10^5$ . Adjust C242 (4 MHz Cal) on the A3 LOOP board for a readout of 4 MHz within 3% ( $\pm 120$  kHz).

**20. Adjust 20 MHz Timing (R128)**

Set the FREQUENCY Hz (START) dial to exactly 20. Set the MULTIPLIER to  $10^6$ . Adjust R128 (20 MHz Cal) on the A3 LOOP board for a frequency of 20 MHz within specification limits (17.6 MHz to 22.4 MHz) for all three functions—square, triangle, and sinewave). NOTE: 20 MHz Cal will interact with 40 MHz Cal.

**21. Check and Adjust High Frequency Dial Tracking (R128, C195, C325, C340)**

Check that the output frequency from 4 MHz to 40 MHz is within specification limits for all three function waveforms. If dial tracking is not within specification limits, it may be necessary to slightly readjust R128 (20 MHz Cal), C195 (40 MHz Cal), and C325 and C340 (HF Loop Comp) to achieve proper dial accuracy. Optimum tracking will result if C325 and C340 (HF Loop Comp) adjustments are performed so as to maintain symmetrical amplitude flatness around the graticule vertical center line. Repeat step 15 and check that amplitude flatness is within specification limits. If necessary, repeat steps 15 through 21.

**22. Adjust Stop Frequency Dial Range (R10)**

With the FG 504 MULTIPLIER at  $10^6$ , push the STOP FREQ/SWEEP button in to STOP FREQ mode. Set SWEEP DURATION to 10 s and FREQUENCY Hz (START) dial to 1. Rotate the STOP FREQ dial so that the index mark points to 40 on the FREQUENCY Hz (START) dial. Change the MULTIPLIER setting to  $10^3$  and adjust R10 (Stop Freq Cal) on the A3 LOOP board for a frequency of 40 kHz. Disconnect termination and cable from frequency counter and FG 504.

**23. Adjust Linear and Logarithmic Sweep Amplitude (R1460, R1475)**

Set the oscilloscope time base for 2 ms/division, trigger source to internal, and the vertical for dc coupled .2 V/division sensitivity. Connect a 10X probe to the oscilloscope vertical input, the probe ground clip to the FG 504 chassis, and connect the probe tip to P1500 pin 1 Ramp on the A2 FUNCTION board. Change the FG 504 SWEEP DURATION setting to 10 ms. Record the voltage level displayed on the oscilloscope. Release the FG 504 STOP FREQ/SWEEP button out to the SWEEP mode, and adjust R1460 (Ramp Peak) on the A2 FUNCTION board for a display voltage level at the peak of the ramp equal to the previously recorded voltage. Push the FG 504 LOG

SWP/LIN button in to the LOG SWP mode, and adjust R1475 (Log Peak) on the A2 FUNCTION board so the peak of the logarithmic ramp is at the same amplitude as the originally recorded voltage. Set SWEEP DURATION to OFF.

**24. Adjust Rise and Fall Time Symmetry (R610)**

Connect the FG 504 OUTPUT through a 50  $\Omega$  cable and a 50  $\Omega$  termination to the oscilloscope vertical input. Push the square wave pushbutton in. Set the MULTIPLIER to  $10^4$ , FREQUENCY Hz (START) dial to 10, RISE AND FALL TIME to .1  $\mu$ s, and VAR RISE AND FALL TIME control fully cw. Obtain a waveform display of one complete cycle centered vertically and horizontally on the graticule. Adjust R610 (Rise and Fall Sym) on the A1 MAIN board so that the top and bottom of the waveform are equal in duration.

**25. Adjust AM Balance (R870)**

Connect a 1 kHz triangle waveform of +2.5 V and -2.5 V (5 V p-p) amplitude (produced from a generator external to the FG 504) through a 50  $\Omega$  cable to the AM INPUT connector on the FG 504. Connect a 50  $\Omega$  cable from the trigger output connector on the triangle generator to the external trigger input on the oscilloscope and set the oscilloscope for external triggering. Push the FG 504 sine wave pushbutton in. Set the FREQUENCY Hz (START) dial to 30. Adjust the oscilloscope time base to display several cycles of the modulation envelope. Adjust the external triangle generator dc offset and amplitude controls for a display with 100% modulation level, 1 ms/division modulation rate, and about 10 to 16 V p-p amplitude with no clipping of peaks. Vertically center the waveform envelope valleys to graticule center. Adjust R870 (AM Bal) on the A2 FUNCTION board so the positive and negative peaks of the envelope are equally spaced from the valleys of the waveform envelope. Disconnect the 50  $\Omega$  cables from the triangle generator to the FG 504 and test oscilloscope external trigger input connector. Set the oscilloscope for internal triggering.

**26. Adjust Sine Offset (R790)**

Set the FG 504 MULTIPLIER to  $10^3$ , and FREQUENCY Hz (START) dial to 10. Push the triangle pushbutton in. Adjust the oscilloscope vertical sensitivity for approximately 8 divisions of display, and adjust the time base sweep speed for about 5 cycles of triangle waveform. Set the oscilloscope vertical input coupling to ground and center the trace vertically. Return the input coupling to the dc position. Push the sine wave pushbutton in. Adjust R790 (Sine Offset) on the A2 FUNCTION board so the sine wave peaks are symmetrical above and below the 0 V (center) oscilloscope graticule line.



**Adjustment Procedure**

**27. Adjust Sine Gain (R855)**

Adjust R855 (Sine Gain) on the A2 FUNCTION board so the sine wave amplitude exactly matches the triangle waveform amplitude while alternately pressing the sine wave and triangle pushbuttons. Disconnect all cables.

**28. Adjust Sine Drive (Distortion) (R740, R155, R52, R360, R215)**

Push the sine wave pushbutton in. Set the FREQUENCY Hz (START) dial to 40. Connect the FG 504 OUTPUT connector through a 50  $\Omega$  cable to a 50  $\Omega$  termination at the distortion analyzer input (use a bnc female-to-banana plug adapter if necessary). Set the

distortion analyzer to 40 kHz. Adjust R740 (Sine Drive) on the A2 FUNCTION board for minimum distortion. It may be necessary to slightly re-adjust R52 (Top Dial Sym Cal) in step 6 and R360 (Triangle DC Level) in step 5 to achieve a minimum distortion reading on the distortion analyzer. Change the FREQUENCY Hz (START) dial setting to 4 and the distortion analyzer to 4 kHz. Touch up R740 (Sine Drive) and R155 (Min Dial Sym Cal) for minimum distortion reading. Repeat this step as necessary to achieve minimum distortion reading. Set the MULTIPLIER to 10 and distortion analyzer to 40 Hz. Touch up R215 (LF Sym Cal) adjustment in step 8 for least distortion (0.5% or less). Remove power from the FG 504; disconnect test equipment and extender cables. Re-connect R14 to its original circuit connection.

# MAINTENANCE AND INTERFACING INFORMATION

## PREVENTIVE MAINTENANCE

Preventive maintenance steps performed on a regular basis will improve the reliability of the FG 504. However, checks of the semiconductors in the absence of a malfunction are not recommended as preventive maintenance measures. The recommended time for performing preventive maintenance is just before instrument adjustment.

### Cleaning

**CAUTION**

*Do not use acetone, MEK, MIBK, benzene, toluene, carbon tetrachloride, trichloroethylene, methyl alcohol, methylene chloride, sulphuric acid, or Freon compounds for cleaning the FG 504. Use only clean water and a mild detergent.*

**Exterior.** Loose dust may be removed with a soft cloth or dry brush. Water and a mild detergent may be used; however, abrasive cleaners should never be used.

**Interior.** Cleaning the interior of the unit should precede adjustment since the cleaning process could alter the settings of calibration adjustments. Use low-velocity compressed air to blow off accumulated dust. Hardened dirt can be removed with a soft dry brush, cotton-tipped swab, or a cloth dampened in a solution of water and mild detergent.

### Adjustment

After cleaning or repairs, do the performance check as described in Section 4 of this manual. If all functions are within specification, no adjustment is needed. If one or more of the specifications are not met, calibrate the instrument as directed in Section 4.

### Lubrication

No lubrication is required in the FG 504.

## TROUBLESHOOTING AIDS

### Theory of Operation

Section 3 of this manual explains circuit operation in detail. The section is a troubleshooting aid when used in conjunction with the circuit diagrams.

### Diagrams

A block diagram and detailed circuit diagrams are located on foldout pages in the Diagrams section. The circuit diagrams show the component values and assigned circuit reference numbers of each component. The first page of the Diagrams section defines the circuit symbols and reference designators used in the manual. Important waveforms and voltages are shown within the diagrams.

### Cam Switch Charts

Cam switches shown on the diagrams are coded on charts to locate the cam number of the switch contact in the complete switch assembly, counting from the front, or knob end, toward the rear of the switch. The charts also indicate with a solid dot when each contact is closed.

### Circuit Board Illustrations

To identify electrical components when troubleshooting, turn to the Parts Location Grid that is located on the back of a foldout page at the left of the related circuit diagrams. Component values, descriptions, and ordering data are given in the Replaceable Electrical Parts list.

### Component and Wiring Color Codes

Colored stripes or dots on electrical components signify electrical values, tolerances, etc., according to EIA standards. Components not color coded usually have information printed on the body. Some wiring coding follows the same EIA standards.

## Testing Equipment

Generally, a wide-band oscilloscope, a low-capacitance probe, and a multimeter are all that is needed to perform basic waveform and voltage checks for diagnostic purposes. The calibration procedure lists specific test equipment necessary to adequately check out the instrument.

## TROUBLESHOOTING TECHNIQUES

This troubleshooting procedure is arranged in an order that checks the simple trouble possibilities before proceeding to extensive troubleshooting.

### Control Settings

Incorrect control settings can appear to be an equipment problem. If there is any question about the correct function or operation of any control, see the operating instructions in Section 2.

If the FG 504 is operating as part of an interconnected system or test setup, also check control settings of the other instruments in the setup. Check for proper interconnections between the power module and the plug-in modules. Check that the signal is properly connected and that the interconnecting cables and signal source are not defective. Check the power source.

If the power module is suspected, try substituting another FG 504 known to be good into the power module. If the trouble persists after substitution, move the FG 504 to other compartments in the power module to determine if the trouble is confined to one compartment or is common to all of them.

### Visual Check

Remove the covers from the FG 504 and look for broken wires, loose or unsoldered connections, or damage to the circuit board. If components damaged from overheating are found, determine the cause of overheating before replacing the component; otherwise, the new component may also be damaged.

### Static-Sensitive Components



*Static discharge can damage any semiconductor component in this instrument.*

This instrument contains electrical components that are susceptible to damage from static discharge. See Table 5-1 for relative susceptibility of various classes of semiconductors. Static voltages of 1 kV to 30 kV are common in unprotected environments.

Observe the following precautions to avoid damage:

1. Minimize handling of static-sensitive components.
2. Transport and store static-sensitive components or assemblies in their original containers, on a metal rail, or on conductive foam. Label any package that contains static-sensitive assemblies or components.
3. Discharge the static voltage from your body by wearing a wrist strap while handling these components. Servicing static-sensitive assemblies or components should be performed only at a static-free work station by qualified service personnel.
4. Nothing capable of generating or holding a static charge should be allowed on the work station surface.
5. Keep the component leads shorted together whenever possible.
6. Pick up components by the body, never by the leads.
7. Do not slide the components over any surface.
8. Avoid handling components in areas that have a floor or work surface covering capable of generating a static charge.
9. Use a soldering iron that is connected to earth ground.
10. Use only special antistatic suction type or wick type desoldering tools.

### Test Equipment

Before using any test equipment to make measurements on static-sensitive components or assemblies, be certain that any voltage or current supplied by the test equipment does not exceed the limits of the component to be tested.

Table 5-1

**RELATIVE SUSCEPTIBILITY TO STATIC DISCHARGE DAMAGE**

Semiconductor Classes	Relative Susceptibility Levels <sup>a</sup>
MOS or CMOS microcircuits or discretes, or linear microcircuits with MOS inputs (Most Sensitive)	1
ECL	2
Schottky signal diodes	3
Schottky TTL	4
High-frequency bipolar transistors	5
JFETs	6
Linear microcircuits	7
Low-power Schottky TTL	8
TTL (Least Sensitive)	9

<sup>a</sup> Voltage equivalent for levels:

- |                  |                  |                          |
|------------------|------------------|--------------------------|
| 1 = 100 to 500 V | 4 = 500 V        | 7 = 400 to 1000 V (est.) |
| 2 = 200 to 500 V | 5 = 400 to 600 V | 8 = 900 V                |
| 3 = 250 V        | 6 = 600 to 800 V | 9 = 1200 V               |

(Voltage discharged from a 100 pF capacitor through a resistance of 100 ohms.)

**Circuit Isolation**

Note the symptom. It often identifies the circuit in which the trouble is located. When trouble symptoms appear in more than one circuit, check the affected circuits by making waveform and voltage measurements.

Incorrect operating of all circuits often means trouble in power supplies. Using a multimeter, check first for correct voltages of the individual regulated supplies according to the circuit diagrams and adjustment procedures. Then check the unregulated supplies of the power modules. Defective components elsewhere in the instruments can appear as power supply problems. In these instances, suspected circuits should be disconnected from apparently bad power supplies one at a time to narrow the search.

**Voltages and Waveforms**

Often defective components can be located by using waveform and voltage indications when they appear on the circuit diagram or in the adjustment procedures. Such waveforms and voltage labels are typical indications and will vary between instruments.

**Component Checking**

If a component cannot be disconnected from its circuit, the effects of the associated circuitry must be considered when evaluating the measurement. Except for soldered-in transistors and integrated circuits, most components can be unsoldered and lifted at one end from the circuit board.

**Transistors and Integrated Circuits (IC).** Turn the power switch off before removing or replacing any semiconductor. See Fig. 5-1 for semiconductor basing.

A good check of transistor operation is actual performance under operating conditions. A transistor can most effectively be checked by substituting a new component for it (or one which has been checked previously). However, be sure that circuit conditions are not such that a replacement transistor might also be damaged. If substitute transistors are not available, use a dynamic tester. Static-type testers are not recommended since they do not check operation under simulated operating conditions. An antistatic suction-type desoldering tool can be used to remove soldered-in transistors; see component replacement procedure for details.

Integrated circuits can be checked with a voltmeter, test oscilloscope, or by direct substitution. A good understanding of the circuit description is essential to troubleshooting circuits containing integrated circuits. Operating waveforms, logic levels, and other operating information for the integrated circuits are given in the circuit description information. Use care when checking voltages and waveforms around the integrated circuits so that adjacent leads are not shorted together. A convenient means of clipping a test probe to the 14- and 16-pin in-line integrated circuits is with an integrated circuit test clip. This device also doubles as an extraction tool.

Replacement semiconductors should be of the original type or a direct replacement. Figure 5-1 shows the lead configuration of the semiconductors used in this instrument system. When removing soldered-in transistors, use an antistatic suction-type de-soldering tool to remove the solder from the holes in the circuit board. See Maintenance Aids.

An extracting tool should be used to remove the 14- and 16-pin integrated circuits to prevent damage to the pins. This tool is available from Tektronix, Inc. See Maintenance Aids. If an extracting tool is not available, use care to avoid damaging the pins. Pull slowly and evenly on both ends of the integrated circuit. Try to avoid having one end of the integrated circuit disengage from the socket before the other end.

**NOTE**  
 LEAD CONFIGURATIONS AND CASE STYLES ARE TYPICAL, BUT MAY VARY DUE TO VENDOR CHANGES OR INSTRUMENT MODIFICATIONS.

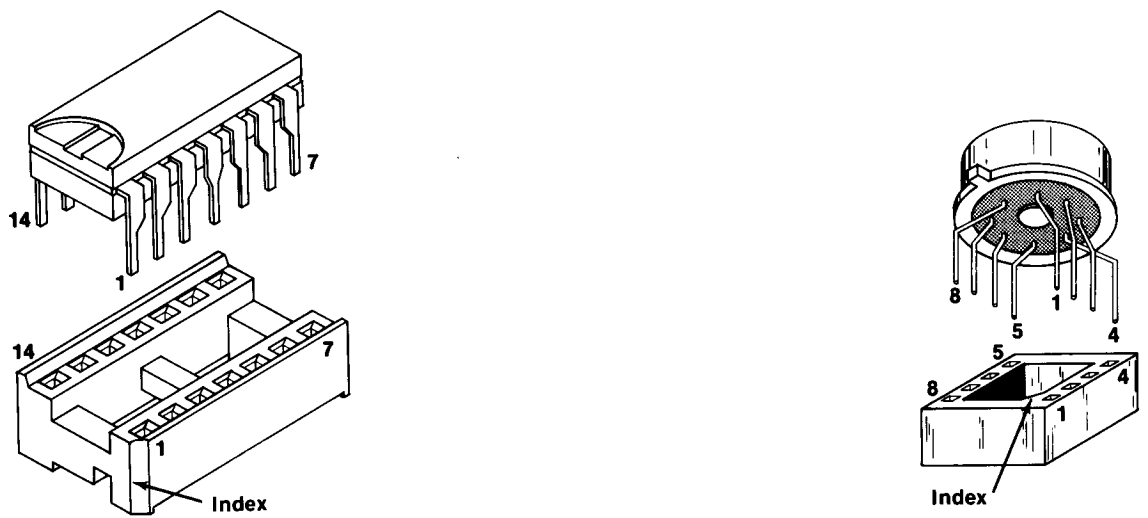
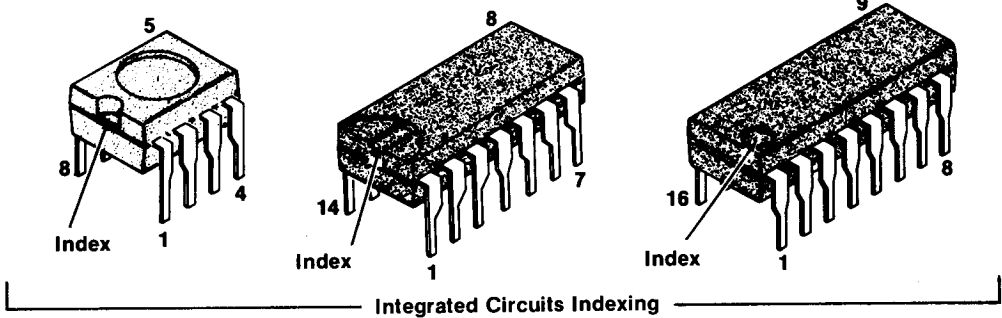
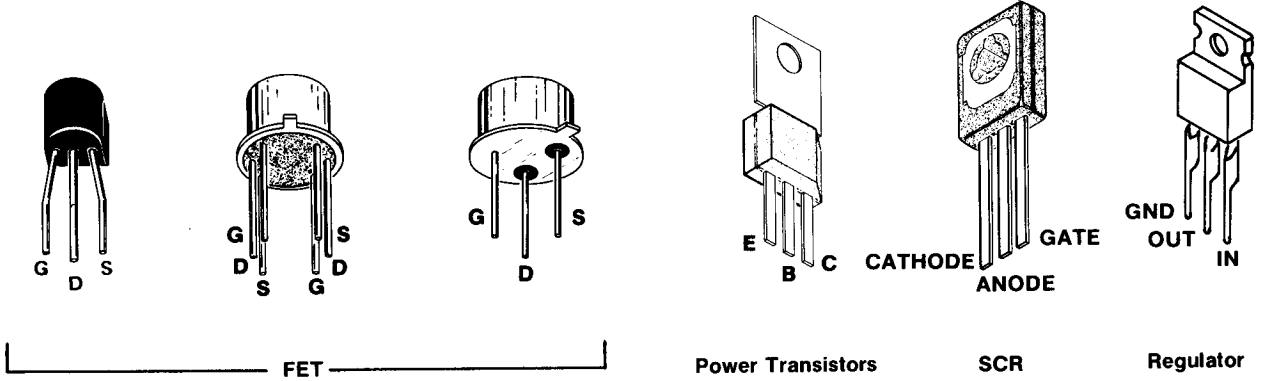
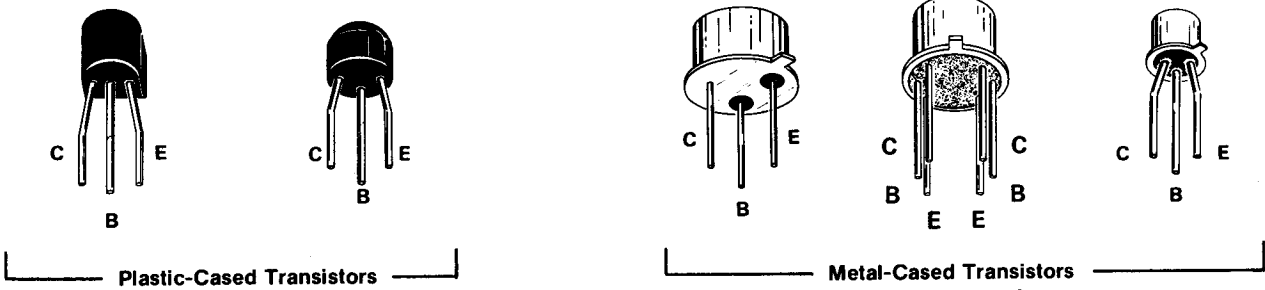

2655-03A

Fig. 5-1. Semiconductor Basing.

**Diodes.** Do not use an ohmmeter that has a high internal current. High currents may damage the diode, so use the RX1000 scale on the ohmmeter.

Ordinary signal diodes may be checked for an open or shorted condition by measuring the resistance between terminals. With the ohmmeter set to the RX1000 scale, the resistance should be very high in one direction and very low when the leads are reversed.

**Resistors.** Check resistors with an ohmmeter. Resistor tolerances are given in the Replaceable Electrical Parts list. Resistors do not normally need to be replaced unless the measured value varies widely from the specified value.

**Capacitors.** A leaky or shorted capacitor can be detected by checking resistance with an ohmmeter on the highest scale. Use an ohmmeter which will not exceed the voltage rating of the capacitor. The resistance reading should be high after initial charge of the capacitor. An open capacitor can best be detected with a capacitor tester, or by checking whether it passes ac signals.

**Cam Switches.** Repair of cam-type switches should be undertaken only by experienced maintenance personnel. Switch alignment and spring tension of the contacts must be carefully maintained for proper operation of the switch. For assistance, contact your local Tektronix Field Office or representative.

**NOTE**

*A cam-type switch repair kit including necessary tools, instructions, and replacement contacts is available from Tektronix, Inc. See Maintenance Aids.*

The cam-type switches consist of rotating cam drums, which are turned by front-panel knobs, and sets of spring-leaf contacts mounted on adjacent circuit boards. The contacts are actuated by lobes on the cams. These switches can be disassembled for inspection, cleaning, repair, or replacement as follows:

1. Remove screws from the switch cover and remove the cover. The switch is now open for inspection or cleaning.

2. To completely remove a switch from the circuit board, first remove any knobs or shaft extensions. Loosen the coupling at the potentiometer at the rear of the switch, and pull the long shaft out of the switch assembly.

3. Remove the screws (from the opposite side of the circuit board) which hold the cam drum to the board.

4. To remove the cam drum from the front support block, remove the retaining ring from the shaft on the front of the switch and slide the cam drum out of the support block. Be careful not to lose the small detent roller.

5. To replace defective switch contacts, follow the instructions given in the switch repair kit.

6. To re-install the switch assembly, reverse the above procedure.

**Incandescent Bulbs.** Most of these light bulbs are mounted on the sub-panel using plastic sleeve stand-offs. Unsolder the lead wires and pull the bulb out of the sleeve from the rear of the sub-panel.

**Circuit Board Removal**

**NOTE**

*Tag or note the locations of all leads and plugs for reassembly reference.*

To remove the Main board (right side board), remove the six screws holding the back panel to the instrument frame. Remove the back panel. Remove the SWEEP DURATION, RISE and FALL TIME and ATTENUATOR (dB) knobs. Disconnect all cable plugs connected to the board. Remove the four screws attaching the board to the plug-in frame and remove the board by sliding the board backwards until the switch shafts clear the front panel holes.

To remove the Function board (center board), first remove all cable plugs attached to the board. Then remove the four screws attaching the board to the spacers. Slide the board to the rear of the instrument until the pushbuttons clear the front panel and remove the board.

To remove the Loop board (left side board), disconnect cable connections to the board. Remove the MULTIPLIER knob. Unsolder the wire from the AM INPUT connector on the front panel to the board. Next remove the four screws attaching the Loop board to the plug-in frame and slide the board to the rear of the plug-in unit until the HOLD push-button clears the front panel. Remove the board from the plug-in.

To remove the Floating Interface board, first remove the six retaining screws on the back panel. Remove the

## Maintenance—FG 504 (SN B040000 & UP)

cable plugs from the board and remove it from the instrument. It will be necessary to remove the screws holding the retaining clips if it is necessary to remove the board from the back panel.

### Checking Transformer Phasing

If the FG 504 is used in early models of the TM 500-Series Power Modules, ripple on the output waveform can be excessive in some cases. The ripple results from Power Module transformer phasing that is incompatible with FG 504 operation; however, the problem is easily cured.

To determine if your Power Module is properly phased, place the FG 504 in operation on two extender cables. Make certain both extender cables are firmly connected (do not attempt to operate the FG 504 with only one extender cable).

Turn to the Rear Interface Connector Assignments pullout at the rear of this section. Locate pin 13A on the Main board (left board when viewing the rear of the instrument). Using an ac voltmeter, measure the voltage from pin 13A to chassis ground (pin 9A or 9B). The normal voltage is about 35 V rms. If the voltage is about 15 V rms, the phasing is incorrect. Correct the phasing by interchanging the wires to pins 13A and 13B in the Power Module. Measure the voltage from pin 1B to chassis ground and interchange the Power Module wires to pins 1A and 1B if indicated. Check all compartments of the Power Module for proper phasing.

### Maintenance

Refer to the TM 500-Series Power Module manuals for complete maintenance information. When replacing cam switch contacts, order High Frequency Cam Switch Repair Kit. See the Maintenance Aids.

#### NOTE

*Do not attempt to operate the instrument unless BOTH plug in cards are connected to the mainframe.*

## PARTS ORDERING AND REPLACING

### Ordering

**Standard Parts.** All electrical and mechanical replacement parts can be obtained through the local Tektronix Field Office or representative. However, many of the standard electronic components can be obtained locally in less time than is required to order them from Tektronix, Inc. Before purchasing or ordering replacement parts, check the Replaceable Parts lists for value, tolerance, rating, and description. When selecting replacement

parts, it is important to remember that the physical size and shape of the component may affect its performance in an instrument. All replacement parts should be direct replacements unless it is known that a different component will not adversely affect the instrument performance.

**Special Parts.** Some parts are manufactured or selected by Tektronix, Inc., to satisfy particular requirements, or are manufactured for Tektronix, Inc., to our specifications. Most of the mechanical parts used in this system have been manufactured by Tektronix, Inc. Order all special parts directly from the local Tektronix Field Office or representative.

**Ordering Procedure.** When ordering replacement parts from Tektronix, Inc., please include the following minimum information:

1. Instrument type (FG 504).
2. Instrument serial number (for example, B040251).
3. A description of the part (if electrical, include the circuit number).
4. Tektronix part number.

Please do not return any instruments or parts before receiving directions from Tektronix, Inc.

A listing of Tektronix Field Offices, Service Centers, and Representatives can be found in the Tektronix Product Catalog and Supplements.

## CUSTOMIZING

### Customizing the Interface

Input and output access to the FG 504 is available at the rear of the floating interface and main circuit boards. Figure 5-2 identifies the contacts and their respective I/O assignments.

A power module mainframe option (Option 2) is available that provides a rear-panel, multi-pin connector to which I/O lines can be hard-wired for external access. Also possible are inter-compartment connections with other plug-in modules in multiple-compartment mainframes.

A slot between pins 23 and 24 on the rear connectors identifies the FG 504 as a member of the signal source family. If the interface is customized, insert barriers in the corresponding positions of the power module jack to prevent other than signal source plug-ins from being used in those compartments. This protects the plug-in should specialized connections be made to those compartments. Consult the Building A System section of the power module manual for further information.

### Custom Timing Capacitor Selection

This feature allows the user to select a swept frequency range. Place the MULTIPLIER in the  $.5 \times 10^1$  position. The factory installed capacitor provides a swept range of 20 Hz to 20 kHz. For example, to calculate a custom range, assume a swept frequency range of 10 Hz to 10 kHz is desired. Figure 1-2 shows that no fixed multiplier setting includes the desired limits. The value of the capacitor that must be installed is determined by the following formula:

$$C_{CUS} = \frac{2200}{F_{MAX}}$$

where  $C_{CUS}$  is in  $\mu\text{F}$ ; and  $F_{MAX}$ , is the maximum frequency required. Apply the formula to the example:

$$C_{CUS} = 0.22 \mu\text{F}.$$

Use a capacitor of any desired value. If the capacitor is mounted in the instrument, physical size is the only limitation. Low leakage capacitors using mylar as dielectrics provide the truest waveforms.

### Phase Modulated Operation

A jumper located on the Loop board allows the VCF INPUT to function as a phase modulating input when the FG 504 is operated in the PHASE LOCK loop mode. The location of this jumper is shown in the illustration on the Internal Adjustments Procedure foldout page at the rear of this manual. The phase modulating input voltage limits are  $\pm 2.5$  V, with an upper frequency limit of 1 kHz. When phase locked, the phase modulating voltage varies the output phase by approximately  $5^\circ/\text{V}$ .



# USING THE REAR INTERFACE CONNECTORS

(See Figure 5-2.)

## Output

This terminal is connected to the front panel OUTPUT connector through a 30 k $\Omega$  resistor. The common terminal for this output is pin 27A (Main board only).

## Sweep Reset Output

A positive-going pulse from about  $-13$  V to about  $+9$  V occurs at this connection at the time the sweep resets. This output is designed to drive at least 10 k $\Omega$ . The pulse can be used to raise the pen on a chart recorder when doing sweep frequency tests on filters or other devices or as end-of-sweep trigger for an external device. Connect the other lead to chassis ground.

## Linear Sweep Output

This terminal is connected to the output of the sweep generator through a 1 k $\Omega$  resistor. Use chassis ground as the return circuit. The waveform at this terminal is identical with the waveform at the front panel LIN SWEEP OUTPUT terminal except in the STOP FREQ mode. In the STOP FREQ mode this rear connection continues to output the linear sweep ramp while the front panel connection outputs a dc voltage equivalent to the peak ramp voltage. To make the output at the rear terminal the same as the LIN SWEEP OUTPUT terminal, remove the lower end of R1525 from the Function board. Connect an eight inch wire from the lower end of R1525 to the lower end of R1520 also located on the Function board. The exact location of these resistors can be found from the Replaceable Parts Location Grid.

## AM Input

This input has the same input characteristics as the AM INPUT connection on the front panel. Use chassis ground for the circuit return.

## Sweep Trigger Input

This terminal is connected to the front panel SWP TRIG INPUT connector through a 1.5 k $\Omega$  resistor. Use chassis ground for the return circuit.

## Trigger Output

This connection is made through a 510  $\Omega$  resistor to the front panel TRIG OUTPUT connector. Use connection 27B for the return circuit.

## Phase Lock Error Voltage

The signal at this terminal is the output of the phase locked loop filter. An output of 0 V indicates the reference frequency is the same as the free-run frequency. A voltage of  $+10$  V (open circuit) indicates a generator output frequency of about 10 dial divisions higher than free-run frequency, and  $-10$  V (open circuit) indicates a generator frequency about 10 dial divisions lower than the free-run frequency. The output impedance is 1 k $\Omega$ . Use the chassis ground as the return circuit.

## Trigger Input

This connection has the same dc input characteristics as the front panel TRIGGER INPUT connector. Use the chassis as the return circuit.

## VCF Input

This connection has the same input characteristics as the front panel VCF INPUT connector. Use contact 22B as the return circuit.

## REAR INTERFACE CONNECTOR ASSIGNMENTS

MAIN BOARD			FLOATING BOARD		
B	PIN #	A	B	PIN #	A
NC	28	OUTPUT (30K)	TRIG OUT COMMON	28	NC
NC	27	OUTPUT COMMON	TRIG OUTPUT	27	GND
NC	26	NC	PHASE LOCK ERROR VOLTAGE	26	SWP RESET OUTPUT
NC	25	NC	TRIGGER/GATE COMMON	25	LINEAR SWEEP OUTPUT
NC	24	NC	TRIGGER/GATE INPUT	24	NC
SIGNAL SOURCE PLUG-IN BARRIER SLOT			SIGNAL SOURCE PLUG-IN BARRIER SLOT		
NC	23	NC	NC	23	AM INPUT
NC	22	NC	VCF INPUT COMMON	22	SWEEP TRIGGER IN
NC	21	NC	VCF INPUT	21	NC
NC	20	NC	NC	20	NC
NC	19	NC	NC	19	NC
NC	18	NC	NC	18	NC
NC	17	NC	NC	17	NC
NC	16	NC	NC	16	NC
NC	15	NC	NC	15	NC
NC	14	NC	NC	14	NC
NC	13	NC	25 V AC WINDING	13	25 V AC WINDING
+33.5 VOLTS	12	+33.5 VOLTS	NC	12	NC
COLLECTOR LEAD PNP SERIES PASS	11	BASE LEAD PNP SERIES PASS	COLLECTOR LEAD PNP SERIES PASS	11	BASE LEAD PNP SERIES PASS
NC	10	EMITTER PNP SERIES PASS	NC	10	EMITTER PNP SERIES PASS
GND	9	GND	GND	9	GND
-33.5 VOLTS	8	-33.5 VOLTS	NC	8	NC
COLLECTOR NPN SERIES PASS	7	EMITTER NPN SERIES PASS	COLLECTOR NPN SERIES PASS	7	EMITTER NPN SERIES PASS
TM 500 BARRIER SLOTS			TM 500 BARRIER SLOTS		
NC	6	BASE NPN SERIES PASS	NC	6	BASE NPN SERIES PASS
NC	5	NC	17.5VAC	5	17.5VAC
GND	4	GND	GND	4	GND
GND	3	GND	GND	3	GND
+11.5 VOLTS	2	+11.5 VOLTS	+11.5 VOLTS	2	+11.5 VOLTS
NC	1	NC	25 V AC WINDING	1	25 V AC WINDING

2655-04A

Fig. 5-2. Rear Interface Connector Assignments.

**Table 5-2**  
**MAINTENANCE AIDS**

The following maintenance aids include items required for some maintenance procedures in this instrument. Equivalent products may be substituted for examples given providing characteristics are similar.

Description	Specifications	Use	Example
1. Soldering Iron	15 Watt	General soldering and unsoldering	ANTEX PRECISION Model C
2. Screwdriver	Phillips #1 tip	Assembly and Disassembly	Xcelite Model X108
3. Screwdriver	Phillips #2 tip	Assembly and Disassembly	Xcelite Model X102
4. Screwdriver	Three-inch shaft; 3/32" flat bit	General	Xcelite R3323
5. Torque Screwdriver	1.5 inch-pounds	FUNCTION switch assembly	Sturtevant-Richmont Torque Products Model PM-5 Roto-Torq
6. Nutdrivers	1/4", 5/16" 3/8", 7/16"	General	Xcelite #8, #10, #12 & #14
7. Open End Wrench	11/16"	General	
8. Solder Wick		Unsoldering	Hex Wik #887-10
9. Lubricant	Versilube	FUNCTION switch lubrication	Tektronix Part No. 006-1353-00
10. Spray Cleaner	No Noise	FUNCTION switch pad cleaning	Tektronix Part No. 006-0442-02
11. Vacuum Desoldering Tool	Antistatic	General	Tektronix Part No. 003-0795-00
12. I.C. Extracting Tool		General	Tektronix Part No. 003-0619-00
13. Cam Switch Repair Kit		Cam switches	Tektronix Part No. 040-0541-00
14. Extender Cables		General	Tektronix Part No. 067-0645-02

# OPTIONS

There are no options for the FG 504 at the time of this printing.

# REPLACEABLE ELECTRICAL PARTS

## PARTS ORDERING INFORMATION

Replacement parts are available from or through your local Tektronix, Inc. Field Office or representative.

Changes to Tektronix instruments are sometimes made to accommodate improved components as they become available, and to give you the benefit of the latest circuit improvements developed in our engineering department. It is therefore important, when ordering parts, to include the following information in your order: Part number, instrument type or number, serial number, and modification number if applicable.

If a part you have ordered has been replaced with a new or improved part, your local Tektronix, Inc. Field Office or representative will contact you concerning any change in part number.

Change information, if any, is located at the rear of this manual.

## SPECIAL NOTES AND SYMBOLS

X000 Part first added at this serial number  
00X Part removed after this serial number

### ITEM NAME

In the Parts List, an Item Name is separated from the description by a colon (:). Because of space limitations, an Item Name may sometimes appear as incomplete. For further Item Name identification, the U.S. Federal Cataloging Handbook H6-1 can be utilized where possible.

## ABBREVIATIONS

ACTR	ACTUATOR	PLSTC	PLASTIC
ASSY	ASSEMBLY	QTZ	QUARTZ
CAP	CAPACITOR	RECP	RECEPTACLE
CER	CERAMIC	RES	RESISTOR
CKT	CIRCUIT	RF	RADIO FREQUENCY
COMP	COMPOSITION	SEL	SELECTED
CONN	CONNECTOR	SEMICOND	SEMICONDUCTOR
ELCTLT	ELECTROLYTIC	SENS	SENSITIVE
ELEC	ELECTRICAL	VAR	VARIABLE
INCAND	INCANDESCENT	WW	WIREWOUND
LED	LIGHT EMITTING DIODE	XFMR	TRANSFORMER
NONWIR	NON WIREWOUND	XTAL	CRYSTAL

CROSS INDEX—MFR. CODE NUMBER TO MANUFACTURER

Mfr. Code	Manufacturer	Address	City, State, Zip
000DN	FUSES UNLIMITED	9740 COZYCRAFT AVENUE	CHATSWORTH, CA 91311
00853	SANGAMO ELECTRIC CO., S. CAROLINA DIV.	P O BOX 128	PICKENS, SC 29671
01121	ALLEN-BRADLEY COMPANY	1201 2ND STREET SOUTH	MILWAUKEE, WI 53204
01295	TEXAS INSTRUMENTS, INC., SEMICONDUCTOR GROUP	P O BOX 5012, 13500 N CENTRAL EXPRESSWAY	DALLAS, TX 75222
02735	RCA CORPORATION, SOLID STATE DIVISION	ROUTE 202	SOMERVILLE, NY 08876
03508	GENERAL ELECTRIC COMPANY, SEMI-CONDUCTOR PRODUCTS DEPARTMENT	ELECTRONICS PARK	SYRACUSE, NY 13201
04222	AVX CERAMICS, DIVISION OF AVX CORP.	P O BOX 867, 19TH AVE. SOUTH	MYRTLE BEACH, SC 29577
04713	MOTOROLA, INC., SEMICONDUCTOR PROD. DIV.	5005 E MCDOWELL RD, PO BOX 20923	PHOENIX, AZ 85036
07263	FAIRCHILD SEMICONDUCTOR, A DIV. OF FAIRCHILD CAMERA AND INSTRUMENT CORP.	464 ELLIS STREET	MOUNTAIN VIEW, CA 94042
12697	CLAROSTAT MFG. CO., INC.	LOWER WASHINGTON STREET	DOVER, NH 03820
13511	AMPHENOL CADRE DIV., BUNKER RAMO CORP.		LOS GATOS, CA 95030
14193	CAL-R, INC.	1601 OLYMPIC BLVD.	SANTA MONICA, CA 90404
14433	ITT SEMICONDUCTORS	3301 ELECTRONICS WAY P O BOX 3049	WEST PALM BEACH, FL 33402
14752	ELECTRO CUBE INC.	1710 S. DEL MAR AVE.	SAN GABRIEL, CA 91776
15238	ITT SEMICONDUCTORS, A DIVISION OF INTERNATIONAL TELEPHONE AND TELEGRAPH CORP.	P.O. BOX 168, 500 BROADWAY	LAWRENCE, MA 01841
17856	SILICONIX, INC.	2201 LAURELWOOD DRIVE	SANTA CLARA, CA 95054
18324	SIGNETICS CORP.	811 E. ARQUES	SUNNYVALE, CA 94086
19396	ILLINOIS TOOL WORKS, INC. PAKTRON DIV.	900 FOLLIN LANE, SE	VIENNA, VA 22180
21847	AERTECH INDUSTRIES	825 STEWART DR.	SUNNYVALE, CA 94086
24546	CORNING GLASS WORKS, ELECTRONIC COMPONENTS DIVISION	550 HIGH STREET	BRADFORD, PA 16701
27014	NATIONAL SEMICONDUCTOR CORP.	2900 SEMICONDUCTOR DR.	SANTA CLARA, CA 95051
32997	BOURNS, INC., TRIMPOT PRODUCTS DIV.	1200 COLUMBIA AVE.	RIVERSIDE, CA 92507
50157	MIDWEST COMPONENTS INC.	P. O. BOX 787 1981 PORT CITY BLVD.	MUSKEGON, MI 49443
50434	HEWLETT-PACKARD COMPANY	640 PAGE MILL ROAD	PALO ALTO, CA 94304
53184	XCITON CORPORATION	5 HEMLOCK STREET	LATHAM, NY 12110
55210	GETTIG ENG. AND MFG. COMPANY	PO BOX 85, OFF ROUTE 45	SPRING MILLS, PA 16875
56289	SPRAGUE ELECTRIC CO.	87 MARSHALL ST.	NORTH ADAMS, MA 01247
59660	TUSONIX INC.	2155 N FORBES BLVD	TUCSON, AZ 85705
71400	BUSSMAN MFG., DIVISION OF MCGRAW-EDISON CO.	2536 W. UNIVERSITY ST.	ST. LOUIS, MO 63107
71590	CENTRALAB ELECTRONICS, DIV. OF GLOBE-UNION, INC.	P O BOX 858	FORT DODGE, IA 50501
72982	ERIE TECHNOLOGICAL PRODUCTS, INC.	644 W. 12TH ST.	ERIE, PA 16512
73138	BECKMAN INSTRUMENTS, INC., HELIPOT DIV.	2500 HARBOR BLVD.	FULLERTON, CA 92634
73899	JFD ELECTRONICS COMPONENTS CORP.	PINETREE ROAD	OXFORD, NC 27565
74970	JOHNSON, E. F., CO.	299 10TH AVE. S. W.	WASECA, MN 56093
75042	TRW ELECTRONIC COMPONENTS, IRC FIXED RESISTORS, PHILADELPHIA DIVISION	401 N. BROAD ST.	PHILADELPHIA, PA 19108
75915	LITTELFUSE, INC.	800 E. NORTHWEST HWY	DES PLAINES, IL 60016
80009	TEKTRONIX, INC.	P O BOX 500	BEAVERTON, OR 97077
90201	MALLORY CAPACITOR CO., DIV. OF P. R. MALLORY AND CO., INC.	3029 E. WASHINGTON STREET P. O. BOX 372	INDIANAPOLIS, IN 46206
91418	RADIO MATERIALS COMPANY, DIV. OF P.R. MALLORY AND COMPANY, INC.	4242 W BRYN MAWR	CHICAGO, IL 60646
91637	DALE ELECTRONICS, INC.	P. O. BOX 609	COLUMBUS, NE 68601
95275	VITRAMON, INC.	P O BOX 544	BRIDGEPORT, CT 06601

Replaceable Electrical Parts—FG 504 (SN B040000 & up)

Ckt No.	Tektronix Part No.	Serial/Model No. Eff	Dscont	Name & Description	Mfr Code	Mfr Part Number
A1	670-3842-03	B040000	B056331	CKT BOARD ASSY:MAIN	80009	670-3842-03
A1	670-3842-04	B056332	B057809	CKT BOARD ASSY:MAIN	80009	670-3842-04
A1	670-3842-05	B057810	B058289	CKT BOARD ASSY:MAIN	80009	670-3842-05
A1	670-3842-06	B058290		CKT BOARD ASSY:MAIN	80009	670-3842-06
A2	670-3841-03	B040000	B058449	CKT BOARD ASSY:FUNCTION	80009	670-3841-03
A2	670-3841-04	B058450		CKT BOARD ASSY:FUNCTION	80009	670-3841-04
A3	670-3840-02	B040000	B056331	CKT BOARD ASSY:LOOP	80009	670-3840-02
A3	670-3840-03	B056332		CKT BOARD ASSY:LOOP	80009	670-3840-03
A4	670-3797-02	B040000	B057809	CKT BOARD ASSY:FLOAT INTERFACE	80009	670-3797-02
A4	670-3797-03	B057810		CKT BOARD ASSY:FLOAT INTERFACE	80009	670-3797-03
C45	283-0167-00			CAP.,FXD,CER DI:0.1UF,10%,100V	72982	8131N145X5R0104K
C72	283-0000-00			CAP.,FXD,CER DI:0.001UF,+100-0%,500V	59660	831-519-Z5U-102P
C78	283-0003-00			CAP.,FXD,CER DI:0.01UF,+80-20%,150V	91418	SP103Z151-4R9
C80	281-0599-00			CAP.,FXD,CER DI:1PF,+/-0.25PF,500V	59660	374-018-COK0109C
C95	283-0003-00			CAP.,FXD,CER DI:0.01UF,+80-20%,150V	91418	SP103Z151-4R9
C98	283-0003-00			CAP.,FXD,CER DI:0.01UF,+80-20%,150V	91418	SP103Z151-4R9
C106	283-0003-00			CAP.,FXD,CER DI:0.01UF,+80-20%,150V	91418	SP103Z151-4R9
C195	281-0123-00			CAP.,VAR,CER DI:5-25PF,100V	59660	518-000A5-25
C210	285-1068-00			CAP.,FXD,PLSTC:5UF,1%,200V	14752	230B1C505F
C240	283-0361-00	B040000	B056331	CAP.,FXD,CER DI:460PF,1%,50V	72982	A02BL0A2LCLG461F
C240	283-0620-00	B056332		CAP.,FXD,MICA D:470PF,1%,300V	00853	D153F471F0
C242	281-0158-00			CAP.,VAR,CER DI:7-45PF,50V	73899	DVJ-5006
C244	285-1066-00			CAP.,FXD,PLSTC:0.05UF,1%,200V	14752	230B1C503F
C246	285-1067-00			CAP.,FXD,PLSTC:0.5UF,1%,200V	14752	230B1C504F
C247	283-0238-00			CAP.,FXD,CER DI:0.01UF,10%,50V	72982	8121N075X7R0103K
C248	285-1050-00			CAP.,FXD,PLSTC:0.1UF,1%,200V	14752	230B1C104F
C250	285-1062-00			CAP.,FXD,PLSTC:0.005UF,0.1%,200V	19396	502F02PP460
C255	283-0167-00			CAP.,FXD,CER DI:0.1UF,10%,100V	72982	8131N145X5R0104K
C275	290-0534-00			CAP.,FXD,ELCTLT:1UF,20%,35V	56289	196D105X0035HA1
C290	290-0534-00			CAP.,FXD,ELCTLT:1UF,20%,35V	56289	196D105X0035HA1
C300	281-0653-00			CAP.,FXD,CER DI:3.3PF,30%,200V	59660	374-018-COJ0339F
C315	283-0003-00			CAP.,FXD,CER DI:0.01UF,+80-20%,150V	91418	SP103Z151-4R9
C325	281-0158-00			CAP.,VAR,CER DI:7-45PF,50V	73899	DVJ-5006
C327	281-0617-00			CAP.,FXD,CER DI:15PF,10%,200V	59660	374-018-COG0150K
C329	283-0639-00			CAP.,FXD,MICA D:56PF,1%,100V	00853	D151E560F0
C331	283-0672-00			CAP.,FXD,MICA D:200PF,1%,500V	00853	D155F2010F0
C340	281-0158-00			CAP.,VAR,CER DI:7-45PF,50V	73899	DVJ-5006
C342	281-0617-00			CAP.,FXD,CER DI:15PF,10%,200V	59660	374-018-COG0150K
C344	283-0639-00			CAP.,FXD,MICA D:56PF,1%,100V	00853	D151E560F0
C346	283-0672-00			CAP.,FXD,MICA D:200PF,1%,500V	00853	D155F2010F0
C380	283-0000-00			CAP.,FXD,CER DI:0.001UF,+100-0%,500V	59660	831-519-Z5U-102P
C382	283-0648-00			CAP.,FXD,MICA D:10PF,5%,100V	00853	D151C100D0
C387	283-0003-00			CAP.,FXD,CER DI:0.01UF,+80-20%,150V	91418	SP103Z151-4R9
C475	283-0003-00			CAP.,FXD,CER DI:0.01UF,+80-20%,150V	91418	SP103Z151-4R9
C480	283-0003-00			CAP.,FXD,CER DI:0.01UF,+80-20%,150V	91418	SP103Z151-4R9
C494	283-0220-00			CAP.,FXD,CER DI:0.01UF,20%,50V	72982	8121N075X7R0103M
C495	283-0094-00			CAP.,FXD,CER DI:27PF,10%,200V	59660	835-583-COG0270K
C510	283-0065-00			CAP.,FXD,CER DI:0.001UF,5%,100V	72982	805-518-Z5D0102J
C534	290-0534-00			CAP.,FXD,ELCTLT:1UF,20%,35V	56289	196D105X0035HA1
C550	283-0220-00			CAP.,FXD,CER DI:0.01UF,20%,50V	72982	8121N075X7R0103M
C570	283-0220-00			CAP.,FXD,CER DI:0.01UF,20%,50V	72982	8121N075X7R0103M
C576	283-0060-00			CAP.,FXD,CER DI:100PF,5%,200V	72982	855-535U2J101J
C588	290-0534-00			CAP.,FXD,ELCTLT:1UF,20%,35V	56289	196D105X0035HA1
C592	283-0632-00			CAP.,FXD,MICA D:87PF,1%,100V	00853	D151E870F0
C594	283-0594-00			CAP.,FXD,MICA D:0.001UF,1%,100V	00853	D151F102F0
C596	283-0238-00			CAP.,FXD,CER DI:0.01UF,10%,50V	72982	8121N075X7R0103K
C598	290-0522-00			CAP.,FXD,ELCTLT:1UF,20%,50V	56289	196D105X0050HA1
C612	283-0220-00			CAP.,FXD,CER DI:0.01UF,20%,50V	72982	8121N075X7R0103M

Replaceable Electrical Parts—FG 504 (SN B040000 & up)

Ckt No.	Tektronix Part No.	Serial/Model No. Eff	Dscont	Name & Description	Mfr Code	Mfr Part Number
C638	283-0111-00			CAP., FXD, CER DI: 0.1UF, 20%, 50V	72982	8121-N088Z5U104M
C642	283-0649-00			CAP., FXD, MICA D: 105PF, 1%, 300V	00853	D153F1050F0
C712	283-0638-00			CAP., FXD, MICA D: 130PF, 1%, 100V	00853	D151F131F0
C745	281-0516-00			CAP., FXD, CER DI: 39PF, +/-3.9PF, 500V	59660	301-000U2J0390K
C784	283-0597-00			CAP., FXD, MICA D: 470PF, 10%, 300V	00853	D153E471K0
C790	290-0534-00			CAP., FXD, ELCTLT: 1UF, 20%, 35V	56289	196D105X0035HA1
C812	283-0003-00			CAP., FXD, CER DI: 0.01UF, +80-20%, 150V	91418	SP103Z151-4R9
C844	283-0003-00			CAP., FXD, CER DI: 0.01UF, +80-20%, 150V	91418	SP103Z151-4R9
C857	281-0093-00			CAP., VAR, CER DI: 5.5-18PF	59660	538-011A5.5-18
C880	290-0534-00			CAP., FXD, ELCTLT: 1UF, 20%, 35V	56289	196D105X0035HA1
C884	290-0534-00			CAP., FXD, ELCTLT: 1UF, 20%, 35V	56289	196D105X0035HA1
C914	283-0642-00			CAP., FXD, MICA D: 33PF, +/-0.5PF, 300V	00853	D10-5E330G
C922	281-0158-00			CAP., VAR, CER DI: 7-45PF, 50V	73899	DVJ-5006
C928	283-0220-00			CAP., FXD, CER DI: 0.01UF, 20%, 50V	72982	8121N075X7R0103M
C934	283-0220-00			CAP., FXD, CER DI: 0.01UF, 20%, 50V	72982	8121N075X7R0103M
C947	283-0111-00			CAP., FXD, CER DI: 0.1UF, 20%, 50V	72982	8121-N088Z5U104M
C950	283-0620-00			CAP., FXD, MICA D: 470PF, 1%, 300V	00853	D153F471F0
C955	283-0220-00			CAP., FXD, CER DI: 0.01UF, 20%, 50V	72982	8121N075X7R0103M
C958	283-0220-00			CAP., FXD, CER DI: 0.01UF, 20%, 50V	72982	8121N075X7R0103M
C965	283-0220-00			CAP., FXD, CER DI: 0.01UF, 20%, 50V	72982	8121N075X7R0103M
C972	283-0353-00			CAP., FXD, CER DI: 0.1UF, 10%, 50V	95275	VJ1210Y104K-H
C975	290-0525-00			CAP., FXD, ELCTLT: 4.7UF, 20%, 50V	56289	196D475X0050KA1
C976	283-0353-00			CAP., FXD, CER DI: 0.1UF, 10%, 50V	95275	VJ1210Y104K-H
C978	290-0525-00			CAP., FXD, ELCTLT: 4.7UF, 20%, 50V	56289	196D475X0050KA1
C1036	283-0220-00			CAP., FXD, CER DI: 0.01UF, 20%, 50V	72982	8121N075X7R0103M
C1047	283-0111-00			CAP., FXD, CER DI: 0.1UF, 20%, 50V	72982	8121-N088Z5U104M
C1050	283-0620-00			CAP., FXD, MICA D: 470PF, 1%, 300V	00853	D153F471F0
C1072	283-0353-00			CAP., FXD, CER DI: 0.1UF, 10%, 50V	95275	VJ1210Y104K-H
C1075	290-0525-00			CAP., FXD, ELCTLT: 4.7UF, 20%, 50V	56289	196D475X0050KA1
C1076	283-0353-00			CAP., FXD, CER DI: 0.1UF, 10%, 50V	95275	VJ1210Y104K-H
C1078	290-0525-00			CAP., FXD, ELCTLT: 4.7UF, 20%, 50V	56289	196D475X0050KA1
C1090	281-0138-00			CAP., VAR, PLSTC: 0.4-1.2PF, 600V	74970	273-0051-001
C1092	281-0158-00			CAP., VAR, CER DI: 7-45PF, 50V	73899	DVJ-5006
C1145	283-0220-00			CAP., FXD, CER DI: 0.01UF, 20%, 50V	72982	8121N075X7R0103M
C1146	283-0111-00			CAP., FXD, CER DI: 0.1UF, 20%, 50V	72982	8121-N088Z5U104M
C1154	290-0525-00			CAP., FXD, ELCTLT: 4.7UF, 20%, 50V	56289	196D475X0050KA1
C1156	283-0220-00			CAP., FXD, CER DI: 0.01UF, 20%, 50V	72982	8121N075X7R0103M
C1160	283-0220-00			CAP., FXD, CER DI: 0.01UF, 20%, 50V	72982	8121N075X7R0103M
C1174	290-0525-00			CAP., FXD, ELCTLT: 4.7UF, 20%, 50V	56289	196D475X0050KA1
C1176	283-0220-00			CAP., FXD, CER DI: 0.01UF, 20%, 50V	72982	8121N075X7R0103M
C1180	283-0220-00			CAP., FXD, CER DI: 0.01UF, 20%, 50V	72982	8121N075X7R0103M
C1200	281-0662-00			CAP., FXD, CER DI: 10PF, +/-0.5PF, 500V	59660	301-000H3M0100D
C1204	283-0003-00			CAP., FXD, CER DI: 0.01UF, +80-20%, 150V	91418	SP103Z151-4R9
C1215	283-0003-00			CAP., FXD, CER DI: 0.01UF, +80-20%, 150V	91418	SP103Z151-4R9
C1217	290-0527-00			CAP., FXD, ELCTLT: 15UF, 20%, 20V	90201	TDC156M020FL
C1258	283-0003-00			CAP., FXD, CER DI: 0.01UF, +80-20%, 150V	91418	SP103Z151-4R9
C1284	290-0525-00			CAP., FXD, ELCTLT: 4.7UF, 20%, 50V	56289	196D475X0050KA1
C1295	283-0003-00			CAP., FXD, CER DI: 0.01UF, +80-20%, 150V	91418	SP103Z151-4R9
C1322	283-0180-00			CAP., FXD, CER DI: 5600PF, 20%, 200V	72982	8121N204 E 562M
C1330	283-0167-00			CAP., FXD, CER DI: 0.1UF, 10%, 100V	72982	8131N145X5R0104K
C1340	283-0167-00			CAP., FXD, CER DI: 0.1UF, 10%, 100V	72982	8131N145X5R0104K
C1380	283-0110-00			CAP., FXD, CER DI: 0.005UF, +80-20%, 150V	56289	19C242B
C1392	283-0003-00			CAP., FXD, CER DI: 0.01UF, +80-20%, 150V	91418	SP103Z151-4R9
C1394	283-0003-00			CAP., FXD, CER DI: 0.01UF, +80-20%, 150V	91418	SP103Z151-4R9
C1438	290-0536-00			CAP., FXD, ELCTLT: 10UF, 20%, 25V	90201	TDC106M025FL
C1440	285-0808-00			CAP., FXD, PLSTC: 0.1UF, 10%, 50V	56289	LP66A1A104K004
C1442	285-0862-00			CAP., FXD, PLSTC: 0.001, 10%, 100V	56289	410P10291
C1445	283-0003-00			CAP., FXD, CER DI: 0.01UF, +80-20%, 150V	91418	SP103Z151-4R9
C1462	281-0523-00			CAP., FXD, CER DI: 100PF, +/-20PF, 500V	72982	301-000U2M0101M
C1468	281-0524-00			CAP., FXD, CER DI: 150PF, +/-30PF, 500V	04222	7001-1381



Replaceable Electrical Parts—FG 504 (SN B040000 & up)

Ckt No.	Tektronix Part No.	Serial/Model No. Eff	Dscont	Name & Description	Mfr Code	Mfr Part Number
C1478	283-0003-00			CAP., FXD, CER DI: 0.01UF, +80-20%, 150V	91418	SP103Z151-4R9
C1492	281-0524-00			CAP., FXD, CER DI: 150PF, +/-30PF, 500V	04222	7001-1381
C1494	281-0543-00			CAP., FXD, CER DI: 270PF, 10%, 500V	72982	301055X5P271K
C1504	281-0662-00			CAP., FXD, CER DI: 10PF, +/-0.5PF, 500V	59660	301-000H3M0100D
C1520	283-0065-00			CAP., FXD, CER DI: 0.001UF, 5%, 100V	72982	805-518-Z5D0102J
C1608	283-0220-00			CAP., FXD, CER DI: 0.01UF, 20%, 50V	72982	8121N075X7R0103M
C1612	283-0001-00			CAP., FXD, CER DI: 0.005UF, +100-0%, 500V	72982	831-559E502P
C1630	290-0117-00			CAP., FXD, ELCTLT: 50UF, +75-10%, 50V	56289	30D506G050DD9
C1650	283-0001-00			CAP., FXD, CER DI: 0.005UF, +100-0%, 500V	72982	831-559E502P
C1661	283-0220-00			CAP., FXD, CER DI: 0.01UF, 20%, 50V	72982	8121N075X7R0103M
C1665	290-0117-00			CAP., FXD, ELCTLT: 50UF, +75-10%, 50V	56289	30D506G050DD9
C1670	290-0519-00			CAP., FXD, ELCTLT: 100UF, 20%, 20V	90201	TDC107M020WLD
C1671	283-0003-00			CAP., FXD, CER DI: 0.01UF, +80-20%, 150V	91418	SP103Z151-4R9
C1672	290-0519-00			CAP., FXD, ELCTLT: 100UF, 20%, 20V	90201	TDC107M020WLD
C1673	283-0003-00			CAP., FXD, CER DI: 0.01UF, +80-20%, 150V	91418	SP103Z151-4R9
C1676	283-0220-00			CAP., FXD, CER DI: 0.01UF, 20%, 50V	72982	8121N075X7R0103M
C1680	290-0786-00			CAP., FXD, ELCTLT: 1500UF, +50-10%, 75VDC	56289	39D793
C1682	290-0786-00			CAP., FXD, ELCTLT: 1500UF, +50-10%, 75VDC	56289	39D793
C1690	290-0415-00			CAP., FXD, ELCTLT: 5.6UF, 10%, 35V	56289	150D565X9035B2
C1694	290-0415-00			CAP., FXD, ELCTLT: 5.6UF, 10%, 35V	56289	150D565X9035B2
C1720	283-0001-00			CAP., FXD, CER DI: 0.005UF, +100-0%, 500V	72982	831-559E502P
C1730	290-0117-00			CAP., FXD, ELCTLT: 50UF, +75-10%, 50V	56289	30D506G050DD9
C1750	283-0001-00			CAP., FXD, CER DI: 0.005UF, +100-0%, 500V	72982	831-559E502P
C1761	283-0220-00			CAP., FXD, CER DI: 0.01UF, 20%, 50V	72982	8121N075X7R0103M
C1765	290-0117-00			CAP., FXD, ELCTLT: 50UF, +75-10%, 50V	56289	30D506G050DD9
C1770	290-0525-00			CAP., FXD, ELCTLT: 4.7UF, 20%, 50V	56289	196D475X0050KA1
C1774	290-0525-00			CAP., FXD, ELCTLT: 4.7UF, 20%, 50V	56289	196D475X0050KA1
C1776	283-0220-00			CAP., FXD, CER DI: 0.01UF, 20%, 50V	72982	8121N075X7R0103M
C1778	290-0525-00			CAP., FXD, ELCTLT: 4.7UF, 20%, 50V	56289	196D475X0050KA1
C1800	290-0525-00			CAP., FXD, ELCTLT: 4.7UF, 20%, 50V	56289	196D475X0050KA1
CR20	152-0141-02			SEMICONV DEVICE: SILICON, 30V, 150MA	01295	1N4152R
CR21	152-0141-02			SEMICONV DEVICE: SILICON, 30V, 150MA	01295	1N4152R
CR85	152-0141-02			SEMICONV DEVICE: SILICON, 30V, 150MA	01295	1N4152R
CR108	152-0141-02			SEMICONV DEVICE: SILICON, 30V, 150MA	01295	1N4152R
CR180	152-0322-00			SEMICONV DEVICE: SILICON, 15V, HOT CARRIER	50434	5082-2672
CR182	152-0322-00			SEMICONV DEVICE: SILICON, 15V, HOT CARRIER	50434	5082-2672
CR184	152-0322-00			SEMICONV DEVICE: SILICON, 15V, HOT CARRIER	50434	5082-2672
CR186	152-0322-00			SEMICONV DEVICE: SILICON, 15V, HOT CARRIER	50434	5082-2672
CR188	152-0322-00			SEMICONV DEVICE: SILICON, 15V, HOT CARRIER	50434	5082-2672
CR190	152-0322-00			SEMICONV DEVICE: SILICON, 15V, HOT CARRIER	50434	5082-2672
CR218	152-0141-02			SEMICONV DEVICE: SILICON, 30V, 150MA	01295	1N4152R
CR220	152-0141-02			SEMICONV DEVICE: SILICON, 30V, 150MA	01295	1N4152R
CR352	152-0322-00			SEMICONV DEVICE: SILICON, 15V, HOT CARRIER	50434	5082-2672
CR356	152-0322-00			SEMICONV DEVICE: SILICON, 15V, HOT CARRIER	50434	5082-2672
CR462	152-0322-00			SEMICONV DEVICE: SILICON, 15V, HOT CARRIER	50434	5082-2672
CR470	152-0322-00			SEMICONV DEVICE: SILICON, 15V, HOT CARRIER	50434	5082-2672
CR556	152-0322-00			SEMICONV DEVICE: SILICON, 15V, HOT CARRIER	50434	5082-2672
CR558	152-0322-00			SEMICONV DEVICE: SILICON, 15V, HOT CARRIER	50434	5082-2672
CR560	152-0141-02			SEMICONV DEVICE: SILICON, 30V, 150MA	01295	1N4152R
CR562	152-0141-02			SEMICONV DEVICE: SILICON, 30V, 150MA	01295	1N4152R
CR564	152-0322-00			SEMICONV DEVICE: SILICON, 15V, HOT CARRIER	50434	5082-2672
CR566	152-0322-00			SEMICONV DEVICE: SILICON, 15V, HOT CARRIER	50434	5082-2672
CR632	152-0141-02			SEMICONV DEVICE: SILICON, 30V, 150MA	01295	1N4152R
CR745	152-0322-01			SEMICONV DEVICE: SET OF 16, MATCHED FOR VF	21847	A2X600A
CR746	152-0322-01			SEMICONV DEVICE: SET OF 16, MATCHED FOR VF	21847	A2X600A
CR747	152-0322-01			SEMICONV DEVICE: SET OF 16, MATCHED FOR VF	21847	A2X600A
CR748	152-0322-01			SEMICONV DEVICE: SET OF 16, MATCHED FOR VF	21847	A2X600A
CR750	152-0322-01			SEMICONV DEVICE: SET OF 16, MATCHED FOR VF	21847	A2X600A

Replaceable Electrical Parts—FG 504 (SN B040000 & up)

Ckt No.	Tektronix Part No.	Serial/Model No. Eff	Dscont	Name & Description	Mfr Code	Mfr Part Number
CR751	152-0322-01			SEMICON D DEVICE:SET OF 16,MATCHED FOR VF	21847	A2X600A
CR752	152-0322-01			SEMICON D DEVICE:SET OF 16,MATCHED FOR VF	21847	A2X600A
CR753	152-0322-01			SEMICON D DEVICE:SET OF 16,MATCHED FOR VF	21847	A2X600A
CR755	152-0322-01			SEMICON D DEVICE:SET OF 16,MATCHED FOR VF	21847	A2X600A
CR756	152-0322-01			SEMICON D DEVICE:SET OF 16,MATCHED FOR VF	21847	A2X600A
CR757	152-0322-01			SEMICON D DEVICE:SET OF 16,MATCHED FOR VF	21847	A2X600A
CR758	152-0322-01			SEMICON D DEVICE:SET OF 16,MATCHED FOR VF	21847	A2X600A
CR762	152-0322-01			SEMICON D DEVICE:SET OF 16,MATCHED FOR VF	21847	A2X600A
CR763	152-0322-01			SEMICON D DEVICE:SET OF 16,MATCHED FOR VF	21847	A2X600A
CR764	152-0322-01			SEMICON D DEVICE:SET OF 16,MATCHED FOR VF	21847	A2X600A
CR765	152-0322-01			SEMICON D DEVICE:SET OF 16,MATCHED FOR VF	21847	A2X600A
CR825	152-0141-02			SEMICON D DEVICE:SILICON,30V,150MA	01295	1N4152R
CR826	152-0141-02			SEMICON D DEVICE:SILICON,30V,150MA	01295	1N4152R
CR842	152-0141-02			SEMICON D DEVICE:SILICON,30V,150MA	01295	1N4152R
CR942	152-0141-02			SEMICON D DEVICE:SILICON,30V,150MA	01295	1N4152R
CR943	152-0141-02			SEMICON D DEVICE:SILICON,30V,150MA	01295	1N4152R
CR960	152-0141-02			SEMICON D DEVICE:SILICON,30V,150MA	01295	1N4152R
CR962	152-0141-02			SEMICON D DEVICE:SILICON,30V,150MA	01295	1N4152R
CR1042	152-0141-02			SEMICON D DEVICE:SILICON,30V,150MA	01295	1N4152R
CR1043	152-0141-02			SEMICON D DEVICE:SILICON,30V,150MA	01295	1N4152R
CR1212	152-0141-02			SEMICON D DEVICE:SILICON,30V,150MA	01295	1N4152R
CR1225	152-0141-02			SEMICON D DEVICE:SILICON,30V,150MA	01295	1N4152R
CR1226	152-0141-02			SEMICON D DEVICE:SILICON,30V,150MA	01295	1N4152R
CR1235	152-0141-02			SEMICON D DEVICE:SILICON,30V,150MA	01295	1N4152R
CR1285	152-0141-02			SEMICON D DEVICE:SILICON,30V,150MA	01295	1N4152R
CR1286	152-0141-02			SEMICON D DEVICE:SILICON,30V,150MA	01295	1N4152R
CR1312	152-0141-02			SEMICON D DEVICE:SILICON,30V,150MA	01295	1N4152R
CR1370	152-0141-02			SEMICON D DEVICE:SILICON,30V,150MA	01295	1N4152R
CR1372	152-0141-02			SEMICON D DEVICE:SILICON,30V,150MA	01295	1N4152R
CR1420	152-0141-02			SEMICON D DEVICE:SILICON,30V,150MA	01295	1N4152R
CR1470	152-0141-02			SEMICON D DEVICE:SILICON,30V,150MA	01295	1N4152R
CR1600	152-0066-00			SEMICON D DEVICE:SILICON,400V,750MA	14433	LG4016
CR1608	152-0061-00			SEMICON D DEVICE:SILICON,175V,100MA	07263	FDH2161
CR1630	152-0066-00			SEMICON D DEVICE:SILICON,400V,750MA	14433	LG4016
CR1652	152-0141-02			SEMICON D DEVICE:SILICON,30V,150MA	01295	1N4152R
CR1665	152-0066-00			SEMICON D DEVICE:SILICON,400V,750MA	14433	LG4016
CR1676	152-0066-00			SEMICON D DEVICE:SILICON,400V,750MA	14433	LG4016
CR1680	152-0488-00			SEMICON D DEVICE:SILICON,200V,1500MA	04713	3N55 FAMILY
CR1682	152-0066-00			SEMICON D DEVICE:SILICON,400V,750MA	14433	LG4016
CR1684	152-0488-00			SEMICON D DEVICE:SILICON,200V,1500MA	04713	3N55 FAMILY
CR1686	152-0488-00			SEMICON D DEVICE:SILICON,200V,1500MA	04713	3N55 FAMILY
CR1700	152-0066-00			SEMICON D DEVICE:SILICON,400V,750MA	14433	LG4016
CR1711	152-0141-02			SEMICON D DEVICE:SILICON,30V,150MA	01295	1N4152R
CR1730	152-0066-00			SEMICON D DEVICE:SILICON,400V,750MA	14433	LG4016
CR1740	152-0141-02			SEMICON D DEVICE:SILICON,30V,150MA	01295	1N4152R
CR1752	152-0141-02			SEMICON D DEVICE:SILICON,30V,150MA	01295	1N4152R
CR1765	152-0066-00			SEMICON D DEVICE:SILICON,400V,750MA	14433	LG4016
CR1776	152-0066-00			SEMICON D DEVICE:SILICON,400V,750MA	14433	LG4016
CR1782	152-0066-00			SEMICON D DEVICE:SILICON,400V,750MA	14433	LG4016
DS50	150-1033-00			LT EMITTING DIO:YELLOW,585NM,40MA MAX	50434	HLMP 1401
DS720	150-1033-00			LT EMITTING DIO:YELLOW,585NM,40MA MAX	50434	HLMP 1401
DS1675	150-1029-00			LT EMITTING DIO:GREEN,565NM,35MA	53184	XC209G
F1120	159-0140-00			FUSE,WIRE LEAD:0.3A,125V,5 SEC	71400	MTH-5
F1615	159-0116-00	B040000	B057809	FUSE,CARTRIDGE:1A,125V,0.4 SEC,0.17 LEADS	75915	273001
F1615	159-0153-00	B057810		FUSE,WIRE LEAD:1.5A,125V,FAST BLOW	71400	GFA 1-1/2
F1616	159-0116-00	B040000	B057809	FUSE,CARTRIDGE:1A,125V,0.4 SEC,0.17 LEADS	75915	273001
F1616	159-0153-00	B057810		FUSE,WIRE LEAD:1.5A,125V,FAST BLOW	71400	GFA 1-1/2
F1715	159-0116-00	B040000	B057809	FUSE,CARTRIDGE:1A,125V,0.4 SEC,0.17 LEADS	75915	273001
F1715	159-0153-00	B057810		FUSE,WIRE LEAD:1.5A,125V,FAST BLOW	71400	GFA 1-1/2

Replaceable Electrical Parts—FG 504 (SN B040000 & up)

Ckt No.	Tektronix Part No.	Serial/Model No. Eff	Dscont	Name & Description	Mfr Code	Mfr Part Number
F1716	159-0116-00	B040000	B057809	FUSE, CARTRIDGE: 1A, 125V, 0.4 SEC, 0.17 LEADS	75915	273001
F1716	159-0153-00	B057810		FUSE, WIRE LEAD: 1.5A, 125V, FAST BLOW	71400	GFA 1-1/2
J20	131-0955-00			CONN, RCPT, ELEC: BNC, FEMALE	13511	31-279
J300	131-1003-00			CONN, RCPT, ELEC: CKT BD MT, 3 PRONG	80009	131-1003-00
J406	131-1003-00			CONN, RCPT, ELEC: CKT BD MT, 3 PRONG	80009	131-1003-00
J418	131-1003-00			CONN, RCPT, ELEC: CKT BD MT, 3 PRONG	80009	131-1003-00
J420	131-1315-00			CONN, RCPT, ELEC: BNC, FEMALE	80009	131-1315-00
J485	131-1003-00			CONN, RCPT, ELEC: CKT BD MT, 3 PRONG	80009	131-1003-00
J640	131-1003-00			CONN, RCPT, ELEC: CKT BD MT, 3 PRONG	80009	131-1003-00
J700	131-0955-00			CONN, RCPT, ELEC: BNC, FEMALE	13511	31-279
J730	131-1003-00			CONN, RCPT, ELEC: CKT BD MT, 3 PRONG	80009	131-1003-00
J732	131-1003-00			CONN, RCPT, ELEC: CKT BD MT, 3 PRONG	80009	131-1003-00
J735	131-1003-00			CONN, RCPT, ELEC: CKT BD MT, 3 PRONG	80009	131-1003-00
J900	131-1003-00			CONN, RCPT, ELEC: CKT BD MT, 3 PRONG	80009	131-1003-00
J1120	131-1003-00			CONN, RCPT, ELEC: CKT BD MT, 3 PRONG	80009	131-1003-00
J1125	131-1315-00			CONN, RCPT, ELEC: BNC, FEMALE	80009	131-1315-00
J1200	131-1315-00			CONN, RCPT, ELEC: BNC, FEMALE	80009	131-1315-00
J1201	131-1003-00			CONN, RCPT, ELEC: CKT BD MT, 3 PRONG	80009	131-1003-00
J1295	131-1003-00			CONN, RCPT, ELEC: CKT BD MT, 3 PRONG	80009	131-1003-00
J1370	131-0955-00			CONN, RCPT, ELEC: BNC, FEMALE	13511	31-279
J1520	131-0955-00			CONN, RCPT, ELEC: BNC, FEMALE	13511	31-279
L300	108-0552-00			COIL, RF: 80NH	80009	108-0552-00
L382	108-0330-00			COIL, RF: 0.4UH	80009	108-0330-00
L515	108-0733-00			COIL, RF: 113NH	80009	108-0733-00
L646	108-0509-00			COIL, RF: 2.45UH	80009	108-0509-00
L945	108-0181-01			COIL, RF: 0.2UH	80009	108-0181-01
L1045	108-0181-01			COIL, RF: 0.2UH	80009	108-0181-01
L1120	108-0237-00			COIL, RF: 80UH	80009	108-0237-00
L1130	108-0057-00			COIL, RF: 8.8UH	80009	108-0057-00
LR880	108-0520-00			COIL, RF: 2.2UH (WOUND ON A 10 OHM RES)	80009	108-0520-00
LR884	108-0520-00			COIL, RF: 2.2UH (WOUND ON A 10 OHM RES)	80009	108-0520-00
Q55	151-0188-00			TRANSISTOR: SILICON, PNP	04713	SPS6868K
Q65	151-0438-00			TRANSISTOR: SILICON, PNP, SEL FROM SPS6927	80009	151-0438-00
Q80	151-0438-00			TRANSISTOR: SILICON, PNP, SEL FROM SPS6927	80009	151-0438-00
Q90	151-0438-00			TRANSISTOR: SILICON, PNP, SEL FROM SPS6927	80009	151-0438-00
Q100	151-0367-00			TRANSISTOR: SILICON, NPN, SEL FROM 3571TP	01295	SKA6516
Q165	151-0188-00			TRANSISTOR: SILICON, PNP	04713	SPS6868K
Q170A, B	151-0232-00	B040000	B056331	TRANSISTOR: SILICON, NPN, DUAL	07263	SP12141
Q170A, B	151-0232-02	B056332		TRANSISTOR: SILICON, NPN	07263	SP14318
Q175	151-0190-00			TRANSISTOR: SILICON, NPN	07263	S032677
Q225	151-0188-00			TRANSISTOR: SILICON, PNP	04713	SPS6868K
Q230	151-0190-00			TRANSISTOR: SILICON, NPN	07263	S032677
Q255A, B	151-1032-00			TRANSISTOR: SILICON, FET, DUAL	17856	DN399
Q270	151-0438-00			TRANSISTOR: SILICON, PNP, SEL FROM SPS6927	80009	151-0438-00
Q280	151-0424-00			TRANSISTOR: SILICON, NPN	04713	SPS8246
Q285	151-0424-00			TRANSISTOR: SILICON, NPN	04713	SPS8246
Q295	151-0438-00			TRANSISTOR: SILICON, PNP, SEL FROM SPS6927	80009	151-0438-00
Q310	151-0447-00			TRANSISTOR: SILICON, NPN	80009	151-0447-00
Q395	151-0424-00			TRANSISTOR: SILICON, NPN	04713	SPS8246
Q406	151-0199-00			TRANSISTOR: SILICON, PNP	04713	SPS6866K
Q410	151-0424-00			TRANSISTOR: SILICON, NPN	04713	SPS8246
Q415	151-0199-00			TRANSISTOR: SILICON, PNP	04713	SPS6866K
Q450	151-0438-00			TRANSISTOR: SILICON, PNP, SEL FROM SPS6927	80009	151-0438-00
Q456	151-0424-00			TRANSISTOR: SILICON, NPN	04713	SPS8246
Q462	151-0199-00			TRANSISTOR: SILICON, PNP	04713	SPS6866K

Replaceable Electrical Parts—FG 504 (SN B040000 & up)

Ckt No.	Tektronix Part No.	Serial/Model No. Eff	Dscont	Name & Description	Mfr Code	Mfr Part Number
Q470	151-0424-00			TRANSISTOR: SILICON, NPN	04713	SPS8246
Q495	151-0424-00			TRANSISTOR: SILICON, NPN	04713	SPS8246
Q500	151-0424-00			TRANSISTOR: SILICON, NPN	04713	SPS8246
Q510	151-0221-00			TRANSISTOR: SILICON, PNP	04713	SPS246
Q530	151-0435-00			TRANSISTOR: SILICON, PNP	04713	SPS8335
Q540	151-0188-00			TRANSISTOR: SILICON, PNP	04713	SPS6868K
Q550	151-0221-00			TRANSISTOR: SILICON, PNP	04713	SPS246
Q570	151-0424-00			TRANSISTOR: SILICON, NPN	04713	SPS8246
Q580	151-0190-00			TRANSISTOR: SILICON, NPN	07263	S032677
Q600}	151-1042-00			SEMICONDC DVC SE: MATCHED PAIR FET	01295	SKA5390
Q610}						
Q615	151-0427-00			TRANSISTOR: SILICON, NPN	80009	151-0427-00
Q620	151-0427-00			TRANSISTOR: SILICON, NPN	80009	151-0427-00
Q640	151-0369-00			TRANSISTOR: SILICON, PNP	01295	SKA6664
Q720	151-0188-00			TRANSISTOR: SILICON, PNP	04713	SPS6868K
Q805	151-0221-00			TRANSISTOR: SILICON, PNP	04713	SPS246
Q825	151-0221-00			TRANSISTOR: SILICON, PNP	04713	SPS246
Q830	151-0190-00			TRANSISTOR: SILICON, NPN	07263	S032677
Q835	151-0220-00			TRANSISTOR: SILICON, PNP	07263	S036228
Q840	151-0367-00			TRANSISTOR: SILICON, NPN, SEL FROM 3571TP	01295	SKA6516
Q930	151-0424-00			TRANSISTOR: SILICON, NPN	04713	SPS8246
Q940	151-0424-00			TRANSISTOR: SILICON, NPN	04713	SPS8246
Q950	151-0411-00			TRANSISTOR: SILICON, NPN	80009	151-0411-00
Q952	151-0285-01			TRANSISTOR: SILICON, PNP, SEL	80009	151-0285-01
Q970	151-0211-02			TRANSISTOR: SILICON, NPN, SEL	80009	151-0211-02
Q980	151-0211-02			TRANSISTOR: SILICON, NPN, SEL	80009	151-0211-02
Q1030	151-0438-00			TRANSISTOR: SILICON, PNP, SEL FROM SPS6927	80009	151-0438-00
Q1040	151-0438-00			TRANSISTOR: SILICON, PNP, SEL FROM SPS6927	80009	151-0438-00
Q1050	151-0450-00			TRANSISTOR: SILICON, PNP, SEL FROM 2N5583	80009	151-0450-00
Q1052	151-0211-02			TRANSISTOR: SILICON, NPN, SEL	80009	151-0211-02
Q1070	151-0285-01			TRANSISTOR: SILICON, PNP, SEL	80009	151-0285-01
Q1080	151-0285-01			TRANSISTOR: SILICON, PNP, SEL	80009	151-0285-01
Q1150	151-0347-00			TRANSISTOR: SILICON, NPN	56289	2N5551
Q1160	151-0440-00			TRANSISTOR: SILICON, PNP	03508	X41E603
Q1170	151-0350-00			TRANSISTOR: SILICON, PNP	04713	SPS6700
Q1180	151-0439-00			TRANSISTOR: SILICON, NPN	80009	151-0439-00
Q1220	151-0190-00			TRANSISTOR: SILICON, NPN	07263	S032677
Q1245	151-0367-00			TRANSISTOR: SILICON, NPN, SEL FROM 3571TP	01295	SKA6516
Q1250	151-0367-00			TRANSISTOR: SILICON, NPN, SEL FROM 3571TP	01295	SKA6516
Q1254	151-0367-00			TRANSISTOR: SILICON, NPN, SEL FROM 3571TP	01295	SKA6516
Q1260	151-0221-00			TRANSISTOR: SILICON, PNP	04713	SPS246
Q1262	151-0221-00			TRANSISTOR: SILICON, PNP	04713	SPS246
Q1280	151-0134-00			TRANSISTOR: SILICON, PNP	80009	151-0134-00
Q1400	151-0190-00			TRANSISTOR: SILICON, NPN	07263	S032677
Q1410	151-0190-00			TRANSISTOR: SILICON, NPN	07263	S032677
Q1420	151-0188-00			TRANSISTOR: SILICON, PNP	04713	SPS6868K
Q1430	151-1021-00			TRANSISTOR: SILICON, JFE	17856	FN815
Q1450	151-0190-00			TRANSISTOR: SILICON, NPN	07263	S032677
Q1610	151-0347-00			TRANSISTOR: SILICON, NPN	56289	2N5551
Q1620	151-0350-00			TRANSISTOR: SILICON, PNP	04713	SPS6700
Q1621	151-0350-00			TRANSISTOR: SILICON, PNP	04713	SPS6700
Q1622	151-0462-00			TRANSISTOR: SILICON, PNP	04713	TIP30C
Q1640	151-0347-00			TRANSISTOR: SILICON, NPN	56289	2N5551
Q1642	151-0347-00			TRANSISTOR: SILICON, NPN	56289	2N5551
Q1650	151-0350-00			TRANSISTOR: SILICON, PNP	04713	SPS6700
Q1652	151-0350-00			TRANSISTOR: SILICON, PNP	04713	SPS6700
Q1660	151-0462-00			TRANSISTOR: SILICON, PNP	04713	TIP30C

Replaceable Electrical Parts—FG 504 (SN B040000 & up)

Ckt No.	Tektronix Part No.	Serial/Model No. Eff Dscont	Name & Description	Mfr Code	Mfr Part Number
Q1677	151-0515-01		SCR: SILICON	04713	2N4441
Q1710	151-0350-00		TRANSISTOR: SILICON, PNP	04713	SPS6700
Q1715	151-0350-00		TRANSISTOR: SILICON, PNP	04713	SPS6700
Q1720	151-0347-00		TRANSISTOR: SILICON, NPN	56289	2N5551
Q1721	151-0347-00		TRANSISTOR: SILICON, NPN	56289	2N5551
Q1722	151-0439-00		TRANSISTOR: SILICON, NPN	80009	151-0439-00
Q1740	151-0350-00		TRANSISTOR: SILICON, PNP	04713	SPS6700
Q1742	151-0350-00		TRANSISTOR: SILICON, PNP	04713	SPS6700
Q1750	151-0347-00		TRANSISTOR: SILICON, NPN	56289	2N5551
Q1752	151-0347-00		TRANSISTOR: SILICON, NPN	56289	2N5551
Q1760	151-0439-00		TRANSISTOR: SILICON, NPN	80009	151-0439-00
Q1776	151-0350-00		TRANSISTOR: SILICON, PNP	04713	SPS6700
Q1777	151-0515-01		SCR: SILICON	04713	2N4441
R5	311-1799-00		RES., VAR, WW: 2 X 10K OHM, 5%, 1W	32997	3540S-591-103103
	-----		(R5 FURNISHED AS A UNIT WITH R125)		
R8	321-0281-00		RES., FXD, FILM: 8.25K OHM, 1%, 0.125W	91637	MFF1816G82500F
R10	311-1267-00		RES., VAR, NONWIR: 5K OHM, 10%, 0.50W	32997	3329P-L58-502
R12	315-0363-00		RES., FXD, CMPSN: 36K OHM, 5%, 0.25W	01121	CB3635
R14	321-0289-00		RES., FXD, FILM: 10K OHM, 1%, 0.125W	91637	MFF1816G10001F
R20	321-0289-00		RES., FXD, FILM: 10K OHM, 1%, 0.125W	91637	MFF1816G10001F
R23	315-0202-00		RES., FXD, CMPSN: 2K OHM, 5%, 0.25W	01121	CB2025
R25	315-0432-00		RES., FXD, CMPSN: 4.3K OHM, 5%, 0.25W	01121	CB4325
R28	321-0276-00		RES., FXD, FILM: 7.32K OHM, 1%, 0.125W	91637	MFF1816G73200F
R30	321-0288-00		RES., FXD, FILM: 9.76K OHM, 1%, 0.125W	91637	MFF1816G97600F
R32	321-0289-00		RES., FXD, FILM: 10K OHM, 1%, 0.125W	91637	MFF1816G10001F
R34	321-0289-00		RES., FXD, FILM: 10K OHM, 1%, 0.125W	91637	MFF1816G10001F
R36	321-0289-00		RES., FXD, FILM: 10K OHM, 1%, 0.125W	91637	MFF1816G10001F
R38	321-0289-00		RES., FXD, FILM: 10K OHM, 1%, 0.125W	91637	MFF1816G10001F
R42	321-0289-00		RES., FXD, FILM: 10K OHM, 1%, 0.125W	91637	MFF1816G10001F
R45	321-0289-00		RES., FXD, FILM: 10K OHM, 1%, 0.125W	91637	MFF1816G10001F
R50	311-1851-00		RES., VAR, NONWIR: 15K OHM, 1W	01121	14M212
	-----		(R50 FURNISHED AS A UNIT WITH S50)		
R51	315-0102-00		RES., FXD, CMPSN: 1K OHM, 5%, 0.25W	01121	CB1025
R52	311-1567-00		RES., VAR, NONWIR: TRMR, 100 OHM, 0.50W	73138	91-89-0
R54	322-0170-00		RES., FXD, FILM: 576 OHM, 1%, 0.25W	75042	CEBTO-5760F
R58	317-0100-00		RES., FXD, CMPSN: 10 OHM, 5%, 0.125W	01121	BB1005
R65	321-0161-00		RES., FXD, FILM: 464 OHM, 1%, 0.125W	91637	MFF1816G464R0F
R68	321-0190-00		RES., FXD, FILM: 931 OHM, 1%, 0.125W	91637	MFF1816G931R0F
R70	315-0820-00		RES., FXD, CMPSN: 82 OHM, 5%, 0.25W	01121	CB8205
R72	315-0330-00		RES., FXD, CMPSN: 33 OHM, 5%, 0.25W	01121	CB3305
R76	321-0190-00		RES., FXD, FILM: 931 OHM, 1%, 0.125W	91637	MFF1816G931R0F
R78	315-0100-00		RES., FXD, CMPSN: 10 OHM, 5%, 0.25W	01121	CB1005
R80	321-0161-00		RES., FXD, FILM: 464 OHM, 1%, 0.125W	91637	MFF1816G464R0F
R85	315-0153-00		RES., FXD, CMPSN: 15K OHM, 5%, 0.25W	01121	CB1535
R88	315-0300-00		RES., FXD, CMPSN: 30 OHM, 5%, 0.25W	01121	CB3005
R90	315-0752-00		RES., FXD, CMPSN: 7.5K OHM, 5%, 0.25W	01121	CB7525
R92	315-0271-00		RES., FXD, CMPSN: 270 OHM, 5%, 0.25W	01121	CB2715
R95	315-0100-00		RES., FXD, CMPSN: 10 OHM, 5%, 0.25W	01121	CB1005
R98	315-0100-00		RES., FXD, CMPSN: 10 OHM, 5%, 0.25W	01121	CB1005
R100	315-0271-00		RES., FXD, CMPSN: 270 OHM, 5%, 0.25W	01121	CB2715
R102	315-0752-00		RES., FXD, CMPSN: 7.5K OHM, 5%, 0.25W	01121	CB7525
R104	315-0300-00		RES., FXD, CMPSN: 30 OHM, 5%, 0.25W	01121	CB3005
R108	315-0153-00		RES., FXD, CMPSN: 15K OHM, 5%, 0.25W	01121	CB1535
R114	307-0108-00		RES., FXD, CMPSN: 6.8 OHM, 5%, 0.25W	80009	307-0108-00
R115	311-1564-00		RES., VAR, NONWIR: TRMR, 500 OHM, 0.5W	73138	91-86-0
R120	311-1835-00		RES., VAR, NONWIR: 100 OHM, 20%, 1W	01121	73M4G040L101M

Replaceable Electrical Parts—FG 504 (SN B040000 & up)

Ckt No.	Tektronix Part No.	Serial/Model No. Eff	Dscont	Name & Description	Mfr Code	Mfr Part Number
R125	311-1799-00			RES., VAR, WW: 2 X 10K OHM, 5%, 0.1W (R125 FURNISHED AS A UNIT WITH R5)	32997	3540S-591-103103
R128	311-1560-00			RES., VAR, NONWIR: 5K OHM, 20%, 0.50W	73138	91-82-0
R130	315-0222-00			RES., FXD, CMPSN: 2.2K OHM, 5%, 0.25W	01121	CB2225
R134	315-0512-00			RES., FXD, CMPSN: 5.1K OHM, 5%, 0.25W	01121	CB5125
R136	315-0200-00			RES., FXD, CMPSN: 20 OHM, 5%, 0.25W	01121	CB2005
R138	321-0318-00			RES., FXD, FILM: 20K OHM, 1%, 0.125W	91637	MFF1816G20001F
R140	315-0392-00			RES., FXD, CMPSN: 3.9K OHM, 5%, 0.25W	01121	CB3925
R143	321-0242-00			RES., FXD, FILM: 3.24K OHM, 1%, 0.125W	91637	MFF1816G32400F
R145	311-1562-00			RES., VAR, NONWIR: 2K OHM, 20%, 0.50W	73138	91-84-0
R147	321-0247-00			RES., FXD, FILM: 3.65K OHM, 1%, 0.125W	91637	MFF1816G36500F
R150	321-0289-00			RES., FXD, FILM: 10K OHM, 1%, 0.125W	91637	MFF1816G10001F
R155	311-1559-00			RES., VAR, NONWIR: 10K OHM, 20%, 0.50W	73138	91-81-0
R158	321-0289-00			RES., FXD, FILM: 10K OHM, 1%, 0.125W	91637	MFF1816G10001F
R160	321-0289-00			RES., FXD, FILM: 10K OHM, 1%, 0.125W	91637	MFF1816G10001F
R162	322-0172-00			RES., FXD, FILM: 604 OHM, 1%, 0.25W	75042	CEBT0-6040F
R165	315-0151-00			RES., FXD, CMPSN: 150 OHM, 5%, 0.25W	01121	CB1515
R170	322-0172-00			RES., FXD, FILM: 604 OHM, 1%, 0.25W	75042	CEBT0-6040F
R172	322-0172-00			RES., FXD, FILM: 604 OHM, 1%, 0.25W	75042	CEBT0-6040F
R175	317-0100-00			RES., FXD, CMPSN: 10 OHM, 5%, 0.125W	01121	BB1005
R195	315-0100-00			RES., FXD, CMPSN: 10 OHM, 5%, 0.25W	01121	CB1005
R200	307-0111-00			RES., FXD, CMPSN: 3.6 OHM, 5%, 0.25W	01121	CB36G5
R202	321-0054-00			RES., FXD, FILM: 35.7 OHM, 5%, 0.125W	91637	MFF1816G35R70F
R204	321-0150-00			RES., FXD, FILM: 357 OHM, 1%, 0.125W	91637	MFF1816G357ROF
R206	321-0246-00			RES., FXD, FILM: 3.57K OHM, 1%, 0.125W	91637	MFF1816G35700F
R208	321-0342-00			RES., FXD, FILM: 35.7K OHM, 1%, 0.125W	91637	MFF1816G35701F
R210	321-0438-00			RES., FXD, FILM: 357K OHM, 1%, 0.125W	91637	MFF1816G35702F
R212	315-0512-00			RES., FXD, CMPSN: 5.1K OHM, 5%, 0.25W	01121	CB5125
R215	311-1559-00			RES., VAR, NONWIR: 10K OHM, 20%, 0.50W	73138	91-81-0
R220	315-0512-00			RES., FXD, CMPSN: 5.1K OHM, 5%, 0.25W	01121	CB5125
R225	315-0150-00			RES., FXD, CMPSN: 15 OHM, 5%, 0.25W	01121	CB1505
R228	315-0150-00			RES., FXD, CMPSN: 15 OHM, 5%, 0.25W	01121	CB1505
R235	315-0100-00			RES., FXD, CMPSN: 10 OHM, 5%, 0.25W	01121	CB1005
R250	315-0200-00			RES., FXD, CMPSN: 20 OHM, 5%, 0.25W	01121	CB2005
R252	315-0510-00			RES., FXD, CMPSN: 51 OHM, 5%, 0.25W	01121	CB5105
R255	315-0431-00			RES., FXD, CMPSN: 430 OHM, 5%, 0.25W	01121	CB4315
R258	315-0220-00			RES., FXD, CMPSN: 22 OHM, 5%, 0.25W	01121	CB2205
R260	315-0220-00			RES., FXD, CMPSN: 22 OHM, 5%, 0.25W	01121	CB2205
R262	315-0431-00			RES., FXD, CMPSN: 430 OHM, 5%, 0.25W	01121	CB4315
R265	315-0120-00			RES., FXD, CMPSN: 12 OHM, 5%, 0.25W	01121	CB1205
R270	315-0102-00			RES., FXD, CMPSN: 1K OHM, 5%, 0.25W	01121	CB1025
R271	321-0054-00			RES., FXD, FILM: 35.7 OHM, 5%, 0.125W	91637	MFF1816G35R70F
R272	321-0223-00			RES., FXD, FILM: 2.05K OHM, 1%, 0.125W	91637	MFF1816G20500F
R275	315-0100-00			RES., FXD, CMPSN: 10 OHM, 5%, 0.25W	01121	CB1005
R280	321-0001-00			RES., FXD, FILM: 10 OHM, 1%, 0.125W	75042	CEAT0-10R00F
R285	315-0102-00			RES., FXD, CMPSN: 1K OHM, 5%, 0.25W	01121	CB1025
R287	321-0054-00			RES., FXD, FILM: 35.7 OHM, 5%, 0.125W	91637	MFF1816G35R70F
R288	321-0223-00			RES., FXD, FILM: 2.05K OHM, 1%, 0.125W	91637	MFF1816G20500F
R290	315-0100-00			RES., FXD, CMPSN: 10 OHM, 5%, 0.25W	01121	CB1005
R295	321-0001-00			RES., FXD, FILM: 10 OHM, 1%, 0.125W	75042	CEAT0-10R00F
R300	307-0093-00			RES., FXD, CMPSN: 1.2 OHM, 5%, 0.50W	01121	EB12G5
R315	301-0122-00			RES., FXD, CMPSN: 1.2K OHM, 5%, 0.50W	01121	EB1225
R317	315-0200-00			RES., FXD, CMPSN: 20 OHM, 5%, 0.25W	01121	CB2005
R322	321-0145-00			RES., FXD, FILM: 316 OHM, 1%, 0.125W	91637	MFF1816G316ROF
R325	315-0470-00			RES., FXD, CMPSN: 47 OHM, 5%, 0.25W	01121	CB4705
R327	315-0101-00			RES., FXD, CMPSN: 100 OHM, 5%, 0.25W	01121	CB1015
R329	315-0122-00			RES., FXD, CMPSN: 1.2K OHM, 5%, 0.25W	01121	CB1225

Replaceable Electrical Parts—FG 504 (SN B040000 & up)

Ckt No.	Tektronix Part No.	Serial/Model No. Eff Dscont	Name & Description	Mfr Code	Mfr Part Number
R331	315-0513-00		RES., FXD, CMPSN: 51K OHM, 5%, 0.25W	01121	CB5135
R336	321-0145-00		RES., FXD, FILM: 316 OHM, 1%, 0.125W	91637	MFF1816G316ROF
R340	315-0470-00		RES., FXD, CMPSN: 47 OHM, 5%, 0.25W	01121	CB4705
R342	315-0101-00		RES., FXD, CMPSN: 100 OHM, 5%, 0.25W	01121	CB1015
R344	315-0122-00		RES., FXD, CMPSN: 1.2K OHM, 5%, 0.25W	01121	CB1225
R346	315-0513-00		RES., FXD, CMPSN: 51K OHM, 5%, 0.25W	01121	CB5135
R350	321-0249-00		RES., FXD, FILM: 3.83K OHM, 1%, 0.125W	91637	MFF1816G38300F
R352	321-0145-00		RES., FXD, FILM: 316 OHM, 1%, 0.125W	91637	MFF1816G316ROF
R356	321-0145-00		RES., FXD, FILM: 316 OHM, 1%, 0.125W	91637	MFF1816G316ROF
R358	321-0248-00		RES., FXD, FILM: 3.74K OHM, 1%, 0.125W	91637	MFF1816G37400F
	-----		(NOMINAL VALUE, SELECTED)		
R360	311-1564-00		RES., VAR, NONWIR: TRMR, 500 OHM, 0.5W	73138	91-86-0
R363	321-0289-00		RES., FXD, FILM: 10K OHM, 1%, 0.125W	91637	MFF1816G10001F
R365	311-1564-00		RES., VAR, NONWIR: TRMR, 500 OHM, 0.5W	73138	91-86-0
R367	321-0208-00		RES., FXD, FILM: 1.43K OHM, 1%, 0.125W	91637	MFF1816G14300F
R370	315-0330-00		RES., FXD, CMPSN: 33 OHM, 5%, 0.25W	01121	CB3305
R372	315-0330-00		RES., FXD, CMPSN: 33 OHM, 5%, 0.25W	01121	CB3305
R375	315-0750-00		RES., FXD, CMPSN: 75 OHM, 5%, 0.25W	01121	CB7505
R380	315-0820-00		RES., FXD, CMPSN: 82 OHM, 5%, 0.25W	01121	CB8205
R382	315-0820-00		RES., FXD, CMPSN: 82 OHM, 5%, 0.25W	01121	CB8205
R385	315-0102-00		RES., FXD, CMPSN: 1K OHM, 5%, 0.25W	01121	CB1025
R387	315-0100-00		RES., FXD, CMPSN: 10 OHM, 5%, 0.25W	01121	CB1005
R390	315-0102-00		RES., FXD, CMPSN: 1K OHM, 5%, 0.25W	01121	CB1025
R395	315-0121-00		RES., FXD, CMPSN: 120 OHM, 5%, 0.25W	01121	CB1215
R397	315-0200-00		RES., FXD, CMPSN: 20 OHM, 5%, 0.25W	01121	CB2005
R398	315-0561-00		RES., FXD, CMPSN: 560 OHM, 5%, 0.25W	01121	CB5615
R400	301-0131-00		RES., FXD, CMPSN: 130 OHM, 5%, 0.50W	01121	EB1315
R402	315-0100-00		RES., FXD, CMPSN: 10 OHM, 5%, 0.25W	01121	CB1005
R406	315-0910-00		RES., FXD, CMPSN: 91 OHM, 5%, 0.25W	01121	CB9105
R409	315-0240-00		RES., FXD, CMPSN: 24 OHM, 5%, 0.25W	01121	CB2405
R410	315-0200-00		RES., FXD, CMPSN: 20 OHM, 5%, 0.25W	01121	CB2005
R412	315-0561-00		RES., FXD, CMPSN: 560 OHM, 5%, 0.25W	01121	CB5615
R415	315-0100-00		RES., FXD, CMPSN: 10 OHM, 5%, 0.25W	01121	CB1005
R417	315-0560-00		RES., FXD, CMPSN: 56 OHM, 5%, 0.25W	01121	CB5605
R419	321-0068-00		RES., FXD, FILM: 49.9 OHM, 1%, 0.125W	91637	MFF1816G49R90F
R420	315-0101-00		RES., FXD, CMPSN: 100 OHM, 5%, 0.25W	01121	CB1015
R450	315-0240-00		RES., FXD, CMPSN: 24 OHM, 5%, 0.25W	01121	CB2405
R452	315-0201-00		RES., FXD, CMPSN: 200 OHM, 5%, 0.25W	01121	CB2015
R454	315-0152-00		RES., FXD, CMPSN: 1.5K OHM, 5%, 0.25W	01121	CB1525
R456	315-0331-00		RES., FXD, CMPSN: 330 OHM, 5%, 0.25W	01121	CB3315
R458	301-0362-00		RES., FXD, CMPSN: 3.6K OHM, 5%, 0.50W	01121	EB3625
R462	323-0172-00		RES., FXD, FILM: 604 OHM, 1%, 0.50W	91637	MFF1226G604ROF
R465	315-0472-00		RES., FXD, CMPSN: 4.7K OHM, 5%, 0.25W	01121	CB4725
R470	323-0172-00		RES., FXD, FILM: 604 OHM, 1%, 0.50W	91637	MFF1226G604ROF
R475	315-0100-00		RES., FXD, CMPSN: 10 OHM, 5%, 0.25W	01121	CB1005
R480	315-0100-00		RES., FXD, CMPSN: 10 OHM, 5%, 0.25W	01121	CB1005
R490	317-0510-00		RES., FXD, CMPSN: 51 OHM, 5%, 0.125W	01121	BB5105
R494	317-0510-00		RES., FXD, CMPSN: 51 OHM, 5%, 0.125W	01121	BB5105
R496	301-0681-00		RES., FXD, CMPSN: 680 OHM, 5%, 0.50W	01121	EB6815
R498	317-0510-00		RES., FXD, CMPSN: 51 OHM, 5%, 0.125W	01121	BB5105
R500	315-0431-00		RES., FXD, CMPSN: 430 OHM, 5%, 0.25W	01121	CB4315
R512	315-0132-00		RES., FXD, CMPSN: 1.3K OHM, 5%, 0.25W	01121	CB1325
R515	315-0111-00		RES., FXD, CMPSN: 110 OHM, 5%, 0.25W	01121	CB1115
R520	311-1373-00		RES., VAR, NONWIR: 5K OHM, 20%, 1W	01121	73U4G040L502M
R522	321-0222-00		RES., FXD, FILM: 2K OHM, 1%, 0.125W	91637	MFF1816G20000F
R524	321-0250-00		RES., FXD, FILM: 3.92K OHM, 1%, 0.125W	91637	MFF1816G39200F
R526	321-0335-00		RES., FXD, FILM: 30.1K OHM, 1%, 0.125W	91637	MFF1816G30101F

Replaceable Electrical Parts—FG 504 (SN B040000 & up)

Ckt No.	Tektronix Part No.	Serial/Model No. Eff	Dscont	Name & Description	Mfr Code	Mfr Part Number
R528	315-0162-00			RES., FXD, CMPSN: 1.6K OHM, 5%, 0.25W	01121	CB1625
R530	321-0222-00			RES., FXD, FILM: 2K OHM, 1%, 0.125W	91637	MFF1816G20000F
R536	321-0371-00			RES., FXD, FILM: 71.5K OHM, 1%, 0.125W	91637	MFF1816G71501F
R538	321-0276-00			RES., FXD, FILM: 7.32K OHM, 1%, 0.125W	91637	MFF1816G73200F
R540	321-0184-00			RES., FXD, FILM: 806 OHM, 1%, 0.125W	91637	MFF1816G806ROF
R544	315-0220-00			RES., FXD, CMPSN: 22 OHM, 5%, 0.25W	01121	CB2205
R548	315-0220-00			RES., FXD, CMPSN: 22 OHM, 5%, 0.25W	01121	CB2205
R552	315-0103-00			RES., FXD, CMPSN: 10K OHM, 5%, 0.25W	01121	CB1035
R572	315-0220-00			RES., FXD, CMPSN: 22 OHM, 5%, 0.25W	01121	CB2205
R574	315-0103-00			RES., FXD, CMPSN: 10K OHM, 5%, 0.25W	01121	CB1035
R576	321-0222-00			RES., FXD, FILM: 2K OHM, 1%, 0.125W	91637	MFF1816G20000F
R580	315-0220-00			RES., FXD, CMPSN: 22 OHM, 5%, 0.25W	01121	CB2205
R582	321-0184-00			RES., FXD, FILM: 806 OHM, 1%, 0.125W	91637	MFF1816G806ROF
R584	321-0276-00			RES., FXD, FILM: 7.32K OHM, 1%, 0.125W	91637	MFF1816G73200F
R586	321-0371-00			RES., FXD, FILM: 71.5K OHM, 1%, 0.125W	91637	MFF1816G71501F
R592	317-0100-00			RES., FXD, CMPSN: 10 OHM, 5%, 0.125W	01121	BB1005
R604	315-0361-00			RES., FXD, CMPSN: 360 OHM, 5%, 0.25W	01121	CB3615
R606	307-0106-00			RES., FXD, CMPSN: 4.7 OHM, 5%, 0.25W	01121	CB47C5
R610	311-1258-00			RES., VAR, NONWIR: 50 OHM, 10%, 0.50W	32997	3329P-L58-500
R612	315-0361-00			RES., FXD, CMPSN: 360 OHM, 5%, 0.25W	01121	CB3615
R615	321-0225-00			RES., FXD, FILM: 2.15K OHM, 1%, 0.125W	91637	MFF1816G21500F
R616	315-0510-00			RES., FXD, CMPSN: 51 OHM, 5%, 0.25W	01121	CB5105
R618	315-0111-00			RES., FXD, CMPSN: 110 OHM, 5%, 0.25W	01121	CB1115
R620	321-0225-00			RES., FXD, FILM: 2.15K OHM, 1%, 0.125W	91637	MFF1816G21500F
R622	315-0560-00			RES., FXD, CMPSN: 56 OHM, 5%, 0.25W	01121	CB5605
R625	315-0132-00			RES., FXD, CMPSN: 1.3K OHM, 5%, 0.25W	01121	CB1325
R630	311-1258-00	B040000	B058289	RES., VAR, NONWIR: 50 OHM, 10%, 0.50W	32997	3329P-L58-500
R630	311-1259-00	B058290		RES., VAR, NONWIR: 100 OHM, 10%, 0.50W	32997	3329P-L58-101
R632	315-0121-00	B040000	B058289	RES., FXD, CMPSN: 120 OHM, 5%, 0.25W	01121	CB1215
R632	315-0101-00	B058290		RES., FXD, CMPSN: 100 OHM, 5%, 0.25W	01121	CB1015
R640	315-0390-00			RES., FXD, CMPSN: 39 OHM, 5%, 0.25W	01121	CB3905
R641	311-1921-00			RES., VAR, NONWIR: 250 OHM, 10%, 0.50W	73138	72-191-0
R642	315-0152-00			RES., FXD, CMPSN: 1.5K OHM, 5%, 0.25W	01121	CB1525
R646	301-0561-00			RES., FXD, CMPSN: 560 OHM, 5%, 0.50W	01121	EB5615
R700	315-0103-00			RES., FXD, CMPSN: 10K OHM, 5%, 0.25W	01121	CB1035
R704	315-0103-00			RES., FXD, CMPSN: 10K OHM, 5%, 0.25W	01121	CB1035
R706	315-0395-00			RES., FXD, CMPSN: 3.9M OHM, 5%, 0.25W	01121	CB3955
R708	321-0371-00			RES., FXD, FILM: 71.5K OHM, 1%, 0.125W	91637	MFF1816G71501F
R710	321-0289-00			RES., FXD, FILM: 10K OHM, 1%, 0.125W	91637	MFF1816G10001F
R716	315-0752-00			RES., FXD, CMPSN: 7.5K OHM, 5%, 0.25W	01121	CB7525
R717	315-0122-00			RES., FXD, CMPSN: 1.2K OHM, 5%, 0.25W	01121	CB1225
R720	315-0102-00			RES., FXD, CMPSN: 1K OHM, 5%, 0.25W	01121	CB1025
R730	321-0771-01			RES., FXD, FILM: 50 OHM, 0.5%, 0.125W	91637	MFF1816G50R00D
R735	321-0771-01			RES., FXD, FILM: 50 OHM, 0.5%, 0.125W	91637	MFF1816G50R00D
R736	315-0101-00			RES., FXD, CMPSN: 100 OHM, 5%, 0.25W	01121	CB1015
R738	321-0082-00	B040000	B058499	RES., FXD, FILM: 69.8 OHM, 1%, 0.125W	91637	MFF1816G69R80F
R738	321-0078-00	B058450		RES., FXD, FILM: 63.4 OHM, 1%, 0.125W	91637	MFF1816G63R40F
R740	311-1175-00			RES., VAR, NONWIR: 100 OHM, 10%, 0.50W	73138	68WR100
R742	315-0100-00			RES., FXD, CMPSN: 10 OHM, 5%, 0.25W	01121	CB1005
R745	321-0289-00			RES., FXD, FILM: 10K OHM, 1%, 0.125W	91637	MFF1816G10001F
R746	315-0470-00			RES., FXD, CMPSN: 47 OHM, 5%, 0.25W	01121	CB4705
R747	321-0110-00			RES., FXD, FILM: 137 OHM, 1%, 0.125W	91637	MFF1816G137ROF
R749	321-0289-00			RES., FXD, FILM: 10K OHM, 1%, 0.125W	91637	MFF1816G10001F
R751	321-0307-00			RES., FXD, FILM: 15.4K OHM, 1%, 0.125W	91637	MFF1816G15401F
R753	321-0067-00			RES., FXD, FILM: 48.7 OHM, 1%, 0.125W	91637	MFF1816G48R70F
R755	321-0307-00			RES., FXD, FILM: 15.4K OHM, 1%, 0.125W	91637	MFF1816G15401F
R757	321-0304-00			RES., FXD, FILM: 14.3K OHM, 1%, 0.125W	91637	MFF1816G14301F
R759	321-0153-00			RES., FXD, FILM: 383 OHM, 1%, 0.125W	91637	MFF1816G383ROF
R761	321-0304-00			RES., FXD, FILM: 14.3K OHM, 1%, 0.125W	91637	MFF1816G14301F



Replaceable Electrical Parts—FG 504 (SN B040000 & up)

Ckt No.	Tektronix Part No.	Serial/Model No. Eff	Dscont	Name & Description	Mfr Code	Mfr Part Number
R763	321-0354-00			RES., FXD, FILM: 47.5K OHM, 1%, 0.125W	91637	MFF1816G47501F
R765	321-0117-00			RES., FXD, FILM: 162 OHM, 1%, 0.125W	91637	MFF1816G162R0F
R767	321-0354-00			RES., FXD, FILM: 47.5K OHM, 1%, 0.125W	91637	MFF1816G47501F
R770	315-0752-00			RES., FXD, CMPSN: 7.5K OHM, 5%, 0.25W	01121	CB7525
R775	315-0102-00			RES., FXD, CMPSN: 1K OHM, 5%, 0.25W	01121	CB1025
R777	315-0820-00			RES., FXD, CMPSN: 82 OHM, 5%, 0.25W	01121	CB8205
R780	315-0820-00			RES., FXD, CMPSN: 82 OHM, 5%, 0.25W	01121	CB8205
R784	321-0326-00			RES., FXD, FILM: 24.3K OHM, 1%, 0.125W	91637	MFF1816G24301F
R787	315-0100-00			RES., FXD, CMPSN: 10 OHM, 5%, 0.25W	01121	CB1005
R790	311-1555-00			RES., VAR, NONWIR: 100K OHM, 20%, 0.5W	73138	91-77-0
R793	315-0100-00			RES., FXD, CMPSN: 10 OHM, 5%, 0.25W	01121	CB1005
R795	321-0756-00			RES., FXD, FILM: 50K OHM, 1%, 0.125W	24546	NA55D5002F
R798	321-0135-00			RES., FXD, FILM: 249 OHM, 1%, 0.125W	91637	MFF1816G249R0F
R800	321-0164-00			RES., FXD, FILM: 499 OHM, 1%, 0.125W	91637	MFF1816G499R0F
R802	321-0214-00			RES., FXD, FILM: 1.65K OHM, 1%, 0.125W	91637	MFF1816G16500F
R805	321-0181-00			RES., FXD, FILM: 750 OHM, 1%, 0.125W	91637	MFF1816G750R0F
R807	315-0200-00			RES., FXD, CMPSN: 20 OHM, 5%, 0.25W	01121	CB2005
R810	321-0181-00			RES., FXD, FILM: 750 OHM, 1%, 0.125W	91637	MFF1816G750R0F
R818	321-0135-00			RES., FXD, FILM: 249 OHM, 1%, 0.125W	91637	MFF1816G249R0F
R820	321-0164-00			RES., FXD, FILM: 499 OHM, 1%, 0.125W	91637	MFF1816G499R0F
R822	321-0214-00			RES., FXD, FILM: 1.65K OHM, 1%, 0.125W	91637	MFF1816G16500F
R830	315-0150-00			RES., FXD, CMPSN: 15 OHM, 5%, 0.25W	01121	CB1505
R835	315-0150-00			RES., FXD, CMPSN: 15 OHM, 5%, 0.25W	01121	CB1505
R840	321-0106-00			RES., FXD, FILM: 124 OHM, 1%, 0.125W	91637	MFF1816G124R0F
R842	321-0106-00			RES., FXD, FILM: 124 OHM, 1%, 0.125W	91637	MFF1816G124R0F
R850	315-0133-00			RES., FXD, CMPSN: 13K OHM, 5%, 0.25W	01121	CB1335
R852	315-0202-00			RES., FXD, CMPSN: 2K OHM, 5%, 0.25W	01121	CB2025
R855	311-1567-00			RES., VAR, NONWIR: TRMR, 100 OHM, 0.50W	73138	91-89-0
R857	315-0241-00			RES., FXD, CMPSN: 240 OHM, 5%, 0.25W	01121	CB2415
R868	321-0235-00			RES., FXD, FILM: 2.74K OHM, 1%, 0.125W	91637	MFF1816G27400F
R870	311-1571-00			RES., VAR, NONWIR: 500 OHM, 0.50W	73138	91-91-0
R872	321-0235-00			RES., FXD, FILM: 2.74K OHM, 1%, 0.125W	91637	MFF1816G27400F
R900	321-0097-00			RES., FXD, FILM: 100 OHM, 1%, 0.125W	91637	MFF1816G100R0F
R914	315-0102-00			RES., FXD, CMPSN: 1K OHM, 5%, 0.25W	01121	CB1025
R920	321-0099-00			RES., FXD, FILM: 105 OHM, 1%, 0.125W	91637	MFF1816G105R0F
R922	315-0161-00			RES., FXD, CMPSN: 160 OHM, 5%, 0.25W	01121	CB1615
R924	315-0510-00			RES., FXD, CMPSN: 51 OHM, 5%, 0.25W	01121	CB5105
R928	301-0681-00			RES., FXD, CMPSN: 680 OHM, 5%, 0.50W	01121	EB6815
R930	317-0510-00			RES., FXD, CMPSN: 51 OHM, 5%, 0.125W	01121	BB5105
R936	301-0681-00			RES., FXD, CMPSN: 680 OHM, 5%, 0.50W	01121	EB6815
R938	315-0510-00			RES., FXD, CMPSN: 51 OHM, 5%, 0.25W	01121	CB5105
R942	321-0097-00			RES., FXD, FILM: 100 OHM, 1%, 0.125W	91637	MFF1816G100R0F
R945	321-0090-00			RES., FXD, FILM: 84.5 OHM, 1%, 0.125W	91637	MFF1816G84R50F
R947	315-0360-00			RES., FXD, CMPSN: 36 OHM, 5%, 0.25W	01121	CB3605
R950	311-1244-00			RES., VAR, NONWIR: 100 OHM, 10%, 0.50W	32997	3386X-T07-101
R952	321-0030-00			RES., FXD, FILM: 20 OHM, 1%, 0.125W	91637	MFF1816G20R00F
R958	SELECTED					
R960	321-0012-00			RES., FXD, FILM: 13 OHM, 1%, 0.125W	91637	MFF1816G13R00F
R965	315-0100-00			RES., FXD, CMPSN: 10 OHM, 5%, 0.25W	01121	CB1005
R970	315-0200-00			RES., FXD, CMPSN: 20 OHM, 5%, 0.25W	01121	CB2005
R974	308-0297-00			RES., FXD, WW: 24.7 OHM, 1%, 3W	91637	RS2B-K24R70F
R980	315-0200-00			RES., FXD, CMPSN: 20 OHM, 5%, 0.25W	01121	CB2005
R982	301-0100-00			RES., FXD, CMPSN: 10 OHM, 5%, 0.50W	01121	EB1005
R984	301-0100-00			RES., FXD, CMPSN: 10 OHM, 5%, 0.50W	01121	EB1005
R1015	311-1558-00			RES., VAR, NONWIR: 20K OHM, 20%, 0.50W	73138	91-80-0
R1016	315-0682-00			RES., FXD, CMPSN: 6.8K OHM, 5%, 0.25W	01121	CB6825
R1024	315-0510-00			RES., FXD, CMPSN: 51 OHM, 5%, 0.25W	01121	CB5105
R1028	301-0681-00			RES., FXD, CMPSN: 680 OHM, 5%, 0.50W	01121	EB6815

Replaceable Electrical Parts—FG 504 (SN B040000 & up)

Ckt No.	Tektronix Part No.	Serial/Model No. Eff	Dscont	Name & Description	Mfr Code	Mfr Part Number
R1030	317-0510-00			RES., FXD, CMPSN: 51 OHM, 5%, 0.125W	01121	BB5105
R1036	301-0681-00			RES., FXD, CMPSN: 680 OHM, 5%, 0.50W	01121	EB6815
R1038	315-0510-00			RES., FXD, CMPSN: 51 OHM, 5%, 0.25W	01121	CB5105
R1042	321-0097-00			RES., FXD, FILM: 100 OHM, 1%, 0.125W	91637	MFF1816G100ROF
R1045	321-0090-00			RES., FXD, FILM: 84.5 OHM, 1%, 0.125W	91637	MFF1816G84R50F
R1047	315-0360-00			RES., FXD, CMPSN: 36 OHM, 5%, 0.25W	01121	CB3605
R1050	311-1244-00			RES., VAR, NONWIR: 100 OHM, 10%, 0.50W	32997	3386X-T07-101
R1052	321-0030-00			RES., FXD, FILM: 20 OHM, 1%, 0.125W	91637	MFF1816G20R00F
R1070	315-0200-00			RES., FXD, CMPSN: 20 OHM, 5%, 0.25W	01121	CB2005
R1074	308-0297-00			RES., FXD, WW: 24.7 OHM, 1%, 3W	91637	RS2B-K24R70F
R1080	315-0200-00			RES., FXD, CMPSN: 20 OHM, 5%, 0.25W	01121	CB2005
R1082	301-0100-00			RES., FXD, CMPSN: 10 OHM, 5%, 0.50W	01121	EB1005
R1084	301-0100-00			RES., FXD, CMPSN: 10 OHM, 5%, 0.50W	01121	EB1005
R1090	322-0215-00			RES., FXD, FILM: 1.69K OHM, 1%, 0.25W	75042	CEBTO-1691F
R1092	315-0100-00			RES., FXD, CMPSN: 10 OHM, 5%, 0.25W	01121	CB1005
R1096	305-0101-00			RES., FXD, CMPSN: 100 OHM, 5%, 2W	01121	HB1015
R1098	305-0101-00			RES., FXD, CMPSN: 100 OHM, 5%, 2W	01121	HB1015
R1100A, B	311-1775-00			RES., VAR, NONWIR: 1.6K X 2.5K OHM, 15%, 0.50W	01121	68-77-0
R1102	323-0068-00			RES., FXD, FILM: 49.9 OHM, 1%, 0.50W	75042	CECTO-49R90F
R1104	323-0068-00			RES., FXD, FILM: 49.9 OHM, 1%, 0.50W	75042	CECTO-49R90F
R1110	307-1024-00			ATTENUATOR, FXD: 50 OHM, 10X	80009	307-1024-00
R1112	307-1024-00			ATTENUATOR, FXD: 50 OHM, 10X	80009	307-1024-00
R1114	307-1037-00			ATTENUATOR, FXD: 50 OHM, 10 DB	80009	307-1037-00
R1120	315-0102-00			RES., FXD, CMPSN: 1K OHM, 5%, 0.25W	01121	CB1025
R1122	315-0102-00			RES., FXD, CMPSN: 1K OHM, 5%, 0.25W	01121	CB1025
R1130	311-1851-00			RES., VAR, NONWIR: 15K OHM, 1W (FURNISHED AS A UNIT WITH S1130)	01121	14M212
R1132	321-0341-00			RES., FXD, FILM: 34.8K OHM, 1%, 0.125W	91637	MFF1816G34801F
R1134	321-0289-00			RES., FXD, FILM: 10K OHM, 1%, 0.125W	91637	MFF1816G10001F
R1136	321-0289-00			RES., FXD, FILM: 10K OHM, 1%, 0.125W	91637	MFF1816G10001F
R1138	321-0289-00			RES., FXD, FILM: 10K OHM, 1%, 0.125W	91637	MFF1816G10001F
R1140	311-1921-00			RES., VAR, NONWIR: 250 OHM, 10%, 0.50W	73138	72-191-0
R1142	321-0289-00			RES., FXD, FILM: 10K OHM, 1%, 0.125W	91637	MFF1816G10001F
R1146	315-0163-00			RES., FXD, CMPSN: 16K OHM, 5%, 0.25W	01121	CB1635
R1150	315-0102-00			RES., FXD, CMPSN: 1K OHM, 5%, 0.25W	01121	CB1025
R1154	315-0102-00			RES., FXD, CMPSN: 1K OHM, 5%, 0.25W	01121	CB1025
R1156	315-0101-00			RES., FXD, CMPSN: 100 OHM, 5%, 0.25W	01121	CB1015
R1160	308-0619-00			RES., VAR, WW: 37.0 OHM, 1%, 3W	91637	RS2B 37.0 OHM 1%
R1164	315-0823-00			RES., FXD, CMPSN: 82K OHM, 5%, 0.25W	01121	CB8235
R1174	315-0102-00			RES., FXD, CMPSN: 1K OHM, 5%, 0.25W	01121	CB1025
R1176	315-0101-00			RES., FXD, CMPSN: 100 OHM, 5%, 0.25W	01121	CB1015
R1180	308-0619-00			RES., VAR, WW: 37.0 OHM, 1%, 3W	91637	RS2B 37.0 OHM 1%
R1190	315-0303-00			RES., FXD, CMPSN: 30K OHM, 5%, 0.25W	01121	CB3035
R1200	315-0103-00			RES., FXD, CMPSN: 10K OHM, 5%, 0.25W	01121	CB1035
R1201	315-0392-00			RES., FXD, CMPSN: 3.9K OHM, 5%, 0.25W	01121	CB3925
R1202	315-0103-00			RES., FXD, CMPSN: 10K OHM, 5%, 0.25W	01121	CB1035
R1204	315-0432-00			RES., FXD, CMPSN: 4.3K OHM, 5%, 0.25W	01121	CB4325
R1210	311-1320-00	B040000	B058449	RES., VAR, NONWIR: 5K OHM, 1W, W/SW (FURNISHED AS A UNIT WITH S1210)	12697	381CM-39700
R1210	311-1320-01	B058450		RES., VAR, NONWIR: 5K OHM, 10%, 1W, SPST SW (FURNISHED AS A UNIT WITH S1210)	12697	CM43494
R1215	315-0511-00			RES., FXD, CMPSN: 510 OHM, 5%, 0.25W	01121	CB5115
R1217	315-0152-00			RES., FXD, CMPSN: 1.5K OHM, 5%, 0.25W	01121	CB1525
R1220	315-0470-00			RES., FXD, CMPSN: 47 OHM, 5%, 0.25W	01121	CB4705
R1222	315-0103-00			RES., FXD, CMPSN: 10K OHM, 5%, 0.25W	01121	CB1035
R1228	315-0511-00			RES., FXD, CMPSN: 510 OHM, 5%, 0.25W	01121	CB5115
R1230	315-0511-00			RES., FXD, CMPSN: 510 OHM, 5%, 0.25W	01121	CB5115
R1234	315-0470-00			RES., FXD, CMPSN: 47 OHM, 5%, 0.25W	01121	CB4705
R1240	315-0511-00			RES., FXD, CMPSN: 510 OHM, 5%, 0.25W	01121	CB5115

Replaceable Electrical Parts—FG 504 (SN B040000 & up)

Ckt No.	Tektronix Part No.	Serial/Model No. Eff	Dscont	Name & Description	Mfr Code	Mfr Part Number
R1242	315-0511-00			RES., FXD, CMPSN: 510 OHM, 5%, 0.25W	01121	CB5115
R1245	315-0561-00			RES., FXD, CMPSN: 560 OHM, 5%, 0.25W	01121	CB5615
R1250	315-0121-00			RES., FXD, CMPSN: 120 OHM, 5%, 0.25W	01121	CB1215
R1254	315-0121-00			RES., FXD, CMPSN: 120 OHM, 5%, 0.25W	01121	CB1215
R1256	315-0152-00			RES., FXD, CMPSN: 1.5K OHM, 5%, 0.25W	01121	CB1525
R1258	315-0362-00			RES., FXD, CMPSN: 3.6K OHM, 5%, 0.25W	01121	CB3625
R1264	315-0681-00			RES., FXD, CMPSN: 680 OHM, 5%, 0.25W	01121	CB6815
R1270	311-1712-00			RES., VAR, NONWIR: 20K OHM, 10%, 1W	01121	SPSG040S203UA
R1274	321-0394-00			RES., FXD, FILM: 124K OHM, 1%, 0.125W	91637	MFF1816G12402F
R1276	315-0472-00			RES., FXD, CMPSN: 4.7K OHM, 5%, 0.25W	01121	CB4725
R1278	321-0260-00			RES., FXD, FILM: 4.99K OHM, 1%, 0.125W	91637	MFF1816G49900F
R1282	315-0271-00			RES., FXD, CMPSN: 270 OHM, 5%, 0.25W	01121	CB2715
R1284	315-0202-00			RES., FXD, CMPSN: 2K OHM, 5%, 0.25W	01121	CB2025
R1295	321-0128-00			RES., FXD, FILM: 210 OHM, 1%, 0.125W	91637	MFF1816G210ROF
R1298	315-0511-00			RES., FXD, CMPSN: 510 OHM, 5%, 0.25W	01121	CB5115
R1300	315-0511-00			RES., FXD, CMPSN: 510 OHM, 5%, 0.25W	01121	CB5115
R1302	315-0511-00			RES., FXD, CMPSN: 510 OHM, 5%, 0.25W	01121	CB5115
R1305	315-0102-00			RES., FXD, CMPSN: 1K OHM, 5%, 0.25W	01121	CB1025
R1308	315-0511-00			RES., FXD, CMPSN: 510 OHM, 5%, 0.25W	01121	CB5115
R1310	321-0079-00			RES., FXD, FILM: 64.9 OHM, 1%, 0.125W	91637	MFF1816G64R90F
R1316	315-0511-00			RES., FXD, CMPSN: 510 OHM, 5%, 0.25W	01121	CB5115
R1320	315-0102-00			RES., FXD, CMPSN: 1K OHM, 5%, 0.25W	01121	CB1025
R1324	315-0102-00			RES., FXD, CMPSN: 1K OHM, 5%, 0.25W	01121	CB1025
R1328	315-0752-00			RES., FXD, CMPSN: 7.5K OHM, 5%, 0.25W	01121	CB7525
R1330	315-0752-00			RES., FXD, CMPSN: 7.5K OHM, 5%, 0.25W	01121	CB7525
R1331	315-0152-00			RES., FXD, CMPSN: 1.5K OHM, 5%, 0.25W	01121	CB1525
R1332	315-0514-00			RES., FXD, CMPSN: 510K OHM, 5%, 0.25W	01121	CB5145
R1334	321-0396-00			RES., FXD, FILM: 130K OHM, 1%, 0.125W	91637	MFF1816G13002F
R1340	315-0152-00			RES., FXD, CMPSN: 1.5K OHM, 5%, 0.25W	01121	CB1525
R1345	315-0102-00			RES., FXD, CMPSN: 1K OHM, 5%, 0.25W	01121	CB1025
R1370	315-0103-00			RES., FXD, CMPSN: 10K OHM, 5%, 0.25W	01121	CB1035
R1372	315-0152-00			RES., FXD, CMPSN: 1.5K OHM, 5%, 0.25W	01121	CB1525
R1375	311-1320-00	B040000	B058449	RES., VAR, NONWIR: 5K OHM, 1W, W/SW (FURNISHED AS A UNIT WITH S1375)	12697	381CM-39700
R1375	311-1320-01	B058450		RES., VAR, NONWIR: 5K OHM, 10%, 1W, SPST SW (FURNISHED AS A UNIT WITH S1375)	12697	CM43494
R1376	315-0332-00			RES., FXD, CMPSN: 3.3K OHM, 5%, 0.25W	01121	CB3325
R1380	315-0106-00			RES., FXD, CMPSN: 10M OHM, 5%, 0.25W	01121	CB1065
R1384	315-0102-00			RES., FXD, CMPSN: 1K OHM, 5%, 0.25W	01121	CB1025
R1386	315-0102-00			RES., FXD, CMPSN: 1K OHM, 5%, 0.25W	01121	CB1025
R1390	315-0102-00			RES., FXD, CMPSN: 1K OHM, 5%, 0.25W	01121	CB1025
R1392	315-0511-00			RES., FXD, CMPSN: 510 OHM, 5%, 0.25W	01121	CB5115
R1394	315-0102-00			RES., FXD, CMPSN: 1K OHM, 5%, 0.25W	01121	CB1025
R1400	321-0272-00			RES., FXD, FILM: 6.65K OHM, 1%, 0.125W	91637	MFF1816G66500F
R1402	321-0287-00			RES., FXD, FILM: 9.53K OHM, 1%, 0.125W	91637	MFF1816G95300F
R1406	321-0193-00			RES., FXD, FILM: 1K OHM, 1%, 0.125W	91637	MFF1816G10000F
R1408	321-0289-00			RES., FXD, FILM: 10K OHM, 1%, 0.125W	91637	MFF1816G10001F
R1410	321-0314-00			RES., FXD, FILM: 18.2K OHM, 1%, 0.125W	91637	MFF1816G18201F
R1412	321-0227-00			RES., FXD, FILM: 2.26K OHM, 1%, 0.125W	91637	MFF1816G22600F
R1416	315-0102-00			RES., FXD, CMPSN: 1K OHM, 5%, 0.25W	01121	CB1025
R1418	315-0272-00			RES., FXD, CMPSN: 2.7K OHM, 5%, 0.25W	01121	CB2725
R1425	315-0103-00			RES., FXD, CMPSN: 10K OHM, 5%, 0.25W	01121	CB1035
R1435	311-1373-00			RES., VAR, NONWIR: 5K OHM, 20%, 1W	01121	73U4G040L502M
R1436	315-0361-00			RES., FXD, CMPSN: 360 OHM, 5%, 0.25W	01121	CB3615
R1438	315-0134-00			RES., FXD, CMPSN: 130K OHM, 5%, 0.25W	01121	CB1345
R1440	315-0155-00			RES., FXD, CMPSN: 1.5M OHM, 5%, 0.25W	01121	CB1555
R1442	315-0134-00			RES., FXD, CMPSN: 130K OHM, 5%, 0.25W	01121	CB1345
R1444	315-0101-00			RES., FXD, CMPSN: 100 OHM, 5%, 0.25W	01121	CB1015
R1448	315-0102-00			RES., FXD, CMPSN: 1K OHM, 5%, 0.25W	01121	CB1025

Replaceable Electrical Parts—FG 504 (SN B040000 & up)

Ckt No.	Tektronix Part No.	Serial/Model No. Eff	Dscont	Name & Description	Mfr Code	Mfr Part Number
R1450	315-0101-00			RES., FXD, CMPSN: 100 OHM, 5%, 0.25W	01121	CB1015
R1452	315-0472-00			RES., FXD, CMPSN: 4.7K OHM, 5%, 0.25W	01121	CB4725
R1456	321-0210-00			RES., FXD, FILM: 1.5K OHM, 1%, 0.125W	91637	MFF1816G15000F
R1458	321-0222-00			RES., FXD, FILM: 2K OHM, 1%, 0.125W	91637	MFF1816G20000F
R1460	311-1562-00			RES., VAR, NONWIR: 2K OHM, 20%, 0.50W	73138	91-84-0
R1462	315-0682-00			RES., FXD, CMPSN: 6.8K OHM, 5%, 0.25W	01121	CB6825
R1466	315-0432-00			RES., FXD, CMPSN: 4.3K OHM, 5%, 0.25W	01121	CB4325
R1467	315-0225-00			RES., FXD, CMPSN: 2.2M OHM, 5%, 0.25W	01121	CB2255
R1470	315-0103-00			RES., FXD, CMPSN: 10K OHM, 5%, 0.25W	01121	CB1035
R1475	311-1559-00			RES., VAR, NONWIR: 10K OHM, 20%, 0.50W	73138	91-81-0
R1476	321-0367-00			RES., FXD, FILM: 64.9K OHM, 1%, 0.125W	91637	MFF1816G64901F
R1478	321-0289-00			RES., FXD, FILM: 10K OHM, 1%, 0.125W	91637	MFF1816G10001F
R1480	321-0318-00			RES., FXD, FILM: 20K OHM, 1%, 0.125W	91637	MFF1816G20001F
R1484	321-0318-00			RES., FXD, FILM: 20K OHM, 1%, 0.125W	91637	MFF1816G20001F
R1486	321-0227-00			RES., FXD, FILM: 2.26K OHM, 1%, 0.125W	91637	MFF1816G22600F
R1488	321-0097-00			RES., FXD, FILM: 100 OHM, 1%, 0.125W	91637	MFF1816G100R0F
R1490	315-0184-00			RES., FXD, CMPSN: 180K OHM, 5%, 0.25W	01121	CB1845
R1495	315-0202-00			RES., FXD, CMPSN: 2K OHM, 5%, 0.25W	01121	CB2025
R1496	321-0408-00			RES., FXD, FILM: 174K OHM, 1%, 0.125W	91637	MFF1816G17402F
R1500	315-0103-00			RES., FXD, CMPSN: 10K OHM, 5%, 0.25W	01121	CB1035
R1504	321-0289-00			RES., FXD, FILM: 10K OHM, 1%, 0.125W	91637	MFF1816G10001F
R1508	321-0253-00			RES., FXD, FILM: 4.22K OHM, 1%, 0.125W	91637	MFF1816G42200F
R1510	321-0289-00			RES., FXD, FILM: 10K OHM, 1%, 0.125W	91637	MFF1816G10001F
R1512	315-0103-00			RES., FXD, CMPSN: 10K OHM, 5%, 0.25W	01121	CB1035
R1514	315-0101-00			RES., FXD, CMPSN: 100 OHM, 5%, 0.25W	01121	CB1015
R1520	315-0102-00			RES., FXD, CMPSN: 1K OHM, 5%, 0.25W	01121	CB1025
R1525	315-0102-00			RES., FXD, CMPSN: 1K OHM, 5%, 0.25W	01121	CB1025
R1602	321-0225-00			RES., FXD, FILM: 2.15K OHM, 1%, 0.125W	91637	MFF1816G21500F
R1605	311-1566-00	B040000	B058289	RES., VAR, NONWIR: 200 OHM, 20%, 0.50W	73138	91-88-0
R1605	311-1565-00	B058290		RES., VAR, NONWIR: 250 OHM, 20%, 0.50W	73138	91-87-0
R1607	321-0218-00			RES., FXD, FILM: 1.82K OHM, 1%, 0.125W*	91637	MFF1816G18200F
R1610	315-0222-00			RES., FXD, CMPSN: 2.2K OHM, 5%, 0.25W	01121	CB2225
R1612	315-0103-00			RES., FXD, CMPSN: 10K OHM, 5%, 0.25W	01121	CB1035
R1614	315-0621-00			RES., FXD, CMPSN: 620 OHM, 5%, 0.25W	01121	CB6215
R1620	315-0103-00			RES., FXD, CMPSN: 10K OHM, 5%, 0.25W	01121	CB1035
R1621	315-0102-00			RES., FXD, CMPSN: 1K OHM, 5%, 0.25W	01121	CB1025
R1623	315-0470-00			RES., FXD, CMPSN: 47 OHM, 5%, 0.25W	01121	CB4705
R1626	308-0755-00			RES., FXD, WW: 0.75 OHM, 5%, 2W	75042	BWH-R7500J
R1627	315-0510-00			RES., FXD, CMPSN: 51 OHM, 5%, 0.25W	01121	CB5105
R1640	315-0752-00			RES., FXD, CMPSN: 7.5K OHM, 5%, 0.25W	01121	CB7525
R1641	315-0562-00			RES., FXD, CMPSN: 5.6K OHM, 5%, 0.25W	01121	CB5625
R1642	321-0306-00			RES., FXD, FILM: 15K OHM, 1%, 0.125W	91637	MFF1816G15001F
R1643	315-0103-00			RES., FXD, CMPSN: 10K OHM, 5%, 0.25W	01121	CB1035
R1644	321-0289-00			RES., FXD, FILM: 10K OHM, 1%, 0.125W	91637	MFF1816G10001F
R1645	315-0103-00			RES., FXD, CMPSN: 10K OHM, 5%, 0.25W	01121	CB1035
R1648	315-0621-00			RES., FXD, CMPSN: 620 OHM, 5%, 0.25W	01121	CB6215
R1650	315-0203-00			RES., FXD, CMPSN: 20K OHM, 5%, 0.25W	01121	CB2035
R1652	321-0257-00			RES., FXD, FILM: 4.64K OHM, 1%, 0.125W	91637	MFF1816G46400F
R1654	321-0096-00			RES., FXD, FILM: 97.6 OHM, 1%, 0.125W	91637	MFF1816G97R60F
R1661	315-0102-00			RES., FXD, CMPSN: 1K OHM, 5%, 0.25W	01121	CB1025
R1662	315-0510-00			RES., FXD, CMPSN: 51 OHM, 5%, 0.25W	01121	CB5105
R1663	308-0767-00			RES., FXD, WW: 1.1 OHM, 5%, 1W	75042	BW20-1R100J
R1675	315-0102-00			RES., FXD, CMPSN: 1K OHM, 5%, 0.25W	01121	CB1025
R1676	315-0102-00			RES., FXD, CMPSN: 1K OHM, 5%, 0.25W	01121	CB1025
R1682	315-0273-00			RES., FXD, CMPSN: 27K OHM, 5%, 0.25W	01121	CB2735
R1702	321-0277-00			RES., FXD, FILM: 7.5K OHM, 1%, 0.125W	91637	MFF1816G75000F
R1705	311-1566-00			RES., VAR, NONWIR: 200 OHM, 20%, 0.50W	73138	91-88-0
R1707	321-0277-00			RES., FXD, FILM: 7.5K OHM, 1%, 0.125W	91637	MFF1816G75000F

Replaceable Electrical Parts—FG 504 (SN B040000 & up)

Ckt No.	Tektronix Part No.	Serial/Model No. Eff	Model No. Dscont	Name & Description	Mfr Code	Mfr Part Number
R1710	315-0752-00			RES., FXD, CMPSN: 7.5K OHM, 5%, 0.25W	01121	CB7525
R1712	315-0103-00			RES., FXD, CMPSN: 10K OHM, 5%, 0.25W	01121	CB1035
R1713	315-0103-00			RES., FXD, CMPSN: 10K OHM, 5%, 0.25W	01121	CB1035
R1714	315-0621-00			RES., FXD, CMPSN: 620 OHM, 5%, 0.25W	01121	CB6215
R1715	315-0362-00			RES., FXD, CMPSN: 3.6K OHM, 5%, 0.25W	01121	CB3625
R1720	315-0103-00			RES., FXD, CMPSN: 10K OHM, 5%, 0.25W	01121	CB1035
R1721	315-0102-00			RES., FXD, CMPSN: 1K OHM, 5%, 0.25W	01121	CB1025
R1723	315-0470-00			RES., FXD, CMPSN: 47 OHM, 5%, 0.25W	01121	CB4705
R1726	308-0755-00			RES., FXD, WW: 0.75 OHM, 5%, 2W	75042	BWH-R7500J
R1727	315-0510-00			RES., FXD, CMPSN: 51 OHM, 5%, 0.25W	01121	CB5105
R1740	315-0682-00			RES., FXD, CMPSN: 6.8K OHM, 5%, 0.25W	01121	CB6825
R1742	321-0306-00			RES., FXD, FILM: 15K OHM, 1%, 0.125W	91637	MFF1816G15001F
R1744	321-0327-00			RES., FXD, FILM: 24.9K OHM, 1%, 0.125W	91637	MFF1816G24901F
R1745	315-0103-00			RES., FXD, CMPSN: 10K OHM, 5%, 0.25W	01121	CB1035
R1746	315-0103-00			RES., FXD, CMPSN: 10K OHM, 5%, 0.25W	01121	CB1035
R1747	315-0912-00			RES., FXD, CMPSN: 9.1K OHM, 5%, 0.25W	01121	CB9125
R1748	315-0621-00			RES., FXD, CMPSN: 620 OHM, 5%, 0.25W	01121	CB6215
R1750	315-0203-00			RES., FXD, CMPSN: 20K OHM, 5%, 0.25W	01121	CB2035
R1752	321-0257-00			RES., FXD, FILM: 4.64K OHM, 1%, 0.125W	91637	MFF1816G46400F
R1754	321-0096-00			RES., FXD, FILM: 97.6 OHM, 1%, 0.125W	91637	MFF1816G97R60F
R1761	315-0102-00			RES., FXD, CMPSN: 1K OHM, 5%, 0.25W	01121	CB1025
R1762	315-0510-00			RES., FXD, CMPSN: 51 OHM, 5%, 0.25W	01121	CB5105
R1763	308-0767-00			RES., FXD, WW: 1.1 OHM, 5%, 1W	75042	BW20-1R100J
R1776	315-0102-00			RES., FXD, CMPSN: 1K OHM, 5%, 0.25W	01121	CB1025
R1777	315-0101-00			RES., FXD, CMPSN: 100 OHM, 5%, 0.25W	01121	CB1015
R1782	315-0273-00			RES., FXD, CMPSN: 27K OHM, 5%, 0.25W	01121	CB2735
RT317	307-0122-00			RES., THERMAL: 50 OHM, 10%	50157	3D1515
RT318	307-0122-00			RES., THERMAL: 50 OHM, 10%	50157	3D1515
RT748	307-0122-00			RES., THERMAL: 50 OHM, 10%	50157	3D1515
RT1456	307-0126-00			RES., THERMAL: 100 OHM, 10% *	14193	2D21-101-D
S50	311-1851-00			RES., VAR, NONWIR: 15K OHM, 1W (FURNISHED AS A UNIT WITH R50)	01121	14M212
S195	260-1208-00			SWITCH, PUSH: DPDT, 28VDC, PUSH-PUSH	80009	260-1208-00
S240	263-1140-00			SW CAM ACTR AS: FREQUENCY	80009	263-1140-00
S590	263-1139-00			SW CAM ACTR AS: RISE AND FALLTIME	80009	263-1139-00
S730A-F	260-1803-00			SWITCH, PUSH: 6 BTN, 2 POLE, 3 IL, 3PP, 10MM	71590	2KBM060000-974
S1100	263-1138-01			SW CAM ACTR AS: AMPLITUDE	80009	263-1138-01
S1130	311-1851-00			RES., VAR, NONWIR: 15K OHM, 1W (FURNISHED AS A UNIT WITH R1130)	01121	14M212
S1210	311-1320-00			RES., VAR, NONWIR: 5K OHM, 1W, W/SW (FURNISHED AS A UNIT WITH R1210)	12697	381CM-39700
S1235A-D	260-1802-00			SWITCH, PUSH: 4 BTN, 2 POLE, INTERLOCK	80009	260-1802-00
S1375	311-1320-00			RES., VAR, NONWIR: 5K OHM, 1W, W/SW (FURNISHED AS A UNIT WITH R1375)	12697	381CM-39700
S1435	263-1137-00			SW CAM ACTR AS: SWEEP DURATION	80009	263-1137-00
U5	156-0158-00			MICROCIRCUIT, LI: DUAL OPERATIONAL AMPLIFIER	18324	MC1458N
U25	156-0158-00			MICROCIRCUIT, LI: DUAL OPERATIONAL AMPLIFIER	18324	MC1458N
U30	156-0158-00			MICROCIRCUIT, LI: DUAL OPERATIONAL AMPLIFIER	18324	MC1458N
U45	156-0067-00			MICROCIRCUIT, LI: OPERATIONAL AMPLIFIER	02735	85145
U155	156-0067-00			MICROCIRCUIT, LI: OPERATIONAL AMPLIFIER	02735	85145
U215	156-0484-00			MICROCIRCUIT, LI: OPERATIONAL AMPLIFIER	80009	156-0484-00
U375	156-0534-00			MICROCIRCUIT, LI: DUAL DIFF AMPL, 14 LD DIP	80009	156-0534-00
U530	156-0067-00			MICROCIRCUIT, LI: OPERATIONAL AMPLIFIER	02735	85145
U710	156-0511-00			MICROCIRCUIT, LI: OPERATIONAL AMPLIFIER	18324	NE531N
U770	155-0032-00	B040000	B057719	MICROCIRCUIT, LI: ML, PRE-AMPLIFIER	80009	155-0032-00
U770	155-0217-00	B057720		MICROCIRCUIT, LI: PLRT INV & TRIG PICK OFF	80009	155-0217-00
U1145	156-0105-00			MICROCIRCUIT, LI: OPERATIONAL AMPLIFIER	27014	LM301AN

Replaceable Electrical Parts—FG 504 (SN B040000 & up)

Ckt No.	Tektronix Part No.	Serial/Model No. Eff	Dscont	Name & Description	Mfr Code	Mfr Part Number
U1215	156-0230-00			MICROCIRCUIT,DI:DUAL D MA-SLAVE FLIP-FLOP	80009	156-0230-00
U1225	156-0369-00			MICROCIRCUIT,DI:TRIPLE LINE RECEIVER	80009	156-0369-00
U1295	156-0230-00			MICROCIRCUIT,DI:DUAL D MA-SLAVE FLIP-FLOP	80009	156-0230-00
U1340	156-0067-00			MICROCIRCUIT,LI:OPERATIONAL AMPLIFIER	02735	85145
U1445	156-0067-00			MICROCIRCUIT,LI:OPERATIONAL AMPLIFIER	02735	85145
U1470	156-0105-00			MICROCIRCUIT,LI:OPERATIONAL AMPLIFIER	27014	LM301AN
U1480	156-0067-00			MICROCIRCUIT,LI:OPERATIONAL AMPLIFIER	02735	85145
U1490	156-0105-00			MICROCIRCUIT,LI:OPERATIONAL AMPLIFIER	27014	LM301AN
U1495	156-0197-00			MICROCIRCUIT,LI:5 TRANSISTOR ARRAY	02735	CA3086
U1500	156-0067-00			MICROCIRCUIT,LI:OPERATIONAL AMPLIFIER	02735	85145
U1690	156-0277-00			MICROCIRCUIT,LI:VOLTAGE REGULATOR	07263	MICROA7805UC
VR23	152-0279-00			SEMICOND DEVICE:ZENER,0.4W,5.1V,5%	04713	SZG35010RL
VR275	152-0306-00			SEMICOND DEVICE:ZENER,0.4W,9.1V,5%	15238	Z5409
VR295	152-0306-00			SEMICOND DEVICE:ZENER,0.4W,9.1V,5%	15238	Z5409
VR310	152-0326-00			SEMICOND DEVICE:ZENER,0.4W,7.5V,5%	80009	152-0326-00
VR380	152-0280-00			SEMICOND DEVICE:ZENER,0.4W,6.2V,5%	80009	152-0280-00
VR462	152-0306-00			SEMICOND DEVICE:ZENER,0.4W,9.1V,5%	15238	Z5409
VR470	152-0306-00			SEMICOND DEVICE:ZENER,0.4W,9.1V,5%	15238	Z5409
VR550	152-0280-00			SEMICOND DEVICE:ZENER,0.4W,6.2V,5%	80009	152-0280-00
VR570	152-0280-00			SEMICOND DEVICE:ZENER,0.4W,6.2V,5%	80009	152-0280-00
VR775	152-0306-00			SEMICOND DEVICE:ZENER,0.4W,9.1V,5%	15238	Z5409
VR805	152-0508-00			SEMICOND DEVICE:ZENER,0.4W,12.6V,5%	80009	152-0508-00
VR932	152-0405-00			SEMICOND DEVICE:ZENER,1W,15V,5%	80009	152-0405-00
VR940	152-0520-00			SEMICOND DEVICE:ZENER,1W,12V,5%	14433	1N4742A
VR1032	152-0405-00			SEMICOND DEVICE:ZENER,1W,15V,5%	80009	152-0405-00
VR1040	152-0520-00			SEMICOND DEVICE:ZENER,1W,12V,5%	14433	1N4742A
VR1608	152-0280-00	B040000	B058289	SEMICOND DEVICE:ZENER,0.4W,6.2V,5%	80009	152-0280-00
VR1608	152-0166-00	B058290		SEMICOND DEVICE:ZENER,0.4W,6.2V,5%	04713	SZ11738
VR1652	152-0147-00			SEMICOND DEVICE:ZENER,0.4W,27V,5%	04713	SZ50622KRL
VR1676	152-0590-00			SEMICOND DEVICE:ZENER,18V,5% AT 7MA	80009	152-0590-00
VR1677	152-0282-00			SEMICOND DEVICE:ZENER,0.4W,30V,5%	04713	1N972B
VR1752	152-0147-00			SEMICOND DEVICE:ZENER,0.4W,27V,5%	04713	SZ50622KRL
VR1776	152-0590-00			SEMICOND DEVICE:ZENER,18V,5% AT 7MA	80009	152-0590-00
VR1777	152-0282-00			SEMICOND DEVICE:ZENER,0.4W,30V,5%	04713	1N972B
W638	131-0566-00			BUS CONDUCTOR:DUMMY RES,2.375,22 AWG	55210	L-2007-1
W1210	131-0566-00			BUS CONDUCTOR:DUMMY RES,2.375,22 AWG	55210	L-2007-1
W1428	131-0566-00			BUS CONDUCTOR:DUMMY RES,2.375,22 AWG	55210	L-2007-1

# DIAGRAMS AND CIRCUIT BOARD ILLUSTRATIONS

## Symbols and Reference Designators

Electrical components shown on the diagrams are in the following units unless noted otherwise:

- Capacitors = Values one or greater are in picofarads (pF).  
Values less than one are in microfarads (μF).
- Resistors = Ohms (Ω).

Symbols used on the diagrams are based on ANSI Standard Y32.2-1975.

Logic symbology is based on ANSI Y32.14-1973 in terms of positive logic. Logic symbols depict the logic function performed and may differ from the manufacturer's data.

The following prefix letters are used as reference designators to identify components or assemblies on the diagrams.

A	Assembly, separable or repairable (circuit board, etc.)	H	Heat dissipating device (heat sink, heat radiator, etc.)	S	Switch or contactor
AT	Attenuator, fixed or variable	HR	Heater	T	Transformer
B	Motor	HY	Hybrid circuit	TC	Thermocouple
BT	Battery	J	Connector, stationary portion	TP	Test point
C	Capacitor, fixed or variable	K	Relay	U	Assembly, inseparable or non-repairable (integrated circuit, etc.)
CB	Circuit breaker	L	Inductor, fixed or variable	V	Electron tube
CR	Diode, signal or rectifier	M	Meter	VR	Voltage regulator (zener diode, etc.)
DL	Delay line	P	Connector, movable portion	W	Wirestrap or cable
DS	Indicating device (lamp)	Q	Transistor or silicon-controlled rectifier	Y	Crystal
E	Spark Gap	R	Resistor, fixed or variable	Z	Phase shifter
F	Fuse	RT	Thermistor		
FL	Filter				

The following special symbols are used on the diagrams:

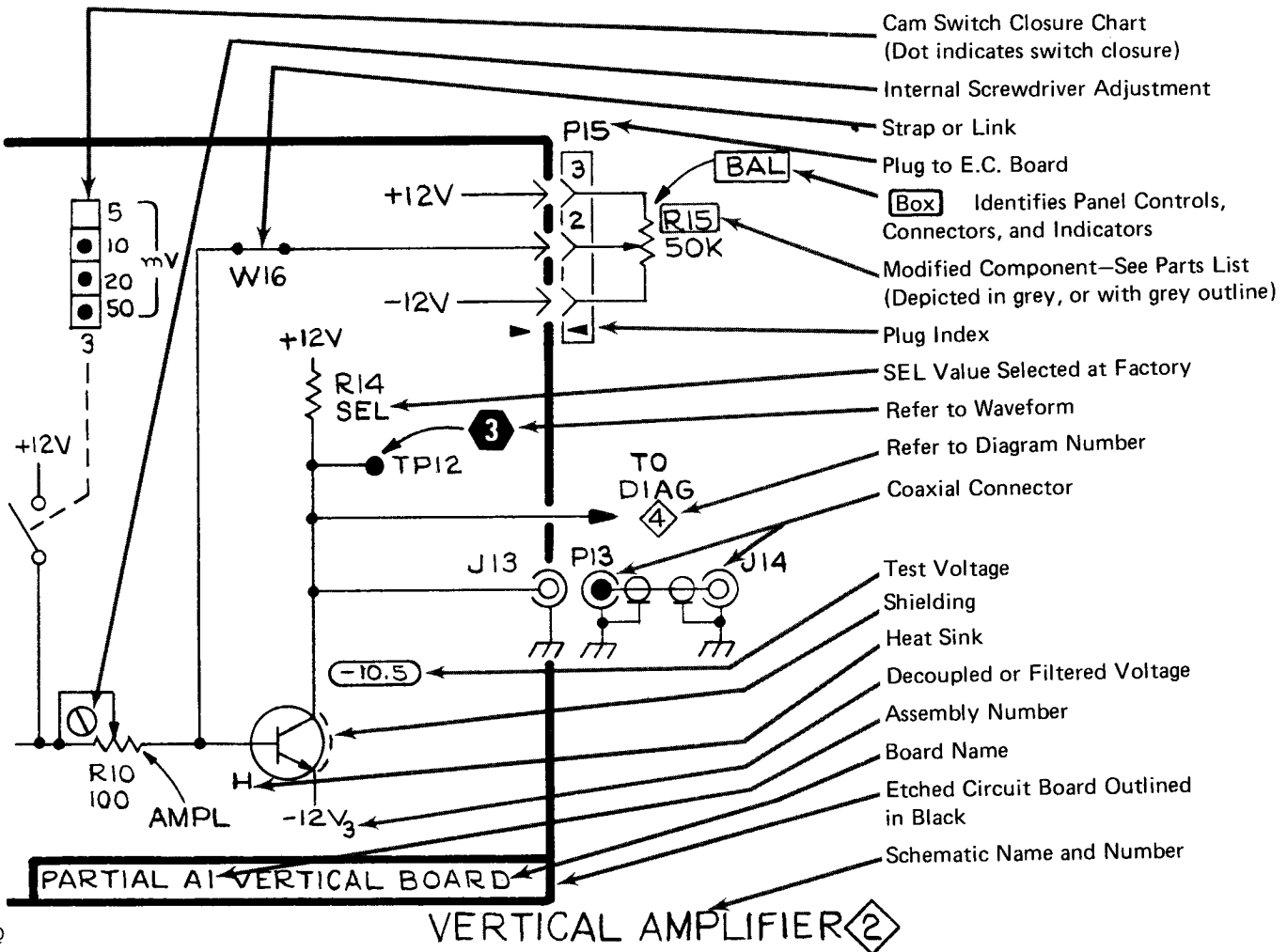

NOTE  
LEAD CONFIGURATIONS AND CASE STYLES ARE TYPICAL, BUT MAY VARY DUE TO VENDOR CHANGES OR INSTRUMENT MODIFICATIONS.

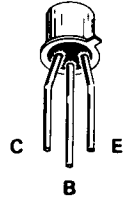
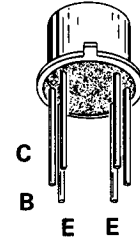
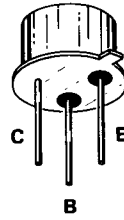
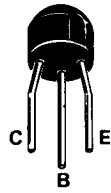
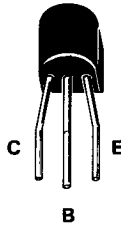

Plastic-Cased Transistors

Metal-Cased Transistors

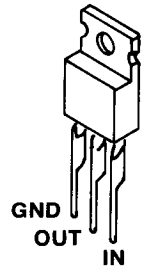
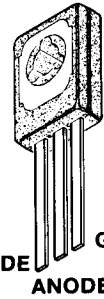
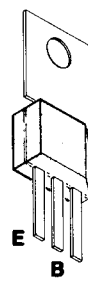
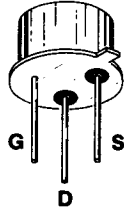
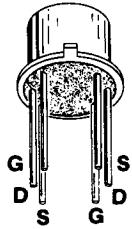

FET

Power Transistors

SCR

Regulator

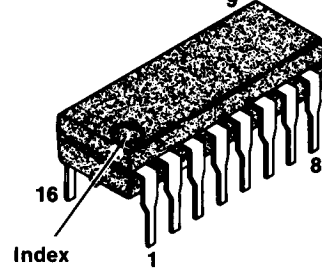
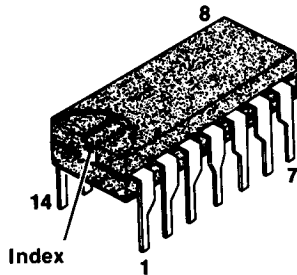
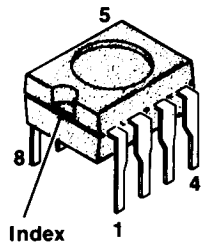

Integrated Circuits Indexing

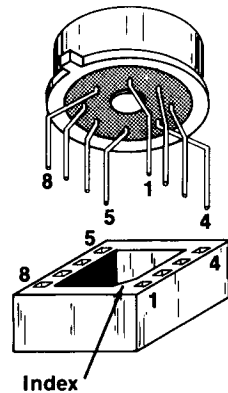
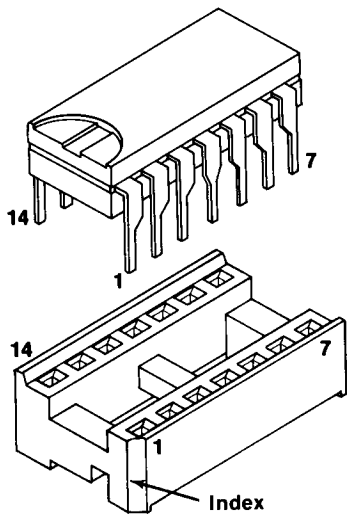

Integrated Circuits Mounting

2655-03A

Fig. 8-1. Semiconductor basing.

REV MAY 1981



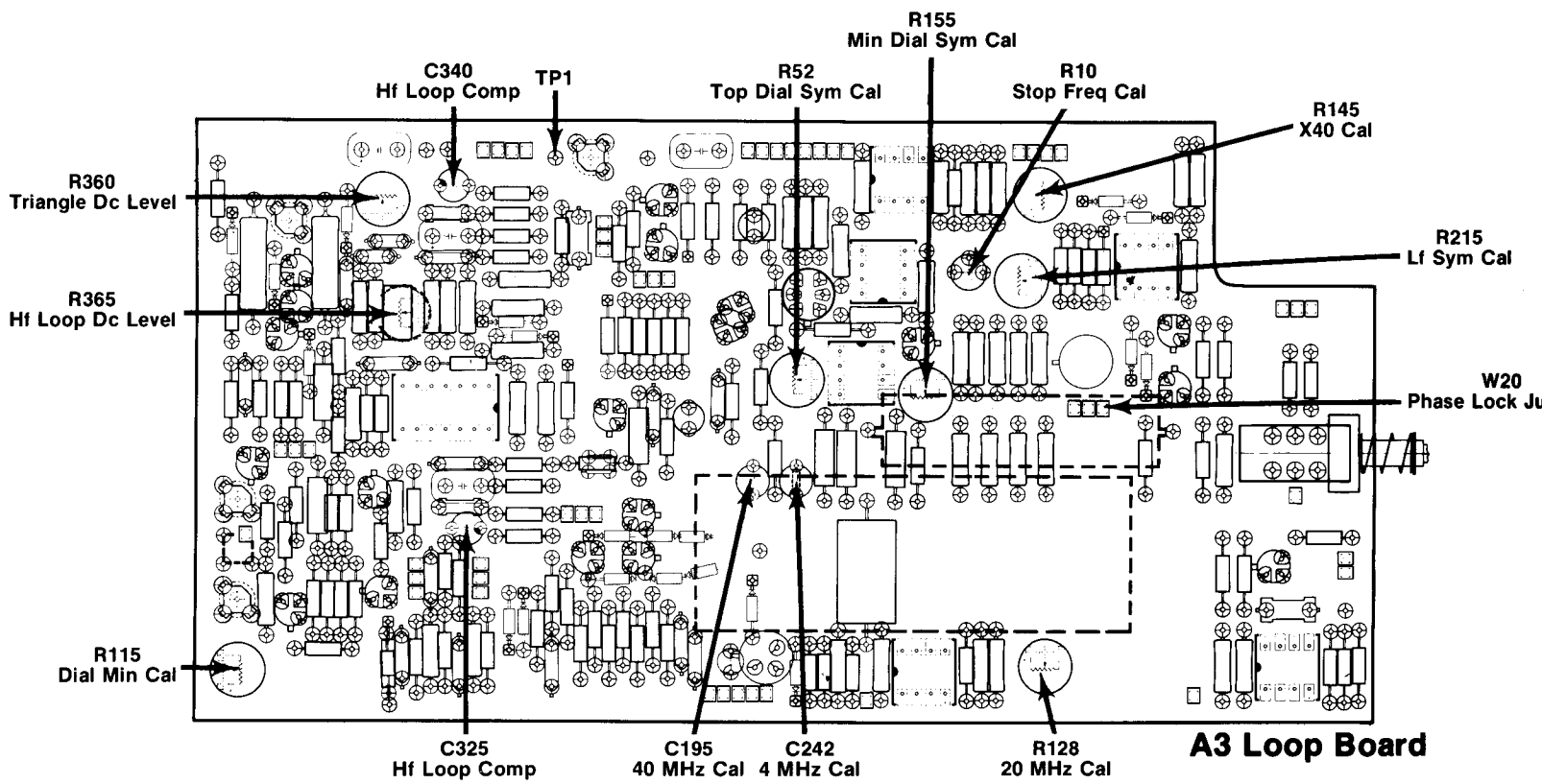

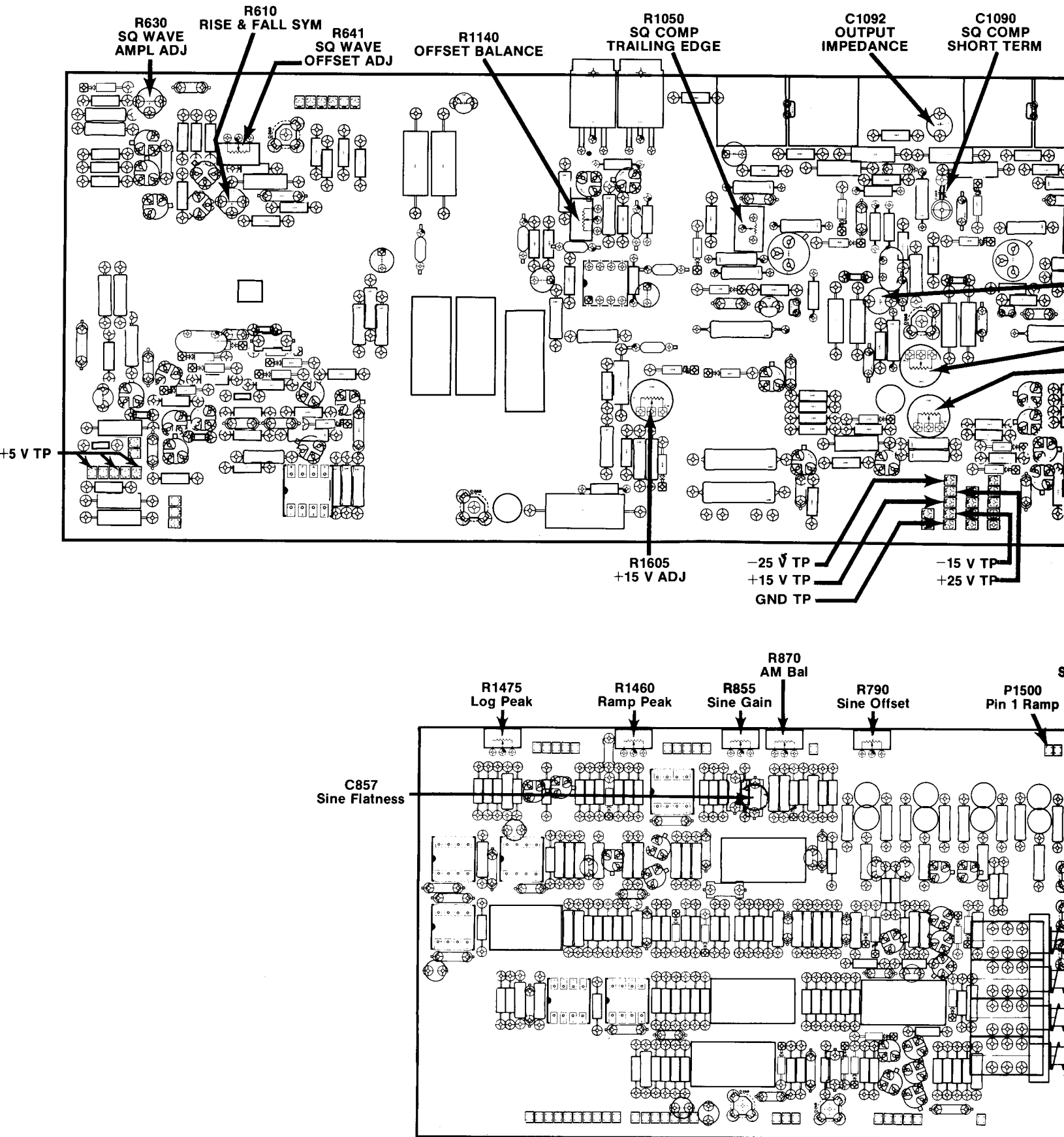
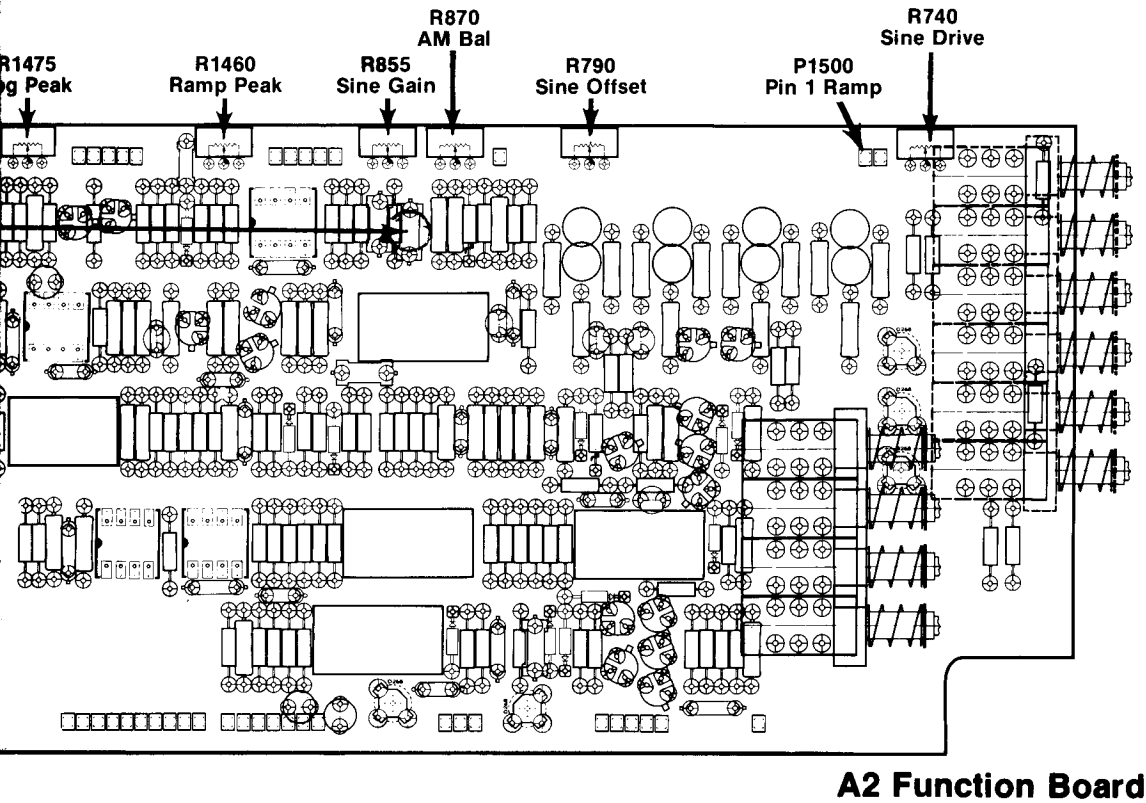
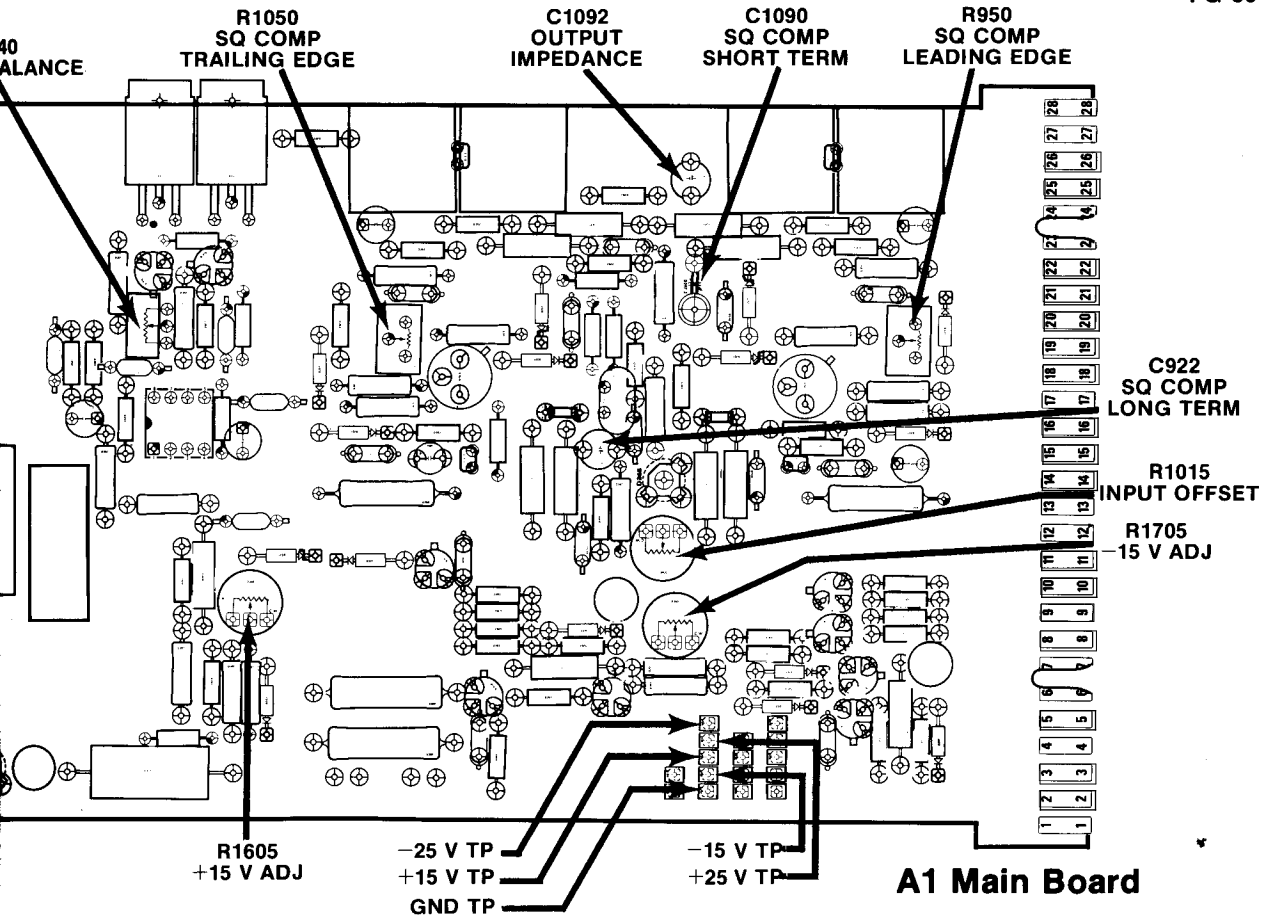

Fig. 8-2. Adjustment locations.

REV A MAY 1980



ADJUSTMENT LOCATIONS

CKT NO	GRID LOC	CKT NO	GRID LOC	CKT NO	GRID LOC	CKT NO	GRID LOC	CKT NO	GRID LOC
C45	†	J300	E2	R36	K2	R252	G4	R452	B4
C72	D5	J406	B5	R38	H3	R255	F4	R454	B4
C78	D6	J412	B5	R42	G2	R258	F3	R456	B4
C80	D5	J418	B6	R45	H3	R260	G3	R458	C4
C95	F6	J485	B2	R52	G4	R262	G2	R462	B3
C98	F6			R54	G2	R265	F3	R465	B3
C106	E6	L300	†	R58	F4	R270	E3	R470	C3
C195	G4	L382	C6	R65	C5	R271	F3	R475	B4
C210	†			R68	D6	R272	F3	R480	C3
C240	†	P5	G1	R70	D5	R275	F4	R700	L6
C242	G4	P20	I1	R72	D5	R280	E2	R704	L6
C244	G4	P125	K3	R76	D6	R285	F2	R706	L6
C246	H5	P710	K6	R78	D6	R287	F2	R708	K6
C247	H4	P720	L5	R80	D4	R288	E3	R710	K6
C248	H4	P1264	F6	R85	E6	R290	F2	R716	K5
C250	G4	P1270	H6	R88	E6	R295	E2	R717	K5
C255	F4	P1275	K5	R90	F6	R300	E2	R720	L5
C275	F4	P1666	D1	R92	E5	R315	E4	R1274	H6
C290	F2			R95	E6	R317	E4	R1276	G6
C300	E2	Q55	E5	R98	E6	R322	E4	R1278	G6
C315	F4	Q65	C5	R100	E6	R325	D5	R1282	G6
C325	D5	Q80	D5	R102	F6	R327	D5	R1284	G6
C327	D5	Q90	E5	R104	E6	R329	D5		
C329	D5	Q100	E5	R108	E6	R331	D4	RT317	E4
C331	D4	Q165	H3	R114	B2	R336	D3	RT318	E4
C340	D2	Q170A	G3	R115	B6	R340	D2		
C342	D2	Q170B	G3	R120	†	R342	D2	S195	K4
C344	D2	Q175	E5	R128	I6	R344	D2	S240	†
C346	D2	Q225	J4	R130	I6	R346	D2		
C380	C6	Q230	J3	R134	K4	R350	D3	U5	H2
C382	C6	Q255A	F3	R136	L4	R352	D3	U25	H6
C387	C3	Q255B	F3	R138	H2	R356	D3	U30	J3
C475	B4	Q270	F3	R140	H2	R358	D3	U45	G3
C480	C3	Q280	F2	R143	I2	R360	C2	U155	H3
C712	K6	Q285	F2	R145	I2	R363	C3	U215	J3
C1284	F6	Q295	E2	R147	I2	R365	C3	U375	D4
C1670	C1	Q310	E4	R150	I3	R367	C3	U710	K6
C1671	C2	Q395	C5	R155	H4	R370	D3		
C1672	F1	Q406	B4	R158	H2	R372	C4	VR23	J3
C1673	C2	Q410	C5	R160	H3	R375	C5	VR275	F2
		Q415	B6	R162	G2	R380	C6	VR295	E3
CR20	J2	Q450	B4	R165	G3	R382	D6	VR310	E4
CR21	J2	Q456	B3	R170	G2	R385	D3	VR380	C6
CR85	D6	Q462	B3	R172	G2	R387	C4	VR462	B3
CR108	D6	Q470	B3	R175	F5	R390	C4	VR470	B3
CR180	E5	Q720	K5	R195	G5	R395	C6		
CR182	F5	Q1280	G6	R200	K4	R397	C6	W20	J4
CR184	F5			R202	K4	R398	C6		
CR186	F5	R8	H3	R204	H4	R400	C5		
CR188	F5	R10	H3	R206	I4	R402	C6		
CR190	E5	R12	I3	R208	I4	R406	B5		
CR218	J3	R14	J2	R210	I4	R409	C5		
CR220	J3	R20	I3	R212	I3	R410	C5		
CR352	D3	R23	J3	R215	I3	R412	B5		
CR356	D3	R25	H6	R220	J4	R415	C5		
CR462	B2	R28	I6	R225	K3	R417	C6		
CR470	C2	R30	I3	R228	K3	R419	B6		
CR1285	G6	R32	I6	R235	H4	R420	B5		
CR1286	F6	R34	J3	R250	G4	R450	C4		

† Located on back of board.

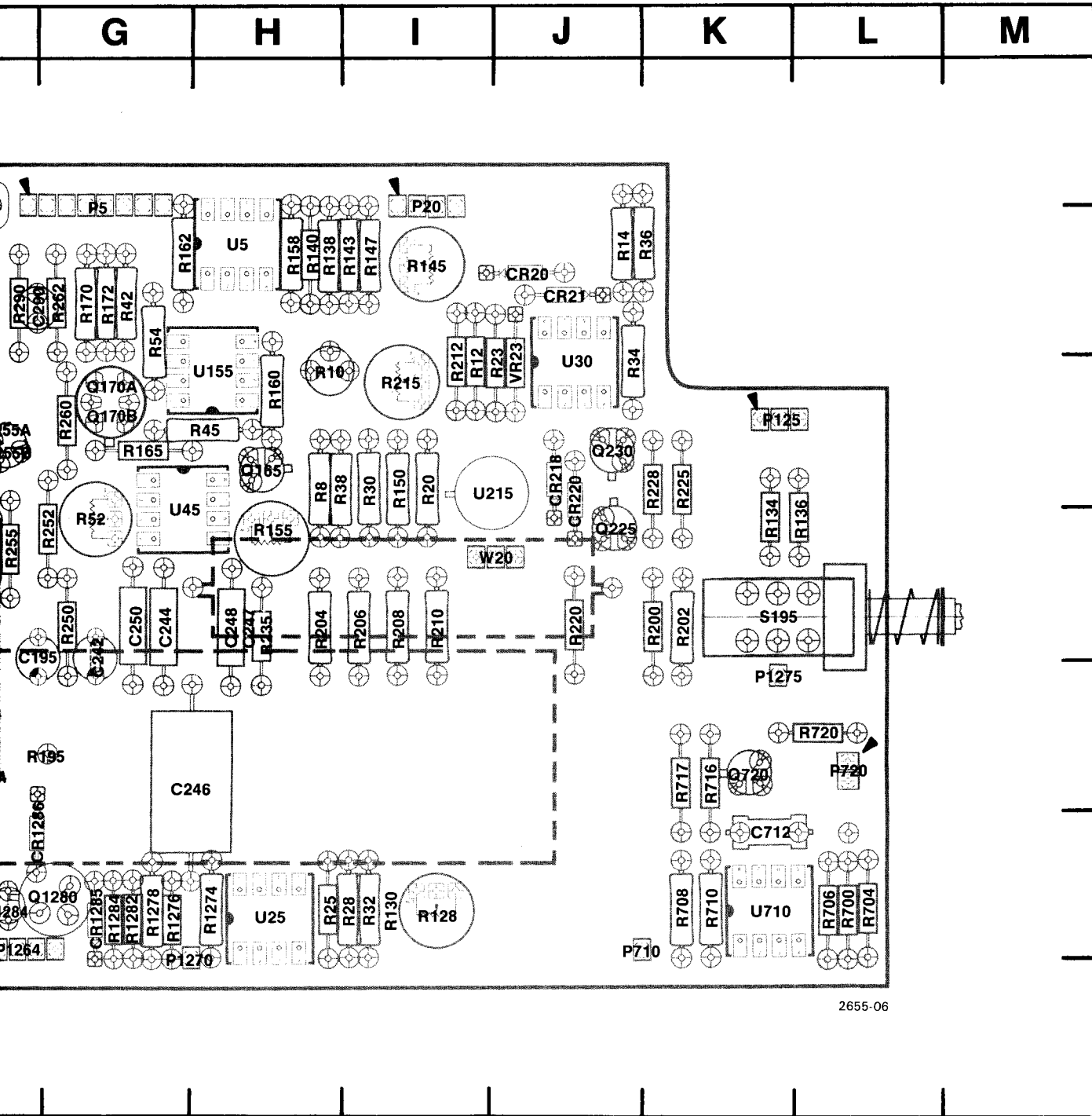

A3 LOOP BOARD  
COMP LOC

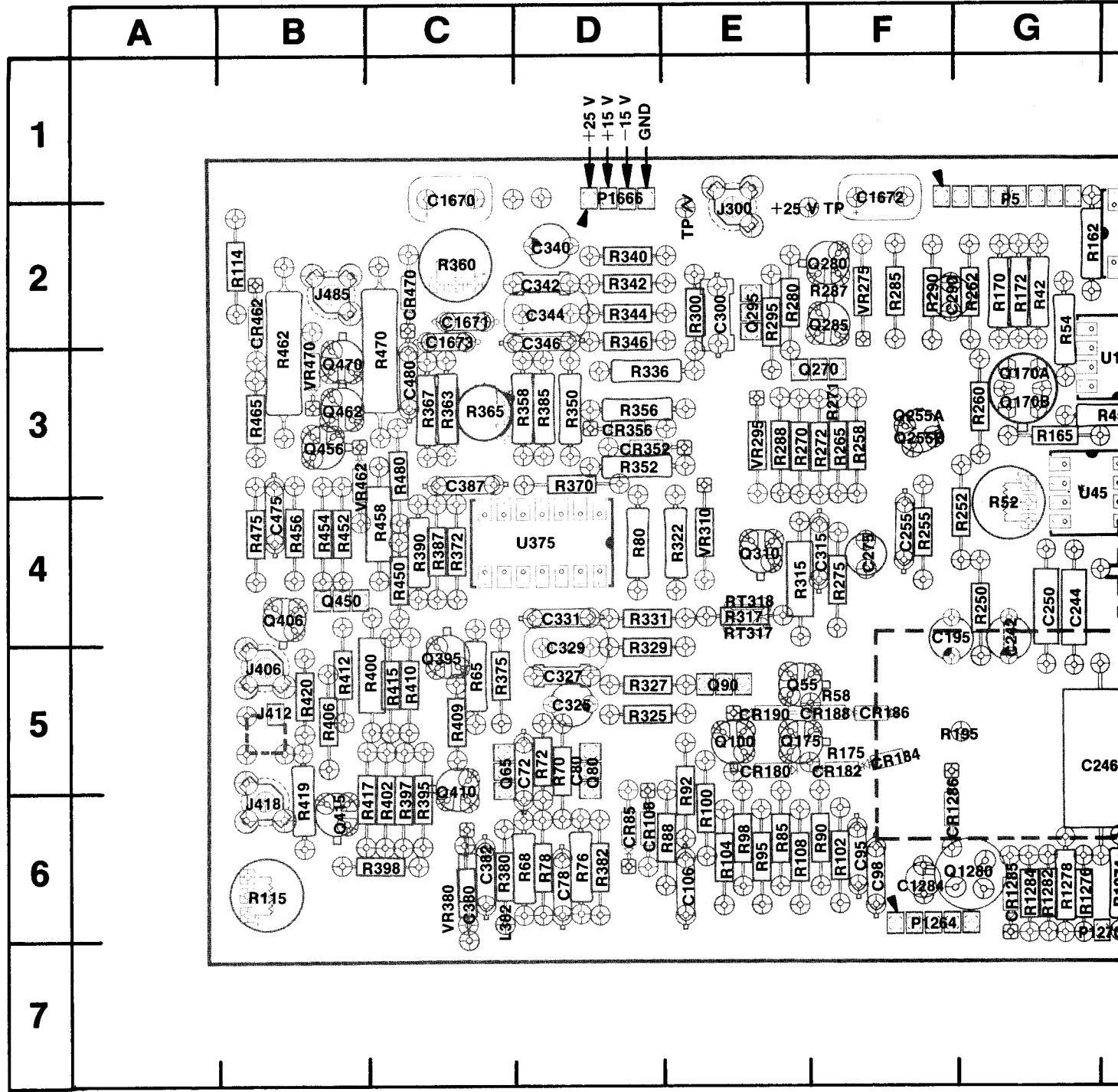

Fig. 8-3. A3 Loop board component loc

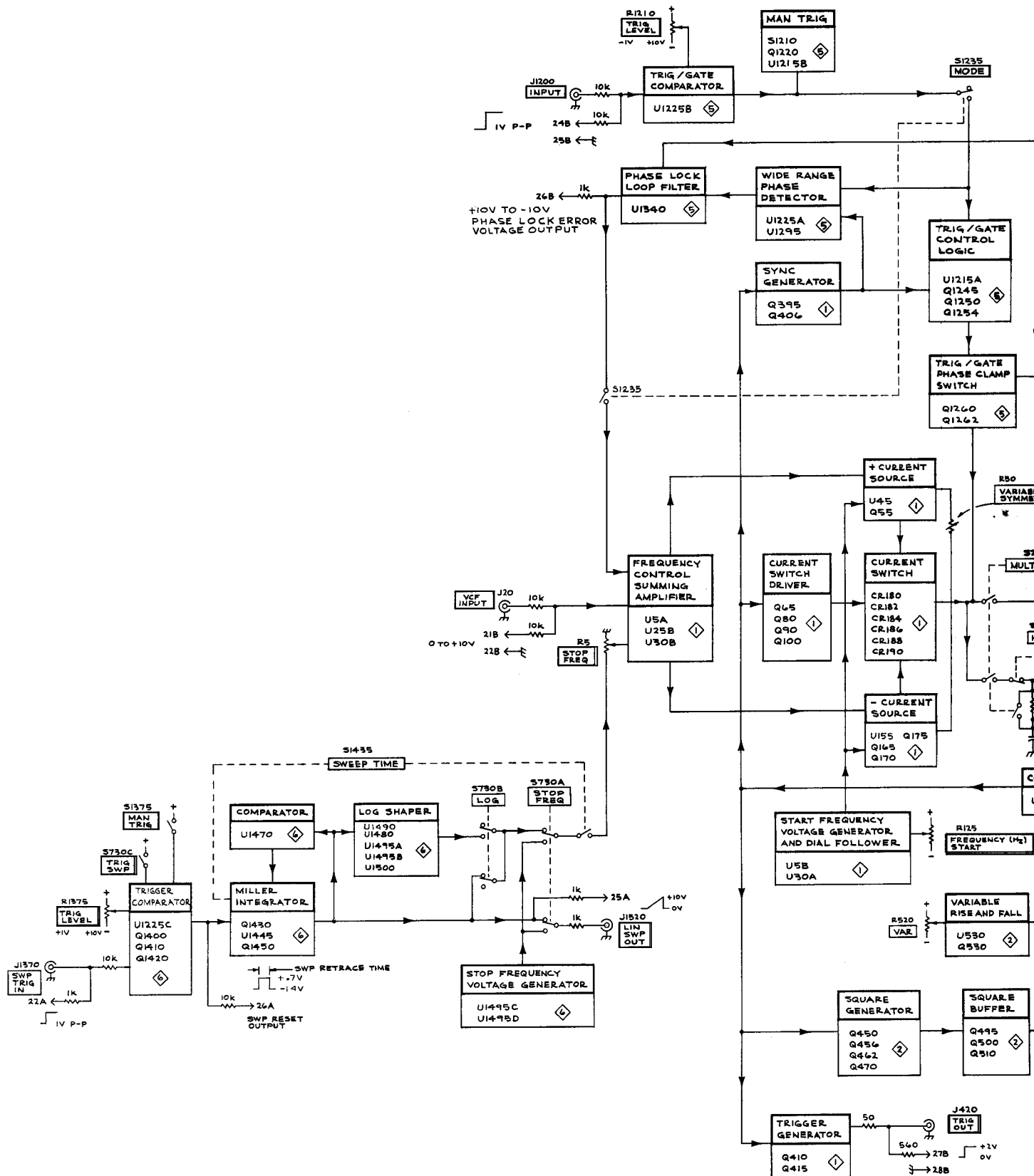
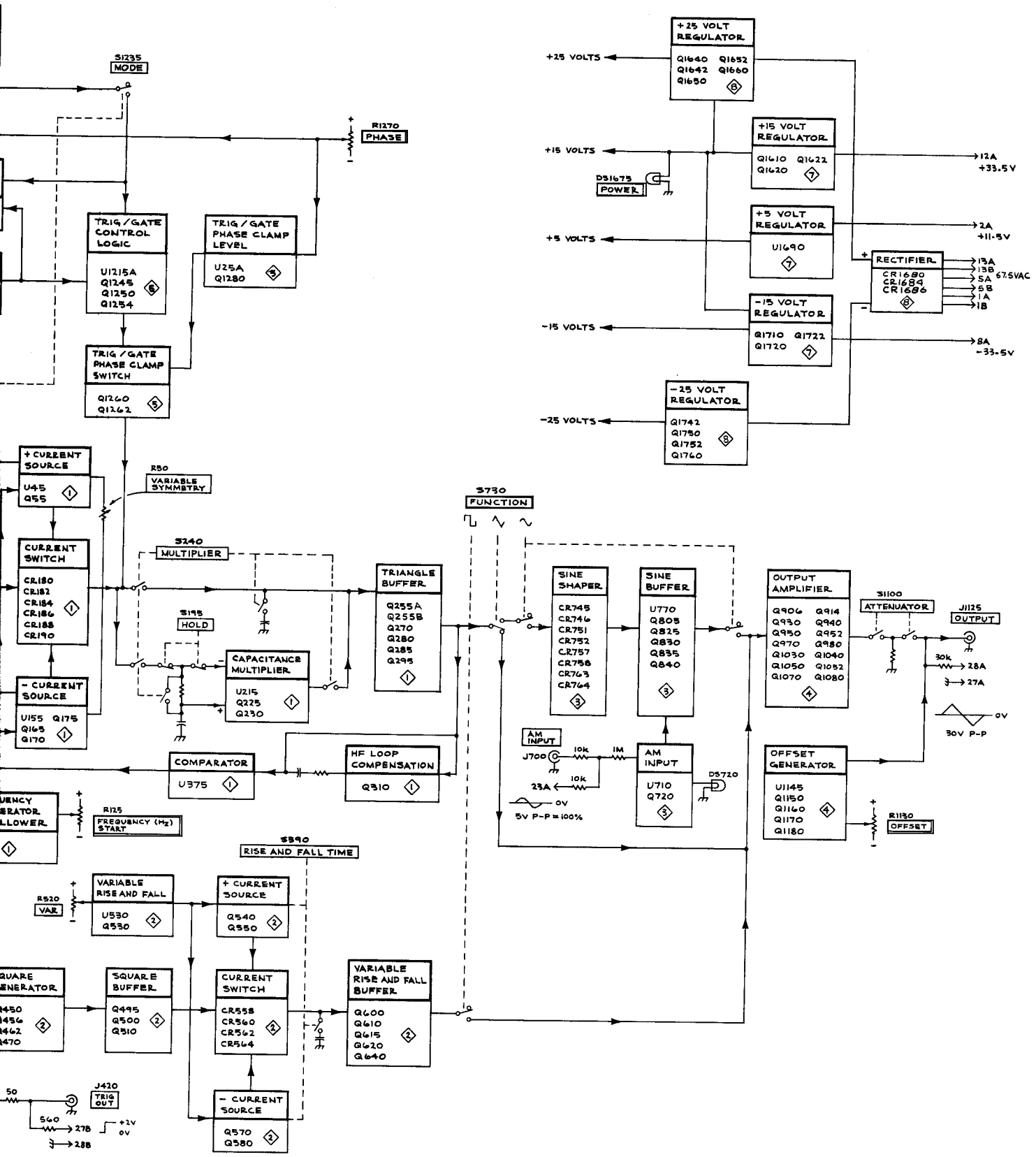
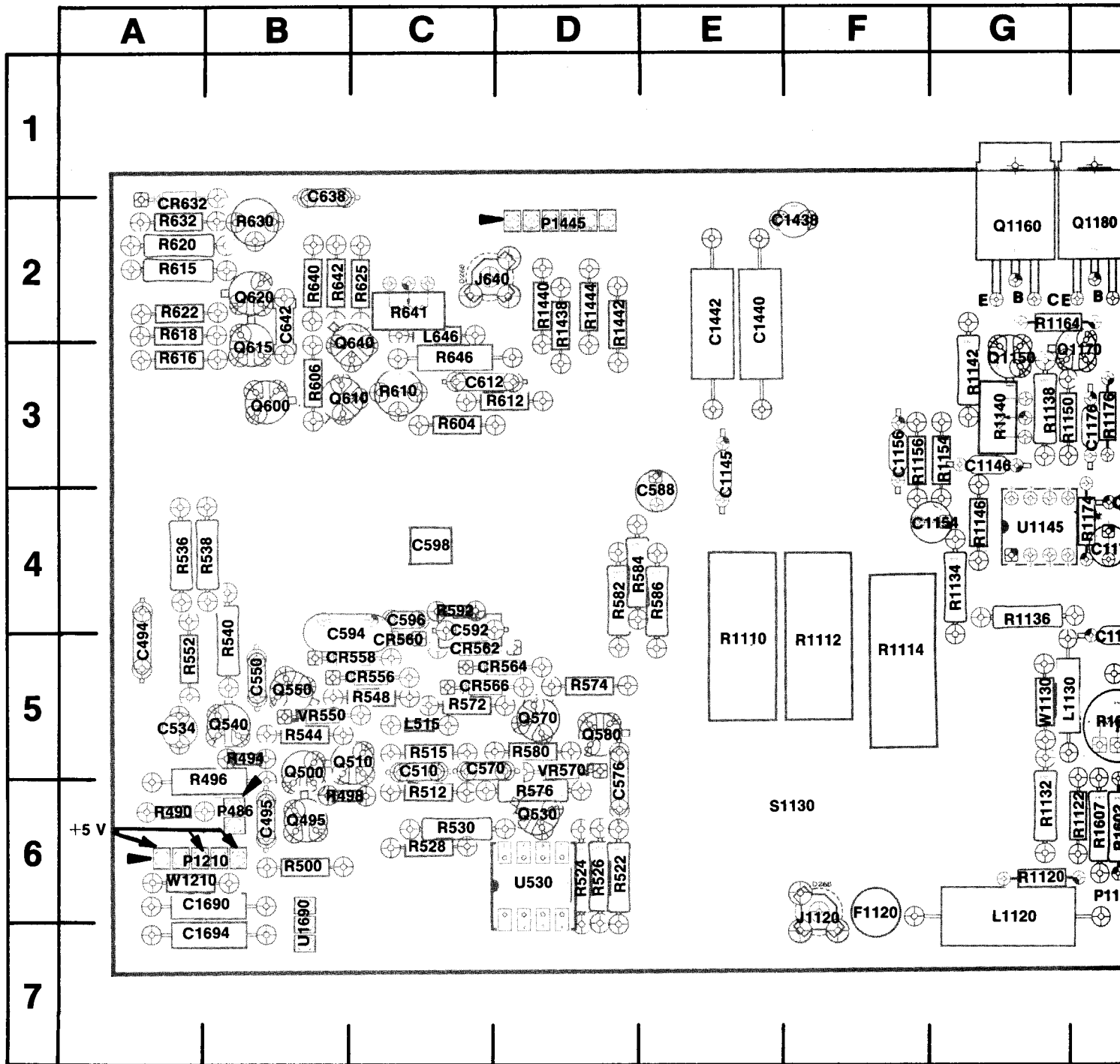

FIG 504 5N804000-UP





Block Diagram







CKT NO	GRID LOC	CKT NO	GRID LOC	CKT NO	GRID LOC	CKT NO	GRID LOC	CKT NO	GRID LOC	CKT NO	GRID LOC
C494	A5	CR556	C5	Q620	B2	R625	C2	R1132	G6	VR1040	J3
C495	B6	CR558	C5	Q640	C2	R630	B2	R1134	G4	VR1608	H5
C510	C5	CR560	C5	Q950	L3	R632	A2	R1136	G5		
C534	A5	CR562	C5	Q970	M2	R640	B2	R1138	G3	W1130	G5
C550	B5	CR564	D5	Q980	L2	R641	C2	R1140	G3	W1210	A6
C570	C5	CR566	C5	Q1050	I3	R642	B2	R1142	G3		
C576	D6	CR632	A1	Q1070	I2	R646	C3	R1146	G4		
C588	E4	CR942	M3	Q1080	J2	R900	K4	R1150	G3		
C592	C4	CR943	M4	Q1150	G3	R914	K3	R1154	G3		
C594	B4	CR960	J3	Q1160	G2	R920	K4	R1156	F3		
C596	C4	CR962	L3	Q1170	H3	R922	K5	R1164	G2		
C598	C4	CR1042	H3	Q1180	H2	R924	K3	R1174	H4		
C612	C3	CR1043	I4	Q1610	I5	R928	K4	R1176	H3		
C638	B1	CR1600	H6	Q1620	J6	R930	K4	R1190	H2		
C642	B2	CR1608	I5	Q1621	K6	R936	L4	R1436	I3		
C914	K4	CR1630	J5	Q1710	L5	R938	L4	R1438	D2		
C922	K4	CR1700	L6	Q1715	L5	R942	M3	R1440	D2		
C928	L4	CR1711	L6	Q1720	M6	R945	M4	R1442	D2		
C934	K4	CR1730	M6	Q1721	M6	R947	L4	R1444	D2		
C947	L4					R950	M3	R1602	H6		
C950	M3	F1120	F6	R490	A6	R952	L3	R1605	H5		
C955	J3	F1615	K5	R494	B5	R958	K3	R1607	H6		
C958	K2	F1715	M6	R496	A5	R960	L3	R1610	J5		
C965	L3			R498	B6	R965	K3	R1612	J5		
C972	L2	J640	C2	R500	B6	R970	L2	R1614	J5		
C975	M2	J900	K4	R512	C6	R974	M4	R1620	J6		
C976	L4	J1120	F6	R515	C5	R980	L2	R1621	J5		
C978	M4			R522	D6	R982	L2	R1623	J5		
C1036	J5	L515	C5	R524	D6	R984	K2	R1626	J6		
C1047	I4	L646	C2	R526	D6	R1015	K5	R1627	J6		
C1050	I3	L945	M4	R528	C6	R1016	K3	R1702	K6		
C1072	I2	L1045	I3	R530	C6	R1024	J3	R1705	K5		
C1075	I2	L1130	G5	R536	A4	R1028	J4	R1707	K6		
C1076	J4	L1120	G6	R538	B4	R1030	J4	R1710	L6		
C1078	I4			R540	B5	R1036	J4	R1712	M5		
C1090	K3	P486	B6	R544	B5	R1038	J4	R1713	M5		
C1092	K2	P1130	H6	R548	C5	R1042	I3	R1714	M5		
C1145	E3	P1210	A6	R552	A5	R1045	I4	R1715	L5		
C1146	G3	P1445	D2	R572	C5	R1047	I4	R1720	L6		
C1154	G4	P1600	K7	R574	D5	R1050	I3	R1721	M5		
C1156	F3	P1665	D6	R576	D6	R1052	J3	R1723	M6		
C1160	H4	P1660	C6	R580	D5	R1070	I2	R1726	M6		
C1174	H4	P1765	D6	R582	D4	R1074	I4	R1727	M6		
C1176	H3			R584	D4	R1080	J2				
C1180	H5	Q495	B6	R586	E4	R1082	J2	S1130	F6		
C1438	F2	Q500	B5	R592	C4	R1084	J2				
C1440	E2	Q510	C5	R604	B3	R1090	K3	U530	D6		
C1442	E2	Q530	D6	R606	B3	R1092	K2	U1145	G4		
C1608	I5	Q540	B5	R610	C3	R1102	I6	U1690	B6		
C1612	J6	Q550	B5	R612	D3	R1104	I6				
C1630	E5	Q570	D5	R615	A2	R1110	E5	VR550	B5		
C1690	B6	Q580	D5	R616	A3	R1112	F5	VR570	D5		
C1694	B7	Q600	B3	R618	A2	R1114	F5	VR932	L3		
C1720	L6	Q610	B3	R620	A2	R1120	G6	VR940	L3		
C1730	D5	Q615	B2	R622	A2	R1122	H6	VR1032	J3		

Controls	Waveshape Number/Control Settings																
	1	2	3	4	5	6	7	8	9	10	11	12	13	14	15	16	17
FREQUENCY Hz START	← .04 →		→ 25 →														
FREQUENCY Hz STOP	← 40 →		→ 0 →														
HOLD RUN	→ I →																
FREQUENCY MULTIPLIER	→ 10 <sup>-1</sup> →																
FREQUENCY VERNIER (VAR)	← Variable + →		→ CW →														
TRIGGER	→ I →																
FREE RUN	→ I →																
TRIG	→ I →																
GATE	→ I →																
Φ LOCK	→ I →																
MAN	→ I →																
LEVEL	→ I →																
STOP FREQ-SWEEP	← 0 →		→ I →														
LOG SWEEP-LIN SWEEP	0	1	0	→ I →													
TRIG SWEEP-FREE RUN	← 0 →		→ I →														
	→ I →																
	→ I →																
	→ I →																
OFFSET P	→ I →																
PHASE	→ I →																
SWEEP DURATION	← 1 ms →		→ OFF →														
VAR	← ccw →		→ I →														
RISE & FALL TIME	← Fixed →		→ I →														
VAR	→ I →																
ATTENUATOR (dB)	→ I →																
VAR	→ I →																
MAN TRIG	→ I →																
TRIG LEVEL	→ I →																
SYMMETRY	→ I →																

Blank indicates nonapplicable.  
 O indicates pushbutton out.  
 I indicates pushbutton in.



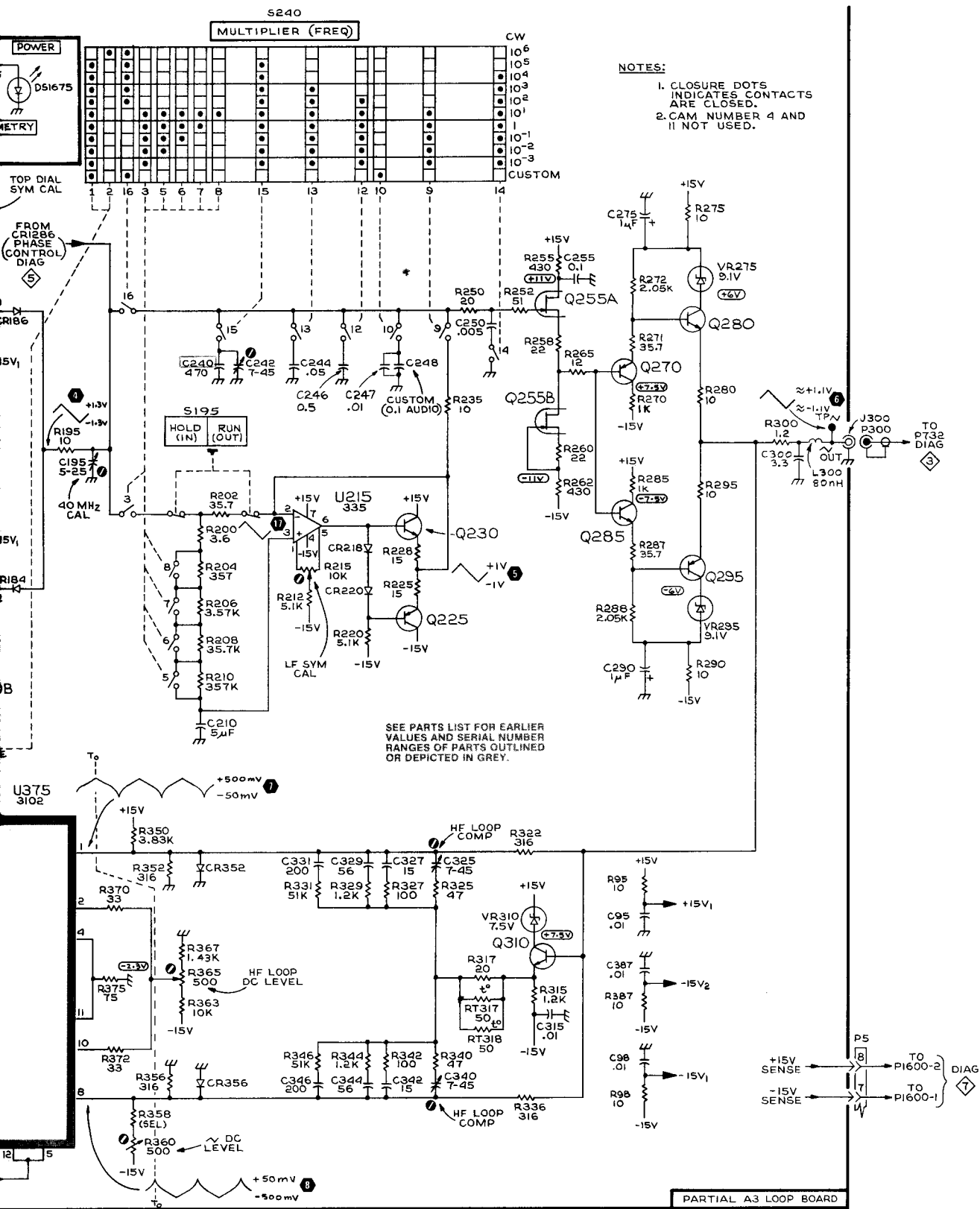

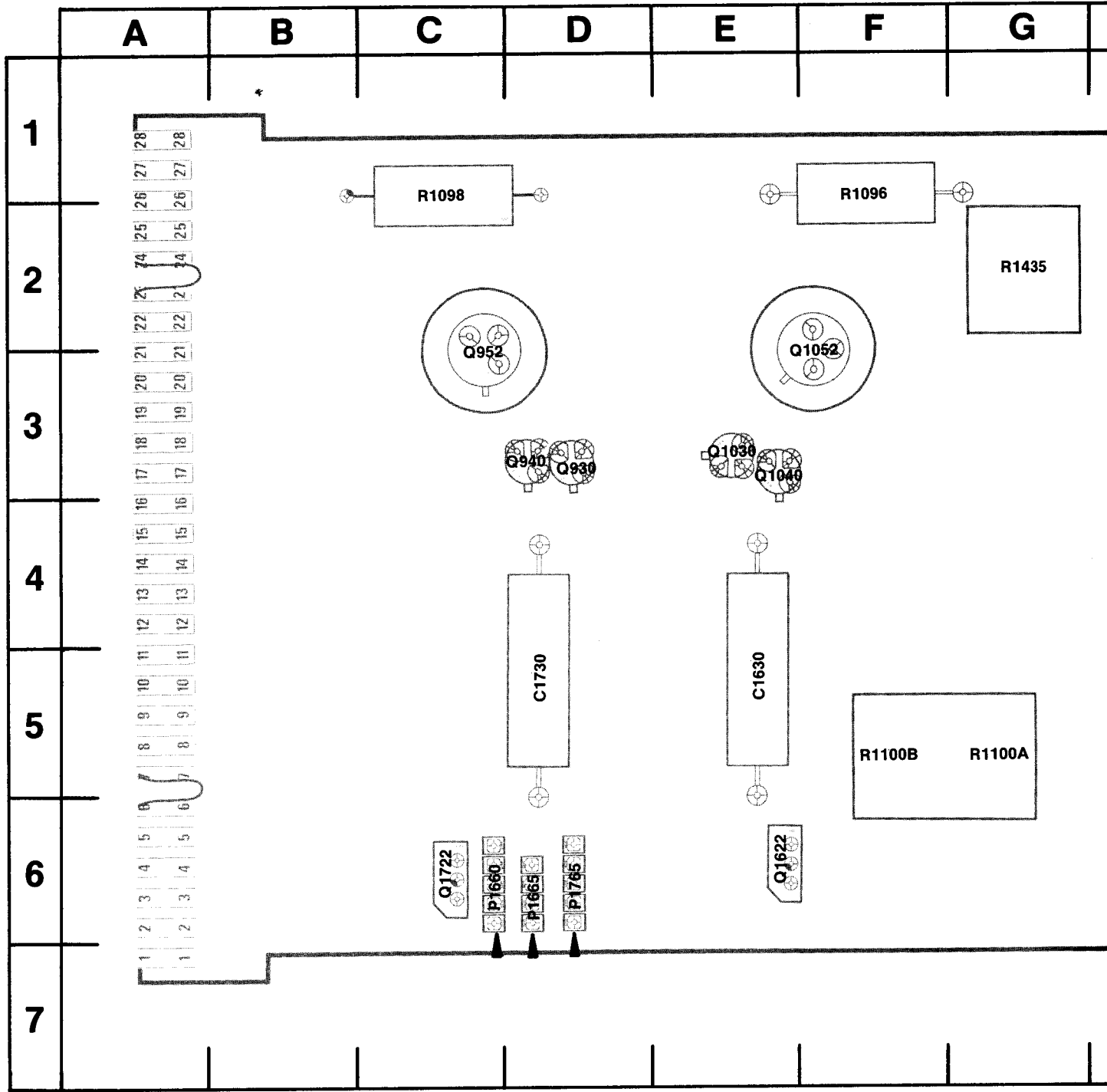
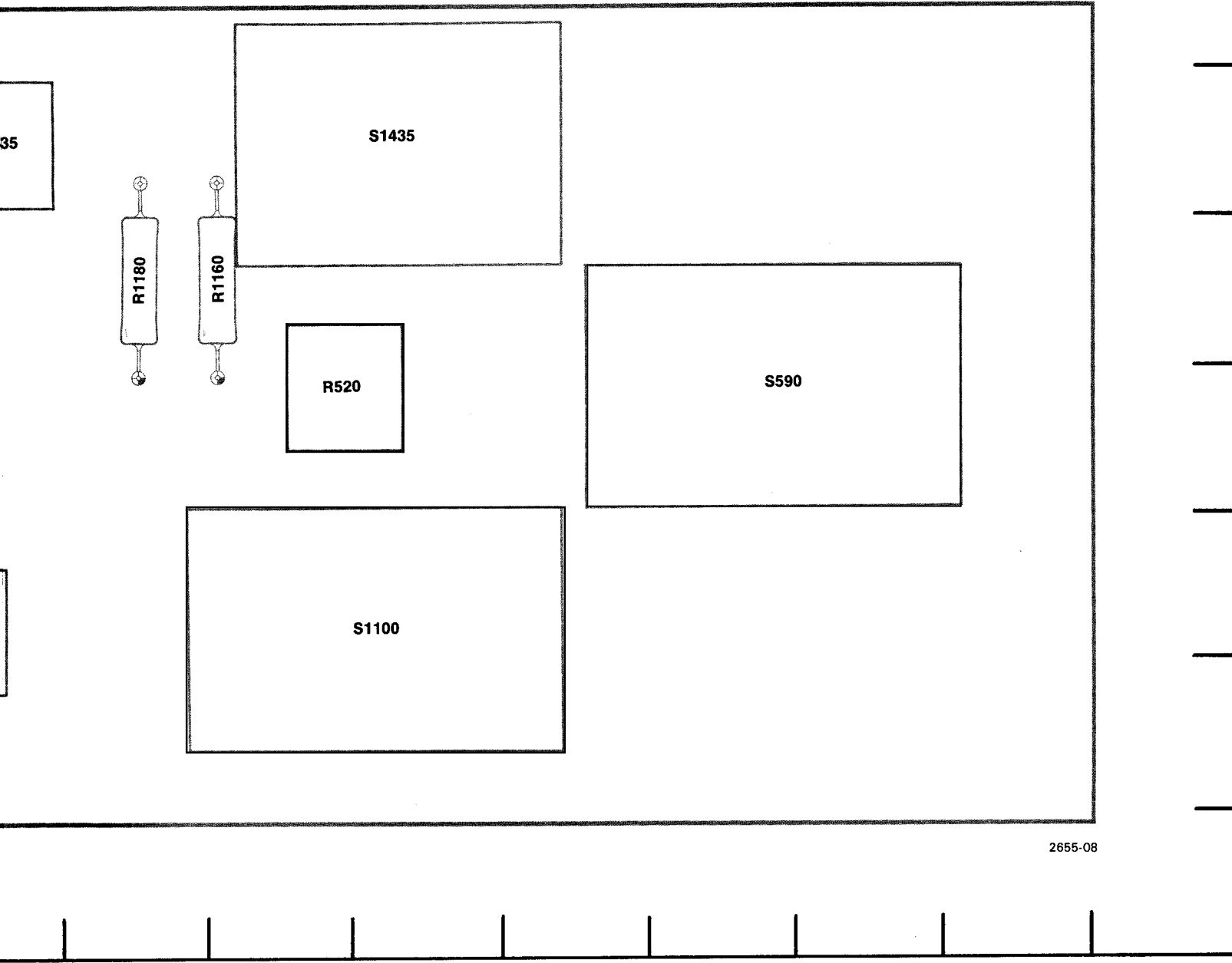

Fig. 8-5. A1 Main board (back)

A1 MAIN BOARD (BACK)  
COM LOC

G	H	I	J	K	L	M	N	O
---	---	---	---	---	---	---	---	---







board (back) component locations.



0

CKT NO	GRID LOC
C1630	E5
C1730	D5
Q930	D3
Q940	D3
Q952	C3
Q1030	E3
Q1040	E3
Q1052	F3
Q1622	E6
Q1722	C6
R520	I4
R1096	F1
R1098	C1
R1100A	G5
R1100B	F5
R1160	I3
R1180	H3
R1435	G2
S590	L4
S1100	J5
S1435	J2

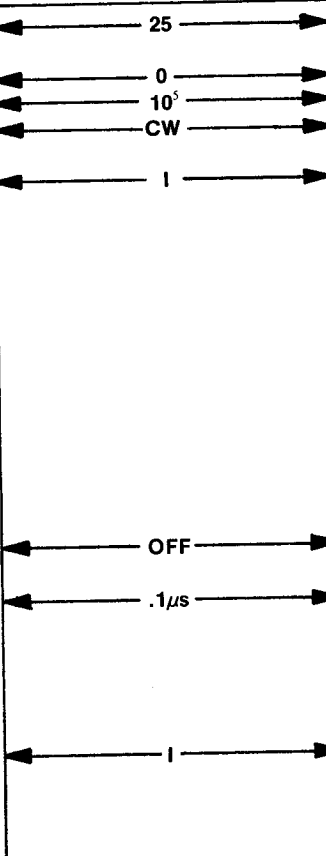
Controls	Waveshape Number/Control Settings
	
FREQUENCY*Hz START FREQUENCY Hz STOP HOLD RUN FREQUENCY MULTIPLIER FREQUENCY VERNIER (VAR) TRIGGER FREE RUN TRIG GATE Φ LOCK MAN LEVEL STOP FREQ-SWEEP LOG SWEEP-LIN SWEEP TRIG SWEEP-FREE RUN    OFFSET P PHASE SWEEP DURATION VAR RISE & FALL TIME VAR ATTENUATOR (dB) VAR MAN TRIG TRIG LEVEL SYMMETRY	

Blank indicates nonapplicable.  
 O indicates pushbutton out.  
 I indicates pushbutton in.

← WAVESHAPENUMBER/CONTROL SETTINGS

VAR RISE AND FALL TIME

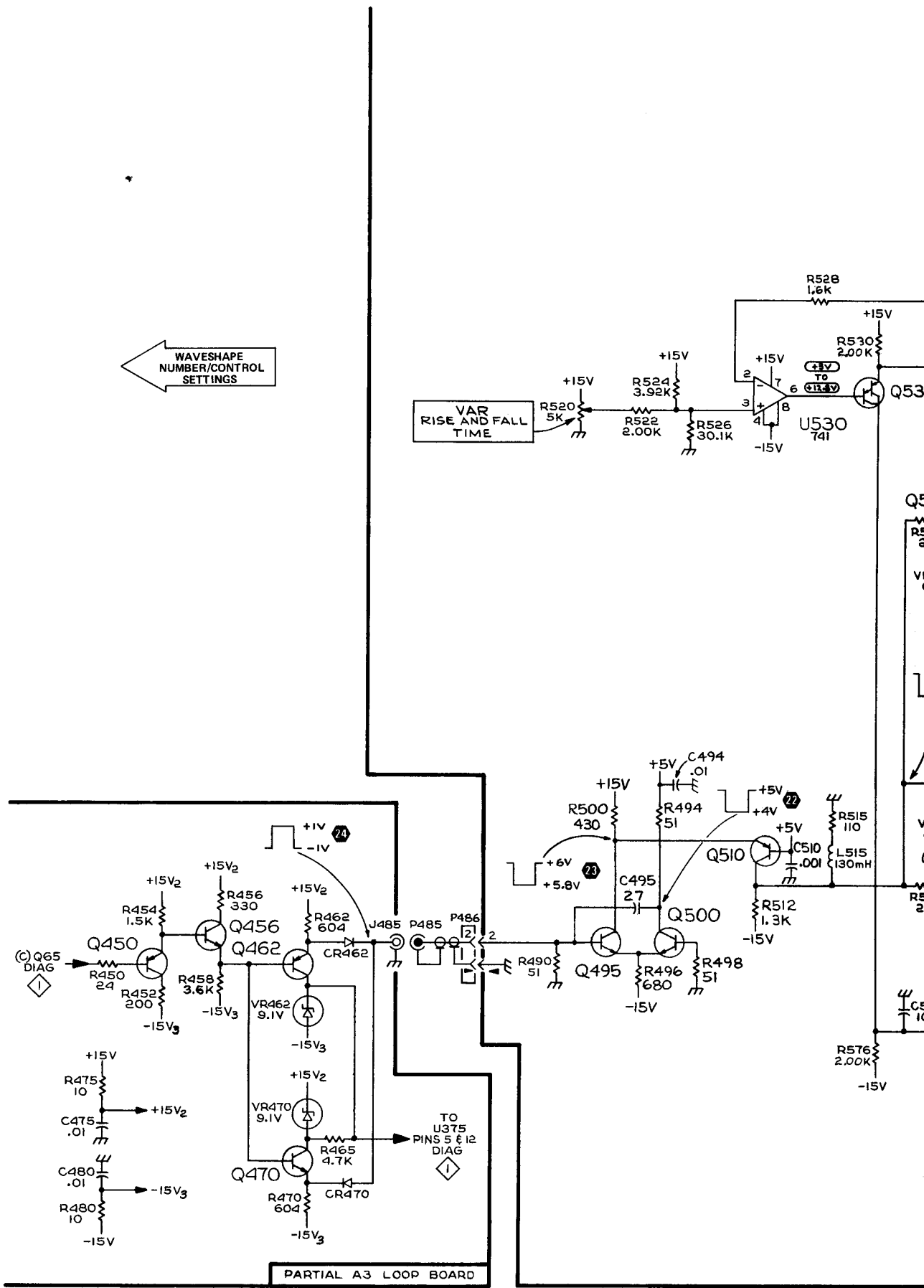

FG504 SNB040000-UP

53X#81

(2028-32) REV

S590

RISE AND FALL TIME

CCW  
FIXED  $\leq 6\text{ ns}$

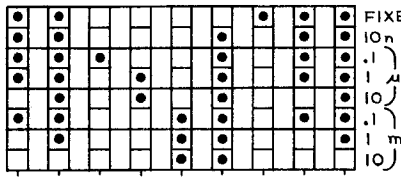

NOTES:

1. CLOSURE DOT INDICATES CONTACT CLOSED.
2. \* MATCHED PAIR.

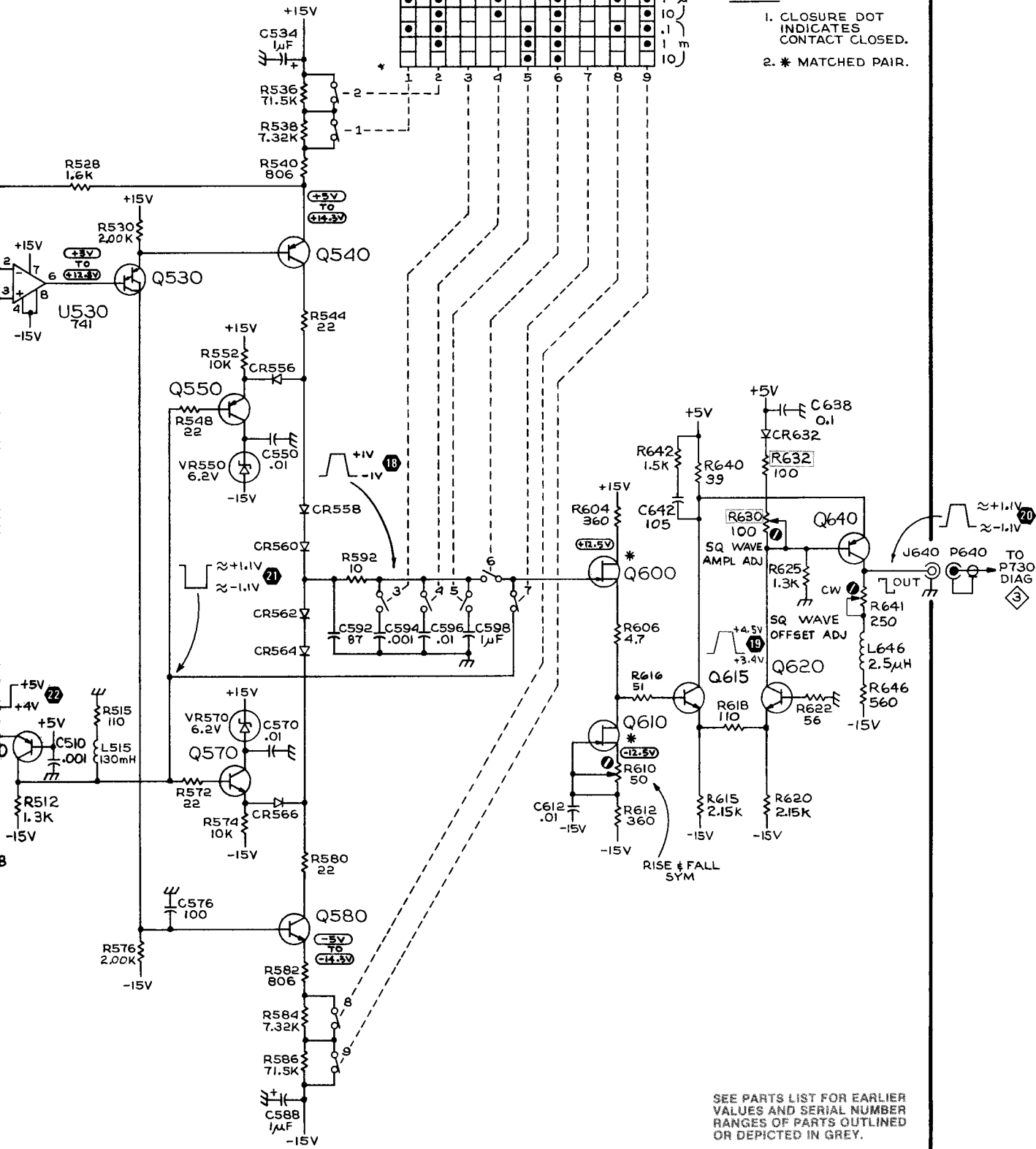

SEE PARTS LIST FOR EARLIER VALUES AND SERIAL NUMBER RANGES OF PARTS OUTLINED OR DEPICTED IN GREY.

PARTIAL A1 MAIN BOARD

(2028-32)2655-14  
REV MAY 1981



SQUARE BUFFER/VARIABLE RISE & FALL

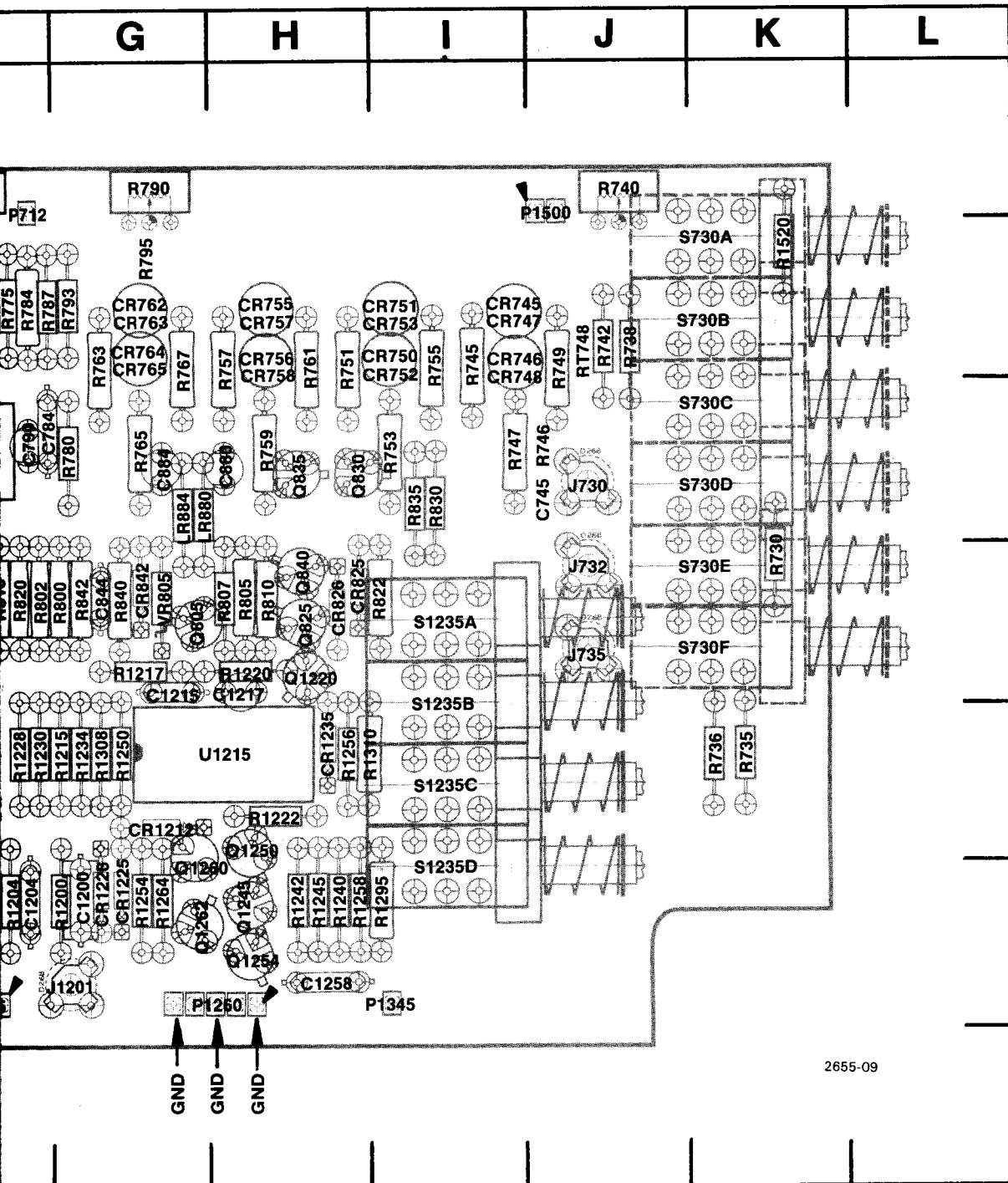



tion board component locations.

CKT NO	GRID LOC	CKT NO	GRID LOC	CKT NO	GRID LOC	CKT NO	GRID LOC	CKT NO	GRID LOC
C745	J3	J730	J3	R777	E4	R1334	D6	S1235B	I4
C784	G3	J732	J4	R780	G3	R1340	D5	S1235C	I5
C790	F3	J735	J4	R784	F2	R1345	C5	S1235D	I5
C812	F4	J1201	G6	R787	F2	R1370	E4		
C844	G4	J1295	E6	R790	G1	R1372	E2	U770	F3
C857	E2			R793	G2	R1376	D4	U1215	H5
C880	H3	LR880	G3	R795	G2	R1380	D4	U1225	F5
C884	G3	LR884	G3	R798	F4	R1384	E4	U1295	E6
C1200	G6			R800	G4	R1386	E4	U1340	D5
C1204	F6	P712	F1	R802	F4	R1390	E4	U1445	B3
C1215	G4	P1160	C6	R805	H4	R1392	D4	U1470	D2
C1217	H4	P1161	D6	R807	H4	R1394	E2	U1480	C3
C1258	H6	P1163	D6	R810	H4	R1400	D3	U1490	B4
C1295	F6	P1215	F6	R818	F4	R1402	D4	U1495	C4
C1322	D5	P1260	H6	R820	F4	R1406	E3	U1500	C5
C1330	E5	P1276	D6	R822	I4	R1408	E3		
C1340	D5	P1277	E6	R830	I3	R1410	E3	VR775	F2
C1380	D3	P1345	I6	R835	I3	R1412	D3	VR805	G4
C1392	D4	P1370	E1	R840	G4	R1416	D4		
C1394	E3	P1440	C1	R842	G4	R1418	D4	W1428	C2
C1445	A3	P1500	J1	R850	F4	R1425	C2		
C1462	D1			R852	F4	R1448	B2		
C1468	D2	Q805	G4	R855	E1	R1450	B2		
C1478	B3	Q825	H4	R857	E2	R1452	B2		
C1492	B4	Q830	H3	R868	F2	R1456	C3		
C1494	B3	Q835	H3	R870	F1	R1458	D3		
C1504	C5	Q840	H4	R872	F2	R1460	D1		
C1770	E6	Q1220	H4	R1200	G6	R1462	D2		
C1774	E6	Q1245	H6	R1201	F6	R1466	D2		
C1778	C3	Q1250	H5	R1202	F6	R1467	D2		
C1800	A4	Q1254	H6	R1204	F6	R1470	C2		
		Q1260	G5	R1215	G5	R1475	B1		
CR745	I2	Q1262	G6	R1217	G4	R1476	B2		
CR746	I2	Q1400	D3	R1220	H4	R1478	B3		
CR747	I2	Q1410	D3	R1222	H5	R1480	C3		
CR748	I2	Q1420	D3	R1228	F5	R1484	C3		
CR750	I2	Q1430	C2	R1230	F5	R1486	C3		
CR751	I2	Q1450	C2	R1234	G5	R1488	C3		
CR752	I2			R1240	H6	R1490	B5		
CR753	I2	R730	K4	R1242	H6	R1495	B4		
CR755	H2	R735	K5	R1245	H6	R1496	B5		
CR756	H2	R736	K5	R1250	G5	R1500	B5		
CR757	H2	R738	J2	R1254	G6	R1504	C5		
CR758	H2	R740	J1	R1256	H5	R1508	C4		
CR762	G2	R742	J2	R1258	H6	R1510	C4		
CR763	G2	R745	I2	R1264	G6	R1512	C4		
CR764	G2	R746	J3	R1295	H6	R1514	C4		
CR765	G2	R747	I3	R1298	D6	R1520	K2		
CR825	H4	R749	J2	R1300	E5	R1525	B2		
CR826	H4	R751	H2	R1302	E5				
CR842	G4	R753	I3	R1305	E5	RT748	J2		
CR1212	G5	R755	I2	R1308	G5	RT1456	C3		
CR1225	G6	R757	H2	R1310	H5				
CR1226	G6	R759	H3	R1316	E6	S730A	K2		
CR1235	H5	R761	H2	R1320	D6	S730B	K2		
CR1312	F6	R763	G2	R1324	E6	S730C	K3		
CR1370	E4	R765	G3	R1328	D5	S730D	K3		
CR1372	E4	R767	G2	R1330	E5	S730E	K4		
CR1420	C2	R770	F4	R1331	E5	S730F	K4		
CR1470	D2	R775	F2	R1332	D6	S1235A	I4		

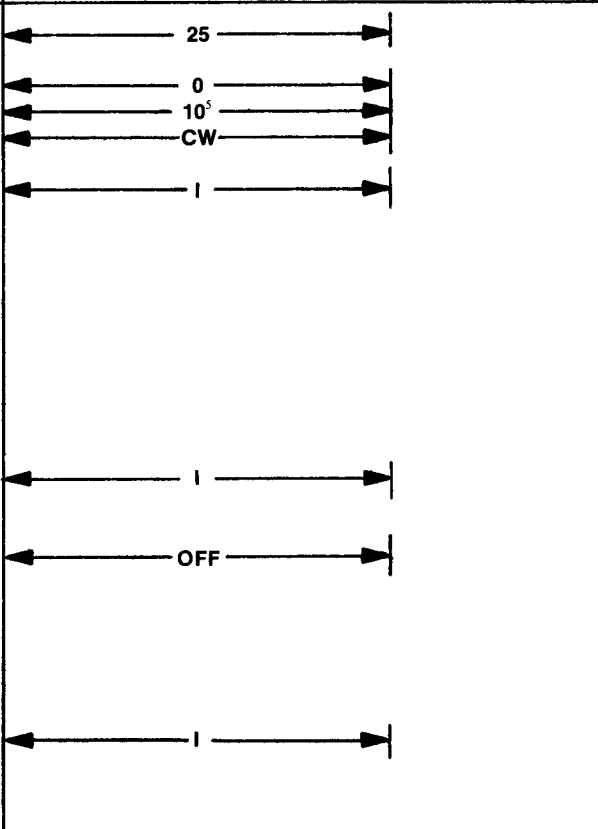
Controls	Waveshape Number/Control Settings
1	25 26 27 28 29 30 31 32
FREQUENCY Hz START FREQUENCY Hz STOP HOLD RUN FREQUENCY MULTIPLIER FREQUENCY VERNIER (VAR) TRIGGER FREE RUN TRIG GATE Φ LOCK MAN LEVEL STOP FREQ-SWEEP LOG SWEEP-LIN SWEEP TRIG SWEEP-FREE RUN    OFFSET P PHASE SWEEP DURATION VAR RISE & FALL TIME VAR ATTENUATOR (dB) VAR MAN TRIG TRIG LEVEL SYMMETRY	

Blank indicates nonapplicable.  
 O indicates pushbutton out.  
 I indicates pushbutton in.



← WAVESHAVE NUMBER/CONTROL SETTINGS

1 FROM P1635

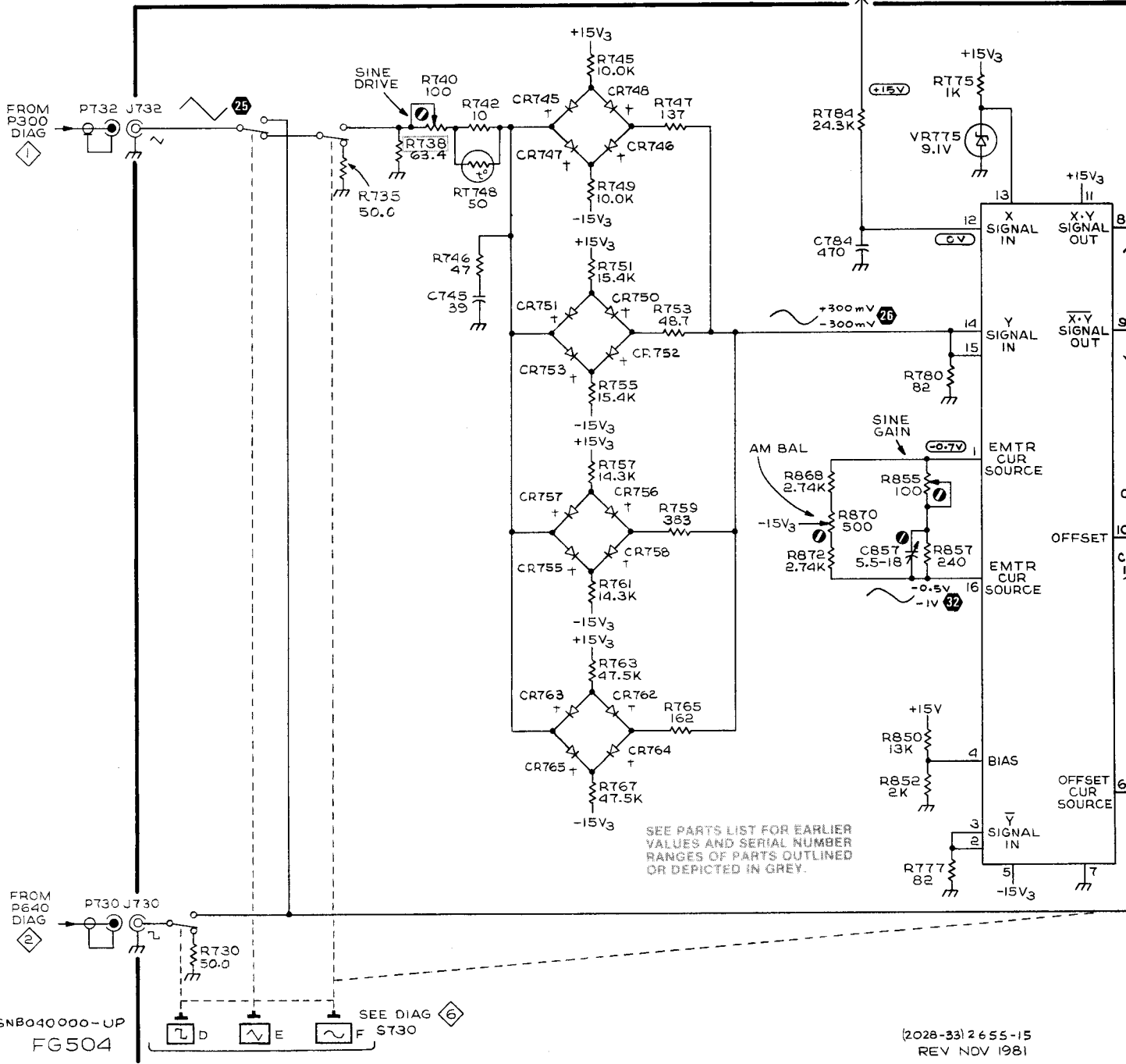
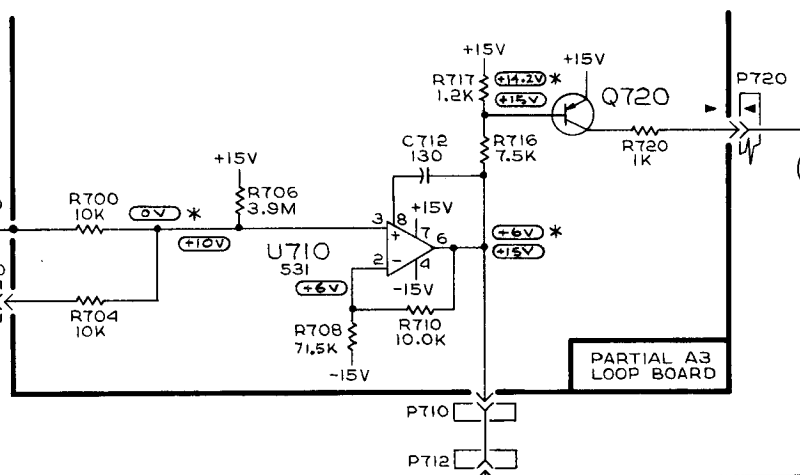

FROM P640 DIAG (2) → P730 J730 → R730 50.0 → SEE DIAG (6) → D, E, F S730

SNB040000-UP  
FG504

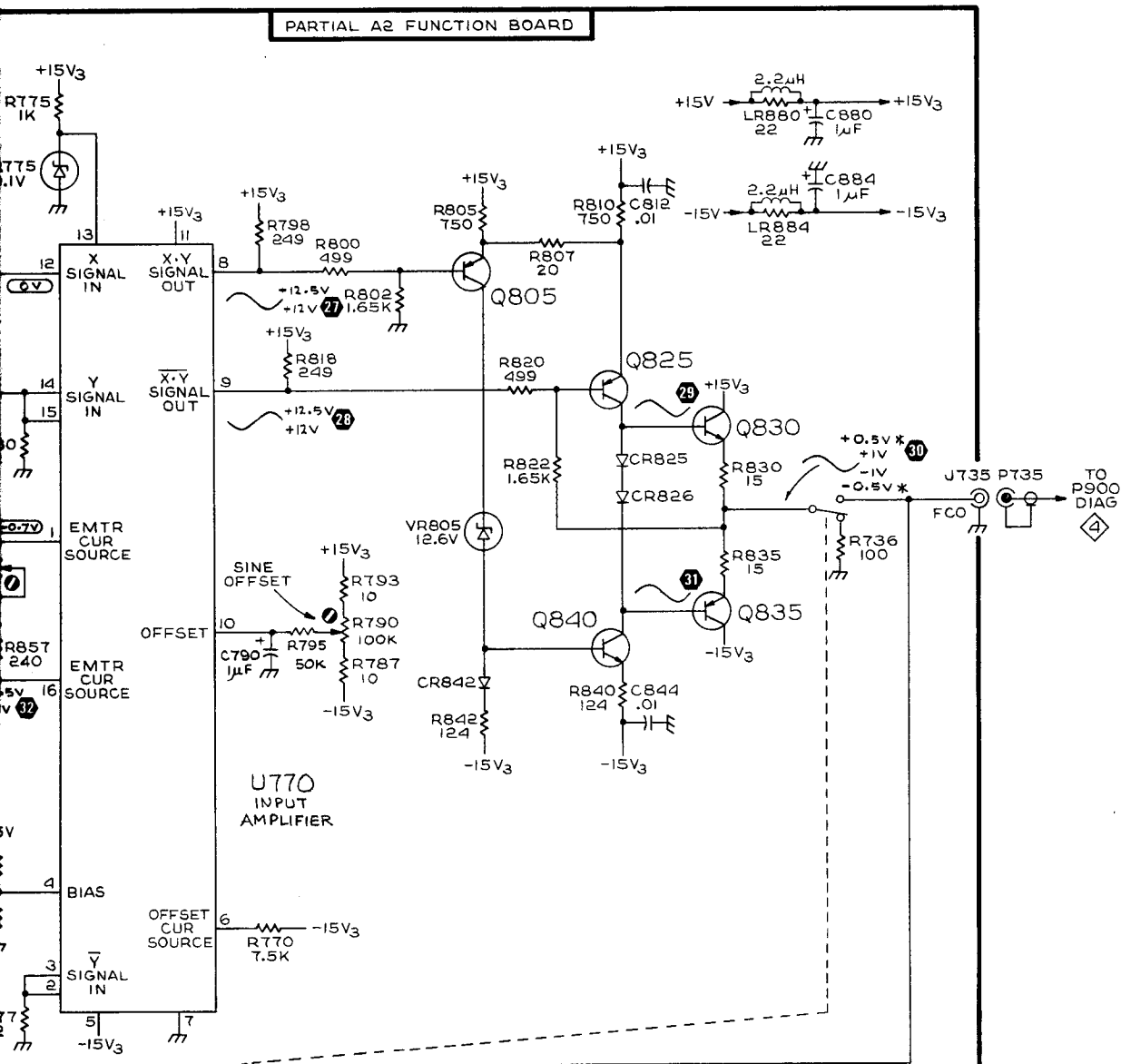
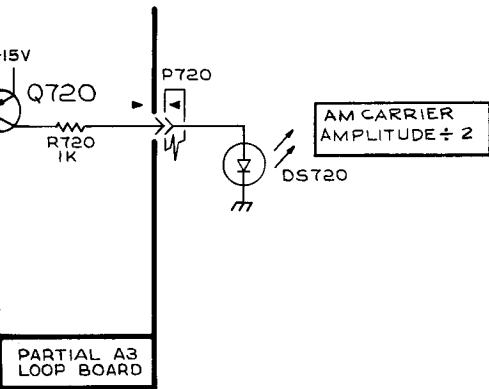

\* WITH AM SIGNAL APPLIED  
† MATCHED SET OF 16 DIODES



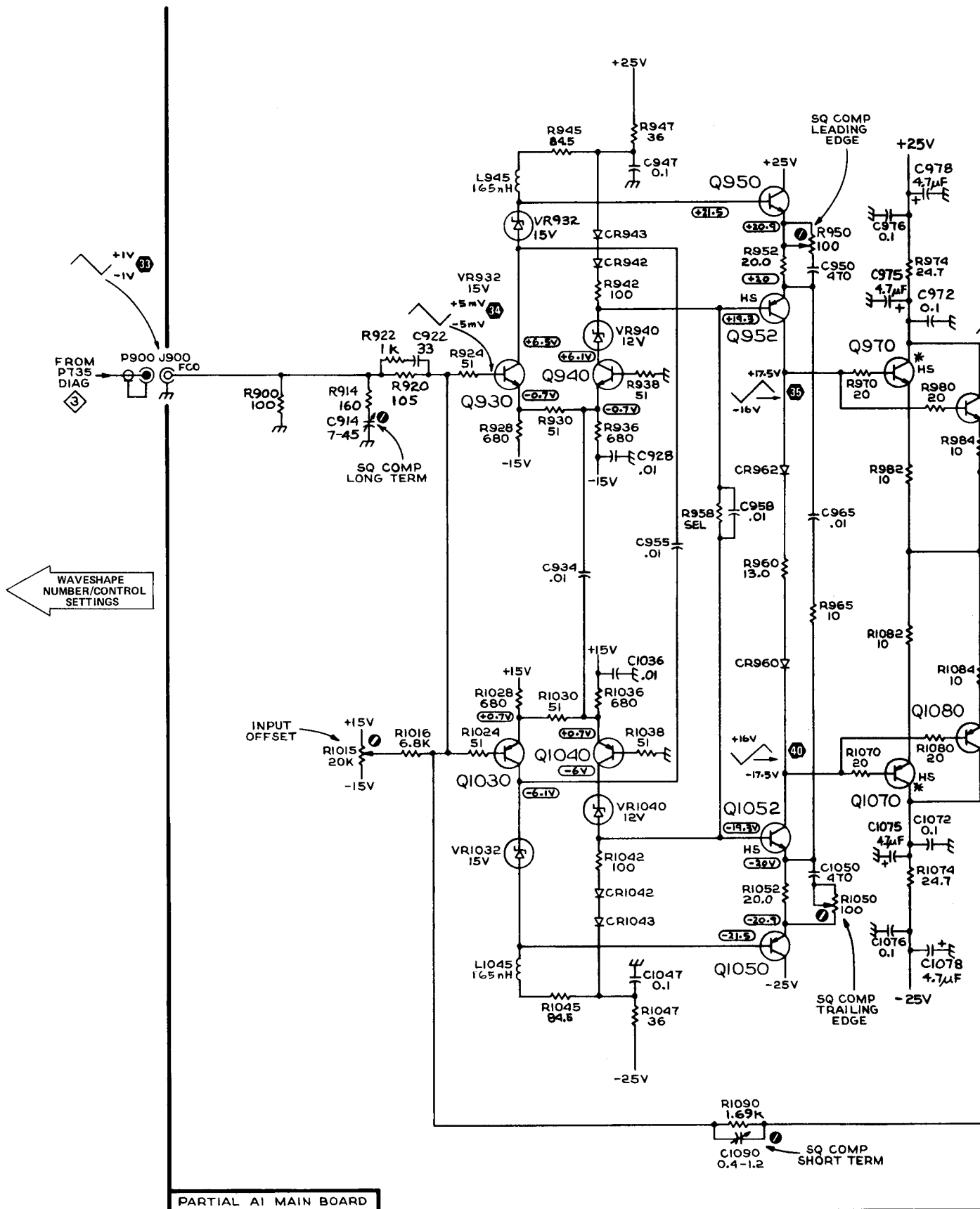

PARTIAL AI MAIN BOARD

**NOTES:**

1. CLOSURE DOTS INDICATE 'A' CONTACTS CLOSED AND 'B' CONTACTS OPEN.
  2. 'B' CONTACTS ARE ON COMPONENT SIDE OF THE BOARD.
- \* MOUNTED TO TOP RAIL.

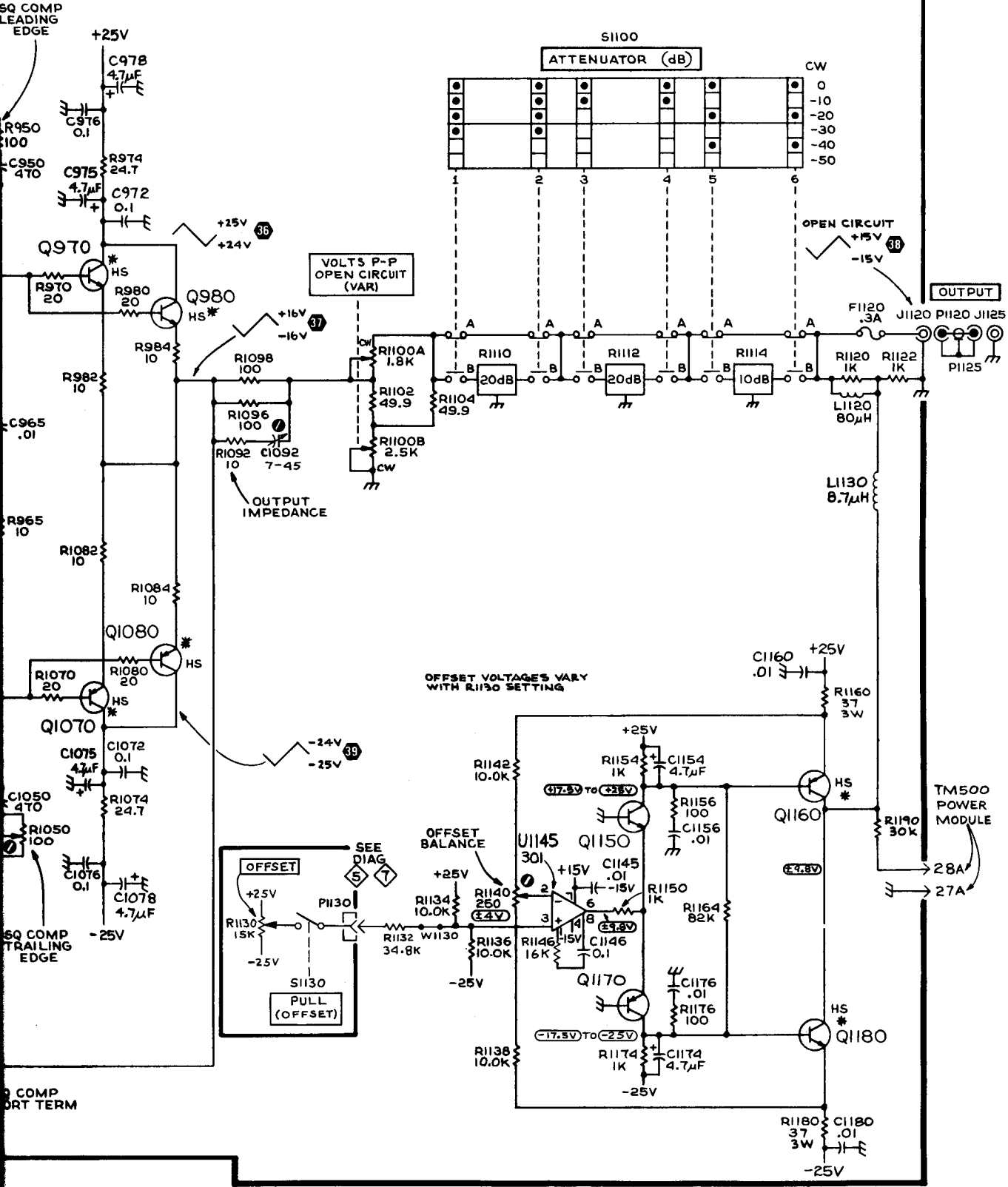



(2028-54)2655-16  
REV MAY 1981

**OUTPUT AMPLIFIER/OFFSET** 4

OUTPUT AMPLIFIER/OFFSET

4

Controls	Waveshape Number/Control Settings																		
	41	42	43	44	45	46	47	48	49	50	51	52	53	54	55	56	57	58	59
FREQUENCY Hz START	←----- 25 -----→																		→
FREQUENCY Hz STOP	←----- 1 -----→																		→
HOLD RUN	←----- 1 -----→																		→
FREQUENCY MULTIPLIER	←----- 10 <sup>+1</sup> -----→																		→
FREQUENCY VERNIER (VAR)	←----- C4 -----→																		→
TRIGGER																			
FREE RUN																			
TRIG																			I
GATE																			I
Φ LOCK																			I
MAN																			I
LEVEL																			I
STOP FREQ-SWEEP																			
LOG SWEEP-LIN SWEEP																			
TRIG SWEEP-FREE RUN																			
																			
																			
																			
OFFSET P	←----- 1 -----→																		→
PHASE																			
SWEEP DURATION	←----- OFF -----→																		→
VAR																			
RISE & FALL TIME																			
VAR																			
ATTENUATOR (dB)	←----- CW -----→																		→
VAR																			
MAN TRIG																			
TRIG LEVEL																			
SYMMETRY	←----- (External Input Required) -----→																		→

Blank indicates nonapplicable.  
O indicates pushbutton out.  
I indicates pushbutton in.

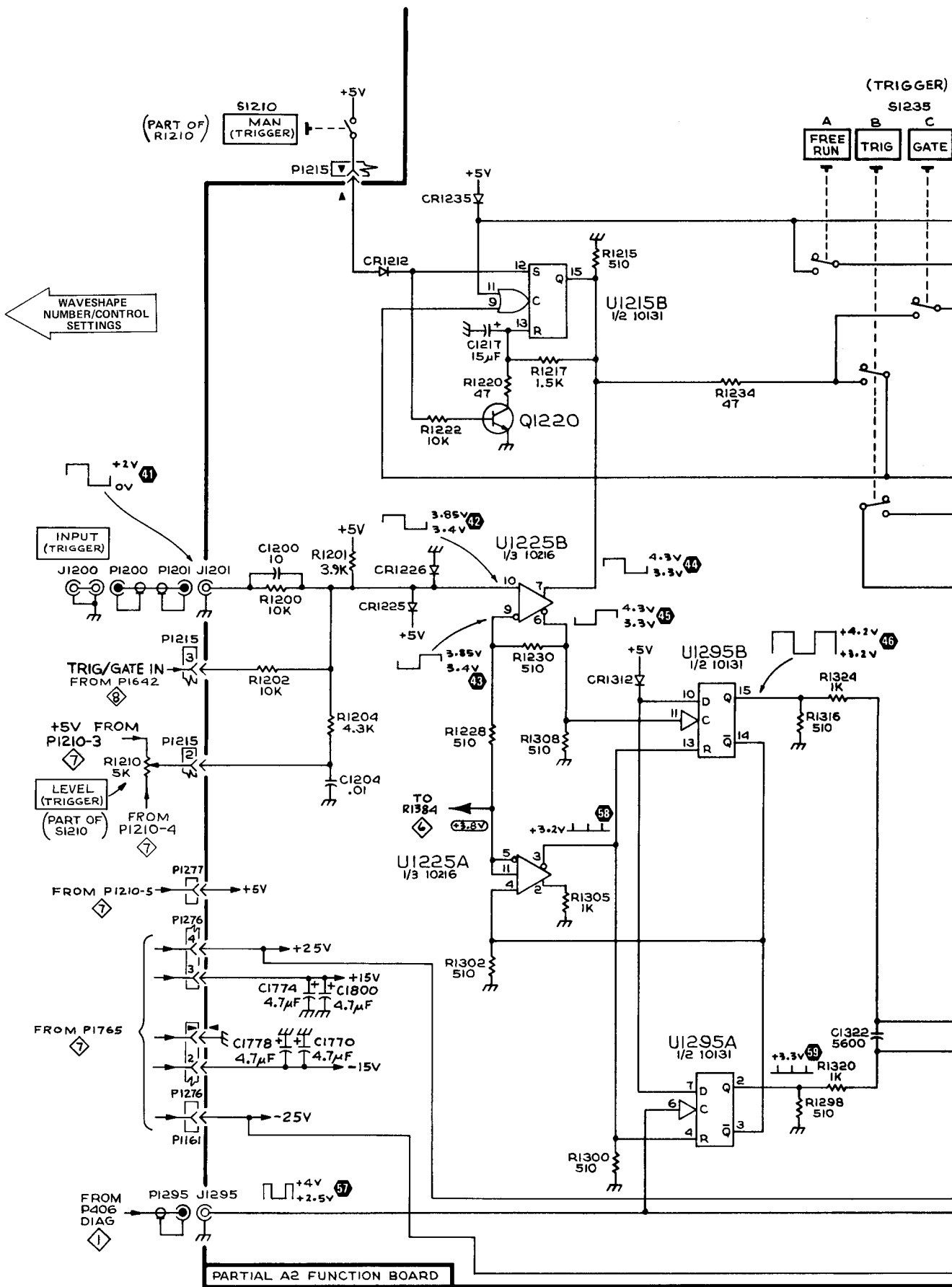

← WAVESHAPES  
NUMBER/CONTROL  
SETTINGS

+1V  
0V (41)  
INPUT  
(TRIGGER)  
J1200 PI200 PI201 J1201

TRIG/GATE IN  
FROM P1642  
PI215  
+5V FROM  
PI210-3  
R1210  
5K  
LEVEL  
(TRIGGER)  
FROM  
PI210-4

FROM PI210-5  
PI277  
PI276  
FROM PI765  
C1774 C1800  
4.7µF 4.7µF  
C1778 C1770  
4.7µF 4.7µF  
+15V  
-15V

FROM  
P406  
DIAG  
PI295 J1295  
+4V  
+2.5V (57)

PARTIAL A2 FUNCTION BOARD

(TRIGGER)  
S1235  
A FREE RUN  
B TRIG  
C GATE





Controls	Waveshape Number/Control Settings
	<div style="display: flex; justify-content: space-between;"> <span>60</span><span>61</span><span>62</span><span>63</span><span>64</span><span>65</span><span>66</span><span>67</span><span>68</span><span>69</span><span>70</span><span>71</span> </div>
FREQUENCY Hz START FREQUENCY Hz STOP HOLD RUN FREQUENCY MULTIPLIER FREQUENCY VERNIER (VAR) TRIGGER FREE RUN TRIG GATE φ LOCK MAN LEVEL STOP FREQ-SWEEP LOG SWEEP-LIN SWEEP TRIG SWEEP-FREE RUN ┌┐ ~ ~ OFFSET P PHASE SWEEP DURATION VAR RISE & FALL TIME VAR ATTENUATOR (dB) VAR MAN TRIG TRIG LEVEL SYMMETRY	<div style="margin-bottom: 10px;"> </div> <div style="margin-bottom: 10px;"> </div> <div style="margin-bottom: 10px;"> </div> <div style="margin-bottom: 10px;"> </div> <div style="margin-bottom: 10px;"> </div>

Blank indicates nonapplicable.  
 O indicates pushbutton out.  
 I indicates pushbutton in.





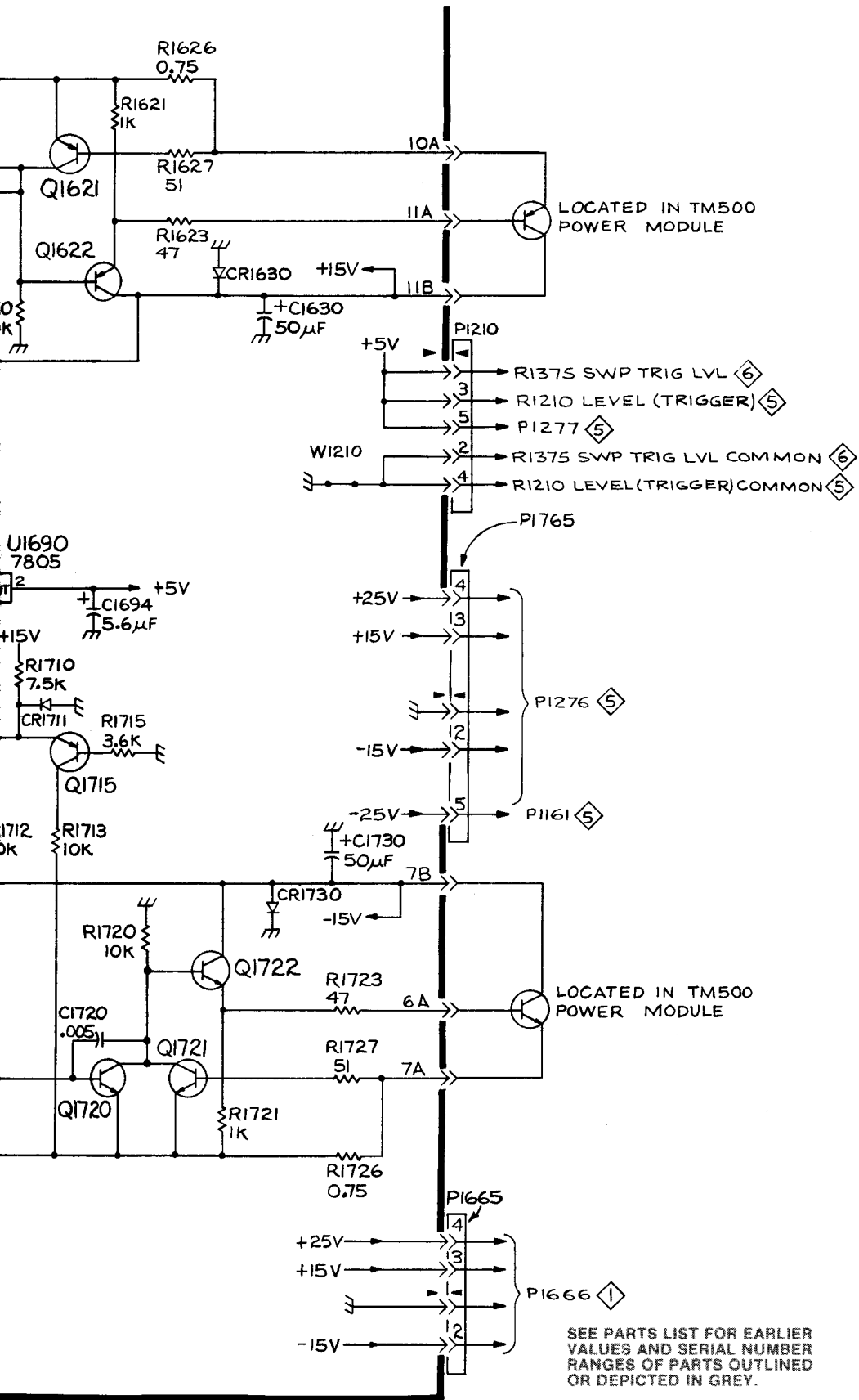

LOCATED IN TM500 POWER MODULE

LOCATED IN TM500 POWER MODULE

SEE PARTS LIST FOR EARLIER VALUES AND SERIAL NUMBER RANGES OF PARTS OUTLINED OR DEPICTED IN GREY.

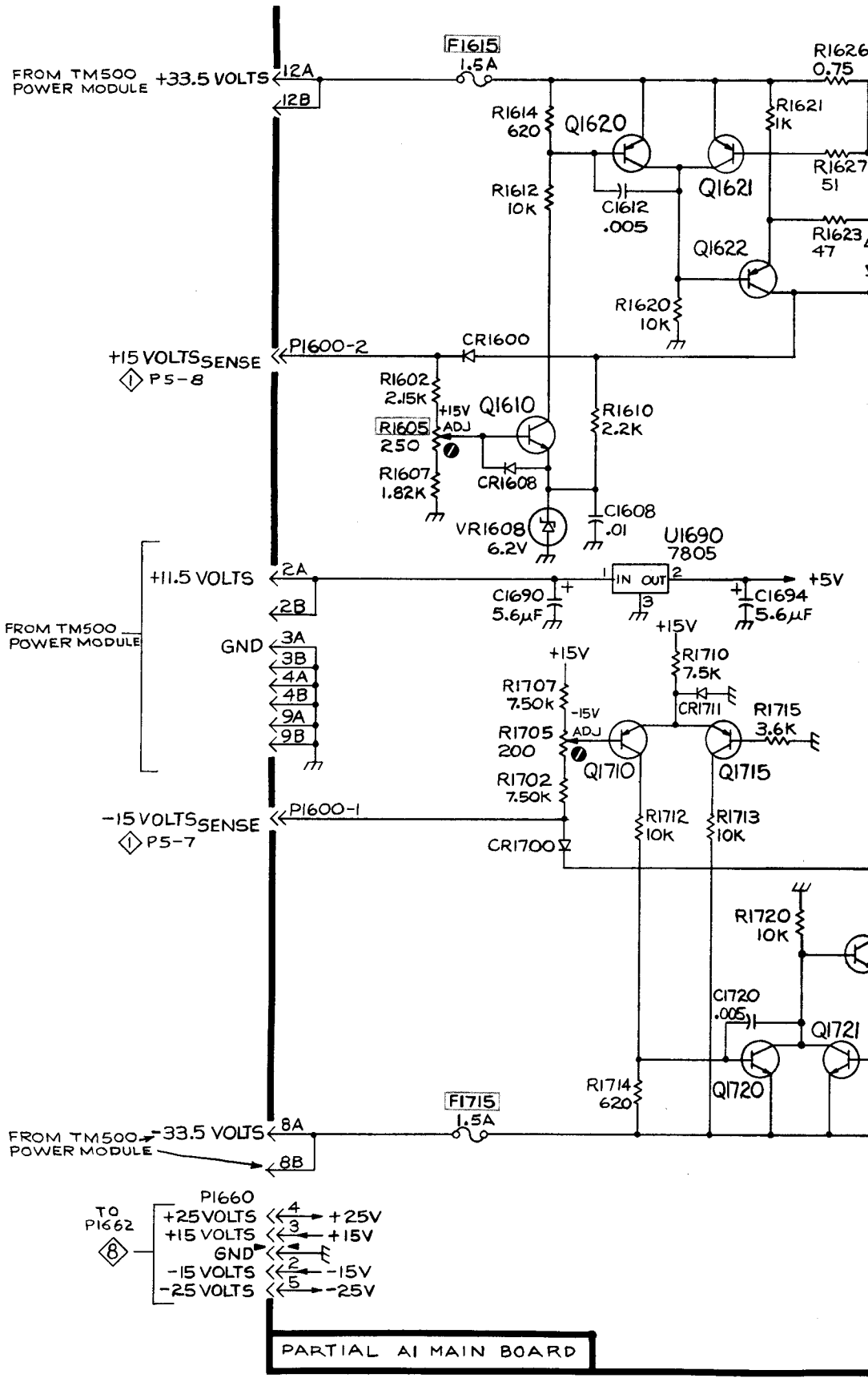



CKT NO	GRID LOC
R1640	C6
R1641	C6
R1642	B6
R1643	C7
R1644	B6
R1645	C6
R1648	C5
R1650	A5
R1652	B5
R1654	B5
R1661	C5
R1662	C5
R1663	C5
R1676	B5
R1682	D4
R1740	A4
R1742	B4
R1744	B4
R1745	B3
R1746	B3
R1747	A3
R1748	C1
R1750	B3
R1752	B2
R1754	C1
R1761	C1
R1762	C3
R1763	B2
R1776	A3
R1777	A3
R1782	D2
VR1652	B5
VR1676	B5
VR1677	B5
VR1752	B2
VR1776	A4
VR1777	B4

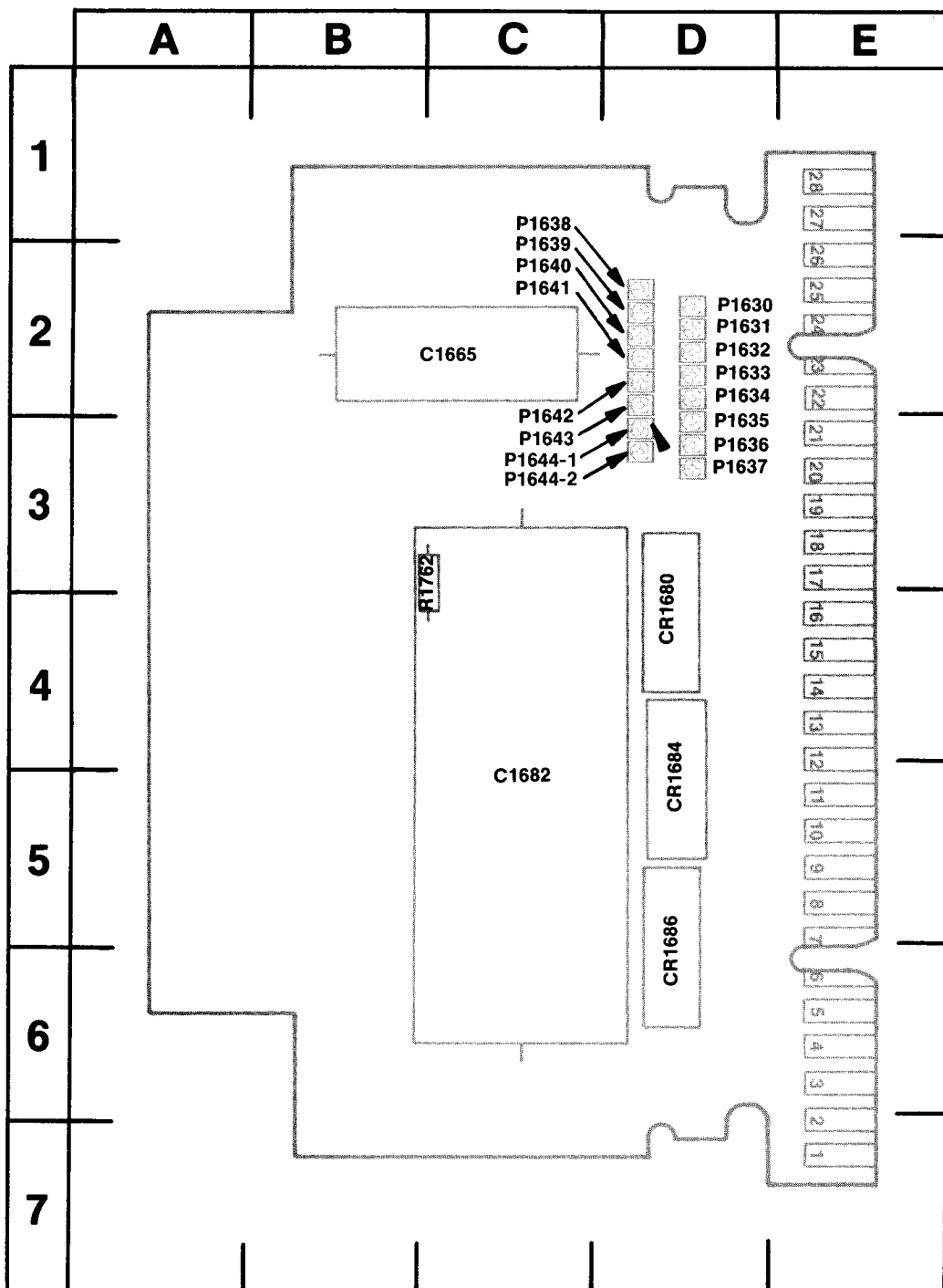

CKT NO	GRID LOC
C1665	C2
C1682	C5
CR1680	D4
CR1684	D5
CR1686	D6
P1630	D2
P1631	D2
P1632	D2
P1633	D2
P1634	D2
P1635	D3
P1636	D3
P1637	D3
P1638	C1
P1639	C1
P1640	C2
P1641	C2
P1642	C2
P1643	C3
P1644-1	C3
P1644-2	C3

Fig. 8-8. A4 Floating Interface board (back) component locations.

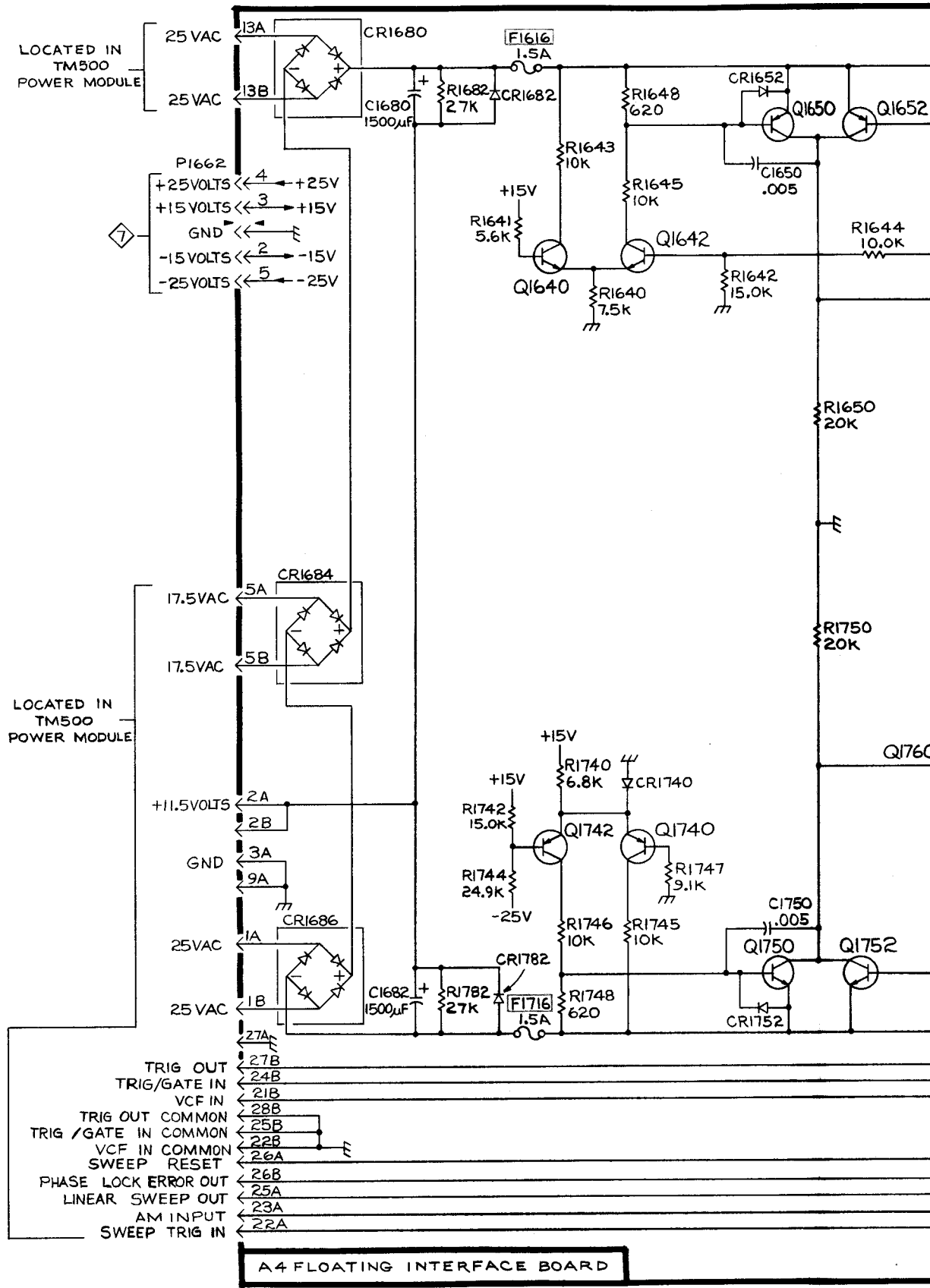



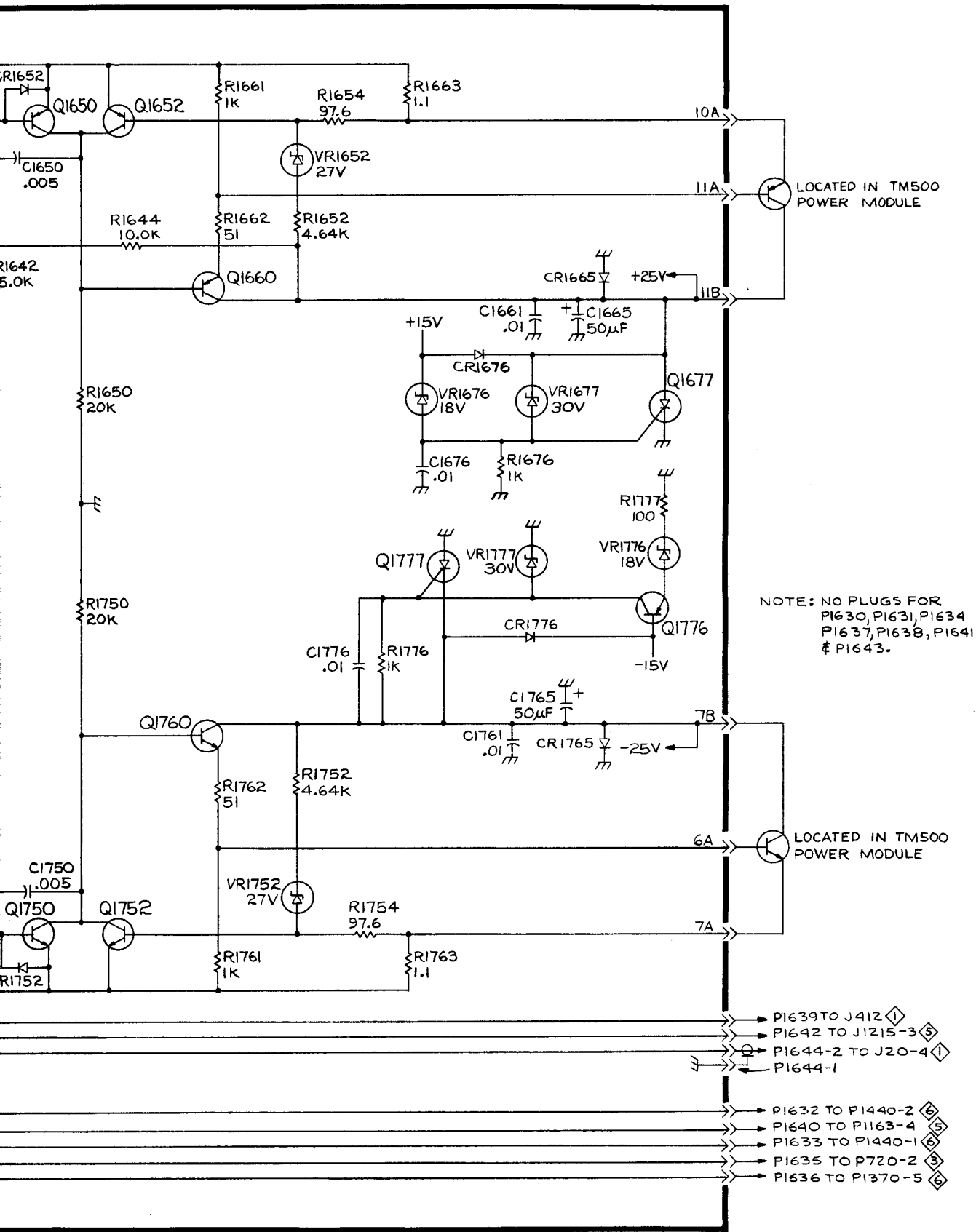

# REPLACEABLE MECHANICAL PARTS

## PARTS ORDERING INFORMATION

Replacement parts are available from or through your local Tektronix, Inc. Field Office or representative.

Changes to Tektronix instruments are sometimes made to accommodate improved components as they become available, and to give you the benefit of the latest circuit improvements developed in our engineering department. It is therefore important, when ordering parts, to include the following information in your order: Part number, instrument type or number, serial number, and modification number if applicable.

If a part you have ordered has been replaced with a new or improved part, your local Tektronix, Inc. Field Office or representative will contact you concerning any change in part number.

Change information, if any, is located at the rear of this manual.

## SPECIAL NOTES AND SYMBOLS

X000 Part first added at this serial number  
00X Part removed after this serial number

## FIGURE AND INDEX NUMBERS

Items in this section are referenced by figure and index numbers to the illustrations.

## INDENTATION SYSTEM

This mechanical parts list is indented to indicate item relationships. Following is an example of the indentation system used in the description column.

```

1 2 3 4 5           Name & Description
Assembly and/or Component
Attaching parts for Assembly and/or Component
-----*-----
Detail Part of Assembly and/or Component
Attaching parts for Detail Part
-----*-----
Parts of Detail Part
Attaching parts for Parts of Detail Part
-----*-----

```

Attaching Parts always appear in the same indentation as the item it mounts, while the detail parts are indented to the right. Indented items are part of, and included with, the next higher indentation. The separation symbol ---\*--- indicates the end of attaching parts.

**Attaching parts must be purchased separately, unless otherwise specified.**

## ITEM NAME

In the Parts List, an Item Name is separated from the description by a colon (:). Because of space limitations, an Item Name may sometimes appear as incomplete. For further Item Name identification, the U.S. Federal Cataloging Handbook H6-1 can be utilized where possible.

## ABBREVIATIONS

"	INCH	ELCTRN	ELECTRON	IN	INCH	SE	SINGLE END
#	NUMBER SIZE	ELEC	ELECTRICAL	INCAND	INCANDESCENT	SECT	SECTION
ACTR	ACTUATOR	ELCTLT	ELECTROLYTIC	INSUL	INSULATOR	SEMICOND	SEMICONDUCTOR
ADPTR	ADAPTER	ELEM	ELEMENT	INTL	INTERNAL	SHLD	SHIELD
ALIGN	ALIGNMENT	EPL	ELECTRICAL PARTS LIST	LPHLDR	LAMPHOLDER	SHLDR	SHOULDERED
AL	ALUMINUM	EQPT	EQUIPMENT	MACH	MACHINE	SKT	SOCKET
ASSEM	ASSEMBLED	EXT	EXTERNAL	MECH	MECHANICAL	SL	SLIDE
ASSY	ASSEMBLY	FIL	FILLISTER HEAD	MTG	MOUNTING	SLFLKG	SELF-LOCKING
ATTEN	ATTENUATOR	FLEX	FLEXIBLE	NIP	NIPPLE	SLVG	SLEEVING
AWG	AMERICAN WIRE GAGE	FLH	FLAT HEAD	NON WIRE	NOT WIRE WOUND	SPR	SPRING
BD	BOARD	FLTR	FILTER	OBD	ORDER BY DESCRIPTION	SQ	SQUARE
BRKT	BRACKET	FR	FRAME or FRONT	OD	OUTSIDE DIAMETER	SST	STAINLESS STEEL
BRS	BRASS	FSTNR	FASTENER	OVH	OVAL HEAD	STL	STEEL
BRZ	BRONZE	FT	FOOT	PH BRZ	PHOSPHOR BRONZE	SW	SWITCH
BSHG	BUSHING	FXD	FIXED	PL	PLAIN or PLATE	T	TUBE
CAB	CABINET	GSKT	GASKET	PLSTC	PLASTIC	TERM	TERMINAL
CAP	CAPACITOR	HDL	HANDLE	PN	PART NUMBER	THD	THREAD
CER	CERAMIC	HEX	HEXAGON	PNH	PAN HEAD	THK	THICK
CHAS	CHASSIS	HEX HD	HEXAGONAL HEAD	PWR	POWER	TNSN	TENSION
CKT	CIRCUIT	HEX SOC	HEXAGONAL SOCKET	RCPT	RECEPTACLE	TPG	TAPPING
COMP	COMPOSITION	HLCPS	HELICAL COMPRESSION	RES	RESISTOR	TRH	TRUSS HEAD
CONN	CONNECTOR	HLEXT	HELICAL EXTENSION	RGD	RIGID	V	VOLTAGE
COV	COVER	HV	HIGH VOLTAGE	RLF	RELIEF	VAR	VARIABLE
CPLG	COUPLING	IC	INTEGRATED CIRCUIT	RTNR	RETAINER	W/	WITH
CRT	CATHODE RAY TUBE	ID	INSIDE DIAMETER	SCH	SOCKET HEAD	WSHR	WASHER
DEG	DEGREE	IDNT	IDENTIFICATION	SCOPE	OSCILLOSCOPE	XFMR	TRANSFORMER
DWR	DRAWER	IMPLR	IMPELLER	SCR	SCREW	XSTR	TRANSISTOR

CROSS INDEX—MFR. CODE NUMBER TO MANUFACTURER

Mfr. Code	Manufacturer	Address	City, State, Zip
K0099	JACKSON BROS (LONDON) LTD.	258 BROADWAY	NEW YORK, NEW YORK 10007
000BK	STAUFFER SUPPLY	105 SE TAYLOR	PORTLAND, OR 97214
000CY	NORTHWEST FASTENER SALES, INC.	7923 SW CIRBUS DRIVE	BEAVERTON, OR 97005
000EX	O'HARA METAL PRODUCT COMPANY	542 BRANNAN STREET	SAN FRANCISCO, CA 94107
00779	AMP, INC.	P O BOX 3608	HARRISBURG, PA 17105
05820	WAKEFIELD ENGINEERING, INC.	AUDUBON ROAD	WAKEFIELD, MA 01880
08261	SPECTRA-STRIP CORP.	7100 LAMPSON AVE.	GARDEN GROVE, CA 92642
11897	PLASTIGLIDE MFG. CORPORATION	P O BOX 867, 1757 STANFORD ST.	SANTA MONICA, CA 90406
12360	ALBANY PRODUCTS CO., DIV. OF PNEUMO DYNAMICS CORPORATION	145 WOODWARD AVENUE	SOUTH NORWALK, CT 06586
13103	THERMALLOY COMPANY, INC.	2021 W VALLEY VIEW LANE P O BOX 34829	DALLAS, TX 75234
22526	BERG ELECTRONICS, INC.	YOUK EXPRESSWAY	NEW CUMBERLAND, PA 17070
42838	NATIONAL RIVET AND MFG. CO.	1-21 EAST JEFFERSON ST.	WAUPUN, WI 53963
55210	GETTIG ENG. AND MFG. COMPANY	PO BOX 85, OFF ROUTE 45	SPRING MILLS, PA 16875
56878	STANDARD PRESSED STEEL COMPANY	BENSON EAST	JENKINTOWN, PA 19046
70276	ALLEN MFG. CO.	P. O. DRAWER 570	HARTFORD, CT 06101
71159	BRISTOL SOCKET SCREW, DIV. OF AMERICAN CHAIN AND CABLE CO., INC.	P O BOX 2244, 40 BRISTOL ST.	WATERBURY, CT 06720
71785	TRW, CINCH CONNECTORS	1501 MORSE AVENUE	ELK GROVE VILLAGE, IL 60007
73743	FISCHER SPECIAL MFG. CO.	446 MORGAN ST.	CINCINNATI, OH 45206
73803	TEXAS INSTRUMENTS, INC., METALLURGICAL MATERIALS DIV.	34 FOREST STREET	ATTLEBORO, MA 02703
74445	HOLO-KROME CO.	31 BROOK ST. WEST	HARTFORD, CT 06110
77250	PHEOLL MANUFACTURING CO., DIVISION OF ALLIED PRODUCTS CORP.	5700 W. ROOSEVELT RD.	CHICAGO, IL 60650
78189	ILLINOIS TOOL WORKS, INC. SHAKEPROOF DIVISION	ST. CHARLES ROAD	ELGIN, IL 60120
78471	TILLEY MFG. CO.	900 INDUSTRIAL RD.	SAN CARLOS, CA 94070
79136	WALDES, KOHINOOR, INC.	47-16 AUSTEL PLACE	LONG ISLAND CITY, NY 11101
79807	WROUGHT WASHER MFG. CO.	2100 S. O BAY ST.	MILWAUKEE, WI 53207
80009	TEKTRONIX, INC.	P O BOX 500	BEAVERTON, OR 97077
83385	CENTRAL SCREW CO.	2530 CRESCENT DR.	BROADVIEW, IL 60153
86928	SEASTROM MFG. COMPANY, INC.	701 SONORA AVENUE	GLENDALE, CA 91201
87308	N. L. INDUSTRIES, INC., SOUTHERN SCREW DIV.	P. O. BOX 1360	STATESVILLE, NC 28677
93907	TEXTRON INC. CAMCAR DIV	600 18TH AVE	ROCKFORD, IL 61101
95987	WECKESSER CO., INC.	4444 WEST IRVING PARK RD.	CHICAGO, IL 60641

# REPLACEABLE MECHANICAL PARTS

## PARTS ORDERING INFORMATION

Replacement parts are available from or through your local Tektronix, Inc. Field Office or representative.

Changes to Tektronix instruments are sometimes made to accommodate improved components as they become available, and to give you the benefit of the latest circuit improvements developed in our engineering department. It is therefore important, when ordering parts, to include the following information in your order: Part number, instrument type or number, serial number, and modification number if applicable.

If a part you have ordered has been replaced with a new or improved part, your local Tektronix, Inc. Field Office or representative will contact you concerning any change in part number.

Change information, if any, is located at the rear of this manual.

## SPECIAL NOTES AND SYMBOLS

X000 Part first added at this serial number  
00X Part removed after this serial number

## FIGURE AND INDEX NUMBERS

Items in this section are referenced by figure and index numbers to the illustrations.

## INDENTATION SYSTEM

This mechanical parts list is indented to indicate item relationships. Following is an example of the indentation system used in the description column.

1	2	3	4	5	Name & Description
					<i>Assembly and/or Component</i>
					<i>Attaching parts for Assembly and/or Component</i>
					---*---
					<i>Detail Part of Assembly and/or Component</i>
					<i>Attaching parts for Detail Part</i>
					---*---
					<i>Parts of Detail Part</i>
					<i>Attaching parts for Parts of Detail Part</i>
					---*---

Attaching Parts always appear in the same indentation as the item it mounts, while the detail parts are indented to the right. Indented items are part of, and included with, the next higher indentation. The separation symbol ---\*--- indicates the end of attaching parts.

**Attaching parts must be purchased separately, unless otherwise specified.**

## ITEM NAME

In the Parts List, an Item Name is separated from the description by a colon (:). Because of space limitations, an Item Name may sometimes appear as incomplete. For further Item Name identification, the U.S. Federal Cataloging Handbook H6-1 can be utilized where possible.

## ABBREVIATIONS

"	INCH	ELCTRN	ELECTRON	IN	INCH	SE	SINGLE END
#	NUMBER SIZE	ELEC	ELECTRICAL	INCAND	INCANDESCENT	SECT	SECTION
ACTR	ACTUATOR	ELCTLT	ELECTROLYTIC	INSUL	INSULATOR	SEMICOND	SEMICONDUCTOR
ADPTR	ADAPTER	ELEM	ELEMENT	INTL	INTERNAL	SHLD	SHIELD
ALIGN	ALIGNMENT	EPL	ELECTRICAL PARTS LIST	LPHLDR	LAMPHOLDER	SHLDR	SHOULDERED
AL	ALUMINUM	EQPT	EQUIPMENT	MACH	MACHINE	SKT	SOCKET
ASSEM	ASSEMBLED	EXT	EXTERNAL	MECH	MECHANICAL	SL	SLIDE
ASSY	ASSEMBLY	FIL	FILLISTER HEAD	MTG	MOUNTING	SLFLKG	SELF-LOCKING
ATTEN	ATTENUATOR	FLEX	FLEXIBLE	NIP	NIPPLE	SLVGR	SLEEVING
AWG	AMERICAN WIRE GAGE	FLH	FLAT HEAD	NON WIRE	NOT WIRE WOUND	SPR	SPRING
BD	BOARD	FLTR	FILTER	OBD	ORDER BY DESCRIPTION	SQ	SQUARE
BRKT	BRACKET	FR	FRAME or FRONT	OD	OUTSIDE DIAMETER	SST	STAINLESS STEEL
BRS	BRASS	FSTNR	FASTENER	OVH	OVAL HEAD	STL	STEEL
BRZ	BRONZE	FT	FOOT	PH BRZ	PHOSPHOR BRONZE	SW	SWITCH
BSHG	BUSHING	FXD	FIXED	PL	PLAIN or PLATE	T	TUBE
CAB	CABINET	GSKT	GASKET	PLSTC	PLASTIC	TERM	TERMINAL
CAP	CAPACITOR	HDL	HANDLE	PN	PART NUMBER	THD	THREAD
CER	CERAMIC	HEX	HEXAGON	PNH	PAN HEAD	THK	THICK
CHAS	CHASSIS	HEX HD	HEXAGONAL HEAD	PWR	POWER	TNSN	TENSION
CKT	CIRCUIT	HEX SOC	HEXAGONAL SOCKET	RCPT	RECEPTACLE	TPG	TAPPING
COMP	COMPOSITION	HLCPS	HELICAL COMPRESSION	RES	RESISTOR	TRH	TRUSS HEAD
CONN	CONNECTOR	HLEXT	HELICAL EXTENSION	RGD	RIGID	V	VOLTAGE
COV	COVER	HV	HIGH VOLTAGE	RLF	RELIEF	VAR	VARIABLE
CPLG	COUPLING	IC	INTEGRATED CIRCUIT	RTNR	RETAINER	W/	WITH
CRT	CATHODE RAY TUBE	ID	INSIDE DIAMETER	SCH	SOCKET HEAD	WSHR	WASHER
DEG	DEGREE	IDENT	IDENTIFICATION	SCOPE	OSCILLOSCOPE	XFMR	TRANSFORMER
DWR	DRAWER	IMPLR	IMPELLER	SCR	SCREW	XSTR	TRANSISTOR

CROSS INDEX—MFR. CODE NUMBER TO MANUFACTURER

Mfr. Code	Manufacturer	Address	City, State, Zip
K0099	JACKSON BROS (LONDON) LTD.	258 BROADWAY	NEW YORK, NEW YORK 10007
000BK	STAUFFER SUPPLY	105 SE TAYLOR	PORTLAND, OR 97214
000CY	NORTHWEST FASTENER SALES, INC.	7923 SW CIRRUS DRIVE	BEAVERTON, OR 97005
000EX	O'HARA METAL PRODUCT COMPANY	542 BRANNAN STREET	SAN FRANCISCO, CA 94107
00779	AMP, INC.	P O BOX 3608	HARRISBURG, PA 17105
05820	WAKEFIELD ENGINEERING, INC.	AUDUBON ROAD	WAKEFIELD, MA 01880
08261	SPECTRA-STRIP CORP.	7100 LAMPSON AVE.	GARDEN GROVE, CA 92642
11897	PLASTIGLIDE MFG. CORPORATION	P O BOX 867, 1757 STANFORD ST.	SANTA MONICA, CA 90406
12360	ALBANY PRODUCTS CO., DIV. OF PNEUMO DYNAMICS CORPORATION	145 WOODWARD AVENUE	SOUTH NORWALK, CT 06586
13103	THERMALLOY COMPANY, INC.	2021 W VALLEY VIEW LANE P O BOX 34829	DALLAS, TX 75234
22526	BERG ELECTRONICS, INC.	YOUK EXPRESSWAY	NEW CUMBERLAND, PA 17070
42838	NATIONAL RIVET AND MFG. CO.	1-21 EAST JEFFERSON ST.	WAUPUN, WI 53963
55210	GETTIG ENG. AND MFG. COMPANY	PO BOX 85, OFF ROUTE 45	SPRING MILLS, PA 16875
56878	STANDARD PRESSED STEEL COMPANY	BENSON EAST	JENKINTOWN, PA 19046
70276	ALLEN MFG. CO.	P. O. DRAWER 570	HARTFORD, CT 06101
71159	BRISTOL SOCKET SCREW, DIV. OF AMERICAN CHAIN AND CABLE CO., INC.	P O BOX 2244, 40 BRISTOL ST.	WATERBURY, CT 06720
71785	TRW, CINCH CONNECTORS	1501 MORSE AVENUE	ELK GROVE VILLAGE, IL 60007
73743	FISCHER SPECIAL MFG. CO.	446 MORGAN ST.	CINCINNATI, OH 45206
73803	TEXAS INSTRUMENTS, INC., METALLURGICAL MATERIALS DIV.	34 FOREST STREET	ATTLEBORO, MA 02703
74445	HOLO-KROME CO.	31 BROOK ST. WEST	HARTFORD, CT 06110
77250	PHEOLL MANUFACTURING CO., DIVISION OF ALLIED PRODUCTS CORP.	5700 W. ROOSEVELT RD.	CHICAGO, IL 60650
78189	ILLINOIS TOOL WORKS, INC. SHAKEPROOF DIVISION	ST. CHARLES ROAD	ELGIN, IL 60120
78471	TILLEY MFG. CO.	900 INDUSTRIAL RD.	SAN CARLOS, CA 94070
79136	WALDES, KOHINOOR, INC.	47-16 AUSTEL PLACE	LONG ISLAND CITY, NY 11101
79807	WROUGHT WASHER MFG. CO.	2100 S. O BAY ST.	MILWAUKEE, WI 53207
80009	TEKTRONIX, INC.	P O BOX 500	BEAVERTON, OR 97077
83385	CENTRAL SCREW CO.	2530 CRESCENT DR.	BROADVIEW, IL 60153
86928	SEASTROM MFG. COMPANY, INC.	701 SONORA AVENUE	GLENDALE, CA 91201
87308	N. L. INDUSTRIES, INC., SOUTHERN SCREW DIV.	P. O. BOX 1360	STATESVILLE, NC 28677
93907	TEXTRON INC. CAMCAR DIV	600 18TH AVE	ROCKFORD, IL 61101
95987	WECKESSER CO., INC.	4444 WEST IRVING PARK RD.	CHICAGO, IL 60641

Replaceable Mechanical Parts—FG 504 (SN B040000 & up)

Fig. & Index No.	Tektronix Part No.	Serial/Model No. Eff Dscont	Qty	1	2	3	4	5	Name & Description	Mfr Code	Mfr Part Number
1-1	200-1837-01	B040000 B049999	2						COVER,PLUG-IN:TOP & BOTTOM	80009	200-1837-01
	200-1837-02	B050000	2						COVER,PLUG-IN:TOP & BOTTOM (ATTACHING PARTS)	80009	200-1837-02
-2	211-0504-00		4						SCREW,MACHINE:6-32 X 0.25 INCH,PNH STL - - - * - - -	83385	OBD
-3	337-1399-04		2						SHIELD,ELEC:SIDE	80009	337-1399-04
-4	366-1609-00		1						KNOB:0.08 ID,0.415OD	80009	366-1609-00
	213-0022-00		2						. SETSCREW:4-40 X 0.188 INCH,HEX SOC STL	74445	OBD
-5	366-1651-00		1						KNOB:GRAY,FCTN FREQSTOP,0.252 ID,0.705 OD	80009	366-1651-00
	213-0153-00		2						. SETSCREW:5-40 X 0.125,STL BK OXD,HEX SKT	000CY	OBD
-6	210-1239-00		1						WSHR,SPR,TNSN:0.96 ID X 0.012,CU BE	86928	5806-42-1
-7	354-0557-01		1						RING,KNOB SKIRT:CLEAR,1.875 OD (ATTACHING PARTS)	80009	354-0557-01
-8	214-2201-00		1						PIN,SPRING:0.187 L X 0.069 OD,STL CD PL	56878	31-S-062-0187
-9	211-0088-00		2						SCREW,MACHINE:2-56 X 0.281"82 DEG,FLH STL - - - * - - -	77250	OBD
-10	366-1031-06		4						KNOB:GRAY--VAR	80009	366-1031-06
	213-0153-00		4						. SETSCREW:5-40 X 0.125,STL BK OXD,HEX SKT	000CY	OBD
-11	366-1170-03		4						KNOB:GRAY,0.25 ID X 0.706 OD,0.6H	80009	366-1170-03
	213-0153-00		8						. SETSCREW:5-40 X 0.125,STL BK OXD,HEX SKT	000CY	OBD
-12	366-1059-02		2						PUSH BUTTON:GRAY,3.0 H X 0.277 OD	80009	366-1059-02
-13	366-1077-01		2						KNOB:GRAY,0.127 ID,0.5 OD,0.531H	80009	366-1077-01
	213-0153-00		2						. SETSCREW:5-40 X 0.125,STL BK OXD,HEX SKT	000CY	OBD
-14	366-0494-07		1						KNOB:GRAY--PULL	80009	366-0494-07
	213-0246-00		1						. SETSCREW:5-40 X 0.093 ITL BK OXD,HEX SKT	71159	OBD
-15	366-1023-08		1						KNOB:GRAY--PULL	80009	366-1023-08
	213-0153-00		1						. SETSCREW:5-40 X 0.125,STL BK OXD,HEX SKT	000CY	OBD
-16	366-1023-07		1						KNOB:GRAY,0.127 ID,0.392 OD,0.466	80009	366-1023-07
	213-0246-00		1						. SETSCREW:5-40 X 0.093 ITL BK OXD,HEX SKT	71159	OBD
-17	366-1690-00		1						KNOB:SIL GY,0.53 X 0.23 X 1.059	80009	366-1690-00
-18	366-1559-01		3						PUSH BUTTON:GRAY,0.43 L X 0.18 W X 0.18 H	80009	366-1559-01
-19	366-1559-00		8						PUSH BUTTON:SIL GY,0.18 SQ X 0.43	80009	366-1559-00
-20	-----		2						CONNECTOR,RCPT:(SEE J700 AND J1520 REPL)		
-21	210-0255-00		2						TERMINAL,LUG:0.391 ID,LOCKING,BRS CD PL	80009	210-0255-00
-22	-----		2						CONNECTOR,RCPT:(SEE J20 AND J1370 REPL)		
-23	-----		3						CONNECTOR,RCPT:(SEE J420,J1125 AND J1200 REPL)		
-24	-----		2						RESISTOR,VAR:(SEE R1210 AND R1375 REPL) (ATTACHING PARTS)		
-25	210-0583-00		2						NUT,PLAIN,HEX:0.25-32 X 0.312 INCH,BRS	73743	2X20317-402
-26	210-0940-00		2						WASHER,FLAT:0.25 ID X 0.375 INCH OD,STL - - - * - - -	79807	OBD
-27	-----		2						RESISTOR,VAR:(SEE R50 AND R1130 REPL) (ATTACHING PARTS)		
-28	210-0583-00		2						NUT,PLAIN,HEX:0.25-32 X 0.312 INCH,BRS	73743	2X20317-402
-29	210-0940-00		2						WASHER,FLAT:0.25 ID X 0.375 INCH OD,STL - - - * - - -	79807	OBD
-30	-----		1						RESISTOR,VAR:(SEE R1270 REPL)		
-31	210-0940-00		1						WASHER,FLAT:0.25 ID X 0.375 INCH OD,STL	79807	OBD
-32	358-0029-00		1						BSHG,MACH.THD:HEX,0.375-32 X 0.438"LONG (ATTACHING PARTS)	80009	358-0029-00
-33	210-0590-00		1						NUT,PLAIN,HEX.:0.375 X 0.438 INCH,STL	73743	2X28269-402
-34	210-0012-00		1						WASHER,LOCK:INTL,0.375 ID X 0.50" OD STL - - - * - - -	78189	1220-02-00-0541C
-35	358-0029-00		3						BSHG,MACH.THD:HEX,0.375-32 X 0.438"LONG (ATTACHING PARTS)	80009	358-0029-00
-36	210-0590-00		3						NUT,PLAIN,HEX.:0.375 X 0.438 INCH,STL	73743	2X28269-402
-37	210-0978-00		3						WASHER,FLAT:0.375 ID X 0.50 INCH OD,STL - - - * - - -	78471	OBD
-38	344-0195-01		4						CLIP,ELECTRICAL:CAM SHAFT	80009	344-0195-01
-39	426-1072-00		11						FRAME,PUSH BTN:PLASTIC	80009	426-1072-00
-40	333-1820-00		1						PANEL,FRONT:	80009	333-1820-00
-41	200-0935-00		3						BASE,LAMPHOLDER:0.29 OD X 0.19 CASE	80009	200-0935-00

Replaceable Mechanical Parts—FG 504 (SN B040000 & up)

Fig. & Index No.	Tektronix Part No.	Serial/Model No. Eff Dscnt	Qty	1	2	3	4	5	Name & Description	Mfr Code	Mfr Part Number
1-42	-----		1						LAMP,LED:(SEE DS1675 REPL)		
-43	352-0157-00		1						LAMPHOLDER:WHITE PLASTIC	80009	352-0157-00
-44	-----		2						LAMP,LED:(SEE DS50 AND DS720)		
-45	352-0157-00		2						LAMPHOLDER:WHITE PLASTIC	80009	352-0157-00
-46	105-0719-00		1						LATCH,RETAINING:PLUG-IN (ATTACHING PARTS)	80009	105-0719-00
-47	213-0113-00		1						SCR,TPG,THD FOR:2-32 X 0.312 INCH,PNH STL -----*	93907	OBD
-48	105-0718-00	B040000	1						BAR,LATCH RLSE:	80009	105-0718-00
	105-0718-01	B056332	1						BAR,LATCH RLSE:	80009	105-0718-01
-49	386-2795-01	B040000	1						SUBPANEL,FRONT:	80009	386-2795-01
	386-2795-02	B050000	1						SUBPANEL,FRONT: (ATTACHING PARTS)	80009	386-2795-02
-50	213-0227-00	B040000	8						SCR,TPG,THD FOR:6-32 X 0.50 DEG,FLH ST	83385	OBD
	213-0123-00	B044320	8						SCREW,TPG,TF:6-32 X 0.375,SPCL TYPE,FLH	93907	OBD
-51	211-0559-00		1						SCREW,MACHINE:6-32 X 0.375"100 DEG,FLH STL	83385	OBD
-52	213-0138-00	B040000	2						SCR,TPG,TF:4-24 X 0.188 INCH,PNH STL	83385	OBD
	211-0007-00	B050000	2						SCREW,MACHINE:4-40 X 0.188 INCH,PNH STL -----*	83385	OBD
	210-0978-00		1						WASHER,FLAT:0.375 ID X 0.50 INCH OD,STL	78471	OBD
-53	337-1967-01	B040000	1						SHIELD,ELEC:REAR SUBPANEL	80009	337-1967-01
-54	401-0331-00		1						DR,TURNS RCDN:6:1 RATIO,0.025 X 1.156 SFT	K0099	4511/DAF/MOD
-55	213-0020-00		2						SETSCREW:6-32 X 0.125 INCH,HEX.SOC STL	70276	OBD
-56	-----		1						RES.,VAR,WV:(SEE R5 AND 125 REPL)		
-57	407-1274-00		1						BRACKET,VAR RES:ALUMINUM	80009	407-1274-00
-58	-----		1						CKT BOARD ASSY:FLOATING INTFC(SEE A4 REPL)		
-59	131-0608-00		14						. TERMINAL,PIN:0.365 L X 0.025 PH BRZ GOLD	22526	47357
-60	131-1425-00		1						CONTACT SET,ELE:R ANGLE,0.150" L,STR OF 36	22526	65521-136
-61	343-0149-00		1						CLAMP,LOOP:NYLON	80009	343-0149-00
-62	351-0449-00		2						GUIDE,CKT BOARD: (ATTACHING PARTS)	80009	351-0449-00
-63	211-0062-00		4						SCREW,MACHINE:2-56 X 0.312 INCH,RDH STL	83385	OBD
-64	210-0405-00		4						NUT,PLAIN,HEX.:2-56 X 0.188 INCH,BRS	73743	12157-50
-65	210-0001-00		4						WASHER,LOCK:INTL,0.092 ID X 0.18"OD,STL -----*	78189	1202-00-00-0541C
-66	334-2208-00		1						MARKER,IDENT:WARNING	80009	334-2208-00
-67	255-0334-00		FT						PLASTIC CHANNEL:12.75 X 0.175X 0.155,NYL	11897	122-37-2500
-68	333-2380-00		1						PANEL,REAR: (ATTACHING PARTS)	80009	333-2380-00
-69	213-0192-00		4						SCR,TPG,THD FOR:6-32 X 0.50 INCH,PNH STL	87308	OBD
-70	386-3657-00	B040000	2						SUPPORT,PLUG-IN:	80009	386-3657-00
	386-3657-01	B044890	2						SUPPORT,PLUG IN: -----*	93907	OBD
	672-0550-01		1						CKT BOARD ASSY:MAIN (ATTACHING PARTS)	80009	672-0550-01
-71	211-0602-00		4						SCR,ASSEM WSHR:6-32 X 0.438 INCH,PNH BRS	80009	211-0602-00
-72	407-1693-00		4						BRACKET,COVER:ALUMINUM	80009	407-1693-00
-73	211-0028-00		2						SCREW,MACHINE:4-40 X 0.188 " BDGH,NYL,SLOT	95987	OBD
-74	210-0406-00		2						NUT,PLAIN,HEX.:4-40 X 0.188 INCH,BRS	73743	12161-50
-75	210-0921-00		2						WASHER,MICA:0.50 X 0.141 X0.005 INCH THK -----*	80009	210-0921-00
	-----		-						CKT BOARD ASSEMBLY INCLUDES:		
-76	384-0282-00		1						. EXTENSION SHAFT:0.125 OD X 0.625 INCH LONG	80009	384-0282-00
-77	384-1407-00		1						. EXTENSION SHAFT:4.55 L X 0.125 OD,AL,CRM	80009	384-1407-00
-78	384-1406-00		1						. EXTENSION SHAFT:6.64 L X 0.125 OD,AL,CRM	80009	384-1406-00
-79	376-0051-01		3						. CPLG,SHAFT,FLEX:0.127 ID X 0.375 OD	80009	376-0051-01
	-----		1						. ACTR ASSY,CAM S:RISE & FALLTIME(SEE S590 REPL) (ATTACHING PARTS)		
-80	211-0116-00	B040000	4						. SCR,ASSEM WSHR:4-40 X 0.312 INCH,PNH BRS	83385	OBD
	211-0292-00	B057710	4						. SCR,ASSEM WSHR:4-40 X 0.29,BRS NI PL -----*	78189	OBD
	-----		-						ACTUATOR ASSEMBLY INCLUDES:		
-81	200-1910-00		1						. . COVER,CONTACT:9 ELEMENTS (ATTACHING PARTS)	80009	200-1910-00
-82	211-0008-00		4						. . SCREW,MACHINE:4-40 X 0.250,PNH,STL,CD PL	83385	OBD
-83	210-0004-00		4						. . WASHER,LOCK:#4 INTL,0.015THK,STL CD PL -----*	000BK	OBD

Replaceable Mechanical Parts—FG 504 (SN B040000 & up)

Fig. & Index No.	Tektronix Part No.	Serial/Model No. Eff Dscont	Qty	1	2	3	4	5	Name & Description	Mfr Code	Mfr Part Number
1-84	131-0963-00		1	.	.	.	.	.	CONTACT,ELEC:GROUNDING	000EX	OBD
-85	210-0406-00		2	.	.	.	.	.	NUT,PLAIN,HEX.:4-40 X 0.188 INCH,BRS	73743	12161-50
-86	214-1139-02		2	.	.	.	.	.	SPRING,FLAT:GREEN COLORED	80009	214-1139-02
-87	214-1752-00		2	.	.	.	.	.	ROLLER,DETENT:	80009	214-1752-00
-88	401-0180-00		1	.	.	.	.	.	BEARING,CAM SW:FRONT & REAR (ATTACHING PARTS)	80009	401-0180-00
-89	354-0390-00		1	.	.	.	.	.	RING,RETAINING:0.338 ID X 0.025" THK,STL - - - * - - -	79136	5100-37MD
-90	105-0702-00		1	.	.	.	.	.	ACTUATOR,SWITCH:CAM SWITCH	80009	105-0702-00
-91	384-0878-14		1	.	.	.	.	.	SHAFT,CAM SW:OUTER CONCENTRIC,W/DRIVER	80009	384-0878-14
-92	210-0406-00		4	.	.	.	.	.	NUT,PLAIN,HEX.:4-40 X 0.188 INCH,BRS	73743	12161-50
-93	401-0178-01		1	.	.	.	.	.	BEARING,CAM SW:CENTER/REAR	80009	401-0178-01
	-----		1	.	.	.	.	.	ACTR ASSY CAM S:AMPLITUDE(SEE S1100 REPL) (ATTACHING PARTS)		
-94	211-0116-00	B040000 B057709	4	.	.	.	.	.	SCR,ASSEM WSHR:4-40 X 0.312 INCH,PNH BRS	83385	OBD
	211-0292-00	B057710	4	.	.	.	.	.	SCR,ASSEM WSHR:4-40 X 0.29,BRS NI PL - - - * - - -	78189	OBD
	-----		-	.	.	.	.	.	ACTR ASSEMBLY INCLUDES:		
-95	200-1911-00		1	.	.	.	.	.	COVER,CAM SW:1.925 L X 0.876 H,AL (ATTACHING PARTS)	80009	200-1911-00
-96	211-0008-00		4	.	.	.	.	.	SCREW,MACHINE:4-40 X 0.250,PNH,STL,CD PL	83385	OBD
-97	210-0004-00		4	.	.	.	.	.	WASHER,LOCK:#4 INTL,0.015THK,STL CD PL - - - * - - -	000BK	OBD
-98	131-0963-00		1	.	.	.	.	.	CONTACT,ELEC:GROUNDING	000EX	OBD
-99	210-0406-00		3	.	.	.	.	.	NUT,PLAIN,HEX.:4-40 X 0.188 INCH,BRS	73743	12161-50
-100	214-1139-00	B040000 B044569	1	.	.	.	.	.	SPRING,FLAT:0.885 X 0.156CU BE GLD CLR	80009	214-1139-00
	214-1139-03	B044570	1	.	.	.	.	.	SPRING,FLAT:RED COLORED	80009	214-1139-03
	214-1139-02		1	.	.	.	.	.	SPRING,FLAT:GREEN COLORED	80009	214-1139-02
-101	214-1752-00		2	.	.	.	.	.	ROLLER,DETENT:	80009	214-1752-00
-102	401-0180-00		1	.	.	.	.	.	BEARING,CAM SW:FRONT & REAR (ATTACHING PARTS)	80009	401-0180-00
-103	354-0390-00		1	.	.	.	.	.	RING,RETAINING:0.338 ID X 0.025" THK,STL	79136	5100-37MD
-104	105-0703-00		1	.	.	.	.	.	ACTUATOR,SWITCH:CAM SWITCH	80009	105-0703-00
-105	384-0878-13		1	.	.	.	.	.	SHAFT,CAM SW:OUTER CONCENTRIC,W/DRIVER	80009	384-0878-13
-106	210-0406-00		1	.	.	.	.	.	NUT,PLAIN,HEX.:4-40 X 0.188 INCH,BRS	73743	12161-50
-107	401-0178-01		1	.	.	.	.	.	BEARING,CAM SW:CENTER/REAR	80009	401-0178-01
	-----		-	.	.	.	.	.	ACTR ASSY,CAM S:SWEEP DURATION(SEE S1435 REPL) (ATTACHING PARTS)		
-108	211-0116-00	B040000 B057709	4	.	.	.	.	.	SCR,ASSEM WSHR:4-40 X 0.312 INCH,PNH BRS	83385	OBD
	211-0292-00	B057710	4	.	.	.	.	.	SCR,ASSEM WSHR:4-40 X 0.29,BRS NI PL - - - * - - -	78189	OBD
	-----		-	.	.	.	.	.	ACTUATOR ASSEMBLY INCLUDES:		
-109	200-1911-00		1	.	.	.	.	.	COVER,CAM SW:1.925 L X 0.876 H,AL (ATTACHING PARTS)	80009	200-1911-00
-110	211-0008-00		4	.	.	.	.	.	SCREW,MACHINE:4-40 X 0.250,PNH,STL,CD PL	83385	OBD
-111	210-0004-00		4	.	.	.	.	.	WASHER,LOCK:#4 INTL,0.015THK,STL CD PL - - - * - - -	000BK	OBD
-112	131-0963-00		1	.	.	.	.	.	CONTACT,ELEC:GROUNDING	000EX	OBD
-113	210-0406-00		2	.	.	.	.	.	NUT,PLAIN,HEX.:4-40 X 0.188 INCH,BRS	73743	12161-50
-114	214-1139-02		2	.	.	.	.	.	SPRING,FLAT:GREEN COLORED	80009	214-1139-02
-115	214-1752-00		2	.	.	.	.	.	ROLLER,DETENT:	80009	214-1752-00
-116	401-0180-00		1	.	.	.	.	.	BEARING,CAM SW:FRONT & REAR (ATTACHING PARTS)	80009	401-0180-00
-117	354-0390-00		1	.	.	.	.	.	RING,RETAINING:0.338 ID X 0.025" THK,STL - - - * - - -	79136	5100-37MD
-118	105-0701-00		1	.	.	.	.	.	ACTUATOR,SWITCH:CAM SWITCH	80009	105-0701-00
-119	384-0878-14		1	.	.	.	.	.	SHAFT,CAM SW:OUTER CONCENTRIC,W/DRIVER	80009	384-0878-14
-120	210-0406-00		4	.	.	.	.	.	NUT,PLAIN,HEX.:4-40 X 0.188 INCH,BRS	73743	12161-50
-121	401-0178-01		1	.	.	.	.	.	BEARING,CAM SW:CENTER/REAR	80009	401-0178-01
-122	-----		1	.	.	.	.	.	CKT BOARD ASSY:MAIN(SEE A1 REPL)		
-123	361-0515-00		2	.	.	.	.	.	SPACER,SWITCH:PLASTIC	80009	361-0515-00
-124	-----		2	.	.	.	.	.	RESISTOR,VAR:(SEE R520,R1435 REPL)		
-125	-----		1	.	.	.	.	.	RESISTOR,VAR:(SEE R1100A,B REPL) (ATTACHING PARTS)		
-126	210-0583-00		1	.	.	.	.	.	NUT,PLAIN,HEX:0.25-32 X 0.312 INCH,BRS	73743	2X20317-402
-127	210-0046-00		1	.	.	.	.	.	WASHER,LOCK:0.261 ID,INTL,0.018 THK,BRS - - - * - - -	78189	1214-05-00-0541C



Replaceable Mechanical Parts—FG 504 (SN B040000 & up)

Fig. & Index No.	Tektronix Part No.	Serial/Model No. Eff Dscont	Qty	1	2	3	4	5	Name & Description	Mfr Code	Mfr Part Number
1-128	407-0553-00		1	.	.	.	.	.	BRACKET,CMPNT:BRASS ALBALOY PL	80009	407-0553-00
	131-0963-00		3	.	.	.	.	.	CONTACT,ELEC:GROUNDING	000EX	OBD
-129	131-1030-00		7	.	.	.	.	.	CONT ASSY,ELEC:CAM SWITCH,BOTTOM	80009	131-1030-00
-130	214-1254-00		2	.	.	.	.	.	HEAT SINK,ELEC:0.422 H X 1.240 INCH OD	05820	209SB
-131	131-0608-00		30	.	.	.	.	.	TERMINAL,PIN:0.365 L X 0.025 PH BRZ GOLD	22526	47357
-132	136-0252-04		9	.	.	.	.	.	SOCKET,PIN TERM:U/W 0.016-0.018 DIA PINS	22526	75060-007
-133	131-1003-00		3	.	.	.	.	.	CONN,RCPT,ELEC:CKT BD MT,3 PRONG	80009	131-1003-00
-134	344-0248-00		3	.	.	.	.	.	CLIP,ATTENUATOR:	80009	344-0248-00
-135	214-1797-00		6	.	.	.	.	.	PIN,ATTEN CLIP:	80009	214-1797-00
-136	342-0324-00		4	.	.	.	.	.	INSULATOR,DISC:TO-5 TRANSISTOR	13103	7717-5N-BLUE
-137	136-0261-00	B040000 B057809	6	.	.	.	.	.	SOCKET,PIN TERM:FOR 0.22 INCH PIN	00779	1-331677-6
	136-0261-00	B057810	2	.	.	.	.	.	SOCKET,PIN TERM:FOR 0.22 INCH PIN	00779	1-331677-6
-138	131-1031-00	B040000 B057809X	22	.	.	.	.	.	CONTACT ASSY,EL:CAM SWITCH,TOP (ATTACHING PARTS)	80009	131-1031-00
-139	210-0779-00	B040000 B056104	22	.	.	.	.	.	RIVET,TUBULAR:0.051 OD X 0.115 INCH LONG	42838	RA-29952715
	210-3082-00	B056105	22	.	.	.	.	.	EYELET,METALLIC:0.047 OD X 0.133 L,BRASS	80009	210-3082-00
				-	-	-	-	-	* - - -		
-140	136-0514-00		2	.	.	.	.	.	SKT,PL-IN ELEC:MICROCIRCUIT,8 DIP	73803	CS9002-8
-141	131-0566-00		2	.	.	.	.	.	BUS CONDUCTOR:DUMMY RES,2.375,22 AWG	55210	L-2007-1
-142	214-2569-00		4	.	.	.	.	.	HEAT SINK,XSTR:(1) TO-5,BE-CU (ATTACHING PARTS)	80009	214-2569-00
-143	211-0232-00		4	.	.	.	.	.	SCREW,MACHINE:4-40 X 0.25 INCH,FIL STL - - - * - - -	83385	OBD
-144	-----		1	.	.	.	.	.	TRANSISTOR:(SEE Q1180 REPL)		
-145	-----		1	.	.	.	.	.	TRANSISTOR:(SEE Q1160 REPL)		
-146	384-1099-00		4	.	.	.	.	.	EXTENSION SHAFT:PUSH BUTTON,1.54 INCH LONG	80009	384-1099-00
-147	-----		1	.	.	.	.	.	CKT BOARD ASSY:FUNCTION(SEE A2 REPL) (ATTACHING PARTS)		
-148	211-0116-00	B040000 B057709	4	.	.	.	.	.	SCR,ASSEM WSHR:4-40 X 0.312 INCH,PNH BRS	83385	OBD
	211-0292-00	B057710	4	.	.	.	.	.	SCR,ASSEM WSHR:4-40 X 0.29,BRS NI PL - - - * - - -	78189	OBD
	-----		-	.	.	.	.	.	CKT BOARD ASSY INCLUDES:		
-149	-----		1	.	.	.	.	.	SWITCH,PUSH:(SEE S730 REPL)		
-150	361-0384-00		6	.	.	.	.	.	SPACER,PB SW:0.133 INCH LONG	80009	361-0384-00
-151	-----		1	.	.	.	.	.	SWITCH,PUSH:(SEE S1235 REPL)		
-152	361-0385-00		4	.	.	.	.	.	SPACER,PB SW:0.164 INCH LONG	80009	361-0385-00
-153	131-0608-00		38	.	.	.	.	.	TERMINAL,PIN:0.365 L X 0.025 PH BRZ GOLD	22526	47357
-154	136-0260-02		4	.	.	.	.	.	SKT,PL-IN ELEC:MICROCIRCUIT,16 DIP,LOW CLE	71785	133-51-92-008
-155	136-0269-02		1	.	.	.	.	.	SKT,PL-IN ELEC:MICROCIRCUIT,14 DIP,LOW CLE	73803	CS9002-14
-156	136-0514-00		6	.	.	.	.	.	SKT,PL-IN ELEC:MICROCIRCUIT,8 DIP	73803	CS9002-8
-157	131-1003-00		5	.	.	.	.	.	CONN,RCPT,ELEC:CKT BD MT,3 PRONG	80009	131-1003-00
-158	136-0252-04		5	.	.	.	.	.	SOCKET,PIN TERM:U/W 0.016-0.018 DIA PINS	22526	75060-007
	672-0552-00		1	.	.	.	.	.	CKT BOARD ASSY:A 670-3840-00WIRED,W/CAM (ATTACHING PARTS)	80009	672-0552-00
-159	211-0601-00		4	.	.	.	.	.	SCR,ASSEM WSHR:6-32 X 0.312,DOUBLE SEMS - - - * - - -	83385	OBD
-160	129-0388-00		4	.	.	.	.	.	POST,ELEC-MECH:1.673 INCH LONG	80009	129-0388-00
	-----		-	.	.	.	.	.	CKT BOARD ASSEMBLY INCLUDES:		
-161	384-0442-00		1	.	.	.	.	.	EXTENSION SHAFT:0.125 OD X 8.452 INCH LONG	80009	384-0442-00
-162	376-0051-01		1	.	.	.	.	.	CPLG,SHAFT,FLEX:0.127 ID X 0.375 OD	80009	376-0051-01
-163	-----		1	.	.	.	.	.	RESISTOR,VAR:(SEE R120 REPL)		
-164	131-0963-00		1	.	.	.	.	.	CONTACT,ELEC:GROUNDING	000EX	OBD
-165	337-1418-01	B040000 B044979	1	.	.	.	.	.	SHIELD,ELEC:CAM SWITCH CASTING	80009	337-1418-01
	337-1418-02	B044980	1	.	.	.	.	.	SHIELD,ELEC:CIRCUIT BOARD (ATTACHING PARTS)	80009	337-1418-02
-166	211-0001-00		3	.	.	.	.	.	SCREW,MACHINE:2-56 X 0.25 INCH,PNH STL	87308	OBD
-167	210-0001-00		3	.	.	.	.	.	WASHER,LOCK:INTL,0.092 ID X 0.18"OD,STL	78189	1202-00-00-0541C
-168	210-1008-00		3	.	.	.	.	.	WASHER,FLAT:0.09 ID X 0.188" OD,BRS - - - * - - -	12360	OBD
-169	342-0167-00		1	.	.	.	.	.	INSULATOR,PLATE:2.45 INCH LONG	80009	342-0167-00
	-----		1	.	.	.	.	.	ACTR ASSY,CAM S:FREQUENCY(SEE S240 REPL) (ATTACHING PARTS)		
-170	211-0116-00	B010100 B057709	4	.	.	.	.	.	SCR,ASSEM WSHR:4-40 X 0.312 INCH,PNH BRS	83385	OBD
	211-0292-00	B057710	4	.	.	.	.	.	SCR,ASSEM WSHR:4-40 X 0.29,BRS NI PL - - - * - - -	78189	OBD
	-----		-	.	.	.	.	.	ACTR ASSY INCLUDES:		
-171	200-1913-00		1	.	.	.	.	.	COVER,CAM SW:18 ELEMENTS (ATTACHING PARTS)	80009	200-1913-00
-172	211-0008-00		4	.	.	.	.	.	SCREW,MACHINE:4-40 X 0.250,PNH,STL,CD PL	83385	OBD
-173	210-0004-00		4	.	.	.	.	.	WASHER,LOCK:#4 INTL,0.015THK,STL CD PL - - - * - - -	000BK	OBD

Replaceable Mechanical Parts—FG 504 (SN B040000 & up)

Fig. & Index No.	Tektronix Part No.	Serial/Model No. Eff Dscont	Qty	1	2	3	4	5	Name & Description	Mfr Code	Mfr Part Number
1-	131-0963-00		1	.	.				CONTACT,ELEC:GROUNDING	000EX	OBD
-174	210-0406-00		2	.	.				NUT,PLAIN,HEX.:4-40 X 0.188 INCH,BRS	73743	12161-50
-175	214-1139-02		1	.	.				SPRING,FLAT:GREEN COLORED	80009	214-1139-02
	214-1139-03		1	.	.				SPRING,FLAT:RED COLORED	80009	214-1139-03
-176	214-1752-00		2	.	.				ROLLER,DETENT:	80009	214-1752-00
-177	401-0180-00		1	.	.				BEARING,CAM SW:FRONT & REAR (ATTACHING PARTS)	80009	401-0180-00
-178	354-0390-00		1	.	.				RING,RETAINING:0.338 ID X 0.025" THK,STL - - - * - - -	79136	5100-37MD
-179	105-0704-00		1	.	.				ACTUATOR,SWITCH:CAM SWITCH	80009	105-0704-00
-180	384-0878-09		1	.	.				SHAFT,CAM SW:3.364 L X 0.248 OD	80009	384-0878-09
-181	210-0406-00		4	.	.				NUT,PLAIN,HEX.:4-40 X 0.188 INCH,BRS	73743	12161-50
-182	401-0178-01		1	.	.				BEARING,CAM SW:CENTER/REAR	80009	401-0178-01
-183	-----		1	.	.				CKT BOARD ASSY:LOOP(SEE A3 REPL)		
-184	131-1031-00		16	.	.				CONTACT ASSY,EL:CAM SWITCH,TOP (ATTACHING PARTS)	80009	131-1031-00
-185	210-0779-00	B040000 B056104	16	.	.				RIVET,TUBULAR:0.051 OD X 0.115 INCH LONG	42838	RA-29952715
	210-3082-00	B056105	16	.	.				EYELET,METALLIC:0.047 OD X 0.133 L,BRASS - - - * - - -	80009	210-3082-00
-186	-----		1	.	.				SWITCH,PUSH:(SEE S195 REPL)		
-187	361-0382-00		2	.	.				SPACER,PB SW:BROWN,0.275 INCH LONG	80009	361-0382-00
-188	131-0608-00		32	.	.				TERMINAL,PIN:0.365 L X 0.025 PH BRZ GOLD	22526	47357
-189	131-0993-01		1	.	.				LINK,TERM.CONNE:2 WIRE BROWN	00779	530153-9
-190	136-0514-00		6	.	.				SKT,PL-IN ELEC:MICROCIRCUIT,8 DIP	73803	CS9002-8
-191	337-2224-00		1	.	.				SHIELD,ELEC:CIRCUIT CARD	80009	337-2224-00
-192	136-0269-02		1	.	.				SKT,PL-IN ELEC:MICROCIRCUIT,14 DIP,LOW CLE	73803	CS9002-14
-193	131-1003-00		4	.	.				CONN,RCPT,ELEC:CKT BD MT,3 PRONG	80009	131-1003-00
-194	342-0324-00		1	.	.				INSULATOR,DISC:TO-5 TRANSISTOR	13103	7717-5N-BLUE
-195	136-0252-04		24	.	.				SOCKET,PIN TERM:U/W 0.016-0.018 DIA PINS	22526	75060-007
-196	214-0579-00		2	.	.				TERM,TEST POINT:BR3 CD PL	80009	214-0579-00
-197	214-1061-00		1	.	.				SPRING,GROUND:FLAT	80009	214-1061-00
-198	426-1245-00		1	.	.				FR SECT,PLUG-IN:LEFT SIDE, TOP AND BOTTOM	80009	426-1245-00
-199	426-1245-01		1	.	.				FR SECT,PLUG-IN:TOP LEFT	80009	426-1245-01
-200	426-1246-02		1	.	.				FR SECT,PLUG-IN:RIGHT SIDE, TOP& BOTTOM	80009	426-1246-02
-201	426-1460-00		1	.	.				FR SECT,PLUG-IN:RIGHT	80009	426-1460-00
-202	179-2398-02		1	.	.				WIRING HARNESS:CHASSIS	80009	179-2398-02
-203	131-0707-00		24	.	.				CONNECTOR,TERM:22-26 AWG,BRS& CU BE GOLD	22526	47439
	131-0708-00		1	.	.				CONTACT,ELEC:0.48"L,28-32 AWG WIRE	22526	47437
-204	352-0171-00		6	.	.				HLDR,TERM CONN:1 WIRE BLACK	80009	352-0171-00
-205	352-0169-00		1	.	.				HLDR,TERM CONN:2 WIRE BLACK	80009	352-0169-00
-206	352-0161-03		1	.	.				CONN BODY,PL,EL:3 WIRE ORANGE	80009	352-0161-03
-207	352-0162-04		1	.	.				CONN BODY,PL,EL:4 WIRE YELLOW	80009	352-0162-04
-208	352-0163-01		1	.	.				CONN BODY,PL,EL:5 WIRE BROWN	80009	352-0163-01
-209	352-0165-06		1	.	.				CONN BODY,PL,EL:7 WIRE BLUE	80009	352-0165-06
	179-2399-01		1	.	.				WIRING HARNESS:FRONT PANEL	80009	179-2399-01
	131-0707-00		45	.	.				CONNECTOR,TERM:22-26 AWG,BRS& CU BE GOLD	22526	47439
	352-0161-00		1	.	.				HLDR,TERM CONN:3 WIRE,BLACK	80009	352-0161-00
	352-0162-00		1	.	.				HLDR,TERM CONN:4 WIRE BLACK	80009	352-0162-00
	352-0163-00		2	.	.				CONN BODY,PL,EL:5 WIRE BLACK	80009	352-0163-00
-210	352-0164-00		1	.	.				CONN BODY,PL,EL:6 WIRE BLACK	80009	352-0164-00
-211	352-0166-00		1	.	.				CONN BODY,PL,EL:8 WIRE BLACK	80009	352-0166-00
	352-0169-00		4	.	.				HLDR,TERM CONN:2 WIRE BLACK	80009	352-0169-00
	352-0171-00		8	.	.				HLDR,TERM CONN:1 WIRE BLACK	80009	352-0171-00
	179-2416-00		1	.	.				WIRING HARNESS:POWER	80009	179-2416-00
	131-0707-00		18	.	.				CONNECTOR,TERM:22-26 AWG,BRS& CU BE GOLD	22526	47439
	352-0162-00		2	.	.				HLDR,TERM CONN:4 WIRE BLACK	80009	352-0162-00
	352-0162-06		1	.	.				HLDR,TERM CONN:4 WIRE,BLUE	80009	352-0162-06
	352-0163-01		1	.	.				CONN BODY,PL,EL:5 WIRE BROWN	80009	352-0163-01
	352-0171-00		1	.	.				HLDR,TERM CONN:1 WIRE BLACK	80009	352-0171-00
	198-2313-00		1	.	.				WIRE SET,ELEC:	80009	198-2313-00
	131-0707-00		20	.	.				CONNECTOR,TERM:22-26 AWG,BRS& CU BE GOLD	22526	47439
-212	175-0828-00		FT	.	.				WIRE,ELECTRICAL:5 WIRE RIBBON	08261	SS-0526-710610C
	175-0860-00		FT	.	.				WIRE,ELECTRICAL:5 WIRE RIBBON	08261	SS-0522-7(1061)
	352-0163-01		1	.	.				CONN BODY,PL,EL:5 WIRE BROWN	80009	352-0163-01
	352-0163-02		2	.	.				CONN BODY,PL,EL:5 WIRE RED	80009	352-0163-02
	352-0163-04		1	.	.				CONN BODY,PL,EL:5 WIRE YELLOW	80009	352-0163-04

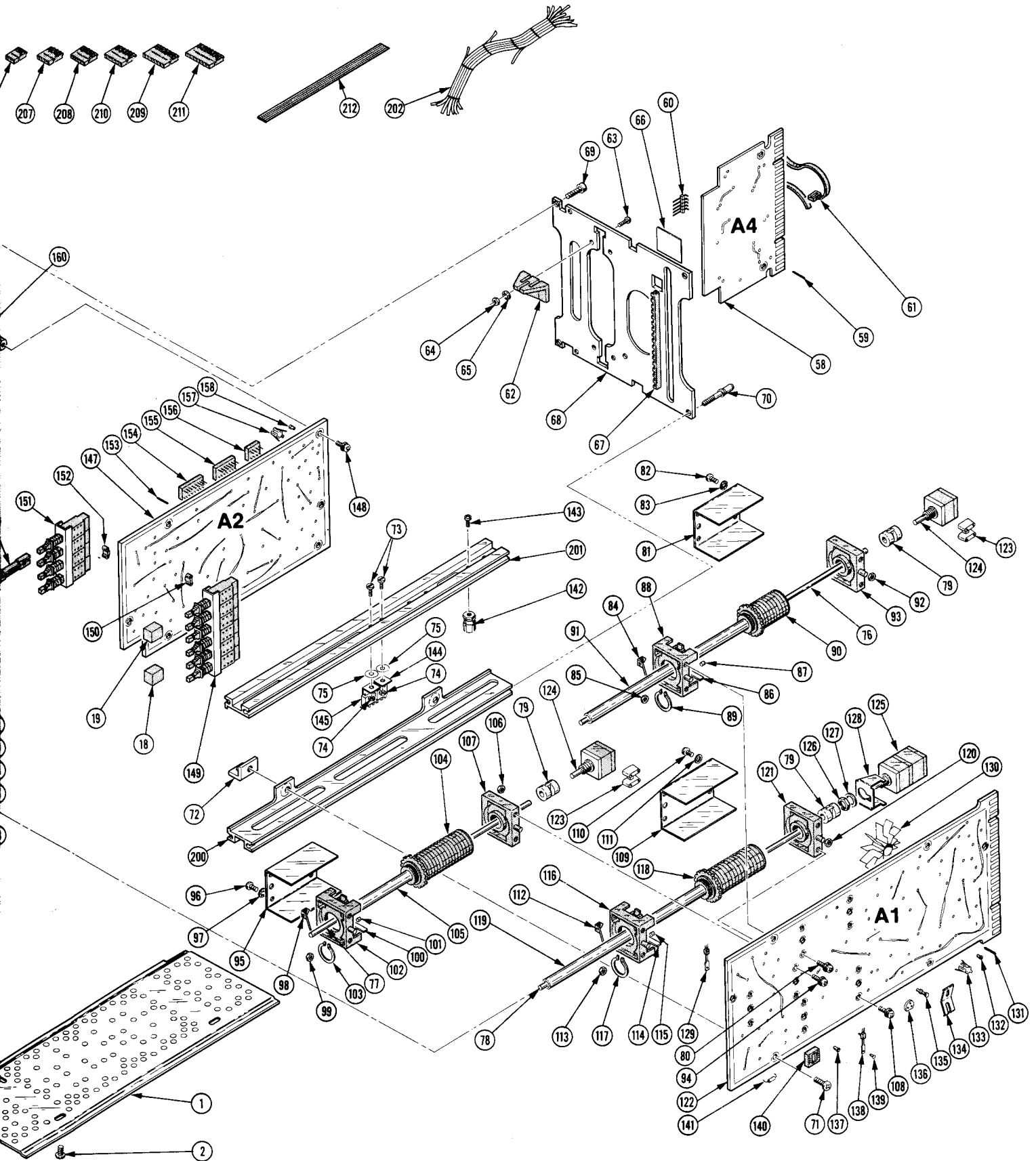

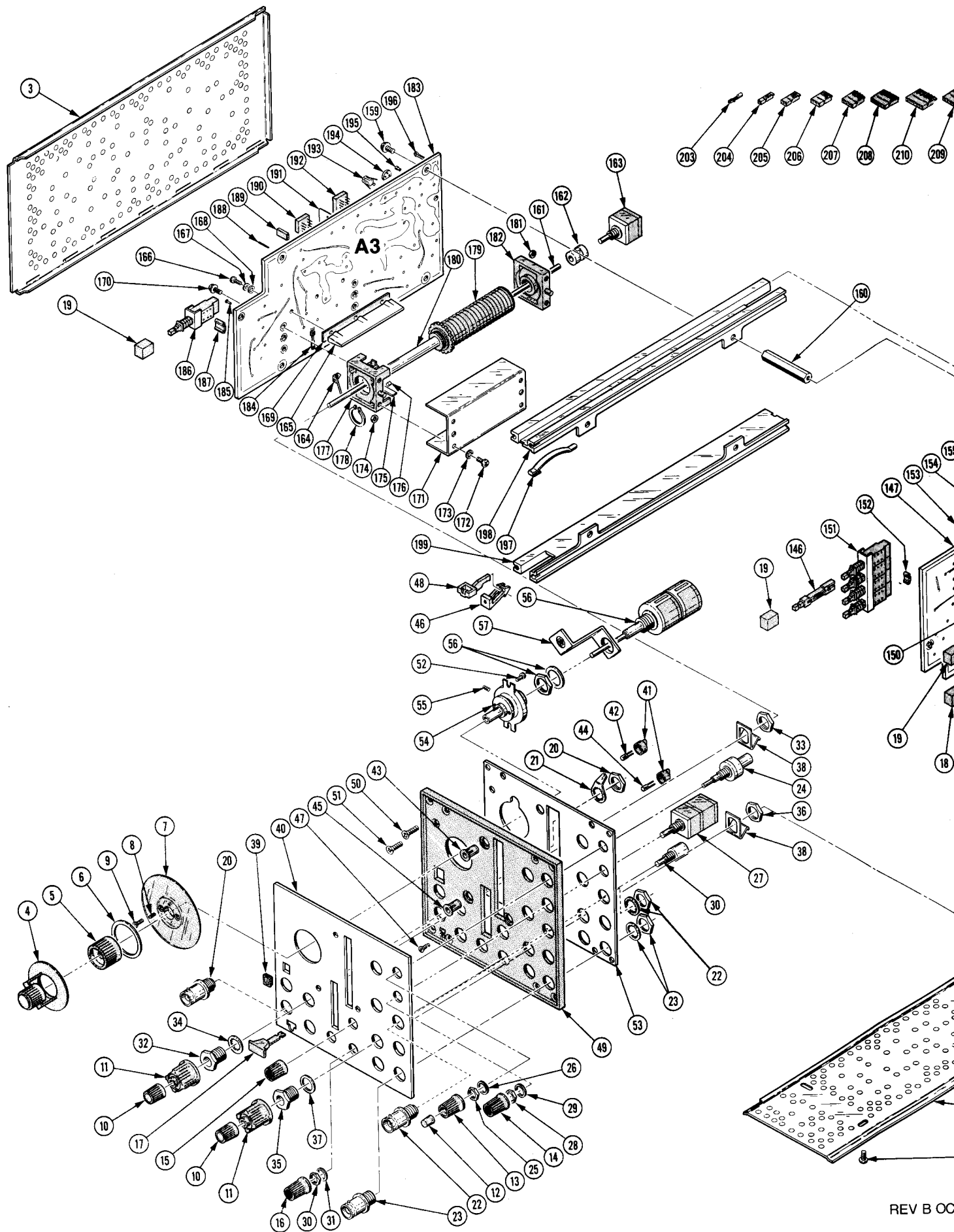

Fig. & Index No.	Tektronix Part No.	Serial/Model No.		Qty						Name & Description	Mfr Code	Mfr Part Number
		Eff	Dscont		1	2	3	4	5			
	070-2655-00			1						MANUAL, TECH: INSTRUCTION	80009	070-2655-00