

Scan by Zenith

TEK SERVICE
MANUAL

070-6735-00
Product Group 46

**CDM250
DIGITAL
MULTIMETER
SERVICE**

Tektronix
COMMITTED TO EXCELLENCE

Tillhör:
TEKTRONIX AB
Service
08/83 00 80

CDM250 DIGITAL MULTIMETER SERVICE

WARNING

THE FOLLOWING SERVICING INSTRUCTIONS ARE FOR USE BY QUALIFIED PERSONNEL ONLY. TO AVOID PERSONAL INJURY, DO NOT PERFORM ANY SERVICING OTHER THAN THAT CONTAINED IN OPERATING INSTRUCTIONS UNLESS YOU ARE QUALIFIED TO DO SO. REFER TO OPERATORS SAFETY SUMMARY AND SERVICE SAFETY SUMMARY PRIOR TO PERFORMING ANY SERVICE.

*Please Check for
CHANGE INFORMATION
at the Rear of This Manual*

Copyright © 1988 Tektronix, Inc. All rights reserved. Contents of this publication may not be reproduced in any form without the written permission of Tektronix, Inc.

Products of Tektronix, Inc. and its subsidiaries are covered by U.S. and foreign patents issued and pending.

TEKTRONIX, TEK, SCOPE-MOBILE, and  are registered trademarks of Tektronix, Inc.

Printed in U.S.A. Specification and price change privileges are reserved.

INSTRUMENT SERIAL NUMBERS

Each instrument has a serial number on a panel insert, tag, or stamped on the chassis. The first two digits designate the country of manufacture. The last five digits of the serial number are unique to each instrument. The country of manufacture is identified as follows:

B000000 Tektronix, Inc., Beaverton, Oregon, U.S.A.

E200000 Tektronix United Kingdom, Ltd., London

G100000 Tektronix Guernsey, Ltd., Channel Islands

HK00000 Hong Kong

H700000 Tektronix Holland, NV, Heerenveen,
The Netherlands

J300000 Sony/Tektronix, Japan

TABLE OF CONTENTS

	Page		Page
LIST OF ILLUSTRATIONS	iii	Section 4	PERFORMANCE CHECK PROCEDURE
LIST OF TABLES	iii		INTRODUCTION
OPERATORS SAFETY SUMMARY	iv		4-1
SERVICING SAFETY SUMMARY	v		TEST EQUIPMENT NEEDED
			4-1
			PREPARATION
			4-2
			PROCEDURE
			4-2
Section 1	GENERAL INFORMATION	Section 5	ADJUSTMENT PROCEDURE
	INTRODUCTION		PREPARATION FOR ADJUSTMENT
	1-1		5-1
	SPECIFICATION		PROCEDURE
	1-1		5-1
Section 2	PREPARATION FOR USE	Section 6	MAINTENANCE
	SAFETY		STATIC-SENSITIVE COMPONENTS
	2-1		6-1
	LINE VOLTAGE		PREVENTIVE MAINTENANCE ...
	2-1		6-2
	POWER CORD		INSPECTION AND CLEANING
	2-1		6-2
	FUSES		TROUBLESHOOTING
	2-2		6-4
	DETAILED OPERATING INFORMATION		TROUBLESHOOTING AIDS ..
	2-2		6-4
			TROUBLESHOOTING TECHNIQUES
			6-5
			TROUBLESHOOTING TIPS ...
			6-8
Section 3	THEORY OF OPERATION		CORRECTIVE MAINTENANCE
	INTRODUCTION		6-13
	3-1		MAINTENANCE PRECAUTIONS
	DIGITAL LOGIC CONVENTIONS		6-13
	3-1		OBTAINING REPLACEMENT PARTS
	BLOCK DIAGRAM DESCRIPTION		6-13
	3-1		REPACKAGING FOR SHIPMENT
	DETAILED CIRCUIT DESCRIPTION		6-13
	3-1		

	Page		Page	
MAINTENANCE AIDS	6-14	Section 7	OPTIONS	
INTERCONNECTIONS	6-14		INTERNATIONAL POWER	
TRANSISTORS AND			CORDS	7-1
INTEGRATED CIRCUITS	6-15			
SOLDERING		Section 8	REPLACEABLE PARTS	
TECHNIQUES	6-15	Section 9	DIAGRAMS	
REMOVAL AND				
REPLACEMENT				
INSTRUCTIONS	6-16		CHANGE INFORMATION	

LIST OF ILLUSTRATIONS

Figure		Page
	The CDM250 Digital Multimeter	vi
2-1	Rear Panel	2-1
2-2	Optional power cords	2-2
3-1	Block Diagram	3-2
9-1	Color codes for resistors.	
9-2	Semiconductor lead configurations.	
9-3	Main circuit board and adjustment locations.	
9-4	Display circuit board.	

LIST OF TABLES

Table		Page
1-1	General Characteristics	1-2
1-2	Electrical Characteristics	1-3
4-1	Test Equipment Required	4-1
4-2	DC VOLTS Range Accuracy	4-2
4-3	AC VOLTS Range Accuracy	4-3
4-4	DC AMPS Range Accuracy	4-4
4-5	AC AMPS Range Accuracy	4-5
4-6	Ohms Range Accuracy	4-5
6-1	Relative Susceptibility to Static-Discharge Damage	6-1
6-2	External Inspection Checklist	6-3
6-3	Internal Inspection Checklist	6-3
6-4	Maintenance Aids	6-14

OPERATORS SAFETY SUMMARY

The general safety information in this part of the summary is for both operating and servicing personnel. Specific warnings and cautions will be found throughout the manual where they apply and do not appear in this summary.

Terms in This Manual

CAUTION statements identify conditions or practices that could result in damage to the equipment or other property.

WARNING statements identify conditions or practices that could result in personal injury or loss of life.

Terms as Marked on Equipment

CAUTION indicates a personal injury hazard not immediately accessible as one reads the markings, or a hazard to property, including the equipment itself.

DANGER indicates a personal injury hazard immediately accessible as one reads the marking.

Symbols in This Manual



This symbol indicates where applicable cautionary or other information is to be found. For maximum input voltage see Tables 1-1 and 1-2.

Symbols as Marked on Equipment



DANGER—High voltage.



Protective ground (earth) terminal.



ATTENTION—Refer to manual.



Replace fuse as specified—Refer to manual.

Power Source

This product is intended to operate from a power source that does not apply more than 250 volts rms between the supply conductors or between either supply conductor and ground. A protective ground connection, by way of the grounding conductor in the power cord, is essential for safe operation.

Grounding the Product

This product is grounded through the grounding conductor of the power cord. To avoid electrical shock, plug the power cord into a properly wired receptacle before making any connections to the product input or output terminals. A protective ground connection, by way of the grounding conductor in the power cord, is essential for safe operation.

Danger Arising From Loss of Ground

Upon loss of the protective-ground connection, all accessible conductive parts (including knobs and controls that may appear to be insulating) can render an electric shock.

Use the Proper Power Cord

Use only the power cord and connector specified for your product.

Use only a power cord that is in good condition.

For detailed information on power cords and connectors, see Figure 2-2.

Use the Proper Fuse

To avoid fire hazard, use only a fuse of the correct type, voltage rating, and current rating as specified in the parts list for your product.

Do Not Operate in an Explosive Atmosphere

To avoid explosion, do not operate this instrument in an explosive atmosphere.

Do Not Remove Covers or Panels

To avoid personal injury, do not remove the product covers or panels. Do not operate the instrument without the covers and panels properly installed.

SERVICING SAFETY SUMMARY

FOR QUALIFIED SERVICE PERSONNEL ONLY

Refer also to the preceding Operators Safety Summary

Do Not Service Alone

Do not perform internal service or adjustment of this product unless another person capable of rendering first aid and resuscitation is present.

Use Care When Servicing With Power On

Dangerous voltages exist at several points in this product. To avoid personal injury, do not touch exposed connections or components while power is on.

Disconnect power before removing protective panels, soldering, or replacing components.

Power Source

This product is intended to operate from a power source that does not apply more than 250 volts rms between the supply conductors or between either supply conductor and ground. A protective ground connection by way of the grounding connector in the power cord is essential for safe operation.



The CDM250 Digital Multimeter.

GENERAL INFORMATION

INTRODUCTION

The TEKTRONIX CDM250 DIGITAL MULTIMETER measures analog quantities and displays them in digital form. The CDM250 measures direct and alternating current from 0 to 10 amps, in six ranges; ac and dc voltage from 0 to 500 volts, in five ranges; and resistance from zero to 20 megohms, in six ranges. All values are displayed on a $3\frac{1}{2}$ -digit, light-emitting diode (LED) indicator. Alternating voltages and currents are displayed in sine wave rms values.

The CDM250 has a locking, multiposition handle that folds under the instrument to allow stacking with other instruments of the same series.

Standard accessories provided with the CDM250 include: a power cord, two test probes (one red and one black), a spare 2 A fuse, and an Operator's manual. For

part numbers and further information about standard and optional accessories, refer to Replaceable Parts (section 8) in this manual. For additional information, contact your Tektronix Sales Office or Distributor and the Tektronix products catalog.

SPECIFICATION

General characteristics are given in Table 1-1. The electrical characteristics given in Table 1-2 are valid when the instrument has been adjusted at an ambient temperature between $+21^{\circ}\text{C}$ and $+25^{\circ}\text{C}$ ($+70^{\circ}\text{F}$ and $+77^{\circ}\text{F}$), has had a warm-up period of at least ten minutes (with the cabinet in place), and is operating at an ambient temperature between $+18^{\circ}\text{C}$ and $+28^{\circ}\text{C}$ ($+64^{\circ}\text{F}$ and $+82^{\circ}\text{F}$), with 75% maximum relative humidity.

Table 1-1
General Characteristics

Characteristics	Performance Requirements
OPERATIONAL	
Display	3 1/2 digit LED displays to ± 1999 counts, positive polarity assumed, minus (-) sign for negative polarity, and the number 1 at the extreme left as the overrange indicator.
Measurements	Ac/dc volts, ac/dc amps, and resistance.
Maximum Common Mode Voltage 	500 V (dc + peak ac).
Zero Adjustment	Automatic
Sampling Rate	2.5 measurements per second, nominal.
PHYSICAL	
Width	240 mm (9.4 in).
Height	64 mm (2.5 in).
Depth	190 mm (7.5 in).
Weight	1.6 kg (3.5 lb).
ENVIRONMENTAL	
Operating Temperature	+10°C to +40°C (+50°F to +105°F), ≤ 75% relative humidity.
Nonoperating Temperature	-10°C to +60°C (+14°F to +140°F), ≤ 80% relative humidity.

Table 1-2
Electrical Characteristics



Characteristics	Performance Requirements
Line Voltage Range	90 to 110, 108 to 132, 198 to 242, and 216 to 250 Vac at 50–60 Hz.
Power Consumption	10 VA, 6 W maximum.
Ground Isolation	Maximum of 500 V (dc + peak ac) from earth ground.
DC VOLTS MEASUREMENT (Manual ranging.)	
Accuracy	\pm (0.5% of reading + 1 count).
Resolution	
200 mV Range	100 μ V.
2 V Range	1 mV.
20 V Range	10 mV.
200 V Range	100 mV.
500 V Range	1 V.
Input Resistance	10 M Ω .
Maximum Response Time	3 seconds.
Maximum Input Voltage 	500 V (dc + peak ac).
AC VOLTS MEASUREMENT (Manual ranging. Average responding, calibrated to read rms value of sine wave.)	
Accuracy	\pm (1.0% of reading + 4 counts) 45 Hz to 500 Hz.
Resolution	Same as DC Volts.
Input Impedance	10 M Ω paralleled by < 100 pF.
Maximum Response Time	8 seconds.
Maximum Input Voltage 	500 V (dc + peak ac).
DC AMPS MEASUREMENT (Manual ranging.)	
Accuracy	
200 μ A, 2 mA, 20 mA, and 200 mA Ranges	\pm (1.0% of reading + 1 count).
2000 mA and 10 A Ranges	\pm (1.0% of reading + 3 counts).

Table 1-2 (cont)

Characteristics	Performance Requirements
DC AMPS MEASUREMENT (cont)	
Resolution	
200 μ A Range	0.1 μ A.
2 mA Range	1 μ A.
20 mA Range	10 μ A.
200 mA Range	100 μ A.
2000 mA Range	1 mA.
10 A Range	10 mA.
Loading Error	
200 μ A, 2 mA, 20 mA, and 200 mA Ranges	300 mV maximum.
2000 mA and 10 A Ranges	1.1 V maximum.
Input Resistance	
200 μ A Range	1 k Ω .
2 mA Range	100 Ω .
20 mA Range	10 Ω .
200 mA Range	1 Ω .
2000 mA Range	0.1 Ω .
10 A Range	0.01 Ω .
Maximum Response Time	3 seconds.
Overload Protection	
2 A Range	2 A, 250 V and 4 A, 600 V fuses.
10 A Range	None.
AC AMPS MEASUREMENT (Manual Ranging. Average responding, calibrated to read rms value of sine wave.)	
Accuracy	\pm (1.5% of reading + 4 counts) 45 Hz to 500 Hz.
Resolution	Same as DC Amps.
Loading Error	
200 μ A, 2 mA, 20 mA, and 200 mA Ranges	300 mV _{rms} maximum.
2000 mA and 10 A Ranges	1.1 V _{rms} maximum.
Maximum Response Time	8 seconds.
Overload Protection	Same as DC Amps.

Table 1-2 (cont)

Characteristics	Performance Requirements
RESISTANCE MEASUREMENT (Manual ranging.)	
Accuracy	
200 Ω Range	\pm (0.75% of reading + 4 counts).
2 k Ω , 20 k Ω , 200 k Ω , and 2000 k Ω Ranges	\pm (0.75% of reading + 1 count).
20 M Ω Range	\pm (1.5% of reading + 5 counts).
Resolution	
200 Ω Range	0.1 Ω .
2 k Ω Range	1 Ω .
20 k Ω Range	10 Ω .
200 k Ω Range	100 Ω .
2000 k Ω Range	1 k Ω .
20 M Ω Range	10 k Ω .
Maximum Test Current	
200 Ω Range	2.5 mA.
2 k Ω Range	250 μ A.
20 k Ω Range	50 μ A.
200 k Ω Range	5 μ A.
2000 k Ω Range	500 nA.
20 M Ω Range	50 nA.
Maximum Open Circuit Voltage	
200 Ω Range	3.2 V.
All Other Ranges	0.6 V.
Maximum Response Time	
200 Ω to 2000 k Ω Ranges	5 seconds.
20 M Ω Range	15 seconds.
Maximum Input Voltage (Accidental)	500 V (dc + peak ac).

PREPARATION FOR USE

SAFETY

This section of the manual tells how to proceed with the initial start-up of the instrument.

Refer to the Safety Summaries at the front of this manual for power source, grounding, and other safety considerations pertaining to the use of the instrument. Before connecting the CDM250 to a power source, read both this section and the Safety Summaries.

supply conductors or between either supply conductor and ground. Normal USA line voltage is 120 Vac. Before connecting the power cord to a power-input source, verify that the LINE VOLTAGE SELECT switches on the Rear Panel are set to the correct line voltage setting. Figure 2-1 shows the location of the LINE VOLTAGE SELECT switches.

LINE VOLTAGE



This instrument may be damaged if operated with the LINE VOLTAGE SELECT switches set for the wrong line voltage.

This product is intended to operate from a power source that does not supply more than 250 Vrms between the

POWER CORD

A protective ground connection, the third wire in the power cord, is necessary for safe operation. To avoid electrical shock, plug the power cord into a properly wired receptacle before making any connections to the equipment input terminals. Do not remove the ground lug from the power cord for any reason. Use only the power cord and connector specified for this equipment.

Instruments are shipped with the required power cord as ordered by the customer (see Figure 2-2). Contact your Tektronix representative or Tektronix Field Office for additional power-cord information.

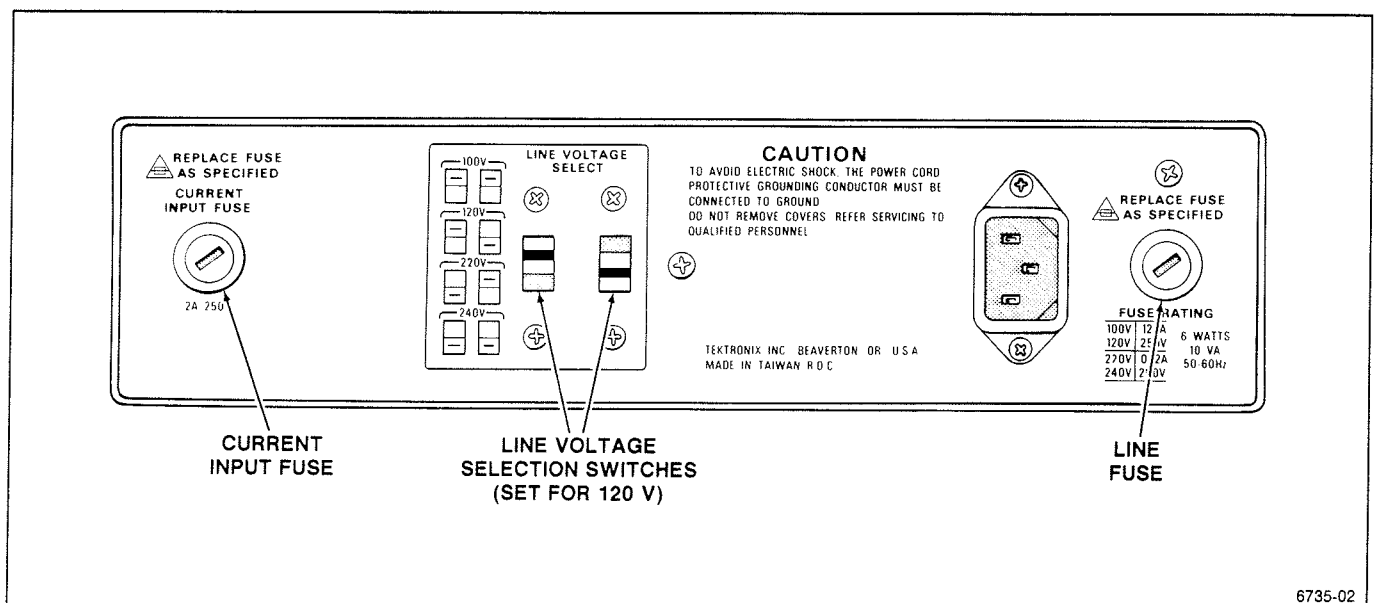

Figure 2-1. Rear Panel.

Preparation for Use—CDM250 Service





Plug Configuration	Option	Power Cord/ Plug Type	Line Voltage	Reference Standards ^b
	U.S. Std.	U.S. 120V	120V	ANSI C73.11 NEMA 5-15-P IEC 83 UL 198.6
	A1	EURO 220V	220V	CEE(7), II, IV, VII IEC 83 IEC 127
	A2	UK ^a 240V	240V	BS 1363 IEC 83 IEC 127
	A3	Australian 240V	240V	AS C112 IEC 127
	A4	North American 240V	240V	ANSI C73.20 NEMA 6-15-P IEC 83 UL 198.6
	A5	Switzerland 220V	220V	SEV IEC 127
<p>^a A 6A, type C fuse is also installed inside the plug of the Option A2 power cord.</p> <p>^b Reference Standards Abbreviations:</p> <p>ANSI—American National Standards Institute AS—Standards Association of Australia BS—British Standards Institution CEE—international Commission on Rules for the Approval of Electrical Equipment IEC—International Electrotechnical Commission NEMA—National Electrical Manufacturer's Association SEV—Schweizerischer Elektrotechnischer Verein UL—Underwriters Laboratories Inc.</p>				

Figure 2-2. Optional power cords.

FUSES

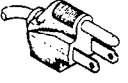
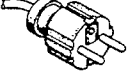

The instrument may be damaged if operated with the wrong type and rating line fuses installed.

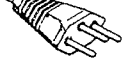
Unplug the power cord and disconnect the test leads from any voltage source before checking or changing the fuses.

Verify the proper value of the fuses with the following procedure. Figure 2-1, Rear Panel, shows the location of the fuses:

1. Disconnect the power cord from the power-input source.
2. Press in the fuse-holder cap and release it with a slight counterclockwise rotation.
3. Pull the cap (with the attached fuse inside) out of the fuse holder.
4. Verify proper fuse value.
5. Install the proper fuse and reinstall the fuse-holder cap.

DETAILED OPERATING INFORMATION

Refer to the Operator's manual for this instrument for instrument operation and measurement procedures.

THEORY OF OPERATION

INTRODUCTION

This section contains a general description of the CDM250 Digital Multimeter circuitry. General operation of the instrument is described in the Block Diagram Description. Each functional circuit is described in more detail in the Detailed Circuit Description.

The schematic diagram and the circuit board illustrations are located in the Diagrams section near the rear of this manual. To understand the circuit descriptions in this section, refer to both the Block Diagram, Figure 3-1 in this section, and to the schematic diagram.

DIGITAL LOGIC CONVENTIONS

Functions and operation of digital logic circuits are represented by logic symbology and terminology. Most logic functions are described using the positive-logic convention. Positive logic is a system of notation whereby the more positive of two levels is the TRUE (or 1) state; the more negative level is the FALSE (or 0) state. In this manual, the TRUE state is referred to as HI, and the FALSE state as LO. The specific voltages that constitute a HI or a LO state vary between specific devices. For device characteristics, refer to the manufacturer's data book.

BLOCK DIAGRAM DESCRIPTION

The CDM250 is an analog-to-digital (A/D) converter system with input circuits, logic display devices, and power supplies necessary to display, in digital form, the value of an input voltage, current, or resistance. The 3½-digit display is driven by the output of the A/D Converter.

Function switches S2, S3, and S4 are used to select the proper input circuits to match the three functions. When S2 (VOLTS) or S4 (Ω) is selected, the input is routed to the Voltage Divider network for Range selection. S3 (A) is used to select the current inputs, which are routed through the Current Shunt for Range selection. The COMMON input to the CDM250 is a floating ground, not connected to the power source (earth) ground, and is isolated to 500 V from earth ground.

The CDM250 block diagram (Figure 3-1) shows the major blocks of circuitry:

- The Voltage Divider accepts incoming voltages for volt and ohm measurements and reduces them to a range that the Analog-to-Digital Converter can accept. This is done through the Range switches.
- The Current Shunt accepts incoming current and develops a low voltage that is proportional to the current. Current range is selected through the Range switches.
- The AC-to-DC Converter is used only when measuring an ac signal. It converts the ac voltage to dc voltage so that the A/D Converter can accept it.
- The Analog-to-Digital Converter takes incoming voltages that have been attenuated below 200 mV and commands the digital display to show the measurement result.
- The 3½-digit display is driven by the output of the A/D Converter and displays the value on a light-emitting diode (LED) indicator.
- The Power Supply provides regulated low-voltage power to all circuits as required.
- The Transformer converts the ac input voltage to lower voltages for use in the power supply.

DETAILED CIRCUIT DESCRIPTION

Voltage Divider

When S2 (VOLTS) or S4 (Ω) is selected, the analog input from the V- Ω jack is routed to the Voltage Divider network for Range selection. When VOLTS is selected, S2 closes. If an ac voltage is to be measured, the input jack accepts the analog voltage and feeds it into the Voltage Divider network. The A/D Converter will not accept ac voltages, so the AC/DC switch (S1) must be set to the AC mode (S1 closed). This sends the ac voltage to the AC-to-DC Converter. When a dc voltage is to be measured (AC/DC switch in the out position), S1 is open and the voltage to be measured goes to the A/D Converter.

When S4 (Ω) is selected, a known reference current is supplied to the V- Ω input jack. The voltage drop developed across the unknown resistance is fed through the Voltage Divider network to the A/D Converter.

Theory of Operation—CDM250 Service

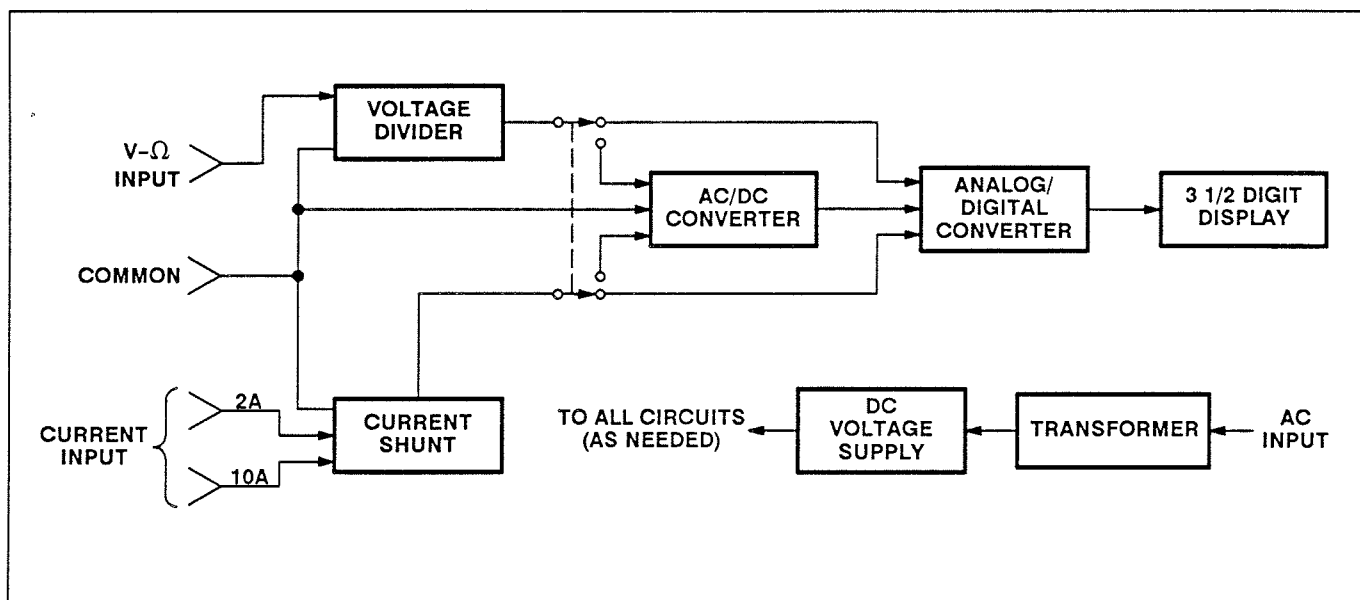

Figure 3-1. Block Diagram.

Current Shunt

When current is being measured and the A (amp) switch S3 is pressed in, S2 and S4 will be open. S3 is not connected to the circuitry but performs the function of opening S2 and S4 (mechanically switching both the VOLTS and Ω buttons to their out positions). With S2 and S4 open, the incoming current will enter the Current Shunt through either the A (2 amp maximum) or 10A (ten amp maximum) jack. If the current enters the A jack, it will be subject to the setting of the Range selection switches (S5, S6, S7, S8, S9, and S10). The Current Shunt develops a voltage that is directly proportional to the current.

If an ac current is applied to the Current Shunt, this proportional voltage will be an ac voltage. To measure an ac current, the AC/DC switch must be set to the AC mode. This closes S1, routing the voltage through the AC-to-DC Converter before it goes to the A/D Converter.

AC-to-DC Converter

As the A/D Converter functions only with dc input voltage, the AC-to-DC Converter converts ac input voltages to dc voltages for application to the A/D Converter.

The CDM250, when in the AC mode, responds to the average value of an input voltage or current, but the

readout is calibrated to indicate the effective or rms value of a sinusoidal wave shape. The meter will underestimate the value of an asymmetrical square-wave input and overestimate the value of a symmetrical square-wave voltage.

Analog-to-Digital (A/D) Converter

This is the most important circuit in the CDM250 because it sets up the voltage and current references for all operating modes.

The A/D Converter operates on a charge-balancing principle. The net charge put into an integrator over one integration cycle is zero. The charging continues for as long as necessary to get the capacitor voltage to cross a fixed threshold level. A reference current is subtracted from the input current and the capacitor discharges until the threshold level is crossed again. The process is repeated until the conversion period is over. A measurement cycle of 2.5 measurements per second is controlled by a 40 kHz crystal oscillator (XTAL).

Resistance is measured with a tightly controlled reference current supplied to the input of the V- Ω jack. The A/D Converter supplies this reference current when the Ω selection switch (S4) is actuated. The reference current is applied, through the input, to the unknown resistance. The voltage drop that develops across the resistance is sensed by the A/D Converter.

Display

The display is a $3\frac{1}{2}$ -digit LED display. This means that the leftmost digit (which is the most significant digit) will either display a "1" or it will be off. The $3\frac{1}{2}$ -digit display is driven by the output of the A/D Converter and shows the number of counts up to 1999, proportional to the input voltage.

Power Supply

The Power Supply provides the regulated low-voltage power required by the instrument circuitry.

The power transformer has a primary and two secondary windings. One secondary winding develops a plus and

minus 5-volt regulated output through a bridge rectifier and two IC regulators. These outputs are the supply voltages for the various circuits in the multimeter.

The other secondary winding supplies a regulated 5 volts to the digital display through a full-wave bridge rectifier and an IC regulator. This 5-volt output drives the LED display.

The COM input jack is tied to a common line between all the circuits in the meter. The common line is not grounded. In other words, all the circuits in the digital meter are floating. Only the primary side of the power supply reaches earth ground through the power cord grounding conductor.

PERFORMANCE CHECK PROCEDURE

INTRODUCTION

This procedure checks the electrical characteristics listed in the Specification part of Section 1 of this manual. If the instrument fails to meet the requirements given in this performance check, the Calibration Procedure in Section 5 should be done. This performance check may also be used as an acceptance test or as a troubleshooting aid.

You do not have to remove the instrument case to do this procedure. All checks can be made with controls and connectors accessible from the outside.

To ensure instrument accuracy, check its performance after every 2000 hours of operation, or once each year if

used infrequently. If these checks indicate a need for readjustment or repair, refer the instrument to a qualified service person.

TEST EQUIPMENT NEEDED

The test equipment listed in Table 4-1 is a complete list of the equipment needed for this performance check. All test equipment is assumed to be operating within tolerance. Detailed operating instructions for test equipment are not given in this procedure. If operating information is needed, refer to the appropriate test equipment instruction manual.

Table 4-1
Test Equipment Required

Item	Minimum Specification	Purpose
DC Voltage Calibrator ^a	Range, 0 to 500 volts. Accuracy, within 0.05%.	DC VOLTS function check.
AC Voltage Calibrator ^a	Range, 0 to 500 volts. Frequency, 50 to 500 Hz. Accuracy, within 0.1%.	AC VOLTS function check.
DC Current Source ^a	Range, 0 to 2 amps. Accuracy, within 0.1%.	DC AMPS function check.
AC Current Source ^a	Range, 0 to 2 amps. Frequency, 50 to 500 Hz. Accuracy, within 0.1%.	AC AMPS function check.
Resistance Standard ^a	Range, 0 ohms to 20 megohms. Accuracy, within 0.1%. (Suitable equipment: Electro Scientific Industries Model DB61.)	OHMS function check.
Adapter	BNC-female-to-dual-banana. (Suitable equipment: Tektronix PN 103-0090-00.)	Used throughout procedure for signal connection.
Coaxial Cable	Impedance: 50 Ω . (Suitable equipment: Tektronix PN 012-0057-01.)	Used throughout procedure for signal connection.
Patch Cords (red and black)	Banana-plug-to-banana-plug. (Suitable equipment: Tektronix PN 012-0031-00 and 012-0039-00.)	Used for signal connection to 10A input connector.

^a This equipment should be traceable to NBS for certification of measurement characteristics.

Performance Check Procedure – CDM250 Service

PREPARATION

1. Ensure that all power switches are off.
2. Ensure that all test equipment and the CDM250 are suitably adapted to the line voltage to be applied.
3. Connect the equipment under test and the test equipment to a suitable line voltage source. Turn all equipment on and allow at least 20 minutes for the equipment to warm up and stabilize.
4. Set the following controls during warm-up time:

AC/DC button	DC (button out)
Function	VOLTS (button in)
Range	200m (button in)

PROCEDURE

1. Check Integrator Zero

- a. Short the CDM250 V-Ω and COM Input terminals together and check that the display shows ±00.0, ±2 counts.

2. Check DC VOLTS Range Linearity

- a. Set the dc voltage calibrator output for +5.00 mV.
- b. Connect the output of the dc voltage calibrator to the CDM250 V-Ω and COM input connectors.
- c. CHECK—that the CDM250 display reads 05.0 ±1 count (04.9 to 05.1).
- d. Set the output polarity of the dc voltage calibrator to negative.
- e. CHECK—that the CDM250 display reads -05.0 ±1 count (-04.9 to -05.1).
- f. Set the dc voltage calibrator output for +100 mV.
- g. CHECK—that the CDM250 display reads 100.0 ±6 counts (99.4 to 100.6).
- h. Set the output polarity of the dc voltage calibrator to negative.

- i. CHECK—that the CDM250 display reads -100.0 ±6 counts (-99.4 to -100.6).

3. Check DC VOLTS Ranges

- a. CHECK—the accuracy of all the DC VOLTS ranges by using Table 4-2 as a reference.

NOTE

Begin the accuracy check with the first settings listed in Table 4-2 and continue down the table, increasing the CDM250 range before increasing the calibrator output voltage.

Table 4-2
DC VOLTS Range Accuracy

CDM250 Range Setting (DC VOLTS)	DC Calibrator Voltage Output	CDM250 Display	Tolerance
200m	+ 180 mV	180.0	± 10 counts (179.0 to 181.0)
2	+ 1.80 V	1.800	± 10 counts (1.790 to 1.810)
20	+ 18.00 V	18.00	± 10 counts (17.90 to 18.10)

WARNING

Dangerous voltages may be encountered at the following settings. Do not contact the output connectors of the voltage calibrator, the input connectors of the CDM250, or the internal circuitry of the CDM250.

200	+ 180.00 V	180.0	± 10 counts (179.0 to 181.0)
500	+ 480.0 V	480	± 4 counts (476 to 504)

- b. Turn the dc voltage calibrator output back to zero volts and disconnect the calibrator.

4. Check AC VOLTS Ranges

NOTE

- a. Set the CDM250 to 200m VOLTS AC.
- b. Set the output of the ac voltage calibrator to 180 mV.
- c. Connect the output of the ac voltage calibrator to the CDM250 V-Ω and COM Input connectors.
- d. CHECK—the accuracy of all the AC VOLTS ranges by using Table 4-3 as a reference.

Begin the accuracy check with the first settings listed in Table 4-3 and continue down the table, increasing the CDM250 range before increasing the calibrator output voltage.

- e. Set the ac voltage calibrator output back to zero volts and disconnect the test equipment.

Table 4-3
AC VOLTS Range Accuracy

CDM250 Range Setting (AC VOLTS)	AC Calibrator Voltage Output	AC Calibrator Output Frequency	CDM250 Display	Tolerance
200m	+ 180 mV	50 Hz	180.0	± 22 counts (177.8 to 182.2)
		100 Hz	180.0	± 22 counts (177.8 to 182.2)
		200 Hz	180.0	± 22 counts (177.8 to 182.2)
		500 Hz	180.0	± 22 counts (177.8 to 182.2)
2	+ 1.800 V	50 Hz	1.800	± 22 counts (1.778 to 1.822)
		100 Hz	1.800	± 22 counts (1.778 to 1.822)
		200 Hz	1.800	± 22 counts (1.778 to 1.822)
		500 Hz	1.800	± 22 counts (1.778 to 1.822)
20	+ 18.00 V	50 Hz	18.00	± 22 counts (17.78 to 18.22)
		100 Hz	18.00	± 22 counts (17.78 to 18.22)
		200 Hz	18.00	± 22 counts (17.78 to 18.22)
		500 Hz	18.00	± 22 counts (17.78 to 18.22)

WARNING

Dangerous voltages may be encountered at the following settings. Do not contact the output connectors of the voltage calibrator, the input connectors of the CDM250, or the internal circuitry of the CDM250.

200	+ 180.00 V	50 Hz	180.0	± 22 counts (177.8 to 182.2)
		100 Hz	180.0	± 22 counts (177.8 to 182.2)
		200 Hz	180.0	± 22 counts (177.8 to 182.2)
		500 Hz	180.0	± 22 counts (177.8 to 182.2)
500	+ 480 V	50 Hz	480	± 9 counts (471 to 489)
		100 Hz	480	± 9 counts (471 to 489)
		200 Hz	480	± 9 counts (471 to 489)
		500 Hz	480	± 9 counts (471 to 489)

Performance Check Procedure—CDM250 Service

5. Check DC Amps Ranges

- a. Set the CDM250 to the 200 μ A DC range. With nothing connected to the CDM250 input connectors, check that the display reads $\pm 00.0 \pm 1$ count.
- b. Set the dc current calibrator to deliver +180 μ A current, and connect the output to the CDM250 A and COM input connectors.
- c. CHECK—that the CDM250 readout displays 180.0 ± 19 counts (178.1 to 181.9).
- d. Turn the dc current source off and reverse the input connections to the CDM250. Turn the dc current source on.
- e. CHECK—that the CDM250 readout displays -180.0 ± 19 counts (-178.1 to -181.9).
- f. Reverse the input connections to the CDM250.
- g. CHECK—the accuracy of the 2 mA through 2000 mA DC Amps ranges by using Table 4-4 as a reference.

NOTE

Begin the accuracy check with the first settings listed in Table 4-4 and continue down the table, increasing the CDM250 range before increasing the calibrator output current.

Table 4-4
DC AMPS Range Accuracy

CDM250 Range Setting (DC A)	DC Current Calibrator Output	CDM250 Display	Tolerance
2m	+1.8 mA	1.800	± 19 counts (1.781 to 1.819)
20m	+18.0 mA	18.00	± 19 counts (+17.81 to +18.19)
200m	+180 mA	180.0	± 19 counts (178.1 to 181.9)
2000m	+1800 mA	1800	± 21 counts (1779 to 1821)

- h. Set the dc calibrator to zero and disconnect it.

6. Check DC Amps 10A Range

- a. Set the CDM250 to 10A DC A.
- b. Connect the dc current calibrator via banana-plug-to-banana-plug leads to the 10A and COM input connectors.
- c. Set the dc current calibrator to deliver 1.99999 A output.
- d. CHECK—that the CDM250 readout displays 2.00 ± 5 counts (1.95 to 2.05).
- e. Set the dc calibrator to zero and disconnect all test equipment.

7. Check AC Amps Ranges

- a. Set the CDM250 to 200 μ A AC.
- b. Set the ac current calibrator to 180 μ A ac, 100 Hz, and connect it to the CDM250 A and COM input connectors.
- c. CHECK—the accuracy of the 200 μ A through 2000 mA AC Amps ranges by using Table 4-5 as a reference.

NOTE

Begin the accuracy check with the first settings listed in Table 4-5 and continue down the table, increasing the CDM250 range before increasing the calibrator output current.

Table 4-5
AC AMPS Range Accuracy

CDM250 Range Setting (AC A)	AC Current Calibrator Output (100 Hz)	CDM250 Display	Tolerance
200 μ	180 μ A	180.0	± 31 counts (176.9 to 183.1)
2m	1.800 mA	1.800	± 31 counts (1.769 to 1.831)
20m	18 mA	18.00	± 31 counts (17.69 to 18.31)
200m	180 mA	180.0	± 31 counts (176.9 to 183.1)
2000m	1800 mA	1800	± 31 counts (1769 to 1831)

- d. Set the ac current calibrator to zero and disconnect it from the CDM250.

8. Check AC Amps 10A Range

- a. Set the CDM250 to AC A 10A.
- b. Connect the ac current calibrator output via banana-plug-to-banana-plug leads to the CDM250 10A and COM input connectors and set the ac current calibrator for 1.99999 A ac, 100 Hz.
- c. CHECK—the CDM250 display reads 2.00 ± 7 counts (1.93 to 2.07).
- d. Set the ac current calibrator output to zero and disconnect the test equipment.

9. Check the Ohms Ranges

- a. Connect the CDM250 V- Ω and COM input connectors to the resistance standard. Set the CDM250 to the Ω function.
- b. CHECK—the ohms range accuracy, using Table 4-6 as a reference.

Table 4-6
Ohms Range Accuracy

Resistance Standard Setting (ohms)	CDM250 Range Setting (Ω)	CDM250 Display	Tolerance
180	200	180.0	± 18 counts (178.2 to 181.8)
1.8 k	2K	1.800	± 15 counts (1.785 to 1.815)
18 k	20K	18.00	± 15 counts (17.85 to 18.15)
180 k	200K	180.0	± 15 counts (178.5 to 181.5)
1.8 M	2000K	1800	± 15 counts (1785 to 1815)
11 M	20M	11.00	± 22 counts (10.78 to 11.22)

- c. Disconnect the test equipment from the CDM250.
- d. CHECK—that the CDM250 display reads 1 (overrange indicator).

This completes the Performance Check Procedure.

ADJUSTMENT PROCEDURE

To ensure instrument accuracy, this Adjustment Procedure should be done every 2000 hours of operation or at least once each year if used infrequently.

PREPARATION FOR ADJUSTMENT

Make the adjustments in this procedure at an ambient temperature of +21°C to +25°C (+70°F to +77°F) and a relative humidity of 75% or less.

It is necessary to remove the top of the cabinet to access the component side of the Main circuit board. Disconnect the power cord from the CDM250 and follow the cabinet removal instructions in the Maintenance section of this manual.

Refer to the appropriate test equipment instruction manuals for test equipment operating information.

Connect the test equipment and the CDM250 to a suitable ac-power source and allow a 20-minute warmup period before making the adjustments.

PROCEDURE

1. Adjust DC VOLTS Range (VR1)

- a. Set the CDM250 to the 200 mVdc range by making the following pushbutton settings:

AC/DC	DC (button out)
Function	VOLTS (button in)
Range	200m (button in)

- b. Set the output of a dc calibrator for exactly 190 mV.
- c. Connect the calibrator output to the CDM250 V-Ω and COM input connectors.
- d. ADJUST—potentiometer VR1 with a small flat-tipped screwdriver until the multimeter digital display reads 190.0 ±1 count (189.9 to 190.1).
- e. Disconnect the dc calibrator from multimeter.

2. Adjust AC VOLTS Range (VR2)

- a. Perform the DC VOLTS adjustment in Step 1.
- b. Set the CDM250 to the 200 mVac range by making the following pushbutton settings:

AC/DC	AC (button in)
Function	VOLTS (button in)
Range	200m (button in)

- c. Set the output of an ac calibrator for exactly 190 mV at 400 Hz.
- d. Connect the output of the ac voltage calibrator to the V-Ω and COM input connectors on the multimeter.
- e. ADJUST—potentiometer VR2 with a small flat-tipped screwdriver until the multimeter digital display reads 190.0 ±1 count (189.9 to 190.1).
- f. Remove the test equipment from the multimeter.

This completes the Adjustment Procedure.

MAINTENANCE

This section of the manual contains information on static-sensitive components, preventive maintenance, troubleshooting, and corrective maintenance.

STATIC-SENSITIVE COMPONENTS

The following precautions apply when performing any maintenance involving internal access to the instrument.

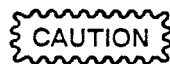

Static discharge can damage any semiconductor component in this instrument.

This instrument contains electrical components that are susceptible to damage from static discharge. Table 6-1 lists the relative susceptibility of various classes of semiconductors. Static voltages of 1 kV to 30 kV are common in unprotected environments.

When performing maintenance, observe the following precautions to avoid component damage:

1. Minimize handling of static-sensitive components.
2. Transport and store static-sensitive components or assemblies in their original containers or on a metal rail. Label any package that contains static-sensitive components or assemblies.
3. Discharge the static voltage from your body by wearing a grounded antistatic wrist strap while handling these components. Servicing static-sensitive components or assemblies should be performed only at a static-free work station by qualified service personnel.
4. Keep anything capable of generating or holding a static charge off the work station surface.
5. Keep the component leads shorted together whenever possible.
6. Pick up components by their bodies, never by their leads.
7. Do not slide the components over any surface.
8. Avoid handling components in areas that have a floor or work-surface covering capable of generating a static charge.

9. Use a soldering iron that is connected to earth ground.
10. Use only approved antistatic, vacuum-type desoldering tools for component removal.

Table 6-1

Relative Susceptibility to Static-Discharge Damage

Semiconductor Classes	Relative Susceptibility Levels ^a
MOS or CMOS microcircuits or discretes, or linear microcircuits with MOS inputs (Most Sensitive)	1
ECL	2
Schottky signal diodes	3
Schottky TTL	4
High-frequency bipolar transistors	5
JFET	6
Linear microcircuits	7
Low-power Schottky TTL	8
TTL (Least Sensitive)	9

^aVoltage equivalent for levels (voltage discharged from a 100-pF capacitor through a resistance of 100 Ω):

1 = 100 to 500 V
2 = 200 to 500 V
3 = 250 V
4 = 500 V
5 = 400 to 600 V

6 = 600 to 800 V
7 = 400 to 1000 V (est)
8 = 900 V
9 = 1200 V

PREVENTIVE MAINTENANCE

Preventive maintenance consists of cleaning, inspection, and checking instrument performance. Preventive maintenance done on a regular basis may prevent some instrument problems and improve reliability. The required frequency of regular maintenance depends on the environment in which the instrument is used. A good time to do preventive maintenance is just before instrument adjustment.

INSPECTION AND CLEANING

Inspect and clean the CDM250 as often as operating conditions require. Dirt inside the instrument can cause overheating and component breakdown because dirt insulates and prevents heat dissipation. It also provides an electrical conduction path that could result in instrument failure, especially under high-humidity conditions.



Do not use chemical cleaning agents which might damage the plastics used in this instrument. Use a nonresidue-type cleaner, preferably isopropyl alcohol or a solution of 1% mild detergent and 99% water. Before using any other type of cleaner, consult your Tektronix Service Center or representative.

Exterior

INSPECTION. Inspect the external parts of the instrument for damage, wear, and missing parts; use Table 6-2 as a guide. Instruments that appear to have been dropped or abused should be checked for correct operation. Defects that could cause personal injury or could further damage the instrument should be repaired at once.



Do not allow moisture to get inside the instrument during external cleaning. Use only enough liquid to dampen the cloth or applicator.

CLEANING. Dust on the outside of the instrument can be removed with a soft cloth or small soft-bristle brush. The brush is useful on and around controls and connectors. Remove remaining dirt with a soft cloth dampened in a mild detergent-and-water solution. Do not use abrasive cleaners.

Interior

WARNING

To avoid electrical shock, disconnect the instrument from the ac power source before inspecting or cleaning the internal circuitry.

To clean or inspect the inside of the instrument, first refer to the removal and replacement instructions in the Corrective Maintenance part of this section.

INSPECTION. Inspect the internal parts of the CDM250 for damage and wear, using Table 6-3 as a guide. Repair any problems immediately. The repair method for most visible defects is obvious, but take particular care if heat-damaged components are found. Since overheating usually indicates other trouble in the instrument, the cause of overheating must be found and corrected to prevent further damage.

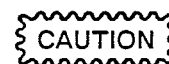

To prevent damage from electrical arcing, ensure that circuit boards and components are dry before applying power to the instrument.

CLEANING. To clean the interior, blow off dust with dry, low-pressure air (approximately 9 psi). Remove any remaining dust with a soft brush or a cloth dampened with a solution of mild detergent and water. A cotton-tipped applicator is useful for cleaning in narrow spaces and on circuit boards.

Table 6-2
External Inspection Checklist

Item	Inspect For	Repair Action
Front-panel buttons	Missing, damaged, or loose buttons.	Repair or replace missing or defective items.
Front-panel connectors	Broken shells, cracked insulation, and deformed contacts. Dirt in connectors.	Replace Front-Panel assembly or replace defective parts. Clean or wash out dirt.
Accessories	Missing items or parts of items, bent pins, broken or frayed cables, and damaged connectors.	Replace damaged or missing items, frayed cables, and defective parts.

Table 6-3
Internal Inspection Checklist

Item	Inspect For	Repair Action
Circuit Boards	Loose, broken, or corroded solder connections. Burned circuit boards. Burned, broken, or cracked circuit-run plating.	Replace circuit board assembly or repair as follows: Clean solder corrosion with an eraser and flush with isopropyl alcohol. Resolder defective connections. Determine cause of burned items and repair. Repair defective circuit runs.
Resistors	Burned, cracked, broken, or blistered.	Replace circuit board assembly or repair as follows: Replace defective resistors. Check for cause of burned component and repair as necessary.
Solder Connections	Cold solder or rosin joints.	Resolder joint and clean with isopropyl alcohol.
Capacitors	Damaged or leaking cases. Corroded solder on leads or terminals.	Replace circuit board assembly or repair as follows: Replace defective capacitors. Clean solder connections and flush with isopropyl alcohol.
Semiconductors	Loosely inserted in sockets. Distorted pins.	Firmly seat loose semiconductors. Remove devices having distorted pins. Carefully straighten pins (as required to fit the socket), using long-nose pliers, and reinsert firmly. Ensure that straightening action does not crack the pins, causing them to break.
Wiring and Cables	Loose plugs or connectors. Burned, broken, or frayed wiring.	Firmly seat connectors. Repair or replace defective wires or cables.
Chassis	Dents, deformations, and damaged hardware.	Replace defective assembly or straighten, repair, or replace defective hardware.

Semiconductor Checks

Periodic checks of the transistors and other semiconductors in this instrument are not recommended. The

best check of semiconductor performance is actual operation in the instrument.

TROUBLESHOOTING

Preventive maintenance done on a regular basis should reveal most potential problems before an instrument fails. However, should troubleshooting be needed, the following information will help to locate the problem. Also, the Theory of Operation and the Diagrams sections of this manual may help with troubleshooting.

TROUBLESHOOTING AIDS

Schematic Diagram

A schematic diagram is located on a tabbed foldout page in the Diagrams section. Portions of circuitry mounted on each circuit board are enclosed by heavy black lines. The assembly number and name(s) of the circuit(s) are shown near the top or the bottom edge of the diagram.

Functional blocks on the schematic diagram are outlined with a wide gray line. Components within the outlined area perform the function named by the block label. The Theory of Operation uses these functional block names when describing circuit operation.

Component numbers and electrical values of components in this instrument are shown on the schematic diagram. Refer to the first page of the Diagrams section for the reference designators and symbols used to identify components. Important voltages and waveforms are also shown on the diagram.

Circuit Board Illustrations

Circuit board illustrations in the Diagrams section show the physical location of each component.

Grid Coordinate System

The schematic diagram and circuit board illustrations have grid borders along their left and top edges. The grid coordinates for the components are given in an accompanying table.

Component Color Coding

An illustration at the beginning of the Diagrams section gives information about color codes and markings on resistors and capacitors.

RESISTORS. Resistors used in this instrument are carbon-film, composition, or precision metal-film types. They are usually color coded with the EIA color code; however, some metal-film type resistors may have the value printed on the body. The color code is interpreted starting with the stripe nearest to one end of the resistor. Composition resistors have four stripes; these represent two significant digits, a multiplier, and a tolerance value. Metal-film resistors have five stripes representing three significant digits, a multiplier, and a tolerance value.

CAPACITORS. Common disc capacitors and small electrolytics have capacitance values marked on the side of the capacitor body. White ceramic capacitors are color coded in picofarads, using a modified EIA code. Dipped tantalum capacitors are color coded in microfarads. The color dot indicates both the positive lead and the voltage rating. Since these capacitors are easily destroyed by reversed or excessive voltage, be careful to observe the polarity and voltage rating when replacing them.

DIODES. The cathode end of each glass-encased diode is indicated by either a stripe, a series of stripes, or a dot. The cathode and anode ends of a metal-encased diode may be identified by the diode symbol marked on its body.

Semiconductor Lead Configurations

The second figure in the Diagrams section shows some typical lead configurations for semiconductor devices that may be used in this instrument. If a semiconductor does not seem to match the configurations shown, consult a manufacturer's data sheet.

TROUBLESHOOTING TECHNIQUES

When troubleshooting the CDM250, be sure to read the troubleshooting techniques given here before going on to CDM250 Troubleshooting Tips. The troubleshooting techniques described in this procedure are general techniques that should be used together with the more specific CDM250 Troubleshooting Tips.

This procedure is arranged to check simple trouble possibilities before doing more extensive troubleshooting.

When a defective component is located, either replace the assembly containing the defective part or replace the component by using the appropriate replacement procedure given under Corrective Maintenance. Replacement assemblies are available through Tektronix and are shown in an exploded-view drawing in Replaceable Parts (section 8) and are described in the parts list in that section.

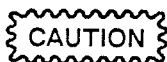

Before using any test equipment to make measurements on static-sensitive, current-sensitive, or voltage-sensitive components or assemblies, ensure that any voltage or current supplied by the test equipment does not exceed the limits of the component to be tested.

1. Check Control Settings

Incorrect control settings can give a false indication of instrument malfunction. If there is any question about the correct function or operation of any control, refer to the CDM250 Operators Manual.

2. Check Associated Equipment

Before proceeding, ensure that any equipment used with the CDM250 is operating correctly. Verify that input signals are properly connected and that the interconnecting cables are not defective. Check that the ac-power-source voltage to all equipment is correct.

3. Visual Check

WARNING

To avoid electrical shock, disconnect the instrument from the ac power source before making a visual inspection of the internal circuitry.

Look for broken connections or wires, damaged components, semiconductors not firmly mounted, damaged circuit boards, or other clues to the cause of a malfunction.

4. Check Instrument Performance and Adjustment

Check the performance of either those circuits where you suspect trouble or the entire instrument. An apparent trouble may be the result of misadjustment. The Performance Check is in Section 4 of this manual, and the Adjustment Procedure is in Section 5.

5. Isolate Trouble to a Circuit

To isolate problems, use any symptoms noticed when checking the instrument's operation to help localize the trouble to a particular circuit. The CDM250 Troubleshooting Tips, following this procedure, may help in locating a problem.

6. Check Individual Components

WARNING

To avoid electrical shock, always disconnect the instrument from the ac power source before removing or replacing components.

The following procedures describe methods of checking individual components. Two-lead components that are soldered in place are most accurately checked by first disconnecting one end from the circuit board. This isolates the measurement from the effects of the surrounding circuitry. See Figure 9-1 for component value identification and Figure 9-2 for semiconductor lead configurations.



When checking semiconductors, observe the static-sensitivity precautions given at the beginning of this section.

TRANSISTORS. A good check of a transistor is actual performance under operating conditions. A transistor can most effectively be checked by substituting a known-good component. However, be sure that circuit conditions are not such that a replacement transistor will also be damaged. If substitute transistors are not available, use a dynamic-type transistor checker for testing. Static-type transistor checks are not recommended, since they do not check operation under simulated operating conditions.

When troubleshooting transistors in the circuit with a voltmeter, measure both the emitter-to-base and emitter-to-collector voltages to find out if they are consistent with normal circuit voltages. Voltages across a transistor may vary with the type of device and its circuit function.

Some of these voltages are predictable. The emitter-to-base voltage for a conducting silicon transistor will normally range from 0.6 V to 0.8 V. The emitter-to-collector voltage for a saturated transistor is about 0.2 V. Because these values are small, the best way to check them is by connecting a sensitive voltmeter across the junction rather than comparing two voltages taken with respect to ground. If the former method is used, both leads of the voltmeter must be isolated from ground.

If voltage values measured are less than those just given, either the device is shorted or no current is flowing in the external circuit. If values exceed the emitter-to-base values given, either the junction is reverse biased or the device is defective. Voltages exceeding those given for typical emitter-to-collector values could indicate either a nonsaturated device operating normally or a defective (open-circuited) transistor. If the device is conducting, voltage will be developed across the resistors in series with it; if open, no voltage will be developed across the resistors unless current is being supplied by a parallel path.

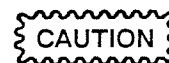

When checking emitter-to-base junctions, do not use an ohmmeter range that has a high internal current. High current may damage the transistor. Reverse biasing the emitter-to-base junction with a high current may degrade the current-transfer ratio (Beta) of the transistor.

A transistor emitter-to-base junction also can be checked for an open or shorted condition by measuring the resistance between terminals with an ohmmeter set to a range having a low internal source current, such as the R X 1 k Ω range. The junction resistance should be very high in one direction and much lower when the meter leads are reversed.

When troubleshooting a field-effect transistor (FET), the voltage across its elements can be checked in the same manner as previously described for other transistors. However, remember that in the normal depletion mode of operation, the gate-to-source junction is reverse biased; in the enhanced mode, the junction is forward biased.

INTEGRATED CIRCUITS. An integrated circuit (IC) can be checked with a voltmeter, test oscilloscope, or by direct substitution. A good understanding of circuit operation is essential when troubleshooting a circuit having IC components. Use care when checking voltages and waveforms around the IC so that adjacent leads are not shorted together. An IC test clip provides a convenient means of clipping a test probe to an IC.

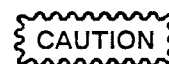

When checking a diode, do not use an ohmmeter scale that has a high internal current. High current may damage a diode. Checks on diodes can be performed in much the same manner as those on transistor emitter-to-base junctions.

DIODES. A diode can be checked for either an open or a shorted condition by measuring the resistance between terminals with an ohmmeter set to a range having a low internal source current, such as the R X 1 k Ω range. The diode resistance should be very high in one direction and much lower when the meter leads are reversed.

Silicon diodes should have 0.6 V to 0.8 V across their junctions when conducting; Schottky diodes about 0.2 V

to 0.4 V. Higher readings indicate that they are either reverse biased or defective, depending on polarity.

RESISTORS. Check resistors with an ohmmeter. Refer to the Replaceable Parts list for the tolerances of resistors used in this instrument. A resistor normally does not require replacement unless its measured value varies widely from its specified value and tolerance.

INDUCTORS. Check for open inductors by checking continuity with an ohmmeter. Shorted or partially shorted inductors can usually be found by checking the waveform response when high-frequency signals are passed through the circuit.

CAPACITORS. A leaky or shorted capacitor can be detected by checking resistance with an ohmmeter set to one of the highest ranges. Do not exceed the voltage

rating of the capacitor. The resistance reading should be high after the capacitor is charged to the output voltage of the ohmmeter. An open capacitor can be detected with a capacitance meter or by checking whether the capacitor passes ac signals.

7. Repair and Adjust the Circuit

If any defective parts are located, follow the replacement procedures given under Corrective Maintenance in this section. After any electrical component has been replaced, the performance of that circuit and any other closely related circuit should be checked. Since the power supplies affect all circuits, performance of the entire instrument should be checked if work has been done on the power supplies. Refer to the Performance Check Procedure and the Adjustment Procedure, Sections 4 and 5 in this manual.

CDM250 TROUBLESHOOTING TIPS**NOTE**

Check resistors with an ohmmeter. Refer to the Replaceable Parts list for the tolerances of resistors used in this instrument. Refer to the parts list or schematic for component values. Also refer to Troubleshooting Techniques in this section for more detailed troubleshooting methods.

Power Supply Checks

1. Set LINE VOLTAGE SELECT switches to the correct line voltage.
2. Check line fuse FS3 for open.
3. Check J3 for good connection.
4. Plug line cord into live receptacle and turn POWER switch ON.
5. Check the ac input and dc output voltages on D5, D6, D7, D8, D9, and D10. If correct voltages not present, replace the Rear Panel Assembly.
6. Reference voltmeter negative lead to mounting screw (collector) of Q2 or Q4 and check output voltage of Q2 for $+5\text{ V} \pm 5\%$ (4.75 to 5.25 V).
7. Reference voltmeter negative lead to mounting screw (collector) of Q2 or Q4 and check output voltage of Q3 for $-5\text{ V} \pm 5\%$ (-4.75 to -5.25 V).
8. Reference voltmeter negative lead to mounting screw (collector) of Q2 or Q4 and check output voltage of Q4 for $+5\text{ V} \pm 5\%$ (4.75 to 5.25 V).
9. If the output voltages are not correct in steps 6, 7, and 8, the ICs on the Main Board Assembly may be defective.

LED Display Not Correct

1. Check output voltage of Q2, Q3, and Q4 (see Power Supply Checks).
2. Check J1 and J2 for good connections.
3. Set the CDM250 to DC VOLTS 500. Short V- Ω to COM with a short jumper. The CDM250 should display 000 or 001 with - (minus) on or off. If it does not, connect oscilloscope common to CDM250 COM and make the following checks.
 - a. Check J1 pin 1 and J2 pins 16 and 29 for +2.8 V.
 - b. Check U1 (checks first three digits in the display):
 - Pins 9 through 18 and pins 23 and 24 for +1 V.
 - Pins 7, 19, 22, and 25 for +2.8 V.
 - c. Check U1 (checks minus sign in display):
 - If - (minus) is on: Check pin 20 for +1 V.
 - If - (minus) is off: Check pin 20 for +2.8 V.
 - d. Check U1 (checks fourth digit in the display).
 - If the fourth digit is 0: Check pins 2 through 8 for +1 V.
 - If the fourth digit is 1: Check pins 2, 5, 6, 7, and 8 for +2.8 V.
 - Check pins 3 and 4 for +1 V.
4. If voltages in step 3 are not correct, replace the Main Board Assembly or U1.
5. If voltages in step 3 are correct and the CDM250 display is not correct, replace the Display Board Assembly.
6. If any U1 pin voltage is -2 V, the LED segment or connection is open; replace the Display Board Assembly.

Does Not Zero in 2 Vdc Range with No Input

Replace Main Board Assembly or go to step 1.

1. Check VR1.
2. Check Function/Range switch; check wiper for good contact.
3. With CDM250 set to 500 Vdc and POWER switch OFF: check the following resistors (may be checked in circuit with power off): R1, R11, R12, R13, R14, R15, R22, R23, R33, R34, and R35.
4. Check C2 and C3.
5. Replace U1.

Maintenance — CDM250 Service

**DC VOLTS Incorrect
when Checked with
Input**

Reads "000"

Replace Main Board
Assembly or go to
step 1.

1. Check Function/Range switch; check wiper for good contact.
2. With CDM250 set to 500 Vdc and POWER switch OFF, check the following resistors (may be checked in circuit with power off): R4, R11, R12, R13, R14, R15, R33, and R39.
3. Replace U1.

**Reading
Unstable**

Replace Main Board
Assembly or go to
step 1.

1. Check Function/Range switch; check wiper for good contact.
2. With CDM250 set to 500 Vdc and POWER switch OFF, check the following resistors (may be checked in circuit with power off): R2, R11, R12, R13, R14, R15, and R33.
3. Check capacitors C3, C4, and C5.
4. Check 40 kHz XTAL for open.
5. Replace U1.

**Reading
Incorrect**

Check calibration
(see Adjustment
Procedure in this
manual).

**Reading Remains
Incorrect**

Replace Main Board
Assembly or go to
step 1.

1. Check potentiometer VR1.
2. Check Function/Range switch; check wiper for good contact.
3. With CDM250 set to 500 Vdc and POWER switch OFF, check the following resistors (may be checked in circuit with power off): R1, R11, R12, R13, R14, R15, R33, R34, and R35.
4. Check capacitor C1.
5. Replace U1.

AC VOLTS Incorrect when Checked with Input

Reads "000"

Replace Main Board Assembly or go to step 1.

1. Check Function/Range switch; check wiper for good contact.
2. With CDM250 set to 500 Vdc and POWER switch OFF, check the following resistors (may be checked in circuit with power off): R5, R9, R11, R12, R13, R14, and R15.

Reads "1"

Replace Main Board Assembly or go to step 1.

1. Check Function/Range switch; check wiper for good contact.
2. With CDM250 set to 500 Vdc and POWER switch OFF, check the following resistors (may be checked in circuit with power off): R8, R10, R11, R12, R13, R14, R15, and R33.
3. Check potentiometer VR2.
4. Check diodes D3 and D4.
5. Replace U2.

Reading Unstable

Replace Main Board Assembly or go to step 1.

1. Check Function/Range switch; check wiper for good contact.
2. With CDM250 set to 500 Vdc and POWER switch OFF, check the following resistors (may be checked in circuit with power off): R22 and R23.
3. Check capacitors C4 and C5.
4. Check capacitor C9 for open.
5. Replace U2.

Reading Incorrect

Replace Main Board Assembly or go to step 1.

1. Check Function/Range switch; check wiper for good contact.
2. With CDM250 set to 500 Vdc and POWER switch OFF, check the following resistors (may be checked in circuit with power off): R6, R11, R12, R13, R14, R15, and R33.
3. Check capacitor C8.
4. Replace U2.

Maintenance – CDM250 Service

**Amps (DC A or AC A)
Reading Incorrect**

Check fuse FS2 and
fuse clip to ensure
good contact.

**Reading Remains
Incorrect**

Replace Main Board
Assembly or go to
step 1.

1. Check Function/Range switch; check wipers for good contact.
2. With CDM250 set to 500 Vdc and POWER switch OFF, check the following resistors (may be checked in circuit with power off): R16, R17, R18, R19, R42, and R43.

**Ohms (Ω) Reading
Incorrect**

Replace Main Board
Assembly or go to
step 1.

1. If DC VOLTS readings are correct, check resistors R36 and R37.
2. With CDM250 set to 500 Vdc and POWER switch OFF, check the following resistors (may be checked in circuit with power off): R38 and R39 for open.
3. Check transistor Q1 for leakage.
4. Check thermistor PTC1 for open.
5. Check Function/Range switch; check wiper for good contact.
6. Replace U1.

CORRECTIVE MAINTENANCE

Replacement assemblies (i.e., Main Board, Front Panel, etc.) can be obtained from Tektronix. Many of the standard electrical components in this instrument can be obtained from your local electrical parts supplier. Corrective maintenance, therefore, consists of either complete assembly replacement or component replacement with locally obtained parts.

MAINTENANCE PRECAUTIONS

To avoid personal injury or damage to equipment, observe the following precautions:

- Disconnect the instrument from the ac-power source before removing or installing components.
- Verify that any line-rectifier filter capacitors are discharged before doing any servicing.
- Use care not to interconnect instrument grounds which may be at different potentials (cross grounding).
- When soldering on circuit boards or small insulated wires, use only a 15-watt, pencil-type soldering iron.

OBTAINING REPLACEMENT PARTS

Replacement assemblies for this instrument (Main Board, Front Panel, Rear Panel, Display Board, and Cabinet) can be obtained through your local Tektronix Field Office or representative. The CDM250 assemblies and their Tektronix part numbers are shown in the exploded-view drawing in section 8 of this manual.

The Replaceable Parts list in section 8 gives the Tektronix part number, name, and description of the CDM250 assemblies and also lists the electrical parts in each assembly. This generic list includes the value, rating, tolerance, and description of the parts in the various assemblies. This list of the electrical parts in each assembly may be useful if parts are obtained from your local supplier, as most CDM250 parts may be ordered from Tektronix at the assembly or kit level only.

NOTE

Physical size and shape of a component may affect instrument performance, particularly at high frequencies. Always use direct replacement components, unless you know that a substitute will not degrade performance.

Ordering Parts

When ordering parts from Tektronix, Inc., be sure to include the following information:

- Instrument type (include all modification and option numbers).
- Instrument serial number.
- A description of the part.
- Tektronix part number.

REPACKAGING FOR SHIPMENT

Save the original carton and packing material for reuse if the instrument should have to be reshipped on a commercial transport carrier. If the original materials are unfit or not available, repackage the instrument as follows:

1. Use a corrugated cardboard shipping carton with a test strength of at least 200 pounds and with an inside dimension at least six inches greater than the instrument dimensions.
2. If the instrument is being shipped to a Tektronix Service Center, enclose the following: the owner's address, name and phone number of a contact person, type and serial number of the instrument, reason for returning, and a complete description of the service needed.
3. Completely wrap the instrument with polyethylene sheeting or equivalent to protect the outside finish and prevent entry of foreign material into the instrument.
4. Cushion the instrument on all sides, using three inches of padding material or urethane foam tightly packed between the carton and the instrument.

Maintenance – CDM250 Service

5. Seal the shipping carton with an industrial stapler or strapping tape.
6. Mark the address of the Tektronix Service Center and also your own return address on the shipping carton.

MAINTENANCE AIDS

The maintenance aids recommended in Table 6-4 include items that may be needed for instrument

maintenance and repair. Equivalent products may be substituted if their characteristics are similar.

INTERCONNECTIONS

Pin connectors used to connect the wires to the interconnect pins are factory assembled. They consist of machine-inserted pin connectors mounted in plastic holders. If the connectors are faulty, the entire assembly should be replaced.

Table 6-4
Maintenance Aids

Description	Specification	Usage	Example
Soldering Iron	15 to 25 W.	General soldering and unsoldering.	Antex Precision Model C.
Phillips Screwdriver		Assembly and disassembly.	
Long-nose Pliers		Component removal and replacement.	Diamalloy Model LN55-3.
Diagonal Cutters		Component removal and replacement.	Diamalloy Model M554-3.
Vacuum Solder Extractor	No Static Charge Retention.	Unsoldering static sensitive devices and components on multi-layer boards.	Pace Model PC-10.
Contact Cleaner	No-Noise.®	Switch and pot cleaning.	Tektronix Part Number 006-0442-02.
IC-removal Tool		Removing DIP IC packages.	Augat T114-1.
Isopropyl Alcohol	Reagent grade.	Cleaning.	2-Isopropanol.

TRANSISTORS AND INTEGRATED CIRCUITS

Transistors and integrated circuits should not be replaced unless they are actually defective. If one is removed from its socket or unsoldered from the circuit board during routine maintenance, return it to its original board location. Unnecessary replacement or transposing of semiconductor devices may affect the adjustment of the instrument. When a semiconductor is replaced, check the performance of any circuit that may be affected.

Any replacement component should be of the original type or a direct replacement. Bend component leads to fit their circuit board holes, and cut the leads to the same length as the original component. See Figure 9-2 in the Diagrams section for the semiconductor lead configurations.

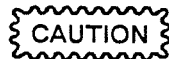

After replacing a power transistor, check that the collector is not shorted to the chassis before applying power to the instrument.

To remove socketed dual-in-line packaged (DIP) integrated circuits, pull slowly and evenly on both ends of the device. Avoid disengaging one end of the integrated circuit from the socket before the other, since this may damage the pins.

To remove a soldered DIP IC when it is going to be replaced, clip all the leads of the device and remove the leads from the circuit board one at a time. If the device must be removed intact for possible reinstallation, do not heat adjacent conductors consecutively. Apply heat to pins at alternate sides and ends of the IC as solder is removed. Allow a moment for the circuit board to cool before proceeding to the next pin.

SOLDERING TECHNIQUES

The reliability and accuracy of this instrument can be maintained only if proper soldering techniques are used to remove or replace parts. General soldering techniques that apply to maintenance of any precision electronic equipment should be used when working on this instrument.

WARNING

To avoid an electrical shock hazard, observe the following precautions before attempting any soldering: turn the instrument off, disconnect it from the ac power source, and wait at least three minutes for line-rectifier filter capacitors to discharge.

Use rosin-core wire solder containing 63% tin and 37% lead. Contact your local Tektronix Field Office or representative to obtain the names of approved solder types.

When soldering on circuit boards or small insulated wires, use only a 15-watt, pencil-type soldering iron. A higher wattage soldering iron may cause etched circuit conductors to separate from the board base material and melt the insulation on small wires. Always keep the soldering iron tip properly tinned to ensure the best heat transfer from the tip to the solder joint. Apply only enough solder to make a firm joint. After soldering, clean the area around the solder connection with an approved flux-removing solvent (such as isopropyl alcohol) and allow it to air dry.

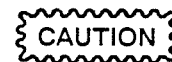

Only a maintenance person experienced in the use of vacuum-type desoldering equipment should attempt repair of any circuit board in this instrument. Many integrated circuits are static sensitive and may be damaged by solder extractors that generate static charges. Perform work involving static-sensitive devices only at a static-free work station while wearing a grounded antistatic wrist strap. Use only an anti-static vacuum-type solder extractor approved by a Tektronix Service Center.

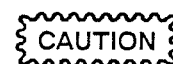

Attempts to unsolder, remove, and resolder leads from the component side of a circuit board may cause damage to the reverse side of the circuit board. The following techniques should be used to replace a component on a circuit board:

1. Touch the vacuum desoldering tool tip to the lead at the solder connection. Never place the tip directly on the board; doing so may damage the board.

NOTE

Some components are difficult to remove from the circuit board due to a bend placed in the component leads during machine insertion. To make removal of machine-inserted components easier, straighten the component leads on the reverse side of the circuit board.

- When removing a multipin component, especially an IC, do not heat adjacent pins consecutively. Apply heat to the pins at alternate sides and ends of the IC as solder is removed. Allow a moment for the circuit board to cool before proceeding to the next pin.



Excessive heat can cause the etched circuit conductors to separate from the circuit board. Never allow the solder extractor tip to remain at one place on the board for more than three seconds. Solder wick, spring-actuated or squeeze-bulb solder suckers, and heat blocks (for desoldering multipin components) must not be used. Damage caused by poor soldering techniques can void the instrument warranty.

- Bend the leads of the replacement component to fit the holes in the circuit board. If the component is replaced while the board is installed in the instrument, cut the leads so they protrude only a small amount through the reverse side of the circuit board. Excess lead length may cause shorting to other conductive parts.
- Insert the leads into the holes of the board so that the replacement component is positioned the same as the original component. Most components should be firmly seated against the circuit board.
- Touch the soldering iron tip to the connection and apply enough solder to make a firm solder joint. Do not move the component while the solder hardens.
- Cut off any excess lead protruding through the circuit board (if not clipped to the correct length in step 3).
- Clean the area around the solder connection with an approved flux-removing solvent. Be careful not to remove any of the printed information from the circuit board.

REMOVAL AND REPLACEMENT INSTRUCTIONS**WARNING**

To avoid electrical shock, disconnect the instrument from the power input source before removing or replacing any component or assembly.

The exploded-view drawings in the Replaceable Parts list may be helpful during removal and replacement of assemblies. Circuit board and component locations are shown in the Diagrams section.

Read these instructions before attempting to remove or install any components.

Cabinet

To remove the cabinet:

- Unplug the power cord from its rear-panel connector.
- Place the instrument upside down on a clean, flat surface.
- Remove the four cabinet-securing screws from the bottom of the instrument. The two rear screws also hold the rear rubber pads (feet) in place. The front screws to be removed are separate from and to the outside of the front pads.
- Carefully turn the instrument right side up, while holding together the top and bottom of the cabinet.
- Remove the top half of the cabinet and the handle.

WARNING

Potentially dangerous voltages exist at several points throughout this instrument. If it is operated with the cabinet removed, do not touch exposed connections or components. Before replacing parts, disconnect the ac-power source from the instrument.

NOTE

Removal of the top half of the cabinet and the handle will access the component side of the Main board and allow adjustment of VR1 and VR2 (see the Adjustment Procedure in section 5).

In addition, most of the checks described in the Troubleshooting part of this section can be done without further disassembly.

To continue to remove the cabinet:

6. Remove one screw near the center of the Main board (between C13 and C1) that attaches the Main board to the bottom of the cabinet.
7. Lift the Main board along with the attached front and rear panels, away from the bottom of the cabinet.

To replace the cabinet, do the reverse of the preceding steps.

Display Board

To remove the Display board:

1. Remove the top of the cabinet.
2. Unplug connectors J1 and J2 from the Main board.
3. Remove three screws, along with their lock washers, that attach the Display board to the front panel.
4. Lift out the Display board.

To replace the Display board, do the reverse of the preceding steps.

Main Board

To remove the Main board:

1. Remove the cabinet and the Display board.
2. Unplug connector J3 from the Main board.
3. Unsolder two wires from the right edge of the Main board (the red wire at 20A and the black wire at COM). Unsolder three wires from the left edge of the

Main board (the black wire and the red wire at FS1 and the red wire at A). Unsolder one wire from the left side near the front (the yellow wire at V-Ω). Clip the plastic wire ties when wires must be separated for board removal.

4. Lift the front and rear panels as a unit away from the Main board.

To replace the Main board, do the reverse of the preceding steps. Use new wire ties to replace those clipped in step 3.

Front Panel Assembly

To remove the Front Panel assembly:

1. Follow the removal steps for the cabinet, Display board, and Main board.
2. Separate the Front panel from the Rear panel as follows:

Remove the two screws and washers securing the Power switch to the Front Panel and remove the screw and washer securing the green ground wire to the Front Panel.

NOTE

The Power switch and the ground wire detached in step 2 are part of the Rear Panel assembly.

To replace the Front Panel assembly, do the reverse of preceding steps.

Rear Panel Assembly

To remove the Rear Panel assembly:

1. Follow the procedure given for Front Panel assembly removal and replacement. Note that the Power switch and ground wire are part of the Rear Panel assembly.

NOTE

When replacing assemblies in the instrument be sure to use new wire ties to replace any clipped during disassembly.

OPTIONS

INTERNATIONAL POWER CORDS

Instruments are shipped with the detachable power cord option ordered by the customer. Descriptive information about international power cord options is given in Section 2. The following list describes the power cords available for this instrument.

Standard	North American, 120 V
Option A1	Universal Euro, 220 V
Option A2	UK, 240 V
Option A3	Australian, 240 V
Option A4	North American, 240 V
Option A5	Switzerland, 220 V

REPLACEABLE PARTS

PARTS ORDERING INFORMATION

Replacement parts are available from or through your local Tektronix, Inc. Field Office or representative.

Changes to Tektronix instruments are sometimes made to accommodate improved components as they become available, and to give you the benefit of the latest circuit improvements developed in our engineering department. It is therefore important, when ordering parts, to include the following information in your order: Part number, instrument type or number, serial number, and modification number if applicable.

If a part you have ordered has been replaced with a new or improved part, your local Tektronix, Inc. Field Office or representative will contact you concerning any change in part number.

Change information, if any, is located at the rear of this manual.

ITEM NAME

In the Parts List, an Item Name is separated from the description by a colon (:). Because of space limitations, an Item Name may sometimes appear as incomplete. For further Item Name identification, the U.S. Federal Cataloging Handbook H6-1 can be utilized where possible.

FIGURE AND INDEX NUMBERS

Items in this section are referenced by figure and index numbers to the illustrations.

INDENTATION SYSTEM

This mechanical parts list is indented to indicate item relationships. Following is an example of the indentation system used in the description column.

```

1 2 3 4 5
Name & Description
Assembly and/or Component
Attaching parts for Assembly and/or Component
    **** END ATTACHING PARTS ****
Detail Part of Assembly and/or Component
Attaching parts for Detail Part
    **** END ATTACHING PARTS ****
Parts of Detail Part
Attaching parts for Parts of Detail Part
    **** END ATTACHING PARTS ****
  
```

Attaching Parts always appear in the same indentation as the item it mounts, while the detail parts are indented to the right. Indented items are part of, and included with, the next higher indentation. The separation symbol - - - - - indicates the end of attaching parts.

ABBREVIATIONS

#	INCH	ELCTRN	ELECTRON	IN	INCH	SE	SINGLE END
ACTR	NUMBER SIZE	ELEC	ELECTRICAL	INCAND	INCANDESCENT	SECT	SECTION
ADPTR	ACTUATOR	ELCTLT	ELECTROLYTIC	INSUL	INSULATOR	SEMICOND	SEMICONDUCTOR
ALIGN	ADAPTER	ELEM	ELEMENT	INTL	INTERNAL	SHLD	SHIELD
AL	ALIGNMENT	EPL	ELECTRICAL PARTS LIST	LPHLDR	LAMPHOLDER	SHLDR	SHOULDERED
ALUM	ALUMINUM	EQPT	EQUIPMENT	MACH	MACHINE	SKT	SOCKET
ASSEM	ASSEMBLED	EXT	EXTERNAL	MECH	MECHANICAL	SL	SLIDE
ASSY	ASSEMBLY	FIL	FILLISTER HEAD	MTG	MOUNTING	SLFLKG	SELF-LOCKING
ATTEN	ATTENUATOR	FLEX	FLEXIBLE	NIP	NIPPLE	SLVG	SLEEVING
AWG	AMERICAN WIRE GAGE	FLH	FLAT HEAD	NON WIRE	NOT WIRE WOUND	SPR	SPRING
BD	BOARD	FLTR	FILTER	OBD	ORDER BY DESCRIPTION	SQ	SQUARE
BRKT	BRACKET	FR	FRAME or FRONT	OD	OUTSIDE DIAMETER	SST	STAINLESS STEEL
BRS	BRASS	FSTNR	FASTENER	OVH	OVAL HEAD	STL	STEEL
BRZ	BRONZE	FT	FOOT	PH BRZ	PHOSPHOR BRONZE	SW	SWITCH
BSHG	BUSHING	FXD	FIXED	PL	PLAIN or PLATE	T	TUBE
CAB	CABINET	GSKT	GASKET	PLSTC	PLASTIC	TERM	TERMINAL
CAP	CAPACITOR	HDL	HANDLE	PN	PART NUMBER	THD	THREAD
CER	CERAMIC	HEX	HEXAGON	PNH	PAN HEAD	THK	THICK
CHAS	CHASSIS	HEX HD	HEXAGONAL HEAD	PWR	POWER	TNSN	TENSION
CKT	CIRCUIT	HEX SOC	HEXAGONAL SOCKET	RCPT	RECEPTACLE	TPG	TAPPING
COMP	COMPOSITION	HLCPS	HELICAL COMPRESSION	RES	RESISTOR	TRH	TRUSS HEAD
CONN	CONNECTOR	HLEXT	HELICAL EXTENSION	RGD	RIGID	V	VOLTAGE
COV	COVER	HV	HIGH VOLTAGE	RLF	RELIEF	VAR	VARIABLE
CPLG	COUPLING	IC	INTEGRATED CIRCUIT	RTNR	RETAINER	W/	WITH
CRT	CATHODE RAY TUBE	ID	INSIDE DIAMETER	SCH	SOCKET HEAD	WSHR	WASHER
DEG	DEGREE	IDENT	IDENTIFICATION	SCOPE	OSCILLOSCOPE	XFMR	TRANSFORMER
DWR	DRAWER	IMPLR	IMPELLER	SCR	SCREW	XSTR	TRANSISTOR

Replaceable Parts - CDM250

CROSS INDEX - MFR. CODE NUMBER TO MANUFACTURER

Mfr. Code	Manufacturer	Address	City, State, Zip Code
	ESCORT	2ND FLOOR NO.37 POA HSIN RD SHIN TIEN	TAI PEI, TAIWAN
80009	TEKTRONIX INC	14150 SW KARL BRAUN DR PO BOX 500	BEAVERTON OR 97707-0001

Fig. & Index No.	Tektronix Part No.	Serial/Assembly No. Effective Dscont	Qty	12345 Name & Description	Mfr. Code	Mfr. Part No.
1-1	118-7928-00		1	CABINET ASSY:	80009	118-7928-00
				.CASE, TOP (QTY. 1)		15-25585-6
				.CASE, BOTTOM (QTY. 1)		15-25585-6A
				.CASE, BOTTOM:W/FOIL SHEILDING (QTY. 1)		11-25005-1
				.HANDLE (QTY. 1)		15-25598-4
				.FEET, FRONT (QTY. 2)		16-25593-5
				.SCREW, PLASTIC (QTY. 2)		15-25047-1
				.SPACER, POST:6-32 HEX, 44.2MM (QTY. 4)		3-25595-1
				.FOOT, BLACK (QTY. 2) (348-1105-00)		16-25593-6

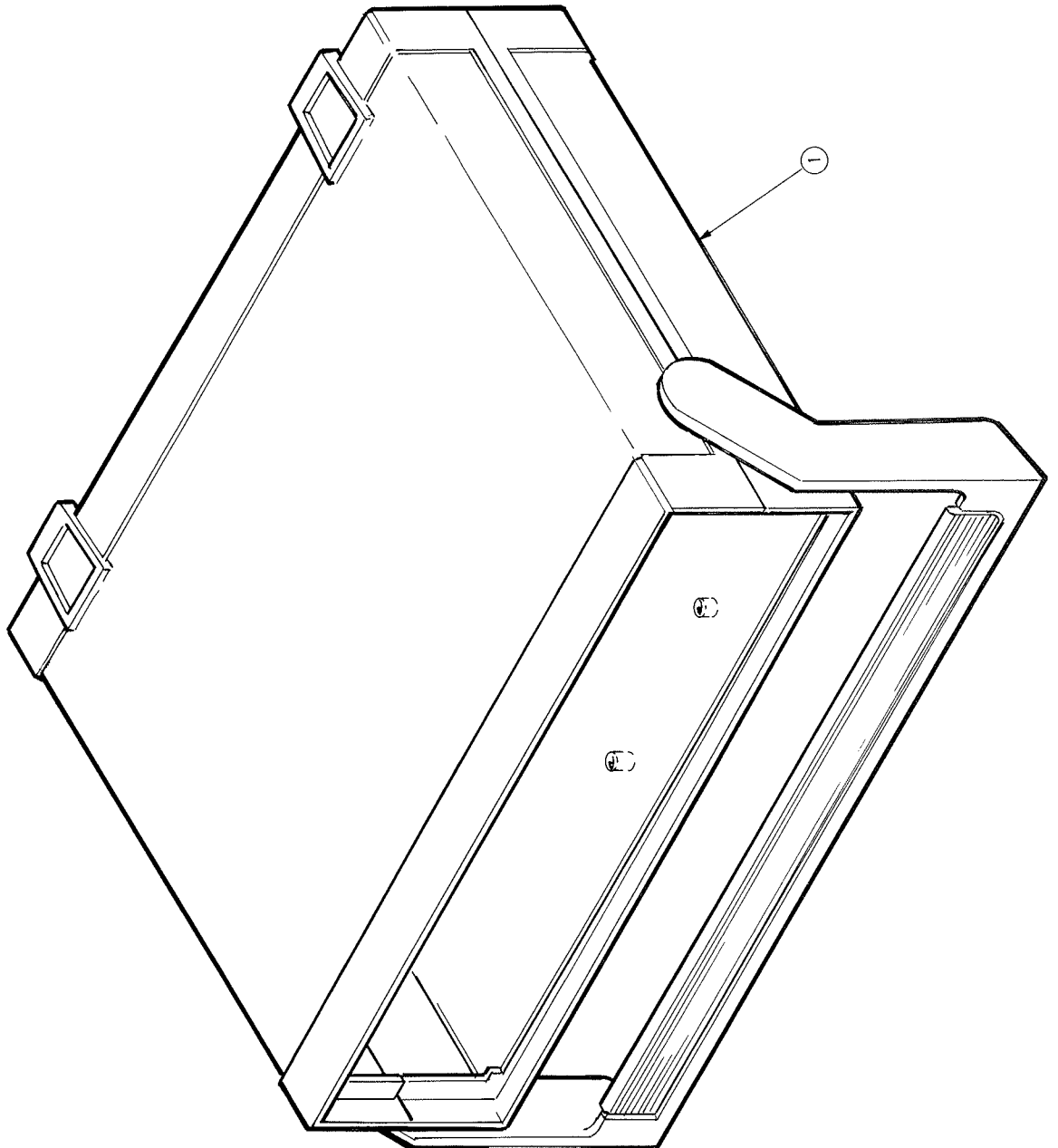

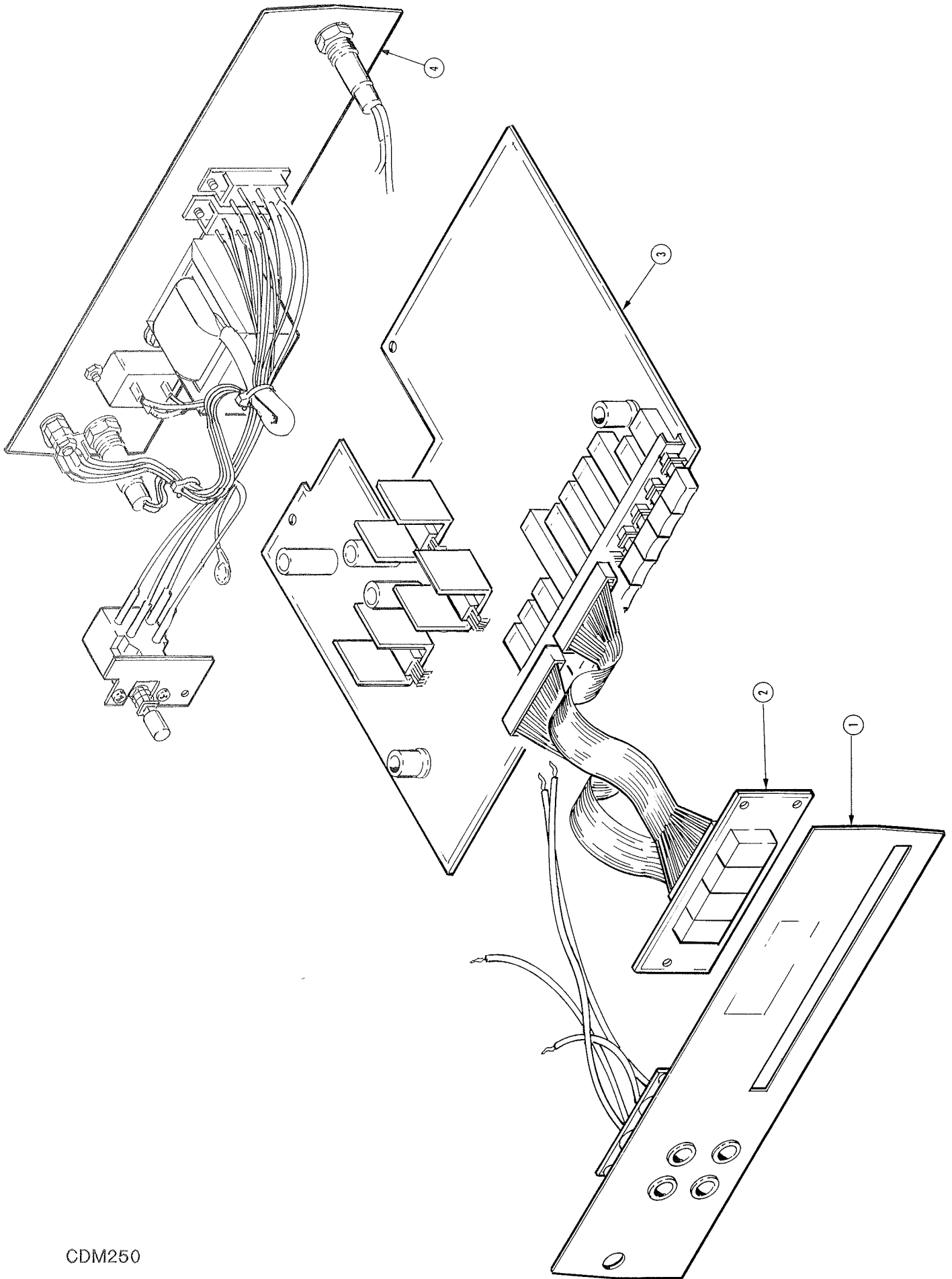

Fig. & Index No.	Tektronix Part No.	Serial/Assembly No. Effective Dscnt	Qty	12345	Name & Description	Mfr. Code	Mfr. Part No.
2-1	118-7929-00		1		FRONT PNL ASSY: .FRONT,PANEL (QTY.1) .CDM250 OVERLAY (QTY. 1) .INPUT TERMINAL CKT BD (QTY. 1) .INPUT SOCKET,RED (QTY. 1) .INPUT SOCKET,WHITE (QTY. 2) .INPUT SOCKET,BLACK (QTY. 1)	80009	118-7929-00 1-25586-2 24-25106-1 25-25564-1A 15-25589-2 15-25589-3 15-25589-4
-2	118-7932-00		1		CIRCUIT BD ASSY:DISPLAY .LED CIRCUIT BD (QTY. 1) .LED DISPLAY:7 SEGMENT (QTY. 3) .LED DISPLAY:+1 (QTY. 1) .WIRE ASSEMBLY:15 POSITION (QTY. 2)	80009	118-7932-00 25-25566-1A 57-25020-10 57-25034-10 30A-25624-15
-3	118-7931-00		1		CIRCUIT BD ASSY:MAIN .CAPACITOR:10UF,+80,-20%,16V (C12,13,15) .CAPACITOR:1000UF,+80,-20%,35V (C10,11,14) .CAPACITOR:0.0033UF,5%,50V (C33) .CAPACITOR:0.01UF,10%,100V (C3) .CAPACITOR:0.1UF,10%,100V (C4,5) .CAPACITOR:0.22UF,10%,100V (C2) .CAPACITOR:0.1UF,10%,250V (C1) .CAPACITOR:0.22UF,20%,16V (C8) .CAPACITOR:1UF,20%,16V (C9) .CAPACITOR:4.7UF,20%,10V (C7) .RESISTOR:100 OHM,5%,1/8W (R39) .RESISTOR,WW:0.09 OHM,1%,2W (R43) .RESISTOR:0.9 OHM,0.5%,1W (R42) .RESISTOR:0.01 OHM,20A (R19) .RESISTOR:9M,0.2% (R11) .RESISTOR:9.1M,5%,1/8W (R6) .RESISTOR:9 OHM,0.5%,1/8W (R18) .RESISTOR:90 OHM,0.5%,1/8W (R17) .RESISTOR:100 OHM,0.5%,1/8W (R33) .RESISTOR:576 OHM,1%,1/8W (R35) .RESISTOR:900 OHM,0.2%,1/8W (R15) .RESISTOR:900 OHM,0.5%,1/8W (R16) .RESISTOR:2.49K,1%,1/8W (R37) .RESISTOR:4.32K,1%,1/8W (R10) .RESISTOR:9K 0.2%,1/8W (R14) .RESISTOR:10K,1%,1/8W (R8) .RESISTOR:13K,1%,1/8W (R36) .RESISTOR:18.2K,1%,1/8W (R34) .RESISTOR:90K,0.2%,1/8W (R13) .RESISTOR:221K,1%,1/8W (R1) .RESISTOR:900K,0.2%,1/8W (R12) .RESISTOR:1M 1%,1/8W (R2) .RESISTOR:470 OHM,5%,1/8W (R40) .RESISTOR:10K,5%,1/8W (R7) .RESISTOR:100K,5%,1/8W (R22,23,38) .RESISTOR:470K,5%,1/8W (R9) .RESISTOR:1M,5%,1/2W (R4,5) .RESISTOR,VAR:200 OHM,20%,200PM (VR1) .RESISTOR,VAR:500 OHM,20%,200PM (VR2) .DIODE:1N4148 (D3,4) .DIODE:1N4004 (D1,2) .DIODE:1N4001 (D5,6,7,8,9,10) .TRANSISTOR:8050C (Q1) .MICROCKT,LINEAR:OPNL AMPL (U2) (NJM062D) .MICROCKT,LINEAR:A/D CONV (U1) (TSC7107CPL) .MICROCKT,LINEAR:VOLT RGTR (Q3) (TSC7107CPL) .MICROCKT,LINEAR:VOLT REG (Q2,4) (HA17805P) .SPARKING GAP:1.5KV (SG1,2) .CRYSTAL:40KHZ,40K OHM (Y1) .POSISTOR:1.5K OHM,20% (PTC1) .FUSE:600V,4A,BBS-4 (FS2) .FUSE CLIP (QTY. 2) .COMBINE SOCKET:15 PIN (J1,2) .IC SOCKET (XU1)	80009	118-7931-00 31-106Z17-2 31-108Z35-2 31-332J50-4 31-103K100-4M 31-104K100-4M 31-224K100-4M 31-104K250-5M 31-224M16-6 31-105M16-6 31-475M10-6 33-101J8T-3 33-R09F2-1DT 33-R9D1-1DT 33-25121-2 33-25162-2 33-915J8T-3 33-9R00D8T-6DT 33-90R0D8T-6DT 33-1000D8T-6DT 33-5760F8T-6DT 33-9000E8T-6DT 33-9000D8T-6DT 33-2491F8T-6DT 33-4321F8T-6DT 33-9001E8T-6DT 33-1002F8T-6DT 33-1302F8T-6DT 33-1822F8T-6DT 33-9002E8T-6DT 33-2213F8T-6DT 33-9003E8T-6DT 33-1004F8T-6DT 33-471J8T-7 33-103J8T-7 33-104J8T-7 33-474J8T-7 33-105J2T-7 34-2011-16I 34-5011-16I 35-25111-1 35-25112-4 35-25112-1 36-25115-3 38-25122-2 40-25422-1 41-25410-N5J 41-25410-P5J 46-25001-15 58-25125-1 59-25121-152 62-25597-2 1-25943-1 15A-25128-15 15A-25129-40
-4	118-7930-00		1		REAR PNL ASSY:	80009	118-7930-00

Replaceable Parts - CDM250

Fig. & Index No.	Tektronix Part No.	Serial/Assembly No. Effective Dscont	Qty	12345	Name & Description	Mfr. Code	Mfr. Part No.
2-					.REAR PANEL (QTY. 1)		1-25054-1
					.FUSE CARRIER (QTY. 1)		62-25604-1
					.FUSE BASE (QTY. 1)		62-25604-3
					.SWITCH,VOLTAGE CONVERSION (QTY. 2)		80-25605-1
					.AC POWER JACK (QTY. 1)		30-25625-1
					.TRANSFORMER (QTY. 1)		63-1923-915
					.SWITCH,POWER (QTY. 1)		80-25604-1
					..HOLDER (QTY. 1)		1-25057-1
					..SCREWS (QTY. 2)		4-11103-0602
					..WASHERS (QTY. 2)		6-12103-03
					.SAFETY GROUND CONNECTION (QTY. 1)		
					..LUG,FOUR LEG (QTY. 1)		1-25071-1
					..LUG,GROUND (QTY. 1)		6-13103-02A
					..SCREW,GOUND (QTY. 1)		4-1113R5-1002
					..NUT,GOUND (QTY. 3)		5-1423R5-02
					..WASHER,FLAT,GROUND (QTY. 1)		6-1113R5-02
					..BUTTON,ROUND,RED (QTY. 1) (134-0210-00)		15-25619-1A

Fig. & Index No.	Tektronix Part No.	Serial/Assembly No. Effective Dscnt	Qty	12345	Name & Description	Mfr. Code	Mfr. Part No.
ACCESSORIES							
	070-6735-00		1		MANUAL, TECH: SERVICE, CDM250	80009	070-6735-00
	070-6736-00		1		MANUAL, TECH: OPERATORS, CDM250	80009	070-6736-00
	159-0308-00		1		FUSE, CARTRIDGE: 4A, 600V	80009	159-0308-00
	159-0313-00 - DOST		1		FUSE, CARTRIDGE: METRIC, 125MA, 250V, SLOW	80009	159-0313-00
	161-0248-00		1		CABLE ASSY, PWR, : 0.002	80009	161-0248-00
	214-4203-00		1		HARDWARE KIT: CDM250	80009	214-4203-00

DIAGRAMS AND CIRCUIT BOARD ILLUSTRATIONS

Symbols

Graphic symbols and class designation letters are based on ANSI Standard Y32.2-1975.

Logic symbology is based on ANSI/IEEE 91-1984. Logic symbols depict the logic function performed and may differ from the manufacturer's data.

The overline on a signal name indicates that the signal performs its intended function when it is in the LO state.

Abbreviations are based on ANSI Y1.1-1972.

Other ANSI standards that are used in the preparation of diagrams by Tektronix, Inc., are:

- Y14.15-1966 Drafting Practices.
- Y14.2M-1979 Line Conventions and Lettering.
- ANSI/IEEE 280-1985 Letter Symbols for Quantities Used in Electrical Science and Electrical Engineering.

American National Standards Institute
1430 Broadway
New York, New York 10018

Component Values

Electrical components shown on the diagrams are in the following units unless noted otherwise:

- Capacitors Values one or greater are in picofarads (pF). Values less than one are in microfarads (μ F).
- Resistors Ohms (Ω).

———— The information and special symbols below may appear in this manual. ————

Assembly Numbers and Grid Coordinates

Each assembly in the instrument is assigned an assembly number (e.g., A20). The assembly number appears on the circuit board outline on the diagram, in the title for the circuit board component location illustration, and in the lookup table for the schematic diagram and corresponding component locator illustration. The Replaceable Electrical Parts list is arranged by assemblies in numerical sequence; the components are listed by component number *(see following illustration for constructing a component number).

The schematic diagram and circuit board component location illustration have grids. A lookup table with the grid coordinates is provided for ease of locating the component. Only the components illustrated on the facing diagram are listed in the lookup table. When more than one schematic diagram is used to illustrate the circuitry on a circuit board, the circuit board illustration may only appear opposite the first diagram on which it was illustrated; the lookup table will list the diagram number of other diagrams that the circuitry of the circuit board appears on.

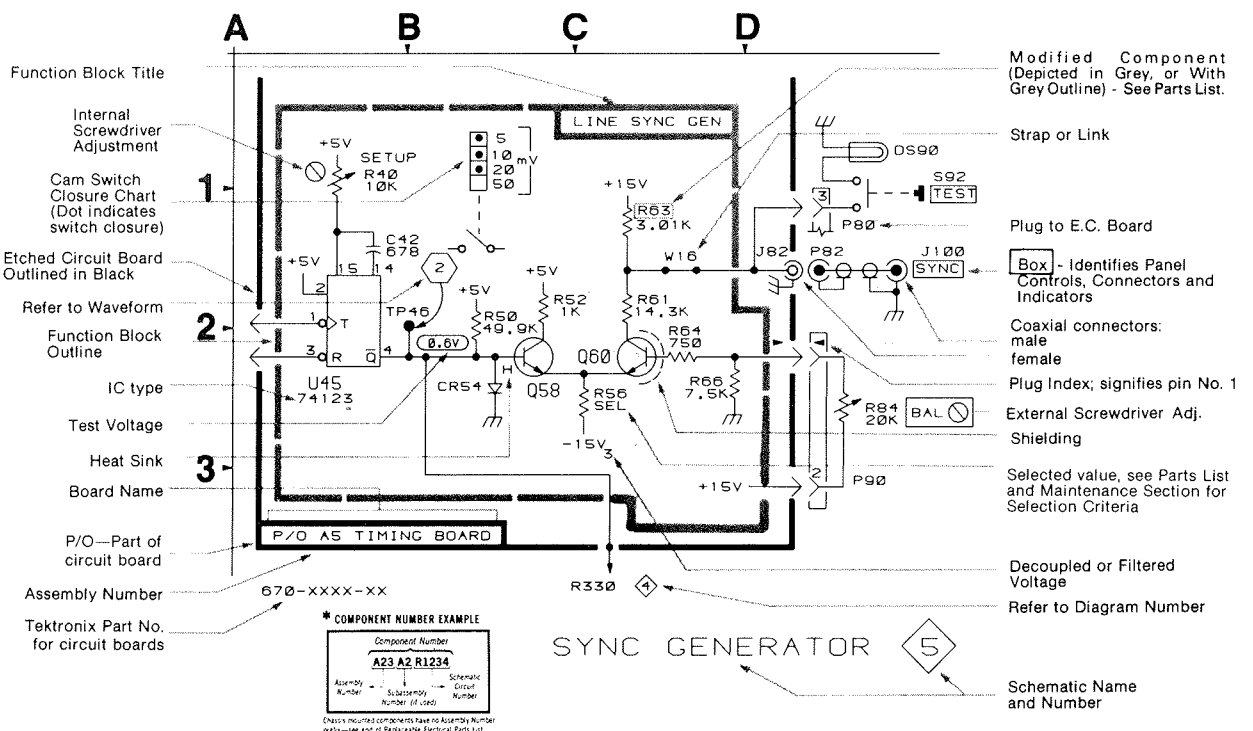

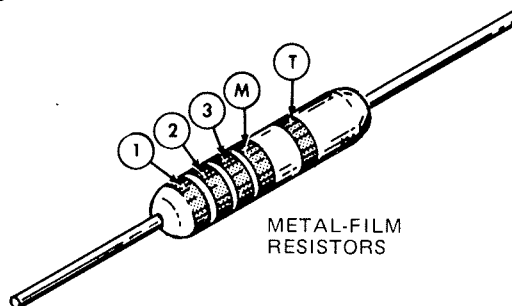
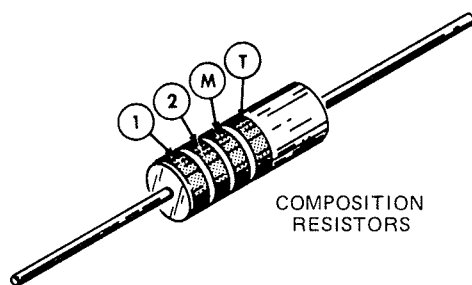

① ② and ③ — 1st, 2nd, and 3rd significant figures
 (M) — multiplier (T) — tolerance

COLOR	SIGNIFICANT FIGURES	RESISTORS	
		MULTIPLIER	TOLERANCE
BLACK	0	1	----
BROWN	1	10	±1%
RED	2	10 ² or 100	±2%
ORANGE	3	10 ³ or 1 K	±3%
YELLOW	4	10 ⁴ or 10 K	±4%
GREEN	5	10 ⁵ or 100 K	±½%
BLUE	6	10 ⁶ or 1 M	±¼%
VIOLET	7	----	±1/10%
GRAY	8	----	----
WHITE	9	----	----
GOLD	--	10 ⁻¹ or 0.1	±5%
SILVER	-	10 ⁻² or 0.01	±10%
NONE	-	----	±20%

(1861-20A)6557-87

Figure 9-1. Color codes for resistors.

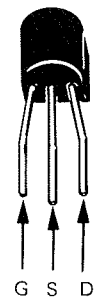
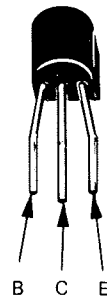
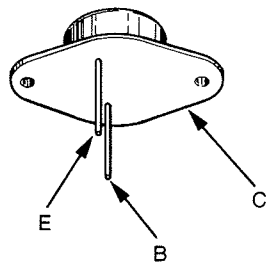
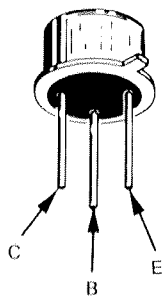

METAL CASE
TRANSISTORS

PLASTIC CASE
TRANSISTORS

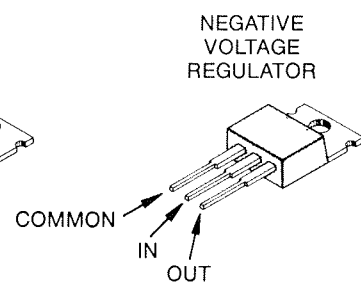
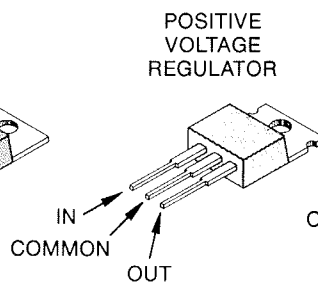
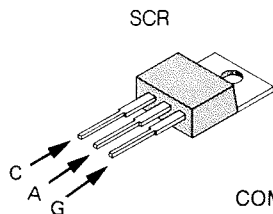
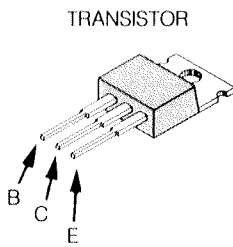

FLAT PACK

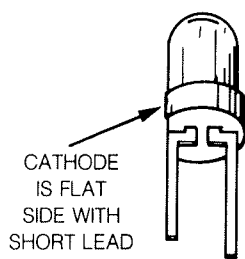

LED

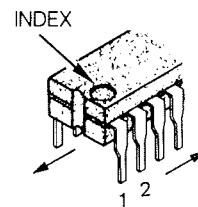

INTEGRATED CIRCUITS

LEAD CONFIGURATIONS AND CASE STYLES ARE TYPICAL, BUT MAY VARY DUE TO VENDOR CHANGES OR INSTRUMENT MODIFICATIONS.

Figure 9-2. Semiconductor lead configurations.

CIRCUIT BOARDS & ADJUSTMENT LOCATIONS

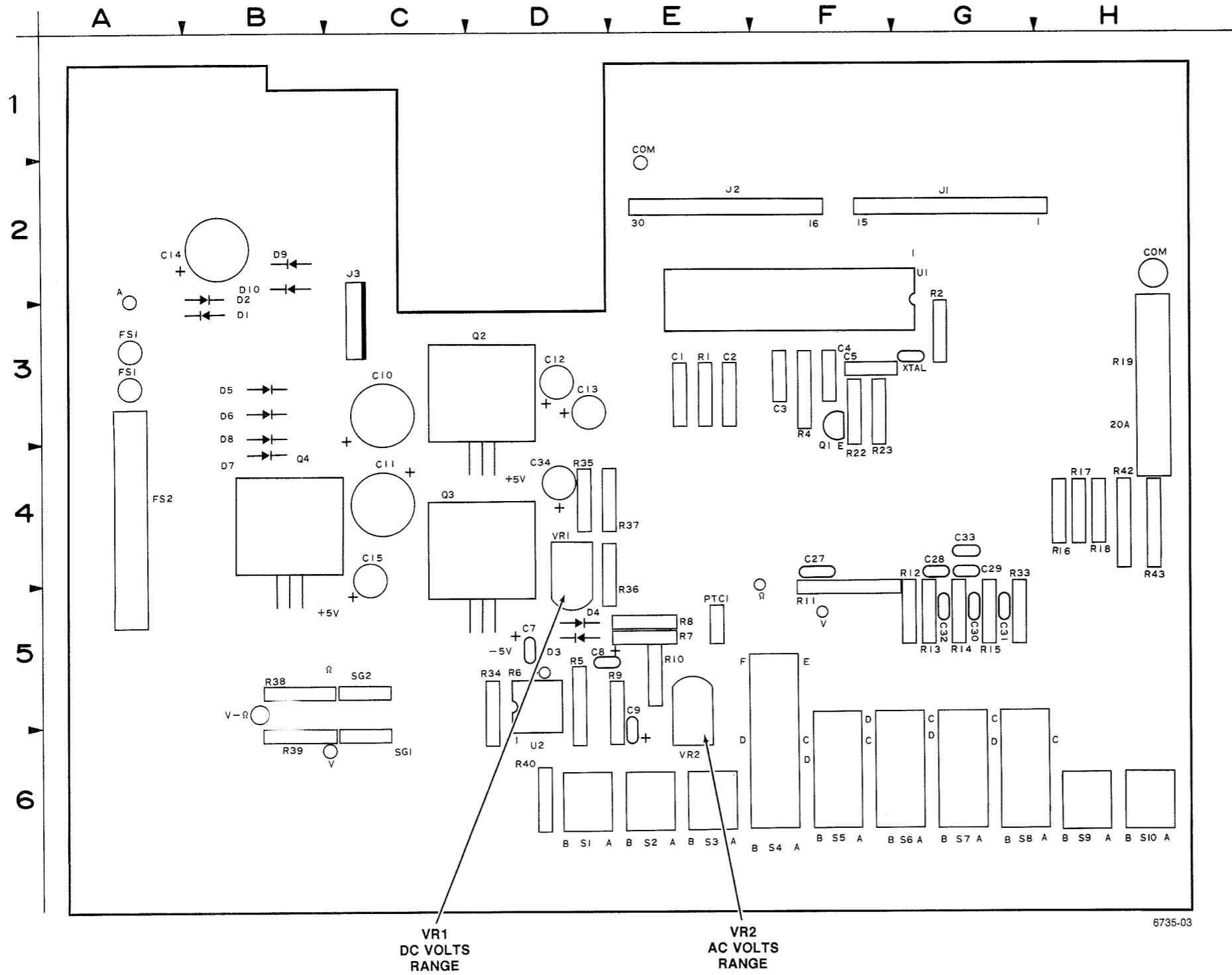
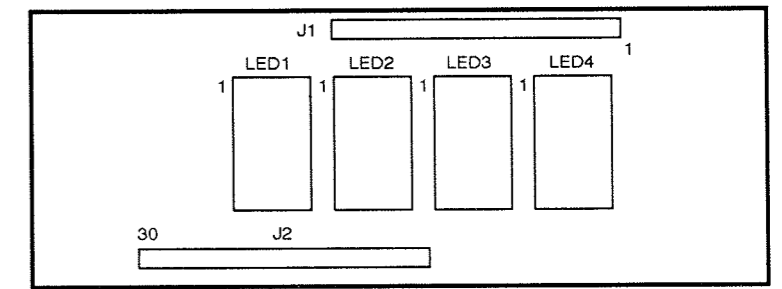

Figure 9-3. Main circuit board and adjustment locations.



6735-04

Figure 9-4. Display circuit board.

CDM250 DIAGRAM

A-1 MAIN BOARD											
CIRCUIT NUMBER	SCHEM LOCATION	BOARD LOCATION	CIRCUIT NUMBER	SCHEM LOCATION	BOARD LOCATION	CIRCUIT NUMBER	SCHEM LOCATION	BOARD LOCATION	CIRCUIT NUMBER	SCHEM LOCATION	BOARD LOCATION
C1	1H	3E	D7	6D	4B	R22	4G	3F	S4F	1G	6F
C10	6E	3C	D8	6D	3B	R23	3G	3F	S5A	5H	6F
C11	6E	4C	D9	7D	2B	R33	3C	5G	S5B	3F	6F
C12	6F	3D				R34	2E	5D	S5C	3B	6F
C13	7F	3D	FS2	5B	4A	R35	3E	4D	S5D	2D	6F
C14	7E	2B				R36	3E	4E	S6A	4C	6G
C15	7F	4C	J1	3J	2G	R37	3E	4E	S6B	5H	6G
C2	1H	3E	J2	1J	2E	R38	1A	5B	S6C	3B	6G
C27	2C	4F	J3	6D	3C	R39	1A	6B	S6D	2D	6G
C29	2C	4G				R4	2G	3F	S7A	4C	6G
C3	2H	3F	PTC1	3B	5E	R40	5H	6D	S7A	5H	6G
C30	3C	5G				R42	5D	4H	S7B	3B	6G
C31	3C	5G	Q1	4G	3F	R43	5D	4H	S7D	2D	6G
C32	2C	5G	Q2	6E	3D	R5	2E	5D	S8A	5J	6G
C33	3C	4G	Q3	6E	4D	R6	1E	5D	S8B	2B	6G
C34	6F	4D	Q4	7E	4B	R7	1F	5E	S8C	5C	6G
C4	2H	3F				R8	1F	5E	S8D	3D	6G
C5	4H	3F	R1	1H	3E	R9	2F	5E	S9A	5C	6H
C7	2F	5D	R10	1E	5E				S9B	2B	6H
C8	1E	5D	R11	2C	5F	S10A	3D	6H	SG1	2B	6C
C9	2F	6E	R12	2C	5G	S10B	5J	6H	SG2	1B	5C
			R13	2C	5G	S1A	2G	6D			
D1	5B	3B	R14	3C	5G	S1B	2E	6D	U1	2H	2F
D10	7D	2B	R15	3C	5G	S2D	2D	6E	U2	2E	5D
D2	5B	2B	R16	4D	4H	S4A	4C	6F			
D3	1F	5D	R17	4D	4H	S4B	3F	6F	VR1	2E	4D
D4	2F	5D	R18	4D	4H	S4C	2G	6F	VR2	1E	5E
D5	6D	3B	R19	5D	3H	S4D	4F	6F			
D6	6D	3B	R2	3H	3G	S4E	2B	6F	XTAL	3H	3G
OTHER PARTS											
CIRCUIT NUMBER	SCHEM LOCATION	BOARD LOCATION	CIRCUIT NUMBER	SCHEM LOCATION	BOARD LOCATION	CIRCUIT NUMBER	SCHEM LOCATION	BOARD LOCATION	CIRCUIT NUMBER	SCHEM LOCATION	BOARD LOCATION
FS1	5A	CHASSIS	S11A	6B	CHASSIS	S12A	7C	CHASSIS	S13A	7C	CHASSIS
FS3	6B	CHASSIS	S11B	7B	CHASSIS	S12B	6C	CHASSIS			

A B C D E F G H J K

1
2
3
4
5
6
7

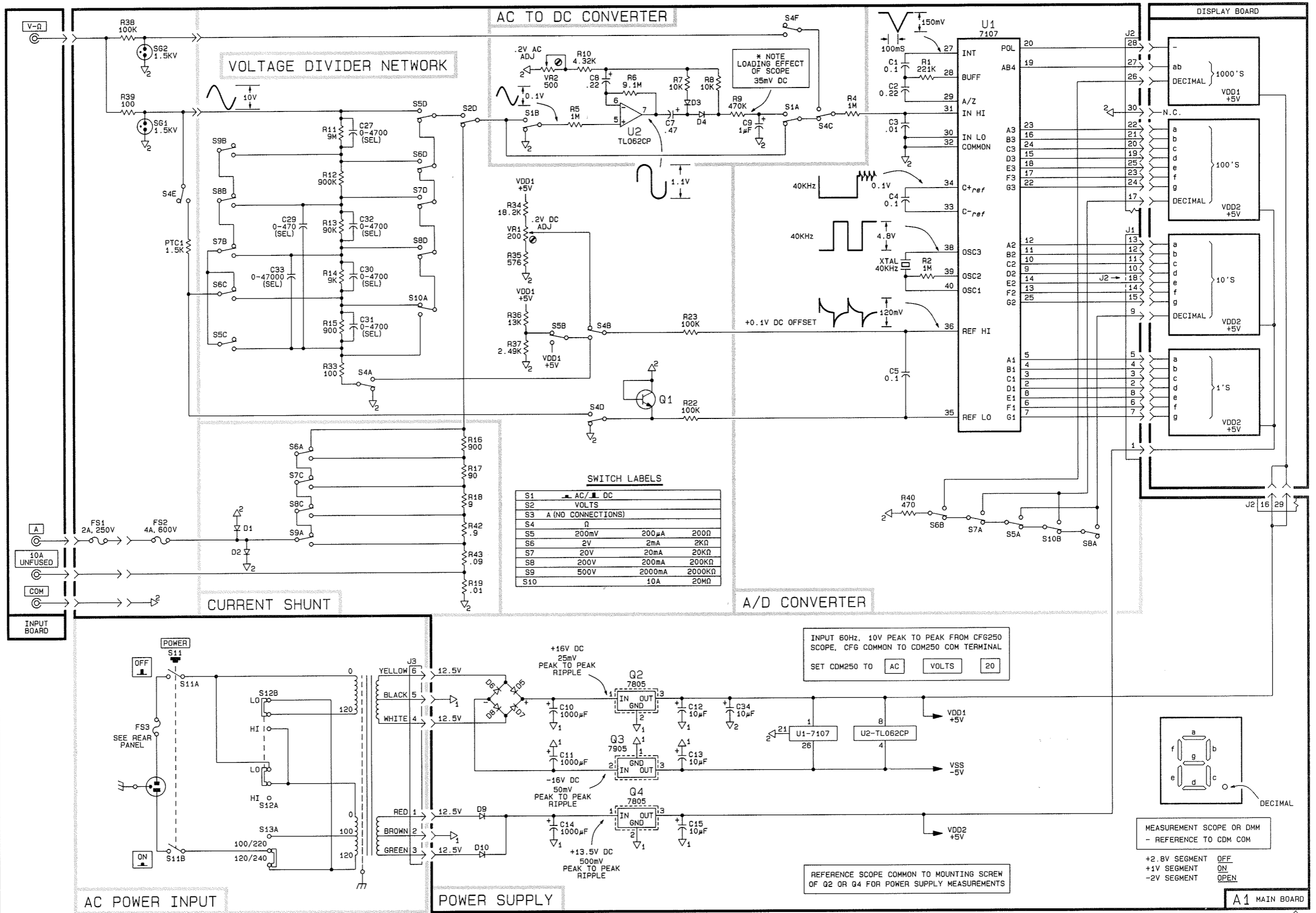

SWITCH LABELS

S1	AC/DC
S2	VOLTS
S3	A (NO CONNECTIONS)
S4	Ω
S5	200mV 200μA 200Ω
S6	2V 2mA 2KΩ
S7	20V 20mA 20KΩ
S8	200V 200mA 200KΩ
S9	500V 2000mA 2000KΩ
S10	10A 20MΩ

INPUT 60Hz, 10V PEAK TO PEAK FROM CFG250 SCOPE, CFG COMMON TO CDM250 COM TERMINAL
 SET CDM250 TO AC VOLTS 20

REFERENCE SCOPE COMMON TO MOUNTING SCREW OF Q2 OR Q4 FOR POWER SUPPLY MEASUREMENTS

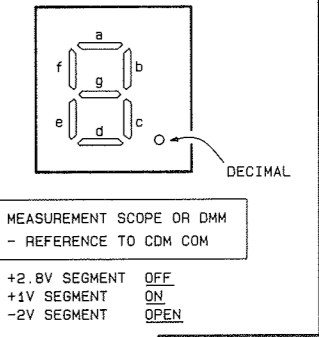

AC POWER INPUT
 CDM250 DIGITAL MULTIMETER