

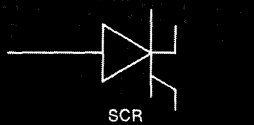

Measurement Concepts

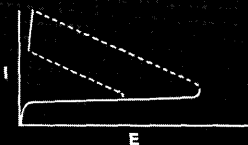
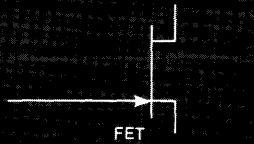
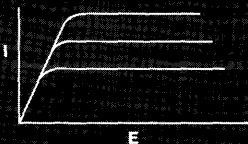
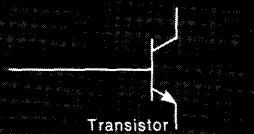
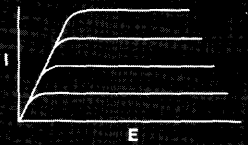
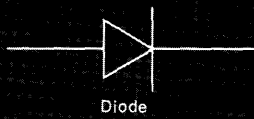
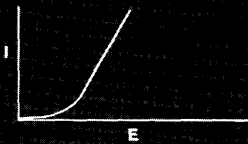
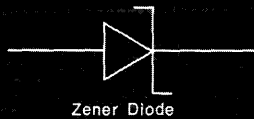
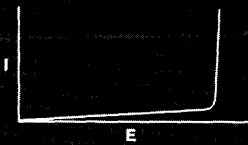
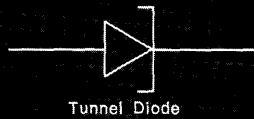
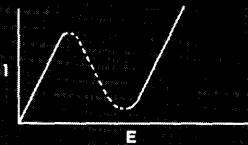

SEMICONDUCTOR DEVICE MEASUREMENTS

BY
JOHN MULVEY

Significant Contributions

by
JOHN TOMLIN
LEE MILES
ED SMITH



MEASUREMENT CONCEPTS

FIRST EDITION, SECOND PRINTING, APRIL 1969
062-1009-00
PRICE \$1.00

© TEKTRONIX, INC.; 1968
BEAVERTON, OREGON 97005
ALL RIGHTS RESERVED

CONTENTS

PREFACE

1	BIPOLAR TRANSISTORS	1
	FORWARD CURRENT TRANSFER	1
	h_{FE} , $h_{FE(INV)}$, h_{fe} , h_{fb} , h_{fc}	
	SATURATION VOLTAGE AND CURRENT	24
	$V_{CE(sat)}$, $I_{CE(sat)}$	
	CUTOFF CURRENT AND VOLTAGE BREAKDOWN	28
	I_{CBO} and $V_{(BR)CBO}$, I_{EBO} and $V_{(BR)EBO}$, I_{CEO} and $V_{(BR)CEO}$, I_{CES} and $V_{(BR)CES}$, I_{CER} and $V_{(BR)CER}$, I_{CEV} and $V_{(BR)CEV}$, I_{CEX} and $V_{(BR)CEX}$, collector sustaining voltage, avalanche breakdown, punch through and reach through	
	SWITCHING TIME	43
	turn-on and turn-off time, delay time, risetime, carrier storage time, fall time	
	INPUT CAPACITANCE	53
	C_{ies} , C_{ibs} , C_{ieo} , C_{ibo}	
	OUTPUT CAPACITANCE	54
	C_{oes} , C_{obs} , C_{oeo} , C_{obo}	
	HIGH-FREQUENCY CURRENT GAIN	54
	f_{hfe} , f_T , f_{hfb}	
	INPUT IMPEDANCE	56
	h_{IE} and h_{ie} , h_{IB} and h_{ib} h_{IC} and h_{ic} , emitter followers	
	OUTPUT ADMITTANCE	62
	h_{oe} , h_{ob} , h_{oc}	
	REVERSE VOLTAGE TRANSFER	67
	h_{re} , h_{rb} , h_{rc}	

continued...

2	FIELD EFFECT TRANSISTORS	71
	LEAKAGE AND BREAKDOWN	71
	I_{GSS} and $V_{(BR)GSS}$	
	drain breakdown	
	FORWARD TRANSFER	79
	I_{DSS} , V_P or $V_{DS(off)}$, G_m	
3	UNIUNCTION TRANSISTORS	89
4	THYRISTORS (SCR's) AND OTHER PNP DEVICES	93
	FORWARD AND REVERSE BLOCKING VOLTAGE	93
5	SIGNAL DIODES AND RECTIFYING DIODES	99
	FORWARD VOLTAGE AND CURRENT	99
	REVERSE VOLTAGE AND CURRENT	105
	REVERSE RECOVERY TIME	106
	STORED CHARGE	116
	RECTIFICATION EFFICIENCY	117
	JUNCTION CAPACITANCE	117
	FORWARD RECOVERY TIME	117
6	ZENER DIODES	119
	V_Z	119
	Z_{ZK}	123
	Z_{ZT}	123
7	TUNNEL DIODES AND BACK DIODES	125
	PEAK-POINT CURRENT AND VOLTAGE	133
	VALLEY-POINT CURRENT AND VOLTAGE	133
	DIFFERENTIAL RESISTANCE	133
	NEGATIVE RESISTANCE	134
	DEFINITIONS OF TERMS	135
	DEFINITIONS OF SYMBOLS	147
	INDEX	155

PREFACE

The concepts for the measurement of semiconductor characteristics that are covered in this book are embodied by instruments and methods widely used today. The purpose of the book is not to expose new ideas, although we certainly hope some will be new to the average reader. Instead, its purpose is to corral what we believe to be many of the better ideas already in use, and discuss them, particularly ideas that involve the use of Tektronix instruments.

The reasons for measuring the characteristics of semiconductor devices fall into about four categories. Either the measurement is for the purpose of producing better components, sorting components, predicting performance in a circuit, or improving a circuit. The characteristics of semiconductor devices that are of practical importance to their use in an electrical circuit can usually be measured with an electrical instrument. Many of those measurements also provide good analytical information for people improving component design or maintaining production quality and specifications.

Much of the discussion relates to measurements actually performed, using specific semiconductor types and instrument types. These will exemplify a variety of measurement considerations and concepts. Only measurements on discrete semiconductor components are discussed. Integrated circuits are not covered.

We hope the book may help engineers and technicians make more meaningful and accurate tests and measurements of the characteristics of diodes, transistors, and other semiconductor devices.

1

BIPOLAR TRANSISTORS

Bipolar transistors are those transistors which normally use current carriers of both polarities. The category consists mainly of the familiar three-terminal two-junction, NPN or PNP types made of either germanium or silicon.

FORWARD CURRENT TRANSFER

h_{FE} -- *Static Forward Current Transfer Ratio*
(Common Emitter)

h_{FE} ,
DC beta
DC current
gain

The static forward current transfer ratio, h_{FE} , of a transistor, otherwise known as DC beta or DC current gain is simply the ratio of its collector current to its base current, assuming, of course, that the polarity and magnitude of the applied currents and voltages are within what could be called a correct, normal operating range for the transistor. The current gain of any particular transistor is apt to vary considerably, depending on where within its normal operating range the transistor is operating. Therefore, to be more specific when we refer to the static forward-current transfer ratio of a transistor, we should say what the collector voltage is supposed to be, and what either the base current or collector current is supposed to be. Usually the collector current is specified, so the base current must be varied until the specified collector current flows. Sometimes the base current may be specified. In that case the resultant collector current is then measured.

collector
current
or base
current
specified

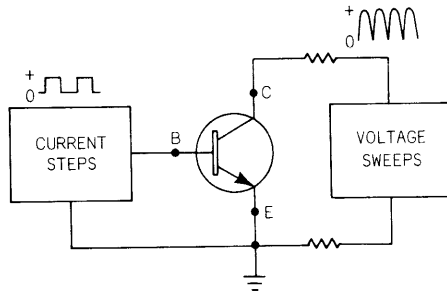
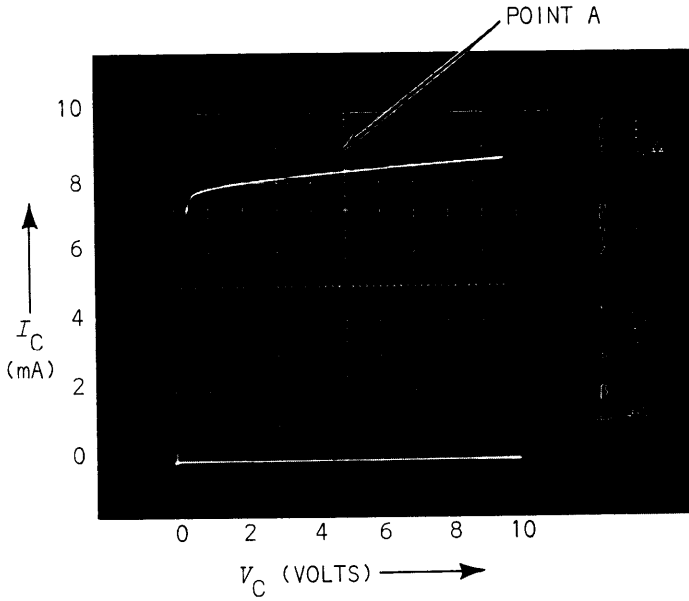

Fig. 1-1. h_{FE} , 2N3904 50- μ A base-current step.

power
dissipation
may limit
measurements

The measurement of base current, collector current, and collector voltage may be done with DC meters to determine DC beta. This method soon runs into a problem when the power dissipated is enough to dominate the temperature of the transistor. It may even cause the transistor to be burned out before the test is completed. It is fundamental that any test or measurement performed on a semiconductor should not alter its characteristics. Care should always be taken to avoid applying excessive currents or voltages, or both, or the characteristics may be altered. Interrupting the applied currents and voltages frequently may be required to keep the internal temperature down, close to that of the desired surrounding temperature.

continually-
pulsed mode
for DC beta

A continually-pulsed mode of measuring DC beta suggests itself for conditions that might otherwise limit the accuracy of the results due to a change in temperature. For determining DC beta under a wide variety of operating conditions few methods can do better than plotting one or more curves to show the entire forward transfer characteristics for the particular transistor being used in the measurement. Transistor curve tracers do that rapidly.

DC beta
at any
point

Fig. 1-1 shows the collector current which flows as the collector voltage of a transistor is swept between zero volts and ten volts by a fullwave rectified sinewave after a specific base current of 50 μA has been applied. The DC beta can be determined for any point on the curve by reading the collector current at that point from the calibrated vertical scale, then dividing that current by the base current selected. An alternate way is to first determine what the beta per division is for the vertical scale, and read DC beta directly from the scale. For example, the beta per division in Fig. 1-1 is 20, the quotient of 1 mA (collector current per division) and 50 μA (the base current per step).

If the purpose in measuring the DC beta of the transistor shown in Fig. 1-1 was to see whether it exceeded 180 when the collector voltage was 5 volts and the base current was 50 μA , the measurement would consist simply of observing whether the curve was above or below Point A, the ninth division at the center vertical graticule line,

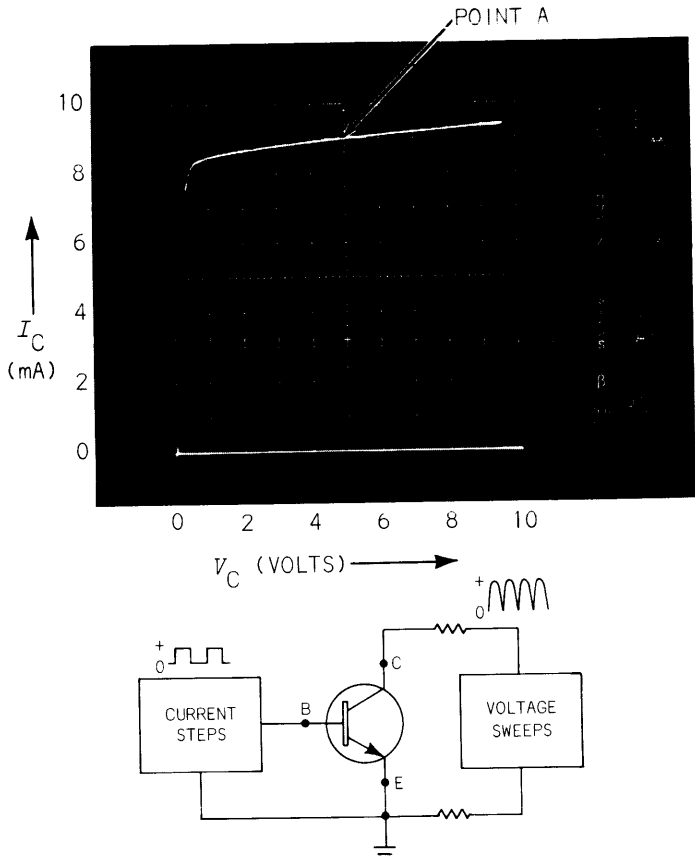

Fig. 1-2. h_{FE} , 2N3904 53- μ A base-current step (50 μ A plus 3 μ A of offset).

go, no-go
testing

because the ninth division corresponds to a beta of 180, and that line corresponds to 5 volts. Such a measurement may also be considered a test; a quantitative test. Rapid go, no-go testing may be performed without ever making a reading from the scale or recording a number.

Fig. 1-2 shows the same transistor passing a collector current of precisely 9 mA at 5 volts, slightly more than in Fig. 1-1. This collector current was achieved by increasing the base current slightly. To determine the DC beta under this set of conditions the collector current should be divided by the base current as before. The only difference is that DC beta would now be determined at a specific collector current rather than at a specific base current.

avoid
heat
influence;
shorten
duty
factor

Measuring DC beta at high currents or high collector voltages in the foregoing way may increase the temperature enough to influence the validity of the measurement. The temperature may be considerably reduced by reducing the percentage of time the transistor is turned on. This may be achieved in a couple of ways. One way is to plot a single-shot curve (single family). A push button or lever switch may be provided for this purpose, and applies base current for only one half of one complete alternation of the power line per curve, 8.3 ms or 10 ms depending on whether the power line frequency is 60 Hz or 50 Hz. Base current drive is removed except momentarily when the pushbutton is depressed. See Fig. 1-3.

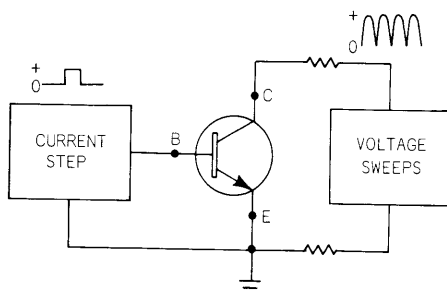
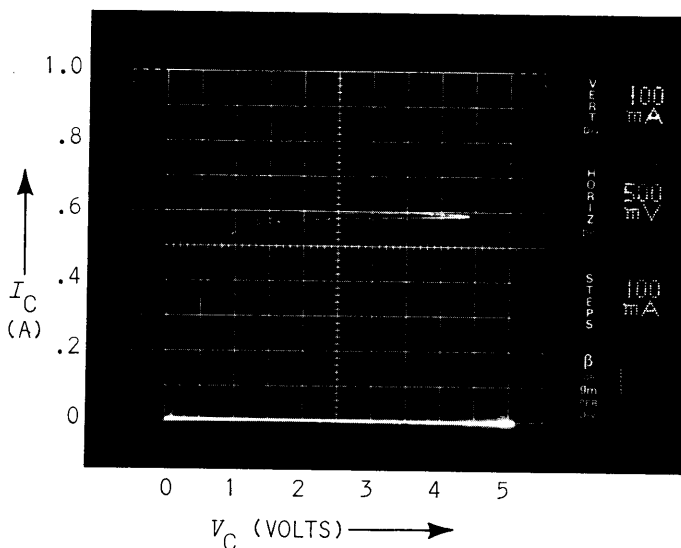

Fig. 1-3. h_{FE} , 2N3904 single-shot curve.
 $h_{FE} = 5.8$, when $V_C = 2.5$ volts.

very short
duty factor

Applying enough base current to induce a high collector current to flow for 1/120th of a second is sometimes long enough to burn out a small transistor, particularly when collector voltage is also high. To determine current gain for exceptionally high collector voltages or collector currents requires turning the transistor on for even shorter intervals of time. Fortunately this can usually be done repetitively at a very low duty factor, so that the average dissipation is low. Pulses of specific amounts of base current may be introduced for intervals as low as 80 μ s at a repetition rate as low as 50 or 60 Hz on the Type 576 Tektronix Curve Tracer.

See Fig. 1-4. Peak power delivered under these conditions is more than 200 times greater than the average power.

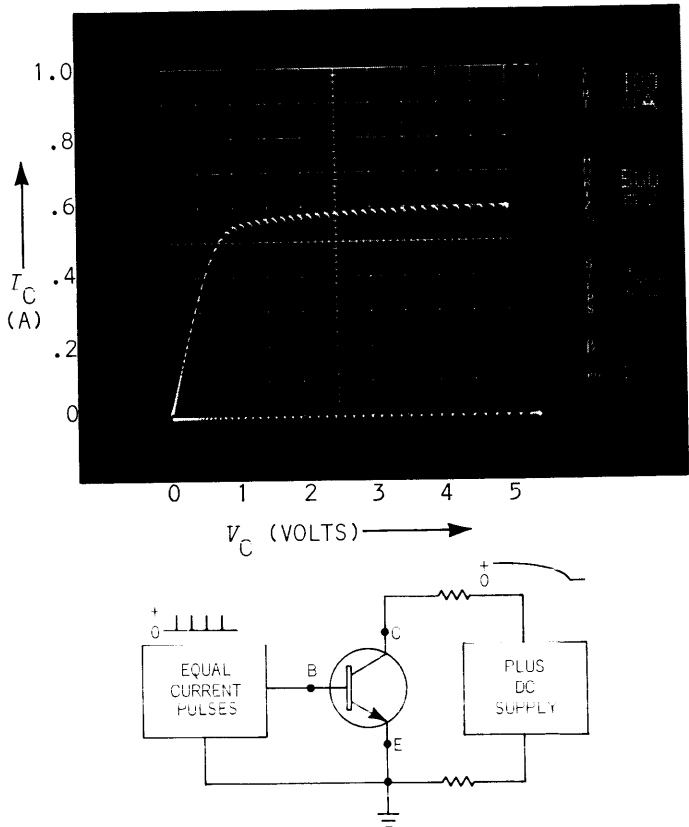

Fig. 1-4. h_{FE} , 2N3904 repetitively pulsed while manually scanned once.

pulsing
the base
current

When this method is used the base current may be pulsed at moments when the swept collector voltage is near its peak value. Or a DC voltage, which may be manually varied, may be applied to the collector. Either way the transistor conducts only a small percentage of the time, at moments when base current pulses are applied. The collector voltage may be set to plot DC beta at a particular collector voltage, or it may be manually varied to simulate a curve. Fig. 1-4 is a time exposure showing the whole range of collector voltages below 5 volts as the collector voltage supply is varied with the peak-collector-volts knob.

learn
heat
effect
before
measuring

Sometimes the main problem with dissipating heat when measuring the characteristics of a transistor is knowing that you have a problem! Usually with a transistor curve tracer you may determine when heat dissipation becomes significant by simulating the measurements at lower currents and voltages, and increasing drive until the effects of heat become apparent. This procedure may require operating the transistor at higher collector voltages or with greater collector current than the test or measurement calls for before the effects are noticed. When it does, of course, the conditions for the desired measurement do not involve a significant heat effect. Reasonable care should be taken to not exceed collector breakdown voltage, or to use a resistor in series with the collector supply that has a high enough value to limit collector current to a safe value if breakdown is exceeded. Should the effects of excessive heat become apparent when even less power is dissipated than required for the measurement, the method of making the measurement will usually need to be changed.

temperature
rises until
heat out =
heat in

Whenever peak collector voltage is high, more heat is produced. How rapidly heat may be dissipated from a transistor will depend on the transistor construction and what method, if any, is used to transfer the heat away. The first hurdle in getting heat out of a transistor is transferring the heat developed in the semiconductor material to the case of the transistor. Temperature will build up rapidly in a transistor whenever a larger amount of heat is generated than can escape rapidly. Temperature invariably increases until the heat escapes at the same rate it is being generated!

overheat
symptoms

Knowing how to recognize symptoms of excessive heat is important. Probably the best procedure to follow is to increase the collector sweep voltage slowly while observing the resulting curves. If at any time while increasing the maximum collector voltage, any curve is not simply an extension of the curve depicted with less peak collector voltage applied, there is probably excessive heat. Usually when an increase in temperature becomes significant, the curve will shift toward a different set of collector-current values. This can be observed quite readily while varying the peak collector voltage slowly. See Fig. 1-5. This photograph is a double exposure showing a repetitively swept peak collector voltage of 2.5 volts for the top curve and 5 volts for the lower curve. Notice also the prominent loop in the longer curve. This loop indicates a significant change in junction temperature *during* the time of each

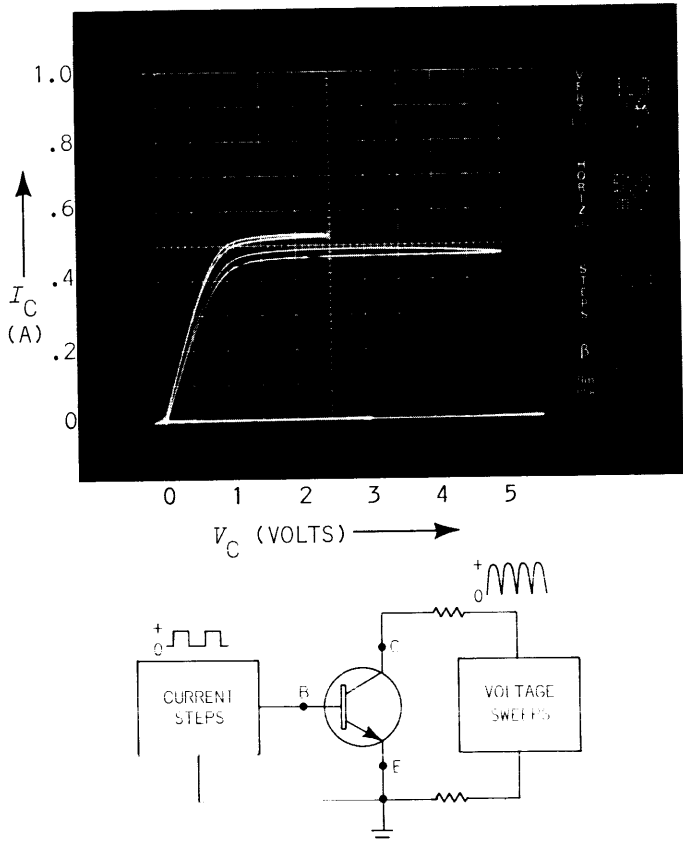

Fig. 1-5. h_{FE} , 2N3904 effects of temperature.

sweep. It is apparent in Fig. 1-3 also, even though the average temperature of the transistor is much less in Fig. 1-3 than in Fig. 1-5.

Fig. 1-6 shows the same transistor being tested as shown in Fig. 1-5, except less heat is being generated. Reduced base current drive, and consequently reduced collector current, account for reduced heat. Also peak collector voltage was reduced from 2.5 volts to 1 volt. Notice how the longer curve is close to being a simple extension of the shorter curve, compared to Fig. 1-5.

When it is necessary to measure the DC beta of a transistor under conditions where temperature is affecting the measurement, there are only two approaches to the problem -- either reduce the energy input to the transistor, or get rid of the heat faster. Both may sometimes be necessary.

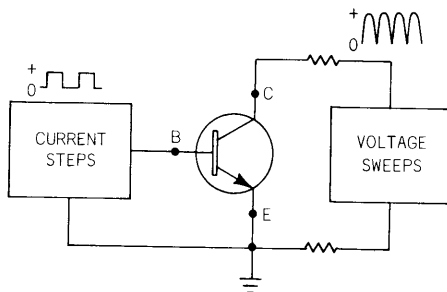
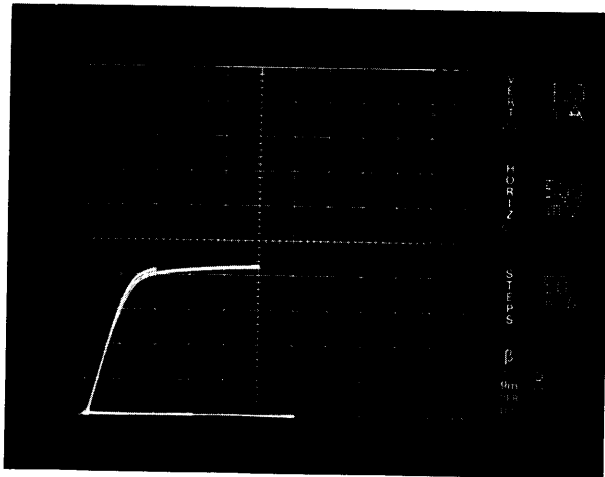

Fig. 1-6. h_{FE} , 2N3904 effects of reduced temperature.

The first thing that may normally be done to reduce the heat generated under test conditions used for Fig. 1-5 and Fig. 1-6 is to reduce the repetition rate of the base current step generator from 50 or 60 Hz to a one-shot basis. This way, only once each time a pushbutton or lever switch is activated, is the selected base current applied. The base current pulse would be applied for only half of the period of one cycle of the line frequency -- usually 8.3 ms or 10 ms. Large power transistors do not normally change temperature appreciably in 10 ms, so one-shot testing of them is generally a satisfactory method. Low-power, low-mass transistors may change temperature significantly during 10 ms. When this happens the curve will consist of a loop instead of a single trace. See Fig. 1-3 and 1-7 for a comparison of two transistors rated for different power. Both are

T rise
fast with
low mass

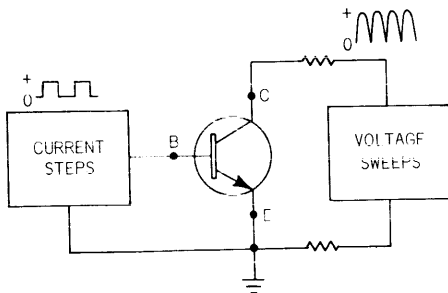
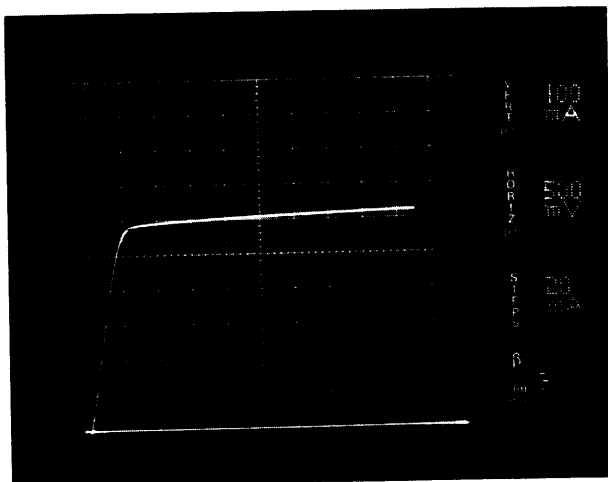

Fig. 1-7. h_{FE} , 2N3441 reduced temperature change for power transistor at comparable peak power.

temperature hysteresis

dissipating about the same peak power. Notice the distinct loop for Fig. 1-3. The loop is caused by junction temperature rising as collector voltage rises towards a peak value. As the collector sweep voltage drops back down from its peak value, the transistor is hotter than while the collector voltage was rising. The retrace does not coincide with the forward trace because less collector current passes when the transistor is hotter -- all other conditions being equal. The case of a transistor does not have to be warm to the touch for the internal semiconductor material to momentarily reach a high temperature. Poor thermal bonds may be detected this way by comparison with a similar transistor that has a good thermal bond.

it's hotter than you think

To measure DC beta of low power transistors where very high peak power is generated, we must reduce the time intervals during which the transistor is conducting to much less than 10 ms. Fig. 1-4 shows a plot of the DC beta of the same transistor as used in Fig. 1-3. The photograph is a time exposure produced by slowly reducing the collector voltage to zero while equal value base current pulses 300 μ s wide are applied.

Some curve tracers will not display as few as two curves at a time for a transistor, the way the curves have been illustrated. These illustrations show a principal curve depicting a range of collector currents at a selected base current and an incidental curve showing the collector current resulting from zero base current. The Tektronix Type 575 Curve Tracer shows a minimum of five curves, under similar conditions, one depicting collector current for zero base current, plus four others depicting collector current for discrete amounts of base current. To measure DC beta with displays of this kind you need only to ignore all curves but the one corresponding to the base current of interest. The base current of interest corresponding to any one of the curves is determined by multiplying the selected base current per step (amount of current increase per step) times the number of steps required to produce that curve. For example, if we were interested in the fifth curve (fourth above the zero base current curve), and the base current increase per step was 20 mA, we would mentally multiply 4 x 20 to determine that 80 mA of base current was applied when that curve

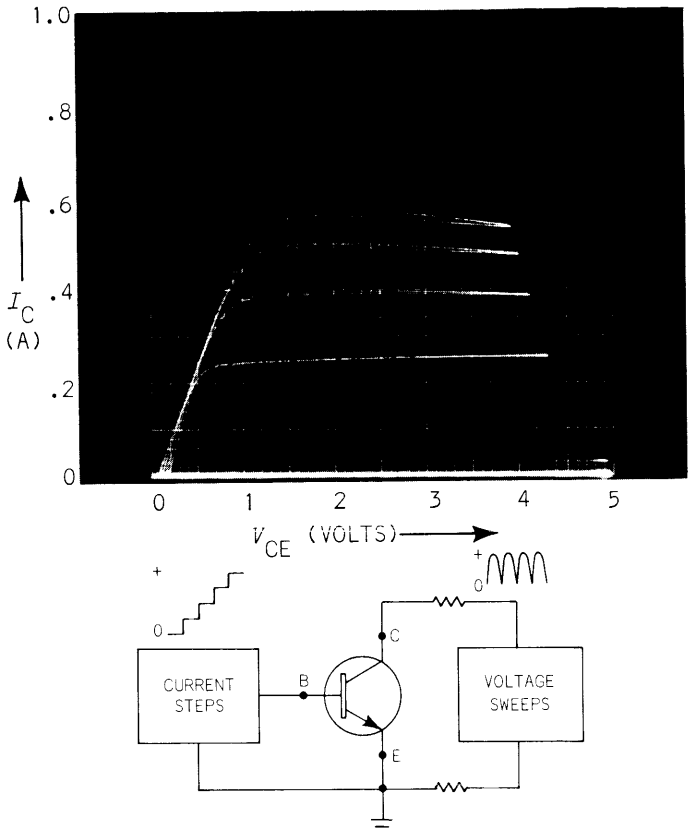

Fig. 1-8. β_{FE} , MPS918 DC beta from a family of curves. Four steps at 20mA per step. High temperature may reduce collector current.

was produced. See Fig. 1-8. The curve corresponding to zero base current is usually a straight line and sometimes not considered a curve. The number of steps from zero is the correct number to multiply by the current per step. The reduction in beta due to increased temperature is apparent because of the negative slope of the top curve.

When more than one curve is displayed other than the zero-current curve, we say a family of curves is displayed. If a set of curves is displayed only once, we say it is a single family display. Sometimes a single family must be displayed to look at a particular curve.

single-
family
procedure

To limit temperature rise as much as possible with a single family display, the curves in the family should be as few as possible, and the curve of interest should be the one depicting the highest current. If the top curve cannot be selected to represent the desired base current, then a curve which can be made to represent the desired base current should be selected, and it should be as close to the top as possible.

static may
not mean
static

Some people will sense a sort of dilemma when they consider the need to limit the temperature rise of a transistor while measuring its static forward current transfer ratio. If the measurement is conducted to predict how a transistor will operate in a circuit under static conditions which are such that transistor temperature is bound to rise considerably, we should see that the term "static forward current transfer ratio" is sometimes a misnomer. Measurements of static characteristics on a repetitive transient basis may fail to predict that the transistor could behave differently or even burn out if operated at a higher duty factor or for longer conduction intervals than used in the measurement technique. For this reason it is sometimes important to know the conduction time and duty factor used in the measurement. The duty factor is determined by dividing the conduction time in each cycle by the time interval of each cycle. That decimal fraction is then multiplied by 100 to express the answer as a percentage.

know
conduction
time and
duty
factor

transistors
not static
components

The measurement of the static forward-current transfer ratio, or the DC beta, of a transistor may be thought of in slightly different terms for greater clarity. Transistors are not used as static components; they are generally used for their ability to change current flow. What we really want to know when we measure the "static" forward current transfer ratio of a transistor is either 1) how much current the collector can deliver at any given collector voltage with a particular amount of base current, or 2) how much base current drive it takes for the collector to deliver a particular amount of current at a given collector voltage. Naturally the more peak power you want out of a transistor, the more limited its conduction duty factor has to be. The smaller the transistor is the more we have to tolerate shorter conduction intervals as well as limited duty factor.

$h_{FE(INV)}$ -- Static Forward Current Transfer Ratio
(Collector And Emitter Leads Reversed)

reverse
terminals

Some transistors may be operated with the collector and emitter leads interchanged. When this is done the base-collector junction is forward biased, and the base-emitter junction is reverse biased. Most circuit designs do not deliberately use this mode of operating a transistor. However, a difference in characteristics in the saturation region is sometimes favorable for circuit design considerations. Typically DC beta is not as high in the reverse direction.

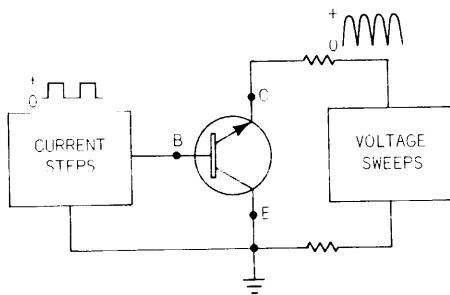
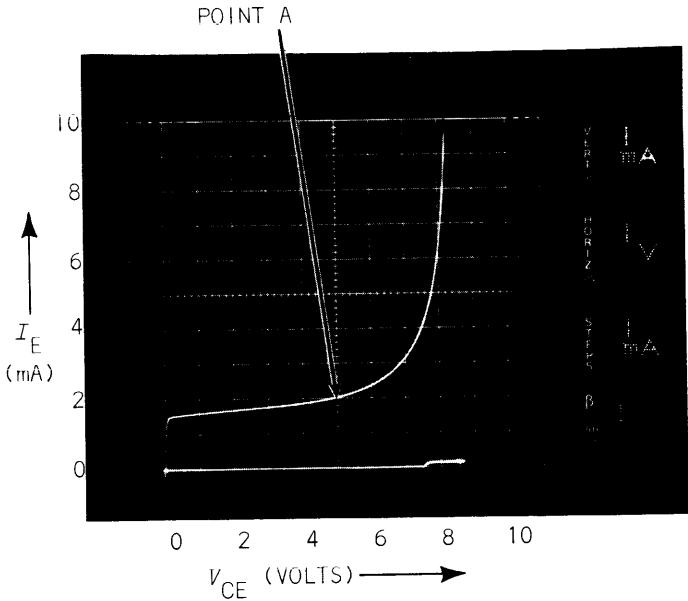

Fig. 1-9. $h_{FE(INV)}$, 2N3904.

$h_{FE} > h_{FE(INV)}$ Transistors made to have very similar characteristics when the collector and emitter terminals are reversed are sometimes called bi-directional transistors, or symmetrical transistors. Fig. 1-9 shows a plot of $h_{FE(INV)}$ for the same transistor as used in Fig. 1-1. A comparison of the two figures will show that for all collector voltages, $h_{FE(INV)}$ is much less than the value of h_{FE} . At point A the beta is 2. All of the measurement techniques and considerations that apply when measuring h_{FE} may be used for measuring $h_{FE(INV)}$.

h_{fe} -- *Small-Signal Short-Circuit Forward Current Transfer Ratio (Common Emitter)*

most
common
parameter
 h_{fe}

The small-signal short-circuit forward current transfer ratio, AC beta, or current gain of a transistor for small input signals of low frequency, is probably the most common transistor characteristic for which there is use and concern. It is the characteristic that lets us predict voltage gain or power gain in some circuits. As with DC beta, AC beta depends on where within the normal operating range the measurement is made. Therefore, measurements of small signal current gain should be made under specified conditions. Collector voltage should be known and either average base current or average collector current also known.

measure
AC beta
output AC
short;
output Z
low

Measurements of AC beta should always be made at the specified collector voltage, even though small percentage deviations in collector voltage typically produce extremely small errors. An expression of the need to measure output signal current at only the specified collector voltage is made when we say that the output must be AC short-circuited. That is another way of saying the output impedance must be very low as far as the output signal is concerned. Otherwise, the collector voltage will be altered by the changes in collector current, and thereby reduce the changes in current.

h_{fe} :
signal
amplification

Implicit in the term "small signal forward current transfer ratio" is the idea of signal amplification. And most small test signals are sinusoidal, so we are often lead to conclude that a measured amount of sinusoidal signal current must be applied, and the resulting sinusoidal output signal current must be extracted and measured to determine the current

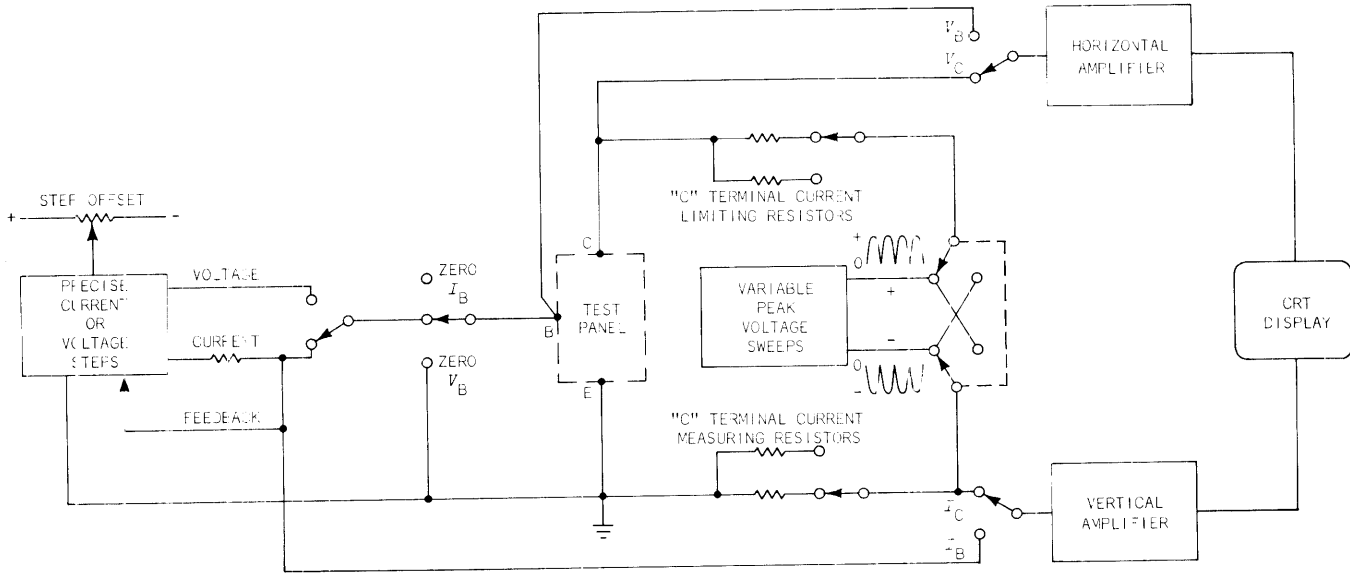

Fig. 1-10. Transistor curve tracer block diagram.

transfer ratio, or current gain. Although there is nothing wrong with such a technique, there are other ways to make the measurement that are sometimes more practical.

ratio of
changes

When we apply an alternating input signal current we simply add to, then subtract from, the base bias current that is already applied; there can be only one amount of base current at any instant. So it is a *change* or difference in base current that we are inducing when we apply a signal current and it is the resulting *change* or difference in collector current that we need to measure. Knowing the change in base current and the resulting change in collector current we can determine the transfer ratio, whether the changes are sinusoidal or some other shape as long as the collector voltage is known, and the rate of change slow enough so the high frequency limitations don't start to take effect.

Transistor curve tracers introduce changes in base current in the form of equal-value steps; steps of selectable known amounts. These steps occur at the same rate as the collector supply voltage is swept between zero volts and some peak value and back to zero, producing a separate curve corresponding to each different value of base current. See Fig. 1-10 for a functional block diagram of a transistor curve tracer. When the curves which are plotted depict collector current vs collector voltage for different values of base current, the change in collector current induced by one step of base current will be proportional to the vertical distance between adjacent curves, and can be read directly from the scale. Which vertical line is chosen for the scale will depend on what collector voltage was specified, because each vertical line corresponds to a particular collector voltage. (However, the whole display can be positioned a particular amount when desired to make a particular collector voltage appear on a line having small graduations.)

Measurement of the small-signal short-circuit forward current transfer ratio of a transistor using a transistor curve tracer consists of the following procedure:

1. Choose the vertical line corresponding to the specified collector voltage;

reading
the
curves

2. Note on that line the distance between the two curves which appear above and below the specified base current (or specified collector current) and lie adjacent to the specified current;
3. Translate that distance to the difference in collector current according to the current per division of the scale;
4. Divide that collector current difference by the base current difference that caused it, depending on the current per step.

An alternate way is to first divide the collector current per division by the base current per step to determine the beta per division. For example, base current steps of 1 mA per step, that produced curves 1 division apart when the collector current per division was 100 mA, would indicate a small-signal current gain of 100. Under similar conditions, if the distance between curves was 1.4 divisions, the current gain would be 140. The Tektronix Type 576 Curve Tracer will indicate the beta per division of the vertical scale so that it doesn't have to be computed.

"small
signal"

constant
current
gain

When measuring small-signal short-circuit current transfer ratio in the way just described, attention should be given to the size of the small signal. A reason for distinguishing between small-signal AC beta and large-signal AC beta is that current gain is sometimes different for small signals than it is for large signals. How small is a small signal? When we carefully define a small signal using numbers, the definition is somewhat arbitrary. In general, however, a small signal is one which is associated with a current gain that is essentially constant for all smaller signals. That also tells us current gain for large-signals depends on the size of the signals.

The same thing which causes a difference between current gain for large signals and current gain for small signals causes a change in gain for small signals if we change the base bias current. In other words, a given difference in base current, starting with *high* base current, may not cause the same change in collector current as if that change in base current were made starting with *low* base current.

When there is a considerable difference in current gain, the effect is readily apparent on a transistor curve tracer by the difference in vertical distance between the curves. Regions where the curves are closer together are regions of lower current gain. See Figs. 1-11 and 1-12.

Typically, as shown in Figs. 1-11 and 1-12, transistors have lower current gain at high values of collector current (and very low values of collector current) than for medium values. Fortunately transistors don't usually have to be operated at high values of average collector current when they are only called upon to handle small signals.

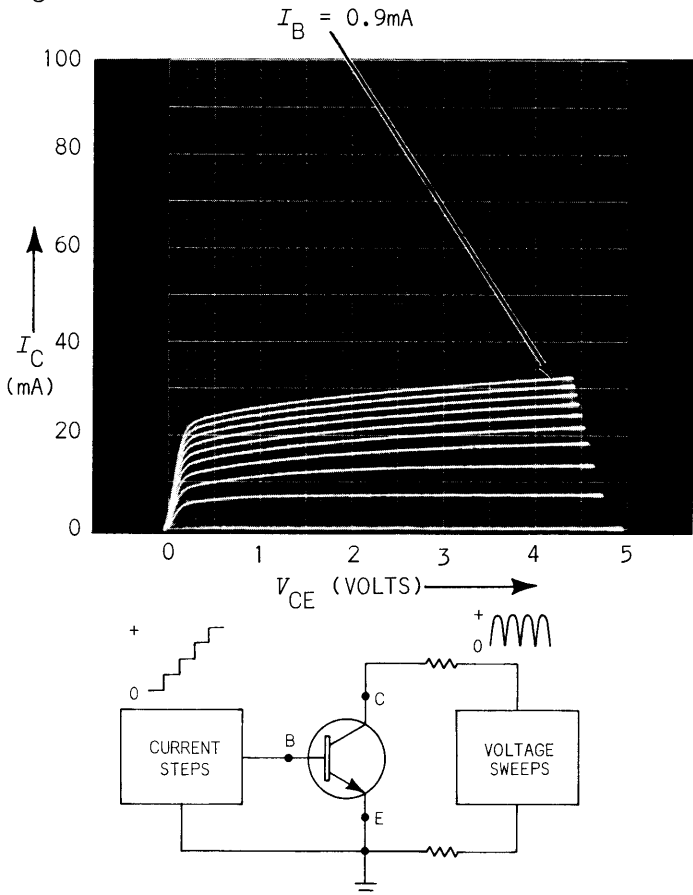

Fig. 1-11. Beta nonlinearity MPS918, 0.1 mA per step.

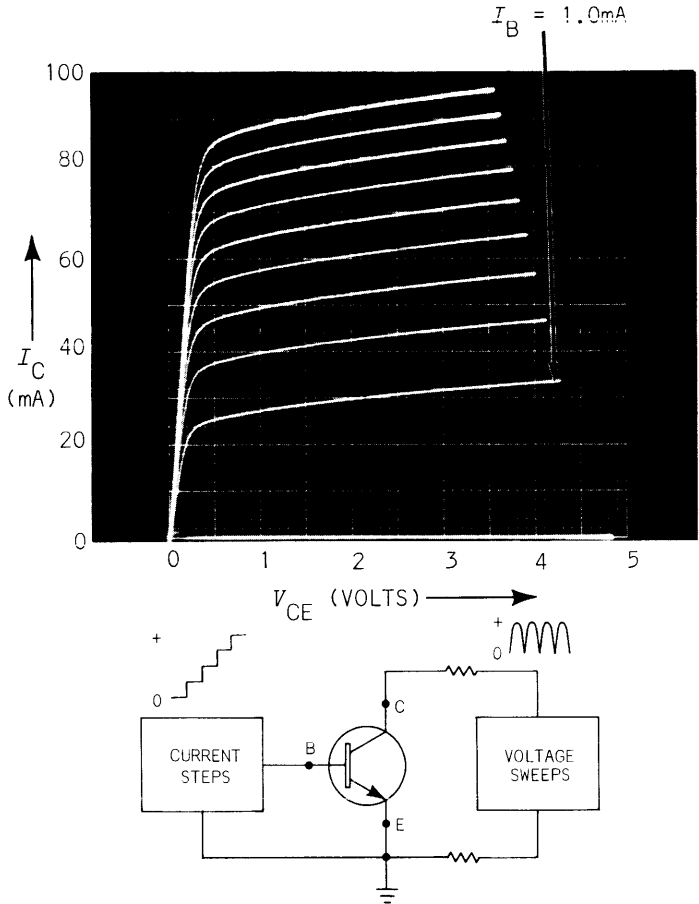

Fig. 1-12. Beta nonlinearity MPS918, 1 mA per step.

linear
versus
nonlinear

Another, but similar, reason for distinguishing between large-signal current gain and small-signal current gain is to distinguish between a linear and a nonlinear range of operation. A nonlinear range can cause signal distortion. AC methods of measuring AC beta may obscure distortion-causing nonlinearities that can be revealed by other methods of testing. The reason is that when sinusoidal signal currents are applied to the base of a transistor, the change in base current is both an increase and a decrease from the average or quiescent base current amount. A condition where an increase in base current produces less of a change in collector current than an equal decrease in base current will cause a distorted output

waveform. But the amplitude of the waveform may not change appreciably. When that happens it is because the reduced current gain for the increasing half of the base current signal was nearly matched by the increase in gain during the other half cycle of the base current signal. DC methods of measuring small-signal current transfer ratio are sometimes superior. See Fig. 1-13. Here we can readily notice a difference in the vertical distance between curves at the vertical centerline signifying a change in beta for each of the base current steps. Consider a sinusoidal base current signal superimposed on a base bias current of 6 mA corresponding to curve B. If its peak amplitude were equal to one base-current step (2 mA) the peak-to-peak collector-current swing at the

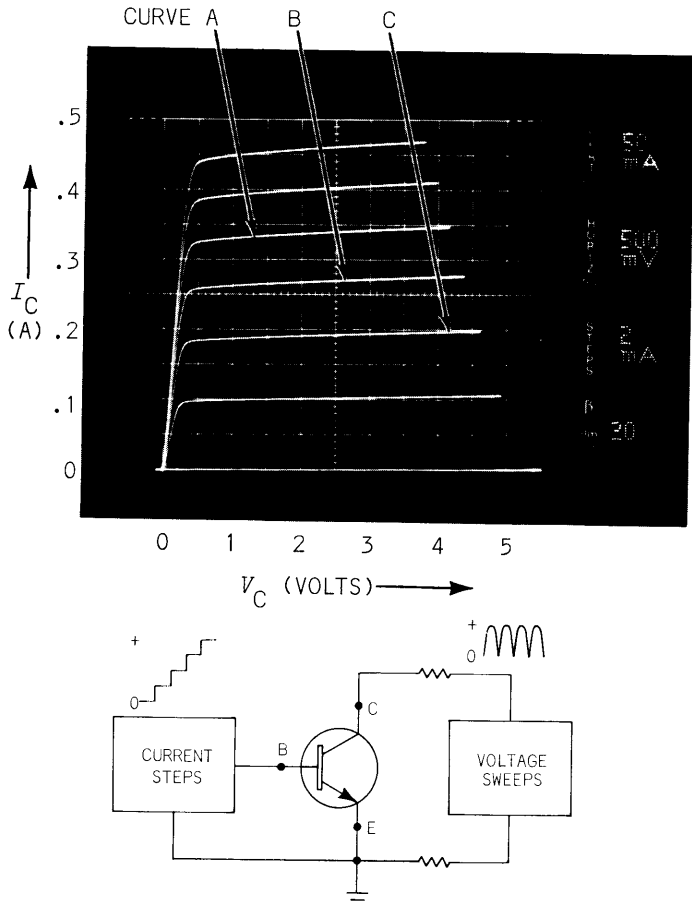

Fig. 1-13. Beta, h_{fe} .

centerline would be 3.0 divisions. Doubling the base current to a peak value equal to two steps would double the collector current swing to 6.0 divisions. Because 6.0 is precisely equal to twice 3.0, we would normally assume that the AC beta was constant for input signals having a peak amplitude of 4 mA or less. The curve tracer reveals a measurable change in beta for signals only half that size. For example, the distance between curve B and curve A is 1.4 divisions, whereas the distance between curve B and curve C is 1.6 divisions. The beta per division is 20 so the small signal beta for the two steps is 28 and 32 respectively. The small signal beta correctly measured by AC methods would have been half way between the two or 30.

base
current
versus
collector
current

Another way to measure the forward current transfer ratio using a curve tracer is to plot base current against collector current using base current as one of the coordinates. There can be a problem with this method in knowing what part of the curves correspond to a given collector voltage. The peak collector voltage varies from sweep to sweep, because of the inevitable IR voltage drop caused by collector current and the combined resistance of the collector-sweep supply and the collector-current-sensing resistors in series with the supply.

h_{fb} -- *Small-Signal Short-Circuit Forward Current Transfer Ratio (Common Base)*

In most cases the measurement of *alpha*, the forward current transfer ratio of transistors operated in the common base mode, can be done more accurately by making the measurement in the common-emitter mode, and converting the answer by formula to the common-base mode.

$$h_{fb} = \frac{h_{fe}}{1 + h_{fe}}$$

A beta of 10	equals an alpha of 0.91;
A beta of 20	equals an alpha of 0.95;
A beta of 50	equalc an alpha of 0.98;
A beta of 100	equals an alpha of 0.99.

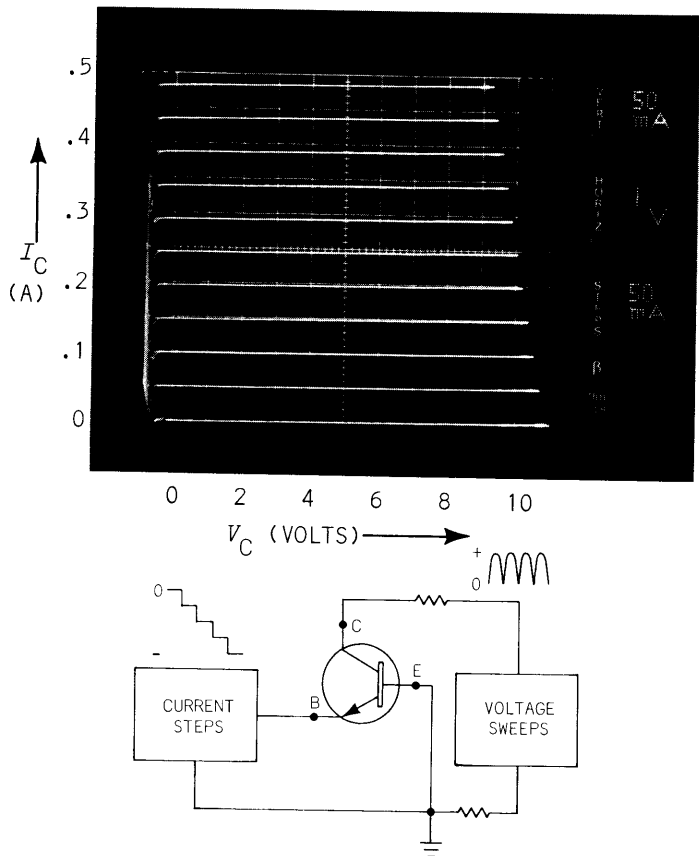

Fig. 1-14. Alpha, h_{FB} .

hard to
measure
alpha
precisely

A two-to-one change in beta from 50 to 100 corresponds to only a one per cent change in alpha. This says we have a very tough measurement to make with precision if we wish to measure alpha directly. Nonetheless, Fig. 1-14 shows a family of curves depicting collector current versus collector voltage with the current-step generator driving the emitter. The display illustrates how nearly equal to emitter current the collector current is for an average transistor. Each current step is equal to the current per division of the vertical scale. The top curve falls short of being coincident with the top of the scale by 3%, indicating a DC alpha of 0.97 if we assume that the instrument is perfect. A small error in the accuracy of the instrument could account for a gross error in measurement. Any deviation in the small-signal alpha from large-signal alpha is nearly

impossible to discern. The extreme equality of separation between the curves suggests that grounded-base operation is capable of providing very linear output voltage swing.

h_{fc} -- *Small-Signal, Short-Circuit Forward Current Transfer Ratio (Common Collector)*

The measurement of this parameter is conducted by first measuring beta under specified conditions, and adding one (1) to the answer. The common-collector mode is similar to the emitter-follower configuration where the emitter is the output terminal. Since emitter current is always the sum of the base current and the collector current, the change in emitter current which accompanies a change in base current is the base current plus the collector current. Because beta is the ratio of collector current to base current, a unit change in base current causes beta times that much change in collector current.

$$h_{fc} = \frac{I_C + I_B}{I_B} = \frac{I_C}{I_B} + 1$$

SATURATION VOLTAGE AND CURRENT

$V_{CE(sat)}$ -- *Collector-to-Emitter Saturation Voltage, DC*

A transistor biased normally and operating in the common-emitter mode is said to be in *saturation* when there is too little collector voltage applied (or remaining) for an increase in base current to cause a significant increase in collector current. On a graph of a transistor showing collector current versus collector voltage for a particular base current, the *saturation voltage* is the collector voltage at a point near or below the knee. On a graph showing a family of such curves the *saturation region* is an area of low current and voltage below the knee of each curve. See Fig. 1-15. From this family of curves we can see that the knees of the curves occur at practically the same collector voltage for different amounts of collector current.

saturation
region

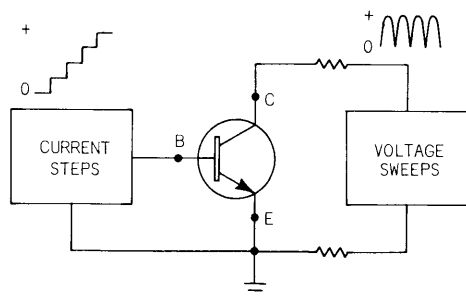
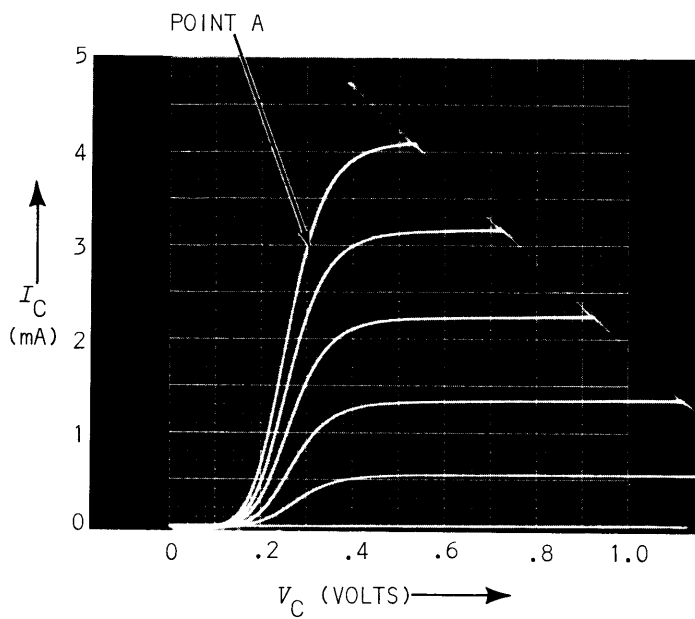

Fig. 1-15. Saturation region.

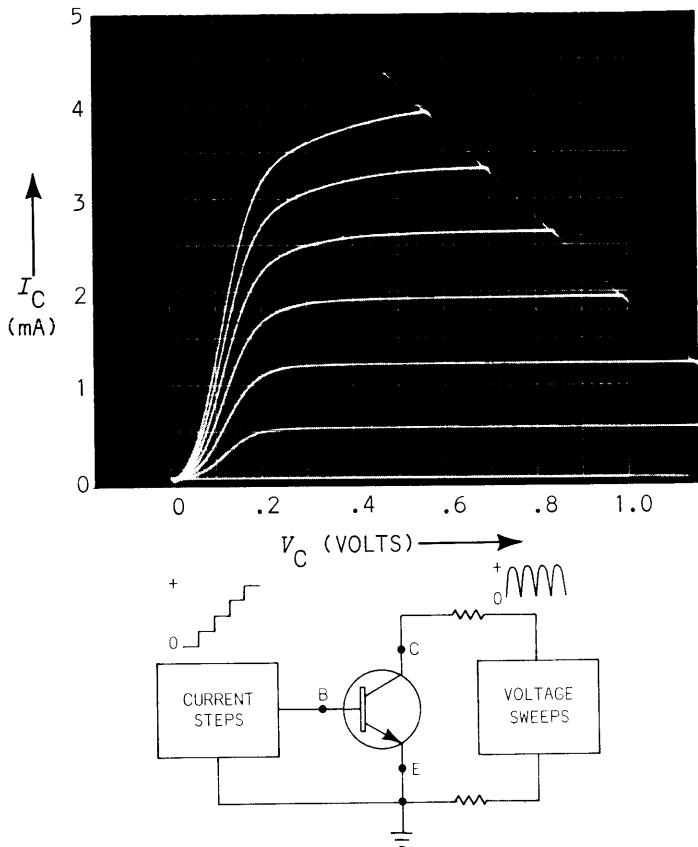

Fig. 1-16. Saturation region.

Fig. 1-16 shows the saturation characteristics of a different type of transistor using identical test conditions and scale factors. Notice the lower saturation voltages for this transistor than for the one whose characteristics are graphed in Fig. 1-15.

$V_{CE}(\text{sat})$
at low
power

Measurement of collector-to-emitter saturation voltage at low power can be done quite readily using a transistor curve tracer with the kind of display shown in Figs. 1-15 and 1-16. It is well to remember, however, that both the base current and collector current should be specified to identify where the measurement should be made, if the purpose of the measurement is to verify a specification. If such a measurement should happen to be at a point on a curve above the knee, it will be of no consequence if the

collector voltage is not excessive because saturation voltage is usually specified to be equal to or less than some maximum value.

Probably the most important reason for knowing about saturation voltage is to predict the performance of a transistor used in DC-to-AC power inverters, chopping circuits, and logic circuits. In these applications it is important to know how low the collector voltage goes because at such times as the transistor is passing the most current for the longest periods of time, and power dissipation at the collector can quickly become excessive. A ten per cent reduction in saturation voltage can reduce collector dissipation by a comparable percentage. This could allow us to deliver extra power to the load -- which may be many times the power dissipated by the transistor.

$r_{CE}(\text{sat})$ -- *Collector-To-Emitter Saturation Resistance*

$$r_{CE(\text{sat})} = V_C / I_C$$

Saturation resistance is an expression for the quotient of collector voltage (V_C) divided by collector current (I_C) for any given value of base current in the collector saturation region of a transistor operated in the common-emitter mode. This ratio is nearly constant for some transistors over a large range of collector current values. When it is fairly constant, collector saturation voltage can be estimated quite accurately over the same range at the given base current or higher base currents. A constant saturation resistance would appear as a curve with a straight slope which intersected the zero voltage and current points on the graph. The steepness of the slope would be a function of the x and y coordinates of the scale and the amount of saturation resistance. The term saturation resistance is sometimes used to mean the dynamic resistance, or slope, at a specified voltage or current point.

Specifications of saturation resistance are usually for maximum tolerable values. Most measurements of saturation resistance are for the purpose of determining saturation voltage. With a display of a family of transistor curves showing collector current versus collector voltage for various base currents, saturation voltage can be more easily

measured directly for nearly any combination of circumstances. So there is seldom need to calculate the saturation resistance except to verify a specification.

Fig. 1-15 shows collector voltage to be 0.3 at an emitter current of 3 mA and a base current of 50 μ A. The saturation resistance at that point is $V_C/I_C = 0.3/0.003 = 100\Omega$. Higher base currents would show less collector voltage needed at the same collector current, so the saturation resistance will be less at higher base currents. At lower values of collector current at the given base current, saturation resistance will be higher even though saturation voltage at lower collector currents is always less. Fig. 1-16 shows a different kind of saturation region, with values for saturation resistance that differ more widely than in Fig. 1-15.

When testing or measuring the saturation voltage of a transistor at very high currents, pulse testing must be used to minimize heat dissipation. Methods may be employed similar to those discussed for measuring the static forward current transfer ratio.

CUTOFF CURRENT AND VOLTAGE BREAKDOWN

I_{CBO} and $V_{(BR)CBO}$ -- *Collector-To-Base Current Leakage And Voltage Breakdown, Emitter Open*

The measurement of reverse bias leakage current and breakdown voltage can logically be considered at the same time. The current that flows through the collector-base junction when reverse biased, and when the emitter lead is open, is very much the same kind of phenomenon as occurs in a simple diode. Usually that current is relatively small, until the voltage is increased sufficiently and breakdown starts to occur. Although the breakdown region is relatively abrupt for most transistor junctions, a precise measurement of breakdown voltage can only be made at a specific reverse current and at a specific temperature. For the same reason reverse currents should always be measured at specified reverse voltages and temperatures or the measurement is of limited use.

$V_{(BR)CBO}$
made at
specified
temperature
and reverse
current

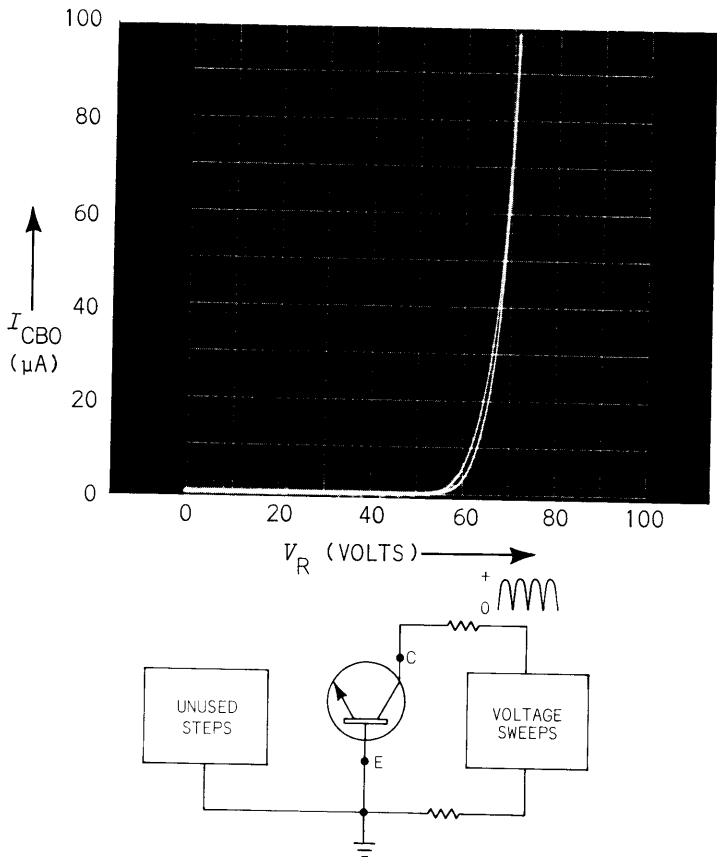

Fig. 1-17. I_{CBO} and $V_{(BR)CBO}$, 2N918. Breakdown region between approximately 50 V and 70 V.

A transistor curve tracer is a simple and accurate instrument with which to plot and measure small reverse currents at any voltage up to the breakdown region. The breakdown region is identified and explored at the same time as reverse current is monitored, when desired. A primary concern with measuring breakdown voltage -- or measuring leakage current near the breakdown region -- is that of destroying the junction in the process. Transistor curve tracers allow insertion of resistors having high resistance values in a series with a swept voltage supply to limit reverse current to a safe value. The peak amplitude of the swept supply voltage can be controlled as needed. Fig. 1-17 shows the collector-base leakage and breakdown region of a typical low power silicon

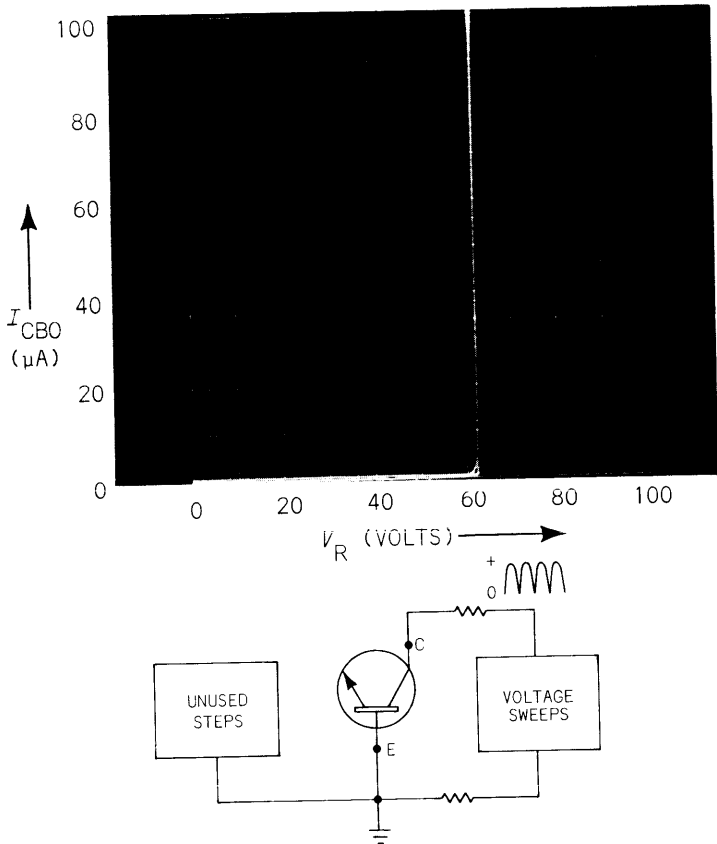

Fig. 1-18. I_{CBO} and $V_{(BR)CBO}$, 2N918. Abrupt breakdown region between 60 volts and 62 volts. Peak current allowed was $100\mu A$.

transistor. The breakdown region does not appear abrupt in this photograph, but the breakdown voltage is obviously between 50 and 70 volts. Another transistor of the same type is shown in Fig. 1-18 that has a much more abrupt breakdown region.

Fig. 1-17 and Fig. 1-18 represent measurements conducted at room temperature with no effort to control the temperature of the transistors. Reverse current was limited as much as possible to make the needed measurements. If we wish to see the effects of increased temperature on the measurement, we can generate the needed heat very conveniently by slowly

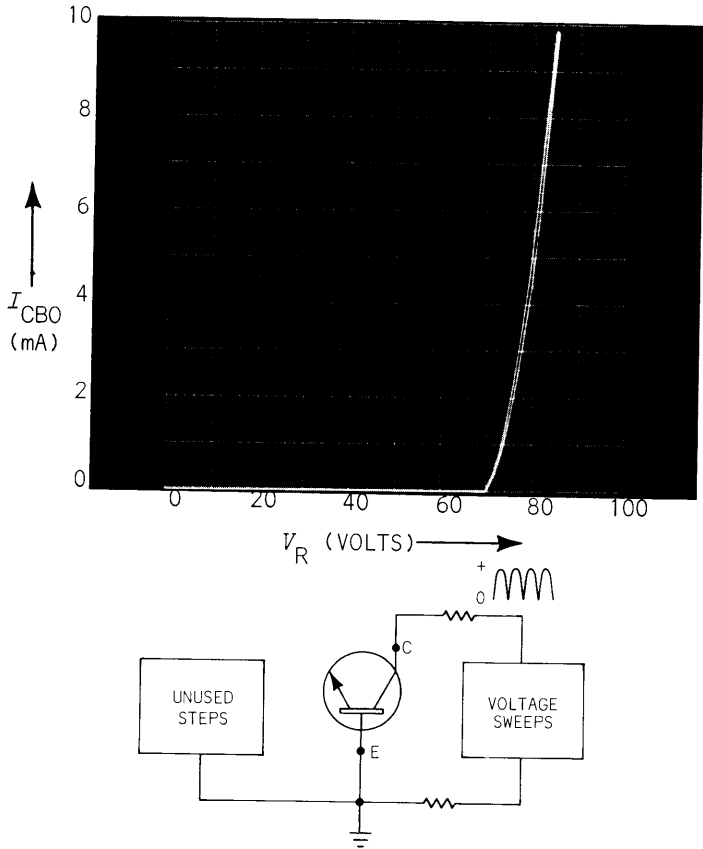

Fig. 1-19. I_{CBO} and $V_{(BR)CBO}$, 2N918. Identical transistor as used in Fig. 1-18 temperature increased by increasing peak leakage current 100X to 10mA. Breakdown voltage increased from 62 volts to 70 volts due to temperature rise.

increasing the peak reverse current with the curve tracer. Fig. 1-19 is the same as Fig. 1-18 but with a peak current 10 mA instead of 0.1 mA. The transistor was too hot to hold. The breakdown voltage increased from 62 volts to 70 volts. The case temperature could have been monitored with a thermocouple attached if we had wished to make a measurement of its characteristics at a specific case temperature. The junction temperature will always be somewhat higher than the case temperature.

I_{EBO} and $V_{(BR)EBO}$ -- *Emitter-To-Base Reverse Current,
And Voltage Breakdown,
Collector Open*

The measurement of reverse current and voltage breakdown between the emitter and base of a transistor when the collector terminal is left disconnected is performed in the same way as for the measurement of leakage and breakdown between the collector and base, already discussed. A comparison of the reverse-current and voltage breakdown characteristics of the collector-base junction of a transistor with the corresponding characteristics of the emitter-base junction of that transistor is sometimes interesting. The breakdown region is often a lower reverse voltage for the emitter-base junction than for the collector-base junction.

I_{CEO} and $V_{(BR)CEO}$ -- *Collector Cutoff Current And
Voltage Breakdown, Base Open*

I_{CEO} and
 $V_{(BR)CEO}$ are
diode
measurements

The reverse-current characteristics and voltage-breakdown characteristics of either the collector-base junction or the emitter-base junction of a transistor with the remaining terminal disconnected is really a measurement of a diode characteristic rather than a measurement of the transistor characteristic. Both of those measurements are useful for predicting some limitations of the transistor, but the measurement of similar characteristics involving conduction through both the collector-base and emitter-base junctions are probably more meaningful. The open-base condition, while also rarely encountered in a practical circuit, does indicate a maximum, or limit, cutoff current.

forward
bias
reverse
bias

The current which flows through a transistor when the base terminal is disconnected, and a current or voltage supply is connected across the emitter and collector terminals, will be forward current for one junction and reverse current for the other junction, depending on the polarity of the supply. When the polarity is such that the emitter-base junction is *forward* biased, the collector-base junction will be *reverse* biased. Reverse bias for the collector-base junction is the normal mode for transistor operation, and it is the correct condition for measuring collector cutoff current and voltage breakdown with zero base current. The base terminal will be "floating" under these

conditions, and there will be a floating voltage at the base terminal equal to the voltage-drop across the emitter-base junction. That voltage will increase with an increase in emitter current.

cutoff
current >
reverse
current

The cutoff current which flows under these conditions is usually much greater than the reverse current which flows through the collector-base junction when the emitter lead is open (I_{CBO}). In fact, collector cutoff current with an open base terminal is as many times greater than collector-base reverse current (I_{CBO}) as the value of the forward current transfer ratio (for low values of collector current). In other words, if beta is 50, then collector cutoff current with the base open will be 51 (50 + 1) times greater than the simple collector-base reverse current with emitter open. The reason for the current increase is that the reverse current through the collector-base junction has to be supplied from the emitter terminal, no other is available, and the carriers injected into the base region to supply that current diffuse and consequently allow many times that amount of current, to pass between emitter and collector.

$V_{(BR)CEO}$ >
 $V_{(BR)CBO}$

Breakdown voltage for any given amount of cut-off current with the base open is less than breakdown voltage for the collector-base junction alone (emitter open). There are several factors that account for reverse current through a PN junction when a given reverse voltage is applied. All of which, except for surface leakage, are temperature dependent. When the surface leakage factor is negligible, reverse current will approximately double with every 6°C increase in temperature, for silicon transistors. For germanium transistors leakage will double about every 10°C. For this reason careful attention must be given to temperature when accurately measuring reverse current (cutoff current). In some normal cases surface leakage current will dominate.

I_{CES} and $V_{(BR)CES}$ -- *Collector Cutoff Current And Voltage Breakdown, Base Shorted To Emitter.*

The collector current, which flows when the base and emitter terminals are shorted together and reverse voltage applied, is a small fraction of that which flows when the base terminal is open. Under these

test conditions most of the collector current passes through the base terminal rather than the emitter terminal because the base region in the transistor is adjacent to the collector region, and the external short offers less opposition to current flow than the internal emitter region. The collector cutoff current which flows is usually somewhat more than when the emitter terminal is open. The resistance between the material comprising the base region within the transistor and the base terminal causes a small voltage drop within the transistor that essentially forward biases the base-emitter junction a small amount. The forward bias permits the emitter to inject additional carriers into the base region and increase the total current. Measurement of collector cutoff current under these conditions is like determining what collector current will flow in a circuit when the transistor is driven from a very low impedance source, and the drive voltage is very close to zero.

I_{CER} and $V_{\text{(BR)CER}}$ -- *Collector Cutoff Current And Voltage Breakdown, Base Returned To Emitter Through A Specified Resistance.*

I_{CER} falls
between
 I_{CEO} and
 I_{CES}

When the base terminal is connected to the emitter terminal through a resistor instead of remaining open or connected directly, the collector cutoff current will be some value between what it is when the base is open and what it is when the base is shorted to the emitter, at any given collector voltage. The resistor value may be selected to simulate the source impedance of a typical base-drive circuit to indicate what collector current would remain when the driving voltage went to zero. The collector breakdown voltage, $V_{\text{BR(CER)}}$, for a given cutoff current will be a voltage in between that for open base, $V_{\text{BR(CEO)}}$, and that for shorted base, $V_{\text{BR(CES)}}$.

I_{CEV} and $V_{\text{(BR)CEV}}$ -- *Collector Cutoff Current And Voltage Breakdown, With Specified Reverse Voltage*

$I_{\text{CEV}} < I_{\text{CES}}$

If a small reverse voltage is applied across the base-emitter terminals, collector cutoff current can be reduced below the value which flows with the base terminal shorted to the emitter terminal.

This reverse base-emitter bias will also increase the voltage at which breakdown occurs, assuming of course, that breakdown voltage is measured at the same collector current value in both cases. Because some current may flow in the base circuit under these conditions, the resistance of the base circuit can cause the base terminal voltage to be less than the base supply voltage. Therefore, the base terminal voltage should either be measured at the base terminal or supplied from a very low resistance source. If the supply voltage and the resistance of the supply are known and specified the cutoff current could be classified as I_{CEX} instead of I_{CEV} .

I_{CEX} and $V_{(BR)CEX}$ -- *Collector Cutoff Current And Voltage Breakdown, With Specified Base Drive Circuit.*

As has been shown by discussions of different conditions for the measurement of collector cutoff current, there may be a big difference in cutoff current depending on what, if any, external connections there may be between the base terminal and the emitter terminal. Predicting collector cutoff current in practical circuits may be simplified by using simulated circuits. Such measurements provide very good data for very similar circuits. The terms I_{CEX} and $V_{BR(CEX)}$ can be used instead of the terms I_{CEV} and $V_{BR(CEV)}$ as long as equivalent conditions are stated.

I_{CEO} greatest with V_C high, temperature high, and I_B zero

Collector cutoff current, although normally never great, may be different in a given transistor depending on the conditions which may be said to constitute cutoff. The highest amount of what could be called cutoff current flows when a transistor has a high collector voltage, has zero base current, and is hot. The easiest way to assure zero base current is to leave the base terminal disconnected or open. Collector cutoff current for this condition is symbolically called I_{CEO} (O for open base). When the base terminal is not left open, but has a resistor of high resistance value connected externally between the base and emitter terminals, the base terminal is practically open but somewhat less cutoff current flows. As the resistance value of the resistor is reduced, cutoff current diminishes. Cutoff current measured under these conditions varies widely,

depending on the value of the resistor, but is symbolized by the letters I_{CER} (R for resistor in the base lead). When the resistor value between the base and emitter is practically zero ohms, the cutoff current is represented by the symbol I_{CES} (S for short circuit between base and emitter terminals).

Collector cutoff current can be diminished further by applying a *reverse* voltage between the base and emitter. The reverse voltage does not need to be great to do its job. One or two volts is usually adequate, when that voltage actually appears between the base and emitter terminals. The symbol for collector cutoff current for a reverse-biased emitter-base junction is I_{CEV} (V for voltage between base and emitter). The symbol I_{CEX} could represent the same situation, as explained earlier.

$$I_{CEV} < I_{CES}$$

Very low cutoff current flows when a reverse voltage is applied between the collector and base if the emitter is open. This configuration does not resemble any ordinary use of a transistor however, so it is somewhat of a misnomer to call it transistor cutoff current. It is really a measurement of a diode characteristic -- the collector-base junction reverse current. The symbol is I_{CBO} (O for open emitter).

Collector Sustaining Voltage

$V_{CEO(SUS)}$
 $V_{CER(SUS)}$
 $V_{CEV(SUS)}$
 $V_{CEX(SUS)}$

measuring
 errors
 near
 breakdown
 region

A considerable error can be made in measuring cutoff current near the breakdown region of some transistors, because of a *negative resistance* characteristic present in this region. In other words, one of two distinct collector currents may flow with a given collector voltage applied, depending on how the collector voltage was chosen and applied, and whether the cutoff current was increased to the value selected or decreased to the value selected. With a transistor curve tracer both points can be shown and easily distinguished. See Fig. 1-20 and Fig. 1-21. The curves in Fig. 1-21 changed from those shown in Fig. 1-20 when the peak collector supply voltage was increased from 210 volts to 220 volts. With a 220-volt supply, avalanche breakdown occurs with zero base current, and the collector voltage drops to 100 volts, but sustains about 180 mA with the particular load used. These curves show that when base current is switched between zero and 3.5 mA, collector current will switch between about 180 mA

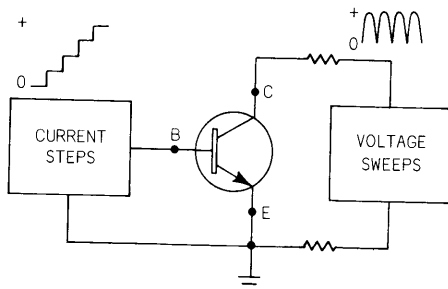
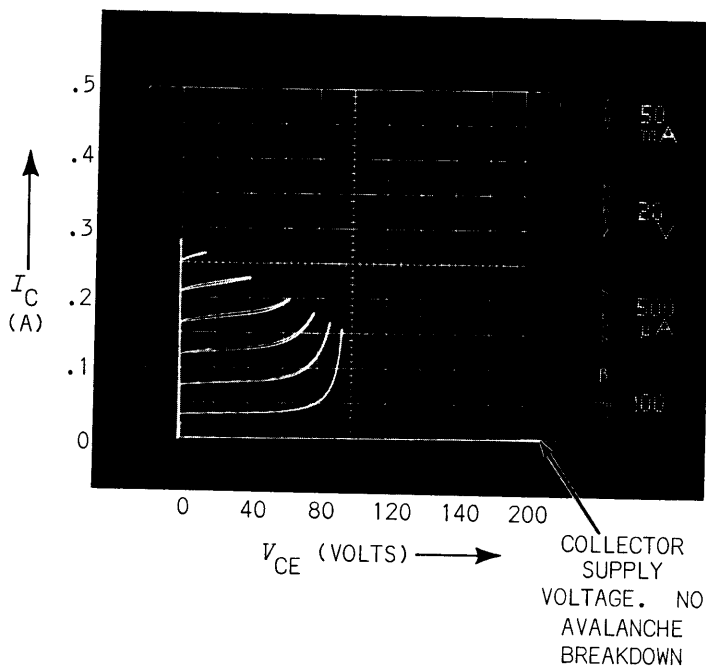

Fig. 1-20. Collector breakdown, 2N4111.

at 100 volts, and 320 mA at close to zero volts, if the supply voltage is 220 volts. The average power dissipation of the transistor would be high. With a collector supply of 210 volts or less, the sustaining voltage would not be significant because the avalanche breakdown would not occur. In that case, the transistor would dissipate very little power because practically zero collector current will flow, even at 210 volts, when base current is zero.

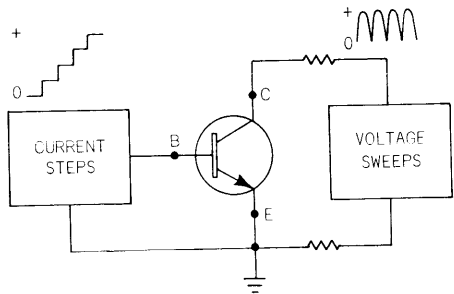
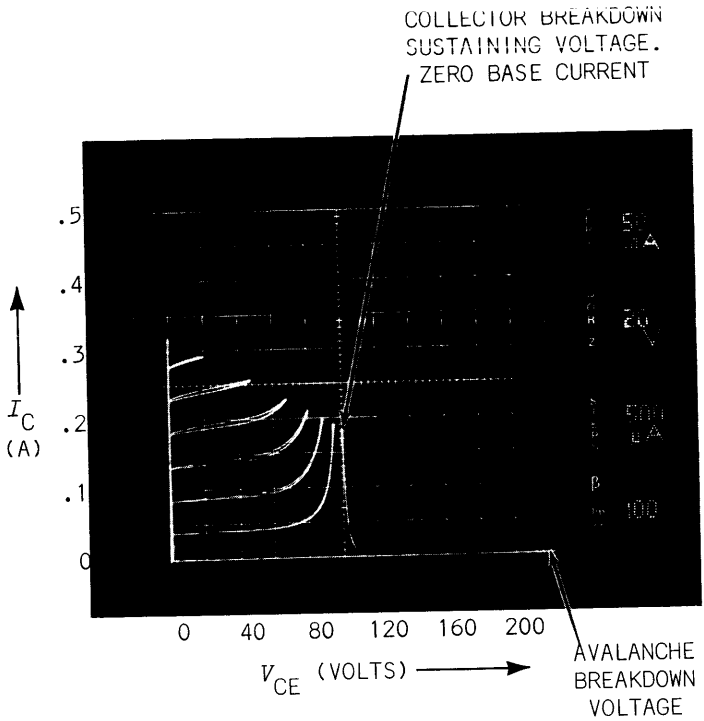

Fig. 1-21. Collector avalanche breakdown and sustaining voltage, 2N4111.

From the shape of the zero base-current curve in Fig. 1-21, different collector sustaining voltages and currents can be predicted for higher values of load resistance by using a corresponding load line.

negative R characteristic

When there is a negative resistance characteristic in the breakdown region, it can be detected by slowly increasing collector voltage until the curve becomes vertical, then turns around and starts back. Peak

current must be carefully limited with a high value series resistor to avoid the possibility of overheating the transistor. Under these conditions increasing the peak collector-supply voltage increases the peak collector current, which reduces the peak collector voltage. Any collector voltage in a (stable) negative resistance region sustains more collector current than when the peak collector voltage is first increased to that voltage under otherwise identical conditions. Similarly, when a transistor is switched from hard-on to hard-off, that is, operated with a high collector-supply voltage and high value series collector load resistor, the cutoff current will be relatively high, and the collector (sustaining) voltage relatively low.

Sustaining voltage is the collector voltage required to sustain a given collector current where that current is the larger of two possible values at that collector voltage under a given set of collector-cutoff conditions. The principal purpose for identifying and measuring collector sustaining voltage is to indicate how the transistor may be operated without excess dissipation. Unless there is a negative resistance characteristic in the cutoff region there is no object in distinguishing between collector breakdown voltage and collector sustaining voltage. Most transistors exhibit no negative resistance characteristic for a cutoff condition where the base is open. But most do exhibit the characteristic when the base is reverse biased, shorted to the emitter, or connected to the emitter through any small value of resistance.

Avalanche Breakdown

avalanche:
dynamic R
drops

The term avalanche or avalanche breakdown is often used synonymously with the term zener breakdown. Although both terms are carefully defined in the section of this book dealing with the definition of terms, the distinction needed for this discussion is between that breakdown where there is simply an abrupt reduction in the dynamic resistance of a device or junction, and that breakdown which is characterized by not only an abrupt reduction in dynamic resistance, but by a negative resistance characteristic. The measurement of the electrical characteristics of devices which have a negative resistance characteristic can sometimes be plagued with errors if the negative resistance characteristic is not known, or its

negative R
is evident
on curve-
tracer

existence not suspected. Even then control of the measurement may be difficult and uncertain. It is sometimes possible to plot graphically the complete resistance characteristics associated with collector-voltage breakdown using a transistor curve tracer. In cases where the negative resistance would be represented by a very radical change in slope, it may not be practical to swamp the negative resistance by a comparable real resistance to plot a whole curve. Nonetheless, avalanche breakdown does not go undetected on a curve tracer, and even when the precise slope of the negative resistance region is not shown, the places where it begins and ends will be apparent.

Whenever a negative resistance characteristic is plotted on a curve tracer for a collector family, as when measuring collector sustaining voltage, for example, the negative resistance region will be unstable if the slope of the load line (established by the resistance in series with the supply) is too steep. As collector current is changed the load line should not intersect more than one point at a time on the curve in the negative resistance region.

When not enough series resistance is used as collector current is increased into a negative resistance region, the current may suddenly step to a higher value, corresponding to lower collector voltage, at a point where the load line does intercept the negative resistance curve -- after that curve has bent and become more steep. When such a step occurs, the transition is usually rapid enough to shock excite connecting leads into damped oscillations due to lead inductance and stray capacitance. Even if no oscillations occur there will be a section of the curve that has to be considered absent. That section will usually be easy to identify because it will be very dim -- indicating the CRT beam was deflected with exceptional velocity during the change from one current value to the next.

Avalanche breakdown in some transistors can occur in extremely short intervals of time. When it can, then even small amounts of stray capacitance in the leads connecting the transistor will momentarily appear as a low impedance load to the transistor collector. In that case even though the current-

limiting resistors in series with the collector supply may have a high enough value (to DC) to constitute a load line that would intercept the negative resistance curve at all points, high frequency parasitic oscillations may prevent plotting the whole negative resistance region.

Some transistors are used for their very fast avalanche characteristics. See Fig. 1-22.

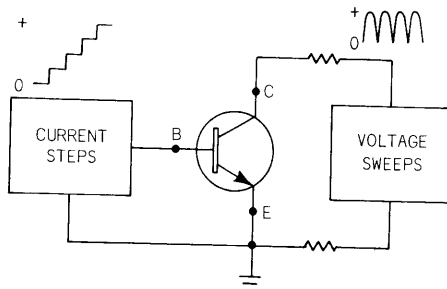
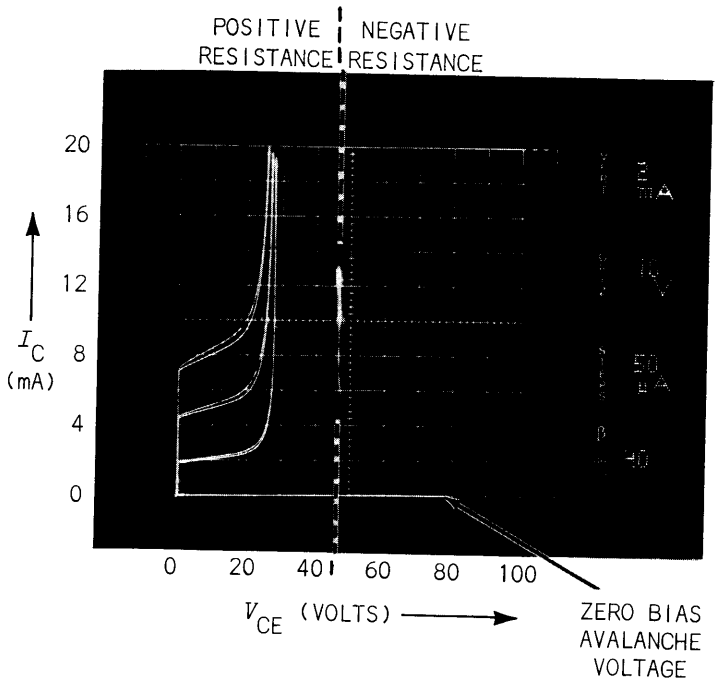

Fig. 1-22. High-speed avalanche transistor. Selected 2N2501.

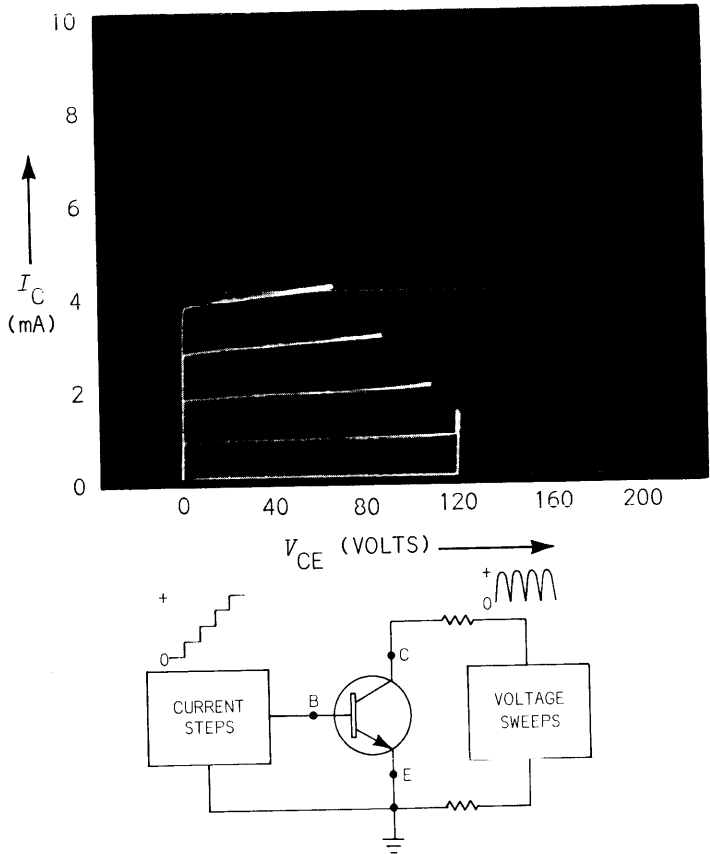

Fig. 1-23. Breakdown due to reach-through, $20\mu\text{A}$ base current steps, 2N3877A.

Punch-Through Or Reach-Through

The terms punch-through or reach-through apply to a collector-breakdown condition where base current has little or no influence on the collector-breakdown voltage. The condition only applies to some transistors, usually ones with a very thin base region. With transistors of this type the collector-base junction depletion region may extend all the way through the base material into the emitter material, when enough collector-to-emitter voltage is applied; before some other form of breakdown occurs. When this happens a good conduction path

between collector and emitter is created at a particular collector voltage, directly through the base material. Increasing collector voltage beyond that value causes a radical increase in collector current.

punch-
through
diagnosis

Breakdown due to the collector-voltage field extending through the base material is easily recognized on a transistor curve tracer. Whenever the breakdown current is the same value regardless of the base current, a transistor curve tracer will show different curves in a collector family joining at the breakdown region. Fig. 1-23 displays peak collector sweep voltage limited enough to show only the bottom two curves joining. However, all five curves merge when collector breakdown current was allowed to increase enough.

Reach-through is a non-destructive form of breakdown as long as collector current is limited.

SWITCHING TIME

The speed and fidelity with which a transistor may fully respond to a sudden discrete change in input current has a relationship to its gain characteristics at high frequencies -- but not a simple relationship. While it is generally true that the transistors which have the better high frequency characteristics are also the ones which are faster in their response to step signals, the best transistors for high frequency sinewave amplifiers don't always make the best switching circuits. This is particularly true when the kind of switching to be done involves driving the transistor into saturation or into cutoff. When the drive is alternately between saturation and cutoff, the correlation is at its worst.

switching-
transistors:
measure
vs
calculate

Even if and when all of the several individual characteristics about a transistor that determine its step response are quantitatively known, predicting the performance of the transistor by use of mathematical equations is laborious and approximate. Testing and measuring step response or switching time of transistors is therefore very common.

Turn-On Time And Turn-Off Time

The semiconductor industry has adopted several terms related to the switching time of transistors. First of all, a distinction is made between the time it takes a transistor to turn on and the time it takes a transistor to turn off. One is called turn-on time and the other called turn-off time. Both the turn-on time and the turn-off time are divided into two intervals, each described by a separate term. Turn-on time is divided into *delay time* and *risetime*. Turn-off time is divided into (carrier) *storage time* and *falltime*. One should remember from the outset that here risetime and falltime have nothing to do with whether the waveform being measured is positive-going or negative-going. Risetime applies to an *increasing* collector current. This time will be coincident with a negative-going collector voltage waveform for an NPN transistor, or a positive-going collector voltage waveform for a PNP transistor. Falltime applies to *decreasing* collector current.

turn-on
= delay plus
risetime

turn-off
= storage
plus
falltime

risetime
- I_C increase
falltime
- I_C decrease

 t_d -- Delay Time

Delay time is the time between the instant when a current step is applied to turn the transistor on, and the instant when collector current has increased to 10% of its final value. To avoid any ambiguity about the instant when a current step is applied, measurement of delay time should be made starting at a point on the applied step 10% of the way to its final level.

define delay
time and
carrier
storage time

Carrier storage time is the time between the instant when base current is cut off, and the instant when collector current diminishes to 90% of its full value. Again, to make the definition and measurement of carrier storage time more precise, the instant when base current is cut off is said to be when it has been reduced to 90% of its full value. See Fig. 1-24.

From this figure showing idealized wave shapes one may erroneously infer that the falltime of the output pulse is about the same as the 90% to 10% falltime of the applied pulse. One may even infer that risetime and falltime are usually about the same. No implications of this kind were intended. It is typical, however, for the risetime and falltime of

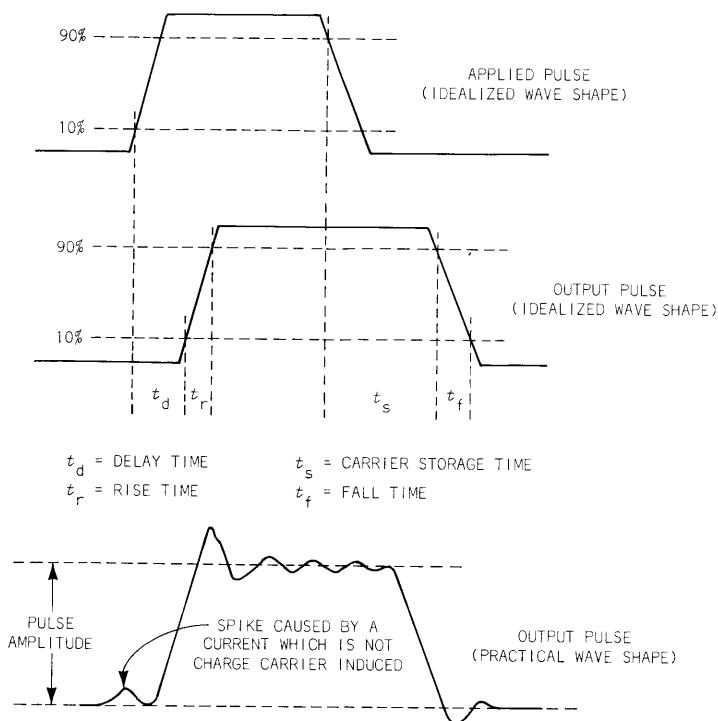

Fig. 1-24. Switching transistor pulse characteristic.

the applied pulse to be close to the same. It is also appropriate that the risetime and falltime of the applied pulse be much shorter than the response stimulated. Otherwise it would not be possible to discern the true response limitations.

Whenever delay time is a significant portion of turn-on time it is principally due to one or a combination of two factors, both associated with the quiescent cutoff condition.

Whenever the emitter-base junction is reverse biased to create the cutoff condition, the emitter-base junction capacitance will be charged to the reverse bias voltage, and constitute a charge that will have to be removed before conduction can start. Of course, the same is true for the stray capacitance of the emitter and base leads, both inside and outside

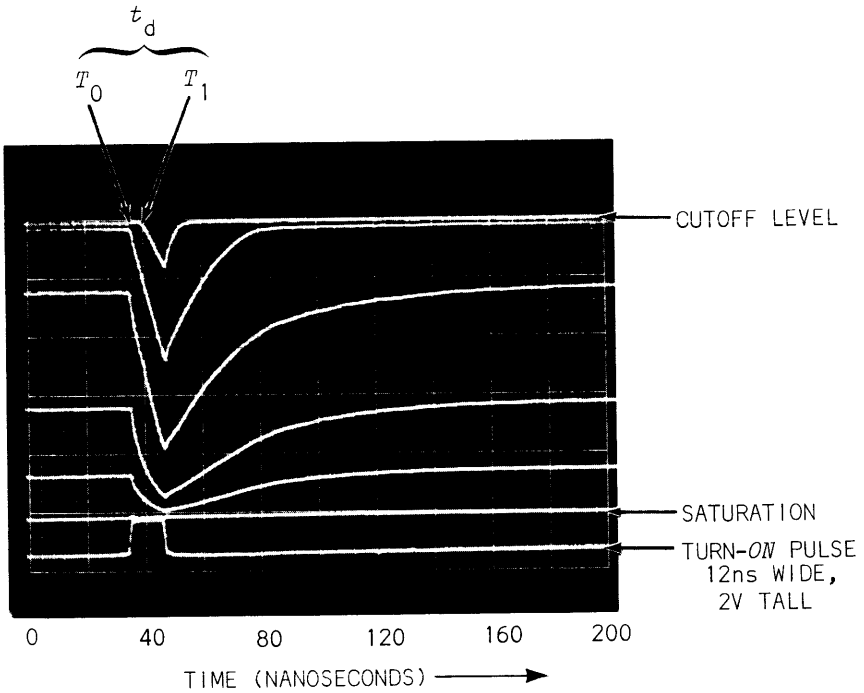

Fig. 1-25. Turn-on characteristics of small high-speed transistor. Six collector voltage curves that correspond to six base bias levels between cutoff and saturation show various rise rates. Turn-on delay (t_d) apparent for only top curve; collector load resistance 250Ω as in Fig. 1-28. Risetime corresponds to falling portions of curves.

of the transistor package. But this capacitance is only of significance when the transistor is back-biased into cutoff. If cutoff is not so hard -- as when the base current or base voltage is only reduced near zero, there is only one principal factor. That is diffusion time -- the time it takes carriers injected into the base region to diffuse and let the base region become a good conduction medium for collector current. A transistor which is switched out of cutoff, but not into saturation, will exhibit as much delay time as if it were switched into saturation. Delay time is usually minimal when the transistor is barely cutoff, and then is turned on hard. In Fig. 1-25 we have shown the collector waveforms that result when a fast-rise turn-on pulse approximately 12 ns wide and 2 volts tall is applied to the base of an NPN transistor through a non-inductive 1000-ohm resistor. An oscilloscope rather than a curve tracer was used. The transistor was biased at six different levels including saturation and cutoff. Only the top curve represents a quiescent cutoff condition. The bottom curve shows the applied pulse and the curve next to the bottom represents the transistor biased into saturation before the turn-on pulse was applied. Notice that none of the curves show any turn-on delay except the top curve, where about 1 minor division (or 4 nanoseconds) of delay is apparent.

t_r -- *Risetime*

Risetime (the negative slope on the collector waveforms in Fig. 1-25), cannot be measured from these curves because the turn-on pulse did not last long enough. But the curves illustrate other things. Even though each curve represents the same increase in base current (2 mA) a considerable difference in slope and amplitude can be seen for the different curves, particularly as collector voltage approaches saturation. This should show us that the change in slope is due to a change in collector voltage. The top curves show a relatively linear rise rate because collector voltage saturation has not been reached. When these curves are allowed to continue toward saturation by making the turn-off pulse last longer they also become rounded, but it is difficult to tell from those curves alone whether the rounding reveals a basic RC type of characteristic or not. Risetime is primarily limited by the collector-base junction capacitance, and all stray capacitance between the collector and base leads, plus the

input
capacitance
change

$$\approx \frac{\Delta V_C}{\Delta V_B}$$

amount of base current available to discharge that capacitance. When the collector voltage changes as a result of changing the collector current -- as it will unless the load impedance is zero -- the collector-base capacitance is, in effect, increased in proportion to the change in collector voltage. The magnitude of the increase is limited by the reverse voltage transfer characteristics of the transistor, and is approximately equal to the ratio of the change in collector voltage to the change in base voltage. This figure can be very large. In essence, current in the base lead must discharge the collector-base capacitance as the collector voltage decreases. So, when current in the base lead is suddenly increased to a new level, most of the increase is at first diverted to discharge the collector-base capacitance. This delays the increase of carriers in the base region, which accounts for most of the risetime. The rise rate is linear except in the region near saturation, because a practically constant current discharges a practically constant capacitance. Collector-base junction capacitance will typically increase as the collector voltage reduces, however, and this also accounts for a slope that is less steep for lower values of collector voltage.

virtual
input
C >>
actual C

The importance of collector-base junction capacitance as a limiting factor on transistor risetime was discussed. The fact is emphasized that the *actual capacitance* values may be only a small fraction of the *virtual capacitance which must be discharged* by base current. Stray capacitance, due to circuit or socket capacitance, between collector leads and base leads can account for a poor correlation of measurements between otherwise identical test fixtures when measuring risetime or rise rate.

$\frac{dV}{dt}$

Some people will prefer measuring rise *rate* to measuring risetime when evaluating the turn-on time of a transistor. Rise rate would be expressed in terms of volts per unit time, but might be measured by determining the time it takes for the slope to cross two discrete voltage levels.

t_s -- *Carrier Storage Time*

Fig. 1-26 is similar to Fig. 1-25 except that a turn-off pulse was applied instead of a turn-on pulse. The applied turn-off pulse is shown on the bottom curve to establish when turn-off commences.

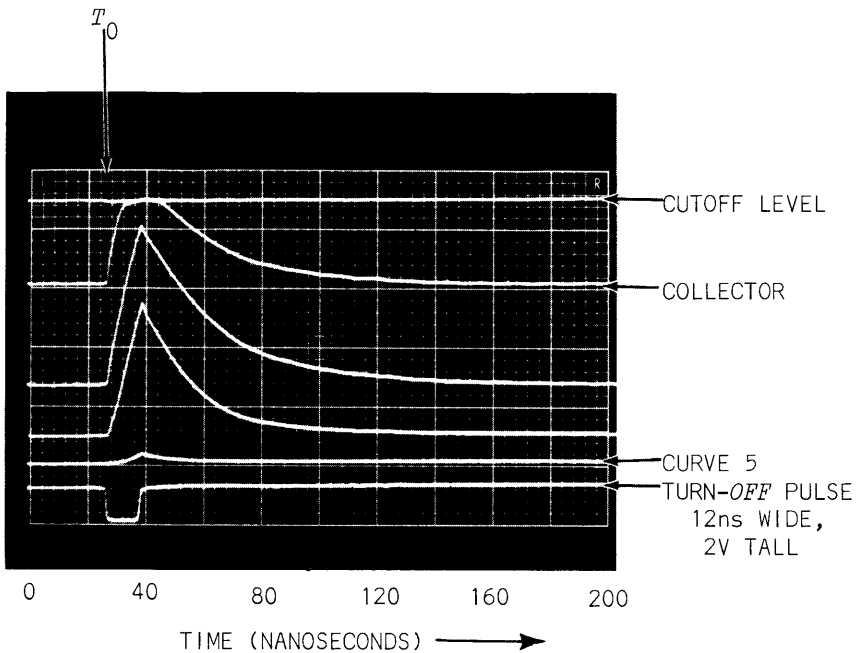

Fig. 1-26. Turn-off characteristics of small high-speed transistor. Five collector-voltage curves that correspond to five base bias levels between saturation and cutoff. Carrier storage time (t_s) apparent in curve 5 is partly due to quiescent saturated condition. Conditions similar to Fig. 1-25 and Fig. 1-28. Turn-off pulse is 2mA (Two volts across 1 k Ω).

The collector curves are of the same NPN transistor as used for Fig. 1-25 and the beginning of turn-off is represented by the up-going portions of those curves. The curve adjacent to the bottom curve is the only curve representing a quiescent saturated condition. Notice that this curve is the only one which does not appear to start to respond the instant the turn-off pulse is applied. Because the turn-off pulse is only about 1.2 volts in amplitude, and it can reduce base current by only about 1.2 mA (through a 1 k Ω series resistance), the collector could not be saturated very much and still show the influence of only a 1.2 mA reduction in base current.

See Fig. 1-27. To show a delay in response to a turn-off pulse, the drive pulse amplitude was increased so that the transistor could be saturated harder and the turn-off pulse still be able to reduce base current enough to let the transistor come well out of saturation. The time scale was reduced from 20 nanoseconds per division to 5 nanoseconds per division, to avoid crowding the curves. The four top curves are produced under identical conditions except that the quiescent bias current was changed. The top two curves represent bias levels that allowed the transistor to remain out of saturation. These two curves show essentially no delay in response to the turn-off pulse. However, the bottom two collector curves represent a saturation condition, and show a delay in response to the turn-off pulse. The curve which shows the greater delay represents the more saturated condition. This delay in response to turn-off is called carrier storage time, or simply storage time (t_s). As the term implies, the delay is attributable^s to an excess of carriers someplace. The excess carriers are primarily in the base material unless the collector-base junction becomes forward-biased in saturation. The primary reason for the excess is that collector voltage has been reduced so greatly by the voltage drop across the collector load resistor, that an insufficient voltage remains to collect all of the carriers that have become mobilized. These excess carriers will eventually disappear due to collector current, and by recombination with others of opposite polarity within the semiconductor material. Storage time will be less if new carriers are not created by allowing some

t_s - storage
time

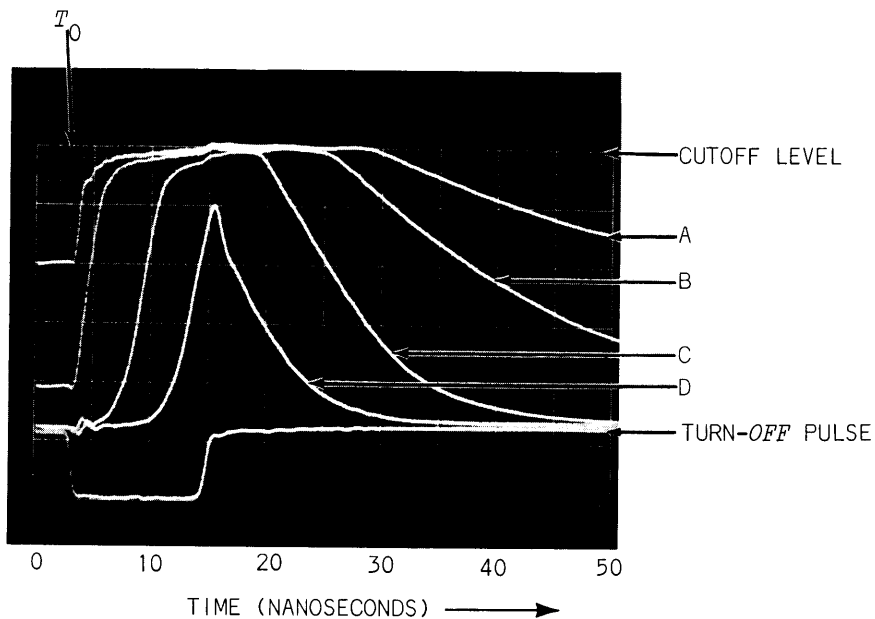

Fig. 1-27. Turn-off characteristics of small high-speed transistor using 6mA turn-off pulse. Four collector-voltage curves corresponding to four bias levels. Turn-off corresponds to rising portions of curves. Curves C and D show storage time (t_s), a delay in response to turn-off pulse, due to beginning in saturated condition. See Fig. 1-28 for circuit.

cutoff pulse
high and
fast reduces
 t_s

residual base current to continue to flow. In other words, the applied cutoff pulse will reduce carrier storage time if it is high in amplitude as well as fast in transition time. When the turn-off pulse is more than tall enough to reduce base current to zero, the direction of current flow in the base lead will reverse and tend to back-bias the emitter-base junction. This momentary reverse current will speed up removal of excess carriers, too.

It is worthwhile noting that the carrier storage time represented by the middle two curves in Fig. 1-27 far exceeds the risetime of the leading edge of the turn-off pulse. If the risetime of the turn-off pulse had not been much shorter than the storage time, there could be a considerable difference in the display and the measurement of storage time.

t_f -- Fall Time

fall time:
same factors
as risetime

Fall time is determined by essentially the same factors that determine risetime. Refer to the paragraphs on risetime for that discussion. Figs. 1-25 and 1-26 show the same transistor under nearly identical test conditions, except Fig. 1-25 shows response to a turn-on pulse whereas Fig. 1-26 shows response to a turn-off pulse. Compare the falling slopes (risetime) of Fig. 1-25 with rising slopes (fall time) of Fig. 1-26.

Fig. 1-28 shows a simplified diagram of the test circuit used to produce the curves photographed and shown in Figs. 1-25, 1-26 and 1-27.

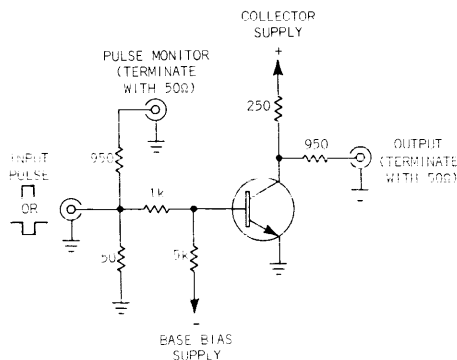

Fig. 1-28. Simplified switching-time test circuit.

INPUT CAPACITANCE

$$C_{ies}, C_{ibs}, C_{ieo}, C_{ibo}$$

The input capacitance of a transistor will depend on whether the transistor is operated in the common-emitter mode or the common-base mode, and it will depend on the value of the load impedance. The symbols C_{ies} and C_{ibs} are used when the output load is zero ohms (output short circuited). To symbolize input capacitance under the opposite extreme of output load resistance (output open circuited), C_{ieo} and C_{ibo} are used. The symbols, therefore, stand for boundary conditions that cannot quite be realized in practice in any case.

The input capacitance of amplifying devices like vacuum tubes and transistors is of interest to a circuit man because that capacitance has a bearing on the high frequency response or switching time of his circuit. In particular it will give a clue to the loading effects on whatever is used to drive the input of the amplifying device. With vacuum tubes, which are voltage-controlled devices ideally having a high input impedance under all conditions, input capacitance will predominate at even audio frequencies when the driving impedance is high. With transistors, that are current-controlled and have an input impedance that is low compared to vacuum tubes, input capacitance has a somewhat different significance.

transistor vs triode

To a very limited extent the plate-grid capacitance of a triode is comparable to the collector-base junction capacitance of a transistor. And to the same limited extent the grid-cathode capacitance is comparable to the emitter-base junction capacitance of a transistor. These two capacitances plus voltage gain are practically all that need be known about a vacuum tube to predict its input capacitance. With transistors, however, several things are radically different:

- real C and virtual C
1. Collector-base junction capacitance changes with collector-base voltage.
 2. Emitter-base junction capacitance may have very little change in charge because base-emitter voltage typically changes slightly when the transistor is turned on.

3. Carrier *diffusion time* acts like capacitance.
4. Carrier *recombination time* acts like capacitance.
5. Some of the real and the virtual capacitances have considerable resistance to charge and discharge through.

Because of the equal importance of these other various characteristics, input capacitance is usually estimated by measuring the two junction capacitances using a capacitance bridge. Input impedance or admittance measurements at various frequencies under various operating conditions using RF bridges are used for a more complete picture. Bridges are offered commercially that permit high frequency measurements to be made beyond 1 GHz.

OUTPUT CAPACITANCE

C_{oes} , C_{obs} , C_{oeo} and C_{obo}

output C vs
HF
performance

The output capacitance of transistors, similar to input capacitance, depends on a complex variety of things. Output capacitance is also of interest primarily because it affects high frequency performance. Besides measuring junction capacitance with a bridge, output admittance measurements are sometimes made at various frequencies from which most high-frequency-limiting factors may be deduced. Admittance and impedance bridges are offered for these kinds of measurements that perform well beyond 1 GHz.

HIGH-FREQUENCY CURRENT GAIN

As with the measurement of input and output admittance at high frequencies, measurement of transfer functions at high frequencies can be made with bridges designed for that purpose.

f_{hfe} -- Cut-Off Frequency for h_{fe}

The small-signal current transfer ratio for transistors operated in the common-emitter mode invariably becomes smaller and smaller at higher and higher frequencies. The frequency at which the

current gain of a transistor driving a low impedance load decreases by 3 decibels (current down 29.3%) is the cut-off frequency. For example, a transistor having a current gain of 100 at low frequencies would have a current gain very close to 70 at the cut-off frequency. There would still be a very considerable gain at the so called "cut-off" frequency.

f_T -- *Frequency of Unity Current Gain, Common-Emitter*

f_T - no gain

As the small-signal short-circuit current gain of a transistor is measured for signals having higher frequencies than f_{hfe} , a frequency can be found where the gain has diminished to unity, or one. At higher frequencies than that the current gain is less than one, that is, a loss. So f_T can be considered the frequency beyond which the transistor will not provide current gain.

gain
bandwidth
product

The frequency f_T can usually be determined using equipment that does not extend to f_T in direct frequency measurement capabilities. The reason is that current gain usually falls off at the rate of 6 db (50%) every time the frequency is doubled, beyond the cut-off frequency. The roll-off curve is usually very similar to a simple RC curve. From such a curve f_T may be extrapolated. Usually a checkpoint or two is selected at one or two frequencies beyond the cut-off frequency to assure a more reliable calculation. The symbol f_T is sometimes called the gain-bandwidth-product frequency, because the product of gain and frequency will be a constant for frequencies beyond f_T and fairly constant for an octave or two below f_T when h_{fe} is high at low frequencies.

f_{hfb} -- *Common-Base Cut-Off Frequency*

The common-base mode does not provide a current gain. Gain is typically very close to one but never is more than one. Nonetheless, even this low gain falls off at high frequencies. The frequency at which the gain falls 3 db below that for low frequencies and DC is f_{hfb} . This cut-off frequency is usually in the same vicinity as f_T .

INPUT IMPEDANCE

bipolar transistors have low Z input

Z input - h_{ie} , h_{ib} , h_{ic} - R input

Bipolar transistors are current-controlled semiconductor devices, and have low input resistance compared to vacuum tubes and field-effect transistors. To calculate the loading effect that a transistor will present to whatever driving source it may be connected to requires a knowledge of its input characteristics. Except at high frequencies where input capacitance may influence input impedance, and except for extremely high frequencies where transistor lead inductance may enter the picture, the input characteristics of a bipolar transistor are essentially resistive in nature. Measurement of h_{ie} , h_{ib} , and h_{ic} -- the small-signal h-parameter common-emitter, common-base, and common-collector symbols for input impedance -- pertain strictly to resistance, because they apply at only low frequencies and DC. Input resistance is, however, typically *nonlinear* if measured over a wide range of driving current.

R input nonlinear

It is because of the nonlinear nature of input resistance that we must be specific about the conditions for measuring it. Any transistor can be operated in a variety of ways to have a wide range of input resistance values. The common-collector mode offers the highest input impedance by quite a margin, extending into megohms, when the load is also a high impedance. The common-base and common-emitter modes have low input impedance values. This range may be from a fraction of an ohm to over 1000 ohms depending on the amount of forward bias, and whether the collector voltage is near saturation. The common-base configuration has the lowest input impedance by a considerable margin, for comparable amounts of collector current.

h_{IE} and h_{ie} -- *Static and Dynamic Input Resistance, Common-Emitter.*

$$h_{IE} = \frac{V_{BE}}{I_B}$$

Static input resistance, h_{IE} , is equal to the quotient of the voltage-drop across the base-emitter terminals and the base current producing that voltage drop -- at a given collector voltage. It can be easily calculated after the current and voltage have been measured with simple DC instruments. Or the currents may be applied and voltages read from the curves presented by a transistor curve tracer. See Fig. 1-29.

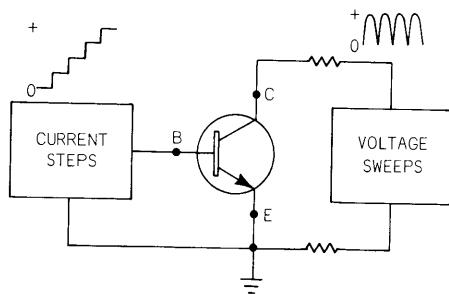
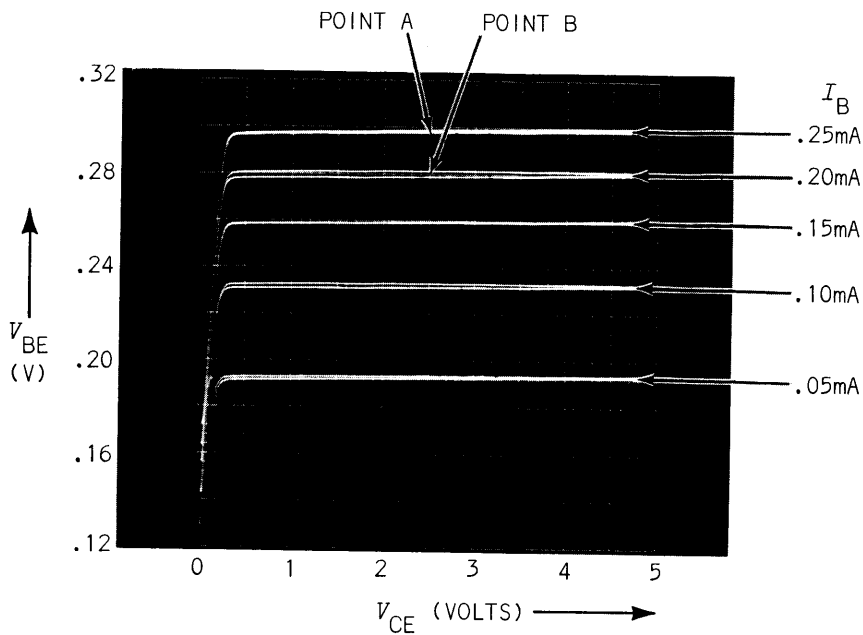

Fig. 1-29. Input resistance, 2N1304. Five constant current base steps applied. Voltage between base and emitter terminal 20 mV/div -- offset 120 mV. Dynamic input resistance (h_{ie}) between point A and point B = 20 mV (ΔV_{BE}) divided by .05 mA (ΔI_B) which equals 400Ω .

From the same display one may also determine *dynamic* (differential) input resistance, h_{ie} . The symbol h_{ie} stands for dynamic input resistance measured with the output load essentially zero ohms. The term "small-signal short-circuit" implies that the collector voltage should remain constant when the base current is changed. When measured on a curve tracer therefore, a vertical line at any horizontal position corresponds to one particular collector voltage. The vertical distance between curves at the horizontal position corresponding to a given collector voltage is proportional to the change in voltage drop at the base induced by a selected change in base current. Dividing the measured change in base voltage, ΔV_{BE} , by the selected change in base current, ΔI_B , gives the differential input resistance for that set of conditions.

$$h_{ie} = \frac{\Delta V_{BE}}{\Delta I_B}$$

By looking at the set of curves and noting the difference in vertical distance between each of them you can instantly perceive the difference in input impedance at various bias conditions. The vertical distance between adjacent curves is directly proportional to the dynamic input resistance at any given collector voltage.

h_{IB} and h_{ib} -- *Static and Dynamic Input Resistance, Common-Base*

$$h_{IB} = \frac{V_{BE}}{I_E}$$

Static input resistance, h_{IB} , is equal to the quotient of the voltage drop across the emitter-base terminals and the emitter current. The collector voltage will have a small influence so it should be specified.

The voltage-drop across the emitter-base terminals is due to *base* current, the same as for the common-emitter mode, not due to emitter current. Therefore, if we were to start with the same amount of base current as we did for a measurement of input impedance in the common-emitter mode, we can compare input impedances of two modes. Under these conditions we would compare the quotient of V_{BE}/I_B with the quotient of V_{BE}/I_E . This is like simply comparing base current (I_B) with emitter current (I_E). In other words, input resistance for the common-base mode is much less than for the common-emitter mode, when other conditions are the same.

measure h_{IF}
and h_{FE} ,
calculate
 h_{IB}

$$h_{IB} = \frac{h_{IE}}{h_{FE} + 1}$$

So h_{IB} may be determined by measuring h_{IE} and h_{FE} , then calculating h_{IB} .

h_{IC} and h_{ic} -- *Static and Dynamic Input Resistance, Common-Collector*

The input impedance for the common-collector configuration is higher than the common-emitter configuration, except when the load is zero ohms. When the load is zero ohms the input resistance is the same as for the common-emitter mode. Therefore, h_{IC} and h_{ic} , which are symbols for static and dynamic input resistance with output short-circuited, can be measured using the common-emitter configuration.

Input Impedance of Emitter-Followers

emitter
output
follows base
input

operating
limits.

The load, in the common-collector mode, is driven by the emitter rather than the collector. The circuit configuration is frequently called an emitter-follower, unless the load is close to zero ohms. Emitter-followers are seldom intended to drive zero ohms, so in practice, the input resistance is higher than for the common-emitter mode. The voltage at the emitter terminal, because it must remain close to the voltage at the base terminal except when the transistor is cut off, will move up and down closely following the voltage excursions on the base. As long as the voltage excursions don't go beyond the voltage level to which the emitter load is returned, where cutoff or breakdown would occur, or too close to the level of the collector supply voltage, where saturation would occur, an emitter follower may be made to operate normally.

When the load driven by an emitter follower is high compared to the input resistance of the same transistor operated in the common-emitter mode, the input resistance is approximately equal to the product of the resistance of the load (R_L) and the common-emitter forward current transfer ratio (h_{FE}).

The static value of input resistance differs somewhat from the simple product of h_{FE} and R_L because the collector-to-emitter voltage does not remain

constant as collector current changes in an emitter-follower. When current increases in an emitter-follower, the emitter voltage approaches the collector voltage and thereby reduces the current transfer. Likewise when base current is reduced and collector current is also thereby reduced, the collector-to-emitter voltage increases. The net increase in collector voltage retards the reduction in emitter current.

The combined effect can readily be discerned and measured on a transistor curve tracer by connecting the selected value of load resistance between the emitter terminal and ground then displaying a family of curves depicting collector current versus collector voltage. See Fig. 1-30. At a collector-to-ground voltage of 5 volts, 4 mA of collector current flows when base current is 0.12 mA ($6 \times .02$ mA). The static input resistance at this point (Point A) on the curve would be equal to the base-to-ground voltage divided by the base current. The base current (0.12 mA) plus the collector current (4 mA) flows through R_L producing 4.12 volts of drop. So the base voltage will be close to 4.12 volts. Actually it will be about 0.6 volts more than that because the base-emitter junction is forward biased. The static input impedance is, therefore:

20 μ A/step
x 6 steps

$$\frac{4.72 \text{ volts}}{.00012 \text{ amperes}} = 40,000 \text{ ohms}$$

This operating point is very close to saturation, as can be seen by the knee on the curve just below the 5-volt collector voltage point on the curve. This transistor would not normally be operated as an emitter follower with more than 4 volts on the base unless it were operated with a higher collector voltage than 5 volts.

The differential input resistance would depend on how the transistor was biased in the quiescent condition and how big the changes of input voltage are. If we consider the quiescent condition to be with .06 mA of base current and 5 volts on the collector, the mid-section of the middle curve (Point C) in Fig. 1-30 is representative. Collector current is 1.7 mA and base current .06 mA, so emitter current is 1.76 mA. This means an emitter voltage of 1.76 volts (voltage drop across 1 kilohm) and a base voltage very close to 0.6 volts higher than that, or 2.36 volts. If we raise

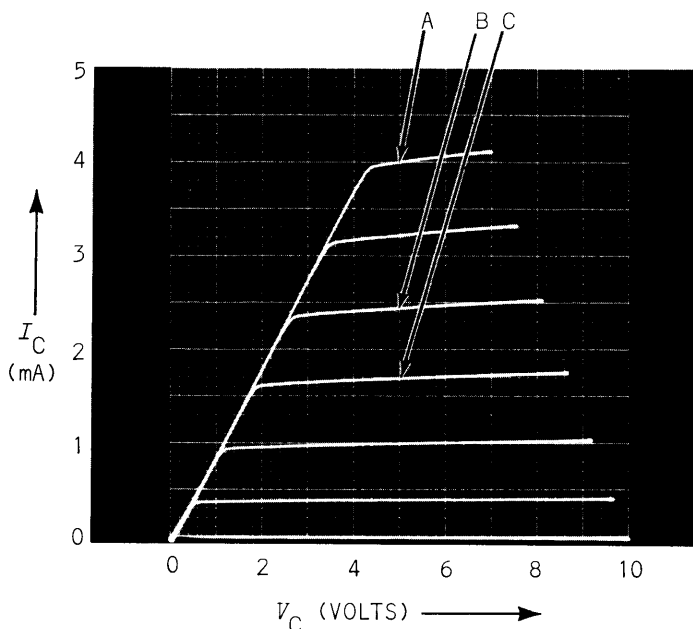

Fig. 1-30. 2N3137 emitter follower conductance characteristics. R_L equals 1000Ω . Base current steps are $20\ \mu\text{A}$.

the base-to-ground voltage enough to increase base current from $.06\ \text{mA}$ to $.08\ \text{mA}$ (Point B), collector current will increase from $1.7\ \text{mA}$ to $2.4\ \text{mA}$, a change of $0.7\ \text{mA}$. Emitter current will change from $1.76\ \text{mA}$ to $2.48\ \text{mA}$, a change of $0.72\ \text{mA}$. If we assume that the base-emitter forward voltage drop remains essentially constant, which it does except near cutoff, the change in emitter voltage is a good measure of the change in base terminal voltage. The change in emitter voltage is proportional to the change in emitter current and is equal to the product of the load resistor, $1\ \text{kilohm}$, and the emitter current change, $0.72\ \text{mA}$. This product equals 0.72 volts. The differential input resistance is equal to a change in base-to-ground voltage divided by the accompanying change in base current. By applying a known base current increase and calculating the base voltage increase, the differential input resistance is determined. In the example the dynamic input resistance is:

$$\begin{aligned} &\text{differential} \\ &\text{input } R \\ &= \frac{\Delta V_B}{\Delta I_B} \end{aligned}$$

$$\frac{0.72\ \text{volts}}{.00002\ \text{amperes}} = 36,000\ \text{ohms}$$

The same measurement can be performed when *reducing* input voltage and current as when *increasing* input voltage and current. The vertical separation between the curves at a particular collector-to-ground voltage is proportional to the differential input resistance.

OUTPUT ADMITTANCE

Admittance is the reciprocal of impedance so measurements of output admittance are similar to measurements of output impedance. A high impedance is the same as a low admittance. Impedance is equal to voltage divided by current so admittance is equal to current divided by voltage.

h_{oe} -- *Dynamic Output Admittance, Common-Emitter*

The output admittance, or output impedance, of a transistor tells us what effect on current through the transistor a change in the output terminal voltage may cause. Measurement of a transistor's output admittance is usually done by simulating a constant-current or "open-circuit" input. Transistor curve tracers simulate this condition very well.

Any curve which is a plot of current versus voltage has a slope which is equivalent to some impedance and some corresponding admittance. The collector current versus collector voltage curves that represent different discrete values of base current have two principal slopes. The slopes below the knees represent *saturation resistance*. Above the knees of the curves, the slopes represent output admittance or output impedance. The more nearly horizontal a section of a curve is, the less will be the output admittance it represents, *provided* current is plotted on the vertical axis and voltage is plotted on the horizontal axis. Most curves on most transistor curve tracers depict current on the vertical axis.

slope above
knees for
Z_{out} or Y_{out}

Small-signal output admittance for the common-emitter mode is measured at a given base current and between two given collector voltages. The difference in collector current that would accompany the change

in collector voltage represented by the difference between two given collector voltages is proportional to output admittance. For the common emitter mode:

$$h_{oe} = \frac{\Delta I_C}{\Delta V_C} \quad \text{when base current is kept constant.}$$

See Fig. 1-31.

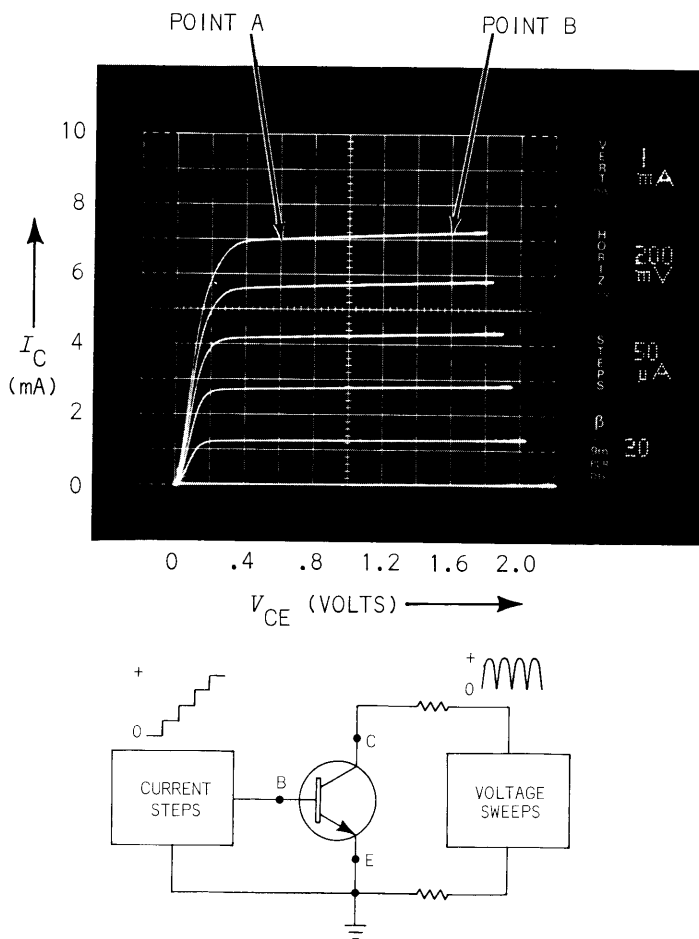

Fig. 1-31. Output admittance (h_{oe}) depends on slope of curves. ΔV_C and ΔI_C between point A and point B determine output admittance for base current of 250 μ A.

When the slope of a curve is nearly horizontal, expanding the display vertically so only a portion remains on screen will accentuate the slope and permit more accurate measurements to be made. See Fig. 1-32.

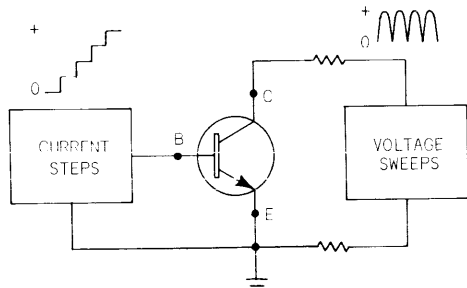
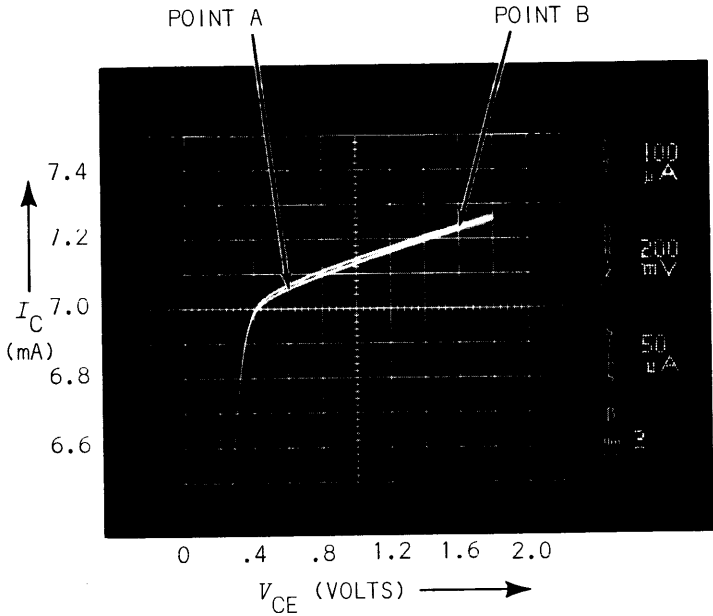

Fig. 1-32. Output admittance measurement accuracy improved with 10X vertical magnification. $\Delta I_C = .18 \text{ mA}$; $\Delta V_{CE} = 1 \text{ V}$.

h_{ob} -- Dynamic Output Admittance, Common-Base

The measurement of the output admittance of a transistor operated in the common-base configuration is done in very much the same way as for the common-emitter configuration. The common-base mode has a lower output admittance than the common-collector mode or the common-emitter mode. It follows that the output impedance for the common-base mode is the highest of the three modes. The slope of the curves which represent graphs of collector current versus collector voltage for various discrete amounts of emitter current is very nearly horizontal, as can be seen in Fig. 1-33. Compare Fig. 1-33 with Fig. 1-34.

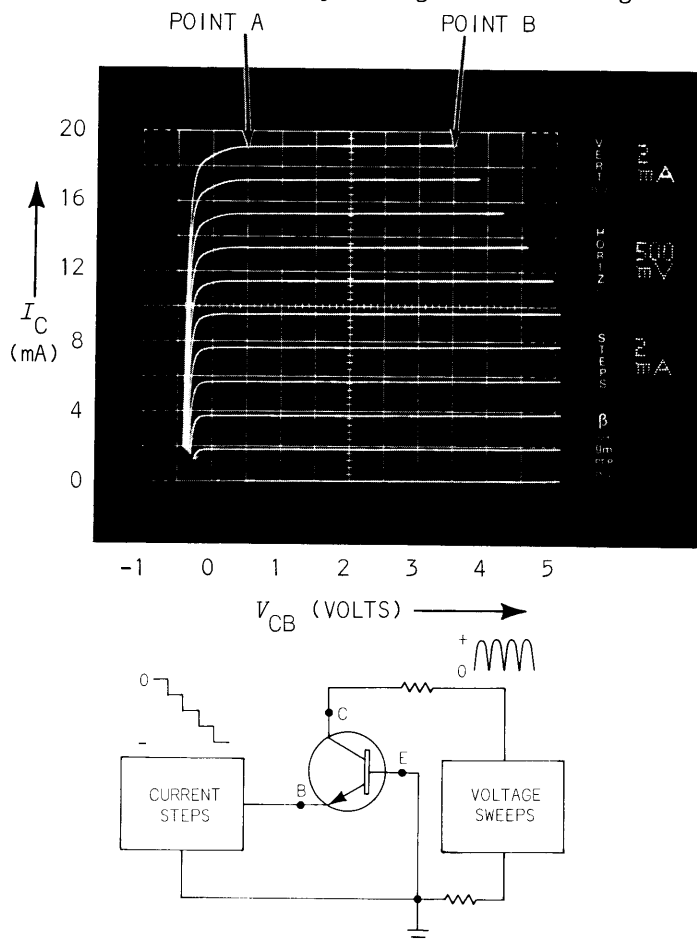

Fig. 1-33. Output admittance (h_{ob}) depends on slope of curves. See Fig. 1-34.

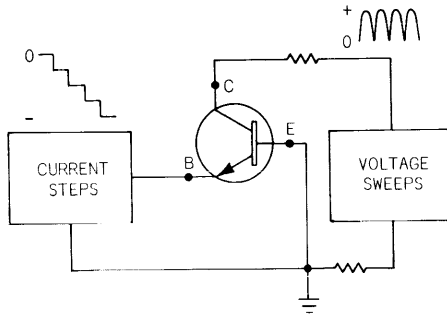
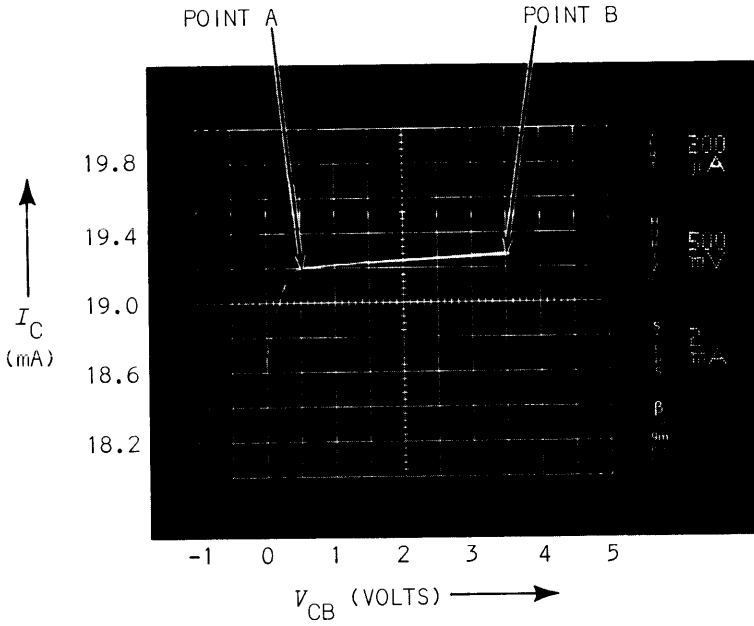

Fig. 1-34. Output admittance (h_{ob}). $\Delta I_C = .08 \text{ mA}$; $\Delta V_{CB} = 3 \text{ V}$.

Output admittance is the quotient of a collector voltage change and an accompanying collector current change at some region out of saturation. Usually emitter current is held constant. For the common-base mode:

$$h_{ob} = \frac{\Delta I_C}{\Delta V_C} \quad \text{when emitter current is kept constant.}$$

h_{oc} -- *Dynamic Output Admittance, Common-Collector*

The measurement of h_{oc} is made by measuring h_{oe} for equivalent conditions and considering the two equal.

REVERSE VOLTAGE TRANSFER

watch it!

Reverse-voltage transfer is a little like forward-current transfer; each is expressed as a ratio of a change at an output terminal compared to an accompanying change at an input terminal. Unlike forward current transfer, where the change in the output current is naturally considered a result of a change in the input current, reverse voltage transfer is the opposite. A change in *output* voltage can be considered to cause a change in *input* voltage when input current is held nearly constant. The reverse voltage transfer characteristic is important because a change in current through a transistor does often cause a considerable change in voltage at the output terminal, depending on the load, and this voltage change may affect the operation of the transistor.

The measurement of the small signal reverse voltage transfer parameters h_{re} , h_{rb} and h_{rc} requires the input current to be constant. This condition is comparable to the current being supplied through a very high resistance -- ideally an infinite resistance or "open-circuit."

h_{re} -- *Reverse Voltage Transfer, Common-Emitter*

Measurement of the reverse voltage transfer ratio for the common-emitter mode using a transistor curve tracer may be accomplished by plotting base voltage versus collector voltage for various discrete base currents. The slope of the curves any place beyond the knees will be an indication of the reverse voltage transfer ratio. The measurement is made by

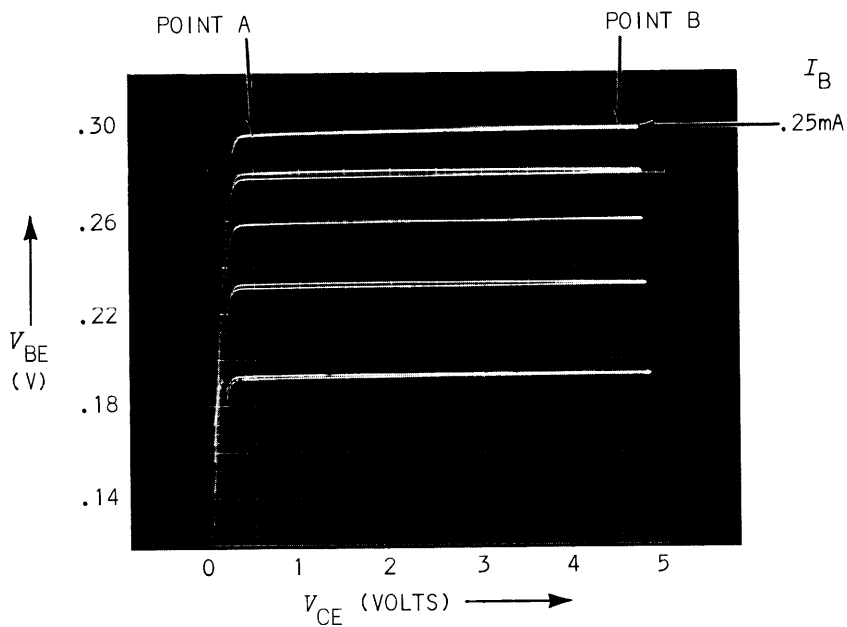

Fig. 1-35. Reverse voltage transfer (h_{re})
 2N1304, at base current of .25 mA.
 ΔV_{CE} between point A and point B is
 4 volts. ΔV_{BE} between same points is
 approximately 4 mV. $h_{re} = \frac{.004V}{4V} =$
 $\frac{1}{1000}$.

first finding the appropriate points on the appropriate curve that constitute the difference in collector voltage required, then measuring the difference in base-emitter voltage drop that corresponds to those points on the curve. Dividing the collector voltage difference (ΔV_C) by the base voltage difference (ΔV_{BE}) yields the transfer ratio. See Fig. 1-35.

h_{rb} -- Reverse Voltage Transfer, Common-Base

The measurement h_{rb} can be made in a way similar to measuring h_{re} , but the accuracy will be even less because the curves will be more nearly horizontal.

h_{rc} -- Reverse Voltage Transfer, Common-Collector

The reverse voltage transfer ratio for the common-collector mode is typically very close to one (1) because h_{re} is typically a very small fraction.

$$h_{rc} = 1 - h_{re}$$

2

FIELD EFFECT TRANSISTORS

LEAKAGE AND BREAKDOWN

I_{GSS} and $V_{(BR)GSS}$ -- *Leakage Current and Breakdown Voltage*

The measurement of leakage current and breakdown voltage of field-effect transistors is usually made with voltage applied between the gate and the source or between the gate and the drain. Or the drain may be shorted to the source, and voltage applied between the gate and the common connection between drain and source. The symbol $V_{(BR)GSS}$ stands for voltage breakdown measured between the gate and the source with the remaining terminal (the drain) shorted to the source. Measurement of breakdown voltage of insulated-gate field-effect transistors should ordinarily not be attempted. When breakdown does occur on this type of field-effect transistor, damage to the transistor may ensue even when current is limited. They may, however, be tested to see that breakdown does not take place below a certain rated voltage.

gate-source
breakdown

destructive
testing

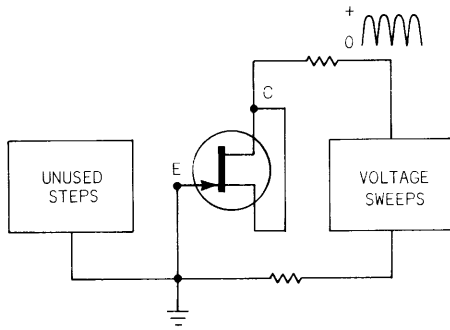
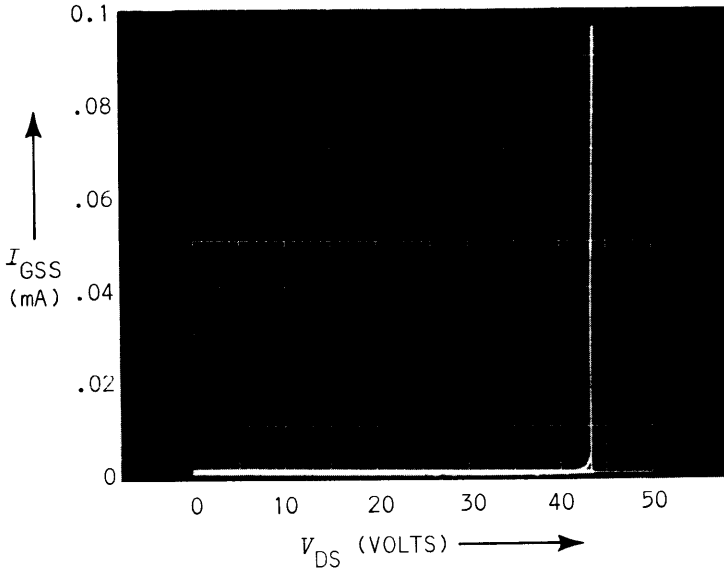

Fig. 2-1. $V_{(BR)GSS}$ 2N4416 junction FET.

Fig. 2-1 shows the breakdown region of an N-channel junction field-effect transistor displayed using a transistor curve tracer. From the photograph, breakdown can be seen to be at about 43 volts. Less than one volt increase in that region causes a current increase from less than 1 microampere to more than 100 microamperes. The manufacturer says the breakdown voltage should be no less than 30 volts at 25°C (room temperature). Breakdown is considered to have occurred for this transistor when 1 microampere of current or more flows.

Leakage current is measured between the gate and source also, usually under the same set of conditions as for measuring breakdown voltage, except somewhat less reverse voltage is applied. The symbol I_{GSS} stands for leakage measured under these conditions.

leakage
measured in
picoamps

Leakage current measurements may call for measurement of picoamperes (10^{-12} amperes). DC Meters are usually required for measurement of currents in the picoampere range. The desired, or specified, reverse voltage is applied, and the meter connected in series to read the current. Some transistor curve tracers will measure leakage current down to somewhat less than 1 nanoampere (1×10^{-9} amperes).

Drain Breakdown

Field effect transistors, like bi-polar transistors, have another kind of breakdown mode, one which occurs during the normal kind of operating conditions, with drain-to-source voltage applied and drain current flowing. Under these conditions breakdown starts when drain current increases greatly as a result of only a small increase in drain voltage. The symbol $V_{(BR)DSS}$ is used to indicate drain breakdown voltage when the gate-to-source voltage is zero, gate shorted to source.

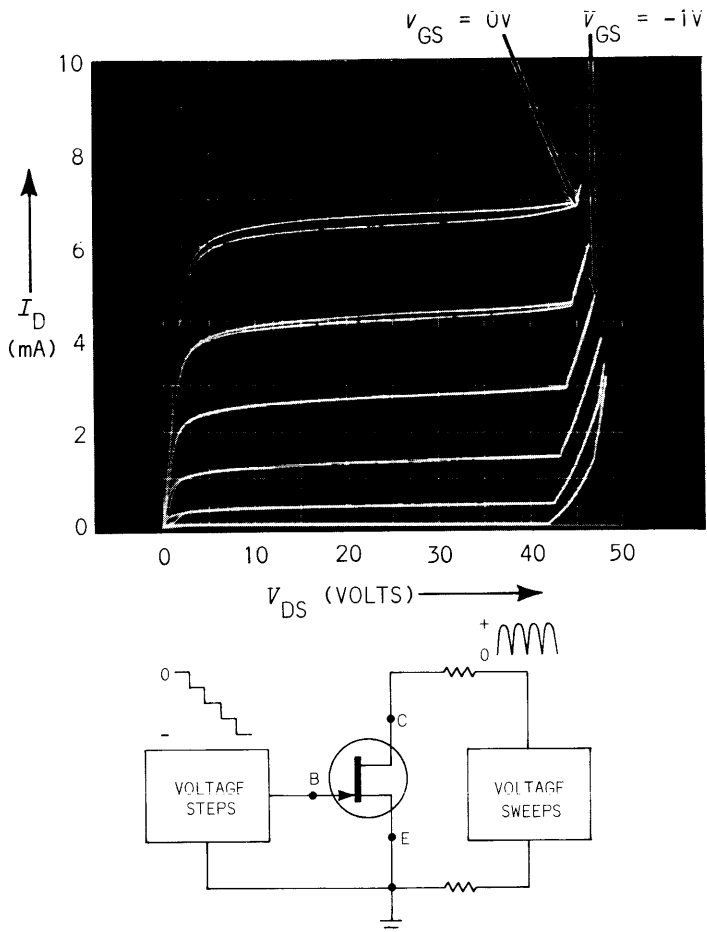

Fig. 2-2. Drain breakdown 2N4416 junction FET.

Fig. 2-2 shows breakdown starting somewhere between about 42 volts and 45 volts. The same junction field effect transistor was used for Fig. 2-2 as for Fig. 2-1, where breakdown was about 43 volts. This is not merely coincidental. Whenever the drain-to-source voltage exceeds the breakdown potential, the input current will add to the output current. Temperature affects the breakdown voltage somewhat. The breakdown voltage increases when temperature increases. This can be shown by comparing Fig. 2-3 with Fig. 2-2. In Fig. 2-3, because the input voltage (V_{GS}) is always zero volts, the average drain current is much higher than when the input

$V_{(BR)GSS}$ increases with temperature

I_D increase
with
temperature

voltage reduces drain current by more than half that value for more than half the time. The higher average drain current in Fig. 2-3 causes the field effect transistor to be hotter. Incidentally, increased temperature causes a *reduction* in drain current -- other conditions being equal. Notice in Fig. 2-3 that zero bias drain current is less than 6 mA when drain voltage is 10 volts, and more than 6 mA under the same conditions except for temperature -- shown in Fig. 2-2. The loops on the high-current curves are an indication of the thermal time-constant for the field effect transistor. Temperature increases as drain current increases, as a sweep voltage increases. That tells us the field effect transistor is hotter when the sweep voltage is reducing than when it was increasing. Drain current will therefore be higher at given drain voltages, as those voltages are passed with increasing sweep voltage, than when passed with decreasing sweep voltage. In other words, the top part of the loops is traced first.

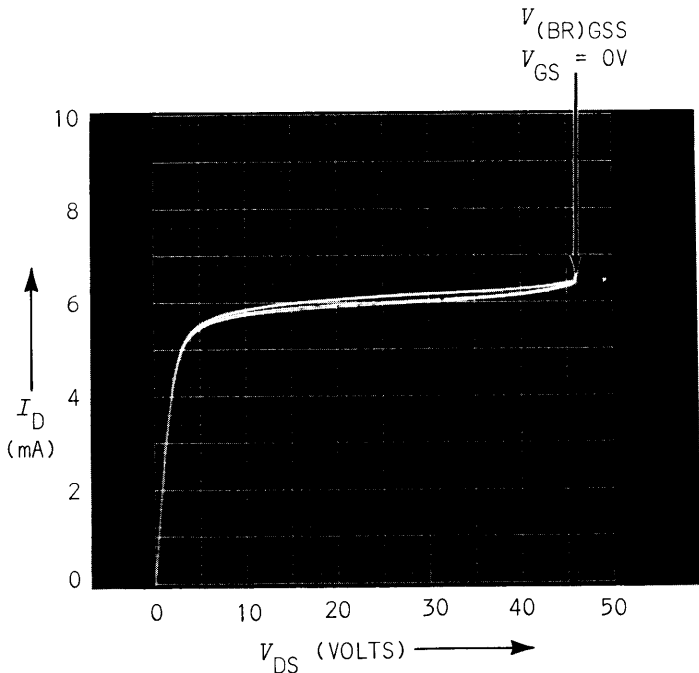

Fig. 2-3. Drain breakdown 2N4416 junction FET voltage increases with increase in temperature. Drain current decreases with temperature. Compare Fig. 2-2.

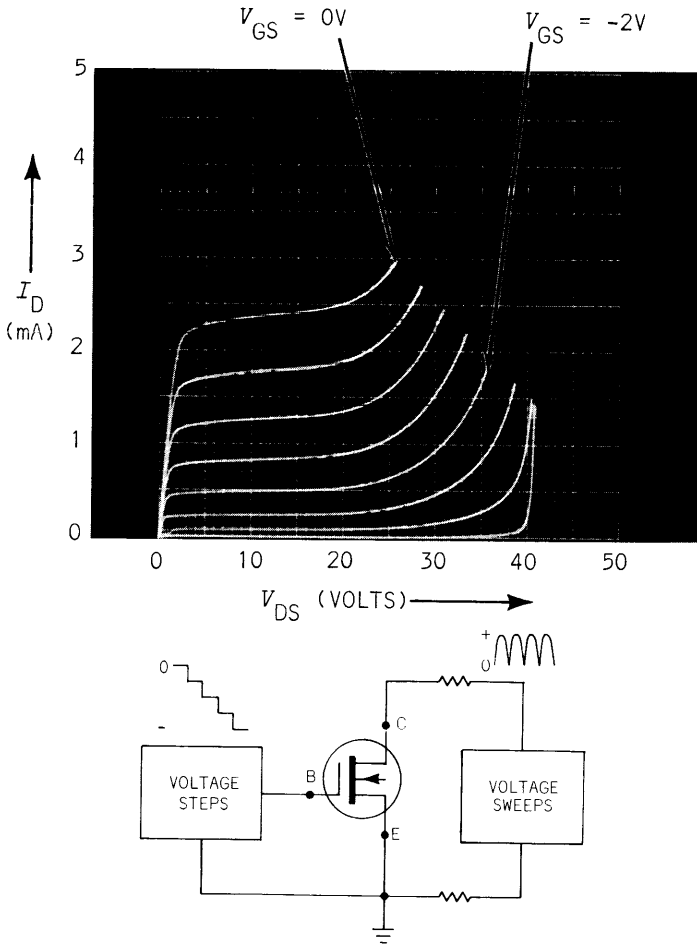

Fig. 2-4. Depletion mode operation showing breakdown. Insulated gate FET M-100.

breakdown
abrupt at
low I_D

See Fig. 2-4. The curves in this figure show a depletion mode, N-channel, insulated-gate field effect transistor operated in the *depletion region* between zero volts input bias and *pinch-off*. Breakdown is apparent for all amounts of gate voltage in that figure, but the breakdown region is most abrupt when the drain current is least. Fig. 2-5 shows the same transistor operated in the enhancement mode. The resistor used in series with the sweep voltage in the curve tracer limits the peak voltage appearing across the drain and source terminals at different values of drain current depending on the gate-drain bias.

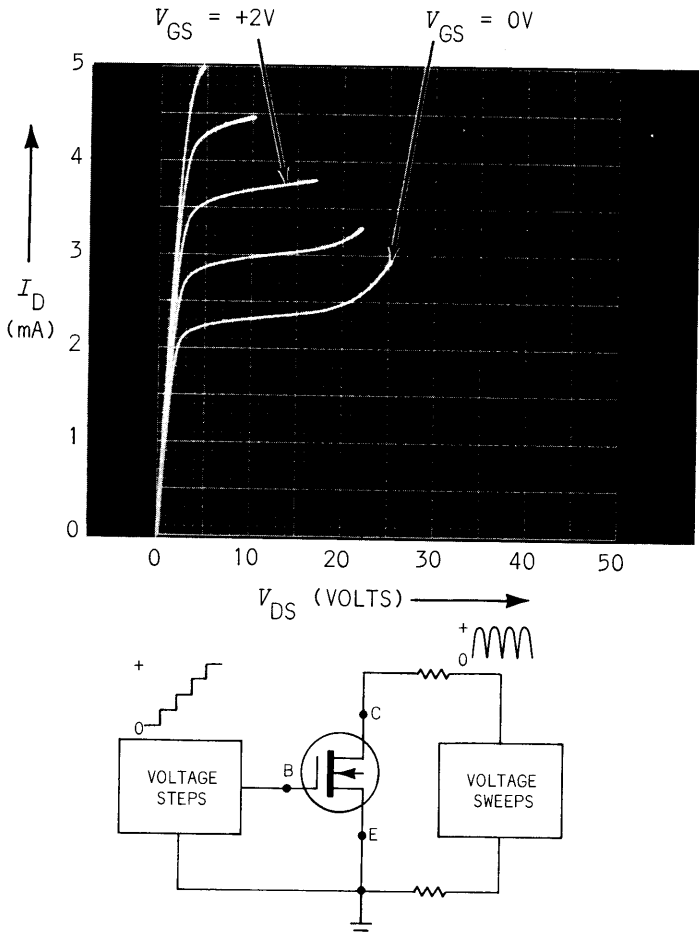

Fig. 2-5. Enhancement mode operation same FET as in Fig. 2-4.

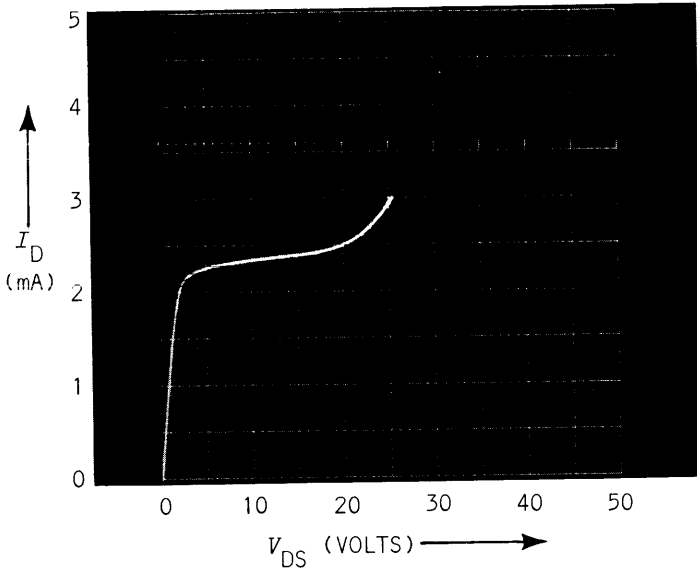

Fig. 2-6. Zero bias drain current. Insulated gate FET M-100.

FORWARD TRANSFER

The measurement of the forward transfer characteristics of field effect transistors is usually a matter of determining how much output current will flow at a given drain voltage with specific amounts of voltage at the input. Or the measurement may be to determine transconductance, how much *change* in output current there is with a specific *change* of input voltage.

I_{DSS} -- Zero Bias Drain Current

An important transfer characteristic is the value of output current which flows when the input voltage is zero. The symbol for this characteristic is I_{DSS} -- the drain current that flows when the source is shorted to the gate. Zero voltage exists between source and gate when the two are shorted together, of course. That drain current will depend on drain voltage too, so drain current should be measured at a specified drain voltage. Temperature may make a considerable difference, so temperature should also be specified.

Fig. 2-6 shows the drain current which flows in a typical N-channel insulated gate field-effect transistor when the gate and source are shorted together and the drain voltage is swept between zero volts and 25 volts at room temperature. Fig. 2-5 shows curves for the same transistor operated with gate voltage drive that starts at zero volts and changes in +0.5-volt steps to enhance (increase) drain current. However, this field-effect transistor is intended primarily to be operated with negative gate voltage drive, that is drive that depletes (reduces) drain current. Fig. 2-4 shows the forward transfer characteristics of the same transistor operated in its normal, depletion mode.

V_P or $V_{DS(OFF)}$ -- *Pinch-off Voltage*

A characteristic which is important for depletion-mode operation is pinch-off voltage -- the input voltage required to turn off drain current

Fig. 2-7 shows the characteristic curves for drain current versus gate voltage for a junction field effect transistor operated with the drain supply

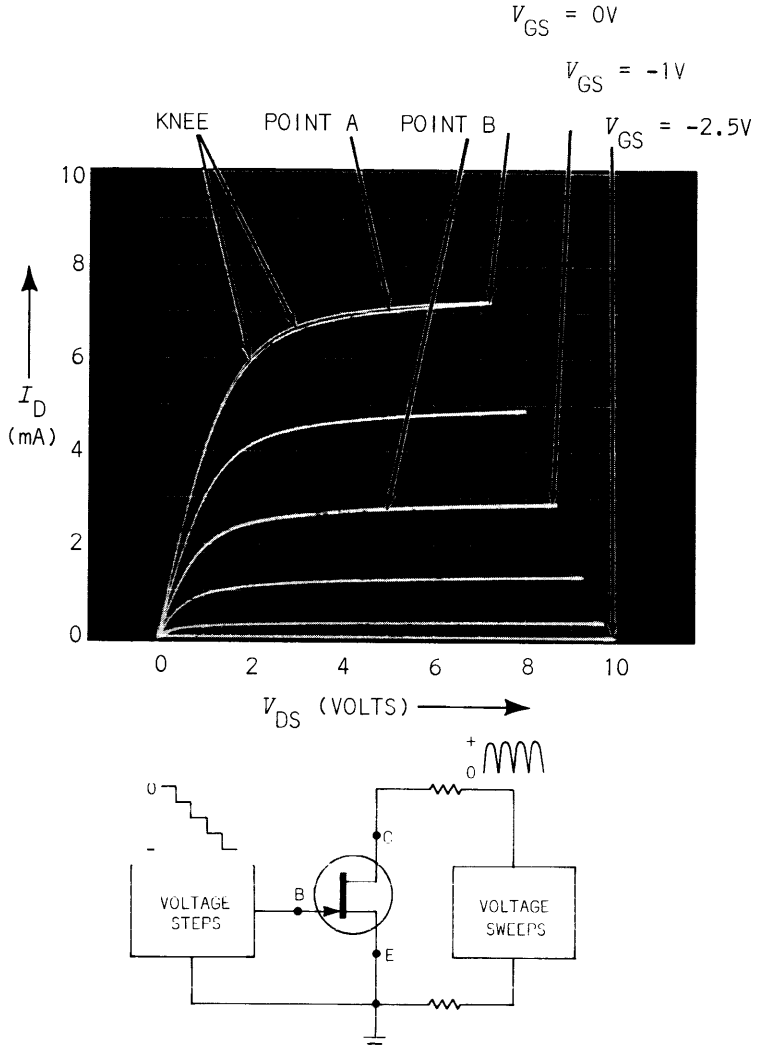

Fig. 2-7. Depletion mode operation of junction FET 2N4416.

pinch-off at
1 nanoamp

voltage swept between zero and ten volts. Gate voltage was increased negative in 0.5-volt steps into the pinch-off region. The figure shows very little current remaining with -2.5 volts applied between the gate and source terminals. Drain current might therefore be said to be pinched off at -2.5 volts. However, if the vertical scale is expanded ten times (see Fig. 2-8), a current of a little less than 40 μA can be observed to be flowing with -2.5 volts applied to the gate terminal. Pinch-off voltage for this field effect transistor is specified by the manufacturer to be less than 6 volts when the drain-to-source voltage is 15 volts, and the drain current is 1 nA or less.

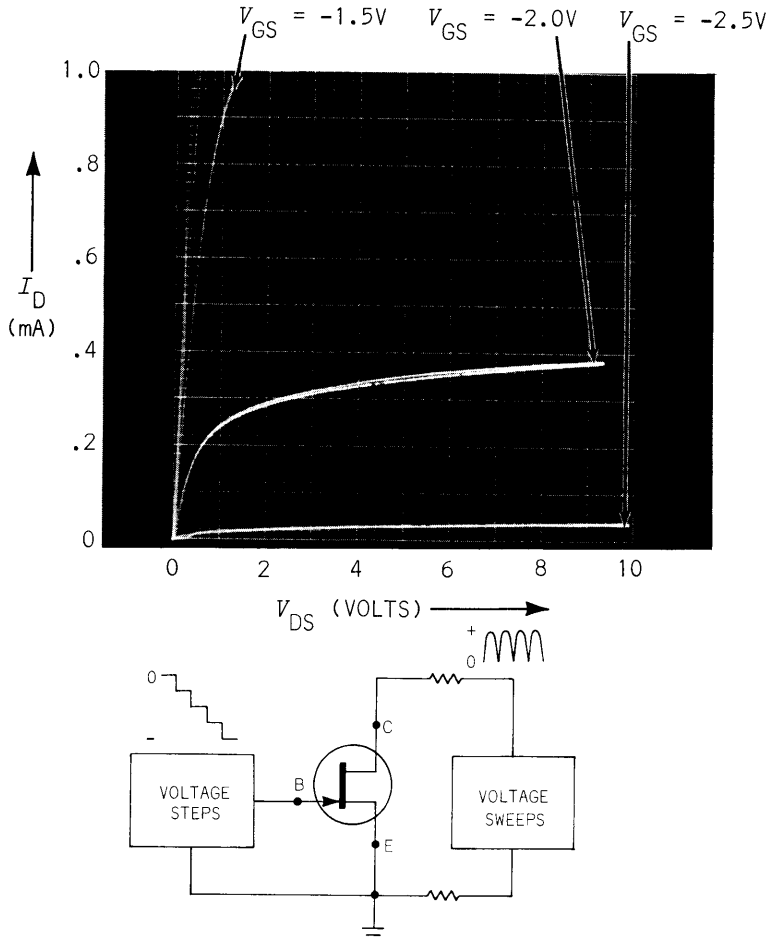

Fig. 2-8. Pinch-off region 2N4416 junction FET.

pinch-off
specified
by
conditions

Some people will consider drain current to be pinched off when it is less than 1% of the zero bias drain current that flows when the drain voltage is at some low value near the knee of the curves. For the set of curves in Fig. 2-7 the knee voltage would be about 2 volts. Drain current at that drain voltage is about 6 mA when the gate-to-source voltage is zero. Any drain current less than 60 μ A (1% of 6 mA) might therefore be considered pinch-off current, similar to cutoff current for bipolar transistors.

Fig. 2-9 shows the depletion mode characteristics of the same field effect transistor as in Fig. 2-7 and Fig. 2-8, but with reduced drive and a different

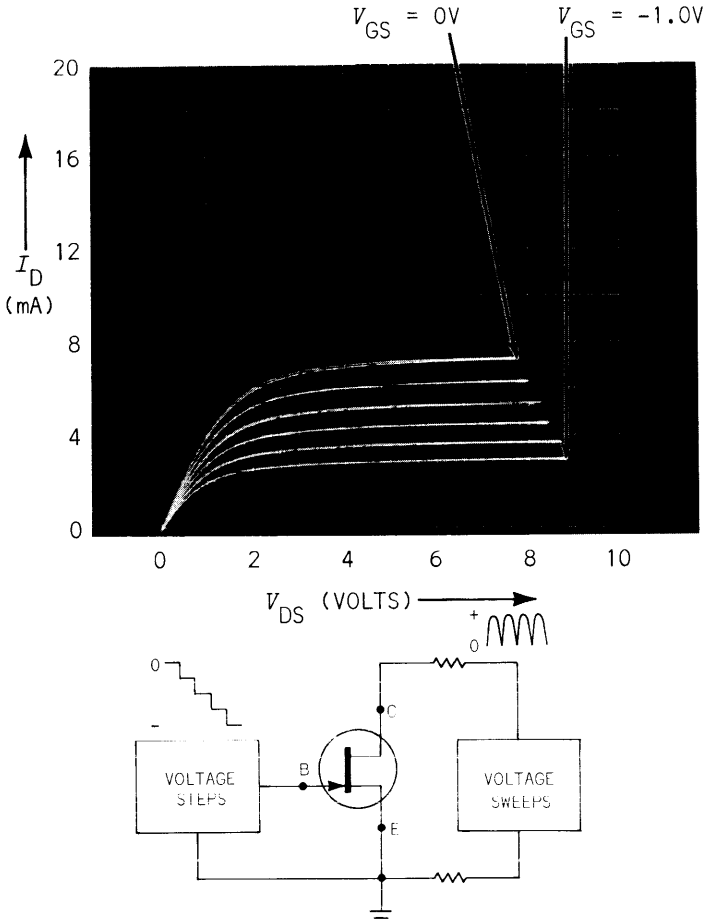

Fig. 2-9. 2N4416 junction FET. V_{GS} source resistance 1Ω . Depletion mode operation.

vertical scale factor. The purpose of showing Fig. 2-9 is to make it easy to contrast depletion mode operation of this junction field effect transistor with enhancement mode operation. Fig. 2-10 shows the enhancement mode. A comparison of Fig. 2-10 with Fig. 2-9 shows a vast increase in drain current when the gate-to-source voltage is increased from +0.8 volts to +1.0 volts. Below +0.6 volts the change in drain current with each equal increment (or decrement) of gate-to-source voltage is nearly equal. The reason for the radical change at about +0.6 volts is that the gate-source junction becomes forward biased, and the device starts to behave similar to a bipolar transistor: It starts to become current controlled instead of voltage controlled. The

voltage-
controlled
vs
current-
controlled

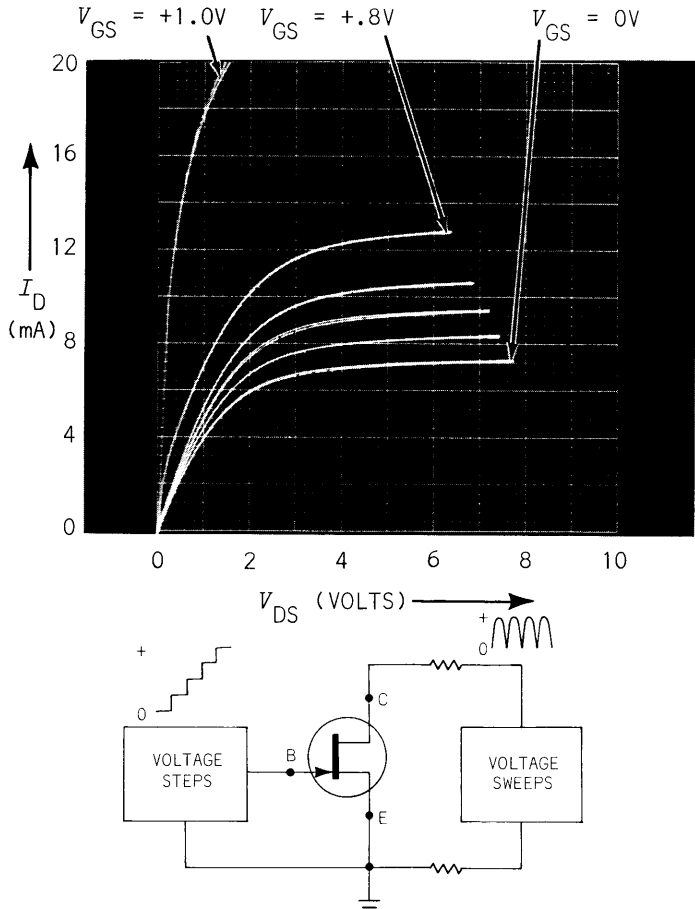

Fig. 2-10. 2N4416 junction FET. V_{GS} source resistance 1Ω . Enhancement mode operation.

gate supply
1000 Ω
vs 1 Ω

impedance of the gate voltage supply becomes very significant for enhancement mode operation of junction field effect transistors. To illustrate this point Fig. 2-11 and 2-12 show depletion versus enhancement operation of the same field effect transistor as in the former figures. There is a 2.5 to 1 greater voltage drive, but from a 1000-ohm supply resistance compared to a one-ohm supply resistance. Notice the great reduction of maximum drain current in Fig. 2-12 compared to Fig. 2-10. The cause, of course, is due to a larger than 2.5 to 1 reduction of gate-to-source voltage when forward current starts to flow. The reduced gate voltage is due to the IR drop across the 1000-ohm supply resistance.

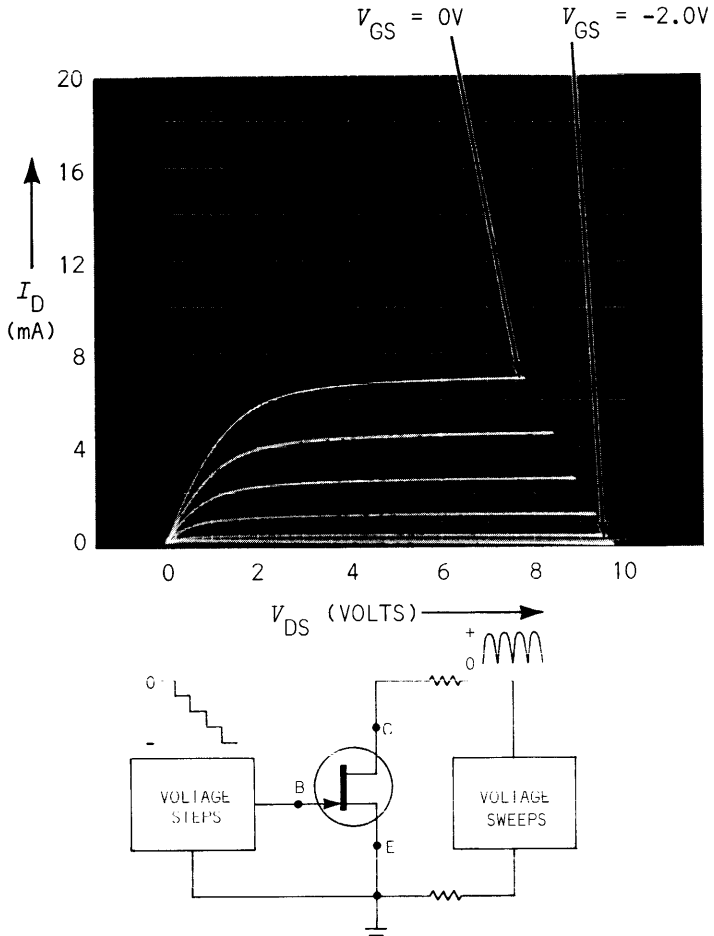

Fig. 2-11. 2N4416 depletion mode operation.
 V_{GS} supply resistance = 1000Ω.

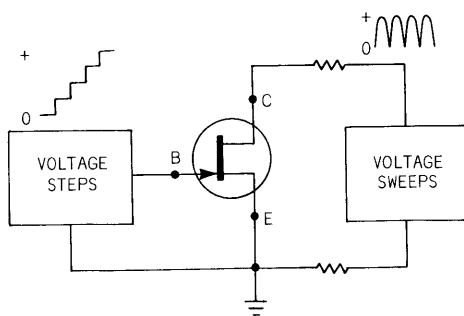
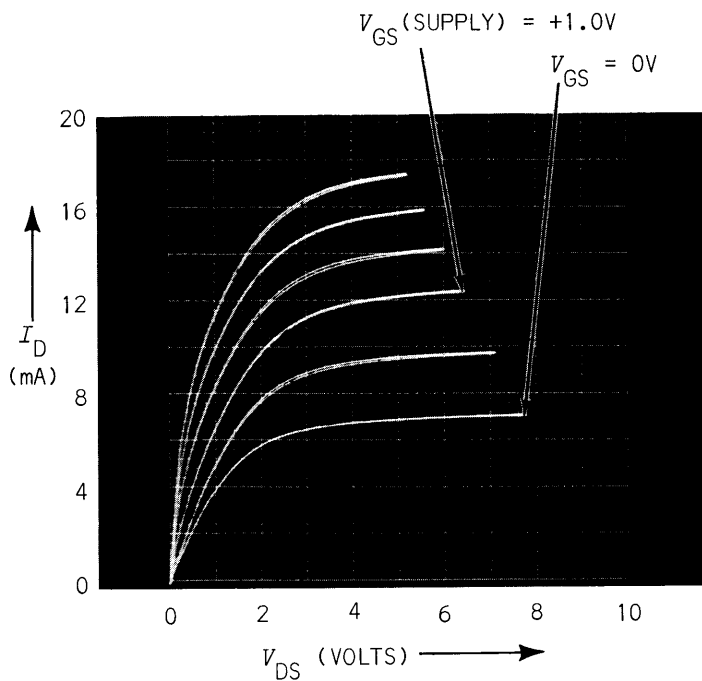

Fig. 2-12. 2N4416 junction FET. V_{GS} supply resistance 1000Ω . Enhancement mode operation.

G_m -- Transconductance (or transadmittance)

The transconductance of a field effect transistor is an important forward transfer characteristic. It is an expression which tells us how much change in output current may be induced by a change in the input voltage.

$$G_m = \Delta I_D / \Delta V_{GS}, \text{ at a given drain-to-source voltage}$$

G_m increases
with I_D

Transconductance is typically higher in any region where drain current is high than in regions where drain current is low. Past the knee, drain voltage has only a slight effect on drain current for a given gate voltage. But the effect of drain voltage on transconductance is even less if the drain current is kept constant as the drain voltage is changed. In other words, for a given field effect transistor the transconductance is more a function of drain current than of drain voltage.

Transconductance is proportional to the vertical distance between curves for a family of drain current versus drain voltage curves, such as shown in Fig. 2-7. In that figure, at a drain voltage of 5 volts, drain current drops from 7 mA (Point A) to 2.8 mA (Point B) for a change in gate voltage from zero volts to -1.0 volts. That is a change of 4.2 mA in output current due to a one volt change in the input voltage.

$$G_m = \frac{.0042 \text{ amperes}}{1 \text{ volt}} = .0042 \text{ mhos} = 4200 \text{ } \mu\text{mhos}$$

G_m greater
in
enhancement
mode

Fig. 2-13 shows an insulated-gate field effect transistor driven by a step generator which steps in one-volt increments from -2 volts to +2 volts. The transconductance for an input voltage near zero with 5 volts between drain and source is somewhat greater for the enhancement direction than for the depletion direction. With +1 volt applied to the gate, drain current increases by 1.4 mA, so transconductance is 1400 micromhos. With -1 volt applied, current decreases by almost 1.1 mA so transconductance is a little less than 1100 micromhos.

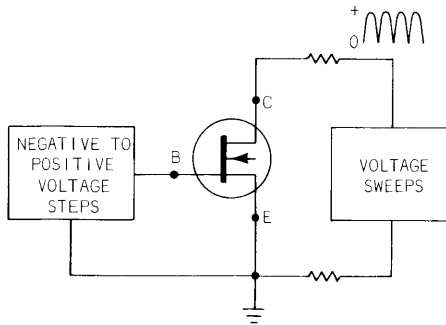
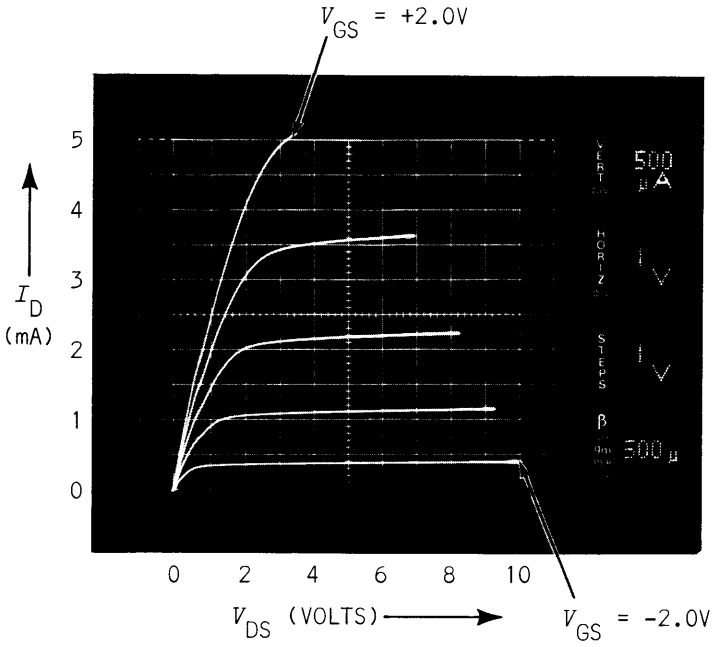

Fig. 2-13. Insulated gate FET M-100 operated in both depletion and enhancement modes.

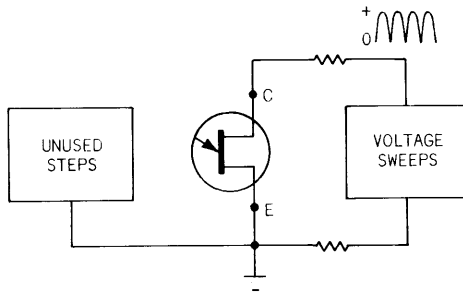
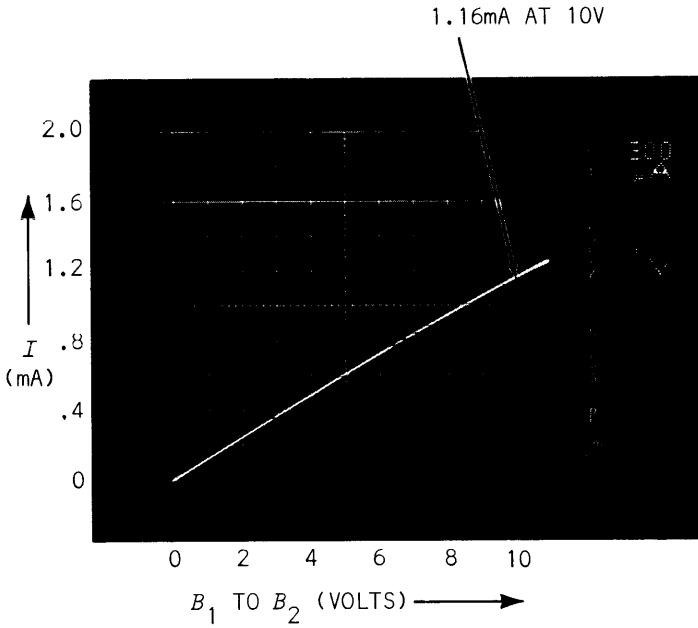
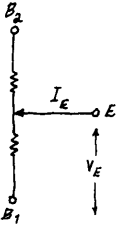

Fig. 3-1. Interbase resistance with emitter terminal open. $10 \text{ V} / .00116 \text{ I} = 8600 \Omega$. 2N5061.

3

UNIUNCTION TRANSISTORS

Unijunction transistors are semiconductor devices having three terminals but only one junction. Two of the terminals are attached to opposite ends of a small bar of properly doped n-type semiconductor material. Somewhere along the bar a junction is made, and the third terminal is attached to the material that forms a junction on the bar. That terminal is called the emitter terminal and the other two are called base terminals - base one (B_1) and base two (B_2).



The conductivity of the bar is fairly linear, and can be measured with an ohmmeter by leaving the emitter terminal open. Or it may be measured on a transistor curve tracer. In Fig. 3-1 the *interbase resistance* was measured to be 8600 ohms with 10 volts applied. With zero voltage applied between the emitter terminal and B_1 the junction will be back biased by the voltage drop V_E in the bar between the junction and B_1 . That voltage drop will depend on the amount of current flowing in the bar and the resistance of the bar material between the emitter terminal and B_1 . The voltage drop constitutes a back bias for the emitter junction. When enough voltage of the proper polarity is applied between the emitter terminal and base *one* the back bias will be overcome and forward current can flow across the emitter junction. When this happens carriers are injected into the bar material making it a better conductor, particularly in the region between the emitter terminal and B_1 . The voltage drop in that region, therefore, diminishes and as it does the emitter current suddenly increases because the original source of back bias diminishes. The effect is regenerative - the greater emitter current induces greater emitter current. Unijunction transistors are principally used for this negative resistance characteristic.

negative
resistance

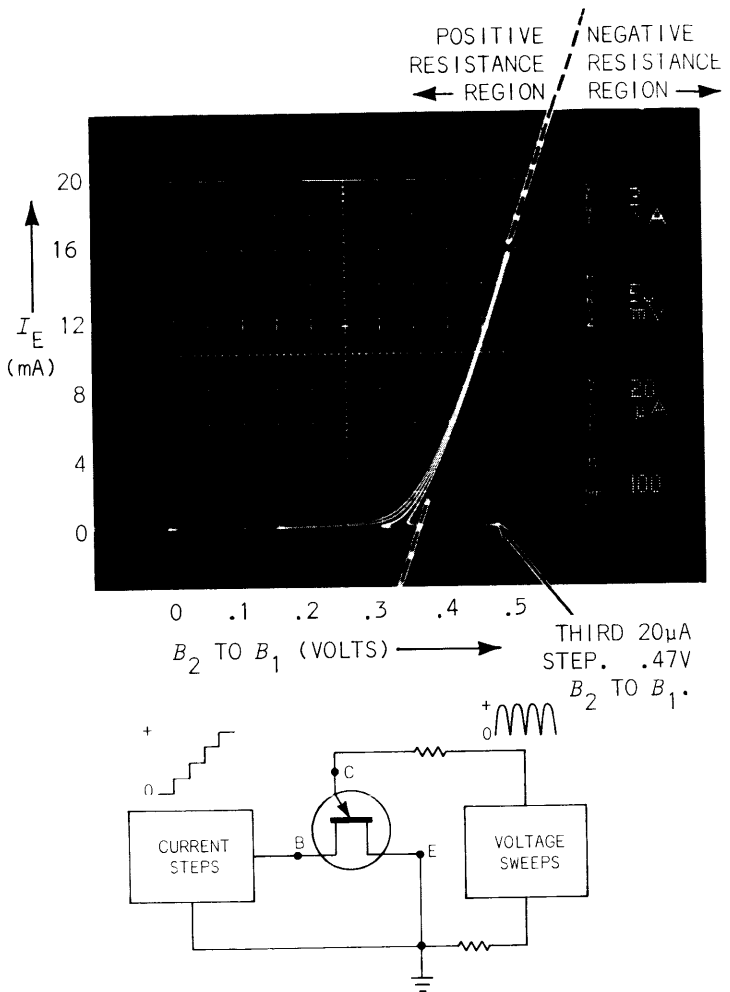

Fig. 3-2. 2N4851 unijunction transistor.

Their conductance characteristics can be explored using a transistor curve tracer. In Fig. 3-2 one of four values of current is applied to the B_2 terminal at all times. The currents are increased from zero to $60\ \mu A$ in $20\text{-}\mu A$ steps 120 times a second. During the time each value of B_2 current flows, the emitter terminal is swept from zero volts to some value which causes 16 mA of emitter current to flow, then goes back to zero. The voltage that appears between the emitter terminal and the B_1 terminal when the voltage sweep voltage is near zero, is caused by the voltage

drop in the bar resulting from current between B_2 and B_1 . That voltage drop is different for each incremental value of step current applied to the B_2 terminal and can be easily identified by the bright dots spaced along the lower horizontal graticule line. For example, the third $20\text{-}\mu\text{A}$ step ($60\text{ }\mu\text{A}$) causes a voltage drop of $.47$ volts between the B_2 terminal and the B_1 terminal.

Each time the sweep voltage increases enough to turn the emitter on, the current flowing between the bases switches to a higher value and emitter current also switches to a higher value. See Fig. 3-3.

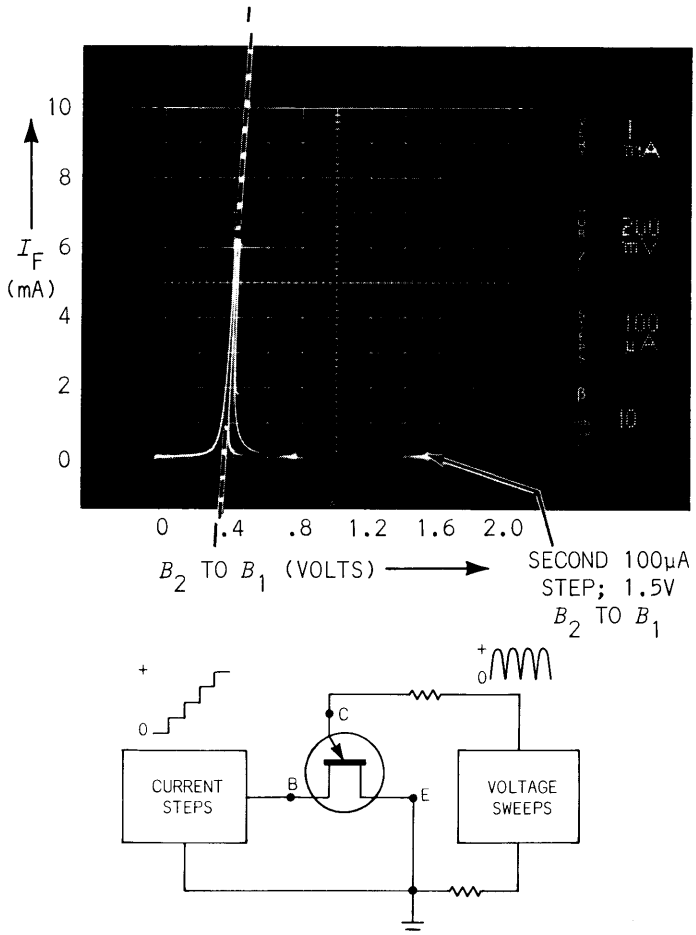

Fig. 3-3. 2N4851 unijunction transistor.

4

THYRISTORS (SCR's) AND OTHER PNPN DEVICES

Most of the conductance characteristics of four-layer semiconductor devices can be explored and measured on a transistor curve tracer. The characteristics of principal interest that may be measured are: 1) forward and reverse blocking (breakdown) voltages and currents; 2) the voltage drop at various forward currents for the *on* condition; 3) the gate-terminal turn-on voltage and current requirements for various values of applied anode-cathode voltage; 4) the value of forward current that holds the device in an *on* condition (holding current).

voltage- or
current-
operated
switch

Thyristors are the same kind of semiconductor device as *Silicon Controlled Rectifiers*. The name thyristor is derived from *thyatron*, a gas tube controlled rectifier. The name *Silicon Controlled Rectifier* is to distinguish the solid-state device from the gas-tube device. Thyristors are largely used to control the conduction duty factor of applied alternating voltage, but they do have many other applications. They can be turned on at any time the applied voltage is of the correct polarity but then cannot be turned off until the applied voltage approaches zero volts, or the current which is flowing diminishes to a value that is very low compared to the permissible peak value.

FORWARD BLOCKING VOLTAGE AND REVERSE BLOCKING VOLTAGE

The forward blocking voltage of a thyristor is the voltage that may be applied between cathode and anode before the device switches to have a low impedance -- assuming little or no voltage or current is applied to the control terminal and that the polarity of the cathode-anode voltage is correct.

Making a measurement of the forward blocking voltage of a thyristor using a curve tracer is done in very much the same way as measuring the reverse breakdown voltage of a transistor. First the gate terminal is usually either shorted to the cathode terminal or

returned to the cathode through a resistor of specified value. In Fig. 4-1 forward blocking voltage was measured at 114 volts for 5 μA of forward current at room temperature (Point A). The thyristor is rated to pass no more than 5 μA of peak forward blocking current at 60 volts, the rated peak forward blocking voltage, at a junction temperature of 125°C. A temperature-controlled oven would be needed to conduct the test at 125°C. *Reverse* blocking voltage would be measured in precisely the same way except the polarity of the sweep voltage would be reversed.

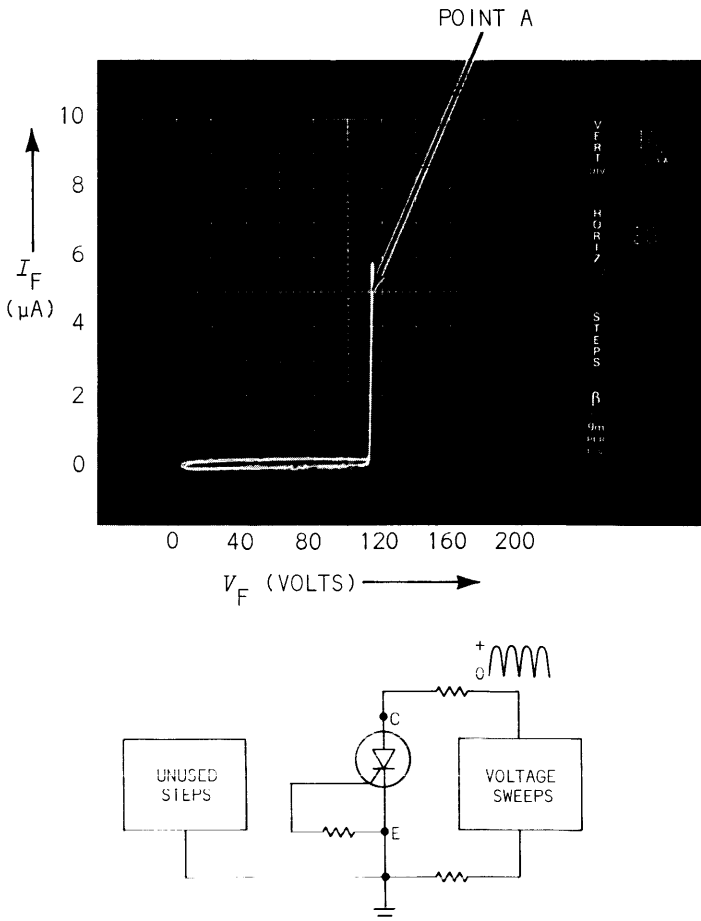

Fig. 4-1. Forward blocking voltage and current 2N5061 thyristor.

turn-off

Fig. 4-2 is similar to Fig. 4-1 except the applied voltage was increased until the thyristor switched to its *on* state with no gate voltage applied and a different vertical scale factor was used. A current-limiting resistor having a high resistance value was selected to limit the forward current. As the sweep voltage approaches its peak value and Point A is reached, avalanche breakdown occurs at the middle one of the three junctions, and the four-layer device appears to be simply two forward biased PN junctions in series. Current suddenly increases

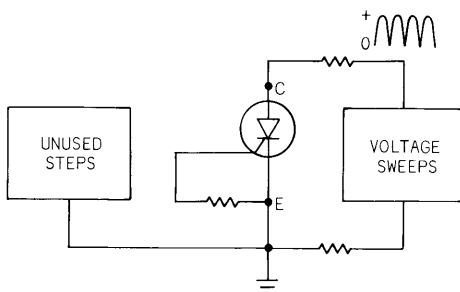
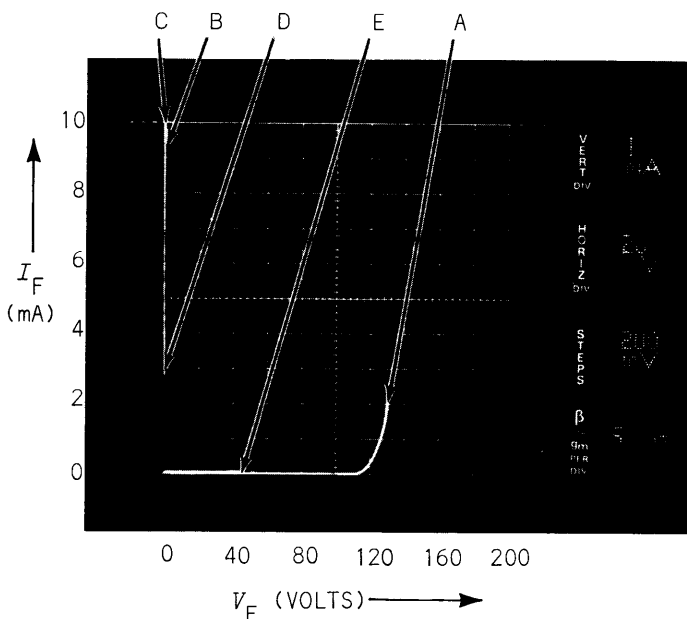

Fig. 4-2. Switching conditions, 2N5061, with zero gate voltage drive.

therefore, limited by the series resistance, and the forward voltage drop decreases to a very low value - Point B on the curve. As the sweep supply voltage increases further to its peak value, forward current increases from Point B to Point C. Current then diminishes as the sweep supply voltage drops toward zero. At Point D, not enough forward current remains to hold the thyristor in the *on* condition and current switches off to Point E.

The value of current at Point D is the holding current for that set of conditions. The conditions existing for Fig. 4-2 are not a normal mode for operating a thyristor but represent a set of boundary conditions. Forward voltage is not usually applied if it exceeds the rated forward blocking voltage. And some current or voltage is usually applied to the gate terminal to switch the thyristor on. Fig. 4-3 is very similar to Fig. 4-2; the only difference is that a small steady value of turn-on voltage was applied to the gate terminal for Fig. 4-3. Two important differences should be noted: Switching takes place at a lower voltage and the value of holding current is reduced.

holding
current

Holding current is usually specified to be equal to or less than some maximum value under stated conditions of temperature, load resistance and anode supply voltage. To select the specified value of load resistance using a transistor curve tracer, both the value of the current-measuring resistor and the selectable series resistor must be considered. Sometimes the correct value may be achieved only by using a third resistor applied at the test terminals. The gate voltage required to switch a thyristor to the *on* state at any given applied anode-cathode voltage can be determined on a Tektronix Type 576 transistor curve tracer. By adjusting the peak supply voltage to the specified amount while the gate terminal voltage is zero the gate voltage can then be slowly increased until switching occurs and the gate voltage then read from the dial. Go-no go tests can be made by first dialing up the specified gate voltage and observing whether switching occurs or fails to occur. The source resistance for gate voltage drive may be specified. If so, the source resistance can be simulated by adding a resistor of appropriate value in series with the supply.

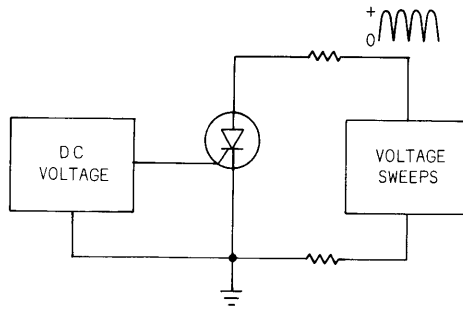
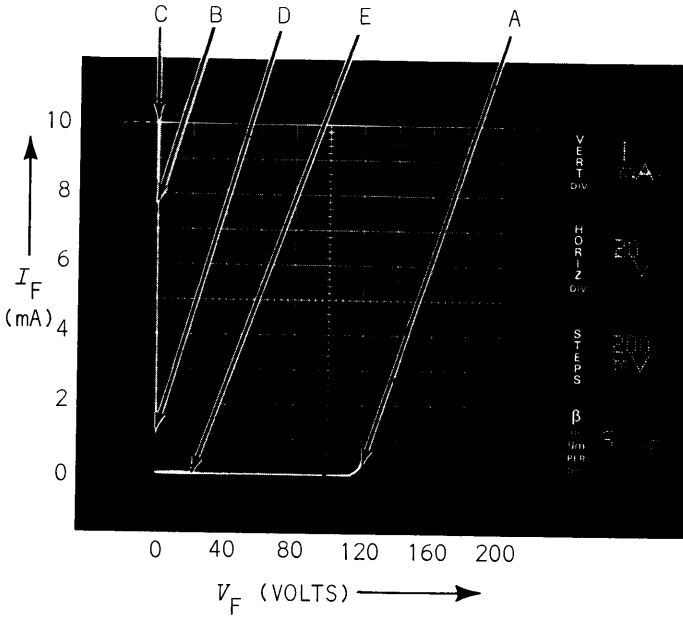

Fig. 4-3. Switching conditions, 2N5061, with small gate voltage drive.

The gate *current* required to switch a thyristor to the *on* state may be tested or measured by means similar to those used for gate *voltage* turn-on measurements.

Fig. 4-4 shows the high-current forward-conductance *on* characteristics of the same thyristor as used in the foregoing figures. The forward voltage drop at a current of one ampere is 1.3 volts. The specified maximum is 1.7 volts.

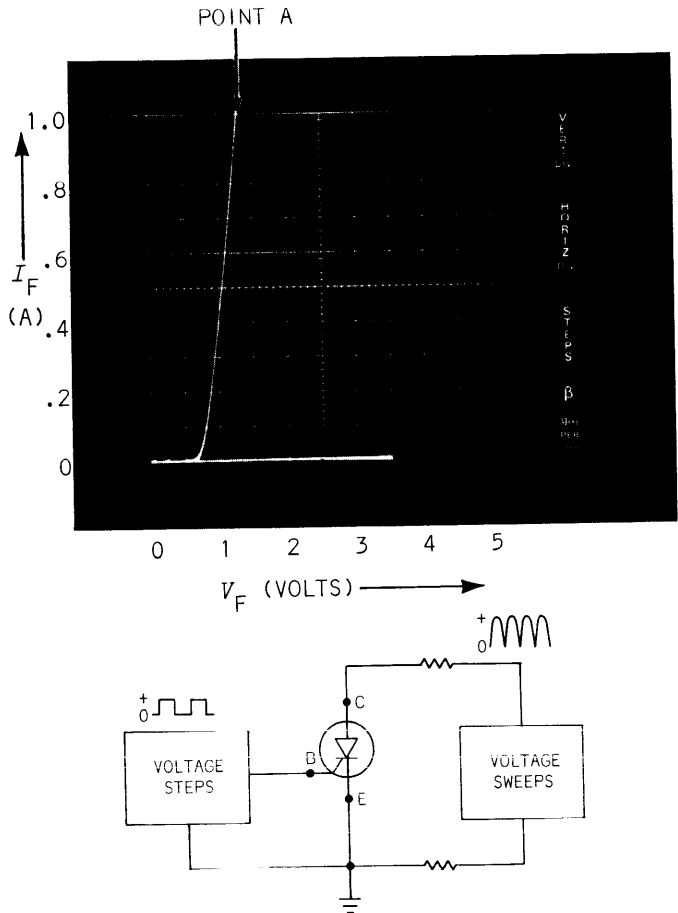

Fig. 4-4. Forward conductance, 2N5061. Alternately on and off.

5

SIGNAL DIODES
AND RECTIFYING DIODES

FORWARD VOLTAGE AND CURRENT

Diodes present a much lower resistance to the flow of current in one direction than for flow in the opposite direction. Except for tunnel diodes and back diodes, simple PN junction diodes present less resistance to current flow when the P material is biased positive with respect to the N material, than when biased in the opposite direction. Tunnel diode and back diode characteristics are discussed in a different section.

I_F vs V_F
nonlinear

The resistance that a diode presents to the flow of a current in the forward direction is not linear over the entire operating range. That is, the forward current is not proportional to the forward voltage, although one increases when the other increases. A measurement of forward resistance, then, depends on the current and the voltage.

I_F vs V_F
display

For most purposes transistor curve tracers do a fine job of showing the forward voltage and forward current relationships of a diode. The curve displayed is simply a graph of the forward current versus the forward voltage. The curve is typically produced by applying a variable (sweep) voltage of the correct polarity through a selectable resistor to one terminal while the other terminal is grounded. Then the voltage drop across the diode is applied through an amplifier to one set of deflection plates while the current through the diode is monitored through a series resistor and the voltage drop across the resistor applied through an amplifier to the other set of deflection plates. When the gain of the amplifiers is correctly set to match the deflection plate sensitivity of the cathode-ray tube, the horizontal and vertical scale will correspond to specific amounts of voltage and current.

Simple DC instruments may also be used to measure current at specific voltages, or measure voltage-drop at specific currents.

Similarly doped, and similar junction-area diodes made of germanium, silicon, or gallium arsenide will have considerably different forward characteristics. Small germanium diodes will have a forward voltage drop of about .4 volts, small silicon diodes about .8 volts and small gallium-arsenide diodes about 1.2 volts at a given forward current of about 10 mA near the knee in the forward conduction curve. Fig. 5-1 is a triple exposure of the forward curves for three such diodes.

V_F for
 GaAs > Si >
 Ge

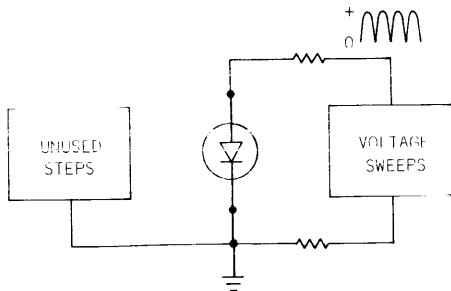
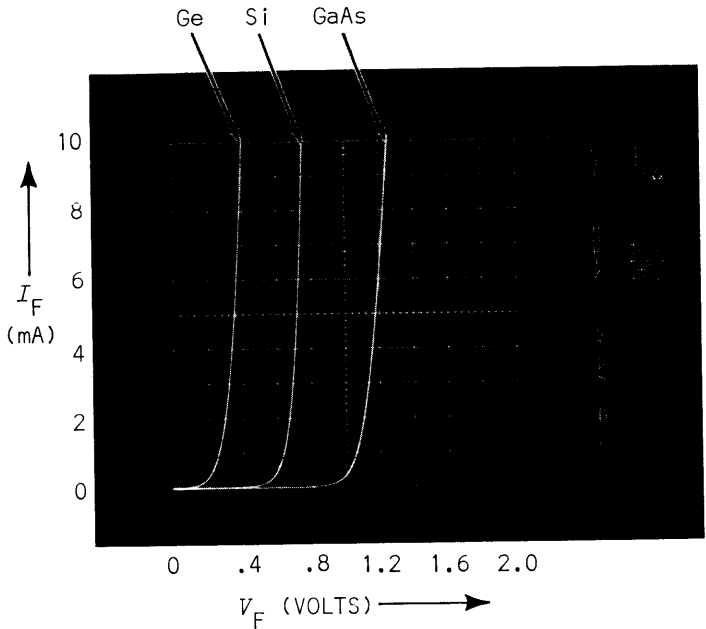

Fig. 5-1. Forward conduction of small germanium, silicon and gallium arsenide diodes.

Large junction-area diodes of a given semiconductor material will have knees at comparable forward voltage drops to small diodes but the curves may not be simple to compare. Large diodes offer less resistance to specific currents than small diodes made from the same material so comparable larger current scales should be used in larger diodes for such a comparison.

I_F vs V_F

Fig. 5-2 shows a double exposure of the forward voltage versus forward current curves of two silicon diodes that are rated for considerably different

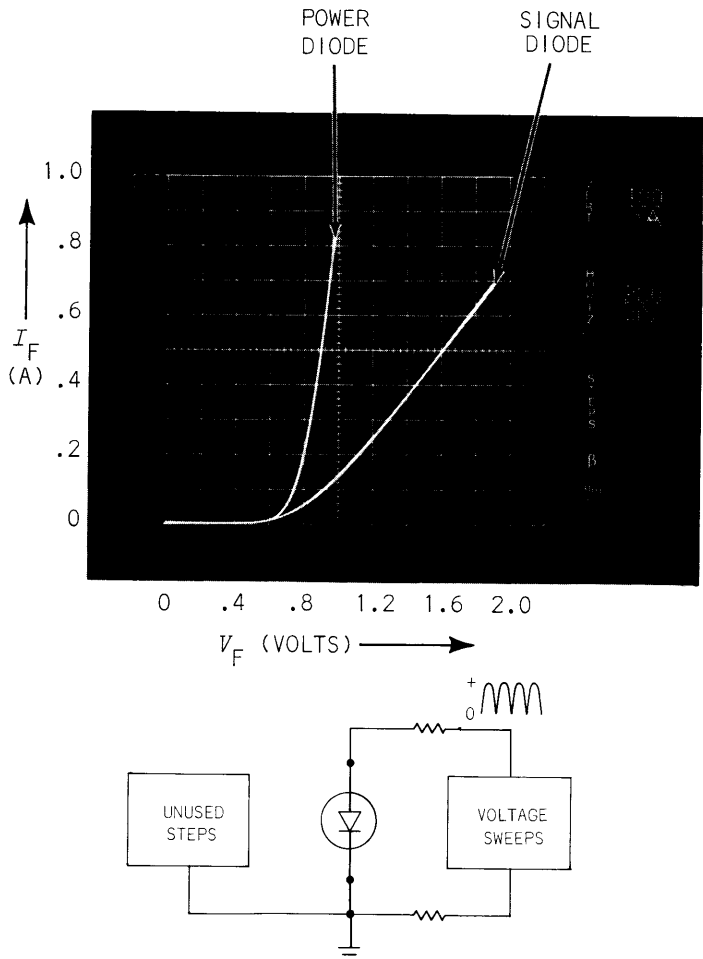

Fig. 5-2. Forward conductance characteristics of two silicon diodes at high currents.

maximum forward currents. Fig. 5-3 shows the same two diodes using a different current scale. Note the greater similarity in the latter figure where forward current is lower.

The measurement of forward DC resistance of the two diodes shown in the double exposure Fig. 5-2 at a forward voltage drop of .8 volts shows the small diode to be 16 ohms and the large diode to be 4 ohms.

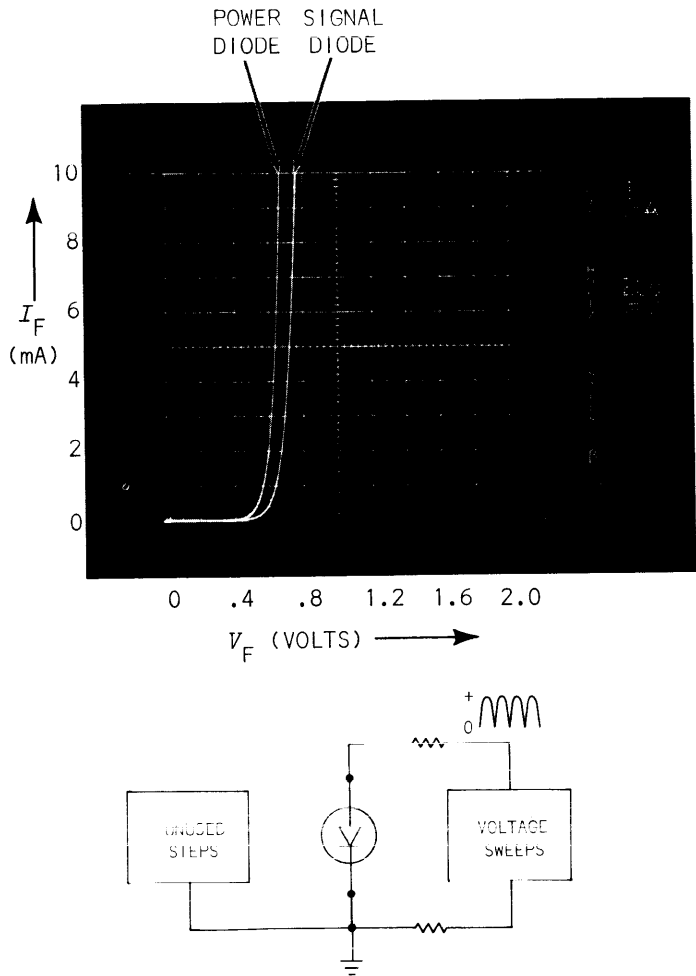

Fig. 5-3. Forward conductance characteristics of two silicon diodes at low currents.

forward DC

$$R = \frac{V_F}{I_F}$$

The forward DC resistance is simply the forward voltage (V_F) divided by the forward current (I_F) at a specified voltage or current. The two measurements could have been made with DC meters.

differential

$$R = \frac{\Delta V_F}{\Delta I_F}$$

Differential resistance is measured between two points on a curve representing the forward current versus forward voltage. See Fig. 5-4. In that figure the points chosen were on the basis of a current difference of 50 milliamperes (from 50 mA to 100 mA). The difference in forward voltage-drop for those two points was difficult to scale, so the horizontal deflection was magnified 10 times as shown in Fig. 5-5. The voltage difference can be seen to be 2.2 divisions, or 44 mV.

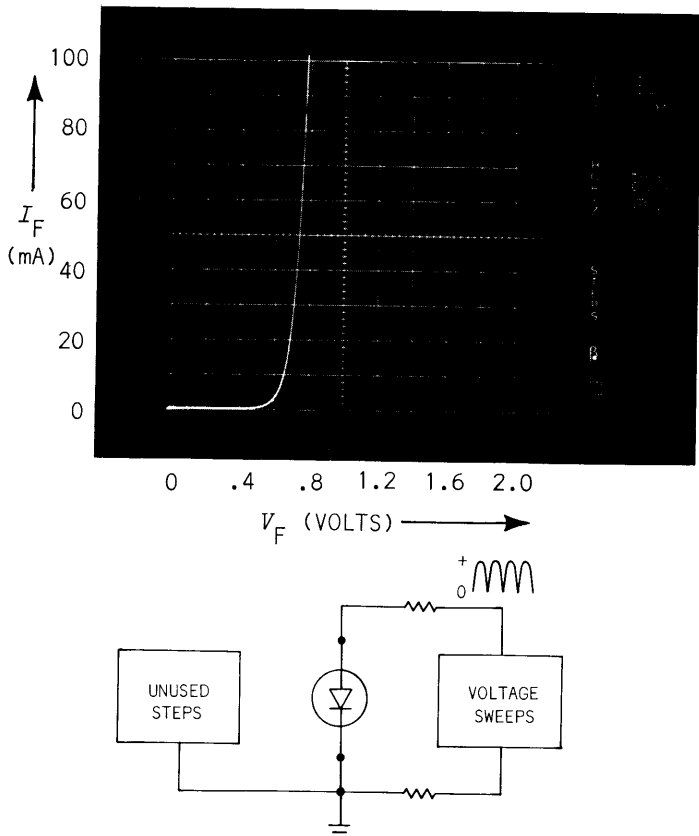

Fig. 5-4. Forward resistance.

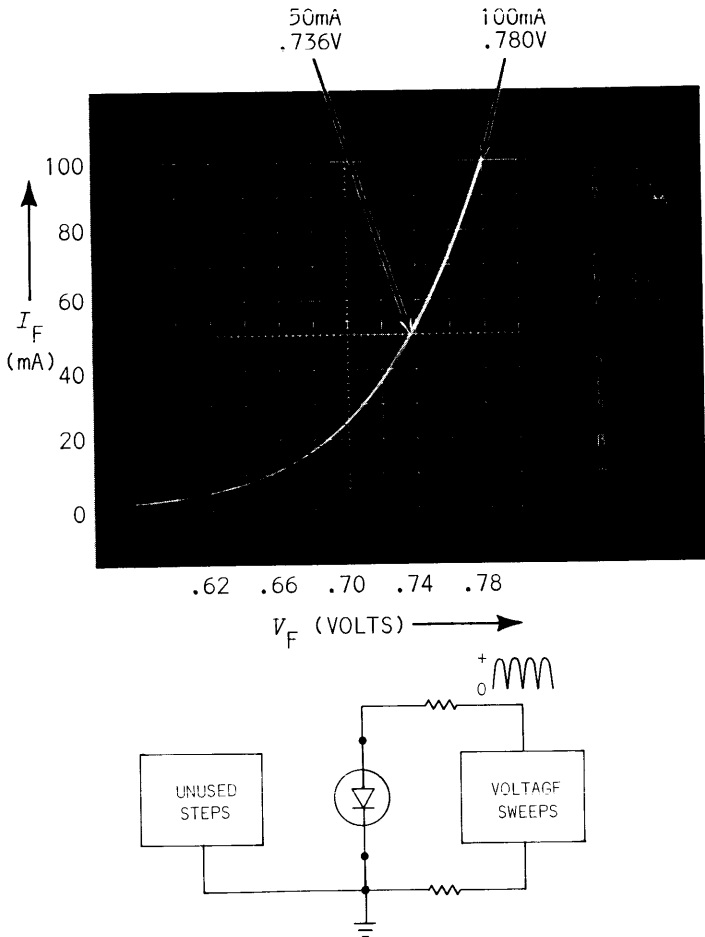

Fig. 5-5. Forward dynamic resistance of a small silicon diode between 50 mA and 100 mA. $\Delta V_F = 44 \text{ mV}$; $\Delta I_F = 50 \text{ mA}$. $.044\text{V} / .050 \text{ I} = .88\Omega$

temperature limitations

When the forward current through a diode becomes excessive, the diode will heat up and fail. The temperature of the diode will rise as the forward current as increased, but the average temperature may not rise greatly if the average power does not rise greatly. The peak current that a diode can tolerate will depend on how long the peak current flows and on the duty factor of the applied peak current. When a very high peak current is applied it will cause a rapid internal temperature rise

which may destroy the diode in a very short time the *first* time applied. Small diodes may be tested for relatively high forward currents using current pulses available on some transistor curve tracers.

REVERSE VOLTAGE AND CURRENT

Voltage is reverse for all simple PN-junction diodes, *except* tunnel diodes and back diodes, when the polarity of the applied voltage is positive on the terminal that goes to the N material compared to the terminal that goes to the P material.

The reverse current that flows when a diode is reverse biased depends on the reverse bias voltage. For most diodes the reverse current is relatively small up to the breakdown region. At and beyond this region small increases in voltage may cause large increases in current. Beyond the knee of a curve showing the transition from low reverse current the differential resistance may become fairly linear even though much lower in value.

Reverse current is frequently called leakage current. However, the term leakage current is also used to distinguish a component of reverse current -- that component which flows around the periphery of the principle junction area, including conduction through or over the surfaces of the diode case.

static
measurements

Transistor curve tracers are excellent instruments for monitoring and measuring the reverse voltage characteristics of diodes under static conditions and low frequency dynamic conditions. Reverse currents from less than 1 nanoampere (1×10^{-9} amperes) may be measured. Reverse voltage of 1000 volts or more is also common. Reverse current versus reverse voltage is plotted on any convenient scale and measurements made at any point.

non-
destructive
testing

Most diodes are rated to pass no more than a specified reverse current when a specified reverse voltage is applied. To verify such a specification using a transistor curve tracer the peak sweep voltage is manually increased to or beyond the voltage specified and current read from the scale. Usually a high value resistor is selected and switched in series with the diode and the sweep voltage. The resistor will limit the current and protect the diode from excessive dissipation in the region of breakdown. Transistor

curve tracers provide a manually-variable peak sweep voltage that occurs at the power line rate (usually 50 or 60 hertz). The sweep voltages are selectable for either plus or minus polarity and are full-wave-rectified power line voltage. But the sweeps may also sometimes be *alternately* plus and minus -- in which case they are unrectified versions of the power line voltage. Connecting two diodes in series and back-to-back while sweeping with alternate polarity voltage is a good way to compare or match the reverse characteristics of two diodes. See Fig. 5-6. In this figure the diodes are seen to have very similar reverse characteristics. In Fig. 5-7 one of the diodes was exchanged for another of the same type which differs considerably.

compare
 D_1 vs D_2

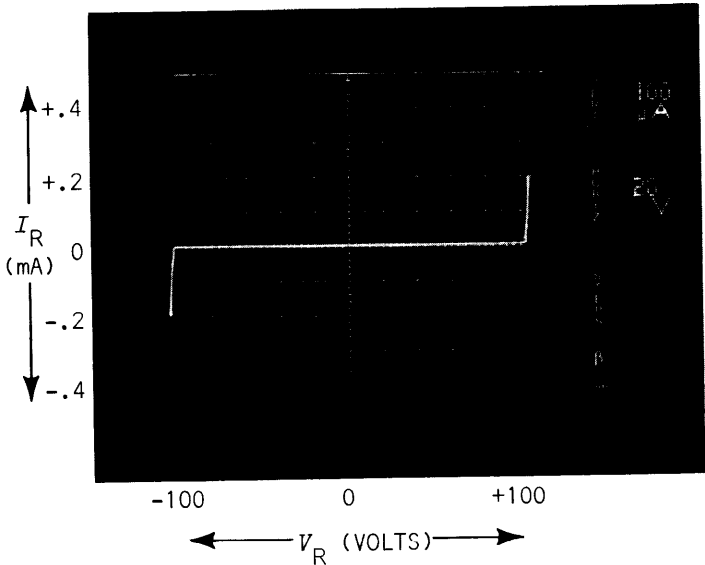
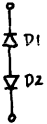

Fig. 5-6. Similar breakdown voltage and resistance of two diodes, type CD8204, placed back to back in series and swept with alternating voltage.

REVERSE RECOVERY TIME

Junction diodes that have been conducting in the forward direction do not instantly offer a high reverse resistance when the polarity of applied voltage is suddenly reversed. Current carriers which have become mobilized and diffused in the region of the junction due to forward current, will provide

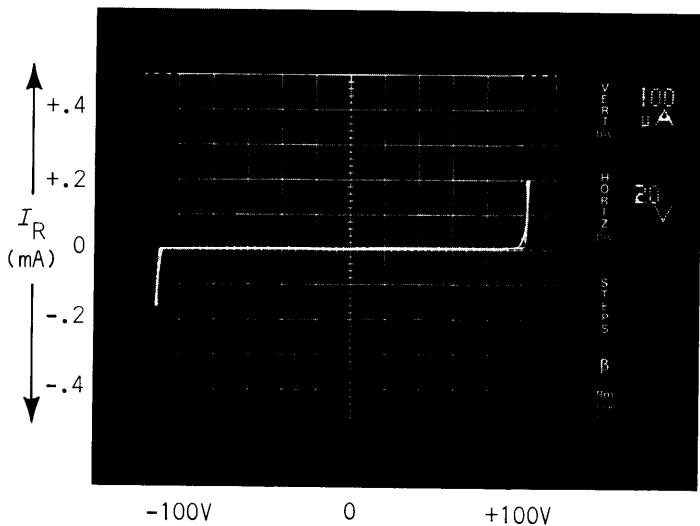

Fig. 5-7. Dissimilar breakdown characteristics of two diodes of same type as in Fig. 5-6.

reverse
recovery
time: t_{rr}

conduction in the reverse direction for a short while. Reverse current flows until the area can be depleted of carriers and become a depletion region. Whereas the carriers would eventually disappear due to recombination if the forward current simply stopped, their removal can be accelerated by applying reverse voltage. Removal by applying reverse voltage results in reverse current momentarily. How long the reverse current will flow depends on the *reverse recovery* time of the diode. But reverse recovery time will also depend on how much current was flowing originally. And it will depend on how much reverse current was induced to flow and how steadily that reverse current flowed while it lasted. The reverse recovery time of a diode is usually measured by applying a specific forward current through the diode, then periodically diverting that current with a current-step or voltage-step having a very short risetime and a specific amplitude sufficient to cause reverse current to flow momentarily. The length of time the reverse current flows will be the reverse recovery time of the diode. The current is usually monitored on an oscilloscope and the time it flows measured directly. To precisely define the time measurement, some point on the leading edge of

measuring
 t_{rr}

the applied turn-off pulse is defined as the beginning of the recovery time interval. This point is usually somewhere between 1% and 10% of the pulse amplitude. And some point on the trailing edge of the induced reverse-current pulse is then defined as the end of the recovery time interval. For convenience the beginning of the recovery time interval may also be defined as some point on the leading edge of the reverse-current pulse. Then the whole time interval can be measured using just one waveform. How the measurement should be made must be carefully described if reasonable correlation of measurements is expected.

Included in such a description should be the amplitude of the pulses, and the source impedance and risetime of the pulse generator used to produce the pulses that divert forward current, and reverse bias the diodes. The oscilloscope response time and sensitivity must also be known to be adequate. For measuring the reverse recovery time of fast diodes, sampling oscilloscopes are usually necessary.

define pulse
character

Just as important as the characteristics of the instruments to be used is the need to use very similar diode test fixtures -- if good correlation of measurements is expected. Nearly any test fixture will show differences in recovery time between different diodes. But to accurately correlate measurements of the same kind made using different instruments and test fixtures is difficult. For measuring the reverse recovery time of the fastest diodes a test fixture should employ circuits carefully designed and constructed using transmission line techniques, to mask lumps of capacitance and inductance associated with discrete components. The diode itself must appear to be as nearly an integral part of a transmission line as possible. The circuit in Fig. 5-8 is such a diagram. That circuit is essentially the same one used for the photographs in Figs. 5-10 through 5-15.

Fig. 5-9 shows the turn-off pulse applied to the diodes tested in the subsequent figures. The displayed risetime is approximately 0.6 nanoseconds and the amplitude is 600 mV when terminated in 50 ohms. The picture was taken with a short, straight, bare wire used in place of a diode. A Tektronix Type 111 Pulse Generator was applied to a Type 1S1 Sampling Plug-in unit through the test circuit. A Tektronix Type 549 Storage Oscilloscope was used for the display.

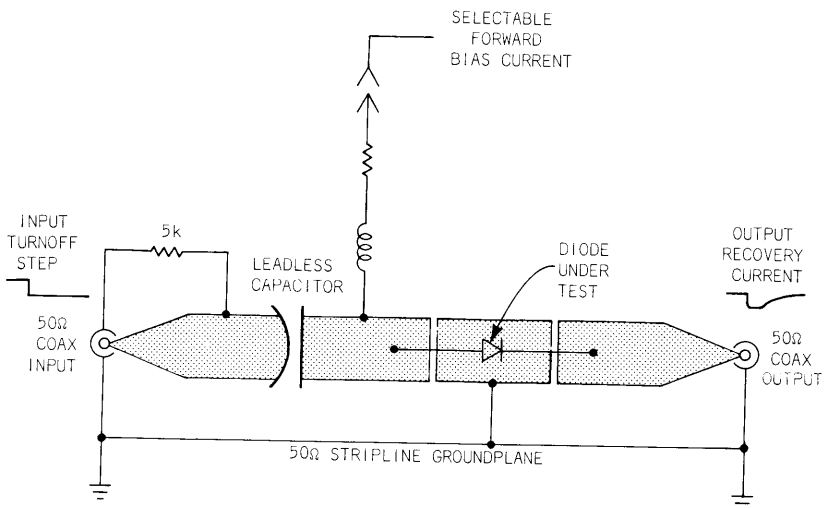

Fig. 5-8. Circuit of reverse recovery-time test fixture. When terminated in 50 ohms the output voltage is equal to 50 mV per ma of current.

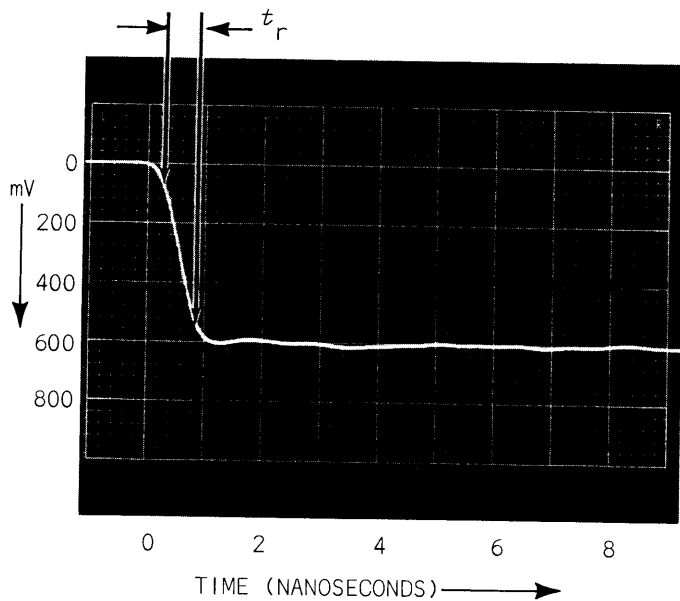

Fig. 5-9. Turnoff pulse from Tektronix Type 111 Pulse Generator.

Figs. 5-10, 5-11, 5-12 and 5-13 are each photographs of two stored traces using four different diodes. The traces depicting low amplitude pulses in each figure correspond to a condition where *no* forward current was applied. The amplitude is a direct function of diode capacitance for those traces. The other four traces resulted from suddenly turning off 2 mA of forward current and applying reverse voltage. The vertical scale is 2 mA per division. Forward current is shown in the top two divisions of the display and reverse current in the bottom four divisions. Let us assume reverse recovery time begins at the point corresponding to the vertical graticule line which is one major division from the left side of the scale. And let us assume the reverse recovery time is said to end when the reverse current diminishes to 1 mA, one half of the forward current.

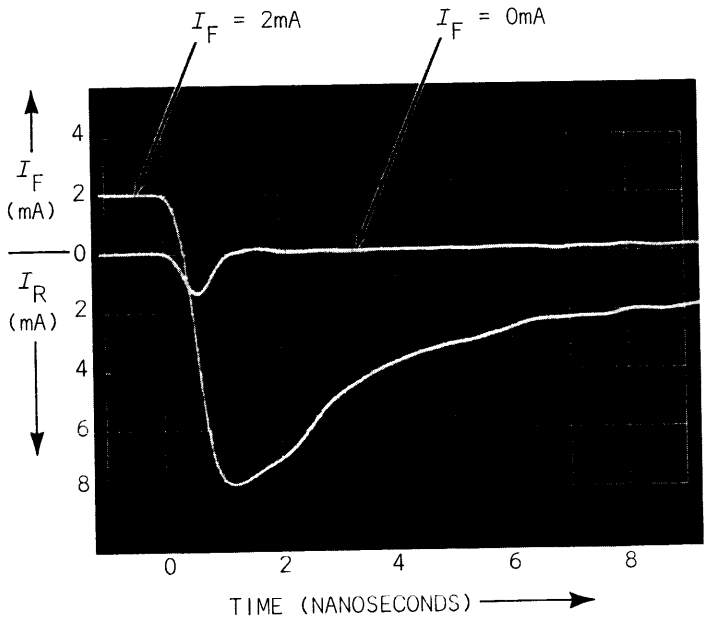

Fig. 5-10. Reverse recovery time, diode T13G.

Fig. 5-10 does not permit us to make this measurement because the horizontal time scale of 1 ns per division is too short. We can say however, that the reverse current nearly reaches 8 mA and that it diminishes to 2 mA in 8 ns.

In Fig. 5-11 a different type diode was used. Reverse current reaches 6 mA, diminishes to 2 mA in about 2.8 ns and recovers to 1 mA in about 5.8 ns.

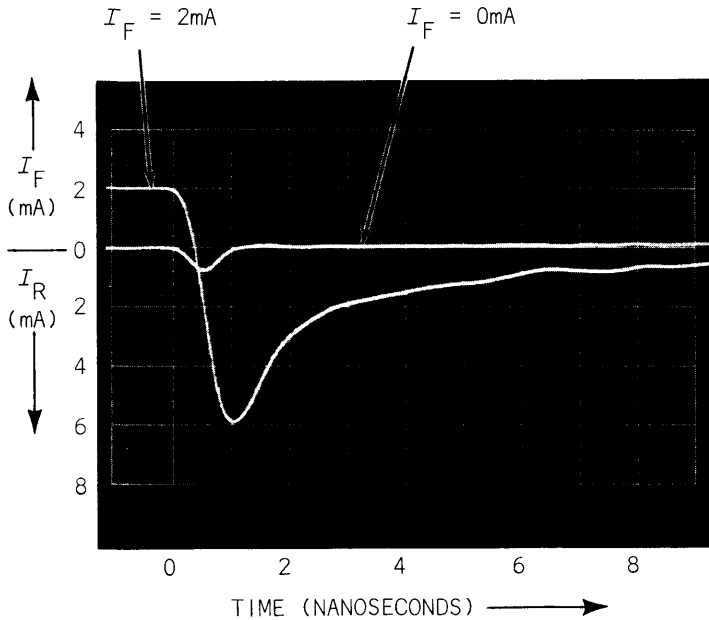

Fig. 5-11. Reverse recovery time, diode GD238.

In Fig. 5-12 a still faster diode was used. Reverse current goes to about 6 mA, recovers to 2 mA in a little over 1.2 ns and reaches 1 mA in about 1.4 ns. Notice that in spite of the shorter recovery time for the diode tested for Fig. 5-12, compared to the one tested for Fig. 5-11, its junction capacitance was greater.

Fig. 5-13 shows very low diode capacitance and no reverse current except that due to diode capacitance. The diode used for this test was not a junction diode but a metal-contact, Schottky barrier diode.

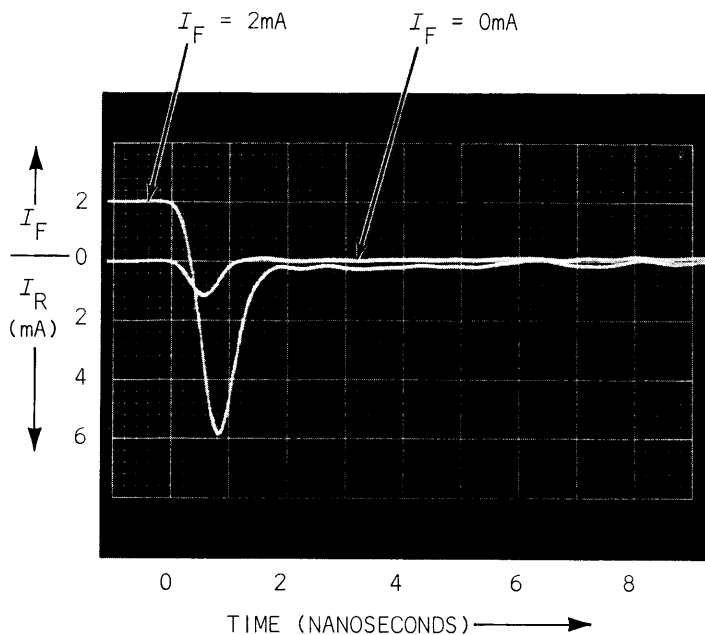

Fig. 5-12. Reverse recovery time, diode CD8204.

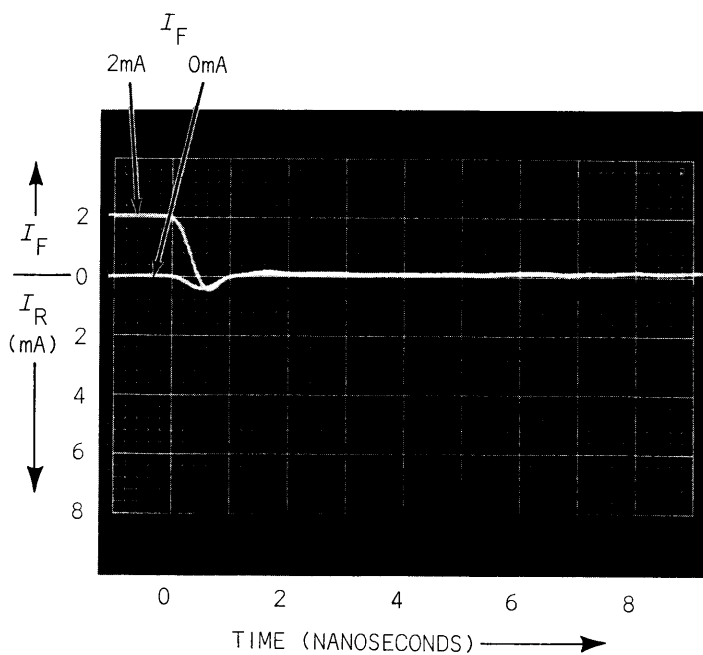

Fig. 5-13. Reverse recovery, Tektronix Schottky-barrier diode.

Snap-Off Diodes (Snap-Diodes, Step-Recovery Diodes)

the snap in
snap-off

The reverse recovery characteristics of snap-off diodes is unique. Whereas they may have a relatively high junction capacitance and a long reverse recovery time, the stored charge due to the presence of mobilized carriers disappears suddenly once the number of carriers is reduced sufficiently. That is the moment when the diodes "snap" or suddenly complete their recovery.

Fig. 5-14 shows the reverse recovery characteristics of a snap-off diode with 2 mA, 1 mA and zero mA of forward current. The zero mA curve shows no storage, only reverse current due to the junction capacitance. The 1 mA curve shows a high reverse current that lasts about 2 ns. The 2 mA curve shows a considerably longer recovery time, but a comparable fast recovery once current starts to diminish.

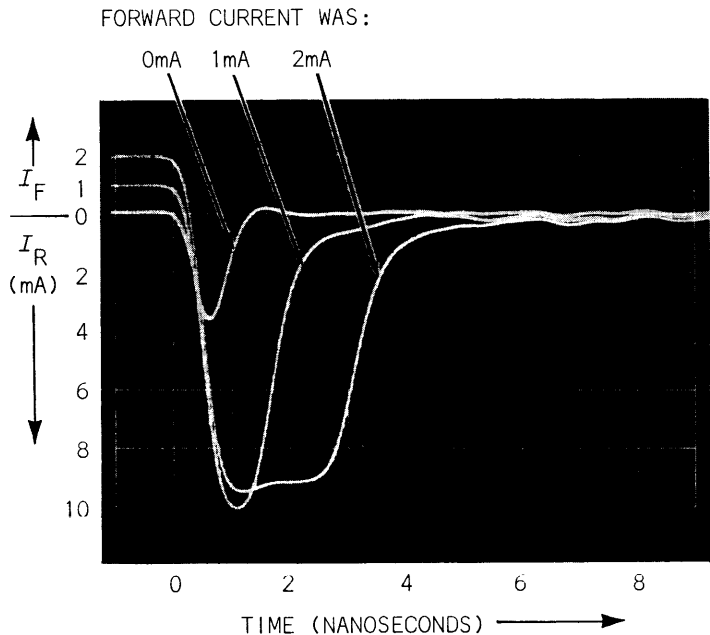

Fig. 5-14. Reverse recovery, snap-off diode.

Fig. 5-15 shows a similar set of curves for the same diode with current per division five times greater (10 mA/division compared to 2 mA/division). The amplitude of the turn-off pulse was also increased five times (3 volts compared to 0.6 volts). Notice the similarity and the speed of turn-off once reverse current starts decreasing, regardless of the reverse recovery time. The three curves correspond to 10 mA, 5 mA and zero mA of forward current. Notice, incidentally, the reduced amplitude of the short pulse that corresponds to recovery from zero forward current, compared to Fig. 5-14. The reduced amplitude is partly attributable to the reduced capacitance of a more highly reverse-biased junction. It is also significant to note that even though the displayed final recovery time (snap-time) was comparable to the curves showing recovery from 2 mA and 1 mA, that the rise rate was approximately five times faster because of the increased amplitude.

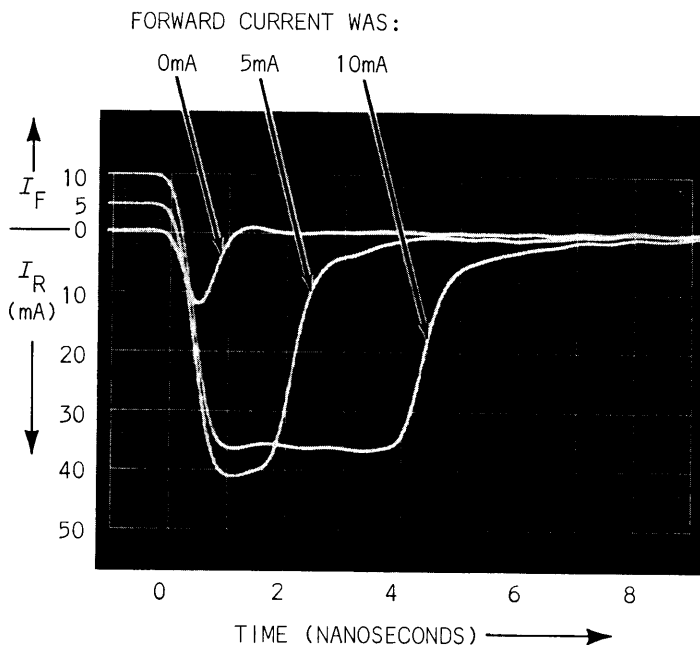

Fig. 5-15. Reverse recovery, snap-off diode.

STORED CHARGE

As one can see from the previous discussion of reverse recovery time, there are considerable differences in recovery time depending on how a diode is forward biased and how it is turned off. There is a need to describe and measure the characteristic of a diode that determines what its recovery time will be under *various* conditions. Looking analytically at a diode for the factors that limit its speed of recovery from conducting in the forward direction, one primarily sees mobilized carriers near the junction area that can turn around and provide a current path in the opposite direction. Until they all recross the junction, or recombine, reverse current can be high. All of these available carriers are similar to a charge stored in a relatively large, leaky capacitor. This capacitance, for the most part, is not real, although a small percentage of it may be. Once the mobile carriers all cross the junction, the real element of capacitance charges in the reverse direction to match the applied reverse voltage. That element of capacitance diminishes somewhat as reverse voltage builds up. The real part of junction capacitance typically has very little to do with recovery from *forward* current. It does contribute considerably to momentary reverse current, but essentially to the same extent regardless of the amount of forward current. In terms of recovery from forward current, then, only stored charge is significant.

carrier
traffic
congestion

apparent
stored
charge

Measurement of stored charge seems to be a more direct way of determining the comparative merits of a diode as a fast switch. Of course junction capacitance has a bearing on the switching speed of a diode also, but that can be measured separately.

Instruments are made which indicate stored charge directly. The principle of the operation of instruments having circuits which follow the *JEDREC Suggested Standard No. 1 (June, 1966)* is basically one of averaging the area under repetitive reverse current pulses. The problem of correlation between instruments of different types using different test circuits, or circuit layouts, can still exist, however. Different test circuits may see a different area under each current pulse of fast diodes if the circuit construction differs substantially. The same average of different areas will yield different results.

stored
charge
measurement
by different
methods not
compatible

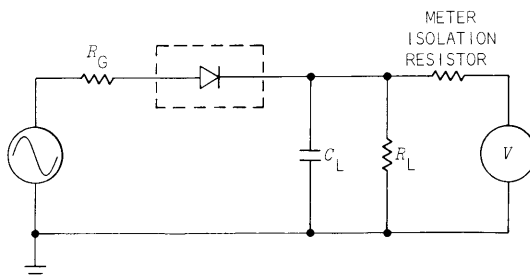

Fig. 5-16.

RECTIFICATION EFFICIENCY

Knowledge of the performance characteristics of a diode as a high frequency rectifier is often required. Junction capacitance and carrier storage are principal limiting factors for such an application. A simple basic circuit may be used, such as in Fig. 5-16, typical of a high-frequency detector circuit. The ratio of the output DC voltage to the peak value of the applied sinusoidal voltage will be an indication of the diode's rectification efficiency.

In a way this method of testing the high frequency characteristics of a diode is similar to measuring stored charge. The amplitude of the applied voltage, the impedance of the sine-wave generator, the size of the load capacitor and the time constant of the output load will have a bearing on the measured efficiency. Great care must be given to stray capacitance and lead inductance in this kind of circuit for the faster diodes.

JUNCTION CAPACITANCE

bridge for
junction C

The junction capacitance of a diode is usually measured with a capacitance bridge. Measurements usually intentionally include the stray capacitance of the package and leads. However, the added capacitance of long leads may be neutralized at the bridge by using the right kind of test fixture. When capacitance is measured without back bias being applied to the junction, the test signal amplitude should be no more than about 100 mV peak to prevent the diode from conducting.

Back bias may be applied to measure the junction capacitance at different values of reverse voltage. Junction capacitance usually decreases as reverse bias is increased and the depletion region widens. *Varactor diodes* are made and used for their voltage-variable capacitance characteristics.

FORWARD RECOVERY TIME

t_{fr} vs t_{rr}

The forward recovery time of most diodes is much less than the reverse recovery time. There is little to recover *from* except stored charge in the junction capacitance, if the diode is reverse biased. However, even without a previously applied reverse bias, some diodes will take a considerable time to become a good conductor in the forward direction. A given forward current will momentarily cause a high forward voltage-drop. After the minority carriers become fully concentrated in the area of the junction, current flows with less resistance. Some factors which contribute to the fast recovery from forward current, impede the mobilization of carriers for turn-on. So some diodes with fast reverse recovery may have relatively poor forward recovery characteristics.

Forward recovery time may be measured in much the same way as reverse-recovery time: Time is measured from some point on the rise of a turn-on pulse to some point on the curve near the end of the momentarily excessive voltage drop across the diode. Ideally a constant current would be applied in the forward direction and the voltage drop across the diode then monitored. The fastest measurements of diode turn-on time, like those of reverse recovery time, require the diode to be in a transmission-line environment. This generally precludes measurement of the voltage directly across the diode. Diode drive, fortunately, does not have to be from a strictly constant-current source for the change in forward voltage-drop of the diode to be monitored. Turn-on time may be measured and compared using the same, or similar, circuits as employed for measurement of reverse-recovery time.

6

ZENER DIODES

V_Z -- Zener Voltage, $V_{(BR)}$

voltage
reference

Zener diodes are designed to be used in the reverse voltage breakdown mode. It is normal for them to conduct in the high impedance (reverse) direction. When they are conducting in the forward direction they behave very much the same as ordinary signal diodes or rectifier diodes. The principle use for zener diodes is to provide a nearly constant voltage drop. In the breakdown voltage region the dynamic, or differential, resistance is relatively low, so that a considerable change in reverse current may occur while the zener voltage remains nearly constant.

measure
with meter

Zener voltage can easily be measured using a current source and DC meters, or it may be measured using a transistor curve tracer. When using a transistor curve tracer, an appropriate value of resistance is placed in series with the sweep voltage supply, then the peak sweep voltage increased slowly until the zener voltage is reached and the desired amount of peak reverse current is observed to flow. Zener diodes are made in various sizes with widely different wattage ratings. The maximum reverse current will depend on how much temperature rise may be tolerated. Ideally there is no reverse current until the zener voltage is reached.

Fig. 6-1 shows a Tektronix Type 576 Transistor Curve Tracer plotting the reverse voltage versus reverse current of a zener diode. The zener voltage can be seen to be approximately 6.2 volts. A more precise measurement of zener voltage may be made by using the ten times magnifier to expand the horizontal deflection, then using the calibrated offset (positioning) control to bring the region back near center-screen. Fig. 6-2 shows the zener voltage to be 6.22 volts when the reverse current is 25 mA.

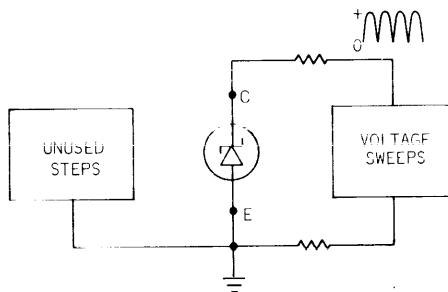
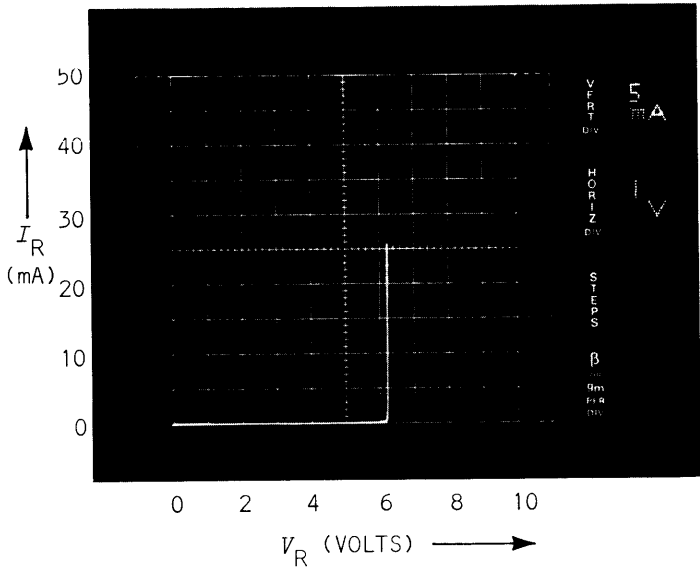

Fig. 6-1. Zener voltage, $V_{(BR)}$, 1N753A.

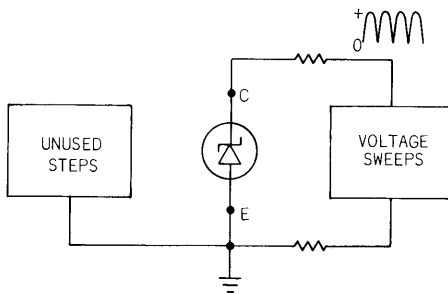
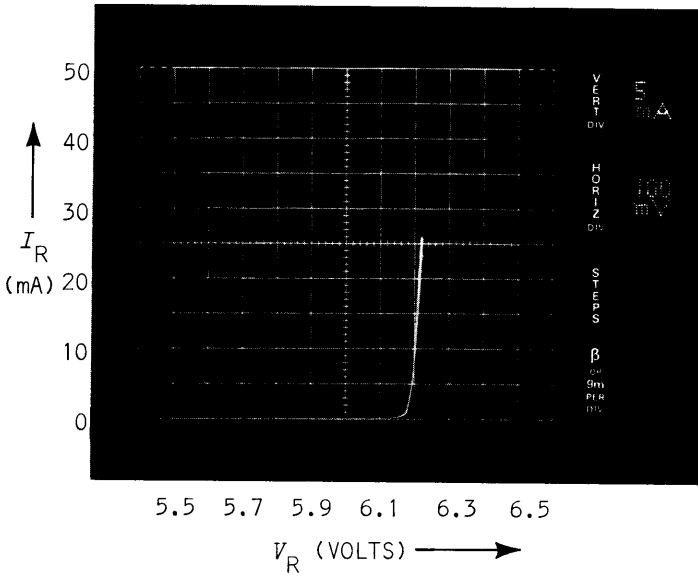

Fig. 6-2. Zener voltage, $V_{(BR)}$, and differential resistance, Z_{ZT} , 1N753A.

zener
temperature
limits

The effect of temperature on zener voltage may be easily observed on a curve tracer. Usually it is only necessary to increase the peak reverse current sufficiently. The temperature will increase as current is increased, and this usually causes zener voltage to increase, for zener voltages above 5 or 6 volts. Some zener diode packages are made which have a very low temperature coefficient.

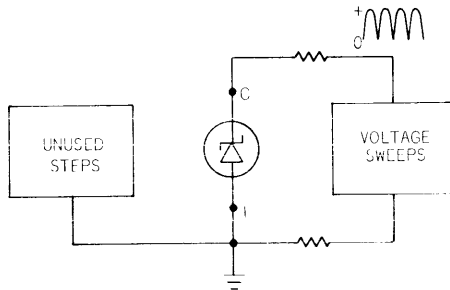
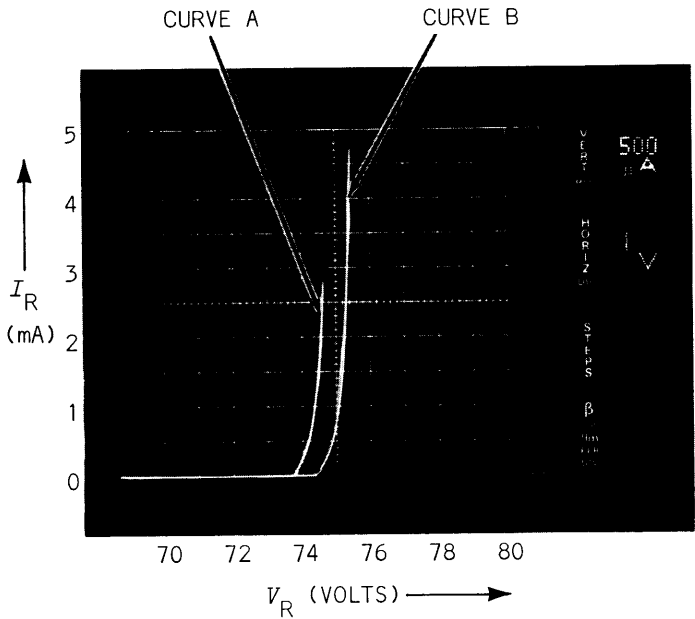

Fig. 6 3. Effect of temperature on zener voltage. Double exposure of same 75-V zener diode. Extra peak current of curve B causes increase in temperature and increase in breakdown voltage.

Fig. 6-3 is a double exposure photograph showing a zener voltage of 74.6 at a reverse current of 2.5 mA (Point A) when the peak current is 2.9 mA. When the peak current is increased to 4.7 mA the zener voltage increases to 75.3 volts at the same reverse current. See Curve B.

Z_{ZK} -- Zener Impedance, DC

The DC impedance (resistance) of a zener diode operated in the breakdown-voltage region will depend on the voltage and the current. By measuring the precise voltage at a given current, then dividing that voltage by the current, the zener impedance, Z_{ZK} , may be calculated.

Z_{ZT} -- Zener Impedance, AC

The dynamic, or differential impedance (resistance), of a zener diode is revealed by the slope of the current-versus-voltage curve in the zener region. This curve is typically very steep, depicting a low differential resistance, when the current is plotted on the vertical axis. To measure differential resistance in this region, two points on the curve are chosen which bracket the area of prime interest, and the voltage and current at these two points then noted. Differential resistance will be the quotient of the difference in the two voltage points, $\Delta V_{(BR)}$, and the difference in the two current points, ΔI_R .

$$Z_{ZT} = \Delta V_{(BR)} / \Delta I_R$$

In Fig. 6-2 voltage increases approximately one minor division (20 mV) when current increases from 10 mA to 25 mA (15 mA).

$$Z_{ZT} = 20/15, \text{ or approximately } 1.3 \Omega.$$

Whenever the curve is a fairly straight line, choosing two widely separated points that bracket the area of prime interest will improve the accuracy of the measurement. If the curve is not nearly straight, a small straight-edge carefully held tangent to the point of prime interest will allow points to be chosen on the scale which are more widely separated, and thereby improve the accuracy of the measurement.

7

TUNNEL DIODES
AND BACK DIODES

negative
resistance

Tunnel diodes are used primarily for their negative resistance characteristics. They make very fast low-power switches and oscillators. Their very fast switching capabilities make it difficult for curve tracers to plot the negative resistance portions of their current-versus-voltage curves without very special attention being given to the diode holder design. Lead inductance and stray capacitance are usually high enough to cause the diode to oscillate while operated in its negative resistance region, regardless of what DC load line is used. But for most purposes it is sufficient to know the limits of the negative resistance region, and curve tracers show these limits quite well.

forward?
back?

Back diodes are essentially the same kind of devices as tunnel diodes, but their use does not generally depend on their having a negative resistance characteristic. They are like very-low-voltage rectifiers, and may in fact be called tunnel rectifiers. Both tunnel diodes and back diodes present less resistance to current flow when the PN-junction is biased with the P-material negative with respect to the N-material than when biased in the opposite direction. This is contrary to other diodes, and poses the question of which direction should be considered the forward direction. The term *tunnel direction* will be used in this discussion when the applied bias makes the P-material positive with respect to the N-material. That polarity is correct to cause tunnel diodes to tunnel, and back diodes to tunnel, or at least tend to tunnel. It is the direction of higher resistance to current flow.

Figs. 7-1 and 7-2 show the tunnel direction characteristics of two tunnel diodes having a 20 to 1 difference in peak point currents.

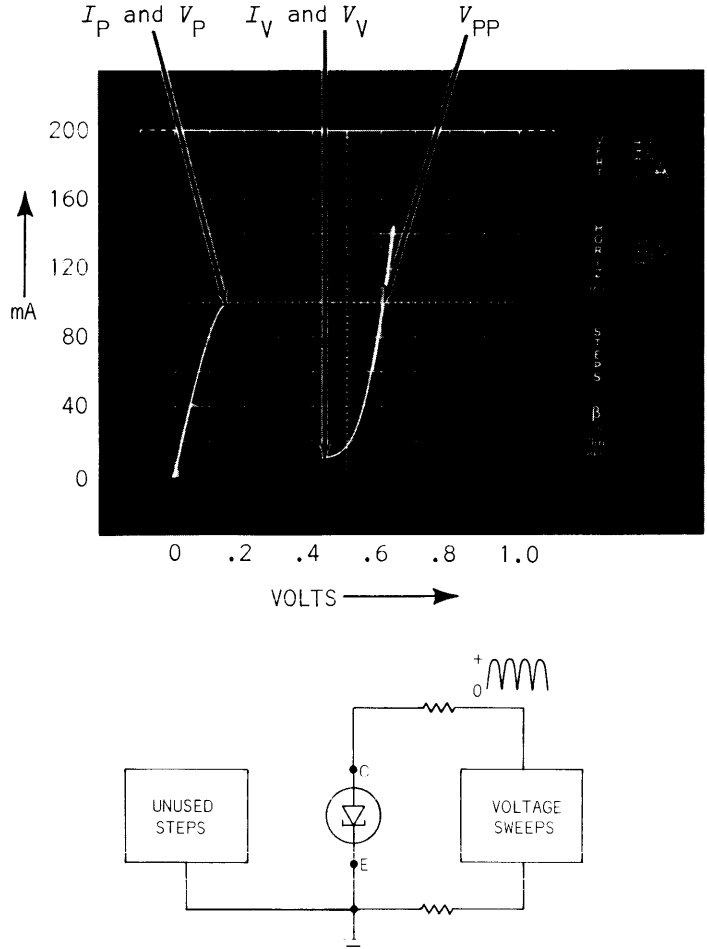

Fig. 7-1. Tunnel-direction conductance curves for 100-mA tunnel diode.

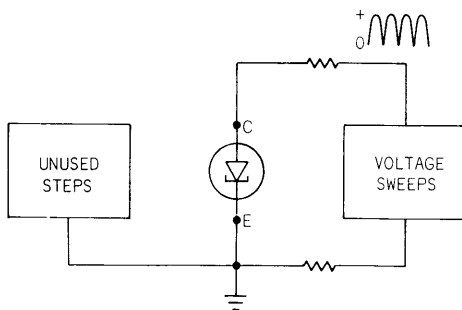
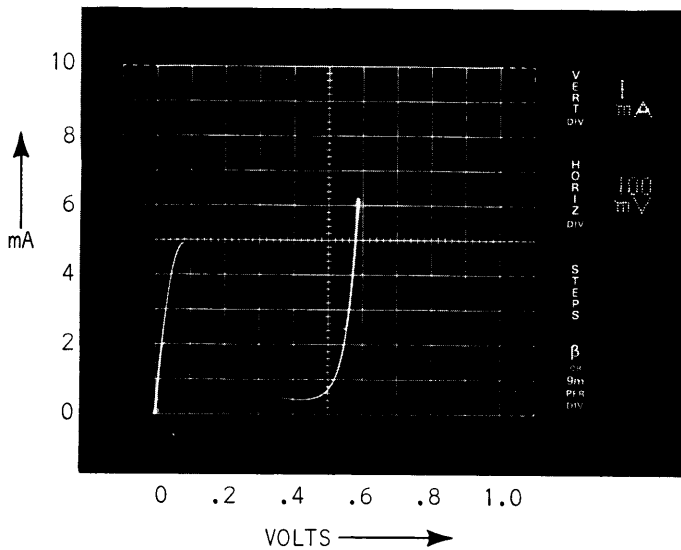

Fig. 7-2. Tunnel-direction conductance curves for 5-mA tunnel diode.

Fig. 7-3 is a double exposure showing both the tunnel diode curve of Fig. 7-2 and the forward conduction curve of an ordinary small silicon diode.

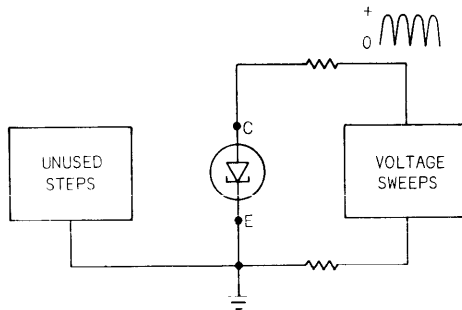
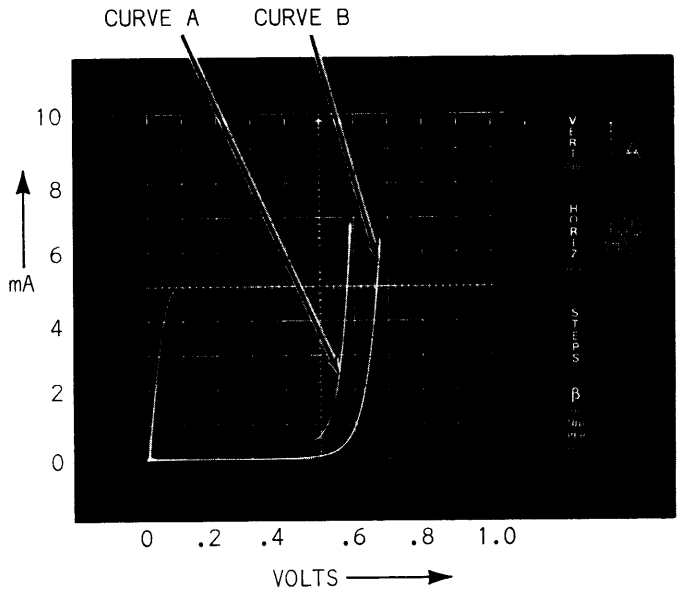

Fig. 7-3. Tunnel direction conductance of 5-mA tunnel diode (curve A) compared to forward conductance of small silicon diode (curve B).

Figs. 7-4 and 7-5 show the tunnel direction curves of a back diode.

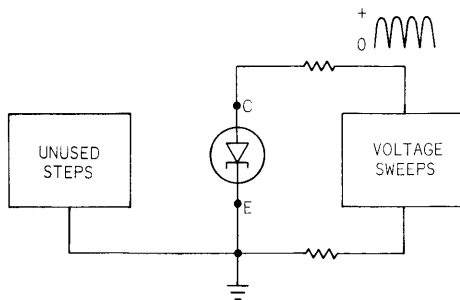
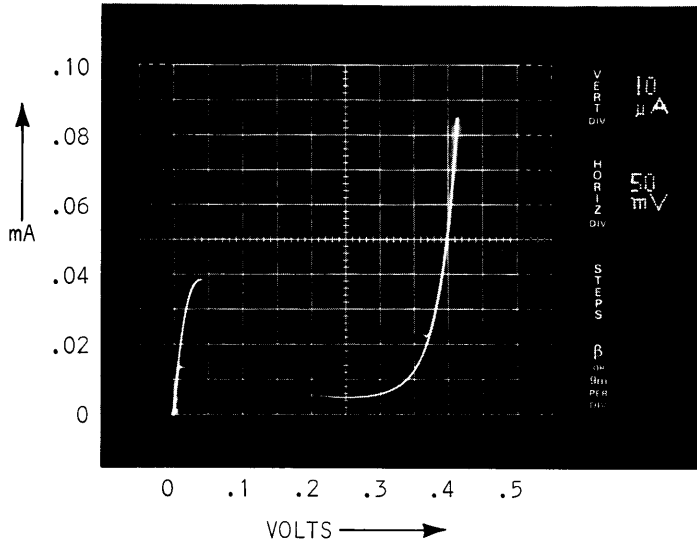

Fig. 7-4. Tunnel-direction conductance of BD-4 back diode.

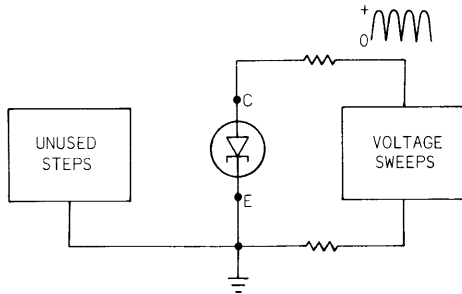
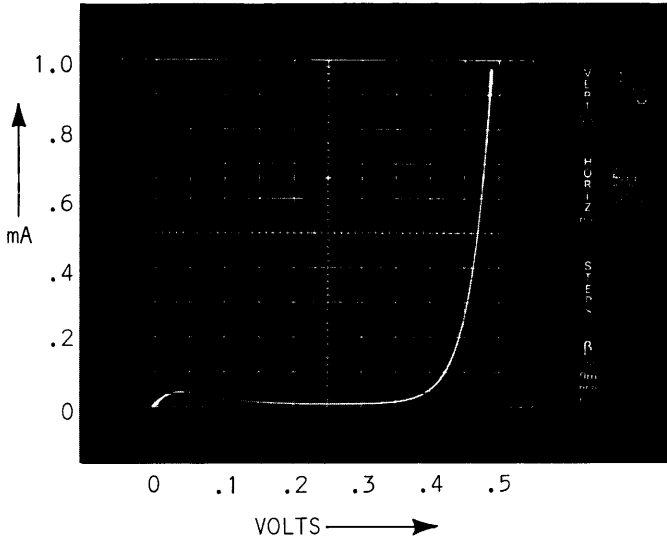

Fig. 7-5. Tunnel-direction conductance of same back diode as in Fig. 7-4; different vertical scale.

Fig. 7-6 is a bi-polarity curve showing both the tunnel direction curve of a tunnel diode, and the low impedance direction curve of that tunnel diode.

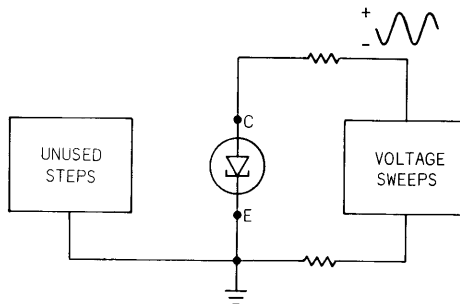
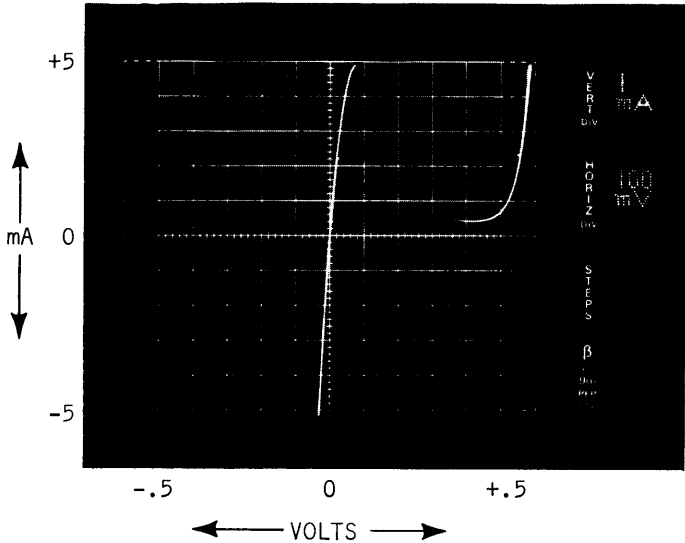

Fig. 7-6. Tunnel-direction and opposite direction conductance of 5-mA tunnel diode. Note lower impedance for opposite direction conduction.

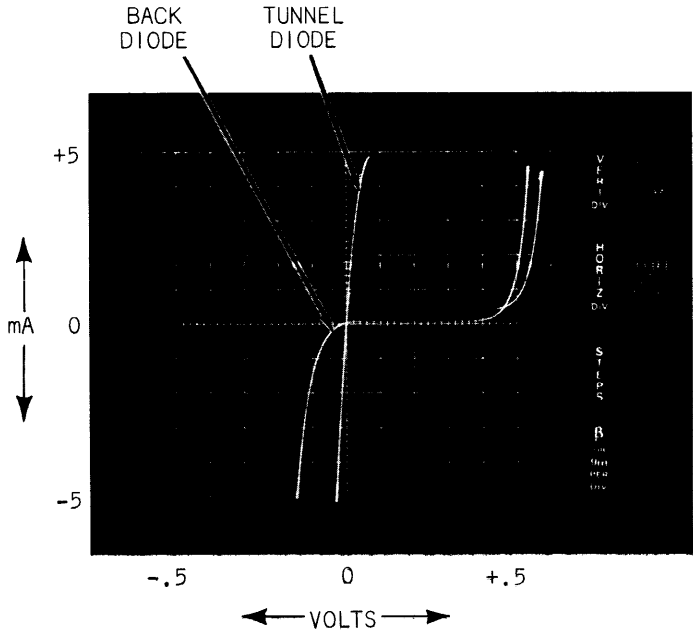

Fig. 7-7. Bi-polarity conductance of back diode compared to tunnel diode; double exposure.

Fig. 7-7 is a double exposure showing bi-polarity curves of a back diode and a tunnel diode.

Fig. 7-1 shows the tunnel direction conductance characteristics of a 100-mA tunnel diode. The following currents and voltages can be read from this figure:

Peak point current	0.1 amps
Valley point current	0.01 amps
Peak point voltage	0.14 volts
Projected peak point voltage	0.61 volts
Valley point voltage	0.44 volts

PEAK POINT CURRENT AND VOLTAGE

The peak-point current of a tunnel diode is the maximum value of current that may flow at a low value of applied voltage. Currents above the peak-point current value are beyond the negative resistance region, so correspond to only one possible value of voltage. The projected peak-point voltage is the lowest value of voltage that may correspond to a current in excess of the peak point current.

The peak point voltage of tunnel diodes is the highest voltage that may exist across a tunnel diode without exceeding the peak point current. The peak point is easily recognized in either Fig. 7-1 or Fig. 7-2. It is the top point on the left hand section of the curves.

VALLEY POINT CURRENT AND VOLTAGE

The valley point is the lowest point on the curve beyond the peak point. This point is sometimes a little more difficult to determine precisely than the peak point because the slope may be nearly horizontal for a considerable distance. Once determined, the valley point current and the valley point voltage can be read directly from the scale. In Fig. 7-2 the valley point voltage is somewhere between 400 and 450 millivolts. Peak points will always be visible on a curve tracer, however; they will not be somewhere in the negative resistance region.

DIFFERENTIAL RESISTANCE

$$\text{differential} \\ R = \frac{\Delta V}{\Delta I}$$

The dynamic or differential resistance of a tunnel diode or back diode depends on the particular diode, and how it is biased or operated. Differential resistance is a function of the slope of the conductance curve. It can be measured by choosing two points on a curve, scaling the difference in current and in voltage between those points, and dividing the difference in voltage (ΔV) by the difference in current (ΔI). Where a slope is changing, a straight edge held tangent to the point of interest will identify the slope. Any two points on the straight edge may then be chosen to determine the differential resistance.

NEGATIVE RESISTANCE

Negative resistance could be measured from the slope of the curve in the negative resistance region if we were to show a curve in that region. However, the average slope in that region is fairly close to the slope of an imaginary line connecting the peak point and the valley point. The resistance of a curve with that slope can be determined from the difference between the valley point voltage and the peak point voltage and the difference between the peak point current and the valley point current:

$$\text{Average Negative Resistance} = \frac{V_V - V_P}{I_P - I_V}$$

In Figure 7-1: $V_V = .44$ volts
 $V_P = .14$ volts
 $I_P = .10$ amperes
 $I_V = .01$ amperes

So the average negative resistance is equal to:

$$\frac{(.44) - (.14) \text{ volts}}{(.10) - (.01) \text{ amperes}} = \frac{.30}{.09} = 3.3 \Omega$$

The difference between valley-point voltage and peak-point voltage is between about 300 and 400 millivolts for all tunnel diodes. Therefore the negative resistance typically varies inversely with the peak point current of different tunnel diodes.

DEFINITIONS OF TERMS

The definitions of the listed terms are the same as appear in Publication 147-0 by the International Electrotechnical Commission, 1966, except for the deletion of some notes that pertain to a term or definition.

GENERAL SEMICONDUCTOR DEVICE TERMS

General terms*Terminal (of a semiconductor device)*

A specified externally available point of connexion.

Electrode (of a semiconductor device)

That part providing the electrical contact between the specified region of a semiconductor device and the lead to its terminal.

Forward direction (of a PN junction)

The direction of continuous (direct) current flow in which a PN junction has the lowest resistance.

Note. — This definition may not apply to tunnel devices.

Reverse direction (of a PN junction)

The direction of continuous (direct) current flow in which a PN junction has the higher resistance.

Note. — This definition may not apply to tunnel devices.

Physical terms*Semiconductor*

A material with resistivity usually in the range between metals and insulators, in which the electrical charge carrier concentration increases with increasing temperature over some temperature range.

Extrinsic semiconductor

A semiconductor with charge carrier concentration dependent upon impurities or other imperfections.

N-type semiconductor

Extrinsic semiconductor in which the conduction electron density exceeds the mobile hole density.

P-type semiconductor

Extrinsic semiconductor in which the mobile hole density exceeds the conduction electron density.

I-type (intrinsic) semiconductor

Nearly pure and ideal semiconductor in which the electron and hole densities are nearly equal under conditions of thermal equilibrium.

Junction

A region of transition between semiconducting regions of different electrical properties.

PN junction

A junction between P and N type semiconductor material.

Alloyed junction

A junction formed by alloying one or more materials to a semiconductor crystal.

Diffused junction

A junction formed by the diffusion of an impurity within a semiconductor crystal.

Grown junction

A junction produced during the growth of a semiconductor crystal from a melt.

Charge carrier (abbreviation: carrier)

In a semiconductor, a mobile (free) conduction electron or mobile hole.

Majority carrier (in a semiconductor region)

The type of carrier constituting more than half of the total charge carrier concentration.

Minority carrier (in a semiconductor region)

The type of carrier constituting less than half of the total charge carrier concentration.

Depletion layer

A region in which the mobile charge carrier density is insufficient to neutralize the net fixed charge density of donors and acceptors.

Breakdown (of a reverse-biased PN junction)

A phenomenon, the initiation of which is observed as a transition from a state of high dynamic resistance to a state of substantially lower dynamic resistance for increasing magnitude of reverse current.

Avalanche breakdown (of a semiconductor PN junction)

A breakdown that is caused by the cumulative multiplication of free charge carriers in a semiconductor under the action of a strong electric field which causes some free carriers to gain enough energy to liberate new hole-electron pairs by ionization.

Avalanche voltage

The applied voltage at which avalanche breakdown occurs.

Thermal breakdown (of a semiconductor PN junction)

A breakdown that is caused by the generation of free charge carriers owing to the cumulative interaction between increasing power dissipation and increasing junction temperature.

Note. — This effect is also known as thermal runaway in some countries.

Zener breakdown (of a semiconductor PN junction)

A breakdown caused by the transition of electrons from the valence band to the conduction band due to tunnel action under the influence of a strong electric field.

Zener voltage

The applied voltage at which Zener breakdown occurs.

Tunnel effect (repetition of definition 07-16-015 of IEC Publication 50 (07) but omitting the note)

The piercing of a potential hill by a carrier, which would be impossible according to classical mechanics, but the probability of which is not zero according to wave mechanics, if the width of the hill is small enough. The wave associated with the carrier is almost totally reflected on the first slope, but a small fraction crosses the hill.

Tunnel action (in a PN junction)

A process whereby conduction occurs through the potential barrier due to the tunnel effect and in which electrons pass in either direction between the conduction band in the N-region and the valence band in the P-region.

Note. — Tunnel action, unlike the diffusion of charge carriers, involves electrons only and for all practical purposes the transit time is negligible.

Photo-electric effect

Interaction between radiation and matter resulting in the absorption of photons and the consequent generation of mobile charge carriers.

Photovoltaic effect

A photo-electric effect wherein an electromotive force is generated.

Types of device*Semiconductor device*

A device whose essential characteristics are due to the flow of charge carriers within a semiconductor.

Semiconductor diode

A two-terminal semiconductor device having an asymmetrical voltage-current characteristic.

Note. — Unless otherwise qualified, this term usually means a device with the voltage-current characteristic typical of a single PN junction.

Voltage reference diode

A diode which develops across its terminals a reference voltage of specified accuracy, when biased to operate within a specified current range.

Voltage regulator diode

A diode which develops across its terminals an essentially constant voltage throughout a specified current range.

Semiconductor rectifier diode

A semiconductor diode designed for rectification and including its associated mounting and cooling attachments if integral with it.

Tunnel diode

A diode having a PN junction in which tunnel action occurs giving rise to negative differential conductance in a certain range of the forward direction of the current-voltage characteristic.

Transistor

A semiconductor device capable of providing power amplification and having three or more terminals.

Note. — Other names may be used to describe certain special types of semiconductor device covered by this definition.

Photoconductive cell

A device in which the photoconductive effect is utilized.

Photovoltaic cell

A device in which the photovoltaic effect is utilized.

Photo-diode

A diode in which the photoelectric effect is utilized.

Photo-transistor

A transistor in which the photoelectric effect is utilized.

Terms related to ratings and characteristics*Reverse voltage*

The voltage across a junction or a diode when biased in the direction corresponding to the higher resistance.

Note. — This definition may not apply to tunnel diodes.

Floating voltage

Voltage between an open-circuited terminal and the reference point when a specified voltage is applied to any of the other terminals.

Breakdown voltage

Reverse voltage at which the reverse current through a junction becomes greater than a specified value.

Cut-off frequency

The frequency at which the modulus of a measured parameter has decreased to $1/\sqrt{2}$ of its low frequency value.

Note. — For a transistor, the cut-off frequency usually applies to the short-circuit small-signal forward current transfer ratio for either the common-base or common-emitter configuration.

Temperatures*Case temperature*

The temperature measured at a specified point on the case of a semiconductor device.

Thermal derating factor

The factor by which the power dissipation rating must be reduced with increase of ambient or case temperature.

SIGNAL DIODE AND RECTIFIER DIODE TERMS*Continuous (direct) reverse voltage*

The value of the constant voltage applied to a diode in the reverse direction.

Peak reverse voltage

The highest instantaneous value of the reverse voltage occurring across a diode including all repetitive and non-repetitive transients.

Reverse current

The total conductive current flowing through the diode when specified reverse voltage is applied.

Forward voltage

The voltage across the terminals which results from the flow of current in the forward direction.

Forward current

The current flowing through the diode in the direction of lower resistance.

Differential resistance

The differential resistance measured between the terminals of the diode under specified conditions of measurement.

Forward d.c. resistance

The quotient of d.c. forward voltage across the diode and the corresponding d.c. forward current.

Reverse d.c. resistance

The quotient of the d.c. reverse voltage across the diode and the corresponding d.c. reverse current.

Small-signal capacitance

Differential capacitance at the diode terminals, measured under given bias conditions.

Reverse recovery time

The time required for current or voltage to recover to a specified value after instantaneous switching from a specified forward current condition to a specified reverse bias condition.

TUNNEL DIODE TERMS

Forward direction

The direction of current flow within the diode for which the characteristic includes negative differential conductance.

Reverse direction

The direction of current flow within the diode for which the characteristic includes only positive differential conductance.

Peak point

The point on the characteristic corresponding to the lowest voltage in the forward direction for which the differential conductance is zero.

Peak point voltage

The voltage value at the peak point.

Peak point current

The current value at the peak point.

Valley point

The point on the characteristic corresponding to the lowest voltage greater than the peak point voltage for which the differential conductance is zero.

Valley point voltage

The voltage value at the valley point.

Valley point current

The current value at the valley point.

Peak to valley point current ratio

The ratio of the peak point current to the valley point current.

Projected peak point

The point on the characteristic where the current is equal to the peak point current, but where the voltage is greater than the valley point voltage.

Projected peak point voltage

The voltage value at the projected peak point.

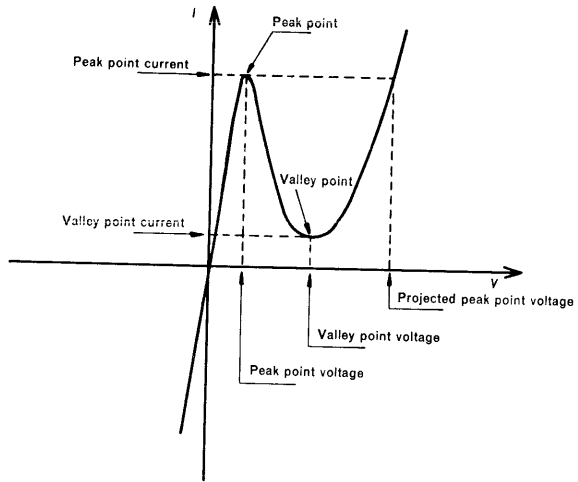

Static voltage-current characteristic of a tunnel diode.

Negative differential conductance region

That part on the characteristic of a tunnel diode between the peak and valley points.

Case capacitance

The residual capacitance between the device terminals when the PN junction is not internally connected.

Series inductance

The total effective internal series inductance under specified conditions.

TRANSISTOR TERMS

General terms*Base terminal*

The specified externally available point of connection to the base region.

Collector terminal

The specified externally available point of connection to the collector region.

Emitter terminal

The specified externally available point of connection to the emitter region.

Collector region

A region between the collector junction and the collector electrode of a transistor.

Emitter region

A region between the emitter junction and the emitter electrode of a transistor.

Base region

A region between the emitter and collector junctions of a transistor.

Collector junction

A junction between the base and collector regions normally biased in the reverse direction and through which the charge carriers flow from a region in which they are minority carriers to one in which they are majority carriers.

Emitter junction

A junction between the base and emitter regions normally biased in the forward direction, and through which the charge carriers flow from a region in which they are majority carriers to one in which they are minority carriers.

Types of transistor**Junction transistor**

Transistor having a base region and two or more junctions.

Note. — The operation of a junction transistor depends upon the injection of minority carriers into the base region.

Bi-directional transistor

A transistor which has substantially the same electrical characteristics when the terminals normally designated as emitter and collector are interchanged.

Note. — Bi-directional transistors are sometimes called symmetrical transistors. This term, however, is deprecated as it might give the incorrect impression of an ideally symmetrical transistor.

Tetrode transistor

A four-electrode transistor, usually a conventional junction transistor having two separate base electrodes and two base terminals.

Unipolar transistor

A transistor which utilizes charge carriers of only one polarity.

Terms related to ratings and characteristics**Punch-through voltage**

The value of the collector-base voltage above which the open-circuit emitter-base voltage increases almost linearly with increasing collector-base voltage.

Note. — “Reach-through voltage” is a term also used in the U.S.A.

Saturation voltage

The residual voltage between collector and emitter terminals under specified conditions of base current and collector current, the collector current being limited by the external circuit.

Cut-off current (reverse current)

Reverse current of the base-collector junction (or base-emitter junction) when the emitter or the collector is open-circuited, the reverse voltage being specified.

Emitter series resistance

The resistance between the emitter terminal and the internal inaccessible emitter point in an equivalent circuit.

Saturation resistance

The resistance between collector and emitter terminals under specified conditions of base current and collector current, when the collector current is limited by the external circuit.

Note. — The saturation resistance may be determined either as the ratio of total voltage to total current or as the ratio of differential voltage to differential current; the method of determination must be specified.

Extrinsic base resistance

The resistance between the base terminal and the internal inaccessible base point in an equivalent circuit.

Collector depletion layer capacitance

The part of the capacitance across a collector-base junction that is associated with its depletion layer.

Note. — The collector depletion layer capacitance is a function of the total potential difference across the depletion layer.

Delay time (of a switching transistor)

The time interval between the application at the input terminals of a pulse which is switching the transistor from a non-conducting to a conducting state, and the appearance at the output terminals of the pulse induced by the charge carriers.

Note. — The time is usually measured between points corresponding to 10% of the amplitude of the applied pulse and of the output pulse, respectively (see Figure 1, page 51).

Rise time (of a switching transistor)

The time interval between the instants at which the magnitude of the pulse at the output terminals reaches specified lower and upper limits respectively when the transistor is being switched from its non-conducting to its conducting state.

Note. — The lower and upper limits are usually 10% and 90% respectively, of the amplitude of the output pulse. (see Figure 1).

Carrier storage time (of a switching transistor)

The time interval between the beginning of the fall of the pulse applied to the input terminals and the beginning of the fall of the pulse generated by charge carriers at the output terminals.

Note. — The time is generally measured between the 90% values of the two pulse amplitudes (see Figure 1).

Fall time (of a switching transistor)

The time interval between the instants at which the magnitude of the pulse at the output terminals reaches specified upper and lower limits respectively when the transistor is being switched from its conducting to its non-conducting state.

Note. The upper and lower limits are usually 90% and 10% respectively, of the amplitude of the output pulse

Small-signal short-circuit forward current transfer ratio

The ratio between the alternating output current and the small sinusoidal input current producing it under small-signal conditions, the output being short-circuited to a.c.

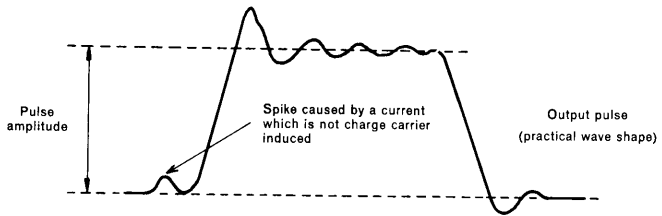
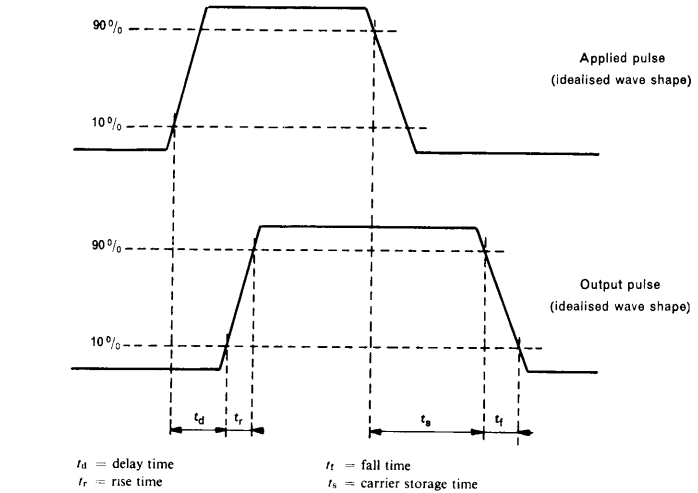

Switching transistor pulse characteristic.

Static value of the forward current transfer ratio

The ratio between the continuous (direct) output and the continuous (direct) input current, the output voltage being held constant.

Small-signal - open-circuit reverse voltage transfer ratio

The ratio of the alternating voltage appearing at the input terminals, when they are a.c. open-circuited, to the alternating voltage applied to the output terminals, under small-signal conditions.

Circuit configuration

Common base

Circuit configuration in which the base terminal is common to the input circuit and to the output circuit and in which the input terminal is the emitter terminal and the output terminal is the collector terminal.

Inverse common base

Circuit configuration in which the base terminal is common to the input circuit and to the output circuit and in which the input terminal is the collector terminal and the output terminal is the emitter terminal.

Common collector

Circuit configuration in which the collector terminal is common to the input circuit and to the output circuit and in which the input terminal is the base terminal and the output terminal is the emitter terminal.

Inverse common collector

Circuit configuration in which the collector terminal is common to the input circuit and to the output circuit and in which the input terminal is the emitter terminal and the output terminal is the base terminal.

Common emitter

Circuit configuration in which the emitter terminal is common to the input circuit and to the output circuit and in which the input terminal is the base terminal and the output terminal is the collector terminal.

Inverse common emitter

Circuit configuration in which the emitter terminal is common to the input circuit and to the output circuit and in which the input terminal is the collector terminal and the output terminal is the base terminal.

DEFINITIONS OF SYMBOLS

Except as noted, the symbols and definitions of symbols are the same as in Electronic Industries Association Standard RS-245A.

BV_{CBO}	Obsolete - see $V_{(\text{BR})\text{CBO}}$
BV_{CEO}	Obsolete - see $V_{(\text{BR})\text{CEO}}$
BV_{CER}	Obsolete - see $V_{(\text{BR})\text{CER}}$
BV_{CES}	Obsolete - see $V_{(\text{BR})\text{CES}}$
BV_{CEX}	Obsolete - see $V_{(\text{BR})\text{CEX}}$
BV_{EBO}	Obsolete - see $V_{(\text{BR})\text{EBO}}$
C_{ibo}	Open-circuit input capacitance, common base
C_{ibs}	Short-circuit input capacitance, common base
C_{ieo}	Open-circuit input capacitance, common emitter
C_{ies}	Short-circuit input capacitance, common emitter
C_{obo}	Open-circuit output capacitance, common base
C_{obs}	Short-circuit output capacitance, common base
C_{oeo}	Open-circuit output capacitance, common emitter
C_{oes}	Short-circuit output capacitance, common emitter
f_{hfb}	Small-signal short-circuit forward current transfer ratio cutoff frequency (common base)
f_{hfe}	Small-signal short-circuit forward current transfer ratio cutoff frequency (common emitter)
f_{T}	Frequency at which small-signal forward current transfer ratio (common emitter) extrapolates to unity

h_{FB}	Static forward current transfer ratio (common base)
h_{fb}	Small-signal short-circuit forward current transfer ratio (common base)
h_{FC}	Static forward current transfer ratio (common collector)
h_{fc}	Small-signal short-circuit forward current transfer ratio (common collector)
h_{FE}	Static forward current transfer ratio (common emitter)
h_{fe}	Small-signal short-circuit forward current transfer ratio (common emitter)
h_{IB}	Static input resistance (common base)
h_{ib}	Small-signal short-circuit input impedance (common base)
h_{IC}	Static input resistance (common collector)
h_{ic}	Small-signal short-circuit input impedance (common collector)
h_{IE}	Static input resistance (common emitter)
h_{ie}	Small-signal short-circuit input impedance (common emitter)
h_{ob}	Small-signal open-circuit output admittance (common base)
h_{oc}	Small-signal open-circuit output admittance (common collector)
h_{oe}	Small-signal open-circuit output admittance (common emitter)
h_{rb}	Small-signal open-circuit reverse voltage transfer ratio (common base)
h_{rc}	Small-signal open-circuit reverse voltage transfer ratio (common collector)
h_{re}	Small-signal open-circuit reverse voltage transfer ratio (common emitter)

I_B	Base current, DC
I_C	Collector current, DC
I_{CBO}	Collector cutoff current, DC, emitter open
I_{CEO}	Collector cutoff current, DC, base open
I_{CER}	Collector cutoff current, DC, with specified resistance between base and emitter
I_{CEV}	Collector cutoff current, DC, with specified voltage between base and emitter
I_{CES}	Collector cutoff current, DC, with base short circuited to emitter
I_{DSS}	Drain current, DC, with gate shorted to emitter*
I_E	Emitter current, DC
I_{EBO}	Emitter cutoff current (DC), collector open
I_{GSS}	Gate leakage current*
$r_{CE}^{(sat)}$	Collector-to-emitter saturation resistance

*Not a part of Standard RS-245-A

$V_{(BR)CBO}$	Breakdown voltage, collector-to-base, emitter open
$V_{(BR)CEO}$	Breakdown voltage, collector-to-emitter, base open
$V_{(BR)CER}$	Breakdown voltage, collector-to-emitter, with specified resistance between base and emitter
$V_{(BR)CES}$	Breakdown voltage, collector-to-emitter, with base short-circuited to emitter
$V_{(BR)CEX}$	Breakdown voltage, collector-to-emitter, with specified circuit between base and emitter
$V_{(BR)DGO}$	Breakdown voltage, drain-to-gate, source open*
$V_{(BR)DSS}$	Breakdown voltage, drain-to-source, gate shorted to source*
$V_{(BR)EBO}$	Breakdown voltage, emitter-to-base, collector open
$V_{(BR)GSS}$	Breakdown voltage, gate-to-source, drain shorted to source*
V_{BC}	Base-to-collector voltage, DC
V_{BE}	Base-to-emitter voltage, DC
V_{CB}	Collector-to-base voltage, DC
V_{CE}	Collector-to-emitter voltage, DC
V_{CEO}	Collector-to-emitter voltage, DC with base open*
$V_{CEO(SUS)}$	Collector-to-emitter (breakdown) sustaining voltage*
V_{CER}	Collector-to-emitter voltage, DC with specified resistor between base and emitter
$V_{CER(SUS)}$	Collector-to-emitter (breakdown) sustaining voltage*
V_{CES}	Collector-to-emitter voltage, DC with base short-circuited to emitter

*Not a part of Standard RS-245-A

$V_{CES(SUS)}$	Collector-to-emitter (breakdown) sustaining voltage*
V_{CEX}	Collector-to-emitter voltage, DC with specified circuit between base and emitter
$V_{CEX(SUS)}$	Collector-to-emitter (breakdown) sustaining voltage*
$V_{CE(sat)}$	Collector-to-emitter saturation voltage, DC
V_{DS}	Drain-to-source voltage, DC
V_{EB}	Emitter-to-base voltage, DC
V_{EC}	Emitter-to-collector voltage, DC
V_{GS}	Gate-to-source voltage, DC
V_{RT}	Reach-through voltage

*Not a part of Standard RS-245-A

INDEX

- Admittance, output, 54, 62
- Alpha, 22, 23
- Avalanche breakdown, 39
- Avalanche breakdown, thyristor, 95
- Avalanche transistor, 41
- Back biased, 47
- Back diodes, 125
- Beta, 19-22
- Beta, AC, 15
- Beta, DC, 1, 3
- Bidirectional transistors, 15
- Bipolar transistor, 1, 56
- Bipolarity conductance curve, 131-132
- Breakdown, FET, 71-75
- Breakdown, reach through, 42
- Breakdown region, 29-32
- Capacitance, diode junction, 112-113
- Capacitance, virtual, 53
- Circuit, switching time, 52
- Collector breakdown, 37-38
- Collector sustaining voltage, 36
- Collector voltage saturation, 47
- Carrier diffusion time, 54
- Carrier recombination time, 54
- Carrier storage time, 44, 48
- Conductance curves, tunnel, 126-132
- Conductance diode forward, 100-102
- Conductance thyristor, 98
- Conduction time, 13
- Current gain, 1
- Current gain, high frequency, 54
- Current gain, unity, 55
- Curves, interpreting, 18-19
- Cutoff current, 28, 33, 35
- Cutoff frequency, 54-55
- Cutoff pulse, 52
- Definition, symbols, 147
- Definition, terms, 135
- Delay time, 44-47
- Depletion/enhancement mode, 87
- Depletion Mode, FET, 76-84
- Differential resistance, 103
- Differential resistance, tunnel diode, 133
- Differential resistance, zener, 119, 121-123
- Diffusion time, 47
- Diode comparison, 106
- Diode, current vs voltage, 99
- Diode, forward conductance, 102
- Diode, forward resistance, 102-104
- Diode junction capacitance, 112-113
- Diode measurements, pulse characteristics, 108
- Diode, temperature effects, 104
- Diodes, Ge, GaAs, Si, 100
- Diodes, signal, 99
- Diodes, varactor, 118
- Drain current vs temperature, 75
- Drain current, zero bias, 78-79
- Duty factor, 6
- Dynamic resistance, 39
- Dynamic resistance, forward, 104
- Enhancement mode, FET, 77, 83, 85-86
- Emitter follower conductance, 61
- Fall time, 44-45, 52
- Field effect transistor, 71
- Forward bias, 32
- Forward blocking voltage, 93-94
- Forward conductance, diode, 100-102
- Forward current transfer, 1, 13, 21
- Forward recovery time measurement, 118
- Forward resistance, diode, 102-104

- Forward transfer, FET, 79
- Gain bandwidth product, 55
- Go, no-go, 4
- Go, no-go test, thyristor, 96
- Heat flow vs temperature, 7
- Heat symptoms, 8
- Holding current, 96
- Input capacitance, 48, 53
- Input impedance, 56-61
- Input resistance, 56-61
- Impedance, zener, 123
- Interbase, resistance, 88-89
- Junction capacitance, diode, 114-117
- Junction capacitance, transistor, 48
- Junction temperature, transistor, 5-13
- Leakage current, diode, 105
- Leakage current, FET, 71-73
- Linear operation, 20
- Loop, 8
- Measurement errors, 36
- Negative resistance, 36, 40, 89, 125, 134
- Output capacitance, 54
- Output admittance, 62-67
- Parasitics, 41
- Peak power, 13
- Pinch-off specification, 82
- Pinch-off voltage, 80
- Power dissipated, 27
- Punch through, 42-43
- Reach through, 42
- Recovery time, forward, 118
- Rectification efficiency, 117
- Repetition rate, 10
- Recovery time, reverse, 106-113
- Resistance, saturation, 62
- Response delay, 50
- Reverse bias, 32
- Reverse blocking voltage, 93-94
- Reverse current, 28-29
- Reverse current vs temperature, 33
- Reverse current, high, 114-116
- Reverse recovery, snap-off, 114-115
- Reverse voltage, diode, 105, 119
- Reverse terminals, 14
- Reverse voltage transfer, 67-69
- Rise rate, 47-48
- Risetime, 44
- Saturation region, 24-27
- SCR, 93
- Silicon controlled rectifier, 93
- Single family, 5
- Single shot, 5
- Snap-off diodes, 114
- Small signal, 18
- Static measurements, diode, 105
- Step-recovery diode, 114
- Storage time, 50, 52
- Stored charge, 116
- Sustaining voltage, 39
- Switching time, transistors, 43-45
- Symbols, defined, 147
- Symmetrical transistors, 15
- Temperature effects, diode, 104
- Temperature effects, FET, 74-75
- Temperature effects, transistor, 5-13, 30-31
- Temperature effect, zener, 122
- Terms, defined, 135
- Test fixture, reverse recovery time, 109
- Thyristor forward conductance, 98
- Thyristor switching, 95-97
- Thyristors, 93
- Transadmittance, FET, 86
- Transconductance, FET, 86
- Transistor, high-speed, 51
- Transistor loading effect, 56
- Tunnel diode conductance, 126-132
- Tunnel diode, peak point, 133
- Tunnel diodes, 125
- Tunnel rectifier, 125
- Turn-off characteristics, 44, 49-51
- Turn-off pulse, 109
- Turn-on characteristics, 44, 46
- Unijunction conductance, 90-91
- Unijunction transistors, 89
- Varactor diodes, 118
- Voltage breakdown, 28
- Zener diodes, 119
- Zener voltage, 119-121

NOTES

*This book is but one of a series.
The series consists of two groups,
circuits and measurements. These
texts present a conceptual approach
to circuits and measurements which
apply to Tektronix products.
Several "concept books" are in
preparation; those now available
are:*

Power Supply Circuits

Oscilloscope Cathode-Ray Tubes

Storage Cathode-Ray Tubes and Circuits

Television Waveform Processing Circuits

Information Display Concepts