

# Service Manual

**Tektronix**

**CMC250  
Frequency Counter  
070-7941-00**

This document applies for firmware version X.XX and above.

**Warning**

The servicing instructions are for use by qualified personnel only. To avoid personal injury, do not perform any servicing unless you are qualified to do so. Refer to the Safety Summary prior to performing service.

**Please check for change information at the rear of this manual.**

First Printing: February 1993

# TABLE OF CONTENTS

	Page		Page
LIST OF ILLUSTRATIONS .....	ii	<b>Section 6 MAINTENANCE</b>	
LIST OF TABLES .....	iii	STATIC-SENSITIVE	
OPERATORS SAFETY SUMMARY .....	iv	COMPONENTS .....	6-1
SERVICING SAFETY SUMMARY .....	v	PREVENTIVE MAINTENANCE .....	6-2
		INSPECTION AND CLEANING .....	6-2
		TROUBLESHOOTING .....	6-4
		TROUBLESHOOTING AIDS .....	6-4
		TROUBLESHOOTING	
		TECHNIQUES .....	6-4
		CMC250 TROUBLESHOOTING	
		TIPS .....	6-7
		CORRECTIVE MAINTENANCE .....	6-12
		MAINTENANCE	
		PRECAUTIONS .....	6-12
		OBTAINING REPLACEMENT	
		PARTS .....	6-12
		REPACKAGING FOR	
		SHIPMENT .....	6-13
		MAINTENANCE AIDS .....	6-13
		INTERCONNECTIONS .....	6-14
		TRANSISTORS AND	
		INTEGRATED CIRCUITS .....	6-14
		SOLDERING TECHNIQUES .....	6-14
		REMOVAL AND	
		REPLACEMENT	
		INSTRUCTIONS .....	6-15
		<b>Section 7 OPTIONS</b>	
		INTERNATIONAL POWER CORDS	7-1
		<b>Section 8 REPLACEABLE PARTS</b>	
		<b>Section 9 DIAGRAMS</b>	
		<b>CHANGE INFORMATION</b>	
<b>Section 1 GENERAL INFORMATION</b>			
INTRODUCTION .....	1-1		
SPECIFICATION .....	1-1		
<b>Section 2 PREPARATION FOR USE</b>			
SAFETY .....	2-1		
LINE VOLTAGE .....	2-1		
POWER CORD .....	2-1		
FUSES .....	2-2		
OPERATING INFORMATION .....	2-2		
<b>Section 3 THEORY OF OPERATION</b>			
INTRODUCTION .....	3-1		
DIGITAL LOGIC CONVENTIONS .....	3-1		
BLOCK DIAGRAM DESCRIPTION .....	3-1		
DETAILED CIRCUIT DESCRIPTION .....	3-1		
<b>Section 4 PERFORMANCE CHECK PROCEDURE</b>			
INTRODUCTION .....	4-1		
TEST EQUIPMENT NEEDED .....	4-1		
PREPARATION .....	4-2		
PROCEDURES .....	4-2		
<b>Section 5 ADJUSTMENT PROCEDURE</b>			
INTRODUCTION .....	5-1		
PREPARATION FOR ADJUSTMENT .....	5-1		
PROCEDURES .....	5-1		

# LIST OF ILLUSTRATIONS

Figure	Page
The CMC250 1 GHz Frequency Counter	vi
2-1 Rear Panel	2-1
2-2 Optional power cords	2-2
3-1 Block diagram	3-2
3-2 U16 digit strobes	3-4
3-3 Operating mode selection	3-5
3-4 GATE (Resolution) selection	3-6
3-5 Additional strobe feedback	3-7
3-6 External decimal point control	3-8
6-1 Digit strobe waveforms from U16	6-9
9-1 Color codes for resistors.	
9-2 Semiconductor lead configurations.	
9-3 Main circuit board and adjustment locations.	

# LIST OF TABLES

Table	Page
1-1 General Characteristics .....	1-2
1-2 Electrical Characteristics .....	1-3
4-1 Test Equipment Required .....	4-1
6-1 Relative Susceptibility to Static-Discharge Damage .....	6-1
6-2 External Inspection Checklist .....	6-3
6-3 Internal Inspection Checklist .....	6-3
6-4 Normal CMC250 Displays .....	6-8
6-5 CH 1 Analog Circuit Waveforms .....	6-10
6-6 GATE Time Logic Check .....	6-10
6-7 FUNCTION Logic Check .....	6-11
6-8 Maintenance Aids .....	6-13

# GENERAL INFORMATION

## INTRODUCTION

The TEKTRONIX CMC250 1.3 GHz Frequency Counter is a multifunction counter that measures the frequency of sine, square, and triangle waves from 5 Hz to 1.3 GHz. The count is shown on an eight-digit display with automatic decimal point placement and an LED indicator showing the display measurement unit (MHz, kHz,  $\mu$ s).

The counter has two input channels: Channel 2 is a special 50  $\Omega$  terminated input for use in high-frequency systems, and Channel 1 is a standard 1 M $\Omega$  input for frequency measurements up to 100 MHz. A Check mode is provided so that the user can make a quick check of instrument operation, and Period and Totalize modes can be used with Channel 1 input signals.

Additional features of the CMC250 include selectable GATE times (resolution) for both channels, a selectable X10 attenuator for 3 V to 42 V input signals, and a selectable low-pass filter for signals below 100 kHz. The counter has front-panel OVERRANGE and GATE (measurement in progress) LED indicators.

The CMC250 comes with a locking, multiposition carrying handle/tilt stand that can be folded under the frequency counter to allow stacking with other instruments of the same series. Standard accessories provided with the CMC250 include a power cord and an operator's manual. For part numbers and further information about standard and optional accessories, refer to Replaceable Parts (section 8) in this manual. For additional information, contact your Tektronix Sales Office or distributor and the Tektronix products catalog.



## SPECIFICATION

General characteristics are given in Table 1-1. The electrical characteristics given in Table 1-2 are valid when the instrument has been adjusted at an ambient temperature between 18°C and 28°C (64°F and 82°F), has had a warmup period of at least one hour, and is operating at an ambient temperature between 0°C and 40°C, with 75% maximum relative humidity.

Table 1-1  
General Characteristics

Characteristic	Description
<b>OPERATIONAL</b>	
Display	Eight-digit, 0.43-inch, seven-segment LED readout, with OVERRANGE, MHz, kHz/ $\mu$ s, and GATE indicators.
FUNCTION Indicators	KHz, MHz, CH2, PERIOD, TOTAL, and CHECK.
GATE Indicators (CH 1/CH 2)	0.01s/0.027s, 0.1s/0.27s, 1.0s/2.7s, and 10s/27s.
Display Update Time	
Frequency Mode	CH 1 - Selected gate time plus fixed 200 ms interval. CH 2 - Selected gate time plus 540 ms interval.
Period Mode	Selected-cycles averaging plus fixed 200 ms interval.
Totalize Mode	Continuous.
CH 1 Input Voltage Attenuation (selectable)	
50 mV to 5 V (LO)	1X.
3 V to 42 V (HI)	10X.
Input Impedance	
CH 1 INPUT	1 M $\Omega$ paralleled by 40 pF.
CH 2 INPUT	50 $\Omega$ .
Time Base	Crystal-controlled oscillator.
<b>PHYSICAL</b>	
Width	240 mm (9.5 in).
Height	64 mm (2.5 in).
Depth	190 mm (7.5 in).
Weight	1.9 kg (4.2 lb).
<b>ENVIRONMENTAL</b>	
Operating Temperature	10°C to 40°C (32°F to +104°F), $\leq$ 75% relative humidity.
Nonoperating Temperature	-10°C to +60°C (-4°F to 140°F), $\leq$ 80% relative humidity.

Table 1-2  
Electrical Characteristics

Characteristics	Performance Requirements
Line Voltage Range	90 to 110, 108 to 132, 198 to 242, and 216 to 250 Vac at 50-60 Hz.
Power Consumption	15 VA, 12 W maximum.
<b>FREQUENCY</b>	
Frequency Range	
Channel 1	5 Hz to 100 MHz sine wave.
Channel 2	80 MHz to 1.3 GHz sine wave.
Accuracy	Time base accuracy $\pm 1$ count.
Resolution (selectable)	
Channel 1	
kHz Mode	0.1 Hz to 100 Hz.
MHz Mode	1 Hz to 1000 Hz.
Channel 2	10 Hz to 10 kHz.
<b>PERIOD</b>	
Range	0.4 $\mu$ s to 0.2 s.
Frequency Range	5 Hz to 2.5 MHz sine wave.
Accuracy	$\pm 1$ count $\pm$ time base error $\pm$ trigger error. <sup>a</sup>
Resolution (selectable)	100 ps to 100 ns.
<b>TOTALIZE</b>	
Range	0 to 99,999,999 counts plus overrange.
Repetition Rate	5 Hz to 10 MHz sine wave.
<b>CHANNEL 1 INPUT</b>	
Bandwidth	5 Hz to 100 MHz, AC coupled.
Maximum Input Voltage 	42 V peak.
Sensitivity (minimum input voltage)	
5 Hz to 30 MHz	20 mVrms.
30 MHz to 100 MHz	50 mVrms.
<b>CHANNEL 2 INPUT</b>	
Bandwidth	80 MHz to 1.3 GHz, AC coupled.
Maximum Input Voltage 	1 Vrms.
Sensitivity (minimum input voltage)	
80 MHz to 600 MHz	10 mVrms.
600 MHz to 900 MHz	25 mVrms.
900 MHz to 1.3 GHz	50 mVrms.

<sup>a</sup> Trigger error is typically  $\pm 0.3$  of reading divided by the number of cycles averaged, for input signals greater than 100 mV with S/N ratio better than 40 dB.

Table 1 -2 (cont)

Characteristics	Performance Requirements
<b>TIME BASE</b>	
Crystal Frequency CH 1	10 MHz.
CH 2	3.90625 MHz.
Setability	±0.1 ppm (±1 Hz).
Temperature Stability (accuracy)	± 10 ppm from 0° to 40°C.
Aging Rate	Less than ± 10 ppm per year.



# THEORY OF OPERATION

## INTRODUCTION

This section contains a description of the CMC250 1.3 GHz Frequency Counter circuitry. General operation of the instrument is described in the Block Diagram Description. Each functional circuit is described in more detail in the Detailed Circuit Description.

The schematic diagram and the Main circuit board illustration are located in the Diagrams section of this manual. To understand the circuit descriptions in this section, refer to both the Block Diagram, Figure 3-1 in this section, and to the schematic diagram.

## DIGITAL LOGIC CONVENTIONS

Functions and operation of digital logic circuits are represented by logic symbology and terminology. Most logic functions are described using the positive-logic convention. Positive logic is a system of notation whereby the more positive of two levels is the TRUE (or 1) state; the more negative level is the FALSE (or 0) state. In this manual, the TRUE state is referred to as high, and the FALSE state as low. The voltages that constitute a high or a low state vary between specific devices. For device characteristics, refer to the manufacturer's data book.

## BLOCK DIAGRAM DESCRIPTION

Signal input to Channel 1 is through the CHANNEL 1 INPUT connector on the front panel. Channel 1 is for frequencies below 100 MHz and has a signal-conditioning feature. The attenuator switch S6 selects either full voltage when INPUT VOLTAGE is set to LO, or passes the signal through a 10X attenuator when INPUT VOLTAGE is set to HI.

Signal input to Channel 2 is through the CHANNEL 2 INPUT connector on the front panel. Channel 2 is for frequencies from 80 MHz to 1.3 GHz, and the Channel 2 Input circuit includes a divide-by-256 feature.

The main counter, integrated circuit U16, performs all frequency, period, and totalization functions and drives the displays. Four control inputs on U16 determine operating mode, resolution, time base frequency, and decimal point placement. Selected time-multiplexed

digit strobes are fed back to these control inputs via the front panel switches. The control inputs set operating conditions according to which strobes are applied.

The time base is a 10 MHz oscillator for Channel 1 measurements and a 3.90625 MHz oscillator for Channel 2 measurements.

The power supply provides regulated dc voltages. The power supply circuit can be set with the LINE VOLTAGE SELECT switches as needed to accommodate various line voltages.

## DETAILED CIRCUIT DESCRIPTION

### Channel 1 Input Circuit

Signals with frequencies below 100 MHz are connected to the Channel 1 Input Circuit via the CHANNEL 1 INPUT connector on the front panel. The input signal is capacitively coupled via C1 to the divider of R2 and R3. When the INPUT VOLTAGE switch S6 is set to 50mV-5V(LO), the full voltage across this divider goes to the Input Buffer; when S6 is set to 3V-42V(HI), the signal is connected through an Attenuator circuit before going to the Input Buffer.

**ATTENUATOR.** Voltage divider R2 and R3 attenuates Channel 1 Input signals by a factor of 10 when the INPUT VOLTAGE switch S6 is set to HI.

**INPUT BUFFER.** Either the entire signal (S6 set to LO) or the attenuated signal (S6 set to HI) is applied to the Input Buffer. The Input Buffer isolates the signal being tested from the circuitry in the frequency counter. This voltage is level-clamped to a maximum of 0.6 volts by transistors Q1 and Q2 and then applied to the high-impedance buffer stage. This consists of FET Q3 which provides good sensitivity over the Channel 1 frequency range and Q4 which serves as a current source for successive stages.

**LOW PASS FILTER.** The Low Pass Filter removes the high-frequency components (noise) from a signal, so that lower frequencies can be accurately counted. When the LOW PASS FILTER switch S7 is ON, D1 and D2 are biased on, providing an ac path to ground through D1, and the filter action of R9 and C9 is enabled. When the switch is OFF, D1 and D2 are off, isolating C9 from ground and disabling the filter action.

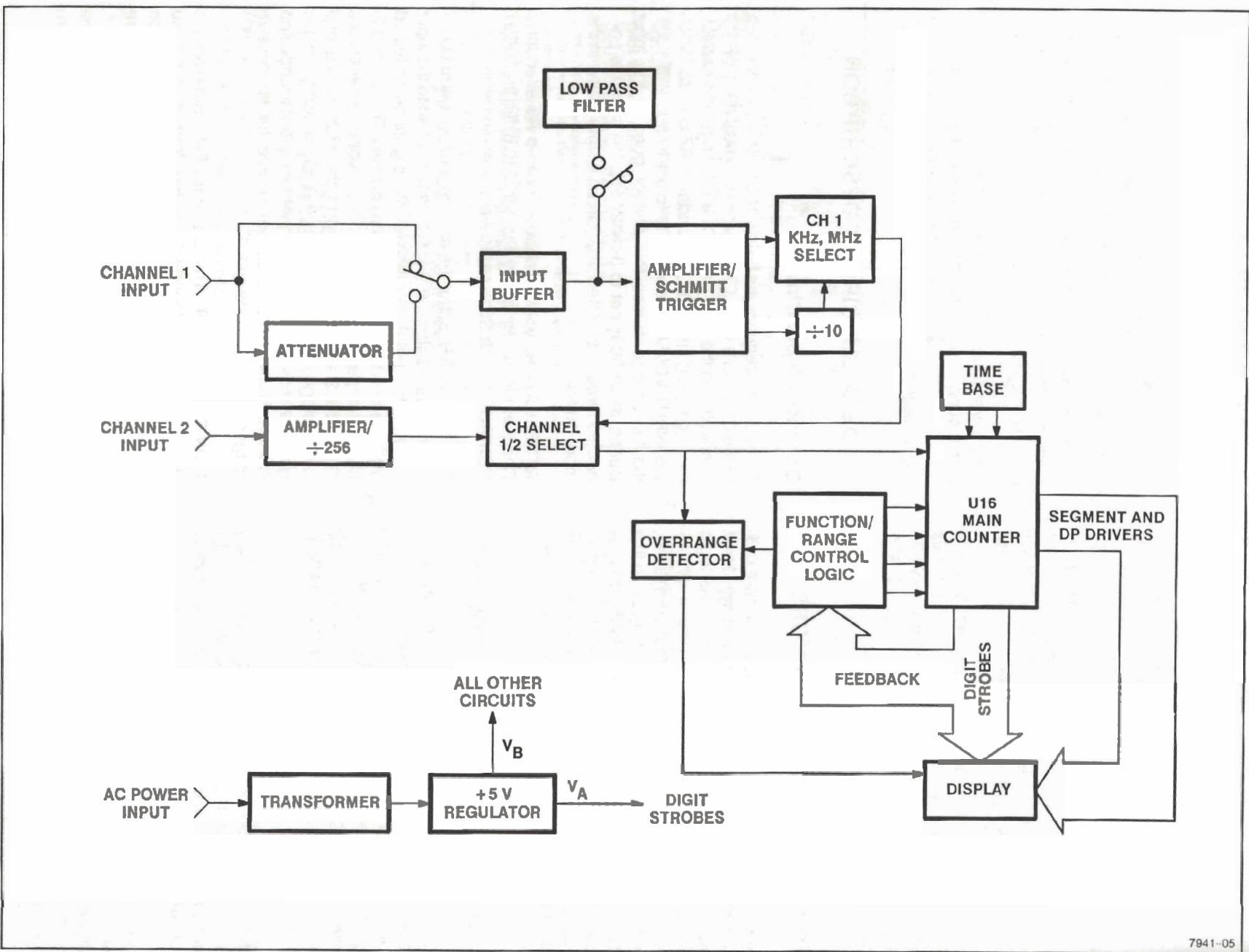

Figure 3-1. Block Diagram.

**AMPLIFIER/SCHMITT TRIGGER.** This circuit amplifies and shapes the Channel 1 signals into square waves suitable for use in the digital circuits in the CMC250. It consists of three-stage ECL amplifier IC1, transistors Q5 and Q6 (used as ECL-to-TTL level shifters), and associated components. The waveform obtained across R25 is a 0 to 2.8 volt square wave with polarity opposite that of the Channel 1 input signal.

### Channel 2 Input Circuit

The Channel 2 Input circuit consists of integrated circuit IC4, diodes D8 and D9, and associated components. Channel 2 input signals are divided by 256 before going to transistors Q7 and Q8 (used as ECL-to-TTL level shifters). The Q7 output goes to the next stage, Channel 1/Channel 2 Select.

### Channel 1 kHz/MHz Select

The Channel 1 TTL-level output is applied to the Channel 1 kHz/MHz Select circuit, consisting of U13, U19, U1, U4, and associated components. U13B input pins 4 and 5 go low whenever U4B pins 4 and 5 are low; so that whenever the kHz mode is selected, the kHz signal is gated through to U13D. At all other times, the MHz (divided by 10) signal from U14 is gated through U13C. U13C pin 9 goes high when U2 pin 2 is high.

**Divide-by-Ten.** The Channel 1 output of U13 pin 3 goes to U14 and U13 pin 12. U14 is a decade ripple counter which functions as a divide-by-ten. Voltage levels on U13 pins 4-13 and U19 pins 2 and 19 select either the decade-divided signal from U14 pin 2 or the undivided signal from U13 pin 3. This selection is governed by two lines: one from U4B pin 6, which is high only during Frequency MHz mode; and one from U2 pin 2, which goes high whenever Frequency MHz mode is selected. The Frequency kHz or MHz selection output (from U19 pin 18) is governed by two lines: one from U1D pin 11, which is low in all modes except TOTALize, and one from U2 pin 4, which goes high whenever Channel 2 mode is selected.

### Channel 1/Channel 2 Select

The combined action of U13, U19, and U1, which is controlled by the front-panel FUNCTION switches, provides U16 with an input signal within its frequency limits. In Frequency MHz mode, the Channel 1 signal is divided by ten in U14 and applied. In Frequency Channel 2 mode, the signal from the Channel 2 input is divided by 256 in IC4 and applied. In Frequency kHz, PERIOD, and TOTALize modes, the Channel 1 signal is applied with no frequency division.

### Channel 1 Signal Gating (TOTALize mode)

In TOTALize mode, inputs to U19 on pins 5 and 6 control the output on pin 18. U1D pin 11 is connected to U19 pin 5; U2 pin 10 is high in TOTALize mode and is connected to U19 pin 6. The undivided signal from U13 pin 3 is gated additionally by the signals at U1D pins 12 and 13. U1D pin 12 is controlled by HOLD switch S2 via flip-flop U1A and U1B. U1D pin 13 is connected via R105 to the rear panel TOTALize START/STOP INPUT. The undivided signal from U13 pin 3 can thus be gated manually by S2 or electronically by a signal applied to the rear-panel INPUT. When no signal is connected to the TOTALize START/STOP INPUT, the input jack is pulled high by R103.

### Function/Range Control Logic

U3C and U3D provide contact switch debounce for the FUNCTION switch S3. Their output clocks U2, a decade counter that selects the operating FUNCTION.

U3A and U3B debounce GATE switch S4. The output triggers U6, a decade counter that selects the operating time base (GATE time).

### Counter Circuit (U16)

IC U16 is the main counter for the instrument. It performs all frequency, period, and totalize functions and drives the displays. U16 requires an input signal of CMOS digital logic levels, a time base, and connections for feedback of display digit strobes.

## Display

**DIGIT STROBES AND FEEDBACK.** U16 multiplexes the display by means of digit strobes D1 through D8. Each strobe goes high in sequence, as shown in Figure 3-2, turning its display digit on momentarily. As each digit is selected, the proper seven-segment and

decimal-point information for that digit is sent out at the same time on pins 8-11 and 13-16. The digit strobes D1-D8 are also used to control U16 by selective feedback to U16 pins 1, 4, 20, and 21. The operating mode resolution, and other parameters are determined by which strobe signal is present at each control input.

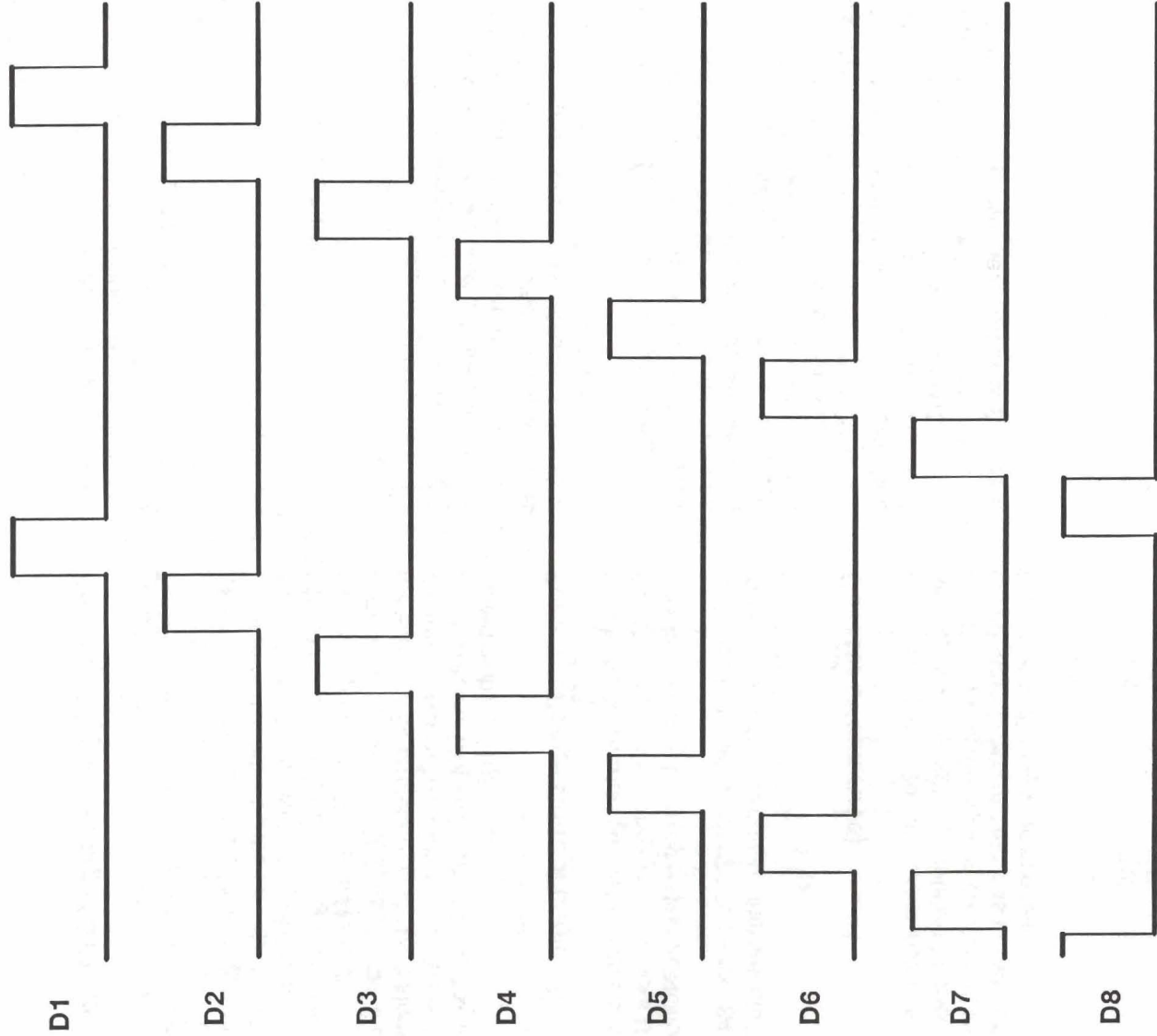
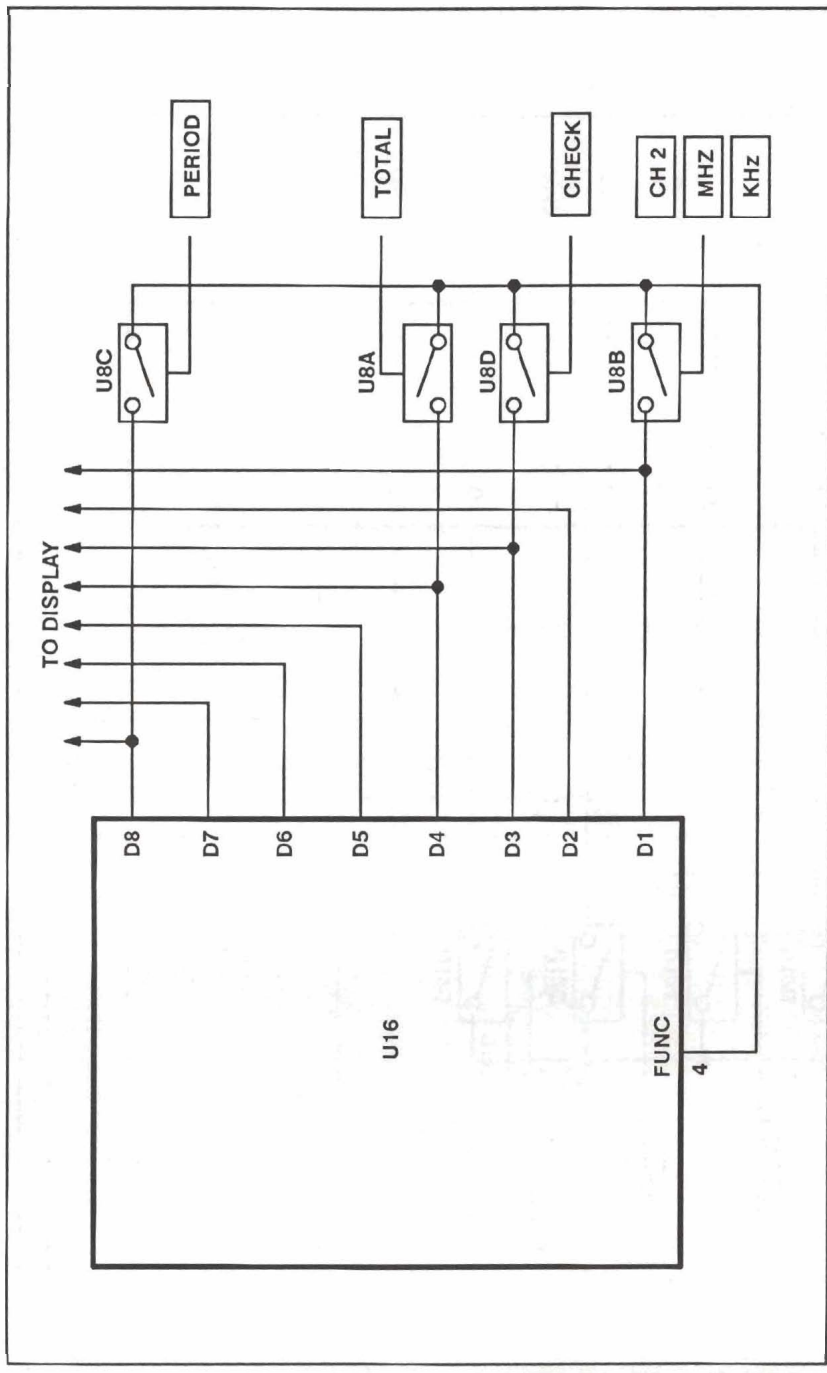

Figure 3-2. U16 digit strobes.

**OPERATING MODE SELECTION.** Operating mode selection is controlled by FUNC (U16 pin 4). This pin is connected to one of digit strobes D1, D3, D4, or D8 via

bilateral switches U8A through U8D (see Figure 3-3). These switches are controlled by FUNC switch S3 via U2.



7941-07

Figure 3-3. Operating mode selection.

**RESOLUTION SELECTION.** Resolution selection is controlled by RANGE (U16 pin 21). Digit strobes D1–D4 are applied directly to pin 21 via bilateral switches U12A

through U12D (see Figure 3–4). These switches are controlled by GATE switch S4 via U6.

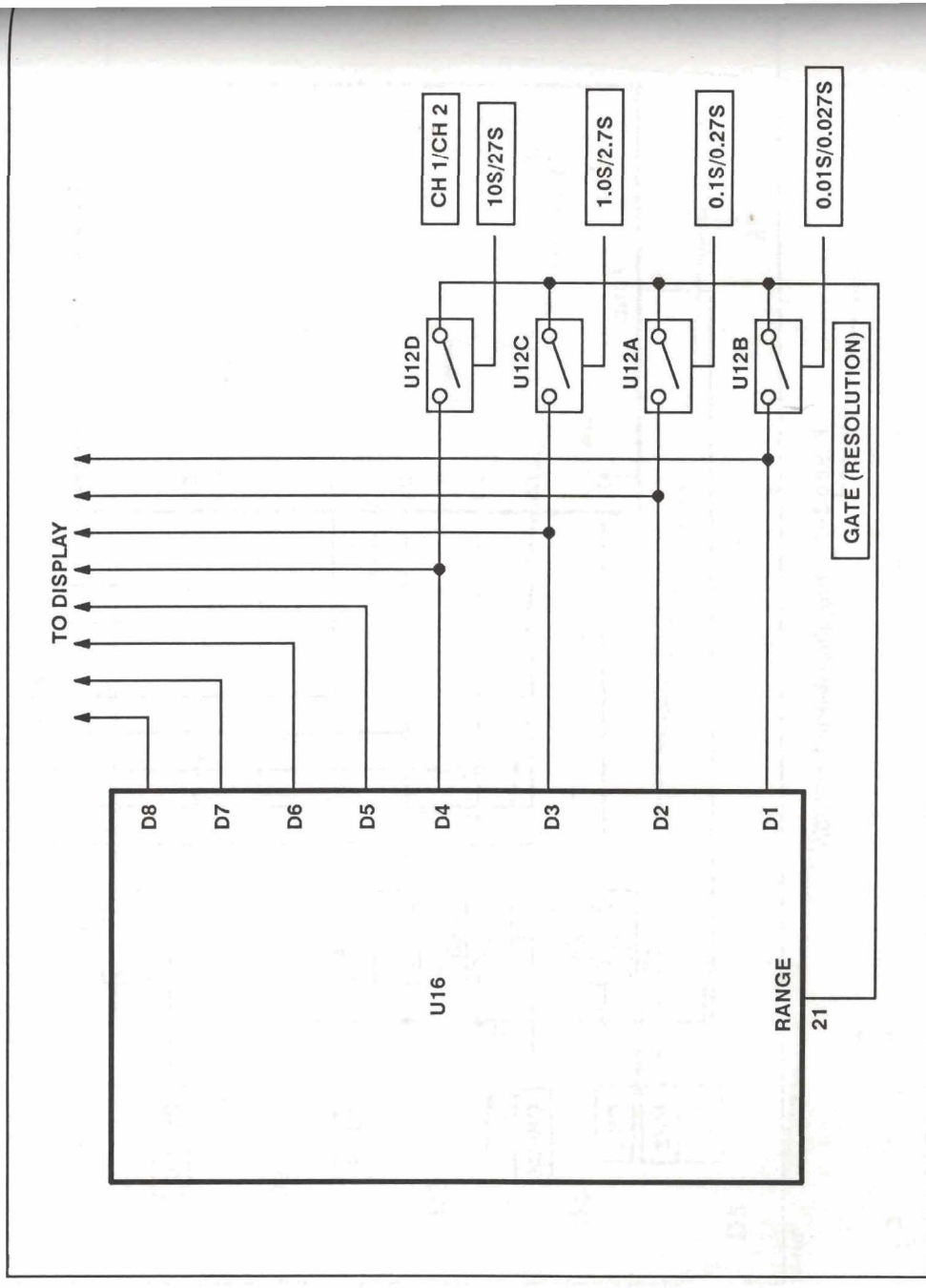
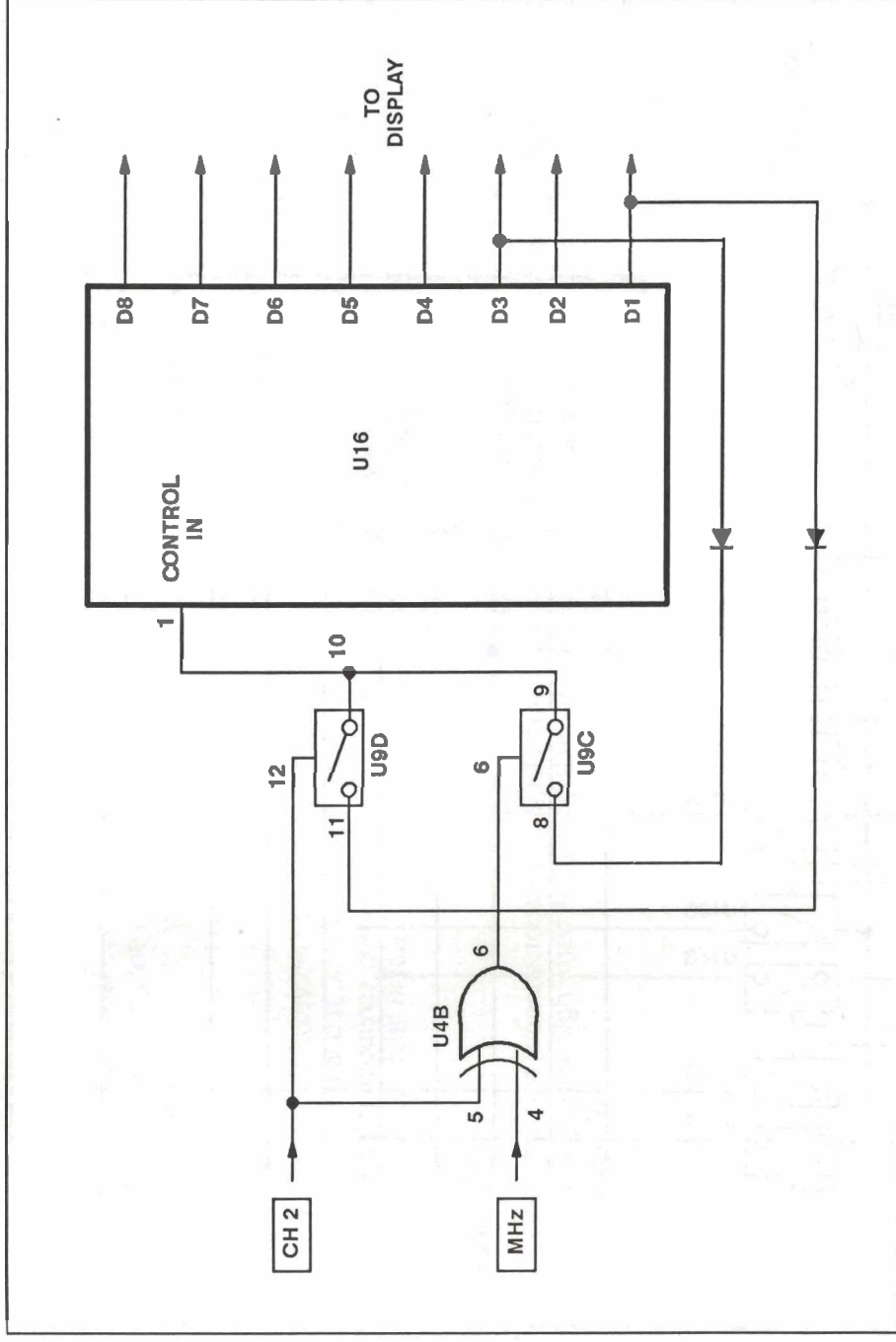

Figure 3-4. GATE (Resolution) selection.

7941-

**ADDITIONAL CONTROL.** Additional control of U16 is provided by feedback of strobos D1 and D3 to CONTROL IN (U16 pin 1). This feedback is through the use of bilateral switches which provide a low-resistance path

from input to output through U9C when control input pin 6 is high; or through U9D when control input pin 12 is high. See Figure 3-5.



7941-09

Figure 3-5. Additional strobe feedback.

**EXTERNAL DECIMAL POINT.** The effect of decade division of the input signal is compensated by shifting the decimal point in the display. This is done by connecting digit strobe D3 to U16 pin 1 (see Figure 3-5). In Frequency kHz, PERIOD, CHECK, and TOTALize modes, D3 is not applied, and automatic decimal point placement is enabled in U16. However, when Frequency

MHz or Channel 2 is engaged, application of D3 instructs U16 to place a decimal point at the display digit whose strobe appears at pin 20 (EXT DP IN). Placement depends upon the resolution (GATE) and operating mode (FUNC) selected. Figure 3-6 shows how placement is determined.

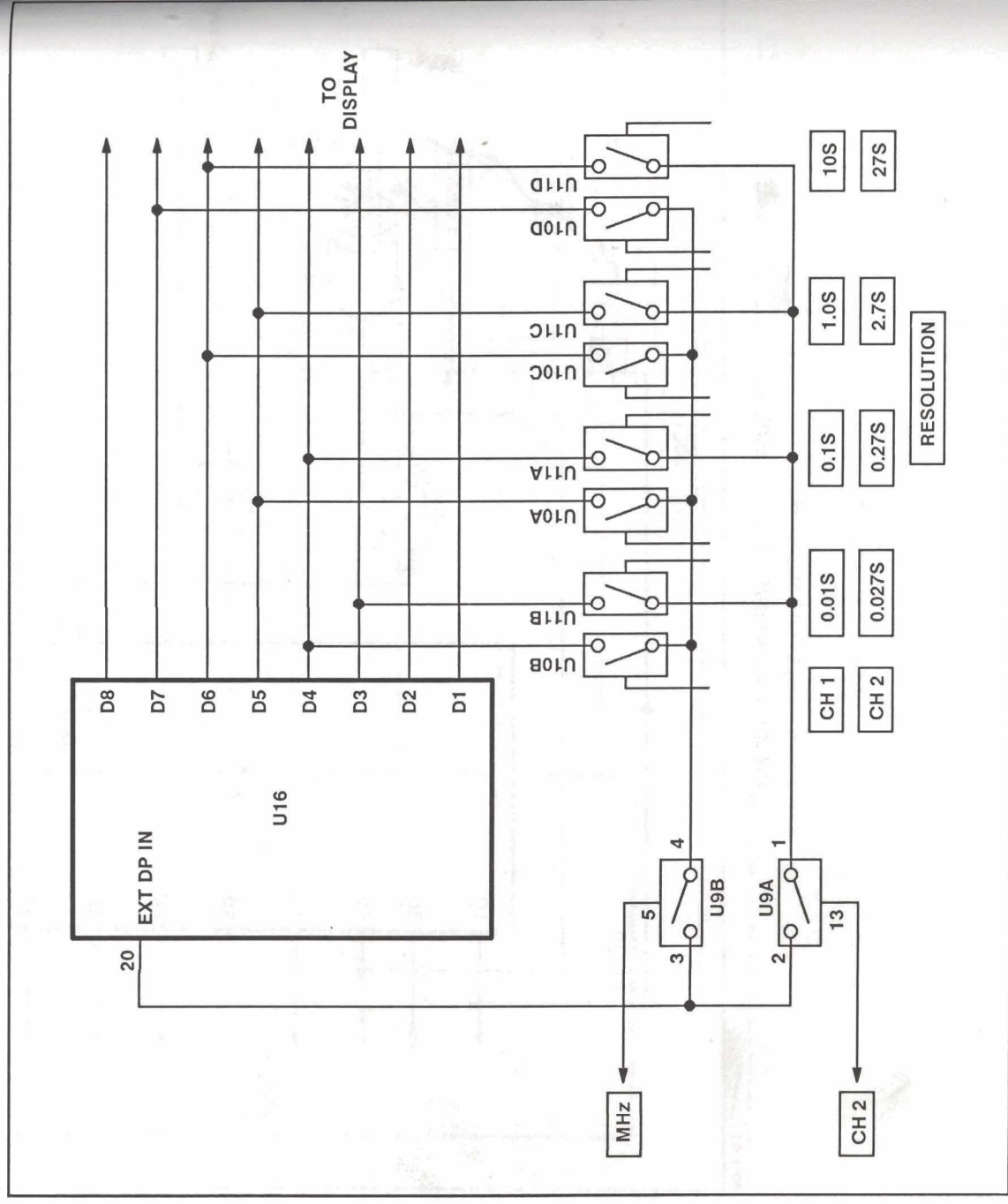

Figure 3-6. External decimal point control.

7941-10



### Time Base

The Channel 1 and Channel 2 time base signals are provided by two separate crystal oscillators. The 10 MHz crystal oscillator for Channel 1 (Y2) is connected to the oscillator input of U16 pin 35 from U17A, which buffers the crystal oscillator output to a level suitable for driving U16. The 3.90625 MHz crystal oscillator for Channel 2 (Y1) is connected to the EXT OSC IN input (pin 33) of U16. The 3.90625 MHz crystal oscillator is required to offset the effect of prescaling the input (by 256) in the Channel 2 input circuit.

### HOLD Switch

The HOLD switch S2 is connected to U16 and U1 pins 11–13 and U19 pins 5 and 6, via U1 pins 1–6. U1A and U1B provide switch debounce and act as a flip-flop to lock the output of U1B high or low.

### LED Indicators

The MHz indicator D24 is connected to the output of U4 pin 6. This output goes high when Frequency MHz or Channel 2 is selected.

The kHz/ $\mu$ s indicator D25 is connected via U4 pin 3 to the Frequency kHz, PERIOD, and CHECK selected. The indicator lights when any of these modes are selected.

The GATE (count) indicator D26 is connected via U7F to U16 pin 3. This pin goes low whenever a measurement is in progress. The kHz, MHz, CH 2, PERIOD, TOTAL, and CHECK indicators LED1–LED6 are connected via U5, which buffers the output of U2. The GATE (time base) indicators are driven by U7, which is connected to the sequential outputs of U6.

### Power Supply

The transformer is a universal type whose primary windings may be selected for various line voltages by the rear panel LINE VOLTAGE SELECT switches, S8 and S9.

The output of the secondary side is rectified by D110, D111, D113, and D114 and filtered by C120 and C124. Regulators Q9 and Q10 provide regulated +5 volts for the instrument.

# PERFORMANCE CHECK PROCEDURE

## INTRODUCTION

This procedure checks many of the electrical characteristics listed in Table 1-2 in Section 1 of this manual. If the instrument fails to meet the requirements given in this performance check, the adjustment procedure in Section 5 should be done. This performance check may also be used as an acceptance test or as a troubleshooting aid.

You do not have to remove the instrument case to do this procedure. All checks can be made using the controls and connectors accessible from the outside of the frequency counter.

To ensure instrument accuracy, check its performance after every 2000 hours of operation, or once each year if

used infrequently. If these checks indicate a need for readjustment or repair, refer the instrument to a qualified service person.

## TEST EQUIPMENT NEEDED

The test equipment listed in Table 4-1 is a complete list of the equipment needed for this performance check and the adjustment procedure in Section 5. All test equipment is assumed to be operating within tolerance. Detailed operating instructions for test equipment are not given in this procedure. If operating information is needed, refer to the appropriate test equipment instruction manual.

**Table 4-1**  
Test Equipment Required

Item	Minimum Specification	Purpose
Oscilloscope	Bandwidth: DC to 20 MHz. (Suitable equipment: TEKTRONIX 2225 50 MHz Oscilloscope or TEKTRONIX 2205 20 MHz Oscilloscope.)	Frequency and sensitivity checks and trigger level adjustment.
Function Generator	Range: 10 Hz to 2 MHz. (Suitable equipment: TEKTRONIX CFG250 2 MHz Function Generator.)	Frequency check and trigger level adjustment.
Leveled Signal Generator	Range: 50 kHz to 100 MHz. (Suitable equipment: TEKTRONIX SG 503 Signal Generator.)	Frequency and sensitivity checks and trigger level adjustment.
Frequency Standard	Accuracy: At least 5 parts in 10 million (0.5 ppm).	Time base accuracy check and time base adjustment.
Alignment Tool	Length: 1-in shaft. Bit size: 3/32 in. (Suitable equipment: Tektronix Part Number 003-0675-00.)	Trigger level adjustment.
Coaxial Cable	50 $\Omega$ , BNC. (Suitable equipment: Tektronix Part Number 012-0057-01.)	Frequency and sensitivity checks and trigger level adjustment.
10X Attenuator	50 $\Omega$ , BNC. (Suitable equipment: Tektronix Part Number 011-0059-02.)	Frequency check.

## PREPARATION

Ensure that all power switches are off.

Ensure that all test equipment and the CMC250 are suitably adapted to the line voltage to be applied.

Connect the equipment under test and the test equipment to a suitable line voltage source. Turn all equipment on and allow at least one hour for the equipment to warm up and stabilize.

Set the CMC250 controls as follows during warm-up time:

INPUT VOLTAGE	50mV-5V(LOW) (button out)
LOW PASS FILTER	OFF (button out)

## PROCEDURES

Check GATE (resolution) settings and display using CHECK mode

### NOTE

*No test equipment is required for this general check of instrument operation. In CHECK mode the input circuit is connected internally to the time base oscillator.*

- a. Set CMC250 FUNC switch to CHECK and set GATE switch to 0.027s/0.01s.
- b. CHECK that display reads  $10000.0 \pm 1$  (9999.9 to 10000.1) kHz and the GATE indicator light is flashing on and off.
- c. Press HOLD (button in) and check that the GATE indicator light remains off. Press HOLD again to release (button out) and check that the GATE indicator resumes flashing.
- d. Hold the RESET button in and CHECK that the display reads .0 and the GATE indicator light is off. Release the RESET button and CHECK that the display reads 10000.0 and GATE indicator resumes flashing.
- e. Set GATE switch to 0.27s/0.1s.
- f. CHECK that the display reads  $10000.00 \pm 1$  (9999.99 to 10000.01) kHz and the GATE indicator is flashing on and off; flashing should

now be slower than it was at the previous GATE setting.

- g. Set the GATE switch to 2.7s/1.0s.
- h. CHECK that the display reads  $10000.000 \pm 1$  (9999.999 to 10000.001) kHz and the GATE indicator is flashing on and off; flashing should now be slower than it was at the previous GATE setting.
- i. Set the GATE switch to 27s/10s.
- j. CHECK that the display reads  $0000.0000 \pm 1$  (999.9999 to 0000.0001) kHz and the OVER-RANGE indicator is lit (0000.0000 or 0000.0001). CHECK that the GATE indicator is flashing on and off; flashing should now be slower than it was at the previous GATE setting.

### NOTE

*At this slower GATE setting, you will notice a delay after you select the 27s/10s GATE setting and before the display changes.*

## 2. Check Channel 1 Frequency Range and Sensitivity

- a. Set the CMC250 FUNC switch to kHz/10MHz and the GATE switch to 2.7s/1.0s.
- b. Set the function generator to 1 kHz.
- c. Connect a coaxial cable from the function generator output through a 10X attenuator and a 50  $\Omega$  termination to the input of the oscilloscope.
- d. Adjust the function generator output amplitude for 150 mV p-p sine wave.
- e. Remove the connection from the oscilloscope and connect it to the CMC250 CHANNEL 1 INPUT connector.
- f. Reduce the frequency from the function generator to 10 Hz.
- g. CHECK that the CMC250 triggers on 10 Hz.
- h. Set the CMC250 FUNC switch to MHz/100MHz.
- i. Remove the coaxial cable from the function generator and connect the signal generator to the oscilloscope. Set the signal generator to

50 kHz. Set the signal generator for 150 mV p-p output. Disconnect the oscilloscope and connect the generator to the CMC250 CHANNEL 1 INPUT connector.

- j. Set the signal generator to 100 MHz.
  - k. CHECK that the CMC250 will trigger on 150 mV p-p at 100 MHz.
  - .. Set the signal generator to 1 MHz.
  - m. Press in the LOW PASS FILTER button on the CMC250.
  - n. CHECK that the CMC250 does not trigger.
  - o. Set the LOW PASS FILTER button to OFF (button out) and set the INPUT VOLTAGE button to 3V-42V(HI) (button in).
  - p. Remove the connection from the CMC250 and connect it to the oscilloscope. Remove the 10X attenuator and the 50  $\Omega$  termination.
  - q. Adjust the signal generator output amplitude for 8.4 V p-p.
  - r. Remove the connection from the oscilloscope and connect it to the CMC250 CHANNEL 1 INPUT connector.
  - s. CHECK that the CMC250 triggers on 1 MHz.
  - t. Disconnect the test equipment.
- 3. Check Channel 2 Sensitivity**
- a. Set the CMC250 FUNC switch to CH 2 and set the GATE switch to 2.7s/1.0s.

- b. Connect a coaxial cable from the signal generator output through a 10X attenuator and a 50  $\Omega$  termination to the input of the oscilloscope.
- c. Set the signal generator to 50 kHz and 150 mV p-p output. Disconnect the oscilloscope and connect the generator to the CMC250 CHANNEL 2 INPUT.
- d. Set the signal generator to 100 MHz.
- e. CHECK that the CMC250 will trigger on 150 mV p-p at 100 MHz.
- f. Disconnect the test equipment.

**4. Check CH 1 and CH 2 Time Base Accuracy**

- a. Connect a 10 MHz signal from the frequency standard to the CMC250 CHANNEL 1 INPUT connector. Set input voltage to 150 mV.
- b. Set CMC250 FUNC switch to kHz/10MHz and the GATE switch to 27s/10s.
- c. CHECK that CMC250 display reads 10000.000 kHz  $\pm 2$  (9999.998 to 10000.002 kHz).
- d. Disconnect the standard signal from the CHANNEL 1 INPUT connector.
- e. Connect a 100 MHz standard signal to the CHANNEL 2 INPUT connector.
- f. Set CMC250 FUNC switch to CH 2 and the GATE switch to 27s/10s.
- g. CHECK that CMC250 display reads 100.00000 MHz  $\pm 2$  (99.99998 to 100.00002).
- h. Disconnect the test equipment.

# ADJUSTMENT PROCEDURE

## INTRODUCTION

There are four calibration adjustments—the Channel 1 Sensitivity adjustment, the Channel 1 Totalize Sensitivity adjustment, and the two Time Base adjustments. To ensure instrument accuracy, the Channel 1 Sensitivity and the Channel 1 Totalize Sensitivity adjustments should be done every 2000 hours of operation or at least once each year if used infrequently. Do not attempt to do the Time Base adjustments unless you have a standard frequency source with a known accuracy of at least five parts in ten million (0.5 ppm).

## PREPARATION FOR ADJUSTMENT

Make the adjustments in this procedure at an ambient temperature of +21°C to +25°C (+70°F to +77°F) and a relative humidity of 75% or less.

It is necessary to remove the top of the instrument cabinet to access the component side of the Main circuit board. Disconnect the power cord from the CMC250 and follow the cabinet removal instructions in the Maintenance section of this manual.

Test equipment needed for these adjustments is described in Table 4-1 at the beginning of the Performance Check Procedure. Refer to the appropriate test equipment instruction manuals for test equipment operating information.

Connect the test equipment and the CMC250 to a suitable ac-power source and allow a 30-minute warmup period before making the Channel 1 Sensitivity adjustment.

## PROCEDURES

### 1. Adjust Channel 1 Sensitivity (R10)

- a. Set the CMC250 front-panel pushbuttons as follows:

FUNC	MHz/100MHz
GATE	2.7s/1.0s
INPUT VOLTAGE	50mV-5V(LO) (button out)
LOW PASS FILTER	OFF (button out)

- b. Connect a 50- $\Omega$  terminated BNC cable from the signal generator to the vertical input of the oscilloscope.

- c. Set the oscilloscope to 10 mV per division.
- d. Set the signal generator to 50 kHz, 56 mV peak-to-peak output (5.6 divisions at 10 mV per division).
- e. Disconnect the cable from the oscilloscope and connect it to the CMC250 CHANNEL 1 INPUT connector.
- f. Set the signal generator to 30 MHz and check the CMC250 display for the correct reading. If reading is correct, go to step h.
- g. ADJUST—Variable resistor R10 on the Main circuit board until the CMC250 readout agrees with the signal generator output reading. Turn R10 to the right until the frequency counter begins to misread the signal; then turn R10 to the left until the counter begins to misread. Center R10 adjustment between the two points where the incorrect readouts begin (the midpoint of the input signal).
- h. Disconnect the cable from the CMC250 and connect it to the vertical input of the oscilloscope.
- i. Set the oscilloscope to 50 mV per division.
- j. Set the signal generator to 50 kHz, 140 mV peak-to-peak output (2.8 divisions at 50 mV per division).
- k. Disconnect the cable from the oscilloscope and connect it to the CMC250 CHANNEL 1 INPUT connector.
- l. Set the signal generator to 99.5 MHz  $\pm$  0.5 MHz, and check the CMC250 display for a correct reading.
- m. ADJUST—R10 until the CMC250 readout agrees with the signal generator output reading. Turn R10 to the right until the frequency counter begins to misread the signal; then turn R10 to the left until the counter begins to misread. Center the R10 adjustment between the two points where the incorrect readouts begin (the midpoint of the input signal).
- n. Disconnect the test equipment.

## Adjustment Procedure—CMC250 Service

### 2. Adjust Channel 1 Totalize Sensitivity (R118)

- a. Set the CMC250 front-panel pushbuttons as follows:

FUNC	TOTAL
INPUT VOLTAGE	50mV-5V(LO)

- b. Connect a TTL-level 50 kHz signal source to the CMC250 rear-panel TOTALIZE INPUT START/STOP connector.
- c. Connect a 60 Hz, 50 mV rms signal to the CMC250 CHANNEL 1 INPUT connector. Note that the display reading increments.
- d. CHECK—the display stops incrementing when the signal is removed from the CHANNEL 1 INPUT connector. If the display continues to increment when the CHANNEL 1 signal source is disconnected, adjust R118 as described in step e.
- e. ADJUST—R118 counterclockwise until the display reading stops incrementing.
- f. Disconnect the TOTALIZE INPUT START/STOP signal.
- g. Connect a 10 MHz 50 mV rms signal to the CHANNEL 1 INPUT connector.
- h. Press and release the RESET button to start the TOTALize count. After 10 seconds, the OVER-RANGE LED will be illuminated.
- i. CHECK—that the OVERRANGE LED remains lit when the HOLD button is pressed. If it does not, repeat Totalize Sensitivity adjustment.
- j. Disconnect test equipment.

### 3. Adjust Time Bases (Trimmers C108 and C113)

#### NOTE

*Do not attempt to adjust the Time Base unless you have a standard frequency source having a known accuracy of at least five parts in ten million (0.5 ppm).*

#### NOTE

*The CMC250 has an accuracy of ten parts per million (10 ppm). This means an error of ten cycles when reading a 1 MHz (seven digit) signal. Most signal sources are not stable enough nor accurate enough for this error to be meaningful.*

- a. Replace the top cover on the disassembled instrument. Ensure that the CMC250 INPUT VOLTAGE is set to LO (button out) and the LOW PASS FILTER is OFF (button out).
- b. Turn the CMC250 POWER ON and allow one hour for it to warm up.
- c. Apply a 10 MHz  $\pm 1$  Hz standard signal to the CMC250 CHANNEL 1 INPUT connector. Select Frequency kHz mode and 1.0 s GATE time.
- d. ADJUST—C113 until the CMC250 display reads 10000.000  $\pm 2$  (9999.998 to 10000.002). Adjust C113 through the CH 1 OSCillator ADJUSTment hole in the rear panel, using a non-metallic alignment tool.

#### NOTE

*If you wish to adjust the Channel 1 time base for even greater accuracy, set the GATE switch 10s and ADJUST C113 until the CMC250 display reads 0000.0000 with the OVERRANGE indicator lit (9999.9998 to 0000.0002 plus OVERRANGE).*

- e. Disconnect the standard signal from the CHANNEL 1 INPUT connector.
- f. Connect a 100 MHz standard signal to the CHANNEL 2 INPUT connector. Select CH 2 mode and 2.7 s GATE time.
- g. ADJUST—C108 through the CH 2 OSCillator ADJUSTment hole in the rear panel until the display reads 100.0000  $\pm 2$  (99.9998 to 100.0002).

#### NOTE

*If you wish to adjust the Channel 2 time base for even greater accuracy, set the GATE switch to 27s and adjust C108 until the CMC250 display reads 100.00000 (99.99998 to 100.00002).*

- h. Disconnect the test equipment.

# MAINTENANCE

This section of the manual contains information on static-sensitive components, preventive maintenance, troubleshooting, and corrective maintenance.

## STATIC-SENSITIVE COMPONENTS

The following precautions apply when performing any maintenance involving internal access to the instrument.



*Static discharge can damage any semiconductor component in this instrument.*

This instrument contains electrical components that are susceptible to damage from static discharge. Table 6-1 lists the relative susceptibility of various classes of semiconductors. Static voltages of 1 kV to 30 kV are common in unprotected environments.

When performing maintenance, observe the following precautions to avoid component damage:

1. Minimize handling of static-sensitive components.
2. Transport and store static-sensitive components or assemblies in their original containers or on a metal rail. Label any package that contains static-sensitive components or assemblies.
3. Discharge the static voltage from your body by wearing a grounded antistatic wrist strap while handling these components. Servicing static-sensitive components or assemblies should be performed only at a static-free work station by qualified service personnel.
4. Keep anything capable of generating or holding a static charge off the work station surface.
5. Keep the component leads shorted together whenever possible.
6. Pick up components by their bodies, never by their leads.
7. Do not slide the components over any surface.

8. Avoid handling components in areas that have a floor or work-surface covering capable of generating a static charge.
9. Use a soldering iron that is connected to earth ground.
10. Use only approved antistatic, vacuum-type desoldering tools for component removal.

**Table 6-1**  
**Relative Susceptibility to**  
**Static-Discharge Damage**

Semiconductor Classes	Relative Susceptibility Levels <sup>a</sup>
MOS or CMOS microcircuits or discretes, or linear microcircuits with MOS inputs (Most Sensitive)	1
ECL	2
Schottky signal diodes	3
Schottky TTL	4
High-frequency bipolar transistors	5
JFET	6
Linear microcircuits	7
Low-power Schottky TTL	8
TTL (Least Sensitive)	9

<sup>a</sup> Voltage equivalent for levels (voltage discharged from a 100-pF capacitor through resistance of 100  $\Omega$ ):

1 = 100 to 500 V	6 = 600 to 800 V
2 = 200 to 500 V	7 = 400 to 1000 V (est)
3 = 250 V	8 = 900 V
4 = 500 V	9 = 1200 V
5 = 400 to 600 V	

# TROUBLESHOOTING

Preventive maintenance done on a regular basis should reveal most potential problems before an instrument fails. However, should troubleshooting be needed, the following information will help to locate the problem. Also, the Theory of Operation and the Diagrams sections of this manual may help with troubleshooting.

## TROUBLESHOOTING AIDS

### Schematic Diagram

A schematic diagram is located on a tabbed foldout page in the Diagrams section. Portions of circuitry mounted on each circuit board are enclosed by heavy black lines. The assembly number and name(s) of the circuit(s) are shown near the top or the bottom edge of the diagram.

Functional blocks on the schematic diagram are outlined with a wide gray line. Components within the outlined area perform the function named by the block label. The Theory of Operation uses these functional block names when describing circuit operation.

Component numbers and electrical values of components in this instrument are shown on the schematic diagram. Refer to the first page of the Diagrams section for the reference designators and symbols used to identify components. Important voltages are also shown on the diagram.

### Circuit Board Illustrations

Circuit board illustrations in the Diagrams section show the physical location of each component.

### Grid Coordinate System

The schematic diagram and circuit board illustrations have grid borders along their left and top edges. The grid coordinates for the components are given in an accompanying table.

### Component Color Coding

An illustration at the beginning of the Diagrams section gives information about color codes and markings on resistors and capacitors.

**RESISTORS.** Resistors used in this instrument are carbon-film, composition, or precision metal-film types. They are usually color coded with the EIA color code; however, some metal-film type resistors may have the value printed on the body. The color code is interpreted starting with the stripe nearest to one end of the resistor. Composition resistors have four stripes; these represent two significant digits, a multiplier, and a tolerance value. Metal-film resistors have five stripes representing three significant digits, a multiplier, and a tolerance value.

**CAPACITORS.** Common disc capacitors and small electrolytics have capacitance values marked on the side of the capacitor body. White ceramic capacitors are color coded in picofarads, using a modified EIA code. Dipped tantalum capacitors are color coded in microfarads. The color dot indicates both the positive lead and the voltage rating. Since these capacitors are easily destroyed by reversed or excessive voltage, be careful to observe the polarity and voltage rating when replacing them.

**DIODES.** The cathode end of each glass-encased diode is indicated by either a stripe, a series of stripes, or a dot. For most diodes marked with a series of stripes, the color combination of the stripes identifies three digits of the Tektronix part number, using the resistor color-code system. The cathode and anode ends of a metal-encased diode may be identified by the diode symbol marked on its body.

### Semiconductor Lead Configurations

The second figure in the Diagrams section shows some typical lead configurations for semiconductor devices that may be used in this instrument. If a semiconductor does not seem to match the configurations shown, consult a manufacturer's data sheet.

## TROUBLESHOOTING TECHNIQUES

When troubleshooting the CMC250, be sure to read the troubleshooting techniques given here before going on to CMC250 Troubleshooting Tips. The troubleshooting methods described in this procedure are general techniques that should be used together with the more specific CMC250 Troubleshooting Tips.

This procedure is arranged to check simple trouble possibilities before doing more extensive troubleshooting.



When a defective component is located, either replace the assembly containing the defective part or replace the component by using the appropriate replacement procedure given in Corrective Maintenance. Replacement assemblies are available through Tektronix and are shown in an exploded-view drawing in Replaceable Parts (section 8) and are described in the parts list in that section.



*Before using any test equipment to make measurements on static-sensitive, current-sensitive, or voltage-sensitive components or assemblies, ensure that any voltage or current supplied by the test equipment does not exceed the limits of the component to be tested.*

### 1. Check Control Settings

Incorrect control settings can give a false indication of instrument malfunction. If there is any question about the correct function or operation of any control, refer to the CMC250 Operators Manual.

### 2. Check Associated Equipment

Before proceeding, ensure that any equipment used with the CMC250 is operating correctly. Verify that input signals are properly connected and that the interconnecting cables are not defective. Check that the ac-power-source voltage to all equipment is correct.

### 3. Visual Check

#### WARNING

*To avoid electrical shock, disconnect the instrument from the ac power source before inspecting the internal circuitry.*

Look for broken connections or wires, damaged components, semiconductors not firmly mounted, damaged circuit boards, or other clues to the cause of a malfunction.

### 4. Check Instrument Performance and Adjustment

Check the performance of either those circuits where you suspect trouble or the entire instrument. An apparent trouble may be the result of misadjustment. The

Performance Check is in Section 4 of this manual, and the Adjustment Procedure in Section 5.

### 5. Isolate Trouble to a Circuit

To isolate problems, use any symptoms noticed when checking the instrument's operation to help localize the trouble to a particular circuit. The CMC250 Troubleshooting Tips, following this procedure, may help in locating a problem.

### 6. Check Individual Components

#### WARNING

*To avoid electrical shock, always disconnect the instrument from the ac power source before removing or replacing components.*

The following procedures describe methods of checking individual components. Two-lead components that are soldered in place are most accurately checked by first disconnecting one end from the circuit board. This isolates the measurement from the effects of the surrounding circuitry. See Figure 9-1 for component value identification and Figure 9-2 for semiconductor lead configurations.



*When checking semiconductors, observe the static-sensitivity precautions given at the beginning of this section.*

**TRANSISTORS.** A good check of a transistor is actual performance under operating conditions. A transistor can most effectively be checked by substituting a known-good component. However, be sure that circuit conditions are not such that a replacement transistor will also be damaged. If substitute transistors are not available, use a dynamic-type transistor checker for testing. Static-type transistor checks are not recommended, since they do not check operation under simulated operating conditions.

When troubleshooting transistors in the circuit with a voltmeter, measure both the emitter-to-base and emitter-to-collector voltages to find out if they are consistent with normal circuit voltages. Voltages across a transistor may vary with the type of device and its circuit function.

Some of these voltages are predictable. The emitter-to-base voltage for a conducting silicon transistor will normally range from 0.6 V to 0.8 V. The emitter-to-collector voltage for a saturated transistor is about 0.2 V. Because these values are small, the best way to check them is by connecting a sensitive voltmeter across the junction rather than comparing two voltages taken with respect to ground. If the former method is used, both leads of the voltmeter must be isolated from ground.

If voltage values measured are less than those just given, either the device is shorted or no current is flowing in the external circuit. If values exceed the emitter-to-base values given, either the junction is reverse biased or the device is defective. Voltages exceeding those given for typical emitter-to-collector values could indicate either a nonsaturated device operating normally or a defective (open-circuited) transistor. If the device is conducting, voltage will be developed across the resistors in series with it; if open, no voltage will be developed across the resistors unless current is being supplied by a parallel path.



*When checking emitter-to-base junctions, do not use an ohmmeter range that has a high internal current. High current may damage the transistor. Reverse biasing the emitter-to-base junction with a high current may degrade the current-transfer ratio (Beta) of the transistor.*

A transistor emitter-to-base junction also can be checked for an open or shorted condition by measuring the resistance between terminals with an ohmmeter set to a range having a low internal source current, such as the R X 1 k $\Omega$  range. The junction resistance should be very high in one direction and much lower when the meter leads are reversed.

When troubleshooting a field-effect transistor (FET), the voltage across its elements can be checked in the same manner as previously described for other transistors. However, remember that in the normal depletion mode of operation, the gate-to-source junction is reverse biased; in the enhanced mode, the junction is forward biased.

**INTEGRATED CIRCUITS.** An integrated circuit (IC) can be checked with a voltmeter, test oscilloscope, or by direct substitution. A good understanding of circuit operation is essential when troubleshooting a circuit having IC components. Use care when checking voltages and

waveforms around the IC so that adjacent leads are not shorted together. An IC test clip provides a convenient means of clipping a test probe to an IC.



*When checking a diode, do not use an ohmmeter scale that has a high internal current. High current may damage a diode. Checks on diodes can be performed in much the same manner as those on transistor emitter-to-base junctions.*

**DIODES.** A diode can be checked for either an open or a shorted condition by measuring the resistance between terminals with an ohmmeter set to a range having a low internal source current, such as the R X 1 k $\Omega$  range. The diode resistance should be very high in one direction and much lower when the meter leads are reversed.

Silicon diodes should have 0.6 V to 0.8 V across their junctions when conducting; Schottky diodes about 0.2 V to 0.4 V. Higher readings indicate that they are either reverse biased or defective, depending on polarity.

**RESISTORS.** Check resistors with an ohmmeter. Refer to the Replaceable Electrical Parts list for the tolerances of resistors used in this instrument. A resistor normally does not require replacement unless its measured value varies widely from its specified value and tolerance.

**INDUCTORS.** Check for open inductors by checking continuity with an ohmmeter. Shorted or partially shorted inductors can usually be found by checking the waveform response when high-frequency signals are passed through the circuit.

**CAPACITORS.** A leaky or shorted capacitor can be detected by checking resistance with an ohmmeter set to one of the highest ranges. Do not exceed the voltage rating of the capacitor. The resistance reading should be high after the capacitor is charged to the output voltage of the ohmmeter. An open capacitor can be detected with a capacitance meter or by checking whether the capacitor passes ac signals.

## 7. Repair and Adjust the Circuit

If any defective parts are located, follow the replacement procedures given under Corrective Maintenance in this section. After any electrical component has been replaced, the performance of that circuit and any other closely related circuit should be checked. Since the power supplies affect all circuits, performance of the

entire instrument should be checked if work has been done on the power supplies. Refer to the Performance Check Procedure and the Adjustment Procedure, sections 4 and 5 in this manual.

## CMC250 TROUBLESHOOTING TIPS

### NOTE

*Refer to the schematic diagram in section 9 for voltages and component values when troubleshooting. Component values and resistor tolerances are given in the Replaceable Parts list. Also refer to Troubleshooting Techniques in this section for more detailed troubleshooting methods.*

The following troubleshooting steps provide a logical procedure for fault isolation. While the procedure cannot pinpoint every possible problem, in most cases it will localize the problem to an area of circuitry.

Most of these troubleshooting steps require removal of the instrument case. See Removal and Replacement Instructions in the Corrective Maintenance part of this section.

### General Fault Isolation

Test each operating mode by applying the input signal frequencies listed in Table 6-4 to the appropriate INPUT connector. The frequency accuracy of the signal isn't critical, but the amplitude should be adequate for a stable reading (around 100 mV). Use caution not to exceed the maximum Channel 2 input ratings. Use the INPUT VOLTAGE and LOW PASS FILTER switches as necessary to stabilize the Channel 1 display. If the CMC250 does not show the "Normal Display" given in Table 6-4, go to the appropriate troubleshooting step. Display faults and indicated troubleshooting steps are as follows:

1. If no display can be obtained, go to "Step 1. No Display."
2. If the display is abnormal (missing decimal points or unlit segments or digits), go to "Step 2. Abnormal Display."
3. If the display appears normal, but the value is incorrect or unstable (either channel), go to "Step 3. Incorrect or Unstable Display Value."

If the problem was not described in 1, 2, or 3, start troubleshooting at "Step 1. No Display" and proceed through each of the steps until the problem is isolated.

### Step 1. No Display

Check supply voltage at U16 pin 25 for approximately +5 volts. If this voltage is not present, check ac input, fuse, and +5 volt (VA) power supply circuit (D110, D111, C120, Q9). If supply voltage is okay, proceed to "Step 2. Abnormal Display."

### Step 2. Abnormal Display

**DIGIT STROBES AND TIME BASE.** Set the unit to any operating mode and check U16 pins 22-24 and 26-30 for all of the digit strobe waveforms shown in Figure 6-1 (D1 through D8). If all of these waveforms are normal, go on to "Display Test." If the waveforms are not as shown in Figure 6-1, check the output of the time base oscillator at U16 pin 38 for a waveform of 10 MHz frequency and peaks of 0 and 2.4 volts. If the waveform at pin 38 is okay, check U16 and display digits; if no output is obtained, check oscillator components, U16, and +5 V (VB) power supply (D113, D114, C124, and Q10).

**DISPLAY TEST.** Enable the display self-test by connecting U16 pins 1 and 22 to each other via a 1N4148 diode (anode to pin 22). The display should be all "eights" with all of the decimal points and the OVER-RANGE indicator on. If not, check displays and U16 segment-driver pins 8-11 and 13-16. Waveforms at each of these pins should approximate a dc level of about 1.0 V, with negative spikes of about 4 kHz.

**DECIMAL POINTS.** If the problem involves decimal points in MHz or CH 2 mode, check the "Mode Selection Logic" described in Step 3 (Incorrect or Unstable Display Value).

**MHZ OR kHz/ $\mu$ s INDICATORS.** If a problem involves these indicators, check the "Mode Selection Logic" described in Step 3 (Incorrect or Unstable Display Value).

**GATE INDICATOR.** If the GATE Indicator, D26, does not function properly, check D26, U7F, and U16 pin 3. D26 is connected via U7F to U16 pin 3, which goes low whenever a measurement is being taken. If U16 pin 3 shows no activity, check the "Mode Selection Logic" described in Step 3.

**FUNC SWITCH INDICATORS.** If the FUNC switch indicators (kHz, MHz, CH 2, PERIOD, TOTAL, and CHECK) do not function properly, check LED1-LED6, U5 and U2.

**GATE SWITCH INDICATORS.** If the GATE switch indicators (0.027s/0.01s, 0.27s/0.1s, 2.7s/1.0s, and 27s/10s) do not function properly, check LED7-LED10, U6 and U7.

Table 6-4  
Normal CMC250 Displays

Input Frequency	Operating Mode	GATE Setting	Normal (Ideal) Display
10 kHz	Frequency kHz	0.01s	10.0
		0.1s	10.00
		1.0s	10.000
		10s	10.0000 <sup>a</sup>
10 kHz	Frequency MHz	0.01s	.010
		0.1s	.0100
		1.0s	.01000
		10s	.010000 <sup>a</sup>
100 MHz	Frequency CH 2	0.027s	100.00
		0.27s	100.000
		2.7s	100.0000
		27s	100.00000 <sup>b</sup>
10 kHz	PERIOD	0.01s	100.0
		0.1s	100.00
		1.0s	100.000
		10s	100.0000
10 kHz	TOTALize	N/A	Display accumulates, with fifth digit from right changing at approximately 1 Hz.
No input needed	CHECK	0.01s	10000.0
		0.1s	10000.00
		1.0s	10000.000
		10s	0000.0000 with OVERRANGE lit <sup>a</sup>
Less than 100 Hz	PERIOD	10s	OVERRANGE lit <sup>c</sup>

<sup>a</sup> Measurement delay of 10 seconds.

<sup>b</sup> Measurement delay of 27 seconds.

<sup>c</sup> Measurement delay of at least ten seconds.

### Step 3. Incorrect or Unstable Display Value

**CH 1 FAULT ISOLATION.** Apply an appropriate signal to Channel 1 and check the waveform at the collector of Q6C. Waveform should be a square wave (0-2.8V) of the same frequency and polarity as the Channel 1 input signal. If the waveform is normal, omit the next step and go to "CH 2 Fault Isolation".

**CHANNEL 1 ANALOG CIRCUITS.** Table 6-5 gives waveform descriptions for the Channel 1 input buffer and signal-shaping circuits, along with the input conditions for each waveform. The order of the Table 6-5 test points is from input (A) to output (L).

**CH 2 FAULT ISOLATION.** Apply an appropriate signal to the Channel 2 input. Check the output of the divide-by-256 prescaler (Channel 2 Input Assembly) at U19 pin 3. A TTL level waveform should be observed; its frequency should be 1/256 of input frequency. Note that because of the high frequency, shape irregularities in this waveform can be expected. If the waveform is correct, check Mode Selection Logic.

**MODE SELECTION LOGIC.** Operating mode, resolution, and other factors are determined by feedback of the U16 digit strobes D1-D8 to various control pins of this same IC. This feedback is controlled, either directly or through logic, by the front panel switches. Tables 6-6 and 6-7 give normal logic conditions in these feedback connections.

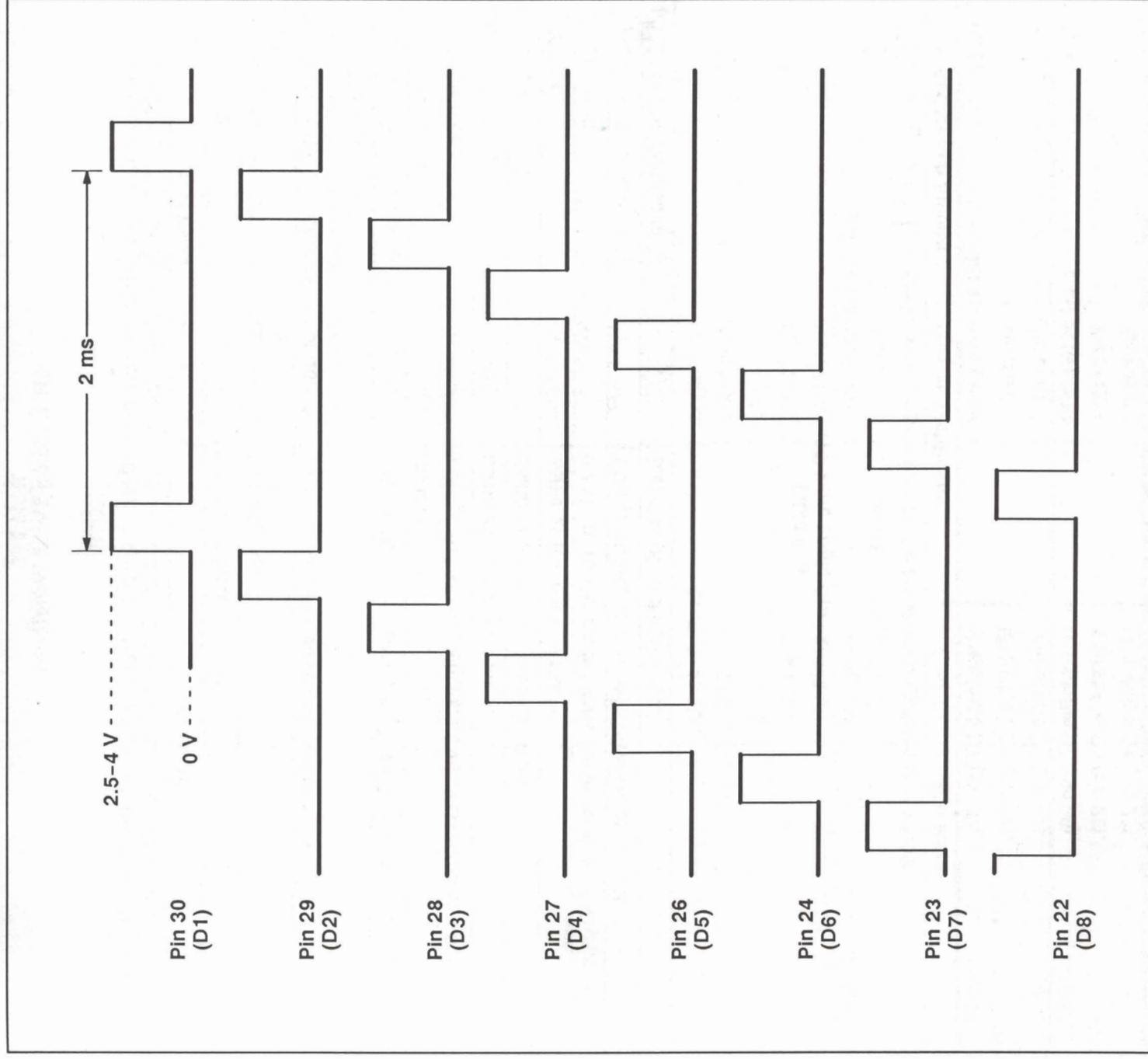

7941-11

Figure 6-1. Digit strobe waveforms from U16.

Table 6-5  
CH 1 Analog Circuit Waveforms

## NOTE

Except where noted otherwise, connect a 10 kHz, 1 Vp-p sine wave to the CH 1 input and set the INPUT VOLTAGE switch to LO (button out) and the LOW PASS FILTER switch to ON (button in).

Test Point	Waveform
(A) Gate of Q3	Identical to input.
(B) Gate of Q3 with INPUT VOLTAGE set to HI (button in).	1/10 amplitude of input.
(C) Source of Q3, connection point of C8, C9, C11, R9; with input frequency of 100 kHz and LOW PASS FILTER OFF.	1 Vp-p 10 kHz sine wave centered at +1.3 V.
(D) IC1 pin 10.	1 Vp-p, 10 kHz sine wave centered at +3.8 V.
(E) IC1 pin 9 or 11	DC level of +3.8 V.
(F) IC1 pin 4 or 7.	1 Vp-p, 10 kHz rounded square wave centered at +3.8 V.
(G) IC1 pin 5 or 6.	Same as (F), but inverted.
(H) IC1 pin 3 or 12.	Same as (F), but with squarer edges.
(I) IC1 pin 2.	Same as (H), but inverted.
(J) IC1 pin 13.	0.7 Vp-p, 10 kHz square wave centered at +3.8 V.
(K) IC1 pin 15, or base of Q5.	1 Vp-p, 10 kHz square wave centered at +3.8 V.
(L) IC1 pin 14, or base of Q6.	Same as (K), but inverted.

Table 6-6  
GATE Time Logic Check

## NOTE

See Figure 6-1, Digit Strobe Waveforms from U16, for the waveforms listed in this table.

GATE Switch Setting	Test Points	Waveform
0.01s	U16 pin 21	U16 strobe D1 (pin 30).
	U9 pin 4	U16 strobe D4 (pin 27).
	U9 pin 1	U16 strobe D3 (pin 28).
0.1s	U16 pin 21	U16 strobe D2 (pin 29).
	U9 pin 4	U16 strobe D5 (pin 26).
	U9 pin 1	U16 strobe D4 (pin 27).
1.0s	U16 pin 21	U16 strobe D3 (pin 28).
	U9 pin 4	U16 strobe D6 (pin 24).
	U9 pin 1	U16 strobe D5 (pin 26).
10s	U16 pin 21	U16 strobe D4 (pin 27).
	U9 pin 4	U16 strobe D7 (pin 23).
	U9 pin 1	U16 strobe D6 (pin 24).

Table 6-7  
FUNCTION Logic Check

## NOTE

See Figure 6-1, Digit Strobe Waveforms from U16, for the waveforms listed in this table.

FUNC Switch Setting	Test Points	Waveform
kHz	U16 pin 4	U16 strobe D1 (pin 30).
	U4 pin 1, 3	Logic high.
	D25	Lit.
	U2 pin 3	Logic high.
MHz	U16 pin 4	U16 strobe D1 (pin 30).
	U9 pin 5	Logic high.
	U9 pin 3	Same as U9 pin 4 (U16 digit strobe selected by GATE Switch, see Table 6-6).
	U16 pin 20	Logic high.
	U4 pin 4	Logic high.
	U2 pin 2	Logic high.
	U4 pin 6	Logic high.
	D24	Lit.
	U9 pin 6	Logic high.
	CH 2	U16 pin 4
U9 pin 12, 13		Logic high.
U9 pin 2		Same as U9 pin 1 (U16 digit strobe selected by GATE Switch, see Table 6-6).
U16 pin 20		Logic high.
U9 pin 6, 9, 10		Logic high.
U4 pin 5, 6		Logic high.
D24		Lit.
U19 pin 4		Logic high.
U2 pin 4		Logic high.
PERIOD		U16 pin 4
	U4 pin 11, 12	Logic high.
	D25	Lit.
	U2 pin 7	Logic high.
TOTAL	U16 pin 4	U16 strobe D4 (pin 27).
	U19 pin 6	Logic high.
	U2 pin 10	Logic high.
CHECK	U16 pin 4	U16 strobe D3 (pin 28).
	U4 pin 13	Logic high.
	U2 pin 1	Logic high.

<sup>a</sup> Digit strobe waveform period should be about 5 ms.

**CH 1 kHz/MHz SELECT.** The gates of U13 select either the MHz or kHz signal, according to the logic state of a line from U2 pin 2 to U13 pin 9 and a line from U4 pin 6 to U13 pins 4 and 5 as follows:

- a. When the lines from U2 pins 2 and 4 are low (the line from U4 pin 6 to U13 pins 4 and 5 is low), U19 pin 2 should have a TTL waveform of the same frequency as the CH 1 input. If the waveform is abnormal, check U13 pins 1-6 and 8-13.
- b. Divide-by-ten: U14 and U13C form a circuit which divides the signal by 10 at U13 pin 3 and selects either the divided signal or the direct signal for application to U16.
- c. The U14 output frequency at pin 2 should be 1/10 of the input at pin 8 (U13 pin 3). If not check U14.

**CHANNEL 1/CHANNEL 2 SELECT.** The selection in U19 is controlled by a line from U2 pin 4 (see Table 6-7),

which goes high whenever CH 2 mode is engaged. When it is high, the output of U1 pin 8 should be selected from the CH 2 prescaler.

When the line from U4 pin 6 is low (meaning some mode other than MHz or CH 2 is selected), the frequency at U1 pin 8 should be the same as that at the Channel 1 input, except in TOTAL mode.

Gating of the direct signal from U19 pin 18 is also controlled by the input to U19 pin 6, which goes low in all modes except TOTAL. In TOTAL mode, U19 pin 18 is enabled by the output of U19 pin 5. This input should be low when the HOLD switch S2 is disengaged and no input is applied to the rear panel connector. If a TTL low is applied to the rear panel connector or if S2 is engaged, U19 pin 5 should go high, disabling U19 pin 18 (constant high output). In that event, the output at U1 pin 8 should be a constant low. If these conditions are not normal, check U19, U1, U2, and S2.

**RESET.** Check that all readings are cleared to zero when the RESET switch is pushed. If not, check S1.

## CORRECTIVE MAINTENANCE

Replacement assemblies (i.e., Main Board, Front Panel, etc.) can be obtained from Tektronix. Many of the standard electrical components in this instrument can be obtained from your local electrical parts supplier. Corrective maintenance, therefore, consists of either complete assembly replacement or component replacement with locally obtained parts.

### MAINTENANCE PRECAUTIONS

To avoid personal injury or damage to equipment, observe the following precautions:

- Disconnect the instrument from the ac-power source before removing or installing components.
- Verify that any line-rectifier filter capacitors are discharged before doing any servicing.
- Use care not to interconnect instrument grounds which may be at different potentials (cross grounding).
- When soldering on circuit boards or small insulated wires, use only a 15-watt, pencil-type soldering iron.

### OBTAINING REPLACEMENT PARTS

Replacement assemblies for this instrument (Cabinet, Main Board, Front Panel, Rear Panel, and Channel 2 Input) can be obtained through your local Tektronix Field Office or representative. The CMC250 assemblies and their Tektronix part numbers are shown in the exploded-view drawing in Section 8 of this manual.

The Replaceable Parts list in Section 8 gives the Tektronix part number, name, and description of each of the CMC250 assemblies. A generic list (no Tektronix part numbers) is also supplied and includes the value, rating, tolerance, and description of the electrical parts on the Main Board. As CMC250 parts can be ordered from Tektronix only at the assembly or kit level, this additional list may be useful if parts are obtained from your local supplier.

### NOTE

*Physical size and shape of a component may affect instrument performance, particularly at high frequencies. Always use direct replacement components, unless you know that a substitute will not degrade performance.*



## Maintenance — CMC250 Service

- If the instrument is being shipped to a Tektronix Service Center, enclose the following: the owner's address, name and phone number of a contact person, type and serial number of the instrument, reason for returning, and a complete description of the service needed.
- Completely wrap the instrument with polyethylene sheeting or equivalent to protect the outside finish and prevent entry of foreign material into the instrument.
- Cushion the instrument on all sides, using three inches of padding material or urethane foam tightly packed between the carton and the instrument.
- Seal the shipping carton with an industrial stapler or strapping tape.
- Mark the address of the Tektronix Service Center and also your own return address on the shipping carton.

## MAINTENANCE AIDS

The maintenance aids recommended in Table 6-8 include items that may be needed for instrument maintenance and repair. Equivalent products may be substituted if their characteristics are similar.

## Ordering Parts

When ordering parts from Tektronix, Inc., be sure to include the following information:

- Instrument type (include all modification and option numbers).
- Instrument serial number.
- A description of the part (if electrical, include its full circuit component number).
- Tektronix part number.

## REPACKAGING FOR SHIPMENT

Save the original carton and packing material for reuse if the instrument should have to be reshipped on a commercial transport carrier. If the original materials are unfit or not available, repack the instrument as follows:

- Use a corrugated cardboard shipping carton with a test strength of at least 200 pounds and with an inside dimension at least six inches greater than the instrument dimensions.

Table 6-8  
Maintenance Aids

Description	Specification	Usage
Soldering Iron	15 to 25 W.	General soldering and unsoldering.
Phillips Screwdriver		Assembly and disassembly.
Long-nose Pliers		Component removal and replacement.
Diagonal Cutters		Component removal and replacement.
Vacuum Solder Extractor	No static charge retention.	Unsoldering static sensitive devices and components.
Contact Cleaner	No-Noise.®	Switch and pot cleaning.
IC-removal Tool		Removing DIP IC packages.
Isopropyl Alcohol	Reagent grade.	Cleaning.

## INTERCONNECTIONS

Pin connectors used to connect the wires to the interconnect pins are factory assembled. They consist of machine-inserted pin connectors mounted in plastic holders. If the connectors are faulty, the entire wire assembly should be replaced.

## TRANSISTORS AND INTEGRATED CIRCUITS

Transistors and integrated circuits should not be replaced unless they are actually defective. If one is removed from its socket or unsoldered from the circuit board during routine maintenance, return it to its original board location. Unnecessary replacement or transplanting of semiconductor devices may affect the adjustment of the instrument. When a semiconductor is replaced, check the performance of any circuit that may be affected.

Any replacement component should be of the original type or a direct replacement. Bend component leads to fit their circuit board holes, and cut the leads to the same length as the original component. See Figure 9-2 in the Diagrams section for the semiconductor lead configurations.

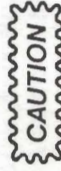

*After replacing a power transistor, check that the collector is not shorted to the chassis before applying power to the instrument.*

To remove socketed dual-in-line packaged (DIP) integrated circuits, pull slowly and evenly on both ends of the device. Avoid disengaging one end of the integrated circuit from the socket before the other, since this may damage the pins.

To remove a soldered DIP IC for replacement, clip all the leads of the device and remove the leads from the circuit board one at a time. If the device must be removed intact for possible reinstallation, do not heat adjacent conductors consecutively. Apply heat to pins at alternate sides and ends of the IC as solder is removed. Allow a moment for the circuit board to cool before proceeding to the next pin.

## SOLDERING TECHNIQUES

The reliability and accuracy of this instrument can be maintained only if proper soldering techniques are used

to remove or replace parts. General soldering techniques that apply to maintenance of any precision electronic equipment should be used when working on this instrument.

### WARNING

*To avoid an electrical shock hazard, observe the following precautions before attempting any soldering: turn the instrument off, disconnect it from the ac power source, and wait at least three minutes for line-rectifier filter capacitors to discharge.*

Use rosin-core wire solder containing 63% tin and 37% lead. Contact your local Tektronix Field Office or representative to obtain the names of approved solder types.

When soldering on circuit boards or small insulated wires, use only a 15-watt, pencil-type soldering iron. A higher wattage soldering iron may cause etched circuit conductors to separate from the board base material and melt the insulation on small wires. Always keep the soldering iron tip properly tinned to ensure the best heat transfer from the tip to the solder joint. Apply only enough solder to make a firm joint. After soldering, clean the area around the solder connection with an approved flux-removing solvent (such as isopropyl alcohol) and allow it to air dry.

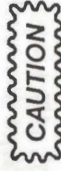

*Only a maintenance person experienced in the use of vacuum-type desoldering equipment should attempt repair of any circuit board in this instrument. Many integrated circuits are static sensitive and may be damaged by solder extractors that generate static charges. Perform work involving static-sensitive devices only at a static-free work station while wearing a grounded antistatic wrist strap. Use only an antistatic vacuum-type solder extractor approved by a Tektronix Service Center.*



*Attempts to unsolder, remove, and resolder leads from the component side of a circuit board may cause damage to the reverse side of the circuit board. The following techniques should be used to replace a component on a circuit board:*

1. Touch the vacuum desoldering tool tip to the lead at the solder connection. Never place the tip directly on the board; doing so may damage the board.

#### NOTE

*Some components are difficult to remove from the circuit board due to a bend placed in the component leads during machine insertion. To make removal of machine-inserted components easier, straighten the component leads on the reverse side of the circuit board.*

2. When removing a multipin component, especially an IC, do not heat adjacent pins consecutively. Apply heat to the pins at alternate sides and ends of the IC as solder is removed. Allow a moment for the circuit board to cool before proceeding to the next pin.

#### CAUTION

*Excessive heat can cause the etched circuit conductors to separate from the circuit board. Never allow the solder extractor tip to remain at one place on the board for more than three seconds. Solder wick, spring-actuated or squeeze-bulb solder suckers, and heat blocks (for desoldering multipin components) must not be used. Damage caused by poor soldering techniques can void the instrument warranty.*

3. Bend the leads of the replacement component to fit the holes in the circuit board. If the component is replaced while the board is installed in the instrument, cut the leads so they protrude only a small amount through the reverse side of the circuit board. Excess lead length may cause shorting to other conductive parts.
4. Insert the leads into the holes of the board so that the replacement component is positioned the same as the original component. Most components should be firmly seated against the circuit board.
5. Touch the soldering iron tip to the connection and apply enough solder to make a firm solder joint. Do not move the component while the solder hardens.
6. Cut off any excess lead protruding through the circuit board (if not clipped to the correct length in step 3).

7. Clean the area around the solder connection with an approved flux-removing solvent. Be careful not to remove any of the printed information from the circuit board.

## REMOVAL AND REPLACEMENT INSTRUCTIONS

### WARNING

*To avoid electrical shock, disconnect the instrument from the power input source before removing or replacing any component or assembly.*

The exploded-view drawings in the Replaceable Parts list may be helpful during removal and replacement of assemblies. Component locations are shown in the Diagrams section.

Read these instructions before attempting to remove or install any components.

### Cabinet Assembly

To remove the cabinet:

1. Unplug the power cord from its rear-panel connector.
2. Place the instrument upside down on a clean, flat surface.
3. Remove the four case-securing screws from the bottom of the instrument. The two rear screws also hold the rear rubber pads (feet) in place. The front screws to be removed are separate from and to the outside of the front pads.
4. Carefully turn the instrument right side up, while holding together the top and bottom of the case.
5. Remove the top half of the case and the handle.

### WARNING

*Potentially dangerous voltages exist at several points throughout this instrument. If it is operated with the cabinet removed, do not touch exposed connections or components. Before replacing parts, disconnect the ac-power source from the instrument.*

**NOTE**

*Removal of the top half of the instrument cabinet and the handle will access the component side of the Main board and allow adjustment of R10 and R118 without further disassembly. (R10 can be adjusted through the rear hole in the metal shield.)*

To continue to remove the cabinet:

6. Remove the two screws securing the Main board to the cabinet bottom; one screw is near TP1 and the other near connector JE.
7. Lift the Main board along with the attached front and rear panels, away from the bottom of the cabinet.

To replace the cabinet, do the reverse of the preceding steps.

**Channel 2 Input Assembly**

The Channel 2 board is located inside a covered metal shield case and is attached to the Front Panel CHANNEL 2 INPUT connector. The assembly includes the Channel 2 board, the metal shield, and the attached wires.

To remove the Channel 2 Input assembly:

1. Remove the top of the instrument cabinet.
2. To access the board, push up on the front corners of the shield cover until the front of the cover is raised and continue removing the cover.
3. Detach the wires connecting the Channel 2 board to the Main board by unplugging the three-pin connector at JE on the Main board.
4. Loosen the nut on the BNC with needle-nose pliers or an open-end wrench.
5. Unsolder the center BNC contact from the Channel 2 board while pulling back on the assembly.

**NOTE**

*To reinstall, place the shield, washer, and nut on the BNC first and tighten the nut; then resolder the BNC center conductor to the circuit board. Reconnect the cable assembly to JE and replace the top shield over the board.*

**Front Panel Assembly**

The Front Panel assembly includes the Front Panel, Display board, and the BNC connectors.

To remove the Front Panel assembly:

1. Remove the Channel 2 Input assembly.
2. Remove the ground-wire screw at the top left corner of the Front Panel.
3. Unplug the black ground wire that goes from the Display board to the Main board; unplug at Main board GND.
4. Unplug the four multiwire connectors from the Display board. The wires are from JA, JC, JD, and JB on the Main board; note location for reassembly.
5. Unsolder the two wires from the CH 1 BNC.
6. Loosen the two Main board screws (one near TP1 and the other near JE).
7. Lift the front of the Main board and slide the Front Panel assembly over the pushbuttons until free.

To replace the Front Panel assembly, reverse the preceding steps.

**Rear Panel Assembly**

To remove the Rear Panel assembly:

1. Remove the cabinet top.
2. Remove the ground-wire screw at the top left corner of the Front Panel.
3. Unplug the six-wire connector from JF on the Main board.
4. Unsolder the two wires from the Rear Panel BNC.
5. Unplug the two connectors on the Display board that are over the Power switch (S5).

## Maintenance – CMC250 Service

6. Slide the heat shrink insulation up and unsolder the four wires from the Power switch. The two blue wires go to the two contacts nearest the edge of the unit, and the red wires go towards the unit's center.

**NOTE**

*For reinstallation: The Power switch just opens and closes the line; so either red wire or either blue wire can be replaced on the rear-most contacts of the switch. Both blues have to be towards the outside edge, and both reds towards the center of the unit.*

7. Lift the Rear Panel assembly up out of the slots in the cabinet.

**Main Board Assembly**

The Main Board assembly includes the Main board, the Front Panel switches, and two board shields.

To remove the Main Board assembly:

1. Remove the top of the cabinet.
2. Remove the Rear Panel assembly.
3. Remove the Front Panel assembly.
4. Remove the two screws attaching the Main Board to the cabinet bottom, one near TP1 and the other near connector JE.
5. Lift the Main board away from the cabinet.

To replace the Main Board assembly, reverse the preceding steps.

**NOTE**

*When replacing assemblies in the instrument, be sure to use new wire ties to replace any that were clipped during disassembly.*

# OPTIONS

## INTERNATIONAL POWER CORDS

Instruments are shipped with the detachable power cord option ordered by the customer. Descriptive information about international power cord options is given in Section 2. The following list describes the power cords available for this instrument.

Standard	North American, 120 V
Option A1	Universal Euro, 220 V
Option A2	UK, 240 V
Option A3	Australian, 240 V
Option A4	North American, 240 V
Option A5	Switzerland, 220 V

# REPLACEABLE PARTS

Replacement parts are available from or through your local Tektronix, Inc. Field Office or representative.

When ordering parts, include the following information in your order: part number, instrument type or number, serial number, and modification number if applicable.

If a part you have ordered has been replaced with a new or improved part, your local Tektronix, Inc. Field Office or representative will contact you concerning any change in part number.

Change information, if any, is located at the rear of this manual.

## ITEM NAME

In the parts list, an item name is separated from the description by a colon(:). Because of space limitations, an item name may sometimes appear as incomplete. For further item name identification, the U.S. Federal Cataloging Handbook H6-1 can be utilized where possible.

## FIGURE AND INDEX NUMBERS

Items in this section are referenced by figure and index numbers to the illustrations.

## INDENTATION SYSTEM

This mechanical parts list is indented to indicate item relationships. Following is an example of the indentations system used in the description column.

1	2	3	4	5	<i>Name &amp; Description</i>
					<i>Assembly and/or component</i>
					<i>Attaching parts for assembly and/or component</i>

### END ATTACHING PARTS

*Detail part of assembly and/or component  
Attaching parts for detail part*

### END ATTACHING PARTS

*Parts of detail part  
Attaching parts for parts or detail part*

### END ATTACHING PARTS

Attaching parts always appear in the same indentation as the item it mounts, while the detail parts are indented to the right. Indented items are part of, and included with, the next higher indentation.

**Attaching parts must be purchased separately, unless otherwise specified.**

## ABBREVIATIONS

Abbreviations conform to American National Standard Y1.1.

**CROSS INDEX — MFR. CODE NUMBER TO MANUFACTURER**

Mfr. Code	Manufacturer	Address	City, State, Zip Code
TK2280	ESCORT INSTRUMENTS CORP	2-FL NO 37 POA HSIN RD PO BOX 3-20 MUCHA	TAIPEI TAIWAN ROC 00080
TK2410	CHUNG TAI PRINTERS	BLOCK B, 12-F VERISTRONG IND CTR 34-36 AU PUI WAN STREET	FO TAN SHANTIN, HONG KONG
80009	TEKTRONIX INC	14150 SW KARL BRAUN DR PO BOX 500	BEAVERTON OR 97077-0001

**ABBREVIATIONS**

**FIGURE AND INDEX NUMBERS**



Replaceable Parts CMC250 Cabinet

Part No.	Part Name	Qty	Part No.
1	FRONT PANEL ASSEMBLY	1	11960A-01
2	REAR PANEL ASSEMBLY	1	11960B-01
3	TOP PANEL ASSEMBLY	1	11960C-01
4	BOTTOM PANEL ASSEMBLY	1	11960D-01

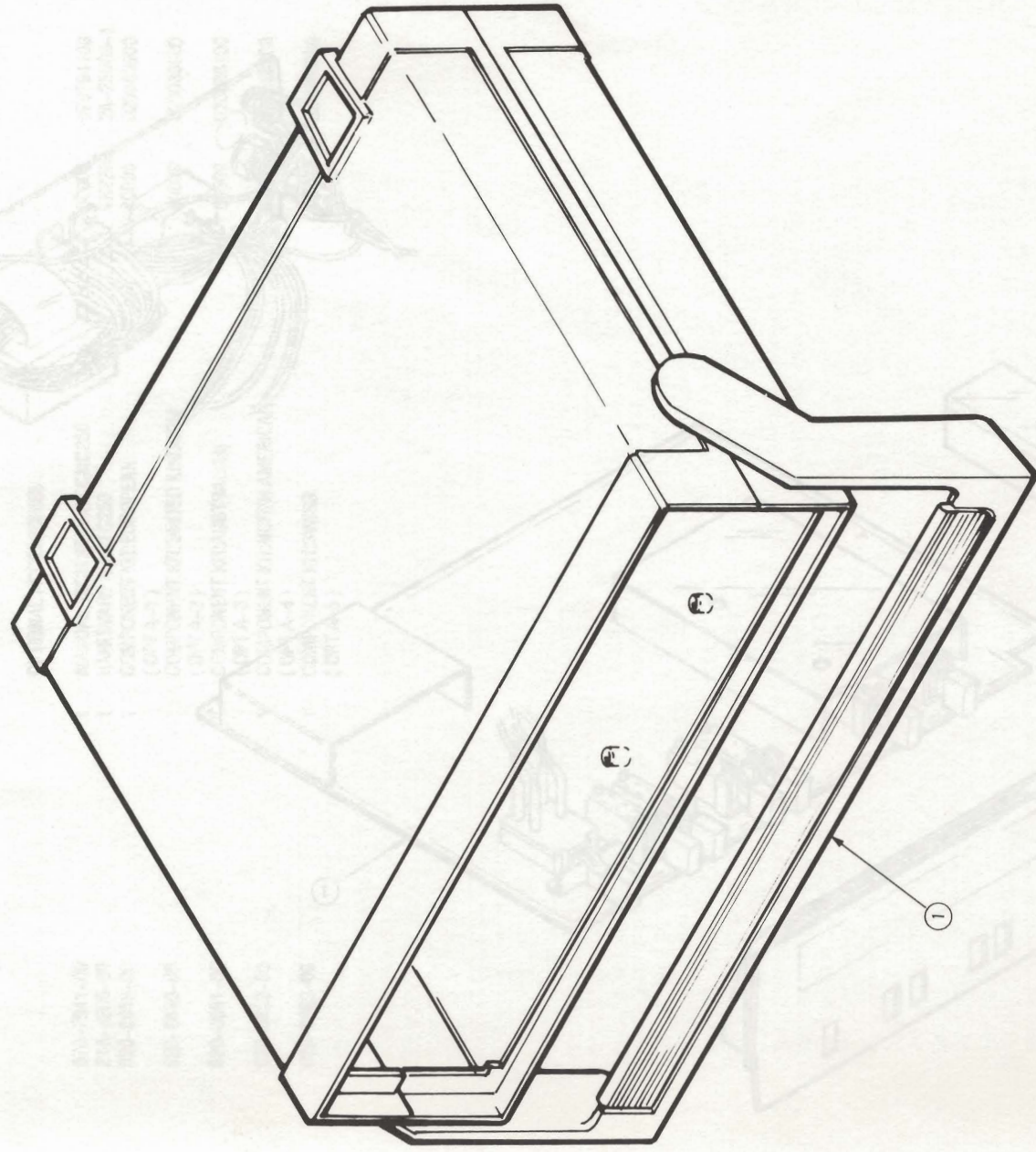

CMC250

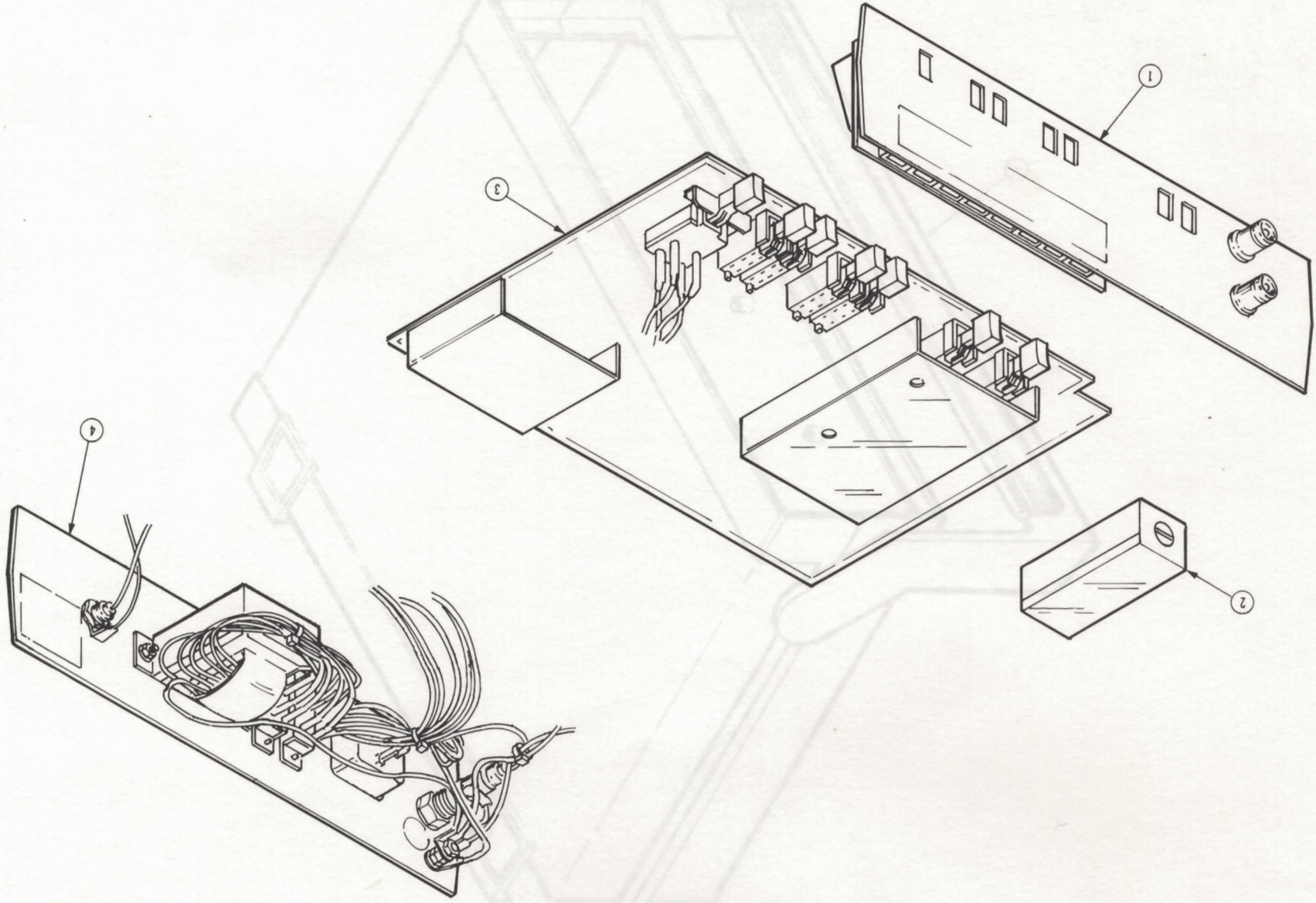

FIG. 2 ASSEMBLIES

Fig. & Index No.    Tektronix Part No.    Serial No. Effective    Dscont    Qty    12345 Name & Description    Mfr. Code    Mfr. Part No.

2	-1	118-8587-00			1	FRONT PNL ASSY:CMC250	80009	118858700
	-2	118-8586-00			1	INPUT ASSEMBLY:CHANNEL 2,CMC250	80009	118858600
	-3	118-8589-00			1	CIRCUIT BD ASSY:MAIN,CMC250 (Electrical parts descriptions on following page)	80009	118858900
	-4	118-8588-00			1	REAR PNL ASSY:CMC250	80009	118858800
						STANDARD ACCESSORIES		
		070-7942-00			1	MANUAL, TECH:OPERATORS,CMC250	TK2410	17739000
		161-0248-00			1	CABLE ASSY,PWR,:	TK2280	30-25635-1
						OPTIONAL ACCESSORIES		
		070-7941-00			1	MANUAL, TECH:SERVICE,CMC250	80009	070794100
		214-4205-00			1	HARDWARE KIT:CFG250	TK2280	2A-25008-1
		020-0859-00			1	COMPONENT KIT:EUROPEAN (OPT A-1)	80009	020085900
		020-0860-00			1	COMPONENT KIT:UNITED KINGDOM (OPT A-2)	80009	020086000
		020-0861-00			1	COMPONENT KIT:AUSTRALIAN (OPT A-3)	80009	020086100
		020-0862-00			1	COMPONENT KIT:NORTH AMERICAN (OPT A-4)	80009	020086200
		020-0863-00			1	COMPONENT KIT:SWISS (OPT A-5)	80009	020086300

Main Circuit Board Assembly (118-8589-00) - Electrical Parts Description

FIG. 2 ASSEMBLIES

Component	Description	Component	Description
C1	CAPACITOR,MPE:0.047UF,10%,250V	Q1	TRANSISTOR:LC1674K
C2	CAPACITOR,C:1PF,+/-0.25PF,500V	Q2	TRANSISTOR:LC1674K
C3	CAPACITOR,C:10PF,5%,500V	Q3	FET:2N5486
C4	CAPACITOR,C:100PF,5%,500V	Q4	TRANSISTOR:MPS3640
C5	CAPACITOR,C:0.01UF,5%,50V	Q5	TRANSISTOR:MPS3640
C6	CAPACITOR,E:47UF,+80/-20%,16V	Q6	TRANSISTOR:MPS3640
C8	CAPACITOR,C:120PF,5%,50V	Q9	MICROCKT:LM340T-5
C9	CAPACITOR,C:0.01UF,5%,50V	Q10	MICROCKT:LM340T-5
C10	CAPACITOR,E:47UF,+80/-20%,16V	Q11	TRANSISTOR:2SC1815
C11	CAPACITOR,E:47UF,+80/-20%,16V	R1	RESISTOR:5.1 OHM,5%,1/8W
C12	CAPACITOR,C:0.01UF,5%,50V	R2	RESISTOR:1.1M OHM,1%,1/8W
C13	CAPACITOR,E:47UF,+80/-20%,16V	R3	RESISTOR:121K OHM,1%,1/8W
C14	CAPACITOR,E:47UF,+80/-20%,16V	R4	RESISTOR:100 OHM,5%,1/2W
C15	CAPACITOR,C:470PF,5%,50V	R5	RESISTOR:100K OHM,5%,1/8W
C101	CAPACITOR,C:0.1UF,+80/-20%,50V	R6	RESISTOR:130 OHM,1%,1/8W
C102	CAPACITOR,C:0.1UF,+80/-20%,50V	R7	RESISTOR:10 OHM,5%,1/8W
C103	CAPACITOR,C:0.1UF,+80/-20%,50V	R8	RESISTOR:470 OHM,5%,1/8W
C104	CAPACITOR,C:0.1UF,+80/-20%,50V	R9	RESISTOR:150 OHM,5%,1/8W
C105	CAPACITOR,C:0.1UF,+80/-20%,50V	R10	RESISTOR,VARIABLE:10K OHM,20%
C106	CAPACITOR,C:0.1UF,+80/-20%,50V	R11	RESISTOR:100K OHM,5%,1/8W
C107	CAPACITOR,C:39PF,10%,50V	R12	RESISTOR:2.2K OHM,5%,1/8W
C108	CAPACITOR,VAR:3.5PF-30PF	R13	RESISTOR:2.2K OHM,5%,1/8W
C109	CAPACITOR,C:39PF,10%,500V	R14	RESISTOR:470 OHM,5%,1/8W
C110	CAPACITOR,C:47PF,5%,50V	R15	RESISTOR:470 OHM,5%,1/8W
C111	CAPACITOR,C:47PF,5%,50V	R16	RESISTOR:180 OHM,5%,1/8W
C112	CAPACITOR,C:15PF,5%,50V	R17	RESISTOR:330 OHM,5%,1/8W
C113	CAPACITOR,VAR:3.5PF-30PF	R18	RESISTOR:470 OHM,5%,1/8W
C114	CAPACITOR,C:0.1UF,+80/-20%,50V	R19	RESISTOR:470 OHM,5%,1/8W
C115	CAPACITOR,C:0.1UF,+80/-20%,50V	R20	RESISTOR:330 OHM,5%,1/8W
C116	CAPACITOR,E:47UF,+80/-20%,16V	R21	RESISTOR:150 OHM,5%,1/8W
C117	CAPACITOR,C:0.1UF,+80/-20%,50V	R22	RESISTOR:470 OHM,5%,1/8W
C118	CAPACITOR,E:47UF,+80/-20%,16V	R23	RESISTOR:470 OHM,5%,1/8W
C119	CAPACITOR,C:0.01UF,5%,50V	R24	RESISTOR:22 OHM,5%,1/8W
C120	CAPACITOR,E:1000UF,+80/-20%,35V	R25	RESISTOR:75 OHM,5%,1/8W
C121	CAPACITOR,C:0.1UF,+80/-20%,50V	R26	RESISTOR:412 OHM,1%,1/8W
C122	CAPACITOR,E:47UF,+80/-20%,16V	R45	RESISTOR:220 OHM,5%,1/8W
C123	CAPACITOR,C:0.01UF,5%,50V	R101	RESISTOR:10K OHM,5%,1/8W
C124	CAPACITOR,E:1000UF,+80/-20%,35V	R102	RESISTOR:3K OHM,5%,1/8W
C125	CAPACITOR,C:0.1UF,+80/-20%,50V	R103	RESISTOR:10K OHM,5%,1/8W
C126	CAPACITOR,E:47UF,+80/-20%,16V	R104	RESISTOR:10K OHM,5%,1/8W
C130	CAPACITOR,C:0.1UF,+80/-20%,50V	R105	RESISTOR:100 OHM,5%,1/8W
C131	CAPACITOR,C:0.1UF,+80/-20%,50V	R106	RESISTOR:470K OHM,5%,1/8W
C132	CAPACITOR,C:0.1UF,+80/-20%,50V	R107	RESISTOR:470K OHM,5%,1/8W
C133	CAPACITOR,C:0.1UF,+80/-20%,50V	R108	RESISTOR:100K OHM,5%,1/8W
C134	CAPACITOR,E:47UF,+80/-20%,16V	R109	RESISTOR:180 OHM,5%,1/8W
D1	DIODE,1N4148	R110	RESISTOR:470 OHM,5%,1/8W
D2	DIODE:1N4148	R111	RESISTOR:360 OHM,5%,1/8W
D101	DIODE:1N4007	R112	RESISTOR:360 OHM,5%,1/8W
D102	DIODE:1N4007	R113	RESISTOR:10K OHM,5%,1/8W
D103	DIODE:1N4148	R114	RESISTOR:10K OHM,5%,1/8W
D104	DIODE:1N4148	R115	RESISTOR:10K OHM,5%,1/8W
D105	DIODE:1N4148	R116	RESISTOR:10K OHM,5%,1/8W
D106	DIODE:1N4148	R117	RESISTOR:180 OHM,5%,1/8W
D107	DIODE:1N4148	R118	RESISTOR,VARIABLE:500K OHM
D108	DIODE:1N4148	R120	RESISTOR,10K OHM,5%,1/8W
D109	DIODE:1N4148	R121	RESISTOR,10K OHM,5%,1/8W
D110	DIODE:1N4002	R122	RESISTOR,10K OHM,5%,1/8W
D111	DIODE:1N4002	R123	RESISTOR,10K OHM,5%,1/8W
D112	DIODE:1N4148	R124	RESISTOR,22M OHM,5%,1/8W
D113	DIODE:1N4002	R125	RESISTOR,22M OHM,5%,1/8W
D114	DIODE:1N4002	R126	RESISTOR,1K OHM,5%,1/8W
D115	DIODE:1N4148	R127	RESISTOR,10K OHM,5%,1/8W
IC1	MICROCKT:MC10116P	R128	RESISTOR,1K OHM,5%,1/8W

Main Circuit Board Assembly (118-8589-00) — Electrical Parts Description (cont)

Component	Description	Component	Description
U1	MICROCKT:CD74HCT00	U11	MICROCKT:MC14066BCP
U2	MICROCKT:MC14017BCP	U12	MICROCKT:MC14066BCP
U3	MICROCKT:HD74LS00	U13	MICROCKT:SN74S00
U4	MICROCKT:SN74HCT86AN	U14	MICROCKT:SN74S196
U5	MICROCKT:MC14049UBCP	U16	MICROCKT:ICM7226AJJ
U6	MICROCKT:MC14017BCP	U17	MICROCKT:MC74HC00
U7	MICROCKT:MC14049UBCP	U18	MICROCKT:74HCT74
U8	MICROCKT:MC14066BCP	U19	MICROCKT:PAL16R4ACN
U9	MICROCKT:MC14066BCP	Y1	CRYSTAL:3.90625MHZ
U10	MICROCKT:MC14066BCP	Y2	CRYSTAL:10MHZ

# DIAGRAMS AND CIRCUIT BOARD ILLUSTRATIONS

## Symbols

Graphic symbols and class designation letters are based on ANSI Standard Y32.2-1975.

Logic symbology is based on ANSI Y32.14-1973 in terms of positive logic. Logic symbols depict the logic function performed and may differ from the manufacturer's data.

The overline on a signal name indicates that the signal performs its intended function when it is in the low state.

Abbreviations are based on ANSI Y1.1-1972.

Other ANSI standards that are used in the preparation of diagrams by Tektronix, Inc. are:

Y14.15, 1966 Drafting Practices.

Y14.2, 1973 Line Conventions and Lettering.

Y10.5, 1968 Letter Symbols for Quantities Used in

Electrical Science and Electrical Engineering.

American National Standard Institute  
1430 Broadway  
New York, New York 10018

## Component Values

Electrical components shown on the diagrams are in the following units unless noted otherwise:

Capacitors = Values one or greater are in picofarads (pF).  
Values less than one are in microfarads ( $\mu$ F).

Resistors = Ohms ( $\Omega$ ).

**— The information and special symbols below may appear in this manual. —**

## Assembly Numbers and Grid Coordinates

Each assembly in the instrument is assigned an assembly number (e.g., A20). The assembly number appears on the circuit board outline on the diagram, in the title for the circuit board component location illustration, and in the lookup table for the schematic diagram and corresponding component locator illustration. The Replaceable Electrical Parts lists arranged by assemblies in numerical sequence; the components are listed by component number \* (see following illustration for constructing a component number).

The schematic diagram and circuit board component location illustration have grids. A lookup table with the grid coordinates is provided for ease of locating the component. Only the components illustrated on the facing diagram are listed in the lookup table. When more than one schematic diagram is used to illustrate the circuitry on a circuit board, the circuit board illustration may only appear opposite the first diagram on which it was illustrated; the lookup table will list the diagram number of other diagrams that the circuitry of the circuit board appears on.

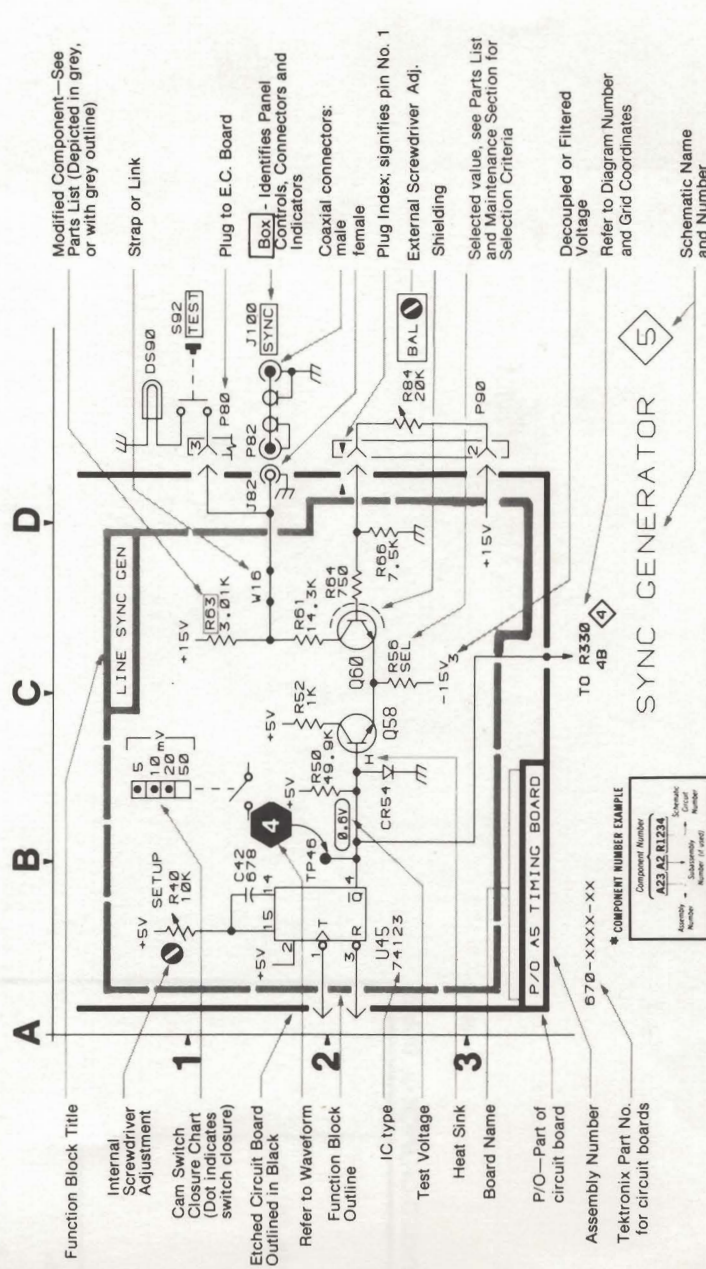

A B C D E F G H

1 2 3 4 5 6

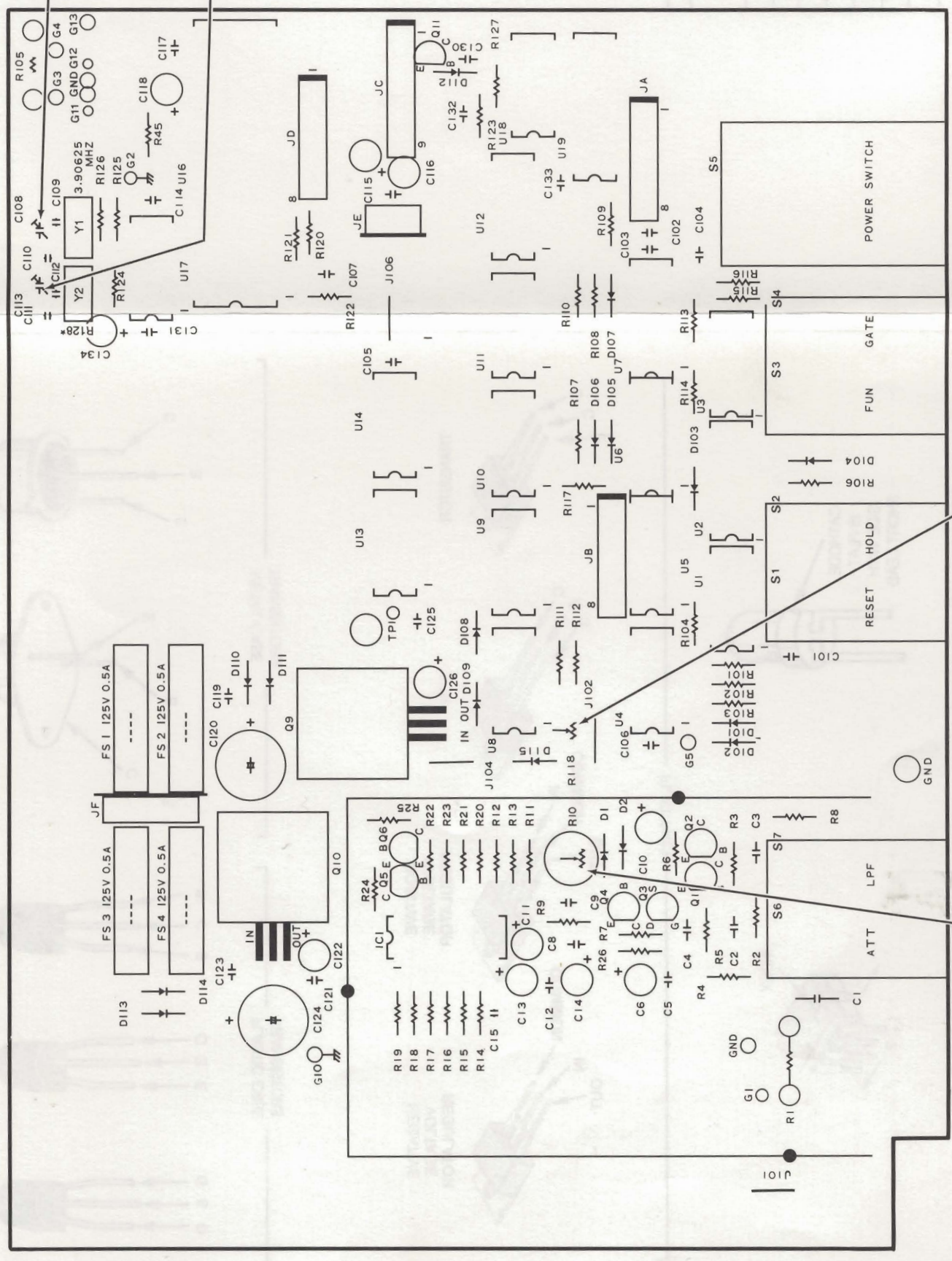

\* MOUNTED ON BACK OF BOARD

R118  
CH 1 TOTALIZE  
SENSITIVITY

R10  
CH 1 SENSITIVITY

(ACCESSIBLE  
THROUGH  
REAR PANEL)

Figure 9-3. Main circuit board and adjustment locations.

## CMC250 DIAGRAM

MAIN BOARD											
CIRCUIT NUMBER	SCHEM LOCATION	BOARD LOCATION	CIRCUIT NUMBER	SCHEM LOCATION	BOARD LOCATION	CIRCUIT NUMBER	SCHEM LOCATION	BOARD LOCATION	CIRCUIT NUMBER	SCHEM LOCATION	BOARD LOCATION
C1	2B	6B	D106	9S	5F	R22	4F	4C	U4B	6F	5D
C2	2B	5C	D107	10M	5G	R23	4E	4C	U4C	7F	5D
C3	2B	6C	D108	6J	4E	R24	3F	3C	U4D	6H	5D
C4	3B	5C	D109	6H	4D	R25	4F	3C	U5A	9K	5E
C5	11E	5B	D110	10C	2D	R26	3C	3C	U5B	8G	5E
C6	11E	5B	D111	10C	2D	R45	3C	2H	U5C	8J	5E
C8	3C	4C	D112	5F	4H	R101	1J	6D	U5D	8J	5E
C9	4C	4C	D113	11C	2B	R102	2J	6D	U5E	9K	5E
C10	4C	5C	D114	11C	2B	R103	1C	6D	U5F	8H	5E
C11	3C	4C	D115	4D	4D	R104	1H	5E	U6	8H	5E
C12	3C	4B	FS1	10C	2D	R105	1C	1H	U7A	8P	5F
C13	2C	4B	FS2	10C	2D	R106	11H	6F	U7B	8N	5F
C14	4C	4B	FS3	10C	2C	R107	10M	4F	U7C	9R	5F
C15	3D	4B	FS3	11C	2C	R108	10M	5G	U7D	10L	5F
C101	2L	6D	FS4	11C	2C	R109	9N	5G	U7E	9P	5F
C102	10M	5G	IC1A	3D	3C	R110	3M	4G	U7F	3L	5F
C103	10D	5G	IC1B	3D	3C	R111	6F	4D	U8A	7K	4D
C104	10D	5G	IC1C	3D	3C	R112	6F	4D	U8B	7J	4D
C105	11D	3F	IC1C	4E	3C	R113	11K	5G	U8C	7J	4D
C106	10D	5D	IC1D	2E	3C	R114	11K	5F	U8D	7K	4D
C107	5J	3G	Q1	3B	5C	R115	11M	6G	U9A	4E	4E
C108	4H	1G	Q2	3B	5C	R116	11L	6G	U9B	6K	4E
C109	4H	1G	Q3	3B	5C	R117	9K	4F	U9C	5H	4E
C110	4J	1G	Q4	3C	5C	R118	4E	4D	U9D	5J	4E
C111	3J	1G	Q5	3C	5C	R120	5K	3G	U10A	6P	4F
C112	3H	1G	Q6	4F	3C	R121	5K	3G	U10B	6N	4F
C113	3H	1G	Q6	3F	3C	R122	5J	3G	U10C	6R	4F
C114	10D	2G	Q9	10D	3D	R123	5L	4H	U10D	6R	4F
C115	5F	3G	Q10	11D	3C	R124	2H	2G	U11A	5N	4F
C116	5F	3H	Q11	4F	4H	R125	3J	2G	U11B	5N	4F
C117	10D	2H	R1	2A	6B	R126	4J	1G	U11C	5P	4F
C118	10E	2H	R2	2B	6C	R127	4F	4H	U11D	5R	4F
C119	10C	2D	R3	2B	6C	R128	3J	1G	U12A	6P	4F
C120	10D	2D	R4	2B	5C	S1	1L	6E	U12B	6N	4G
C121	11D	3B	R5	2B	5B	S2	2H	6E	U12C	6R	4G
C122	11E	3C	R6	3B	5C	S3	11K	6E	U12D	6S	4G
C123	11C	2B	R7	3C	5C	S4	11L	6F	U13A	4G	3E
C124	11D	3B	R8	3C	5C	S5	10A	6G	U13B	5F	3E
C125	10D	3E	R9	4B	6C	S6	2B	6H	U13C	4G	3E
C126	10E	4D	R10	3C	4C	S7	4B	6C	U13D	4G	3E
C130	4F	4H	R11	3C	4C	U1A	1J	5E	U14	3G	3F
C132	10D	4H	R12	3C	4C	U1B	2J	5E	U16	3K	2H
C133	10D	4H	R13	3C	4C	U1C	2J	5E	U17A	2J	2G
C134	10E	1G	R14	4D	4C	U1D	4J	5E	U17B	3J	2G
D1	4C	5C	R15	4D	4B	U1E	1F	5E	U17C	3J	2G
D2	4C	5C	R16	4D	4B	U2	11G	5E	U17D	3J	2G
D101	1D	6D	R17	3D	4B	U3A	11M	5E	U18A	4H	4H
D102	1D	6D	R18	3E	4B	U3B	11M	5F	U18B	4H	4H
D103	10K	6D	R19	4E	3B	U3C	11J	5F	U19	5H	4H
D104	10K	6F	R20	3E	3B	U3D	11J	5F	Y1	4J	1G
D105	10N	5F	R21	4E	4C	U4A	6F	5D	Y2	3H	1G
OTHER PARTS											
FS5	10A	CHASSIS	S8	10A	CHASSIS	S9	10B	CHASSIS			



A B C D E F G H J K L M N P R Y S Y T Y U

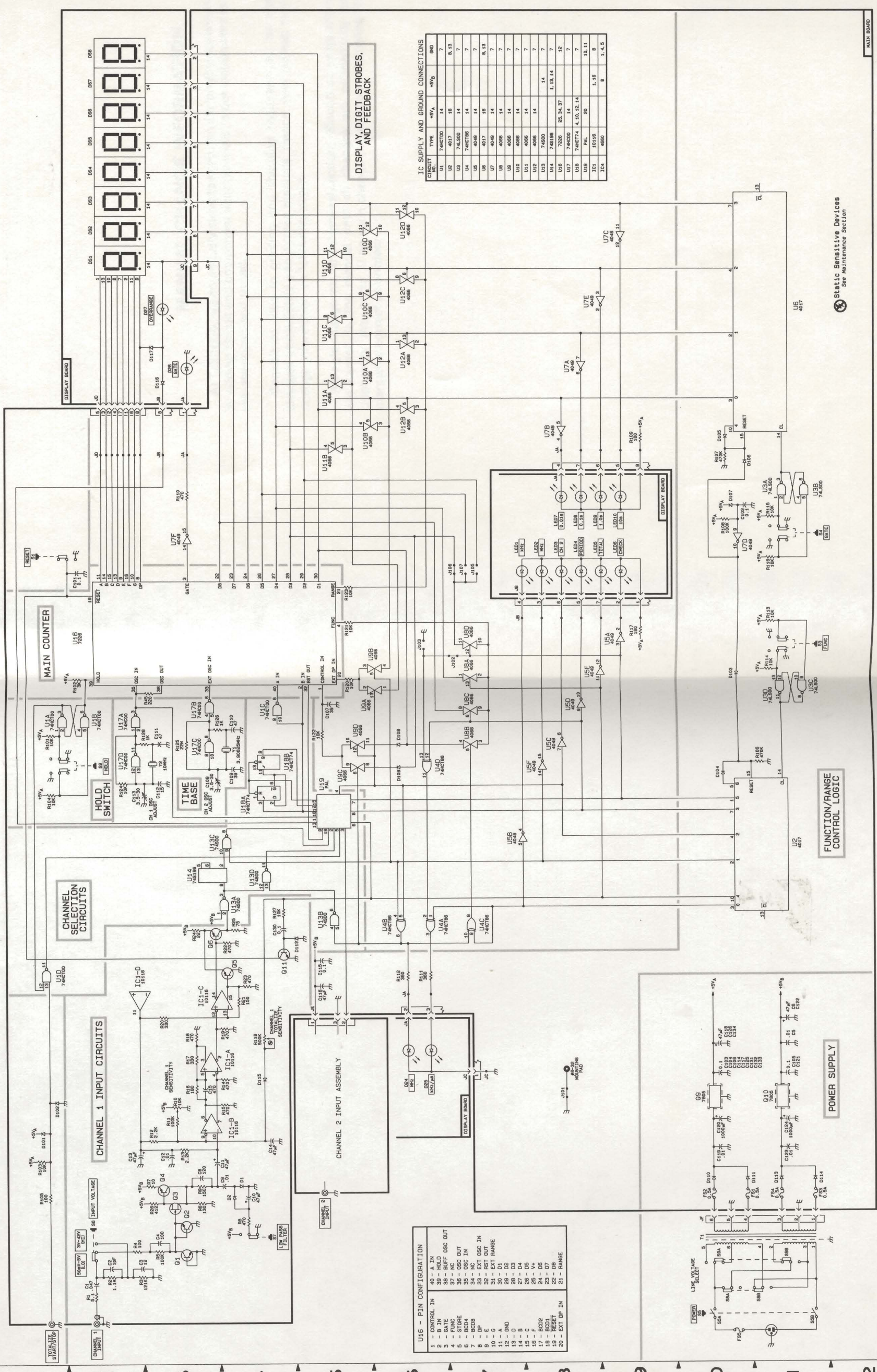

**U16 - PIN CONFIGURATION**

1	- CONTROL IN
2	- B IN
3	- HOLD OSC OUT
4	- FUNK
5	- STORE
6	- OSC IN
7	- BCD4
8	- BCD8
9	- CP
10	- G
11	- A
12	- GND
13	- D
14	- C
15	- B
16	- F
17	- BCD2
18	- BCD3
19	- BCD5
20	- EXT DP IN

**IC SUPPLY AND GROUND CONNECTIONS**

IC UNIT	TYPE	+5V <sub>A</sub>	+5V <sub>B</sub>	GND
U1	74C700	14		7
U2	74300	15		8, 13
U3	74LS00	14		7
U4	74C700	14		7
U5	4049	14		7
U6	4049	14		7
U7	4049	14		7
U8	4086	14		7
U9	4086	14		7
U10	4086	14		7
U11	4086	14		7
U12	4086	14		7
U13	74500	14		7
U14	745196	20, 24, 37	1, 13, 14	12
U15	7256	14		7
U16	74C774	4, 10, 12, 14		7
U17	74C774	4, 10, 12, 14		7
U18	PAL	20		10, 11
U19	10118	8		1, 16
U20	4680	8		1, 4, 5

Static Sensitive Devices  
See Maintenance Section

J Y K Y L Y M Y N Y P Y R Y S Y T Y U

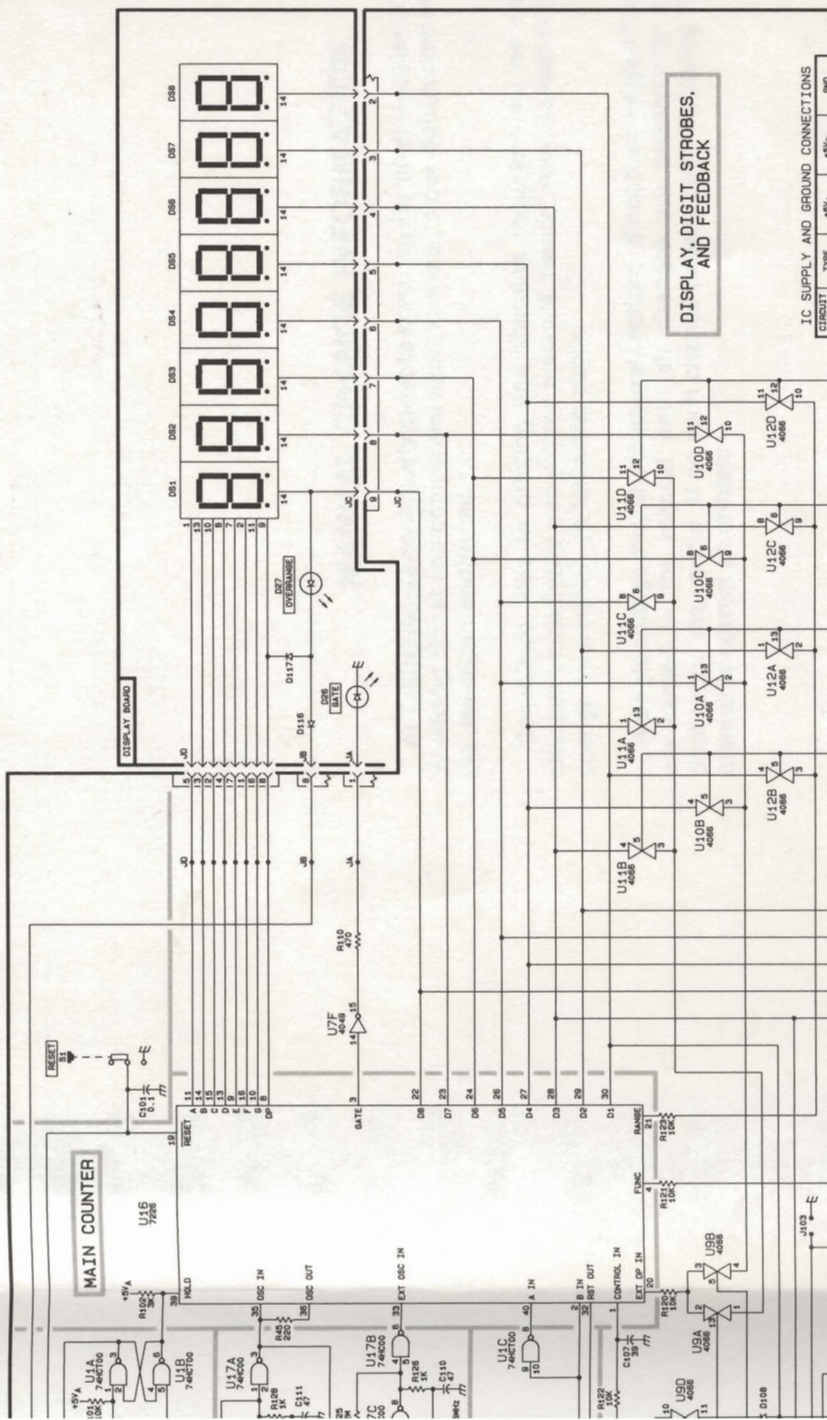

A B C D E F G H J K

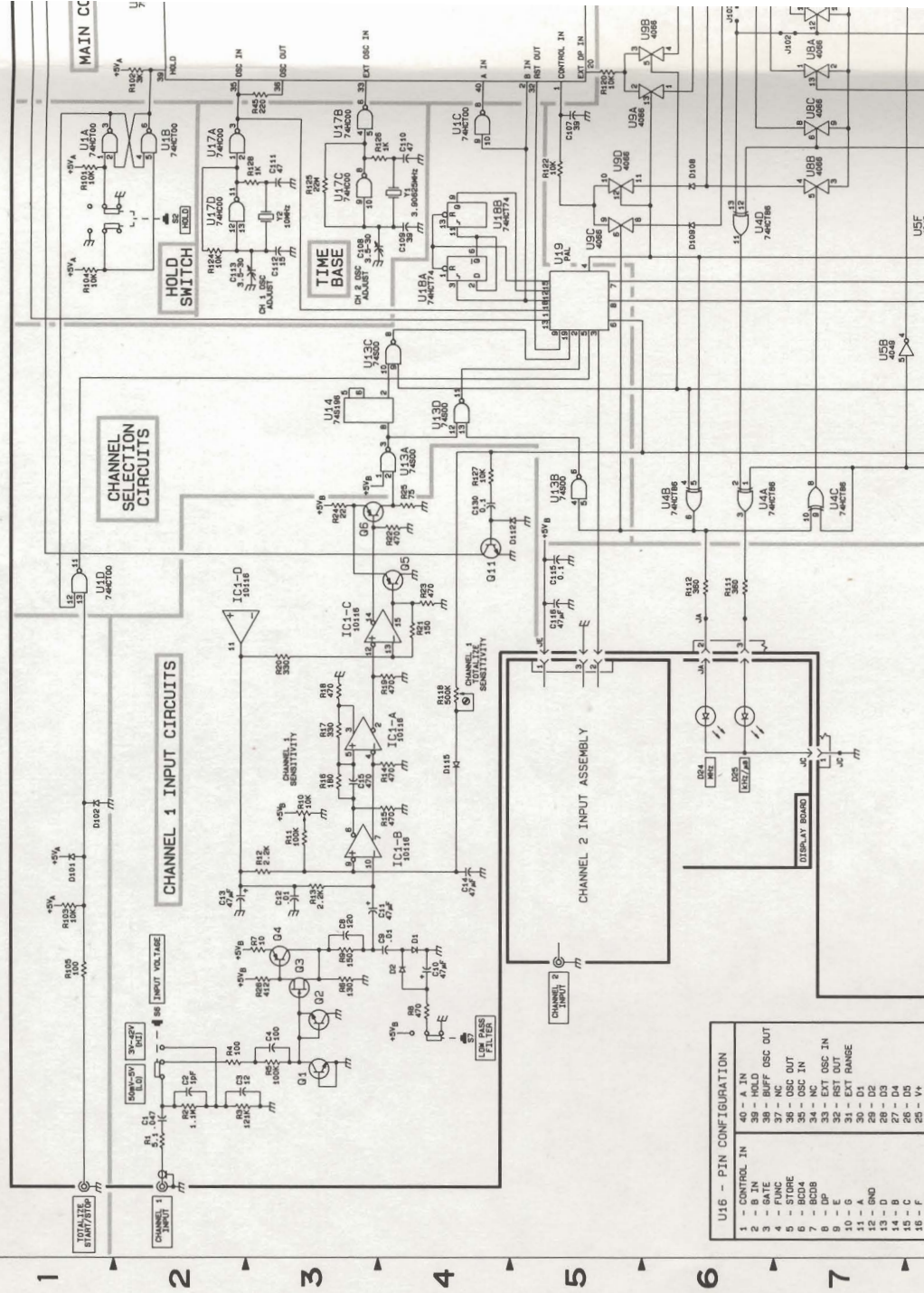

**U16 - PIN CONFIGURATION**

1	-	CONTROL IN
2	-	IN
3	-	RELD
4	-	FUNC
5	-	STORE
6	-	BCD4
7	-	OSC IN
8	-	OSC
9	-	EXT OSC IN
10	-	EXT RANGE
11	-	A
12	-	AND
13	-	D
14	-	B
15	-	C
16	-	V+

IC SUPPLY AND GROUND CONNECTIONS

CIRCUIT NO.	TYPE	+5V <sub>A</sub>	+5V <sub>B</sub>	800
U1	74ACT00	14		7
U2	4017	16		8, 13
U3	74LS00	14		7
U4	74ACT08	14		7
U5	4049	14		7
U6	4017	16		8, 13
U7	4049	14		7
U8	4086	14		7
U9	4086	14		7
U10	4086	14		7
U11	4086	14		7
U12	4086	14		7
U13	74LS00		14	7
U14	74LS198	25, 34, 37	1, 13, 14	7
U16	7226	25, 34, 37		12
U17	74C00	14		7
U18	74ACT74	4, 10, 12, 14		7
U19	PAL	20		10, 11
TC1	50118		1, 16	8
TC4	4860		8	1, 4, 5

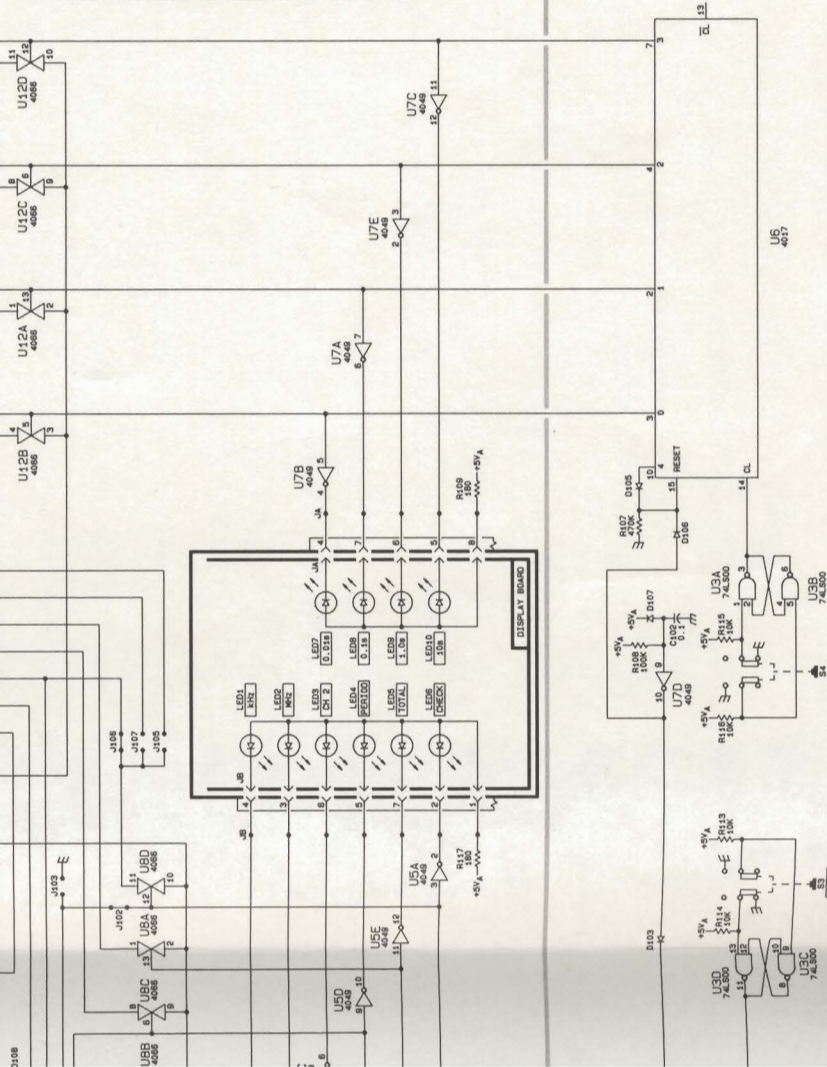

Static Sensitive Devices  
See Maintenance Section

MAIN BOARD

1.3 GHz FREQUENCY COUNTER 1

U16 - PIN CONFIGURATION	
1	- CONTROL IN
2	- A IN
3	- HOLD
4	- BUFF OSC OUT
5	- FUNC
6	- STORE
7	- BCD4
8	- BCD8
9	- E
10	- G
11	- A
12	- BNO
13	- B
14	- D
15	- C
16	- F
17	- BCD2
18	- V+
19	- RESET
20	- EXT DP IN
21	- RANGE

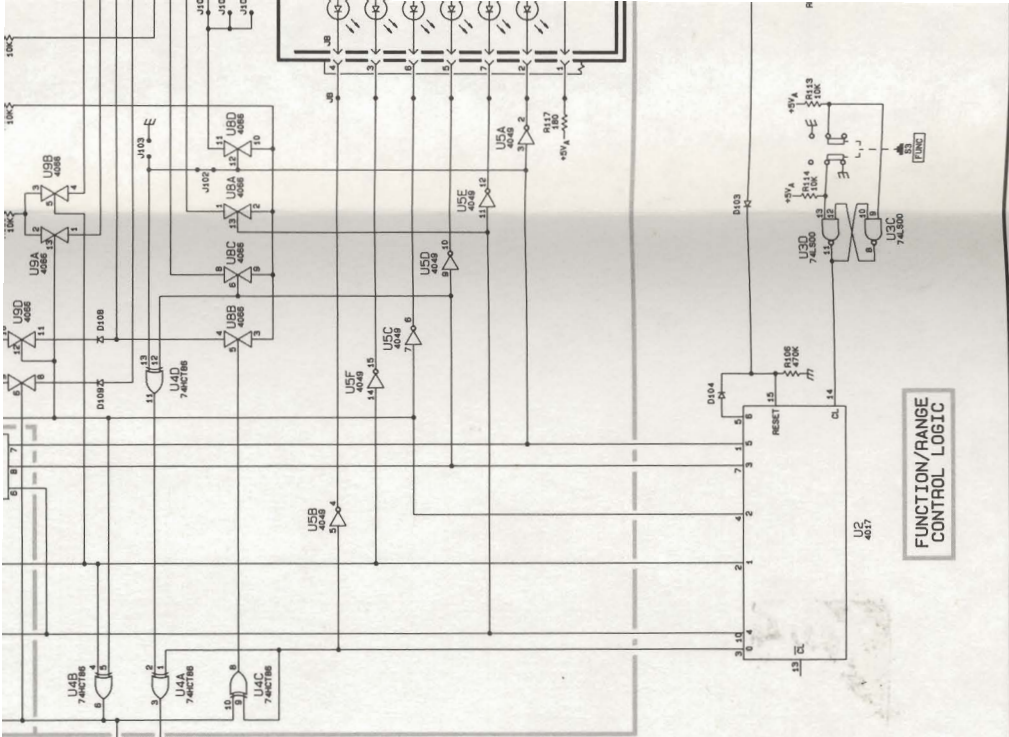

FUNCTION/RANGE CONTROL LOGIC

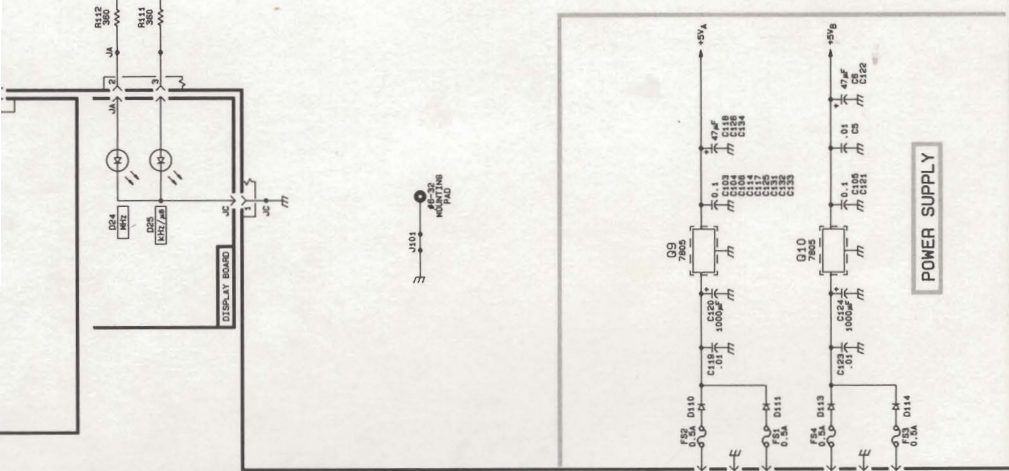

POWER SUPPLY

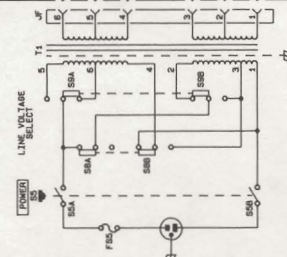

7841-01

CMC250

6 7 8 9 10 11 12