

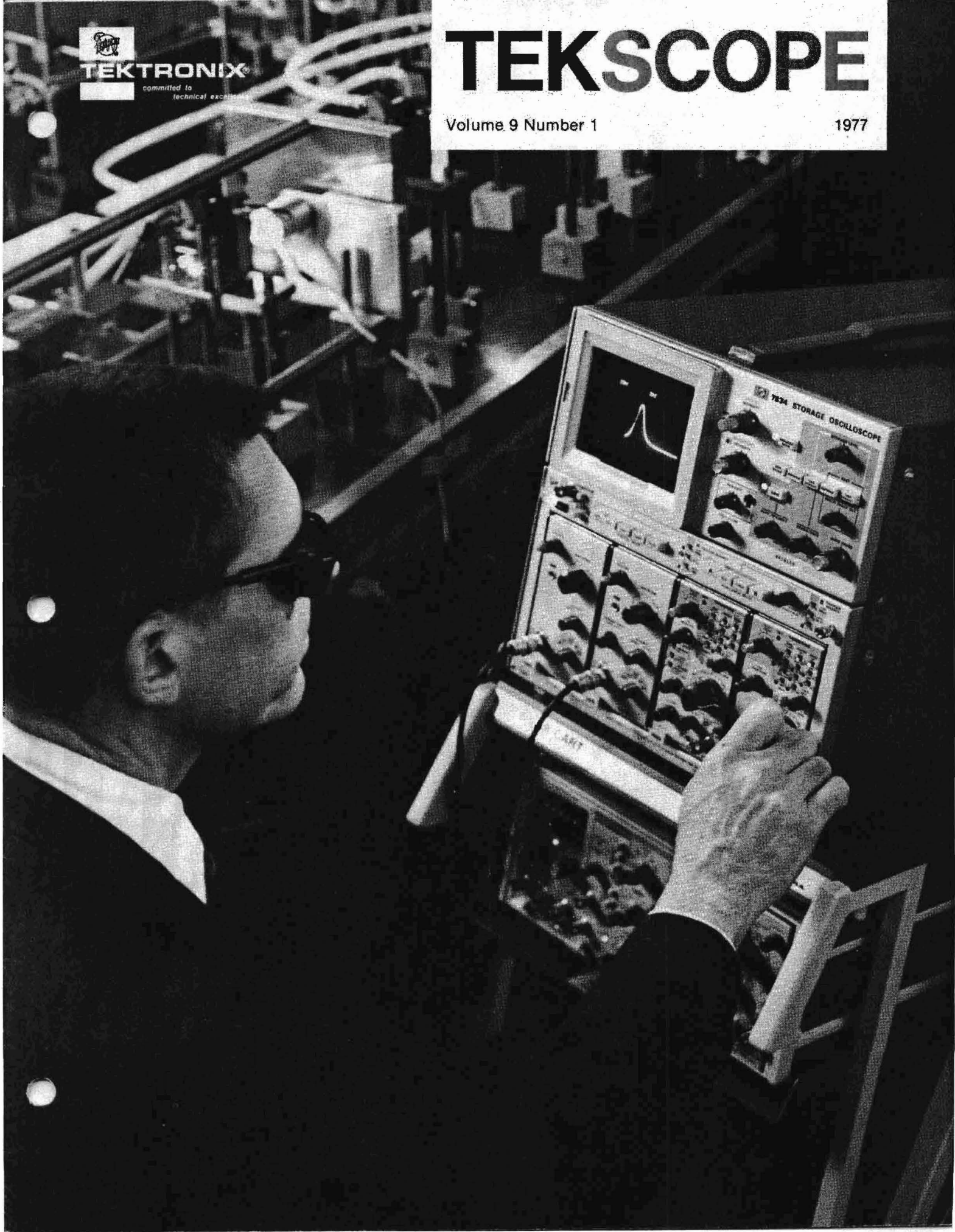

TEKSCOPE

Volume 9 Number 1

1977



TEKSCOPE



TEKTRONIX®

committed to
technical excellence

Customer Information from Tektronix, Inc.,
Beaverton, Oregon 97077

Editor: Gordon Allison

Contents

2 A big step forward for direct-view storage.

The new 7834 Storage Oscilloscope combines 400 MHz bandwidth and 2500 cm/ μ s stored writing speed in a four plug-in 7000 Series mainframe to bring you a new high in performance and versatility in a general purpose oscilloscope.

6 Counter and oscilloscope combination makes difficult measurements.

Selective counter measurements are easy to make using an oscilloscope with delaying sweep and dual trace algebraic add functions.

11 Testing three-terminal regulators with a curve tracer.

A 577/178 Curve Tracer provides an ideal answer to the need for performing short run incoming inspection tests, circuit design, or device characterization of three-terminal regulators.

14 Tektronix products get dirty, too!

Part II describes "dry cleaning" techniques for those users who can't release their instruments long enough for a thorough wash job.

Cover: Dr. Gail Massey of Oregon Graduate Center studies a YAG laser pulse stored and displayed on the 400 MHz 7834 Storage Oscilloscope.

Copyright © 1977, Tektronix, Inc. All rights reserved. U.S.A. and Foreign Products of Tektronix, Inc. are covered by U.S.A. and Foreign Patents and/or Patents Pending. TEKTRONIX, TEK, SCOPE-MOBILE, TELEQUIPMENT and  are registered trademarks of Tektronix, Inc. Printed in U.S.A.



Jerry Rogers



Ken Hawken

A big step forward for direct-view storage

State of the art direct-view storage takes a big step forward with the introduction of the TEKTRONIX 7834 Storage Oscilloscope. Up to now the maximum stored writing speed has been 1000 cm/ μ s in the 7633 plug-in oscilloscope and 1350 cm/ μ s in the 466 portable. Both are 100 MHz instruments.

The new writing speed mark is 2500 cm/ μ s, and it's coupled with 400 MHz bandwidth in the new 7834. This means you can now capture a 3.5 cm high, single-event risetime of 1.4 ns.

The 7834 is a general-purpose laboratory oscilloscope with all of the synergistic measurement power produced by the four plug-in capability of the 7000 Series. For example, real time and spectrum analyzer plug-ins can be housed to simultaneously present both time and frequency domain displays for a given signal. Using the 7834's variable persistence storage mode, a steady display of the time domain can be viewed while observing slow changes in the spectral content. In another configuration, logic analyzer and real time plug-ins can be combined to zero in on a logic fault and then display that fault in real time, even though it may occur only once.

Multimode storage

The 7834 features multimode storage—bistable, variable persistence, and fast modes for each, pioneered in the 7623 a few short years ago.

The bistable storage display is characterized by having two intensity levels—the stored-image intensity and the background level. There are two such modes: BISTABLE and FAST BISTABLE. The chief advantage of both of these modes is long view-time. Once an image is

stored, it can be viewed for an extended period. The BISTABLE mode is the simplest of all to use, with no adjustments for storage sensitivity other than the intensity control. Also, with a high resistance to blooming, this mode is unsurpassed for storing extremely low-frequency events that require a slow moving spot on the crt. This mode, therefore, can capture waveforms with extreme differences in spot movement speed. The chief limitation is writing speed. The FAST BISTABLE mode also is resistant to blooming and overcomes the low writing-speed limitation. It is the second fastest mode of the instrument, with a writing speed of 350 cm/ μ s in reduced scan, and is useful in capturing single-shot information.

Variable-persistence storage displays are characterized by controllable persistence (the rate at which the stored display fades). Typically, this rate of fading may be adjusted from 1 or 2 seconds to well over a minute. There are two such modes: VARIABLE PERSISTENCE and FAST VARIABLE PERSISTENCE. The chief advantage of these modes is high writing speed. When the storage controls are optimized, writing speed is many times greater than in the corresponding bistable modes. The storage controls may also be adjusted to provide high-contrast displays that are especially advantageous for photography. In both variable-persistence modes, view time (the length of time a stored trace is distinguishable from the background) is less than in the bistable modes, and is shortest of all when adjusted for highest writing speed. View time can be increased by using the SAVE mode as on other storage oscilloscopes.

The VARIABLE PERSISTENCE mode in the 7834 can convert a dim display of a fast, low-repetition-rate signal, into a bright, flicker-free display for easy viewing of signals that are beyond the display capability of non-storage instruments. By varying the persistence (or rate of fading), the best compromise can be reached between lack of flicker and ability to follow changes in the waveform.

The FAST VARIABLE PERSISTENCE mode provides the highest writing speed of all, 2500 cm/ μ s in reduced scan. This mode is most useful for capturing high-speed single-shot events such as fast rise pulses encountered in laser fusion research, destructive testing, and high speed computer development, that occur only once, or at very low rep-rates at best. The 7834 offers an unprecedented ability to display these pulses.

New operational features

The 7834 has several features not found on other storage oscilloscopes. These features add convenience and flexibility. For example, the MULTI-TRACE DELAY control extends the usefulness of the transfer-storage modes (FAST BISTABLE and FAST VARIABLE PERSISTENCE). When a time base operates in a repetitive

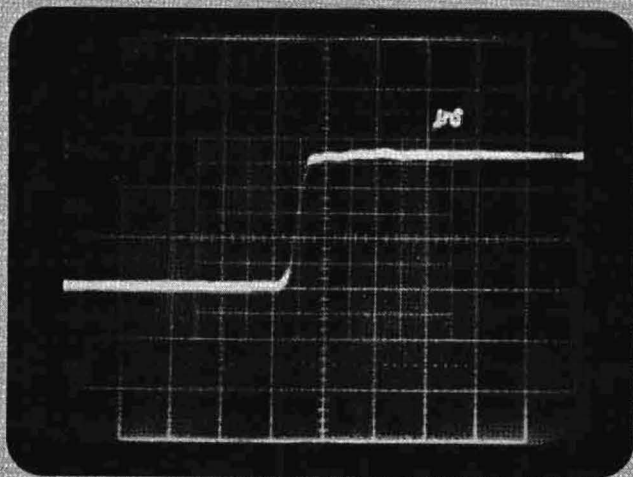

Fig. 1. Stored display of a single-shot, fast rise time signal.

manner (rather than single sweep), this control varies the display time between successive sweeps. An "infinite" position provides the same effect as single-sweep operation. One application of the multi-trace delay control is in making calibration adjustments. The operator simply sets the delay equal to the time required to change an adjustment. The new result is then automatically displayed (along with the old), freeing the operator from manually resetting the oscilloscope time base for each trace. Another application is to store a periodic waveform that occurs in a longer sequence of events. The multi-trace delay may be adjusted to blank out unwanted events and allow triggering only on the desired waveform.

The Remote-Storage inputs give the user control over several essential storage functions. With Remote Erase, Reset, and the new Remote Save inputs, the operator can conveniently conduct experiments at a distance from the oscilloscope, or control these functions automatically from other equipment.

A new Remote-Storage Gate input provides the user additional capability in the fast-storage modes. Use of this input, along with a second time base, permits capturing several closely spaced events on the same display, an ability not possible in fast-storage modes on previous instruments.

Two types of Auto Erase are available in the 7834. One is an adjustable periodic function that erases on a regular basis whether or not a stored display is present. The other type provides an adjustable display time after each stored event, and will not erase unless the time base has been triggered.

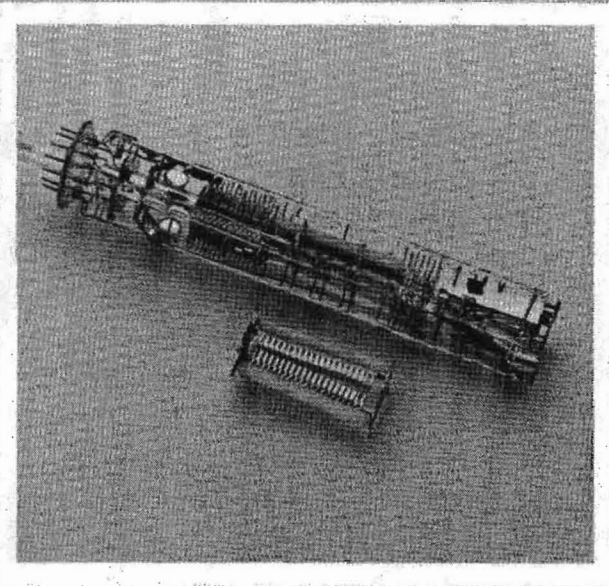

Fig. 2. Electron gun structure of the 7834 cathode ray tube. The vertical deflection structure, with the shield removed, is shown below the vertical deflection portion of the gun.

Gated or Free Run readout selection is located on the front panel. This feature is especially convenient when switching between storage (where Gated is often used) and non-storage operation (where Free Run is typically more desirable). Previously, the Gated/Free Run switch had been located inside the mainframe, requiring removal of a sidecover to change modes.

Fast X-Y storage is possible in the 7834 because of a horizontal-mode selector switch and the availability of two horizontal plug-in compartments. Previously, X-Y storage was possible only in the slower, or non-transfer, storage modes.

Cathode ray tube

Much of the 7834's advanced performance is achieved through extending the capabilities of the cathode-ray tube (crt) to provide multi-mode storage. Both bistable and variable persistence designs are incorporated into the crt. In addition, a new focusing structure and improved electron-gun design are used to reach the high stored writing-rate. Further, a more sensitive deflection system was needed to reach the 400-MHz design goal for the vertical system passband.

In designing the crt, we built upon the experience gained with the 7633 transfer-storage tube. Transfer storage is the technique whereby two storage meshes are used to capture and display information, especially fast transients.

The writing beam stores an image on a highly sensitive short-view-time target. The image is then transferred to the second storage mesh, which has lower sensitivity but much longer view times. This second mesh

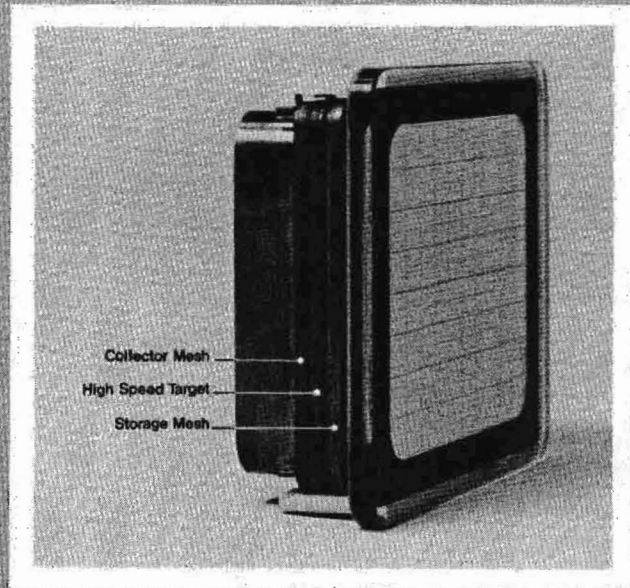

Fig. 3. A cutaway of the front portion of the 7834 cathode ray tube, showing the three-mesh structure used to achieve transfer storage.

can be operated in either a bistable or a variable persistence mode.¹

A number of performance improvements were required of the crt to be suitable for a 400-MHz storage oscilloscope. These include both improved gun design and storage uniformity.

The gun design changes include a traveling-wave deflection system similar to that used in the TEKTRONIX 7904 Oscilloscope, the deflection sensitivity is improved to 1.7 V/cm/kV (a 50% improvement over the 7633 crt). To obtain a faster stored writing speed, an improved gun system was designed to deliver greater charge density to the target. The gun voltage was increased to improve the secondary-emission yield at the target and to reduce the space charge spreading of the writing beam. Independent X- and Y- focusing systems were designed, together with a vertical-only scan expansion lens, to obtain the required vertical-deflection sensitivity. The new focusing system results in improved trace width for the same beam current. More sensitive horizontal plates were designed to help in obtaining faster sweep speeds. An overall improvement in gun performance of 2.5 times was realized.

Additional gain in writing speed was obtained by improving the background uniformity of the display. Since a trace that will store on one part of the target may not store on another part, the writing speed specifications are quoted for the slowest portion of the target within the display area. To this end, the flood-gun collimation system was computer designed to improve landing characteristics and consequently improve background uniformity. This typically reduced the ratio

between reduced scan and full scan variable persistence writing speeds from 8:1 to 6:1. Some performance gains over the previous fast-storage crt used in the 7633 are shown in Figure 4. This shows the typical writing speed expressed as tracewidths/second as a function of Intensity for the two fastest storage modes (variable persistence fast and bistable fast, in reduced scan). The reduced-scan mode of operation typically results in an eight-times improvement in writing speed over the full scan operation, due to the increased gun voltage and the reduced effect of target uniformity on writing speed. In the fastest mode, the writing speed approaches 10^{11} tracewidths/second. This compares with the photographic writing speed of the 7904. These stored traces are viewable for tens of seconds and are easily photographed.

Writing speed

Unless someone is very familiar with storage terminology, a writing speed specification may not be very meaningful except in a relative sense, where one storage oscilloscope is better than another. Therefore, a review of some basic storage concepts will better relate what the high performance of the 7834 does for your measurement needs. Writing speed is defined as the highest rate of spot movement on the crt face that will leave behind a stored image. Spot movement that is faster than writing speed will not leave an image, resulting in step response displays with no vertical edge, or sine wave displays with the center missing.

To be more precise, writing speed can be related to common waveforms by the equations:

$$(1) WS = \pi fA$$

$$(2) WS = \frac{kA}{T_r}$$

Equation (1) is for a sine wave of frequency, f , in megahertz, and peak-to-peak amplitude, A , in centimeters, yielding writing speed in $\text{cm}/\mu\text{s}$. Thus, a writing speed of $2500 \text{ cm}/\mu\text{s}$ will store a 250 MHz sine wave with 3.2 cm peak-to-peak amplitude.

Equation (2) describes writing speed in terms of the vertical edge of a pulse or step response. The value of k ranges from 0.8 for a linear ramp, to 2.2 for a single-pole response. A value of 1.0 applies to a Gaussian or typical step response. T_r is the 10-90% rise time in μs and A is the amplitude in cm, to yield writing speed in $\text{cm}/\mu\text{s}$. Thus, a writing speed of $2500 \text{ cm}/\mu\text{s}$ will store a 2.5 cm Gaussian step response with 1-ns rise time.

The 7834 achieves its maximum specified writing speed of $2500 \text{ cm}/\mu\text{s}$ in a reduced scan mode, with 0.45 cm divisions. Writing speed in divisions is calculated by dividing by 0.45; thus, a 3.2-cm sine wave will be 7.1 divisions peak-to-peak. In these relationships, horizontal movement is not taken into account. However, for beam movement of more than three vertical divisions

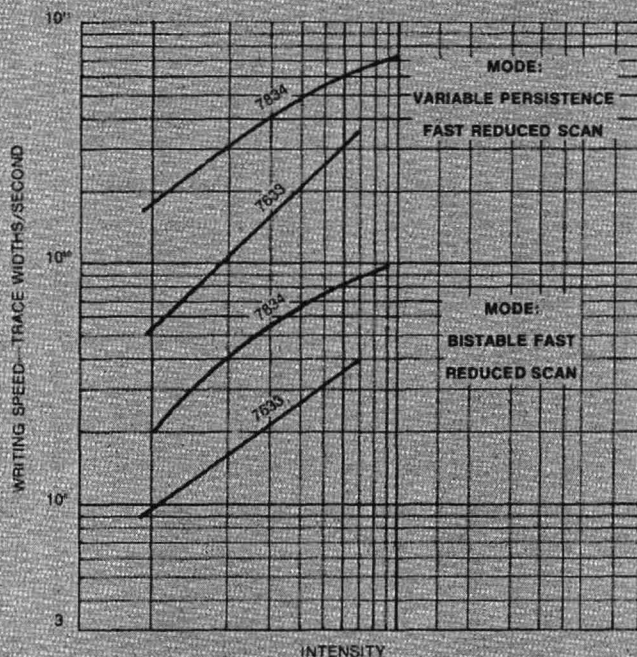

Fig. 4. Relative performance of the 7834 and 7633 Storage Oscilloscopes are shown in this graph of stored writing speed as a function of Intensity level setting.

for every horizontal division, the effect of horizontal movement is less than five percent, and can usually be neglected.

General design features

Construction of the 7834 is much like the modular 7704A. The instrument is divided into two main modules that may be easily separated for ease of service. Like other 7000 Series four-plug-in mainframes, the 7834 has a high-efficiency power supply. This supply runs cooler and is much lighter than a conventional regulated supply. It is also more immune to electro-magnetic interference through the power line. The 7834 circuitry is highly protected from overloads such as a spurious short between various crt electrodes.

Acknowledgments

Project Engineer Chuck Scott directed the 7834 design. Electrical design was by John Durecka, Dave Morgan, Joe Peter and Jerry Rogers. Mark Anderson did the mechanical design. Gene Andrews was Project Manager.

The 7834 CRT development was headed by Project Manager Pete Perkins who did the collimation studies. Ken Hawken was CRT Project Engineer and Steve Blazo did the new CRT gun design. Dave Coffey did the CRT Manufacturing Engineering.

Marketing planning was done by Dave McCullough, and Mike Hurley is the Marketing Program Supervisor. Dwayne Wolfe is Manufacturing Manager. 

¹ See Tekscope July 1972



Emory Harry

Counter and oscilloscope combination makes difficult measurements

Modern electronic counters are versatile, accurate instruments used in a wide variety of applications. However, many measurements are difficult or even impossible to make with conventional counters. Here are a few examples:

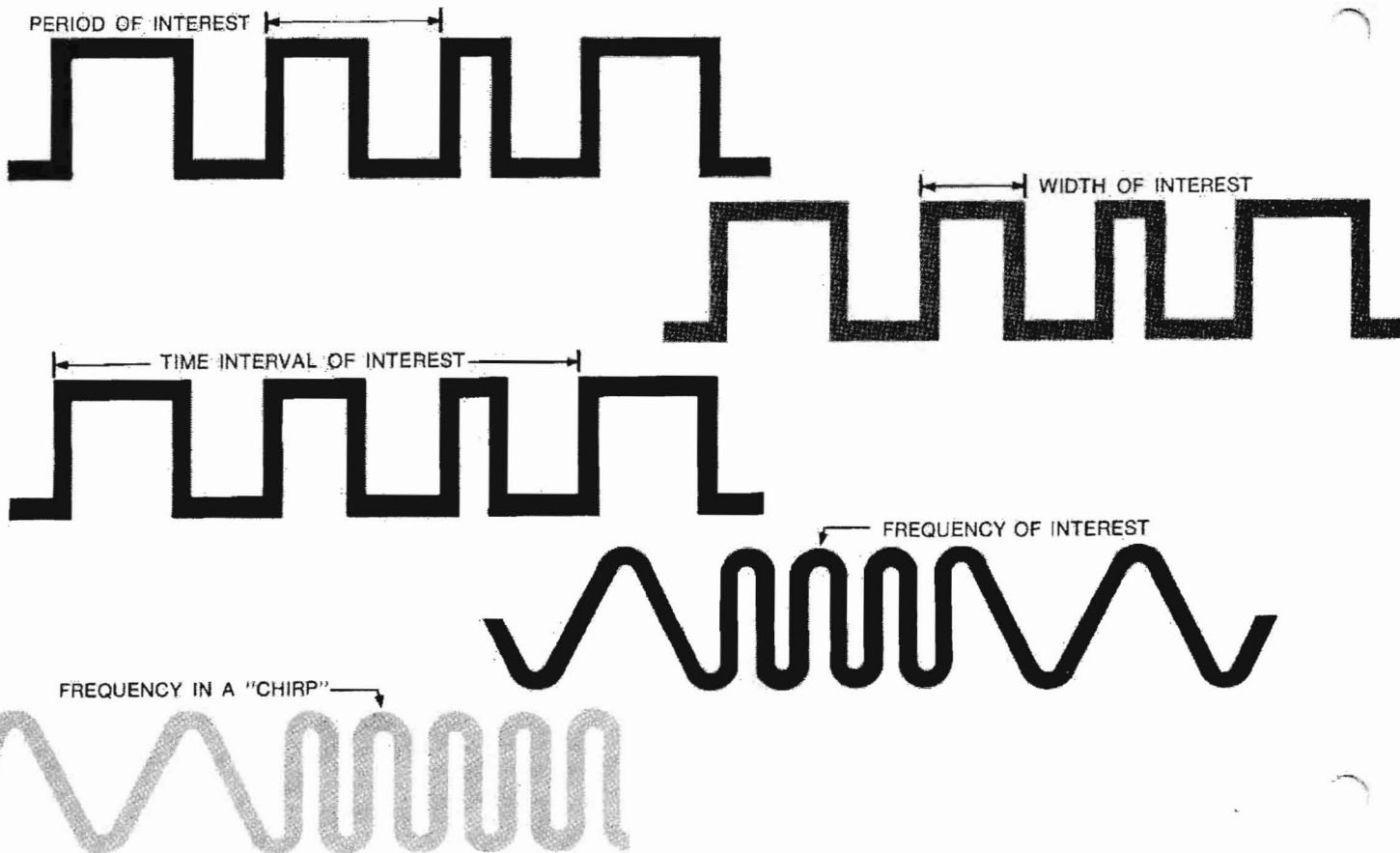

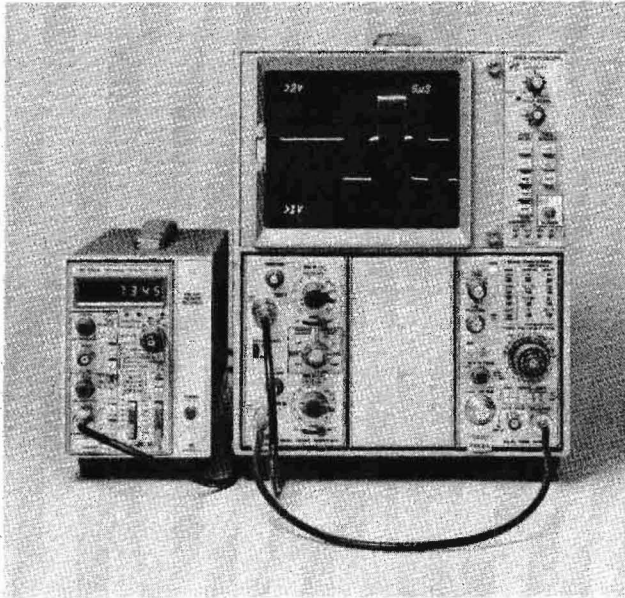

Fig. 1. A counter and oscilloscope set up to measure the width of the elevated pulse displayed on the oscilloscope crt.

In each example, the counter's trigger circuits cannot discriminate between the part of the waveform of interest and the part not of interest.

A few counters offer input gating that allows the input signal channel of the counter to be gated on and off with an external gate or control signal. This makes most of these difficult measurements possible; however, the appropriate gating signal is rarely conveniently available. A few counters offer Variable Hold-Off or Delay, which introduces a variable delay in the Time Interval mode, between when Channel A triggers and Channel B is permitted to trigger. This feature also makes some of these difficult measurements possible, but it can only be used in the Time Interval mode, and the approximate amount of delay required must be known.

Almost all of these difficult measurements can, of course, be made directly with an oscilloscope, but not with the same degree of accuracy a counter offers.

Counter and oscilloscope

A counter and an oscilloscope can be combined into a powerful measurement tool that can conveniently make these otherwise difficult or even impossible measurements. With the technique to be described, the counter can be made to measure any selected portion of the waveform displayed on the oscilloscope. Thus, the flexibility and visual verification offered by an oscilloscope is combined with the accuracy of a counter.

The technique involves summing or algebraically adding the portion of the waveform of interest with a pulse, so that the pulse creates a voltage pedestal upon which the portion of interest rides. With a portion of the waveform elevated, the counter's trigger threshold

VERTICAL SIGNAL OUTPUT

Mainframes	Bandwidth	Amplitude
7900 Series	140 MHz with 7A24 or 7A26 75 MHz with 7A18	500 mV/div into 1 M Ω 25 mV/div into 50 Ω
7700 Series	70 MHz with 7A24 or 7A26 55 MHz with 7A18	500 mV/div into 1 M Ω 25 mV/div into 50 Ω
7600 Series	75 MHz with 7A18	500 mV/div into 1 M Ω 25 mV/div into 50 Ω
7503/7504	55 MHz with 7A12	500 mV/div into 1 M Ω 25 mV/div into 50 Ω
7313/R7313	20 MHz with 7A18	500 mV/div into 1 M Ω 25 mV/div into 50 Ω
549	\geq 5 MHz with 1A1	1.5 V/div into 1 M Ω
544/546/547/ RM544/RM546/ RM547	15 MHz with 1A1	300 mV/div into 1 M Ω
535A/R535	5 MHz with 1A1	1.5 V/div into 1 M Ω
545A/B/ RM545A/B	\approx 20 MHz with 1A1	1.2 V/div into 1 M Ω

Fig. 2. TEKTRONIX oscilloscopes having delayed gate and vertical signal outputs suitable for this application.

(triggering level) can be set so that the counter triggers only on the desired portion.

If a Dual-Trace, Delayed Sweep Oscilloscope with a Vertical Signal Output and a Delayed Gate Output is used in conjunction with the counter, no other equipment is required. The Delayed Gate serves as the necessary pulse, the Dual-Trace Amplifier performs the summing function, and the Vertical Signal Output (a waveform identical to that displayed on the crt of the oscilloscope) is connected to the input of the counter. Figure 1 shows a 7603 Mainframe, 7A18 Dual-Trace Amplifier, 7B53A Delayed Sweep Time Base, and DC 505A Universal Counter/Timer in the described configuration. Figure 2 is a chart of TEKTRONIX Oscilloscopes with the necessary combination of features, and the bandwidth and amplitude of the Vertical Signal Outputs.

Making the measurement

The waveform, a portion of which is to be measured, is connected to Channel 1 vertical input of the oscilloscope and the controls are set for a stable display approximately two divisions in amplitude. The wide range of input amplitudes a laboratory oscilloscope can accept offers the added advantage of signal conditioning: amplifying or attenuating a waveform prior to being connected to the counter input.

With the waveform portion of interest displayed on-screen, the oscilloscope's Horizontal Mode switch is placed in the Intensified mode and the brightened portion of the trace is adjusted to intensify the portion of interest. The Delayed Gate Output, a pulse whose width and position relative to the oscilloscope trigger point is identical to the intensified portion of the trace,

is then connected to Channel 2 vertical input. The Vertical Mode switch is set to Channel 2 and the controls adjusted for a display two divisions in amplitude. Switching to the Algebraic Add mode, the two waveforms (the delayed gate and the input waveform) will now be summed and the combination will be approximately four divisions in amplitude as in Figure 1. If the delayed gate is positioned properly, the portion of the input waveform of interest will be elevated approximately two divisions.

The oscilloscope's Vertical Signal Output is now connected to the counter input and the counter's Trigger Level control is set so the counter triggers only on the elevated portion.

Setting the counter trigger level

If the counter has a DC Trigger Level Output, the trigger level can be set by monitoring this output with a DMM, setting it to the desired voltage level as read from the oscilloscope's crt. If the counter does not have a DC Trigger Level Output, the following technique will aid in setting the counter trigger level.

The amplitude of the voltage pedestal is lowered approximately 50% by adjusting the oscilloscope's Channel 2 Variable Volts Per Division control for a display about three divisions in amplitude. Adjusting the counter's Trigger Level control in the positive direction until the counter quits triggering, then in the negative direction until the counter just starts counting, or counts erratically, will set the counter to trigger on the positive-most portion of the input waveform. Now, returning the Channel 2 Volts per Division control to its original position (a four division display) will result in the counter triggering at the 50% point on the elevated portion of the waveform. This same technique can be used to set the counter's trigger level at other than the 50% point if desired.

Counter modes

Now let's consider making selected pulse or cycle measurements in the various counter modes available. Universal counters, as opposed to single function or frequency only counters, offer a variety of modes such as Period, Width, and Time Interval, as well as Frequency. Each mode requires that the width of the oscilloscope's delayed gate—the elevating pulse—be set a little differently.

Period

If a period measurement is to be made, the pedestal must be wide enough and so positioned in time that the entire period of interest is elevated as shown in Figure 3. In the Period mode, the counter will trigger at a point on the first positive or negative going slope, whichever is selected, and at the same point on the following slope of the same polarity.

Employing this technique, the Period mode can be used to measure frequency ($F = \frac{1}{T}$) when the frequency varies, or when it is a burst or chirp. In the Frequency mode a counter measures the average input frequency during the gate time. However, with this technique, frequency can be measured for as short a period as one cycle. The linearity of a swept frequency can even be measured cycle by cycle.

Width

If a width measurement is to be made, the set-up is the same as for a period measurement, except that the elevating pedestal must only be wide enough to elevate the width of interest as shown in Figure 4. The counter in the Width mode will measure the time between a point on the first slope of the selected polarity and the same point on the following slope of the opposite polarity.

Time interval

A counter that offers a Time Interval mode has two input channels and measures the time between when the first channel, Channel A, triggers and the second channel, Channel B, triggers. The slopes and trigger levels for each channel can be selected independently. In the Time Interval mode, Channel B is held off (not permitted to trigger) until A triggers; however, Channel B cannot normally be held off or prevented from triggering the next time the input waveform reaches its trigger level. With this technique, B can be held off as long as required to permit the counter to measure the time between any desired points on the input waveform. Unlike the Period and Width modes, the width of the pedestal or elevating pulse is adjusted to be slightly narrower than the time interval of interest. As shown in Figure 5, the A trigger level is set to trigger just as it was in the Width or Period modes, but the B trigger level is set below the level of the pedestal. Therefore, B will not trigger until the elevating pulse has returned to the lower level and the input waveform passes through the B trigger level. B can be held off or prevented from triggering as long as desired by increasing the width of the pedestal.

Small variations in pedestal width should cause no variation in counter reading if the pedestal is properly positioned. If the counter display varies directly with pedestal width, an erroneous reading is being obtained.

The two input channels can be connected to a single waveform or to two separate waveforms, and a portion of either waveform can be selected and elevated. A portion of each of two waveforms can also be elevated and thereby selected, however, this would require an additional pulse and summing amplifier.

Frequency

Making frequency measurements directly is not practical using this technique because the counter's gate and

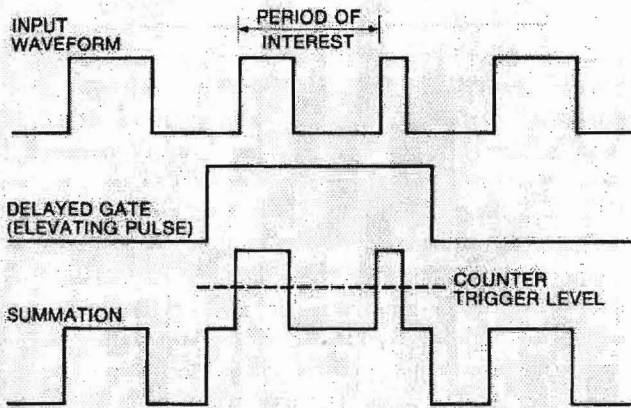

Fig. 3. In period measurement, delayed gate width must be wide enough to elevate entire period of interest.

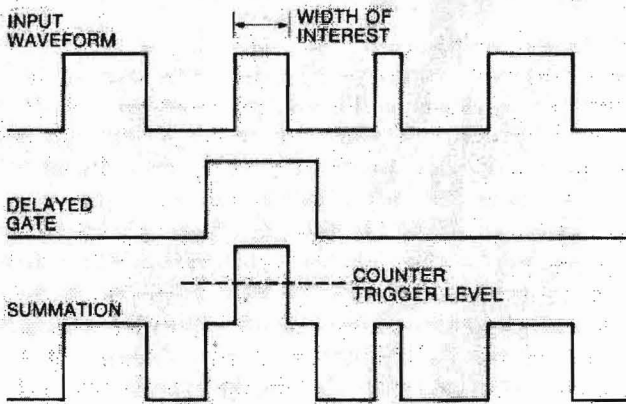

Fig. 4. Delayed gate set properly for width measurement.

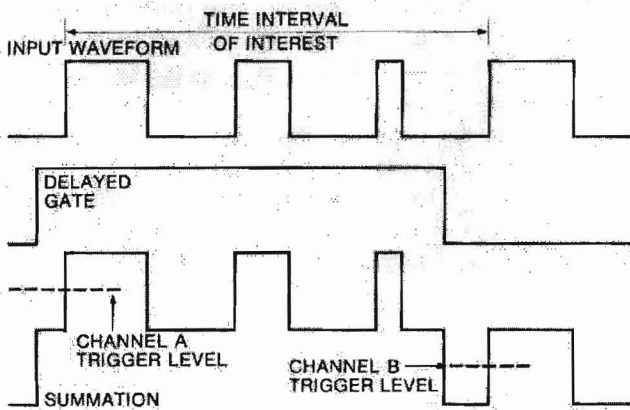

Fig. 5. For time interval measurements, delayed gate is set slightly shorter in duration than time interval to be measured.

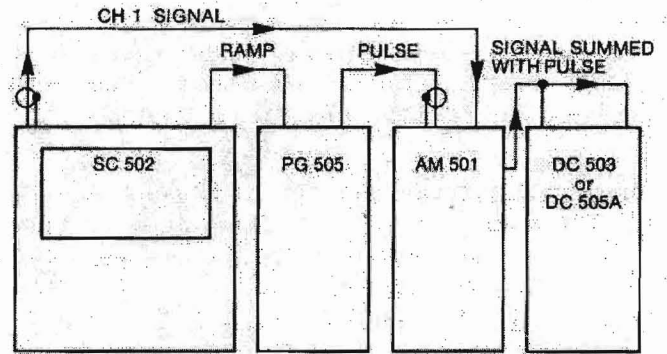

Fig. 6. TM 500 Series configuration for making gated counter measurements with a non-delayed sweep oscilloscope. The AM 501 performs the summing function normally provided by the oscilloscope.

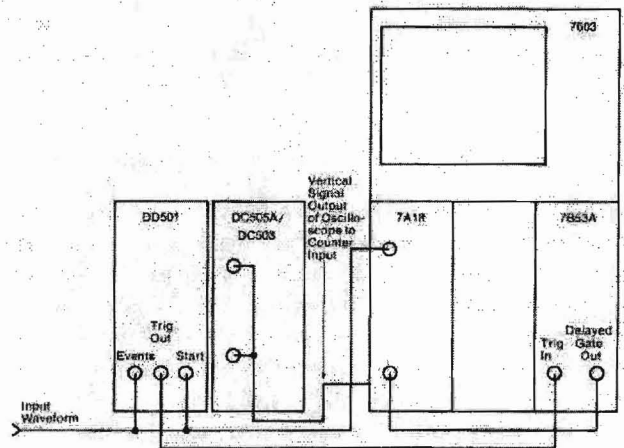

Fig. 7. The DD 501 Digital Delay simplifies trigger selection when delaying the triggering of the counter for several pulses or cycles.

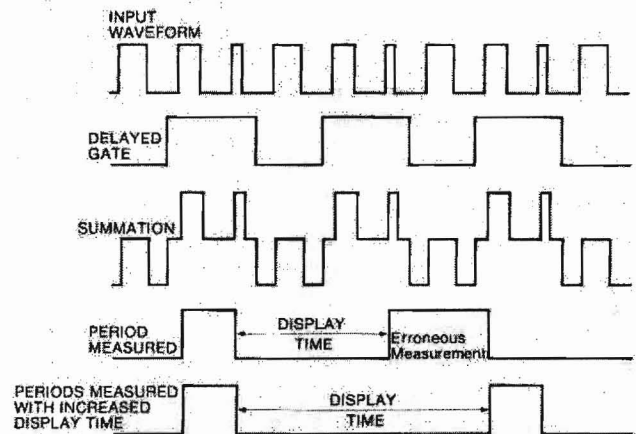

Fig. 8. Erroneous readings can occur at some display time settings. If the counter readout is erratic or too large a number, increase the display time with the Display Time Control.

the elevating pulse would have to be synchronized. Frequency measurements can be made, as mentioned earlier, in the Period mode, and, because frequency is the reciprocal of time, the conversion is simple.

Averaging

In the Period, Width, and Time Interval modes, it is often desirable to average to achieve the desired accuracy. If the counter offers Width Averaging and Time Interval Averaging, it is simply a matter of switching to that mode. The counter will accumulate readings in decade multiples and average them. No change in the procedure for a single Time Interval or Width measurement is necessary. For period averaging, however, an alteration to the technique is necessary. In period averaging, the number of periods to be averaged must all be elevated. To average 10 periods, 10 or more successive or continuous periods must be elevated. To average 100 periods, 100 or more successive or continuous periods must be elevated. A larger number of averages can be selected, but since the purpose of this technique is to make a selective measurement of a small portion of a signal, it is unlikely that higher averaging factors will be commonly used in the Period mode.

Using a non-delayed sweep oscilloscope

If a Non-Delayed Sweep Oscilloscope is used, a separate pulse generator with delay, like the TEKTRONIX PG 505 or PG 508, must be incorporated to generate the necessary pulse. The pulse generator must have delay so its output can be positioned in time relative to the input waveform.

If the oscilloscope does not have an Algebraic Add mode, a separate amplifier like the AM 501 can be incorporated to serve this function.

The TM 500 product line provides an ideal solution to the problem. Figure 6 is a diagram showing the SC 502 Non-Delaying Sweep Oscilloscope, PG 505 Pulse Generator, AM 501 Amplifier, and either the DC 503 or DC 505A Universal Counter/Timer with the appropriate interconnections in the TM 500 Mainframe. This particular system is usable from dc to between 50 kHz and 100 kHz, limited by summing amplifier bandwidth and pulse generator rise times.

Digital delay

When it is necessary to delay the triggering of the counter for a large number of pulses or cycles, it can become impractical due to the limited resolution offered by the crt of an oscilloscope, even with a magnifier. For example, it would be almost impossible to position the pulse or pedestal on the one thousandth input pulse to measure its period, width, or time interval. Even with a times ten magnifier, there would be ten input pulses or cycles per division on the crt. The DD 501 Digital Delay solves this problem. It can delay by up

to one hundred thousand events and generate a trigger at the selected number of events.

When the DD 501 is used with this technique, it is connected as shown in Figure 7. The input signal is connected to the DD 501 Start and Events inputs and the input of the oscilloscope. The output of the Digital Delay is connected to the External Trigger input of the oscilloscope, and the appropriate number of events, pulses, or cycles to be delayed is dialed up on the DD 501 front panel. The counter is driven by the summed pedestal and signal from the scope vertical output or by a separate summing amplifier. When the selected number of events takes place, the DD 501 puts out a trigger that triggers the scope and the delayed gate. A faster oscilloscope sweep speed can now be used, which offers enough resolution to position the elevating pulse.

If it is necessary to delay by time, the counter's time base output can be connected to the DD 501 input. The counter's time base acts as a clock that the DD 501 counts.

Erroneous reading

Some ranges of input repetition rates can cause an oscilloscope to trigger on different pulses on each sweep, however, this can be corrected with Trigger Hold-off if the oscilloscope has this feature, or with the Variable Time Per Division if it does not. In either case the basic repetition rate of the oscilloscope's sweep generator is changed so that the oscilloscope triggers at the same point or on the same pulse for each sweep. With the technique described in this note, it is possible to have essentially the same problem with a counter. The counter has a measurement cycle time or repetition rate which is determined by the length of time it takes to make the measurement, plus the display time. As shown in the period measurement in Figure 8, if the counter's measurement cycle time results in the display time ending in the middle of the period to be measured, an erroneous period measurement results. And the same thing can occur in the Width or Time Interval modes. The indication is an erratic reading or a reading that is too large. The fourth waveform from the top in Figure 8 shows an erroneous, too long, period. To correct the problem, the counter's display time is increased with the Display Time Control as shown in Figure 8. The counter now has a slower repetition rate or longer measurement cycle time and does not reset in the middle of the period, width, or time interval to be measured.



Ralph Livermore

Testing three-terminal regulators with a curve tracer

The increasing cost of on-board three-terminal regulators has created a need for a fast and easy means of testing these devices. Many of you already possess that capability and may not realize it.

The Tektronix 577-D1 Storage Curve Tracer and 178 Linear IC Test Fixture provide the basic capability. All you need to add is the Three-Terminal Regulator Test Unit—a plug-in accessory for the 178—plus a socket adapter for your particular device, and you're in business. It's an ideal solution for short run inspection, circuit design, or device characterization.

The Regulator Test Unit comes in two similar models—one wired for negative regulator devices and one for positive units. Each slides into the 178, which is itself a slide-in module for the 577. A snap-on escutcheon plate customizes the 178 function switch to either positive or negative test units.

Functionally, the 577 Mainframe supplies the display and its controls, primary power supply, and a step generator that serves as a variable load. The 178 further

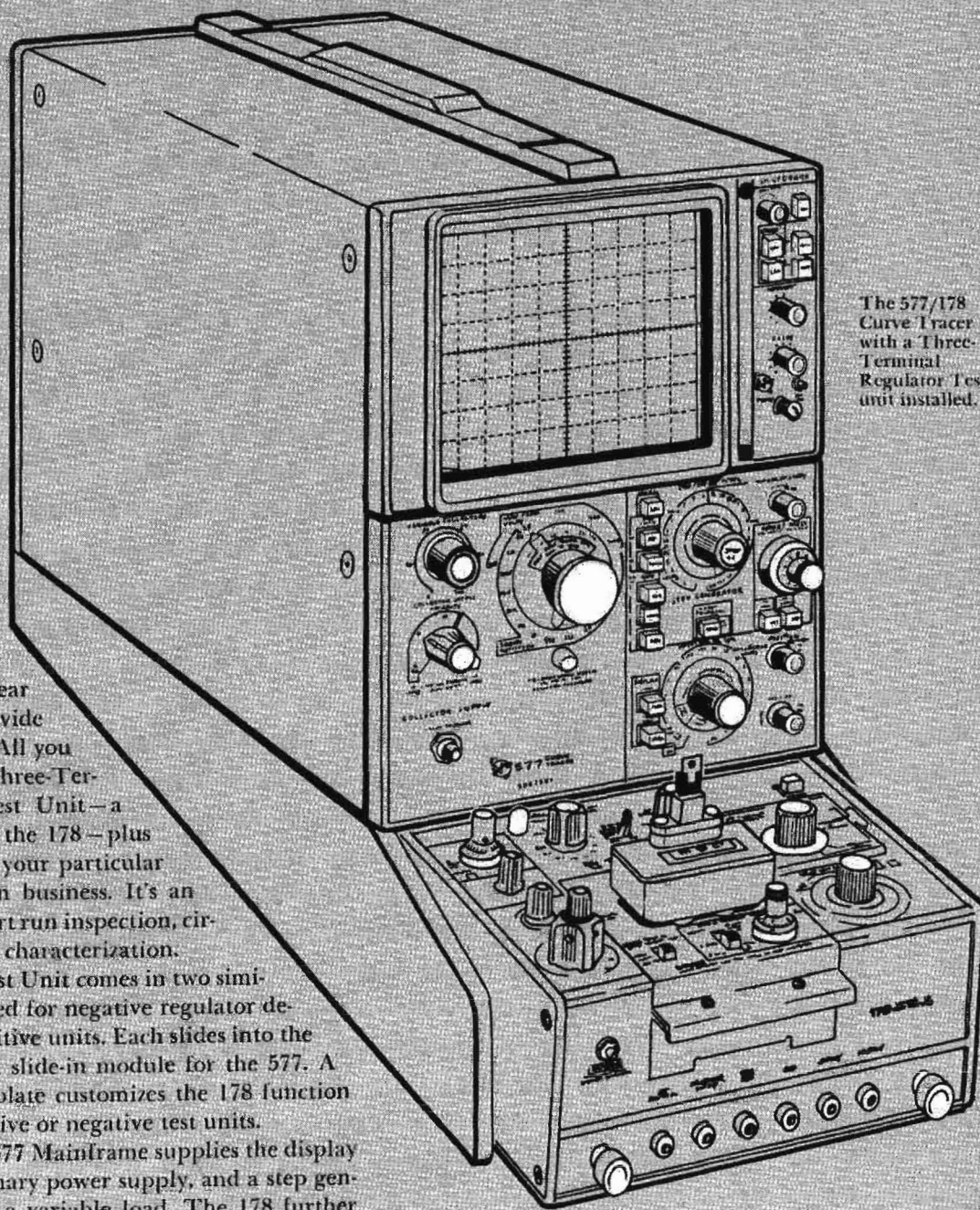

The 577/178 Curve Tracer with a Three-Terminal Regulator Test unit installed.

regulates the supply voltages and provides the function selector switch, which sets up the internal circuits for the appropriate tests. The 178 also has provision to sweep the input supply voltages at a selected rate and amplitude for line regulation and other tests.

Four basic tests on three-terminal regulators can be performed on the 577/178: load regulation, line regulation, quiescent or common current, and dropout voltage. A fifth test, ripple rejection, can also be performed, depending on how it is specified. The devices can be tested over an input range of 0 to 60 volts, with load currents up to 2 amperes (pulsed).

Load regulation

Load regulation is the change in regulator output voltage over the specified range of load current, with provision made to keep chip temperature constant.

This test is done on the curve tracer using the step generator as a current sink or variable load. The step generator is operated in the pulse mode to provide a load that is active for only a small part of the duty cycle, thus keeping chip dissipation low and possible temperature rise small.

The display in Figure 1 shows the change in output voltage (vertical axis) as the load current is stepped over the specified range (horizontal axis). In Figure 2 the vertical sensitivity has been increased to improve the resolution of the measurement. The Output Voltage Comparison Dial is set so the trace crosses the bottom graticule line precisely at the rated load current point. The change in output voltage is then easily determined by multiplying the VERT UNITS/DIV setting by the indicated change in output voltage on the vertical axis.

Line regulation

Another important specification we need to check is line regulation—the change in regulator output voltage over a specified range of input voltage—with provisions made to keep the chip temperature constant.

The curve tracer provides the necessary test conditions by adding a swept voltage to the input voltage supply, while providing a constant, short duty-cycle load for the output.

In the display in Figure 3, the vertical axis represents regulator output voltage deviation from the comparison voltage, and the horizontal axis represents regulator input voltage.

Line regulation characteristics at different values of load current can be checked by setting the step generator to step through the desired range of load currents as in Figure 3.

Quiescent or common current

A third characteristic often of interest to the circuit designer is the current used by the regulator for its in-

ternal functioning. It is called quiescent or common current. The regulator test unit uses a common-terminal supply to produce an artificial ground through which the device-under-test quiescent current is measured.

The curve tracer can display quiescent current under three different conditions: steady state, with constant load and line (input) voltage change, and with constant input voltage and changes in the load. Changes in input voltage are provided by the sweep generator on the 178 Linear IC Test Fixture. Load changes are produced by using the 577 step generator in the current-sinking mode.

The display in Figure 4 plots quiescent current on the vertical axis, versus load current on the horizontal.

Dropout voltage test

The fourth characteristic of interest that can be checked with the 577 Curve Tracer is dropout voltage. The dropout voltage test is similar to the line regulation test except, in this instance, we are concerned with the minimum input voltage at which the regulator no longer regulates. Figure 5 is an illustration of the dropout voltage test. The input-output voltage differential at which the circuit ceases to regulate is dependent upon load current and junction temperature, and is typically two volts.

Ripple rejection test

Ripple rejection tests can also be performed on the curve tracer as displayed in Figure 6. The supply voltage is swept at a frequency just below 120 Hz to produce the display. Each trace represents a different load current as presented by the step generator. Storage is a necessity in achieving this display since it takes about a second to produce.

Conclusion

The 577-D1 Storage Curve Tracer with a 178 Linear IC Test Fixture and Three-Terminal Regulator Test Unit provides a low-cost, versatile means of performing incoming inspection tests, circuit design, or device characterization of three-terminal regulators. Most of the specified tests can be performed. The 577 also serves as a valuable analytical tool to evaluate those devices rejected by highly automated incoming inspection systems, and to analyze performance under operating conditions other than those specified on the spec sheet. 

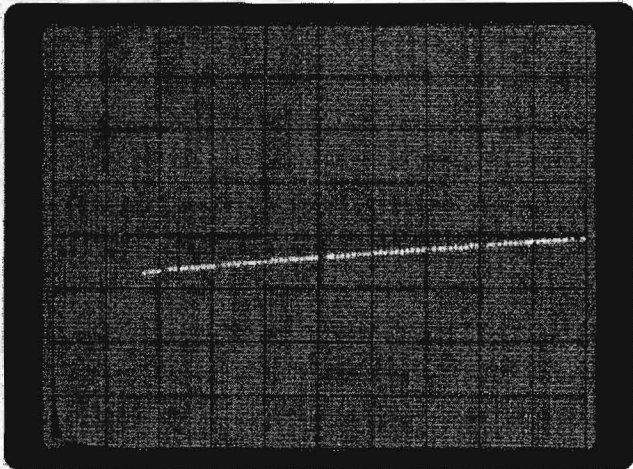

Fig. 1. Load regulation test. Output voltage displayed vertically at 50 mV/div, offset to +5V; load current displayed horizontally at 20 mA/div.

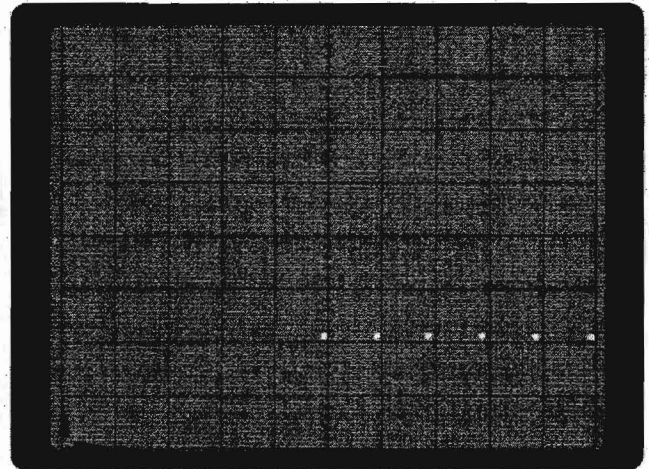

Fig. 4. Quiescent current test. Quiescent current displayed vertically at 2 mA/div, zero current at center-screen; load current displayed horizontally at 100 mA/div.

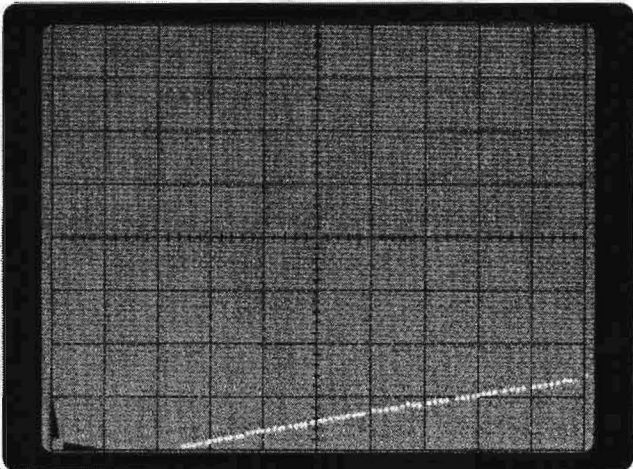

Fig. 2. Same measurement as Fig. 1, except vertical sensitivity increased to improve resolution, and trace moved to bottom of screen for easier reading.

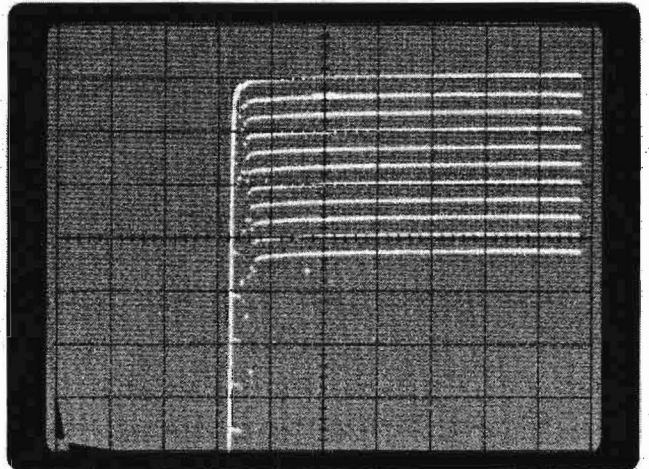

Fig. 5. Dropout voltage test. Output voltage displayed vertically at 10 mV/div, top trace is offset to 5V; input voltage displayed horizontally at 2V/div.

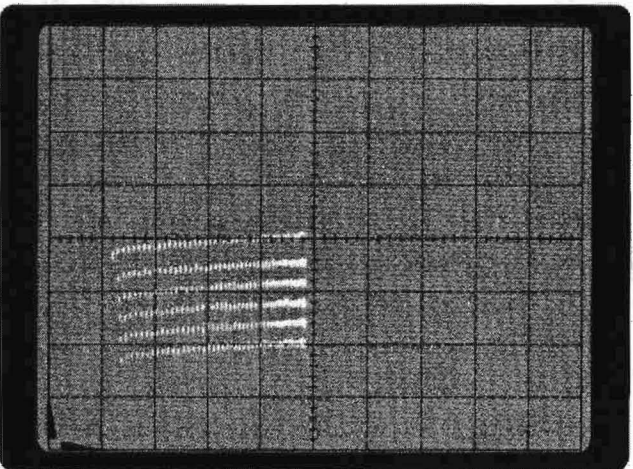

Fig. 3. Line regulation test. Output voltage displayed vertically at 5 mV/div; input voltage displayed horizontally at 5V/div, load currents are 100 mA/step.

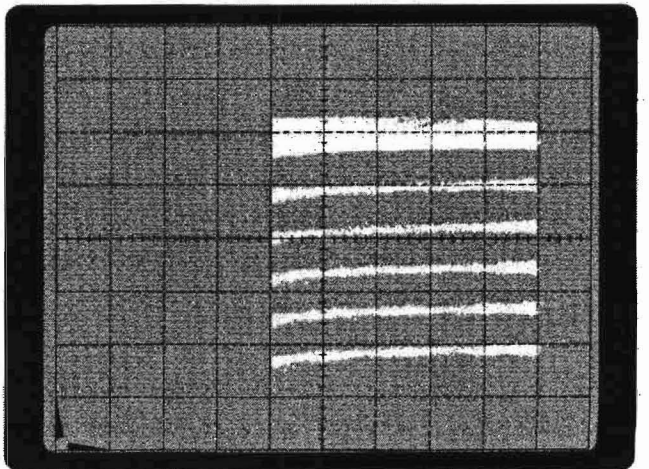

Fig. 6. Ripple rejection test. Output voltage displayed vertically at 5 mV/div; input voltage displayed horizontally at 2V/div; load currents are 100 mA/step. Rejection is about 76 dB.



Charles Phillips

Servicescope

Tektronix products get dirty, too!

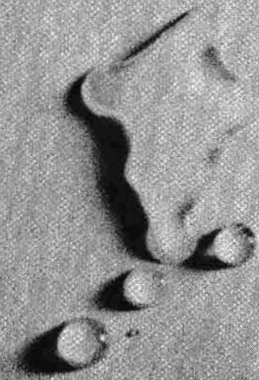

Part II—Dry cleaning

In Part I of this article we described the tools and techniques used to give your Tektronix instrument a bath, or perhaps "shower" would be a more appropriate term. There are times when the customer needs quick turn around on an instrument and can't tolerate the 24-hour drying time needed for a wet wash. In this instance, dry cleaning may serve as a reasonable alternative.

The wash booth makes a convenient place to perform the dry cleaning operation. With the side and bottom panels removed, compressed air and a small paint brush will remove most of the interior dust, unless the instrument has been in a greasy environment.

To clean the front panel you should reinstall the side covers and lightly spray the front panel only, using the 5% Kelite solution and rinsing with water. Be careful not to get excess water in the instrument. Just a little spray applied on an angle works best.



Use a toothbrush and detergent to clean the knobs and connectors, and rinse with warm water. The side covers can be removed and, along with the bottom panel, be washed separately after removing the instrument from the booth. They should be placed in the oven to dry. Compressed air is used to remove as much water as practicable from the front panel area, and the instrument is then placed in the oven for 15 to 20 minutes, or until you're ready to work on it.

The graticule and graticule cover may be cleaned as described in Part I. A word of caution regarding the use of glass cleaner—some leave a static charge on the graticule, which will distort the crt trace until it bleeds off. Soap and water is the best solution.

Air filters can be cleaned easily with detergent and hot water. A cleansing powder, such as Ajax, sprinkled on a wet filter and allowed to soak a minute or two, will help on extra greasy ones. We recommend not using oil or filter coat on any filters as there is the possibility of oil getting inside the instrument.

Cleansing cam switches

Unless you are having problems with the cam switches in the instrument, we do not recommend removing the switch covers during the cleaning procedure. You should also take care not to spray detergent into the switches.

If a cam switch needs cleaning, this can best be accomplished by removing the switch cover and spraying the switch with a 5% solution of Kelite spray white with an equal amount of ammonia (non-sudsing, non-soapy type). The switch should then be thoroughly rinsed with soft or distilled water. The switch contacts should then be sprayed with isopropyl alcohol, let set for 60 seconds, and blown out with compressed air. Occasionally operate the switch in all positions while the alcohol is still on the contact area, and while blowing out the instrument. Oven dry in the usual manner.

Cam switches need no lubrication as the switch pads are designed to operate dry for the life of the instrument.

Conclusion

Whether you wet wash or dry clean an instrument will be determined by how dirty the instrument is, and the time available to do the job. Solid state instruments can be washed as easily and safely as vacuum tube types. Precautions against spraying detergent and water directly on power transformers and covered cam switches should be diligently observed. Cleaning agents such as

trichlorethylene, Freon, and others containing halogens, should not be used. They can damage aluminum electrolytic capacitors and some printed circuit board materials used in critical applications.

It takes valuable time to properly clean an instrument. However, the improvement in maintainability and the increase in user satisfaction makes the investment a worthwhile one. 

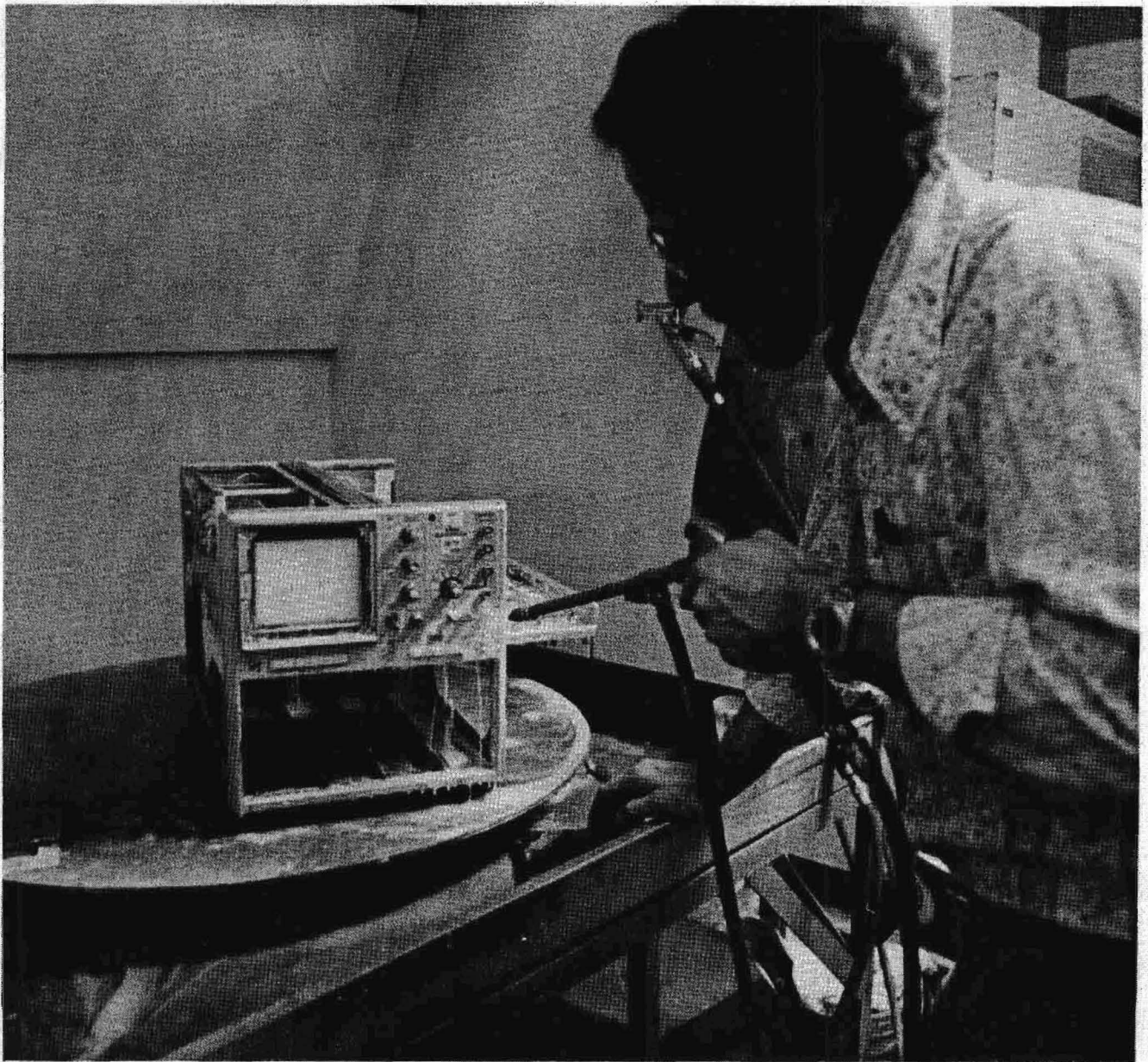

Fig. 1. Dave Phillips, Factory Service Center, washes a 7000-Series Oscilloscope.

Customer maintenance training classes for '77

All classes will be conducted at Beaverton, Oregon. There is no fee for classes except as noted.

All maintenance classes teach operation, signal flow, calibration, trouble-shooting and repair of the representative instrument. A combination of lecture and lab sessions are the usual format for maintenance training. Any prestudy literature besides maintenance manuals will be mailed directly to you.

7704A/7904/7633

The 7000 series classes are a combination of the 7704A/7904/7633 oscilloscopes. The prerequisite for the 7904/7633 class is training on the 7704A. Class duration is two weeks, first week devoted to 7704A, second week devoted to 7904/7633. Plug-ins taught are representative of the most frequently purchased units with these main frames.

Class dates: June 13-24, 1977
Aug. 8-19, 1977
Oct. 17-28, 1977
Dec. 5-16, 1977

465/475

The 465/475 oscilloscopes maintenance class is taught to the component level of troubleshooting and repair. The student is encouraged to study the circuit description portion of the respective manual. Class duration is one week.

Class Dates: June 27-July 1, 1977
Aug. 22-26, 1977
Oct. 31-Nov. 4, 1977

5100/5400

The 5100/5400 oscilloscopes are new products on the 1977 customer training schedule. Representative plug-ins are selected for these products. Class duration is one week.

Class dates: July 11-15, 1977
Nov. 7-11, 1977

Logic Analyzers

The 7D01/DF-1 logic analyzer is a new product on the 1977 customer training schedule. The prospective student is encouraged to study the circuit description in the 7D01/DF manual. Class duration is one week.

Class date: Sept. 12-16, 1977

TM503/DC503/DM502

TG501/PG501/FG501

The TM500 products selected for instruction represent each of the major categories in the Test and Measurement area. Class duration is one week.

Class dates: June 6-10, 1977
Aug. 1-5, 1977
Oct. 10-14, 1977

WDI—R7912/1350

The student must have operational knowledge of the 7704A series oscilloscope; he also must have satisfactorily completed study of the Audio Circuit description training program on the R7912. This package (062-2708-00) is available for \$175.00 through the local Tektronix field office; it should be ordered at least 60 days prior to class participation as the subject material is quite lengthy. Class duration is one week. A class fee of \$700 per student is charged for this training.

Class dates: July 11-15, 1977
Oct. 3-7, 1977

DPO—P7001/CP1151

No customer maintenance classes are scheduled for 1977. An audio circuit description training package is available for \$185.00 through your local Tektronix field office. Part number (062-2707-00)

4051/4631

The 4051 intelligent terminal is a new product on the 1977 customer training schedule. Understanding of microprocessor is necessary for full appreciation of class content. Class duration is two weeks.

Class Dates: June 20-July 1, 1977
Dec. 5-16, 1977

4010/4014/4631

The 4010/4012/4014/4006 graphic display terminal class is taught to board level maintenance; greater depth is taught when signal flow concepts are necessary. Class duration is one week.

Class Dates: June 6-10, 1977
Oct. 3-7, 1977
Nov. 7-11, 1977

4081/4905/4641

The 4081 intelligent terminal system is a new product on the 1977 customer training schedule. Understanding of microcomputer and microprocessor theory is necessary for full appreciation of class content. Class duration is two weeks.

Class Dates: July 18-29, 1977
Sept. 26-Oct. 7, 1977

A-3849

TEKTRONIX, INC.
P.O. BOX 500
BEAVERTON, OR. 97005

**BULK RATE
U.S. POSTAGE
PAID
Tektronix, Inc.**