



MODEL 8183 NETCLOCK/GPS

GPS MASTER CLOCK

INSTRUCTION MANUAL

SPECTRACOM CORPORATION
101 DESPATCH DRIVE
EAST ROCHESTER, NY 14445-1484

PHONE 585-381-4827
FAX 585-586-6309

www.spectracomcorp.com

Copyright © 2003 Spectracom Corporation. All rights reserved.
Contents of this publication may not be reproduced in any form
without the written permission of Spectracom Corporation.

REVISIONS, IF ANY, ARE LOCATED AT THE END OF THE MANUAL

MANUAL REVISION 1.7
FEBRUARY 2003

TIME OF DAY PRODUCT FIVE YEAR WARRANTY

LIMITED WARRANTY AND WARRANTY CLAIMS: Spectracom warrants each new product manufactured and sold by it to be free from defects in material, workmanship, and construction, except for batteries, fuses, or other material normally consumed in operation that may be contained therein, for five years after shipment to the original purchaser (which period is referred to as the "warranty period"). This warranty shall not apply if the product is used contrary to the instructions in its manual or is otherwise subjected to misuse, abnormal operations, accident, lightning or repairs or modifications not performed by Spectracom. Spectracom is not responsible for products that it does not manufacture.

Software and receiver modules not manufactured by Spectracom and any cable assemblies and adapters are warranted for one year from date of shipment and subject to exceptions listed above.

Spectracom's obligation under this warranty is limited to in-factory service and repair, at Spectracom's option, of the product or the component thereof which is found to be defective. If in Spectracom's judgment the defective condition in a Spectracom product is for a cause listed above for which Spectracom is not responsible, Spectracom will make the repairs or replacement of components and charge its then current price, which buyer agrees to pay.

Spectracom shall not have any warranty obligations if the procedure for warranty claims is not followed. Notify Spectracom of the claim with full information as to the claimed defect. Spectracom products shall not be returned unless a return authorization number is issued by Spectracom. Spectracom products must be returned with the description of the claimed defect and identification of the individual to be contacted if additional information is needed. Spectracom products must be returned properly packed with transportation charges prepaid.

EXCEPT FOR THE LIMITED WARRANTY STATED ABOVE, SPECTRACOM DISCLAIMS ALL WARRANTIES OF ANY KIND WITH REGARD TO SPECTRACOM PRODUCTS OR OTHER MATERIALS PROVIDED BY SPECTRACOM, INCLUDING WITHOUT LIMITATION ANY IMPLIED WARRANTY OR MERCHANTABILITY OR FITNESS FOR A PARTICULAR PURPOSE.

Spectracom shall have no liability or responsibility to the original customer or any other party with respect to any liability, loss, or damage caused directly or indirectly by any Spectracom product, material, or software sold or provided by Spectracom, replacement parts or units, or services provided, including but not limited to any interruption of service, excess charges resulting from malfunctions of hardware or software, loss of business or anticipatory profits resulting from the use or operation of the Spectracom product or software, whatsoever or howsoever caused. In no event shall Spectracom be liable for any direct, indirect, special or consequential damages whether the claims are grounded in contract, tort (including negligence), or strict liability.

EXTENDED WARRANTY COVERAGE

Extended warranties can be purchased for additional periods beyond the standard five-year warranty. Contact Spectracom during the last year of the standard five-year warranty for extended coverage.

TABLE OF CONTENTS

SECTION 1 **GENERAL INFORMATION**

1.0	INTRODUCTION	1-1
1.1	FEATURES	1-2
1.2	UNPACKING	1-2
1.3	WARRANTY INFORMATION AND PRODUCT SUPPORT	1-3
1.4	MANUAL ERRATA AND SPECIAL DOCUMENTATION	1-4
1.5	SPECIFICATIONS	1-5
1.5.1	Receiver	1-5
1.5.2	Display	1-5
1.5.3	Status Indicators	1-5
1.5.4	RS-232 Serial Comm	1-6
1.5.5	RS-485 Remote Outputs	1-6
1.5.6	IRIG Output	1-7
1.5.7	1PPS Output	1-7
1.5.8	Frequency Output	1-8
1.5.9	Timer Output	1-8
1.5.10	Alarm Outputs	1-8
1.5.10.1	Alarm Classification	1-8
1.5.10.2	Alarm Interface	1-9
1.5.11	Input Power	1-9
1.5.12	Mechanical and Environmental	1-10
1.5.13	Declaration of Conformity	1-10
1.5.14	Model 8225 GPS Antenna Specifications	1-11
1.5.14.1	Electrical Specifications	1-11
1.5.14.2	Mechanical Specifications	1-11
1.5.15	Model 8226 Impulse Suppressor	1-11
1.5.16	Model 8227 Inline Amplifier	1-11

SECTION 2 **INSTALLATION**

2.0	INTRODUCTION	2-1
2.1	MODEL 8225 GPS ANTENNA	2-1
2.1.1	Antenna Installation	2-1
2.2	ANTENNA CABLE	2-2
2.2.1	Cable Lengths	2-3
2.3	MODEL 8226 IMPULSE SUPPRESSOR	2-3
2.4	MODEL 8227 GPS INLINE AMPLIFIER	2-5
2.5	NETCLOCK/GPS PREPARATION FOR USE	2-6
2.5.1	Antenna Connection	2-6
2.5.2	Power Connection	2-6
2.5.3	Chassis Ground	2-7
2.5.4	Configuration	2-7
2.6	INITIAL OPERATION	2-9
2.7	QUALIFYING THE INSTALLATION	2-9
2.7.1	GPS Signal Status	2-9
2.7.2	Tracking Histogram	2-11

SECTION 3 OPERATION

3.0	INTRODUCTION	3-1
3.1	FRONT PANEL FUNCTIONS	3-1
3.1.1	Display	3-1
3.1.2	GPS Lock Lamp	3-1
3.1.3	Time Sync Lamp	3-3
3.2	REAR PANEL FUNCTIONS.....	3-3
3.2.1	GPS Antenna	3-3
3.2.2	1PPS Output	3-4
3.2.3	Frequency Output	3-4
3.2.4	IRIG Output and IRIG Level Adjust	3-4
3.2.5	RS-232 Serial Communication Ports	3-6
3.2.6	Remote Outputs	3-7
3.2.7	Serial Setup Interface	3-8
3.2.8	Timer Output	3-10
3.2.9	Alarm Outputs	3-11
3.2.10	DC Power	3-13
3.2.11	Chassis Ground	3-13
3.3	DATA FORMAT DESCRIPTION	3-14
3.3.1	Format 0	3-14
3.3.2	Format 1	3-16
3.3.3	Format 2	3-17
3.3.4	Format 3	3-19
3.3.5	Format 4	3-21
3.3.6	Format 90	3-22
3.4	REMOTE OUTPUT USAGE	3-24
3.4.1	RS-485 Guidelines	3-24
3.4.2	Connection Method	3-25
3.4.3	Termination	3-39

SECTION 4 SOFTWARE COMMANDS

4.0	INTRODUCTION	4-1
4.1	ANTENNA CABLE DELAY	4-3
4.2	DISPLAY OUTPUT CONFIGURATION	4-4
4.3	DISPLAY ALARM LOG	4-5
4.4	DATE.....	4-6
4.5	RESTORE FACTORY DEFAULTS	4-7
4.6	DISPLAY TRACKING HISTOGRAM	4-8
4.7	DISPLAY OSCILLATOR LOG.....	4-10
4.8	DAYLIGHT SAVING TIME	4-13
4.9	EVENT RELAY	4-16
4.10	FRONT PANEL FORMAT	4-20
4.11	FREQUENCY OUTPUT.....	4-22
4.12	GPS SIGNAL STRENGTH.....	4-23
4.13	HELP DISPLAY	4-26
4.14	IRIG CONFIGURATION.....	4-27
4.15	LOCATION	4-29
4.16	GPS LOCK TIME OUT	4-30
4.17	REMOTE OUTPUT CONFIGURATION.....	4-31
4.18	RESET GPS RECEIVER.....	4-32

4.19	SERIAL COMM CONFIGURATION	4-33
4.20	SET MODE.....	4-35
4.21	STATUS COMMAND	4-36
4.22	SYNC TIME OUT	4-37
4.23	TIME.....	4-38
4.24	TEST MODE	4-39
4.25	VERSION COMMAND.....	4-40

SECTION 5 SERVICE INFORMATION

5.0	INTRODUCTION	5-1
5.1	RECEPTION TROUBLESHOOTING.....	5-1
	5.1.1 No Reception	5-1
	5.1.2 Low GPS Quality	5-2
	5.2.4 Antenna Coax	5-4
5.2	OSCILLATOR ADJUSTMENT.....	5-4
	5.2.1 Adjustment Procedure	5-4

APPENDIX A INDOOR GPS ANTENNA

A.0	INTRODUCTION	A-1
A.1	MODEL 8228 GPS ANTENNA.....	A-1
	A.1.1 Antenna Installation	A-2

APPENDIX B IRIG CODE DESCRIPTION

B.0	INTRODUCTION	B-1
B.1	IRIG B OUTPUT	B-1
	B.1.1 IRIG B General Description	B-1
B.2	IRIG E OUTPUT	B-5
	B.2.1 IRIG E General Description	B-5

ILLUSTRATIONS

FIGURE 1-1	NETCLOCK/GPS MASTER CLOCK	1-1
FIGURE 2-1	ANTENNA INSTALLATION	2-2
FIGURE 2-2	MODEL 8226 IMPULSE SUPPRESSOR	2-3
FIGURE 2-3	CONNECTOR ASSEMBLY INSTRUCTIONS	2-4
FIGURE 2-4	MODEL 8227 GPS INLINE AMPLIFIER	2-5
FIGURE 2-5	CABLE GUIDELINES	2-6
FIGURE 2-6	CABLE CLAMP INSTALLATION	2-7
FIGURE 3-1	NETCLOCK/GPS FRONT PANEL	3-2
FIGURE 3-2	NETCLOCK/GPS REAR PANEL	3-5
FIGURE 3-3	SERIAL COMM PIN NUMBERING	3-6
FIGURE 3-4	REMOTE OUTPUTS	3-8
FIGURE 3-5	RS-485 OUTPUT	3-8
FIGURE 3-6	PIN NUMBERING	3-9
FIGURE 3-7	TIMER RELAY CONTACTS	3-10
FIGURE 3-8	ALARM RELAY CONTACTS	3-12
FIGURE 3-9	ONE-WAY BUS INSTALLATION	3-25
FIGURE 3-10	SPLIT BUS CONFIGURATION	3-26
FIGURE 3-11	WIRE STRAIN RELIEF	3-27
FIGURE 3-12	TIMEVIEW RS-485 INTERFACE	3-28
FIGURE 3-13	MODEL 8179T TIMETAP RS-485 INTERFACE	3-28
FIGURE 3-14	MODEL 8188 RS-485 INTERFACE	3-29
FIGURE 3-15	TIMEBURST RS-485 INTERFACE	3-29
FIGURE 4-1	COMMAND STRUCTURE	4-1
FIGURE 4-2	TIME DIFFERENCE MAP	4-21
FIGURE A-1	MODEL 8228 GPS ANTENNA	A-1
FIGURE A-2	ANTENNA MOUNTING GUIDELINES	A-2
FIGURE B-1	IRIG B TIME CODE	B-2
FIGURE B-2	IRIG E TIME CODE	B-6

TABLES

TABLE 1-1	MODEL 8183 ANCILLARY KIT	1-3
TABLE 2-1	CONFIGURATION TABLE	2-8
TABLE 3-1	SERIAL COMM PIN ASSIGNMENTS	3-7
TABLE 3-2	PIN ASSIGNMENTS	3-9
TABLE 3-3	ALARM OPERATION	3-12
TABLE 3-4	QUALITY INDICATORS	3-18
TABLE 3-5	CABLE SOURCES FOR RS-485 LINES OVER 1500 FEET	3-24
TABLE 3-6	CABLE SOURCES FOR RS-485 LINES UNDER 1500 FEET	3-25
TABLE 4-1	ALPHABETICAL LIST OF COMMANDS	4-2
TABLE 5-1	TYPICAL ANTENNA CABLE RESISTANCE VALUES	5-1
TABLE 5-2	TELEVISION STATIONS WITH GPS JAMMING POTENTIAL	5-3
TABLE 5-3	FM RADIO FREQUENCIES WITH GPS JAMMING POTENTIAL	5-3
TABLE B-1	IRIG B CONTROL FUNCTION FIELD	B-4
TABLE B-2	IRIG E CONTROL FUNCTION FIELD	B-7

SECTION 1: GENERAL INFORMATION

- 1.0 INTRODUCTION
- 1.1 FEATURES
- 1.2 WARRANTY INFORMATION AND PRODUCT SUPPORT
- 1.3 MANUAL ERRATA AND SPECIAL DOCUMENTATION
- 1.4 UNPACKING
- 1.5 SPECIFICATIONS

GENERAL INFORMATION

1.0 INTRODUCTION

The Spectracom NetClock/GPS Master Clock, shown in Figure 1-1, is a precise, traceable time provider. The NetClock/GPS receives and recovers time information from the Global Positioning System (GPS) constellation of satellites. The GPS constellation consists of 24 satellites placed in 6 orbital planes spaced equally around the equator and inclined at a 55-degree angle. This design assures reliable worldwide coverage 24 hours a day. Each satellite contains a redundant system of highly accurate and stable atomic clock sources. The satellite's timing, orbital position and other system parameters are monitored and controlled by ground stations maintained by the US Department of Defense and US Naval Observatory.

The NetClock/GPS Master Clock provides timing outputs accurate to within 100 microseconds of UTC. Standard Master Clock outputs include RS-232, RS-485, IRIG B/E and a one pulse per second. The NetClock/GPS is ideally suited as a Master Clock in all applications requiring an accurate and traceable time source. Typical applications include computer network timing, utility billing, financial transactions, public safety and transportation.

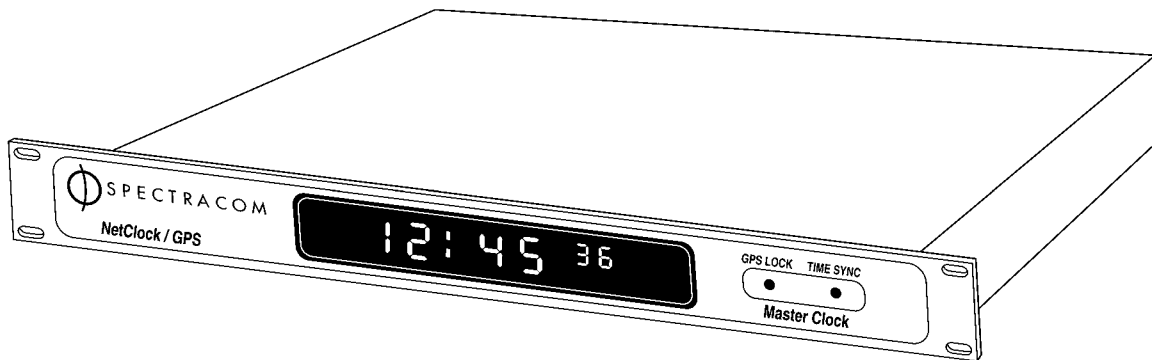

FIGURE 1-1 NETCLOCK/GPS MASTER CLOCK

1.1 FEATURES

The Spectracom NetClock/GPS offers the following features:

- **RELIABLE WORLDWIDE COVERAGE:** The NetClock/GPS can receive and track up to eight satellites simultaneously.
- **ACCURACY:** The NetClock/GPS 1PPS output is within ± 500 nanoseconds of UTC. The time data outputs are within 100 microseconds of UTC.
- **MULTIPLE TIME DATA OUTPUTS:** Each clock includes two RS-232 and two RS-485 time data ports. Output data formats and baud rates are configured using the RS-232 setup port. An IRIG output is also provided as standard. Possible IRIG outputs include IRIG B or IRIG E, amplitude modulated and pulse width coded signal formats.
- **PROGRAMMABLE EVENT TIMER:** Relay contacts are programmable with up to eight events with selectable start and stop times. Events can be scheduled for daily and weekly routines or a specific date.

1.2 UNPACKING

Upon receipt, carefully examine the carton and its contents. If there is damage to the carton that results in damage to the unit, contact the carrier immediately. Retain the carton and packing materials in the event the carrier wishes to witness the shipping damage. Failing to report shipping damage immediately may forfeit any claim against the carrier. In addition, notify Spectracom Corporation of shipping damage or shortages, to obtain replacement or repair services.

Remove the packing list from the envelope on the outside of the carton. Check the packing list against the contents to be sure all items have been received, including an instruction manual and ancillary kit. Table 1-1 lists the items included in the NetClock/GPS ancillary kit.

A 115 VAC to 12 VDC wall adapter, part number T00058, is provided in each ancillary kit. This adapter is compatible with receptacles found in the United States and Canada. An International Power Adapter is also available from Spectracom. Specify part number PS00142. This tabletop adapter operates over a wide voltage and frequency range allowing worldwide operation.

Description	Part Number	Quantity
Terminal Block, 3-position	P13003	3
Terminal Block, 7-position	P13007	1
6-32 screw, 7/16"	H06070	1
#6 Split lock washer	H06001	1
#6 Flat washer	H06002	1
Cable Clamp	MP00719	1

TABLE 1-1 MODEL 8183 ANCILLARY KIT

1.3 WARRANTY INFORMATION AND PRODUCT SUPPORT

Warranty information is found on the leading pages of this manual. The Model 8183 contains a GPS receiver that is not manufactured by Spectracom Corporation and therefore carries a one-year warranty. In addition, the AC power adapter carries a one-year warranty. Should it become necessary to exercise the warranty, contact Spectracom Corporation to obtain a replacement or service.

Spectracom continuously strives to improve its products and therefore greatly appreciates any and all customer feedback given. Please participate in Spectracom's Customer Satisfaction Survey found on our web site at:

<http://www.spectracomcorp.com>

The online survey is also used for warranty registration of your new Spectracom products. All completed entries are automatically entered into a monthly prize give away drawing.

Technical support is available by telephone. Please direct any comments or questions regarding application, operation, or service to Spectracom Customer Service Department. Customer Service is available Monday through Friday from 8:30 A. M. to 5:00 P.M. Eastern time.

Telephone Customer Service at: **585-381-4827**.

Section 1: General Information

In addition, please contact customer service to obtain a Return Material Authorization Number (RMA#) before returning any instrument to Spectracom Corporation. Please provide the serial number and failure symptoms. Transportation to the factory is to be prepaid by the customer. After obtaining an RMA# ship the unit back using the following address:

Spectracom Corporation
Repair Department, RMA# xxxxxx
101 Despatch Drive
East Rochester, NY 14445

Product support is also available by e-mail. Questions on equipment operation and applications may be e-mailed to Spectracom Sales Support at:

mailroom@spectracomcorp.com

Repair or technical questions may be e-mailed to Spectracom Technicians at:

techsupport@spectracomcorp.com

Visit our web page for product information, application notes and upgrade notices as they become available at:

<http://www.spectracomcorp.com>

1.4 MANUAL ERRATA AND SPECIAL DOCUMENTATION

Information concerning manual corrections or product changes occurring after printing is found in the Errata Section. An erratum, when required, is found at the end of this manual. Please review and incorporate changes into the manual whenever an Errata Section is included.

Spectracom will make instrument modifications upon special request. The documentation associated with any modification is provided in addition to this manual.

1.5 SPECIFICATIONS

This section contains specifications for the NetClock/GPS and Model 8225 GPS Antenna.

1.5.1 Receiver

Received Standard:	L1 C/A Code transmitted at 1575.42 MHz.
Satellites Tracked:	Up to eight simultaneously.
Acquisition Time:	Typically <20 minutes from cold start.
Acquisition Sensitivity:	-105 dBm to -137 dBm.
Tracking Sensitivity:	-139 dBm.
Timing Accuracy:	<500 nanoseconds with Selective Availability “SA” on.
Antenna Connector:	Type N, female.

1.5.2 Display

Display Type:	Red LED.
Digit Height:	0.8 inches for hours and minutes. 0.56 inches for seconds.
Display Options:	12 or 24-hour format, UTC or local time, enable DST/STD time changes.

1.5.3 Status Indicators

Front panel bi-color LED's indicate operational status.

GPS Lock:	Indicates GPS satellite tracking status. Lamp is green when the receiver has tracked at least one satellite within the period allotted for the GPS Lock Alarm. The lamp is red during initial operation or whenever a GPS Lock Alarm or CPU Alarm is asserted. The GPS Lock Alarm period is programmable up to 23 hours: 59 minutes: 59 seconds in 1-second increments. Factory default is 15 minutes.
-----------	--

Time Sync:	Indicates accuracy of time data outputs. Lamp is green when at least one satellite is tracked within the period
------------	---

Section 1: General Information

allotted for the Time Sync Alarm. The lamp is red during initial operation and when a Time Sync Alarm is asserted. A red lamp indicates the time data output accuracy may not be within published specifications. Time Sync Alarm period is programmable up to 23 hours: 59 minutes: 59 seconds in one-second increments. Factory default is two hours.

1.5.4 RS-232 Serial Communication Ports

Signal:	Selected data format in RS-232 levels when interrogated by the connected device. The port may also be configured for continuous once-per-second output.
Connector:	DB9 female, pin assignments conform to EIA/TIA-574 standard, data communication equipment (DCE). Flow control not required.
Character structure:	ASCII, 1 start, 8 data, 1 stop, and no parity.
Accuracy:	Data stream on time marker within ± 100 microseconds of UTC for Formats 0, 1, 3, and 90 selected. Formats 2 and 4 are within ± 1 millisecond of UTC.
Configuration:	Baud rate and output data formats are selected using the Serial Setup Interface. Bit rate selections are 1200, 2400, 4800 and 9600 baud. There are six data format selections available. In addition, time zone offset, DST rule and interrogation character can be configured. Each RS-232 Serial Comm port is independently configurable.

1.5.5 RS-485 Remote Outputs

Signal:	Selected data format in RS-485 levels, output once per second.
Connector:	Two (2) removable 3-position terminal blocks (supplied).
Character Structure:	ASCII, 1 start, 8 data, 1 stop, and no parity.
Accuracy:	Data stream on time marker within ± 100 microseconds of UTC for Formats 0, 1, 3, and 90 selected. Formats 2 and 4 are within ± 1 millisecond of UTC.

Configuration: Baud rate and output data formats are selected using the Serial Setup Interface. Bit rate selections are 1200, 2400, 4800, and 9600 baud. There are six data format selections available. In addition, time zone offset and DST rule can be configured. Each Remote Output is independently configurable.

1.5.6 IRIG Output

Signal: Selectable IRIG B or IRIG E, amplitude modulated sine wave (AM) or pulse-width-coded (TTL).

AM Carrier: IRIG B-1000 Hz.
IRIG E-100 Hz or 1000 Hz.

AM Signal Level: Adjustable from 0 to 10 V p-p mark amplitude into loads of 600 ohms or greater. Factory set to 2.0 V p-p.

Accuracy: IRIG-B, IRIG-E 1000 Hz AM: ± 20 microseconds of UTC.
IRIG-E 100 Hz AM: ± 200 microseconds of UTC.
IRIG-B, IRIG-E TTL: ± 2 microseconds of UTC.

Connector: BNC female.

Configuration: IRIG formats B or E in AM or TTL levels. Time data is configurable with time zone offsets and DST rules. Signature Control may also be placed on the output signal. This feature removes the modulation code from the IRIG output whenever the selected alarm condition is present. The output is restored when the fault is corrected.

1.5.7 1PPS Output

Signal: One pulse-per-second square wave derived from the GPS receiver.

Signal Level: TTL compatible into high impedance loads, 1.5 V base-to-peak into 50 ohms.

Pulse Width: 200 milliseconds.

Accuracy: Positive edge within ± 500 nanoseconds of UTC when locked to GPS.

Connector: BNC female.

Section 1: General Information

1.5.8 Frequency Output

Signal:	10 MHz sinewave.
Signal Level:	350 mVrms into 50 ohms.
Harmonics:	Better than 30 dB down.
Spurious:	Better than -35 dB down.
Accuracy:	$\pm 1 \times 10^{-8}$ typical.
Connector:	BNC female.
Output Options:	Signal options are selected via the Serial Setup Interface. Output options include Signature Control and TTL IRIG. Signature Control: This feature removes the output signal whenever the selected alarm condition is present. The output is restored when the fault condition is corrected. Pulse Width Coded IRIG: The Frequency Output connector may be configured to provide the selected IRIG format as a pulse width coded, TTL compatible output.

1.5.9 Timer Output

Events:	Eight (8) events with programmable on and off times.
Event Schedule:	Events may be scheduled for daily and weekly routines, or a specific date.
Relay Contacts:	NO, NC, and common. Contact rating 30 VDC, 2 Amps.
Connector:	3-position terminal block (supplied).

1.5.10 Alarm Outputs

Alarm relays allow remote monitoring of operational status. Relay contacts are provided for Major and Minor Alarms. Alarm status is also included in performance and status logs obtained through the Serial Setup Interface.

1.5.10.1 Alarm Classification

Major Alarm: A Major Alarm is asserted when detected faults compromise output accuracy. The alarm relays reset when the fault condition is corrected. Faults and conditions listed below actuate a Major Alarm:

Time Sync:	The period of time allotted for operation without tracking a satellite has expired. Time out period is programmable from 1 minute to 24 hours.
------------	--

CPU Fault:	The CPU is unable to communicate with the GPS receiver.
Test Mode:	Unit has been placed in Test Mode operation.
Frequency Error:	Measured oscillator frequency error exceeds 1×10^{-7} .
Power Failure:	The NetClock/GPS has lost power.

Minor Alarm: A Minor Alarm is asserted when failures detected do not immediately affect output accuracy. The alarm relays reset when the fault condition is corrected. Faults and conditions listed below actuate a Minor Alarm:

GPS Lock:	The period of time allotted for operation without tracking a satellite has expired. Time out period is programmable from 1 minute to 24 hours.
Oscillator Adjust:	Warns that the TCXO time base oscillator requires an adjustment to maintain operation within specifications.
Test Mode:	Unit has been placed in Test Mode operation.
Antenna Problem:	The antenna sense circuitry warns when the antenna is not connected, or a cable short or open exists.
SmartWatch Invalid:	A failure has been detected with the non-volatile RAM/Timekeeping integrated circuit.

1.5.10.2 Alarm Interface

Alarm Outputs:	Major Alarm, Minor Alarm.
Relay Contacts:	NO, NC and common.
Contact Rating:	30 VDC, 2 Amps.
Connector:	7-position terminal block (supplied).

1.5.11 Input Power

AC Input:	115 VAC \pm 10%, 60 Hz, 5 watts.
DC Input:	12 to 36 VDC, 20 Watts.
Connector:	Barrel, 5.5mm O.D., 2.1mm I. D.
Polarity:	Positive shell, negative center.
Optional Power:	International Power Supply, PS00142, operates from a 100 to 250 VAC 50/60 Hz power line.

Section 1: General Information

1.5.12 Mechanical and Environmental

Dimensions:	1.75 H x 19.0 W x 10.0 D inches (44 H x 483 W x 254 D mm).
Rack mount:	EIA 19", front panel mounting holes for one standard rack unit.
Weight:	4.25 lbs. (2.0 kg).
Temperature:	0° to 50°C operating range.

1.5.13 Declaration of Conformity

EMC Directive 89/336/EEC: 1989	
Emissions	Unit meets all requirements for a Level B Group 1 device as specified in documents EN55022: 1994 + A1: 1995 + A2: 1997 using test methodologies described in: Cispr22: 1997, EN61000-3-3: 1995, EN61000-3-2: 1995
Immunity	EN55024: 1998, Cispr24: 1997, EN61000-4-8, EN61000-4-11, EN61000-4-2: 1995, EN6100-4-3:1997,EN61000-4-4: 1996, EN61000-4-6 Part 4 section 6
SAFETY	Directive 93/42/96: 1996 Low Voltage directive, Directive 92/59/EEC General Product Safety Directive, EN 60950: 1992 Safety of Information Technology Equipment, and UL60950 3 rd Edition Safety of Information Technology Equipment. Safety Compliance Certification Number SAF3259A.02.

SUPPLEMENTAL INFORMATION

The product herewith complies with the requirements of the Marking Directive 93/68/EEC: 1993 and carries the CE mark accordingly. The Technical File required by this directive is maintained at Spectracom Corporation.

1.5.14 Model 8225 GPS Antenna Specifications

1.5.14.1 Electrical Specifications

Type: Active, 30dB gain.
Frequency: 1575.42 MHz.
Temperature Range: -30° to 80° C (-22° to 176°F).
Connector: N type, Female.
Recommended Cable: RG-213.
Maximum Cable Length: 200 feet. Longer cable lengths require the Model 8227 Inline Amplifier.
Power: 5 Volts, 27 milliamps, powered by receiver.

1.5.14.2 Mechanical Specifications

Assembled Length: 24 inches (61 cm)
Housing Diameter: 3.5 inches (8.9 cm).
Housing Material: PVC.
Assembled Weight: 1.3 lbs. (.60 kg).
Mounting: Hose clamps (furnished) on vent pipe.

1.5.15 Model 8226 Impulse Suppressor

Connectors: Type N Female
Turn On Time: 4 nanoseconds for 2 kV/ns
Turn On Voltage: +7 V, -1 VDC
Frequency Range: 1.2 to 2.0 GHz
VSWR: 1.1:1 or better
Insertion Loss: 0.1 dB maximum

1.5.16 Model 8227 Inline Amplifier

Connectors: Type N Female
Gain: 20 ±3 dB
VSWR: ≤1.5:1
Power: 3 - 9 VDC, 7.5 ±1 milliamps

SECTION 2: INSTALLATION

- 2.0 INTRODUCTION
- 2.1 MODEL 8225 GPS ANTENNA
- 2.2 ANTENNA CABLE
- 2.3 MODEL 8226 IMPULSE SUPPRESSOR
- 2.4 MODEL 8227 GPS INLINE AMPLIFIER
- 2.5 NETCLOCK/GPS PREPARATION FOR USE
- 2.6 INITIAL OPERATION
- 2.7 QUALIFYING THE INSTALLATION

INSTALLATION

2.0 *INTRODUCTION*

This section describes the installation of the Model 8225 GPS Antenna and related accessories. This section also describes the NetClock/GPS preparation for use, initial operation, installation, qualification and configuration. To ensure proper operation, please read this section prior to equipment installation and usage.

For installations where mounting an outdoor antenna is not possible, Spectracom offers the Model 8228 GPS Window Mount antenna. Refer to Appendix A for additional information on the Model 8228.

2.1 *MODEL 8225 GPS ANTENNA*

The Model 8225 is an active antenna tuned to receive the GPS 1575.42 MHz L1 band satellite broadcast. The received signals are passed through a narrow bandpass filter and preamplifier within the antenna. The active antenna circuitry provides 30 dB of gain and requires +5 VDC at 27 milliamps. This is provided by the NetClock/GPS receiver over the antenna coax. Each antenna is terminated with a type “N” female connector. The Model 8225 features a compact weatherproof design measuring 3.5 inches in diameter.

2.1.1 *Antenna Installation*

The GPS antenna must be installed outdoors in a location where an unobstructed view of the sky exists. Rooftops generally make good locations due to clear overhead sky with views to the horizon. This type of location allows the antenna to see and track the maximum number of satellites throughout the day. Installations with obstructed views may prove operational, but can experience reduced reception quality and the inability to simultaneously track the maximum number of satellites. In addition to clear sky coverage, select a site that would not allow the antenna to become buried in drifted or accumulated snow or ice. Avoid placing the GPS antenna in close proximity to broadcast antennas whenever possible.

Each antenna includes a mating PVC mast assembly and two hose clamps to simplify installation. The hose clamps can be used to affix the mast assembly to a vent pipe. Spectracom offers an antenna base, Model 8213, for installations where vent pipe mounting is not practical or desired. The Model 8213 is constructed of aluminum and is furnished with ballast for stability. Both mounting methods are illustrated in Figure 2-1.

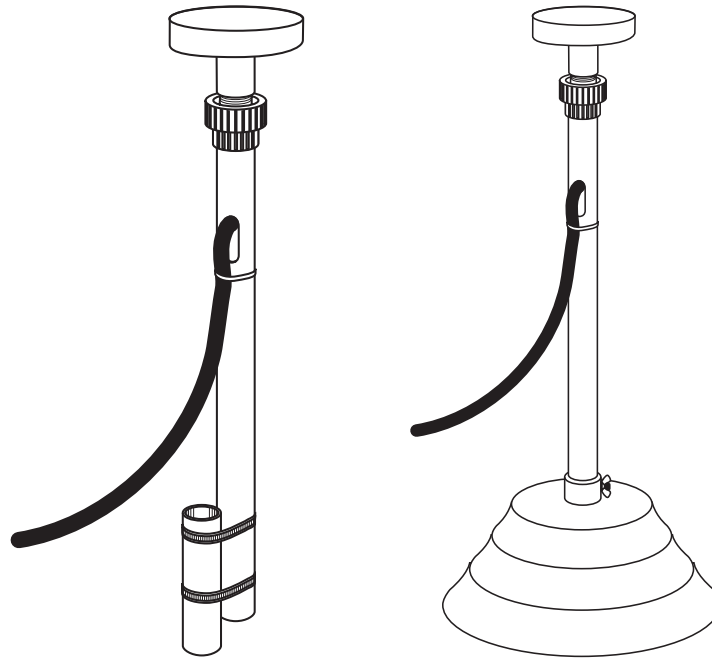

FIGURE 2-1 ANTENNA INSTALLATION

2.2 ANTENNA CABLE

Spectracom recommends RG-213 type coax, such as Belden 8267, for the GPS antenna cable. To simplify the installation process, Spectracom offers GPS cable assemblies terminated with Type N Male connectors. Specify part number CA07xxx, where xxx equals the length in feet.

If the antenna cable is purchased locally, select coax suitable for outdoor use. Consider the cable's weather ability, temperature range, UV resistance, and attenuation characteristics.

Do not allow the antenna cable to be placed in standing water, as water may permeate through the coax jacket over time. On flat roof installations, the coax can be suspended by cable hangers or placed in sealed PVC conduit. Apply a weather proofing sealant or tape over all outdoor connections.

Installation of a surge protection device in the antenna line is recommended to protect the NetClock/GPS receiver and connected devices from lightning damage. Spectracom offers the Model 8226 Impulse Suppressor to shunt potentially damaging voltages on the antenna coax to ground. Refer to Section 2.3 for a complete description of the Model 8226.

2.2.1 Cable Lengths

Using Spectracom CA07xxx or Belden 8267 coax, the maximum antenna cable length permitted is 200 feet. These cables attenuate the GPS signal by 10 dB per 100 feet of coax. Installations requiring longer antenna cables may use the Model 8227 Inline Amplifier, or lower loss cable. Refer to Section 2.4 for additional information on the Model 8227.

When selecting alternate antenna cable sources, the attenuation characteristics at the GPS frequency of 1575.42 MHz must be known. To ensure optimum receiver performance, the total antenna cable attenuation must not exceed 20 dB. Cable attenuation of greater than 20 dB requires the use of a Model 8227 Inline Amplifier.

2.3 MODEL 8226 IMPULSE SUPPRESSOR

Spectracom recommends the use of an inline coaxial protector for all products with an outside antenna. Spectracom offers the Model 8226, Impulse Suppressor, to protect the receiver from damaging voltages occurring on the antenna coax. Voltages exceeding the impulse suppresser trip point are shunted to the system ground. The Model 8226 is designed to withstand multiple surges.

Mount the suppressor indoors, preferably where the coax enters the building. Install the suppressor on a grounding panel or bulkhead as shown in Figure 2-2.

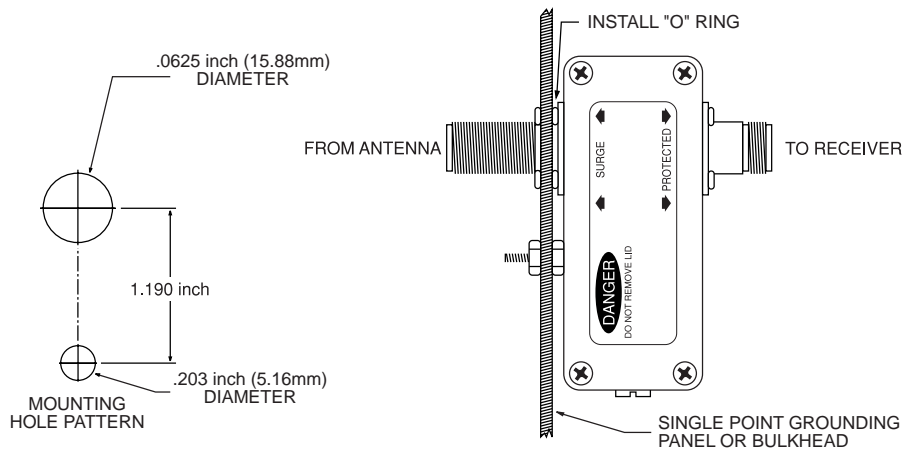

FIGURE 2-2 MODEL 8226 IMPULSE SUPPRESSOR

Each Model 8226 includes two clamp type male N connectors. These connectors can be used to splice the Model 8226 into the antenna coax. The connectors are compatible with RG-213 type coax such as Spectracom CA07xxx or Belden 8267. Connector assembly instructions are shown in Figure 2-3.

Section 2: Installation

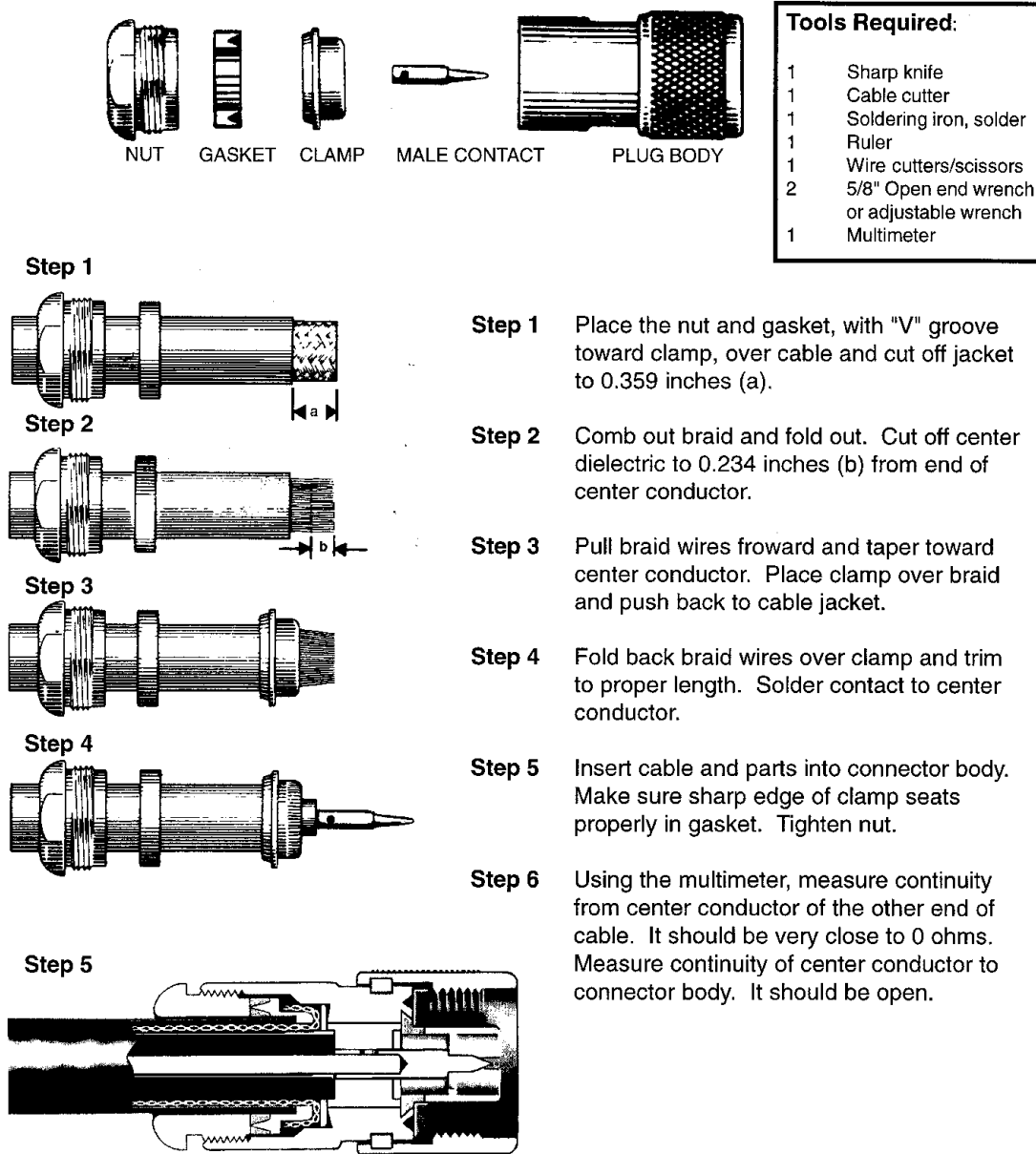

FIGURE 2-3 CONNECTOR ASSEMBLY INSTRUCTIONS

2.4 MODEL 8227 GPS INLINE AMPLIFIER

An inline amplifier is required whenever GPS antenna cable lengths cause greater than 20 dB attenuation. Using Spectracom CA07xxx or Belden 8267 coax, an amplifier is needed whenever antenna cable lengths exceed 200 feet.

The Model 8227 GPS Inline Amplifier, shown in Figure 2-4, extends the maximum cable length to 400 feet. The Model 8227 provides 20 dB of gain and is powered by the NetClock/GPS receiver.



FIGURE 2-4 MODEL 8227 INLINE AMPLIFIER

Each Model 8227 includes two clamp type male N connectors. These connectors can be used to splice the Model 8227 into the antenna coax. The connectors are compatible with RG-213 type coax such as Spectracom CA07xxx or Belden 8267. Refer to Figure 2-3 for connector assembly instructions.

A five-foot long coaxial cable is also provided with each Model 8227. This cable connects the amplifier to the surge suppressor. This cable is rated for indoor usage only.

Refer to Figure 2-5 for Model 8227 installation guidelines. The cable lengths shown in Figure 2-5 represent Spectracom CA07xxx cable. The equivalent cable loss expressed in dB, is provided for use with other cables.

Place the inline amplifier within 100 feet (10 dB cable loss) of the antenna to optimize the signal to noise ratio. Whenever possible install the inline amplifier indoors and after the impulse suppressor. Connect the surge suppressor to the inline amplifier using the supplied 5-foot cable. The amplifier can be installed outdoors, providing care is taken to weatherproof the connections. Due to unique system dynamics of the antenna, amplifier and receiver, a minimum of cable length of 200 feet (20 dB cable loss) is required to prevent overloading the receiver.

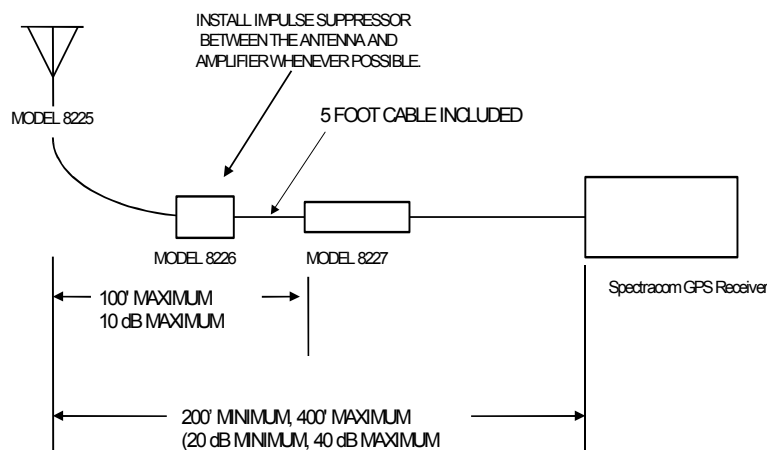

FIGURE 2-5 CABLE GUIDELINES

2.5 *NETCLOCK/GPS PREPARATION FOR USE*

This section outlines the set-up procedure to prepare the NetClock/GPS for operation.

2.5.1 *Antenna Connection*

Install the Model 8225 Antenna as outlined previously in this section. Connect the antenna cable to the rear panel GPS ANTENNA connector.

2.5.2 *Power Connection*

An external AC to DC power adapter powers the NetClock/GPS. The standard clock is provided with a 115 VAC 50/60 Hz wall mount adapter. Spectracom also offers an International Power Supply, part number PS00142. This table-top adapter can operate from a 90 to 240 VAC, 47/63 Hz power source. The international power adapter is shipped with a line cord compatible with AC receptacles (NEMA 5-15R) commonly found in the United States and Canada. Alternate type line cords may be obtained locally.

Both adapters are terminated with a barrel type connector that plugs into the rear panel DC power jack. Secure the power connector by installing the cable clamp included in the ancillary kit as shown in Figure 2-6.

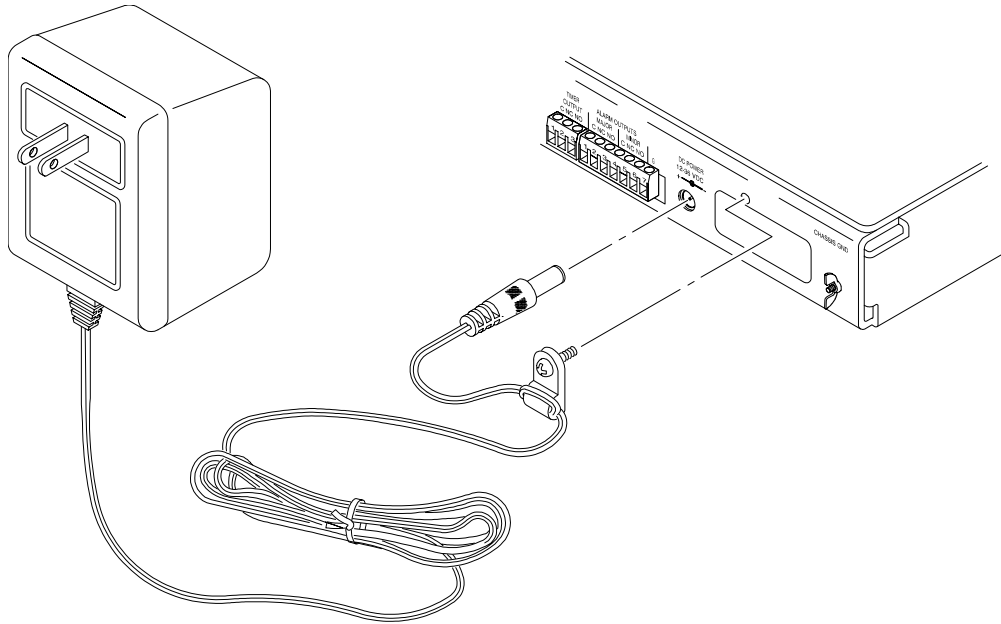

FIGURE 2-6 CABLE CLAMP INSTALLATION

2.5.3 Chassis Ground

The chassis ground lug allows the NetClock/GPS chassis to be connected to an earth ground or single point ground. Connecting the chassis to a single point ground system may be required in some installations to ensure optimum lightning protection. An earth ground is also recommended in installations where excessive noise on the power line degrades receiver performance.

2.5.4 Configuration

The NetClock/GPS time outputs and operational parameters are configurable to meet the requirements of many applications. Time data format output on the RS-232 and RS-485 ports, baud rate, IRIG format, Daylight Saving Time and time difference from UTC are just some of the configuration selections. Commands to configure the clock are entered through the RS-232 Serial Setup Interface port. Table 2-1 is a partial list of configurable functions or outputs. Included in the table are the output functions, configuration command, factory configuration, and user selections. Refer to Section 3, *Operation*, for a complete description of each output and Section 4, *Software Commands*, for information on the various commands.

Section 2: Installation

OUTPUT / FUNCTION	COMMAND	FACTORY CONFIGURATION	USER CONFIGURATION
Serial Comm 1	SER1	Baud Rate = 9600 Format # = 0 Request Char = T Time Diff = +00:00 DST = 0	Baud Rate = Format # = Request Char = Time Diff = DST =
Serial Comm 2	SER2	Baud Rate = 9600 Format # = 0 Request Char = T Time Diff = +00:00 DST = 0	Baud Rate = Format # = Request Char = Time Diff = DST =
Remote Output 1	REM1	Baud Rate = 9600 Format # = 0 Time Diff = +00:00 DST = 0	Baud Rate = Format # = Time Diff = DST =
Remote Output 2	REM2	Baud Rate = 9600 Format # = 0 Time Diff = +00:00 DST = 0	Baud Rate = Format # = Time Diff = DST =
IRIG Output ¹	IRIG	IRIG Format = B Level = AM Carrier = 1000Hz Sig Control = None Time Diff = +00:00 DST = 0	IRIG Format = Level = Carrier = Sig Control = Time Diff = DST =
Display Format	FPF	Display Fmt = 24 hour Time Diff = +00:00 DST = 0	Display Fmt = Time Diff = DST =
Frequency Output	FREQ	Freq. Output = 10 MHz Sig Control = None	Freq. Output = Sig Control =
Lock Time Out	LOCK	GPS Lock Time Out = 00:15:00	GPS Lock Time Out =
Sync Time Out	SYNC	Time Sync Time Out = 02:00:00	Time Sync Time Out =

Note 1: IRIG AM signal level set by rear panel potentiometer. Factory set for 2.0 Volts peak-to-peak mark amplitude.

TABLE 2-1 CONFIGURATION TABLE

2.6 INITIAL OPERATION

Upon completing antenna and power connections, plug the adapter into an AC receptacle. At power ON, the GPS LOCK and TIME SYNC lamps are red. The initial clock time is derived from the nonvolatile RAM/Timekeeping integrated circuit. The receiver will now acquire and lock to GPS satellites currently in view of the antenna. If the receiver is unable to acquire a satellite within 15 minutes, a Minor Alarm is asserted.

The GPS LOCK lamp turns green after tracking at least one satellite for one minute. The TIME SYNC lamp remains red until the receiver has acquired the complete system almanac from at least one satellite. Typically, the entire process of acquiring satellites and retrieving the almanac requires 20 minutes to accomplish. Once the GPS LOCK and TIME SYNC lamps turn green the NetClock/GPS shall operate in accordance with the specifications published in this manual.

2.7 QUALIFYING THE INSTALLATION

Typically, the front panel TIME SYNC lamp turns green within 20 minutes of power on. This lamp indicates that receiver is tracking at least one qualified satellite. If the GPS LOCK lamp does not change from red to green, a cable or reception problem may exist. Refer to Section 5.1 for troubleshooting assistance.

Reception quality can be evaluated using the performance and status logs provided by the receiver. Commands to retrieve operational information are issued through the rear panel RS-232 Serial Setup Interface port. To communicate with the receiver, a terminal or computer with terminal emulation software (i.e. ProComm Plus, Hyper-Terminal, etc.) is required. Configure the terminal for ANSI emulation, 9600 baud and a character structure of 1 start, 8 data, 1 stop and no parity. XON/XOFF flow control is supported.

2.7.1 GPS Signal Status

The **G****P****S** **S****i****g****n****a****l** **S****t****a****t****u****s** command, **GSS**, provides an instantaneous view of the GPS reception quality. This command is used to verify proper antenna placement and receiver performance of an installation. The GSS response indicates the number of satellites the receiver is currently tracking and their relative signal strength. The resulting GPS quality and Position Fix Status are also included. A complete description of the **GSS** command can be found in Section 4 of this manual.

Issue the GSS command as shown below.

Type: **GSS <ent>**

An example response is shown on the following page.

Section 2: Installation

TRACKING 4 SATELLITES

GPS STATE= 3D-FIX DOP= 03.7

LATITUDE= N 43 06 59.746 LONGITUDE= W 077 29 15.242 HEIGHT= +00110 METERS

QUALITY= PASSED

CHAN	VID	MODE	STREN	STAT
01	24	08	043	A2
02	04	08	029	A2
03	10	00	000	00
04	05	08	053	A2
05	18	00	000	00
06	30	00	000	00
07	01	08	047	A2
08	06	00	000	00

Tracking: The receiver must track at least one qualified satellite to operate. Typically, the receiver shall track 6 or more satellites with the Model 8225 GPS Antenna. If the Model 8228 indoor window mount antenna is used, the receiver will typically track 3 or more satellites.

GPS State: Under normal operation the receiver will indicate 3-D Fix. A Searching or 2-D Fix message indicates that fewer than 4 qualified satellites are currently tracked.

DOP: Dilution of Precision indicates the degree of uncertainty of a Position Fix. The DOP value shall be $0 \leq \text{DOP} < 10$ when in 3-D Fix mode.

Quality: A PASSED message indicates the receiver is tracking at least one qualified satellite. A FAILED message indicates the received GPS signals did not meet minimum requirements.

Satellite Data: Data on each satellite currently tracked is provided in table form.

The CHAN column represents the GPS Receiver Channel Number, 1 through 8.

VID is the Vehicle (satellite) Identification Number, 1 through 37.

The MODE column provides the Channel Tracking Mode for each satellite. The GPS qualifying algorithm accepts only satellites having a Mode value of 08.

The relative signal strength of each satellite currently tracked is found in the STREN column. The maximum signal level is 55.

The satellite status flag code is found in the STAT column. Typically, the STAT value is A2.

If the receiver does not meet the minimum requirements described above, refer to Section 5, *Service Information*, for troubleshooting assistance.

2.7.2 Tracking Histogram

The **D**isplay **T**racking **H**istogram command, **DH**, is used to evaluate the long-term reception quality. The tracking histogram records the number of satellites tracked and qualified every second. At the end of the hour, a log is created and the counters are restarted. The command responds with the last four hourly entries and the histogram currently in process. A complete description of the **DH** command is found in Section 4 of this manual.

Allow the receiver to operate for at least 5 hours before evaluating the tracking histogram. Issue the DH command as shown below:

Type: **DH <ent>**

An example response is shown below:

```
TIME= 16:00:00 DATE= 2000-05-11 QUALIFIED HISTOGRAM
0= 00000 1= 00026 2= 00287 3= 03287 4= 00000
5= 00000 6= 00000 7= 00000 8= 00000 Q= 03600
```

```
TIME= 17:00:00 DATE= 2000-05-11 QUALIFIED HISTOGRAM
0= 00000 1= 00000 2= 00429 3= 02292 4= 00879
5= 00000 6= 00000 7= 00000 8= 00000 Q= 03600
```

```
TIME= 18:00:00 DATE= 2000-05-11 QUALIFIED HISTOGRAM
0= 00000 1= 00087 2= 00693 3= 02761 4= 00059
5= 00000 6= 00000 7= 00000 8= 00000 Q= 03600
```

```
TIME= 19:00:00 DATE= 2000-05-11 QUALIFIED HISTOGRAM
0= 00026 1= 00382 2= 00947 3= 02245 4= 00000
5= 00000 6= 00000 7= 00000 8= 00000 Q= 03574
```

```
TIME= 19:49:45 DATE= 2000-05-11 QUALIFIED HISTOGRAM
0= 00000 1= 00267 2= 01374 3= 01344 4= 00000
5= 00000 6= 00000 7= 00000 8= 00000 Q= 02985
```

In this example, the receiver tracked one satellite for 26 seconds, two satellites for 287 seconds and three satellites for 3287 seconds for the hour ending 16:00:00. The "Q" value of 3600 indicates the receiver had tracked at least one qualified satellite for the entire hour (3600 seconds). Note the partial histogram shown in the time stamp of 19:49:45.

For optimum performance, the receiver should consistently track three or more satellites. The Q value should typically be 3600 for most entries. Occasional drops below 3600 are considered acceptable. If the majority of the histograms show tracking less than three satellites or Q values less than 3000, the receiver may not provide reliable operation. Refer to Section 5.1, *Reception Troubleshooting*, for recommendations.

SECTION 3: OPERATION

- 3.0 INTRODUCTION
- 3.1 FRONT PANEL FUNCTIONS
- 3.2 REAR PANEL FUNCTIONS
- 3.3 DATA FORMAT DESCRIPTION
- 3.4 REMOTE OUTPUT USAGE

OPERATION

3.0 INTRODUCTION

This section describes the front and rear panel functions and operational information for the NetClock/GPS.

3.1 FRONT PANEL FUNCTIONS

Refer to Figure 3-1, NetClock/GPS Front Panel, and the following paragraphs for front panel functions.

3.1.1 Display

The front panel display provides GPS synchronized time. The display characters are red LED digits measuring 0.8 inches high for the hours and minutes, and 0.56 inches for the seconds. The display area features a red filter with an anti-glare surface for optimum viewing.

The display can be configured to display time in a 12 or 24 hour format, Coordinated Universal Time (UTC) or local time with or without Daylight Saving Time corrections. The command **FPF** configures the front panel display format options. Refer to Section 4, *Software Commands*, for a complete description of this command.

In addition to providing time, the display communicates when an adjust oscillator alarm is activated by displaying all 8's every three seconds. This alarm warns that the GPS disciplined TCXO time base requires an adjustment to ensure proper operation. The adjustment compensates for crystal aging and centers the TCXO within its control range. Typically, this adjustment is not necessary until after many years of operation. Refer to Section 5, *Service Information*, for the TCXO adjustment procedure.

3.1.2 GPS Lock Lamp

This bi-color LED indicates the receiver lock status to GPS. At power on this lamp is red. The lamp turns green after the receiver has tracked and qualified at least one satellite for one minute.

The lamp remains green if the receiver continues to track, or has tracked, at least one qualified satellite within the period allotted for the GPS Lock Alarm. The default period is set for 15 minutes. The GPS Lock Alarm period can be configured up to 24 hours using the **LOCK** command. Refer to Section 4 for a complete description of the **LOCK** command.

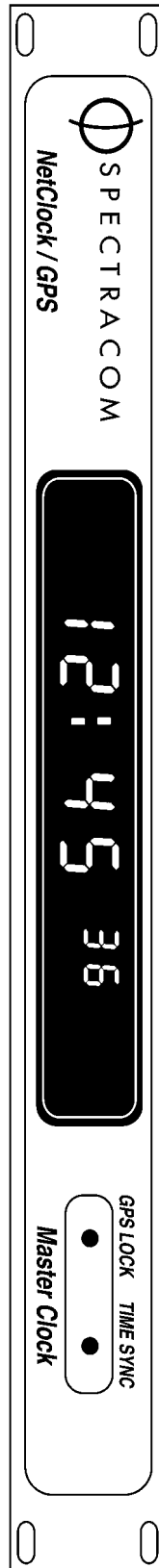

FIGURE 3-1 NETCLOCK/GPS FRONT PANEL

The lamp turns red when the receiver is unable to track any satellites and the GPS Lock period has expired. At this point a Minor Alarm is asserted.

After the receiver reacquires at least one qualified satellite for one minute, the GPS Lock lamp turns green and the Minor Alarm is reset.

Refer to Section 3.2.9 for additional information on the GPS Lock Alarm.

3.1.3 Time Sync Lamp

This bi-color LED indicates the time synchronization status to GPS. At power on this lamp is red, indicating that the clock is not synchronized and time data accuracy does not meet specification.

The lamp turns green when the receiver has acquired at least one satellite and has recovered the GPS system almanac. The entire GPS system almanac takes 12.5 minutes to transmit. The time data accuracy shall now conform to specifications. The lamp remains green if the receiver continues to track, or has tracked, at least one qualified satellite within the period allotted for the Time Sync Alarm. The default period is two hours. The duration of the Time Sync Alarm period is dependent on the accuracy requirement of the application. The Time Sync Alarm period can be configured up to 24 hours using the **SYNC** command. Refer to Section 4 for a complete description of the **SYNC** command.

The lamp turns red when the receiver is unable to track any satellites and the Time Sync Alarm period has expired. At this point, a Major Alarm is asserted to warn that time data accuracy may be compromised.

The lamp returns to green only upon acquiring and qualifying at least one satellite for 1 minute if the almanac data is still valid. If the almanac is invalid or lost due to a power failure, the clock will have to again recover the complete almanac (12.5 minutes). The Major Alarm relay is reset and timing accuracy shall meet specification. Refer to Section 3.2.9 for additional information on the alarm relay operation.

3.2 REAR PANEL FUNCTIONS

Refer to Figure 3-2, NetClock/GPS Rear Panel, and the following paragraphs for rear panel functions.

3.2.1 GPS Antenna

This type N connector is the antenna input to the GPS receiver. The Model 8225 GPS Antenna and the Model 8227 Inline Preampifier receive operational power, +5 VDC, from this connector.

Section 3: Operation

3.2.2 1PPS Output

This BNC connector provides a GPS derived one pulse-per-second output. The leading edge of this TTL compatible signal is within ± 500 nanoseconds of UTC with selective availability (SA) on. The leading edge can be adjusted to compensate for antenna cable delays using the command **ACD**.

Refer to Section 4, *Software Commands*, for additional information on the **ACD** command.

3.2.3 Frequency Output

The Freq Output BNC connector is factory configured to provide a 10 MHz sinewave output. The signal is derived from the GPS disciplined TCXO time base. Frequency accuracy is better than 1×10^{-8} (± 0.1 Hz). Signal level is 350 mVrms into 50 ohms. The 10 MHz output may be used as a time base for signal generators, frequency counters or other devices accepting an external reference frequency.

The Freq Output connector can be configured to provide a pulse width coded (TTL) IRIG output. This feature permits a single NetClock/GPS to synchronize both voice logging equipment requiring an IRIG AM signal and recall recorders (Zetron 3022) requiring IRIG TTL. The IRIG format, IRIG B or IRIG E, is the same type selected for the IRIG output connector. The command **FREQ** configures the output signal. Refer to Section 4, *Software Commands*, for additional information.

3.2.4 IRIG Output and IRIG Level Adjust

IRIG is an acronym for Inter-Range Instrumentation Group. In the late 1950's this group created a series of time code standards suitable for use with recording oscillographs, magnetic tape and real time transmission. Each IRIG code specifies a carrier frequency that is modulated to encode date and time, as well as control bits to time stamp events. Initially, IRIG applications were primarily military and government associated. Today, IRIG is commonly used to synchronize voice loggers, recall recorders and sequential event loggers found in emergency dispatch centers and power utilities.

The NetClock/GPS is able to provide an IRIG B or IRIG E code in amplitude modulated (AM) or pulse width coded (TTL) formats. A signature control feature may be enabled for any IRIG output. Signature control removes the modulation code when a GPS Lock or Time Sync Alarm is asserted.

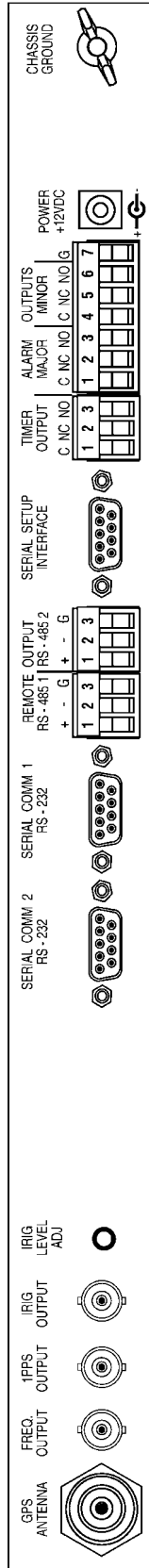

FIGURE 3-2 NETCLOCK/GPS REAR PANEL

Section 3: Operation

Amplitude modulated IRIG E is available with a 100 Hz or 1000 Hz carrier frequency. IRIG B by default, is only available with a 1000 Hz carrier. The signal level of the IRIG AM output is controlled by the IRIG Level ADJ potentiometer. The IRIG level is adjustable from 0 to 10 V peak-to-peak to meet the signal level requirements of various devices. The level adjust potentiometer has no effect on IRIG TTL outputs.

The IRIG output connector is configured using the command **IRIG**. Refer to Section 4, *Software Commands*, for a complete description of this command.

Appendix B of this manual provides detailed information on the IRIG B and IRIG E codes.

3.2.5 RS-232 Serial Communication Ports

The NetClock/GPS has two serial communication ports labeled Serial Comm 1 and Serial Comm 2. These ports provide an ASCII RS-232 data stream in the selected data format. There are five time data format selections and one position data stream in NMEA 0183 format available. Refer to Section 3.3 for a complete description of each data format. In addition to data formats, baud rate, UTC time difference and operation mode of both ports are selectable. A port may be enabled to output when interrogated by the connected device or continuously every second.

When using the Serial Comm ports in the interrogation mode, any keyboard symbol, number or upper case letter may be configured to request the time. The factory default request character is a capital letter T. NetClock/GPS responds with an asterisk (*) to all invalid commands or characters received. Do not follow a time request character with a line terminator (carriage return, enter, etc.).

The serial communication ports are configured by the commands **SER1** and **SER2**. Refer to Section 4, *Software Commands*, for a complete description of these commands.

The Serial Comm connectors are 9-pin series D females. Connector pin numbering is shown in Figure 3-3. Serial Comm pin assignments are listed in Table 3-1.

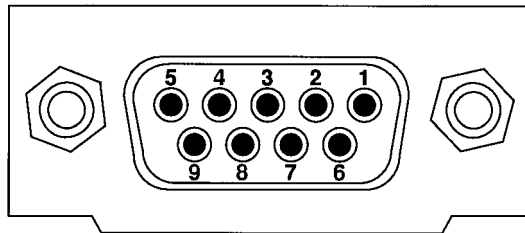

FIGURE 3-3 SERIAL COMM PIN NUMBERING

PIN	SIGNAL	I/O	DESCRIPTION
2	RXD	O	Receive Data
3	TXD	I	Transmit Data
5	GND	-	Signal Common
6	DSR	O	Data Set Ready
7	RTS	*	Request to Send
8	CTS	*	Clear to Send

*Pins 7 and 8 are connected together internally.

TABLE 3-1 SERIAL COMM PIN ASSIGNMENTS

Per EIA/TIA-574 standard, the NetClock/GPS Serial Comm ports are classified a data circuit-terminating equipment or DCE. Data is output on Pin 2, RXD and time commands are input on Pin 3, TXD. When connecting to data terminal equipment, DTE, (i.e. a personal computer) a one-to-one cable is used. Interfacing to a DCE requires reversing Pins 2 and 3 or a null modem. The Serial Comm ports require no flow control. The Request to Send and Clear to Send signals are internally connected together, and the DSR signal is held high through a pull-up resistor. The character structure is set for no parity, 8 data bits and 1 stop bit.

3.2.6 Remote Outputs

The NetClock/GPS has two Remote Outputs labeled RS-485 1 and RS-485 2. These outputs provide a continuous once-per-second time data stream in the selected data format. There are five time data format selections and one position data stream in NMEA 0183 format available. Refer to Section 3.3 for a complete description of the data format structures.

In addition to data formats, baud rate and UTC time difference of each output is selectable. The commands **REMI** and **REM2** configure the port's setup. Refer to Section 4 for a complete description of these commands.

A 3-position terminal block is supplied in the ancillary kit for each Remote Output. Connector pin assignments are shown in Figure 3-4.

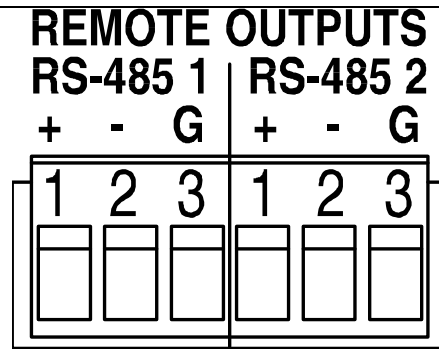

FIGURE 3-4 REMOTE OUTPUTS

RS-485 is a balanced differential transmission requiring twisted pair cabling. RS-485 characteristics make it ideal to distribute time data throughout a facility. Each Remote Output can provide time to 32 devices at cable lengths up to 4000 feet. Refer to Figure 3-5 for a schematic representation of each RS-485 output driver. Relative to RS-485 specifications, the A terminal (Pin 2) is negative with respect to the B terminal (Pin 1) for a mark or binary 1. The A terminal is positive to the B terminal for a space or binary 0.

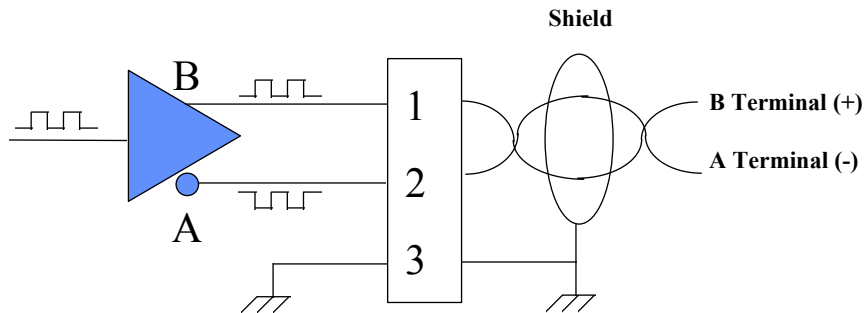

FIGURE 3-5 RS-485 OUTPUT

Spectracom offers many devices that accept the RS-485 data stream as an input reference. These products include display clocks, RS-485 to RS-232 converters, NTP time provider, talking clocks and radio link products to meet various time applications and requirements. For information on Remote Output usage refer to Section 3.4 of this chapter.

3.2.7 Serial Setup Interface

The Serial Setup Interface is an RS-232 communication port. Commands to configure output signal options, set operational parameters, perform test functions, view receiver performance and clock configuration are entered here. Refer to Section 4, *Software Commands*, for a complete description of the NetClock/GPS command set.

The Serial Setup Interface connector is a 9-pin series D female. Connector pin numbering is shown in Figure 3-6. Pin assignments are listed in Table 3-2.

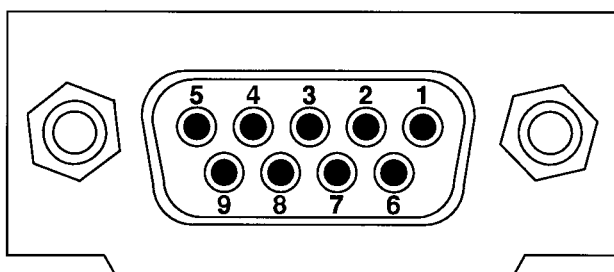

FIGURE 3-6 PIN NUMBERING

PIN	SIGNAL	I/O	DESCRIPTION
2	RXD	O	Receive Data
3	TXD	I	Transmit Data
5	GND	-	Signal Common
6	DSR	O	Data Set Ready
7	RTS	*	Request to Send
8	CTS	*	Clear to Send

*Pins 7 and 8 are connected together internally.

TABLE 3-2 PIN ASSIGNMENTS

The Serial Setup Interface communicates at 9600 baud with a character structure of 8 data bits, no parity, and 1 stop bit. Per EIA/TIA 574 standard, the setup port is classified as a data circuit-terminating equipment or DCE. Data is output on Pin 2, RXD and commands are input on Pin 3, TXD. When connecting to data terminal equipment, DTE, (i.e. a personal computer) a one to one cable is used. Interfacing to another DCE device (i.e. a modem) requires a null modem connection. Flow control is not required, though XON/XOFF is supported. The Request to Send (RTS) and Clear to Send (CTS) lines are internally connected together. Data Set Ready, DSR, is continuously held high by a pull up resistor.

The Serial Setup Interface is also used to update the flash memory with new code. This feature allows implementation of new features or code changes into field installed units. Upgrade announcements are posted on the Spectracom WEB page as they become available. The Internet address is www.spectracomcorp.com. A read me file is included in the batch file to provide the necessary instructions. Upgrades may also be provided on disk on a request basis only. Contact Spectracom customer service for upgrade requests and information.

3.2.8 Timer Output

The NetClock/GPS features a programmable 8-event timer with relay contact outputs. The relay contacts can control a bell, whistle, siren or other device based upon the timer setup. Each event has an assigned start and stop time having one second resolution. An event can be scheduled for daily, monthly or specific date occurrences.

An example of a daily event schedule is to sound the siren at the fire station at noon every day for five seconds.

An example of a dated event is to schedule a test of the emergency evacuation horns on May 9th, 2001 from 10:00 AM to 10:05 AM.

The event timer is configured using the command *EVNT*. Refer to Section 4, *Software Commands*, for a complete description on Event Timer programming.

Timer relay contacts are rated at 2.0 Amps, 30 VDC. A schematic representation of the timer relay contacts is shown in Figure 3-7. The mating 3-position terminal block is supplied in the ancillary kit.

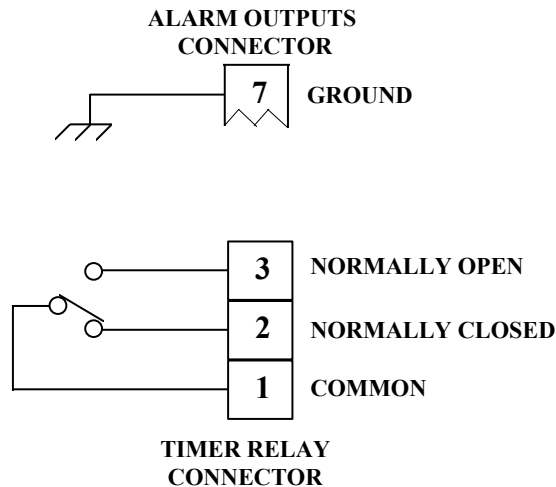

FIGURE 3-7 TIMER RELAY CONTACTS

When an event start time is reached the timer relay is energized producing continuity between Pins 1 (common) and 3 (normally open). At stop time, the relay is reset producing continuity between Pins 1 and 2 (normally closed). The relay contacts can be referenced to ground by connecting to Pin 7 of the Alarm Outputs connector.

3.2.9 Alarm Outputs

The NetClock/GPS divides alarm conditions into two categories, Major and Minor. A Major Alarm is asserted when fault conditions exist which affect the operation or accuracy of the unit. A Minor Alarm warns of conditions having no immediate effect on total operation, but may require corrective action.

A Major Alarm is asserted when the following alarms and conditions exist:

- Frequency Alarm: Measured oscillator frequency error exceeds 1×10^{-7} .
- Time Sync Alarm: The period of time allotted for operation without tracking a satellite has expired. Factory default period is 2 hours. The time sync period is programmable from 1 minute to 23 hours: 59 minutes: 59 seconds using the **SYNC** command described in Section 4, *Software Commands*.
- CPU Fault: The CPU is unable to communicate with the GPS receiver.
- Test Mode: Unit is placed in Test Mode operation.
- Power Failure: The NetClock/GPS has lost power.

A Minor Alarm is asserted when the following alarms and conditions exist:

- Oscillator Adjust: Warns that oscillator is operating within 10% of the minimum or maximum control setting. The oscillator requires manual adjustment.
- GPS Lock Alarm: The period of time allotted for operation without tracking a satellite has expired. Factory default is 15 minutes. The GPS lock period is programmable from 1 minute to 23 hours: 59 minutes: 59 seconds using the **LOCK** command described in Section 4, *Software Commands*.
- Antenna Problem: The antenna sense circuitry warns when the antenna is not connected or a cable short or open is detected.
- SmartWatch Invalid: A failure has been detected with the non-volatile RAM/Timekeeping integrated circuit. Memory is retained using lithium batteries having a minimum life expectancy of ten years. Contact Spectracom for IC replacement.
- Test Mode: Unit is placed in Test Mode operation.

The alarm relay contacts are rated at 2.0 Amps, 30 VDC. A schematic representation of the alarm relay contacts is shown in Figure 3-8. The mating 7-position terminal block is furnished in the ancillary kit.

Section 3: Operation

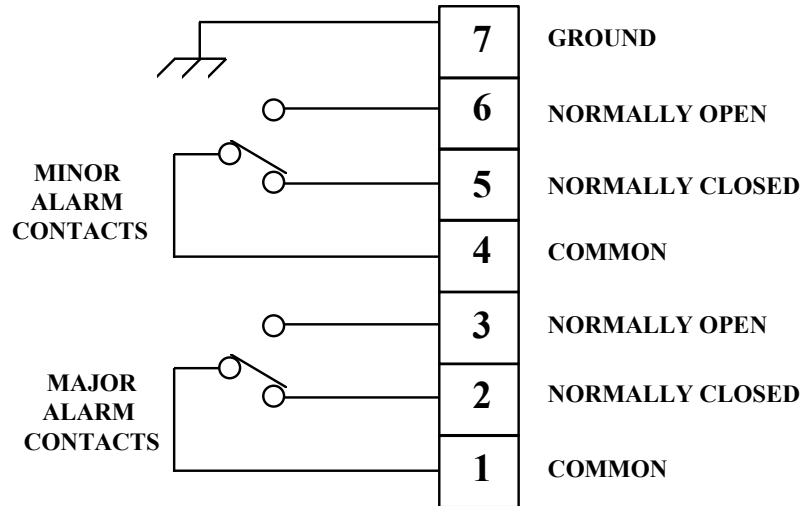

FIGURE 3-8 ALARM RELAY CONTACTS

Table 3-3 lists the alarm condition and the resulting contact status. During normal operation the Major Alarm relay is energized causing continuity between pins 1 and 3.

NOTE: The Major Alarm relay is reset when a Major Alarm is asserted. Therefore, continuity exists between Pins 1 and 2 during a Major Alarm condition.

The Minor Alarm relay is energized when a Minor Alarm is asserted. Therefore, continuity exists between Pins 4 and 6 during a Minor Alarm condition.

OPERATIONAL STATUS	MAJOR CONTACTS		MINOR CONTACTS	
	CLOSED	OPEN	CLOSED	OPEN
NORMAL OPERATION	1-3	1-2	4-5	4-6
MINOR ALARM	1-3	1-2	4-6	4-5
MAJOR ALARM	1-2	1-3	4-5	4-6
MINOR AND MAJOR ALARM	1-2	1-3	4-6	4-5

TABLE 3-3 ALARM OPERATION

The alarm relays reset when the condition causing the alarm is corrected. Relay contacts are isolated from ground. Contacts can be tied to ground by jumpering to Pin 7 of the Alarm Outputs connector.

In addition to alarm relays, operational status and alarm log history can be monitored using the Serial Setup Interface commands **STAT** and **DAL**. These commands are described in Section 4 of this manual.

3.2.10 ***DC Power***

The standard NetClock/GPS is powered by a 115 VAC to 12 VDC wall mount adapter. The power jack accepts barrel-type plugs with 5.5 mm O.D. shell and 2.1 I.D. center. Replacement adapters are available from Spectracom, specify part number T00058.

A power cord strain relief is provided in the ancillary kit to retain the power plug. Install the strain relief as described in Section 2.2.2.

An International Power Supply is also available from Spectracom, part number PS00142. This tabletop adapter can operate from a 100-250 VAC, 50/60 Hz power source. The PS00142 power adapter is shipped with a detachable line cord that is compatible with AC receptacles (NEMA 5-15R) commonly found in the United States and Canada. Alternate type line cords or adapters may be obtained locally.

3.2.11 ***Chassis Ground***

The chassis ground lug allows the clock chassis to be connected to a single point grounding system. Connecting the chassis to a single point ground system may be required in some installations to ensure optimum lightning protection. A separate earth ground is also recommended in installations where excessive noise on the power line degrades the GPS receiver performance.

Section 3: Operation

3.3 DATA FORMAT DESCRIPTION

This section describes each of the data format selections available on the NetClock/GPS Serial Comm and RS-485 Outputs. Format selection is made as part of the Serial Comm and Remote port configuration. Most applications utilize Data Format 0 or Data Format 2.

3.3.1 Format 0

Format 0 includes a time sync status character, day of year, time reflecting time zone offset and DST corrections when enabled. Format 0 also includes the DST/Standard Time indicator, and the time zone offset value. Format 0 data structure is shown below:

```
CR LF I ^ ^ DDD ^ HH:MM:SS ^ DTZ=XX CR LF
```

where:

CR = Carriage Return
LF = Line Feed
I = Time Sync Status (space, ?, *)
^ = space separator
DDD = Day of Year (001 - 366)
HH = Hours (00-23)
: = Colon separator
MM = Minutes (00-59)
SS = Seconds (00- 60)
D = Daylight Savings Time indicator (S,I,D,O)
TZ = Time Zone
XX = Time Zone offset (00-23)

The leading edge of the first character (CR) marks the on-time point of the data stream.

The time sync status character I is defined as described below:

(Space) = Whenever the front panel Time Sync lamp is green.
? = When the receiver is unable to track any satellites and the Time Sync lamp is red.
* = When the receiver time is derived from the battery backed clock or set manually through the Serial Setup Interface.

The Daylight Saving Time indicator D is defined as:

- S = During periods of Standard time for the selected DST schedule.
- I = During the 24-hour period preceding the change into DST
- D = During periods of Daylight Saving Time for the selected DST schedule
- O = During the 24-hour period preceding the change out of DST

Example: 271 12:45:36 DTZ=08

The example data stream provides the following information:

Sync Status: Time synchronized to GPS
Date: Day 271
Time: 12:45:36 Pacific Daylight Time
D = DST, Time Zone 08 = Pacific Time

Section 3: Operation

3.3.2 Format 1

This format provides the fully decoded time data stream. Format 1 converts the received day of year data (001-366) to a date consisting of day of week, month, and day of the month. Format 1 also contains a time sync status character, year, and time reflecting time zone offset and DST correction when enabled. Format 1 data structure is shown below:

CR LF I ^ WWW ^ DDMMYY ^ HH:MM:SS CR LF

where:

CR	=	Carriage Return
LF	=	Line Feed
I	=	Time Sync Status (space, ?, *)
^	=	space separator
WWW	=	Day of Week (SUN, MON, TUE, WED, THU, FRI, SAT)
DD	=	Numerical Day of Month (^1-31)
MMM	=	Month (JAN, FEB, MAR, APR, MAY, JUN, JUL, AUG, SEP, OCT, NOV, DEC)
YY	=	Year without century (99, 00, 01 etc.)
HH	=	Hours (00-23)
:	=	Colon separator
MM	=	Minutes (00-59)
SS	=	Seconds (00 - 60)

The leading edge of the first character (CR) marks the on-time point of the data stream.

The time sync status character I is defined as described below:

(Space)	=	Whenever the front panel Time Sync lamp is green.
?	=	When the receiver is unable to track any satellites and the Time Sync lamp is red.
*	=	When the receiver time is derived from the battery backed clock or set manually through the Serial Setup Interface.

Example: * FRI 20APR01 12:45:36

The example data stream provides the following information:

Sync Status:	The clock is not time synchronized to GPS. Time is derived from the battery backed clock or set manually
Date:	Friday, April 20, 2001
Time:	12:45:36

3.3.3 *Format 2*

This format provides a time data stream with millisecond resolution. The Format 2 data stream consists of indicators for time sync status, time quality, leap second and Daylight Saving Time. Time data reflects UTC time and is in the 24-hour format. Format 2 data structure is shown below:

CR LF IQYY ^ DDD ^ HH:MM:SS.sss ^ LD
where:

- CR = Carriage Return
- LF = Line Feed
- I = Time Sync Status (space, ?, *)
- Q = Quality Indicator (space, A, B, C, D)
- YY = Year without century (99, 00, 01 etc.)
- ^ = space separator
- DDD = Day of Year (001 - 366)
- HH = Hours (00-23 UTC time)
- :
- MM = Minutes (00-59)
- SS = Seconds (00-60)
- .
- SSS = Milliseconds (000-999)
- L = Leap Second Indicator (space, L)
- D = Daylight Saving Time Indicator (S,I,D,O)

The leading edge of the first character (CR) marks the on-time point of the data stream.

The time sync status character I is defined as described below:

- (Space) = Whenever the front panel Time Sync lamp is green.
- ? = When the receiver is unable to track any satellites and the Time Sync lamp is red.
- * = When the receiver time is derived from the battery backed clock or set manually through the Serial Setup Interface.

The quality indicator Q provides an inaccuracy estimate of the output data stream. When the receiver is unable to track any GPS satellites, a timer is started. Table 3-4 lists the quality indicators and the corresponding error estimates based upon the GPS receiver 1 PPS stability and the time elapsed tracking no satellites. The Tracking Zero Satellites timer and the quality indicator reset when the receiver reacquires a satellite.

Section 3: Operation

Inaccuracy Code	Time Error (mSec)	Time Since Unlock (Hours)
Space	<1	Locked
A	<10	<10
B	<100	<100
C	<500	<500
D	>500	>500

TABLE 3-4 QUALITY INDICATORS

The leap second indicator L is defined as:

- (Space) = When a leap second correction is not scheduled for the end of the month.
- L = When a leap second correction is scheduled for the end of the month.

The Daylight Saving Time indicator D is defined as:

- S = During periods of Standard time for the selected DST schedule.
- I = During the 24-hour period preceding the change into DST.
- D = During periods of Daylight Saving Time for the selected DST schedule.
- O = During the 24-hour period preceding the change out of DST.

Example: ?A01 271 12:45:36.123 S

The example data stream provides the following information:

Sync Status: The clock has lost GPS time sync. The inaccuracy code of “A” indicates the expected time error is <10 milliseconds.

Date: Day 271 of year 2001.

Time: 12:45:36 UTC time, Standard time is in effect.

3.3.4 Format 3

Format 3 provides a format identifier, time sync status character, year, month, day, time with time zone and DST corrections, time difference from UTC, Standard time/DST indicator, leap second indicator and on-time marker. Format 3 data structure is shown below:

FFFFI^YYYYMMDD^HHMMSS±HHMM L # CR LF

where:

- FFFF = Format Identifier (0003)
- I = Time Sync Status (Space, ? *)
- ^ = space separator
- YYYY = Year (1999, 2000, 2001 etc.)
- MM = Month Number (01-12)
- DD = Day of the Month (01-31)
- HH = Hours (00-23)
- MM = Minutes (00-59)
- SS = Seconds (00-60)
- ± = Positive or Negative UTC offset (+,-) Time Difference from UTC
- HHMM = UTC Time Difference Hours, Minutes (00:00-23:00)
- D = Daylight Saving Time Indicator (S,I,D,O)
- L = Leap Second Indicator (space, L)
- # = On time point
- CR = Carriage Return
- LF = Line Feed

The time sync status character I is defined as:

- (Space) = Whenever the front panel Time Sync lamp is green.
- ? = When the receiver is unable to track any satellites and the Time Sync lamp is red.
- * = When the receiver time is derived from the battery backed clock or set manually through the Serial Setup Interface.

The time difference from UTC, ±HHMM, is selected when the Serial Comm or Remote port is configured. A time difference of -0500 represents Eastern Time. UTC is represented by +0000.

Section 3: Operation

The Daylight Saving Time indicator D is defined as:

- S = During periods of standard time for the selected DST schedule.
- I = During the 24-hour period preceding the change into DST.
- D = During periods of Daylight Saving Time for the selected DST schedule.
- O = During the 24-hour period preceding the change out of DST.

The leap second indicator L is defined as:

- (Space) = When a leap second correction is not scheduled at the end of the month.
- L = When a leap second correction is scheduled at the months end.

Example: 0003 20010415 124536-0500D #

The example data stream provides the following information:

- Data Format: 3
- Sync Status: Time Synchronized to GPS.
- Date: April 15, 2001.
- Time: 12:45:36 EDT (Eastern Daylight Time), The time difference is 5 hours behind UTC.
- Leap Second: No leap second is scheduled for this month.

3.3.5 *Format 4*

Format 4 provides a format indicator, time sync status character, modified Julian date, time reflecting UTC with 0.1 millisecond resolution and a leap second indicator. Format 4 data structure is shown below:

FFFFIMJDXX^HHMMSS.SSSS^L CR LF

where:

- FFFF = Format Identifier (0004)
- I = Time Sync Status (Space, ? *)
- MJDXX = Modified Julian Date
- HH = Hours (00-23 UTC time)
- MM = Minutes (00-59)
- SS.SSSS = Seconds (00.0000-60.0000)
- L = Leap Second Indicator (^, L)
- CR = Carriage Return
- LF = Line Feed

The start bit of the first character marks the on-time point of the data stream.

The time sync status character I is defined as:

- (Space) = Whenever the front panel Time Sync lamp is green.
- ? = When the receiver is unable to track any satellites and the Time Sync lamp is red.
- * = When the receiver time is derived from the battery backed clock or set manually through the Serial Setup Interface.

The leap second indicator L is defined as:

- (Space) = When a leap second correction is not scheduled at the end of the month.
- L = when a leap second correction is scheduled at the months end.

Example: 0004 50085 124536.1942 L

The example data stream provides the following information:

- Data format: 4
- Sync Status: Time synchronized to GPS.
- Modified Julian Date: 50085
- Time: 12:45:36.1942 UTC
- Leap Second: A leap second is scheduled at the end of the month.

Section 3: Operation

3.3.6 Format 90

Format 90 provides a position data stream in NMEA 0183 GPGGA GPS Fix data format. The Format 90 data structure is shown below:

```
$GPGGA,HHMMSS.SS,ddmm.mmmm,n,dddmm.mmmm,e,Q,SS,YY.y,+AAAAA.a,M,,,,*CC CR LF
```

where:

\$GP = GPS System Talker
GGA = GPS Fix Data Message
HHMMSS.SS = Latest time of Position Fix, UTC. This field is blank until a 3D fix is acquired
ddmm.mmmm,n = Latitude
 dd = degrees, 00...90
 mm.mmmm = minutes, 00.0000....59.9999
 n = direction, N = North, S = South
dddmm.mmmm,e = Longitude
 ddd = degrees, 000...180
 mm.mmmm = minutes, 00.0000....59.9999
 e = direction, E = East, W = West
Q = Quality Indicator,
 0 = No 3D fix
 1 = 3D fix
SS = Number of satellites tracked, 0...8
YY.Y = Dilution of precision, 00.0...99.9
+AAAAA.a,M = Antenna height in meters, referenced to mean sea level
,,,, = Fields for geoidal separation and differential GPS not supported
cc = Check sum message, HEX 00...7F
 Check sum calculated by Xoring all bytes between \$ and *.
CR = Carriage Return
LF = Line Feed

Example:

\$GPGAA,151119.00,4307.0241,N,07729.2249,W,1,06,03.2,+00125.5,M,,,*3F

The example data stream provides the following information:

Time of Position Fix:	15:11:19.00 UTC
Latitude:	43° 07.0241' North
Longitude:	77° 29.2249' West
Quality:	3D fix
Satellites Used:	6
Dilution of Precision:	3.2
Antenna Height:	+125.5 meters above sea level
Check Sum:	3F

3.4 REMOTE OUTPUT USAGE

The Remote Outputs provide a continuous once-per-second time data stream in RS-485 levels. RS-485 is a balanced differential transmission, which offers exceptional noise immunity, long cable runs and multiple loading. These characteristics make RS-485 ideal for distributing time data throughout a facility. Each Remote Output can drive 32 devices over cable lengths up to 4000 feet. Spectracom manufactures wall clocks, NTP time providers, RS-485 to RS-232 converters and radio link products that utilize the RS-485 data stream as an input. Figures 3-9 and 3-10 illustrate typical RS-485 time data bus interconnections. Follow the guidelines listed below when constructing the RS-485 data bus.

3.4.1 RS-485 Guidelines

Cable selection: Low capacitance, shielded twisted pair cable is recommended for installations where the RS-485 cable length is expected to exceed 1500 feet. Table 3-5 suggests some manufacturers and part numbers for extended distance cables. These cables are specifically designed for RS-422 or RS-485 applications; they have a braided copper shield, nominal impedance of 120 ohms, and a capacitance of 12 to 16 picofarads per foot.

RS-485 cable may be purchased from Spectracom. Specify part number CW04xxx, where xxx equals the length in feet.

MANUFACTURER	PART NUMBER
Belden Wire and Cable Company 1-800-BELDEN-1	9841
Carol Cable Company 606-572-8000	C0841
National Wire and Cable Corp. 232-225-5611	D-210-1

TABLE 3-5 CABLE SOURCES FOR RS-485 LINES OVER 1500 FEET

For cable runs less than 1500 feet, a lower-cost twisted pair cable may be used. Refer to Table 3-6 for possible sources. In addition, Category 5 cable may be used for cable runs less than 1500 feet.

MANUFACTURER	PART NUMBER
Alpha Wire Corporation 1-800-52ALPHA	5471
Belden Wire and Cable Company 1-800-BELDEN-1	9501
Carol Cable Company 606-572-8000	C0600

TABLE 3-6 CABLE SOURCES FOR RS-485 LINES UNDER 1500 FEET

3.4.2 Connection Method

The RS-485 transmission line must be connected in a daisy chain configuration as shown in Figure 3-9. In a daisy chain configuration, the transmission line connects from one RS-485 receiver to the next. The transmission line appears as one continuous line to the RS-485 driver.

A branched or star configuration is not recommended. This method of connection appears as stubs to the RS-485 transmission line. Stub lengths affect the bus impedance and capacitive loading which could result in reflections and signal distortion.

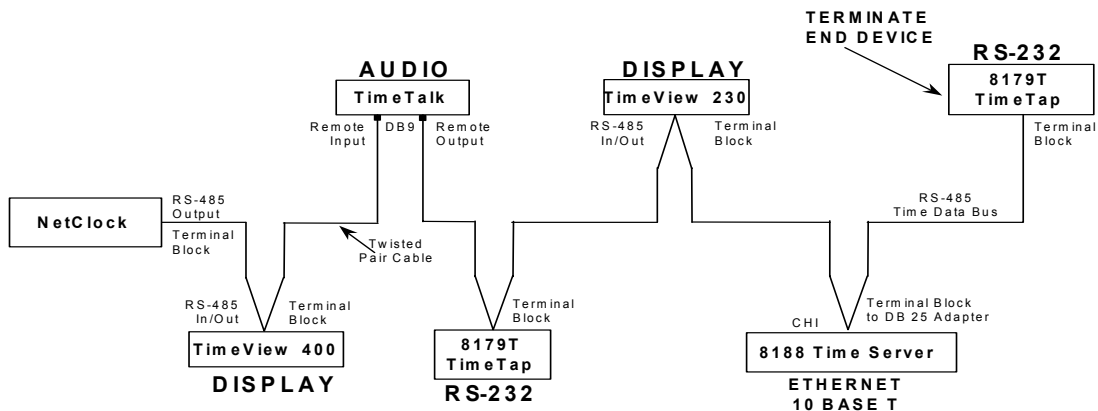

FIGURE 3-9 ONE-WAY BUS INSTALLATION

Section 3: Operation

The RS-485 Output can be split in two directions as shown in Figure 3-10. This allows the NetClock/GPS to be centrally located. Connecting in this method can simplify installation and possibly reduce the amount of cable required.

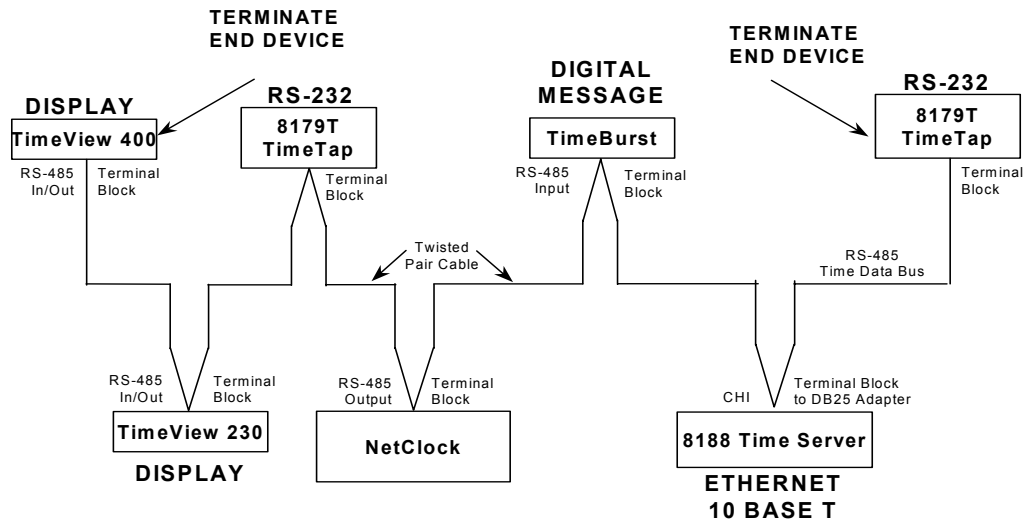

FIGURE 3-10 SPLIT BUS CONFIGURATION

Most RS-485 connections found on Spectracom equipment are made using a removable terminal strip. Wires are secured by a jaw that compresses the wires when tightened. When using small diameter wire, 22-26 gauge, a strain relief can be fashioned by wrapping the stripped wire over the insulating jacket as shown in Figure 3-11. Wrapping the wires in this manner prevents smaller gauge wires from breaking off when exposed to handling or movement.

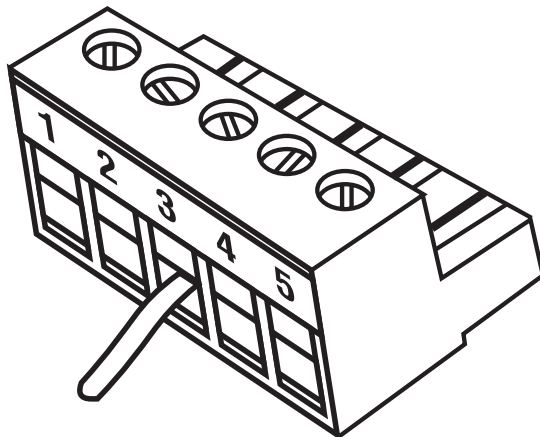

FIGURE 3-11 WIRE STRAIN RELIEF

Section 3: Operation

The Spectracom Model 8175, TimeView 230, is a display clock with 2.3 inch high digits. The Model 8177 TimeView 400 features 4.0 inch display digits. TimeView display clocks use a 6-position terminal block to connect to the RS-485 data bus. Connect the TimeView to the NetClock/GPS RS-485 Output as shown in Figure 3-12. The TimeView display clocks accept only Data Formats 0 or 1.

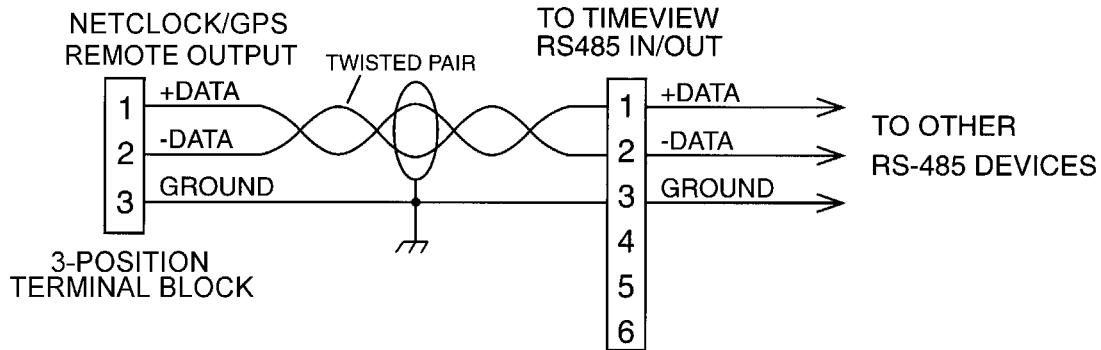

FIGURE 3-12 TIMEVIEW RS-485 INTERFACE

The Model 8179T, TimeTap, is an RS-485 to RS-232 converter. The Model 8179T has a DB9 RS-232 interface that receives operational power from the RS-232 flow control pins RTS or DTR. Connect the TimeTap to the RS-485 data bus as shown in Figure 3-13.

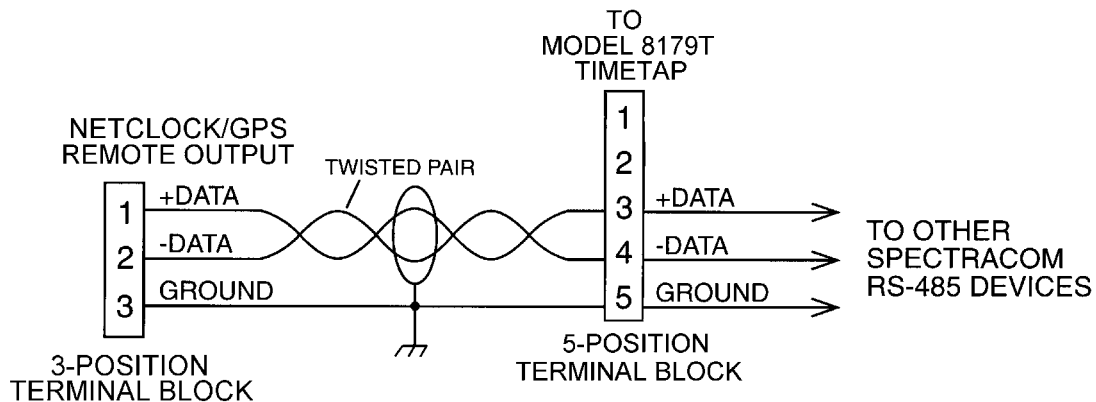

FIGURE 3-13 MODEL 8179T TIMETAP RS-485 INTERFACE

Spectracom Model 8188, NetClock/ETS is an Ethernet Time Server that supports NTP and SNTP time protocols. The Model 8188 accepts either Format 0 or Format 2 and connects to the RS-485 data bus through a three-position terminal block. Connect the Model 8188 to the Netclock/GPS as shown in Figure 3-14.

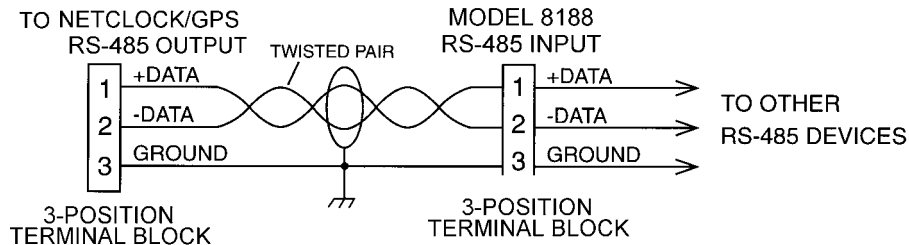

FIGURE 3-14 MODEL 8188 RS-485 INTERFACE

The Model 8185, TimeBurst™, provides a digital time-of-day data burst to a radio transmitter. The TimeBurst, when used with the Spectracom Model 8186 TimeBridge™, provides community-wide time synchronization from a single NetClock/GPS. The TimeBurst accepts only Format 0. Connect the TimeBurst to the RS-485 data bus using a 3-position terminal block as shown in Figure 3-15.

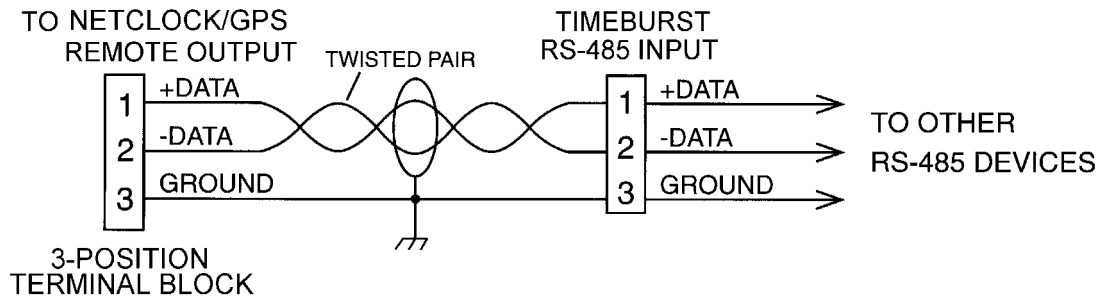

FIGURE 3-15 TIMEBURST RS-485 INTERFACE

3.4.3 Termination

A termination resistor is required on devices located at the ends of the RS-485 transmission line. Terminating the cable end preserves data integrity by preventing signal reflections.

For a one-way bus installation (shown in Figure 3-9), terminate the last device on the bus. The RS-485 data bus can be split in two directions as shown in Figure 3-10. In a split bus configuration, terminate the devices installed on each end of the bus. Most Spectracom products include a built in termination switch to terminate the RS-485 bus when required.

SECTION 4: SOFTWARE COMMANDS

4.0 INTRODUCTION

4.1...4.25 RS-232 COMMAND SET

SOFTWARE COMMANDS

4.0 INTRODUCTION

From the rear panel Serial Setup Interface port the user may configure, control and monitor the NetClock/GPS. Table 4-1 provides a listing of the command set in alphabetical order. These commands contain a hierarchy of *Read*, *Set* and *Test Modes*. Figure 4-1 illustrates the command structure. *Read Mode* is the base level, this mode the user may only view responses to commands. From *Read Mode*, the user may select to enter *Test* or *Set Mode*. *Set Mode* allows the user to not only view command responses, but configure changes to certain NetClock/GPS functions. *Test Mode* allows the user access to special test commands, as well as all *Read* and *Set Mode* commands. After entering *Set Mode* or *Test Mode*, the unit will “time out” and return to *Read Mode* after 15 minutes of inactivity.

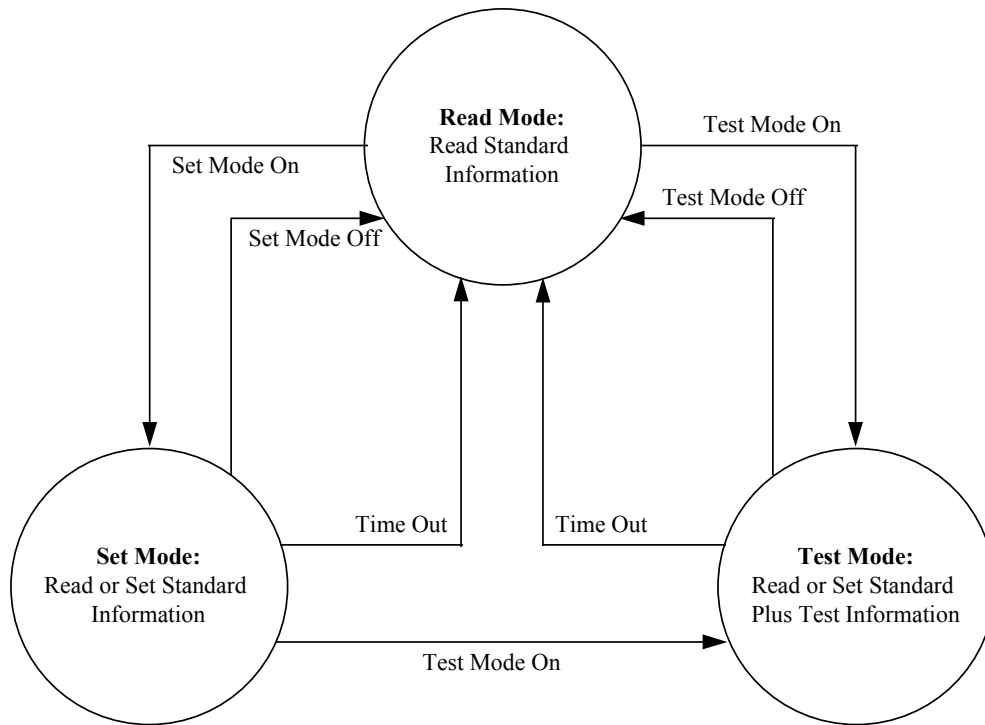

FIGURE 4-1 COMMAND STRUCTURE

Section 4: Software Commands

COMMAND	Description	Mode	Section
ACD	Antenna Cable Delay	Set	4.1
CONF	Display Output Configuration	Read	4.2
DAL	Display Alarm Log	Read	4.3
DATE	Date	Set	4.4
DEF	Set to Factory Defaults	Test	4.5
DH	Display Tracking Histogram	Read	4.6
DOL	Display Oscillator Log	Read	4.7
DST	Display DST rules	Read	4.8
EVNT	Event Output	Set	4.9
FPF	Front Panel Display format	Set	4.10
FREQ	Frequency Output Setup	Set	4.11
GSS	GPS Signal Strength	Read	4.12
HELP	Help Display	Read	4.13
IRIG	IRIG Output Setup	Set	4.14
LOC	Location	Set	4.15
LOCK	GPS Lock time-out	Set	4.16
REMX	Setup Remote Outputs	Set	4.17
RGPS	Reset GPS receiver	Test	4.18
SERx	Setup Serial Comm Ports	Set	4.19
SM	Set Mode		4.20
STAT	Display Status	Read	4.21
SYNC	Time Sync time-out	Set	4.22
TIME	Time	Set	4.23
TM	Test Mode		4.24
VER	Version	Read	4.25

TABLE 4-1 ALPHABETICAL LIST OF COMMANDS

4.2 **DISPLAY OUTPUT CONFIGURATION**

The command, **CONF**, displays the current settings for the clocks outputs. To view the output configurations, issue the **CONF** command as shown below:

Type: **CONF<ent>**

Sample response:

*FRONT PANEL FORMAT= 12 HOUR
TIME DIFF= -05:00 DST= 1*

*IRIG FORMAT= B LEVEL= AM CARRIER= 1000 HZ
SIGNATURE CONTROL= NONE TIME DIFF= -05:00 DST= 1*

FREQUENCY OUTPUT= 10 MHZ SIGNATURE CONTROL= NONE

*SERIAL PORT 1
BAUD RATE= 9600 FORMAT #= 02 REQUEST CHAR= T
TIME DIFF= -05:00 DST= 1*

*SERIAL PORT 2
BAUD RATE= 9600 FORMAT #= 02 REQUEST CHAR= T
TIME DIFF= -05:00 DST= 1*

*REMOTE PORT 1
BAUD RATE= 9600 FORMAT #= 01
TIME DIFF= -05:00 DST= 1*

*REMOTE PORT 2
BAUD RATE= 9600 FORMAT #= 01
TIME DIFF= -05:00 DST= 1*

4.3 *DISPLAY ALARM LOG*

The command, **DAL**, causes the clock to output the alarm history log. Each time a change in alarm status occurs, an alarm log is created. An alarm log includes the UTC time and date of the log, event relay status, alarm relay status and lists the conditions causing the alarms. The alarm log can be displayed a page at a time by adding the letter **P** to the command. At the end of each page the option to display more or quit will be given.

Type: **DAL <ent>**
 - OR -
DAL P <ent> (paged output)

An example of a paged alarm log is shown below:

```

TIME = 14:01:03 DATE = 2001-04-12 STATUS CHANGE
EVENT RELAY          = OFF
ALARM RELAYS: MAJOR = ON  MINOR = ON
ACTIVE ALARMS: MAJOR AND MINOR
FREQUENCY
IN TEST MODE
ADJUST OSCILLATOR
TIME = 14:01:11 DATE = 2001-04-12 STATUS CHANGE
EVENT RELAY          = OFF
ALARM RELAYS: MAJOR = ON  MINOR = ON
ACTIVE ALARMS: MAJOR AND MINOR
FREQUENCY
IN TEST MODE
TIME = 14:02:13 DATE = 2001-04-12 STATUS CHANGE
EVENT RELAY          = OFF
ALARM RELAYS: MAJOR = ON  MINOR = ON
ACTIVE ALARMS: MAJOR
FREQUENCY
TIME = 14:03:39 DATE = 2001-04-12 STATUS CHANGE
EVENT RELAY          = OFF
ALARM RELAYS: MAJOR = ON  MINOR = ON
ACTIVE ALARMS: MAJOR AND MINOR
FREQUENCY
MORE <ANY KEY> QUIT <ESC>
TIME = 14:09:50 DATE = 2001-04-12 STATUS CHANGE
EVENT RELAY= OFF
ALARM RELAYS: MAJOR = ON  MINOR = ON
ACTIVE ALARMS: MAJOR AND MINOR
FREQUENCY
ADJUST OSCILLATOR

END OF LOG

```

4.4 *DATE*

The *DATE* command reads or sets the date of the NetClock/GPS. To retrieve the current UTC date, issue the *DATE* command as shown below:

Type: *DATE <ent>*
Response: *DATE = YYYY-MM-DD*
Where: *YYYY* = Year value, 1999, 2000, 2001, etc.
MM = Month value, 01 to 12, 01= January, 04= April
DD = Day of the month, 01 to 31
- = Hyphen

To set the date, place the clock in *Set Mode*, then issue the *DATE* command as follows:

Type: *DATE YYYY-MM-DD <ent>*
Where: *YYYY-MM-DD* = As defined above.

The clock responds with the date message reflecting the date entered.

NOTE: The date can not be set on clocks tracking GPS satellites. The set date is overwritten with the received date information.

Example: Set the date for May 9, 2001.

Type: *SM ON <ent>*
Response: *SET MODE ON*
Type: *DATE 2001-05-09 <ent>*
Response: *DATE =2001-05-09*

4.5 RESTORE FACTORY DEFAULTS

The **DEF** command returns all selectable parameters to the factory default settings. The clock must be placed in *Test Mode* to execute the **DEF** command. The factory default settings are listed below:

FRONT PANEL FORMAT= 24 HOUR
TIME DIFF= +00:00 DST= 0

IRIG FORMAT= B LEVEL = AM CARRIER= 1000 HZ
SIGNATURE CONTROL= NONE TIME DIFF= +00:00 DST= 0

FREQUENCY OUTPUT= 10 MHZ SIGNATURE CONTROL= NONE

SERIAL PORT 1
BAUD RATE= 9600 FORMAT#= 00 REQUEST CHAR= T
TIME DIFF= +00:00 DST= 0

SERIAL PORT 2
BAUD RATE= 9600 FORMAT#= 00 REQUEST CHAR= T
TIME DIFF= +00:00 DST= 0

REMOTE PORT 1
BAUD RATE= 9600 FORMAT#= 00
TIME DIFF= +00:00 DST= 0

REMOTE PORT 2
BAUD RATE= 9600 FORMAT#= 00
TIME DIFF= +00:00 DST= 0

LOCK TIME OUT= 00:15:00
SYNC TIME OUT= 02:00:00

To restore the clock to factory default settings enter the following:

Type: **TM ON <ent>**

Sample response: TIME= 15:31:57 DATE= 2001-04-18 STATUS CHANGE
EVENT RELAY= OFF
ALARM RELAYS: MAJOR= ON MINOR= ON
ACTIVE ALARMS: MAJOR AND MINOR
IN TEST MODE

Type: **DEF <ent>**

Response: ALL PARAMETERS SET TO FACTORY DEFAULTS

4.6 *DISPLAY TRACKING HISTOGRAM*

This command outputs the tracking histogram. The histogram records the number of qualified satellites tracked each second. At the end of every hour, a log entry is created and the counters start again. The command responds with the last four hourly entries of the histogram and current histogram in process. The tracking histogram is useful in verifying receiver and antenna performance.

Type: *DH* <*ent*>

The tracking histogram is output in the following format:

```
TIME= HH:MM:SS DATE= YYYY-MM-DD QUALIFIED HISTOGRAM
```

```
0= XXXXX 1= XXXXX 2= XXXXX 3= XXXXX 4= XXXXX  
5= XXXXX 6= XXXXX 7= XXXXX 8= XXXXX Q=QQQQQ
```

Where: *HH:MM:SS* = UTC time log was created.
 YYYY-MM-DD = Date log was created.
 XXXXX = Number of seconds the receiver tracked the listed
 quantity of satellites since the beginning of the
 hour, 0...3600.
 QQQQQ = Number of seconds since the beginning of the hour
 the GPS signal was qualified, 0...3600.

Typically, the receiver tracks two to three satellites when using a Model 8228 Window Mount GPS Antenna. When using the Model 8225 Outdoor antenna, the receiver will typically track five or more satellites. The NetClock/GPS needs to track only one qualified satellite to provide accurate and traceable time.

Occasionally, there may be periods when the receiver is unable to track satellites. When this occurs, the Time Sync alarm count down timer is started. The Sync Alarm Timer resets whenever the receiver reacquires and qualifies at least one satellite for one minute. If a receiver is unable to receive and qualify any satellites within the SYNC alarm period (default is two hours), a Time Sync Alarm is asserted.

Satellites are qualified as valid when the received vehicle ID number is greater than 1 and the satellite is available for Position Fix usage. The qualification count "Q" is incremented for each second these conditions are met. Typically, the Q value for each hour should exceed 3000.

Example: To view the satellite tracking histogram type the following:

Type: **DH** <ent>

Typical response:

*TIME= 16:00:00 DATE= 2001-04-08 QUALIFIED HISTOGRAM
0= 00000 1= 00000 2= 00000 3= 00000 4= 00000
5= 00000 6= 00000 7= 01109 8= 02491 Q= 03600*

*TIME= 17:00:00 DATE= 2001-04-08 QUALIFIED HISTOGRAM
0= 00000 1= 00000 2= 00000 3= 00000 4= 00000
5= 00000 6= 00414 7= 03186 8= 00000 Q= 03600*

*TIME= 18:00:00 DATE= 2001-04-08 QUALIFIED HISTOGRAM
0= 00000 1= 00000 2= 00000 3= 00000 4= 00000
5= 00000 6= 00067 7= 02919 8= 00614 Q= 03600*

*TIME= 19:00:00 DATE= 2001-04-08 QUALIFIED HISTOGRAM
0= 00000 1= 00000 2= 00000 3= 00000 4= 00000
5= 00000 6= 00000 7= 00254 8= 03346 Q= 03600*

*TIME= 19:18:50 DATE= 2001-04-08 QUALIFIED HISTOGRAM
0= 00000 1= 00000 2= 00000 3= 00000 4= 00000
5= 00000 6= 00000 7= 00000 8= 01130 Q= 01130*

END OF LOG

4.7 DISPLAY OSCILLATOR LOG

The TCXO Oscillator Log History may be viewed by sending the **DOL** command. The oscillator log response begins with a header containing all firmware version levels and the time and date since power up. Entries are made to this log when the following events occur:

1. **Valid Frequency Measurement:** Every 100 seconds the TCXO 10 MHz oscillator frequency is measured against the GPS 1 PPS reference. Valid frequency measurements contain a UTC time and date stamp, current D/A value, fractional frequency error and measured frequency. An example of a Valid Frequency Measurement is shown below:

```
TIME = 13:04:17 DATE = 2001-04-12 D/A = 823C FREQ ERROR = -1.00E-09  
FREQ CNT = 999, 999, 999
```

2. **Automatic D/A Adjustment:** The TCXO frequency is controlled by a D/A converter. A new D/A value or automatic adjustment is determined when three of the last 3 or 4 Valid Frequency Measurements agree within 2×10^{-8} . Each Automatic Adjustment Log contains a UTC time and date stamp, match count, adjustment count, average frequency error and new D/A value. An example Automatic Adjustment Log is shown below:

```
TIME = 13:17:53 DATE = 2001-04-12 AUTOMATIC D/A ADJUSTMENT  
MATCH CNT = 02468 FREQ ADJ CNT = 01875
```

The Match Count is the number of automatic adjustments made since power on. The Frequency Adjustment Counter is the number times since power on a new D/A value was created.

3. **Manual Adjustment:** This log records whenever the D/A has been set manually by the user. The Manual Adjustment Log, shown below, contains a UTC time and date stamp and the manually set D/A value.

```
TIME = 13:25:00 DATE = 2001-04-12 D/A MANUALLY SET TO = 8238
```

4. **Reset GPS Receiver:** Each time the GPS receiver is reset using the *Test Mode* command, **RGPS**, a log is created. The Reset GPS Log, shown below, contains a UTC time and date stamp and a self-test message.

```
TIME = 13:28:07 DATE = 2001-04-12 RESET GPS RECEIVER  
SELF-TEST = PASS
```

A numeric self-test response indicates a GPS receiver problem, contact Spectracom.

Section 4: Software Commands

5. **Power On Reset:** The Power On Reset log contains a UTC time and date stamp and flash memory page selected. This log is created when power is restored to the clock. An example of the Power On Reset log is shown below:

```
TIME = 13:21:20 DATE = 2001-04-12 POWER ON RESET  
USING FLASH PAGE = 00
```

6. **First Satellite Acquired:** This log time stamps when the receiver acquires a satellite for the first time. An example log entry is shown below:

```
TIME = 13:21:34 DATE = 2001-04-12 FIRST SATELLITE ACQUIRED
```

7. **3D-Fix Acquired.** This log entry records whenever the receiver acquires a re-acquires a 3-D fix for 1 minute. The log entry contains a UTC time and date stamp and position fix data. An example of this log is shown below:

```
TIME = 13:22:48 DATE = 2001-04-12 3-D FIX ACQUIRED  
LATITUDE = N 43 07 01.527 LONGITUDE = W 077 29 14.260 HEIGHT = +00139.85 METERS
```

The **DOL** response can be output in a continuous format or a paged format by adding the **P** parameter to the command. While in *Read Mode* the **DOL** response is three pages long. The **DOL** response is extended to 24 pages by placing the clock in *Test Mode*.

Type: **DOL <ent>**
- OR -
DOL P <ent> (paged output)

The oscillator log may be sorted for specific types of entries by adding the corresponding entry number to the command line.

Type: **DOL # <ent>**
- OR -
DOL P # <ent> (paged output)

Where: # = Entry number, 1...7

- 1 = Valid Frequency Measurement
- 2 = Automatic D/A Adjustment
- 3 = Manual Adjustment
- 4 = Reset GPS Receiver
- 5 = Power on Reset
- 6 = First Satellite Acquired
- 7 = 3-D Fix Acquired

Example: Retrieve the complete oscillator log in a paged format:

Type: **DOL P <ent>**

Section 4: Software Commands

Response:

```
Spectracom Corporation Netclock/GPS Model 8183
Software Version 2.07 Date: September 02, 2000 14:31:28
Unit Started 20:42:39 2001-02-15
Front Panel Version 1.02
IRIG Version 1.02
Serial Port 1 Version 2.03
Serial Port 2 Version 2.03
Remote Port 1 Version 2.03
Remote Port 2 Version 2.03
GPS Receiver = 8 Channel GT Version 2
  TIME= 18:47:00 DATE= 2001-04-08 AUTOMATIC D/A ADJUSTMENT
  MATCH CNT= 14399 FREQ ADJ CNT= 13410
  AVG FREQUENCY ERROR= -5.00E-09 NEW D/A= 8167
  TIME= 18:48:42 DATE= 2001-04-08 D/A= 8167 FREQ ERROR= +4.00E-09
  FREQ CNT= 1,000,000,004
  TIME= 18:50:24 DATE= 2001-04-08 D/A= 8167 FREQ ERROR= -5.00E-09
  FREQ CNT= 999,999,995
  TIME= 18:52:06 DATE= 2001-04-08 D/A= 8167 FREQ ERROR= +1.00E-09
  FREQ CNT= 1,000,000,001
  TIME= 18:52:06 DATE= 2001-04-08 AUTOMATIC D/A ADJUSTMENT
  MATCH CNT= 14400 FREQ ADJ CNT= 13410
  AVG FREQUENCY ERROR= +0.00E-09 NEW D/A= 8167
  MORE<ANY> QUIT<ESC>
```

Example: Retrieve only the Automatic Adjustment Logs:

Type: **DOL 2 <ent>**

Response:

```
SPECTRACOM CORPORATION NETCLOCK GPS
Software Version 2.07 Date: September 02, 2000 14:31:28
Unit Started 20:42:39 2001-02-15
Front Panel Version 1.02
IRIG Version 1.02
Serial Port 1 Version 2.03
Serial Port 2 Version 2.03
Remote Port 1 Version 2.03
Remote Port 2 Version 2.03
GPS Receiver = 8 Channel GT Version 2
  TIME = 16:40:38 DATE = 2001-04-12 AUTOMATIC D/A ADJUSTMENT
  MATCH CNT = 02512 FREQ ADJ CNT = 01932
  AVG FREQUENCY ERROR = -4.00E-09 NEW D/A = 8175
  TIME = 16:45:44 DATE = 2001-04-12 AUTOMATIC D/A ADJUSTMENT
  MATCH CNT = 02513 FREQ ADJ CNT = 01933
  AVG FREQUENCY ERROR = -3.00E-09 NEW D/A = 817B
  TIME = 16:50:50 DATE = 2001-04-12 AUTOMATIC D/A ADJUSTMENT
  MATCH CNT = 02514 FREQ ADJ CNT = 01934
  AVG FREQUENCY ERROR = -3.00E-09 NEW D/A = 8181
  TIME = 16:55:56 DATE = 2001-04-12 AUTOMATIC D/A ADJUSTMENT
  MATCH CNT = 02515 FREQ ADJ CNT = 01935
  AVG FREQUENCY ERROR = -3.00E-09 NEW D/A = 8187
  TIME = 17:01:02 DATE = 2001-04-12 AUTOMATIC D/A ADJUSTMENT
  MATCH CNT = 02516 FREQ ADJ CNT = 01936
  AVG FREQUENCY ERROR = -2.00E-09 NEW D/A = 818B
```

END OF LOG

4.8 DAYLIGHT SAVING TIME

Daylight Saving Time corrections can be implemented on the NetClock/GPS display, IRIG, Serial Comm and Remote Outputs. Each output has a configuration command that allows selection of a DST rule applied to that output. There are six DST rules to choose from numbered 1 through 6.

Note: To select always Standard Time place a 0 (zero) in the command space reserved for the DST rule number.

The factory default rules are as follows:

North America - DST RULE #1
INTO DATE= 1RST SUN APR TIME= 02:00 ADJ= 01:00
OUT-OF DATE= LAST SUN OCT TIME= 02:00

United Kingdom - DST RULE #2
INTO DATE= LAST SUN MAR TIME= 02:00 ADJ= 01:00
OUT-OF DATE= LAST SUN OCT TIME= 02:00

Continental Europe - DST RULE #3
INTO DATE= LAST SUN MAR TIME= 02:00 ADJ= 01:00
OUT-OF DATE= LAST SUN SEP TIME= 02:00

China - DST RULE #4
INTO DATE= 04-12 TIME= 02:00 ADJ= 01:00
OUT-OF DATE= 09-12 TIME= 02:00

Australian 1 - DST RULE #5
INTO DATE= LAST SUN OCT TIME= 02:00 ADJ= 01:00
OUT-OF DATE= LAST SAT MAR TIME= 02:00

Australian 2 - DST RULE #6
INTO DATE= LAST SUN OCT TIME= 02:00 ADJ= 01:00
OUT-OF DATE= 1ST SAT MAR TIME= 02:00

To review the current list of DST rules, issue the **DST** command as shown below:

Type: **DST <ent>**

Specific rules can be viewed by adding the DST rule number to the command as shown below:

Type: **DST# <ent>**

Where: # = DST rule, 1...6

Section 4: Software Commands

Any of the six DST rules can be modified to keep up with changes in DST implementation. Rules are structured in a week # - day of week - month or a month - day format.

To change when DST begins (into date), issue the following command:

Type: ***DSTX IN WWWW DDD MMM HH:MM HH:MM <ent>***

Where: ***X*** = Rule number, 1...6
WWWW = Week number, 1rst, 2nd, 3rd, 4th, LAST
DDD = Day of week, SUN, MON, TUE, WED, THU, FRI, SAT
MMM = Month, JAN, FEB, MAR, APR, JUN, JUL, AUG, SEP, OCT, NOV, DEC.
HH:MM = Time of change hours:minutes
HH:MM = Amount of change hours:minutes
- OR -

Type: ***DSTX IN MM DD HH:MM HH:MM <ent>***

Where: ***X*** = Rule number, 1...6
MM = Month 01...12
DD = Day of month 01...31
HH:MM = Time change, hours:minutes
HH:MM = Amount of change, hours:minutes

To change when DST ends (out-of date), issue the following command:

Type: ***DSTX OUT WWWW DDD MMM HH:MM <ent>***

Where: ***X*** = Rule number, 1...6
WWWW = Week number, 1rst, 2nd, 3rd, 4th, LAST
DDD = Day of week, SUN, MON, TUE, WED, THU, FRI, SAT
MMM = Month, JAN, FEB, MAR, APR, MAY, JUN, JUL, AUG, SEP, OCT, NOV, DEC.
HH:MM = Time of change, hours:minutes
- OR -

Type: ***DSTX OUT MM DD HH:MM <ent>***

Where: ***X*** = Rule number, 1...6
MM = Month, 01...12
DD = Day of month, 01...31
HH:MM = Time of change hours:minutes

Section 4: Software Commands

Example: Congress has decided to extend Daylight Saving time by 2 weeks. DST will now start the last Sunday in March and end on the first Sunday in November. The time of the change (2:00am), and the amount of the change (1 hour) remains unchanged.

Follow the steps below to implement the new North American DST rule.

Type: ***SM ON <ent>***

Response: *SET MODE ON*

Type: ***DST1 IN LAST SUN MAR 02:00 01:00***

Response: *DST RULE #1*

INTO DATE = LAST SUN MAR TIME = 02:00 ADJ = 01:00

OUT-OF-DATE = LAST SUN OCT TIME = 02:00

Type: ***DST1 OUT 1RST SUN NOV 02:00***

Response: *DST RULE #1*

INTO DATE = LAST SUN MAR TIME = 02:00 ADJ = 01:00

OUT-OF-DATE = 1RST SUN NOV TIME = 02:00

4.9 *EVENT RELAY*

The Event Timer Relay output can be programmed with up to eight events. The event program includes, event enable, on time, off time, schedule, and time base selection. Each of these parameters is divided into separate commands.

To view the current program for all eight events:

Type: *EVNT <ent>*

Default Response: *EVENT # ACTIVE = NO DAY = EVERY
ON TIME = 00:00:00 OFF TIME = 00:00:00 TIME BASE = UTC.*

Where: # = Event Number, 1...8.

To view a specific event, include the event number following the command as shown below:

Type: *EVNT [#] <ent>*

Where: # = Event number, 1...8

Example response: *EVENT 2 ACTIVE = YES DAY = WEEK DAYS
ON TIME = 10:32:00 OFF TIME = 10:35:00 TIME BASE = FRONT PANEL*

EVENT TIMER PROGRAMMING

An event is programmed using a series of commands to configure each parameter. The unit must be placed in *Set Mode* when using these commands.

EVENT ENABLE/DISABLE

The *ACTIVE* command enables or disables an event program. The command is entered as shown below:

Type: *EVNT [#] ACTIVE [YES: NO] <ent>*

Where: # = Event number, 1...8
YES = Event enabled
NO = Event disabled

SET EVENT ON AND OFF TIMES

The event ON time is programmed as shown below:

Type: ***EVNT [#] ON [HH:MM:SS]<ent>***

The Event OFF time is programmed as shown below:

Type: ***EVNT [#] OFF [HH:MM:SS]<ent>***

Where: # = Event number, 1...8
HH:MM:SS = Hours:Minutes:Seconds

SELECT EVENT SCHEDULE

Event routines can be scheduled on a daily, monthly or on a specific date.

Daily event schedules are programmed using the ***DAY*** command as shown below:

Type: ***EVNT [#] DAY
[ALL:WKD:WKE:SUN:MON:TUE:WED:THU:FRI:SAT]<ent>***

Where:# =Event number, 1...8
ALL = Everyday
WKD = Weekdays, Monday...Friday
WKE = Weekends, Saturday/Sunday
SUN = Sunday
MON = Monday
TUE = Tuesday
WED = Wednesday
THU = Thursday
FRI = Friday
SAT = Saturday

Section 4: Software Commands

Monthly event schedules are programmed using the **MONTHLY** command as shown below:

Type: **EVNT [#] MONTHLY [DD]<ent>**

Where: # = Event number, 1...8
DD = Day of Month, 01...31

Events may also be configured for a specific date. The **DATE** command structure is shown below:

Type: **EVNT [#] DATE [YYYY-MM-DD]<ent>**

Where: # = Event number, 1...8
YYYY = Year
MM = Month number, 01...12
DD = Day of month, 01...31
- = Hyphen

SELECT TIME BASE

The Time Base of the Event Timer can be configured to follow the time found on the front panel, IRIG output, Serial Comm outputs, Remote Outputs or UTC time. Select the Event time base using the **TIME** command as shown below:

Type: **EVNT [#] TIME [UTC:IRIG:FP:REM1:REM2:SER1:SER2]<ent>**

Where: # = Event number, 1...8
UTC = UTC Time
IRIG = IRIG Time
FP = Front panel display time
REM1 = Remote Output 1 time
REM2 = Remote Output 2 time
SER1 = Serial Comm 1 time
SER2 = Serial Comm 2 time

NOTE: The programmed time in the event configuration is always expressed in 24-hour format. For example, a time of 2:00 PM is programmed in as 14:00.

Example Program:

Configure Event 3 to ring the end of shift bell at 5:00 pm for 5 seconds on weekdays. The time shall follow the front panel display. Follow the steps listed below to program Event 3 as described.

- Step 1 - Place the unit in *Set Mode*
Command: **SM ON <ent>**
- Step 2 - Enable Event 3
Command: **EVNT 3 ACTIVE YES<ent>**
- Step 3 - Set ON Time
Command: **EVNT 3 ON 17:00:00 <ent>**
- Step 4 - Set OFF Time
Command: **EVNT 3 OFF 17:00:05 <ent>**
- Step 5 - Select Schedule
Command: **EVNT 3 DAY WKD <ent>**
- Step 6 - Select Time Base
Command: **EVNT 3 TIME FP <ent>**
- Step 7 - Turn Off *Set Mode*
Command: **SM OFF**

Example Program Complete.

4.10 FRONT PANEL FORMAT

The command, **FPF**, reads and sets the front panel display configuration. Display options include 12 or 24 hour display format, UTC or local time with or without DST corrections.

To view the current display configuration, issue the **FPF** command as shown below:

Type: **FPF <ent>**
Default Response: *FRONT PANEL FORMAT= 24 HOUR*
TIME DIFF= +00:00 DST= 0

To change the front panel display format, place the clock in *Set Mode* and issue the **FPF** command as follows:

Type: **FPF [12:24] [±HH:MM] [#] <ent>**

Where: **12** = 12 Hour Display Format
24 = 24 Hour Display Format
±HH:MM = Time Difference from UTC, ±00:00...±12:00; Refer to Figure 4-2 for UTC time difference map.
= DST rule number, 0...6.

Where: 0 = No DST, Always Standard Time
1 = North American
2 = United Kingdom
3 = Continental Europe
4 = China
5 = Australian 1
6 = Australian 2

Example, configure the front panel display for 12 hour format, Eastern Time with Daylight Saving Time.

Type: **SM ON <ent>**
Response: *SET MODE ON*
Type: **FPF 12 -05:00 1 <ent>**
Response: *FRONT PANEL FORMAT = 12 HOUR*
TIME DIFF = -05:00 DST = 1

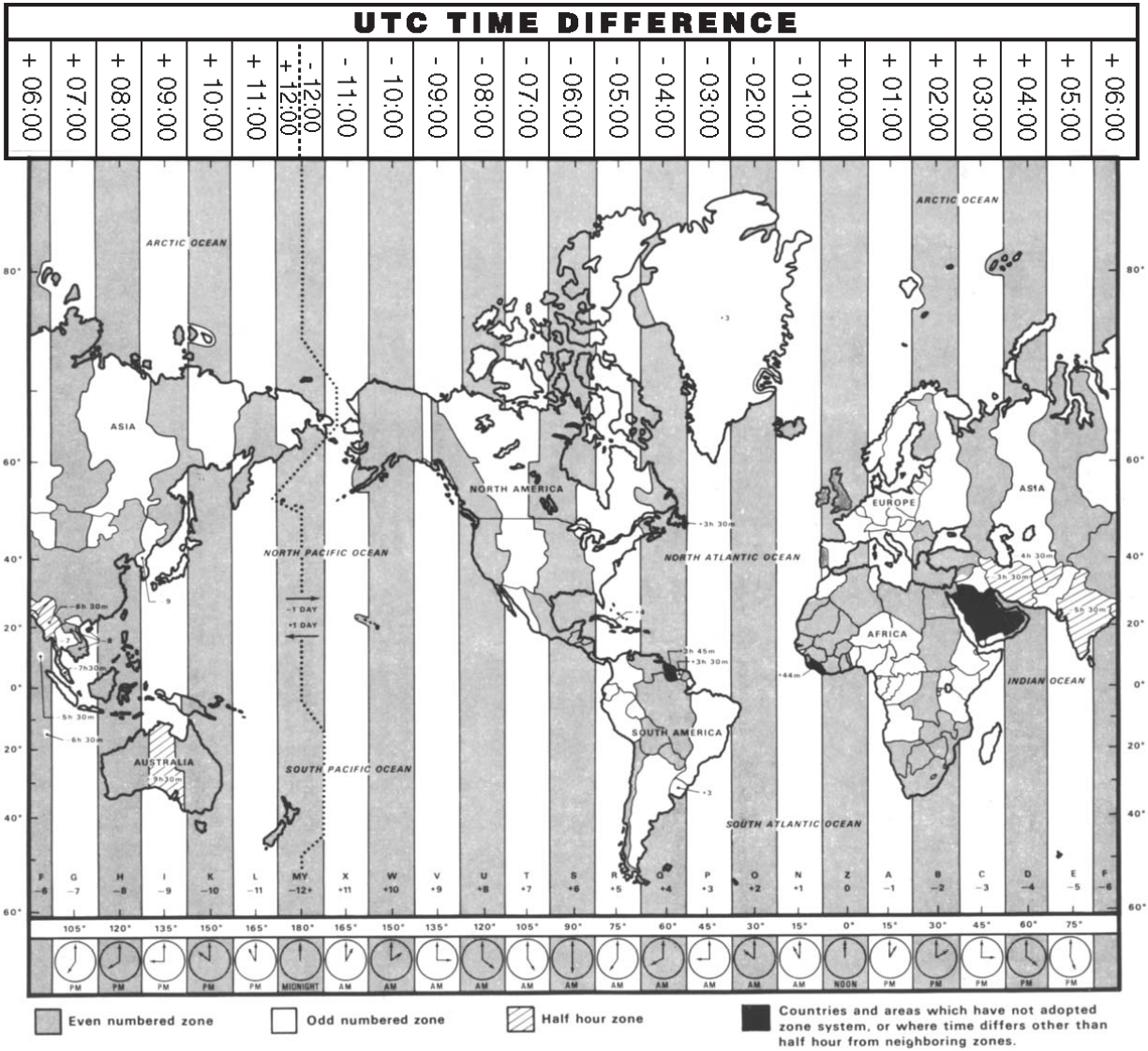

FIGURE 4-2 TIME DIFFERENCE MAP

4.11 FREQUENCY OUTPUT

The command, **FREQ**, reads and sets the configuration of the FREQ Output connector. The FREQ Output signal selections are a 10-MHz sine wave or a pulse width coded (TTL) IRIG. The 10-MHz is derived from the GPS disciplined TCXO time base. The format of the TTL IRIG signal, IRIG B or IRIG E, is selected using the IRIG configuration command. Signature Control can be added to the 10 MHz output only. Signature Control removes the output signal when the selected alarm condition, GPS Lock or Time Sync is active. The output is restored when the alarm condition is reset.

The current FREQ Output configuration can be viewed using the **FREQ** command as shown below:

Type: **FREQ <ent>**
Default Response: *Frequency Output = 10 MHz Signature Control = NONE*

To change the FREQ Output configuration, place the unit in *Set Mode* and issue the **FREQ** command as follows:

Type: **FREQ [10:0] [NONE: LOCK: SYNC] <ent>**
Where: **10** = 10 MHz sine wave
0 = IRIG TTL
NONE = No signature control enabled.
LOCK = Removes output when GPS Lock Alarm is asserted.
SYNC = Removes output when Time Sync alarm is asserted.

NOTE: Signature Control is not available on the IRIG TTL output.

Example: Configure the FREQ Output connector for a 10 MHz signal under Time Sync Signature Control.

Type: **SM ON <ent>**
Response: *SET MODE ON*
Type: **FREQ 10 SYNC <ent>**
Response: *FREQUENCY OUTPUT = 10 MHz SIGNATURE CONTROL = SYNC*

Example: Configure the FREQ Output connector to output IRIG TTL.

Type: **SM ON <ent>**
Response: *SET MODE ON*
Type: **FREQ 0 <ent>**
Response: *FREQUENCY OUTPUT = IRIG TTL*

4.12 GPS SIGNAL STATUS

The GPS Signal Strength command, **GSS**, provides an indication of receiver operation and quality of the received GPS signal. This command is useful in verifying proper antenna placement and receiver performance during installation.

The **GSS** response provides overall tracking status, position solution and a table containing individual satellite data.

Issue the **GSS** command as shown below:

Type: **GSS <ent>**

Example Response is shown below:

```

Tracking 3 Satellites
GPS State= 2D-FIX DOP= 04.3
Latitude= N 43 07 01.541 Longitude= W 077 29 15.136 Height= +00102.85 meters
Quality= PASSED
CHAN  VID   MODE  STREN  STAT
01    09    08    048    A2
02    00    00    000    00
03    00    00    000    00
04    00    00    000    00
05    00    00    000    00
06    24    08    038    A2
07    02    08    022    A2
08    00    00    000    00
    
```

The overall tracking status and position information is presented in the format shown below:

```

TRACKING X SATELLITES
GPS STATE= SSSS DOP = 33.3
LATITUDE=[N:S][DD MM SS.SSSS] LONGITUDE=[E:W][DDD MM SS.SSSS] HEIGHT=+HHHH.HH METERS
QUALITY= QQQQQ
    
```

Where: **X** = Number of satellites currently tracking; 0...8.
 Typically the window antenna tracks two to three satellites.
 The NetClock/GPS requires only one satellite to provide accurate and traceable time.

Section 4: Software Commands

- SSSS* = Fix Mode; SEARCHING, 2D-FIX, 3D-FIX. Searching is the typical mode when using the window mount antenna. 2D-FIX is possible if the receiver is tracking at least three qualified satellites. The receiver latitude and longitude can be determined from a 2D-Fix. 3D-FIX is possible if the receiver is tracking at least four qualified satellites. The receiver location and elevation can be solved from a 3D-Fix.
- ##.#* = Dilution of precision; 00.0...99.9.
This value indicates the degree of uncertainty of a Position Fix due to the geometry of the satellites used in the solution. The lower the DOP value, except 00.0, the lower the degree of uncertainty.
- N* = North Latitude
S = South Latitude
- DDD MM SS.SSS* = Latitude Degrees:Minutes:Seconds
E = East Longitude
W = West Longitude
- DD MM SS.SSS* = Longitude Degrees:Minutes:Seconds
- HHHH.HH* = Height of GPS antenna expressed in meters. The height solution is relative to the GPS reference ellipsoid and not sea level.
- QQQQQ* = Results of GPS qualification, Passed, Failed. The GPS signal is considered qualified when at least one satellite is received having a vehicle ID greater than 1 and is available for Position Fix usage.

NOTE: Position data contained in this response shall be all zeroes until a 2D-Fix is acquired. Elevation data is available when a 3D-Fix is acquired.

Information on each satellite the receiver is currently tracking is presented in table form. The table columns are described below:

- CHAN = Channel Number of the GPS receiver, 01...08
- VID = Vehicle (satellite) Identification Number, 01...37
- MODE = Channel Tracking Mode, 01...08.
 - Where: 00 - Code Search 05 - Message Sync Detect
 - 01 - Code Acquire 06 - Satellite Time Avail
 - 02 - AGC Set 07 - Ephemeris Acquire
 - 03 - Freq Acquire 08 - Avail for Position
 - 04 - Bit Sync Detect
- STREN = Signal strength value relative to SNR, 000... 55. The higher the number, the greater the received signal.
- STAT = Channel status flag. Convert the hexadecimal code word to binary to find the status flags set.
 - (MSB) Bit 7: Using for Position Fix
 - Bit 6: Satellite Momentum Alert Flag
 - Bit 5: Satellite Anti-Spoof Flag Set
 - Bit 4: Satellite Reported Unhealthy
 - Bit 3: Satellite Reported Inaccurate (>16 meters)
 - Bit 2: Spare
 - Bit 1: Spare
 - (LSB) Bit 0: Parity Error

Example: HEX code word A0 translates to the following flags set.

- Bit 7: Using for Position Fix
- Bit 5: Satellite Anti-Spoof Flag Set

4.13 *HELP DISPLAY*

The **HELP** command lists the commonly used commands and command structure. **HELP** is available by using the following commands:

Type: **HELP** <ent>

- OR -

? <ent>

Response:

*SPECTRACOM CORPORATION NETCLOCK/GPS
COMMAND LIST FOLLOWS (SET MODE MUST BE ON TO CHANGE PARAMETERS)
TIME [HH:MM:SS] = CURRENT UTC TIME
DATE [YYYY-MM-DD] = CURRENT UTC DATE
LOC [D DD MM SS.sss D DDD MM SS.sss] = CURRENT LOCATION
STAT= DISPLAY STATUS INFORMATION
DSS= DISPLAY SIGNAL STRENGTH
CONF= SHOW SETUP INFO FOR ALL OUTPUTS
SERx [BAUD FMT REQ TD DST]= SET UP SERIAL PORT
REMx [BAUD FMT TD DST]= SET UP REMOTE PORT
IRIG [FMT LEVEL CARRIER SIGNATURE TD DST]= SET UP IRIG
FPF [FMT TD DST]= FRONT PANEL SET UP
FREQ [OUTPUT SIGNATURE] = SET UP FREQUENCY OUTPUT
LOCK [HH:MM:SS]= GPS LOCK ALARM TIME OUT
SYNC [HH:MM:SS]= TIME SYNC ALARM TIME OUT
DSTx [RULE PARAMETERS] = SET UP DST RULES
EVNT [# CMD PARAM] = SET UP THE EVENT TIMER
ACD [XXXXXX.XXX]= ANTENNA CABLE DELAY
DAL [P] = DISPLAY ALARM LOG
DOL [P] = DISPLAY OSCILLATOR LOG
DH [P] = DISPLAY HISTOGRAM LOG
SM [ON:OFF]= SET MODE
FOR FURTHER INFORMATION PLEASE CONSULT YOUR MANUAL*

Additional information on the command structure is found by retrieving the command usage message. To obtain the usage message, type the command followed by a question mark (?). The IRIG usage message is shown below.

Type: **IRIG** ?<ent>

Response: *USAGE>*

*IRIG B [AM:TTL] [NONE:LOCK:SYNC] [TD] [DST]
IRIG E AM [100:1000] [NONE:LOCK:SYNC] [TD] [DST]
IRIG E TTL [NONE:LOCK:SYNC] [TD] [DST]*

4.14 IRIG CONFIGURATION

The command, **IRIG**, reads and sets the IRIG output configuration. IRIG configuration options include: format, signal, carrier, signature control, UTC or local time with or with DST corrections. The current IRIG output configuration can be viewed using the **IRIG** command as shown below:

```
Type:  IRIG <ent>
Default Response:  IRIG FORMAT= B LEVEL= AM CARRIER= 1000HZ
                   SIGNATURE CONTROL= NONE TIME DIFF= +00:00 DST= 0
```

To change the IRIG output configuration, place the clock in *Set Mode* and issue the appropriate **IRIG** command shown below. Note the **IRIG** command varies between IRIG B and IRIG E. This variation is due to the IRIG E carrier frequency selection. IRIG E is available with a 100 Hz or 1000 Hz carrier. IRIG B carrier frequency is always 1000 Hz.

```
Type:  IRIG B [AM:TTL] [NONE:LOCK:SYNC] [TD] [DST] <ent>
        - OR -
        IRIG E AM [100:1000] [NONE:LOCK:SYNC] [TD] [DST] <ent>
        - OR -
        IRIG E TTL [NONE:LOCK:SYNC] [TD] [DST] <ent>
```

```
Where:  B = IRIG B
        E = IRIG E
        AM = Amplitude Modulated, sine wave
        TTL = Pulse width coded, TTL compatible square wave
        100 = 100 Hz carrier, IRIG E
        1000 = 1000 Hz carrier, IRIG E
        NONE = No Signature Control
        LOCK = Signature Control asserted by GPS Lock status
        SYNC = Signature Control asserted by Time Sync status
        TD = Time difference from UTC, ± 00:00...±12:00, refer to Figure
              4-2, UTC Time Difference Map.
        DST = DST Rule Number, 0...6.
```

```
Where: 0 = No DST, always Standard Time
        1 = North America
        2 = United Kingdom
        3 = Continental Europe
        4 = China
        5 = Australian 1
        6 = Australian 2
```

Section 4: Software Commands

Example: Set the IRIG port for amplitude modulated IRIG E, 100 Hz carrier, Eastern time with DST and Signature Control based upon Time Sync status.

Type: ***SM ON <ent>***

Response: *SET MODE ON*

Type: ***IRIG E AM 100 SYNC -05:00 1***

Response: *IRIG FORMAT = E LEVEL = AM CARRIER = 100 HZ
SIGNATURE CONTROL = SYNC TIME DIFF = -05:00 DST = 1*

4.15 LOCATION

The command, **LOC**, is for reading or setting the current location of the receiver. This command displays the current latitude and longitude calculated by the GPS receiver. During initial installation it may speed up the time to first fix if the user inputs an approximate position using this command. The GPS receiver constantly calculates its position based on the satellites it is receiving. Once the unit has acquired its first fix, entering a new position using this command has no effect. Also, after initial installation the receiver will keep its current position in Non-Volatile RAM so that on subsequent power cycles the unit will reach first fix much faster than at initial installation.

To view the current receiver location, issue the **LOC** command as shown below:

Type: **LOC <ent>**

Example Response: *CURRENT LOCATION: LATITUDE = N 43 07 00.407 LONGITUDE = W 077 29 13.442*

To enter a new location place the clock in *Set Mode* and issue the **LOC** command as follows:

Type: **LOC [N:S] [DD MM SS.SSS][E:W] [DDD MM SS.SSS] <ent>**

Where: **N** = North Latitude

S = South Latitude

DD MM SS.SSS = Latitude Degrees:Minutes:Seconds

E = East Longitude

W = West Longitude

DDD MM SS.SSS = Longitude Degrees:Minutes:Seconds

4.16 GPS LOCK TIME OUT

The **LOCK** command reads or sets the GPS lock time out period. A timer is started whenever the receiver is not tracking any satellites. The timer is reset when the receiver reacquires a satellite. A GPS lock alarm is asserted if the receiver fails to reacquire satellites within the allotted time out period. A GPS Lock alarm actuates the Minor Alarm relay and removes outputs placed under Lock Signature Control.

To view the current GPS lock time out period issue the **LOCK** command as shown below:

Type: **LOCK <ent>**
Default Response: *GPS LOCK TIME OUT= 00:15:00*

To change the lock time out value, place the clock in *Set Mode* and issue the **LOCK** command as follows:

Type: **LOCK [HH:MM:SS] <ent>**
Where: HH:MM:SS = Hours:Minutes:Seconds

NOTE: Due to alarm sequencing, Minor escalating to Major, the LOCK time out period must be shorter than the SYNC time out period.

Example: Change the lock time out period to 1 Hour and 30 Minutes.

Type: **SM ON <ent>**
Response: *SET MODE ON*
Type: **LOCK 01:30:00 <ent>**
Response: *GPS LOCK TIME OUT= 01:30:00*

4.17 REMOTE OUTPUT CONFIGURATION

The commands, **REM 1** or **REM 2**, read or set the configuration of the Remote Outputs. Remote Output configuration options include: baud rate, data format, UTC or local time with or without DST corrections.

To view the current Remote Output configurations, issue the command **REMx** as shown below:

Type: **REMx <ent>**
Default Response: *REMOTE PORT X*
BAUD RATE= 9600 FORMAT#= 00
TIME DIFF= +00:00 DST= 0

Where: **X** = Remote Output number: 1, 2

To change the Remote Output configuration, place the clock in *Set Mode* and issue the **REMx** command as follows:

Type: **REMx [BAUD] [FMT] [TD] [DST] <ent>**
Where: **X** = Remote Output number 1,2
BAUD = Baud Rate: 1200, 2400, 4800, 9600
FMT = Data Format: 00, 01, 02, 03, 04, 90: Refer to Section 3.3 for a complete description of the data formats available.
TD = Time Difference from UTC , ±00:00...±12:00; Refer to Figure 4-2, UTC Time Difference Map.
DST = DST rule number, 0..6.
Where: 0 = No DST, always Standard Time
1 = North America
2 = United Kingdom
3 = Continental Europe
4 = China
5 = Australian 1
6 = Australian 2

Example: Configure Remote Output 2 for data format 1, 1200 baud, Mountain time with DST corrections.

Type: **SM ON <ent>**
Response: *SET MODE ON*
Type: **REM2 1200 01 -07:00 1 <ent>**
Response: *BAUD RATE = 1200 FORMAT # = 01*
TIME DIFF = -07:00 HOURS DST = 1

4.18 **RESET GPS RECEIVER**

The command, **RGPS**, completely resets the GPS receiver. This is a radical procedure and should only be done if the receiver fails to acquire satellites. The **RGPS** command returns the receiver to default values. Next, a self-test is performed on the receiver. If the self-test is successful, a pass message is included in the response. An unsuccessful self-test will provide a numeric code in the self-test status message. The entire process takes about 10-12 seconds. At this point, the receiver will perform as if it has just arrived from the factory. It may take 20 to 30 minutes to achieve first fix. This command is only available in *Test Mode*. To issue a GPS reset, follow the example below:

```
Type: TM ON <ent>
Response: TEST MODE ON
          - OR -
          TIME = 20:42:11 DATE = 2001-04-21
          STATUS CHANGE EVENT RELAY = ON
          ALARM RELAYS: MAJOR = ON MINOR = ON
          ACTIVE ALARMS: MAJOR AND MINOR
          IN TEST MODE

Type: RGPS <ent>
Response: TIME= 20:42:32 DATE= 2001-04-21 RESET GPS RECEIVER
          SELF-TEST= PASS
```

4.19 SERIAL COMM CONFIGURATION

The commands, **SER1** and **SER2**, read or set the configuration of the Serial Comm outputs. Serial Comm configuration options include baud rate, data format, request character, UTC or local time with or without DST corrections.

To view the current Serial Comm configurations issue the **SERx** command as shown below:

```
Type:  SERX <ent>
Default Response: SERIAL PORT x
                BAUD RATE = 9600 FORMAT# = 00 REQUEST CHAR = T
                TIME DIFF = +00:00 DST = 0
```

Where: **X** = Serial Comm Number 1, 2

To change a Serial Comm port configuration, place the clock in *Set Mode* and issue the **SERx** command as follows:

```
Type:  SERX [BAUD] [FMT] [REQ] [TD] [DST] <ent>
Where:  X = Serial Comm Number 1,2
        BAUD = Baud Rate: 1200, 2400, 4800, 9600
        FMT = Data Format: 00, 01, 02, 03, 04, 90: Refer to Section 3.3
              for a complete description of the data formats available.
        REQ = Request Character. Any symbol, number or uppercase letter
              can be configured as the request character. The Serial
              Comm port will output the selected data format upon
              receiving this character. The Serial Comm port can also be
              configured to output continuously once-per-second by
              typing the word NONE as the request character.
        TD = Time Difference from UTC, ±00:00...±12:00; Refer to
              Figure 4-2, UTC Time Difference Map.
        DST = DST rule number, 0..6.
              Where: 0 = No DST, always Standard Time
                    1 = North America
                    2 = United Kingdom
                    3 = Continental Europe
                    4 = China
                    5 = Australian 1
                    6 = Australian 2
```

NOTES: A once-per-second output is enabled when the request character is set for **NONE**.

The time contained in data formats 02, 04, and 90 always reflect UTC time. The time difference parameter in the Serial Comm configuration command has no effect on output time.

Section 4: Software Commands

Example: Configure Serial Comm 1 to respond with data format 03 whenever a ? is received. Set the bit rate at 4800 Baud and time reflecting Pacific Standard time (no DST corrections).

Type: ***SM ON <ent>***
Response: *SET MODE ON*
Type: ***SER1 4800 03 ? -08:00 0 <ent>***
Response: *SERIAL PORT 1*
BAUD RATE = 4800 FORMAT # = 03 REQUEST CHAR = ?
TIME DIFF = -08:00 DST = 0

4.20 SET MODE

This command is used to read or enter *Set Mode* operation. As a safeguard, the unit must be placed into *Set Mode* whenever operational parameters are entered. The unit “times out” of *Set Mode* and returns to *Read Mode* operations if no commands are issued for 15 minutes. To read the *Set Mode* status (ON or OFF), issue the **SM** command as shown below:

Type: **SM <ent>**
Response: *SET MODE ON*
 or
 SET MODE OFF

To place the unit into *Set Mode*:

Type: **SM ON <ent>**
Response: *SET MODE ON*

To return the unit to *Read Mode*:

Type: **SM OFF <ent>**
Response: *SET MODE OFF*

4.21 *STATUS COMMAND*

The *STAT* command provides the current UTC time and date, tracking status, position, time remaining in GPS lock and time sync timers, event and alarm relay status and a list of active alarms.

To retrieve the operational status, issue the *STAT* command as follows:

Type: *STAT <ent>*

Example Response:

```
TIME= 19:18:41 DATE= 2001-04-08  
TIME SYNC STATUS= OK GPS LOCK STATUS= OK  
GPS SIGNAL= QUALIFIED  
OSCILLATOR STATUS= LOCKED  
EVENT RELAY = OFF  
ALARM RELAYS: MAJOR= OFF MINOR= ON  
ACTIVE ALARMS: MINOR  
ANTENNA PROBLEM
```

4.22 SYNC TIME OUT

The **SYNC** command reads or sets the Sync Time Out period. A timer is started whenever the receiver is not tracking any satellites. The timer is reset when the receiver reacquires a satellite. A Time Sync Alarm is asserted if the receiver fails to reacquire satellites within the allotted time out period. A Time Sync Alarm causes a Major Alarm and removes outputs placed under SYNC Signature Control. To view the current sync time out period, issue the **SYNC** command as shown below:

Type: **SYNC <ent>**
Default Response: *TIME SYNC TIME OUT= 02:00:00*

To change the sync time out value, place the clock in *Set Mode* and issue the **SYNC** command as follows:

Type: **SYNC HH:MM:SS <ent>**
Where:**HH:MM:SS** = Hours:Minutes:Seconds

NOTE: Due to alarm sequencing, Minor elevating to Major, the SYNC time out period must be longer than the LOCK time out period.

Example: Change the SYNC time out period to 8 hours.

Type: **SM ON <ent>**
Response: *SET MODE ON*
Type: **SYNC 08:00:00 <ent>**
Response: *TIME SYNC TIME OUT= 08:00:00*

4.23 *TIME*

The command, *TIME*, reads or sets the time of the NetClock/GPS.

To retrieve the current UTC time, issue the *TIME* command as shown below:

Type: *TIME <ent>*
Response: *TIME = HH:MM:SS*
Where: *HH* = UTC hours 00...23
MM = Minutes 00...59
SS = Seconds 00...60

To set the time, place the clock in *Set Mode* and issue the *TIME* command as follows:

Type: *TIME HH:MM:SS <ent>*
Where: *HH:MM:SS* = As defined above.
Response: *Time message reflecting the time entered.*

NOTE: Clocks tracking GPS satellites can not be set using this command.
The received time data overwrites the set time.

Example: Manually set the TIME 13:45:00.

Type: *SM ON <ent>*
Response: *SET MODE ON*
Type: *TIME 13:45:00 <ent>*
Response: *TIME = 13:45:00*

4.24 TEST MODE

This command is used to read or enter *Test Mode* operation. *Test Mode* commands are used in factory testing and field troubleshooting. The unit “times out” of *Test Mode* and returns to *Read Mode* if no commands are issued for 15 minutes. Major and Minor alarms are asserted whenever the clock is in *Test Mode*.

To read the *Test Mode* status (ON or OFF), issue the **TM** command as shown below:

Type: **TM <ent>**
Response: *TEST MODE ON*
 - OR -
 TEST MODE OFF

To place the clock into *Test Mode* operation, issue the **TM** command as follows:

Type: **TM ON <ent>**
Response: *TIME = HH:MM:SS DATE = YYYY-MM-DD STATUS CHANGE*
 EVENT RELAY = OFF
 ALARM RELAYS: MAJOR = ON MINOR = ON
 ACTIVE ALARMS: MAJOR AND MINOR
 IN TEST MODE
 - OR -
 TEST MODE ON

4.25 *VERSION COMMAND*

This command provides all the software version levels of the programs contained in the clock. The time and date the unit was first powered ON is recorded. To retrieve version information, issue the **VER** command as shown below:

Type: **VER <ent>**

Example Response:

*Spectracom Corporation Netclock/GPS Model 8183
Software Version 2.07 Date: September 02, 2000 14:31:28
Unit Started 20:42:39 2001-02-15
Front Panel Version 1.02
IRIG Version 1.02
Serial Port 1 Version 2.03
Serial Port 2 Version 2.03
Remote Port 1 Version 2.03
Remote Port 2 Version 2.03
GPS Receiver = 8 Channel GT Version 2*

SECTION 5: SERVICE INFORMATION

5.0 INTRODUCTION

5.1 RECEPTION TROUBLESHOOTING

5.2 TCXO ADJUSTMENT

SERVICE INFORMATION

5.0 INTRODUCTION

This section provides information on troubleshooting GPS reception problems and instructions for adjusting the TCXO oscillator.

5.1 RECEPTION TROUBLESHOOTING

Please review this section prior to calling the Spectracom Customer Service Department. If following the guidelines outlined in this section cannot solve the reception problem, please call for Customer Service at 585-381-4827.

5.1.1 No Reception

Cable or connector problem: Measure the antenna cable resistance to verify the integrity of the cable and connectors. Remove the antenna cable from the rear panel of the receiver and measure the resistance from the coax center to shield. Refer to Table 5-1 for typical resistance values of the antenna and inline amplifier alone and when combined.

DEVICE	DESCRIPTION	RESISTANCE
8228	Indoor Antenna	140 ohms
8225	Outdoor Antenna	180 ohms
8227	In-line Amplifier	165 ohms
8225 and 8227	Antenna/Amplifier	85 ohms

TABLE 5-1 TYPICAL ANTENNA CABLE RESISTANCE VALUES

Failed impulse suppressor: The Model 8226 provides lightning protection when the outdoor GPS antenna is used. The Model 8226 has a high impedance when measuring from the center conductor to ground and a low throughput resistance. A failing impulse suppressor may be tripping prematurely. The easiest way to test the Model 8226 is to temporarily replace it with a Type N barrel connector. If the receiver begins tracking satellites within 20 minutes, the impulse suppressor has failed and must be replaced.

Cable length: Excessively long or improper cable type may prevent the receiver from tracking satellites. Refer to Section 2.2 for cable recommendations when using the Model 8225 Outdoor Antenna. The Model 8228 Indoor Antenna is supplied with 50 feet of antenna cable. Do not substitute or add coax to the provided cable.

Antenna location: The antenna must have a good view of the sky. Refer to Section 2.1 for outdoor antenna guidelines and Appendix A for indoor antenna guidelines.

Section 5: Service Information

GPS reset: In rare occasions, the GPS receiver may require a reset to set the receiver to default values. The receiver must be placed in Test Mode to issue the GPS Reset command. Issue the GPS Reset command, **RGPS**, as shown below:

Type: **TM ON <ent>**

The unit will respond with a message stating Test Mode has been enabled. During Test Mode operation, the Major and Minor alarms are asserted.

Type: **RGPS <ent>**

After an approximate 10 second delay, the receiver responds with a reset status message. Allow 20 minutes for the receiver to begin tracking satellites.

Receiver location: Setting the current receiver position may assist in obtaining a satellite fix. To enter a new location, place the clock in *Set Mode* and issue the **LOC** command as follows:

Type: **SM ON <ent>**

Response: **SET MODE = ON**

Type: **LOC [N:S] [DD MM SS.SSS][E:W] [DD MM SSS.SSS]<ent>**

where:

N =	North Latitude
S =	South Latitude
DD MM SS.SSS =	Latitude Degrees:Minutes:Seconds
E =	East Longitude
W =	West Longitude
DDD MM SS.SSS =	Longitude Degrees:Minutes:Seconds

NOTE: The approximate location is adequate, zeros may be used for the seconds values.

Allow 20 minutes for the receiver to begin tracking satellites.

5.1.2 Low GPS Quality

Cable Length: Excessively long or improper cable type may cause low GPS quality due to cable attenuation. Long GPS antenna lengths may require an inline amplifier or lower loss cable. Refer to Section 2.2 for GPS cable recommendations and Section 2.4 for inline amplifier information when using the Model 8225 Outdoor Antenna

The Model 8228 Indoor Antenna is provided with a 50-foot antenna cable. Do not substitute or add coax to the provided cable.

Antenna location: The antenna must have a view of the sky with views to the horizon. Nearby obstructions can reduce the receiver's ability to track the maximum number of satellites available.

Section 5: Service Information

Local Interference: Another reason for poor reception is harmonics from a local broadcast interfering with the GPS L1 carrier of 1575.42 MHz. Certain television or FM radio broadcasts, while operating within their frequency allocation, can cause GPS jamming due to harmonics of the carrier. Television interference presents a greater challenge due to higher output power, typically 2-3 MW. Table 5-2 lists the potentially problem television stations and their respective GPS harmonic.

CHANNEL	HARMONIC
66	2 nd
23	3 rd
10	8 th
7	9 th
6	18 th & 19 th
5	20 th

TABLE 5-2 TELEVISION STATIONS WITH GPS JAMMING POTENTIAL

FM radio stations, while lower in radiated power, can cause GPS jamming also. Table 5-3 lists the potentially problem radio frequencies and their respective GPS harmonic.

FREQUENCY	HARMONIC
104.8 - 105.2	15 th
98.3 - 98.7	16 th
92.5 - 92.9	17 th
87.3 - 87.7	18 th

TABLE 5-3 FM RADIO FREQUENCIES WITH GPS JAMMING POTENTIAL

If relocating the antenna away from the interfering source does not solve the problem or if relocation is not possible contact Spectracom Tech Support for assistance.

5.2 OSCILLATOR ADJUSTMENT

Over time the NetClock/GPS TCXO oscillator may require an adjustment to compensate for crystal aging. The NetClock/GPS warns when this adjustment is needed by asserting an Adjust Oscillator Alarm. This condition causes the front panel display to flash all 8's every three seconds and activates the Minor Alarm relay. An Adjust Oscillator Alarm is asserted when the frequency controlling D/A converter approaches a control range limit. Typically, this alarm provides a two to three month warning before a control range end is reached.

On rare occasions, an oscillator may experience a sudden shift in frequency, causing an Adjust Oscillator and a Frequency Alarm. When this occurs, both Major and Minor alarms are activated. The D/A is set to a control range end unable to correct the oscillator frequency. Frequency error shall exceed 1×10^{-7}

This section describes the oscillator adjustment procedure using a frequency counter and an RS-232 terminal. The frequency counter must have a time base accuracy and measurement resolution of at least 1×10^{-7} (1.0 Hz at 10 MHz).

A PC running terminal emulation software (HyperTerminal, ProComm Plus, etc.) can be used as an RS-232 terminal. Configure the terminal for ANSI emulation, 9600 baud and a character structure of 1 start, 8 data, 1 stop and no parity. Flow control is not required, although XON/XOFF is supported.

5.2.1 Adjustment Procedure

Perform the steps listed below to adjust the TCXO oscillator.

1. If the unit is rack mounted, remove it from the rack.
2. Disconnect the GPS antenna.
3. Remove the top cover.
4. Connect the terminal to the Serial Setup Interface port.
5. Place the NetClock/GPS in Test Mode by sending the TM command as follows:

Type: ***TM ON <ent>***

Response: *TIME= 19:22:03 DATE= 2001-04-08 STATUS CHANGE
EVENT RELAY = OFF
ALARM RELAYS: MAJOR= ON MINOR= ON
ACTIVE ALARMS: MAJOR AND MINOR
IN TEST MODE
ADJUST OSCILLATOR*

Section 5: Service Information

6. The FREQ output connector can be configured to output 10 MHz or IRIG TTL. Verify the FREQ output connector is configured for 10 MHz by sending the following command:

Type: **FREQ <ent>**

Response: FREQUENCY OUTPUT= 10 MHZ SIGNATURE CONTROL= NONE

If the response was *FREQUENCY OUTPUT= IRIG TTL*, issue the FREQ command as shown below to configure the output to 10 MHz.

Type: **FREQ 10 NONE<ent>**

7. Set the D/A to the center of it's control range by setting the D/A to 8000 as shown below:

Type: **DA 8000<ent>**

8. Connect the frequency counter to the rear panel FREQ output connector. Locate the TCXO oscillator, labeled U32, in the center front of the circuit board. Adjust the TCXO in very small amounts until a frequency of 10 MHz \pm 5 Hz is obtained.

9. Set the D/A control voltage to its maximum value by sending the SHI command as shown below:

Type: **SHI<ent>**

Response: *D/A = CCCC*

Record the upper limit oscillator frequency.
 $F_{HI} = \underline{\hspace{10em}}$ Hz.

10. Set the D/A control value to its minimum value by sending the SLO command as shown below:

Type: **SLO<ent>**

Response: *D/A = 3333*

Record the lower limit oscillator frequency
 $F_{LO} = \underline{\hspace{10em}}$ Hz.

11. Subtract the lower limit frequency, F_{LO} , from the upper limit frequency, F_{HI} , to determine the pull range of the oscillator. This difference is entered as the Hertz Range Value.

F_{HI} minus $F_{LO} = HR$

Enter the hertz range value by sending the HR command as shown below:

Section 5: Service Information

Type: ***HR XXX.XXX***
where XXX.XXX = Hertz Range Value

Response: *Hertz Range = XXX.XX D/A = 8000*

12. Return the unit to normal operation by taking it out of Test Mode.

Type: ***TM OFF<ent>***

The oscillator adjustment procedure is now complete. Replace the top cover and reinstall the unit. The NetClock/GPS will require a 20-minute period to reacquire and lock to the GPS reference.

APPENDIX A: INDOOR GPS ANTENNA

A.0 INTRODUCTION

A.1 MODEL 8228 GPS ANTENNA

INDOOR GPS ANTENNA

A.0 INTRODUCTION

The standard Spectracom NetClock/GPS package includes the Model 8225 Outdoor GPS Antenna. This antenna is intended for rooftop or tower installation. For installations where mounting an outdoor antenna is not possible or desirable, Spectracom offers the Model 8228 Indoor Window Mount GPS Antenna. This section describes the installation of Model 8228 GPS antenna.

A.1 MODEL 8228 GPS ANTENNA

The Model 8228, shown in Figure A-1, is an active antenna tuned to receive the GPS 1575.42 MHz L1 band satellite broadcasts. The received signals are passed through a narrow bandpass filter and a preamplifier within the antenna. The active antenna circuitry provides 28 dB of gain and requires +5 VDC at 20 milliamps. Power is provided by the GPS receiver over the antenna coax. The antenna is affixed to a window using the supplied mounting bracket.

Each antenna is terminated with an SMA male connector and includes a 50-foot interconnecting coax cable. A Type N male to SMA female adapter is required to connect this cable to a NetClock/GPS receiver. The adapters can be ordered from Spectracom, specify part number A000-001-0000.

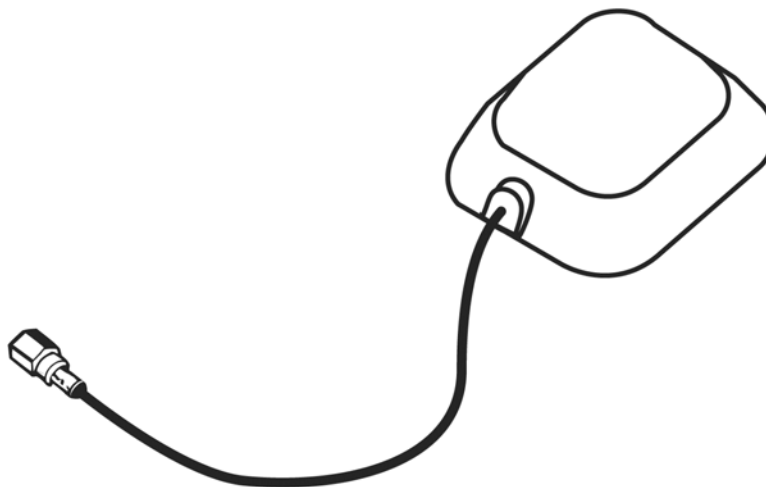

FIGURE A-1 MODEL 8228 GPS ANTENNA

A.1.1 Antenna Installation

There are two factors to consider when installing the Model 8228 GPS Antenna:

1. Select a window having the best view of the sky as possible.
2. Make certain the selected window does not require more than the supplied 50-foot coax to connect to the NetClock/GPS.

Avoid selecting windows having nearby trees, tall shrubs or other obstructions that may block the antenna's view of the sky. Installing the antenna behind metal screens or blinds may reduce signal reception. Refer to Figure A-2 for additional mounting guidelines.

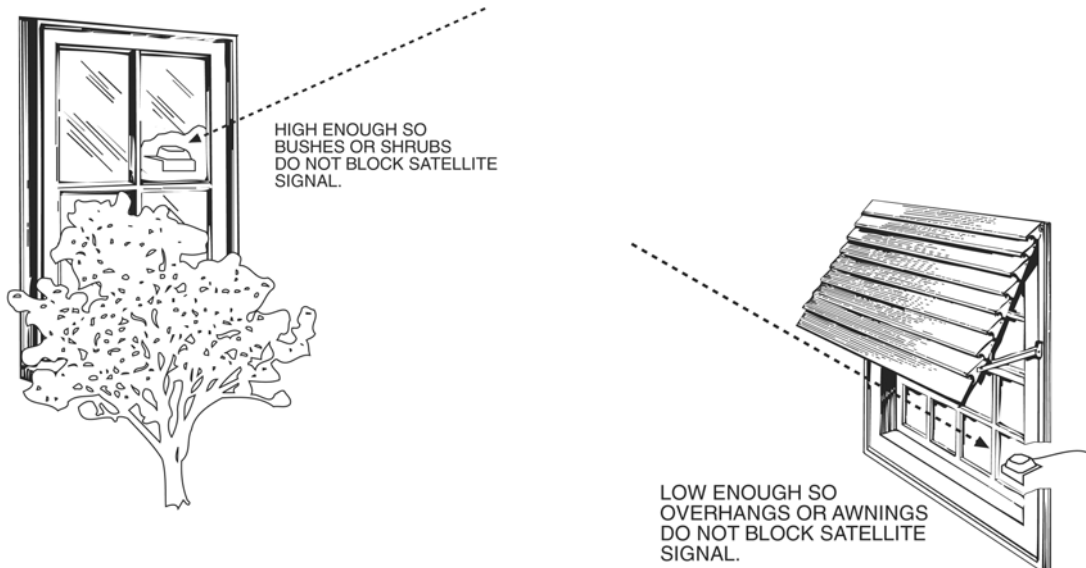

FIGURE A-2 ANTENNA MOUNTING GUIDELINES

The supplied mounting bracket adheres to the window using double-sided adhesive foam tape. Affix the bracket to a clean window, oriented as shown in Figure A-2. The antenna is secured to the mounting bracket by either screws or magnetic base.

In some installations, the required antenna cable may exceed the supplied 50-foot length. NEVER add cable to extend the cable length beyond 50 feet. Lower loss cable or an inline amplifier must be used to assure proper operation. Contact Spectracom Tech Support at 585-381-4827 for recommendations.

To assure proper operation, refer to Qualifying the Installation found in Section 2 of this manual.

APPENDIX B: IRIG CODE DESCRIPTION

B.0 INTRODUCTION

B.1 IRIG B CODE

B.2 IRIG E CODE

IRIG CODE DESCRIPTION

B.0 INTRODUCTION

This Appendix contains a detailed description of the IRIG codes the Netclock/GPS can provide. The Netclock/GPS can be configured to output IRIG B or IRIG E codes in amplitude modulated or pulse width coded formats. In addition, the IRIG outputs may be configured with signature control. The time contained in the IRIG output can be configured to reflect Universal Coordinated Time (UTC) or local time with or without daylight saving time corrections. The command IRIG configures the IRIG output options and is described in Section 4, *Software Commands*.

B.1 IRIG B OUTPUT

The IRIG B code contains the Binary Coded Decimal (BCD) time of year, Control Function (CF) field and the Straight Binary Seconds time of day. Figure B-1 illustrates the IRIG B data structure. The BCD time of year provides the day of the year, 1-366, and the time of day including seconds. The hour of the day is expressed in 24 hour format. The SBS time is the number of seconds elapsed since midnight. The Control Function field contains year information and a time sync status bit.

B.1.1 IRIG B General Description

1. Time frame: 1.0 seconds.
2. Code digit weighting:
 - A. Binary Coded Decimal time-of-year.
Code word - 30 binary digits.
Seconds, minutes hours, and days.
Recycles yearly.
 - B. Straight Binary Seconds time-of-day.
Code word - 17 binary digits.
Seconds only, recycles daily.

IRIG B TIME

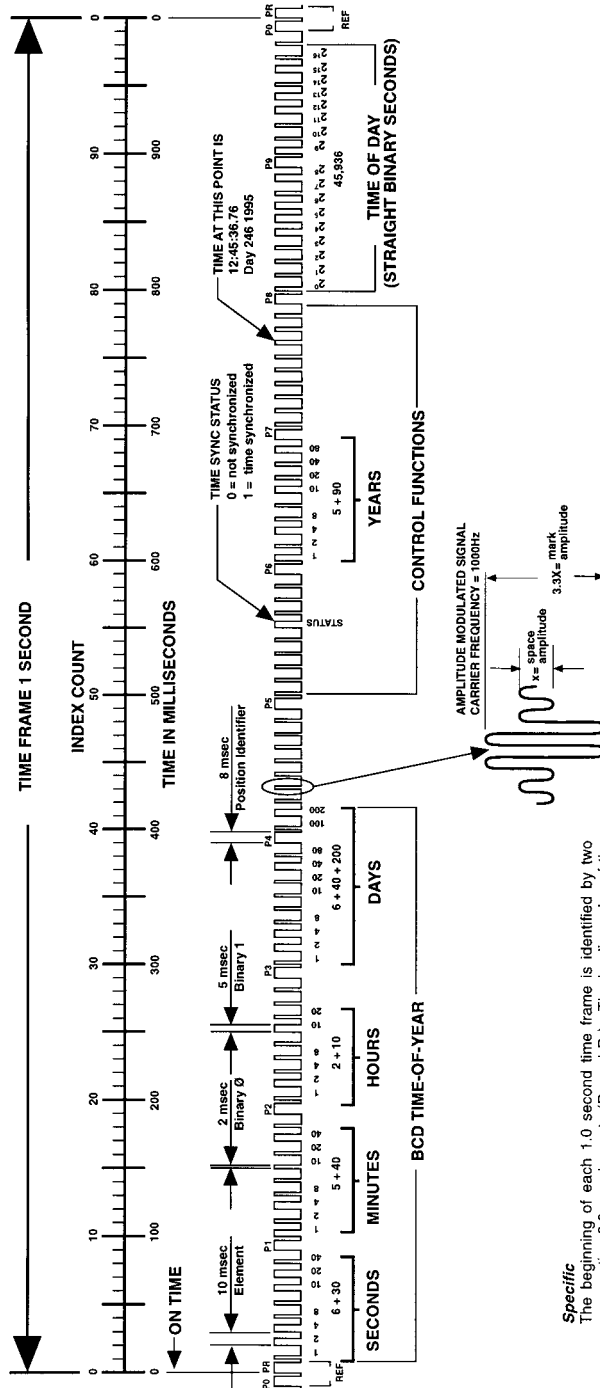

Specific

The beginning of each 1.0 second time frame is identified by two consecutive 8.0 ms elements (P₁ and P₂). The leading edge of the second 8.0 ms element (P₂) is the "on time" reference point for the succeeding time code. 10 pps position identifiers P₃, P₄, ..., P₇ (8.0 ms duration) occur 10 ms before "on time" and refer to the leading edge of the succeeding element.

The two time code words and the control functions presented during the time frame are pulse width coded. The binary "zero" and index markers have a duration of 2.0 ms, and the binary "one" has a duration of 5.0 ms. The leading edge is the 100 pps "on time" reference point for all elements.

The binary coded decimal (BCD) time-of-year code word consists of 30 digits beginning at index count 1. The binary coded subword elements occur between position identifiers P₅ and P₇ (7 for seconds; 6 for minutes; 10 for hours; 10 for days) until the code word is complete. An index marker occurs between the decimal digits in each subword to provide separation for visual resolution. The least significant digit occurs first. The BCD code recycles yearly.

Twenty-seven control functions occur between position identifiers P₈ and P₁₀. Any control function element or combination of control function elements can be programmed to read a binary "one" during any specified number of time frames. Each control element is identified on the Control Function Field Table.

The straight binary (SB) time-of-day code word occurs between position identifiers P₁₁ and P₂₀. Seventeen digits give the time-of-day in seconds with the least significant digit occurring first. A position identifier occurs between the 9th and 10th binary coded elements. The straight binary code recycles every 24 hours.

FIGURE B-1 IRIG B TIME CODE

3. Code word structure:

BCD: Word seconds digits begin at index count 1. Binary coded elements occur between position identifier elements P₀ and P₅ (7 for seconds, 7 for minutes, 6 for hours, and 10 for days) until the code word is complete. An index marker occurs between decimal digits in each group to provide separation for visual resolution. Least significant digit occurs first.

CF: IRIG formats reserve a set of elements known as Control Functions (CF) for the encoding of various control, identification, or other special purpose functions. IRIG B has 27 Control Functions located between elements 50 and 78. The NETCLOCK/GPS uses the Control Functions to encode year information and time sync status.

Table B-1 lists the Control Function Field and each element's function.

Element 55 is the time sync status bit. Element 55 is a Binary 1 when the front panel time sync lamp is green, and a Binary 0 when the lamp is red.

Year information consists of the last two digits of the current year (i.e. 97, 98, 99 etc.). Elements 60 through 63 contain the binary equivalent of year units. Elements 65 through 68 contain the binary equivalent of tens of years. In keeping with IRIG formats, the least significant bit occurs first. All unused Control Functions are filled with a space (Binary 0).

SBS: Word begins at index count 80. Seventeen Straight Binary Coded elements occur with a position identifier between the 9th and 10th binary coded elements. Least significant digit occurs first.

4. Pulse rates:

- A. Element rate: 100 per second.
- B. Position identifier rate: 10 per second.
- C. Reference marker rate: 1 per second.

5. Element identification: The "on time" reference point for all elements is the pulse leading edge.

- A. Index marker (Binary 0 or uncoded element): 2 millisecond duration.
- B. Code digit (Binary 1): 5 millisecond duration.

Appendix B: IRIG Code Description

- C. Position identifier: 8 millisecond duration.
 - D. Reference marker, 1 per second. The reference marker appears as two consecutive position identifiers. The second position identifier marks the on-time point for the succeeding code word.
6. Resolution:
- Pulse width coded signal: 10 milliseconds.
 Amplitude modulated signal: 1 millisecond.
7. Carrier frequency: 1 kHz when modulated.

ELEMENT #	C.F. DIGIT #	FUNCTION
50	1	Space
51	2	Space
52	3	Space
53	4	Space
54	5	Space
55	6	Time Sync Status
56	7	Space
57	8	Space
58	9	Space
59	PID P6	Position Identifier
60	10	Years Units Y1
61	11	Years Units Y2
62	12	Years Units Y4
63	13	Years Units Y8
64	14	Space
65	15	Years Tens Y10
66	16	Years Tens Y20
67	17	Years Tens Y40
68	18	Years Tens Y80
69	PID P7	Position Identifier
70	19	Space
71	20	Space
72	21	Space
73	22	Space
74	23	Space
75	24	Space
76	25	Space
77	26	Space
78	27	Space

TABLE B-1 IRIG B CONTROL FUNCTION FIELD

B.2 IRIG E OUTPUT

The IRIG E code contains the Binary Coded Decimal (BCD) time of year and Control Functions. Figure B-2 illustrates the IRIG E data structure. The BCD time of year provides the day of year, 1-366, and time of day to tens of seconds. The hour of the day is expressed in 24 hour format. The Control Function field includes a time sync status bit, year information and SBS time of day.

B.2.1 IRIG E General Description

1. Time frame: 10 seconds.
2. Code Digit Weighting:

Binary Coded Decimal time of year.
Code word - 26 binary digits.
Tens of seconds, minutes, hours, and days.
Recycles yearly.
3. Code Word Structure: BCD word tens of seconds digits begin at index count 6. Binary coded elements occur between position identifier elements P₀ and P₅ (3 for seconds, 7 for minutes, 6 for hours, and 10 for days) until the code word is complete. An index marker occurs between decimal digits in each group to provide separation for visual resolution. Least significant digit occurs first.
4. Control Functions: IRIG formats reserve a set of elements known as Control Functions (CF) for the encoding of various control, identification, or other special purpose functions. IRIG E has 45 Control Functions located between elements 50 and 98. The NETCLOCK/GPS uses the Control Function field to encode year data, time sync status, and SBS time data. Table B-2 lists the Control Function Field and each element's function.

Element 55 is the time sync status bit. Element 55 is a Binary 1 when the front panel time sync lamp is green, and a Binary 0 when the lamp is red.

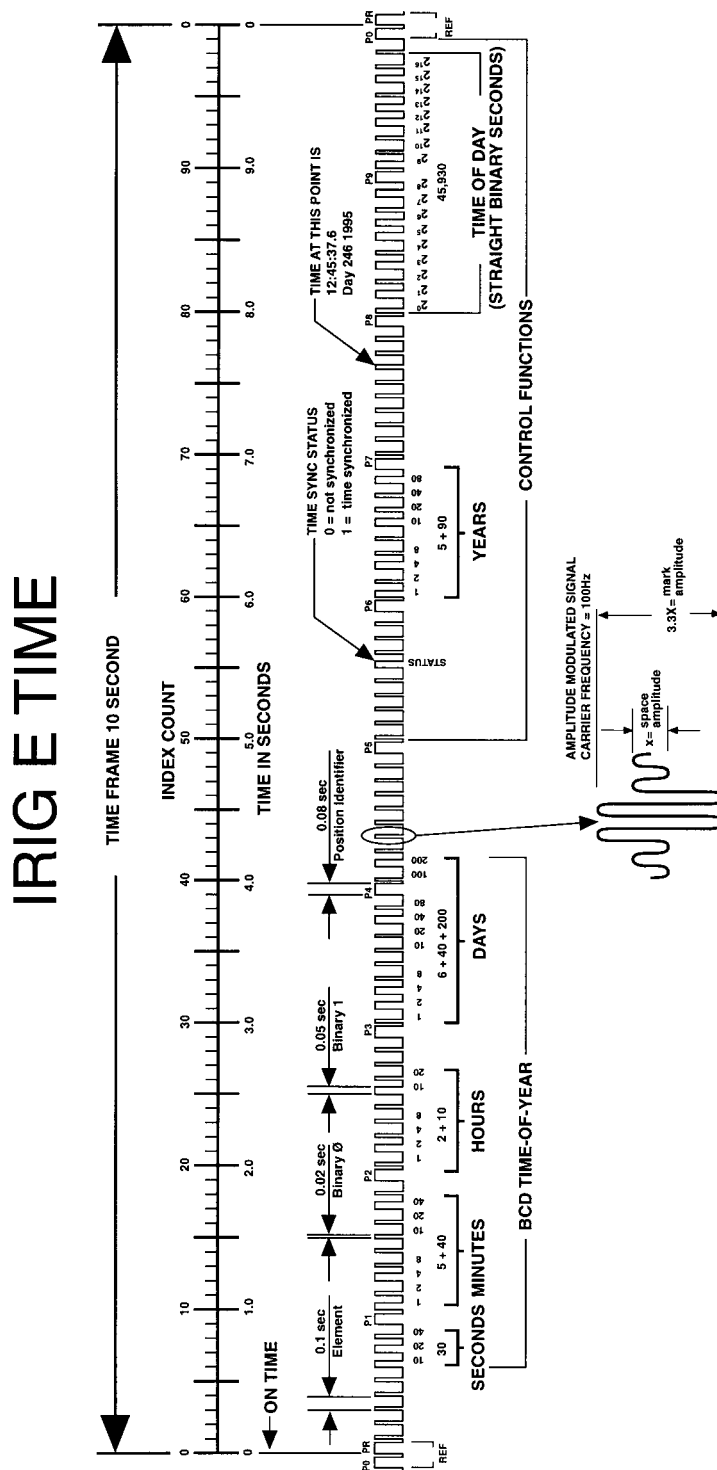

FIGURE B-2 IRIG E TIME CODE

The binary coded decimal (BCD) time-of-year code word consists of 26 digits beginning at index count 6. The binary coded subword elements occur between position identifiers P₆ and P₁₀ (3 for seconds; 7 for minutes; 6 for hours; 10 for days) until the code word is complete. An index marker occurs between the decimal digits in each subword to provide separation for visual resolution. The least significant digit occurs first. The BCD code recycles yearly.

Specific
The beginning of each 10 second time frame is identified by two consecutive 80 ms elements (P₀ and P₁). The leading edge of the second 80 ms element (P₁) is the "on time" reference point for the succeeding time code. 1 pps position identifiers P₀.....P₁₀ (80 ms duration) occur 0.1 second before 1 pps "on time" and refer to the leading edge of the succeeding element.

Forty-five control functions occur between position identifiers P₆ and P₁₀. Any control function element or combination of control function elements can be programmed to read a binary "one" during any specified number of time frames. Each control element is identified on the Control Function Field Table.

The time code word and the control functions presented during the time frame are pulse width coded. The binary "zero" and index markers have a duration of 20 ms, and the binary "one" has a duration of 50 ms. The leading edge is the 10 pps "on time" reference point for all elements.

BIT #	CF ELEMENT #	FUNCTION
50	1	SPACE
51	2	SPACE
52	3	SPACE
53	4	SPACE
54	5	SPACE
55	6	TIME SYNC STATUS
56	7	SPACE
57	8	SPACE
58	9	SPACE
59	PID P6	POSITION IDENTIFIER
60	10	YEAR UNITS Y1
61	11	YEAR UNITS Y2
62	12	YEAR UNITS Y4
63	13	YEAR UNITS Y8
64	14	SPACE
65	15	YEAR TENS Y10
66	16	YEAR TENS Y20
67	17	YEAR TENS Y40
68	18	YEAR TENS Y80
69	PID P7	POSITION IDENTIFIER
70	19	SPACE
71	20	SPACE
72	21	SPACE
73	22	SPACE
74	23	SPACE
75	24	SPACE
76	25	SPACE
77	26	SPACE
78	27	SPACE
79	PID P8	POSITION IDENTIFIER
80	28	SBS 2 ⁰
81	29	SBS 2 ¹
82	30	SBS 2 ²
83	31	SBS 2 ³
84	32	SBS 2 ⁴
85	33	SBS 2 ⁵
86	34	SBS 2 ⁶
87	35	SBS 2 ⁷
88	36	SBS 2 ⁸
89	PID P9	POSITION IDENTIFIER
90	37	SBS 2 ⁹
91	38	SBS 2 ¹⁰
92	39	SBS 2 ¹¹
93	40	SBS 2 ¹²
94	41	SBS 2 ¹³
95	42	SBS 2 ¹⁴
96	43	SBS 2 ¹⁵
97	44	SBS 2 ¹⁶
98	45	SPACE
99	PID P0	POSITION IDENTIFIER

TABLE B-2 IRIG E CONTROL FUNCTION FIELD

Appendix B: IRIG Code Description

Year information consists of the last two digits of the current year (i.e. 98, 99, etc.). Elements 60 through 63 contain the binary equivalent of year units. Elements 65 through 68 contain the binary equivalent of tens of years. In keeping with IRIG formats, the least significant bit occurs first.

Elements 80 through 97 are encoded with the Straight Binary Seconds (SBS) time data. The SBS time data is incremented in 10-second steps and recycles every 24 hours.

5. Pulse rates:
 - A. Element rate: 10 per second.
 - B. Position identifier rate: 1 per second.
 - C. Reference marker rate: 1 per 10 seconds.
6. Element identification: The "on time" reference point for all elements is the pulse leading edge.
 - A. Index marker (Binary 0 or uncoded element): 20 millisecond duration.
 - B. Code digit (Binary 1): 50 millisecond duration.
 - C. Position identifier: 80 millisecond duration.
 - D. Reference marker: 80 millisecond duration, 1 per 10 seconds. The reference marker appears as two consecutive position identifiers. The second position identifier or reference marker is the on-time point for the succeeding code word.