



RBL SERIES
OPERATOR'S MANUAL

DYNALOAD DIVISION
36 NEWBURGH RD. HACKETTSTOWN, NJ 07840
PHONE (908) 850-5088 FAX (908) 850-0679

TABLE OF CONTENTS

Introduction	Page 3
Front Panel Operation	Page 4
Electrical Connections	
Terminal Identification	Page 5
Terminal Strip	Page 5
“D” Paralleling Connector	Page 5,11
AC Input	Page 5,11
Typical Rear Panel Connections	Page 6
E+ and E- Wiring Tips.....	Page 7
Effects of Cable Length	Page 7
Current Oscillation	Page 7
Line Loss	Page 7
Terminal Block Connections.....	Page 7
S+ and S- Wiring Tips.....	Page 7
EN	Page 8
SYN	Page 8
CS	Page 8
REM	Page 8
Terminal Block Terminal.....	Page 9
Terminal Block Connection Optional Equipment Wiring	Page 10
Operating Instructions	Page 12
CI- Constant Current Mode	Page 13
CR- Constant Resistance Mode	Page 13
CV- Constant Voltage Mode	Page 14
CP- Constant Power Mode	Page 14
Full Scale Range Switching	Page 14
Synchronized Paralleling	Page 14
Slew Rate Adjust	Page 14
Pulse Loading	Page 16
Manual Operation	Page 16
Effects of Cable Inductance on Pulse Loading	Page 17
Transconductance	Page 18
Remote Programming	Page 18
Fault Indicators	Page 19
Undervoltage Lockout.....	Page 19
Condition Indicators	Page 19
Location, Airflow and Maintenance.....	Page 20
Operator Safety Instructions.....	Page 21
Specifications	
Outline Drawings	

INTRODUCTION

The Dynaload is a precision instrument which simulates DC loads to test power supplies, generators, servo systems, batteries and similar DC sources.

The RBL series provides four (4) modes of operation: Constant Current, Constant Resistance, Constant Voltage and Constant Power. These are selected via push buttons on the front panel. Remote programming is available via a 0-10V analog programming input in any of the four (4) modes. This is located on the rear of the unit. For example: If the constant current mode is selected, then the 0-10V analog programming input will control the current setting proportionately from 0 to the selected full scale. The four modes of operation are outline below:

CONSTANT CURRENT

The Dynaload will sink the set current regardless of the input voltage.

CONSTANT RESISTANCE

The Dynaload will sink current linearly proportional to the input voltage. This is set in Amps/Volt, or $1/R$.

CONSTANT VOLTAGE

The Dynaload will sink the current required to maintain the voltage of the source connected to it.

CONSTANT POWER

The Dynaload will sink the current required at its present input voltage to maintain the desired power level.

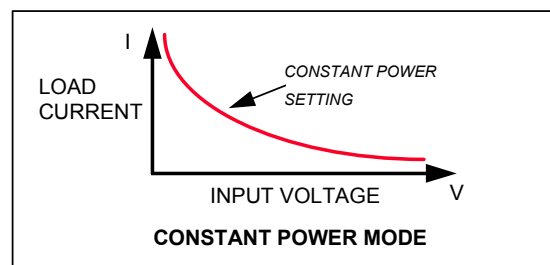
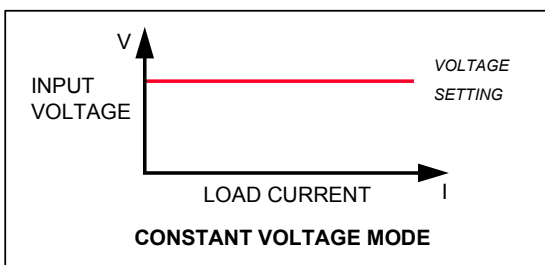
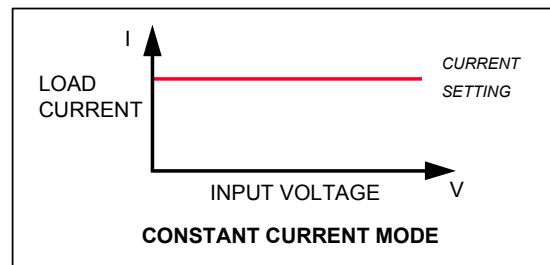
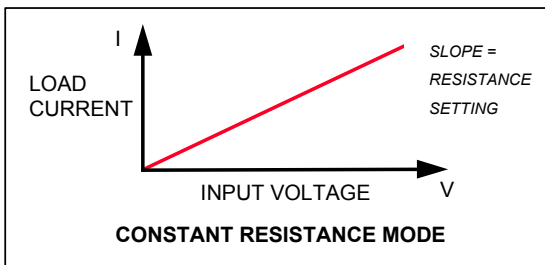

FRONT PANEL OPERATION

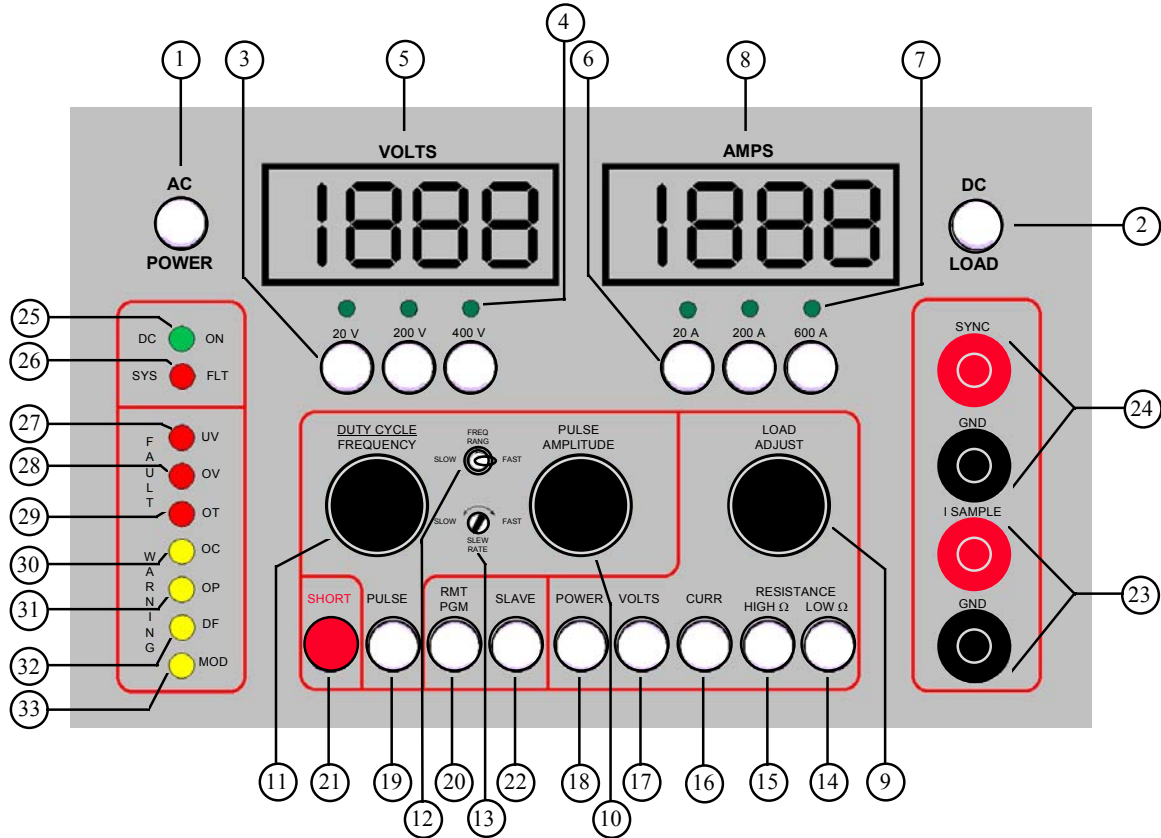

- | | |
|--|--|
| <ol style="list-style-type: none"> 1. AC Power 2. DC On 3. Voltmeter / Voltage Full Scale Range Selection* 4. Voltmeter / Voltage Full Scale Range Indicators 5. Voltmeter - 3 1/2 Digit 6. Ammeter / Current Full Scale Range Selection* 7. Ammeter / Current Full Scale Range Indicators 8. Ammeter - 3 1/2 Digit 9. DC Level Load Adjust Knob 10. Pulse Peak Amplitude Adjust Knob 11. Pulse Generator Frequency Adjust Knob And Duty Cycle Adjust Knob (Concentric Configuration) 12. Pulse Frequency Range Selector Switch (3 Ranges) 13. Transient Slew Adjust (10 Turn) 14. Constant Resistance (Low Ohm) Mode Selector 15. Constant Resistance (High Ohm) Mode Selector 16. Constant Current Mode Selector | <ol style="list-style-type: none"> 17. Constant Voltage Mode Selector 18. Constant Power Mode Selector 19. Pulse Mode Selector 20. Remote Programming Mode Selector 21. Short Circuit (Momentary Action) 22. Slave Mode Selector 23. Current Sample Output Jacks 24. Internal Pulse Generator Sync Output Jacks 25. DC On Status Indicator 26. System Fault Indicator 27. Undervoltage Fault Indicator 28. Overvoltage Fault Indicator 29. Over Temperature Fault Indicator 30. Current Limit Warning Indicator 31. Power Limit Warning Indicator 32. Discrete Fault Warning Indicator 33. Module Fault Warning Indicator |
|--|--|

ELECTRICAL CONNECTIONS

TERMINAL IDENTIFICATION

E-, E+ are the power inputs for connection to the power source. These are the large blades on the rear of the unit.

CAUTION - Only the power source-to-load connections are to be made to these studs.

THE TERMINAL STRIP

SENSE- (S-) AND SENSE+ (S+) - are the voltage sense terminals. Do not attempt to connect these inputs as the load inputs, internal damage may occur.

E- AND E+ - are connected internally to the power input studs. They are to be used only as a convenient connection point for the sense terminals when sensing the voltage locally.

EN – This terminal is the remote DC enable. A connection between (EN) and (S-) will turn the DC on.

SYN - this terminal supplies a 15 V sync signal for triggering external instrumentation.

REM - this terminal is the connecting point for remote programming from an external programming source. This input is referenced to (S-)

CS - this terminal is provided for the current sample output signal. The current sample output should be referenced to the (S-) terminal.

THE "D" CONNECTOR

This connector is used for synchronized parallel Dynaload operation.

AC INPUT

This connection provides the Dynaload with its operating power and its safety ground. Power requirements are 1 amp @ 115VAC per unit.

TYPICAL REAR PANEL CONNECTIONS

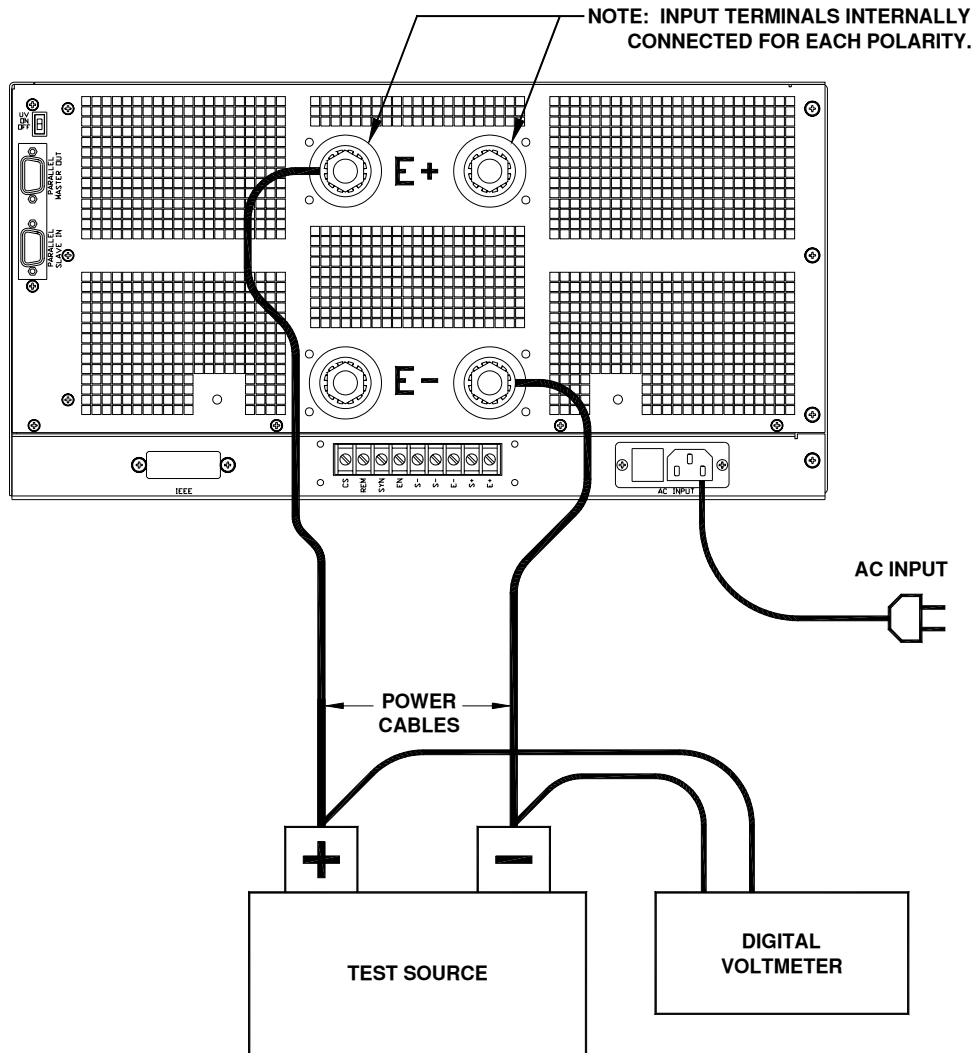

E+ AND E- WIRING TIPS

- Use short cables that are large enough in cross-section to handle the power source's current output.
- Twist and/or bundle the E+, E- cable(s). This will reduce self-inductance.
- Use lugs to secure the E+, E- cables to the studs.
- Connect only the power source to load cables to these studs; all other connections must be made via the terminal strip located below the studs.

EFFECTS OF CABLE LENGTH

CURRENT OSCILLATION

The Dynaload regulation loop is designed to operate at a maximum response time of 10 μ S. This is not affected by manipulating the slew rate. When operating in any of the constant DC modes, the external cable length can effect the performance of the load. If the total inductance of the power cables is excessive, a parasitic oscillation could occur. It is always recommended to monitor the current sample output to verify that the load is operating without high frequency current oscillation. If this situation occurs refer to the section on effects of cable inductance on pulse loading for recommended solutions on page 17.

LINE LOSS

If the Dynaload is not configured for remote voltage sensing, the voltage display and voltage readback will reflect what appears to be an erroneous number. The voltage display will indicate the voltage present at the input terminals. This number will be effected by the current level. Wire is a resistor, and will lose voltage as the current is increased. A general rule of thumb is to size your wire at 500 circular mils per amp of load current. This will allow a maximum of 10 degrees centigrade rise in temperature of the wire. The resistance of wire is approximately 107 ohms per 1000 feet for 100 circular mils of cross-sectional area. You can use Ohm's law ($E = I \times R$) to calculate the line losses for your particular application.

TERMINAL BLOCK CONNECTIONS

S- AND S+ WIRING TIPS

S- and S+ (Sense- and Sense+) are used to sense the load voltage. They may be connected at the back of the Dynaload, or remotely at the source. In addition, all input and output signals are referenced to S-. In any single or multiple load system, S- should be connected to E- (or the negative of the source) at **one and only one point**.

CAUTION - Damaging current loops could result from multiple connections to E-.

The Dynaload is supplied with two (2) metal straps between the S-, E- terminals and between the S+, E+ terminals on the terminal strip. These are to facilitate voltage sense wiring when sensing locally.

The S-, S+ external sense leads can be connected any where between the power source and the Dynaload. However, it is recommended that the voltage sense wires are connected to the power source terminals. This will eliminate potential errors due to voltage drop in the cable. It is also recommended to use shielded wire for remote voltage sense leads to prevent external noise from being introduced into the system.

In a master/slave (parallel) configuration, (S-) must only be connected to the E- source at the master Dynaload. The D connector cable(s) between master and slave(s) provides the S- loop to the slave(s).

EN

This input is used for remote operation of the DC on/off function. This input is TTL negative true in order for the load to operate. It is normally tied to the (S-) for local control. This input operates in parallel with the front panel control. If the front panel is in the OFF position the enable can toggle the DC on and off. If the front panel is in the ON position, the enable will **NOT** function to turn the DC off.

SYN

For instrumentation triggering purposes a 15V square wave synchronous to the internal pulse generator is supplied. This signal is also available on the front panel. As with all signals in or out, it is referenced to S (-). The signal is generated with a 10Kohm pull-up resistor to 15V, and an open collector pull-down to S-. The amplitude of the square wave may be externally limited without damage to the load. When not in pulse mode, this output remains high until a current change is executed. At this time, the output is pulsed low for scope triggering.

CS

A 0-10V signal representing 0-full scale current in each of the selected current ranges is generated. This signal is a true representation of the current level and waveform being generated by the load. Connect an oscilloscope or other external instruments to this terminal as monitoring devices. The instruments should be referenced to terminal S-. Shielded wire is recommended.

REM (EXTERNAL MODULATION)

This is the remote control input signal. 0 to 10 volts in yields 0 to full scale loading in whatever mode and range is selected. When a signal or waveform is presented at this input it will translated directly into your current level and waveform. The signal source should be referenced to S-.

TERMINAL BLOCK CONNECTIONS

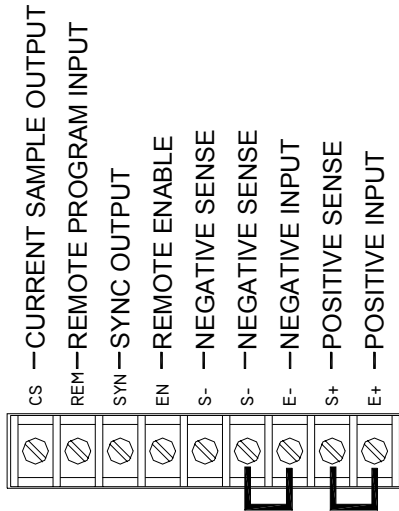

FOR LOCAL VOLTAGE SENSING, CONNECT (S+) TO (E+) AND CONNECT (S-) TO (E-). FACTORY INSTALLED JUMPERS ARE PROVIDED.

NOTE:
 THE POSITIVE AND NEGATIVE INPUTS ARE PROVIDED ON THE TERMINAL BLOCK FOR EASE OF CONNECTION. DO NOT CONNECT THESE INPUTS TO YOUR TEST SOURCE AT ANY TIME. DAMAGE TO THE UNIT MAY RESULT.

REMOTE VOLTAGE SENSE

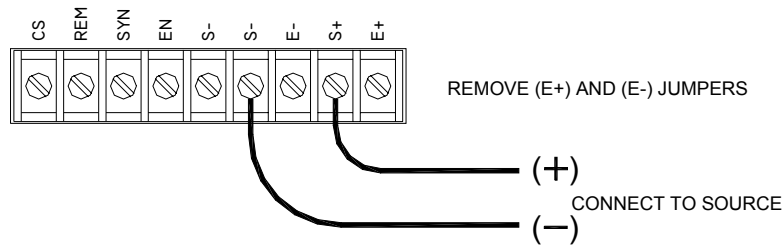

FOR IMPROVED VOLTAGE READBACK, USE THE REMOTE VOLTAGE SENSING CAPABILITIES.

1. REMOVE THE JUMPERS FROM (E+) TO (S+) AND (E-) TO (S-).
2. CONNECT THE (S+) TERMINAL TO THE POSITIVE OUTPUT ON THE TEST SOURCE.
3. CONNECT THE (S-) TERMINAL TO THE NEGATIVE OUTPUT ON THE TEST SOURCE.

TERMINAL BLOCK CONNECTIONS OPTIONAL EQUIPMENT WIRING

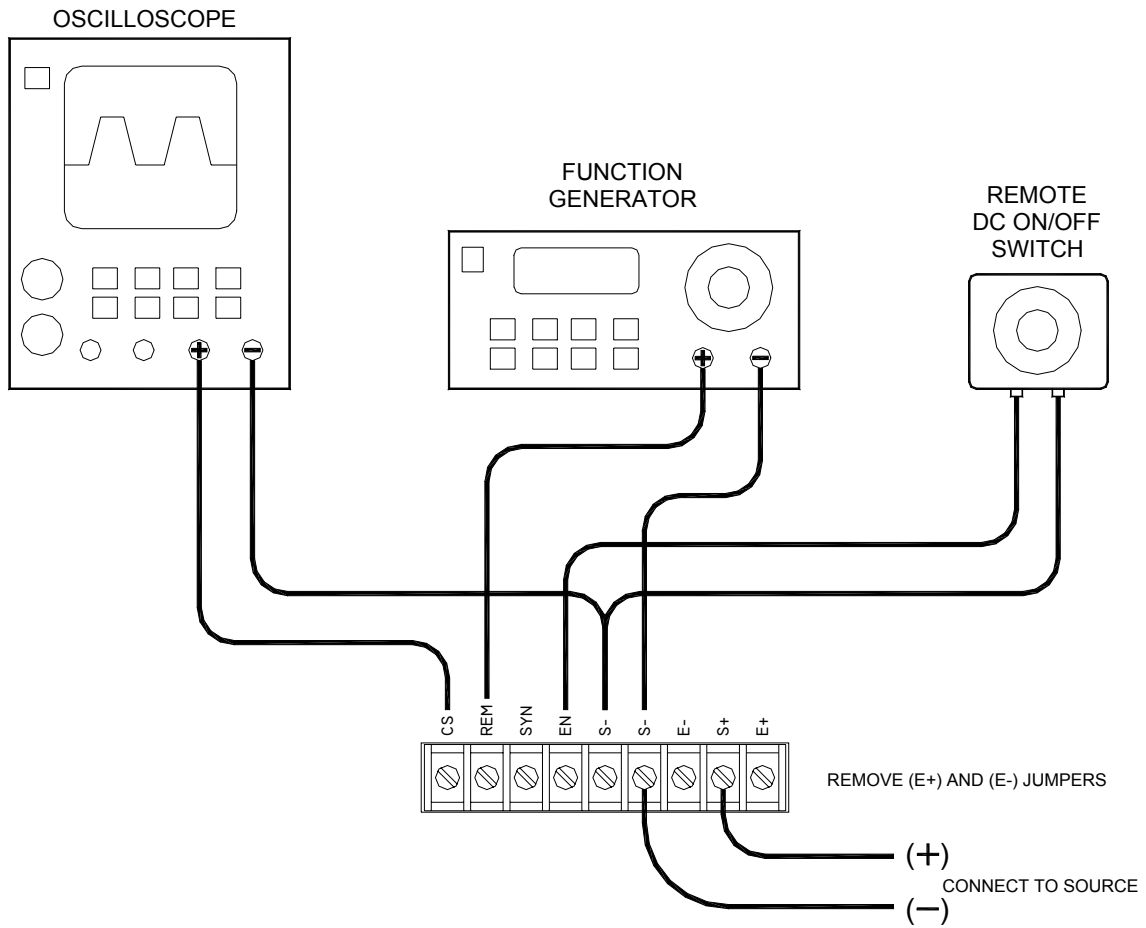

"D" CONNECTOR WIRING

- The nine (9)-pin "D" connector is used to link the master unit to slave units. This is a standard RS232 cable which is necessary in master/slave systems. If you are purchasing this cable, be sure the PIN configuration is always 1 to 1. Not all RS232 cables are provided this way and a crossover of PINS will cause erroneous operation.

AC INPUT WIRING TIPS

- The standard U.S. 3-prong cord is provided with your Dynaload.
- The voltage selector tab is to the left of the 3-prong AC connector.

SAFETY WARNING: Make sure that the power cord is removed before continuing.

The AC input module on the rear of the Dynaload will have one of two possible selectors. Only the labeling on the selector is different, the applicable ranges are identical. The selector will be labeled as follows:

[100,120,200,240]...or...[115,125,230,250]

Use the table below to set the voltage selector position for your input voltage. The selected voltage should be positioned adjacent to the molded arrow on the top of the input module.

AC INPUT VOLTAGE	SELECTOR	
90V - 110V	(N/A)	(N/A)
108V- 132V	120	125
180V - 220V	200	230
216V - 264V	240	250

SAFETY WARNING: The power cord provides a chassis ground through a third conductor. Make sure that your power outlet is of the 3-conductor type with the correct pin connected to earth ground.

- Connect the AC cord first to your Dynaload then to the utility outlet.
- Fuse replacement part number is MDA-3 (3 amp, 250 volt, slow blow)

OPERATING INSTRUCTIONS

The following procedure is recommended for operating the Dynaload:

1. AC switch should be turned off.
2. Connect DC source to E+ and E-. Always watch for correct polarity.
3. If external analog programming is to be used, connect signal source.
4. Connect AC power. Be sure you have selected the correct AC input position on the load.
5. Turn on AC power; meters should come on and fan should run.
6. Check to see that the voltage and current ranges selected are correct.
7. Press the DC-ON button. This will close the relays and connect the source to the power dissipating circuitry. The DC on LED will illuminate.
8. Turn on the power source to be tested.
9. Press the mode select button for the mode you wish to operate in. Adjust the load control pot in the clockwise direction to set the desired load current.
10. The load will now be operating at the set level

CI - CONSTANT CURRENT MODE

This mode of operation allows the user to set a fixed current. This set level will not change regardless of changes in the source voltage. Some power sources such as variable power supplies are rated at a fixed maximum load current and adjustable over a predetermined voltage range. For example: 5-30V @ 20A. If the resistive load characteristic were used for this type of a test, it would be necessary to reset the load each time the power supply voltage was changed in order to maintain desired load current. However, if the load is in the constant current mode, the current is constant regardless of input voltage fluctuations.

It should be noted that many power supplies are designed for short circuit protection by internal current limiting and foldback, therefore, the supply may not start up into a constant current load. Accordingly, it is suggested that the Constant Resistance mode be used as a load when simulating short circuit protection and recovery of most power supplies, unless otherwise specified by the manufacturer.

NOTE: The constant current mode should never be used to test a constant current source. The regulation of the two units will fight for control of the current and an unstable oscillation will result.

CR - CONSTANT RESISTANCE MODE

The constant resistance mode regulates the load current in direct proportion to the load voltage. There are eighteen different resistance ranges available. These are derived from the nine different voltage and current combinations available, and the two different resistance modes (HIGH and LOW). The actual resistance values, expressed in Ohms, are outlined in the specification section of this manual. In general, select the appropriate voltage and current range for the source, and then determine if the high resistance range or the low resistance range is required. Other ranges may be selected to tailor the response to a particular application. For example: Given a 48V source capable of 60A. Select the 200V, and 200A ranges. If the high resistance mode is selected, the maximum current capability is

$$0.5 \text{ Amps/Volt} \times 48 \text{ Volts} = 24 \text{ Amps MAX. -- Too Low!}$$

Select the low resistance mode:

$$5 \text{ Amps/Volt} \times 48 \text{ Volts} = 240 \text{ Amps MAX. -- sufficient current capability.}$$

The resolution of the load may be improved by selecting the 400V range. This yields

$$2.5 \text{ Amps/Volt} \times 48 \text{ Volts} = 120 \text{ Amps MAX.}$$

This provides double the resolution, but it reduces voltage sensitivity.

NOTE: The resistance may be entered in Ohms or Amps/Volt (1/R). This option is selected through the front panel menus.

CV - CONSTANT VOLTAGE MODE

The constant voltage mode can best be described as a shunt regulator or a zener diode. The load will not conduct any current until the source voltage tries to exceed the voltage set point. Once the source voltage is high enough the load will shunt current in order to regulate the voltage. The regulating voltage is adjustable from full scale of the range selected to approximately zero. The constant voltage mode is used to simulate a battery to a battery charger or for special applications, such as a shunt regulator.

NOTE: Never use the constant voltage mode for testing a constant voltage source. The regulators of the two devices will buck each other trying to gain control of the voltage which will lead to an unstable condition.

CP - CONSTANT POWER MODE

In constant power mode, the Dynaload will dissipate a set wattage anywhere up to the maximum power rating of the unit. The Dynaload will automatically adjust the current level inversely in response to a change in voltage.

CAUTION: If the source voltage decays to zero volts the load will attempt to draw infinite current.

FULL SCALE RANGE SWITCHING

The RBL series provides selection of one of three full scale input voltage ranges and one of three full scale input current ranges. The full scale voltage and current ranges may be selected in any combination resulting in nine (9) operational ranges per unit.

The selectable ranges provide increased resolution. For example: Setting 10 amps may be difficult using the 600 amp full scale. By selecting a lower full scale, 100 amps, the resolution of the meters, programming input, and the current sample output are greatly increased.

SYNCHRONIZED PARALLELING

The synchronized paralleling function allows the user to connect two (2) or more loads in parallel. One unit is controlled through normal operation, the master. The additional units, the slaves, are connected via a nine (9) pin serial cable and respond to the control signals sent by the master. In all operating modes, the master and all slaves will share the current in proportion to the selected current range.

SLEW RATE ADJUST

The slew rate adjustment is utilized to compensate for long load input cables which could cause oscillation or overshoot in the load due to high inductance on the loads input. The slew rate setting is set at the factory for 100 μ s for a 0 to selected full scale transition. Minimum slew rate is 10 microseconds; Maximum is 40,000 microseconds, 40 milliseconds.

Operating two or more RBL Dynaloads in parallel requires a number of control signals to be shared among the units. These signals are present on two 9-pin “D” connectors on the rear of the RBL. Other than the analog programming signal, all signals are active low- when active, they are pulled to Sense (-), when inactive, they float to +15 Volts. The analog programming signals, MASTER OUT and REMOTE IN, are 0 to 10 Volts for 0 to Selected Full Scale. MASTER OUT is available on the top connector, and REMOTE IN is available on the bottom connector. All other signals are present on both connectors.

The pin assignments are as follows:

PIN #	FUNCTION
1.	MASTER OUT / REMOTE IN
2.	Low Current Range Select
3.	Medium Current Range Select
4.	DC ON/OFF (slave) Select
5.	Short Circuit
6.	Current Average Out
7.	Fault, Critical
8.	Fault, Warning
9.	Sense (-) (used for signal return)

The REMOTE IN signal is also present on the terminal block.

Other than DC ON/OFF, all the other signals are independent of the slave mode, and may be used in any mode. Only DC ON/OFF is linked through the slave mode.

Note: Slave mode selects the constant mode of operation, locking out the other modes.

PULSE LOADING

Pulse loading is available in all four (4) modes of operation. Use the following steps when operating in pulse mode. It is best practice to connect an oscilloscope to the current sample output to monitor your current levels and waveform.

MANUAL OPERATION

1. Use the CI, CP, CV or CR button to set the baseline current, power, voltage, or resistance respectively.
2. Use the FREQ adjust knob to set the frequency.
3. Use the DUTY CYCLE adjust knob to set the duty cycle.
4. Use the PEAK button to set the amplitude of the pulse.

NOTE: The peak setting is added to the baseline setting.

5. The slew rate can be adjusted via the front panel access. This is factory set at 100 microseconds.
6. Use the RUN button to initiate pulse loading.

The slew rate setting is set at the factory for 100 microseconds, but is adjustable through the front panel.

It is recommended to monitor the current sample output with an oscilloscope to observe the actual current amplitude and waveform.

If waveforms other than square waves are required, this can be accomplished by programming the loads using an external analog program source. (See remote programming on page 18).

NOTE: In constant voltage mode the load is increased by lowering the voltage. Therefore, in constant voltage pulse mode, the baseline voltage is higher than the peak setting. In constant resistance pulse mode, the baseline resistance is added in parallel with the peak resistance.

EFFECTS OF CABLE INDUCTANCE ON PULSE LOADING

When the Dynaload is used for high current pulse loading, the effects of cable inductance must be considered. The critical parameters are the rise time and the minimum compliance specifications. If the inductance of the cables from the voltage source is great enough to cause the voltage at the Dynaload to go below the minimum compliance level, then excessive current wave form distortion will occur. This is the result of the power devices driving into saturation. They attempt to reach the programmed current, however they cannot because of the low drain voltage. Once in a saturated state, the response time is much slower. The result is a significant overshoot on the rising edge of the pulse.

In order to prevent this from occurring, it should be noted that:

1. 1 microhenry = 2.4 feet of wire (total).
2. 50A @ 50 microseconds rise time = 1 volt drop with 1 microhenry.
3. The inductive drop cannot exceed the difference between the source voltage and the minimum compliance.

For example: To test a 10V source with a 100A pulse, and assuming a 3 Volt minimum compliance, the maximum cable length would be:

$$E \text{ Max drop} = 7V$$

$$E = L \frac{di}{dt} \qquad 7V = L \frac{100A}{50\mu s}$$

$$L = 3.5 \text{ microhenries maximum}$$

Maximum cable length = 8.4 feet total
or 4.2 feet per cable from source to Dynaload.

If the distance from the load to the source must be greater than this, there are several methods to increase the maximum distance. One way is to use several insulated conductors. This cuts the inductance in half if 4 are used instead of 2, or by one-third if 6 are used. This double or triples the maximum length, respectively. Another method is to slow down the rise time of the pulse generator before applying it to the regulation loop. Increasing the slew rate to 100 microseconds will double the maximum cable length. The third method is to use a large electrolytic capacitor at the Dynaload studs that can supply current necessary to counteract the inductive drop of the cable.

If the previous example required 15 feet of total cable length or 6.25 microhenries, which would be 12.5V of inductive drop, then the capacitor would have to supply 5.5v @ 100A for 50 microsecond. By the formula:

$$E = \frac{I \cdot T}{C}$$

The capacitor required would be 900 microfarads.

TRANSCONDUCTANCE

There exists a little known characteristic of power MOSFET'S called transconductance. Today's MOSFET'S are designed for high speed switch mode operation where the operation is full ON or full OFF. The Dynaload uses these FET's in their linear region where the transconductance effect becomes apparent. When the gate of a FET is pulsed, the drive circuitry must overcome the inherent miller capacitance to reach the desired gate voltage. When the pulsed gate signal is very small the transconductance of the component will limit the rise time of the FET. When operating the Dynaload at pulsed currents less than 10% of full scale, the rise time of the current waveform will be much slower than expected. Since this roll off in response is dependent on the number of FET's used in the power tray and the actual current pulse desired, it is very difficult to provide exact equations to define the effect. It is suggested to select a load which will provide the desired pulse level while operating at current levels greater than 10% of the full current rating of the load. If the baseline current is greater than 10% of full scale current and the pulsed waveform is added above this baseline the effects of transconductance will be eliminated. The greatest distortion occurs when pulsing from a zero current baseline.

NOTE: Range switching will have no effect on operation in the transconductance region.

REMOTE PROGRAMMING

The RBL series is analog programmable in all four modes of operation. The loading in a particular voltage or current range is directly proportional to the 0-10 volt programming input. For example: If the constant current mode is selected and the 200A range is selected, a programming voltage of 5 volts is required to program the load to 100A. Waveforms can be programmed with the remote programming input as long as they do not exceed the capability of the load. The slew rate setting is set at the factory for 100 microseconds for a 0 to selected full scale transition, but is adjustable from the front panel.

FAULT INDICATORS

Red is alarm or major fault. (Unit will shut down, but the fan will continue to run.)

UV - Undervoltage - DC ON will not function until voltage is present.
(Over ride switch provided on rear panel)

OV - Overvoltage - Unit will disconnect from source

OT - Overtemperature- Unit will shut down

Yellow is a warning or minor fault. (Unit may continue to operate, but may be out of regulation.)

OC - Overcurrent - Unit has reached the set current limit or the current limit of the selected range.

OP - Overpower- Unit has reached the set power limit.

SAT - Saturation - Saturation condition whereby one or more of the electronic power components are completely turned-on. This may be due to insufficient source voltage or inadequate wiring. This may also indicate electronic component failure.

MOD -Module - Indicates that there is an abnormal operating condition at the module level.

UNDERVOLTAGE LOCKOUT

The UV switch on the rear panel has two positions, ON and OFF. When the switch is ON, the DC relay will not engage and the SYS and UV fault indicators will be on until there is greater than .4 volts applied to the DC inputs. Anytime the voltage drops below .4 volts the relays will disengage and the UV alarm will be latched. Please note that the DC relays will re-engage and the SYS fault LED will extinguish when the input voltage goes over .4 volts. When the UV switch is in the OFF position this action is inhibited allowing for load operation under .4 volts.

CONDITION INDICATORS

In systems with parallel loads, and on single loads, the system fault indicator will illuminate if any load in the system has a fault.

The DC-ON indicator illuminates when the load is active. If a load is in the slave mode, the indicator will illuminate yellow when the slave is enabled and the master is off.

When the master is turned on, the slave DC-ON will illuminate green.

LOCATION, AIRFLOW, MAINTENANCE

The figures shown in appendix A are the dimensions of your Dynaload. In addition to the rack mounting ears, the use of slides or shelf type supports is required. The RBL chassis is equipped with mounting holes that match Jonathan 110QD-24-2 slides. The slide mounting screws **must** be #10 - 32 x 5/16 truss head.

The internal fan cools the unit by drawing in air from the front and exhausting it out the back. Keeping the airflow inlet and outlet screens open and free of dust and other airflow inhibitors will help keep your Dynaload's operating temperature within the intended design limits. We suggest that the loads be cleaned and free of dust build-up at least once a year.

The load can operate without performance derating over the temperature range of 0 to 40°C and with derated power dissipation capability up to 50°C.

OPERATOR SAFETY INSTRUCTIONS

It is very important that these safety instructions and operation instructions are read and understood prior to the installation and use of this electronic load. Failure to follow these basic guidelines could result in serious injury or death.

This electronic load is inherently safe by design. It cannot produce any hazardous voltages or currents; however, when in use it may expose the operator to the hazards of the DC source which the load is connected to. This equipment is intended for use by trained personnel and there are no operator serviceable parts inside. All service and calibration must be performed by authorized personnel.

WARNING

Be sure all AC and DC power for both the load, the test source, and any peripheral equipment is OFF prior to making any connections to the load.

Be sure the proper AC input range is selected before attaching the line cord.



Be sure the load selected is properly rated for the voltage and current generated by the DC source.

Be sure all connections are correct and secure, and that all safety covers are in place before applying power.

If the unit is to be mounted, please consider the weight and position of the equipment to prevent the rack from becoming top heavy. A top-heavy rack can create a tip over hazard.

All air intake and exhaust ports should be kept clear of obstructions.

SAFETY SYMBOLS

SYMBOLS	DEFINITIONS	PUBLICATION
	CAUTION, RISK OF ELECTRIC SHOCK	ISO 3864, No. B.3.6
	CAUTION, REFER TO INSTRUCTION MANUAL	ISO 3864, No. B.3.1
	EASILY- TOUCHED HIGHER TEMPERATURE PARTS	ISO 3864