



**MODEL
64
FET VOLT-OHMMETER**

**TT TRIPLETT
INSTRUCTION MANUAL**

SAFETY RULES

WARNING

This tester has been designed with your safety in mind. However, no design can completely protect against incorrect use. Electrical circuits can be dangerous and/or lethal when lack of caution or poor safety practices are used.

READ THE MANUAL

Read this Instruction Manual carefully and completely.

Voltages and currents within the capability of this test equipment can be hazardous. Follow the instructions in this manual for every measurement. Read and understand the general instructions before attempting to use this tester. Do not exceed the limits of the tester.

SAFETY CHECK

Double check the switch setting and lead connections before making measurements. Are you following all of the instructions?

Disconnect the tester or turn off the power before changing switch positions.

Do not connect to circuits with voltage present when switch is in any ohms or current position.

When replacing fuses use only specified type fuses and insert in correct fuse holder.

DON'T TOUCH

Don't touch exposed wiring, connections or other "live" parts of an electrical circuit. If in doubt, check the circuit first for voltage before touching it.

Turn off the power to a circuit before connecting

SAFETY RULES (cont'd.)

test probes to it. Be sure there is no voltage present before you touch the circuit.

Do not use cracked or broken test leads.

HIGH VOLTAGE IS DANGEROUS

Always start with the power off. Be sure there is no voltage present before making connections to the circuit.

Don't touch the tester, its test leads, or any part of the circuit while it is on.

Before disconnecting the tester, turn the circuit off and wait for the meter to return to "zero".

DISTRIBUTION CIRCUITS PACK A PUNCH

In high energy circuits such as distribution transformers and bus bars, dangerous arcs of explosive nature can occur if the circuit is shorted. If the tester is connected across a high energy circuit when set to a low resistance range, a current range, or any other low impedance range, the circuit is virtually shorted.

Special equipment designed for use with these circuits is available. Contact a qualified person for assistance before attempting to make measurements on any high energy circuit.

SAFETY IS NO ACCIDENT

TABLE OF CONTENTS

| | Page No. |
|-----------------------------------|----------|
| Specifications | 4 |
| Description | 8 |
| Preparation for Use | 10 |
| General Instructions | 11 |
| Operating Instructions | 14 |
| Measuring DC Volts | 14 |
| Measuring AC Volts | 16 |
| Measuring dB | 18 |
| Measuring Resistance | 20 |
| Junction Test | 23 |
| Maintenance | 24, 32 |
| Calibration | 26 |
| Accessories | 27 |
| Replaceable Parts List | 29 |
| Disassembly Instructions. | 31 |
| Parts Location | 34 |
| Schematic (Fold Out) | 35 |
| Warranty | 36 |
| Printed in U. S. A. | 3 |

SPECIFICATIONS

DC VOLTS

Ranges

.3 - 1 - 3 - 10 - 30 - 100 - 300 - 1000.

Accuracy - $\pm 3\%$ all ranges.

Input Resistance - 11.12 Meg all ranges.

Overload Protection - 0 to 1000 VAC for 30 sec.
max.

AC Rejection Filter - N. M. R. 40 dB.

Isolation Resistor - 1.12 Megohms located inside
tester.

Response Time - 0 to FS 1 - 1.5 sec. with 0 to 5%
overshoot.

Polarity Switch reverses polarity of test leads.

Function - AC - DC Ω Switch located on left side of
tester.

AC VOLTS

Ranges

.3 - 1 - 3 - 10 - 30 - 100 - 300 - 1000.

Accuracy - $\pm 3\%$ at 60 Hz all ranges.

Input Resistance - 10 Megohms all ranges.

Input Capacity - 50 pF max.

SPECIFICATIONS (cont'd.)

Frequency Compensation

All ranges except 300 and 1000 V.

Frequency Range 20 Hz to 20 kHz.

Detection - Average calibrated in RMS on sine
wave.

Response Time - 0 to FS .5 - 1 sec. with 0 to 5%
overshoot.

Input - Direct Coupled - For AC coupling external
capacitor is used.

Overload Protection - 0 to 1000 VAC for 30 sec.
max.

OHMMETER - 10 Ohms Center Scale

Measurement Range - .2 to 100 Megohms.

Ranges

x1 - x10 - x100 - x1K - x10K - x100K - x1 Meg.

Low Power Ohms

Rx1 - x10 - x100 - x1K - x10K - x100K.

Max. Voltage - 90 Millivolts.

Max. Short Circuit Current on x1 Range - 9 mA.

Max. Power - .8 mW.

Conventional Ohms

Rx1 Megohm.

Max. Voltage - .9 Volt

Max. Short Circuit Current - .09 μ A.

Max. Power - .08 μ W.

SPECIFICATIONS (cont'd.)

Accuracy - $\pm 3\%$ of arc.

Response Time - Same as DCV except for Rx1
Meg range which is 4 sec.

Overload Protection - 0 to 1000 VAC for 30 sec.
max.

Battery Drain 10 mA continuous when in Ohms
Function.

Polarity - Red Probe, plus, when Polarity Switch
is in plus position.

JUNCTION TEST - For checking diodes and transistor
junctions; forward and reverse conduction.

Scale - Calibrated in junction voltage which in turn
determines whether the junction is silicon - ger-
manium, open or shorted.

Max. Voltage - .9 V.

Max. Short Circuit Current - .9 mA.

Max. Power - .8 mW.

Polarity Switch reverses polarity of test leads same
as ohmmeter.

Overload Protection - 0 to 1000 VAC for 30 sec.
max.

SPECIFICATIONS (cont'd.)

DECIBELS

Ranges
-30 dB to +32 dB.

Accuracy - $\pm 3\%$ at 60 Hz all ranges.

METER - Suspension approx. 50 μ A. Separate
housing for easy replacement.

TEST LEADS - One red and one black test lead sup-
plied, each 48 inches long.

CARRYING HANDLE - Position indent provides inclined
tester stand.

BATTERIES

Two 9 V transistor batteries - NEDA 1604,
Alkaline M-1604.

Battery Life - 9 V - one year on continuous.

1 1/2 V D Cell - NEDA 13F. Battery Life - one
month on continuous when left in ohms position.

Battery Test - Checks voltage of one 9 V battery,
the battery with highest drain.

FUSES - 1 Amp at 250 V and 2 Amp at 1000 V.

CASE - Color green - high impact thermoplastic.

SIZE - Approx. 3 1/4" x 5 1/4" x 7 1/4".

WEIGHT - Approx. 2 3/4 pounds.

DESCRIPTION

The Triplet Model 64 FET Volt-Ohmmeter is a multi-range instrument for general electrical and electronic trouble shooting and measurement. It has been especially designed to satisfy the need for a precision instrument which can stand up under rigorous hard usage of the industrial and maintenance environment and at the same time provide a degree of safety in its use heretofore unavailable with an instrument of this kind. Maintenance is simplified by designing an independent meter module for quick replacement or service and easy to follow parts layout.

X'TRA RUGGED: Unique design and selection of materials permits the instrument to withstand the normal accidents of dropping and rough handling which occur in hard day to day use. The Model 64 is warranted to withstand an accidental drop up to a five foot height with deviation from its stated accuracy not exceeding $\pm 4\%$. The warranty does not include mechanical parts being defaced (scratched, etc.) from a drop or normal usage.

OVERLOAD PROTECTED: The instrument has been engineered for significant reduction in the need for maintenance by virtual elimination of parts burn out (other than fuses), and parts damage from severe mechanical abuse. Two fuses are employed for unusual protection to the instrument and safety for the user. The 1 Amp instrument fuse is used for normal overload conditions. A spare is included in the instrument. Protection is provided for high energy fault currents beyond the capabilities of the instrument fuse, up to the capacity of the 2 Amp/1000V (20 kW) fuse.

SAFETY DESIGNED: Unusual effort has gone into the instrument's design to provide the greatest possible safety to

DESCRIPTION (cont'd.)

the user.

The Model 64 provides a specially engineered internal electrical system to prevent explosive arcs in high energy circuits up to the 2 Amp/1000V (20 kW) fuse capacity. Complete insulation of the instrument itself plus a new type test lead are additional safety features.

The carrying handle can be rotated to provide a stand for placing the instrument at a viewing angle of approximately 30 degrees.



A separately sealed battery compartment permits access to batteries and fuses without removal of the remainder of the instrument. In addition, battery acids are sealed off to prevent damage to components.

PREPARATION FOR USE

INSTALL BATTERIES:

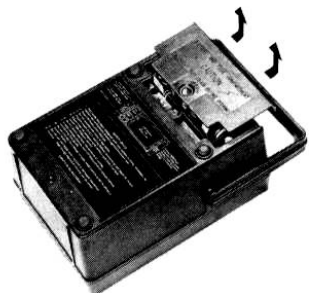

1. Loosen captive screw.
2. Slide cover off.
3. Install batteries, routing wires as shown.
4. Replace cover.

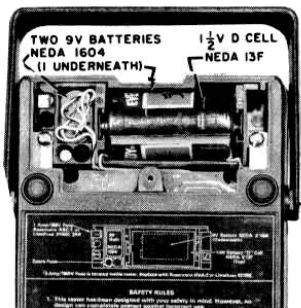

ADJUST POINTER TO ZERO:

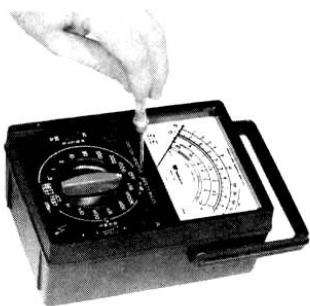

10

With unit in operating position and range switch in "off" position, use a screwdriver to adjust pointer for a zero indication.

GENERAL INSTRUCTIONS

START WITH HIGHEST RANGE

When the approximate value of the voltage or current being measured is not known, always start with the highest range to avoid overload and blowing a fuse.

RANGE CHOICE

For greatest accuracy choose the range which allows readings to be made in the upper (right hand) portion of the scale. Accuracies are rated as percent of full scale so the closer to full scale the better the accuracy except on ohms ranges where best accuracy occurs near half scale.

DO NOT CHANGE SWITCHES UNDER LOAD

Quality switches are used but any switch will arc if changed while under load. Disconnect the test probes or shut off the circuit under test before the range switch or polarity switch positions are changed. This practice will result in increased life and reliability of the instrument.

MEASUREMENT ERRORS

Readings on the sensitive ranges may sometimes be different than expected due to thermoelectric or electrochemical effects.

Readings on the high resistance ranges can be affected by touching the circuit causing the body to act as a shunting resistor.

Consideration should be given to the loading affect of the instrument when measuring voltages from sources of high impedance.

11

GENERAL INSTRUCTIONS (cont'd.)

NOMENCLATURE

POINTER

SCALES - See page 13.

ZERO ADJUST CONTROL - with range switch in "300 Volts" position adjust for zero pointer indication.

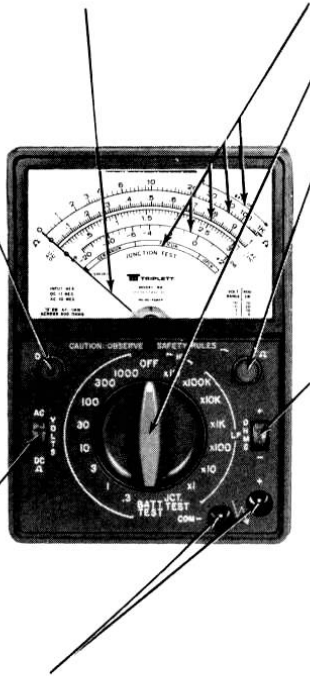

AC - DC Ω SWITCH - selects AC or DC response for voltage ranges.

RANGE SWITCH - selects measurement range.

OHMS ADJUST CONTROL - sets full scale indication on ohms ranges with test leads open.

POLARITY SWITCH - when in the "+" position a positive voltage applied to the "+" jack will cause an upscale pointer deflection and on the "JUNCTION TEST" range the "+" jack will be positive. When in the "-" position the polarity is reversed.

INPUT JACKS - plug black test lead into "COM-" jack and red test lead into "+" jack.

GENERAL INSTRUCTIONS (cont'd.)
USE OF SCALES

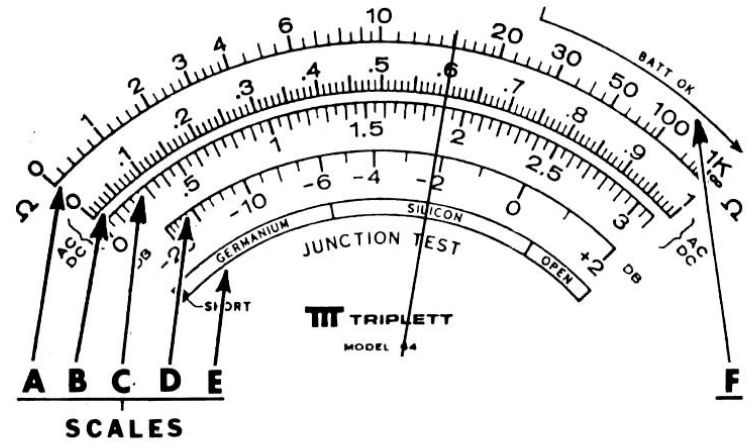

| Range Switch Position | Read Scale | Reading For Above Indication | Range Switch Position | Read Scale | Reading For Above Indication |
|-----------------------|------------|------------------------------|-----------------------|------------|------------------------------|
| 1000V AC/DC | B | 600V AC/DC | x1 | A | 15 Ω |
| 300V AC/DC | C | 190V AC/DC | x10 | A | 150 Ω |
| 100V AC/DC | B | 60V AC/DC | x100 | A | 1500 Ω |
| 30V AC/DC | C | 19V AC/DC | x1K | A | 15K Ω |
| 10V AC/DC | B | 6V AC/DC | x10K | A | 150K Ω |
| 3V AC/DC | C | 1.9V AC/DC | x100K | A | 1.5 Meg Ω |
| 1V AC/DC | B | .6V AC/DC | x1M | A | 15 Meg Ω |
| 0.3V AC/DC | C | .19V AC/DC | Jct. Test | E | Silicon |
| 1V AC/DC | D | -2.2 dB | Batt. Test | F | Replace Batt. |

OPERATING INSTRUCTIONS

BATTERY TEST

In the BATT TEST position the pointer should indicate in the designated portion of the dial. When the indication falls short or if the unit cannot be properly zeroed, the 9 volt batteries should be replaced.

The 1 1/2 volt "D" cell is operational only on the ohms ranges and should be replaced when a full scale indication cannot be obtained on the ohms ranges with the OHMS ADJUST CONTROL fully clockwise.

MEASURING DC VOLTS

1. Select desired range.
2. Set AC - DC Ω switch to DC Ω .
3. Set polarity switch to desired position.
4. Insert test leads into tester, red to + input, black to COM.
5. Short test leads together and adjust zero adjust control for zero indication on the meter.
6. Connect test leads to voltage to be measured. If reading is below 1/3 scale, set range selector to next lower range. If beyond full scale set range selector to a higher range.
7. Read appropriate range 1 or 3.

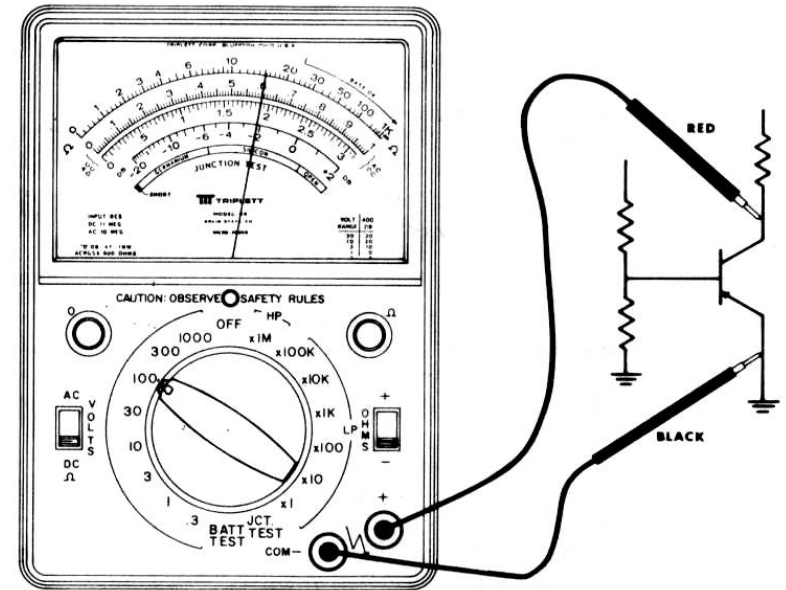

Measuring DC Volts

OPERATING INSTRUCTIONS (cont'd.)

MEASURING dB

1. Set up tester same as for AC volts.
2. Connect test leads to voltage to be measured. Read dB scale and add to range marking given on lower right of meter dial. For example, if meter reads -2 and range is set to +10 dB (+3 volts) the level would be +10 dB - 2 dB = 8 dB.
3. If source to be measured contains a DC voltage, use an external capacitor to block the DC voltage. Capacitor should be .01 μ F or larger with a proper voltage rating.
4. Both AC and DC dB measurements can be made in a manner described in the above paragraphs. If DC dB measurements are made no external capacitor is used.

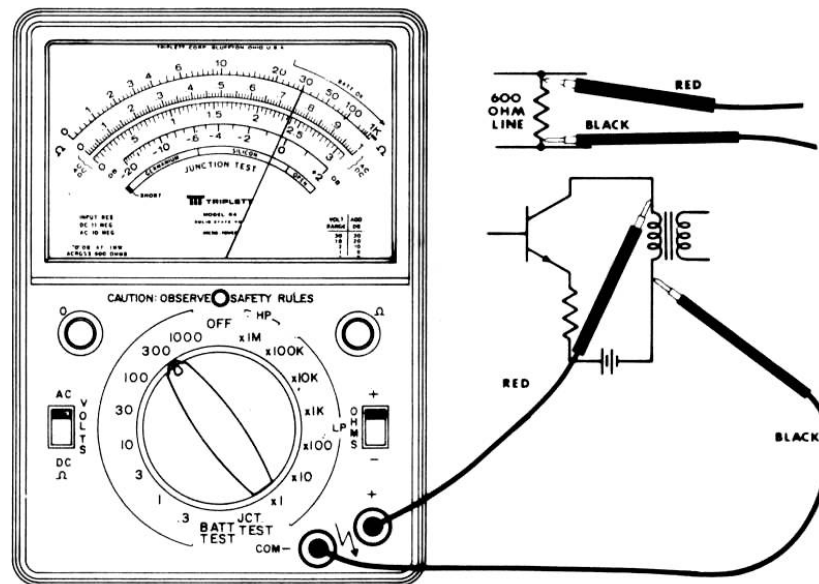

Measuring dB

OPERATING INSTRUCTIONS (cont'd.)

MEASURING RESISTANCE

1. Set AC - DC Ω switch to DC Ω .
2. Set polarity switch to + position. With this setting a + voltage is applied to the red test lead.
3. Insert test leads, red to + input and black to COM.
4. For best results start with the RANGE SWITCH in the "x1K" position and with the test leads shorted together adjust the ZERO ADJUST CONTROL for a zero pointer indication. Then with the test leads open adjust the "OHMS ADJUST CONTROL" for a full scale (∞) indication.
5. Set RANGE SWITCH to desired range.
6. Connect test leads to resistance to be measured and read the ohms scale (uppermost on dial). The reading is then multiplied by the range setting. For example, if the range setting is Rx100 and the reading is 20 then the value of resistance measured is 2000 Ω .

On the "x1" range the indication is normally around .1 ohm with the leads shorted due to test lead and fuse resistance. This indication should be noted and subtracted from readings made on this range. Errors will result if zeroing is attempted on this range.

NOTE - Ranges Rx1 thru Rx100K are low power ohms, 90 millivolts applied across resistor under

OPERATING INSTRUCTIONS (cont'd.)

test. One range Rx1 Meg is conventional ohms with .9 volt across the resistance to be measured.

For maximum battery life, the unit should not be left in one of the ohms ranges or JUNCTION TEST when not in use.

OPERATING INSTRUCTIONS (cont'd.)

JUNCTION TEST

The ohms ranges with exception of Rx1 Meg have an open circuit voltage of 90 mV which allows "in-circuit" measurements to be made in silicon semiconductor circuits as the junctions appear to have a near infinite resistance at this voltage.

The JUNCTION TEST range is provided to check and identify semiconductor junctions as the open circuit voltage is nominally .9 volts.

1. Set RANGE SWITCH to Junction Test.
2. Set AC - DC Ω switch to DC Ω position.
3. Connect test leads to semiconductor junction either diode, transistor or IC.
4. Note reading, with one position of polarity of the polarity switch. Reverse polarity and note reading again.

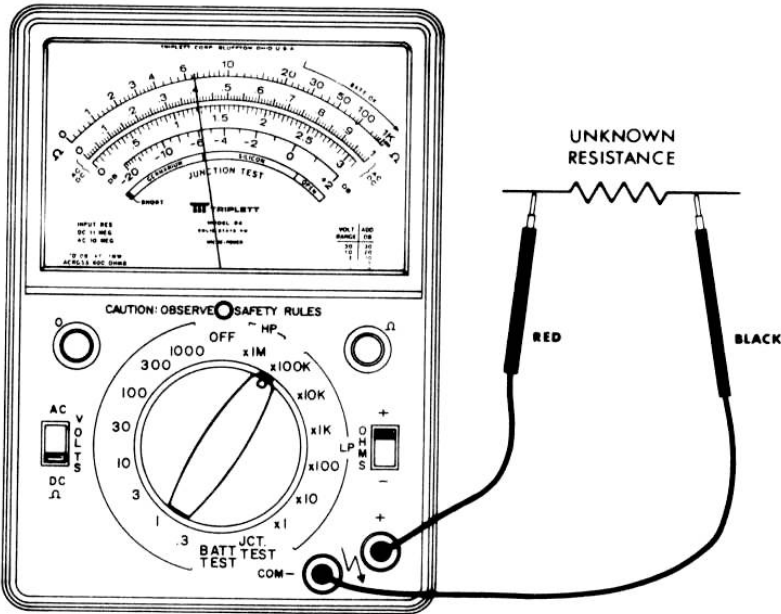

Measuring Resistance

In one position (reverse conduction) the junction should read ∞ if junction has low leakage. In the other position of the polarity switch, (forward conduction) the pointer will read either shorted, or junction forward voltage drop indicating germanium or silicon material or ∞ if the junction is open.

MAINTENANCE

Experience has shown that many difficulties are due to either dead batteries or to blown fuses.

Two fuses are included in the unit, a 1 amp standard type fuse and a 2 amp, 1000 volt backup fuse to protect against high energy overloads. The 1 amp fuse is accessible from the battery compartment and can be replaced using the following procedure:

To replace 1 amp fuse:

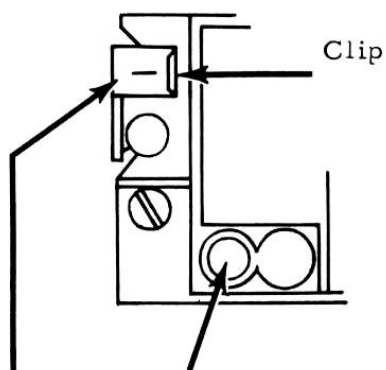

Spare Fuse

1 Amp/250 Fuse (Bussmann ABC-1 or Littelfuse 314001 3 AB)

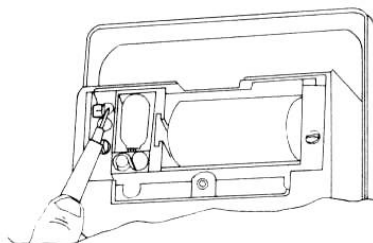

MAINTENANCE (cont'd.)

The 2 amp fuse is accessible by removing the case and then raising the PC Board (see Disassembly Instructions) page 31.

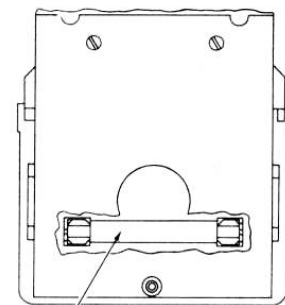

2 AMP 1000V FUSE
(BUSSMANN HVA-2 OR
LITTELFUSE 621002)
UNDER P.C. BOARD

SPARK GAP

A spark gap has been incorporated in this instrument to protect it from high voltage low energy transients. No maintenance is required in normal use.

CAUTION - Disconnect tester before servicing spark gap.

Should the tester be subjected to conditions which could cause sustained heavy arcing, the gap may become dirty or shorted.

Clean by passing thin feeler stock thru the gap. If the gap cannot be restored to normal operation by cleaning, replace with a new spark gap.

CALIBRATION

Calibration adjustments are made as follows:

1. Ensure that the unit is properly zeroed.
2. Place the RANGE SWITCH to the 1 volt position, connect a 1 volt DC $\pm 1/2\%$ source to the input leads and adjust the "Full Scale Cal." pot for a full scale pointer indication.
3. Place the RANGE SWITCH in the 3 volt position, the AC - DC Ω switch to the AC position, connect a 10 kHz voltage source with an amplitude of 3 volts $\pm 1/2\%$ and adjust the "3 VAC COMP" capacitor for a 3 volt indication.
4. Place the RANGE SWITCH to the 30 volt position, connect a 10 kHz voltage source with an amplitude of 30 volts $\pm 1/2\%$ and adjust the "30 VAC COMP" capacitor for a 30 volt indication.

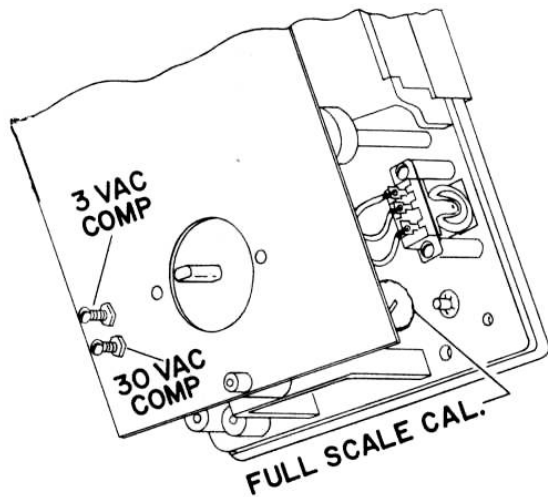

26

ACCESSORIES

1. Miniature Clip For High Density Circuits

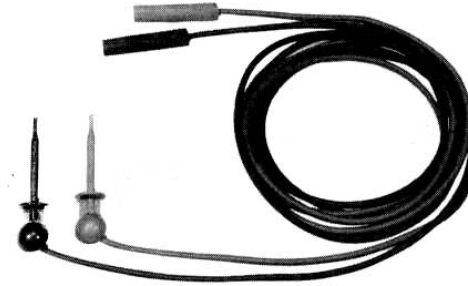

Part No.
79-373

2. Leather Case



Part No.
10-2739

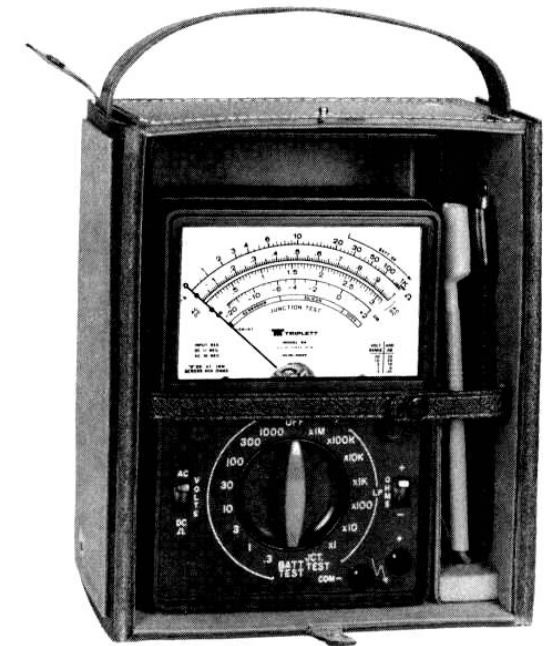

27

ACCESSORIES (cont'd.)

Replaceable Parts Model 64

3. 30 kVDC Probe

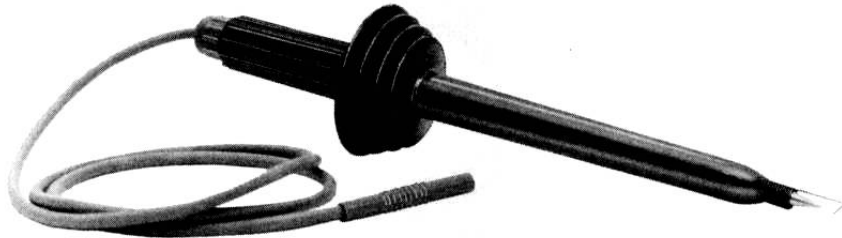

When using place range switch to 300 V position.

| <u>Description</u> | <u>Ref. No.</u> | <u>Part No.</u> |
|-----------------------------|-----------------|-----------------|
| Battery, 1.5V | B1 | 2426-1 |
| Battery, 9V | B2 | 37-36 |
| Battery, 9V | B3 | 37-36 |
| Fuse, 1 Amp, 1 1/4" Long | F1 | 3207-58 |
| Fuse, 2A, 1000V | F2 | 3207-60 |
| Instrument Assembly | | 52-6681 |
| PC Board w/Components | | 87-452 |
| Capacitor, .1 μ F | C1 | 43-445 |
| Capacitor, 33 pF | C2 | 43-301 |
| Capacitor, 100 pF | C3 | 43-345 |
| Capacitor, 1000 pF | C4 | 43-346 |
| Capacitor, Var. 1.5 - 10 pF | C5 | 43-428 |
| Capacitor, Var. 1.5 - 10 pF | C6 | 43-428 |
| Capacitor, .01 μ F | C7 | 43-441 |
| Diode, 1N4148 | CR1 | 127-114 |
| Diode | CR2 | 127-28 |
| Diode, 1N4004 | CR3 | 127-93 |
| Diode, 1N4004 | CR4 | 127-93 |
| Lamp, Neon | DS1 | 67-98 |
| Transistor, 2N3964 | Q1 | 127-107 |
| Transistor, 2N5172 | Q2 | 127-73 |
| Transistor, 2N3964 | Q3 | 127-107 |
| Dual FET, Siliconix E411 | Q4 | 127-117 |
| Resistor, Var. 100 | R1 | 16-294 |
| Resistor, Carbon, 1 M | R2 | 15R-105JB |
| Resistor, Prec. 10 | R3 | 15K-100FTC5 |
| Resistor, W. W. 90 | R4 | 15-5617 |
| Resistor, Carbon, 1k, 1/2W | R5 | 15R-102JC |
| Resistor, W. W. 90 | R6 | 15-5617 |
| Resistor, W. W. 900 | R7 | 15-5616 |
| Resistor, Carbon, 1 M | R8 | 15R-105JB |
| Resistor, Carbon, 10 M | R9 | 15R-106JB |

Replaceable Parts Model 64 (cont'd.)

| <u>Description</u> | <u>Ref. No.</u> | <u>Part No.</u> |
|---------------------------|-----------------|-----------------|
| Resistor, Carbon, 100k | R10 | 15R-104JB |
| Resistor, Carbon, 470k | R11 | 15R-474JB |
| Resistor, Carbon, 75k | R12 | 15R-753JB |
| Resistor, Var. 20k | R13 | 16-295 |
| Resistor, Prec. 9k | R14 | 15K-9001TC5 |
| Resistor, Prec. 8.06k | R15 | 15K-8061TA3 |
| Resistor, Prec. 8.06k | R16 | 15K-8061TA3 |
| Resistor, Carbon, 10k | R17 | 15R-103JB |
| Resistor, Var. 50k | R18 | 16-218 |
| Resistor, Carbon, 1 M | R19 | 15R-105JB |
| Resistor, Prec. 90k | R20 | 15K-9002TC5 |
| Resistor, Prec. 900k | R21 | 15K-9003TC5 |
| Resistor, Prec. 9 M | R22 | 15K-9004ND7 |
| Resistor, Prec. 1.12 M | R23 | 15K-1124TA3 |
| * Resistor, Prec. 8.06k | R24 | 15K-8061TA3 |
| * Resistor, Prec. 806 | R25 | 15K-8060TA3 |
| * Resistor, Prec. 2.55k | R26 | 15K-2551TA3 |
| Resistor, Prec. 10 Meg | R27 | 15-851 |
| Switch, Rotary | SW1 | 22-694 |
| Switch, Ass'y. Rocker | SW2 | 22-661 |
| Switch, Ass'y. Rocker | SW3 | 22-661 |
| Panel Ass'y. | | 28-1172 |
| Knob Ass'y. | | 34-163 |
| Contact, Battery | | 46-156 |
| Contact, Battery | | 92-8 |
| Socket | | 2455-318 |
| Spark Gap | | 12380 |
| Spring, Fuse | | 42-278 |
| Fuse Clip | | 2451-129 |
| Spring, Fuse Clip Back Up | | 42-289 |
| Knob, Ohms Adjust | | 34-164 |
| Case Assembly | | 10-2837 |
| Cover Assembly | | 10-2844 |
| Test Leads and Hardware | | 79-374 |

* Calibration Resistors

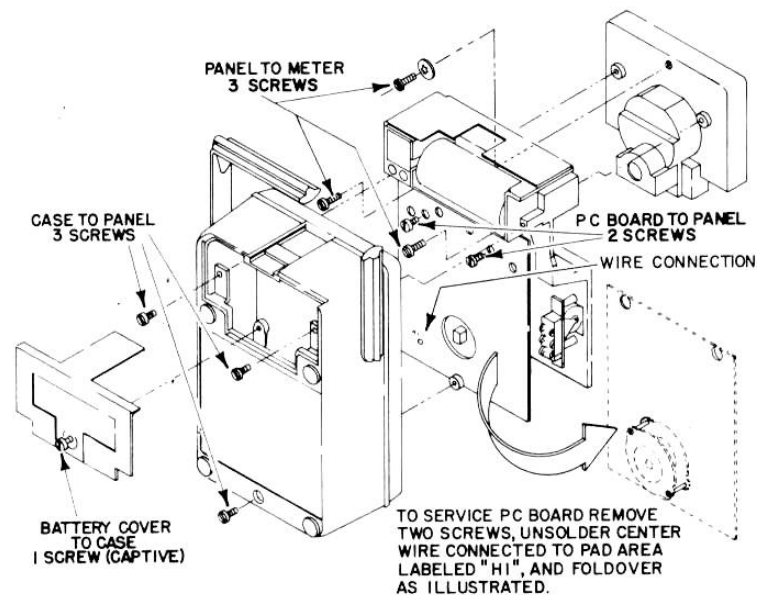

Disassembly Instructions

PARTS REPLACEMENT

Parts available for replacement are listed in the parts list. When replacing any parts, be careful to not disturb or damage any others. Do not overheat resistors or diodes, but be sure to make a good solder connection.

In some cases, it is wise to leave part of the lead from the old component and solder the new component to the old lead to prevent damage to surrounding components.

If there is evidence of smoke or an electrical arc inside the VOM, return the VOM to the factory or an authorized service center. There is a chance of hidden damage that could cause another failure in the VOM.

REPAIR OR SERVICE

For repair of the VOM, return it to the factory or an authorized service center. To help in repairing the VOM, give a detailed description of the problem and any other data that might be helpful such as what kind of circuit was being measured when the problem was discovered.

If the VOM is damaged by an overload and there is evidence of smoke or an electrical arc inside, return it to the factory or an authorized service center for inspection and repair. There could be some hidden damage that would cause a future failure of the VOM.

TEST LEADS

Check the test leads periodically. Leads that are worn, have damaged insulation, damaged plugs, damaged probes or loose parts should be replaced.

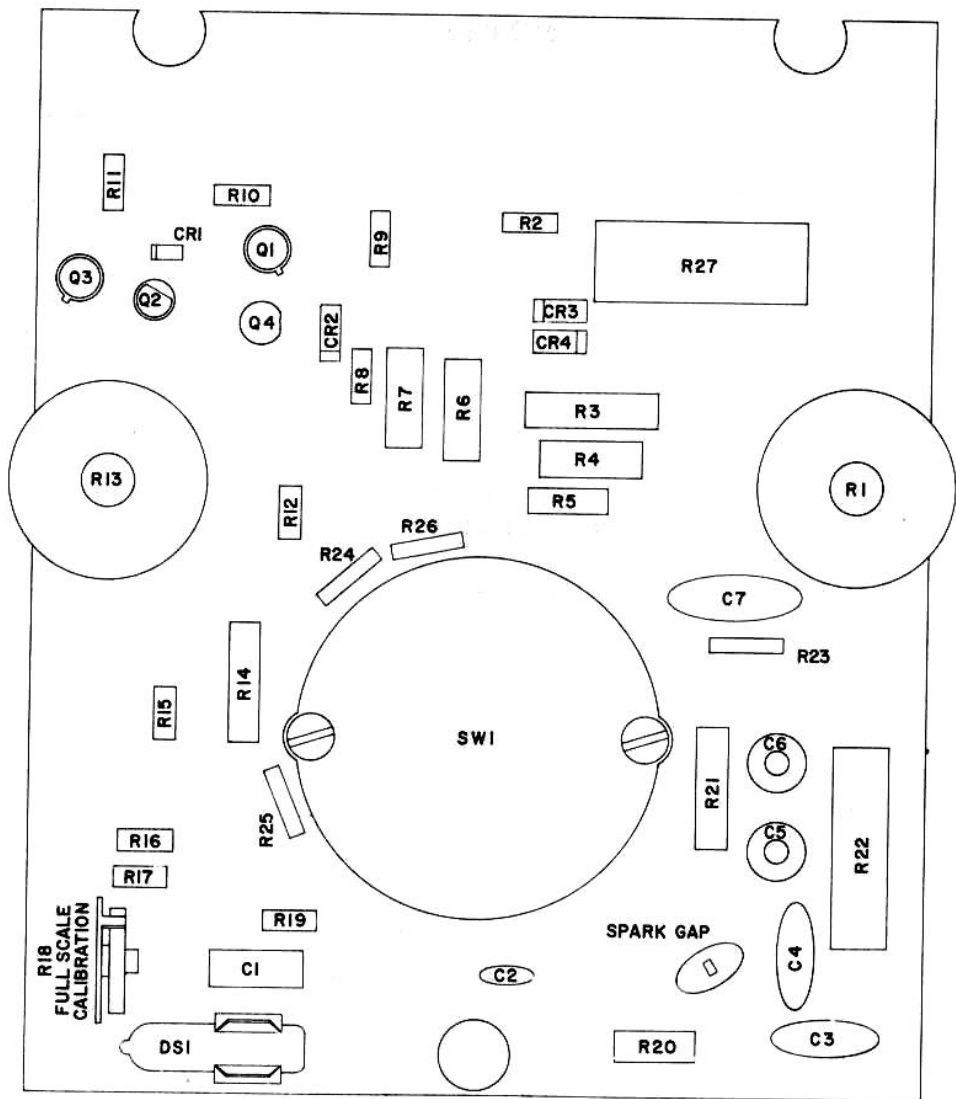

Parts Location
(Circuit Board)

DECKS VIEWED FROM KNOB END OF SWITCH.

● POSITION NO. 1.

⊙ STRUT SCREW.

ROTARY SWITCH SHOWN IN .3 VOLT POSITION.

* CALIBRATION RESISTORS

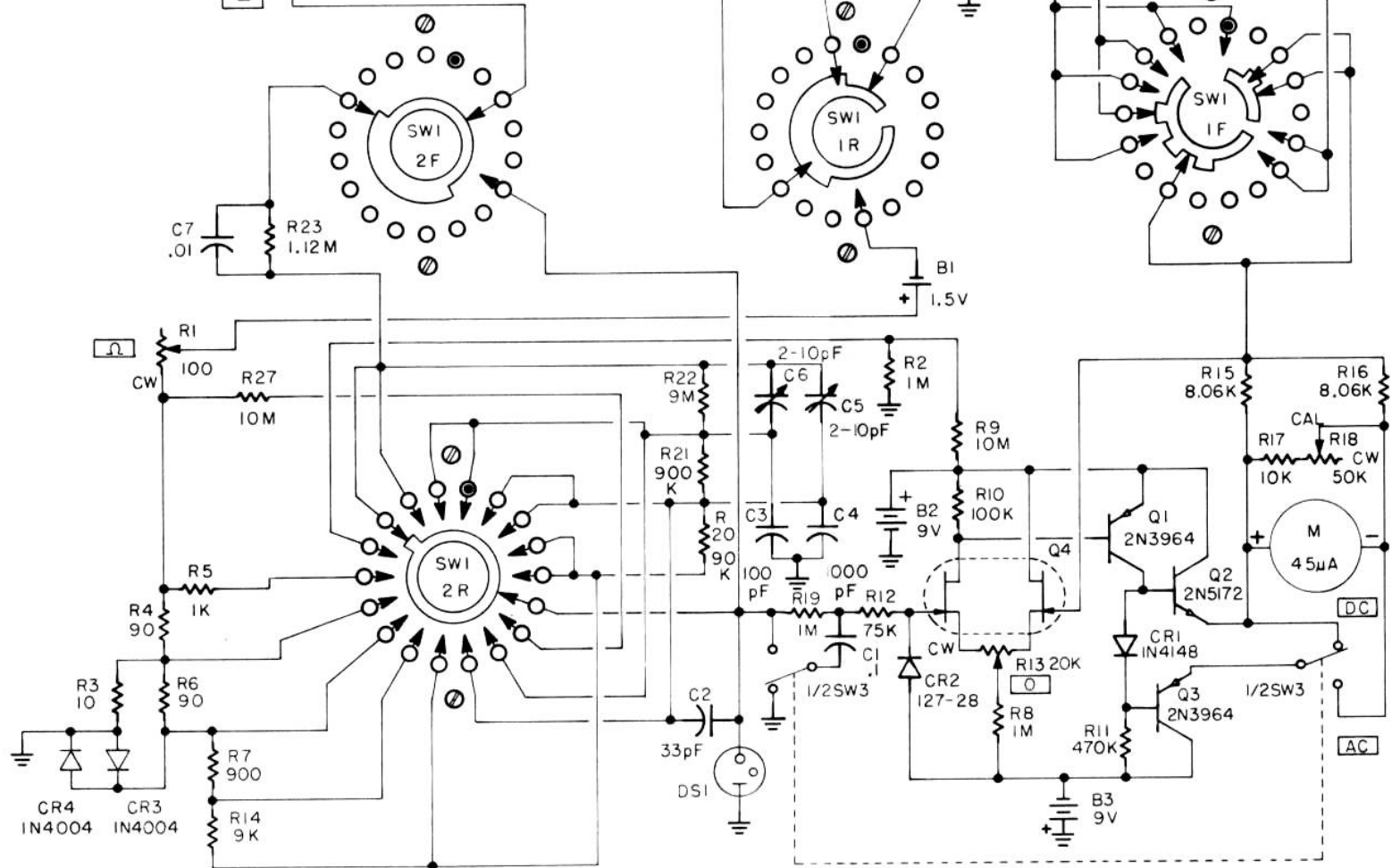
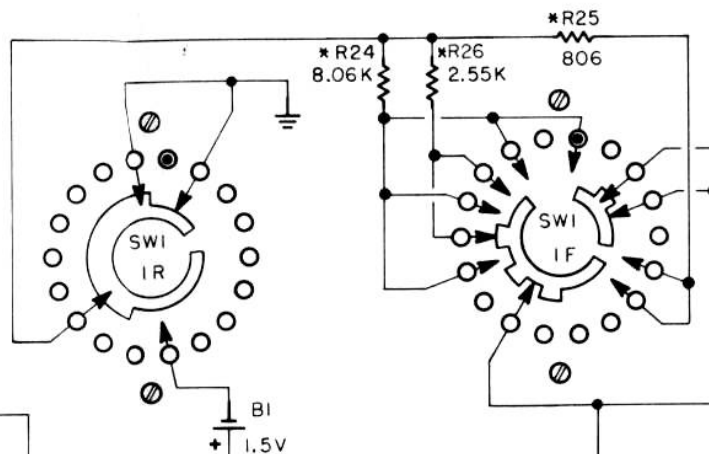
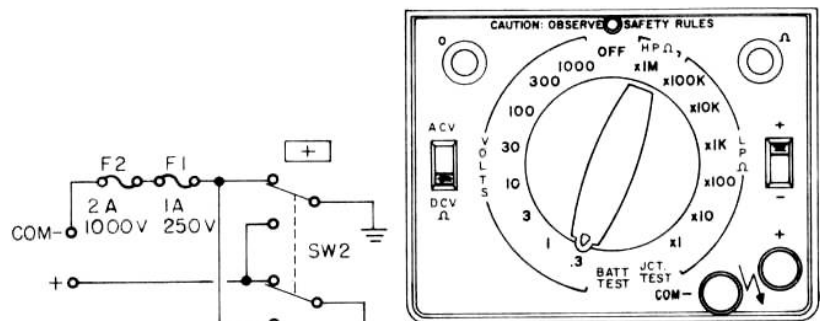

LIMITED WARRANTY

The Triplett Corporation warrants instruments and test equipment manufactured by it to be free from defective material or factory workmanship and agrees to repair or replace such products which, under normal use and service, disclose the defect to be the fault of our manufacturing, with no charge for parts and service. If we are unable to repair or replace the product, we will make a refund of the purchase price. Consult the Instruction Manual for instructions regarding the proper use and servicing of instruments and test equipment. Our obligation under this warranty is limited to repairing, replacing or making refund on any instrument or test equipment which proves to be defective within one year from the date of original purchase.

This warranty does not apply to any of our products which have been repaired or altered by unauthorized persons in any way so as, in our sole judgment, to injure their stability or reliability, or which have been subject to misuse, abuse, misapplication, negligence or accident or which have had the serial numbers altered, defaced, or removed. Accessories, including batteries, not of our manufacture used with this product are not covered by this warranty.

To register a claim under the provisions of this warranty, return the instrument or test equipment to Triplett Corporation, Bluffton, Ohio 45817, transportation prepaid. Upon our inspection of the product, we will advise you as to the disposition of your claim.

ALL WARRANTIES IMPLIED BY LAW ARE HEREBY LIMITED TO A PERIOD OF ONE YEAR, AND THE PROVISIONS OF THE WARRANTY ARE EXPRESSLY IN LIEU OF ANY OTHER WARRANTIES EXPRESSED OR IMPLIED.

The purchaser agrees to assume all liability for any damages and bodily injury which may result from the use or misuse of the product by the purchaser, his employees, or others, and the remedies provided for in this warranty are expressly in lieu of any other liability Triplett Corporation may have, including incidental or consequential damages.

Some states do not allow the exclusion or limitation of incidental or consequential damages, so the above limitation or exclusion may not apply to you. No representative of Triplett Corporation or any other person is authorized to extend the liability of Triplett Corporation in connection with the sale of its products beyond the terms hereof.

Triplett Corporation reserves the right to discontinue models at any time, or change specifications, price or design, without notice and without incurring any obligation.

This warranty gives you specific legal rights, and you may have other rights which vary from state to state.