

HEIJNEN B.V.
Bedrijfsstraat 2
3500 Hasselt
Tel. (0 11) 210006
Telex 39047

8

Description and Operating Manual



Automatic Measuring Set for Telephone Channels

for measurements performed with commissioning,
service acceptance tests and maintenance of FDM and PCM systems

PCM-3

1-6-79



AUTOMATIC MEASURING SET PCM-3

for measurements performed with commissioning,
service acceptance tests and maintenance of
FDM and PCM systems

Description and Operating Manual 822/01/02/03 C...

1.6.79 Han

0.2.1.80 2650 GN v. 2596

Subject to change without notice
Printed in the Federal Republic of Germany

Wandel & Goltermann

PRECISION ELECTRONIC
MEASURING INSTRUMENTS

INTRODUCTION

1.	SPECIFICATIONS	1-1
1.1.	Operating function	1-1
1.2.	Test object matching	1-1
1.3.	Send signals	1-2
1.4.	Summary of measurement modes, level ranges and frequency ranges	1-4
1.5.	Use as level generator or as level meter	1-5
1.6.	Measurement modes and their error limits in the preferred range of relative level and for generator terminated by Z and receiver fed by $Z_{\text{source}} = 0$	1-5
1.7.	Attenuation characteristic of the filters	1-10
1.8.	Additional inputs and outputs (rear side)	1-13
1.9.	Measuring sequence	1-13
1.10.	Additional devices	1-16
1.11.	General data	1-18
1.12.	Ordering information	1-20
2.	OPERATION	2-5
2.1.	Setting-up and putting into service	2-5
2.1.1.	Setting-up the instrument	2-5
2.1.2.	Operating controls	2-5
2.1.3.	A.C. line connection	2-5
2.2.	Preliminary settings	2-6
2.2.1.	Operating functions	2-6
2.2.2.	Matching to the object under test	2-7
2.2.2.1.	Setting relative level	2-7
2.2.2.2.	Generator output; output impedance	2-7
2.2.2.3.	Receiver input; input impedance	2-8
2.3.	Test set-up and connection of objects under test	2-8
2.3.1.	Loop measurements	2-8
2.3.2.	End-to-end measurements	2-9
2.3.3.	Separate measurement of the send or receive part of a PCM multiplex equipment	2-10
2.3.4.	Measurements on a test object with digital interfaces	2-11
2.3.5.	Connection through the Test Point Scanner MU-3	2-11

2.4.	Measurement modes of the PCM-3	2-12
2.4.1.	Summary of measurement modes	2-13
2.4.2.	Explanation of particular measurement modes	2-15
2.4.2.1.	Overall loss	2-15
2.4.2.2.	Attenuation/frequency distortion	2-16
2.4.2.3.	Variation of gain with input level	2-16
2.4.2.4.	Crosstalk	2-16
2.4.2.5.	Impedance balance ratio	2-16
2.4.3.	Measurement mode number	2-17
2.4.4.	Single measurement and incremental step measurement	2-17
2.4.5.	Block measurement and measuring program	2-18
2.5.	Data entry	2-18
2.5.1.	Entry of a single measurement	2-19
2.5.1.1.	Selection of measurement mode	2-19
2.5.1.2.	Entry of send parameters	2-22
2.5.1.3.	Run of single measurements	2-23
2.5.1.4.	Measurement by incremental step	2-23
2.5.2.	Entry of a block measurement	2-24
2.5.2.1.	Selection of measurement mode	2-24
2.5.2.2.	Indication of the send parameters and tolerance limits	2-25
2.5.2.3.	Run of block measurements	2-25
2.5.3.	Entry of a measuring program	2-26
2.5.3.1.	Assembly of the program	2-26
2.5.3.2.	Change of program, clear	2-27
2.5.3.3.	Program configuration and execution	2-27
2.6.	Measurement sequence conditions	2-31
2.6.1.	Measurement run switch	2-31
2.6.2.	Halt switch	2-31
2.6.3.	Print release	2-32
2.7.	Indicator area	2-33
2.7.1.	Measurement run information	2-33
2.7.2.	Measurement mode display	2-34
2.7.3.	Send parameter display	2-34
2.7.3.1.	Send level indicator	2-34
2.7.3.2.	Send frequency indicator	2-35
2.7.3.3.	Additional symbols	2-35
2.7.4.	Measured result display	2-36
2.8.	Rear connections	2-37
2.8.1.	A.C. voltage output	2-37
2.8.2.	Receiver input	2-37
2.9.	Additional devices (Plug-in subassemblies).	2-38
2.9.1.	Printer interface	2-38
2.9.2.	IEC-Bus-interface	2-40
2.9.3.	End-to-end and signalling distortion measuring device	2-41
2.9.3.1.	End-to-end measuring device	2-41
2.9.3.2.	Signalling distortion measuring device	2-41
2.9.4.	Interface for PDA-3, PDG-3, MU-3	2-44

3.	TECHNICAL INSTRUCTIONS	3-1
3.1.	Extension to the Automatic Measuring System PA-3	3-1
3.1.1.	Setting-up instruments and connecting cables	3-1
3.1.2.	Instrument adjustments	3-1
3.1.3.	Measurement run and indication of results	3-5
3.1.4.	Computer control	3-5
3.2.	Characteristics of the Digital Signal Instruments PDA-3 and PDG-3	3-5
3.2.1.	PCM Digital Signal Analyzer PDA-3	3-6
3.2.2.	PCM Digital Signal Generator PDG-3	3-6
3.3.	Consideration of CCITT Recommendation G.712 as affecting PCM-3/PA-3	3-7
3.3.1.	Attenuation/frequency distortion	3-8
3.3.2.	Variation of gain with input level	3-8
3.3.3.	Measurement of idle channel noise	3-9
3.3.4.	Total distortion, including quantizing distortion	3-10
3.3.5.	Interchannel crosstalk	3-11
3.3.6.	Go-to-return crosstalk or level in own channel	3-13
3.3.7.	Impedance of audio input and output parts	3-14
3.3.8.	Out-of-band signals at the channel input	3-14
3.3.9.	Spurious out-of-band signals at the channel output	3-15
4.	FUNCTION AND CHARACTERISTICS	4-3
4.1.	Send section	4-3
4.2.	Receive section	4-4
4.3.	Digital section	4-7
4.4.	End-to-end and signalling distortion measuring device	4-10
5.	FUNCTION CHECKING, MAINTENANCE AND GENERAL INFORMATION	5-1
5.1.	Function checking	5-1
5.1.1.	Short test of digital section	5-1
5.1.2.	Short test of measuring section	5-1
5.1.3.	Further checks on measuring sections	5-2
5.1.4.	Operation of PCM-3 as level generator only	5-3
5.1.5.	Operation of PCM-3 as level meter only	5-4
5.1.6.	Additional test modes	5-4
5.2.	Maintenance and general information	5-5
5.2.1.	Mechanical assembly	5-5
5.2.2.	Insertion of plug-in subassemblies	5-6
5.2.3.	Changing the customer program memory	5-6

5.2.4.	Conversion from dBm to dB calibration	5-6
5.2.5.	Changing fuses	5-8
5.2.6.	Modification of the measuring signal for signalling distortion .	5-8
5.2.7.	Use in 19-inch racks	5-8
5.2.8.	Shipping instructions	5-10
5.2.9.	Matching to the V.24 Printer Interface.	5-11
5.2.9.1.	Baud rate	5-12
5.2.9.2.	Acknowledgements from the printer	5-12
5.2.9.3.	Waiting (Standby) Time during "CR" and "LF"	5-12
5.2.9.4.	Interface testing	5-13
5.2.9.5.	Matching to special properties of a printer.	5-13

INTRODUCTION

With the expansion of short haul networks, PCM techniques are becoming increasingly more significant. And the increasing installation of digital transmission systems has been accompanied by the growing need for comprehensive measurements of use in operating and servicing these systems.

Almost all of the great number of measurements, in particular those involved with PCM terminal equipment measurements orientated to CCITT Recommendation G. 712, can be traced to level measurements. The relevant analog parameter can be measured at high accuracy with the PCM-3 Automatic Measuring Set. Furthermore, measurements are possible also at the AF ports of FDM systems and sub-assemblies.

The PCM-3 comprises a send section and a receive section as well as control and evaluation sections with incorporated intelligence in the form of a microprocessor. Thus, the PCM-3 has the ability to take over a typical pre-settings needed for the measurement mode being used at the time. That is : selecting the bandwidths, the drive signal, the integrating time and similar settings. Additionally, the PCM-3 takes the burden off of the user who is no longer bothered by the routine type of adjustments such as changing the frequency or level when the measurement is moved from test point to test point.

In addition to single measurements with the send parameters level and frequency freely selected, all types of measurement are stored together with given measuring points as block measurements. By combining such block measurements complete measuring programs are obtained, which run automatically. The entry of measurement modes as well as the start up of measuring run results from a keyboard on the instrument front panel.

The measured results can be compared with stored limit values. The PCM-3 indicates a tolerance exceeded and interrupts the test program for corresponding adjustment. A printer, for example, may be connected via a V.24-printer interface, which prepares the format for a printed out tabulation of measured values. Thus errors are avoidable which frequently occur in lengthy runs due to the slackening concentration of the operator.

End-to-end measurements are carried out using two Automatic Measuring Sets PCM-3 (with built-in end-to-end measuring devices). In this case the same measuring modes and sequence must be set up at the send and at the receive sides. The control of the measuring run proceeds from the receive side PCM-3, which transmits the start and stepping pulses via an audio channel to the send side. A signalling distortion measuring device is fitted in on the same sub-assembly as the end-to-end measuring subassembly.

For automatic measurements on all telephone channels the Test Point Scanner MU-3 is intended. This ancillary equipment can sequentially connect up to 30 channels with the measuring sections of the PCM-3. From that for instance with crosstalk measurements requiring the multiplicity of combinations between send and receive channels, the effort expended in operating the measuring instruments is greatly reduced. The changeover at the 2 Mbit/s level of a PCM system or at the group level of an FDM system results as well through the MU-3. Furthermore, the Test Point Scanner contains a measurement bridge for measuring the return loss and the impedance-balance-ratio.

A further expansion of the PCM-3, necessary for the separate measurements at the PCM send or receive side, is made up from the Digital Signal Analyzer PDA-3 and the Digital Signal Generator PDG-3. Thereby the transitions are possible from the ports of the telephone channels to the ports of the digital signals of the PCM transmissions, and vice versa. Thus, the equipment combination, PCM-3, MU-3, PDA-3 and PDG-3 form the Automatic Measuring System for Telephone Channels PA-3. All equipment functions are controlled, via an interface, from the Automatic Measuring Set PCM-3.

Moreover, the possibility exists also for the control to be taken over by an external computer. An IEC-Bus-interface card for the PCM-3 is available for the connection to the computer. By this means, the user, himself, can set-up a measuring program according to his requirements.

The instruments can be protected for transport or storage by front and back covers. For mounting in 19-inch rack conforming with DIN 41 494 suitable mounting brackets are obtainable.

The Automatic Measuring Set PCM-3 can be supplied in various instrument versions which are suited to national specifications. The following table gives an example of the differences. The foregoing description and operating manual refers to the versions BN 822/01, BN 822/02 and BN 822/03.

Instrument version	Lettering on cover plate	Total Distortion measurement with	Output or Input impedance
BN 822/01	German	Noise or 421 Hz sinusoidal	600 Ω , 850 Ω
BN 822/02	English	Noise or 421 Hz sinusoidal	600 Ω , 900 Ω
BN 822/03	English	856 Hz sinusoidal weighted or unweighted	600 Ω , 900 Ω

1 Specifications

1. SPECIFICATIONS

PCM-3, BN 822/01, BN 822/02 and BN 822/03

All the limit values given in the specifications are valid for the rated range of use of power supply and ambient temperature stated in Section 1.11.

1.1. Operating functions

Setting with switch **5**:

Loop measurement

End-to-end measurement Generator

End-to-end measurement Receiver

Computer control; the PCM-3 or PA-3 can be controlled by a computer via an IEC-Bus-Interface card (see 1.10.2.).

1.2. Test object matching

1.2.1. Relative level **15** , **18**

Setting for Generator and Receiver

in steps of 0.1 dB in the range - 19.9 to + 9.9 dB

Preferred range

Generator - 17.0 to + 3.0 dB

Receiver - 9.9 to + 9.9 dB

A red LED signals that the send level range or level measuring range is restricted, outside the preferred range (compare Sect. 1.3.3.)

1.2.2. Generator output **17**

balanced floating

Output impedance, switchable

for BN 822/01 600 Ω, 850 Ω

for BN 822/02 and /03 600 Ω, 900 Ω

Return loss in the frequency range 200 Hz to 4 kHz ≧ 46 dB

4 kHz to 20 kHz ≧ 34 dB

Signal balance ratio according to CCITT-Rec. O.121

for level > - 60 dBm in the range 200 Hz to 20 kHz ≧ 50 dB

Max. d.c. voltage to ground 100 V

D. C. drain not permitted!

1.2.3. Receiver input 20

balanced, floating

Input impedance, switchable

for BN 822/01 600 Ω, 850 Ω, 10 kΩ
 for BN 822/02 and /03 600 Ω, 900 Ω, 10 kΩ

Return loss in the frequency range 200 Hz to 4 kHz ≥ 46 dB
 4 kHz to 72 kHz ≥ 30 dB

Signal balance ratio according to CCITT-Rec. O.121
 in the frequency range 200 Hz to 4 kHz ≥ 50 dB
 4 kHz to 72 kHz ≥ 40 dB

Max. permissible input level + 20 dBm
 Max. d. c. voltage to ground 100 V

D. C. drain not permitted!

1.3. Send signals

1.3.1. Sinusoidal signals

Frequency range 200 Hz to 20.2 kHz

The frequency is adjustable by a switched divider; therefore only a certain frequency locking interval is possible. On entering an arbitrarily chosen frequency, the next possible lock frequency is selected and indicated on the send parameter display 3.

The generator frequency is crystal - controlled.

Max. deviation of the frequency actually generated
 from that entered $\pm 2\%$

Resolution of the frequency display
 for $0.2 \text{ kHz} \leq f < 1 \text{ kHz}$ 0.001 kHz
 for $1 \text{ kHz} \leq f < 10 \text{ kHz}$ 0.01 kHz
 for $10 \text{ kHz} \leq f \leq 20.2 \text{ kHz}$ 0.1 kHz

Harmonic distortion for k_2 and k_3 at 0 dBm0 and
 fundamental frequency in the range 200 Hz to 4 kHz ≥ 46 dB
 4 kHz to 20.2 kHz ≥ 40 dB

Harmonic distortion of the 421 Hz sinusoidal signal (BN 822/01 and /02) or
 856 Hz (BN 822/03) at 0 dBm0, total distortion
 measurement and taken into account to 4 kHz ≥ 60 dB

1.3.2. Pseudo random noise signal

Nearly Gaussian distribution

Noise band 350 to 550 Hz

Shift register (17-stage) and send filter according to CCITT-Rec. O.131

Spacing of spectral lines approx. 4.6 Hz

Peak factor, $20 \log |\hat{u}/U_{r.m.s.}|$ 10.5 dB \pm 0.5 dB

Attenuation curve of send filter see Sect. 1.7.1.

1.3.3. Send level

Calibration in Power level (dBm0)

Instrument can be resoldered internally for change to voltage level (dB0)

Entry range

in preferred range of the relative level (comp. 1.2.1.) and for $Z_{out} = 600 \Omega$

for sinusoidal signal at least + 10.0 to - 60.0 dBm0

for noise at least 0.0 to - 60.0 dBm0

for any relative level L_{rel} and internal resistance Z_{out}

for sinusoidal signal (+ 13 - L_{rel} - K) dBm0 to (-77 - L_{rel} - K) dBm0

for noise (+ 3 - L_{rel} - K) dBm0 to (-77 - L_{rel} - K) dBm0

However, lower limit of level range is restricted to - 80 dBm0.

Correction factor K :

Z_{out}	Power level	Voltage level
600 Ω	0 dB	0 dB
850 Ω	1.5 dB	0 dB
900 Ω	1.8 dB	0 dB

Error limits of the send level

Total error see 1.6.1.

Frequency response of sinusoidal signal up to 4 kHz see 1.6.3.

4 kHz to 20.2 kHz see 1.6.9.

Error limits of send level at fixed frequency

referred to the value at - 10 dBm0 see 1.6.4.

1.4. Summary of measurement modes, level ranges and frequency ranges

Measurement mode	Send Frequency	Send level Least range in the preferred range of relative level	Receive level	Display range for result	Receive filter (see also 1.7.)	Meas. mode No.	Measurement modes, and error limits Section:	
LEVEL	0.200 to 3.97 kHz	+ 10.0 (+7.6 for PDG-3) to - 60.0 dBm0	+ 10.0 to - 60.0 dBm0	as with receive level	0.2 to 4 kHz	10 12 14	1.6.1.	
	Noise 350 to 550 Hz	0.0 to - 60.0 dBm0	0.0 to - 60.0 dBm0	(Resolution 0.1 dB)	350 to 550 Hz	11 13 15		
OVERALL LOSS at 814 Hz (comp. 1.5.1.)	0.814 kHz	+ 10.0 (+7.6 for PDG-3) to - 60.0 dBm0	+ 10.0 to - 60.0 dBm0	± 6.00 dBm0 (Resolution 0.01 dB)	0.2 to 4 kHz	20 to 25	26 to 29	1.6.2.
ATTENUATION/FREQUENCY DISTORTION	0.200 to 3.97 kHz (Ref. value 0.814 kHz)	+ 10.0 (+7.6 for PDG-3) to - 60.0 dBm0	+ 10.0 to - 60.0 dBm0	± 6.00 dB provided that overall loss at 814 Hz is in the range ± 3 dB (Resolution 0.01 dB)	0.2 to 4 kHz	30 to 35	36 to 39	1.6.3.
VARIATION OF GAIN WITH INPUT LEVEL (Ref. - 10 dBm0)	0.814 kHz	+ 10.0 (+7.6 for PDG-3) to - 60.0 dBm0	+ 10.0 to - 60.0 dBm0	± 6.00 dB	selective	40 42 44	46 to 49	1.6.4.
	≥ - 10 dBm0: 0.814 kHz < - 10 dBm0: Noise	+ 10.0 (+7.6 for PDG-3) to - 60.0 dBm0	+ 10.0 to - 60.0 dBm0	provided that overall loss at - 10 dBm0 is in the range ± 3 dB (Resolution 0.01 dB)	selective or 350 to 550 Hz	41 43 45		
IDLE CHANNEL NOISE	Generator OFF		Weighted -20.0 to - 85.0 dBm0	as with receive level range (Resolution 0.1 dB)	Psophometric weighting	50 52 54	56 to 59	1.6.5.
			Unweighted - 20.0 to - 80.0 dBm0		0.2 to 4 kHz	51 53 55		
TOTAL DISTORTION (including quantizing distortion BN 822/01 BN 822/02)	Noise 350 to 550 Hz	0.0 to - 60.0 dBm0	0.0 to - 60.0 dBm0	0.0 to 40.0 dB (Resolution 0.1 dB)	Signal: 350 to 550 Hz Distortion: 815 to 3330 Hz Reference band width: 3100 Hz	60 62 64	66 to 69	1.6.6.
	Sinusoidal 0.421 kHz	+ 10.0 (+7.6 for PDG-3) to - 60.0 dBm0	+ 10.0 to - 60.0 dBm0			61 63 65		
TOTAL DISTORTION (including quantizing distortion) BN 822/03	Sinusoidal 0.856 kHz	+ 10.0 (+7.6 for PDG-3) to - 60.0 dBm0	+ 10.0 to - 60.0 dBm0	0.0 to 43.0 dB (Resolution 0.1 dB)	Distortion: psophometric weighting	60 62 64	66 to 69	1.6.6.
				0.0 to 40.0 dB (Resolution 0.1 dB)	Distortion: unweighted 0.2 to 4 kHz	61 63 65		
CROSSTALK (comp. 1.5.2.)	0.814 kHz	Fixed value 0 dBm0	- 20.0 to - 85.0 dBm0	as with receive level (Resolution 0.1 dB)	selective	70 to 75	76 to 79	1.6.7.
RETURN LOSS	0.200 to 3.97 kHz	Fixed value - 10 dBm0	+ 10.0 to - 60.0 dBm0	0.0 to 40.0 dB	0.2 to 4 kHz	80 81	86 to 89	1.6.8.
SIGNAL BALANCE RATIO	0.200 to 3.97 kHz	Fixed value 0 dBm0	+ 10.0 to - 60.0 dBm0	0.0 to 56.0 dB	0.2 to 4 kHz	82 83		
OUT-OF-BAND SIGNALS	Generator OFF		0.0 to - 60.0 dBm0	as with receive level	4.6 to 72 kHz	90	96 to 97	1.6.9.
	4.6 to 20.2 kHz	Fixed value 0 dBm0	0.0 to - 60.0 dBm0	as with receive level	0.2 to 4 kHz	91		
	0.2 to 3.4 kHz	Fixed value 0 dBm0	0.0 to - 60.0 dBm0	as with receive level	4.6 to 72 kHz	92		
SIGNALLING DISTORTION Option BN 822/00.03	10 Hz (20 Hz) rectangular			± 10.0 ms (Resolution 0.1 ms)		93 94	98 99	1.10.3.2.
PDG-3 and PDA-3 MANUAL	Analog generator OFF		Analog receiver OFF			95		Operating functions PDG-3 and PDA-3 may be set manually

1.5. Use as level generator or as level meter

1.5.1. Use of the PCM-3 as level generator only

One of the Test Modes 05 to 09 (see also Sect. 5.1.4. and 5.1.5.) can be entered. The Generator can then be adjusted in the full level and frequency range.

Example: **[M]** 05 **[E]**, **[L]** -20 **[E]**, **[F]** 5.05 **[E]**

1.5.2. Use of the PCM-3 as level meter only

(without a send parameter having to be entered).

A wideband level measurement (0.2 to 4 kHz) can be carried out with Test Mode No. 03

Example: **[M]** 03 **[E]**, **[S]**.

The generator remains blanked.

1.6. Measurement modes and their error limits in the preferred range of relative level and for generator terminated by Z and receiver fed by Z_{source} = 0.

1.6.1. LEVEL

Measurement mode	Measurement on	Send parameters	Error limits of level		Send side		Receive side	Remarks	
			in level range	in freq. range	Z = 600 Ω	850/900 Ω			
10	MUX	[L] Var.	+ 10 to - 40 dBm0	0.2 to 4 kHz	± 0.15 dB	± 0.15 dB	± 0.2 dB	End-to-end and loop measurements. Intrinsic noise level of receiver approx. - 95 dBm	
		[F] Var.	+ 10 to - 60 dBm0		± 0.2 dB	± 0.2 dB	± 0.25 dB		
11	MUX	[L] Var.	0 to - 40 dBm0		± 0.2 dB	± 0.25 dB	± 0.2 dB	End-to-end and loop measurement	
		Noise	0 to - 60 dBm0		± 0.25 dB	± 0.3 dB	± 0.25 dB		
12	MUX-S	[L] Var.	3 to - 40 dBm0	0.2 3, 4 kHz	± 0.15 dB		± 0.3 dB	PDA-3 is required in addition	Error limits of the PDA-3 included
		[F] Var.	+ 3 to - 55 dBm0		± 0.2 dB		± 0.5 dB		
13	MUX-S	[L] Var.	- 6 to - 40 dBm0		± 0.2 dB		± 0.35 dB		
		Noise	- 6 to - 55 dBm0		± 0.25 dB		± 0.5 dB		
14	MUX-R	[L] Var.	+ 3 to - 40 dBm0	0.2 to 4 kHz	± 0.05 dB		± 0.2 dB	PDG-3 is required in addition	Error limits of the PDG-3 included
		[F] Var.	+ 3 to - 55 dBm0		± 0.15 dB		± 0.25 dB		
15	MUX-R	[L] Var.	- 6 to - 40 dBm0		± 0.03 dB		± 0.2 dB		
		Noise	- 6 to - 60 dBm0		± 0.08 dB		± 0.25 dB		
16 to 19	Block Measurements: Measuring step sequence of one of the modes 10 to 15 with send parameters pre-programmed in accordance with customer specification.								

1.6.2. OVERALL LOSS at 814 Hz

Measure- ment mode	Measure- ment on	Send parameters	Error limits of measured overall loss				Remarks	
			in level range	in freq. range	loop measurement	end-to-end measurement		
20	MUX	- 10 dBm0 0.814 kHz	0 to - 20 dBm0	at 814 Hz	± 0.03 dB	± 0.20 dB		
21	MUX	<input type="checkbox"/> L Var. 0.814 kHz	+ 5 to - 40 dBm0	at 814 Hz	± 0.05 dB	± 0.25 dB		
22	MUX-S	- 10 dBm0 0.814 kHz	0 to - 20 dBm0	at 814 Hz	± 0.07 dB	± 0.25 dB	PDA-3 is required in addition	Error limits of the PDA-3 included
23	MUX-S	<input type="checkbox"/> L Var. 0.814 kHz	+ 3 to - 40 dBm0	at 814 Hz	± 0.12 dB	± 0.30 dB		
24	MUX-R	- 10 dBm0 0.813 kHz	0 to - 20 dBm0	at 813 Hz	± 0.10 dB	± 0.10 dB	PDG-3 is required in addition	Error limits of the PDG-3 included
25	MUX-R	<input type="checkbox"/> L Var. 0.813 kHz	+ 3 to - 40 dBm0	at 813 Hz	± 0.15 dB	± 0.15 dB		
26 to 29	Block Measurements: Measuring step sequence of one of the modes 21, 23, 25 with send parameters pre-programmed in accordance with customer specification.							

1.6.3. ATTENUATION/FREQUENCY DISTORTION referred to the value at 814 Hz

Measure- ment mode	Measure- ment on	Send parameters	Error limits of frequency response				Remarks	
			in level range	in freq. range	Send side	Receive side		
30	MUX	- 10 dBm0 <input type="checkbox"/> F Var.	0 to - 20 dBm0	0.2 to 4 kHz	± 0.03 dB	± 0.04 dB	End-to-end and loop measurements	
31	MUX	<input type="checkbox"/> L Var. <input type="checkbox"/> F Var.	+ 5 to - 40 dBm0	0.2 to 4 kHz	± 0.03 dB	± 0.04 dB	End-to-end and loop measurements	
32	MUX-S	- 10 dBm0 <input type="checkbox"/> F Var.	0 to - 20 dBm0	0.2 to 3.4 kHz	± 0.03 dB	± 0.08 dB	PDA-3 is required in addition	Error limits of the PDA-3 included
33	MUX-S	<input type="checkbox"/> L Var. <input type="checkbox"/> F Var.	+ 3 to - 40 dBm0	0.2 to 3.4 kHz	± 0.03 dB	± 0.08 dB		
34	MUX-R	- 10 dBm0 <input type="checkbox"/> F Var.	0 to - 20 dBm0	0.2 to 4 kHz	± 0.01 dB	± 0.04 dB	PDG-3 is required in addition	Error limits of the PDG-3 included
35	MUX-R	<input type="checkbox"/> L Var. <input type="checkbox"/> F Var.	+ 3 to - 40 dBm0	0.2 to 4 kHz	± 0.01 dB	± 0.04 dB		
36 to 39	Block Measurements: Measuring step sequence of one of the modes 31, 33, 35 with send parameters pre-programmed in accordance with customer specification.							

1.6.4. VARIATION OF GAIN WITH INPUT LEVEL referred to the value at - 10 dBm0

Measure- ment mode	Measure- ment on	Send parameters	Accuracy of variation of gain with input level				Remarks	
			in level range	in freq. range	Send side	Receive side		
40	MUX	L Var. 0.814 kHz	+ 10 to - 60 dBm0	at 814 Hz	± 0.05 dB	± 0.06 dB	End-to-end and loop measurements	
41	MUX	L Var. 0.814 kHz	+ 10 to - 10 dBm0	at 814 Hz	± 0.05 dB	± 0.06 dB	End-to-end and loop measurements	
		Noise	- 10.1 to - 60 dBm0	350 to 550 Hz	± 0.05 dB	± 0.09 dB		
42	MUX-S	L Var. 0.814 kHz	+ 3 to - 40 dBm0	at 814 Hz	± 0.05 dB	± 0.1 dB	PDA-3 is required in addition	Error limits of the PDA-3 included
			+ 3 to - 55 dBm0			± 0.2 dB		
43	MUX-S	L Var. 0.814 kHz	+ 3 to - 40 dBm0	at 814 Hz or 350 to 550 Hz	± 0.05 dB	± 0.12 dB		
		Noise	+ 3 to - 55 dBm0			± 0.2 dB		
44	MUX-R	L Var. 0.813 kHz	+ 3 to - 40 dBm0	at 813 Hz	± 0.05 dB	± 0.06 dB	PDG-3 is required in addition	Error limits of the PDG-3 included
			+ 3 to - 60 dBm0		+ 0.05/ - 0.15 dB			
45	MUX-R	L Var. 0.813 kHz	+ 3 to - 40 dBm0	at 813 Hz or 350 to 550 Hz	± 0.04 dB	± 0.09 dB		
		Noise	+ 3 to - 60 dBm0		± 0.08 dB			
46 to 49	Block Measurements: Measuring step sequence of one of the modes 40 to 45 with send parameters pre-programmed in accordance with customer specification							

1.6.5. IDLE CHANNEL NOISE

Measure- ment mode	Measure- ment on	Send parameter	Error limits of measured idle channel noise			Remarks		
			in level range	in freq. range	Receive side			
50	MUX	Generator	- 20 to - 75 dBm0	Psophometric weighting	± 0.7 dB	Intrinsic noise approx. -113 dBm	End-to-end and loop measurement	
		OFF	- 20 to - 85 dBm0		+ 0.8/- 0.7 dB			
51	MUX	Generator	- 20 to - 70 dBm0	0.2 to 4 kHz	± 0.3 dB	Intrinsic noise approx. - 105 dBm		
		OFF	- 20 to - 75 dBm0		+ 0.4/- 0.3 dB			
52	MUX-S	Generator	- 20 to - 60 dBm0	Psophometric weighting	± 1 dB	PDA-3 is required in addition	Error limits of the PDA-3 included	
		OFF	- 20 to - 70 dBm0		± 2 dB			
53	MUX-S	Generator	- 20 to - 60 dBm0	0.2 to 4 kHz	± 0.7 dB			
		OFF	- 20 to - 70 dBm0		± 1.5 dB			
54	MUX-R	Fix idle channel character signal	- 20 to - 75 dBm0	Psophometric weighting	± 0.7 dB	PDG-3 is required in addition		
			- 20 to - 85 dBm0		+ 0.8/- 0.7dB			
55	MUX-R	Pseudo- random character signals	- 20 to - 70 dBm0	0.2 to 4 kHz	± 0.3 dB			
			- 20 to - 75 dBm0		+ 0.4/- 0.3 dB			
56 to 59	Block Measurements: Measuring step sequence of one of the modes 50 to 55 with send parameters pre-programmed in accordance with customer specification							

1.6.6. TOTAL DISTORTION (incl. quantizing distortion): S/Q

Measurement mode	Measurement on	Send parameters		Error limits of measured total distortion in level range			Remarks		
		BN 822/01 BN 822/02	BN 822/03		BN 822/01 and /02	BN 822/03			
60	MUX	L Var. Noise	L Var. 0.856 kHz	- 6 to - 60 dBm0	± 0.5 dB	± 0.8 dB	End-to-end and loop measurements	Q-values ≥ - 72 dBm0	
				0 to - 6 dBm0	± 1.5 dB	± 0.8 dB			
61	MUX	L Var. 0.421 Hz	L Var. 0.856 kHz	+ 3 to - 60 dBm0	± 0.5 dB	± 0.6 dB			
				+ 10 to + 3 dBm0	± 1.5 dB	± 1.5 dB			
62	MUX-S	L Var. Noise	L Var. 0.856 kHz	- 6 to - 55 dBm0	± 0.8 dB	---	Error limits of the PDA-3 included.	PDA-3 is required in addition (Q ≥ -72 dBm0)	
				+ 3 to - 55 dBm0	---	± 1.2 dB			
63	MUX-S	L Var. 0.421 kHz	L Var. 0.856 kHz	+ 3 to - 55 dBm0	+ 0.8 dB	+ 1 dB			
64	MUX-R	L Var. Noise	L Var. 0.853 kHz	- 6 to - 55 dBm0	± 0.5 dB	---	For distortion values generated digital signal see characteristics of the PDG-3	PDG-3 is required in addition (Q ≥ -72 dBm0)	
				+ 3 to - 55 dBm0	---	+ 0.8 dB			
65	MUX-R	L Var. 0.422 kHz	L Var. 0.853 kHz	+ 3 to - 55 dBm0	± 0.5 dB	± 0.6 dB			
66 to 69	Block Measurements: Measuring step sequence of one of the modes 60 to 65 with send parameter pre-programmed in accordance with customer specification								

1.6.7. INTERCHANNEL CROSSTALK (70, 72, 74) or Go-to-return crosstalk in own channel (71, 73, 75)

Measurement mode	Measurement on	Send parameter	Error limits of the level (without idle noise contribution of the test object) in receive level range			Receive side	Remarks		
			in receive level range	in receive freq. range	Send side (+ 10 to -40 dBm0)				
70	MUX	0 dBm0 0.814 kHz	- 20 to - 75 dBm0	810 to	± 0.15 dB	± 0.4 dB	Intrinsic noise approx. - 113 dBm	End-to-end and loop measurements	
			- 20 to - 85 dBm0	820 Hz		± 0.5 dB			
71	MUX	L Var. 0.814 kHz	- 20 to - 75 dBm0	810 to	± 0.15 dB	± 0.4 dB			
			- 20 to - 85 dBm0	820 Hz		± 0.5 dB			
72	MUX-S	0 dBm0 0.814 kHz	- 20 to - 60 dBm0	810 to	± 0.15 dB	± 0.8 dB	PDA-3 is required in addition	Error limits of the PDA-3 included	
			- 20 to - 70 dBm0	820 Hz		± 1.7 dB			
73	MUX-S	L Var. 0.814 kHz	- 20 to - 60 dBm0	810 to	± 0.15 dB	± 0.8 dB			
			- 20 to - 70 dBm0	820 Hz		± 1.7 dB			
74	MUX-R	0 dBm0 0.813 kHz	- 20 to - 75 dBm0	810 to	± 0.05 dB	± 0.4 dB	PDG-3 is required in addition	Error limits of the PDG-3 included	
			- 20 to - 85 dBm0	820 Hz		± 0.5 dB			
75	MUX-R	L Var. 0.813 kHz	- 20 to - 75 dBm0	810 to	± 0.05 dB	± 0.4 dB			
			- 20 to - 85 dBm0	820 Hz		± 0.5 dB			
76 to 79	Block Measurements: Measuring step sequence of one of the modes 70 to 75 with send parameters pre-programmed in accordance with customer specification.								

1.6.8. RETURN LOSS AND SIGNAL BALANCE RATIO

Measure- ment mode	Measure- ment on	Send parameters	Error limits of the measured return loss or signal balance ratio			Remarks
			in frequency range	Measured value	Z = 600 Ω, 850 Ω, 900 Ω	
80	MUX Input	- 10 dBm0 <input type="checkbox"/> F Var.	0.2 to 4 kHz	0 to 30 dB	± 0.6 dB	MU 3/BN 823 is required for measurement No end-to-end measurement. Error limits of the PCM-3 and MU-3 included
				30 to 40 dB	± 1.1 dB	
81	MUX Output	- 10 dBm0 <input type="checkbox"/> F Var.	0.2 to 4 kHz	0 to 30 dB	± 0.6 dB	
				30 to 40 dB	± 1.1 dB	
82	MUX Input	0 dBm0 <input type="checkbox"/> F Var.	0.2 to 4 kHz	0 to 40 dB	± 0.6 dB	
				40 to 50 dB	± 0.9 dB	
				50 to 56 dB	± 1.1 dB	
83	MUX Output	0 dBm0 <input type="checkbox"/> F Var.	0.2 to 4 kHz	0 to 40 dB	± 0.6 dB	
				40 to 50 dB	± 0.9 dB	
				50 to 56 dB	± 1.1 dB	
86 to 89	Block Measurement: Measuring step sequence of one of the modes 80 to 83 with send parameters pre-programmed in accordance with customer specification.					

1.6.9. OUT-OF-BAND SIGNALS

Measure- ment mode	Measure- ment on	Send parameters	Error limits of the level		Send side 0 dBm0/0.2 to 20.2 kHz	Receive side	Remarks	
			in receive level range	in receive freq. range				
90	MUX	Generator	0 to - 40 dBm0	4.6 to 72 kHz	---	*) ± 0.5 dB	Intrinsic noise <input type="checkbox"/> M 90, 92: approx. - 70 dBm <input type="checkbox"/> M 91: approx. - 75 dBm	
		OFF	0 to - 50 dBm0					*) + 1.0/ - 0.6 dB
91	MUX	0 dBm0 <input type="checkbox"/> F Var.	0 to - 45 dBm0	0.2 to 4 kHz	± 0.2 dB	± 0.3 dB		
			0 to - 55 dBm0			+ 0.7/ - 0.3 dB		
92	MUX	0 dBm0 <input type="checkbox"/> F Var.	0 to - 40 dBm0	4.6 to 72 kHz	± 0.2 dB	*) ± 0.5 dB	For relative level of the receiver ≥ 0 dB, the sta- ted receive level range is extended downwards by 10 dB.	
			0 to - 50 dBm0			*) + 1.0/ - 0.6 dB		
						*) in the fre- quency range 5 to 72 kHz (see Sect.1.7.8)		
96, 97	Block Measurements: Measuring step sequence of one of the modes 90, 91, 92 with send parameters pre-programmed with customer specification.							

1.7. Attenuation characteristic of the filters

1.7.1. Send filter 350 to 550 Hz

For generation of the pseudo-random noise signal.
Attenuation referred to the value at 421 Hz corresponding to the CCITT-Rec. O.131.

< 250 Hz	≧ 55 dB
300 Hz	≧ 20 dB
350 Hz	≧ 3 dB
550 Hz	≧ 3 dB
580 Hz	≧ 20 dB
> 605 Hz	≧ 60 dB

1.7.2. Receive filter 350 to 550 Hz

Attenuation referred to the value at 421 Hz

≧ 200 Hz	> 20 dB
260 Hz	≧ 3 dB
350 to 550 Hz	≧ 0.2 dB
610 Hz	≧ 3 dB
≧ 700 Hz	> 34 dB

1.7.3. Noise filter for total distortion measurement in BN 822/01 and /02

Attenuation referred to the value at 2450 Hz corresponding to the CCITT-Rec. O.131. Receive band 815 to 3330 Hz

≧ 150 Hz	≧ 60 dB
650 Hz	> 55 dB
700 Hz	> 35 dB
750 Hz	> 20 dB
800 Hz	≧ 3 dB
900 to 3200 Hz	≧ ± 0.5 dB
3350 Hz	≧ 3 dB
3500 Hz	> 10 dB
3600 Hz	> 20 dB
3700 Hz	> 40 dB
3750 Hz	> 50 dB
≧ 5000 Hz	> 60 dB

1.7.4. Receive filters for total distortion measurement in BN 822/03

Test-signal band pass filter 850 Hz
Attenuation referred to the value at 850 Hz

\leq 750 Hz	\geq 45 dB
800 to 900 Hz	\leq 2 dB
\geq 1100 Hz	\geq 50 dB

Test-signal band stop filter 850 Hz
 can be connected in series with the 200 Hz to 4 kHz filter (see sect. 1.7.5.) or
 with the Psophometer Filter (see 1.7.7.)

Conforms with CCITT-Recommendation G 712, Method 2
 Attenuation referred to the value at 300 Hz

\leq 400 Hz	\leq 0.5 dB
\leq 700 Hz	\leq 3 dB
800 to 890 Hz	> 50 dB
815 to 884 Hz	> 60 dB
\geq 1000 Hz	\leq 3 dB
\geq 1360 Hz	\leq 0.5 dB

1.7.5. Receive filter 200 Hz to 4 kHz

Attenuation referred to the value at 814 Hz

\leq 100 Hz	> 32 dB
120 Hz	> 10 dB
200 Hz to 4 kHz	$\leq \pm 0.03$ dB
7 kHz	> 10 dB
\geq 8 kHz	> 32 dB

1.7.6. Selective Filter

Attenuation referred to the value at 814 Hz, 3-dB limit frequencies approx.
 798 Hz and 836 Hz

\leq 500 Hz	> 50 dB
750 Hz	> 20 dB
805 Hz	< 1 dB
810 to 820 Hz	$\leq \pm 0.3$ dB
825 Hz	< 1 dB
880 Hz	> 20 dB
\geq 1050 Hz	> 40 dB

1.8. Additional inputs and outputs (rear side)

1.8.1. Receiver input 25

balanced, floating

For connecting the analog output of the Digital Signal Analyzer PDA-3.

The input 25 is connected through instead of the receiver input 20 on selection of a measurement mode for measuring the send side of a PCM system under test (MUX-S).

Input impedance 600 Ω
Return loss in the frequency range 200 Hz to 4 kHz ≥ 46 dB
Signal balance ratio according to CC ITT-
Recommendation O.121 in the frequency range
200 Hz to 4 kHz ≥ 50 dB

1.8.2. A.C. voltage output 24

Unbalanced

For observing the receive signal by oscilloscope

Output impedance 600 Ω

Output level when terminated with 600 Ω for measurements, producing a measured value within the measuring range (display 4) - 15 to + 5 dB¹⁾

1.9. Measuring sequence

1.9.1. Single measurements

Run selected with slide switch 6 1 x or repetitive
Channel stepping on Test Point Scanner MU-3 manual

Measurement mode and entry numbers according to Sect. 1.4.

Data entry via keyboard 13

Meas. Mode No. : M xx E
Level in dBm0 : L yy E
Frequency in kHz : F zz E

Level or frequency-
increment, e. g. : Δ L vv E
Measurement release : S or Δ S

1) Series A: - 21 to - 1 dB

1.9.2. Block measurements

Sequence of single measurements with send parameters pre-programmed according to arranged customer specification.

Run selected with switch [6] with halt after each single step
or complete without halt

Channel stepping on Test Point Scanner MU-3 manual

Data entry [13]
Meas.Mode No. : [M] xx [E]
Measurement release : [S]

Level, frequency and tolerance are arranged in pre-program. The tolerance values can be displayed by pressing [Δ] [L].

1.9.3. Measuring program

Built-up from any number of block measurements. The programmed block measurements are indicated by the LED program panel [10], and worked off in the sequence of numbering, beginning with the measurement mode number last entered. (The lowest mode number must therefore be entered last, or as the case may be, keyed in at the conclusion of data entry.)

Program halts are selected by switch [6] after each measurement step (if necessary, step repetition) block, channel cycle or run without stop (total cycle).

Stopping of selected channels of the Test Point Scanner MU-3 automatic

Data entry [13] : [M] 1 xx [E]
[M] 2 yy [E]
[M] ⋮ zz [E]
[M] 1 xx [E], [S]

1.9.4. Further switches for measuring sequence

Switch [7] selects Halt, if out of Tolerance
or no halt

A warning lamp lights, if "NO HALT" is combined with "Print Out/OFF" by [9].

Switch [9] (with printer connected)
optional Print if out of tolerance
or permanent
or off

Push-button [8] for manual print release

CLEAR key 12

Clear "M" : The measurement mode indicated in the meas. mode display 2 is cleared in the measuring program.

Clear "ALL" : All programmed meas. modes are cleared.

1.9.5. Operating information

1.9.5.1. Lamps 1

"Measuring": indication of measuring, during a measuring step

"Program halt" : program interrupted, between programmed measuring steps

1.9.5.2. Measurement mode display 2

2-digit liquid crystal display

No. 00 : no entry or entry of impossible measurement mode or after power interruption

1.9.5.3. Send parameter display 3

3-digit liquid crystal display

for indication of send level or send frequency, of the appropriate unit (dBm0, dB0, dB, kHz) as well as additional symbols.

... kHz pseudo-random noise signal

↑ Entry of too large parameter value.
Display shows the max. possible value.

↓ Entry of too small parameter value.
Display shows the min. possible value.

With F entry is rounded off to the next possible locking frequency.

1.9.5.4. Measured result display 4

3-digit liquid crystal display

for indication of the measured result, the appropriate unit (dBm0, dB0, dB) as well as additional symbols.

↑ Measured value larger than

↓ Measured value smaller than

↕ Flashing double arrow: Measurement not possible, e.g. send parameter missing.
Or calibration step or attenuator setting not possible.

... Z-value out of tolerance during signalling distortion measurement (comp. Section 1.10.3.2.).

In measurement modes 93, 94, 98 and 99 the measured value is displayed in ms without unit.

"Out of tolerance" lamp lights when measured value exceeds the tolerance.

1.9.6. Measuring times

The measuring time depends on the type of measurement and the deviation of the result from the expected value.

In the following table average times of measurement are given - in that they are typical for measuring program.

Meas. mode no.	Average measuring time per step
10 ... 19	approx. 1.5 s
20 ... 29	approx. 1.5 s
30 ... 39	approx. 0.9 s
40 ... 49	Sine Wave Noise
	approx. 0.9 s
	approx. 1.5 s
50 ... 59	approx. 2.2 s
60 ... 69	approx. 3.5 s
70 ... 79	approx. 1.5 s
80 ... 89	approx. 2.0 s
90, 91, 92, 96, 97	approx. 1.5 s
93, 94, 98, 99	approx. 1.1 s

1.10. Additional devices

1.10.1. V. 24 Printer interface

Additional plug-in card BN 822/00.07
for connecting to a printer with V. 24 (RS-232) interface.

1.10.2. IEC -Bus-interface

Additional plug-in card BN 822/00.02
may be inserted alternatively with printer interface.

1.10.3. End-to-end and signalling distortion measuring device Additional plug-in card BN 822/00.03

1.10.3.1. Interface for end-to-end measurement

For transmission of start and stepping pulses, as well as Δ -start pulses in end-to-end measurements from receiver (PCM-3) to generator (PCM-3) via an auxiliary telephone channel.

The end-to-end measurement pre-supposes synchronous programming of the generator and receiver equipments.

Generator output 29

balanced

Output impedance	600 Ω
Return loss at 1.97 kHz	> 20 dB
Signal balance ratio at 1.97 kHz	> 40 dB

Send signal

A. C. pulse (keyed sinusoidal a. c. voltage)

Frequency of a. c. voltage	1.97 kHz \pm 3 %
Pulse duration : start and stepping pulse	approx. 50 ms
Δ -start pulse	approx. 150 ms
Send level of a. c. for $Z_{out} = Z_L$	- 17 dBm

Receiver input 29

balanced

Input impedance	600 Ω
Return loss at 1.97 kHz	> 20 dB
Signal balance ratio at 1.97 kHz	> 40 dB

Receive signal

Level range of a. c. (continuous tone ON)	+ 10 to - 30 dBm
Receive frequency range	selective
3 dB points	approx. 1.91 and 2.03 kHz
Max. permissible input level	+ 20 dBm
D.C. voltage not permitted!	

1.10.3.2. Signalling distortion measuring device

Measuring method : Measurement of the deviation of the mark-to-space ratio of a 10 Hz or 20 Hz rectangular signal, averaged over 1 sec.

Measurement modes 93, 94, 98, 99

Signalling generator

Frequency	10 Hz \pm 0.1 %
can be resoldered internally for change to	20 Hz \pm 0.1 %
Mark-to-space ratio	50 %
can be resoldered internally for change to	40 %
or	60 %

Outputs

per each output for measurement modes 93 and 94, wired to a 14-pole

Amphenol socket 29

Output impedance (electronic switch)

Mark (pulse)	< 30 Ω
Space	> 20 k Ω
Max. d. c. load	200 mA
Max. switching voltage	70 V

Signalling receiver
 Measuring range ± 10 ms
 Resolution 0.1 ms

Inputs
 per each input for measurement modes 93 and 94, wired to a 14-pole
 Amphenol socket 29

The input must be connected to earth. Short-circuit impedance of
 the driving switch $< 250 \Omega$
 Input impedance 470Ω against - 5 V internal d. c. voltage
 Short circuit current 10 mA

Short- or open-circuit impedances in the range 300Ω to $20 \text{ k}\Omega$ will be indicated
 by appearance of the decimal points in the measured result display 4 and ligh-
 ting of the diode lamp "Out of tolerance".

Error limits of the displayed signalling distortion
 (generator and receiver) ± 0.1 ms

1.10.4. Interface for PDA-3, PDG-3, MU-3

Additional plug-in card BN 822/00.04
 for the control of the instruments PDA-3, PDG-3 and MU-3 through the PCM-3.
 Three 14-pole Amphenol sockets 26 , 27 and 28 with serial interface.

Connecting cable
 to PDA-3, PDG-3 and MU-3 (cable length 60 cm each) K 337

1.11. General data

1.11.1. Power supply

A. C. line voltage

Setting at a. c. voltage selector	Rated range of use
110 V	96.5 to 121 V
117 V	103 to 129 V
127 V	111.5 to 140 V
220 V	193 to 242 V
227 V	199 to 250 V
237 V	208 to 261 V

A.C. line frequency, rated range of use 47.5 to 63 Hz
 Power consumption approx. 130 VA
 Protection class according to IEC 348 and VDE 0411 class I

1.11.2. Permissible ambient temperature

Rated range of use + 5 to + 40 °C
 Range of storage and transport - 20 to + 60 °C

1.11.3. Dimensions and weight

Dimensions	Bench model	19" rack mounting (DIN 41 494)
Width with handles . . .	477 mm	Width . . . 443 mm
Overall height	244 mm	Height . . . 220 mm
Depth with handles . . .	425 mm	Depth . . . 370 mm
Weight		approx. 20 kg

1.12. Ordering Information

Automatic Measuring Set for Telephone Channels PCM-3

Lettering	Total distortion, measured with	Impedances	
German	Noise or 421 Hz sinusoidal	600 Ω/850 Ω	BN 822/01
English	Noise or 421 Hz sinusoidal	600 Ω/900 Ω	BN 822/02
English	856 Hz sinusoidal	600 Ω/900 Ω	BN 822/03

Options for fitting to PCM-3 :

IEC-Bus-interface	BN 822/00.02
End-to-end and signalling distortion measuring device	BN 822/00.03
Interface for MU-3, PDG-3, PDA-3	BN 822/00.04
V. 24 printer interface	BN 822/00.07

Accessories (at extra cost):

Transportation Protective Covers (1 set for front and back panels)	SD 5
---	------

Additional measuring instruments for configuring into the Automatic Measuring System PA-3 (also see appropriate spec. sheets)

Test Point Scanner MU-3 (Main Frame)	BN 823/00
AF Switching Unit for 15 channels, MUE-31	BN 824/00
Switching Unit 2 Mbit/s, balanced, MUE-32	BN 825/00
Switching Unit 2 Mbit/s, unbalanced, MUE-33	BN 826/00
Additional device for the MU-3:	
Remote control card for PCM-3	BN 823/00.04
PCM Digital Signal Analyzer PDA-3	BN 867/01
Optional devices for the PDA-3 :	
Remote control card	BN 867/00.01
Digital/Analog converter	BN 867/00.02
PCM Digital Signal Generator PDG-3	BN 859/01
Optional devices for the PDG-3 :	
Remote control card	BN 859/00.01
Additional memory for noise	BN 859/00.02
64-kbit/s input	BN 859/00.03
V.24 Printer e.g. Model Trend 800 RO	

Subject to change without notice

Return Loss

The effect introduced by the return loss of the receiver input or the generator output is included in the error specified for the level reading of a receiver or the output level of a generator.

Moreover, the specified error takes into account that a level meter is operated as "terminated" (input impedance = source impedance = Z_0). This is also valid for a level generator (output impedance = load impedance = Z_0).

Bridging Loss

A receiver operated in the "high impedance" (bridging) mode introduces a level error due to the finite input impedance. The error's maximum value when measured at a testpoint of source impedance $Z/2$ is expressed as a_B , the bridging loss.

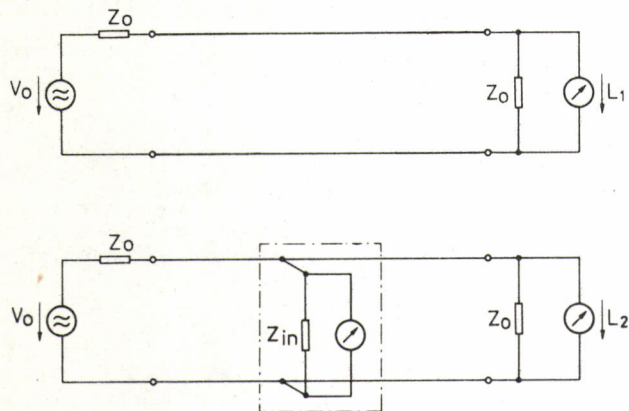

The bridging loss is defined as follows:
Bridging loss $a_B = L_2 - L_1$

$$a_B = 20 \lg \left| 1 + \frac{1}{2} \frac{Z_0}{Z_{in}} \right|$$

Therefore, the bridging loss is the level difference caused by the high impedance level meter input bridging a system terminated with Z_0 .

In every case, $Z_{in} \gg Z_0$, which results in:

$$a_B \cong 4.3 \frac{Z_0}{Z_{in}} \text{ [dB]}$$

For that reason, the specified value of $a_{B,1}$ related to the value Z_1 (e.g. 600 Ohms) can be easily recalculated to yield the value of $a_{B,2}$ for the value Z_2 (e.g. 900 Ohms):

$$a_{B,2} = a_{B,1} \cdot \frac{Z_2}{Z_1}$$

Impedance balance ratio

The specifications given for the input or output balance are provided by the methods defined in CCITT Recommendation O. 121.

This same Recommendation states that:
"The signal balance ratio is an overall measurement of the symmetry of a device and includes the influence of the impedance balance ratio as well as the influence of unwanted longitudinal voltages produced by a generator or the influence of the common-mode rejection ratio of a receiver."

To describe the degree of balance of a device (generator or receiver) under operational conditions in most cases it is sufficient to measure and specify the signal balance ratio only. Thus, the specifications in this Operating Manual are provided by measurement of signal balance ratio. This is done through employment of an accurately center-tapped inductor with both of the tightly-coupled half windings being completely symmetrical. Each half represents $Z/2$.

Measurement of Generator Signal Balance Ratio

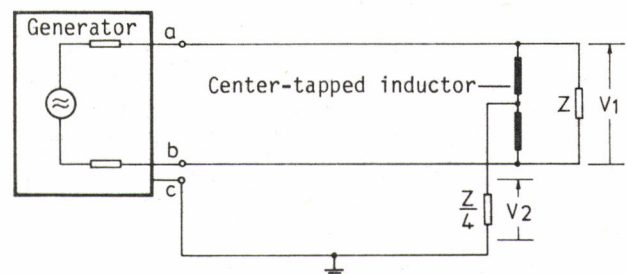

Generator signal balance ratio is defined as:

$$a_B = 20 \log \left| \frac{V_1}{V_2} \right| \text{ [dB]}$$

Measurement of Receiver Signal Balance Ratio

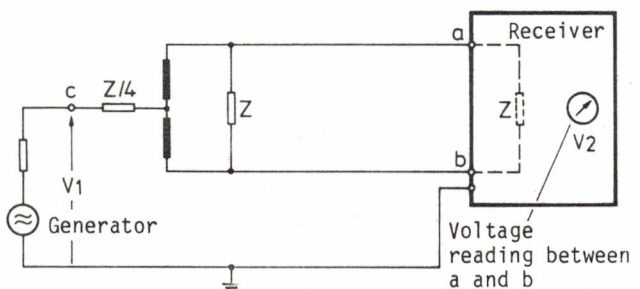

Receiver signal balance ratio is defined as:

$$a_B = 20 \log \left| \frac{V_1}{V_2} \right| \text{ [dB]}$$

The dotted impedance, Z , is the input impedance of the device under test. If the input impedance is a high value, then this impedance must be externally connected in the parallel.

2. OPERATION

Operating controls and connectors of the PCM-3

The framed numerals coincide with the numbers printed on the front panel
Fig. 2-1 Front View

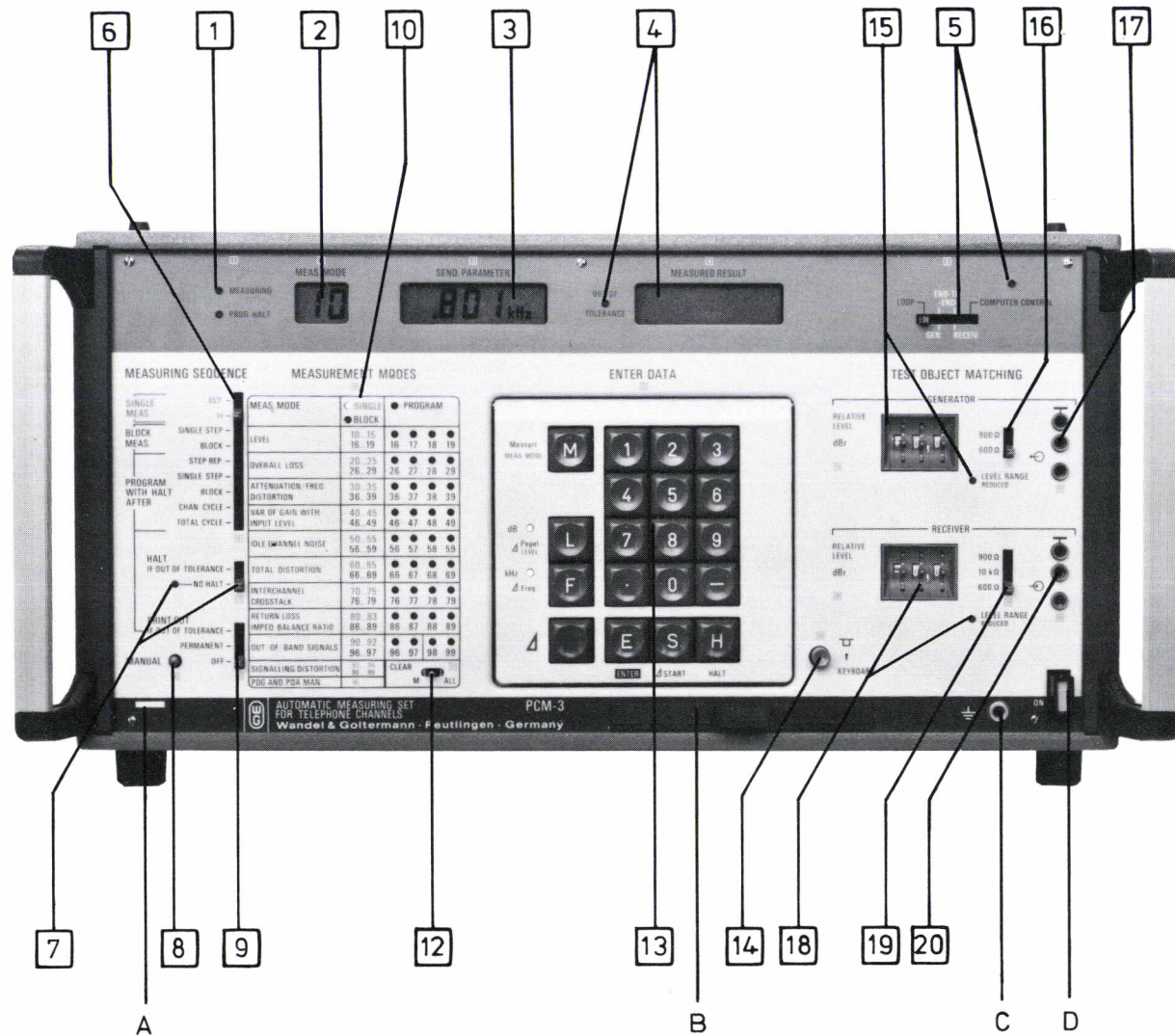

Fig. 2-1

- 1 Marking lamps for "Measuring" condition (25 GI 1) and "Program halt" (25 GI 2)
 - 2 Display for measurement mode number (25 JC 18)
 - 3 Display for send parameters Frequency/Level (25 JC 19)
 - 4 Digital readout for measured result (25 JC 20) and marking lamp for "Out-of-tolerance" (25 GI 3)
 - 5 Operating function switch 28 S 3 and marking lamp 28 GI 3 for computer control
 - 6 Slide-switch 27 S 3 for execute measurement run
 - 7 Switch 27 S 4 for "program halt" if out of tolerance and marking lamp "No halt" (27 GI 40)
 - 8 Push-button 27 S 2 for manual print release
 - 9 Selector switch 27 S 5 for print-out of the measured result } via printer interface
 - 10 Measurement mode table with marking lamps 27 GI 1...39
 - 12 Toggle switch 27 S 1 for clearing selected measurement mode (s)
 - 13 Keyboard for data entry (26 S 1...19) and marking lamps "Frequency" (26 GI 1) and "Level" (26 GI 2)
 - 14 Release knob for tilting keyboard
 - 15 Relative level switch 28 S 1 for send level and marking lamp "Level range reduced" 28 GI 1
 - 16 Output impedance switch (28 S 4) 600 Ω/850 Ω or 600 Ω/900 Ω resp.
 - 17 Generator output 40 Bu 1
 - 18 Relative level switch 28 S 2 for receive level and marking lamp "Level range reduced" 28 GI 2
 - 19 Input impedance switch (28 S 5) 600 Ω/850 Ω/ 10 kΩ or 600 Ω/ 900 Ω/10 kΩ resp.
 - 20 Receiver input 4 Bu 1
- A Serial index and instrument no.
B Drawer for Abbreviated Operating Instructions
C Earthing terminal 1 Bu 3
D A. C. line switch 1 S 301

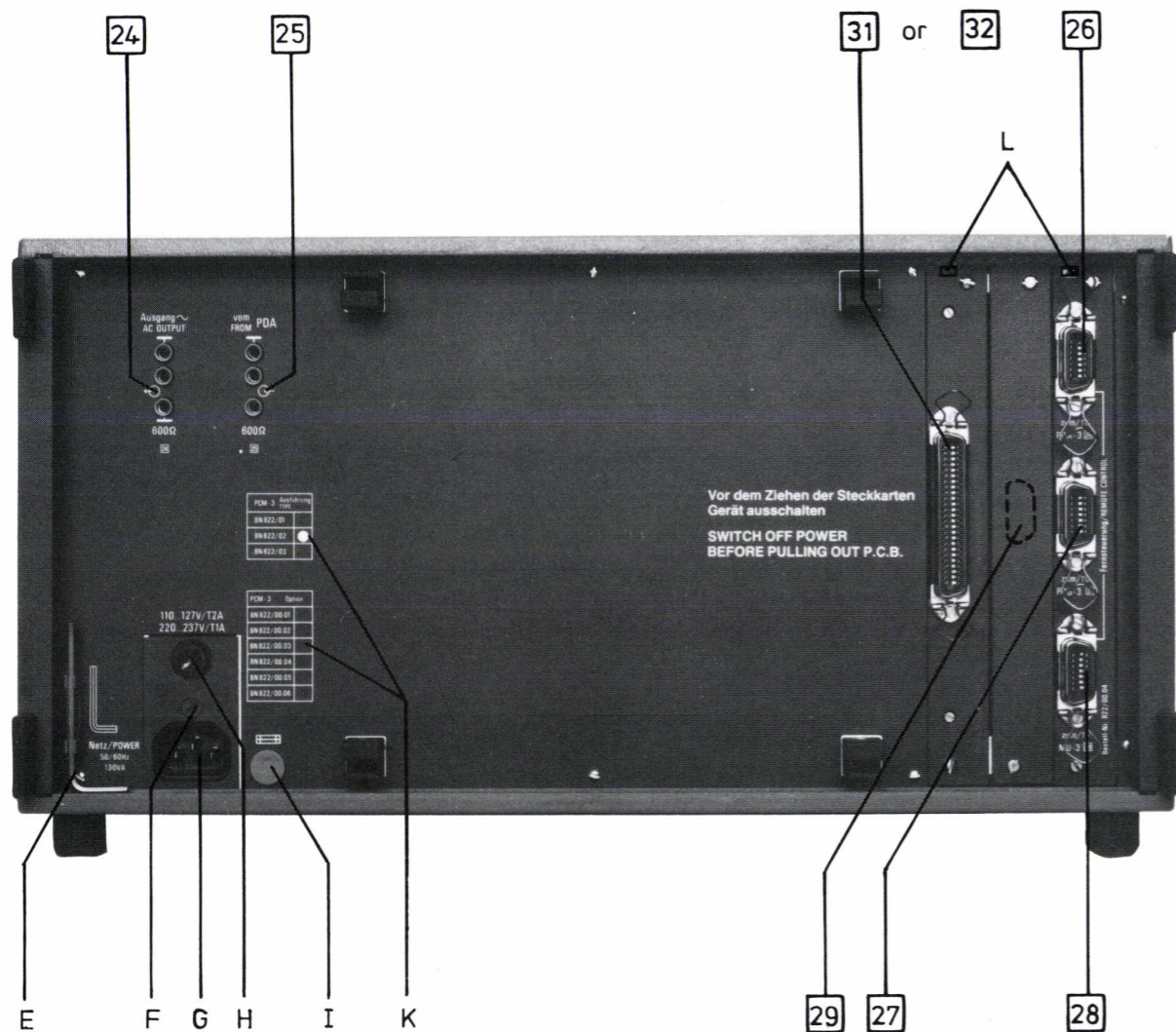

Fig. 2-2

Fig. 2-2 Rear view of the PCM-3

The framed numerals coincide with the printed numbers on the back panel

Basic instrument

- 24 A.C. voltage output 7 Bu 1, $Z = 600 \Omega$
- 25 Receiver input 4 Bu 2 "From PDA", $Z = 600 \Omega$
- E Allen wrench for removal of cabinet
- F A. C. line voltage selector 1 S 302
- G A. C. power line connection 1 St 101
- H Line fuse 1 Si 101
- I Replacement fuses
- K Data on equipment version and on option incorporated
- L Colour coding for plug-in position - arrangement

Interface for MU-3, PDG-3, PDA-3 BN 822/00.04

- 26 Remote control connection 31 Bu 3 for PDA-3
- 27 Remote control connection 31 Bu 2 for PDG-3
- 28 Remote control connection 31 Bu 1 for MU-3

End-to-end and signalling distortion measuring device BN 822/00.03

- 29 14-pole connector 14 Bu 1

IEC-Bus-interface BN 822/00.02

- 31 IEC-Bus-interface 33 Bu 1 for computer control
- or alternatively

V. 24 Printer interface BN 822/00.07

- 32 Data output 35 Bu 1 for printer with V.24 Interface

2. OPERATION

2.1. Setting-up and putting into service

2.1.1. Setting-up the instrument

The Automatic Measuring Set PCM-3 is for use in ambient temperatures between + 5 ° and + 40 °C. In use with larger installations or mounting into racks, care must be taken over suitable ventilation so that the temperature limit is not exceeded (see also section 5.2.7.)

For storage and transport temperatures between - 20 ° and + 60 °C can be tolerated. In this case it is recommended that displays, indicators, and controls be protected against mechanical damage by the transport cover SD 5 on the front and rear sides.

The PCM-3 works in a vertical position and may also be used with the front panel tilted. To bring the instrument to a slightly inclined position, the stirrup fixed to the front feet of the instrument can be hinged forward. The key board on the front-plate is swung out by pressing the release knob **14** for more convenient entry of data.

2.1.2. Operating controls

The operating controls, indicating devices, and connecting sockets for the objects under test are arranged on the front panel. On the rear of the instrument are located other sockets for connection of peripheral instruments. Position and markings of the controls are to be seen in figs. 2-1 and 2-2. The brief designations given make it easy to locate the controls on the schematic diagrams of the Appendix, for example 28 S 3 is the switch no. 3 on the schematic diagram **(28)**.

A 6-page abbreviated operating instruction for the PCM-3 is in drawer B under the keyboard.

2.1.3. A. C. line connection

The instrument can be used on A. C. mains with frequencies between 47.5 and 63 Hz. It is shipped with the line voltage selector switch F on the rear of the PCM-3 set at 220 V. If necessary the setting can be changed to 110, 117, 127,

227 and 237 V. For the voltages 110, 117 and 127 V the fuse H is to be changed. The following fuse sizes are specified:

110, 117, 127 V : T 2A D (2A slow-blow)
220, 227, 237 V : T 1A B (1A slow-blow)

For fuse changing see Section 5.2.5.

The Automatic Measuring Set is connected to the a. c. line via the power cord supplied.

The line connection G is located on the rear of the PCM-3. The case as well as the earthing terminal C are connected to the protective conductor. The instrument conforms with safety class I to VDE 0411 or IEC Publ. 348. It is ready for operation on pressing the a. c. line switch D, which is indicated by the measurement mode 00 in the display 2.

2.2. Preliminary settings

2.2.1. Operating functions

The PCM-3 can be set up for loop measurements, end-to-end measurements or computer control, by operating the function switch 5. Loop measurements are carried out with one PCM-3, since the automatic test set comprises both send and receive units. For this mode of operation the switch 5 is set to "LOOP".

End-to-end measurements can be made with two measuring sets PCM-3. The function switch 5 is for this purpose on the send side PCM-3 set to "END-TO-END GEN." and set to "END-TO-END RECEIV." on the receive side PCM-3. If both measuring sets are fed with the same data and the same program is chosen, then the "receiver" PCM-3 can control the "generator" PCM-3 through an auxiliary channel. The test set-up is shown in Fig. 2-5.

Computer control of the PCM-3 (switch 5 in position "COMPUTER CONTROL") renders all front-panel controls inoperative. This is indicated by the red lamp particularly at 5. The displays are in operation on the dark grey area of the panel. Thus the execution of the measuring program can be checked and the test results read-off even while the set is under control of the computer. The external

computer is connected via the IEC-Bus-interface, whose mounting is described in Section 5.2.2. Further particular details on the computer programming and IEC-Bus-interface may be obtained from the separate programming informations.

2.2.2. Matching to the object under test

2.2.2.1. Setting relative level

Relative levels are assigned to the test points within a transmission system. The relative level zero is the reference level for the measurements in the system. Measured values which are referred to this quantity are designated by means of the suffix 0 to the unit, e.g. dBm0.

In making measurements on PCM systems the send level and receive level can be set directly or read off directly in dBm0 as the case may be, provided that the relative level has been set beforehand with the relative level switch according to the point being measured.

Relative levels in the range - 19.9 to + 9.9 dBr can be set in steps of 0.1 dB with the thumb wheel selectors 15 and 18. The preferred range for the generator lies between - 17.0 and + 3.0 dBr, for the receiver between - 9.9 and + 9.9 dBr. If these preferred ranges are exceeded, the appropriate "LEVEL RANGE REDUCED" indicator lamp lights up, i. e. the send level range or level measuring range given in the specification is reduced.

2.2.2.2. Generator output; output impedance

The send unit in the PCM-3 provides a balanced, floating output 17 at a 3-pole carrier frequency connector. Slide-switch 16 changes the output impedance between the two customary values 600 Ω and 850 Ω or 600 Ω and 900 Ω , as the case may be. 850 Ω is the input impedance of the signalling converter in 2 wire systems. The power level at the generator output is referred to the output impedance selected.

A d.c. voltage between generator output and ground must not exceed 100 V.

D. C. drain is not permitted.

2.2.2.3. Receiver input; input impedance

The receiver input **20** brought to the front panel is balanced and floating. The slide-switch **19** can select the input impedances of 600 Ω , 850 Ω or 900 Ω resp. as well as 10 k Ω . The high impedance input is provided for measurements on test objects already terminated. The power level measured is referred to 600 Ω or 850 Ω or 900 Ω as the case may be and in the "10 k Ω " position to 600 Ω likewise. If in the last case the reference should be to 850 Ω or 900 Ω , the receive side relative level **18** is to be increased by + 1.5 dB or + 1.8 dB respectively.

Warning : The input level into socket **20** must not exceed the value + 20 dBm.
The permissible d. c. voltage to ground is limited to 100 V. D. C. drain is not permitted!

The input socket **25** on the rear of the instrument is specially provided for the connection of the PCM Digital Signal Analyzer PDA-3. The signal present at this point will only be switched through to the receive part in the measurement modes for the send side terminal (MUX-S). The input impedance is 600 Ω .

2.3. Test set-up and connection of objects under test

The Automatic Measuring Set PCM-3 is adapted for measurements on PCM-systems and assemblies as well as on FDM assemblies as for example, channel converters. The circuit under test is to be connected to the PCM-3 on the voice-frequency side with balanced cables. With the PCM Digital Signal Analyzer PDA-3 and the PCM Digital Signal Generator PDG-3 access to the digital side of PCM-equipment for measurements is likewise possible.

In what follows various measuring arrangements are proposed.

2.3.1. Loop measurements

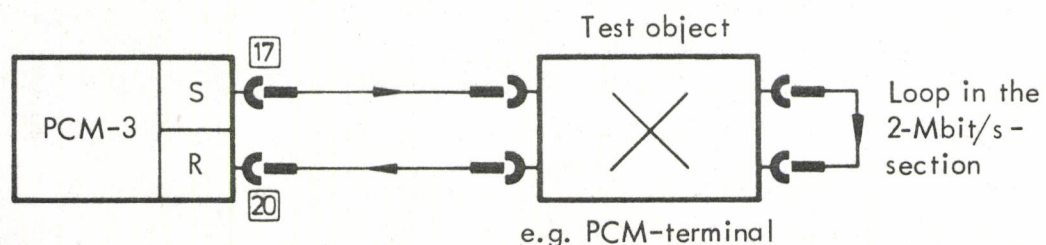

Fig. 2-3 Loop circuit of test object

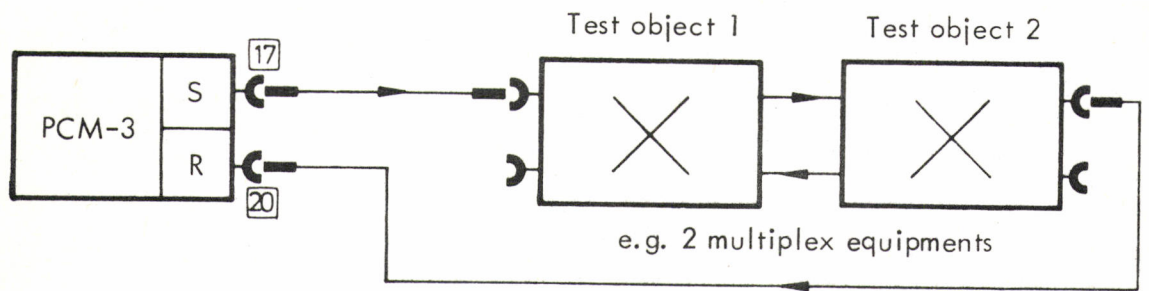

Fig. 2-4 Back-to-back operation

The function switch **5** is to be set in "LOOP" position for the measurements of Figs. 2-3 or 2-4.

2.3.2. End-to-end measurements

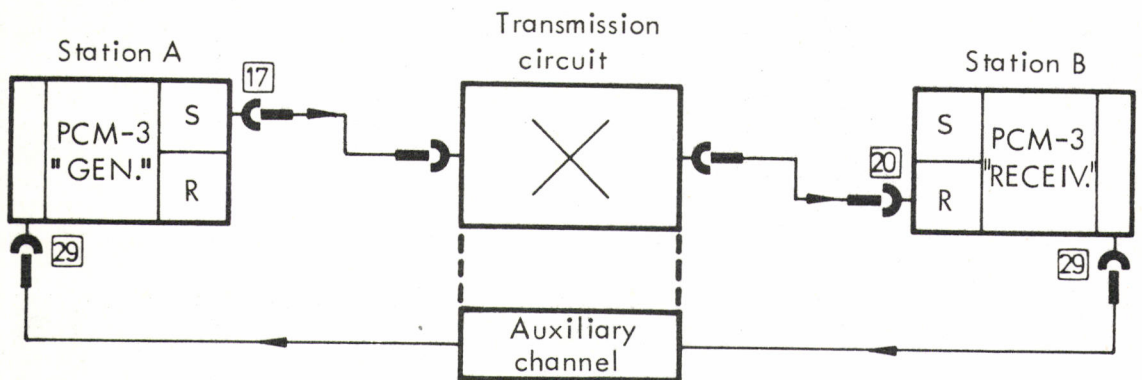

Fig. 2-5 End-to-end measurements with two Automatic Measuring Sets PCM-3

In end-to-end measurements both of the PCM-3 Automatic Measuring Sets must be set to the same test object matching, the same measurement mode, and the same execute run. The receive side PCM-3 (with switch **5** in the position "END-TO-END RECEIV.") controls the test execute run of the send side PCM-3 (with switch **5** in position "END-TO-END GEN.") via an auxiliary channel (order wire or unoccupied telephone channel). In both Automatic Measuring Sets, an end-to-end measuring device BN 822/00.03 is required, which renders an automatic step-by-step action by means of start and stepping pulses (comp. 2.9.3.1.) possible.

2.3.3. Separate measurement of the send or receive part of a PCM multiplex equipment

The basic instrument PCM-3 can be equipped with the additional interface card BN 822/00.04. It then comprises all the measurement modes and measurement programs, to measure send and receive parts of a PCM multiplex equipment separately, when used together with the PCM Digital Signal Analyzer PDA-3 and the PCM Digital Signal Generator PDG-3. The measurement is usually made in the "LOOP" operating mode, but also may be carried out as an end-to-end measurement.

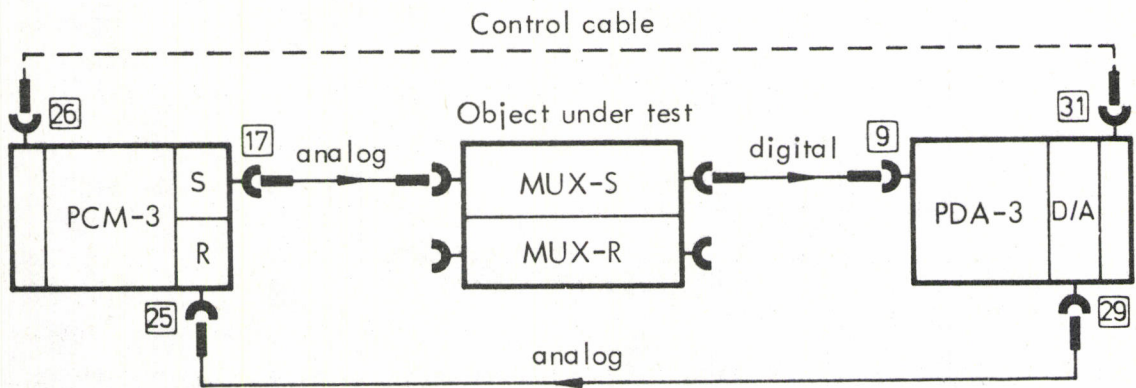

Fig. 2-6 Measurement of the send part of a PCM multiplex equipment

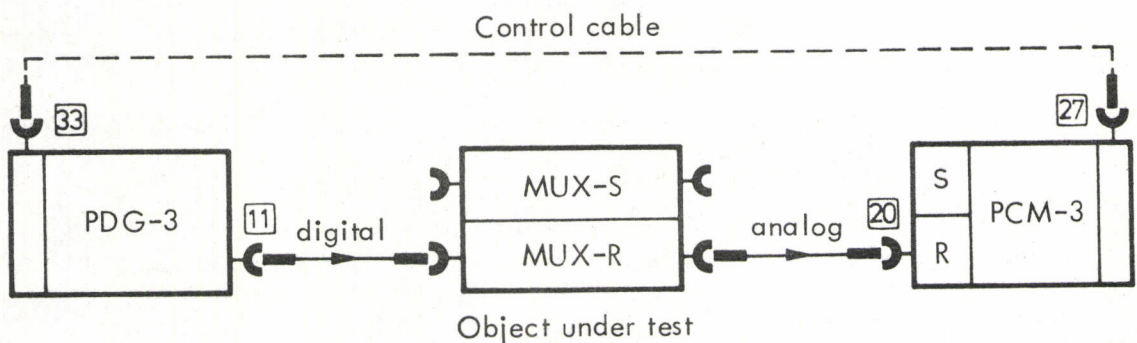

Fig. 2-7 Measurement of the receive part of a PCM multiplex equipment

The necessary settings on the digital instruments PDA-3 and PDG-3 are to be taken from the respective operating manuals. However, in the case of control through the PCM-3 the correct signal code must be only set as well as the telephone channel in use without a Test Point Scanner MU-3.

2.3.4. Measurements on a test object with digital interfaces

Measurements can also be carried out on test objects with digital interfaces only, for example transmultiplexers, with the instruments of the Automatic Measuring System PA-3. In this the Digital Signal Generator PDG-3 serves as a signal source. The measurement is made at the output of the object under test with a Digital Signal Analyzer PDA-3 and the receive section of the PCM-3 connected in series.

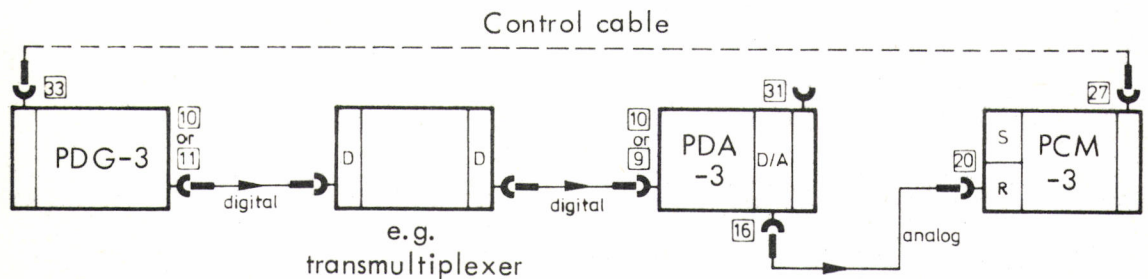

Fig. 2-8 Measurement of a test object with digital interfaces only

Warning: The Digital Signal Analyzer PDA-3 must not be remotely controlled in the test set-up of Fig. 2-8. The respective remote control cable must therefore not be inserted. Furthermore, the connection for the analog signal between PDA-3 and PCM-3, in contrast to the otherwise normal connections on the rear of the instruments must be placed between the output [16] on PDA-3 and input [20] on PCM-3. The relative level [18] at the input of the PCM-3 is to be set at 0 dBr.

The test arrangement described corresponds largely to the arrangement in Fig. 2-7. Thus all measurement mode numbers, which are allocated for the measurement of the receive part of PCM multiplex equipment can also be used in this case.

2.3.5. Connection through the Test Point Scanner MU-3

For measurements on several telephone channels, it is recommended that the object under test be connected through the Test Point Scanner MU-3. If the MU-3 is equipped with two AF switching units, 30 send and 30 receive channels can be

connected in sequence to the measuring circuits of the PCM-3, the change-over can be effected manually or automatically through a remote control card in the PCM-3. A further unit incorporated in the MU-3 makes it possible to set up for loop or end-to-end measurements in the 2 Mbit/s section of PCM systems or in the group section of FDM systems. Furthermore the digital instruments PDA-3 and PDG-3 can be connected. The connection is made automatically in the measurement mode referred to. See also Section 3.1.

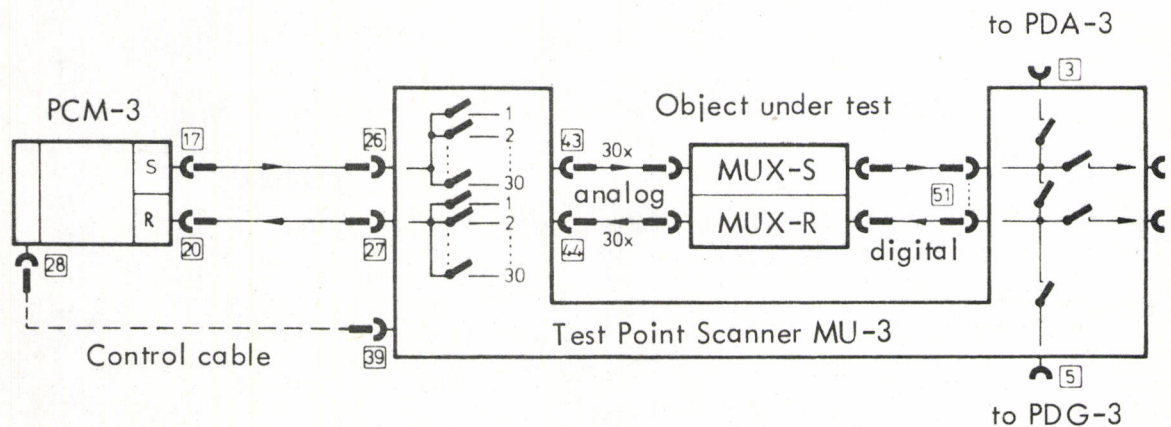

Fig. 2-9 Test set-up with Test Point Scanner MU-3

The description and operating manual for the Scanner MU-3 contains details, for example the allocation of the multipole connectors, etc.

2.4. Measurement modes of the PCM-3

The typical instrument settings of the PCM-3 for the most important telephone channel tests are filed in read-only-memories. After selecting the measurement mode with a two digit address the instrument thereupon takes certain settings automatically, which are guided by the CCITT-Recommendations.

On the send side the following settings can be programmed:

- Sinusoidal signal of specified frequency
- Noise in the range 350 to 550 Hz
- Specified send level or Generator blanked

On the receive side of the PCM-3 the following settings are determined:

- Level measuring range

Indicator range and resolution
Corresponding receive filter
Integration time and
Mode of signal detection.

2.4.1. Summary of measurement modes

From the summary table in Fig. 2-10 all the measurement modes of the PCM-3 can be seen (1st column). The large number of combinations between various telephone channels in cross-talk testing can only be carried out in reasonable time by use of the Test Point Scanner MU-3. The MU-3 also contains the measuring bridge for return loss and impedance balance ratio measurements - corresponding to CCITT - Recommendation O. 121.

The measuring device for signalling distortion is to be found on an additional plug-in subassembly for the PCM-3, the plug-in card BN 822/00.03. In the measurement mode "PDG-3 and PDA-3 manual" the send and receive sections of the basic PCM-3 instrument are switched OFF.

In the 2nd column the test object is quoted:

- MUX is the abbreviation for multiplex equipment consisting of send and receive parts. The measurement is made on the low frequency side of the telephone channels (analog - analog), that is the test object may also be an FDM assembly.
- MUX-S means the send part of the multiplex equipment. It is measured between the voice frequency side and the 2-Mbit/s side (analog- digital). For this measurement the PCM Digital Signal Analyzer PDA-3 is required.
- MUX-R means the receive part of the multiplex equipment. The measurement is made using the PCM Digital Signal Generator PDG-3 between the 2-Mbit/s side and the voice-frequency side (digital-analog).
- KZU is the abbreviation for signalling character signal converter.

The next two columns of the table state the send parameters frequency and level. This shows whether it deals with a constant value or whether the setting can be

Measurement mode	System under test	Send frequency	Send level Least range of relative level in preferred range	Receive level Least range of relative level in preferred range	Display range for result	Receive filter
Level	MUX MUX-S MUX-R	Sinusoidal 0.2 to 3.97 kHz	+10 to -60 dBm0	+10 to -60 dBm0	As with receive level	0.2 to 4 kHz
		Noise 350 to 550 Hz	0 to -60 dBm0	0 to -60 dBm0		350 to 550 Hz
Overall loss at 814 Hz	MUX MUX-S MUX-R	814 Hz	+10 to -60 dBm0	+10 to -60 dBm0	±6.00 dB	0.2 to 4 kHz
Attenuation/freq. distortion	MUX MUX-S MUX-R	0.2 to 3.97 kHz (Ref. value: 814 Hz)	+10 to -60 dBm0	+10 to -60 dBm0	±6.00 dB	0.2 to 4 kHz
Variation of gain with input level	MUX MUX-S MUX-R	814 Hz	+10 to -60 dBm0 (Ref. value -10 dBm0)	+10 to -60 dBm0	±6.00 dB	Selective
		≥ -10 dBm0: 814 Hz sinus. < -10 dBm0: Noise	+10 to -60 dBm0 (Ref. value: -10 dBm0)	+10 to -60 dBm0		Selective or 350 to 550 Hz
Idle channel noise	MUX MUX-S MUX-R	Sender OFF		Weighted: -20 to -85 dBm0	As with receive level	Psophometric weighting
				Unweighted: -20 to -80 dBm0		0.2 to 4 kHz
Total distortion (incl. quantizing distortion) BN 822/01 and BN 822/02	MUX MUX-S MUX-R	Noise 350 to 550 Hz	0 to -60 dBm0	0 to -60 dBm0	0 to 40.0 dB	Signal 350 to 550 Hz
		Sinusoidal 421 Hz	+10 to -60 dBm0	+10 to -60 dBm0		Distortion 815 to 3330 Hz (B _{ref} = 3100 Hz)
Total distortion (incl. quantizing distortion) BN 822/03	MUX MUX-S MUX-R	Sinusoidal 856 Hz	+10 to -60 dBm0	+10 to -60 dBm0	Weighted: 0 to 43.0 dB Unweighted: 0 to 40.0 dB	Distortion psophometric weighting or unweighted
Crosstalk	MUX MUX-S MUX-R	814 Hz	0 dBm0	-20 to -85 dBm0	As with receive level	Selective
Return loss	Send and receive channels	0.2 to 3.97 kHz	-10 dBm0	+10 to -60 dBm0	0 to 40.0 dB	0.2 to 4 kHz
Signal balance ratio		0.2 to 3.97 kHz	0 dBm0	+10 to -60 dBm0	0 to 56.0 dB	0.2 to 4 kHz
Out-of-band signals	MUX	Sender OFF		0 to -60 dBm0	As with receive level	4.6 to 72 kHz
		4.6 to 20.2 kHz	0 dBm0	0 to -60 dBm0	As with receive level	0.2 to 4 kHz
		0.2 to 3.4 kHz	0 dBm0	0 to -60 dBm0	As with receive level	4.6 to 72 kHz

Measurement mode	Send frequency	Display of result	Further information
Signalling distortion (available option)	10 Hz (20 Hz) rectangular	±10 ms resolution 0.1 ms	Measuring method: Measure the mark-space ratio deviation of a 10 Hz or 20 Hz rectangular signal during 1 second. Display of deviation in ms.
	Specimen: KZU		
PDG-3 and PDA-3 manual	Analog sender OFF	Analog receiver OFF	The PDG-3 and PDA-3 are manually adjustable

MUX = Multiplexer (send and receive sides)
 MUX-S = Send side of multiplexer, measurement with PCM-3 and Digital Signal Analyzer PDA-3
 MUX-R = Receive side of multiplexer, measurement with PCM-3 and Digital Signal Generator PDG-3
 KZU = Signalling character signal converter, measurement with additional device BN 822/00.03
 The measurement bridge for return loss and signal-balance-ratio is contained in the MU-3 Test Point Scanner

varied for a specified measurement mode (directly through the data entry or by programmed store).

The settings of the receive section of the PCM-3 are given invariably for each measurement mode. The 5th column shows the range for the receive level, the next column for the test result. Within the indicator range the results are compared by the instrument with stored tolerance limits if necessary. The last column shows the receive filter effective in each case. In the speech channel it will measure either unweighted (0.2 to 4 kHz) or psophometrically weighted (according to CCITT - Recommendation P. 53). Selective measurements are made with a frequency of 814 Hz. Receive filters with pass-bands from 350 to 550 Hz and 815 to 3330 Hz are used for measurement of noise signals. For out-of-band measurements the receive band amounts to 4.6 to 72 kHz. The attenuation curve of the filter is given in Section 1.7 of the Specifications.

2.4.2. Explanation of particular measurement modes

2.4.2.1. Overall loss

In the "Overall loss" mode, the image attenuation under real operational conditions is measured with the PCM-3. This holds for power level calibration (dBm0) and for voltage level calibration (dB0).

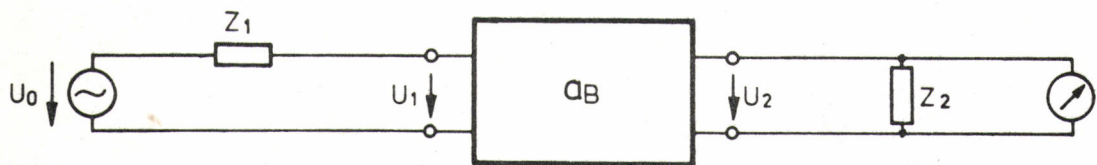

Fig. 2-11 Image attenuation

If the input impedance [19] of the receive section is switched to 10 k Ω , the PCM-3 calculates with reference to a 600 Ω impedance. In this case, the test object must be terminated externally with a resistance $Z_2' = \frac{10 \text{ k}\Omega \times Z_2}{10 \text{ k}\Omega - Z_2}$.

Thus $Z_2 = Z_2' \parallel 10 \text{ k}\Omega$, therefore, for example, for

$Z_2' = 638 \Omega$ we find $Z_2 = 638 \Omega \parallel 10 \text{ k}\Omega = 600 \Omega$.

In measurements with 10 k Ω input impedance the relative level [18] of the receive section must be increased by + 1.5 dB for $Z = 850 \Omega$ and by + 1.8 dB for $Z = 900 \Omega$.

2.4.2.2. Attenuation/frequency distortion

The attenuation/frequency distortion (frequency characteristic of the overall loss) will be measured with reference to the value at 814 Hz.

The full measuring range of ± 6.00 dB is only available, when the overall loss at 814 Hz lies within a range of ± 3 dB.

2.4.2.3. Variation of gain with input level

The variation of gain with input level is measured with reference to the value at - 10 dBm0.

The full measuring range of ± 6.00 dB is only available, when the overall loss at - 10 dBm0 lies in a range of ± 3 dB.

2.4.2.4. Crosstalk

In this measurement mode the interchannel crosstalk can be measured (single measurement Nos. 70, 72 and 74). Furthermore the go-to-return crosstalk in own channel can be measured with two multiplex equipments back-to-back (single measurement Nos.71). On the single measurements Nos. 73 (MUX-S) and 75 (MUX-R) a selective level measurement is made in own channel.

2.4.2.5. Impedance balance ratio

The two-pole impedance balance ratio is measured.

The test circuit contained in the Test Point Scanner MU-3 complies with CCITT-Recommendation O.121. Further details are to be found in the description and operating manual for the MU-3.

2.4.3. Measurement mode number

On the front panel of the PCM-3 is printed a table of measurement modes 10 . To each measurement mode there is a group of 10 measurement mode numbers, for example, overall loss 20 ... 29. Within the group of ten are figures 0 to 5 with single measurements and figures 6 to 9 with block measurements (see sections 2.4.4. and 2.4.5.)

Over and above these, the numbers corresponding to the test objects are further sub-divided according to the following system:

	Measurement mode number	Test object	Required PCM digital unit
Single measurements (blue numbers)	X0, X1	MUX	-
	X2, X3	MUX-S	PDA-3
	X4, X5	MUX-R	PDG-3
Block measurements	X6 ... X9	depends on programming	

This system holds for the measurement modes with numbers 10 to 79. In the Section 1.4 of the specifications all the measurement mode numbers and the appropriate measurement modes and parameters are set out.

2.4.4. Single measurement and incremental step measurement

In a single measurement only one measuring point is considered. The send parameters level and/or frequency can be freely selected according to measurement mode. Tolerance values can not be entered.

Measuring sequences may be set-up by means of increasing the generator frequency in steps (incrementing). The development of steps also applies to the generator level.

In single measurement it is necessary to switch by hand a Test Point Scanner MU-3 which is connected.

The single measurements are designated on the PCM-3 front panel in blue mode numbers.

2.4.5. Block measurement and measuring program

A block measurement consists of a sequence of single measurements.

The send parameters for each measuring point are filed in read-only memories.

Furthermore tolerance values with which the measured result is compared are stored. The data stored in the production dept. correspond to individual customers desires or to standard programs. The measuring points are referred to particularly critical levels or frequencies which are characteristic for the response curve.

A Test Point Scanner MU-3 which has been connected must be switched by hand to the channel desired in the case of block measurements.

A measuring program, which can run automatically consists of a sequence of block measurements. In this case the MU-3 scans through within each measurement mode all the telephone channels to be investigated (that is, once they have been pre-selected).

The measurement mode numbers for block measurements or program as the case may be, are clearly seen on the test mode table **10** on the front panel of the PCM-3. The previously programmed data can be drawn from the separate documentation on the measuring parameters.

2.5. Data entry

The keyboard **13** is used for entry of data, that is, the measurement mode number and send parameters, and for release or stop of the measuring run. After pressing the release knob **14** the keyboard can be swung into a tilt position convenient for operation.

The following keys are located near the numerical, decimal point and sign keys:

M	=	Measurement mode
L	=	Level
F	=	Frequency
Δ	=	Delta for incremental step
E	=	"Enter" as end of each entry of values
S	=	Start for release of measurement or sequence of measurements
H	=	Halt for interruption of a measuring sequence.

Basically each figure entered must be completed with the Enter key **E** .

After a power interruption of the Automatic Measuring Set PCM-3 data have to be re-entered.

2.5.1. Entry of a single measurement

Before data entry the measuring sequence switch **6** should be set to one of the blue engraved positions for single measurements "1x" or "REP." The position "1x" is for a one-shot measurement while in "REP." position the measurement will be constantly repeated (for example for alignment procedures or in setting-up an incrementing process). In table **10** the lamp "SINGLE" measurement comes on.

2.5.1.1. Selection of measurement mode

- Press measurement mode key **M** and enter the two digit measurement mode numbers. Check the mode number appearing in the display **2** . A previously entered or mistakenly entered measurement mode is thus simply overwritten.
- Press enter key **E** ; the measurement mode is acknowledged in the display **2** . If the mode is not possible, the display then indicates "00".

Figure 2-12 shows a summary of all single measurement modes in table form.

This table is also contained in the abbreviated operating instructions in drawer B of the PCM-3.

Measurement modes (conform with CCITT-Rec. G.712)	Measurement via	Free parameter	Meas. Mode No.
Level with sinusoidal signal Receive range, 200 Hz to 4 kHz	MUX	L F	10
	MUX-S	L F	12
	MUX-R	L F	14
Level with noise signal Receive range, 350 to 550 Hz	MUX	L	11
	MUX-S	L	13
	MUX-R	L	15
Overall loss at fixed level at 814 Hz and -10 dBm0 Receive range, 200 Hz to 4 kHz	MUX		20
	MUX-S		22
	MUX-R		24
Overall loss at any chosen level at 814 Hz Receive range, 200 Hz to 4 kHz	MUX	L	21
	MUX-S	L	23
	MUX-R	L	25

Fig. 2-12 a Single measurement modes

Measurement modes (conform with CCITT-Rec. G.712)	Measurement via	Free parameter	Meas. Mode No.
Attenuation/Freq. distortion at -10 dBm0 referred to the value at 814 Hz Receive range, 200 Hz to 4 kHz	MUX	<input type="checkbox"/> F	30
	MUX-S	<input type="checkbox"/> F	32
	MUX-R	<input type="checkbox"/> F	34
Attenuation/Freq. distortion at any chosen level referred to the value at 814 Hz Receive range, 200 Hz to 4 kHz	MUX	<input type="checkbox"/> L <input type="checkbox"/> F	31
	MUX-S	<input type="checkbox"/> L <input type="checkbox"/> F	33
	MUX-R	<input type="checkbox"/> L <input type="checkbox"/> F	35
Variation of gain with input level for sinusoidal signal at 814 Hz referred to -10 dBm0 Receive range, selective	MUX	<input type="checkbox"/> L	40
	MUX-S	<input type="checkbox"/> L	42
	MUX-R	<input type="checkbox"/> L	44
Variation of gain with input level referred to -10 dBm0 with noise signal 350 to 550 Hz at <-10 dBm0 with 814 Hz sinus. signal at ≥-10 dBm0 Receive range with sinusoidal signal: selective	MUX	<input type="checkbox"/> L	41
	MUX-S	<input type="checkbox"/> L	43
	MUX-R	<input type="checkbox"/> L	45
Idle channel noise psophometric weighting	MUX		50
	MUX-S		52
	MUX-R		54
Idle channel noise wideband: 200 Hz to 4 kHz	MUX		51
	MUX-S		53
	MUX-R		55
Version BN 822/01 or /02	Total distortion with noise signal (incl. quantizing distortion) noise, 350 to 550 Hz Receive range 815 to 3330 Hz $\Delta f_{ref} = 3100$ Hz	<input type="checkbox"/> L	60
		<input type="checkbox"/> L	62
		<input type="checkbox"/> L	64
	Total distortion with sinusoidal signal (incl. quantizing distortion) sinusoidal signal: 421 Hz Receive range 815 to 3330 Hz $\Delta f_{ref} = 3100$ Hz	<input type="checkbox"/> L	61
		<input type="checkbox"/> L	63
		<input type="checkbox"/> L	65

Fig. 2-12 b Single measurement modes

Measurement modes (conform with CCITT-Rec. G.712)		Measurement via	Free parameter	Meas. Mode No.
Version BN 822/03	Total distortion with sinusoidal signal (incl. quantizing distortion) sinusoidal signal: 856 Hz Receive range: psoph. weighted	MUX	<input type="checkbox"/>	60
		MUX-S	<input type="checkbox"/>	62
		MUX-R	<input type="checkbox"/>	64
	Total distortion with sinusoidal signal (incl. quantizing distortion) sinusoidal signal: 856 Hz Receive range: wideband 200 Hz to 4 kHz; $\Delta f_{ref} = 3100$ Hz	MUX	<input type="checkbox"/>	61
		MUX-S	<input type="checkbox"/>	63
		MUX-R	<input type="checkbox"/>	65
Interchannel crosstalk at 0 dBm0 and 814 Hz Receive range, selective		MUX MUX-S MUX-R		70 72 74
Go-to-return crosstalk or level in own channel at 814 Hz Receive range, selective		MUX MUX-S MUX-R	<input type="checkbox"/> <input type="checkbox"/> <input type="checkbox"/>	71 73 75
Return loss send level: -10 dBm0 (possible in conjunction with MU-3)		Send ch. Rec. ch.	<input type="checkbox"/> <input type="checkbox"/>	80 81
Impedance balance ratio send level: 0 dBm0 (possible in conjunction with MU-3)		Send ch. Rec. ch.	<input type="checkbox"/> <input type="checkbox"/>	82 83
Out-of-band signals	Out-of-band noise 4.6 kHz to 72 kHz	MUX		90
	Discrimination against out-of-band input signals with 0 dBm0 Setting range: 200 Hz to 20.2 kHz Out-of-band frequency range 4.6 to 20.2 kHz Receive band: 200 Hz to 4 kHz	MUX	<input type="checkbox"/>	91
	Spurious out-of-band signals at the channel output Setting range: 200 Hz to 20.2 kHz Test Frequency range: 300 Hz to 3.4 kHz Receive band: 4.6 to 72 kHz	MUX	<input type="checkbox"/>	92
Signalling distortion (available option) Test signal: rectangular at 10 Hz or 20 Hz repetition rate Measuring range: ± 10 ms		Output a Output b		93 94
PDG-3 and PDA-3 in manual operation				95

Fig. 2-12 c Single measurement modes

The measurement mode numbers for measurements via MUX-S or MUX-R as the case may be, can only be selected, if the Digital Signal Analyzer PDA-3 or the Digital Signal Generator PDG-3 is connected to the PCM-3.

2.5.1.2. Entry of send parameters

If the send parameters of level and/or frequency can be selected in the case of a mode entered, the diode lamp near the key **L** or **E** lights up.

- For entry of send level press key **L** and enter the level expressed in dBm0 (i.e. dBm reduced to dBm0). The input entry range extends over the preferred range of the relative level and for $Z_{out} = 600 \Omega$:
for noise at least from 0.0 to - 60.0 dBm0,
for sinusoidal signal at least from + 10.0 to - 60.0 dBm0.
Minus sign and decimal point must be entered if necessary. The value entered appears as a check in the display **3**.
- Press the Enter key **E**; the value of level is acknowledged in display **3**.
If the range of input entry is exceeded, the instrument and the display take up the next value possible. In this case an arrow before the value of level signals that the instrument is at the upper (\uparrow) or lower (\downarrow) end of its limits.
- Press the key **F** to enter frequency and key in send frequency in kHz. The frequency range extends from 0.200 kHz to 3.97 kHz or in the case of measurement mode "out-of-band signals" to 20.2 kHz. The frequency entered appears in display **3**.
- Press the Enter key **E**; the frequency value is acknowledged in display **3**.
On account of the internal send frequency generation, all sub-harmonics of the 8 kHz sampling frequency of PCM systems are avoided, and the send frequency can thus deviate by up to $\pm 2\%$ from the value entered.
Exceeding the input entry range causes the generator and the indicator to take up the next value possible. In this case an arrow before the frequency value signals that the instrument is on the upper end (\uparrow) or lower end (\downarrow) of its range.

If the send level and/or frequency are fixed in the meas. mode selected, then by pressing key **L** or key **F** resp. the stored values are indicated in the display **3**.

2.5.1.3. Run of single measurements

After the entry of measurement mode and send parameters (Enter key pressed) the send signal is available at output [17] of the PCM-3.

- Press the Start key [S]; the receive section of the PCM-3 begins the measurement. This condition is indicated by the diode lamp [1] "MEASURING". The instrument possibly carries out a premeasurement for calibration, then after that measures the receive level and brings out the measured result for display in window [4]. Thereupon the diode lamp [1] "MEASURING" goes out.
- In the position "1x" of the measuring sequence switch [6] the single measurement is now completed. By pressing the Start key [S] the measurement may be repeated as often as desired.
- In the uppermost position "REP." of the measuring sequence switch [6] the single measurements, including the pre-measurement are repeated continually. The repetition can be interrupted, if the Halt key [H] is pressed or if the switch [6] is set to the position "1x". After that the diode lamp [1] "PROG. HALT" lights up.

2.5.1.4. Measurement by incremental step

If the level and/or frequency can be selected as required in a single measurement, then a measurement series can be formed by incremental stepping.

- Set the measuring sequence switch [6] to "REP." or "1x"
- Enter the mode number with [M], press Enter key [E]
- If necessary enter the non-variable send parameter [L] or [F], press Enter key [E]
- Enter the initial send parameter to be varied:
Level key [L], key in highest or lowest value of level of the sequence of measurements, Press Enter key [E]
or
Frequency key [F], lowest test frequency, Enter key [E].

- Step spacing (increment) to be entered:
Press key **[Δ]** and Level key **[L]**, key in level step with correct sign before it in dB, Press key **[E]**
or
Press key **[Δ]** and Frequency key **[F]**, key in frequency step (only positive steps possible) in kHz, press Enter key **[E]**.

The following step spacings are possible:

Level step ΔL from ± 0.1 dB to ± 20.0 dB

Frequency step ΔF from $+ 0.01$ kHz to $+ 1.00$ kHz.

- Start and sequence of measurement:
If the switch **[6]** is set to the position "REP.", then the keys **[Δ]** and **[S]** are to be pressed. Thereupon the instrument measures point by point until it reaches the end of the range for the send level or for the send frequency and then stops. The measured result appears momentarily after each measuring step in the display **[4]**. For documentation a printer can be connected via an interface card. The varying send parameter can be observed in the display **[3]**.
By pressing the Halt key **[H]** or turning the switch **[6]** to "1x" the measuring sequence can be interrupted. The interruption will be indicated by the diode lamp **[1]** "PROG. HALT".
- If the switch **[6]** is in the position "1x" then the measurement is made at the first measuring point after start with key **[S]**. Each further measuring point is to be selected by pressing the keys **[Δ]** and **[S]**.
If the key **[S]** only is depressed, the incremental step is omitted and the instrument repeats the measurement of the point just set up. By pressing the keys **[Δ][S]** the instrument steps on to the next test point.

2.5.2. Entry of a block measurement

2.5.2.1. Selection of measurement mode

If the measuring sequence switch **[6]** is in one of the block measurement positions "SINGLE STEP" or "BLOCK", the diode lamp "BLOCK" lights up on the measurement mode table **[10]**. Thus the measurement mode can be selected:

- Press key **M**, key in measurement mode number.
As check the mode number appears in display **2**.
- Press Enter key **E**, the measurement mode will be acknowledged by display **2**. If the measurement mode selected is impossible, the display goes to "00".

The numbers for the block measurements and the pre-programmed constant send parameters as well as the stored tolerance limits can be drawn from the separate documentation on the measuring parameters.

2.5.2.2. Indication of the send parameters and tolerance limits

After entry of measurement mode those send parameters which vary in the block measurement from test point to test point can be read off in the display **3**.

Pressing the corresponding **L** or **F** key displays the non-variable parameter. Since the keyboard is not operative, as long as the instrument is "MEASURING", indication of the send parameters is only possible at "PROG. HALT" LED **1** or before pressing the key **S**.

There is also the possibility of displaying the stored tolerance limits.

If keys **A** and **L** are pressed (the tolerances are always level tolerances) display **4** shows first the upper (\uparrow) tolerance limit then after the next operation of the keys **A** and **L** the lower tolerance limit (\downarrow). According to the measurement mode, the tolerance limits are displayed without any unit symbol dB or dBm0, but as level difference (dB) or as absolute level reduced to dBm0. They belong to the measuring point, whose send parameters are shown in display **3**. For a measuring run in "Single steps" the tolerance values for each measuring point can be indicated.

2.5.2.3. Run of block measurements

After the entry of measurement mode (Enter key pressed) the send signal is present at the output **17** for the first measuring point.

- Press Start key **S**. While the PCM-3 carries out the measurement the diode lamp **1** "MEASURING" is on. As soon as the measured result comes up and appears in display **4** the diode lamp goes out again.

- In the "SINGLE STEP" position of the measuring sequence switch 6 the first measuring point of the block measurement is thus completed. Now the diode lamp 1 "PROG. HALT" lights. After again pressing the Start key S the set goes through measuring point No. 2 and so on. After the last measuring point (on pressing key S), the PCM-3 switches back to the first measuring point. Thus the block measurement can be repeated, for example, for another telephone channel.
 - In the position "BLOCK" of the measuring sequence switch 6 the PCM-3 carries out all single steps of the block measurement one after the other. After evaluation of the measured result for the last measuring point the measuring program goes back again to the measuring point No. 1 and stays there. The execution of the measuring run can be observed by means of the variable send parameter on the display 3 .
- By pressing the Halt key H the program execution can be interrupted. The diode lamp 1 "PROG. Halt" signals the interruption.

2.5.3. Entry of a measuring program

2.5.3.1. Assembly of the program

To select a program the measuring sequence switch 6 has to be set to one of the positions "Program with Halt after...". The diode lamp "PROGRAM" on the measurement mode table 10 will light. After that the block measurements scheduled for the measuring program can be entered in any suitable sequence (comp. also Section 2.5.2.1.).

- Press key M , enter 1st mode number, press key E
- Press key M , enter 2nd mode number, press key E

and so forth.

Since the program is executed with increasing measurement mode numbers, the lowest number is to be keyed in last or at the end of the program entry to be keyed once again (M , mode number, E).

Each block measurement entered will be acknowledged after pressing the enter key, in the mode display 2 . At the same time the lamp lights opposite the measure-

ment mode number concerned in the measurement mode table [10]. The lighting lamps give a summary of the measurement modes allocated in the program.

2.5.3.2. Change of program, clear

If single or block measurements are occasionally carried out after the entry of a program (switch [6], data entry [13]), the program selected remains stored in the instrument. On switching the measuring sequence switch [6] back to "Program" the diode lamp panel again shows in [10] the mode numbers of the program. Solely after a power interruption of the PCM-3 is the program information lost.

A selected program can be extended each time by the entry of further measurement modes. To clear a measurement mode erroneously entered or no longer needed, select this mode: key [M], mode number key, key [E]; mode indicated in display [2]. If now the clear key [12] is brought in position "M", the mode shown in display [2] vanishes out of the program. At the same time the diode lamp for this mode in the mode table [10] goes out.

In the position "all" of the clear key [12] the complete measuring program, that is all the selected measurement modes selected, is cleared. This is also the case during a measurement in progress, or also if the measuring sequence switch [6] is in one of the positions for single measurement or block measurement.

2.5.3.3. Program configuration and execution

As already mentioned a measuring program consists of a sequence of block measurements. If the PCM-3 is working together with a Test Point Scanner MU-3 the measurements can be made on all channels selected by the MU-3.

It is clear from Fig. 2-13, that the complete program (complete cycle) is formed from individual channel cycles. In a channel cycle a measurement mode (block), runs through all the channels selected by the MU-3. The block itself is composed of several single steps. Each single measurement step possibly entails ultimately several initial adjustments, measurements, calculator operations and output functions in the PCM-3 instrument.

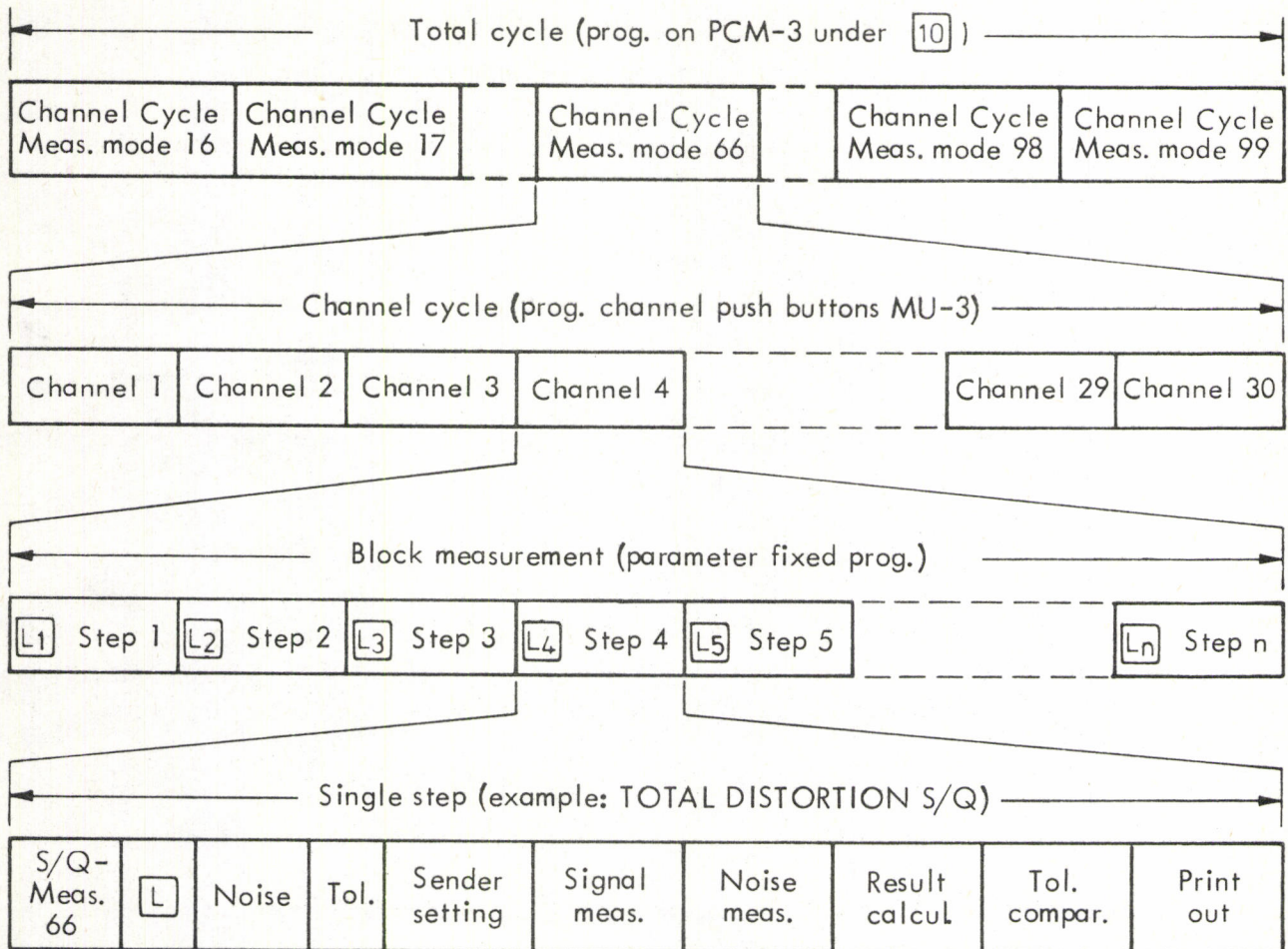

Fig. 2-13 Program configuration and possibilities of measuring run (Automatic Measuring Set PCM-3 with Test Point Scanner MU-3)

With switch 6, different types of program execution can be selected (comp. Fig. 2-13):

- "Total cycle"

In this switch position the PCM-3 begins with the measurement mode shown in display 2 after pressing Start key S. All measuring points in this mode (block) are measured in sequence. When the Test Point Scanner MU-3 is used, this mode is repeated for the next and all subsequent channels selected (channel cycle). Following on this the PCM-3 goes on to the next measurement mode. This second block also covers all channels in turn, likewise the third and so forth.

After the last measuring point in the program, therefore at the end of the total cycle the PCM-3 goes back again to the starting point and remains there. Once more the total cycle can be run by pressing key **S**. A program interruption is possible by using the Halt key **H**; then the diode lamp **1** "PROG. HALT" lights. To continue the measurement the Start key **S** must again be pressed.

- "Channel cycle"

When the MU-3 Test Point Scanner is connected the PCM-3 goes through the first measurement mode on all selected channels, after pressing the Start key **S**, and stops after the last channel. The diode lamp **1** "PROG. HALT" lights up.

After a new start the next measuring mode is executed as a channel cycle, and so forth. After the last measurement mode the diode lamp **1** "PROG. HALT" remains unlit.

Without the Test Point Scanner MU-3 all the measurement modes follow one another in turn. The instrument only stops after the last measurement mode. In this case there is no difference from the position "Total cycle" of switch **6**.

- "Block"

After the Start key **S** has been pressed, the measurement mode shown in the display **2** is worked through as a block. After the last measuring point of this block the instrument interrupts the measurement and the lamp **1** "PROG. HALT" lights up. The next entered mode number appears in measurement mode display **2** when using the set without MU-3.

The second block measurement begins after the Start key **S** is pressed. If the last measurement mode ends in this way, the PCM-3 returns to the starting point of the program. Since the complete measurement cycle is now concluded, the lamp **1** "PROG. HALT" remains unlit.

With the Test Point Scanner MU-3 connected, it steps on to the next channel after each program halt. After the last channel there follows the next measurement mode, which can be released again with the Start key **S** for each channel.

- "Single step"

In this position of the switch pressing the Start key only releases one step. After that the PCM-3 stops and lamp "PROG. HALT" lights up. The sequence of steps is the same as with the automatically running total cycle, that is block for block and with MU-3 connected through all channels in each case. After the last single-step of the last block the program jumps back to the starting point and the lamp "PROG. HALT" remains unlit.

- "Step repetition"

With this type of execution the single step to be measured is carried out after pressing Start key (measurement mode in display , send parameters in display). At the end of the measurement the lamp "PROG. HALT" lights up. By again making the key stroke Start the same measuring step can be repeated as often as desired.

The switch enables the measuring program to be run as complete or with programmed stops. In the later case each program part is released with the pressing of Start key . A partial program can also be selected directly and picked up for measurement purposes independently of the complete program.

If only one specified measurement mode is to be measured over all channels, for example, the mode required is to be selected in the "CHAN. CYCLE" position of switch (key , mode number, key and start the measurement process with key).

If a single mode for only one channel is needed, the switch must be in the "BLOCK" position of the program range. The measurement mode is to be selected on the PCM-3 and the required channel by means of a push-button on MU-3. The same measurement can also be carried out as a "block measurement" (switch in position "BLOCK" of the block meas. range).

Within a selected block it is possible to execute a run in single steps, if the switch is in position "Program with Halt after Single Step". In this way, for example, only the measured results of interest can be recorded on an attached printer by manual release (push-button). For the individual measuring points stored values of send parameters and tolerance limits can be monitored (see Section 2.5.2.2.).

If an alignment at a test point is foreseen, these setting positions are as follow: Switch [6] on "Program with halt after single step"; key [M], measurement mode number, key [E]; set channel on the MU-3 manually; press Start key [S] as often as necessary till the test point is reached. Then set switch [6] to "STEP REP." and repeat the measuring step during the alignment by key stroke [S]. Frequently the alignment is necessitated by a transgression of tolerance limits. If the switch [7] is at "Halt if out of tolerance" on the execution of a total cycle, the program is interrupted when an out-of-tolerance condition is reached. Set the switch [6] to "STEP REP." for the alignment, so that the measured result may be shown again by pressing the Start key [S]. If the measurement at this measuring point is to be automatically and continually repeated, then set the switch [6] on "Single measurement REP.". Now the single measurement corresponding to the block measurement concerned is to be selected, and the send parameter or parameters, as the case may be, for the measuring point are to be entered. After release with key [S] the measurement is repeated, as long as it is interrupted by the Halt key [H].

2.6. Measurement sequence conditions

The execution of a test run depends on the positions of three slide switches [6], [7] and [9].

2.6.1. Measurement run switch [6]

This switch should be set to one of the positions required before entry of data, Single measurement, Block measurement or Program. After release with Start key [S] the measurement is executed according to the position of switch [6] for example, in single steps, as a block, channel cycle or as a total program.

The correlation between the setting of measurement run switch [6] and the measurement mode [10] and the data entry [13] is described in Section 2.5.

2.6.2. Halt switch [7]

The measurement run of the PCM-3 is interrupted in the position "Halt if out of tolerance" of the switch [7], when the measured result goes beyond the programmed tolerance limits. The interrupt is signalled by lamp [1] "PROG. HALT". In single measurements, the halt switch is inoperative, since in this case comparison with tolerance is not carried out.

In the position "NO HALT" the measurement proceeds in the out-of-tolerance condition. If switch 9 is at the same time in position "Print out OFF", the red warning lamp at "NO HALT" lights. The out-of-tolerance result does not bring about a halt in the execution of the measurement run and further is not printed out in the test records. The out-of-tolerance condition can be observed however by the "out of tolerance" lamp near display 4 .

Even if no printer is connected to the PCM-3, the "no halt" lamp 7 operates in the manner described above.

2.6.3. Print release

With the slide switch 9 the type of printed record can be specified. The PCM-3 must be equipped with the printer interface plug-in card BN 822/00.07, whose data output is connected to the printer.

In the switch position "Print-out if out of tolerance" only those results, which exceed the stored tolerances, will be printed.

In the position "Print-out permanent" every measured result is printed, so that a record in the form of a complete tabulation of measured values exists (for example for acceptance tests). A possible out-of-tolerance value is noted on the recording by the symbol * and/or red printing.

If switch 9 is in the "OUT" position, the connected printer receives no data and no print command.

The printer can be released by hand by pressing key 8 "Manual". The requisite condition here is that, on the PCM-3 the measurement, the sequence of measurements or the program is now completed or the test run has reached a program halt, lamp 1 .

The printed record begins independently of the release with a heading for each measurement mode which contains in addition to the mode number, the fixed parameters (level, frequency, channel). The measured result printed out is associated with the variable parameter if required.

Particular details of the print program of the PCM-3 and on the format of recording may be taken from Section 2.9.1. "Printer interface".

2.7. Indicator area

All the indications, giving information as to the operating condition of Automatic Measuring Set PCM-3, can be obtained from the indicator units in the dark grey area on the upper part of the front panel. The digital displays as well as the lamp "MEASURING", function also under computer control and provide a check on the measurement run execution.

2.7.1. Measurement run information

The lamp "MEASURING" lights up, when the PCM-3 is carrying out a measuring step. This condition lasts from the pressing of the Start key until the measured result is to hand. While the result is being displayed and if necessary, while the printer is recording it, the lamp goes out. It lights up again, when the next measuring step is released.

As long as the PCM-3 is measuring, no new data can be entered via the keyboard . The keyboard is free for entry of data, only after the Halt key has been pressed for example.

The lamp "PROG. HALT" indicates that a sequence of measurements is interrupted between two measurement steps. This is the case, if either:

- the key has been depressed in data entry
- the measurement run switch is in the position "Single step" in a block measurement or in a program, in one of the positions "Single step", "Block" or "Channel cycle" (with Test Point Scanner MU-3)
- the measurement run switch has been changed during the measurement run from the program position "Total cycle" or in block measurement from the position "Block" to one of the above named positions, or in single measurement from "REP." to "1 x" or
- the measured value has exceeded the tolerance limits and the Halt switch is on "Halt if out of tolerance" in this case.

If the lamp "PROG. HALT" lights up, the keyboard is free for data entry. Both lamps are out, as long as the instrument is in the rest condition, that is, before a measurement is started or at the conclusion of the measurement. But also between two measurement steps the test result is displayed and is printed out if necessary, neither lamp lights.

2.7.2. Measurement mode display 2

After switching on the instrument or after power interruption, the figures 00 appear in the two-digit liquid crystal display . The entry of the desired measurement mode number is indicated in the display 2 and acknowledged after pressing the ENTER key. If the display shows 00, an impossible mode has been entered or an incorrect position of the test run switch 6 selected.

In the execution of a measuring program the measurement modes at each time can be followed in the display 2 .

2.7.3. Send parameter display 3

The three-digit liquid crystal display serves as indicator of the send parameters with appropriate unit (dBm0, dB0, dB, kHz) as well as additional symbols.

For single measurements the input entry of send parameters freely chosen can be observed in the display 3 . A fixed send level or frequency given beforehand is indicated on pressing the key L or the key F concerned. The entry of incremental steps in level or in frequency is likewise visible. In this case after the start of a sequence of measurements the variable (stepping) send parameter is indicated with its value at each time.

In block measurements or programs the variable send parameter appears in display 3 . The other fixed parameter can be displayed before release of the measurement by pressing the appropriate key L or F as the case may be. During the measuring run, the variable setting is always displayed in display 3 , so that the individual measurement steps can be followed through.

2.7.3.1. Send level indicator

The level is displayed together with the unit:

- dBm0 : absolute power level expressed in "power dBm units"
- dB0 : absolute voltage level expressed in "voltage dB units"
- dB : step in level (increment)

The level indicator resolution is 0.1 dB

When the PCM-3 generator is blanked (e.g. for measuring noise on a direct channel) only the unit, dBm0 or dB0 appears in display without any figures in front.

For the level at the generator output the relation below is valid:

absolute level (dBm, dB) = level expressed in dBm0 or dB0 + relative level (dBr)

that is, level at socket = level display + relative level setting

2.7.3.2. Send frequency indicator

The send frequency is indicated with the kHz unit. Due to the way in which the frequencies are generated only certain frequencies of the spectrum are possible.

On this account the frequency entered is rounded off to the next possible lock frequency of the spectrum.

The frequency resolution is for frequencies:

from 200 Hz to < 1 kHz : 0.001 kHz

from 1 kHz to < 10 kHz : 0.01 kHz

from 10 kHz to 20.2 kHz : 0.1 kHz

With pseudo-random noise signals in the frequency range 350 Hz to 550 Hz in the display there appears "... kHz"

If the PCM-3 generator is blanked, only the kHz unit appears without any figures in front.

Frequency steps (increments) can be entered with the same frequency resolution.

The resulting send frequencies are likewise locked to the frequency spectrum.

2.7.3.3. Additional symbols

If there is entry of a send parameter (including incremental step entry) exceeding the possible range of level or frequency, the instrument takes the value at the limit of the range. This value appears also - together with an arrow - on the send parameter display .

This means:

↑ : too large a parameter entered. The display shows the maximum possible value

↓ : too small a parameter entered. The display shows the minimum value possible.

The symbol "... kHz" appears for the pseudo-random noise signal.

2.7.4. Measured result display 4

At the end of a measurement process the measured result is indicated in the display 4. If the measured value exceeds the stored tolerance limit the "Out of tolerance" red warning lamp comes on. In the measurement modes: Level, Idle Channel Noise, Cross-talk and Out-of-band signals the PCM-3 indicates the level expressed in dBm0 or dB0 with a resolution of 0.1 dB. For power levels the unit dBm0 appears in the liquid crystal display 4 and for voltage level calibration dB0. For the receiver input level 20 the following relation holds:

absolute level (dBm, dB) = level expressed in dBm0 or dB0 + relative level (dBr)
that is, level at socket 20 = level display 4 + relative level setting 18

In overall loss or variation of gain measurements the resolution for the level difference is increased to 0.01 dB. The indicator range is then ± 6.00 dB with respect to a reference value.

In the case of total distortion measurement, the signal-to-noise level ratio is indicated in dB. The indication of return loss and impedance balance ratio is likewise made in dB. The resolution is 0.1 dB in each case.

Signalling distortion can be measured with the optional measuring device BN 822/00.03. Results are displayed in the range ± 10 ms with a resolution of 0.1 ms.

The unit "ms" does not appear in display 4.

The additional symbols in the measured result display 4 signify:

↑ : the measured value is larger than the displayed value

↓ : the measured value is smaller than the displayed value

↑: flashing double arrow : send parameter missing or calibration step not possible (for example, test circuit broken) or attenuator setting not possible.

The symbol "...", appears if the Z-value in the signalling distortion measurement lies outside the tolerance. At the same time the "out of tolerance" lamp comes on.

As described in the section 2.5.2.2. display [4] can indicate the stored tolerance values for block measurements (or for a program as the case may be). The numerical value is indicated without unit, so that it cannot be mistaken for a measured result.

2.8. Rear connections

2.8.1. A. C. voltage output [24]

The receive signal is available at the 3-pole carrier frequency socket [24], for observing by oscilloscope for example. This output is in the signal path of the receive section immediately before detection. The signal has therefore passed through the weighting filter selected according to the measurement mode.

The output impedance of the unbalanced a. c. output is 600 Ω . With a termination of 600 Ω the output level for measurements, which produce a reading within the measuring range (measured result display [4]): Series A : - 21 to - 1 dB, Series B and subsequent series - 15 to + 5 dB.

2.8.2. Receiver input [25]

This additional input is provided for connecting to the analog output of a Digital Signal Analyzer PDA-3. The input [25] is switched through in measurement modes for testing the send side of a PCM equipment under test (MUX-S) instead of the receiver input [20].

The input [25] is provided with a 3-pole carrier frequency socket and is balanced floating; the input impedance is 600 Ω .

2.9. Additional devices (Plug-in subassemblies)

The range of application of the PCM-3 basic instrument can be extended by plug-in subassemblies (see Section 5.2.2. Insertion of plug-in subassemblies). The printer interfaces BN 822/00.07 feeds measured results and print commands to a printer for recording. Alternatively an IEC-Bus interface BN 822/00.02 may be inserted in the same position for control of the PCM-3 by external computer. The BN 822/00.03 equipment is for synchronisation between two PCM-3 Automatic Measuring Sets for end-to-end measurements and measurement of signalling distortion. For the extension to the PA-3 Automatic Measuring System, the interface card BN 822/00.04 effects control of the PDA-3, PDG-3 and MU-3 units.

The position of the plug-in subassemblies can be seen in Fig. 2-2.

2.9.1. Printer interface

A printer can be attached with advantage of recording measured results, especially on long series of measurements and bulky test programs.

By means of the V. 24 (RS 232 C) interface BN 822/00.07 printers with such an interface can be connected to the PCM-3. There are many types of printers on the market with this interface. The following requirements must be met by a printer to be suitable for PCM-3:

- V. 24 (RS-232) interface with 25-pole Cannon plug (male)
- 80 or more characters per line
- ASCII code alpha-numeric 7 bit (or 8 bit with parity bit) capital letters (at least)
- Receive only version is sufficient, however, send and receive version can also be used
- Data transmission speed - one of the following:
150, 300, 600, 1200, 2400 bit/s
- Printing speed is according to the data transmission speed (approx. 1/10 of it)
- Parity bit included or not. If included: Even or odd

It is recommended to use a printer with a speed of 30 characters per second or more.

Below are the names of some manufacturers of printers meeting the above specification. The succession does not refer to any recommendation because it is up to the user to select the manufacturer and model also under the aspects of availability, reliability, service problems, etc.

If requested, a printer may also be purchased via Wandel & Goltermann.

Manufacturer	Model
Computer Devices, Inc.	Miniterm 1201
Digital Equipment	Decwriter LA 35, LA 36
Transtel Communications	Teleprinter
Trend Communications	Printer 800

V.24-Interface see also Section 5.2.9., page 5-11

ATTENUATION FREQ. DISTORTION/FREQUENZGANG DER RESTDAEMPUNG (37) TEST AA								

LEVEL/PEGEL DBM0 = -10.0								
CHNL KANL NO.	FREQ. FREQ. KHZ	RESULT ERGBNS DB	FREQ. FREQ. KHZ	RESULT ERGBNS DB	FREQ. FREQ. KHZ	RESULT ERGBNS DB	FREQ. FREQ. KHZ	RESULT ERGBNS DB
01	0.200	+ 0.02	0.300	+ 0.02*	0.401	+ 0.02*	0.500	+ 0.01
	0.601	+ 0.01	0.814	+ 0.00	1.010	+ 0.00	1.485	+ 0.00
	2.000	+ 0.00	2.500	+ 0.00	3.000	- 0.01	3.510	+ 0.00
	4.010	+ 0.01	5.430	+ 0.28	6.160	+ 4.16		
04	0.200	+ 0.02	0.300	+ 0.02*	0.401	+ 0.02*	0.500	+ 0.01
	0.601	+ 0.01	0.814	+ 0.00	1.010	+ 0.00	1.485	+ 0.00
	2.000	+ 0.00	2.500	+ 0.00	3.000	+ 0.00	3.510	+ 0.00
	4.010	+ 0.01	5.430	+ 0.28	6.160	+ 4.16		
VAR. OF GAIN WITH INPUT LEVEL/PEGELABHAENGIGKEIT DER VERSTAERKUNG (46) TEST AA								

SINE/SINUS								
FREQUENCY/FREQUENZ KHZ = 0.814								
CHNL KANL NO.	LEVEL PEGEL DBM0	RESULT ERGBNS DB	LEVEL PEGEL DBM0	RESULT ERGBNS DB	LEVEL PEGEL DBM0	RESULT ERGBNS DB	LEVEL PEGEL DBM0	RESULT ERGBNS DB
01	+10.0	+ 0.00	+ 0.0	+ 0.00	-10.0	+ 0.00	-11.0	+ 0.00
	-12.0	+ 0.01	-13.0	+ 0.01	-14.0	+ 0.00	-15.0	- 0.01
	-16.0	+ 0.00	-17.0	+ 0.00	-18.0	+ 0.00	-20.0	+ 0.00
	-30.0	+ 0.00	-40.0	- 0.01	-50.0	+ 0.00	-60.0	- 0.01
04	+10.0	+ 0.00	+ 0.0	+ 0.00	-10.0	+ 0.00	-11.0	- 0.01
	-12.0	+ 0.01	-13.0	+ 0.00	-14.0	+ 0.00	-15.0	- 0.01
	-16.0	- 0.01	-17.0	- 0.01	-18.0	+ 0.00	-20.0	- 0.01
	-30.0	+ 0.00	-40.0	- 0.01	-50.0	- 0.01	-60.0	- 0.01

Fig. 2-14 Examples of print-out format

In Fig. 2-14 two examples of print-out format are shown. The first record relates to a measurement of the attenuation/frequency distortion ("Meas. mode 37") with a send level of -10.0 dBm0. This distortion is measured in the channels 1 and 4. Out-of-tolerance values are marked by symbol * and/or by red printing. The other record pertains to the measurement of variation of gain with input level ("Meas. mode 46").

2.9.2. IEC-Bus-interface

The PCM-3 Automatic Measuring Set or the PA-3 Measuring System for example can be controlled by an external computer via the IEC-Bus-interface with international standard interface socket [31]. The computer takes over the matching of the test object (relative level, impedance), the data entry (measurement mode, send parameters), the control of the measuring sequence as well as the evaluation and storage of the measured data. A printer can be connected for example directly to the computer for documentation of the measured results.

Instead of a complete test record only out-of-tolerance measured results can be printed. The corresponding selector switch [9] is located on the lower left of the front of the PCM-3. The printer can be released in addition "MANUAL" with push-button [8]. Section 2.6.3. explains the print release.

The switch [5] on the PCM-3 is to be set in the position "Computer control" for this mode of operation. Then all controls of the Automatic Measuring Set are inoperative. The execution of the measuring run can be followed through on the digital displays [2], [3] and [4] and the lamp [1] "Measuring".

In the PA-3 Automatic Measuring System the instruments PDA-3, PDG-3 and MU-3 are likewise controlled through the basic PCM-3 instrument. Therefore only one IEC-Bus connection is required between the computer and PA-3. The allocation and layout of terminals on socket [31] as well as other details are to be obtained from the programming information.

2.9.3. End-to-end and signalling distortion measuring device

2.9.3.1. End-to-end measuring device

The plug-in subassembly BN 822/00.03 contains the necessary optional device for end-to-end measurement. For this purpose both the send side and receive side PCM-3 units must be fitted with this subassembly. The test set-up and instrument setting are described in section 2.3.2. Terminal allocation of connector [29] see figure 2-17.

The end-to-end device has a balanced generator output [29] with an output impedance of 600Ω . A pulsed sinusoidal a. c. voltage with a frequency of 1.97 kHz is used as send signal. The pulse length for the start and stepping commands is about 50 ms and for increment start command about 150 ms. The send level of the a. c. voltage is -17 dBm into a 600Ω load impedance.

This send signal is fed through an auxiliary channel from the controlling PCM-3 on the receive side to the send side PCM-3. There the control signals reach the receiver input [29] of the end-to-end device and are selectively measured. The input level range extends from -30 to +10 dBm; the maximum permissible level is +20 dBm. The input impedance is 600Ω .

2.9.3.2. Signalling distortion measuring device

A further facility of the plug-in subassembly BN 822/00.03 enables signalling distortion measurements to be made. For this purpose a 10 Hz or 20 Hz rectangular signal is fed to the object under test. On the receive side the distortion of the pulse duty ratio is measured digitally and averaged over 10 or 20 cycles as the case may be (measuring time 1 second) and the deviation indicated.

Not only loop measurements but also end-to-end measurements can be carried out provided that both PCM-3 are fitted with this measuring device. Using the Test Point Scanner MU-3 the signalling distortion can be measured on up to 30 channels. The test set-up can be seen in Fig. 2-15.

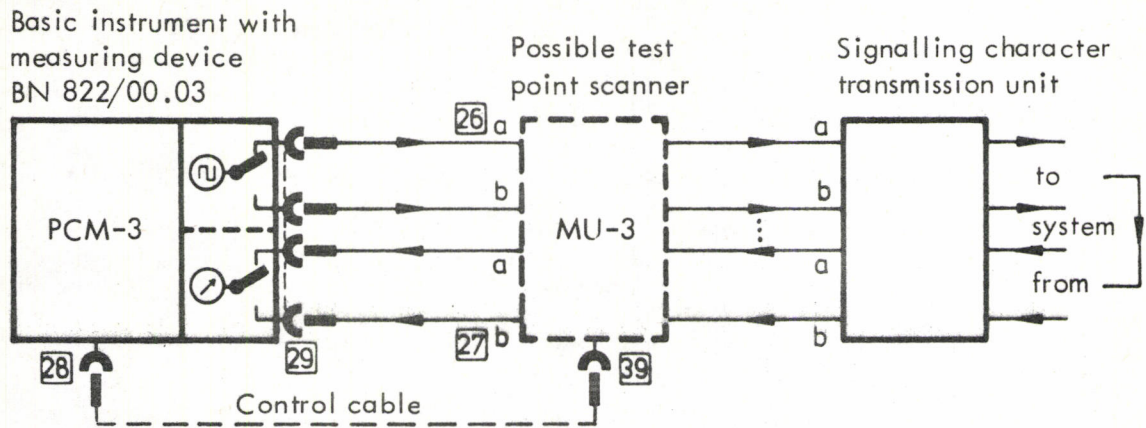

Fig. 2-15 Test Set-up for Signalling distortion measurement

There is the further possibility of measuring a signalling character unit as well as a multiplex equipment in one test run. For this two test point scanners are required in accordance with Fig. 2-16. The control signals from the PCM-3 can be looped through in the parallel connected remote control sockets [39] and [40] of the MU-3. The scanners can be programmed as "1. MU-3" and "2. MU-3" (internally in the MU-3 or through its additional control socket [38] : bridge from terminal 8 to 14 brings in "2. MU-3"). In all the "analog" block measurement modes the "1. MU-3" is controlled by the PCM-3 and in measurement modes 93, 94, 98 and 99 (signalling distortion measurement) the "2. MU-3" is controlled by the PCM-3. For this reason when only one MU-3 is connected, care should be taken, that this is so programmed.

The outputs and inputs (a1/a2 and b1/b2 respectively) of the signalling distortion measuring device are brought out to the 14-pole connector [29]. Fig. 2-17 shows the lay-out and allocation of the terminals.

Measurement mode numbers 93 and 94 are to be selected on the PCM-3 for single measurements. In mode 93 measurements are made on the a-wire (signal path for slow signalling character transmission) and in mode 94 they are made on the b-wire (signal path for fast signalling character transmission). Measurement modes 98 and 99 are provided for block measurements. In signalling distortion measurement the display [3] does not show any send parameters. By pressing Start key [S] the measuring process is released.

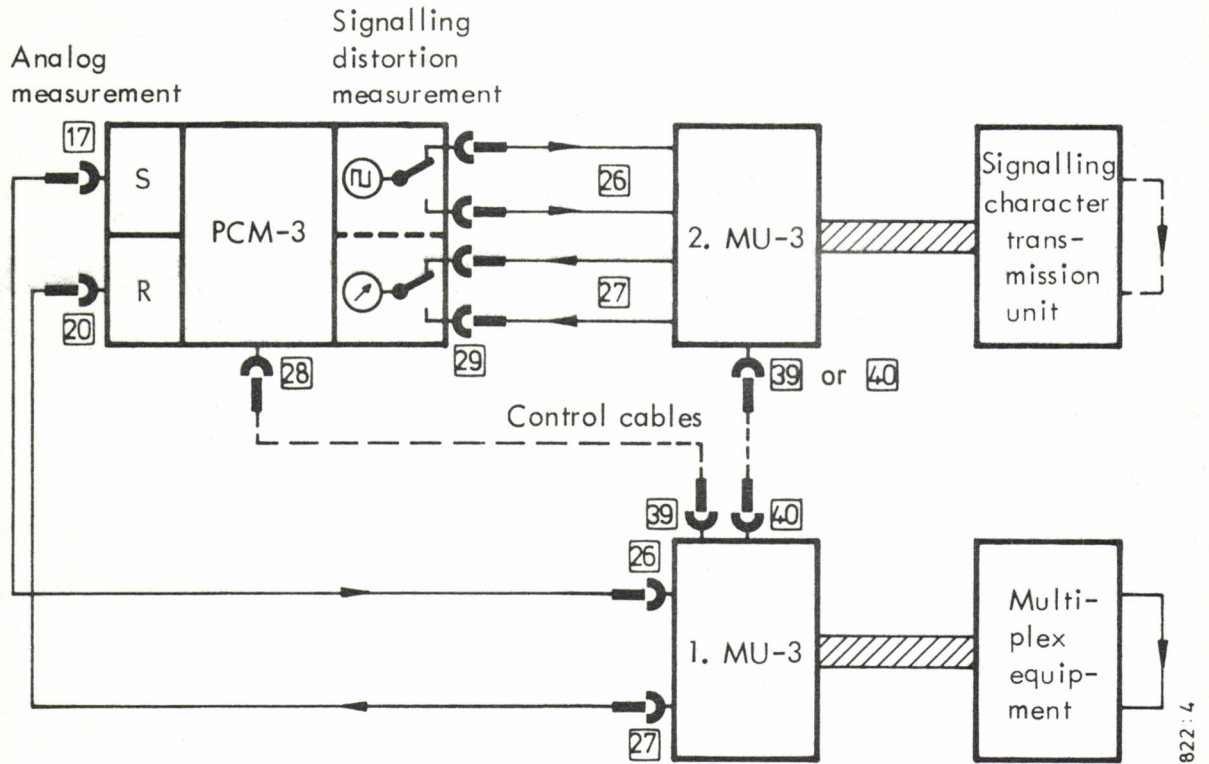

Fig. 2-16 Arrangement for analog measurement on a multiplex equipment and for measurement of signalling distortion on a signalling character unit

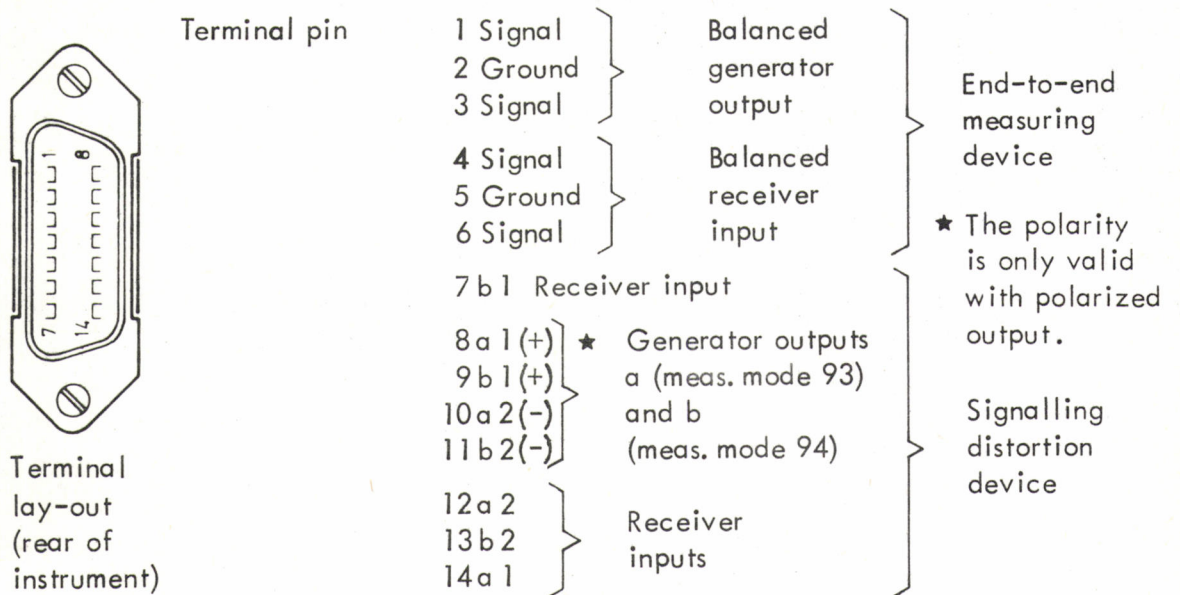

Fig. 2-17 Terminal allocation of socket 29 for end-to-end and signalling distortion measurements

The signalling character signal output is normally unpolarized. In order that with low current drain ($< 7 \text{ mA}$) during pulse duration the output impedance doesn't get too high, the polarized signalling output should be used by resoldering traps (see section 5.2.6.). In this case the polarity of the battery in the system under test must be considered.

The measured result is indicated in the display 4 of the PCM-3 as a numerical value without the unit "ms". The measuring range is $\pm 10 \text{ ms}$ with a resolution of indication of 0.1 ms . A positive signalling distortion indicates a lengthening of the duration of the pulse compared with the pause, a negative distortion a shortening of the pulse duration. The pulse duty cycle is weighted by the signalling receiver on account of the source impedance (switching function) at its input. With short or open-circuit impedances in the range of 300Ω to $20 \text{ k}\Omega$ the "out-of-tolerance" lamp lights and the decimal points "... " appear in display 4.

The signalling generator delivers a rectangular signal at the frequency of 10 Hz . The circuit can be resoldered, however, to give a frequency of 20 Hz . The duty cycle is normally 50% . By resoldering internally ratios of 40% and 60% can be obtained. The modification of the signalling character signal is described in section 5.2.6.

2.9.4. Interface for PDA-3, PDG-3, MU-3

The interface card BN 822/00.04 has three 14-pole remote control connectors for control of the following instruments by the PCM-3 :

Socket 26 PCM - Digital Signal Analyzer PDA-3

Socket 27 PCM - Digital Signal Generator PDG-3

Socket 28 Test Point Scanner MU-3

The control signals are presented in bit parallel and byte serial form. Terminal allocation can be seen in Fig. 2-18.

The special connecting cables K 337 are provided for connection to the instruments (each 60 cm long). If other cables are used, the observance of radio interference standards is not guaranteed.

The Test Point Scanner MU-3 has two parallel connected remote control connectors. If the measurement task requires this a second MU-3 may be controlled via the second connector.

Terminal
lay-out
(rear of
instrument)

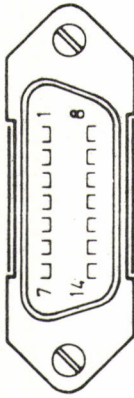

Sockets 26, 27 or 28 :

Terminal pin	
1	D 7
2	D 6
3	A 2 ⁰
4	A 2 ¹
5	A 2 ²
6	D 2
7	Ground
8	Select
9	D 1
10	D 0
11	D 5
12	D 4
13	D 3
14	Ground

Fig. 2-18 Terminal allocation of socket for remote control outputs

The PDA-3, PDG-3 and MU-3 units are connected to the PCM-3 by this interface card also for the external computer control of the PA-3 Automatic Measuring System. Data and control signals for all units are handled by an IEC-Bus-cable from the computer to the IEC-Bus-interface in the PCM-3 basic instrument.

3. TECHNICAL INSTRUCTIONS

3. TECHNICAL INSTRUCTIONS

3.1. Extension to the Automatic Measuring System PA-3

The range of application of the PCM-3 Automatic Measuring Set can be extended with additional instruments. Measured results can be recorded by attaching a printer. All measurements to be carried out sequentially on several telephone channels are simplified by means of the MU-3 Test Point Scanner. A further stage of extension consists of adding to these the digital signal instruments PDA-3 (Analyzer) and PDG-3 (Generator). This combination of instruments forms the PA-3 Automatic Measuring System. With it measurements can be made between the audio side (MUX) of PCM and FDM-systems or bays as well as measurements at PCM terminals from audio side to digital side (MUX-S) and vice versa (MUX-R).

3.1.1. Setting-up instruments and connecting cables

To obtain a comprehensive set-up and satisfactory cable connections it is necessary to position the instruments on one another as in Fig. 3-1. However, there is also the possibility of building up a 19-inch rack (see Section 5.2.7.)

The cabling on front and rear sides can be seen from the figures 3-1 and 3-2. If the Test Point Scanner MU-3 is equipped with the MUE-33 (unbalanced) Switching Unit instead of MUE-32 (balanced), take the corresponding cables to the coaxial sockets of PDA-3 and PDG-3. Care should be taken that all instruments are set to the correct a. c. line voltage before connecting a. c. mains.

3.1.2. Instrument adjustments

The operation and characteristics of the additional instruments are described in the respective operating manuals. Only basic adjustments are necessary however, for operation within the PA-3 Measuring System because all the important instrument functions are controlled from the PCM-3 basic instrument through an interface.

The printer obtains all commands and data from the data output 32 of the printer interface BN 822/00.07 inserted in the PCM-3.

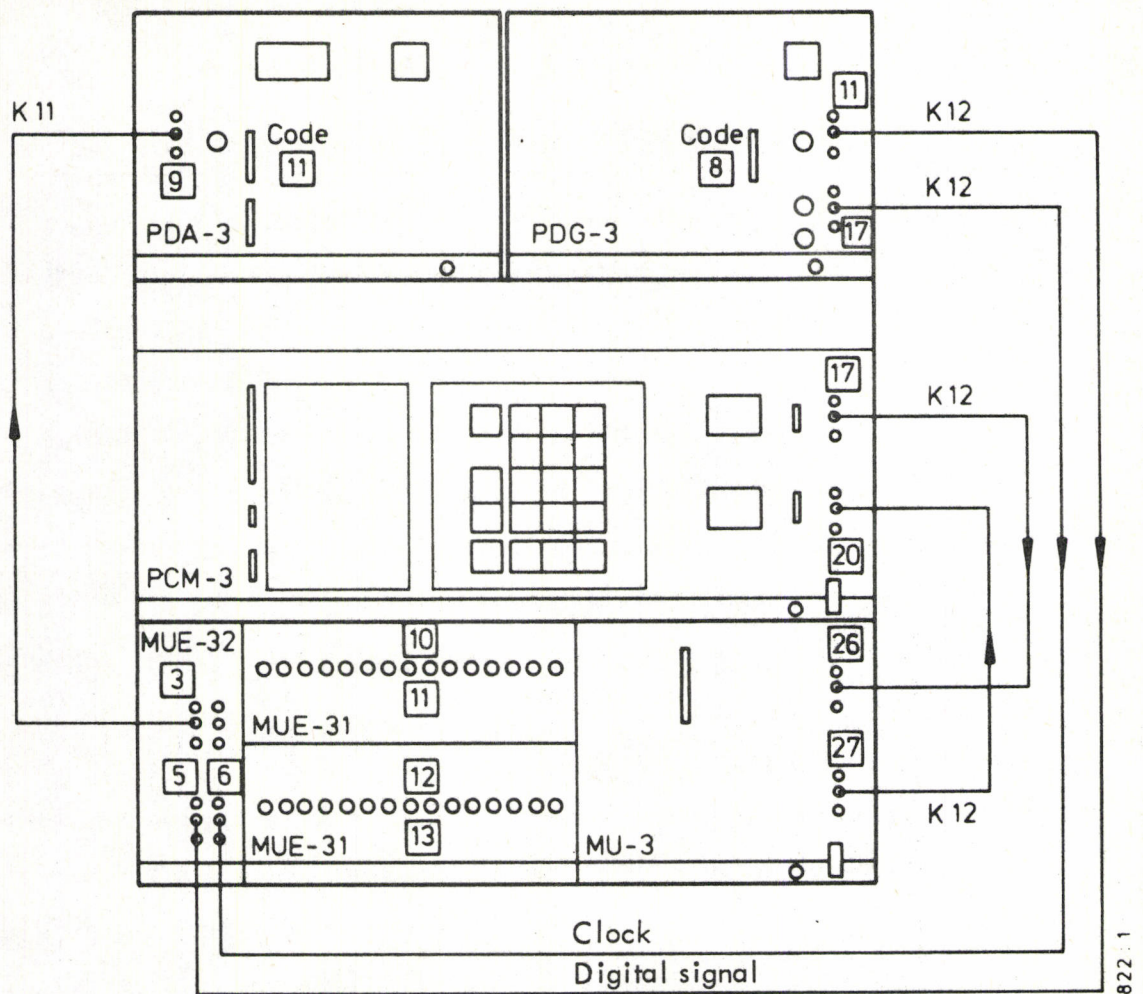

Fig. 3-1 Cable connections between the front sides of the instruments in the PA-3 Automatic Measuring System

Test and control cables (length) for PA-3

3-pole CF cable: 2 x K 11 (75 cm)
4 x K 12 (100 cm)

14-pole cable: 3 x K 337 (60 cm)
with special shielding

Adjustment on:

PDA-3 and PDG-3: Set code with slide-switch 11 or 8

MU-3: Select the channels to be measured with push-buttons 10 ... 13 .

The control of the PDA-3, PDG-3 and MU-3 units fitted with remote-control cards, is effected through the BN 822/00.04 interface card in the PCM-3.

Adjustments on the PDA-3 and PDG-3:

Select the code with slide-switch **11** on the PDA-3 and slide-switch **8** on the PDG-3. The telephone channel is automatically selected when using the MU-3, in accordance with the preselection on the MU-3. If the MU-3 is not available, the channel must be set on the PDA-3 by switch **8** and on the PDG-3 by switch **5**.

In the measurement mode 95 the PDA-3 and PDG-3 instruments can be manually operated; the control does not operate from the PCM-3. In this case moreover, the send and receive sections of the PCM-3 are switched off.

Adjustments on the MU-3:

The send (transmit) channels or receive channels in a channel cycle are selected on the push-buttons of the MUE-31 Switching Unit (s).

In single measurements and block measurements a specified channel is selected by pressing the appropriate channel push-button. To switch on to the next channel selected, press the "stepping" push-buttons **24** or **25**.

In a measuring program all the selected channels will be automatically tested. After the last channel cycle the program is ended.

In crosstalk measurements the assignment of send and receive channel must be preset on the MU-3. The switch **36** on the rear side of the MU-3 has three positions for this purpose:

$\neq n$, that is measure on all channels except the channel, on which the signal is actually sent.

$n + 1$, that is measure on the channel which follows next to the send channel in time.

$n \pm 1, \pm 2$, that is measure on the two channels coming before or after the send channel.

Adjustments on the PCM-3:

All technical characteristics of the PCM-3 are valid for operation within the PA-3 Automatic Measuring System. The necessary adjustments are already described in Chapter 2. OPERATION.

3.1.3. Measurement run and indication of results

Both the control and operation of the PA-3 Automatic Measuring System are effected through the PCM-3 instrument. Data entry, selection of measuring sequence, the display of the measurement mode [2], the send parameters [3] and measured result [4] are described in chapter 2. The accuracy of the indicated or printed measured results is given in Section 1.6. There the error limits of the digital signal instruments are considered in the case of measurements through MUX-S (with PDA-3) and through MUX-R (with PDG-3).

3.1.4. Computer control

The data communication between computer and measuring system is brought over the IEC-Bus-interface BN 822/00.02 in the PCM-3. This interface card is inserted in place of the printer interface (see Section 5.2.2. for fitting). A printer for recording of the measured results can be controlled directly from the computer.

Details of the IEC-Bus-interface and the computer control are to be obtained from the separate programming informations.

3.2. Characteristics of the Digital Signal Instruments PDA-3 and PDG-3

The automatic testing of a PCM primary multiplex terminal is possible with the PDA-3 Digital Signal Analyzer and PDG-3 Digital Signal Generator as complement to the PCM-3.

The two following sections set forth the most important instrument characteristics. Further particulars are to be found from the corresponding data sheets and operating manuals.

3.2.1. PCM Digital Signal Analyzer PDA-3

For the measurement at the send side, the PCM-3 sends a low distortion sinusoidal signal into one of the 30 channel inputs associated with the multiplex equipment. The PDA-3, after synchronizing to the PCM frame, extracts digital signals corresponding with the analog input signal. The PDA-3 is connected to the digital interface (e. g. between multiplexer and line terminal equipment). These aforementioned digital signals are displayed, at choice either positive or negative, as a maximum or minimum character signal.

The PDA-3, in itself an independent instrument, is equipped with an optional device the "Digital/Analog Converter", and is operated within the PA-3 Automatic Measuring Setup for Telephone Channels. From the 8-BIT-WORD of a selected telephone channel, the D/A converter recovers the digitally encoded analog signal. Then the PCM-3 measures and evaluates the analog signal. In this way, all the essential characteristics as described in CCITT Recommendations G. 711 and G. 712 are determined for the send side only of a multiplex equipment. Along with the measurements of variations with level and frequency of the analog/digital conversion of the encoder, the most important measurements are made to determine the quantizing distortion of the encoder. This latter, indeed, to a considerable extent determines the total distortion of a PCM system.

3.2.2. PCM Digital Signal Generator PDG-3

The PDG-3 produces not only the complete PCM frame (with frame alignment signal (sync. word), alarm signal (non. sync. word) and multiframe alignment signal), but also digital character signal sequences corresponding to defined sinusoidal signal frequencies and levels.

The PCM character signal sequences are applied to a chosen telephone channel. In the rest of the channels, stuffing character signals are sent in order to simulate unoccupied channels. At the output of the PCM multiplexer, the receive section of the PCM-3 is used to monitor the analog level which results from transmitted PCM character signal sequences.

Adjustment of the overall loss of the decoder is done with the aid of a PDG-3 generated digital signal with the level, 0 dBm0, at 1 kHz. This is the so-called

"digital milliwatt" produced in conformance with CCITT Recommendation G. 711. For the examinations of the variation of level with frequency or the variation of gain with input level, the frequencies and levels of the PCM character signal sequences can be varied in fine steps over wide ranges. Moreover, every level is adjustable at every frequency.

The available device, "Simulated Noise Signal" delivers a character signal sequence corresponding to a pseudo-random band-limited noise signal. With that, an exclusive test of the receive side is possible.

Idle channel noise can be examined by simulating the toggling about the a. c. zero of a decoder which does not have an applied input signal. For that, in any chosen telephone channel the stuffing character signal sign is alternated either periodically at the frequency of the set-in sinusoidal signal or at a pseudo-random rate.

The alarm device in the system can be checked by means of inserting error bits into the frame alignment signal (channel time slot 0).

And thus, the most important parameters of a PCM receive terminal can be automatically acquired. These parameters are: overall loss, variation of loss with frequency, variation of gain with input level, idle channel noise, crosstalk, decoding errors, as well as alarm signalling functions.

3.3. Consideration of CCITT Recommendation G. 712 as affecting PCM-3/PA-3

The CCITT has formulated a series of recommendations to standardize PCM systems. Thus the recommendation G. 711 describes possible encoding laws for the translation of the amplitude samples into corresponding 8-bit code words, the recommendation G. 712 the quality requirements between audio inputs and audio outputs of the PCM systems and the recommendation G. 732 the frame structure for the PCM system 30 with the bit rate frequency 2048 kbit/s, the frame alignment conditions and the possibilities of transmission of exchange signalling.

Instruments for testing the quality of PCM-systems must have regard to the above quoted recommendations. This is true in particular for the PCM-3 Automatic Measuring Set or for the PA-3 Automatic Measuring System. Some of the points of CCITT Recommendation G. 712 will, therefore be examined in the following.

3.3.1. Attenuation/frequency distortion

The recommendation G. 712 gives the information in the tolerance diagram shown in Fig. 3-3. The reference frequency is to be 800 Hz (nominal value, no sub-harmonics of 8 kHz sampling frequency) and the send level 0 dBm0.

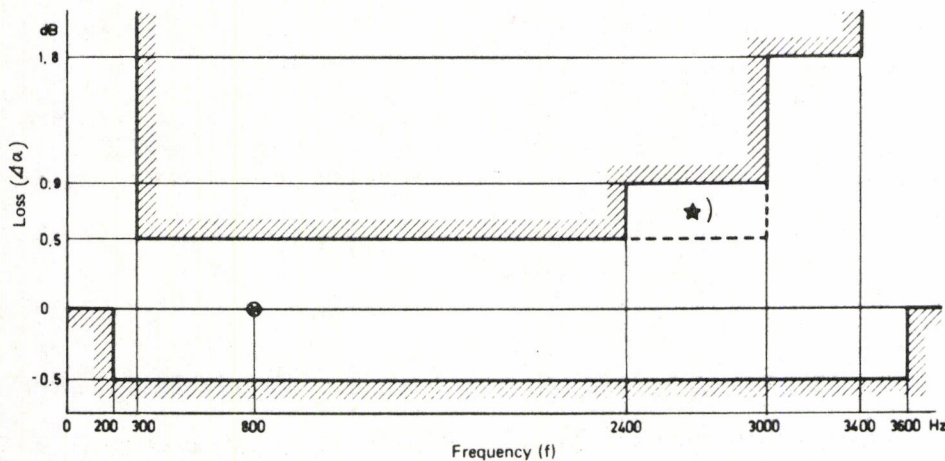

★) In the case of several PCM channels in tandem, it may be necessary to extend the + 0.5 dB limit from 2400 Hz to 3000 Hz.

Fig. 3-3 Permissible attenuation/frequency distortion of PCM channels in accordance with CCITT, variation of attenuation Δa with respect to frequency f .

In the PCM-3 this measurement is carried out with a reference frequency of 814 Hz and a send level of - 10 dBm0 or any optionally selected level. The relative measurement is preceded by a calibration step at 814 Hz as preliminary measurement. The resolution of the result indication is 0.01 dB.

3.3.2. Variation of gain with input level

The CCITT recommends as for this measurement two optional methods:

Method 1 uses a suitable noise signal in the level range - 60 to - 10 dBm0. For this send signal the variations of gain of a channel referred to the gain at a send level of - 10 dBm0 should be within the tolerance limits shown in Fig. 3-4a.

Furthermore a sinusoidal signal (between 700 and 1100 Hz in frequency) is applied for the level range - 10 to + 3 dBm0. In this case the variation of gain referred to the gain at a level of - 10 dBm0 should lie within the limits shown in Fig. 3-4b.

Method 2 uses a sinusoidal send signal (frequency between 700 and 1100 Hz) for the level range - 55 to + 3 dBm0. The tolerance limits for the variation of gain referred to the value at - 10 dBm0 are presented in Fig. 3-4c.

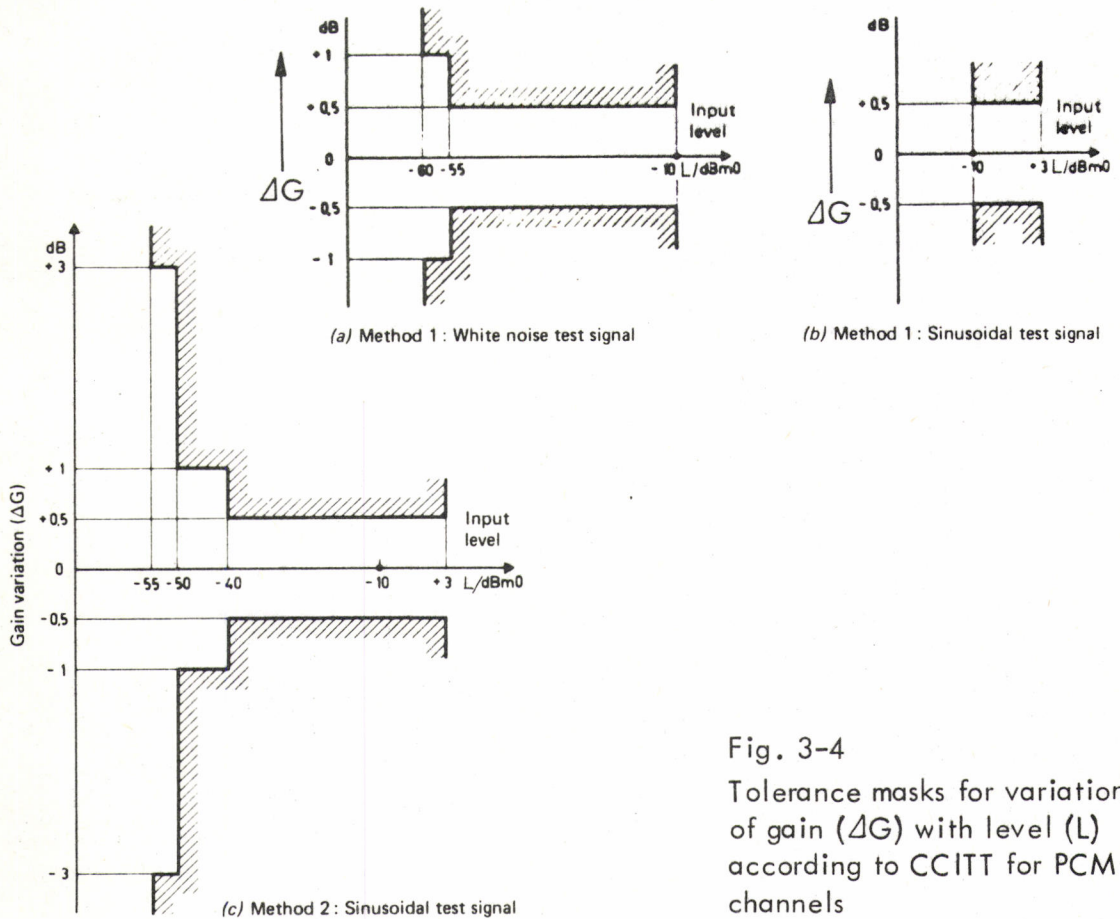

Fig. 3-4
Tolerance masks for variation of gain (ΔG) with level (L) according to CCITT for PCM-channels

The PCM-3 allows for both methods. In method 1 a pseudo-random noise signal in the range 350 to 550 Hz serves as a send signal for level $< - 10$ dBm0 and for send levels $\geq - 10$ dBm0 an 814 Hz sinusoidal signal is used. This sinusoidal signal is also used in method 2. The receive level is measured in the frequency range 350 to 550 Hz or selectively at 814 Hz as the case may be. A calibration step with the reference level of - 10 dBm0 precedes the relative measurement. The resolution of the result indication is 0.01 dB.

3.3.3. Measurement of idle channel noise

According to the CCITT the weighted idle channel noise should not exceed the value of -65 dBm0p, if the output and input ports of the channel are correctly terminated. With the PCM-3 it is possible to make weighted noise level measure-

ments in the range -20 to -85 dBm0 but unweighted level measurements in the range -20 to -80 dBm0 as well.

The psophometric weighting filter corresponds to CCITT Recommendation P. 53. The attenuation characteristic is shown in Section 1.7.6. The unweighted measurements are made in the frequency range 200 Hz to 4 kHz.

3.3.4. Total distortion, including quantizing distortion

The CCITT Recommendation provides for two methods.

Method 1: When measuring with a suitable noise signal the ratio of signal-to-total distortion (S/Q) should lie above the range of figure 3-5.

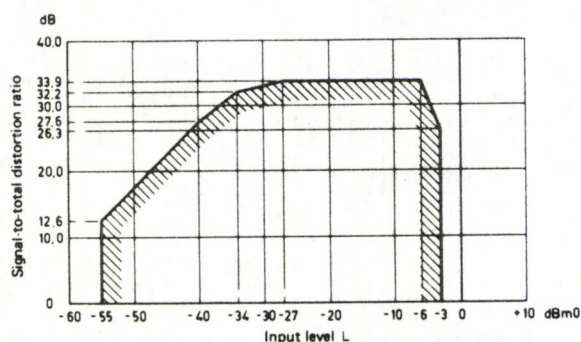

Fig. 3-5 Tolerance mask for signal-to-total distortion ratio S/Q with a shaped noise test signal as a function of the signal level L (method 1)

The limits are based on a shaped noise signal with Gaussian distribution of amplitudes. CCITT Recommendation O.131 describes a method of generating a pseudo-random noise signal for practical operation.

Method 2: When a sine-wave test signal is applied to the input port of the channel for measurement the S/Q values should lie above the range given in Figure 3-6.

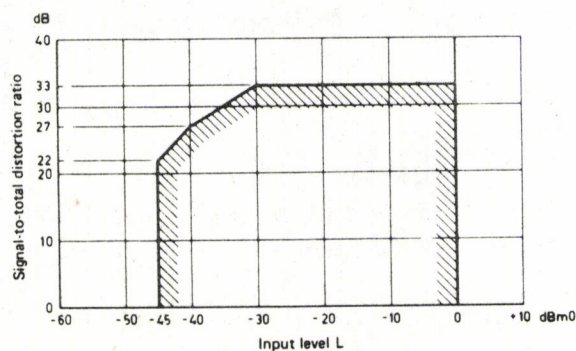

Fig. 3-6 Tolerance mask for signal-to-total distortion ratio S/Q for sine-wave test signal as a function of the signal level L (method 2)

The BN 822/01 and BN 822/02 models of the PCM-3 allow for measurements of S/Q with shaped noise signal as well as with a sinusoidal signal. The noise signal is generated as a pseudo-random noise in accordance with CCITT O. 131 (see Section 4.1.) and limited in frequency range to between 350 and 550 Hz. After the start of the measurement the signal level is then measured by the receive section of the PCM-3 and the value stored. For this measurement of S the 350 to 550 Hz receive filter is brought into the receive path. The subsequent Q measurement is made with a noise filter, whose pass-band is 815 to 3330 Hz. The noise attenuator is adjusted and the Q value is stored. Then the digital section of the PCM-3 takes the quotient S/Q and converts the value to that for a telephone channel band-width (300 to 3400 Hz). The range for measurement and indication is 0 to 40 dB with a resolution of 0.1 dB. A range of 0 to - 60 dBm0 is available for the send and receive levels.

The total distortion can also be measured with a sine-wave test signal at a frequency of 421 Hz. The procedure for the S and the Q measurement is carried out with the same receive filters as with the shaped noise signal and the results are evaluated in the same way. The level range possible in this case extends from + 10 to - 60 dBm0.

In the BN 822/03 model the total distortion is measured with an 856 Hz sinusoidal signal. For this the S measurement is made selectively with an 856 Hz band-pass filter. For the Q measurement an 856 Hz band-stop filter is brought in to the signal path. The Q-value can be measured weighted or unweighted.

3.3.5. Interchannel crosstalk

The CCITT Recommendation states with regard to the measurement of crosstalk with a sine-wave signal (frequency between 700 and 1100 Hz, subharmonics of 8 kHz excluded), that with a level of 0 dBm0 on a send channel, the crosstalk level measured on any other channel should not be greater than - 65 dBm0.

The PCM-3 Automatic Measuring Set uses an 814 Hz sine-wave signal with a level of 0 dBm0 for this measurement. The 814 Hz band-pass filter is brought into the receive section so that the idle noise contribution of the system under test does not restrict the range of measurement. The range for the receive level and

indication of results extends from - 20 to -85 dBm0. The inherent noise is at about - 113 dBm, the resolution of result indication is 0.1 dB. The corresponding measurement mode numbers are 70, 72 and 74.

The crosstalk can be measured simply and speedily with the Test Point Scanner MU-3. For this the MU-3 can be preset in three different modes of operation (slide switch 36 at rear of the instrument). In the mode " $\neq n$ " the test signal is applied to a specific channel and the PCM-3 receiver input is applied in turn to all the receive channels except the one into the send channel of which the test tone is being applied (Fig. 3-7 a). The send channels, in which no tone is sent, are terminated by the MU-3 with Z. They can furthermore be occupied by an activating signal. For measurements in a channel cycle or total cycle, the MU-3 sends the test tone signal on to the next channel after each execution of a measurement run on the receive channels. Further details can be obtained from the description and operating manual for the Test Point Scanner MU-3.

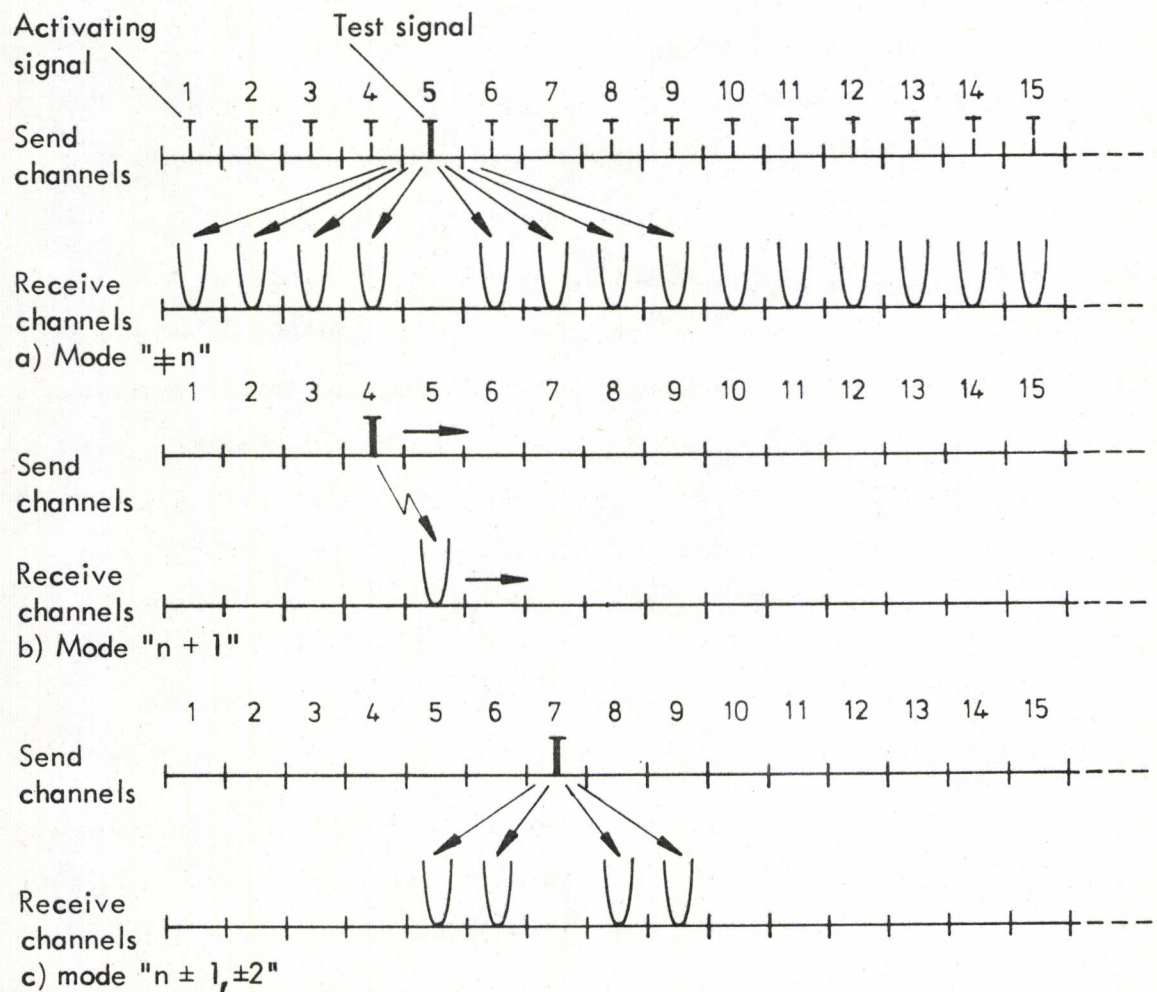

Fig. 3-7 Channel switching in crosstalk measurements with the MU-3

In switch position "n + 1" the crosstalk is only measured on the receive channel which follows the channel (in time), into whose corresponding send channel the signal is being directly sent. (See Fig. 3-7 b). In measuring in a channel cycle or in a total cycle the MU-3 moves on one step in send and receive channel after each measurement. In the switch position "n ± 1, ± 2" the crosstalk is measured in the two receive channels respectively, which come before or after the send channel fed with a test tone. This mode of operation can be seen in Fig. 3-7 c.

3.3.6. Go-to-return crosstalk or level in own channel

The go-to-return crosstalk, that is the ratio between signal level in one send channel and crosstalk level in its own receive channel, according to CCITT, should be better than 60 dB, when a sine-wave signal at 0 dBm0 level and any frequency between 300 and 3400 Hz is applied.

The PCM-3 uses an 814 Hz sine-wave signal for crosstalk testing, which is measured selectively; the signal level is variable. In the corresponding measurement mode No. 71 the attached Test Point Scanner MU-3 works in the "Channel Measurement" mode of operation that is, the measurement is made in the receive channel, into whose send channel the tone is sent. Two back-to-back multiplex equipments, as shown in the arrangement of Fig. 3-8, are used for test.

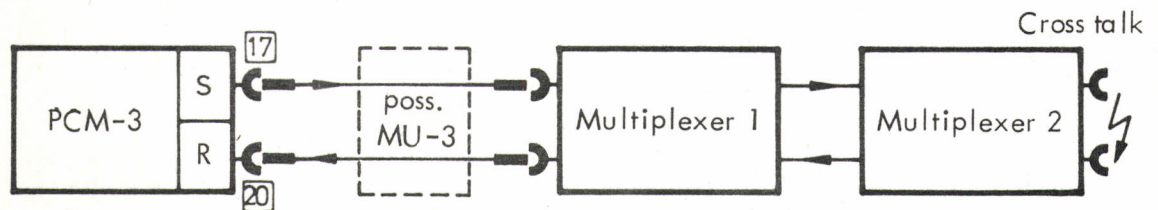

Fig. 3-8 Measuring of go-to-return crosstalk

The send and receive channels of the audio side of the multiplex equipment No. 2 are terminated with 600 Ω but not connected together. The crosstalk at the far end is fed back and measured at the audio side of multiplex equipment No. 1. The relationship is:

$$\text{Go-to-return crosstalk in dB} = \text{signal level in dBm0} - \text{receive level in dBm0}.$$

3.3.7. Impedance of audio input and output ports

The nominal impedance at the four-wire audio ports should be 600 Ω balanced to conform with CCITT. Deviation from the nominal value, measured as a return loss against the nominal value, should be not less than 20 dB in the frequency range 300 to 3400 Hz.

The audio input and output on the PCM-3 and the PA-3 instruments are made balanced. The impedance is 600 Ω and in the case of the PCM-3 can be switched to 850 or 900 Ω , as the case may be. 850 Ω is the impedance of the signal converter in two-wire systems.

A bridge for measuring return loss and impedance balance ratio is built in the Test Point Scanner MU-3. The reference impedance can be selected by switch either 600 Ω or 850 Ω (or 900 Ω optional). The measurement of return loss (measurement mode Nos. 80 and 81) is carried out with a send level of - 10 dBm0 and the impedance balance ratio (measurement modes Nos. 82 and 83) with 0 dBm0. A send frequency in the range 200 Hz to 4 kHz is available. Details of these measurements can be obtained from the operating manual for the MU-3.

3.3.8. Out-of-band signals at the channel input

The minimum requirements to be observed for discrimination against interference according to CCITT are the following: with a sine-wave signal in the frequency range 4.6 to 72 kHz at the audio input of a channel, the level at the audio output of a spurious interfering frequency signal should measure at least 25 dB below the level of the test signal.

For this test, single measurement No. 91 is provided. It is possible to transmit frequencies between 4.6 and 20.2 kHz with a level of 0 dBm0. The receive band-width is 200 Hz to 4 kHz with a range of indication for the interfering level from 0 to - 60 dBm0. The send side low-pass filter in the multiplex equipment is tested by this in-band measurement (see Fig. 3-9).

3.3.9. Spurious out-of-band signals at the channel output

In accordance with CCITT a sine-wave signal in the range 300 Hz to 3400 Hz is fed to the audio input with a level of 0 dBm0. The out-of-band interfering signal at the audio output when measured selectively should be less than - 25 dBm0.

In the PCM-3 a signal in the range 200 to 3.4 kHz can be sent with a fixed level of 0 dBm0. The interference level is measured in the broad band between 4.6 and 72 kHz at the audio output. The level measuring range and indicator range extends from 0 down to - 60 dBm0. This out-of-band measurement checks the receive side low-pass filter of the multiplex equipment (compare Fig. 3-9).

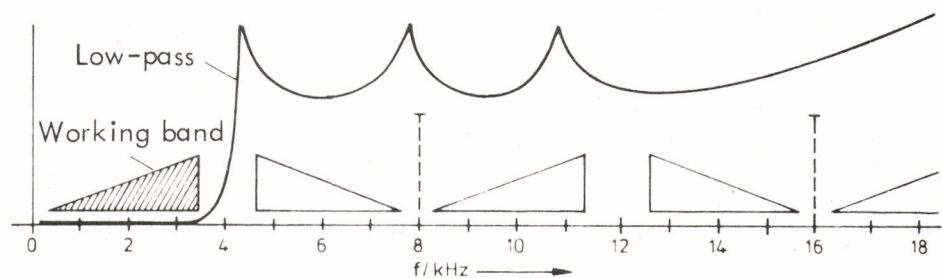

Fig. 3-9 Out-of-band signals. The frequency band shown arises from the working band 300 Hz to 3.4 kHz and the sampling frequency of 8 kHz. The working band is separated by a send-side or receive-side low-pass filter as the case may be.

4. FUNCTIONS AND CHARACTERISTICS

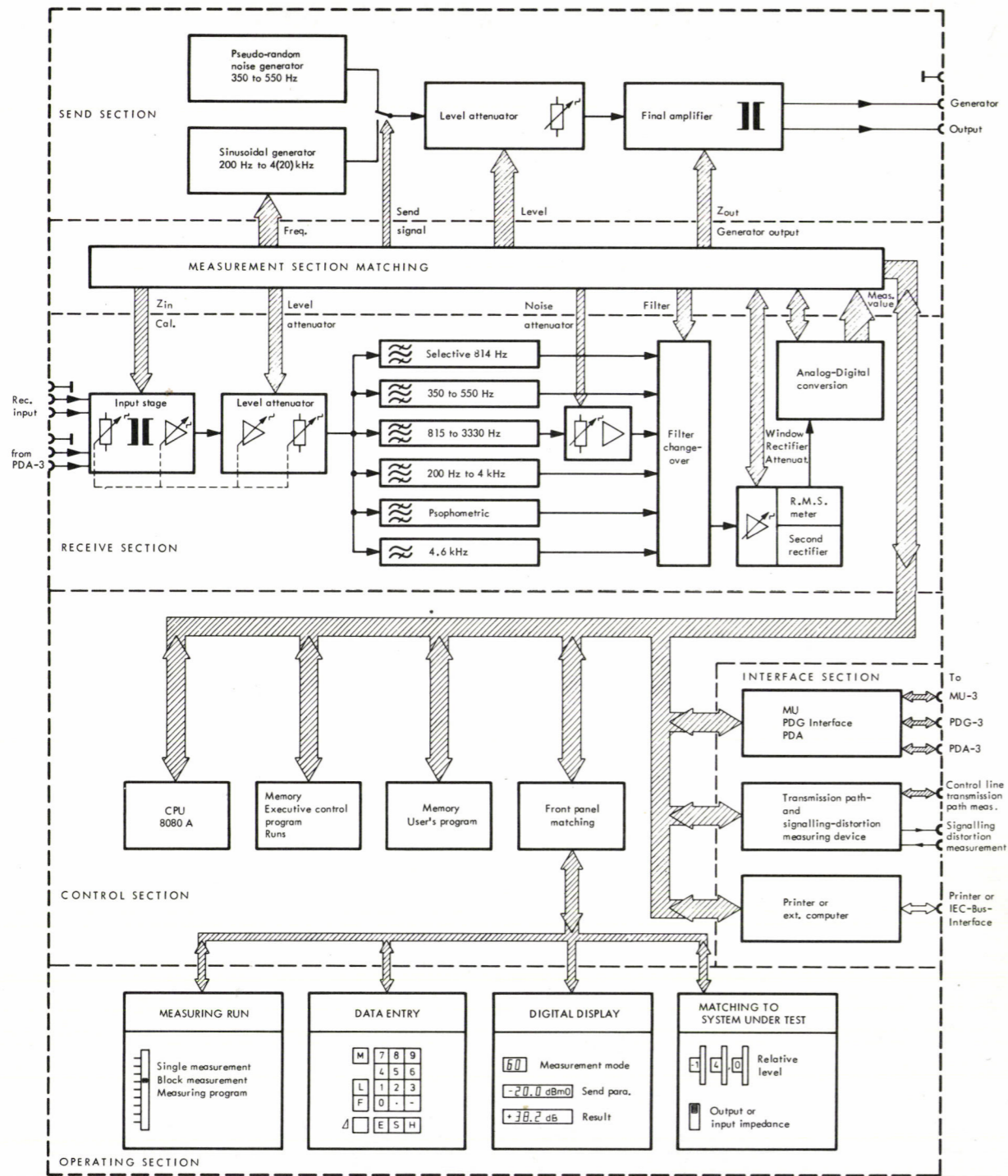

Fig. 4-1 Simplified block diagram of the PCM-3

4. FUNCTION AND CHARACTERISTICS

As is evident from the simplified block diagram (Fig. 4-1) the PCM-3 comprises a send section and a receive section as well as a digital section with control and interface sections.

4.1. Send section

The send section consists of the noise generator, sinusoidal generator, level attenuator and final amplifier sub-assemblies.

The noise generator produces a pseudo-random noise signal for measurement of total distortion and variation of gain with input level. In accordance with CCITT, a 17-stage shift register with feedback followed by a band-pass filter serves as signal source. The clock frequency of about 600 kHz for the shift register is derived from a crystal oscillator. From this a 4.6 Hz spectral line spacing is obtained for a binary sequence duration of $(2^{17} - 1) = 131071$ bits. The band-pass filter with its band width of 350 to 550 Hz converts the pseudo-random distribution of pulse width into a corresponding amplitude distribution. The peak factor (crest-factor) = peak value referred to the r. m. s. value of the noise voltage is $10.5 \text{ dB} \pm 0.5 \text{ dB}$.

The sinusoidal generator delivers a frequency and amplitude stabilized sinusoidal output voltage in the range 200 Hz to 20.2 kHz. A 2019 kHz crystal oscillator followed by a digital divider determines the nominal frequency. The division ratio is computed in the control section of the PCM-3 on the basis of the frequency data entered. Division ratios and crystal frequency are determined, so that the resulting frequency spacing has always a displacement from sub-harmonics of the 8 kHz sampling frequency of a PCM system. The frequency entered is automatically rounded off to the nearest possible lock frequency of the spectrum.¹⁾ The deviation of the lock frequency in relation to the value entered is always less than 2%. The output signal of the frequency divider is used in a control loop, to form a constant frequency triangular voltage. This is converted into a sine-wave voltage, whose amplitude is held constant in a second control loop.

1) A table of possible frequencies is given in the brochure "PCM-3. Standard Measuring Parameters" on the back of page 1.

According to each measurement mode selected, either the noise signal or the sinusoidal signal is fed to the level attenuator. In this unit the constant input level can be attenuated by a total of some 70 dB with smallest steps of 0.1 dB. The level attenuator is constructed of resistances and as a tapped transformer. The attenuator control comes from the control section and is related to the adjusted relative level, output impedance and upper or lower limits of level.

The final amplifier increases the level coming from the attenuator by 20 dB and feeds the output transformer. As the transformer permits further attenuation to be switched in, there is a level range of + 13 to - 77 dBm (at 600 Ω) available at the balanced generator output. With the noise signal the maximum level is + 3 dBm, in order to avoid overloading the test object with the peak factor of 10.5 dB. The generator output can be connected directly to the receiver input for overall loss measurement through an internal calibrate loop within the instrument.

With exception of the relative level and output impedance adjustments on the front panel, the rest of the adjustments (frequency, level) are made indirectly through the control section via the measurement section matching. The adjustment data are transferred via an 8-bit data bus to the corresponding buffer store in the send section. The instant of time for acceptance of the data is marked by allocated addresses.

4.2. Receive Section

The receive section contains the input amplifier and attenuator, receive filters, filter change-over switch and rectifier as well as the analog/digital converter.

The analog input signal comes to the input stage either from the test object via the front-panel socket or from the PDA-3 Digital Signal Analyzer via the rear input of the PCM-3. A third input is connected directly to the generator output during a calibration step in the overall loss measurement by means of an internal connection. The switchable pre-attenuator is followed by the input transformer and a switchable pre-amplifier stage. By means of further level attenuators and amplifiers, the signal voltages are adjusted to suit the dynamic range of the following filter circuits and analog/digital converter. The corresponding setting instructions

come from the control section of the PCM-3. A low-pass filter with a cut-off frequency of 120 kHz limits the maximum receive band width.

For the various measurement modes, different receive filters are fitted in the PCM-3, which are selected by the filter change-over switch. The allocation of filters inserted and of the measurement modes can be seen in the summary table in Fig. 2-10 (section 2.4.1.). The attenuation characteristic of these filters is given in the technical specifications under section 1.7. Active elements are included in all filters, with exception of the 4.6 kHz high-pass filter, which together with low-pass filters placed in the signal path defines the frequency range for out-of-band measurements. The selective filter (795 to 835 Hz) is connected for measurement of the 814 Hz sinusoidal signals, the 350 to 550 Hz band-pass filter for measurements with pseudo-random noise. The 350 to 550 Hz band-pass filter is also used for the S-measurement in total distortion - (S/Q)- measurement with "noise". The Q-measurement is made with an 815 to 3330 Hz band-pass filter, which is followed by the noise attenuator. This transformer attenuator is regulated by the PCM-3 control section, so that the filter change-over switch receives the correct level. The narrower band-width of the Q-Filter (815 to 3330 Hz) as compared with the telephone channel band-width (300 to 3400 Hz) is corrected for by additional amplification. The 200 Hz to 4 kHz wideband filter is connected in circuit for all unweighted measurements over the whole telephone channel frequency band. For noise measurements a psophometric weighting filter in accordance with CCITT is provided. The selection of receive filters needed for each measurement mode respectively, is done by the filter change-over switch, which is operated in turn by the control section of the PCM-3.

The filter change-over is followed by the final amplifier and an additional amplifier, which operates in measurements of increased sensitivity. The signal path is momentarily interrupted during the switching of attenuators and filters, to suppress transients (comp. Fig. 4-2).

For signal rectification two different circuits are available. The r.m.s. meter is used for all modes, which have "noise" as measuring signal or in which a receive signal of unknown wave-form may be expected, as, for example, in the measurement of idle channel noise. The circuit can work with peak factors of at least

15 dB; its time-constant is about 150 ms. The second rectifier forms the average value of the signal. It is chiefly applied in difference measurements with sinusoidal signals. The time-constant of the average rectifier is about 15 ms.

The a.c. voltage output on the rear of the PCM-3 is connected through a buffer stage before the rectifier circuits. The output signal therefore, has passed through the switched-in receive filter and the different attenuators and amplifiers.

The rectified signal is converted into digital form and the logarithm is taken. The analog/digital converter is an integrating converter with automatic zero balance for drift correction. The integration time is 200 ms, 500 ms or 2 s respectively according to measurement mode. The converter, which employs the dual-slope technique, uses a dynamic range of 20 dB. A quasi-logarithmic representation of the measured value is achieved by ranging the counting time in steps during the reference voltage integration period. This logarithmic pre-scaling approximates to the logarithm function by means of a polygonal curve. The accurate conversion of the corresponding straight segments into a logarithmic scale over the level range of 6 dB is the task of the microprocessor. The resolution then is 0.01 dB. A window discriminator monitors the rectifier output voltage. This level monitor determines with comparators, whether the voltage is inside or outside given threshold limits. Going beyond the threshold results in an attenuator correction or an overshoot signal (compare Fig. 4-2), if a measurement mode is used, in which a correction of this kind is released.

The relative level and input impedance of the receive section can be directly adjusted on the front panel. All other adjustments are made indirectly by the control section through the measurement section matching.

Signal at change-over
of attenuator, filter
or frequency
to interrupt signal
path for 200 ms
each time

Signal voltage before
the rectifier

Rectified voltage
before A/D converter

Signal for the A/D
converter

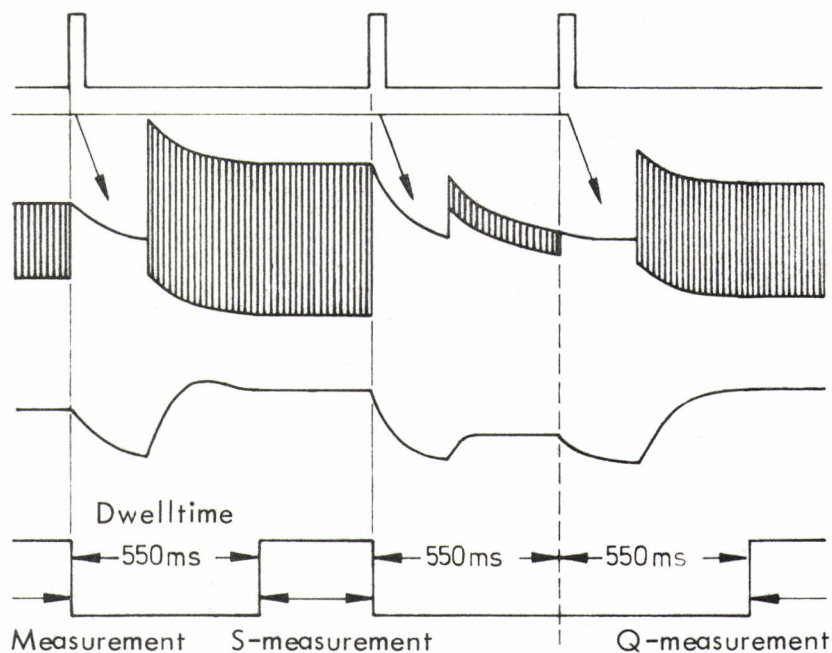

Answer of level monitor:
level too low, Q-attenuator corrected by 10 dB

Fig. 4-2 Form of signal at rectifier and analog/digital converter (Example S/Q measurement)

4.3. Digital section

The digital section of the PCM-3 controls the adjustment of the analog measuring section (send and receive section), takes care of the correct execution of the measuring run and evaluates the measured results. Peripheral instruments can be controlled through special interface cards. The selection of the specified measurement and indication of measured values is effected through the operating section. Control of the automatic measuring set can be assumed by an external computer through an IEC-Bus-interface card.

The construction of the digital section can be seen in principle in Fig. 4-1. The "brain" of the automatic measuring set consists of the central processing unit (CPU) - a type 8080 A microprocessor - and memory circuits. The memories contain various programs such as control-, execution-, measurement mode- and operational programs, further constant values and the send parameters for block measurements. The numerical values of the measuring parameters (level, frequency, to-

lerance) departing from the standard program, can be programmed according to the customers instructions. In this way measurements to special requirements in test specifications and standard specifications can be carried out by selecting a measurement mode number which has been allocated.

The complete input and output elements are connected with the microcomputer through a front panel matching circuit. The most important input and output functions are the test object matching, the setting of the measuring sequence, data entry and the digital numerical display.

By means of additional interface cards further instruments can be connected to the PCM-3. One of the interfaces serves to control the Test Point Scanner MU-3, the Digital Signal Generator PDG-3 and the Digital Signal Analyzer PDA-3. Operation of two Automatic Measuring Sets PCM-3 in end-to-end measurements is possible with another interface card. In this case both send and receive side PCM-3 must have the same program. The PCM-3 operated as receiver can control the generator synchronously through an audio-channel by means of start and stepping pulses. The interface card for end-to-end measurements also includes a measuring device for determining signalling distortion.

The system elements are connected with one another by means of a data bus for data transfer within the PCM-3. An address bus is used to define which system element is to receive data and which to transmit. A control bus coordinates the data flow and makes possible the control of the micro-computer itself.

The program structure of the PCM-3 is modular with hierarchical branching of the modules (see Fig. 4-3). The highest level receives the initialising program, which is executed, for example, after switching the instrument on, or on erasing a program (key 12 in position "ALL"). On the next level, the measurement tasks, entered via the operating section or the IEC-Bus-card, are transmitted to the PCM-3. With the start command, the control program, guiding and monitoring the complete measuring run, proceeds. A single measurement can be dealt with or a complete measuring program of some hundreds of test points, whose test parameters are filed in ROM (customer's program). The control program loads the measuring parameters, starts up the measurement, evaluates the measured results, controls the digital display and feeds out the printer information. After the measurement

task is concluded, the control program reports back to the next higher level, in order, for example, to receive the next task from the operating section.

The control program itself can delegate tasks downwards, as, for example the execution of a single overall loss measurement. This measurement runs through a corresponding test module, which for its part calls upon the next lower level (test sub-program), e. g. for the adjustment of the send level attenuator. Finally basic sub-programs like addition, subtraction, etc., are required for determination of the attenuator adjustment.

Fig. 4-3 shows the modular program structure and quotes some typical tasks for the individual hierarchical steps. Each module is capable of running itself on receipt of the required parameter and reports back to its superior module, when the task is carried out. In this way the program is easily checked out (for example, in error tests) and easy to modify without interaction with the modules. Besides that, this concept ensures a high software reliability.

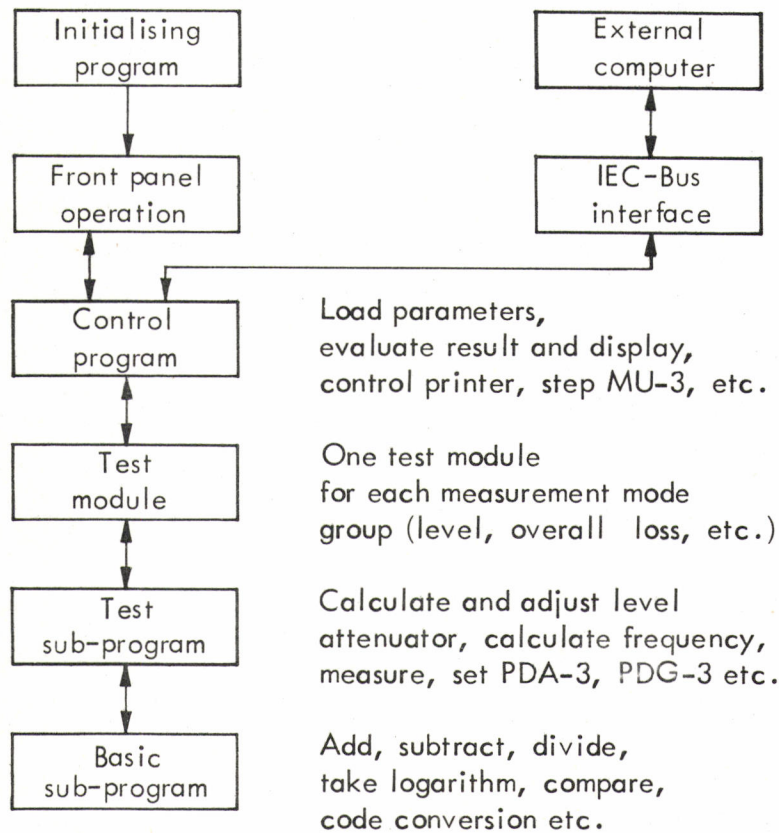

Fig. 4-3 Program structure of the PCM-3

4.4. End-to-end and signalling distortion measuring device

The BN 822/00.03 plug-in subassembly in contrast to the other interface cards, serves not only for transmission of data (with input-output, decoder and store) but also contains components for signal generation and measurement.

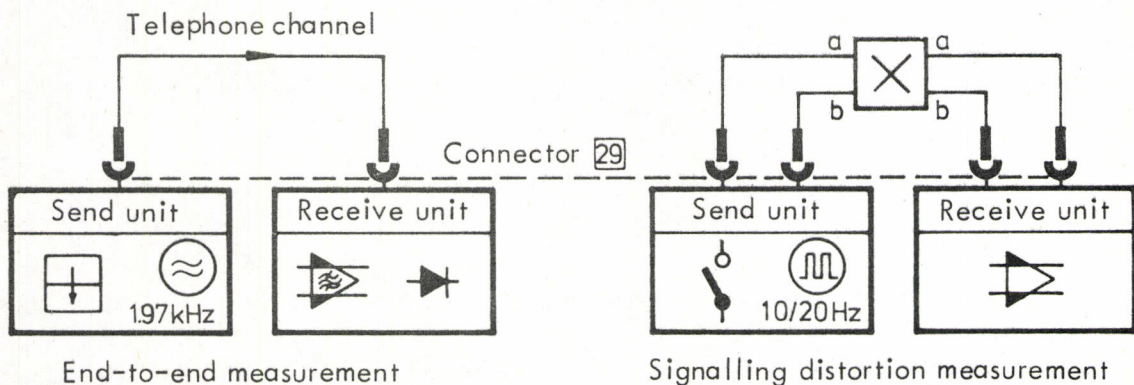

Fig. 4-4 Block diagram of devices for end-to-end and signalling distortion measuring devices

For end-to-end measurement, the receive-side PCM-3 takes over the control. It generates the necessary control pulses in the send unit of the end-to-end measuring device, by keying a 1.97 kHz sinusoidal signal. The start and stepping commands have a pulse duration of about 50 ms; the Δ -start command for incrementing is about 150 ms in length. The control pulses are transferred via one channel of the circuit under test or an auxiliary telephone channel to the send-side (controlled) PCM-3. At this end the receive unit of the end-to-end measuring device is in operation. This selective receiver forms rectangular pulses corresponding to the 1.97 kHz signals, which control the measuring execution in the send-side PCM-3.

The signalling character signal distortion can be measured either as the end-to-end measuring operation or as a loop test. By selecting the "Signalling distortion" measurement mode a rectangular pulse generator is switched-on in the send unit of the measuring device. The frequency of the 10 Hz rectangular pulse signal can be resoldered to 20 Hz. The duty cycle is 50 % normally (pulse duration to period duration) and can be resoldered to 40 % or 60 %. This send signal is available at output a or output b according to measurement mode number. The

rectangular signal goes from here to the a-wire or to the b-wire, if necessary through the MU-3 Test Point Scanner, of the signalling character transmission unit. The transmitted rectangular signal is assessed by the receive unit of the measuring device at the output of the object under test on the basis of the short-circuit and open-circuit impedance. The digital section of the PCM-3 averages the deviation of the duty cycle over ten periods (or 20 periods in the case of a 20 Hz generator frequency) and displays the mean value in ms with correct sign. With too high a short-circuit impedance or too low an open-circuit impedance the instrument indicates out-of-tolerance condition.

**5. FUNCTION CHECKING, MAINTENANCE
AND GENERAL INFORMATION**

5. FUNCTION CHECKING, MAINTENANCE AND GENERAL INFORMATION

5.1. Function checking

The following data are for the purpose of checking through the functioning of the PCM-3. It should thus be established whether the instruments show any great error (for example due to damage in transport). Before connecting to a . c. line voltage, check the voltage selector adjustment on the rear of the set.

5.1.1. Short test of digital section

With measurement mode no. 01, the memory on the central processor unit (CPU card), the memory cards I and II, as well as the memory elements on the possibly built-in interface plug-in cards can be checked through for correct functioning. If a scanner MU-3 is connected to the PCM-3, at least one channel push-button (AF Switch MUE-31) shall be pressed at the MU-3.

"Measuring sequence" switch 6 in position "Single Measurement 1 x" or "REP.".

Data entry on keyboard 13 :

M 01 E , S

If the test is free of faults, the measured result display 4 shows 000. In case of an instrument fault, the display 4 shows a 3 digit octal code error number, which gives the service department information as to the faulty sub-assembly.

The duration of this test run is approx. 12 seconds.

5.1.2. Short test of measuring sections

Adjustments on the PCM-3:

Relative level 15 and 18 on 0 dBr.

Generator output impedance 16 and receiver input impedance 19 set to 600 Ω .

Generator output 17 and receiver input 20 to be connected together with a balanced CF cable.

In measurement mode No. 02 a level measurement is made with 0 dBm0 and at a frequency of 814 Hz.

Measuring sequence switch 6 in position "Single measurement 1 x" or "REP."

Data entry:

M 02 E , S

The test value shown in measured result display 4 must be in the range ± 0.3 dBm0.

With any larger deviation, the send level is to be checked with, for example, the Milliwatt Power Meter EPM-1 from Wandel & Goltermann. In this way it can be determined whether the error is caused by the send unit or by the receive unit.

5.1.3. Further checks on measuring sections

With the existing measurement modes 10 to 99 the measuring sections can be checked through their various functions.

Settings on the PCM-3:

Relative level 15 , 18 on 0 dBr, impedance 16 , 19 on 600 Ω .

Generator output 17 connected with receiver input 20 .

Switch 6 in position "Single Measurement 1 x" or "REP."

Data entry:

M xx E , and (as necessary)

L yy E , and/or

F zz E , S

The send parameters entered must not go beyond the ranges quoted in Section 1.6. "Measurement modes and their error limits".

For the measured result display 4 the following limits, with $Z = 600 \Omega$ and relative level 0 dBr, apply:

Meas. mode No.	Measured result display <input type="checkbox"/> 4
10, 11	as send level (dBm0) ± 0.5 dB
20, 21	in the range ± 0.05 dB
30, 31	± 0.07 dB
40, 41	± 0.14 dB

Meas. mode No.	Measured result display 4
50	↓ - 95.0 dBm0
51	↓ - 90.0 dBm0
60, 61	↑ + 40.0 dB
70, 71 (without MU-3)	↑ - 10.0 dBm0 or send level ± 0.5 dB
80 ... 89	cannot be selected without MU-3
90	↓ - 70.0 dBm0
91	at f = 814 Hz : ± 0.5 dB
92	at f = 10.1 kHz : ± 0.7 dB
93, 94, 98, 99	± 0.1 1)
95	no indication on 4 (and 3)

The table holds also good for all block measurement modes, which are covered corresponding to the quoted mode numbers.

5.1.4. Operation of PCM-3 as level generator only

With measurement modes Nos. 05 to 09 the send unit can be adjusted over the complete level and frequency range (see also section 5.1.6.).

In the position "Single measurement 1 x" or "REP." of measuring sequence switch 6, data entry 13 follows as in example:

M 05 E , L - 20 E , F 5.05 E

Warning: The Start key S must not be used.

In this mode of operation, if a selective level meter, e.g. SPM-12 by Wandel & Goltermann, is connected to the generator output 17, it is possible to check output level, relative level 15, distortion factor a_{k2} , a_{k3} , and send frequency approximately. The precise generator frequency can be measured with a frequency counter, e.g. FZ-4. The output level of 0 dBm can be measured with higher absolute accuracy with the Milliwatt Power Meter EPM-1 and balanced 600 Ω test probe. The EPM-1 also affords a check of the frequency characteristic.

1) Only with the Signalling Distortion Measuring Device BN 822/00.03 and connection between generator output and receiver input at socket 29 (see Fig. 2-17).

5.1.5. Operation of PCM-3 as level meter only

With measurement mode No. 03 a wide-band level measurement in the range 200 Hz to 4 kHz can be carried out.

In the position "Single measurement 1 x" or "REP." of the measuring sequence switch the data entry follows:

M 03 E , S

No send parameter is to be entered; in this mode the generator remains switched off. The measured result display shows the level of sinusoidal signal at the receiver input (level range + 10 to - 60 dBm0, frequency range 200 Hz to 4 kHz).

With a suitable level generator, e. g. PS-12 by Wandel & Goltermann, the functions of the receive section, especially the automatic attenuator balance and result display, can be checked.

5.1.6. Additional test modes

The measurement mode Nos. 05 to 09 are also provided for service work (fault finding and alignment), compare section 5.1.4. They make it possible with the "Halts" incorporated, to break down a single measurement step into its constituent partial steps, for example, attenuator adjustment or measuring and calibration step.

Besides this, the necessary combinations of send frequency and receive filter specially for alignment are possible. With these measurement modes, therefore, the selection of some of the receive filters can be checked.

Measuring sequence switch in position "Single measurement 1 x" or "REP.".

Data entry :

M xx E , L yy E , F zz E

Release measurement for partial step: S

The send level range of adjustment is at least + 10 to - 60.0 dBm0 and the send frequency range is 0.200 to 20.2 kHz.

The following adjustments are programmed in the receive section:

Meas. mode No.	Adjustment of receive section (measurement mode, filter, rectifier)
05	Level measurement 0.2 to 4 kHz, average rectifier and halt
06	Level measurement selective and halt
07	Idle noise measurement, psophometric weighting and halt
08	Variation of gain, selective, sinewave/noise and halt
09	Out-of-band measurement to 72 kHz (without high-pass filter) and halt

5.2. Maintenance and general information

Caution: Disconnect a. c. line plug before opening the cabinet of instrument.
The instrument must be switched off before taking out the plug-in cards.

5.2.1. Mechanical assembly

The cabinet dimensions correspond to the DIN norm 41 494 as well as the American standard ASA C 83.9.

The instrument can therefore be mounted into a 19-inch rack. Covers, base and side panels are manufactured in robust aluminium casting.

The cover or base can be taken off after loosening the 6 Allen head screws (Allen wrench E on rear of instrument). The power section is mounted on the right-hand side panel. The supply voltages are fed to the actual chassis via 4 plug connectors. After releasing these four connectors the chassis can be removed together with front and rear panels upwards or downwards from the cabinet respectively. The locking cap I and replacement fuses should be removed on the rear beforehand, since these parts belong to a unit of the power section.

Most of the circuits are on boards, which can be withdrawn from above. The upper cabinet cover and the card retaining bars only need be unscrewed in this case. Fig. 5-1 shows the PCM-3 with cover removed.

Note: The two lower plug connectors between power section and chassis are accessible, if the next plug-in cards 822-C (in the BN 822/01), 822-CA (in the BN 822/02) or 822-CB (in the BN 822/03) and 822-AB respectively, are taken out. The supply plugs must not be interchanged when the chassis is re-assembled.

5.2.2. Insertion of plug-in subassemblies

The plug-in subassemblies BN 822/00.02 to BN 822/00.04 and BN 822/00.07 are mounted from the rear of the instrument. The left-hand of the three positions (looking from the rear of the instrument, Fig. 5-1) is provided to accept the printer interface BN 822/00.07 or alternatively the IEC-Bus-interface BN 822/00.02. The middle position can accommodate the end-to-end and signalling distortion measuring device BN 822/00.03 and the right-hand position the BN 822/00.04 interface for the PDA-3, PDG-3 and MU-3.

The correct card connector place is given by a colour code on the printed metal plate of the plug-in subassembly as well as on the guide-rails of the basic PCM-3 instrument.

Before mounting a subassembly, the corresponding blank cover plate with two fixing screws should be removed then the subassembly can be guided in the rails and plugged in. The mechanical fixing is done with two screws as for the blank cover plate.

5.2.3. Changing the customer program memory

The customer program stored on the memory card II (822-J) can be changed after removing the instrument cover and retaining bar. The plug-in card can be released from the connector strip by pulling up the plastic handles and taken out vertically, as may be seen from Fig. 5-1. Now another memory card can be inserted.

5.2.4. Conversion from dBm to dB calibration

The PCM-3 Automatic Measuring Set can be converted from power level calibration (dBm or dBm0) to voltage level calibration (dB or dB0). The cabinet cover and card retaining bar are to be taken out, so that the plug-in card 822-F "Converter and Logarithmizer" can be drawn out upwards (see Fig. 5-1). On this card,

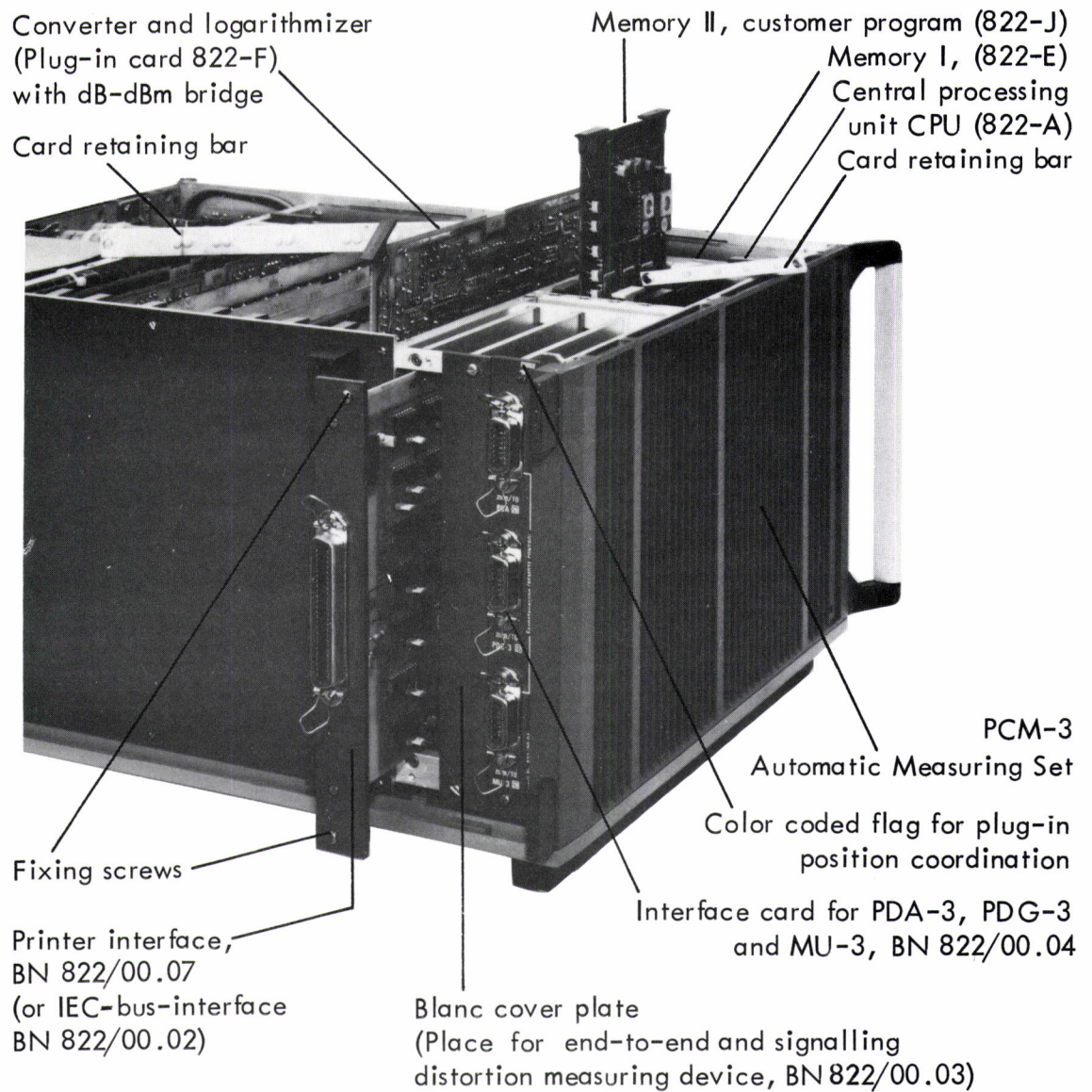

Fig. 5-1 Basic PCM-3 instrument with cover removed from cabinet; mounting positions for additional plug-in subassemblies

next to the large integrated circuit 8 IC 21 (type SAB 8255-C) two solder terminals x and y are to be found, which are linked by a bridging strap for dBm-calibration. To convert to dB-calibration the bridging strap is to be removed.

Thus the digital section uses the voltage level calibration to calculate in setting level and in evaluation and brings the send level and the measured result together with the dB0 unit, or dB respectively, to the display.

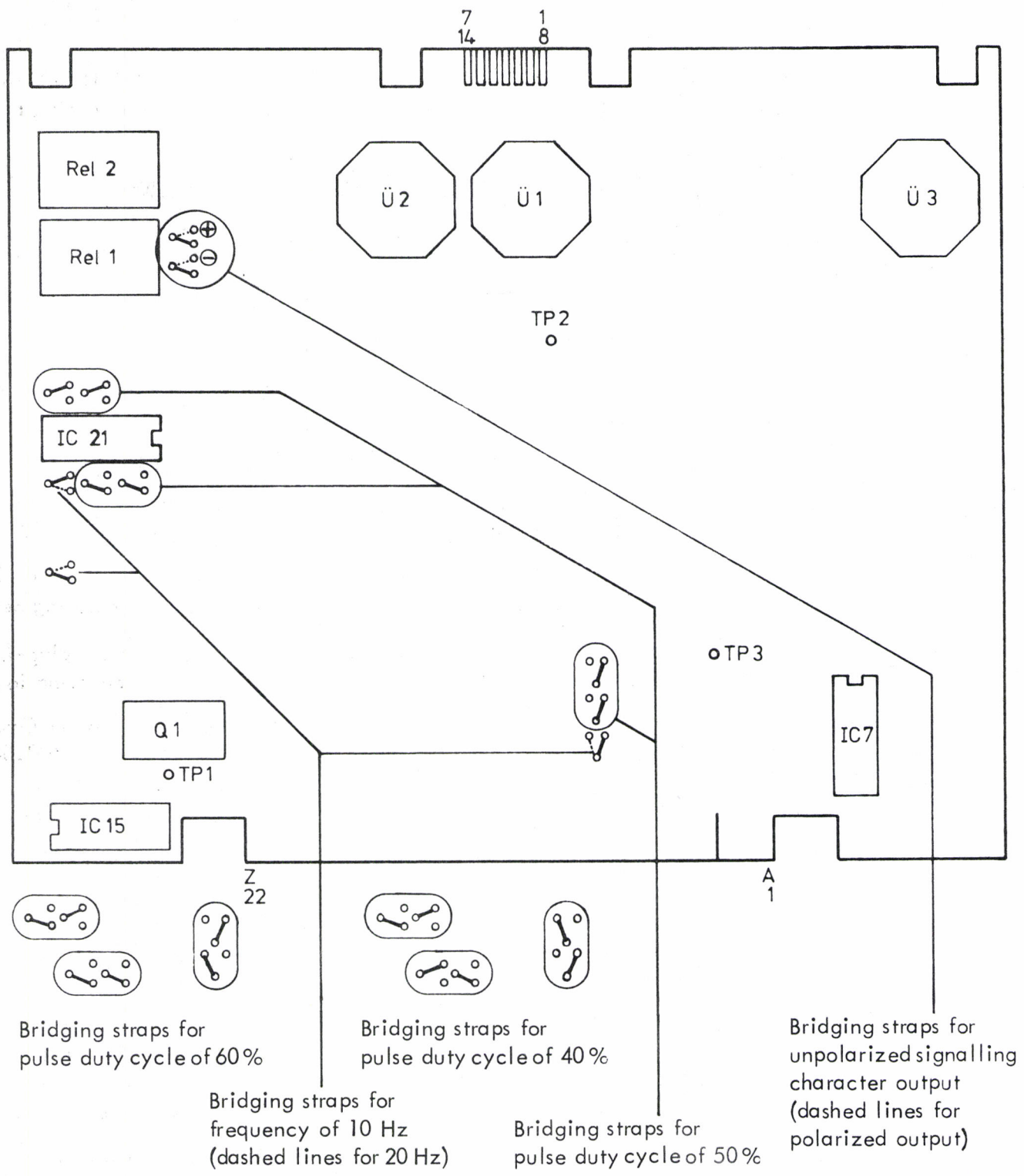



Fig. 5-2 Position of the bridging straps on the signalling distortion measuring device (simplified component plan of the standard version)

5.2.5. Changing fuses

The a. c. line fuse can be changed by unscrewing the fuse cap H on the rear of the instrument. The necessary fuse sizes are printed on the rear of the instrument, also see Section 2.1.3. Behind the plastic cap I designated "  " are the spare fuses.

5.2.6. Modification of the measuring signal for signalling distortion

The plug-in subassembly BN 822/00.03 "End-to-end and signalling distortion measuring device" generates a rectangular signal for determining the distortion of the signalling character. This signal normally has a frequency of 10 Hz and a pulse duty cycle of 50 % (pulse length to period duration). The circuit can, however be modified to give a frequency of 20 Hz as well as a pulse duty cycle of 40 % or 60 %:

After releasing the two fixing screws on the rear of the PCM-3 (compare Fig. 5-1) the plug-in subassembly should be withdrawn from the basic instrument. Then the bridging straps can be resoldered in accordance with Fig. 5-2.

5.2.7. Use in 19-inch racks

In the use of the instrument as chassis for 19-inch rack installing, mounting brackets must be attached to both sides. The complete set of "mounting brackets" including fixing screws is obtainable under ordering No. BN 700/00.05. The instrument feet are to be removed from the underside and the guide studs from the top before installing.

Warning: When fitting in cabinet racks, care must be taken, that the upper limits of the rated range of use of ambient temperature are not exceeded. In general, the following precautions are necessary:

- a) There must be a space of one unit of height (44.4 mm) between the instruments.
- b) Air must be able to enter through this space from the front and flow through the instrument in so far as the instrument below does not permit air to circulate.

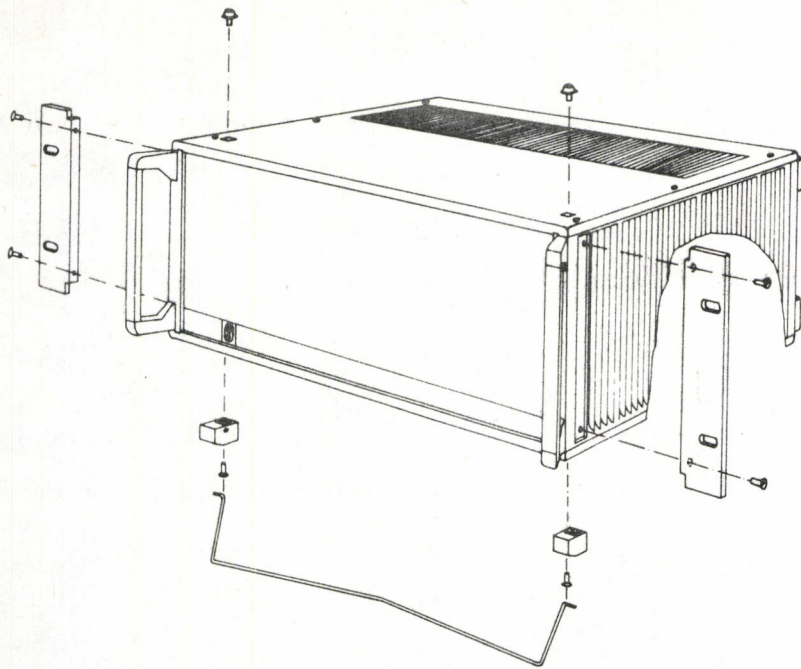

Fig. 5-3 Conversion of bench model to rack mounting

- c) Adequate air ventilating fans must be built in for taking out heat produced within the cabinet. Suitable filters should be provided, to prevent dust getting to the instruments.

5.2.8. Shipping instructions

Damage proof shipment of this measuring instrument is only ensured by packing of correct type. When the original packing is lost, we recommend that the instrument should be packed in the following way:

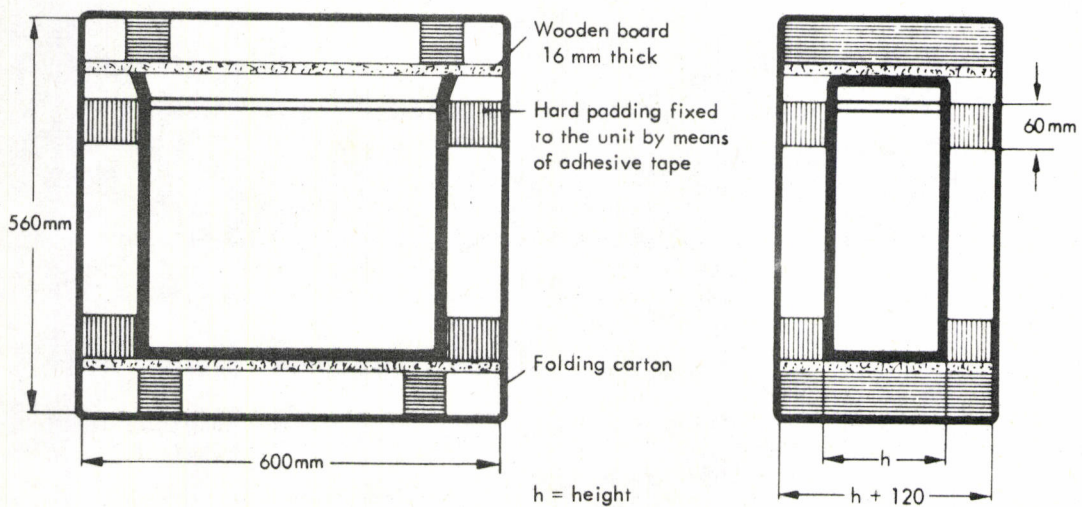

Fig. 5-4 Shipping instructions

5.2.9. Matching to the V.24 Printer Interface

The Printer Interface BN 822/00.07 takes into account the CCITT Recommendations V. 24 and V. 28 or the corresponding Standards (RS 232 C, DIN 60 020). Switches on the Interface p.c.b. permit the data output 32 to be matched to various printers. See Fig. 5-5.

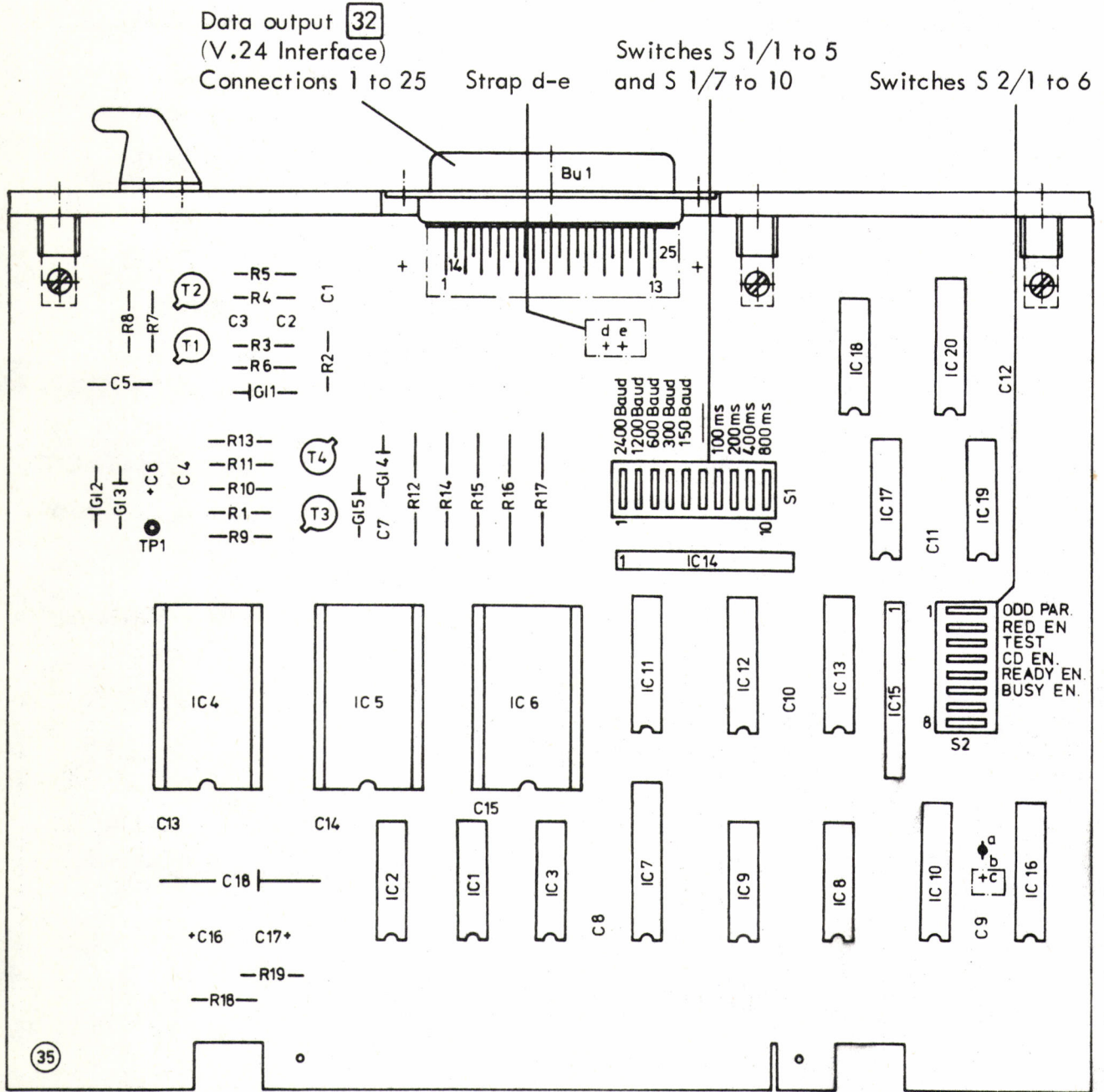

Fig. 5-5 V.24 Printer Interface BN 822/00.07

5.2.9.1. Baud rate

The baud rate is selected with switches S 1/1 to 5. But only one switch at a time may be closed to select the appropriate rate of the printer.

5.2.9.2. Acknowledgements from the printer

The printer can send positive or negative acknowledgements to the PCM-3 in order to indicate whether it is ready or not ready to accept data for printing. For that purpose, connection 11 of data output 32 can have either of two signals applied to it: the signal, BUSY, or its complementary signal, READY. To activate one of these signals, switch S 2/6 BUSY EN(able) or S 2/5 READY EN(able) is actuated. However, only one of the two switches may be closed at a time.

If the printer puts out the signals BUSY or READY through connection 14, then the strap "d-e" on the Interface card must be soldered in. When this is done and if connection 11 in the printer is already assigned, then the associated line must be disconnected; e. g. by scratching away the conducting line on the Interface card.

And also via connection 20 on connector 32, the printer is given the capability of participating in data communications. (Signal "108.2" according to CCITT, "CD" according to RS 232 C, or "S1.2" according to DIN). Activation is accomplished through switch S 2/4 "CD EN(able)".

When a printer does not furnish the signals, "BUSY", "READY", or "CD", the corresponding switches must be open (not actuated).

5.2.9.3. Waiting (Standby) Time during "CR" and "LF"

If a printer with the aforementioned acknowledgements cannot be matched to an interface, and, despite that, needs a dead time for "CR" (Carriage Return) and "LF" (Line Feed) during which characters must not be sent, then a waiting time can be programmed on the Interface card. This is selected with switches S 1/7 to 10. Many combinations are possible, consequently delay times of 100 ms to 1500 ms can be selected in steps of 100 ms.

The Trend Printer 800 recommended by Wandel & Goltermann does not require a waiting time.

5.2.9.4. Interface testing

A test permits determining whether or not the waiting time has been correctly adjusted and whether or not the acknowledgements from the printer are correctly processed. For that purpose, the switch TEST S 2/3 on the Interface card is closed. A measurement is made with the PCM-3, but the result is of no consequence, and a printout is initiated. Either manually via push button MANUAL on the front panel, or automatically by the PCM-3. Thereupon, the printer must repeat the following character sequence on every line: 0 1 2 3 ... etc., a total of 80 ASCII characters per line with the Hex. values 30 to 5 F.

These character sequences repeat continuously until the PCM-3 is switched OFF or the process is interrupted by actuation of switch 12 CLEAR.

Special attention must be paid to observe that the characters are correct at the beginning of each line. The waiting time can also be changed during a test run.

5.2.9.5. Matching to special properties of a printer

If the printer does not accept EVEN PARITY characters, switch S 2/1 ODD PAR(ity) should be switched in.

The Trend Printer 800 has a ribbon shift function. With that, the ASCII character "SO" (Hex OE) causes printout in red, and "SI" (Hex. OF) black printout. If a red printout is not wanted, or if these characters disturb another printer, then these signals can be suppressed: Switch S 2/2 RED EN(able) is switched out.



Wandel & Goltermann GmbH & Co

Post Box 45 · D-7412 Eningen u.A. · Telephone 891-1 · Telex 729 833