

9100 Handheld Spectrum Analyzer Series



Applications Guide
Version 2.00

boosting wireless efficiency

- Notice** Every effort was made to ensure that the information in this document was accurate at the time of printing. However, information is subject to change without notice, and Willtek reserves the right to provide an addendum to this document with information not available at the time this document was created.
- Copyright** © Copyright 2006 Willtek Communications GmbH. All rights reserved. Willtek and its logo are trademarks of Willtek Communications. All other trademarks and registered trademarks are the property of their respective owners. No part of this guide may be reproduced or transmitted electronically or otherwise without written permission of the publisher.
- Trademarks** Willtek is a trademark of Willtek Communications GmbH in Germany and other countries.
- Ordering information** This guide is issued as part of the **9100 Handheld Spectrum Analyzer Series**. The order number for a published guide is M 290 504.
- [Table 1](#) shows the order numbers for the 9100 Handheld Spectrum Analyzer Product Packages.

Table 1

Order Number	Description
M 100 411	9101 Handheld Spectrum Analyzer Bench Edition
M 248 800	9101 Handheld Spectrum Analyzer Field Edition
M 100 412	9102 Handheld Spectrum Analyzer Bench Edition
M 248 806	9102 Handheld Spectrum Analyzer Field Edition
M 248 801	9102 Handheld Spectrum Analyzer Tracking Edition
M 248 802	9102 Handheld Spectrum Analyzer VSWR/DTF Edition

Table of Contents

About This Guide		vii
	Purpose and scope.....	viii
	Assumptions.....	viii
	Related information.....	viii
	Technical assistance.....	viii
	Conventions.....	ix

Safety Notes		xi
	Safety warnings.....	xii

Chapter 1	Overview	1
	About the 9100 Handheld Spectrum Analyzer Series.....	2
	Features and capabilities.....	3
	Physical description.....	4
	Editions, options and accessories.....	4

Chapter 2	Basic Operation	5
	Introduction.....	6
	Before first time use.....	6
	Using the handle.....	6
	Carrying the instrument.....	6
	Positioning the instrument.....	7
	Connecting the 9100 Handheld Spectrum Analyzer.....	7
	DC IN connector.....	8
	RF IN connector.....	8
	RF OUT connector.....	9
	EXT. TRIG. connector.....	9
	Multi Port.....	9
	Headphone jack.....	10
	SERIAL (RS-232) connector.....	10

LAN connector.....	10
Powering the unit.....	11
Starting measurements.....	11
Using the front panel.....	11
Overview.....	11
Battery status LED.....	12
Display.....	12
Results area.....	12
Marker field.....	12
Input field.....	13
Softkey descriptions.....	13
Keypad.....	13
Function keys.....	13
Cursor keys.....	15
Numeric keys.....	15
Enter keys.....	15
Escape key.....	16
Backspace key.....	16
Softkeys.....	16
Entering numbers and text.....	17
Selecting the measurement mode.....	17
Changing center frequency, span, or reference level.....	17
Changing RBW, VBW, sweep time, or attenuation.....	17
Switching to automatic mode.....	18
Switching to manual mode.....	18
Working with the markers.....	18

Chapter 3

Typical Applications	21
Introduction.....	22
Taking measurements on a sine wave signal.....	22
Frequency and level measurements.....	22
Harmonics.....	24
Taking measurements on a burst or clocked signal.....	26
Analyzing spurious signals, temporary spikes and glitches.....	30
Testing a passive device in transmission mode.....	32
Antenna measurements.....	34
Introduction.....	34
Measurement types.....	35
Reflection measurements.....	35
Distance-to-fault measurements.....	36
Performing antenna measurements using the 9102 in the field.....	36
Preparative steps.....	37
Performing reflection measurements.....	38
Performing distance-to-fault measurements.....	41
Analyzing and documenting quality measurement results in the office.....	45
EMF measurements.....	46
Introduction to EMF measurements.....	47
Radiation emission.....	47
Radiation immission.....	48
Measurement methods.....	48
Stirring method.....	49
Multipoint method.....	49

Measurement antennas	50
9170 Biconical Antenna	51
9171 Isotropic Antenna	52
Directional antennas.....	53
EMF measurements with the 9102	53
Performing an automatic EMF measurement	54
Performing a manual EMF measurement.....	58
The measurement result.....	61
Analyzing and documenting EMF measurement results.....	62

Publication History**63**

About This Guide

- "Purpose and scope" on page viii
- "Assumptions" on page viii
- "Related information" on page viii
- "Technical assistance" on page viii
- "Conventions" on page ix

Purpose and scope

The purpose of this guide is to help you successfully use the 9100 Handheld Spectrum Analyzer Series features and capabilities. This guide focuses on application scenarios for the 9100 Handheld Spectrum Analyzer Series. It includes a short description of the basic usage followed by a number of application examples for both the 9101 and the 9102 Handheld Spectrum Analyzer. For a full description of all the features refer to the respective user's guides.

Assumptions

This guide is intended for novice and intermediate users who want to use the 9100 Handheld Spectrum Analyzer Series effectively and efficiently. We are assuming that you are familiar with basic telecommunication concepts and terminology.

Related information

Use this guide in conjunction with the following information:

- 9100 Handheld Spectrum Analyzer: getting started manual, M 295 204
- 9101 Handheld Spectrum Analyzer: user's guide, M 290 004
- 9102 Handheld Spectrum Analyzer: user's guide, M 290 204

Technical assistance

If you need assistance or have questions related to the use of this product, call one of Willtek's technical assistance centers. You can also contact Willtek by e-mail at customer.support@willtek.com.

Table 1 Technical assistance centers

Region	Phone number	Fax number
Europe, Middle East, Asia, Africa	+49 (0) 89 996 41 386 +49 (0) 89 996 41 227	+49 (0) 89 996 41 440
Americas	+1 973 386 9696	+1 973 386 9191
China	+86 21 5836 6669	+86 21 5835 5238

Conventions

This guide uses naming conventions and symbols, as described in the following tables.

Table 2 Typographical conventions

Description	Example
User interface actions appear in this typeface .	On the Status bar, click Start .
Buttons or switches that you press on a unit appear in this TYPEFACE .	Press the ON switch.
Code and output messages appear in this typeface.	All results okay
Text you must type exactly as shown appears in this typeface .	Type: a:\set.exe in the dialog box
Variables appear in this <typeface>.	Type the new <hostname>.
Book references appear in this typeface .	Refer to Newton's Telecom Dictionary
A vertical bar means "or": only one option can appear in a single command.	platform [a b e]
Square brackets [] indicate an optional argument.	login [platform name]
Slanted brackets < > group required arguments.	<password>

Table 3 Keyboard and menu conventions

Description	Example
A plus sign + indicates simultaneous keystrokes.	Press Ctrl+s
A comma indicates consecutive keystrokes.	Press Alt+f,s
A slanted bracket indicates choosing a submenu from menu.	On the menu bar, click Start > Program Files .

Table 4 Symbol conventions





	This symbol represents a general hazard.
	This symbol represents a risk of electrical shock.
	NOTE This symbol represents a note indicating related information or tip.

Table 5 Safety definitions

	WARNING Indicates a potentially hazardous situation which, if not avoided, could result in death or serious injury.
	CAUTION Indicates a potentially hazardous situation which, if not avoided, may result in minor or moderate injury.

Safety Notes

This chapter provides the safety notes for the 9100 Handheld Spectrum Analyzer Series. Topics discussed in this chapter include the following:

- ["Safety warnings" on page xii](#)

Safety warnings

This product is designed for indoor use. As exposure to water can damage the instrument it has to be protected against moisture when used outdoors.



WARNING

This is a safety class A equipment in accordance with EN 61326. It may produce radio interference affecting household equipment; the user may be forced to execute appropriate measures against radiation.



WARNING

Only use a 50 Ω N-type connector to connect to the **RF IN** port of the 9100. Use of any other connector may result in damage of the instrument.



WARNING

Do not cover the ventilation slits (at the bottom left-hand corner and on the top). Covering them may result in serious damage and fire.



WARNING

The maximum input power level at the **RF IN** connector is 30 dBm (1 W). Higher input levels may result in serious damage of the instrument.



WARNING

Operate the instrument within the temperature range from 5°C (40°F) to 45°C (110°F) only. Operation outside this range will lead to invalid results.



Safety advice for the battery

Do not crush. Do not heat or incinerate. Do not short-circuit. Do not dismantle. Do not immerse in any liquid, it may vent or rupture! Do not charge below 0°C (32°F) nor above 45°C (110°F).



Battery usage

The battery is for use with the 9100 only. Willtek does not accept any liability for damage of the battery or other equipment if the battery is used with other electric or electronic equipment.



Using an external power supply at the **DC IN** connector

Do not power the 9100 with any other external power supply than the one recommended and supplied by Willtek.

Overview

1

This chapter provides a general description of the 9100 Handheld Spectrum Analyzer Series. Topics discussed in this chapter include the following:

- ["About the 9100 Handheld Spectrum Analyzer Series" on page 2](#)
- ["Features and capabilities" on page 3](#)
- ["Physical description" on page 4](#)
- ["Editions, options and accessories" on page 4](#)

About the 9100 Handheld Spectrum Analyzer Series

The 9101 and 9102 Handheld Spectrum Analyzers are lightweight, full-featured spectrum analyzers for many applications:

- Used for installation troubleshooting, repair and maintenance e.g. in wireless local loop and modern 2.4 GHz Wi-Fi systems.
- Used for acceptance and installation troubleshooting of antenna and cable installations.
- Used in R&D labs to assess the electromagnetic radiation and to verify measures against EMI.
- Used in manufacturing to check and align the output of RF modules or units of RF modules.
- Used in the field to measure and verify base station emissions.
- Used in mobile phone repair to detect and locate faulty mobile phone parts and components.

Typical measurements with the 9100 Handheld Spectrum Analyzer Series include transmitter testing, alignment of modulators and measuring switch break-through. Measurement results and instrument settings can easily be transferred to a PC for presentation or post-processing.

Within the 9100 Handheld Spectrum Analyzer Series Willtek offers the 9102 Handheld Spectrum Analyzer whose capabilities can be expanded towards a scalar network analyzer by additional options such as a Tracking Generator option, the 9160 VSWR/DTF Bridge and the 9130 VSWR/DTF Reflection Measurement Option. For base station installation or maintenance engineers the 9102 offers the full scope of common performance measurements of the BTS antenna systems: Return Loss (Reflection), Tower-Mounted Amplifier (Transmission) and Distance to Fault measurement with a standard resolution of 500 points (min. 0.05 m) in one lightweight device.

This rugged instrument is suitable for stationary and mobile usage and meets many application needs.



Features and capabilities

Frequency range from 100 kHz to 4 GHz

Digital IF for accurate measurements

Auto mode for basic parameters

Six markers, up to five delta markers

Large and bright display

Small footprint, large front

Lightweight, high battery power

Remote control via RS-232 or LAN

Physical description

The 9100 Handheld Spectrum Analyzer Series is delivered with the 9100 Data Exchange Software which can also be ordered separately (order number M 897 137).

The user-accessible parts of the 9100 Handheld Spectrum Analyzer Series can be broken down into several sections:

- Front panel with large screen, softkeys, numerical, cursor, and function keys.
- Connectors accessible from the top and the left-hand side of the instrument.
- On/off switch, power supply connector and battery shelf.
- Handle which can be turned in steps to serve as a stand, allowing the instrument to be operated at an angle.

Editions, options and accessories

The Willtek 9101 and 9102 are available in several editions. Furthermore Willtek offers a wide range of accessories for the 9100 Handheld Spectrum Analyzer Series. For detailed information on editions, options and accessories and the relevant ordering numbers refer to the 9100 getting started guide or the 9102 or 9101 user's guide. Both manuals are delivered with your instrument. Furthermore you will find the latest news on editions, options and accessories on the Willtek website.

Basic Operation

2

This chapter describes the basic usage of the instrument. Topics discussed in this chapter are as follows:

- "Before first time use" on page 6
- "Using the handle" on page 6
- "Connecting the 9100 Handheld Spectrum Analyzer" on page 7
- "Powering the unit" on page 11
- "Starting measurements" on page 11
- "Using the front panel" on page 11
- "Selecting the measurement mode" on page 17
- "Changing center frequency, span, or reference level" on page 17
- "Changing RBW, VBW, sweep time, or attenuation" on page 17
- "Working with the markers" on page 18

Introduction

This chapter provides an overview on the most important basic steps and general procedures in using the instrument. The descriptions contained in this manual are intended as a quick general reference. For a detailed description of the general operation and model-specific descriptions of the overall functionality and usage refer to the 9101 or 9102 user's guide.

Before first time use

The 9101's Field and the 9102's Field, Tracking and VSWR/DTF Editions are delivered with a high-capacity rechargeable battery module. This battery must be charged before first-time use. Please allow six hours to charge the battery while the instrument is connected to an external power supply and switched off. For further information on the scope of delivery of the individual editions of the 9100 Handheld Spectrum Analyzer Series refer to the getting started manual delivered with your instrument. This manual also includes detailed information on installing and maintaining the battery module.

Using the handle



Carrying the instrument

The instruments of the 9100 Handheld Spectrum Analyzer Series can be carried easily by their handle. The handle should be kept in the upright position for transport to ensure that it is safely carried. To put the handle back in the upright position, press the button and turn the handle.

Positioning the instrument

The 9100 Handheld Spectrum Analyzer Series instruments can be used in different positions: the upright position and two tilt positions. The first tilt position is recommended when using the instrument on a work-bench. The second tilt position is useful when standing while operating the 9100.

- Put the instrument upright. With the handle in parallel with the instrument body, this takes up the least footprint. The connectors and the power switch are easily accessible from the top.
- The 9100 can also be operated in a slanted position.
 - 1 Press the button at the handle and turn the handle back a little bit.
 - 2 Release the button and continue turning the handle back. The button locks in the first tilt position.



- 3 Repeat steps 1 and 2 if you want to lock the handle in the second (and final) tilt position.
- 4 Release the instrument on the handle.

Connecting the 9100 Handheld Spectrum Analyzer

The instruments of the 9100 Handheld Spectrum Analyzer Series offer different connectors for a variety of applications. The following section describes the connectors available on the 9101 and 9102 instruments and provides information on technical data and application purposes. The connectors available on the top of the instrument differ between the 9101 and the 9102. The connectors available on the left-hand side are identical.



Figure 1 9101 connectors on the top of the instrument

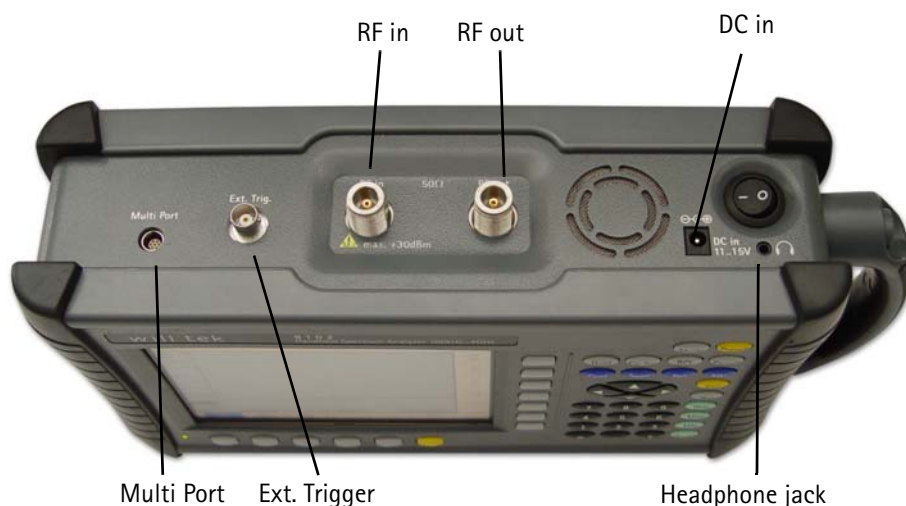

Figure 2 9102 connectors on the top of the instrument

DC IN connector

The 9100 can be operated either from the internal battery or from an external DC source such as the power supply which is delivered with the 9100, or a car battery. The DC voltage must be in the range from 11 to 15 V.

In addition, the battery is loaded when an external DC source is connected. The instrument should be switched off before connecting the DC source.

Apply the source to the **DC IN** connector at the top of the 9100.

RF IN connector

RF IN is a 50 Ω N-type connector (female).

If you have a 50 Ω shielded RF cable with an N-type connector (male) to connect to the unit under test, simply screw the connector tightly to the instrument.

If you have a 50 Ω shielded RF cable with a BNC connector (male), use an N to BNC adapter to connect the cable to the 9100. Willtek offers an appropriate adapter. For information on accessories for the 9100 Handheld Spectrum Analyzer Series refer to your getting started manual or your user's guide.



CAUTION

The maximum allowable input level at the **RF IN** connector is 1 W. Higher levels at this port can damage the instrument!



CAUTION

Only use a 50 Ω N-type connector to connect to the **RF IN** port of the 9100. Use of any other connector may result in damage of the instrument.

Take care of proper termination

Use of cables and sources with an impedance other than 50 Ω results in inaccurate measurements.

RF OUT connector **RF OUT** is a 50 Ω N-type connector (male).

This connector caters for example for tracking generator measurements. See the user's guide contained on the User Documentation CD delivered with your instrument for a detailed description of the measurement functions for which this connector is used.

NOTE

This connector is available on the 9102 Handheld Spectrum Analyzer for serial numbers 0404001 and higher.

EXT. TRIG. connector Mainly used in spectrum analysis measurements. Using this connector the unit can be provided with an external trigger signal. Here, an external device that triggers the measurement by sending an impulse can be connected for example.



WARNING

The **EXT. TRIG.** input is designed for TTL input levels only. Higher levels at this port can damage the instrument!

Multi Port In order to provide for external adapters, amplifiers and accessories the instrument offers a multifunction connector. It can for example be used to read data stored in external devices (e.g. calibration data).

NOTE

This connector is available on the 9102 Handheld Spectrum Analyzer for serial numbers 0404001 and higher.

Headphone jack In addition to the build-in loudspeaker the instrument also offers a standard 3.5 mm headphone jack. When you connect the headphones to the instrument the loudspeaker will be automatically disabled.

NOTE

This connector is available on the 9102 Handheld Spectrum Analyzer for serial numbers 0404001 and higher.



Figure 3 9100 connectors on the left-hand side of the instrument

SERIAL (RS-232) connector

This 9-pin sub-D connector on the left-hand side of the 9100 Handheld Spectrum Analyzer Series can be used to control the 9100 remotely via serial interface (RS-232). The command set and the responses conform to the SCPI standard and are explained in the user's guide.

The RS-232 connector can also be used to load and store results and settings and to update the operating software in conjunction with the 9100 Data Exchange Software. See the user's guide for more details.

To connect the 9100 to a controlling PC, use a null modem (PC to PC) cable. This cable is delivered with the 9100.

LAN connector

The 9100 Handheld Spectrum Analyzer Series can also be controlled via local area network (LAN), using a TCP/IP connection. This high-speed connection can as well be used to transfer traces to a PC or to update the system software.

The IP address can be set up in the system configuration menu or via RS-232. The 9100 can be operated in networks using 100 Mbps, but is capable of transmitting and receiving at 10 Mbps only.

Setting up the IP address, the command set to control the 9100 and the responses from the instrument are explained in the full user's guide.

Connect the instrument to the LAN with a standard LAN cable with RJ-45 connectors. Alternatively, you can connect the 9100 to a PC directly using a cross patch cable.

Powering the unit



The 9100 is switched on and off using the power switch located at the top of the instrument. It takes about 55 seconds for the 9100 to load and start its software.

Starting measurements

The 9100 starts measuring and displaying results automatically after powering the instrument. It starts in the measurement mode last active.

Using the front panel

Overview The 9100 front panel is divided into different sections as follows (the following graphic uses a 9102 front panel as an example):

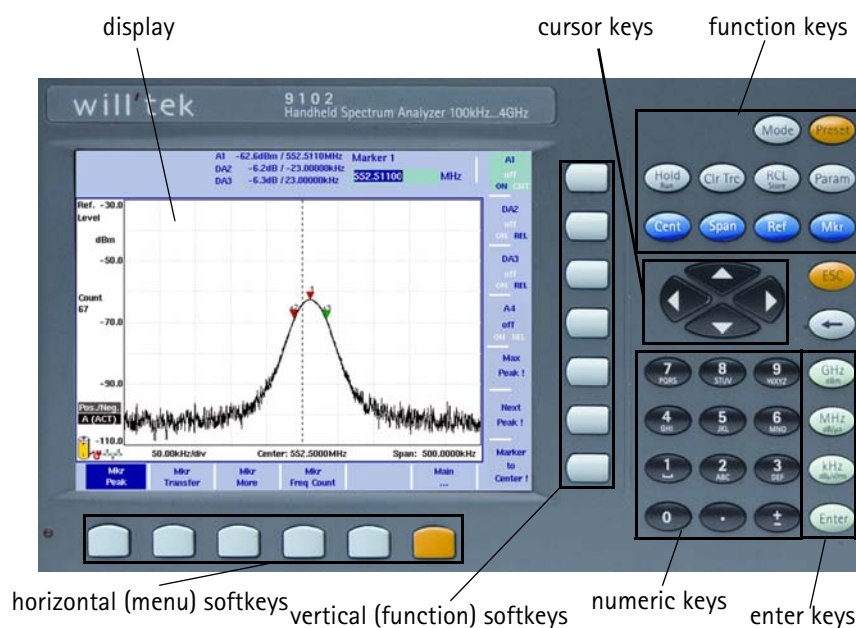

Figure 4 Front panel elements

Battery status LED

This LED has different states indicating the status of the battery. For detailed information on the LED states refer to the 9101 or 9102 user's guide or the 9100 getting started manual.

Display

The 6.5 inch display is divided into the following sections (see Figure 5):

- Results area
- Marker field
- Input field
- Softkey descriptions

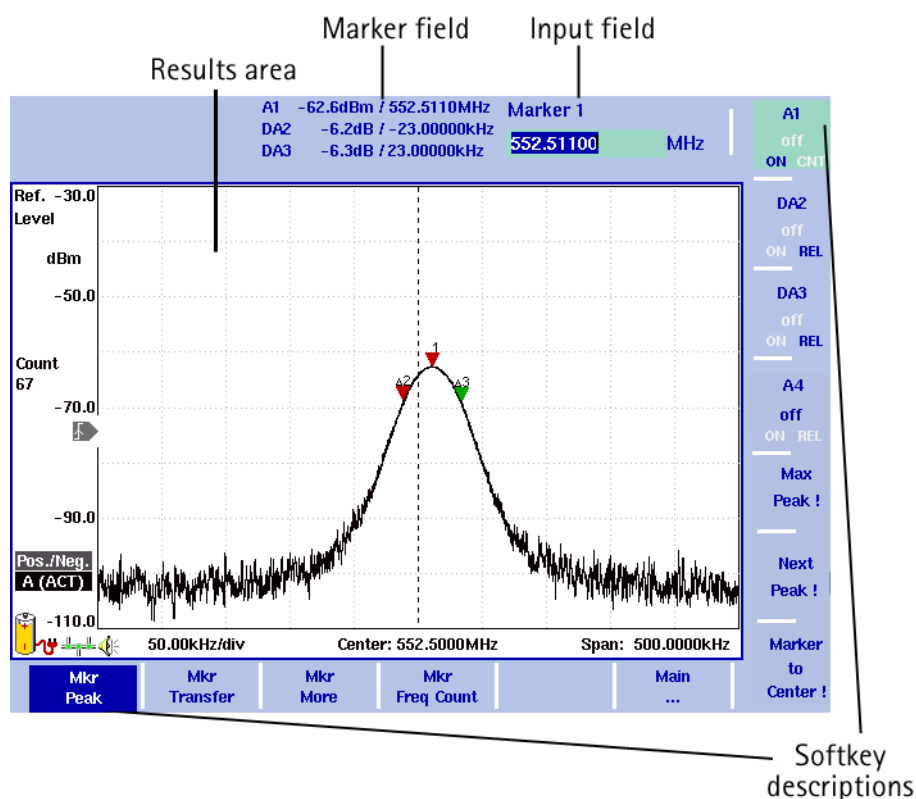

Figure 5 Display sections

Results area

The results area utilizes most of the screen and provides you with the measurement results. A grid of ten vertical and eight horizontal rows eases readability of the results from the axes. There may be one or two graphs, depending on the number of traces selected.

Marker field

A1	-68.0dBm / 2.246400GHz
DA6	2.8dB / 921.6000MHz
B5	-53.5dBm / 2.808000GHz
B2	-54.3dBm / 1.800000GHz

If any of the markers is active, the marker field is displayed, showing the measurement values at the marker positions. Up to four markers are displayed with their level and frequency values. If you use four markers and activate a fifth (up to six markers are available) one marker value will be hidden and the new one will be displayed instead. By pressing the relevant marker softkey you can display the hidden marker value again. A marker can be switched from absolute to relative values. The values are then shown relative to those of marker 1 (e.g. A1).

Input field

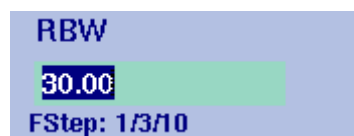

The input field allows you to enter a number or a text, depending on the selected function. The meaning of the input value is expressed by the header line. Values or text are entered using the numeric keys; the input field is closed with one of the green enter keys. Some input fields have an additional explanation of the step size beneath. The step size applies when the value is changed using the up/down cursor keys instead of the numeric keys.

Softkey descriptions

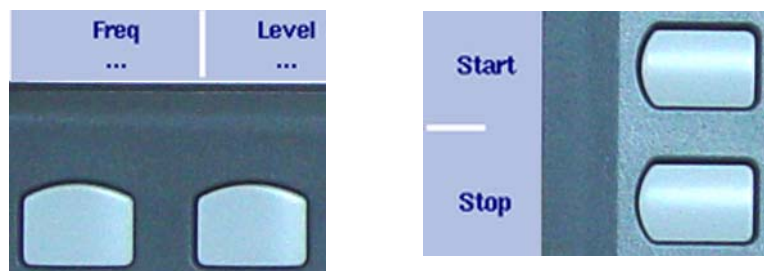

The softkey descriptions indicate the assignment of a function to a softkey. They are aligned to the lower side with the horizontal softkeys and to the right-hand side with the vertical softkeys.

Keypad

The front panel carries a large number of keys, giving you direct access to functions and menus and allowing you to enter test parameters such as the center frequency. The keypad is divided into the following sections:

Function keys



The function keys have specific functions which do not change. For further details on the function keys refer to the 9101 or 9102 user's guide.

The function keys are:

Table 1 Function keys

Key	Function
Mode 	Measurement mode selection.
Preset 	Presets all the entry fields of the selected mode to the factory default settings.
Hold/Run 	Stops and starts sweeps.
Param 	This function key calls up the parameter pages summarizing the current settings.
Rcl/Store 	Provides access to the Memory menus.
Clr Trc 	Resets previous results, sweep counter and failure counter and starts a new sweep.
Cent 	Direct access to the center frequency input field within the Frequency menu.
Span 	Direct access to the frequency span input field within the Frequency menu.
Ref 	Direct access to the reference level input field.
Mkr 	Access to the Marker menu.

Cursor keys



In an input field, the up and down cursor keys are used to increase or decrease the current value. The left and right cursor keys move the cursor position by one digit.

If a marker field is active, the up and down cursors move the marker by half a division up or down, respectively. The left and right cursor keys move the marker pixelwise.

Immediate reaction

Any change of an input parameter with the cursor keys has immediate effect. With the straight feedback on the screen, you can easily adjust parameters to the optimum values with a trial-and-error approach.

Numeric keys



The numeric keys allow you to enter a value in a way similar to a pocket calculator. On some input fields, you can enter text instead, as on a mobile phone.

Invalid entries

If you enter an invalid number or string, the 9100 beeps and corrects the entry to the closest valid value.

Enter keys

Any input of numerical or alphanumeric entries must be closed or can be affected by one of the enter keys. The meaning of the individual enter keys is as follows:

Table 2 Enter keys





Key	Function
	In frequency input fields, closes the entry by applying the unit GHz (gigahertz). In power input fields, assigns the unit dBm to the entered value.
	In frequency input fields, closes the entry by applying the unit MHz (megahertz). In power input fields, assigns the unit dB to the entered value. In time parameter input fields, assigns the unit μs to the value.

Table 2 Enter keys

Key	Function
kHz/dB μ V/ms 	In frequency input fields, closes the entry by applying the unit kHz (kilohertz). In power input fields, assigns the unit dB μ V to the entered value. In time parameter input fields, assigns the unit ms to the value.
Enter 	Confirms an entry without a unit and with the units hertz and seconds.

Escape key



Pressed while an input field is open, this key closes this input field without changing the previous value. Pressed within a menu the key leads to the main menu.

Backspace key



Deletes the last entered alphanumeric (backspace).
When an input field is entered, all digits are marked. By pressing the backspace key, the entire entry is deleted.

Softkeys

The functions of the softkeys change with the description on the screen given next to the respective key.

Horizontal (menu) softkeys

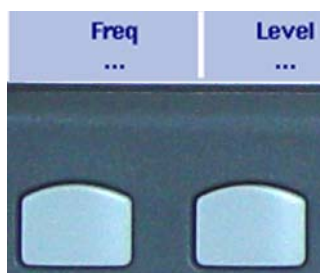

The horizontal softkeys provide access to the various menus. The active menu is highlighted; the functions and parameters within a menu are offered on the vertical softkeys.

Vertical (function) softkeys



The vertical softkeys allow you to change the settings of the 9100.

Entering numbers and text

Whenever an input field is open, it expects you to enter either numbers or characters (where characters may also include numerical digits). You will notice immediately what the 9100 expects as the numeric keys have the appropriate function. When the 9100 software expects a numerical entry, pressing a numeric key results in the appropriate digit to appear in the input field. When all digits, the sign and the decimal point have been entered as required, one of the enter keys must be pressed. Numbers often carry a unit with them; the enter keys provide the appropriate units. Some input fields can be filled with alphanumeric text instead. The numeric keys can then be used to enter characters. The keys may have several letters or numbers assigned. For further details on entering numbers and text including the assignment of keys for alphanumeric text entry refer to your 9101 or 9102 user's guide.

Selecting the measurement mode

The 9100 provides different measurement modes enabling you to select between different predefined types of measurements for specific applications. To select a measurement mode press the **MODE** function key. The Mode menu will be displayed. Choose the required measurement mode by pressing the appropriate softkey. For a detailed description of the measurement modes refer to your 9101 or 9102 user's guide.

Changing center frequency, span, or reference level

These functions are easily accessible from the main menu.

- 1 Push the respective function softkey on the vertical softkey bar.
- 2 Enter a new value.
- 3 Close the input field by pushing one of the enter keys.

The change takes effect immediately.

Changing RBW, VBW, sweep time, or attenuation

These parameters are accessible from the main menu. They can be changed automatically by the 9100 with a change of any of the other parameters, or can be adjusted manually.

In the main menu, the vertically aligned keys for resolution bandwidth (RBW), video bandwidth (VBW), sweep time, and attenuation indicate whether the parameter is in auto(matic) or manual mode: The current setting is highlighted.

Switching to automatic mode

To change the setting from manual to automatic, proceed as follows:

- 1 Push the function softkey once.
The function softkey is activated. This is indicated by highlighting the softkey.
- 2 Push the same function softkey for a second time.
The highlighting of "manual" disappears and "auto" is highlighted instead. Next time you change any of the other values, the parameter in automatic mode is changed by the instrument for best results and visibility.

Switching to manual mode

When the function softkey is set to automatic, you may want to adjust the parameter manually. Or you may want to adjust another parameter without the function in question being changed automatically. Both can be achieved by setting the function softkey to manual mode.

You can switch to manual mode

- either by selecting the function softkey and then entering a new input value,
- or by selecting the function softkey and pushing it again to change from auto to manual mode.

Working with the markers

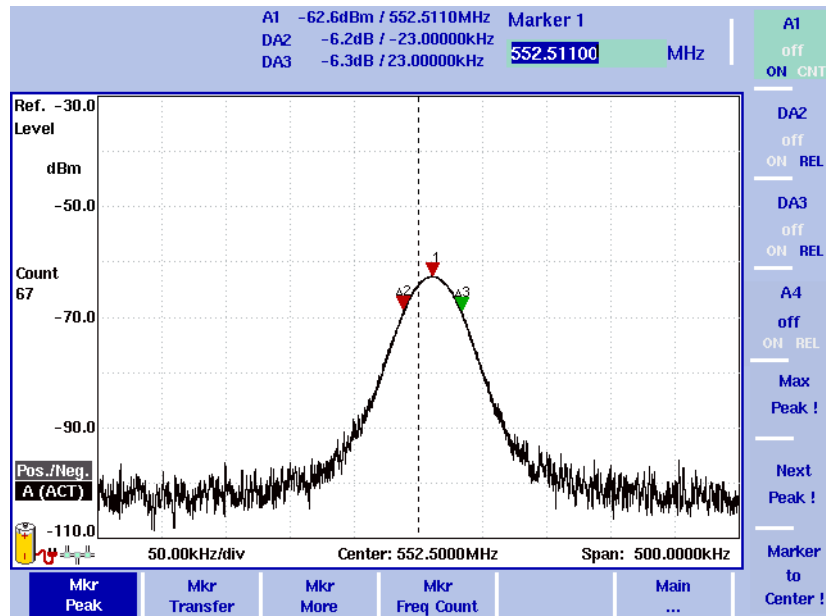

Figure 6 Example of markers

The 9100 includes powerful and easy-to-use marker functions. Up to six markers can be used; up to five of them can be delta markers.

Markers are easy to place and you can easily affect the center frequency and the reference level upon a keypress. If you use two traces you can also use markers on trace A and trace B. The markers are named accordingly (e.g. A1, B1). Delta markers are identified by D (e.g. DA1).

It is important to note that if you place the cursor on a signal peak and then reduce the span, the marker position may be offset a little from the peak. This is due to the limited resolution of the displayed frequencies when using a wide span. After reducing the span, the marker should be readjusted to the new peak.

You can enable or disable markers or defining them as delta markers by selecting Marker in the measurement mode's main menu or by pressing the **MKR** function key in any menu. For further details and instructions concerning markers refer to your 9101 or 9102 user's guide.

Typical Applications

3

This chapter describes typical applications of spectrum analysis and how to solve concrete measurement tasks using the 9100 Handheld Spectrum Analyzer Series. The topics discussed in this chapter are as follows:

- ["Taking measurements on a burst or clocked signal" on page 26](#)
- ["Analyzing spurious signals, temporary spikes and glitches" on page 30](#)
- ["Testing a passive device in transmission mode" on page 32](#)
- ["Antenna measurements" on page 34](#)
- ["EMF measurements" on page 46](#)

Introduction

This chapter gives an overview on typical applications for the 9101 and 9102 Handheld Spectrum Analyzer. It concentrates on typical measurement tasks describing the relevant application's background and showing how to solve the tasks using the 9100 Handheld Spectrum Analyzer Series. As the measurement modes available differ between the two models of the series some measurements are model-specific. If this is the case, the relevant section specifies the model offering the measurement mode required for performing the measurement described. If there is no information concerning the model the application example applies to both the 9101 and the 9102 Handheld Spectrum Analyzer.

Taking measurements on a sine wave signal

A sine wave is a typical signal being measured because it appears at many places in radio and electronic equipment. For example, a sine wave is the basic signal from which clock signals in computers are generated. Also, two sine waves can be the product of a carrier and a modulating audio tone.

Typical parameters of the sinusoidal (sine waveform) signal are level, frequency, and harmonics. These can be easily measured with the instruments of the 9100 Handheld Spectrum Analyzer Series.

Frequency and level measurements

The correct frequency is vital for radio and computer equipment to work properly. For computers, a deviation of 10% may be tolerable, but radio signals must apply frequencies with a tolerance of less than 1%.

In most cases it is also important that the level (power or voltage) of the sine wave is at least in the right order of magnitude. Before being able to take a measurement, the spectrum analyzer must be set up to display the signal in the right frequency range and with optimum reference level and attenuation.

In order to view a specific frequency range, for example close around the carrier frequency of the signal to be measured, the horizontal scale can be adjusted. The frequency range measured and displayed is usually called frequency span.

Any signal has its own amplitude. A very large signal may exceed the upper limit of the display, while a very low signal may be hidden in the noise floor at the bottom end of the display. The noise floor comes from the fact that any spectrum analyzer has a limited dynamic range, that is the range between the lowest and highest signal it can measure accurately. To reach the best dynamic range for the signal that you want to measure, it is important to adjust the reference level, that is the level at the top of the display. Most spectrum analyzers automatically adjust the internal attenuation when the user selects the reference level, so that the analyzer shows the best possible level range for the selected reference level.

Let's assume that we expect a sine wave signal at 10 MHz. This frequency is comparatively low and it is sufficient to view the spectrum from 0 to 20 MHz which narrows down the displayed spectrum to the significant range and provides a reasonable frequency resolution. If the expected sine wave frequency is significantly higher, it is more useful to select a range of a couple of Megahertz around this frequency.

The following steps help to analyze the signal frequency and level:

- 1 Press **PRESET** to set the 9100 to a known state.
The start and stop frequencies are 0 and 3.6 GHz, respectively, so the spectrum in this range is visible, with a line representing the sine wave signal at 10 MHz.
- 2 Set the stop frequency to 20 MHz by pressing the **Stop** softkey, entering **20** on the numerical keypad and pressing the **MHZ** function key.
A signal curve appears in the right half of the display, with the peak at 10 MHz. This is a view of the signal at a higher resolution of the bandwidth.
- 3 It may be necessary to enhance the dynamic range displayed on the screen by adjusting the reference level (the maximum displayed level); this sets the internal attenuation of the 9100 accordingly:
Press the **Ref. Level** softkey and push the **UP/DOWN** cursor keys so that the signal peak appears about 5 to 10 dB below the top.
This leaves enough margin for temporary changes of the signal level.
- 4 You may see a relatively high noise floor. This can be decreased by averaging the measurements: Select **Trace > Mode: A Average**.

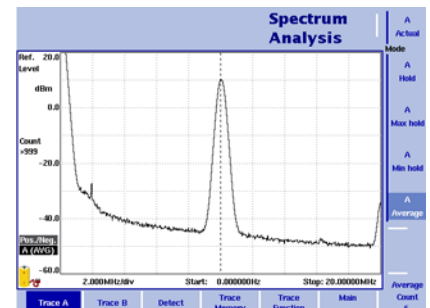
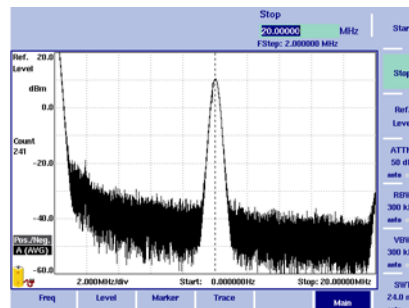

- 5 One or several markers can be set to point to individual frequencies of the measured spectrum. The numerical values for level and frequency at these points are displayed at the top:
Push the **MKR** function key to set a marker at the highest peak.
If no higher signals are present, this will set a marker, indicated by a small triangle, at the peak of the signal to be measured.
- 6 If you need the frequency displayed with higher accuracy, select a smaller frequency span (range) around the signal:
 - Press **Marker to Center**.
This centers the signal on the display.
 - Press the **SPAN** function key and enter a lower value, e.g. 1 MHz.

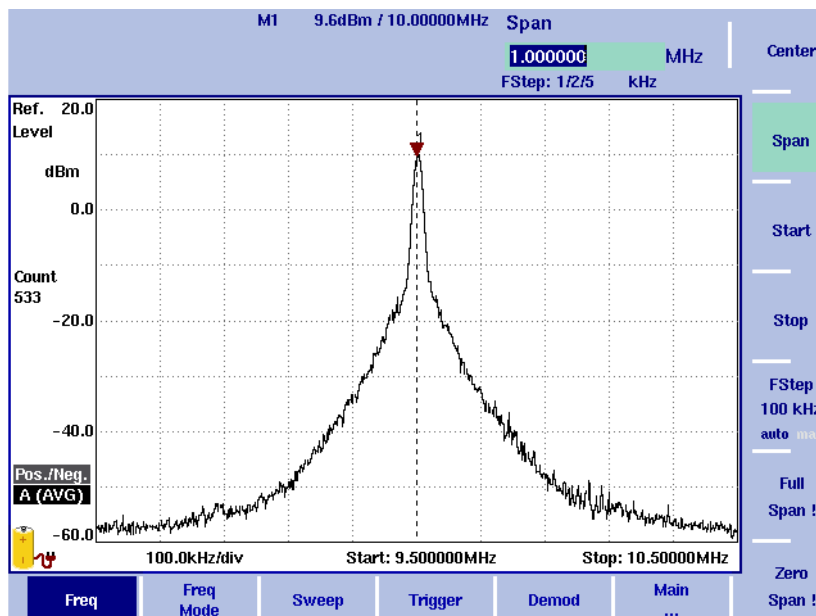

Harmonics

Harmonics appear when the sine wave signal is of low spectral purity. In extreme cases, the signal has many strong harmonics because the signal isn't really a sine wave but e.g. a square wave. The signal is then composed of a main wave and harmonics. These harmonics may be multiples of the main wave or multiples of a modulating frequency. This means they can be in the range of 100 kHz around the carrier or may be multiples of the original frequency.

While a square wave generates wanted harmonics, unwanted harmonics are called spurious emissions.

Frequencies with harmonics can best be tracked with the markers. Markers point to a displayed frequency (and level), so the resolution at which a point on the measurement curve is measured depends on the frequency resolution on the screen. The smaller the frequency span, the higher the frequency resolution on the display and hence of the marker. When reducing the span, it can be a good idea to readjust the markers to benefit from the higher frequency resolution.

To check spurious emissions and harmonics, proceed as follows (from the last example):

- 1 Select a small frequency span (range) of ± 250 kHz around the signal:
 - Press **MKR > Marker to Center**.
This centers the signal on the display.
 - Press the **SPAN** function key and enter a lower value, e.g. 500 kHz.

- 2 Add markers and place them on the next significant peaks (several dB above the slope of the signal):
 - Press the **MKR** function key.
 - Press the **A2** softkeys followed by several pushes on **Next Peak** until the marker is on the next significant peak.
 - Press the **A3** softkeys followed by several pushes on **Next Peak** until the next significant peak is reached.
- 3 Turn the absolute markers A2 and A3 into delta markers indicating values relative to marker A1:
 - Press the softkey **A3** until **REL** is highlighted. The marker is now indicated as a delta marker, DA3 instead of A3.
 - Press the softkey **A2** until **REL** is highlighted. The marker is now indicated as a delta marker, DA2 instead of A2.
- 4 Check the spectrum and the markers: Are additional peaks high enough to seriously affect the signal quality? How high are they relative to the main signal (sine wave)? The pass/fail criteria for the spurious emissions depend on the actual signal requirements.

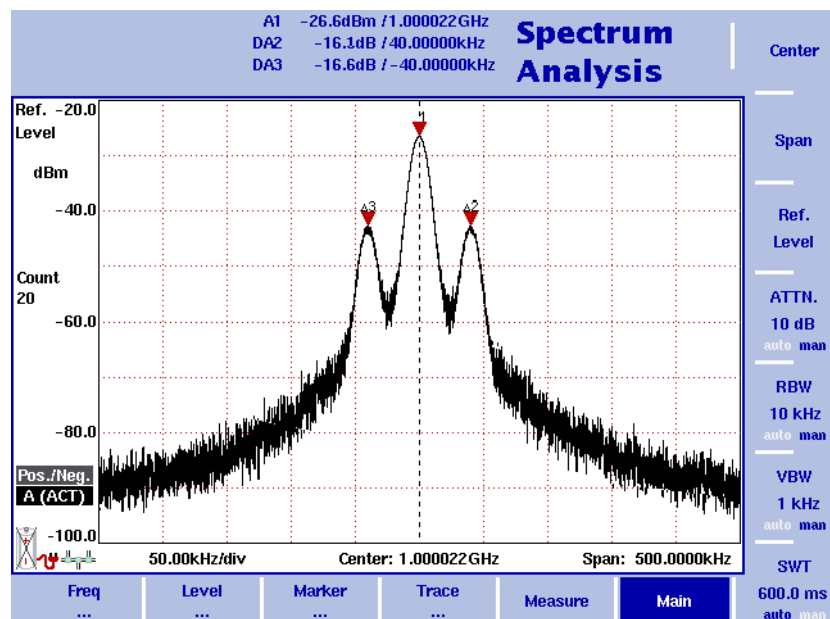

- 5 Select a larger frequency span of at least five times the original signal to observe harmonics:
 - Select **SPAN**, enter **70** and close the input field with the **MHZ** enter key.
- 6 Place delta markers DA2 and DA3 on the second and third significant peak:
 - Press **MKR** > **DA2** > **Max Peak** > **Next Peak** (repeat **Next Peak** if the peak found does not differ much from the surrounding level).
 - Press **DA3** > **Max Peak** > **Next Peak** > **Next Peak** (repeat **Next Peak** if the peak found does not differ much from the surrounding level).

- 7 Check the spectrum and the markers: Are additional peaks high enough to seriously affect the signal quality? How high are they relative to the main signal (sine wave)? The Pass/Fail criteria for the harmonics emissions depend on the actual signal requirements.

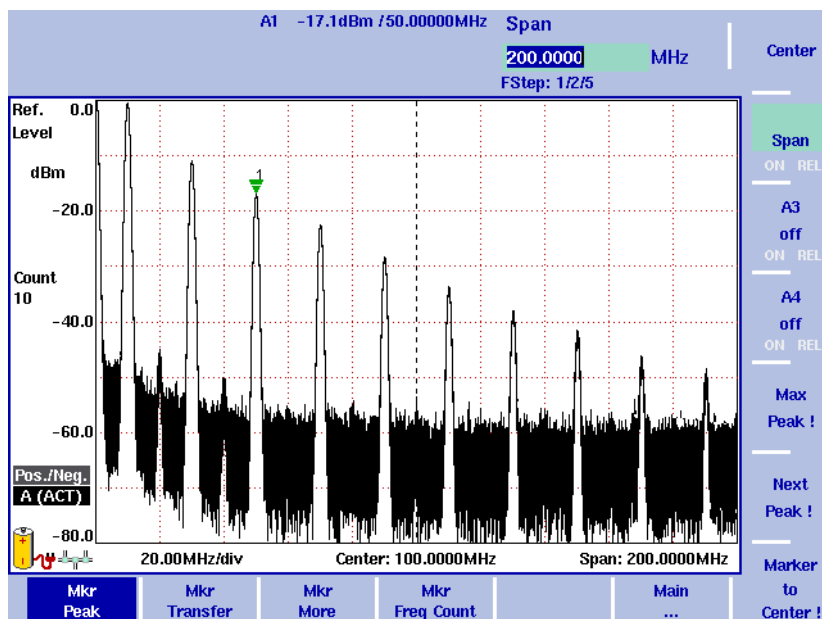

Taking measurements on a burst or clocked signal

Burst or clocked signals combine the characteristics of modulated signals with those of discontinuous signals. Modulated signals, on the one hand, have a wider spectrum that may vary to a certain extent. On the other hand, discontinuous signals appear and disappear, so the right moment for taking measurements is important.

The spectrum of a modulated signal does not have a constant single peak but consists of a wider lobe (e.g. about 50 kHz for a typical FM radio signal, 800 KHz for a GSM signal or 1.2 MHz for an IS-95 CDMA signal). As the information transmitted on the carrier isn't always the same, the spectrum slightly varies. So if the typical spectrum is of importance, it is a good idea to average the spectrum measurements. If, however, the worst-case spectral components shall be measured, you will want to view the peaks from several spectrum measurements and hence the max hold mode should be selected.

Periodic, discontinuous signals can be measured, but require additional settings to ensure that the measurements include the active part of the signal; otherwise the Willtek 9100 Handheld Spectrum Analyzer Series could measure during time intervals when the signal is not present. In addition to the modulation spectrum, the burst length and shape are important parameters. These can be measured in the time domain, not in the frequency domain.

The following considerations should be made when measuring time-domain parameters:

- Measuring in the time domain means that the spectrum analyzer displays the signal over time, not over frequency, that means the frequency span is zero.
- The start of the measurement should be triggered by the rising edge of the signal, that means a signal level threshold must be defined that is above the noise floor and below the level when the signal is active (on).
- The duration of the measurement (sweep time) must be equal to or exceed the length of the burst, otherwise only a part of the burst will be shown.

Measuring frequency-domain parameters requires slightly different considerations when setting up the spectrum analyzer:

- Defining a video trigger in the frequency domain makes no sense because the frequency observed by the spectrum analyzer is changing permanently.
- The duration of the measurement (sweep time) should be so high that for each measurement point, the interval of at least two bursts is measured to ensure that the measurement includes the wanted signal. Note that the spectrum measured this way includes both modulation and switching components.

The following example is the measurement of a burst signal from a GSM mobile phone transmitting on channel 63, that means on a carrier frequency of 902.6 MHz. The signal level at the input of the spectrum analyzer is -10 dBm.

To take measurements, proceed as follows:

- 1 Press **PRESET** to set the 9100 to a known state.
The start and stop frequencies are 0 and 3.6 GHz, respectively.
- 2 Press the **CENT** function key and enter the center frequency of 902.6 MHz.
- 3 Press the **SPAN** function key and enter a span of 1 MHz.
A chopped version of the spectrum appears.
- 4 Change the sweep time to the maximum: Select **Main > SWT** and enter 5 s.
The spectrum appears; the positive/negative peak detector is enabled and thus the display shows both values with a black line between peaks for each frequency point.
- 5 To eliminate the black lines, select the positive peak detector: Press **Trace > Detect > Detector: Pos. Peak**.
A curve appears as shown in the following picture.

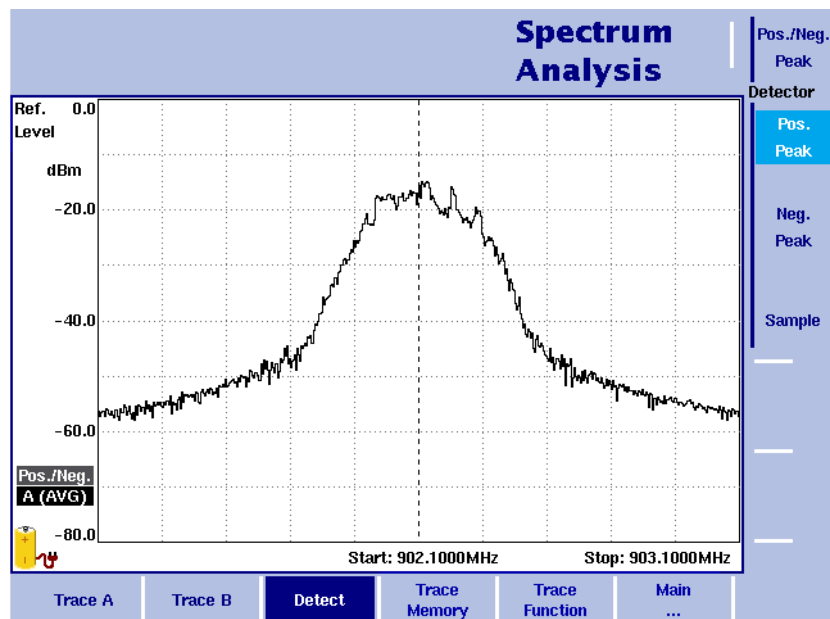

- 6 To measure the level over time, press **SPAN** and select 0 MHz.
- 7 Set a measurement bandwidth that includes the significant spectrum components: Press **Main > RBW** and enter 1 MHz.
- 8 Select a sweep time slightly higher than the burst length: Press **Main > SWT** and select 1 ms.
- 9 Set the video bandwidth to a high level to avoid smoothing to corrupt the signal shape: Press **VBW** and enter 1 MHz.
Burst measurements appear in arbitrary intervals.
- 10 Enable the video trigger with a trigger threshold of about 40 dB below the burst level: Press **Freq > Trigger > Video** and enter -50 dBm.
Burst measurements appear frequently.
- 11 Burst flatness: Use a marker and a delta marker to view variations of the power level in the active part of the burst.
- 12 Burst versus noise level: Use a marker and a delta marker to view the difference between the signal level and the noise level (in the picture below, the difference is 45.9 dB).

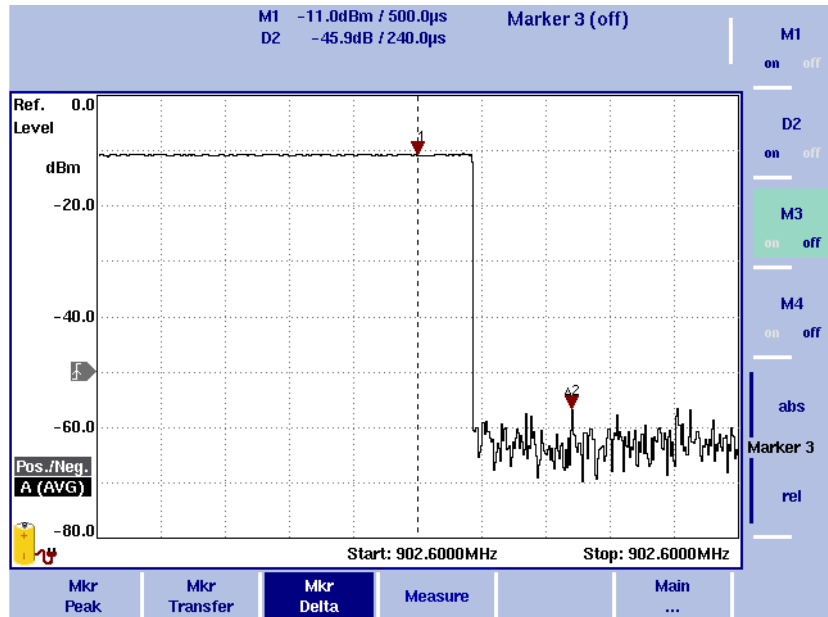

13 Burst length: Place a marker at the beginning of the burst and a delta marker at the end of the burst. Read the burst length (582 μ s in the example below).

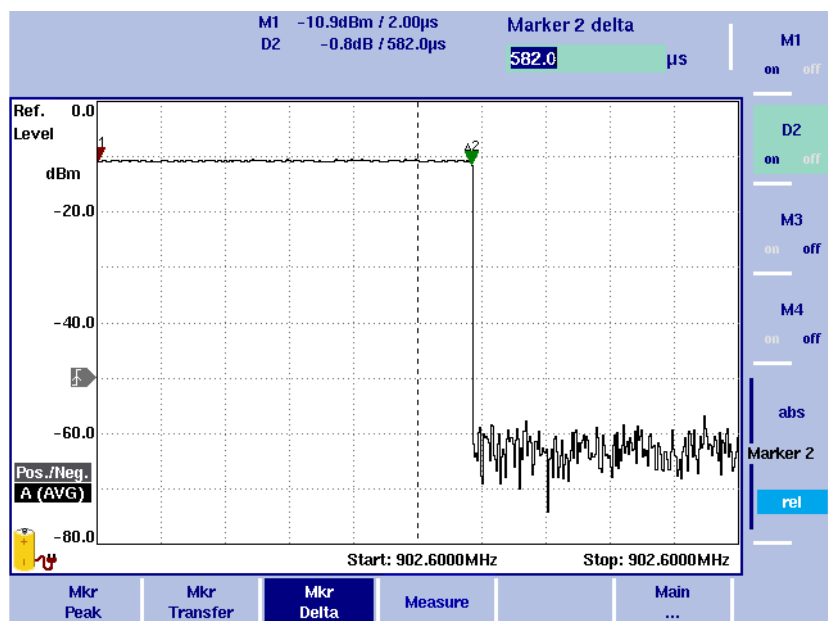

Analyzing spurious signals, temporary spikes and glitches

Spurious signals are components close to or far from the desired frequency band. They are part of the overall signal, although usually outside the frequency range containing the desired signal, and can originate from crosstalk or active components in the electronics.

Temporary spikes and glitches result in spectrum components that may not be observed immediately on the spectrum analyzer. It takes some time and a peak-hold function to get them onto the screen.

Spurious signals and temporary spikes may be tolerable within certain limits, but may harm system performance when they exceed the limits. On the 9100, limit lines can be used to mark go/nogo areas and a Pass/Fail verdict clearly indicates if the signal is inside or outside limits.

Markers and delta markers can indicate the frequencies at which critical signal components occur and can be used to read absolute levels as well as levels relative to the main signal component.

These unwanted signal components can be analyzed as follows:

- 1 Press **PRESET** to set the 9100 to a known state.
The start and stop frequencies are 0 and 3.6 GHz, respectively.
- 2 Press **CENT** and enter the center frequency of the signal to be observed.
- 3 Press **SPAN** and enter a frequency range to be observed, e.g. 100 MHz.
- 4 Select **Main > Trace > Mode: A Max hold** to catch intermittent signals.
After some time, the display may look as follows (wanted signal at the center frequency, two spurious or unwanted signals).

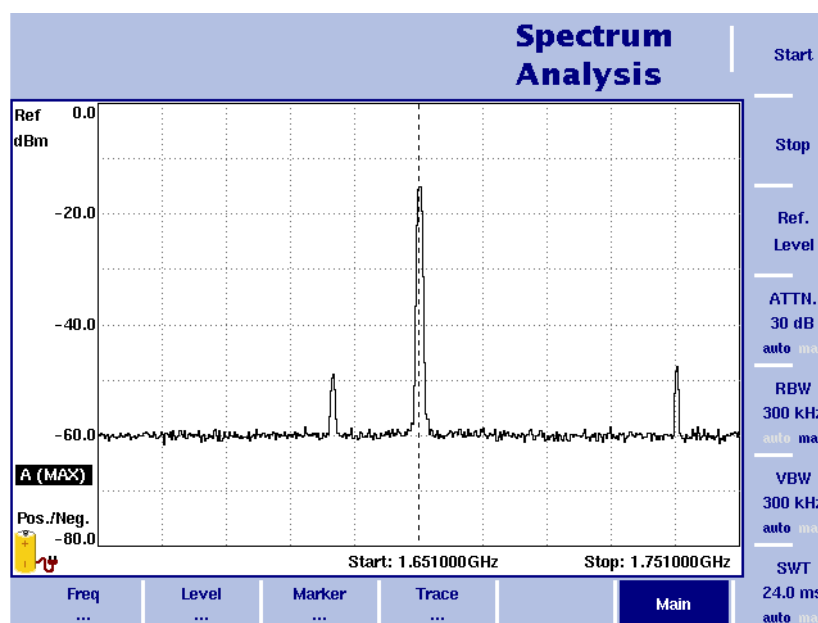

- 5 If you need this measurement frequently, it might be a good idea to define a template, that means limit lines. These can form the basis for a clear pass/fail statement that is easy to read and understand.
The limit lines (template) can be defined on a PC. For further details refer to your 9101 or 9102 user's guide.
- 6 To load the template (limit lines) from the PC to the 9100, first save it locally on the PC and then press **Send to 9100**.
- 7 Press **Level > Memory > Recall Limits** to select one out of a number of available templates.
- 8 Select **Limits Evaluation > Upper Limit** to enable the limits (upper limit).
The template or upper limit is drawn and the 9100 displays a pass or fail indication at the upper left-hand corner.

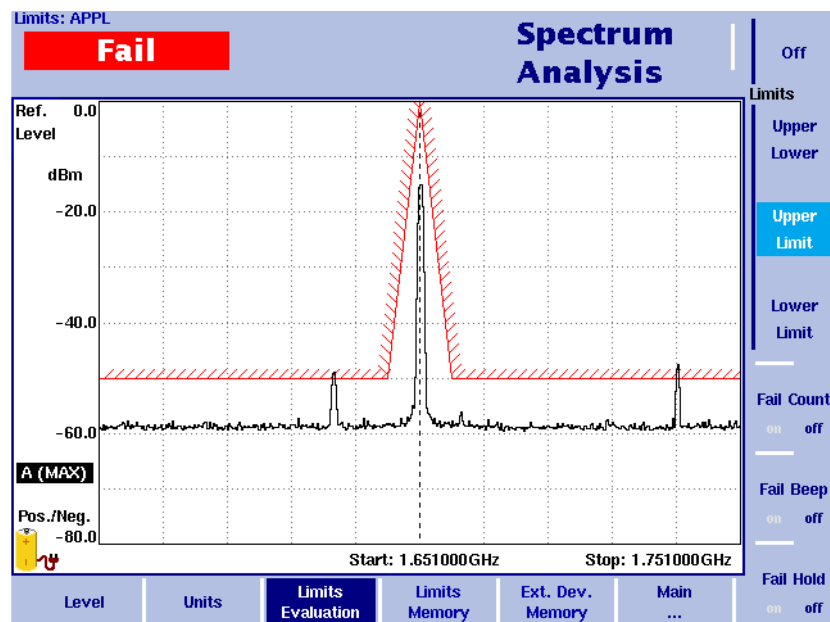

- 9 Enable markers and place them on the wanted signal and the spurious signals: Press the **MKR** function key to enable the Marker menu and the first marker, which is placed on the highest peak. Press **A2** and move it to the spurious signal by pressing **Next Peak** several times. Repeat this step with **A3** and the next spurious signal.
Frequency and level of the spurious signals are indicated at the top.
- 10 Enable delta markers for A2 and A3 by pressing the softkeys **A2** and **A3** until **REL** is highlighted and the markers are indicated as delta markers by DA2 and DA3.
You can now view the frequency and level of each spurious signal relative to the wanted signal, which is required in many specifications and signal comparisons.

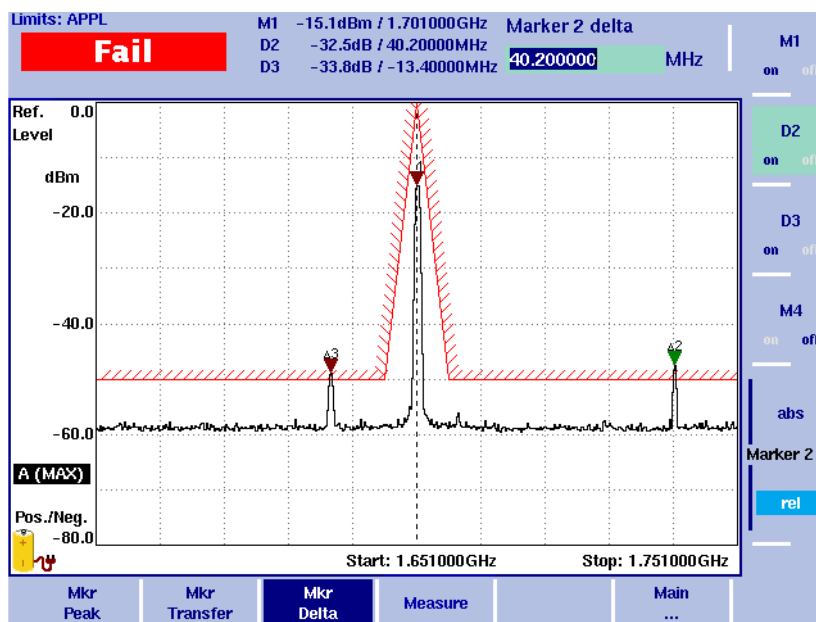

Testing a passive device in transmission mode

In the 9102's transmission mode you can test the frequency behavior of active and passive devices. An example for an application of this mode is testing the frequency behavior of a bandpass filter which transmits a band of frequencies and blocks or absorbs all other frequencies not in the specified band.

NOTE

The transmission mode is available on the 9102 Handheld Spectrum Analyzer (Tracking and VSWR/DTF edition) and is model-specific.

To test the frequency behaviour of a bandpass filter proceed as follows:

- 1 Push the **MODE** function key.
The Mode menu appears. Select **Tracking ... > Transmission**.
The Transmission main menu appears. Establish a cable connection between the **RF IN** and the **RF OUT** connectors.
- 2 In the Transmission main menu press the **Tracking Generator** softkey.
- 3 In order to eliminate slight ripples in the display press the **Normalize A** softkey until "on" is highlighted. The message "Normal.d" on the left side of the result display indicates that the display is normalized.
- 4 Open the connection between the **RF IN** and the **RF OUT** connectors and connect the bandpass filter to the instrument.
The following picture shows the bandpass filter measurement setup.

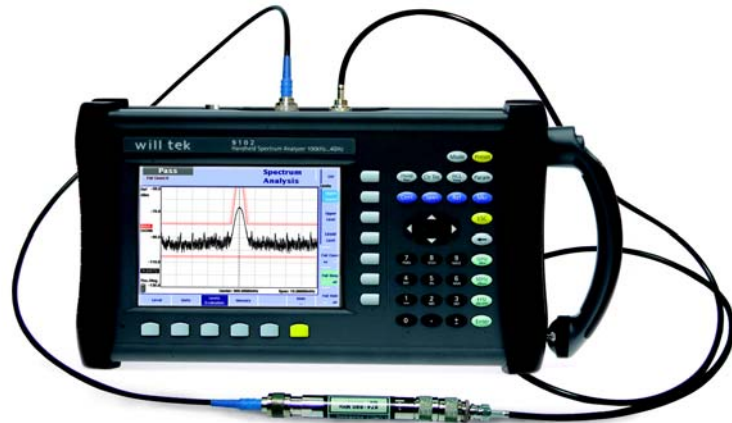

- 5 In order to examine the signal displayed in more detail you can change the center frequency. Furthermore you can change the parameters for level, tracking output, start and stop frequency, span and hardware attenuation. For detailed descriptions of these processes, refer to your 9102 user's guide.

NOTE

If you change measurement parameters, e.g. tracking output, frequency settings or attenuation, it may be necessary to repeat the normalizing procedure. If this is the case, the message "Normalize" will be displayed against a red background on the left side of the result display.

- 6 The result display shows the frequencies which are transmitted and the frequencies which are blocked by the bandpass filter.

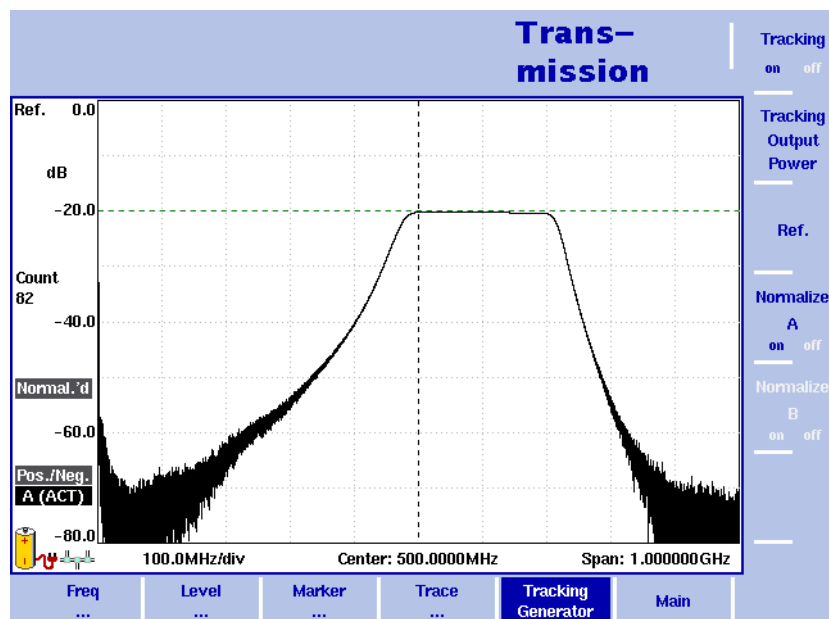

Antenna measurements

A very important application area of the 9102 Handheld Spectrum Analyzer consists of antenna measurements for the purpose of antenna performance analysis during installation, maintenance and acceptance-testing of antenna systems. The three core components of mobile radio systems, base station, antenna system and connection to the core network or switching, are often installed by different companies. Every company has to perform an acceptance test and document the quality of their work. The following sections show how to test and document antenna system quality using the Willtek 9102 Handheld Spectrum Analyzer in conjunction with the 9130 VSWR/DTF Reflection Measurement Option and the 9160 VSWR/DTF Bridge.



Introduction

Modern transmitter sites for mobile networks consist of a base station, the connection to the core network (via a dedicated line or a radio link) and the antenna system. The antenna system in turn consists of flexible, thin jumper cables going from the base station to the tower, rigid feeder cables with a low loss going up the tower to the antennas, the antennas themselves as well as possibly additional devices like amplifiers and downtilt controls. The quality of the installed system is influenced by cables, connectors, integrated filters and amplifiers. Transmission quality is especially influenced by mechanical aspects. For example, if cable connectors are not properly bolted together or cables are squeezed or bent too tightly, this can have adverse effects on transmission quality.

Usually the antenna system is installed before the base station is delivered. The system can thus be tested starting from the antenna connectors. The system components are designed for transmission of high frequency signals with an impedance of 50Ω . Ideally, on applying such a signal to the antenna cable it will be transmitted via the antenna without any reflection. Any discontinuity in the cable, a short circuit or any other change in the impedance (e.g. by a tight bent in the cable) will cause at least part of the transmission power to be reflected. The reflected power is in this case no longer available to the mobile network's subscribers and will be returned to the power amplifier. The resulting standing waves cause an excess in voltage and may in the worst case damage or destroy the amplifier or integrated filters.

Apart from this there can also be other adverse effects which may be less dramatic, however still damaging the reputation and image of the mobile network provider. Less than optimal transmission on the antenna cable may cause calls to be dropped or handovers from one base station to the other to fail. This means that the mobile connection cannot be used which in turn leads to an avoidable loss of earnings for the network provider. Customer satisfaction on the other hand is crucial for a network operator's image and reputation. An even more serious scenario occurs, if networks operated or rented by government institutions or public safety organisations cannot be used due to bad antenna systems. This can result in damage of property or even loss of human lives.

An optimal antenna system construction is therefore crucial in order to ensure optimal coverage and prevent material fatigue.

Measurement types

The most common antenna measurements performed during antenna system installation, maintenance and acceptance testing are the reflection and the distance-to-fault (DTF) measurements.

Reflection measurements

Using reflection measurements you can test transmission quality in the sender and receiver range and assess the match of the antenna system's components. Within the measurement instrument the reflection is measured via a Wheatstone measurement bridge. Willtek offers the 9160 VSWR/DTF Bridge for this purpose. Thus an impedance measurement is performed. Even a small impedance error causes a relatively high voltage change and can therefore easily be measured. The impedance measured will then be converted into a reflection factor and displayed on the instrument.

The two most common parameters are Voltage Standing Wave Ratio (VSWR) and return loss. Using the reflection measurement mode of the 9102 Handheld Spectrum Analyzer you can display the measured value either as return loss, VSWR or other custom units, e.g. reflection coefficient (ρ) or reflected power ratio.

The Voltage Standing Wave Ratio is often stated for high frequency devices. The measurement value is linear and higher than, or ideally equal to 1. The VSWR is displayed as a function of the frequency. For antenna systems limit values are usually specified for specific frequency ranges.

The course of the return loss is displayed as a logarithmic value in dB. In contrast to the linear display also smaller reflections are clearly visible on the graphical display. For a total power reflection of 10 % the measurement instrument will show a return loss of 10 dB. In mobile radio systems an antenna system with a return loss of 17 to 20 dB is considered to be of good quality.

Distance-to-fault measurements

In addition to testing transmission quality in the sender and receiver range antenna system quality can also be assessed in view of fault locations. Cable kinks, bad connections at the transition between jumper and feeder cables as well as a partial short circuit may have adverse effects on transmission quality, especially in the longer term. With the distance-to-fault measurement you can determine cable faults of this kind. This measurement is based on the local impedance change caused by the cable fault. The measurement instrument performs an internal reflection measurement in the frequency range and transforms the result via inverse FFT into the time domain. If the propagation velocity of the cable is known, the instrument can then transform the results into the location domain. As a result the instrument graphically displays the reflection behaviour as a distance function. A cable kink can thus be easily be recognized, its position can be determined via the distance information displayed.

Performing antenna measurements using the 9102 in the field

The 9102 Handheld Spectrum Analyzer in conjunction with the 9130 VSWR/DTF Reflection Measurement Option and the 9160 VSWR/DTF Bridge offers VSWR/DTF measurement modes for performing the antenna measurements required for assessing the quality of an antenna system and described in the previous sections:

- Using the reflection measurement mode all functional parameters relevant for reflection measurements are available at a glance. This mode enables you to test performance and match of antenna systems over the desired frequency range in one view.
The reflection measurement modes offers scalar and vector reflection measurements and displays all common reflection measurement units such as return loss, rho, VSWR and the reflected power ratio.
- The distance to fault measurement mode enables a detailed analysis of the antenna feeder cables with a total length of up to 2000 m. Using this measurement mode you can easily detect and locate weak connectors, cable kinks, water ingress or other cable-related problems. Even small reflections are detected and result in a displayed distance to fault. For performing a distance to fault measurement the cable characteristics have to be entered. Willtek provides predefined cable parameter files for most known coaxial cables used for antenna installations. These parameter files can easily be uploaded to the 9102. However, the parameters for rare cable types can be set step by step on the instrument.

Preparative steps Before you actually start a reflection or distance-to-fault measurement the following preparative steps are necessary.

Connecting the 9160 VSWR/DTF Bridge

The 9102 in its Tracking or VSWR/DTF edition includes a tracking generator whose signal is transmitted via a separate port. For testing antenna and cable systems the sent and received signals are coupled via a measurement bridge. Thus measurements can be performed from the end of the cable connected to the base station. Willtek offers the 9160 VSWR/DTF Bridge as a tailormade measurement bridge for the 9102. This bridge is a Wheatstone measurement bridge, an electrical bridge circuit for the precise comparison of resistances well suited for measuring small impedance changes.

In order to prepare your 9102 for performing antenna measurements connect the 9160 Bridge to the RF in and RF out connectors as well as to the Multi Port connector on the top of the instrument as shown in the following picture. For further details on the connectors available on the instrument, refer to ["Connecting the 9100 Handheld Spectrum Analyzer" on page 7.](#)



Calibration

Before starting measurements the measurement instrument has to be calibrated using a highly precise terminator. For reference calibration a calibration standard with an open, short and load reference connector has to be connected. The purpose of this calibration procedure is for example to eliminate inaccuracies within the instrument and at the connector which can for example be caused by temperature changes. Willtek offers Open/Short/Load Type 7/16" male and Type N male calibration sets as well as test port extension cables with different connector standards (N and 7/16" DIN).

Calibration sets



Test port extension cable



A detailed description of the calibration processes for reflection and DTF measurements is included in the relevant step by step measurement description.

Connecting the cable to be measured

The open end of a cable to be measured often has a 9/16 inch connector. Use an adapter cable to establish a connection between the cable to be measured and the N connector of the 9160 VSWR/DTF bridge.

Performing reflection measurements

In order to perform a reflection measurement proceed as follows:

- 1 Press the **MODE** function key. The Mode menu is displayed.
- 2 Select the reflection measurement mode by pressing **VSWR/Tracking... > Reflection**. The Reflection main menu appears.

NOTE

The reflection measurement mode is available on the 9102 Handheld Spectrum Analyzer in conjunction with the 9130 VSWR/DTF Reflection Measurement option and is model-specific.

- 3 The next step is specifying the frequency. Press the **Freq** softkey to select the desired frequency band. The Frequency menu is displayed.

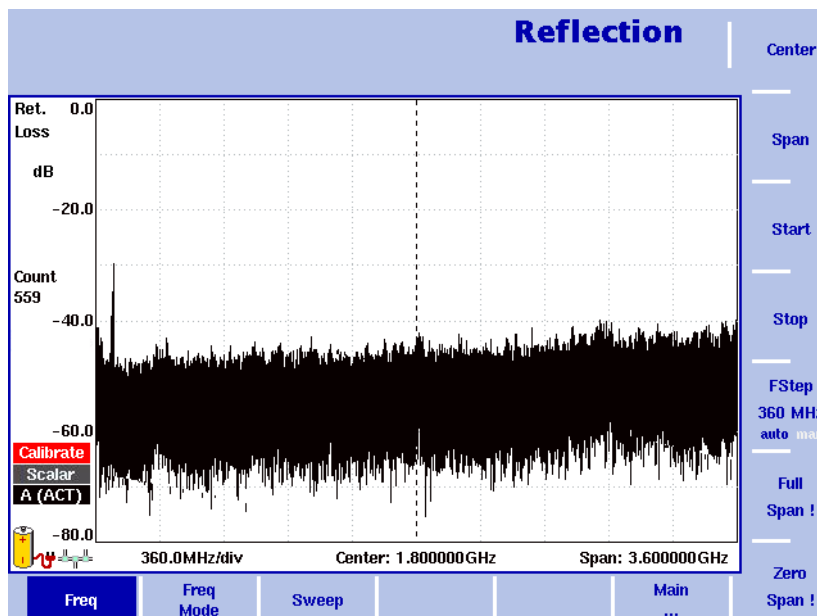

Figure 7 Frequency menu

- 4 There are different methods to set the frequency range to be measured; the range can be expressed by either the start and stop frequencies (i.e. first and last frequencies on the display), or by center frequency and span (i.e. the center and the frequency range), or by other combinations of center frequency, span, start and stop frequencies. For further details on setting the frequency, refer to the 9102 user's guide delivered with your instrument.
- 5 After specifying the frequency the next step is reflection calibration. First, connect the test port extension cable to the 9160 VSWR/DTF Bridge.
- 6 In the Reflection main menu press **Reflection Cal.** softkey. The Reflection Calibration menu is displayed.

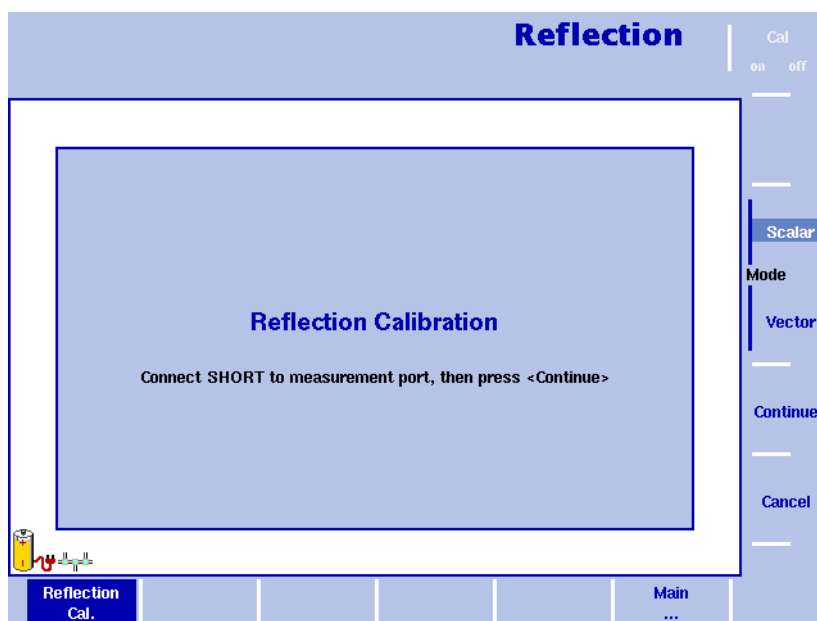

Figure 8 Reflection Calibration menu

- 7 Select the mode to be used for your measurement by pressing the **Scalar** or **Vector** softkey. The scalar measurement measures the level of the reflected signal. The vector measurement is even more precise and also measures the phase of the reflected signal. It increases measurement accuracy as well as the return loss measurement range.

The 9100 will guide you through the calibration process by onscreen messages as shown in [Figure 8](#). When prompted as shown connect the calibration set to the test port extension cable and press **Continue**. You can abort the calibration process by pressing the **Cancel !** softkey.

- 8 When calibration is completed the Reflection main menu will be displayed again. On the left-hand side of the results display the calibration icon will now be displayed in green and read "Calib'd" (Calibrated). The measurement graph shows full reflection (0 dB return loss) as soon as the calibration set is removed. The instrument is now ready for starting the actual reflection measurement.
- 9 The next step is to set the unit to be used for your reflection measurement. The reflection mode supports all common reflection measurement units: return loss, VSWR, reflection factor or reflected power. In the Reflection main menu select **Level > Units**. The Unit menu is displayed on the right-hand side of the screen.
- 10 Select Return Loss, VSWR, Refl. Factor or Refl. Power by pressing the respective softkey followed by **ENTER**. The selected unit will be displayed on the left-hand side of the results display.
- 11 After specifying the unit for your reflection measurement you can adjust the level parameters. Depending on the unit you specified via the Units menu the display of the Level menu changes to enable you to set the level parameters for the individual units. For a detailed description on the procedure of setting the level parameters, refer to the 9102 user's guide delivered with your instrument.

After specifying the reflection measurement parameters you can use the 9102's trace, marker and limit line functionality to further analyze and document measurement results. For a detailed description of these functionalities, refer to the 9102 user's guide.

The following picture shows a reflection measurement results display after selecting return loss as a unit and applying markers and limit lines to the measurement. Due to the activation of limit lines the 9102 provides a simple Pass verdict and shows the limit lines on screen. If the reflection is higher than the limit, the test result is displayed as "Fail".

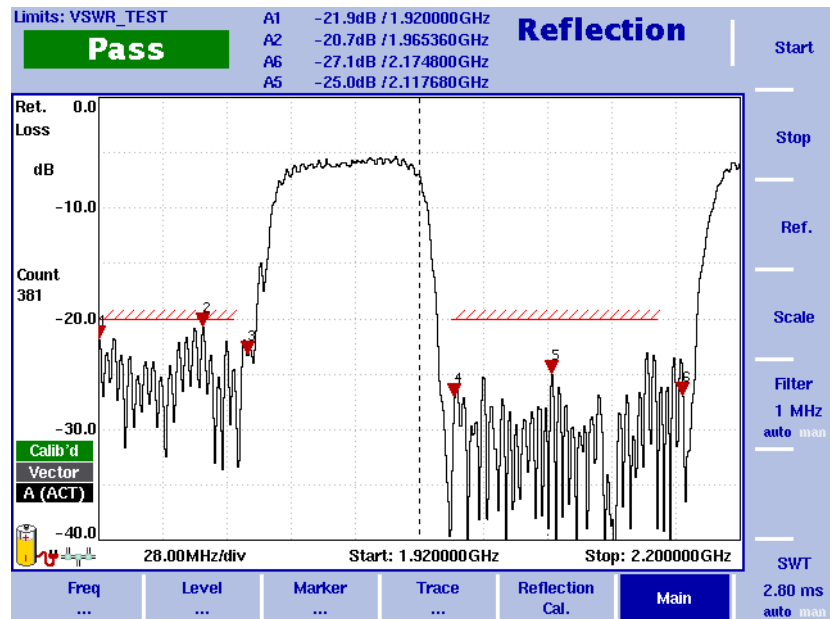

Figure 9 Reflection measurement results display

Performing distance-to-fault measurements

In order to perform a distance-to-fault measurement proceed as follows:

- 1 Press the **MODE** function key. The Mode menu is displayed.
- 2 Select the distance to fault measurement mode by pressing **VSWR/Tracking... > Distance to Fault**. The Distance to Fault main menu appears.

NOTE

The distance to fault measurement mode is available on the 9102 Handheld Spectrum Analyzer in conjunction with the 9130 VSWR/DTF Reflection Measurement option and is model-specific.

Setting the unit

- 1 The first step is to set the unit for reflection. In the Distance to Fault main menu select **Level > Units**. The Unit menu is displayed on the right-hand side of the screen.
- 2 Select dB or mRho by pressing the respective softkey followed by **ENTER**. The selected unit will be displayed on the left-hand side of the results display: "Ref." and "dB", if you select dB. "Refl. factor" and "mRho", if you select Rho.

Setting the cable length

- 1 The next step is to set the length of the cable to be tested. First, you have to specify the unit of the cable length. To do so press the **Distance Unit** softkey in the Distance to Fault main menu.
- 2 Toggle the softkey to the required unit, metre or feet, and press **ENTER**. The unit will be displayed in the cable length field of the results display as well as on the Cable Length input field.

- 3 In the Distance to Fault main menu press the **Cable Length** softkey. The Cable Length input field is displayed.
- 4 Enter the cable length in the unit specified and press **ENTER**.

Specifying the cable settings

- 1 The next step is specifying the cable settings. For most known coaxial cables Willtek provides predefined parameter files which are included in the delivery of the 9100 Data Exchange Software which is supplied with your instrument. The files can be easily transferred to the instrument to be available for selection during DTF measurements. For information on transferring predefined cable types to your instrument, refer to the 9100 Data Exchange Software chapter in your 9102 user's guide. If the cable to be tested is a common cable type contained in the predefined parameter file you can select its settings for use within the DTF measurement after transferring the parameter file. To choose predefined parameter files stored on the instrument for your measurement select **Cable > Cable Memory**. The Cable Memory menu is displayed.
- 2 Press the **Recall Cable Type** softkey. A dropdown list containing all cable types stored on the system is displayed.
- 3 Select the required cable type using the **UP/DOWN** arrow keys and press **ENTER**. The settings of the selected cable type are now automatically used for the DTF measurement.
- 4 If you intend to test a rare cable type you can also specify the cable parameters step by step and save them collectively as a userdefined cable type for later use on the instrument. For the values to be entered, refer to the manufacturer's information for the cable to be tested. To specify the cable settings manually select **Cable > Cable Setting** in the „Distance to Fault“ main menu. The Cable Setting menu is displayed.
- 5 Either press the **Cable Dielec.** softkey to specify the cable's dielectric which is linked to the velocity factor and specifies the isolation between the cable's conductors. The Cable Dielectric input field is displayed. Enter the value specified for the cable and press **ENTER**. Or press the **Cable Velocity Factor** softkey to specify the propagation velocity of the cable. The Cable Velocity Factor input field is displayed. Enter the velocity factor specified for the cable to be tested and press **ENTER**.
- 6 Press the **Cut Off Freq.** softkey to specify the cable's cut off frequency, which is the frequency up to which the cable transmits. The Cut Off Frequency input field is displayed. Enter the frequency specified for the cable to be tested and press **ENTER**.
- 7 Press the **Cable Attn.** softkey to specify the cable attenuation. You can enter the value in dBm per 100 m or dBm per 100 ft, depending on the unit you specified for the cable length. The Cable Attn. softkey can be toggled accordingly and Cable Attenuation input field will be displayed with showing the units specified. Enter the attenuation specified for the cable to be tested and press **ENTER**.

Setting center frequency and span

- 1 The next step is to set the center frequency and span. Push the **CENT** function key or the **Center** softkey in the Distance to Fault main menu. The vertical softkeys include Center and Span. An entry field appears, indicating the center frequency currently set and the step size for the up/down cursor keys.
- 2 Enter a new frequency using the numeric keys, the cursor keys and the **BACKSPACE** key.
- 3 Conclude the entry by pushing an enter key for the unit (**GHz/dBm** for gigahertz, **MHz/dB/μS** for megahertz, **KHz/DBμV/MS** for kilohertz, or **ENTER** for hertz).
- 4 Push the **Span** softkey. If you intend to set the span manually, enter the frequency for the range from the left to the right end of the display. If you want the span to be set automatically, toggle the Span softkey to auto.

NOTE

If you specify the same value for the center frequency as for the cable cutoff frequency, your measurement becomes invalid as the cutoff frequency is the maximum frequency up to which the cable transmits signals. In this case the measurement would not make any sense.

Calibrating

- 1 The next step is performing the distance-to-fault calibration process. First connect the test port extension cable to the 9160 VSWR/DTF Bridge.
- 2 In the Distance to Fault main menu press the **DTF Cal.** softkey. The distance to fault Calibration menu is displayed.

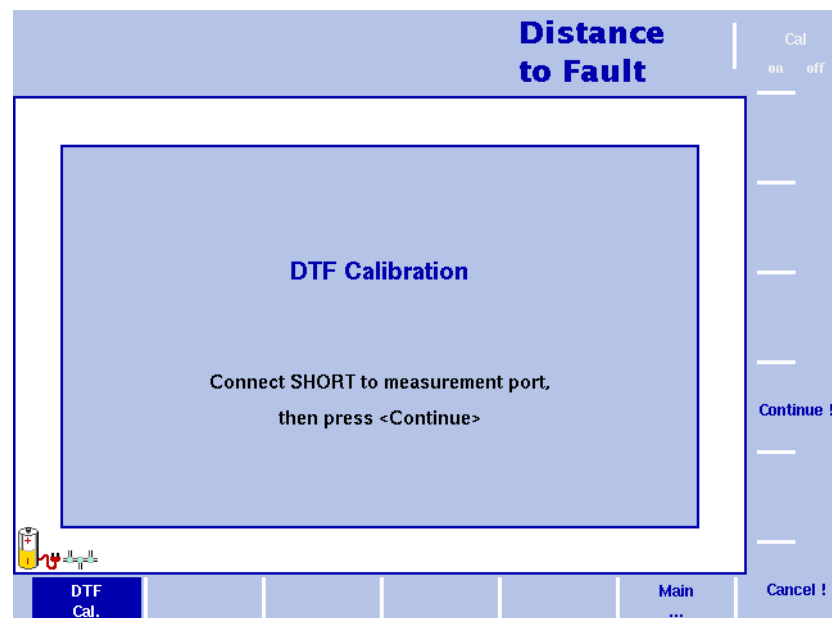

Figure 10 DTF Calibration menu

- 3 The 9102 will guide you through the calibration process by onscreen messages as shown in Figure 10. When prompted as shown connect the calibration set to the test port extension cable and press **Continue**. You can abort the calibration process by pressing the **Cancel !** softkey.
- 4 When calibration is completed the Distance to Fault main menu will be displayed again. On the left-hand side of the results display the calibration icon will now be displayed in green and read "Calib'd" (Calibrated).

Specifying level parameters

As the last step of specifying the parameters for your DTF measurement you can now adjust the level parameters. Depending on the unit you specified via the Units menu the display of the Level menu changes to enable you to set the level parameters for the individual units. For a detailed description on the procedure of setting the level parameters, refer to the 9102 user's guide delivered with your instrument.

The measurement result

As for reflection measurements you can use the 9102's trace, marker and limit line functionality to further analyze and document measurement results after entering all DTF measurement parameters. For a detailed description of these functionalities refer to the 9102 user's guide.

The following picture shows a distance to fault measurement results display for a userdefined cable type after selecting the reflection unit mRho and the cable length unit m. Markers (in the distance to fault mode the markers appear in line style) have been applied to mark the peak reflection values, i.e. the impedance changes measured and converted into the reflection factors. Cable faults can thus easily be identified.

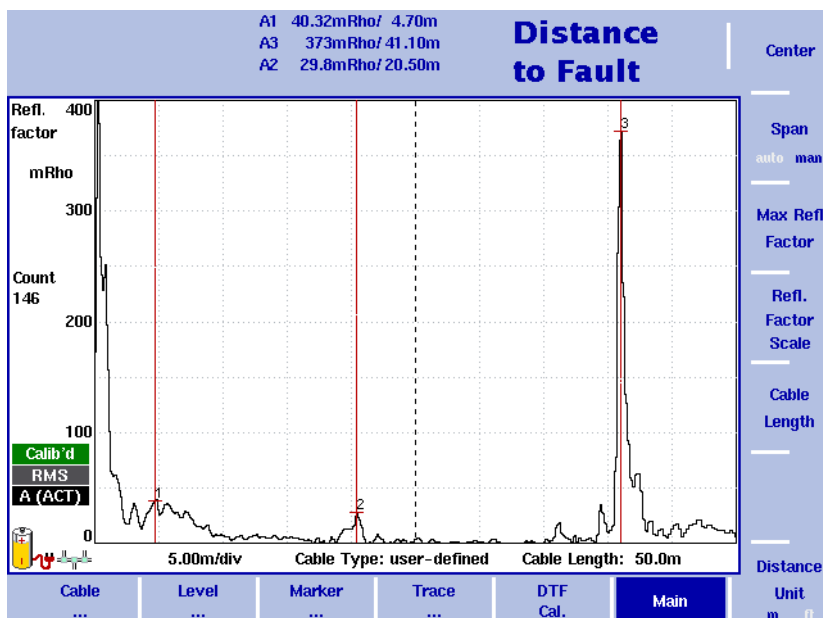

Figure 11 Distance to fault measurement results display

Analyzing and documenting quality measurement results in the office

Typically, you would want to document the tasks performed during antenna system installation, maintenance and acceptance-testing after returning to the office. Documented return loss and DTF measurements are required for final acceptance of an antenna system. You can transfer the results of the measurements performed with your 9102 Handheld Spectrum Analyzer via a LAN or RS-232 interface and using the 9100 Data Exchange Software, which is included in the delivery of your 9102, to your PC. The results are displayed on the PC as they are displayed on the instrument.

The 9100 Data Exchange Software offers special methods for documenting your measurement results. In addition to the six markers that can be set on the 9102 you can include up to four additional markers in the measurement result display on your PC and have comment fields assigned to them. Thus up to ten markers can be used on each trace. Using the additional four markers with their comment fields you can mark and comment on values that are within tolerance limits although critical. The measurement values at the marker positions are of course included in the display. Using the limit line functionality result values can be assessed at a glance. You can also include measurement parameters in the display to document the measurement conditions.

Following is an example of a distance to fault measurement results display edited within the 9100 Data Exchange Software. In this display trace A has been selected, markers have been added and comments assigned to them. The comments are displayed below the measurement trace alongside the marker result values under the heading Markers Trace A. For a detailed description of the usage of the 9100 Data Exchange Software, refer to your 9102 user's guide.

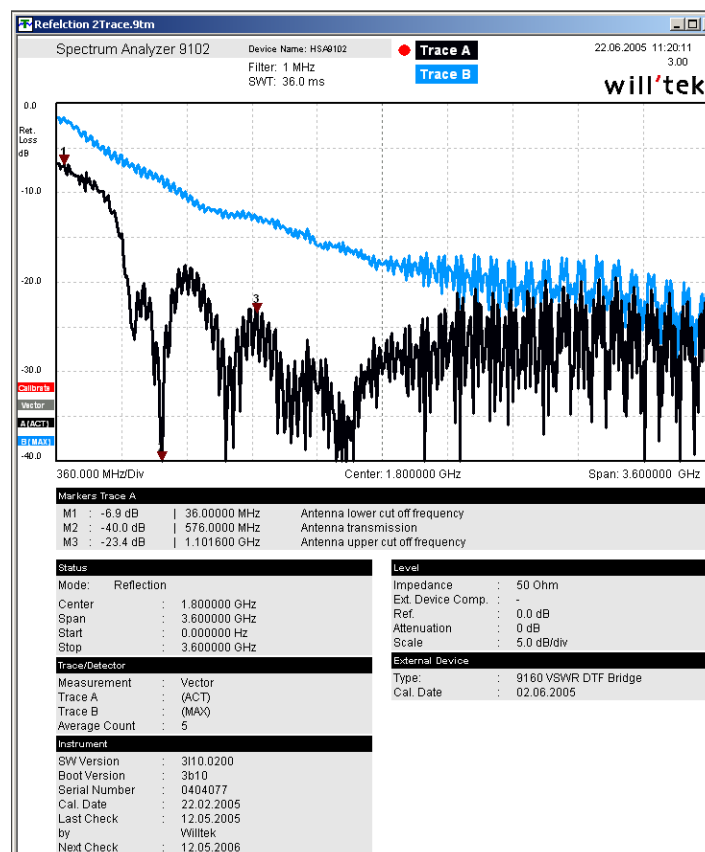

After adjusting the measurement results display to your requirements using the 9100 Data Exchange Software you can transfer it to your word processing program for inclusion into your test documentation. You can save the display in a file selecting one of nine possible graphical formats (e.g. TIF, JPEG etc.) or copy it to the clipboard. Then you can paste the file or picture into your test documentation. You can now provide your client with a comprehensive documentation on the quality of your work reinforced by a combination of graphics and numerical measurement values (markers).

EMF measurements

More and more sources of electromagnetic fields, mostly transmitters for mobile radio, broadcasting and other radio services, are being created and installed. Equipment for home and office communication and other technical devices also contribute to the exposure to electromagnetic fields in the working environment and at home. For health protection regulatory bodies have implemented limit recommendations which were turned into national laws. Network operators, companies installing transmitters for broadcasting and regulatory bodies are faced by the challenge of verifying that limits specified for electromagnetic fields are observed by the sources at hand.

The Willtek 9102 Handheld Spectrum Analyzer in conjunction with the 9131 EMF Measurement Option and the appropriate accessories, i.e. antennas, offers a handheld solution and easy-to-use solution for this application area.



The following sections provide you with an introduction to the concepts of EMF verification and show how to perform EMF measurements with the 9102 in conjunction with the 9131 EMF Measurement Option.

Introduction to EMF measurements

Electromagnetic fields are usually measured over a defined frequency range to determine the amount of radiation emitted by certain sources, such as broadcast stations or mobile phone base stations. Thus, measurements should be performed on a frequency where radiation is expected, e.g. on a broadcast or cellular radio frequency. For precise measurements a frequency-selective receiver with high sensitivity, a large dynamic range and precise measurements of the field strength is required. These are the prerequisites for accurate and reproducible measurement results.

Basically, there are two different measurement approaches in EMF verification:

- Radiation emission and
- radiation immission

The equipment and the methods used vary according to measurement type. With the 9102 Handheld Spectrum Analyzer in conjunction with the 9131 EMF Measurement Option and the appropriate accessories, i.e. antennas, Willtek offers a measurement solution covering the different approaches and requirements.

In the following two sections the radiation emission and immission concepts are explained. Furthermore these sections provide you with an overview on the equipment needed in order to perform EMF measurements depending on the measurement approach.

Radiation emission

Using this measurement type operators of cellular networks and broadcast stations verify that the radiation of a particular transmitter installed is within the limits specified by law and regulatory bodies. In many countries worldwide regulatory bodies stipulate a proof of regulation adherence. The radiation emission measurement is a directional measurement determining the electromagnetic field emitted by a transmitter. Within the measurement setup a directional antenna helps to measure the emitted radiation.

Measurement setup for emission measurements

For performing emission measurements according to ICNIRP (International Commission on Non-Ionizing Radiation Protection) standard with the 9102 you just need the following two pieces of equipment:

- 9102 Handheld Spectrum Analyzer equipped with the 9131 EMF Measurement Option and the 9132 RMS Detector Option
- A directional antenna

Willtek offers two different directional antennas for performing radiation emission measurements. For a detailed description of these two antennas, refer to ["Directional antennas" on page 53](#).

This measurement setup consisting of the 9102 and the directional antenna provides a handheld solution for performing radiation emission measurements easily and efficiently.

Radiation immission For engineering offices and regulatory bodies the specific radiation exposure in a particular place is of special interest. During an immission measurement the electromagnetic field exposure is measured at different locations within a designated area to identify minimum and/or maximum radiation. Typical applications for this kind of measurement are for example:

- Measurements for defining security zones in close proximity of transmitter sites
- Measurements for determining radiation exposure of representative and especially sensitive facilities, e.g. schools, nursery schools and hospitals situated in proximity of transmitter sites
- Long-term measurements for determining immission fluctuations

Measurement setup for immission measurements

As for emission measurements you just need two pieces of equipment for performing immission measurements with the 9102:

- 9102 Handheld Spectrum Analyzer equipped with the 9131 EMF Measurement Option and the 9132 RMS Detector Option
- 9170 Biconical Antenna (for a detailed description refer to ["9170 Biconical Antenna" on page 51](#))
or
- 9171 Isotropic Antenna (for a detailed description refer to ["9171 Isotropic Antenna" on page 52](#))

The type of antenna you use depends on your measurement requirements. The detailed descriptions of the two different antenna types in ["Measurement antennas" on page 50](#) provide you with useful information for selecting the appropriate measurement antenna for your EMF measurement.

In this measurement setup the 9102 captures the electromagnetic waves from all directions and displays the overall field strength in the desired frequency range.

Measurement methods

The location for performing EMF measurements is usually predefined. A main goal of performing EMF measurements is determining the radiation people are exposed to in their everyday life, so the measurements are usually done at locations where people stay for a while, e.g. their work place, home, but also restaurants or sidewalks etc. At the measurement locations a search for the maximum field strength has to be performed in order to determine the radiation exposure caused for example by mobile network base stations. For longterm EMF measurements first the maximum field strength is determined and then the antenna is placed on the location of maximum exposure. Basically there are two methods for determining the maximum field strength within a designated measurement area:

- The stirring method or
- the multipoint method

Using each of the two methods the user will move with the antenna within the area to be measured as shown in the following graphic depicting a user determining the maximum field strength using a measurement setup involving an isotropic antenna.

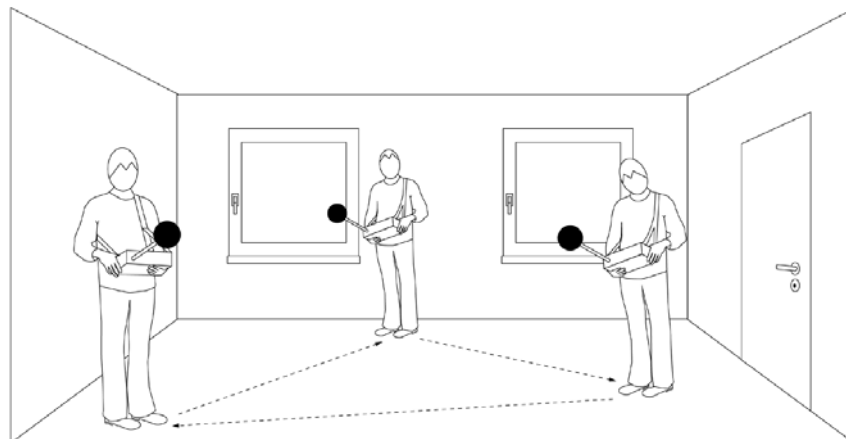

Stirring method

Using the stirring method the user sets the measurement instrument to maximum hold and moves the antenna within the designated measurement area. Depending on the antenna used the user has to be very thorough in covering the designated measurement area in order to capture the different locations, directions of incidence, and polarisations equally. Using an isotropic antenna directions of incidence and polarisations can be neglected, thus an isotropic antenna provides a more comfortable solution for using the stirring method. For further details on the characteristics of different antennas, refer to "[Measurement antennas](#)" on page 50. After completing the coverage of the designated measurement area the measurement instrument provides the maximum field strength value.

Multipoint method

The multipoint approach involves a predefined multipoint matrix providing the user with designated measurement points. For this purpose the dimensions of the measurement area first have to be determined and the measurement points have to be specified. At each measurement point a measurement has to be taken. As three measurements are required at each point (one for each direction, x , y , z), it is recommended to use an isotropic antenna for performing measurements using the multipoint method. For further details on the characteristics of different antennas, refer to "[Measurement antennas](#)" on page 50. The user performs the measurement at each of the measurement points and documents the individual measurement results.

Another possibility is to use a simplified approach to the multipoint method. As for the stirring method the user sets the measurement instrument to maximum hold and moves within the designated measurement area covering all predefined measurement points using an isotropic antenna.

Compared to the stirring method the multipoint method, whether in its pure or in its simplified form, has the advantage of offering a guideline to the user performing the measurements and thus constitutes a more structured approach.

Measurement antennas

The antenna is one of the most important factors in EMF measurements. There are different types of antennas which can be used for measuring field strength depending on your measurement requirements. Willtek offers a range of antennas for different measurement requirements:

- The 9170 Biconical Antenna with a frequency range from 60 to 2500 MHz for immission measurements
- The 9171 Isotropic Antenna with a frequency range from 50 to 3000 MHz for immission measurements
- The 9172 and 9173 Directional Antennas, two antennas with a frequency range of 80 to 1000 MHz and 300 to 3000 MHz respectively for emission measurements

For ordering details for Willtek antennas and antenna accessories, refer to the 9102 user's guide delivered with your instrument.

During measurements the antenna converts the free progressive wave into a line wave. For antenna calibration a correction table containing k factors is required. These factors are proportionality factors which correct the antenna's frequency response and help to convert the measured power or voltage to field strength or power density. Using the k factor table the measured level is converted into the relevant quantities, the field strength measured in V/m and the power density measured in W/m².

Willtek delivers its measurement antennas in conjunction with the appropriate correction factor tables. Using the 9100 Data Exchange Software you can transfer the k factor tables delivered to your instrument. With the 9171 Isotropic antenna this step is not necessary as the factors are stored in a memory inside the antenna interface. You can also use the 9100 Data Exchange Software to collect the correction data for antennas from other vendors and transfer them to your 9102. For further details on using the 9100 Data Exchange Software, refer to the 9102 user's guide included on the documentation CD delivered with your instrument. After transferring the correction tables to the instrument they will be available for selection for EMF measurements.

Willtek also offers antenna accessories like a tripod as well as calibrated cables. Thus you will be able to master any situation in the field using the 9102 and its accessories. If you use a tripod and cable setup for your measurements, cable attenuation is taken into account by activating the appropriate cable factor on the instrument.

Following is a general technical description of the different measurement antenna types providing information on the relevant measurement purpose as well as technical details. For a detailed description of all individual steps to be taken during EMF measurements using the different measurement antenna types, refer to ["Performing an automatic EMF measurement" on page 54](#) and ["Performing a manual EMF measurement" on page 58](#).

9170 Biconical Antenna



Biconical antennas are characterised by their dipole-like structure. The two reception lobes are highly symmetrical and provide the biconical antenna with two main reception directions with an opening angle of 120° each. When manually turning the biconical antenna during measurements into three main planes (x, y, z) the same antenna element is used for the measurements in each of the different directions. This leads to an unmatched isotropy and thus makes biconical antennas most suitable for high-precision measurements. Mounting the antenna on a turning device you can easily turn the antenna in the directions indicated on the device and perform the measurements for each plane. Thereby a globe-like coverage for the measurement, comparable to the one using an isotropic antenna, is achieved as shown in the following graphic.

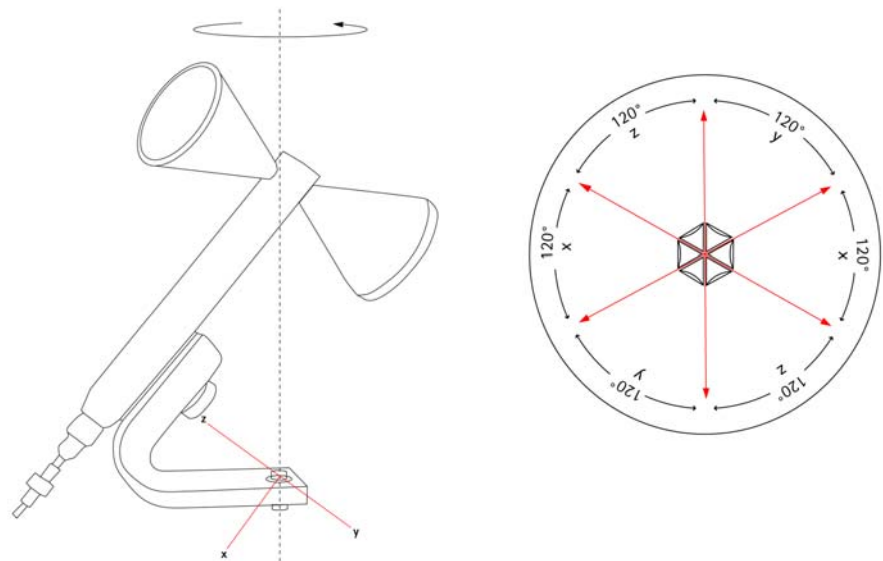

The 9102 supports consecutive measurements in three axes and automatically calculates the resulting field strength.

Willtek offers the 9170 Biconical Antenna for EMF immission measurements with the 9102 and the 9131 EMF Measurement Option.

For ordering information and technical specifications of the 9170 Biconical Antenna, refer to your 9102 user's guide.

9171 Isotropic Antenna



The most comfortable and fastest solution for performing EMF immission measurements comprises using an isotropic antenna. In an isotropic antenna three antennas or dipole elements, one for each direction (x, y and z), are arranged orthonogally and combined by interconnection as shown in the following graphic.

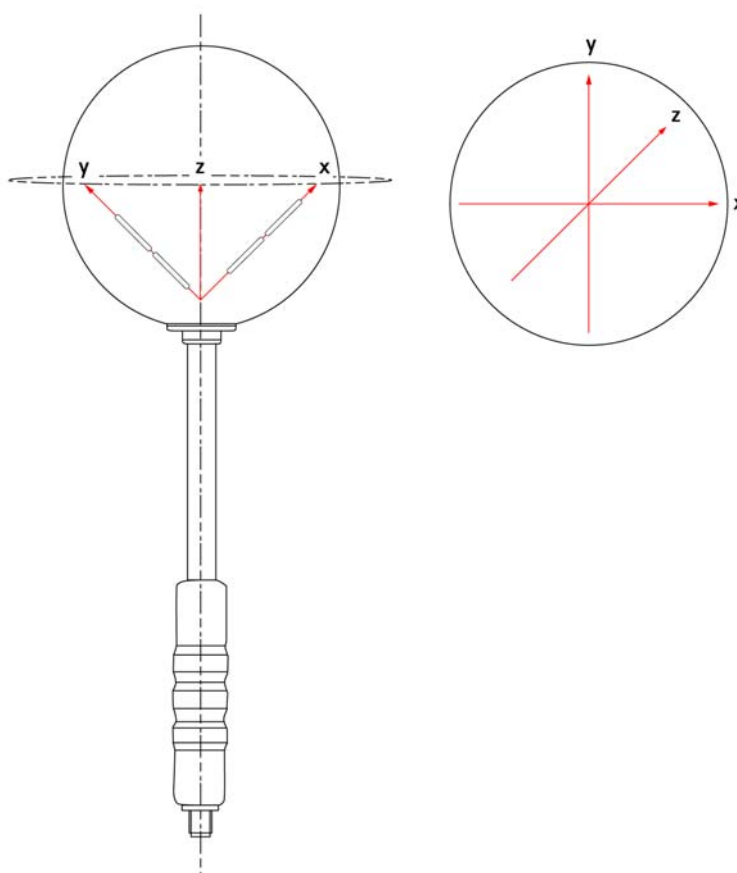

Willtek offers the 9171 Isotropic Antenna for EMF immission measurements with the 9102 equipped with the 9131 EMF Measurement Option. The 9171 Isotropic Antenna is controlled by the 9102 Handheld Spectrum Analyzer, rendering manual rotation of the antenna during measurements unnecessary. This antenna enables you to perform fast automatic measurements. Remote control is achieved by way of a circuit integrated into the antenna. The circuit is connected to the 9102's Multi Port connector via an additional shielded cable with a high-precision connector. Via this connection the 9102 also reads the calibration data, i.e. the k factor correction information, automatically from the EPROM within the circuit. As soon as you connect the cable to the 9102's Multiport the instrument automatically detects the antenna and loads a set of individual calibration values from the antenna.

On starting the measurement the instrument automatically controls the antenna's receiving direction, performs the measurements in each direction and calculates the isotropic total value from the three individual measurement values.

For ordering information and technical specifications of the 9171 Isotropic Antenna, refer to your 9102 user's guide.

Directional antennas

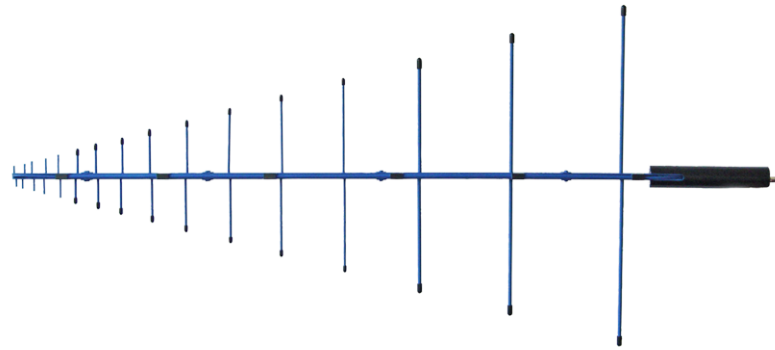

Directional antennas are log-periodic broadband antennas covering a wide spectrum of applications. They are typically used for measuring the emission from a specific antenna site.

Willtek offers two different directional antennas of 1 m length each accommodating different frequency ranges:

- 9172 Directional Antenna - 80 to 100 MHz
- 9173 Directional Antenna - 300 to 3000 MHz

Thanks to their small angle of beam and their excellent frequency response, these two directional antennas can also be used for EMF prequalification and for finding interferers. With these two antenna types and their overlapping frequency ranges, the whole range of commercial radio services is covered.

For ordering information and technical specifications of the 9172 and 9173 Directional Antennas, refer to your 9102 user's guide.

EMF measurements with the 9102

The 9102 in conjunction with the 9131 EMF Measurement Option offers the EMF (EMI) measurement mode allowing you to perform radiation measurements easily and efficiently. All you need to effectively record electromagnetic fields is the 9102 with the 9131 EMF Measurement Option installed and the appropriate antenna for your measurement method.

The EMF (EMI) measurement mode enables you to perform automatic EMF measurements upon the press of a button. In this mode, the 9102 measures the electromagnetic field over a user-definable frequency range and displays the field strength in V/m or the power density in W/m². All necessary functions, e.g. detecting the peak value over a given time period or integrating the broadband signal power over a given frequency range, are available. You can compare the recorded measurement values with the relevant threshold values.

Results can be displayed in logarithmic or linear format, the displayed range quickly and easily being adapted to the measured signal. The measured signals can be displayed both graphically and numerically in logarithmic or linear terms.

In EMF (EMI) mode the 9102 measures the electrical field strength (E) as well as the power density (S) to enable you to compare the measured EMF with the binding limits specified by the responsible regulatory bodies. You can specify which result should be displayed.

The display unit for the electrical field strength is V/m.

The electrical field strength is calculated as the square root taken from $S \times R_0$, with R_0 being the air wave resistance of 377Ω .

The 9102 displays the total electrical field strength by adding all measurement values measured for the three directions x, y, z.

E_{result} is calculated as the square root taken from $E_{x\text{result}}^2 + E_{y\text{result}}^2 + E_{z\text{result}}^2$.

The display unit for the power density is W/m².

It is calculated as $S = E_r^2 \div R_0$. R_0 again being the air wave resistance of 377Ω .

The following sections explain how to perform EMF measurements with the 9102. As the most typical application examples in this area are immission measurement we will concentrate on two different immission measurement examples: an automatic measurement in conjunction with the 9171 Isotropic Antenna and a manual measurement in conjunction with the 9170 Biconic Antenna.

The preparative steps which have to be performed before starting the actual measurement, e.g. selecting the EMF (EMI) measurement mode, setting the required frequency range, selecting the measurement unit and specifying the measurement result to be displayed (power density or field strength) are identical for both measurements with the exception of connecting the antennas to the 9102. The steps involved in this procedure depend on the antenna used.

NOTE

Due to the physical nature of EMF measurements the following has to be taken into account.

When performing measurements on broadband signals the electrical field strength or the power density displayed may show deviations. In this case the measurement has to be performed via a channel power measurement.

Furthermore a very big or very small relation between span and RBW may lead to false measurements or invalid measurement results.

Performing an automatic EMF measurement

With the 9171 Isotropic Antenna you can perform measurements in automatic mode. A prerequisite for performing automatic measurements is that the 9171 Isotropic Antenna's controller cable is connected to the 9102's multiport. Via this connection the 9102 reads the relevant correction data from the antenna and controls the measurement. However, if you use a tripod measurement setup in conjunction with an extension cable, the cable attenuation also has to be taken into account by using cable correction data. For further information this measurement setup, cable attenuation and on activating cable correction data, refer to your 9102 user's guide.

There are two different options selectable from the Measure menu for performing automatic measurements: Auto and Quick. In the following application example we will concentrate on the Auto mode. For a description of the Quick mode, a special form of the Auto mode, refer to your 9102 user's guide.

Auto measurements provide you with the comfort of the 9102 controlling the measurement process for all three measurement panes. Once you start your Auto measurement the 9102 will run automatically through all measurements and calculate and display the overall measurement result from the individual results for x, y and z. However, you can specify the measurement time.

Connecting the isotropic antenna

The first preparative step is to establish a connection between the 9102 and the 9171 Isotropic antenna. To do so, simply connect the antenna directly to the 9102's RF in connector and connect the controller cable to the 9102's Multi Port connector. As soon as you have connected the antenna to both connectors the 9102 automatically detects the antenna and loads the correction data.

NOTE

If you connect the antenna controller to the instrument with the EMF (EMI) mode already running, it takes about 10 seconds for the 9102 to detect the antenna. In order to avoid any disturbance of the process do not press any buttons on the instrument during this time.

Selecting the EMF (EMI) measurement mode

To select the EMF (EMI) mode, proceed as follows:

- 1 Push the **MODE** function key.
The Mode menu appears.
- 2 Select **EMF (EMI)**.
The EMF (EMI) main menu appears.

NOTE

The EMF (EMI) mode is available on the 9102 in conjunction with the 9130 EMF Measurement Option and is model specific.

Setting the unit

After selecting the EMF (EMI) measurement mode the next step is to select the unit.

- 1 In the main menu, select **Level > Units**.
- 2 You can use logarithmic or linear units. In order to toggle the display between logarithmic and linear units press the **Unit** softkey in the lower right corner of the display and select log or lin.
- 3 You can now choose between the following units via the Unit softkey in the upper right corner of the display.
Logarithmic units: dBm/m², dBμV/m and dBV/m
Linear units: V/m, mW/m²

Setting the frequency range

The next step is to set the frequency range for the EMF measurement. In the EMF (EMI) main menu press the **Freq** softkey to select the desired frequency band. Now the EMF (EMI) Frequency menu is displayed.

There are different methods to set the frequency range to be measured; the range can be expressed by either the start and stop frequencies (i.e. first and last frequencies on the display), or by center frequency and span (i.e. the center and the frequency range), or by other combinations of center frequency, span, start and stop frequencies. All four parameters are accessible in the 9102's Frequency menu. For further details the different methods of setting the frequency range refer to your 9102 user's guide.

Specifying the display calculation

After setting the frequency range we now specify which measurement result the 9102 is to display: field strength (E) in V/m or power density (S) in W/m². You can switch the display between these two results values.

NOTE

This step is preparative and has to be taken before you start your actual measurement in automatic as well as manual mode.

To switch the display between electrical field strength and power density, proceed as follows



- 1 In the EMF (EMI) main menu select **Measure > Display Calculation**.
- 2 Toggle the **Display** softkey until the required option, E for electrical field strength and S for power density, is highlighted. In the upper left corner of the display the appropriate value will be displayed during your measurement in the relevant unit: electrical field strength in V/m and power density in W/m².

Setting the reference level

The next step is setting the reference level for the measurement display. The reference level basically determines the level at the top of the display. The vertical axis is divided into eight horizontal lines; you can adjust the scale (which defaults to 10 dB per line) to your preferences.

In order to set the reference level proceed as follows:

- 1 In the main menu, push the **Ref. Level** softkey. You can also select **Level** followed by **Ref. Level** Alternatively, push the **REF** function key. The reference level input field opens.

NOTE

Depending on the unit you use and the specified display calculation the Ref. Level softkey changes to Ref. Power or Ref. Voltage. Furthermore the input field name and the display on the left-hand side of the screen changes accordingly.

- 2 Enter the new reference power or voltage either using the numeric keys, closing the input field with the appropriate enter key, or with the **UP/DOWN** arrow keys.

The new reference level appears at the top of the vertical axis. The reference is based on the actually set output power.

For further details on specifying level settings refer to your 9102 user's guide.

Activating the antenna factor settings

After the antenna is detected and the correction data are loaded the 9102 switches to the Level menu and the **Antenna Factor** softkey is highlighted. To activate the antenna factor, press the **Antenna Factor** softkey until **on** is highlighted.

Starting the Auto measurement

You can now start your actual EMF measurement in Auto mode. In order to do so proceed as follows:

- 1 In the EMF (EMI) main menu select **Measure**. The EMF (EMI) Measure menu is displayed.

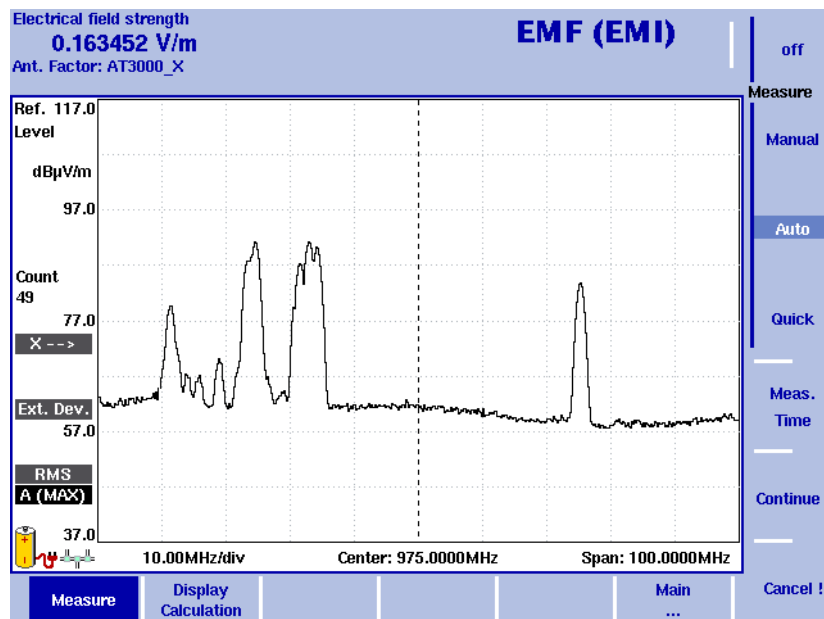



Figure 12 Measure menu

- 2 In the Measure menu select **Meas. Time**. An input field for the measurement time will be displayed.
- 3 Enter the time interval to be used for measuring on each of the measurement panes. The default is 360 seconds, the maximum value is 600 seconds. Press **ENTER** to set the measurement time.
- 4 Now select the **Auto** softkey and press **Continue !** to start the Auto measurement.

- 5 On the right-hand side of the display the red Measure indicator shows that a measurement is in progress: **Measure**. Above this indicator the direction measured is shown (x as the first one):

You can abort the measurement by pressing the **Cancel !** softkey.
- 6 On completing the measurement for the x measurement pane the Measure indicator disappears and the 9102 automatically switches to y followed by z.
- 7 On completion of the measurement the measurement result is displayed with the graph automatically put on hold and the overall calculated electrical field strength or power density, depending on the selection you have made via **Measure > Display Calculation** (see "[Specifying the display calculation](#)" on page 56) is displayed. You can now save your results trace on the instrument.

Performing a manual EMF measurement

The manual measurement mode provides you with a comfortable way of performing EMF measurements using the 9170 Biconical Antenna. For this type of EMF measurement the 9170 Biconical Antenna is turned manually in each of the measurement directions (x, y and z), usually mounted on a turning device. For each direction the 9102 performs the measurement of electrical field strength or power density depending on the selection you have made via **Measure > Display Calculation** (see "[Specifying the display calculation](#)" on page 56). You start the individual measurements manually after turning the antenna in the relevant direction. As for automatic measurements you can also specify the measurement time for each direction. On completing all three measurements the 9102 calculates the total result value.

As the k factor correction data are not automatically loaded and activated when using a biconical antenna you have to activate the appropriate correction table manually on your instrument. Also, as the biconical antenna will often be mounted on a tripod and connected to the 9102 via an extension cable, the cable factor has to be activated manually. For further information on this measurement setup, cable attenuation and on activating cable correction data refer to your 9102 user's guide.

Connecting the biconic antenna

The first step is to establish a connection between the 9102 and the 9170 Biconical Antenna. In order to do so simply connect the antenna via an RF cable to the 9102's RF in connector.

Steps identical to automatic mode

The following measurement steps are identical to the ones described for the automatic measurement:

- Selecting the EMF (EMI) measurement mode
- Setting the unit
- Setting the frequency range
- Specifying the display calculation
- Setting the reference level

For detailed descriptions of these measurement steps refer to "Performing an automatic EMF measurement" on page 54.

Specifying antenna factor settings

The scope of delivery of the 9170 Biconical Antenna includes the appropriate k factor correction table. The data are available within the 9100 Data Exchange Software. For details on downloading the data the 9102 and managing antenna factors within the 9100 Data Exchange Software refer to your 9102 user's guide.

To activate the appropriate antenna factor for your EMF measurement, proceed as follows:

- 1 In the EMF (EMI) main menu select **Level > Ant. Factor Memory**. The Antenna Factor Memory menu is displayed.

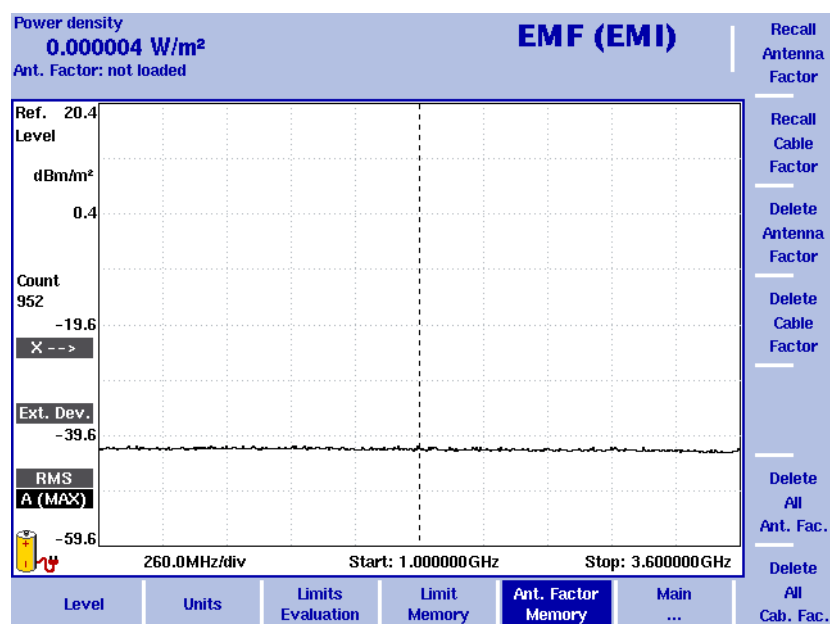

Figure 13 Antenna Factor menu

- 2 Press the **Recall Antenna Factor** softkey. A dropdown list showing all antenna factors stored on the system is displayed.
- 3 Select the appropriate antenna factor and press **ENTER**. Now the Level menu is displayed again.

To activate the antenna factor selected, toggle the **Antenna Factor** softkey until **on** is highlighted.

Starting the manual measurement

You can now start your actual EMF measurement in Auto mode. In order to do so proceed as follows:

- 1 In the Measure menu select **Meas. Time**. An input field for the measurement time will be displayed.
- 2 Enter the time interval to be used for measuring on each of the measurement panes. The default is 360 seconds, the maximum value is 600 seconds. Press **ENTER** to set the measurement time.
- 3 Now select the **Manual** softkey. The softkeys for the three different measurement directions (x, y and z) are available on the right-hand side with x highlighted as the first measurement direction and the x direction indicator displayed on the left-hand side as shown in the following picture.

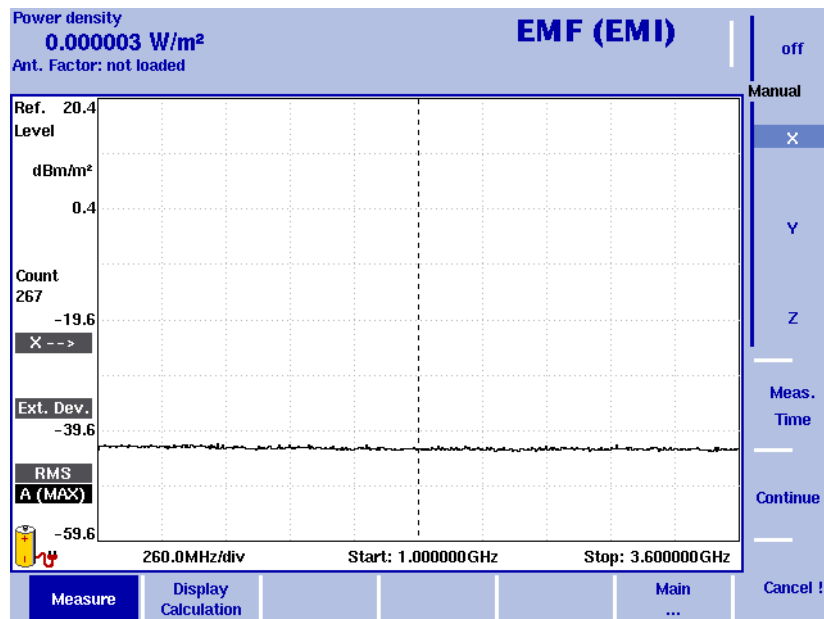

Figure 14 Softkeys for manual measurements

- 4 Press **Continue !** to start the first measurement. On the right-hand side of the display the red Measure indicator shows that a measurement is in progress: **Measure**. You can abort the measurement by pressing the **Cancel !** softkey. After completion of the measurement the Measure indicator disappears.
- 5 Now press the **Y** softkey followed by **Continue !** to start the measurement for the y direction. The procedure is identical to the one described for the x direction above.
- 6 After completion of the y measurement press the **Z** softkey followed by **Continue !**. The procedure is identical to the one described for the x direction above.

- 7 On completion of the measurement the measurement result is displayed with the graph automatically put on hold and the overall calculated electrical field strength or power density, depending on the selection you have made via **Measure > Display Calculation** (see "[Specifying the display calculation](#)" on page 56) is displayed. You can now save your results trace on the instrument.

The measurement result

As for the other 9102 measurement modes you can use the 9102's trace, marker and limit line functionality to further analyze and document measurement results after entering all DTF measurement parameters. For a detailed description of these functionalities refer to the 9102 user's guide.

Following is a measurement results display of an EMF measurement showing the electrical field strength in V/m in linear terms with the specified unit dB μ V/m. markers have been used to indicate the measured values at different frequencies.

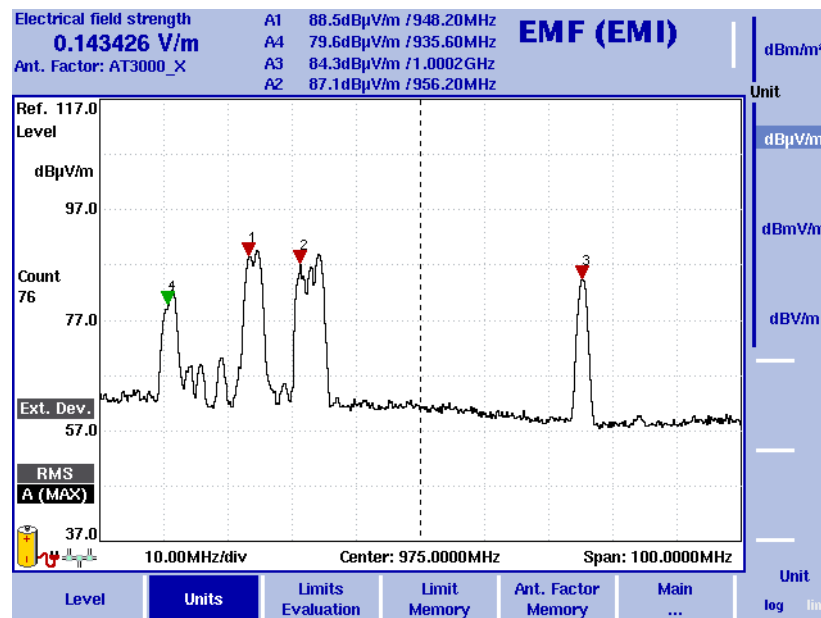

Figure 15 EMF (EMI) measurement

Analyzing and documenting EMF measurement results

You can transfer the results of the measurements performed with your 9102 Handheld Spectrum Analyzer via a LAN or RS-232 interface and using the 9100 Data Exchange Software, which is included in the delivery of your 9102, to your PC. The results are displayed on the PC as they are displayed on the instrument.

The 9100 Data Exchange Software also offers special methods for documenting your measurement results. In addition to the six markers that can be set on the 9102 you can include up to four additional markers in the measurement result display on your PC and have comment fields assigned to them. Thus up to ten markers can be used on each trace. Using the additional four markers with their comment fields you can mark and comment on values that are within tolerance limits although critical. The measurement values at the marker positions are of course included in the display. Using the limit line functionality result values can be assessed at a glance. You can also include measurement parameters in the display to document the measurement conditions.

For a detailed description of the 9100 Data Exchange Software refer to your 9102 user's guide.

Publication History

Revision	Comment
0509-100-A	First version
0512-200-A	Section for EMF (EMI) application added.
0608-200-A	New layout.

Willtek and its logo are trademarks of Willtek Communications GmbH. All other trademarks and registered trademarks are the property of their respective owners.

Specifications, terms and conditions are subject to change without notice.

© Copyright 2006 Willtek Communications GmbH. All rights reserved.

No part of this manual may be reproduced or transmitted in any form or by any means (printing, photocopying or any other method) without the express written permission of Willtek Communications GmbH.

Manual ident no. M 290 504

Manual version
0608-200-A

English

Willtek Communications GmbH
85737 Ismaning
Germany
Tel: +49 (0) 89 996 41-0
Fax: +49 (0) 89 996 41-440
info@willtek.com

Willtek Communications UK
Cheadle Hulme
United Kingdom
Tel: +44 (0) 161 486 3353
Fax: +44 (0) 161 486 3354
willtek.uk@willtek.com

Willtek Communications SARL
Roissy
France
Tel: +33 (0) 1 72 02 30 30
Fax: +33 (0) 1 49 38 01 06
willtek.fr@willtek.com

Willtek Communications Inc.
Parsippany
USA
Tel: +1 973 386 9696
Fax: +1 973 386 9191
willtek.cala@willtek.com
sales.us@willtek.com

Willtek Communications
Singapore
Asia Pacific
Tel: +65 943 63 766
willtek.ap@willtek.com

Willtek Communications Ltd.
Shanghai
China
Tel: +86 21 5835 8039
Fax: +86 21 5835 5238
willtek.cn@willtek.com

© Copyright 2006 Willtek Communications GmbH. All rights reserved.
Willtek Communications, Willtek and its logo are trademarks of Willtek Communications GmbH. All other trademarks and registered trademarks are the property of their respective owners.

Note: Specifications, terms and conditions are subject to change without prior notice.

will'tek