

9102 Handheld Spectrum Analyzer



User's guide
Version 5.00

boosting wireless efficiency

Notice Every effort was made to ensure that the information in this document was accurate at the time of printing. However, information is subject to change without notice, and Willtek reserves the right to provide an addendum to this document with information not available at the time this document was created.

Copyright © Copyright 2006 Willtek Communications GmbH. All rights reserved. Willtek and its logo are trademarks of Willtek Communications. All other trademarks and registered trademarks are the property of their respective owners. No part of this guide may be reproduced or transmitted electronically or otherwise without written permission of the publisher.

Trademarks Willtek is a trademark of Willtek Communications GmbH in Germany and other countries.

Specifications, terms and conditions are subject to change without notice. All trademarks and registered trademarks are the property of their respective companies.

Ordering information This guide is issued as part of the **9102 Handheld Spectrum Analyzer**. The order number for a published guide is 290 204. The following table shows the order numbers for the 9102 Handheld Spectrum Analyzer Product Packages. For details on the scope of delivery for the individual editions please refer to your getting started manual.

Table 1 Editions of the 9102 Handheld Spectrum Analyzer

Order number	Description
M 100 412	9102 Handheld Spectrum Analyzer Bench Edition
M 248 806	9102 Handheld Spectrum Analyzer Field Edition
M 248 801	9102 Handheld Spectrum Analyzer Tracking Edition
M 248 802	9102 Handheld Spectrum Analyzer VSWR/DTF Edition

Table of Contents

About This Guide		xv
	Purpose and scope.....	xvi
	Assumptions.....	xvi
	Related information.....	xvi
	Technical assistance.....	xvi
	Conventions.....	xvii

Safety Notes		xix
	Safety warnings.....	xx

Chapter 1	Overview	1
	About the 9102 Handheld Spectrum Analyzer.....	2
	What's new.....	2
	Version 5.00.....	2
	Version 4.50.....	3
	Version 4.11.....	3
	Version 4.10.....	3
	Version 4.01.....	3
	Version 3.10.....	3
	Version 3.01.....	4
	Features and capabilities.....	4
	Options and accessories.....	4
	Physical description.....	9
	Maintaining your unit.....	10

Chapter 2	General Operation	11
	Connecting the 9102 Handheld Spectrum Analyzer.....	12
	DC IN connector.....	12
	RF IN connector.....	12

RF OUT connector.....	13
EXT. TRIG. connector.....	13
Multi Port.....	13
Headphone jack.....	13
SERIAL (RS-232) connector.....	14
LAN connector.....	14
Powering up the unit.....	14
Starting measurements.....	15
Using the front panel.....	15
Overview.....	15
Battery status LED.....	15
Display.....	16
Results area.....	16
Trace finder.....	19
Marker field.....	19
Input field.....	19
Softkey descriptions.....	19
Keypad.....	20
Function keys.....	20
Cursor keys.....	21
Numeric keys.....	22
Enter keys.....	22
Escape key.....	22
Backspace key.....	23
Softkeys.....	23
Entering numbers and text.....	24
Filling in a numerical input field.....	24
Filling in a text input field.....	25
Changing the input.....	26
Selecting the measurement mode.....	27
Working with the markers.....	29
Enabling and moving a marker.....	30
Disabling a marker.....	30
Enabling a delta marker.....	30
Disabling a delta marker.....	31
Setting a marker on a frequency relative to marker 1.....	31
Changing the center frequency with a marker.....	31
Changing the reference level with the marker.....	31
Assigning the marker frequency to FStep.....	32
Using limit lines.....	32
Overview.....	32
Using simple limits.....	33
Switching simple limits on and off.....	33
Defining upper and lower limits.....	33
Using limit templates.....	34
Selecting limit lines within the 9102.....	34
Activating and deactivating limit templates.....	34
Deleting limit files in the 9102.....	35
Counting limit failures.....	35
Resetting the counter.....	35
Enabling a beep upon failures.....	35
Viewing a failed measurement.....	35
Printing.....	36
Logging the current position (GPS-assisted).....	36

Connecting the GPS receiver	36
Enabling the GPS receiver	37
Taking GPS-assisted location measurements	37
Changing the GPS display settings	38
Controlling the 9102 from a PC	38
Returning from remote control to local mode	38
Checking general settings	38
Reading the serial number	38
Reading the software version number	39
Reviewing the calibration	39
Checking installed options	40
Installing a new option	41
Changing the display brightness	41
Enabling and disabling beeps	42
Assigning a device name to the instrument	42
Adjusting date and time in the instrument	42
Changing the baud rate on the RS-232 port	43
Changing the IP address of the 9102	44
Changing the IP address of the PC	45
Changing the IP port used by the 9102	46
Configuring a printer	47
Selecting user interface colors	47
Working with stored settings	49
Storing instrument settings	49
Reusing an instrument settings name	50
Reloading instrument settings	50
Deleting a settings file	50
Deleting all instrument settings files	50
Restoring factory settings for all modes	50

Chapter 3

Spectrum Analysis Operation	53
Selecting the measurement mode	54
Changing the frequency settings	54
Setting start and stop frequency	55
Setting center frequency and span	55
Changing the main menu for different frequency parameters	55
Viewing the complete frequency band	56
Performing measurements in the time domain	56
Selecting the step size for the frequency input	56
Selecting RBW, VBW and SWT	57
Setting up the level parameters	57
Setting the reference level	58
Setting the hardware attenuation	58
Changing the vertical scale	58
Selecting the level unit for input and output	59
Compensating gains and losses	59
Enabling external device compensation	59
Turning external device compensation off	59
Deleting files for external device compensation	60
Changing the input impedance	60
Applying special functions on the signal	61
Using a trigger	61

Performing a limited number of measurements	62
Demodulating an AM or FM signal	63
Setting up the trace	64
Selecting the trace mode	64
Turning the second trace on and off	66
Subtracting trace B from trace A	66
Adding trace B to trace A	67
Defining the number of measurements for averaging	68
Selecting the detection method	68
Copying traces inside the 9102	69
Storing and loading traces	70
Storing a trace	70
Reusing a trace name	71
Reloading a trace	71
Deleting a trace	71
Deleting all traces	71
Special measurement functions	72
Channel power	72
Adjacent channel power ratio (ACPR)	72
Occupied bandwidth (OBW)	73
Selecting the measurement type	74
Switching special measurement functions off	74
Changing the channel width	75
Changing the channel spacing	75
Reading the channel power	75
Changing the occupied bandwidth percentage	75
Changing general analyzer parameters	76
Viewing the spectrum analysis mode parameters	76

Chapter 4

Channel Power Operation	77
About the channel power mode	78
Channel power	79
Adjacent channel power ratio (ACPR)	80
Occupied bandwidth (OBW)	80
Selecting the measurement mode	81
Operating in channel power mode	82
Reading the channel power	83
Changing the occupied bandwidth percentage	83
Working with communication systems and frequency settings	83
Selecting a communication system on the 9102	83
Setting up a new communication system	84
Deleting a communication system	85
Deleting all communication systems	85
Undeleting default communication systems	85
Using the 9100 Data Exchange Software with communication systems ..	85
Defining the frequency span	86
Changing the channel	86
Changing the sweep time	86
Setting up the level parameters	86
Setting the reference level	87
Setting the hardware attenuation	87
Changing the vertical scale	88

Selecting the level unit for input and output.....	88
Compensating gains and losses.....	88
Enabling external device compensation.....	88
Turning external device compensation off.....	89
Deleting files for external device compensation.....	89
Changing the input impedance.....	89
Setting up the trace.....	90
Selecting the trace mode.....	90
Turning the second trace on and off.....	92
Subtracting trace B from trace A.....	92
Adding trace B to trace A.....	93
Defining the number of measurements for averaging.....	93
Selecting the detection method.....	93
Copying traces inside the 9102.....	94
Storing and loading traces.....	95
Storing a trace.....	95
Reusing a trace name.....	96
Reloading a trace.....	96
Deleting a trace.....	96
Deleting all traces.....	96
Viewing the channel power mode parameters.....	97

Chapter 5	Power Sensor Operation	99
	About the power sensor mode.....	100
	Connecting the 9162 Insertion Power Sensor.....	101
	Setting up the 9102 for insertion power measurements.....	102
	Starting the insertion power mode.....	102
	Setting up the signal type and frequency.....	102
	Defining the displayed measurement unit.....	103
	Reading the power measurement.....	103
	Forward power.....	103
	Reverse power.....	103

Chapter 6	Signal Generator Operation	105
	About the signal generator mode.....	106
	Selecting the measurement mode.....	106
	Switching the signal generator on and off.....	106
	Changing the frequency.....	106
	Selecting the frequency mode.....	106
	Setting the center frequency.....	107
	Setting start and stop frequency.....	108
	Selecting the step size for the frequency input.....	108
	Setting the level.....	109
	Applying special functions on the signal.....	109
	Performing a limited number of measurements.....	109

Chapter 7	Transmission Operation	111
	About the transmission mode.....	112
	Selecting the measurement mode.....	112

Switching the tracking generator on and off.....	113
Normalizing the trace	113
Setting the tracking output power.....	114
Changing the frequency settings.....	115
Setting start and stop frequency.....	115
Setting center frequency and span.....	116
Changing the main menu for different frequency parameters.....	116
Viewing the complete frequency band.....	117
Performing measurements in the time domain	117
Selecting the step size for the frequency input.....	117
Selecting RBW, VBW and SWT.....	118
Setting up the level parameters.....	118
Switching the display.....	119
Setting the reference level	119
Setting the hardware attenuation.....	119
Changing the vertical scale.....	120
Compensating gains and losses.....	120
Enabling external device compensation.....	120
Turning external device compensation off.....	120
Deleting files for external device compensation	121
Applying special functions on the signal.....	121
Using a trigger	121
Performing a limited number of measurements.....	123
Setting up the trace	123
Selecting the trace mode.....	124
Turning the second trace on and off.....	125
Subtracting trace B from trace A.....	125
Adding trace B to trace A	126
Trace Offset.....	126
Defining the number of measurements for averaging	126
Selecting the detection method.....	127
Copying traces inside the 9102	127
Storing and loading traces	128
Storing a trace	129
Reusing a trace name.....	129
Reloading a trace.....	129
Deleting a trace.....	129
Deleting all traces	130
Viewing the transmission mode parameters.....	131

Chapter 8	The 9130 VSWR/DTF Reflection Measurement Option	133
	About the 9130 VSWR/DTF Reflection Measurement Option.....	134
	Specifications.....	134
	Measurement modes	135
	Hardware requirements.....	136
	Connecting the 9160 VSWR/DTF Bridge	136
	Calibration.....	137

Chapter 9	Reflection Operation	139
	About the reflection mode	140
	Selecting the measurement mode.....	141

Preparative steps	141
Changing the frequency settings	142
Setting start and stop frequency	142
Setting center frequency and span	143
Changing the main menu for different frequency parameters	143
Viewing the complete frequency band	144
Performing measurements in the time domain	144
Selecting the step size for the frequency input	144
Reflection calibration	145
Changing the units settings	146
Setting up the level parameters	147
Setting the reference level for return loss	147
Changing the vertical scale for return loss	147
Setting the maximum for VSWR	147
Changing the scale for VSWR	147
Setting the maximum for reflection factor	148
Changing the scale for reflection factor	148
Setting the maximum for reflection power	148
Changing the scale for reflection power	148
Performing a limited number of measurements	149
Setting up the trace	149
Selecting the trace mode	149
Turning the second trace on and off	150
Subtracting trace B from trace A	151
Adding trace B to trace A	151
Trace Offset	151
Defining the number of measurements for averaging	151
Copying traces inside the 9102	152
Storing and loading traces	152
Storing a trace	152
Reusing a trace name	153
Reloading a trace	153
Deleting a trace	153
Deleting all traces	153
Using limits	154
Viewing the reflection mode parameters	155

Chapter 10

Distance to Fault Operation	157
About the distance to fault mode	158
Selecting the measurement mode	159
Preparative steps	159
Selecting the measurement unit	159
Specifying the cable length	160
Selecting the distance unit	160
Setting the length	160
Specifying cable settings	160
Using predefined parameter files	160
Specifying parameters step by step	161
Setting center frequency and span	161
Distance to fault calibration	162
Specifying the level parameters	163
Setting the reference level for dB	163

Changing the vertical scale for dB	163
Setting the maximum for reflection factor	164
Changing the scale for reflection factor	164
Setting up the trace	164
Using limits	164
Viewing the distance to fault parameters	165

Chapter 11

Cable Loss Operation	167
About the cable loss mode	168
Selecting the measurement mode	168
Preparative steps	169
Changing the frequency settings	169
Setting start and stop frequency	170
Setting center frequency and span	170
Changing the main menu for different frequency parameters	171
Viewing the complete frequency band	171
Performing measurements in the time domain	171
Selecting the step size for the frequency input	171
Cable loss calibration	172
Setting up the level parameters	173
Setting the reference level	173
Changing the vertical scale	173
Performing a limited number of measurements	173
Using limits	174
Viewing the cable loss parameters	174

Chapter 12

EMF (EMI) Operation	175
About the EMF (EMI) mode	176
EMF measurements	177
Radiation emission	178
Measurement setup for emission measurements	178
Radiation immission	178
Measurement setup for immission measurements	178
Measurement methods	179
Stirring method	180
Multipoint method	180
Measurement antennas	181
9170 Biconical Antenna	182
9171 Isotropic Antenna	184
Directional antennas	186
EMF measurements with the 9102	187
Connecting the antenna	188
Connecting the 9170 Biconical Antenna	188
Connecting the 9171 Isotropic Antenna	188
Connecting a directional antenna	188
Using a tripod	188
Selecting the measurement mode	189
Selecting the unit	189
Selecting the frequency range	190
Setting start and stop frequency	191
Setting center frequency and span	191

	Changing the main menu for different frequency parameters.....	192
	Viewing the complete frequency band.....	192
	Performing measurements in the time domain.....	192
	Selecting the step size for the frequency input.....	192
	Selecting RBW, VBW and SWT.....	193
	Specifying the display calculation.....	194
	Specifying level settings.....	194
	Setting the reference level.....	194
	Setting the hardware attenuation.....	195
	Performing automatic measurements.....	195
	Activating the antenna factor settings.....	195
	Specifying cable factor settings for extension cables.....	196
	Auto measurements.....	197
	Quick measurements.....	198
	Performing manual measurements.....	198
	Specifying antenna factor settings.....	199
	Specifying cable factor settings for extension cables.....	199
	Performing the measurement.....	199
	Setting up the trace.....	201
	Using limits.....	201
	Using Markers.....	201
	Viewing the EMF (EMI) mode parameters.....	202
Chapter 13	Troubleshooting	203
	Recharging problems with the 9102B.....	204
	Handling system errors.....	205
Chapter 14	Updating the Instrument Software	207
	Entering the Setup Application Software menu.....	208
	Setting a password.....	208
	Performing a serial update.....	209
	Performing a LAN update.....	211
	Determining the Host IP address.....	212
Chapter 15	9100 Data Exchange Software	213
	About the 9100 Data Exchange Software.....	214
	Installation requirements.....	214
	Understanding the license conditions.....	214
	Installing the software.....	214
	Starting the software.....	215
	Connecting the PC to the 9102.....	216
	Using a predefined configuration for the connection.....	216
	Serial interface connection.....	216
	LAN (TCP/IP) connection.....	217
	Saving the configuration.....	217
	Loading measurement results from the 9102.....	217
	Viewing the actual trace on the PC.....	218
	Toggling the view mode.....	218
	Showing and hiding parameters.....	219

Showing and hiding markers	219
Continually loading live traces.....	219
Transferring a saved trace to the PC.....	220
Saving, loading and printing results on the PC	221
Storing results on the PC.....	221
Loading a trace file on the PC	221
Printing measurement results.....	221
Affecting the layout	221
Printing a trace.....	222
Printing several traces	222
Saving results to a graphics file.....	223
Saving results to a text file.....	223
Copying the trace into a document	223
Graphics copy and paste	223
Data copy and paste.....	224
Creating screen shots.....	225
Working with measurement results	226
Adding markers	226
Change the reference level and scale.....	228
Using a grid.....	229
Entering text.....	229
Defining and loading limit templates.....	229
Defining limits	230
Changing limit lines	231
Displaying an example trace in the Limits Editing menu.....	231
Storing a template on the PC.....	231
Loading a template from the PC	232
Transferring a template to the 9102.....	232
Defining and loading external coupling parameters.....	233
Defining the external coupling factor	234
Loading an external coupling loss file to the 9102.....	234
Managing communication systems for channel power measurements.....	235
Editing communication system parameters on the PC.....	235
Managing cable types for distance-to-fault measurements	236
Uploading predefined cable types to the instrument	236
Defining cable types.....	237
Transferring cable types from the 9102	237
Managing antenna factors for EMF measurements	238
Defining an antenna factor.....	239
Loading antenna factor files to the 9102	239
Managing cable factors for EMF measurements	240
Defining a cable factor.....	240
Loading cable factor files to the 9102	241
Working with settings	241
Exchanging a settings file between 9102 and PC	241
Changing 9102 settings on the PC	241
Managing files on the PC and on the 9102.....	242
File types and directory structure	242
Starting the File Manager.....	243
Copying configuration files from the 9102 to the PC.....	244
Deleting files.....	244
Including the GPS position in the trace.....	244

Chapter 16	SCPI Command Reference	247
	Overview	248
	General commands	248
	Commands affecting the event status register.....	250
	Commands affecting the service register.....	251
	System commands.....	254
	Sense commands.....	260
	Input commands	286
	MMemory commands.....	287
	Instrument commands	299
	fDisplay commands.....	304
	Calculate commands.....	308
	Format commands.....	317
	Service commands.....	318
	SCPI errors.....	321
Chapter 17	Programming Examples	325
	Overview	326
	Command examples	326
	Introduction	326
	Prerequisites	326
	Over serial interface	326
	Over LAN interface.....	326
	Settings	326
	Center frequency.....	326
	Span	327
	Resolution bandwidth.....	327
	Video bandwidth	327
	Sweep time	328
	Reference level	328
	Scale	328
	Input attenuation.....	328
	Detector	329
	Trace	329
	Marker	329
	Measurements	330
	Trace	330
	Sweep.....	330
	Max Peak	331
	Next Peak.....	331
	Marker level.....	331
	Marker frequency.....	331
	Others.....	332
	Identity.....	332
	Reset	332
	Error queue	332
	Echo.....	332
	Local mode.....	333
	Application examples	334
	Signal monitoring	334
	Signal search.....	335

Appendix A	Index of SCPI Commands	337
<hr/>		
Appendix B	Predefined settings	343
	Predefined measurement settings.....	344
	Predefined channel power communication systems.....	345
	Preinstalled systems on the 9102	345
	Predefined systems in the 9100 Data Exchange Software.....	346
	Predefined cable types.....	348
<hr/>		
Appendix C	Menu Structure	353
	Mode function key menus.....	354
	Application menus	355
<hr/>		
Appendix D	Warranty and Repair	359
	Warranty information.....	360
	Equipment return instructions.....	361
<hr/>		
Appendix E	Software License	363
	End-user license agreement	364
<hr/>		
Index		365
<hr/>		
Publication History		377

About This Guide

- "Purpose and scope" on page xvi
- "Assumptions" on page xvi
- "Related information" on page xvi
- "Technical assistance" on page xvi
- "Conventions" on page xvii

Purpose and scope

The purpose of this guide is to help you successfully use the 9102 Handheld Spectrum Analyzer features and capabilities. This guide includes task-based instructions that describe how to install, configure, use, and troubleshoot the 9102 Handheld Spectrum Analyzer. Additionally, this guide provides a description of Willtek's warranty, services, license, and repair information as well as the software license agreement.

Assumptions

This guide is intended for novice and intermediate users who want to use the 9102 Handheld Spectrum Analyzer effectively and efficiently. We are assuming that you are familiar with basic telecommunication concepts and terminology.

Related information

Use this guide in conjunction with the following information:

Willtek 9100 Handheld Spectrum Analyzer Series: getting started manual, order number M 295 204

Willtek 9100 Handheld Spectrum Analyzer Series: applications guide, M 290 504

Willtek also offers a glossary on "Spectrum and network analysis" terms. The order number is SPEC/CT812/0105/EN.

Technical assistance

If you need assistance or have questions related to the use of this product, call Willtek's technical support. You can also contact Willtek by e-mail at customer.support@willtek.com.

Table 1 Technical assistance centers

Region	Phone number	Fax number
Europe, Middle East, Asia, Africa	+49 (0) 89 996 41 311	+49 (0) 89 996 41 440
Americas	+1 973 386 9696	+1 973 386 9191
China	+86 21 5836 6669	+86 21 5835 5238

Conventions

This guide uses naming conventions and symbols, as described in the following tables.



Table 2 Typographical conventions

Description	Example
User interface actions appear in this typeface .	On the Status bar, click Start .
Buttons or switches that you press on a unit appear in this TYPEFACE .	Press the ON switch.
Code and output messages appear in this typeface.	All results okay
Text you must type exactly as shown appears in this typeface .	Type: a : \set.exe in the dialog box.
Variables appear in this <typeface>.	Type the new <hostname>.
Book references appear in this typeface .	Refer to Newton's Telecom Dictionary
A vertical bar means "or": only one option can appear in a single command.	platform [a b e]
Square brackets [] indicate an optional argument.	login [platform name]
Slanted brackets < > group required arguments.	<password>

Table 3 Keyboard and menu conventions

Description	Example
A plus sign + indicates simultaneous keystrokes.	Press Ctrl+s
A comma indicates consecutive keystrokes.	Press Alt+f,s
A slanted bracket indicates choosing a submenu from menu.	On the menu bar, click Start > Program Files .

Table 4 Symbol conventions

	This symbol represents a general hazard.
	This symbol represents a risk of electrical shock.
	NOTE This symbol represents a note indicating related information or tip.

Safety Notes

This chapter provides the safety notes for the 9102 Handheld Spectrum Analyzer.

Safety warnings

This product is designed for indoor use. As exposure to water can damage the instrument it has to be protected against moisture when used outdoors.



WARNING

This is a safety class A equipment in accordance with EN 61326. It may produce radio interference affecting household equipment; the user may be forced to execute appropriate measures against radiation.



WARNING

Only use a 50 Ω N-type connector to connect to the **RF IN** port of the 9102. Use of any other connector may result in damage of the instrument.



WARNING

Do not cover the ventilation slits (at the bottom left-hand corner and on the top). Covering them may result in serious damage and fire.



WARNING

The maximum input power level at the **RF IN** connector is 30 dBm (1 W). Higher input levels may result in serious damage of the instrument.



WARNING

Operate the instrument within the temperature range from 5°C (40°F) to 45°C (110°F) only. Operation outside this range will lead to invalid results.



Safety advice for the battery

Do not crush. Do not heat or incinerate. Do not short-circuit. Do not dismantle. Do not immerse in any liquid, it may vent or rupture! Do not charge below 0°C (32°F) nor above 45°C (110°F).



Battery usage

The battery is for use with the 9102 only. Willtek does not accept any liability for damage of the battery or other equipment if the battery is used with other electric or electronic equipment.



WARNING

The 9162 Insertion Power Sensor may be hot during and after operation.



WARNING

Do not feed more than +47 dBm into the 9162 Insertion Power Sensor, the device may be destroyed otherwise.

Overview

1

This chapter provides a general description of the 9102 Handheld Spectrum Analyzer. Topics discussed in this chapter include the following:

- ["About the 9102 Handheld Spectrum Analyzer" on page 2](#)
- ["What's new" on page 2](#)
- ["Features and capabilities" on page 4](#)
- ["Options and accessories" on page 4](#)
- ["Physical description" on page 9](#)
- ["Maintaining your unit" on page 10](#)

About the 9102 Handheld Spectrum Analyzer

The 9102 is a lightweight, full-featured spectrum analyzer for many applications:

- Installation troubleshooting, repair and maintenance.
- Acceptance and installation troubleshooting of antenna and cable installations.
- Assessment and verification of electromagnetic radiation to verify against EMI.
- Production test and alignment of the output of RF modules.
- Field measurements and verification of base station emissions.
- Used to detect and locate faulty mobile phone parts and components.

Typical measurements with the 9102 Handheld Spectrum Analyzer include transmitter testing, alignment of modulators and measuring switch breakthrough. Additional options such as a tracking generator option, the 9160 VSWR/DTF Bridge and the 9130 VSWR/DTF Reflection Measurement Option expand the capabilities of the 9102 towards a scalar network analyzer. The analyzer is fully controllable via front panel or by remote control from a PC.

For base station installation or maintenance engineers the 9102 offers the full scope of common performance measurements of the BTS antenna systems: Return Loss (Reflection), Tower-Mounted Amplifier (Transmission) and Distance to Fault measurement with a standard resolution of 500 points (min. 0.05 m) in one lightweight device.

Measurement results and instrument settings can easily be transferred to a PC for presentation or post-processing. This rugged instrument is suitable for stationary and mobile usage and meets many application needs.

What's new

Version 5.00 New options supported:

- 9168 GPS Receiver Option
- 9162 Insertion Power Sensor
- 9151 Frequency Extension 7.5 GHz

New features in 9100 Data Exchange Software version 5.00

- Marker description with break-out line can be added to the trace
- Trace data or graphics can be copied to the clipboard and pasted into a word processor or spreadsheet application
- Printout header can be defined

- Version 4.50** In DTF mode, the calibration cable dielectric and length can be entered.
Minor corrections.
- Version 4.11** Improvements:
- Trace average function corrected.
 - Too low sweep time at 200 kHz RBW now gets an UNCAL warning.
- Version 4.10** New features:
- Supports 100 Hz and 300 Hz RBW filters, 10 kHz span and 250 s sweep time in 9101B and 9102B models. Those features are not available for older instruments.
- Improvements:
- SCPI remote control bugfix for marker value.
- Version 4.01** New features:
- New EMF (EMI) Measurement Option.
For an extensive description of the new EMF (EMI) measurement mode available with this option refer to [Chapter 11 "EMF \(EMI\) Operation"](#).
 - New features within the 9100 Data Exchange Software supporting the new EMF (EMI) Measurement Option.
For further details refer to [Chapter 14 "9100 Data Exchange Software"](#).
 - New trace finder functionality.
For further details refer to ["Trace finder" on page 19 in Chapter 1 "Overview"](#).
- Version 3.10** New features:
- New VSWR/DTF Reflection Measurement Option including the measurement modes reflection, distance to fault and cable loss
 - Marker functionality: six markers for all measurement modes, markers can be set on trace A and trace B.
 - New look and feel of the parameter windows
 - Direct printing
 - New Printer Config menu
 - RMS Option with RMS detector
 - Absolute and relative display within Transmission mode
 - Trace offset by division within Transmission mode

- Trace Memory menu: functions Store Trace and Recall Trace act on both traces.
- Channel Power mode: Measure menu moved to main menu.
- Specific backlight display settings for operation on battery to save energy.

Improvements:

- Full support of external device in the Mode window
- Improved frequency counter
- Improved Level StepDown functionality of MinValue
- Improved Color Scheme menu: eight input fields available for all screen components

Version 3.01

New feature:

New function in the Trace Function menu: Add A + B → A. For a description of these functions refer to the ["Setting up the trace"](#) sections of in [Chapter 3 "Spectrum Analysis Operation"](#) and [Chapter 4 "Channel Power Operation"](#).

Improvement:

Measure menu improved. Access to Measure menu from Spectrum Analysis main menu.

Features and capabilities

- VSWR and DTF measurements supporting antenna installation and verification (option)
- Tracking generator option enables cable measurements in the field
- Radiation measurements of base stations and broadcast stations (EMF option)
- Scalar network analysis (amplifier gain over frequency or filter characteristics) and antenna measurements
- Prequalification for EMC (electromagnetic compatibility) tests
- Displayed average noise level at -117 dBm
- Dynamic range of 70 dB

Options and accessories

The following options and accessories are available:

Table 5 Options for the 9102 Handheld Spectrum Analyzer

Order number	Description
M 897 261	9130 VSWR/DTF Reflection Measurement Option
M 897 274	9131 EMF Measurement Option
M 897 275	9132 RMS Detector Option
M 248 966	9160 VSWR/DTF Bridge
M 248 804	9102 Tracking Generator Upgrade
M 248 811	9168 GPS Receiver Option
M 248 968	Insertion Power Sensor
M 230 035	9151 Frequency Extension 7.5 GHz

Table 6 Accessories for the 9102 Handheld Spectrum Analyzer

Order number	Description
M 205 012	Battery module (rechargeable, 7.2 Ah)
M 241 015	9100 outdoor backpack
M 241 013	9100 soft carrying bag
M 204 097	1500 battery charger
M 248 328	9100 power supply
M 860 389	9100 12 V car adapter
M 867 037	9100 safety lock
M 897 137	9100 Data Exchange Software
M 860 388	9100 serial communication cable
M 248 640	1205 RF Probe 20 dB (includes N to BNC adapter) frequency range 100 kHz to 4 GHz RF attenuation (nominal at 50 Ω) 20 dB including adapter N (male), BNC (female)
M 248 971	1207 Inductive Probe frequency range 4 MHz to 6 GHz 30 dB amplifier
M 860 368	9170 Biconical Antenna
M 248 809	9171 Isotropic Antenna
M 860 158	9172 Directional Antenna, 80 to 1000 MHz
M 860 159	9172 Directional Antenna, 300 to 3000 MHz
M 860 264	Antenna, 400 MHz band (TNC)
M 860 261	Antenna, 900 MHz band (TNC)
M 860 262	Antenna, 1800 MHz band (TNC)
M 860 260	Antenna, 1880 MHz band (BNC)

Table 6 Accessories for the 9102 Handheld Spectrum Analyzer

Order number	Description
M 860 146	Antenna, 2400 MHz band (TNC)
M 886 098	Adapter N (male) to TNC (female)
M 886 097	Adapter N (male) to BNC (female)
M 886 205	Matching pad N 50 Ω to N 75 Ω
M 886 204	Matching pad N 50 Ω to F 75 Ω
M 874 061	Attenuator 18 GHz, 6 dB
M 860 548	Calibration set Open/Short/Load, type DIN 7/16 inch male
M 860 549	Calibration set Open/Short/Load, type N male
M 860 396	Composite cable 10 m for 9171
M 860 256	Antenna tripod
M 860 395	Bag for antenna tripod

9100 battery module



1500 battery charger



9100 soft carrying bag



9100 outdoor backpack



9100 12 V car adapter



9100 safety lock



9100 serial communication cable



1205 RF Probe 20 dB



1207 Inductive Probe



9168 GPS Receiver Option

9162 Insertion Power Sensor



9170 Biconical Antenna



9171 Isotropic Antenna



9172 and 9173 Directional Antennas

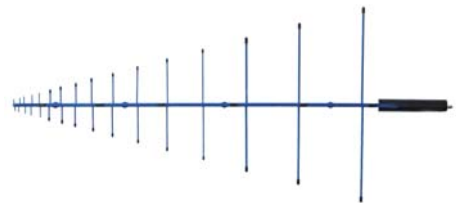

Antenna 900 MHz band (TNC)
Antenna 1800 MHz band (TNC)
Antenna 1880 MHz band (BNC)
Antenna 2400 MHz band (TNC)



Adapter N - TNC
Adapter N - BNC



Matching pad N 50 Ohm to
N 75 Ohm
Matching pad N 50 Ohm to
F75 Ohm



Attenuator 18 GHz, 6 dB



Calibration Set Open/Short/Load,
type DIN 7/16 inch male



Calibration Set Open/Short/Load,
type N male



Physical description

The 9102 Handheld Spectrum Analyzer is delivered with the 9100 Data Exchange Software which can also be ordered separately.

The user-accessible parts of the 9102 can be broken down into several sections:

- Front panel with large screen, softkeys, numeric, cursor and function keys.
- Connectors accessible from the top and the left-hand side of the 9102.
- On/off switch, power supply connector and battery shelf.
- Handle which can be turned in steps to serve as a stand, allowing the 9102 to be operated at an angle.

Maintaining your unit

Willtek seeks to permanently improve its products. Software updates are available on the Internet at www.willtek.com. For a detailed description of updating the Application Software please refer to [Chapter 14 "Updating the Instrument Software"](#).

The 9102 Handheld Spectrum Analyzer is a measurement device. As with all such instruments, the 9102 should be calibrated on a regular basis to ensure accuracy. Willtek recommends calibration of the 9102 at yearly intervals.

Please take also advantage of our Frequently Asked Questions and our electronic newsletter, both available on the Internet.

Further questions regarding the 9102 Handheld Spectrum Analyzer can be directed to customer.support@willtek.com.

General Operation

2

This chapter describes the instrument's functions that are independent of the selected mode. Topics discussed in this chapter are as follows:

- ["Connecting the 9102 Handheld Spectrum Analyzer" on page 12](#)
- ["Powering up the unit" on page 14](#)
- ["Starting measurements" on page 15](#)
- ["Using the front panel" on page 15](#)
- ["Selecting the measurement mode" on page 27](#)
- ["Working with the markers" on page 29](#)
- ["Using limit lines" on page 32](#)
- ["Printing" on page 36](#)
- ["Logging the current position \(GPS-assisted\)" on page 36](#)
- ["Controlling the 9102 from a PC" on page 38](#)
- ["Returning from remote control to local mode" on page 38](#)
- ["Checking general settings" on page 38](#)
- ["Working with stored settings" on page 49](#)
- ["Restoring factory settings for all modes" on page 50](#)

Connecting the 9102 Handheld Spectrum Analyzer

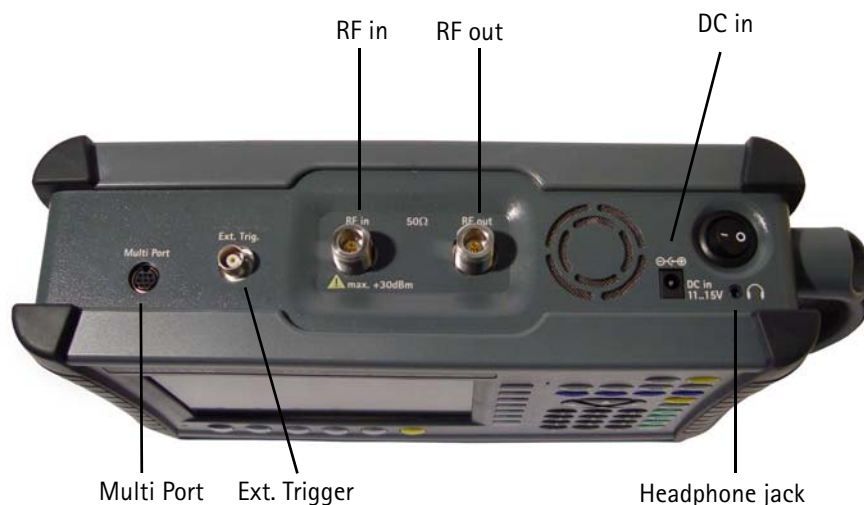

Figure 1 9102 connectors on the top of the instrument

DC IN connector The 9102 can be operated either from the internal battery or from an external DC source such as the power supply which is delivered with the 9102. In addition, the battery is loaded when an external DC source is connected. See the specifications in your getting started manual for details of the required DC source. Here you will also find detailed information on installing and maintaining the battery.

Apply the source to the **DC IN** connector at the top of the 9102.

RF IN connector RF in is a 50 Ω N-type connector (female).

If you have a 50 Ω shielded RF cable with an N-type connector (male) to connect to the device under test, simply screw the connector tightly to the 9102.

If you have a 50 Ω shielded RF cable with a BNC connector (male), use an N to BNC adapter to connect the cable to the 9102. Willtek offers an appropriate adapter; see section "[Options and accessories](#)" on page 4.



WARNING

The maximum allowable input power level at the **RF IN** connector is 30 dBm (1 W). Higher levels at this port can damage the instrument!



CAUTION

Only use a 50 Ω N-type connector to connect to the **RF IN** port of the 9102. Use of any other connector may result in damage of the instrument.

Take care of proper termination

Use of cables and sources with an impedance other than 50 Ω results in inaccurate measurements.

If you want to test a device with an impedance of 75 Ω , refer to section ["Changing the input impedance" on page 60](#) to adapt the 9102 settings.

RF OUT connector **RF OUT** is a 50 Ω N-type connector (male).

The link between the device under test and the 9102 Handheld Spectrum Analyzer may be attenuated, for example because the link is an antenna or includes a power splitter, or a long cable. The effect of the attenuation on the measurement results can be compensated by entering the attenuation value in the 9102, see section ["Compensating gains and losses" on page 59](#).

EXT. TRIG. connector Mainly used in spectrum analysis measurements. Using this connector the unit can be provided with an external trigger signal. Here, an external device that triggers the measurement by sending an impulse can be connected.



WARNING

The **EXT. TRIG.** input is designed for TTL input levels only. Higher levels at this port can damage the instrument!

Multi Port In order to provide for external adapters, amplifiers and accessories the instrument offers a multifunction connector. The Multi Port enables the instrument to trigger a measurement onto an external signal. Furthermore it can be used to read data stored in external devices (e.g. calibration data).

Headphone jack In addition to the build-in loudspeaker the instrument also offers a standard 3.5 mm headphone jack. When you connect the headphones to the instrument the loudspeaker will be disabled automatically.



Figure 2 9102 connectors on the left-hand side of the instrument

SERIAL (RS-232) connector

This 9-pin sub-D connector on the left-hand side of the 9102 Handheld Spectrum Analyzer can be used to control the instrument remotely via serial interface (RS-232). The command set and responses are explained in section ["SCPI Command Reference" on page 247](#).

Use a null modem (PC to PC) cable to connect the 9102 to a controlling PC.

LAN connector

The 9102 can also be controlled via local area network (LAN) using a TCP/IP connection. The LAN connector is located on the left side of the instrument. The IP address can be set up in the System Configuration menu or via RS-232. The 9102 can be operated in networks operating at 100 Mbps, but is capable of transmitting and receiving at 10 Mbps only.

The command set to control the 9102 and the responses from the 9102 are explained in section ["SCPI Command Reference" on page 247](#).

Connect the 9102 to the LAN with a standard LAN cable with RJ-45 connectors.

Powering up the unit



The 9102 is switched on and off using the power switch located at the top of the instrument. It takes about 55 seconds for the 9102 to load and start its software.

Starting measurements

The 9102 starts measuring and displaying results automatically after powering the instrument. It starts in the measurement mode last active.

Using the front panel

Overview The front panel is divided into different sections as follows:

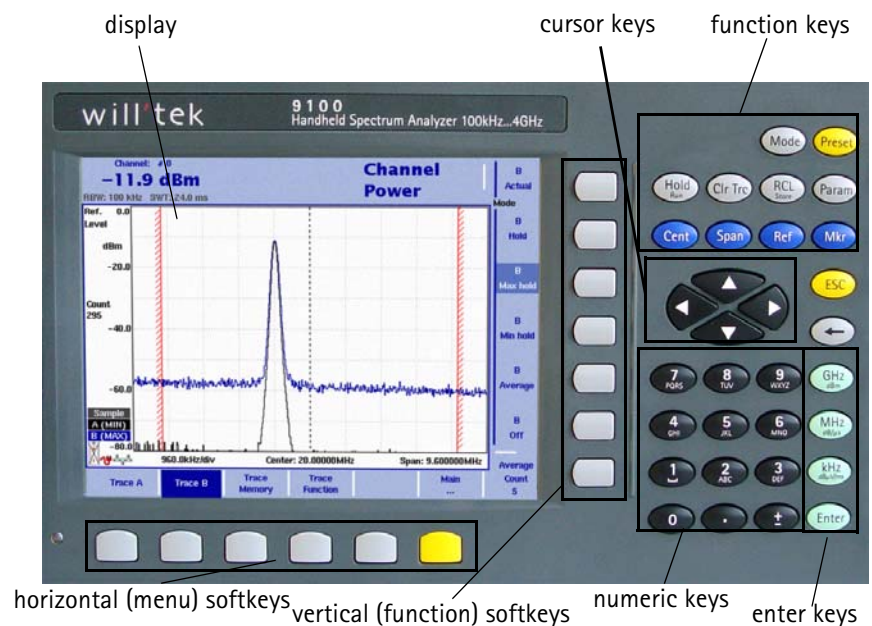

Figure 3 Front panel elements

Battery status LED This LED has different states:

- The LED lights green when the 9102 is being operated from its battery and no external power is supplied.
- The LED lights yellow when the battery is connected to an external power supply and being loaded.
- The LED is off when the loading procedure is completed, the battery is fully loaded or when there is no battery in the 9100's battery compartment.
- When the LED is flashing yellow quickly and permanently, there is a problem with the battery or the charger. Please report this problem to a Willtek service center.

NOTE

Signal level measurement results may be impaired when the battery is low, that means when the battery has less than 10% of its nominal capacity. See [Table 7 on page 17](#) for an indication when the battery is low. For a detailed description on installing and charging the battery please refer to your getting started manual.

Display The 6.5 inch display is divided into the following sections (see [Figure 4](#)):

- Results area
- Marker field
- Input field
- Softkey descriptions

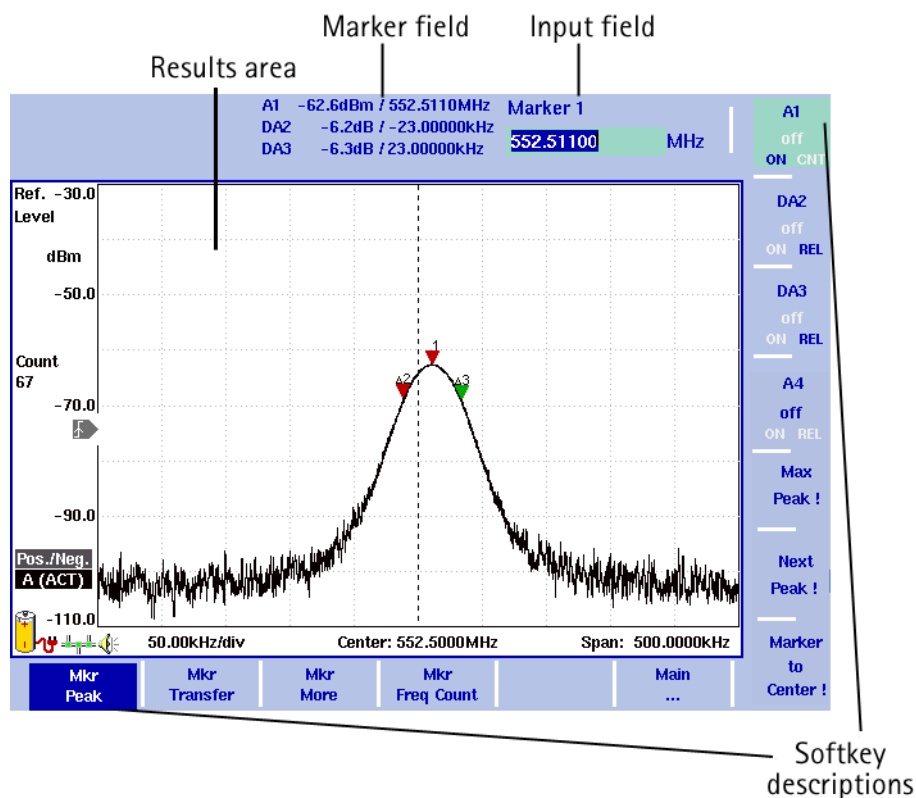

Figure 4 Display sections

Results area Results area (graph)

The results area utilizes most of the screen and provides you with the measurement results. A grid of ten vertical and eight horizontal rows eases readability of results from the axes. There may be one or two graphs, depending on the number of traces selected.

Horizontal axis

The horizontal axis is the frequency axis for the spectral components. The zero span mode is an exception, as the horizontal axis is the time axis in this case. Another exception is the Distance to Fault mode, as in this mode this axis displays the distance in metres or feet depending on the unit you select. The values of the frequencies at both ends of the scale are indicated (start and stop frequencies).









Vertical axis

The vertical axis reflects the RF power. Depending on your choice of the level unit, the RF power is indicated in dBm, dBV, dBmV, or dBμV. The top end of the power scale is called the reference level.

Symbols (icons)

Apart from the results graph itself, several icons are available to indicate the status of the 9102 as follows:

Table 7 Icons on the display

Symbol	Meaning
	The 9102 is taking its operating current from the battery. The colored area marks how much of the capacity is still available. For 30% or more, the area is indicated in yellow; from 10% to 30%, the area is shown in red, and in white for less than 10%. The 9102 sounds a double beep when the capacity goes below 30% of its nominal value and two double beeps below 10%.
	The 9102 is connected to an external DC supply.
	The 9102 cannot determine the battery charge although the battery can still be used and recharged. Please contact Willtek service to have your battery checked.
	The 9102 cannot determine the battery charge; typically appears during the last third of operating time of battery operation. Please contact Willtek service to have your battery checked.
	The battery is not installed and the 9102 is operated from the external power supply.
	The 9102 is connected to a local area network (LAN).
	A video trigger has been set at the power level indicated. The icon also displays the slope of the trigger.
	Demodulation is switched on so that the 9102 emits the demodulated signal at the loudspeaker.

Other screen elements

The bar to the left of the vertical axis carries some or all of the elements shown below:

Table 8 Texts on the left-hand side

Text	Meaning
Ref. Level	Indicates the top-most level on the vertical (power) axis. Can be modified with the REF function key.
dBm dB μ V dBmV dBV V mV μ V mW μ W dB μ V/m dBmV/m dBV/m V/m mW/m ²	Shows the unit in which power, is displayed. Can be changed in the Level > Units menu. Units can be switched between logarithmic and linear by pressing the Units softkey. Logarithmic units are: dBm, dB μ V, dBmV, dBV, dB μ V/m, dBmV/m, dBVm. Linear units are: V, mV, μ V, mW μ W, V/m, mW/m ² .
HOLD	Indicates when measurements have been halted with a press of the HOLD/RUN function key.
Count	The number following shows the progress of the measurements, that means it indicates how many measurements with the present configuration have already been taken. The counter continues while the trace hold mode is enabled. It is reset whenever a parameter affecting the measurements is changed, that means frequencies, filters or attenuation.
Ext. Dev.	Indicates that the external device compensation is turned on, that means the attenuation of any coupling device is taken into account. The external device compensation can be set up as shown in section "Compensating gains and losses" on page 59 .
UNCAL	When displayed, the filter and sweep time setting do not permit proper measurements.
Pos./Neg. Pos. Peak Neg. Peak Sample RMS	Shows the current detector setting. The detector can be changed as explained in section "Selecting the detection method" on page 68 . The RMS detector is available if the 9132 RMS Detector Option is installed and activated on your 9102.
A/B (ACT) A/B (HLD) A/B (MAX) A/B (MIN) A/B (AVG)	Shows the currently selected trace mode for the respective trace. The background color of the text coincides with the color of the graph. For more information on trace modes, see section "Selecting the trace mode" on page 64 .

Trace finder

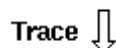

If more than 90 percent of a results trace is not shown onscreen because it is above or below screen boundaries, a trace finder icon consisting of an up or down arrow and the word "Trace" shows where the trace can be found. The trace finder icon is positioned in the middle of the results display. By modifying the reference level accordingly you can bring the trace back into view.

Marker field

A1	-68.0dBm / 2.246400GHz
DA6	2.8dB / 921.6000MHz
B5	-53.5dBm / 2.808000GHz
B2	-54.3dBm / 1.800000GHz

If any of the markers is active, the marker field is displayed, showing the measurement values at the marker positions. Up to four markers are displayed with their level and frequency values. If you use four markers and activate a fifth (up to six markers are available) one marker value will be hidden and the new one will be displayed instead. By pressing the relevant marker softkey you can display the hidden marker value again. A marker can be switched from absolute to relative values. The values are then shown relative to those of marker 1 (e.g. A1).

Input field

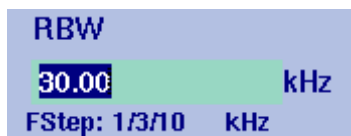

The input field allows you to enter a number or a text, depending on the selected function. The meaning of the input value is expressed by the header line. Some input fields have an additional explanation of the step size beneath. The step size applies when the value is changed using the up/down cursor keys instead of the numeric keys.

Softkey descriptions

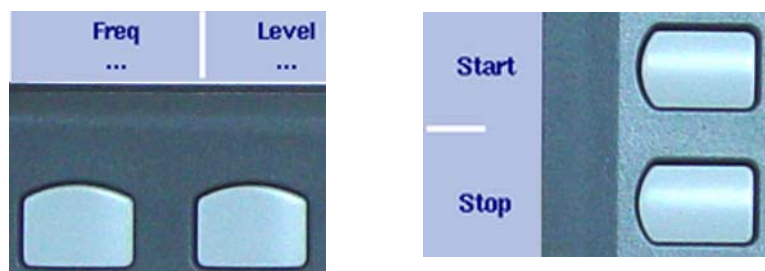

The softkey descriptions indicate the assignment of a function to a softkey. They are aligned to the lower side with the horizontal softkeys and to the right-hand side with the vertical softkeys. See ["Softkeys" on page 23](#) for more information.

Keypad The front panel carries a large number of keys, giving you direct access to functions and menus and allowing you to enter test parameters such as the center frequency. The keypad is divided into the following sections:

Function keys



The function keys have specific functions which do not change. Therefore they are sometimes also referred to as "hardkeys" in contrast to the softkeys, whose functions change with the description given on the screen.

The function keys are:

Table 9 Function keys











Key	Function
	Measurement mode selection. This function key allows you to select between different predefined types of measurements for specific applications. It also provides access to system settings.
	<p>Presets all the entry fields of the selected mode to the factory default settings. It does not affect the settings of other modes.</p> <p>To prevent accidental resets, the preset function does not execute after a short keypress. Press this function key for at least half a second to return to the defaults. In addition to this function key the 9102 Handheld Spectrum Analyzer offers the Factory Settings function for resetting all modes. See "Restoring factory settings for all modes" on page 50 for more information.</p>
	Stops and starts sweeps.
	<p>This function key calls up the parameter pages summarizing the current settings. Press Exit to close the parameter window.</p> <p>Note that the parameter windows differ between the measurement modes.</p> <p>Parameters that lead to an UNCAL warning are marked with a diamond.</p>

Table 9 Function keys

Key	Function
Rcl/Store 	Provides access to the Memory menus.
Clr Trc 	This function key resets previous results (including averages), the sweep counter and the failure counter, and starts a new sweep.
Cent 	Direct access to the center frequency input field within the Frequency menu.
Span 	Direct access to the frequency span input field within the Frequency menu.
Ref 	Direct access to the reference level input field.
Mkr 	Access to the Marker menu.

Cursor keys



In an input field, the up and down cursor keys are used to increase or decrease the current value. The left and right cursor keys move the cursor position by one digit.

If a marker field is active, the up and down cursors move the marker by half a division up or down, respectively. The left and right cursor keys move the marker pixelwise.

Immediate reaction

Any change of an input parameter with the cursor keys has immediate effect. With the straight feedback on the screen, you can easily adjust parameters to the optimum values with a trial-and-error approach.

Numeric keys



The numeric keys allow you to enter a value in a way similar to a pocket calculator. On some input fields, you can enter text instead, as on a mobile phone.

Invalid entries





If you enter an invalid number or string, the 9102 beeps and corrects the entry to the closest valid value.

The \pm key offers an additional feature. After connecting a PCL printer to the 9102 you can print screens directly by pressing this key. For details on configuring printers and printing refer to ["Configuring a printer" on page 47](#) and ["Printing" on page 36](#).

Enter keys

Any input of numerical or alphanumeric entries must be closed or can be affected by one of the enter keys. The meaning of the individual enter keys is as follows:

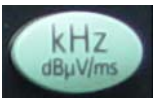
Table 10 Enter keys

Key	Function
GHz/dBm 	In frequency input fields, closes the entry by applying the unit GHz (gigahertz). In power input fields, assigns the unit dBm to the entered value.
MHz/dB/ μ s 	In frequency input fields, closes the entry by applying the unit MHz (megahertz). In power input fields, assigns the unit dB to the entered value. In time parameter input fields, assigns the unit μ s to the value.
kHz/dB μ V/ms 	In frequency input fields, closes the entry by applying the unit kHz (kilohertz). In power input fields, assigns the unit dB μ V to the entered value. In time parameter input fields, assigns the unit ms to the value.
Enter 	Confirms an entry without a unit and with the units hertz and seconds.

Escape key



If pressed while an input field is open, the **ESCAPE** key closes this input field without changing the previous value.

Backspace key



Deletes the last entered alphanumerical (backspace).

When an input field is entered, all digits are marked. By pressing the backspace key, the entire entry is deleted.

Softkeys

The functions of the softkeys change with the description on the screen given next to the respective key.

Horizontal (menu) softkeys



The horizontal softkeys provide access to the various menus. The name of the active menu is highlighted; the functions of a menu are offered on the vertical softkeys. Submenus are indicated with three dots ("..."); the menu softkey without the dots leads you one level up in the menu hierarchy.

Vertical (function) softkeys



The vertical softkeys allow you to change the settings of the 9102.

The vertical softkeys in the 9102 carry out one of the following functions:

- Normal settings – by pushing the softkey, an entry field appears on the top of the display, allowing you to enter numerical or alphanumerical data. The data become valid after pushing one of the enter keys. Some of the softkeys for normal settings also describe the currently set value. Example: The Channel softkey in channel power mode.



- Combined entry and selection – this type of softkey allows you to change a value and also to change a related setting, for example changing between automatic and manual parameter setting. The first push on the softkey opens the entry field like the normal settings softkey. Pushing it several times results in the 9102 toggling between the available options. The option

currently selected is indicated in blue while the inactive options are shown in white.

Example: The RBW softkey.



- Execution – by pushing the softkey, the function described is performed. An execution softkey is indicated by an exclamation mark.

Example: Max Peak softkey in the Marker menu.



- Selection – several selection softkeys allow you to choose between different options. The selection softkeys for one function are indicated by a vertical bar connecting the softkeys, and a text describing the function. The option currently active is highlighted, i.e. indicated by inverted colors.

Example: The TrigMode softkeys in the Sweep menu.

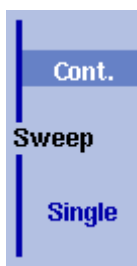

Entering numbers and text

Whenever an input field is open, it expects you to enter either numbers or characters (where characters may also include numerical digits). You will notice immediately what the 9102 expects as the numeric keys have the appropriate function.

Filling in a numerical input field

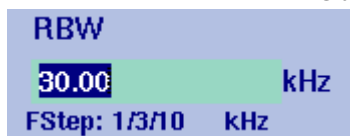

When the 9102 software expects a numerical entry, pressing a numeric key results in the appropriate digit to appear in the input field. The 9102 may or may not allow you to enter a decimal number or a signed value, so the keys for the decimal point and for changing the sign of the number are either active or not. When all digits, the sign and the decimal point have been entered as required, one of the enter keys must be pressed. Numbers often carry a unit with them; the enter keys provide the appropriate units.

Acoustical reaction on inputs

After entering a new parameter value, one of two acoustical alarms may appear:

- Short beep (hint): The parameter is out of limits, or the input affects an associated parameter; the respective parameter has been corrected by the 9102 Handheld Spectrum Analyzer.
Example 1: An invalid stop frequency of 8 GHz has been entered, resulting in a short beep and the maximum stop frequency being set.
Example 2: The start frequency is set to 2 GHz, the stop frequency is set to 4 GHz and the user enters a new span of 3 GHz. For units without the frequency extension, this results in the start frequency being changed to 1 GHz and a short beep to sound because the new span would result in a stop frequency beyond the maximum of 4 GHz.
- Long beep (error): A parameter is set to an invalid value and the 9102 Handheld Spectrum Analyzer resumes the old value, sounding an error beep.
Example: After entering a new (invalid) attenuation value of 60 dB, the 9102 Handheld Spectrum Analyzer sounds a long beep and sets the attenuation back to the previous value.

Filling in a text input field

Store Settings

RT1HN87

Some input fields can be filled with alphanumerical text instead. The numeric keys can then be used to enter characters. The keys may have several letters or numbers assigned. The assignment of the keys in this case is as follows:

Table 11 Keys for alphanumerical text entry

Key	Assignment
0	0
1	1
2	A, B, C, 2
3	D, E, F, 3
4	G, H, I, 4
5	J, K, L, 5
6	M, N, O, 6
7	P, Q, R, S, 7
8	T, U, V, 8
9	W, X, Y, Z, 9
.	not assigned
±	not assigned

To enter a character, push the key rapidly and repeatedly until the desired character appears in the input field.

Changing the input

Once an input field is open, you can move the cursor with the **LEFT/RIGHT** cursor keys to place it within the number or text. Additional digits or characters can be entered, or you can delete the digit or character in front of the cursor using the **BACKSPACE** key.

Selecting the measurement mode

The 9102 provides different measurement modes:

- The spectrum analysis mode is most versatile. It provides most of the options included in all other modes. For more information on this mode, refer to [page 53](#).
- The channel power mode allows you to measure the radiated power within a certain frequency band. Read more about the channel power mode on [page 77](#).
- The transmission mode, which is available in the (VSWR/)Tracking ... submenu accessible from the Mode menu, allows you to determine the frequency characteristics of active and passive devices. Read more about this mode on [page 111](#).
- The signal generator mode, which is also available in the (VSWR/)Tracking ... submenu, can be used to generate a signal for stimulating an electronic circuit. Read more about this mode on [page 105](#).

If the 9130 VSWR/DTF Reflection Measurement Option is installed and activated on your 9102, three additional modes are available in the VSWR/Tracking ... submenu. If the option is not installed, this submenu has the menu name Tracking ... and the additional modes are not available. For details on the 9130 VSWR/DTF Reflection Measurement Option please refer to [Chapter 8: "The 9130 VSWR/DTF Reflection Measurement Option"](#). For details on checking installed options and installing new ones refer to ["Checking installed options" on page 40](#) and ["Installing a new option" on page 41](#).

All three modes can be selected in the VSWR/Tracking ... submenu accessible from the Mode menu:

- The reflection mode provides high-precision measurements of the reflection of antenna systems via vector measurements on the reflected wave. Read more about this mode on [page 139](#).
- The distance to fault mode offers a detailed analysis of antenna feeder cables in order to identify causes for faults like weak connectors, cable kinks etc. Read more about this mode on [page 157](#).
- The cable loss mode allows you to determine the average cable loss. Read more about this mode on [page 167](#).

If the 9131 EMF Measurement Option is installed and activated on your 9102, an additional measurement mode is available for selection:

The EMF (EMI) mode allows you to measure radiation from transmitters, e.g. base stations and broadcast stations, easily and efficiently. In this mode the 9102 measures the electromagnetic field over a user-definable frequency range and displays field strength or power density. Read more about this mode on [page 175](#).

In addition, the Mode menu provides access to the system settings, e.g. the I/O configuration, and to version information. See section ["Checking general settings" on page 38](#) for more details.

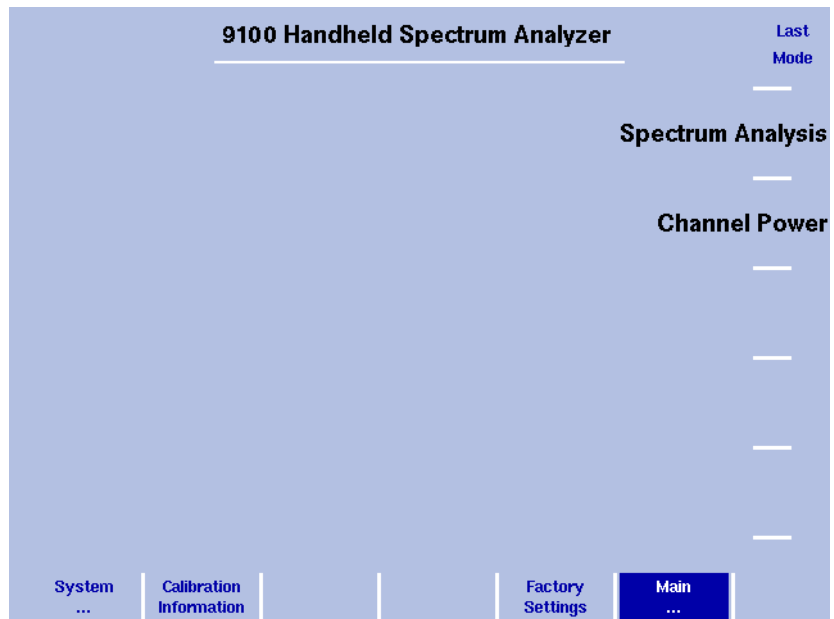

Figure 5 Selecting a measurement mode

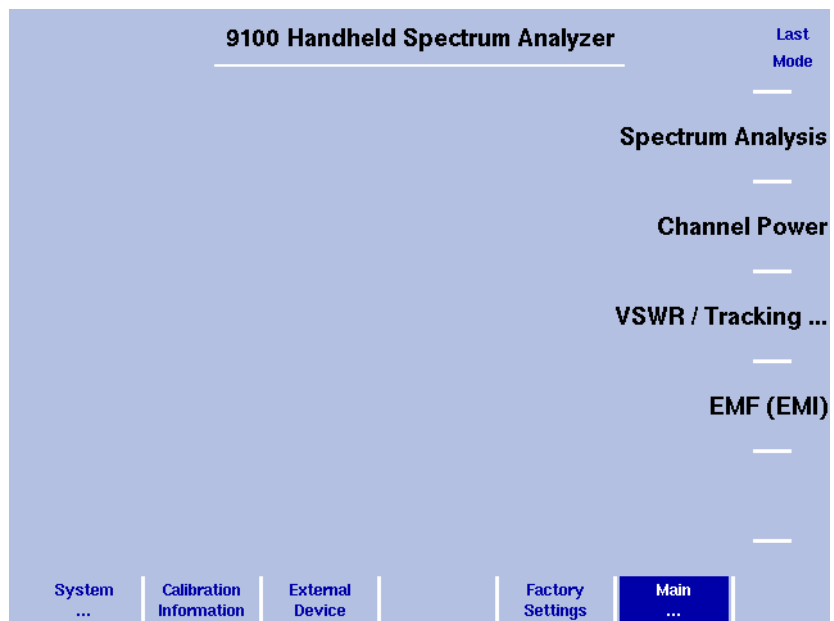

Figure 6 Selecting a measurement mode

To select the measurement mode, proceed as follows:

- 1 Push the **MODE** function key.
The Mode menu appears (see [Figure 6](#)).
- 2 Select a new mode or return to the mode last active by pressing the respective softkey. To select the modes signal generator, transmission, reflection, distance to fault and cable loss select the **(VSWR)/Tracking...** softkey

followed by the relevant mode softkey.

NOTE

The modes reflection, distance to fault and cable loss are available if the 9130 VSWR/DTF Reflection Measurement Option is installed and activated on your 9102. The EMF (EMI) mode is available, if the 9131 EMF Measurement Option is installed and activated. For details on checking installed options and installing new ones refer to "Checking installed options" on page 40 and "Installing a new option" on page 41.

The main menu of the selected mode appears. If you select a new mode, all parameters are set to the values which were used when the mode was last active. If, however, you resume the last active mode, measurements are continued.

Working with the markers

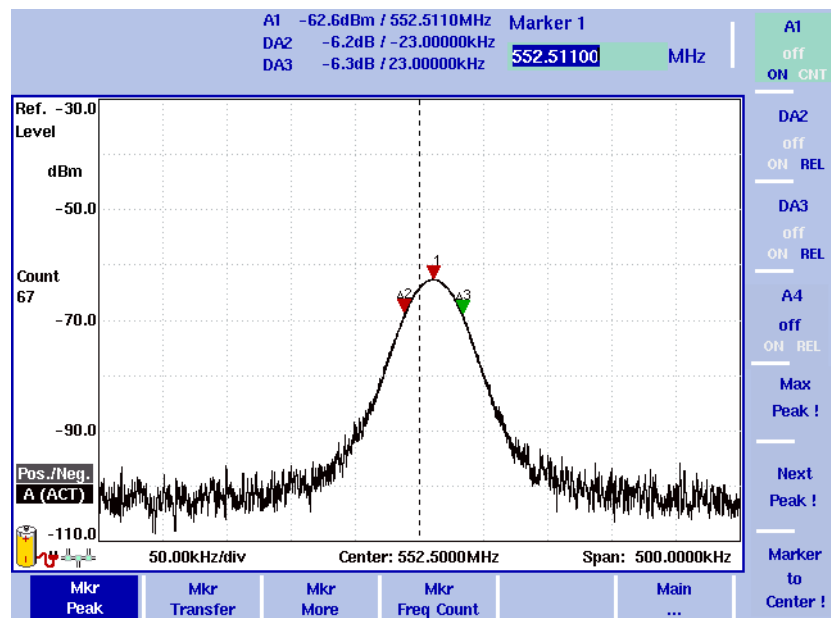

Figure 7 Example of markers

The 9102 includes powerful and easy-to-use marker functions. Up to six markers can be used; up to five of them can be delta markers. Markers are easy to place and you can easily affect the center frequency and the reference level upon a keypress. If you use two traces you can also use markers on trace A and trace B. The markers are named accordingly (e.g. A1, B1). Delta markers are identified by D (e.g. DA1).

It is important to note that if you place the cursor on a signal peak and then reduce the span, the marker position may be offset a little from the peak. This is due to the limited resolution of the displayed frequencies when using a high span. After reducing the span, the marker should be readjusted to the new peak.

Enabling and moving a marker

- 1 From the main menu, select **Marker**. Or push the **MKR** function key in any menu.
If you select **Marker** from the main menu when no marker is active, the softkey for marker 1 is highlighted.
To enable marker 1, toggle the softkey until "ON" is highlighted.
The input field for marker 1 appears.
If you use the **MKR** function key when no marker is active, marker 1 (A1 or B1) will be enabled at the maximum peak. The input field for marker 1 appears.
- 2 If you want to enable another marker, push the appropriate softkey (**A1** through **A4** or **B1** through **B4**). If you want to use more than four markers, press the **Mkr More** softkey to display the marker softkeys for marker 5 and marker 6 and proceed as described for markers 1 to 4.
The marker is enabled and the input field opens; the selected marker appears in the marker field in the top bar of the display.
- 3 If required, move the marker to another position using the cursor keys, one of the softkeys **Max Peak** and **Next Peak**, or by entering the frequency with the numeric keys and the appropriate enter key.

Disabling a marker

- 1 From the main menu, select **Marker**. Or push the **MKR** function key in any menu.
The Marker menu appears and the input field for marker 1 appears.
- 2 Push the softkey (one of **A1** through **A6** or **B1** through **B6**) for the marker which you want to disable. If you use more than four markers you can display the softkeys for marker 5 and 6 by pressing the **Mkr More** softkey. Toggle the softkey until "OFF" is highlighted. The marker is disabled and the respective marker values disappear in the marker field at the top. By toggling to "ON" again the marker will be enabled again.

Enabling a delta marker

For delta markers, the power level and frequency relative to marker 1 is displayed in the marker field. Marker 1 cannot be a delta marker. If marker 1 is not yet enabled when you enable another marker as a delta marker, marker 1 will be enabled automatically.

- 1 From the main menu, select **Marker**, or push the **MKR** function key in any menu.
- 2 Select the softkey for the marker which you want to turn into a delta marker (**A2** through **A6** or **B2** through **B6**). If you use more than four markers you can display the softkeys for marker 5 and 6 by pressing the **Mkr More** softkey.
If not already enabled, the marker is turned on.
- 3 Push the softkey until "REL" is highlighted. The respective marker in the marker field is indicated as a delta marker, e.g. DA2 instead of A2.

Disabling a delta marker

- 1 From the main menu, select **Marker**, or push the **MKR** function key in any menu.
The Marker menu and the marker 1 input field appear.
- 2 Select the softkey for the delta marker that you want to disable (e.g. DA2). If you use more than four markers you can display the softkeys for marker 5 and 6 by pressing the **Mkr More** softkey.
- 3 To disable the marker completely, push the softkey until "OFF" is highlighted. To turn the delta marker into a normal marker displaying absolute values again toggle the softkey to "ON".

Setting a marker on a frequency relative to marker 1

- 1 Enable a delta marker as described in ["Enabling a delta marker"](#).
For the selected delta marker, the input field shows the frequency relative to marker 1.
- 2 Enter a (signed) frequency relative to the frequency at marker 1, either using the numeric keys and the respective enter key, or moving the cursor to that frequency with the help of the cursor keys.
The marker field indicates the desired frequency offset for that marker, along with the power level relative to the power at marker 1.

Changing the center frequency with a marker

This function modifies the center frequency, adapting the frequency of a selectable marker.

- 1 From the main menu, select **Marker**, or push the **MKR** function key in any menu.
The Marker menu and the input field for marker 1 appear.
- 2 If you want to use the frequency at a marker position other than marker 1, push the appropriate softkey (**A2** through **A6** or **B2** through **B6**). If you use more than four markers you can display the softkeys for marker 5 and 6 by pressing the **Mkr More** softkey.
- 3 Push the **Marker to Center** softkey.
The center frequency changes to the frequency at which the selected marker is located. The frequency span only changes if the change in center frequency would lead to an invalid start or stop frequency.

Changing the reference level with the marker

The reference level can be changed to the level at a marker position as follows:

- 1 From the main menu, select **Marker**, or push the **MKR** function key in any menu.
- 2 Select the **Mkr Transfer** menu.
- 3 If you want to use the power level at a marker position other than marker 1, push the appropriate softkey (**A2** through **A6** or **B2** through **B6**). If you use more than four markers you can display the softkeys for marker 5 and 6 by pressing the **Mkr More** softkey.
- 4 Push the **Marker to Ref. Lvl** softkey.
The reference level changes to the level of the selected marker.

Assigning the marker frequency to FStep

For measurements of harmonics or intermodulation products, it can be useful to easily change between frequencies in user-defined steps. The "Marker to FStep" function assigns the active marker (or delta marker) frequency to FStep, the step width for the selection of center frequency and marker frequency.

Assumption: One of the markers A1 through A6 or B1 to B6 is active.

- 1 From the main menu, select **Marker > Mkr Transfer** to access the Marker Transfer menu.
- 2 Push **Marker to FStep**.
The FStep parameter assumes manual mode. If the currently active marker is an absolute marker, the frequency at the marker position becomes the new FStep value.
Alternatively, if the currently active marker is a relative (delta) marker, the difference between the frequencies at the active marker and marker 1 becomes the new FStep value.
If the new FStep value is higher than 1 GHz, the old FStep value is maintained and the 9102 sounds a hint beep.

Using limit lines

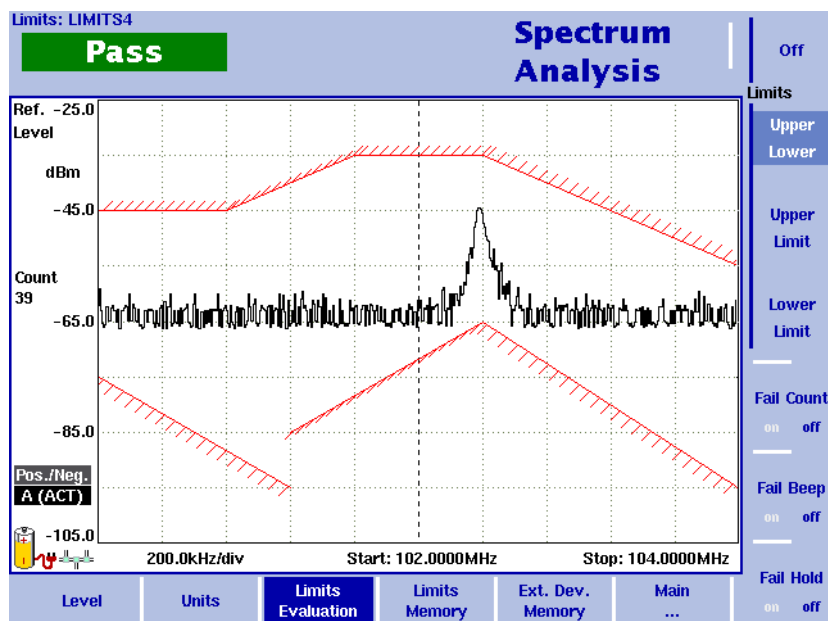

Figure 8 Example of limit lines in spectrum analysis

Overview

A very useful feature of the 9102 is the possibility to set limits for the trace A results. These are displayed on the screen and the 9102 can show if the results exceed the limits.

Two different limit modes exist in the 9102. In the first case, the limits exist of horizontal lines for the upper and lower limit. This method is called "simple limits"; the limits can be entered directly in the Limits menus of the 9102.

In the second case, there are more complex limits as shown in the example in [Figure 8](#). These limits can be entered with a comfortable tool on a PC and loaded to the 9102 via RS-232 or LAN interface. A set of limit lines can be used to define a measurement template. There are versatile tools around these limits available on the 9102, such as a fail counter, a beep when a failure occurs, or a measurement hold function upon failure. The limits can be used both in the frequency and in the time domain.

Up to 99 sets of limits can be stored on the 9102.

The actual limit values must be defined on a PC and loaded to the 9102 using the 9100 Data Exchange Software. Several limit files can be stored on the 9102. The name of the current limit file is indicated in the upper left-hand corner.

Note that the limits are defined within a grid, no matter what the units on the vertical and horizontal axes are. This way, you can apply the limits to different frequency ranges and power levels. It is your responsibility, however, to select a useful frequency range, reference level and level scale.

Note that a FAIL indication may occur if the start frequency is 0 Hz and an upper limit is set at this frequency.

Using simple limits

Simple limits consist of constant upper and lower limits. They must be activated to take effect. Once activated, each measurement is accompanied by a Pass/Fail verdict indicating whether or not the measurement result was within the limits.

Switching simple limits on and off



By switching limit lines on, any previously active limit template is disabled.

- 1 Press **Level > Limits Memory**.
- 2 Press the **Simple Limits** softkey so that the new choice (on or off) is highlighted.

When switching limits on, red horizontal lines indicating the upper and lower limits appear. A Pass/Fail verdict is displayed with every new measurement in the upper left corner of the screen. The text above the verdict ("Simple Limits") indicates that the verdict applies to simple limits. When switching limits off, the limit lines and the verdict disappear.

Defining upper and lower limits

The limits can be changed only when simple limits are activated. The range of valid entries depends on the power scale displayed (vertical axis) as follows:

Table 12 Valid entries for upper/lower simple limits (relative to reference level)

Scale	Valid range
1 dB/division	-8 ... 0 dB
3 dB/division	-24 ... 0 dB

Table 12 Valid entries for upper/lower simple limits (relative to reference level)

Scale	Valid range
5 dB/division	-40 ... 0 dB
10 dB/division	-80 ... 0 dB
15 dB/division	-120 ... 0 dB
20 dB/division	-160 ... 0 dB

Follow the steps below to define simple upper and lower limits.

- 1 Press **Level > Limits Memory**.
- 2 Press the **Upper** softkey, enter a new value for the upper limit (in dB, relative to the reference level) (or move the upper limit with the **UP/DOWN** cursor keys) and confirm with **MHz/DB/μs** or **ENTER**.
The upper limit line is moved to the new value.
- 3 Press the **LOWER** softkey, enter a new value for the lower limit (in dB) (or move the lower limit with the **UP/DOWN** cursor keys) and confirm with **MHz/DB/μs** or **ENTER**.
The lower limit line is moved to the new value.

Using limit templates

Limits can be comfortably defined with a PC-based tool and loaded to the 9102. This is described in full detail in chapter ["9100 Data Exchange Software" on page 213](#). The sections below describe how to recall, delete, activate and deactivate limit templates.

Selecting limit lines within the 9102

- 1 From the main menu, select **Level > Limits Memory**.
The Limits Memory menu appears.
- 2 Push the **Recall Limit Template** softkey.
An entry field appears, together with a file selection box.
- 3 Select a file either by moving the selection to its file name using the **UP/DOWN** cursor keys, or by entering the file name in the entry field and closing the input field by pressing **ENTER**.
The file with the limits is loaded and the upper/lower limits are activated immediately.

Activating and deactivating limit templates

- 1 Select a limits file (see section ["Selecting limit lines within the 9102"](#)).
- 2 Select **Level > Limits Evaluation**
The Limits Evaluation menu appears.
- 3 Select the limits option you want by pushing the appropriate softkey from the following choice: **Off**, **Upper/Lower**, **Upper Limit**, **Lower Limit**.
If you selected **Off**, no limits are displayed. Otherwise, the selected limits curve (upper and/or lower limits) appears on the screen. A Pass/Fail indication is given for each measurement trace in the upper left-hand corner.

- Deleting limit files in the 9102**
- 1 From the main menu, select **Level > Limits Memory**.
 - 2 a. To delete an individual file, push **Delete Limit Template**, select a limits file with the **UP/DOWN** cursor keys and push **ENTER** to delete an individual file (pressing **ESC** aborts the process before the file is deleted).

b. To delete all limit files stored in the 9102, push **Delete All Templates**. Confirm by pressing **ENTER**, if you really want to delete all limit files.

Counting limit failures When limit checking is enabled, a failure counter can be activated. The number of failures appears below the Pass/Fail verdict. The counter makes particular sense for statistical evaluations. For this application, it is important to define the number of measurements. The following sequence can be useful to obtain a failure count in conjunction with a defined number of measurement traces.

- 1 Select a limited number of traces (**Freq > Sweep**, see ["Performing a limited number of measurements" on page 62](#)).
- 2 From the main menu, select **Level > Limits Evaluation > Fail Count** to turn the failure counter on; if it was on already it should be switched off and on again.
The failure counter is reset to 0.
- 3 Push the **HOLD/RUN** softkey to start the measurement.
Both the measurement counter and the failure counter start from 0. When the selected number of traces has been reached, the measurements are stopped and you can read the failure count.

Resetting the counter The failure counter for the limits check can be reset by turning it off and then on again (in the **Level > Limits Evaluation** menu).

- Enabling a beep upon failures**
- 1 From the main menu, select **Level > Limits Evaluation**.
The Limits Evaluation menu appears.
 - 2 Push the **Fail Beep** softkey to activate or deactivate the beep counter:
If activated, a beep sounds each time the measured signal exceeds the limits.

Viewing a failed measurement This feature can be useful if you want to stop the measurement and view the measured signal when it fails the limits. Note that the 9102 should be set to continuous measurements.

- 1 From the main menu, select **Level > Limits Evaluation**.
- 2 Push the **Fail Hold** softkey once or twice to enable or disable the hold-on-fail function.
The measurements are halted when a failure occurs. The trace of the failed signal remains on screen.

Measurements can also be stored and recalled in the 9102 for later analysis or comparison. This is shown in ["Storing and loading traces" on page 70](#).

With the 9100 Data Exchange Software, traces can also be transferred to and viewed and stored on a PC. For more details, please refer to chapter ["9100 Data Exchange Software" on page 213](#).

Printing

The 9102 offers the possibility of printing measurement results, for example traces, directly from the instrument. In order to print results screens on a connected printer simply press the \pm key on the numeric keypad of the 9102's front panel.

NOTE

If an input field is active while you press the \pm key, it has the \pm functionality assigned to it. In this case printing is not possible. In order to be able to print deactivate the input field first by deselecting the respective softkey.

For details on supported printers and configuring a printer refer to ["Configuring a printer" on page 47](#).

Logging the current position (GPS-assisted)

The 9102 can show the current location and record measurement data along with the actual position at the time of the measurement. This can be useful when taking measurements of the electromagnetic immission (EMI) at various points.

All it needs is the 9168 GPS Receiver Option. With the option installed and switched on, the 9102 can indicate the coordinates (in minutes or degrees), the altitude (in meters or feet), the speed (in kilometers per hour or knots) and date and time.

This information is available on the screen of the 9102 Handheld Spectrum Analyzer, via remote control applying the set of SCPI commands over RS-232 or LAN, or in the measurement trace after data transfer to a PC with the 9100 Data Exchange Software.

The option requires Willtek's GPS receiver for the 9100 series, plus an option key installed in the 9100. See ["Installing a new option" on page 41](#) on how to install a new software option.

Connecting the GPS receiver

- 1 Plug the RS-232 connector of the GPS receiver into the RS-232 jack of the 9102 Handheld Spectrum Analyzer.
- 2 Connect the other connector of the GPS receiver to the Multi Port of the 9102.

Before the current location can be viewed, the GPS receiver must be switched on (see below).

Enabling the GPS receiver

The GPS Receiver Option is switched on by selecting the **MODE > GPS Data** menu and turning **GPS Data** on.

The GPS Data menu indicates the current position.

The location data can also be displayed as part of the trace loaded onto the PC with the 9100 Data Exchange Software. See section "[Viewing the actual trace on the PC](#)" on page 218 for more information.

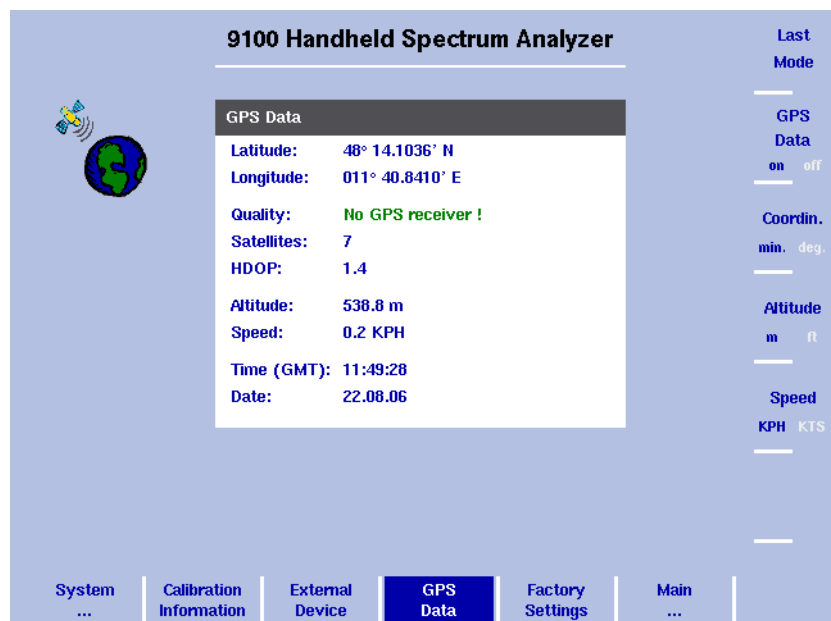

Note

GPS receivers work best in outdoor environments with not too many clouds. No signal may be received and hence no location presented while the receiver is located indoors.

Note

After activation of the GPS receiver, it may take 45 s until the first measurement is displayed.

Taking GPS-assisted location measurements

The coordinates are shown in the GPS Data menu; they are also logged together with the trace. The coordinates can be displayed along with the measurements in the 9100 Data Exchange Software; see section "[Including the GPS position in the trace](#)" on page 244.

The GPS Data menu shows one of the following GPS status messages in the Quality field:

- "No GPS receiver!": The 9102 did not find a valid GPS receiver connected.

- “No Signal”: The 9102 found a GPS receiver, but there are no GPS coordinates available as yet.
- “Receiver Warning”: Measurement data are available, but from less than four satellites. Four satellites are necessary to determine latitude, longitude and altitude.
- “Data OK”: Measurements are available from at least four satellites, resulting in the valid display of the information.

Changing the GPS display settings

In the **MODE > GPS Data** menu, use the **Coordin.** key to toggle between longitude and latitude display in degrees only (decimal scale) or in degrees and minutes.

The altitude can be displayed in either meters or feet. In the **MODE > GPS Data** menu, use the **Altitude** key to toggle between meters and feet.

The speed of the measuring device can be displayed in either kilometers per hour (KPH) or in knots. (KTS). In the **MODE > GPS Data** menu, use the **Speed** key to toggle between KPH and KTS.

Controlling the 9102 from a PC

The 9102 can be used under remote control from a PC. The interfaces supported for this are the serial interface (RS-232) and the LAN (TCP/IP). Please refer to section [“SCPI Command Reference” on page 247](#) for more information on remote control.

Returning from remote control to local mode

To gain manual control after using the 9102 under remote control, press **ESCAPE**.

Checking general settings

This section covers information about the unit, setting display brightness, time and date, and configuring the remote control interfaces of the 9102.

Reading the serial number

You can find the serial number of your 9102 as follows:

- 1 Push the **MODE** function key.

2 Select **System**.

The System Information display appears (see Figure 9), showing the serial number, the installed software version and the installed option.

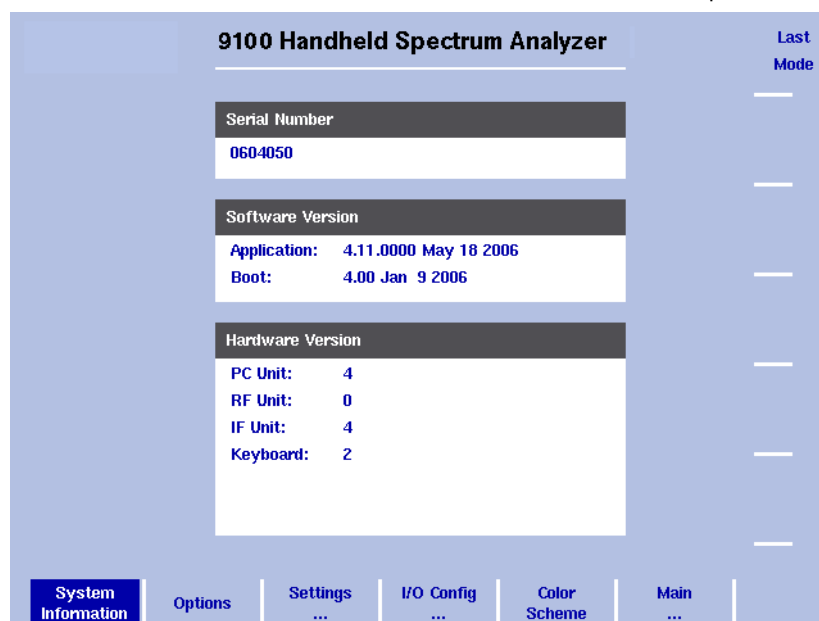

Figure 9 System Information menu

Reading the software version number

Before loading a new software version or reporting problems, you may want to check the currently installed version.

- 1 Press the **MODE** function key followed by the **System** softkey. The System Information menu appears.
- 2 Read and note the software version number in the field entitled Application.

Reviewing the calibration

As for all test instruments, the 9102 Handheld Spectrum Analyzer's accuracy should be checked against its specifications. This process is called calibration. If the 9102 accuracy falls outside the specified tolerance, it may be necessary to correct the instrument.

Willtek recommends a calibration interval of one year. The 9102 stores the date of the last calibration by a Willtek-certified lab and the date when the next calibration is due. In addition, you can document when the calibration date has been reviewed last.

To check if the 9102 is due for calibration, proceed as follows:

Press the **MODE** function key followed by the **Calibration Information** softkey. The Calibration Information menu appears.



Figure 10 Calibration Information menu

- 1 Here the calibration details for the instrument are displayed. The Calibration Number area shows the calibration number. The first line of the Calibration area indicates the date of the last calibration and the organization calibrating the 9102. The second line indicates when and by whom the calibration has been checked last. The third line indicates when the next calibration is due. This date is typically one year after the last calibration.
- 2 Push the **Date Last Check** softkey to change the last check date. It will be set to the actual date as set by the built-in real-time clock.
- 3 Push the **Name Last Check** softkey to enter the name of the person that carried out the last calibration date review.

Checking installed options

Willtek provides different application programs and options for the 9102 Handheld Spectrum Analyzer. These may or may not be active on your instrument. To check which options are actually installed on your 9102, take the following steps:

- 1 Press the **MODE** function key followed by the **System** softkey. The System Information menu appears.
- 2 Select **Options**. The Options menu appears, indicating the installed options in bold print with a tick in front; the options not installed are shown in grey.

Installing a new option

Software options can be installed by entering an activation key which you can purchase from Willtek or one of its representatives. To install a new option:

- 1 Press the **MODE** function key followed by the **System** softkey. The System Information menu appears.

- 2 Select **Options** and press **Activate Options**.
- 3 Enter the activation key and press **ENTER**.
 If the code is valid, the appropriate option is shown in bold print with a tick in front, indicating that the option is accessible now.

Changing the display brightness

- 1 Push the **MODE** function key.
- 2 Select **System > Settings**.
 The general settings display appears (see [Figure 11](#)), showing the current display backlight setting as a percentage.
- 3 Press the **Display Extern** softkey to change the backlight setting for usage while the 9102 is connected to an external power supply
 Press the **Display Battery** softkey to change the backlight setting for running the 9102 on battery. Here, you can specify a reduced backlight setting for battery usage in order to save energy.
 In both cases the backlight input field is highlighted.
- 4 Enter a new value in the field for the backlight setting you intend to change and confirm with **ENTER**, or change the current value with the **UP/DOWN** cursor keys.
 The 9102 display uses the new brightness values.

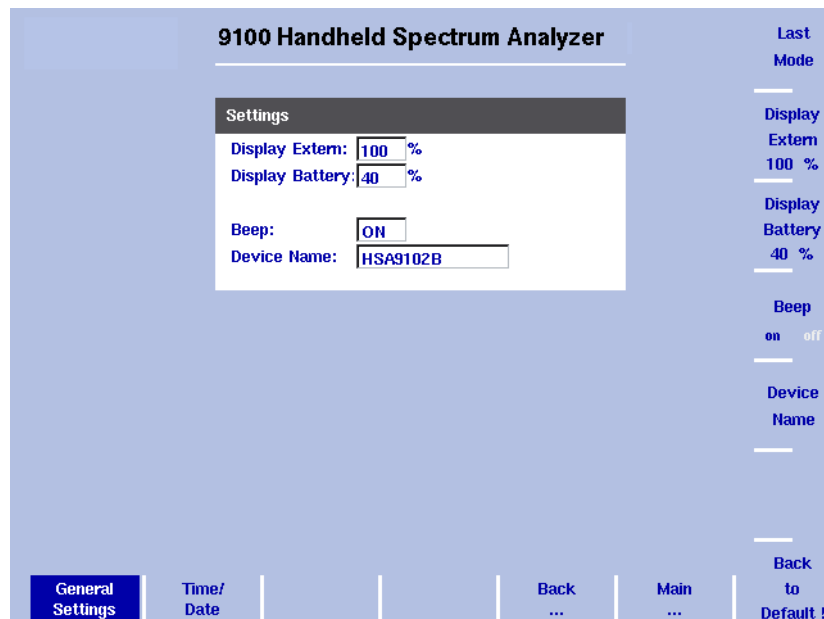

Figure 11 General Settings menu

NOTE

The display setting for adjusting the brightness is not affected by a press on the **PRESET** function key but by a push on the **Back to Defaults** softkey.

Enabling and disabling beeps

Warning and error beeps can be turned off and on in the General Settings menu:

- 1 Push the **MODE** function key.
- 2 Select **System > Settings**.
The general settings display appears, showing the current setting for beeps (on or off).
- 3 Press the **Beep** softkey several times until the desired setting is highlighted (on or off).
The beep input field shows the current setting.

NOTE

This parameter is not affected by a press on the **PRESET** function key but by a push on the **Back to Defaults** softkey.

Assigning a device name to the instrument

A device name for the 9102 can be useful if you have several units of the 9102 Handheld Spectrum Analyzer. They can be identified if you choose different names for them. The name also appears on traces transferred to the PC with the 9100 Data Exchange Software.

You can enter a new name as follows:

- 1 Push the **MODE** function key.
- 2 Select **System > General Settings**.
The general settings display appears, showing the current device name.
- 3 Press the **Device Name** softkey.
The device name input field is active so you can overwrite the current name.
- 4 Enter a new name (max. 11 characters; see section ["Filling in a text input field" on page 25](#) to learn how to do this) and close the entry field by pressing **ENTER**.
The new name is displayed in the device name field.

NOTE

This parameter is not affected by a press on the **PRESET** function key but by a push on the **Back to Defaults** softkey.

Adjusting date and time in the instrument

The 9102 Handheld Spectrum Analyzer includes a real-time clock. It can be used to show the actual date and time or to compare it with the date when the next calibration is due.

In order to change the date and time, proceed as follows:

- 1 Push the **MODE** function key.
- 2 Select **System > Settings > Time/Date**.
The time/date display appears showing the current date and time.

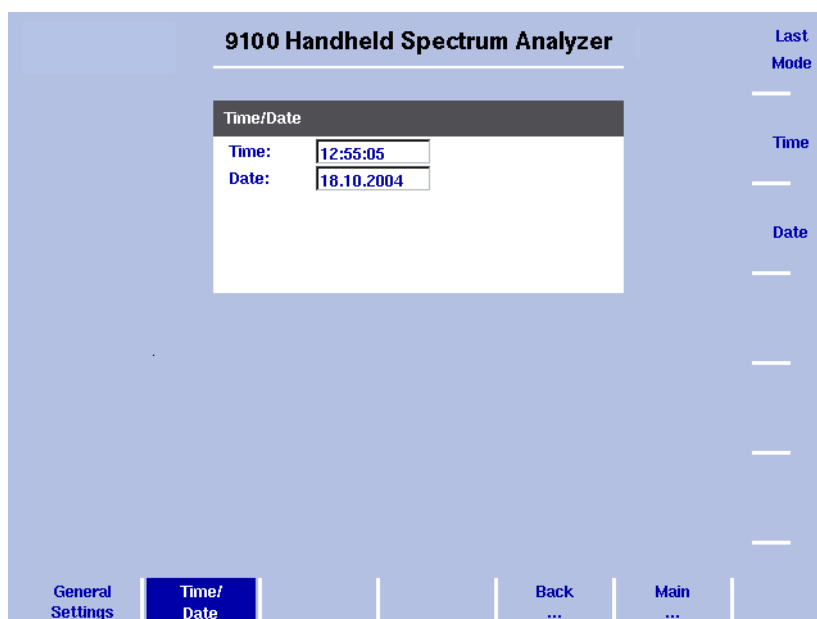

Figure 12 Time/Date menu

- 3 Press the **Time** softkey.
The time input field is active so you can move the cursor with the **LEFT/RIGHT** cursor keys behind a digit that needs to be changed, push the **BACKSPACE** key to erase it and enter a new digit.
- 4 Press the **Date** softkey.
The date input field is active so you can overwrite the old date with a new one or move the cursor with the **LEFT/RIGHT** cursor keys behind a digit that needs to be changed, push the **BACKSPACE** key to erase it and enter a new digit.
- 5 Press **ENTER** or another function key to confirm the entry.
The new date and time are shown on the Time/Date menu.

NOTE

These parameters are affected neither by a press on the **PRESET** function key nor by a push on the **Back to Defaults** softkey.

Changing the baud rate on the RS-232 port

- 1 Push the **MODE** function key.
- 2 Select **System > I/O Config > RS 232 Config**.
The RS 232 Config menu is displayed (see [Figure 13](#)), showing the current RS-232 bit rate (or baud rate) and interface settings.
- 3 To change the data rate, push the **Baudrate** softkey and select a new rate with the **UP/DOWN** cursor keys.
The change takes effect immediately.

NOTE

This parameter is not affected by a press on the **PRESET** function key but by a push on the **Back to Defaults** softkey.



Figure 13 RS 232 Configuration

NOTE

The described procedure for changing the baud rate applies to serial numbers 5004001 and higher.

Changing the IP address of the 9102

The IP address should be adapted to the address space in use in your environment and should be unique for each device on that network.

- 1 Push the **MODE** function key.
- 2 Select **System > I/O Config**
The TCP/IP Config menu is displayed, showing the current TCP/IP settings.

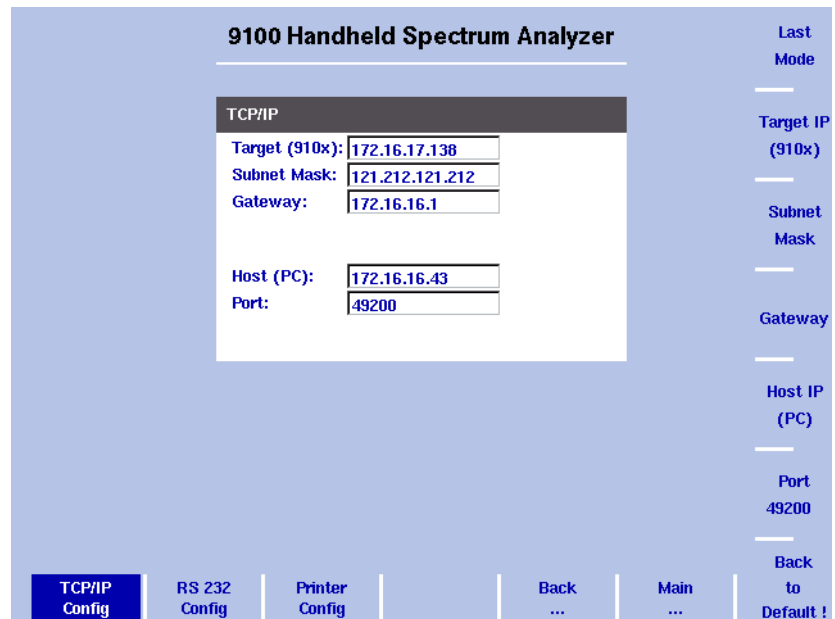

Figure 14 TCP/IP Configuration

- 3 Select **System > I/O Config**.
The port configuration display appears, showing the current TCP/IP settings.
- 4 To change the IP address of the 9102, press the **Target IP** softkey.
The address field is highlighted.
- 5 Overwrite the entire IP address or select a field with the **LEFT/RIGHT** cursor keys, enter a new IP address and press **ENTER**.
- 6 To change the subnet mask press the **Subnet Mask** softkey. The Subnet Mask field is highlighted.
- 7 Overwrite the entire subnet mask or select a field with the **LEFT/RIGHT** cursor keys, enter a new one and press **ENTER**.
- 8 To change the gateway press the Gateway softkey. The Gateway field is highlighted.
- 9 Overwrite the entire gateway or select a field with the **LEFT/RIGHT** cursor keys, enter a new one and press **ENTER**.
- 10 For the change to take effect, switch the 9102 off and then on again.
- 11 Ensure that your application on the PC addresses the 9102 using this IP address so that the two units can communicate with each other.

Changing the IP address of the PC

For remote control of the 9102 Handheld Spectrum Analyzer from a PC, the IP address of that PC can be entered on the instrument.

- 1 Push the **MODE** function key.
- 2 Select **System > I/O Config**
The TCP/IP Config menu is displayed (see [Figure 14](#)), showing the current TCP/IP settings.

- 3 Select **System > I/O Config**.
The port configuration display appears, showing the current TCP/IP settings.
- 4 To change the IP address of the 9102, press the **Host IP** softkey.
The address field is highlighted.
- 5 Overwrite the entire IP address or select a field with the **LEFT/RIGHT** cursor keys, enter a new IP address and press **ENTER**.
- 6 Reboot the 9102 (that means, switch it off and on again) for the new settings to work.

Changing the IP port used by the 9102

When the 9102 Handheld Spectrum Analyzer is to be controlled remotely from a PC, the PC must address the remote control application within the 9102 with an IP port number. The 9102 uses a default of 49200 which can be changed easily as follows:

- 1 Push the **MODE** function key.
- 2 Select **System > I/O Config**
The TCP/IP Config menu is displayed, showing the current TCP/IP settings.
- 3 To change the IP port of the 9102, push the **Port** softkey.
The address field is highlighted.
- 4 Overwrite the entire IP address or select a field with the **LEFT/RIGHT** cursor keys, enter a new IP address and press **ENTER**.
- 5 Reboot the 9102 (that means, switch it off and on again) for the new settings to work.

The **Back to Default** softkey resets the parameter to its default value.

Configuring a printer

You can connect a printer for direct printing via the \pm key on the 9102's front panel.

- 1 Push the **MODE** function key.
- 2 Select **System > I/O Config > Printer Config**
The printer settings are displayed.

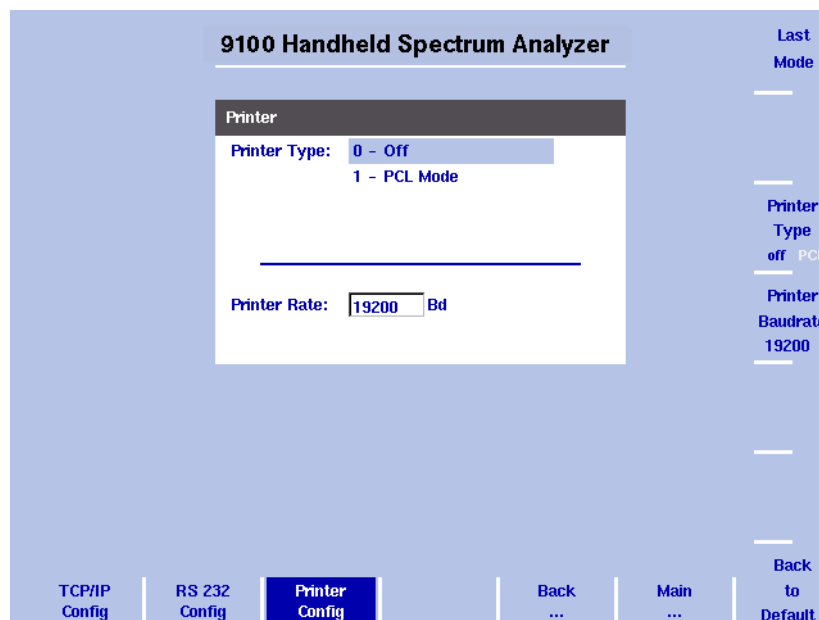

Figure 15 Printer Configuration menu

- 3 In order to configure a connected PCL 5 printer for direct printing press the softkey **Printer Type** and toggle it to PCL by pressing it until this option is highlighted.
- 4 In order to specify the baud rate of the printer press the **Printer Baudrate** softkey. The Printer Rate input field is highlighted. The default is 19200.

NOTE

Direct printing works with PCL 5 printers with integrated drivers. Pure GDI printers are not supported.

Selecting user interface colors

You can change the colors of some of the user interface elements in the Color Scheme menu. The available colors are shown in the color palette at the top of the display and in [Table 13](#).

Table 13 Color palette in the 9102 user interface

Color number	Color
1	black
2	grey
3	blue

Table 13 Color palette in the 9102 user interface

Color number	Color
4	green
5	violet
6	yellow
7	red
8	brown

The colors of the traces, the grid and the limit lines can be modified as follows:

- 1 Push the **MODE** function key.
- 2 Select **System > Color Scheme**.
 The color scheme display appears (see Figure 16), showing the current color settings.

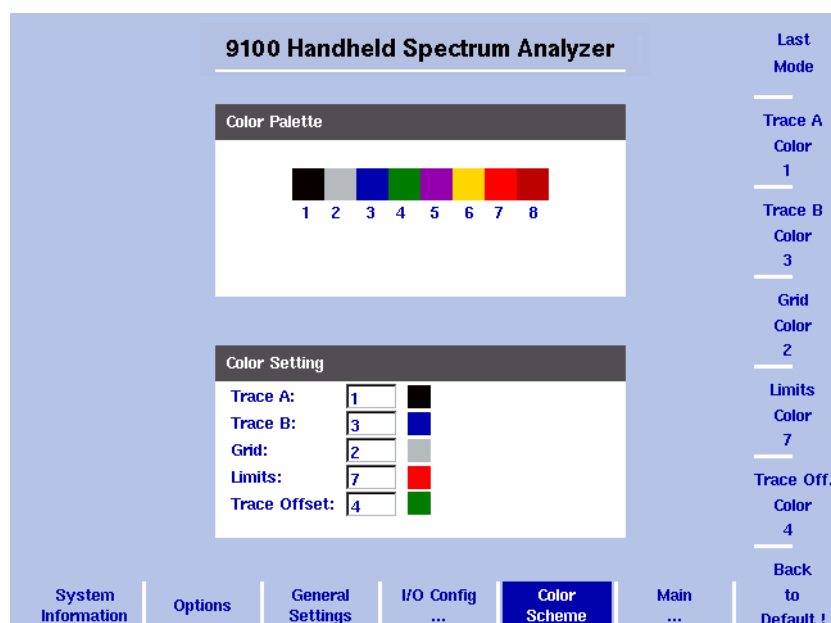

Figure 16 Color scheme menu

- 3 To change the color of a user interface element, push the appropriate softkey (Trace A, Trace B, Grid, Limits or Trace Offset Color).
 The input field on the left is activated.
- 4 To select a new color, enter a number corresponding to the colors in the color palette and press **ENTER**, or use the **UP/DOWN** cursor keys to change the color.
 The color field to the left of the input field changes according to the selection made.
- 5 Press the **Last Mode** softkey to return to the measurement screen.
 The new color scheme takes effect immediately.

Working with stored settings

The 9102 Handheld Spectrum Analyzer provides the capability of storing all the parameters for a particular measurement, allowing to recall these parameters whenever the measurement shall be repeated under the same conditions, and this includes the measurement mode. A large number of parameter sets can be stored under different names that allow fast and easy identification; each parameter set name may consist of up to 11 characters.

In addition to using these files of parameter sets on the same 9102, you can also transfer them to a PC for backup, easy modification and amendment using a standard text editor, or for using the same parameters on multiple 9102 instruments. This is described in more detail in sections ["Working with settings" on page 241](#) and ["Managing files on the PC and on the 9102" on page 242](#).

Storing instrument settings

You can store the instrument settings as a whole under a name with up to 11 characters. The procedure to enter text in alphanumerical input fields is explained in section ["Entering numbers and text" on page 24](#).

- 1 From the main menu, select **RCL/STORE > Settings > Store Setting**. An input field opens, allowing you to enter a name for the instrument settings. Below the input field, a list of existing settings files is indicated.
- 2 Enter a name for the settings. To use and modify an existing name, you can move the cursor to a suitable settings name with the **UP/DOWN** cursor keys. The selected trace name also appears in the input field; use the **LEFT/RIGHT** cursor keys to move the cursor to the appropriate position within the settings name to enter additional characters or delete existing ones.
- 3 Confirm your choice by pressing **ENTER**. The input field closes and the instrument settings are stored under the selected name.

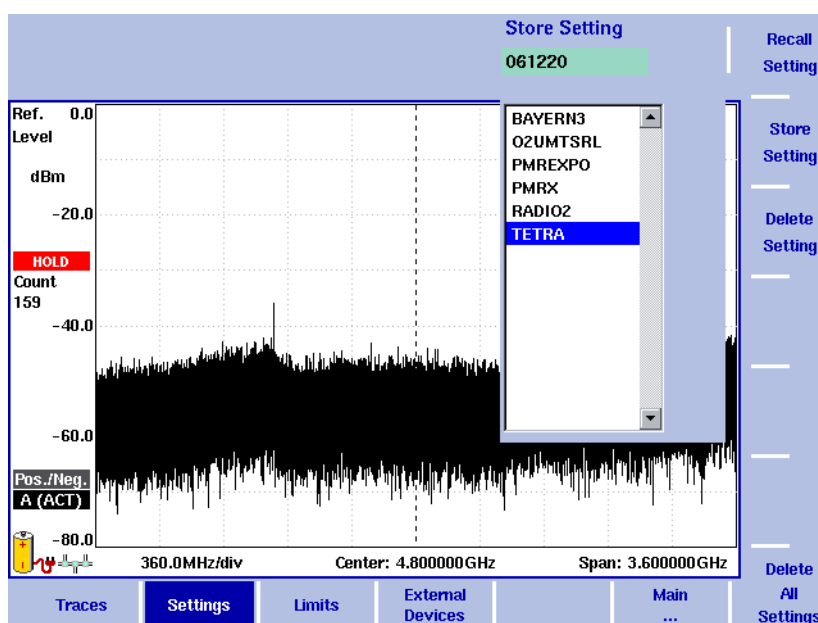

Reusing an instrument settings name

You cannot overwrite an existing settings file using the same settings name. If you want to reuse a settings name, you will have to delete the old one first.

Reloading instrument settings

- 1 From the main menu, select **RCL/STORE > Settings > Recall Setting**. An input field opens, allowing you to enter the settings name. Below the input field, a list of existing settings is indicated.
- 2 Enter the name of the settings file to load, or choose one with the **UP/DOWN** cursor keys.
- 3 Confirm your choice by pressing **ENTER**.
The input field closes and the selected settings are loaded. The previously active settings are not stored automatically but discarded.

Deleting a settings file

Stored settings files can be deleted. Note that there will be no warning; once you have selected and requested a file to be deleted, this will occur immediately.

- 1 From the main menu, select **RCL/STORE > Settings > Delete Setting**. An input field for the name of the settings file to be deleted appears, together with a file selection box.
- 2 Select the settings file to be deleted using the **UP/DOWN** cursor keys. Alternatively, enter the settings name with the numeric keys.
- 3 Confirm your choice by pressing **ENTER**.
The settings file is deleted from the list.
- 4 Select another instrument settings file for deletion, or press **ESCAPE** to leave the entry field and the file selection box.

Deleting all instrument settings files

Instead of deleting settings files individually, all files can be deleted in one step. You will be asked to confirm this step.

- 1 From the main menu, select **RCL/STORE > Settings > Delete All Settings**.
A query appears, asking you to confirm your selection.
- 2 Press **ENTER** to have all settings files deleted.
The query disappears. All settings files are deleted.

Restoring factory settings for all modes

In addition to the **PRESET** function key (see ["Using the front panel" on page 15](#)), which resets the mode currently selected to its factory default settings, the 9102's Mode menu offers the Factory Settings function. This function resets all modes to their factory default settings and returns you to the spectrum analysis mode. In order to restore the factory settings for all modes proceed as follows:

- 1 Press the **MODE** function key.
The Mode menu is displayed.
- 2 Press the **Factory Settings** softkey. The Factory Settings menu appears.
- 3 Press the **Preset All** softkey. A message will be displayed asking you to confirm that all modes should be reset.
- 4 Press **ENTER** to confirm the process. All modes will now be reset to their factory settings.

Spectrum Analysis Operation

3

This chapter describes the instrument's functions that are specific to the spectrum analysis mode. Topics discussed in this chapter are as follows:

- "Selecting the measurement mode" on page 54
- "Changing the frequency settings" on page 54
- "Selecting RBW, VBW and SWT" on page 57
- "Setting up the level parameters" on page 57
- "Changing the input impedance" on page 60
- "Applying special functions on the signal" on page 61
- "Setting up the trace" on page 64
- "Storing and loading traces" on page 70
- "Special measurement functions" on page 72
- "Viewing the spectrum analysis mode parameters" on page 76

Selecting the measurement mode

The 9102 provides different measurement modes. To select spectrum analysis mode, proceed as follows:

- 1 Push the **MODE** function key.
The Mode menu appears.
- 2 Select **Spectrum Analysis**.
The Spectrum Analysis main menu appears.

Changing the frequency settings

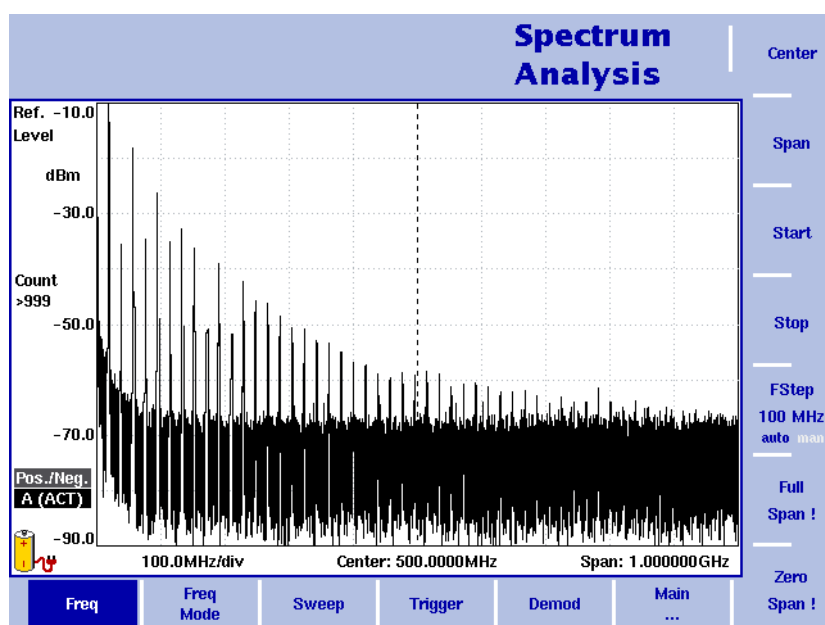

Figure 17 Frequency menu

There are different methods to set the frequency range to be measured; the range can be expressed by either the start and stop frequencies (i.e. first and last frequencies on the display), or by center frequency and span (i.e. the center and the frequency range), or by other combinations of center frequency, span, start and stop frequencies.

All four parameters are accessible in the **Freq** menu. On the main menu, however, only one of the combinations mentioned above is shown, depending on the parameter last entered.

NOTE

Changing a frequency parameter may affect an associated parameter.

Example: If you change the span to the maximum of 4 GHz (without the frequency extension being installed), the start and stop frequencies are changed to 0 and 4 GHz, respectively.

Setting start and stop frequency



- 1 Push the **CENT** function key (or the **Freq** softkey in the main menu). The vertical softkeys include Start and Stop softkeys.
- 2 Push the **Start** softkey. An entry field appears, indicating the start frequency currently set and the step size for the **UP/DOWN** cursor keys.
- 3 Enter a new frequency using the numeric keys, the cursor keys and the **BACKSPACE** key.
- 4 Conclude the entry by pushing an enter key for the unit (**GHZ** or **MHZ**). If the start frequency entered is lower than the stop frequency, the horizontal axis will display the range from the new start to the stop frequency. If the new start frequency is higher than or equal to the stop frequency, the start frequency is used as the center frequency with zero span, i.e. the signal at the selected frequency will be shown in the time domain.
- 5 Push the **Stop** softkey and enter the frequency for the right end of the display.

You can also place softkeys for the start and stop frequencies available on the main menu by changing the frequency mode, see [page 55](#).

Setting center frequency and span



- 1 Push the **CENT** function key (or the **Freq** softkey in the main menu). The vertical softkeys include Center and Span. An entry field appears, indicating the center frequency currently set and the step size for the **UP/DOWN** cursor keys.
- 2 Enter a new frequency using the numeric keys, the cursor keys and the **BACKSPACE** key.
- 3 Conclude the entry by pushing an enter key for the unit (**GHZ** or **MHZ**).
- 4 Push the **Span** softkey and enter the frequency for the range from the left to the right end of the display.

You can also place softkeys for the center frequency and the span available on the main menu by changing the frequency mode, see section "[Changing the main menu for different frequency parameters](#)" below.

Changing the main menu for different frequency parameters



The main menu shows two softkeys for the definition of the frequency range on the display. Different methods exist to define the range as depicted above; you can configure these softkeys to one of the two allowable combinations as follows:

- 1 From the main menu, select **Freq > Freq Mode**.
- 2 Select the combination of softkeys that you want to see in the main menu (**Start/Stop** or **Center/Span**).
- 3 Return to the main menu by pushing the **Main ...** softkey. The main menu appears and displays the selected combination of keys.

Note that the description of the horizontal frequency axis changes with the selected parameter set.

Viewing the complete frequency band



To change the frequency range to the full bandwidth supported by the 9102, proceed as follows:

- 1 From the main menu, push the **Freq** softkey.
The Frequency menu is displayed.
- 2 Push the **Full Span** softkey.
The leftmost frequency changes to 0 Hz and the rightmost frequency to 4 GHz, or to 7.5 GHz if the Frequency Extension 7.5 GHz option is installed.

Performing measurements in the time domain



Measurements on a selected center frequency can also be displayed in the time domain.

- 1 From the main menu, push the **Freq** softkey.
The Frequency menu is displayed.
- 2 Push the **Center** softkey and enter the desired center frequency; close the input field by selecting the appropriate unit with one of the enter keys.
- 3 Push the **Zero Span** softkey.
The horizontal axis becomes the time axis. The scale width is identical to the sweep time. See [Figure 18 on page 62](#) for an example.

Selecting the step size for the frequency input



The center, start and stop frequencies can be set by either entering a new value with the numeric keys, or by using the arrow keys (**UP**, **DOWN**) to increase or decrease the current setting. The step size for an arrow keypress can be either automatically selected by the 9102, or manually adjusted.

Manually setting the frequency step size

- 1 From the main menu, select **Freq**.
- 2 Push the **FStep** key.
The Freq Step entry field opens.
- 3 Enter a new frequency step value and close the entry field by pressing the appropriate enter key determining the unit (**GHZ/DBM** for gigahertz, **MHz/DB/μs** for megahertz, **KHz/DBμV/MS** for kilohertz, or **ENTER** for hertz).
The auto/manual selection switches to manual and the selected frequency step size is displayed on the softkey.

Setting the frequency step size selection to automatic

- 1 From the main menu, select **Freq**.
- 2 Push the **FStep** softkey several times until the "auto" selection is highlighted.

Selecting RBW, VBW and SWT



The resolution bandwidth (RBW) is the 3 dB bandwidth of the IF filter for selecting the signal to be measured. The resolution bandwidth describes the ability of the spectrum analyzer to discriminate between adjacent signals of similar amplitude. Only signals spaced at a frequency of more than the RBW can be discriminated from one another.

The 9102 can be set to automatically select the resolution bandwidth, depending on the frequency span.

The video bandwidth (VBW) is the lowpass bandwidth over which several results for one frequency point are smoothed. The lower the video bandwidth, the smoother the signal curve and the less variations there are.

The 9102 can be set to select the video bandwidth automatically as a function of the resolution bandwidth.

The sweep time (SWT) determines how long it takes for a complete sweep over the measured frequency range (span).

The 9102 can be set to automatically select the sweep time, depending on RBW and VBW. If manually set, the sweep time should be selected long enough for the filtered signal to reach steady state. The 9102 will output an "UNCALibrated" warning if the sweep time is too low.

To set the resolution bandwidth, the video bandwidth or the sweep time, proceed as follows:

- 1 In the main menu, select the appropriate softkey (**RBW**, **VBW**, or **SWT**).
- 2 Enter the value and complete the entry with the appropriate enter key for the unit, select a new value with the help of the **UP/DOWN** cursor keys, or switch to **auto** to leave the setting to the 9102.

Changing between automatic and manual mode

Push the appropriate softkey (**RBW**, **VBW**, or **SWT**) several times until the desired selection (auto or manual) is highlighted.

Setting up the level parameters

The accuracy and the dynamic range between the measured signal and the noise floor depend on the proper setting of the level settings. These consist of the reference level and the attenuation.

The reference level basically determines the level at the top of the display. The vertical axis is divided into eight horizontal lines; you can adjust the scale (which defaults to 10 dB per line) to your preferences.

The attenuation setting can be coupled to automatically follow the reference level setting. For reference levels of -20 dBm and lower, the attenuation is set to 10 dB; the maximum attenuation is 50 dB.

Attenuation or gain due to external coupling can be compensated by frequency-dependent coupling factors, so that the displayed measurement values reflect the power at the device under test.



WARNING

The maximum input power level at the **RF IN** connector is 30 dBm (1 W). Higher input levels may result in serious damage of the instrument.

Setting the reference level

- 1 In the main menu, push the **Ref.** softkey or select **Level** followed by **Ref.**. Alternatively, push the **REF** function key.
The reference level input field opens.
- 2 Enter the new reference level either using the numeric keys, closing the input field with the appropriate enter key, or with the **UP/DOWN** arrow keys.
The new reference level appears at the top of the vertical axis. The reference is based on the actually set output power.

Setting the hardware attenuation

- 1 In the main menu, push the **Attenuation** softkey.
The Attenuation input field opens.
- 2 Enter a new attenuation value in the range from 0 to 50 dB (in 10 dB steps) and close the input field with one of the enter keys, or use the **UP/DOWN** arrow keys to select the attenuation value in the range 10 to 50 dB.
If the attenuation value is changed, the attenuation option will change to "manual".

NOTE

The attenuation value of 0 dB can be set only with the numeric keys to avoid accidental deactivation. The 0 dB setting should be selected carefully because too high input levels at the input may damage the instrument.

NOTE

For precision measurements, the input level subtracted by the attenuation should not exceed -23 dBm.

Changing the vertical scale

The scale for the vertical axis (power) can be changed in the range from 1 to 20 dB per division (vertical line in the displayed grid) in 1-3-5 steps as follows:

- 1 From the main menu, select **Level**.
- 2 Push the **Scale** softkey.
The Scale input field opens.
- 3 Select a new scale by entering a new number of dB per division numerically and pressing the **ENTER** or **MHz/DB/μs** key, or by pushing the **UP/DOWN** cursor keys.

Selecting the level unit for input and output

- 1 In the main menu, select **Level > Units**.
- 2 You can use logarithmic or linear units. In order to toggle the display between logarithmic and linear units press the **Unit** softkey in the lower right corner of the display and select log or lin.
- 3 You can now choose between the following units via the Unit softkey in the upper right corner of the display.
Logarithmic units: dBm, dB μ V, dBmV and dBV
Linear units: V, mV, μ V, mW, μ W.

Compensating gains and losses

If the device under test is connected to the 9102 Handheld Spectrum Analyzer via an amplifier or a device attenuating the signal, such as an antenna or a long cable, the measurement results are wrong by the gain or loss factor. This factor may be a constant or even frequency-dependent.

To view the correct measurement results, the gain or loss can be compensated. The 9102 can even compensate a frequency-dependent factor; a correction curve or table can be entered on an external PC using the 9100 Data Exchange Software and loaded to the 9102. The section "[Defining and loading external coupling parameters](#)" on page 233 explains this part in more detail.

Enabling external device compensation

Once correction values are stored in the 9102, they can be selected and activated as follows:

- 1 From the main menu, select **Level > Ext. Dev. Memory**.
- 2 Push **Recall Ext. Dev. Comp.**
A pull-down menu appears with a list of names for the compensation tables available in the 9102.
- 3 Select a compensation table using the **UP/DOWN** cursor keys and confirm your choice by pressing **ENTER**.
Compensation is still off, but the 9102 changes automatically to the Level menu.
- 4 Push the **Ext. Dev. Comp.** softkey until "on" is highlighted.
The text "Ext. Dev.", together with the name of the file loaded, appears on the upper left-hand corner of the results display.

NOTE

If a file was selected previously, steps 1 thru 3 can be omitted. In this case, select **Level** and continue with step 4.

Turning external device compensation off

- 1 From the main menu, select **Level**.
- 2 Press **Ext. Dev. Comp.** until "off" is highlighted.
The text "Ext. Dev." to the left of the results display disappears.

Deleting files for external device compensation

You can delete files containing compensation parameters as follows:

- 1 From the main menu, select **Level > Ext. Dev. Memory**.
- 2 a. To delete an individual compensation file from the 9102 memory, push **Delete Ext. Dev. Comp.** Select a file name and press **ENTER**.
The compensation file is deleted from the list. Note that there will be no warning; once you have selected and requested a file to be deleted, this will occur immediately.
b. To delete all the compensation files from the 9102, push **Delete All** and confirm with **ENTER**.
All compensation files are deleted.

Changing the input impedance



Most RF applications are using an impedance of 50 Ω ; other applications such as cable TV apply 75 Ω . The 9102 is designed with an input impedance of 50 Ω ; it can, however, be used for testing a device with an impedance of 75 Ω by using the software impedance switch. The measurement results from the 50 Ω input are recalculated to fit the different impedance.

On the 9102, simply select the correct impedance value so that the 9102 can translate the internal measurement values to the power before the coupler.

- 1 Connect the device under test to the 9102 Handheld Spectrum Analyzer.
- 2 From the main menu, select **Level**.
- 3 In the vertical menu, select the impedance of the device, that means select **Impedance: 50 Ω** or **Impedance: 75 Ω** , respectively.
New measurement results are presented with the new impedance value taken into account. In addition, if the impedance is changed to 75 Ω and the power had been displayed in dBm, the new measurements are shown in dB μ V. If the impedance is changed to 50 Ω and the power had been displayed in dB μ V, the new measurements are shown in dBm.

NOTE

Signal reflections on the cable between the 50 Ω and the 75 Ω device affect the measurement accuracy of the 9102 Handheld Spectrum Analyzer. For more accurate results, Willtek recommends using an impedance converter; such a converter will cause attenuation affecting the results. This attenuation can be compensated as explained in section "[Compensating gains and losses](#)" on page 59.

Applying special functions on the signal

This section shows how the measurement can be triggered, how the number of measurements can be limited and how you can listen to the sound of the demodulated signal.

Using a trigger



The 9102 can either start signal analysis at a random point in time, or start the measurement when a given signal threshold is passed. Starting measurements depending on the actual signal level is only supported in zero span mode.

Selecting untriggered signal analysis

- 1 From the main menu push **Freq > Trigger**.
The Trigger menu appears.
- 2 Push the **Free Run** softkey.
The softkey is highlighted and the 9102 is ready for measurements at random times.

Selecting a trigger threshold in the RF signal

- 1 From the main menu push **Freq > Trigger**.
The Trigger menu appears.
- 2 Push the **Video** softkey.
The **Video** softkey is highlighted and an input field for the trigger level appears.

NOTE

The Video trigger is available in zero span mode only, otherwise the softkey description is grayed out.

- 3 Enter the trigger level (in dBm) and complete the entry by pushing either the **GHZ/DBM** or the **ENTER** key.
The trigger threshold is displayed at the power axis; the symbol also indicates the slope (direction in which the signal passes the threshold to start the measurement).
- 4 If necessary, change the slope between positive and negative direction by pushing the **Slope** softkey.
The active slope is indicated at the power axis by the following symbol (see also [Figure 18](#)):

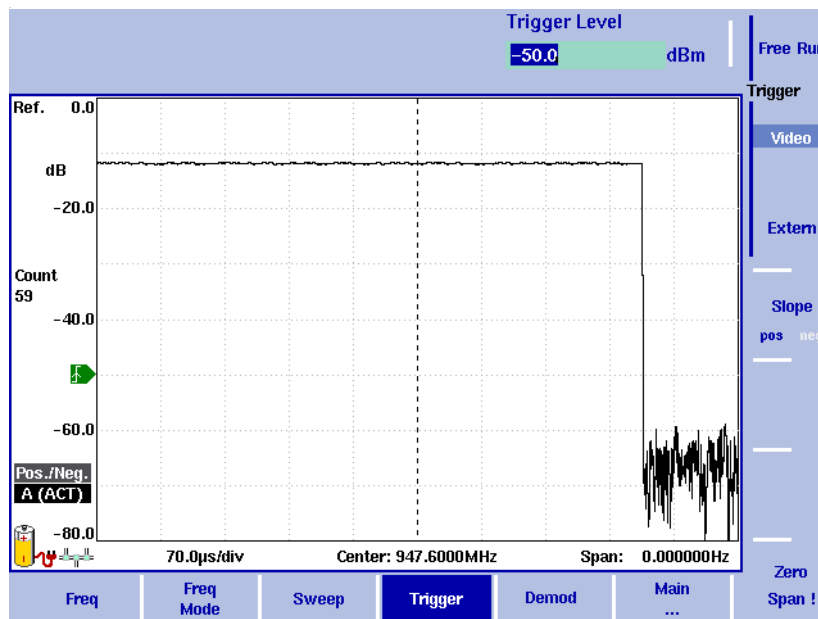

Figure 18 Triggered measurement (in the time domain)

Using an external trigger

In order to use a TTL trigger signal generated by an external device, proceed as follows:

- 1 Connect the external device to the **EXT. TRIG.** connector on the top of the instrument.
- 2 In the the main menu, enter the Sweep menu by pushing **Freq > Trigger**. The Trigger menu appears.
- 3 Push the **Extern** softkey. The softkey is highlighted. After activating the external trigger the instrument waits to receive an impulse. When an impulse is detected on the external trigger entrance one sweep is performed. Afterwards the instrument waits for the next trigger event.

Performing a limited number of measurements



The 9102 can run measurements continuously or a defined number of times. Limiting the number of measurements can be useful for statistical analyses.

- 1 From the main menu, select **Freq > Sweep**. The Sweep menu appears.
- 2 Select the trigger mode: Push **Cont.** for continuous measurements or **Single** for a limited number of measurements. The selected trigger mode is highlighted.
- 3 To enter the number of measurements, push the **Single Count** softkey, enter a number in the range from 1 to 1000 and press **ENTER**. If Trigger Mode is set to Single, the 9102 performs the defined number of measurements and enters Hold mode.

- To restart single-mode measurements, push the **HOLD/RUN** function key or the **Single** softkey.
- To stop a continuous measurement, push the **HOLD/RUN** function key. Push it again to resume measurements.

Demodulating an AM or FM signal



The 9102 has the ability to demodulate an AM (amplitude modulation) or FM (frequency modulation) signal and to output the signal at the built-in loud-speaker. The signal should have a signal strength of at least -50 dBm; the demodulation bandwidth is about 10 kHz.

The 9102 can be set to either demodulate one signal permanently, or to toggle between the different frequencies. When set to permanently demodulate one signal, the 9102 demodulates the signal at the center position.

When the 9102 is set to toggle between frequencies, it uses the marker frequencies (marker M1 is enabled if not already active). After performing and displaying a new measurement, the 9102 demodulates and outputs the received signal for a short duration. This duration is selectable in the range from 1 to 10 seconds. The 9102 demodulates the carrier at the marker position; the demodulated signal is output for the selected duration. If more than one marker is active, demodulation is resumed at the next marker frequency and so on until a piece of the signal at all active markers has been demodulated. The process starts anew with a new measurement.

The speaker volume can be selected as a percentage of the speaker's maximum capacity.

- 1 Set a marker to the center frequency of the signal to be demodulated (see section ["Setting up the trace" on page 64](#)).
- 2 From the main menu, select **Freq > Demod**. The Demodulation menu appears.
- 3 Select the demodulation method (**AM**, **FM**, or **Off**). The selected method is highlighted.
- 4 Choose between permanent demodulation and intermittent demodulation at multiple markers by pressing the respective **Demod** softkey.
- 5 If demodulation at marker is selected, you can change the duration of the output of the demodulated signal:
 - Push the **Duration** softkey. The Demod Duration input field opens.
 - Enter the new duration using the numeric keys. Conclude the entry with a push on one of the enter keys with the appropriate unit: push **KHZ/DB μ V/MS** for milliseconds or **ENTER** for seconds.
- 6 To adjust the speaker volume, push the **Volume** softkey, enter a new volume level from 0 to 100% and press **ENTER**.

Setting up the trace

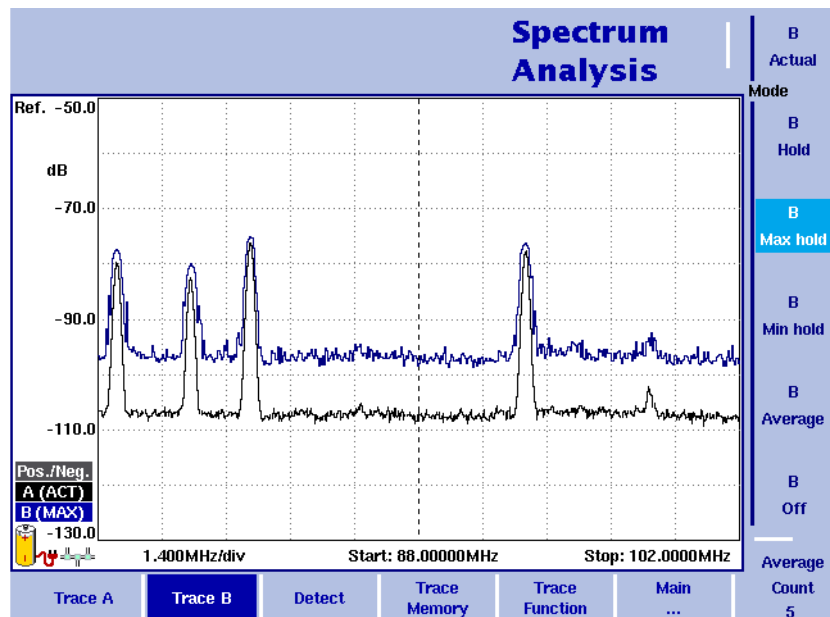

Figure 19 Example of two traces

The trace functions provide different views of the measurements, for example the actual measurement or an average over the last couple of measurements. You can even select two different views of the measurement. Another possibility is to compare the actual measurement with an older measurement which has been stored in the 9102 and loaded to one of the trace views (see section ["Storing and loading traces" on page 70](#)).

The 9102 samples many measurements for each frequency point. With the detector functions, you can define the method to select which of the samples is displayed.

Selecting the trace mode

The 9102 has five different modes to display a trace:

- In actual mode, the 9102 shows a complete new measurement in each trace. Subsequent traces are independent of each other.
- In hold mode, the last measurement is kept on the display; measurements continue but are not displayed.
- In max hold mode, the 9102 takes new measurements and, for each frequency point, compares the new measurement with the previous result. If the new measurement value is higher than the previous result, the new measurement value becomes the new result value; otherwise the old result value is kept. This way, the highest result since the start of the Max hold measurement (or a parameter change) is kept and displayed.

- Similarly, in min hold mode, the 9102 takes new measurements and compares the new measurement with the previous result. If the new measurement value is lower than the previous result, the new measurement value becomes the new result value; otherwise the old result value is kept. This way, the lowest result since the start of the Min hold measurement (or a parameter change) is kept and displayed.
- In average mode, the new measurement and previous ones are averaged for each frequency point displayed. The 9102 uses a recursive algorithm for averaging.

To select whether you want to view an actual measurement, stop and hold the last measurement, see the lowest or highest data for each frequency or an average value, proceed as follows:

- 1 In the main menu, select **Trace**.
- 2 Select the trace you want to modify (**Trace A** or **Trace B**) using the horizontal softkeys.
- 3 Select the trace mode with the vertical softkeys (**Actual**, **Hold**, **Max hold**, **Min hold**, **Average**).
The trace mode is shown at the left-hand side of the vertical axis, e.g. **A (ACT)**.

NOTE

For fastest valid results it is advisable to briefly activate the actual mode before selecting any other mode.

NOTE

When the trace is on hold, the measurement and failure counters continue counting. A second trace, if active, continues updating.

Turning the second trace on and off

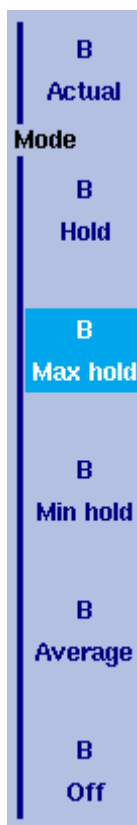

You can define two different trace views, e.g. one with the actual values and one with the maximum values. While the first view (Trace A) is always active, the second can be switched off. The functions of turning Trace B on or off and selecting the trace mode are combined as follows:

- 1 From the main menu, select **Trace > Trace B**.
- 2 To turn trace B on, select the trace mode (**Actual, Hold, Max hold, Min hold, or Average**). To turn trace B off, select **Off**.
If activated, the trace mode is displayed left to the vertical axis, e.g. **B (MAX)**.

Subtracting trace B from trace A

If you have used two different trace views as described above, you can show the difference between trace A and trace B by subtracting trace B from trace A as follows:

- 1 In the Trace menu select the softkey **Trace Function** followed by the softkey **Subtract A – B → A**.
- 2 Select **on** to subtract trace B from trace A. On the left-hand side of the result area the term "Subtract" will now be displayed to indicate that a mathematical function is being performed.
- 3 The result is displayed in trace A.

NOTE

If trace A is on Hold, this function is not available and thus the **Subtract A – B → A** softkey is greyed out.

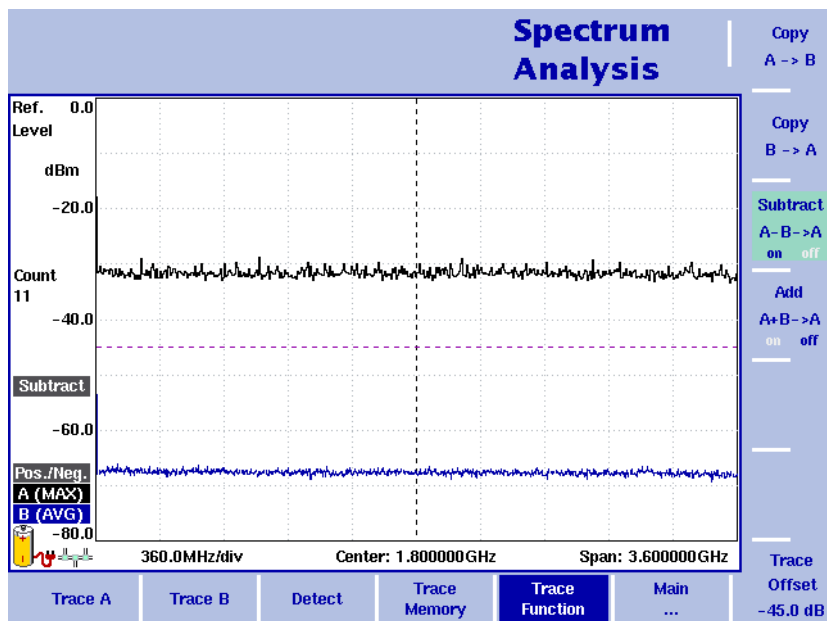

Figure 20 Subtract A - B → A on

Adding trace B to trace A

If you have used two different trace views, you can also show the sum of trace A and trace B by adding the two traces as follows:

- 1 In the Trace menu select the softkey **Trace Function** followed by the softkey **Add A + B → A**.
- 2 Select **on** to add B to trace A. On the left-hand side of the result area the term "Add" will now be displayed to indicate that a mathematical function is being performed.
- 3 The result is displayed in trace A.

Defining the number of measurements for averaging

When the trace mode is set to averaging, it may be useful to adjust the number of measurements over which the 9102 averages the results. The average count value that can be defined in the Trace menus applies to both traces alike.

The 9102 uses a recursive algorithm in which a new result is added to the older averages with a weighting factor; the description below indicates how to change this weighting factor.

- 1 Enter the Trace menu (select **Trace > Trace A** or **Trace B** from the main menu).
- 2 Push the **Average Count** softkey.
The Average input field opens.
- 3 Enter the number of measurements over which to average the results, in the range from 2 to 128.
- 4 Press **ENTER**.

Selecting the detection method



For each new measurement, the 9102 selects one or two values from a number of measurements for each frequency value. The method is user-definable; the following methods are available (see also [Figure 21](#)):

- Positive/negative peak: Both the largest and smallest values are taken and displayed as a vertical bar.
- Positive peak: Only the largest value is displayed.
- Negative peak: The smallest value is shown.
- Sample: A sample measurement value is picked.
- If the 9132 RMS Detector Option is installed and activated on your 9102, the root mean square detector showing the RMS-effective level of the measured signal is also available. If the 9132 RMS Detector Option is not installed on your instrument, the RMS detector will be greyed out.

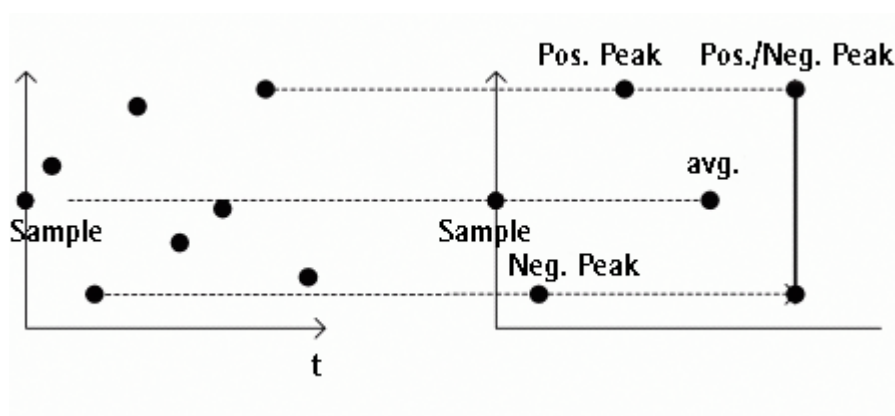

Figure 21 Trace detectors

The detection method applies to both traces. Select the detection method as follows:

- 1 From the main menu, select **Trace > Detect**.
- 2 Select the trace method from the Detector section of the vertical softkeys. The selected detection method is indicated at the left-hand side of the display.

Copying traces inside the 9102

You can copy an actual measurement from trace A to trace B or vice versa; this way you can keep the last measurement results on the screen and at the same time continue measuring or change the settings of the 9102 Handheld Spectrum Analyzer. The previous results in the target trace will be erased; the target trace will assume hold mode.

To copy the measurement data from one trace to another, proceed as follows:

- 1 From the main menu, select **Trace > Trace Function**.
- 2 To copy the measurement results in trace A to trace B, press **Copy A → B**.
To copy results from trace B to trace A, press **Copy B → A**.

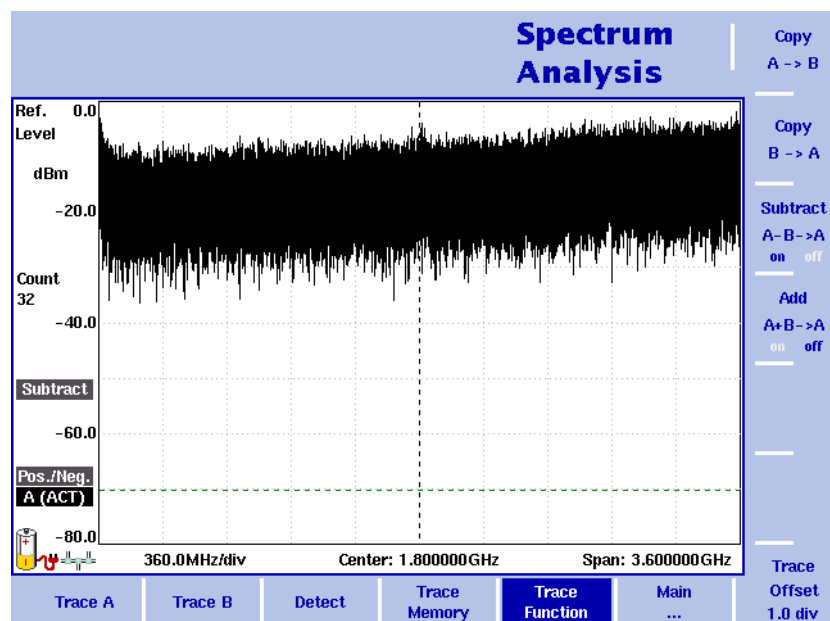

Figure 22 Trace Function menu

NOTE

If you first press **Copy A → B**, then **Copy B → A** (or vice versa), both traces will display the same results and will be in hold mode.

Storing and loading traces

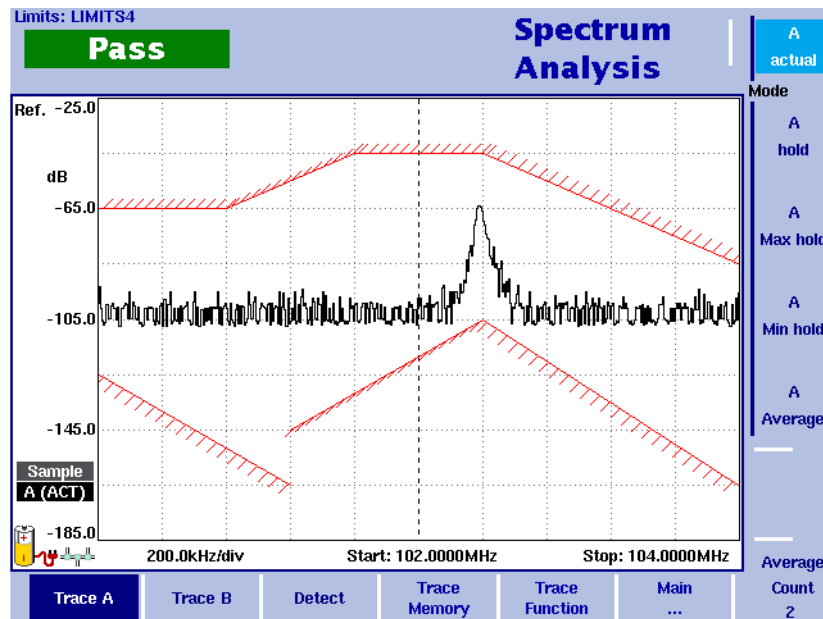

Figure 23 Trace A menu

The 9102 provides the capability to store up to 99 traces in the 9102 and load them again at random. The stored trace can then be examined or compared to a recent measurement. In addition, stored traces can also be transferred to a PC using the 9100 Data Exchange Software which is delivered with the 9102. For details on the software refer to [Chapter 15 "9100 Data Exchange Software"](#).

Storing a trace

You can store either trace A and trace B. Any trace can be stored under a name with up to 11 characters. The procedure to enter text in alphanumeric input fields is explained in section ["Entering numbers and text" on page 24](#). Note that along with the trace, the instrument settings such as frequency range, level range and markers are stored.

- 1 From the main menu, select **Trace > Trace Memory**.
- 2 Push either **Store Trace**.
An input field opens, allowing you to enter a name for the trace. Below the input field, a list of existing traces is indicated.
- 3 Enter a name for the trace. To use a modified trace name, you can move the cursor to a suitable trace name with the **UP/DOWN** cursor keys. The selected trace name also appears in the input field; use the **LEFT/RIGHT** cursor keys to move the cursor to the appropriate position within the trace name to enter additional characters or delete existing ones.
- 4 Confirm your choice by pressing **ENTER**.
The input field closes and the trace is stored under the selected name.

Reusing a trace name You cannot overwrite an existing trace using the same trace name. If you want to reuse a trace name, you will have to delete the old trace first.

- Reloading a trace**
- 1 From the main menu, select **Trace > Trace Memory**.
 - 2 Push **Recall Trace**.
An input field opens, allowing you to enter the trace name. Below the input field, a list of existing traces is indicated.
 - 3 Enter the name of the trace to load, or choose one with the **UP/DOWN** cursor keys.
 - 4 Confirm your choice by pressing **ENTER**.
The input field closes and the trace is displayed.

NOTE

Along with the trace, the 9102 also loads the settings that were used when the trace was saved. These will overwrite the current settings such as frequency range, reference level and markers.

Deleting a trace Stored traces can be deleted. Note that there will be no warning; once you have selected and requested a file to be deleted, this will occur immediately.

- 1 From the main menu, select **Trace > Trace Memory**.
- 2 Push **Delete Trace**.
An input field for the name of the trace to be deleted appears, together with a trace selection box.
- 3 Select the trace to be deleted using the **UP/DOWN** cursor keys. Alternatively, enter the trace name with the numeric keys.
- 4 Confirm your choice by pressing **ENTER**.
The trace is deleted from the trace list.
- 5 Select another trace for deletion, or press **ESCAPE** to leave the entry field and the trace selection box.

Deleting all traces Instead of deleting traces individually, all traces can be deleted in one step. You will be asked to confirm this step.

- 1 From the main menu, select **Trace > Trace Memory**.
- 2 Press **Delete All**.
A query appears, asking you to confirm your selection.
- 3 Press **ENTER** to have all traces deleted.
The query disappears. All traces are deleted.

Special measurement functions

Within spectrum analysis mode, three different frequency-selective types of power measurements are supported:

- Channel power
- Adjacent channel power ratio (ACPR)
- Occupied bandwidth (OBW)

These are similar to the measurement types in channel power mode (see chapter "Channel Power Operation" on page 77), without the restrictions that the channel power mode poses with predefined parameters such as span and resolution bandwidth.

Channel power

This measurement includes the power of the selected channel. A channel is defined by center frequency and channel width (not the span in this case); see "Changing the channel width" on page 75.

The 9102 displays the numerical result of the channel power measurement on the top-left. The measured bandwidth is indicated graphically with bandwidth boundaries shown in red.

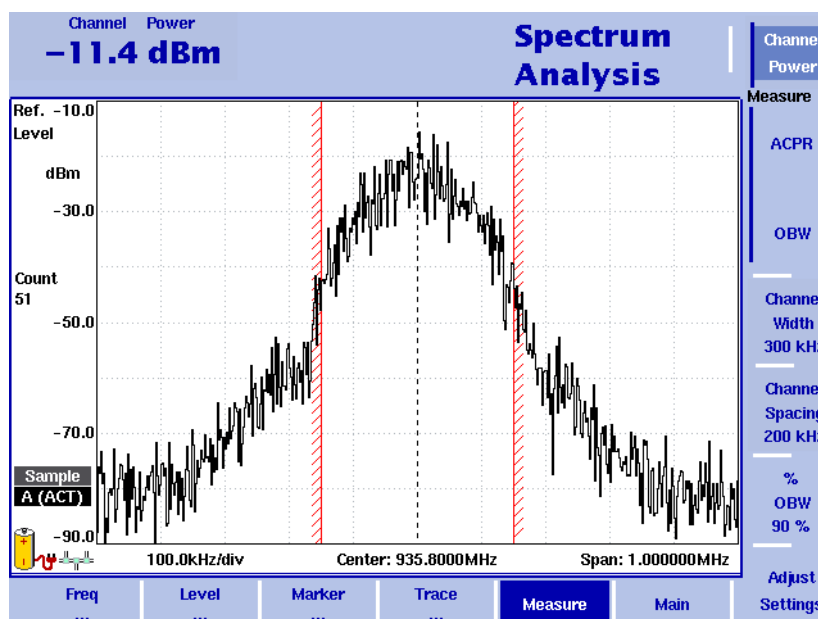

Adjacent channel power ratio (ACPR)

ACPR is the relation between the power transmitted in a neighboring (upper and/or lower) channel and that in the communication channel used. The measurement can be used to assess the quality of the modulator and the transmitter. The higher the result, the worse the transmitter because transmission in other channels may interfere with another ongoing communication.

The 9102 determines the adjacent channels by the channel width and channel spacing input parameters (see sections ["Changing the channel spacing"](#) and ["Changing the channel width" on page 75](#)). It displays the numerical results of the adjacent channel power ratio measurements for the left (lower) and right (upper) channels on the top-left. The measured bands are indicated graphically with bandwidth boundaries shown in red.

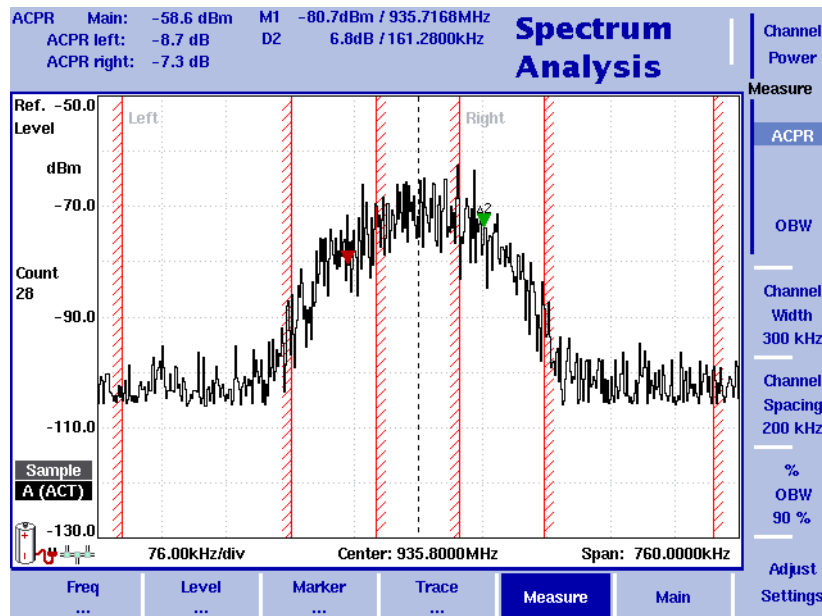

Occupied bandwidth (OBW)

The occupied bandwidth identifies the frequency range into which a given percentage of the signal power falls. The frequency range is not necessarily symmetric around the center frequency but is selected so that the bandwidth to hold a certain user-defined OBW percentage is minimized. See section ["Changing the occupied bandwidth percentage" on page 75](#).

OBW is indicated as an absolute value in the upper left-hand corner of the display, together with the OBW percentage; marker A1 and delta marker DA2 are assigned the lower and upper frequencies characterizing the frequency range. The power is measured over three times the normal channel bandwidth. The red boundary indicators mark the normal channel bandwidth as selected in the Channel System menu.

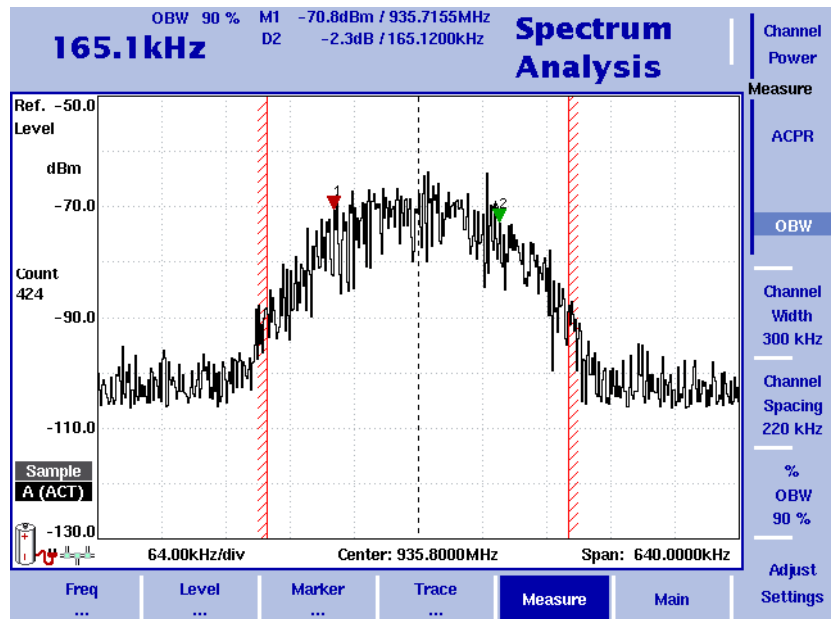

NOTE

If the selected resolution bandwidth is high and the occupied bandwidth very low, there may be rare cases in which all the power for the occupied bandwidth is mapped to one point in the spectrum display. In such a case, the 9102 displays "N/A" (not available) instead of the bandwidth, and the markers usually indicating the bandwidth boundaries are invisible. Increase the occupied bandwidth or decrease the resolution bandwidth to receive results.

Selecting the measurement type

To select the type of measurement within spectrum analysis mode, proceed as follows:

- 1 From the Spectrum Analysis main menu, select **Measure**.
- 2 Select a measurement type using the vertically aligned softkeys in the **Measure** section.
The numerical result for the selected measurement appears in the upper left-hand corner of the display.

Switching special measurement functions off

To return to normal spectrum analysis measurements without special measurement functions, simply press the softkey of the selected measurement type again. This will deactivate the special measurements.

Changing the channel width

The channel width is the bandwidth which the transmission is expected to occupy. It can be set for channel power and ACPR measurements as follows:

- 1 From the Spectrum Analysis main menu, select **Measure**.
- 2 Press **Channel Width**, enter a new value and press the respective enter key for the unit.
The new measurement bandwidth for channel power and ACPR is displayed with the softkey.

Changing the channel spacing

The channel spacing is distance in frequency between two adjacent channels. It can be set for the ACPR measurements as follows:

- 1 From the Spectrum Analysis main menu, select **Measure**.
- 2 Press **Channel Spacing**, enter a new value and press the respective enter key for the unit.
The new channel spacing for ACPR is displayed with the softkey.

Reading the channel power

In addition to the display elements explained on [page 15](#), the channel power mode also includes a large display of the channel power, along with the channel, resolution bandwidth and sweep time. Please see the graphs on [page 72](#) and the following for typical measurements.

Changing the occupied bandwidth percentage

OBW measurements identify the frequency range in which a certain percentage of the transmit power falls. The percentage value can be changed as follows:

- 1 From the Spectrum Analysis main menu, select **Measure**.
- 2 Press **% OBW** and enter a new percentage value in the range from 5 to 99.
- 3 Push **ENTER** to close the input field.
If the OBW measurement type is selected, the new OBW percentage value is indicated in the upper left-hand corner of the display.
The 9102 recalculates the frequency range based on the new percentage value.

Changing general analyzer parameters

For the channel power, ACPR and OBW measurements within the spectrum analysis mode, the general settings such as center frequency, span, resolution bandwidth, can be changed as usual. A single-button approach to adjusting span, resolution bandwidth, video bandwidth, detector and trace mode is described below.

- 1 From the Spectrum Analysis main menu, select **Measure**.
- 2 Press **Adjust Settings**.
Resolution bandwidth and video bandwidth are automatically set to optimum values (automatic mode). The trace detector is set to sample and the trace mode is set to actual.
If channel power measurements are selected, the span is set to 120% of the selected channel width. For ACPR measurements, the span is adjusted to $1.2 \times \text{channel width} + 2 \times \text{channel spacing}$. The OBW span is three times the channel width.

Viewing the spectrum analysis mode parameters

You can get an overview of all parameters set for this mode in the Parameter Window. To view the parameters, press the **PARAM** function key. To close the Parameter Window and return to the menu you opened it from, press the **ESCAPE** function key, the **Exit** softkey or the **PARAM** function key. To close the parameter page and change to the relevant main menu press the **Main** softkey.

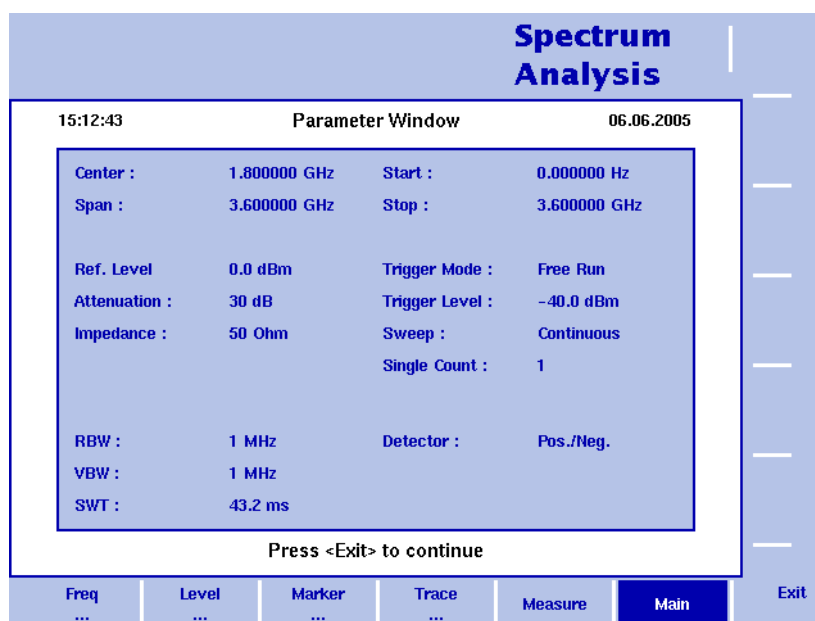

Figure 24 Spectrum analysis mode parameters

Channel Power Operation

4

This chapter describes the instrument's functions in channel power measurement mode. Topics discussed in this chapter are as follows:

- ["About the channel power mode" on page 78](#)
- ["Selecting the measurement mode" on page 81](#)
- ["Operating in channel power mode" on page 82](#)
- ["Reading the channel power" on page 83](#)
- ["Changing the occupied bandwidth percentage" on page 83](#)
- ["Working with communication systems and frequency settings" on page 83](#)
- ["Setting up the level parameters" on page 86](#)
- ["Changing the input impedance" on page 89](#)
- ["Setting up the trace" on page 90](#)
- ["Storing and loading traces" on page 95](#)
- ["Viewing the channel power mode parameters" on page 97](#)

About the channel power mode

The 9102 offers different measurement modes, e.g. spectrum analysis and channel power measurements. The channel power mode allows you to measure the radiated power within a certain frequency band with a single button press. This mode reduces the complexity of all the setup possibilities for defined communication systems. Several communication systems are predefined in the 9102 or can be downloaded from a PC using the 9100 Data Exchange Software; see section ["Managing communication systems for channel power measurements" on page 235](#) for more details.

Within channel power mode, three different frequency-selective types of power measurements are supported, for details on selecting the measurement type refer to ["Selecting the measurement mode" on page 81](#):

- Channel power
- Adjacent channel power ratio (ACPR)
- Occupied bandwidth (OBW)

These measurement types are available both in channel power and in spectrum analysis mode. However, in contrast to the spectrum analysis mode, which looks at the power level at a certain frequency, the channel power mode uses a system approach. A system consists of several channels, each channel has a unique channel number assigned to it. Within a system the channels have the same bandwidth and channel spacing. Depending on the system the channels may overlap, follow each other directly or be separated by spaces.

In order to distinctly specify a system the following parameters have to be set on the 9102:

- First channel
- Last channel
- Channel width
- Channel spacing
- First frequency

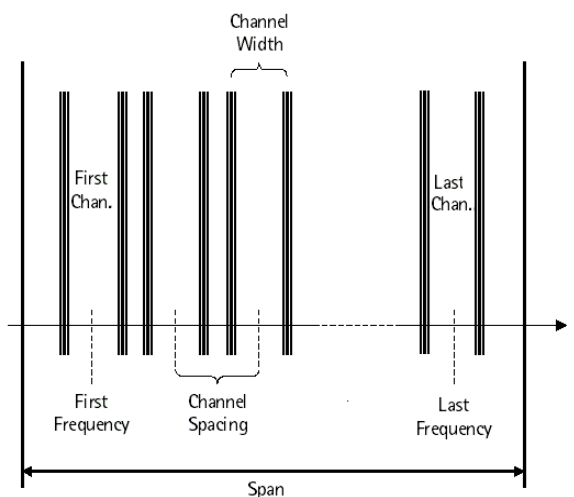

You can define systems and store them on the 9102. However, you can also make use of predefined systems available on the instrument. For a complete listing of the communication systems preinstalled on the instrument refer to ["Preinstalled systems on the 9102" on page 345.](#)

Channel power

This measurement includes the power of the selected channel. The channel can be selected in the main menu whereas parameters like channel width (the measurement bandwidth) and channel spacing can be viewed and changed in the Channel System menu.

The 9102 displays the numerical result of the channel power measurement on the top-left. The measured bandwidth is indicated graphically with bandwidth boundaries shown in red.

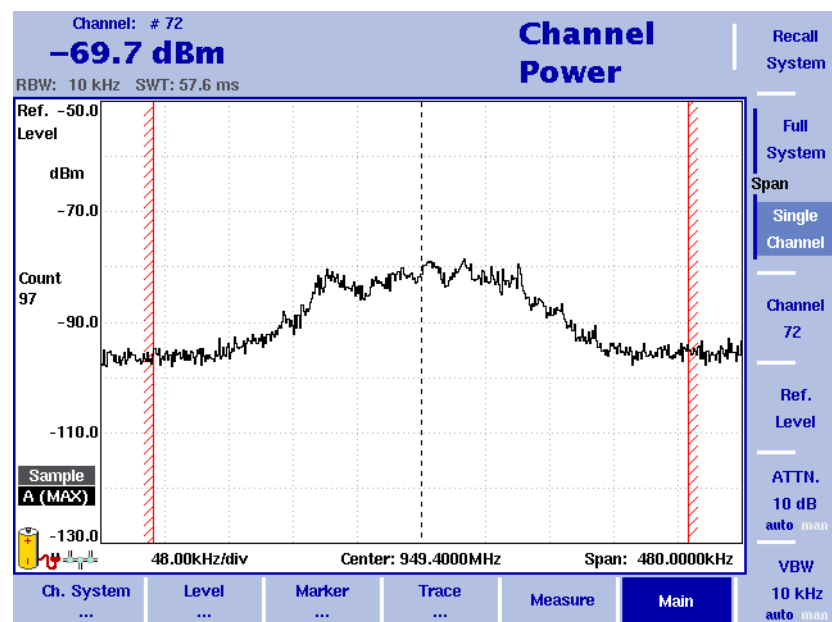

Adjacent channel power ratio (ACPR)

ACPR is the relation between the power transmitted in a neighboring (upper or lower) channel and that in the channel used for communication. The measurement can be used to assess the quality of the modulator and the transmitter; the higher the result, the worse the transmitter because transmission in other channels may interfere with another ongoing communication.

The 9102 displays the numerical results of the adjacent channel power ratio measurements for the left (lower) and right (upper) channels on the top-left. The measured bands are indicated graphically with bandwidth boundaries shown in red.

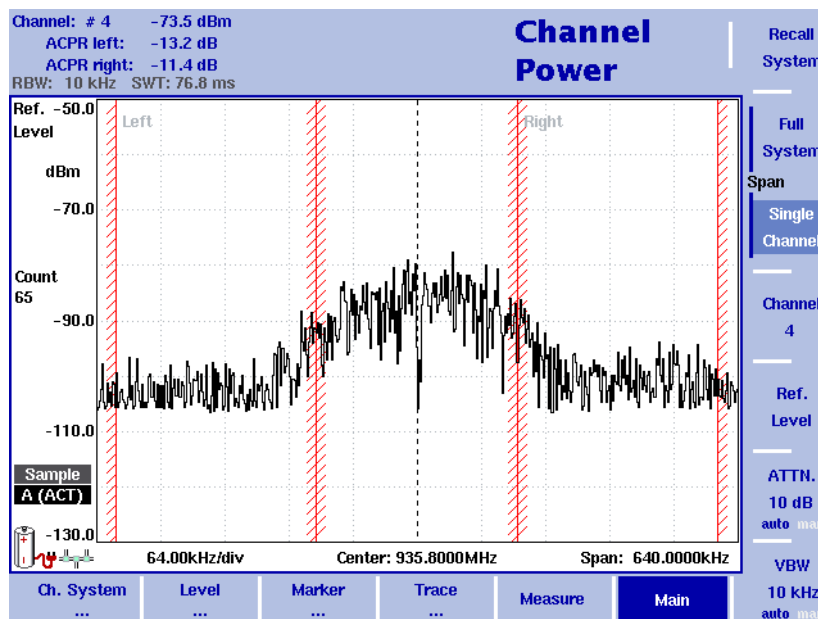

For further details on the selection and availability of the ACPR measurement type refer to ["Selecting the measurement mode" on page 81](#).

Occupied bandwidth (OBW)

The occupied bandwidth identifies the frequency range into which a given percentage of the signal power falls. The frequency range is not necessarily symmetric around the center frequency but is selected so that the bandwidth to hold a certain user-defined OBW percentage is minimized. See section ["Changing the occupied bandwidth percentage" on page 83](#).

OBW is indicated as an absolute value in the upper left-hand corner of the display, together with the OBW percentage; marker A1 and delta marker DA2 are assigned the lower and upper frequencies characterizing the frequency range. The power is measured over three times the normal channel bandwidth. The red boundary indicators mark the normal channel bandwidth as selected in the Channel System menu.

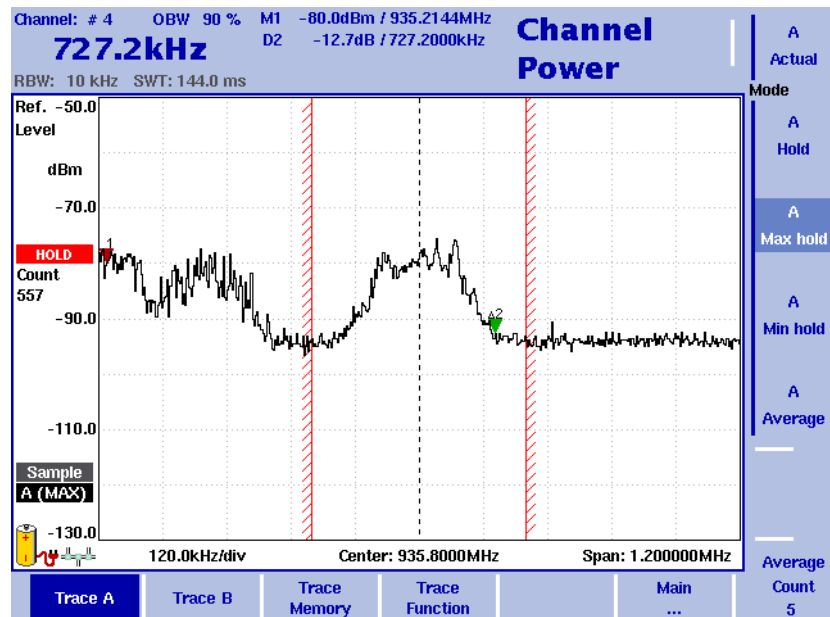

NOTE

If the selected resolution bandwidth is high and the occupied bandwidth very low, there may be rare cases in which all the power for the occupied bandwidth is mapped to one point in the spectrum display. In such a case, the 9102 displays "N/A" (not available) instead of the bandwidth, and the markers usually indicating the bandwidth boundaries are invisible. Increase the occupied bandwidth to receive results.

Selecting the measurement mode

To select the channel power mode, proceed as follows:

- 1 Push the **MODE** function key.
- 2 Select the **Channel Power** softkey.
The main menu of the channel power mode appears. If you select a new mode, all parameters are set to the values used when the mode was last active. If, however, you resume the last active mode, the measurements continue without any changes to the parameters.

To select the type of measurement within the channel power mode, proceed as follows:

- 1 Push the **Measure** softkey.
- 2 Select a measurement type using the vertically aligned function softkeys (Channel Power, ACPR, or OBW).

NOTE

Adjacent Channel Power Ratio (ACPR) measurements are available only in those communication systems where the channel bandwidth does not exceed the channel spacing; otherwise, the measurement range of the adjacent channel would overlap with that in the selected channel. As an alternative, use the ACPR measurements within the spectrum analysis mode (page 72).

Operating in channel power mode

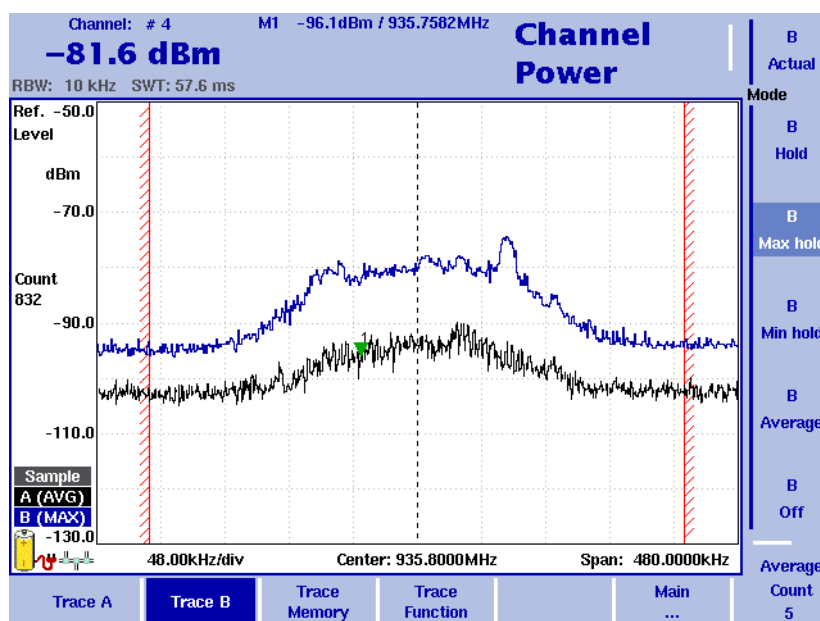

Figure 25 Example of a channel power measurement

This mode provides a measurement of the integral power within a given bandwidth. The measurement mode can be selected as described on page 81.

In channel power mode, the frequency parameters, filters and sweep time cannot be selected individually. Instead, a communication system can be selected or defined in which the 9102 shall measure the channel power; the frequency parameters are stored with the communication system settings.

A few communication systems such as GSM are predefined in the 9102. More predefined system settings are available in the 9100 Data Exchange Software and can be downloaded to the 9102. In addition, the settings for an alternative communication system can be defined by the user, stored in the 9102 and recalled for channel power measurements.

Reading the channel power

In addition to the display elements explained on [page 16](#), the channel power mode also includes a large display of the channel power, along with the channel, resolution bandwidth and sweep time. In the example in [Figure 25 on page 82](#), the 9102 indicates the frequency range over which the channel power is measured between red vertical bars.

Changing the occupied bandwidth percentage

OBW measurements identify the frequency range in which a certain percentage of the transmit power falls. The percentage value can be changed as follows:

- 1 From the Channel Power main menu, select **Channel System**.
- 2 Press **% OBW** and enter a new percentage value in the range from 5 to 99.
- 3 Press **ENTER** to close the input field.
If the OBW measurement type is selected, the new OBW percentage value is indicated in the upper left-hand corner of the display.
The 9102 recalculates the frequency range based on the new percentage value.

NOTE

The occupied bandwidth can also be changed via the Measure menu.

Working with communication systems and frequency settings

Selecting a communication system on the 9102

You can activate communication system settings stored on the 9102 as follows:

- 1 In the main menu of the channel power mode, select **Ch. System > System Memory**.
The System Memory menu appears.
- 2 Press **Recall System**.
A scroll box appears, showing the available communication systems. Enter the system name as stored in the 9102, or move the **UP/DOWN** cursor keys to move the cursor to the system to be measured.
- 3 Press **ENTER** to confirm.
The input field and the scroll box disappear and the spectrum of the selected band is measured. The channel power of the first channel is displayed in the upper left-hand corner.

The 9102 comes with preinstalled communication systems. For a listing of all the channel systems preinstalled on the 9102 refer to ["Preinstalled systems on the 9102" on page 345.](#)

NOTE

Apart from the channel width the parameters for preinstalled configuration systems cannot be modified.

Setting up a new communication system

A new communication system can be defined in terms of frequency range, channel bandwidth and spacing, and channel numbering; channels can then be addressed easily by their channel number rather than the carrier or center frequency. You can set up a new communication system as follows:

- 1 In the main menu, select **Ch. System**.
The Channel System menu appears.
- 2 Press **First Channel** and enter the first channel number in use by the system, then close the input field by pressing **ENTER**.
- 3 Press **Last Channel** to enter the number of the last channel in use by the system; close the input field by pressing **ENTER**.
- 4 Press **Channel Width** to change the measurement bandwidth; ensure to select the right unit (e.g. kHz).
- 5 Select the **Channel Spacing** softkey, enter the spacing between channel numbers and close the input field by pressing the enter key for the appropriate frequency unit.
- 6 Press the **1st Ch. Center** softkey and enter the carrier frequency for the first channel in use (channel number defined with the first softkey). Close the input field using the enter key for the appropriate unit (e.g. MHz).
- 7 For occupied bandwidth (OBW) measurements, select **% OBW** and enter the percentage value. Confirm the value by pressing **ENTER**.
- 8 Select **System Memory > Store System**, enter a new name for the system and press **ENTER**.

NOTE

Existing systems cannot be overwritten; you must delete the old system first. If you delete a predefined system that is delivered with the 9102, it can be restored as depicted in section ["Undeleting default communication systems" on page 85.](#)

Deleting a communication system

To delete a the communication system settings stored on the 9102, take the following steps.

- 1 From the main menu, select **Ch. System > System Memory**.
The System Memory menu appears.
- 2 Push the **Delete System** softkey.
A scroll box with the list of available communication systems appears.
- 3 Select the system settings to be deleted by moving the **UP/DOWN** cursor keys to the respective system settings name, and confirm by pressing **ENTER**.
The system settings are deleted from the list.
- 4 Press **ESCAPE** to close the input field and the scroll box.

Deleting all communication systems

You can clean up previously stored communication systems and easily delete all of them, including those that were originally delivered with the 9102.

- 1 From the main menu, select **Ch. System > System Memory**.
The System Memory menu appears.
- 2 Push the **Delete All** softkey.
A box appears, asking you to confirm that you want to delete all communication system settings.
- 3 Press **ENTER** to confirm deletion or **ESCAPE** to prevent the 9102 from deleting all the communication systems.
If confirmed, all the communication systems are deleted, that means the list of communication systems will be empty.

Undeleting default communication systems

If you have deleted communication systems that were delivered with the 9102, you can restore these system settings.

- 1 From the main menu, select **Ch. System > System Memory**.
The System Memory menu appears.
- 2 Push the **Restore Default Systems** softkey.
The 9102 creates all the communication systems that were originally delivered with the 9102.

Using the 9100 Data Exchange Software with communication systems

With the 9100 Data Exchange Software, more communication systems can be defined, loaded to the 9102 and selected for use. See section "[Managing communication systems for channel power measurements](#)" on page 235 for more information. Furthermore, within the 9100 Data Exchange Software further predefined communication systems are available for transfer to your 9102. For a listing of the communication systems available refer to "[Predefined systems in the 9100 Data Exchange Software](#)" on page 346.

Defining the frequency span

The 9102 can display either the full spectrum used by the system, or the channel to be measured. Select the frequency span as desired:

In the main menu, select either **Full System** or **Single Channel**. If you select Full System, the full frequency band as defined for the communication system will be displayed. If you select Single Channel, only the frequency range of the currently selected channel will be shown.

Changing the channel

- 1 In the main menu, push the **Channel** softkey.
The Channel input field opens.
- 2 Enter the desired channel number within the communication system at hand, or select the channel number with the **UP/DOWN** cursor keys.
- 3 Press **ENTER** to confirm.
The channel power for the selected channel is indicated in the upper left-hand corner.

Changing the sweep time

The sweep time (SWT) determines how long it takes for a complete sweep over the measured frequency range (span).

By default, the 9102 automatically selects the sweep time depending on other measurement parameters such as the span. In some cases it may be an advantage to manually select a different sweep time. This is the case with pulsed signals where a longer sweep time may increase the measurement accuracy. If manually set, the sweep time should be selected long enough for the filtered signal to reach steady state. The 9102 will output an "UNCALibrated" warning if the sweep time is too low.

To change the sweep time in channel power mode, proceed as follows:

- 1 From the main menu, select **Measure**.
- 2 Push the **SWT** softkey.
- 3 Enter the new sweep time and confirm with the appropriate enter key for the unit.

Setting up the level parameters

The accuracy and the dynamic range between the measured signal and the noise floor depend on the proper setting of the level settings. These consist of the reference level and the attenuation.

The reference level basically determines the level at the top of the display. The vertical axis is divided into eight horizontal rows; you can adjust the scale (which defaults to 10 dB per line) to your preferences.

The attenuation setting can be coupled to automatically follow the reference level setting. For reference levels of -20 dBm and lower, the attenuation is set to 10 dB; the maximum attenuation is 50 dB.

Attenuation or gain due to external coupling can be compensated by frequency-dependent coupling factors, so that the displayed measurement values reflect the power at the device under test.



WARNING

The maximum allowable input power level at the **RF IN** connector is 30 dBm (1 W). Higher input levels may result in serious damage of the instrument.

Setting the reference level

- 1 In the main menu, push the **Ref.** softkey or select **Level** followed by **Ref.**. Alternatively, push the **REF** function key. The Reference Level input field opens.
- 2 Enter the new reference level either using the numeric keys, closing the input field with the appropriate enter key, or with the **UP/DOWN** arrow keys. The new reference level appears at the top of the vertical axis. The reference is based on the actually set output power.

Setting the hardware attenuation

- 1 In the main menu, push the **Attenuation** softkey. The Attenuation input field opens.
- 2 Enter a new attenuation value in the range from 0 to 50 dB (in 10 dB steps) and close the input field with one of the enter keys, or use the **UP/DOWN** arrow keys to select the attenuation value in the range from 10 to 50 dB. If the attenuation value is changed, the attenuation option will change to "auto".

NOTE

The attenuation value of 0 dB can be set only with the numeric keys to avoid accidental deactivation. The 0 dB setting should be selected carefully because input levels that are too high at the input may damage the instrument.

NOTE

For precision measurements, the input level subtracted by the attenuation should not exceed -23 dBm.

Changing the vertical scale

The scale for the vertical axis (power) can be changed in the range from 1 to 20 dB per division (vertical line in the displayed grid) in 1-3-5 steps as follows:

- 1 In the main menu, select **Level**.
- 2 Push the **Scale** softkey.
The Scale input field opens.
- 3 Select a new scale by entering a new number of dB per division numerically and pressing the **ENTER** or **MHz/DB/μs** key, or by pushing the **UP/DOWN** cursor keys.

Selecting the level unit for input and output

- 1 In the main menu, select **Level > Units**.
- 2 You can use logarithmic or linear units. In order to toggle the display between logarithmic and linear units press the **Unit** softkey in the lower right corner of the display and select log or lin.
- 3 You can now choose between the following units via the Unit softkey in the upper right corner of the display.
Logarithmic units: dBm, dBμV, dBmV and dBV
Linear units: V, mV, μV, mW, μW.

Compensating gains and losses

If the device under test is connected to the 9102 Handheld Spectrum Analyzer via an amplifier or a device attenuating the signal, such as an antenna or a long cable, the measurement results are wrong by the gain or loss factor. This factor may be a constant or even frequency-dependent.

To view the correct measurement results, the gain or loss can be compensated. The 9102 can even compensate a frequency-dependent factor; a correction curve or table can be entered on an external PC using the 9100 Data Exchange Software and loaded to the 9102. Section ["Defining and loading external coupling parameters" on page 233](#) explains this part in more detail.

Enabling external device compensation

Once correction values are stored in the 9102, these can be selected and activated as follows:

- 1 In the main menu, select **Level > Ext. Dev. Memory**.
- 2 Press **Recall Ext. Dev. Comp.**
A pull-down menu appears with a list of names for the compensation tables available in the 9102.
- 3 Select a compensation table using the **UP/DOWN** cursor keys and confirm your choice by pressing **ENTER**.
- 4 Select the **Level** menu and push the **Ext. Dev. Comp.** softkey until "On" is highlighted.
The text "Ext. Dev." appears to the left of the results display.

Turning external device compensation off

- 1 In the main menu, select **Level**.
- 2 Push **Ext. Dev. Comp.** until "Off" is highlighted.
The text "Ext. Dev." to the left of the results display disappears.

Deleting files for external device compensation

You can delete files containing compensation parameters as follows:

- 1 In the main menu, select **Level > Ext. Dev. Memory**.
- 2 a. To delete an individual compensation file from the 9102 memory, press **Delete Ext. Dev. Comp.** Select a file name and press **ENTER**.
The compensation file is deleted from the list. Note that there will be no warning; once you have selected and requested a file to be deleted, this will occur immediately.
b. To delete all the compensation files from the 9102, push **Delete All** and confirm by pressing **ENTER**.
All compensation files are deleted.

Changing the input impedance



Most RF applications are using an impedance of 50 Ω ; other applications such as cable TV apply 75 Ω . The 9102 is designed with an input impedance of 50 Ω ; it can, however, be used for testing a device with an impedance of 75 Ω by using the software impedance switch. The measurement results from the 50 Ω input are recalculated to fit the different impedance.

On the 9102, simply select the correct impedance value so that the 9102 can translate the internal measurement values to the power before the coupler.

- 1 To connect a 75 Ω device, connect the device under test to the 9102 Handheld Spectrum Analyzer.
- 2 In the main menu, select **Level**.
- 3 In the vertical menu, select the impedance of the device, that means select **Impedance: 50 Ω** or **Impedance: 75 Ω** , respectively.
New measurement results are presented with the new impedance value taken into account. In addition, if the impedance is changed to 75 Ω and the power had been displayed in dBm, the new measurements are shown in dB μ V. If the impedance is changed to 50 Ω and the power had been displayed in dB μ V, the new measurements are shown in dBm.

NOTE

Signal reflections on the cable between the 50 Ω and the 75 Ω device affect the measurement accuracy of the 9102 Handheld Spectrum Analyzer. For more accurate results, Willtek recommends using an impedance converter; such a converter will cause attenuation affecting the results. This attenuation can be compensated as explained in section ["Compensating gains and losses" on page 88](#).

Setting up the trace

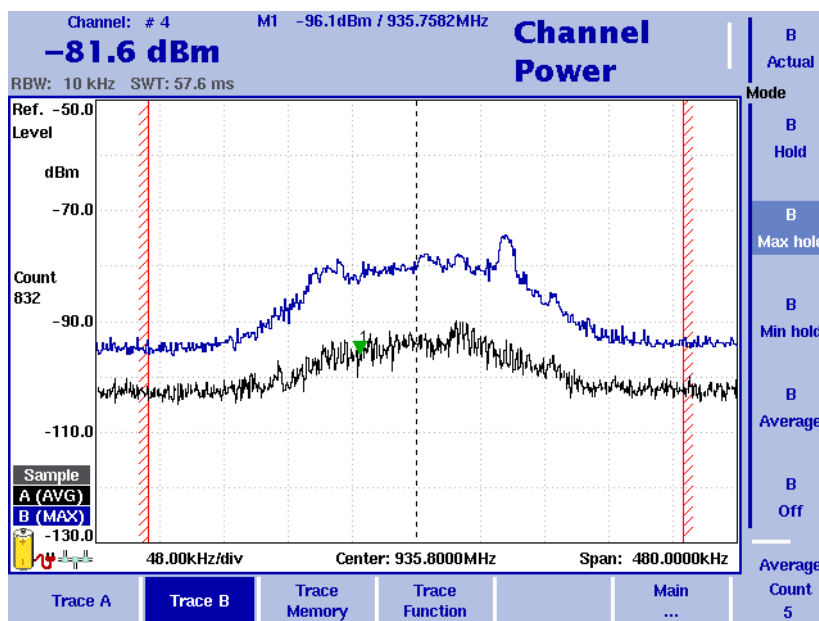

Figure 26 Example of two traces in channel power mode

The trace functions provide different views of the measurements, for example the actual measurement or an average over the last couple of measurements. You can even select two different views of the measurement. Another possibility is to compare the actual measurement with an older measurement which has been stored in the 9102 and loaded to one of the trace views (see section ["Storing and loading traces" on page 95](#)).

The 9102 samples many measurements for each frequency point. With the detector functions, you can define the method to select which of the samples is displayed.

Selecting the trace mode

The 9102 has five different modes to display a trace:

- In Actual mode, the 9102 shows a complete new measurement in each trace. Subsequent traces are independent of each other.
- In hold mode, the last measurement is kept on the display; measurements continue but are not displayed.
- In max hold mode, the 9102 takes new measurements and, for each frequency point, compares the new measurement with the previous result. If the new measurement value is higher than the previous result, the new measurement value becomes the new result value; otherwise the old result value is kept. This way, the highest result since the start of the max hold measurement (or a parameter change) is kept and displayed.

- Similarly, in min hold mode, the 9102 takes new measurements and compares the new measurement with the previous result. If the new measurement value is lower than the previous result, the new measurement value becomes the new result value; otherwise the old result value is kept. This way, the lowest result since the start of the min hold measurement (or a parameter change) is kept and displayed.
- In average mode, the new measurement and previous ones are averaged for each frequency point displayed. The 9102 uses a recursive algorithm for averaging.

To select whether you want to view an actual measurement, stop and hold the last measurement, see the lowest or highest data for each frequency or an average value, proceed as follows:

- 1 In the main menu, select **Trace**.
- 2 Select the trace you want to modify (**Trace A** or **Trace B**) using the horizontal softkeys.
- 3 Select the trace mode with the vertical softkeys (**Actual**, **Hold**, **Max hold**, **Min hold**, **Average**).
The trace mode is shown at the left-hand side of the vertical axis, e.g. **A (ACT)**.

NOTE

For fastest valid results it is advisable to briefly activate the actual mode before selecting any other mode.

NOTE

When the trace is on hold, the measurement and failure counters continue counting. A second trace, if active, continues updating.

Turning the second trace on and off



You can define two different trace views, e.g. one with the actual values and one with the maximum values. While the first view (Trace A) is always active, the second can be switched off. The functions of turning Trace B on or off and selecting the trace mode are combined as follows:

- 1 From the main menu, select **Trace > Trace B**.
- 2 To turn trace B on, select the trace mode (**Actual, Hold, Max hold, Min hold, or Average**). To turn trace B off, select **Off**.
If activated, the trace mode is displayed left to the vertical axis, e.g. **B (MAX)**.

Subtracting trace B from trace A

If you have used two different trace views as described above, you can show the difference between trace A and trace B by subtracting trace B from trace A as follows:

- 1 In the Trace menu select the softkey **Trace Function** followed by the softkey **Subtract A – B → A**.
- 2 Select **on** to subtract trace B from trace A. On the left-hand side of the result area the Term "Subtract" will now be displayed to indicate that a mathematical function is being performed.
- 3 The result is displayed in trace A.

NOTE

If trace A is on Hold, this function is not available and thus the **Subtract A – B → A** softkey is greyed out.

Adding trace B to trace A

If you have used two different trace views, you can also show the sum of trace A and trace B by adding the two traces as follows:

- 1 In the Trace menu select the softkey **Trace Function** followed by the softkey **Add A + B → A**.
- 2 Select **on** to add B to trace A. On the left-hand side of the result area the term "Add" will now be displayed to indicate that a mathematical function is being performed. The result is displayed in trace A.

Defining the number of measurements for averaging

When the trace mode is set to averaging, it may be useful to adjust the number of measurements over which the 9102 averages the results. The average count value that can be defined in the Trace menus applies to both traces alike.

The 9102 uses a recursive algorithm in which a new result is added to the older averages with a weighting factor; the description below indicates how to change this weighting factor.

- 1 Enter the Trace menu (select **Trace > Trace A** or **Trace B** from the main menu).
- 2 Push the **Average Count** softkey.
The Average input field opens.
- 3 Enter the number of measurements over which to average the results, in the range from 2 to 128.
- 4 Press **ENTER**.

Selecting the detection method

In channel power mode, the detection method is set to Sample by default. If the 9132 RMS Detector Option is installed and activated on your 9102, the root mean square detector showing the RMS-effective level of the measured signal is also available. In order to set the detection method to RMS proceed as follows:

- 1 From the main menu, select **Trace > Detect**.
- 2 Select the RMS from the Detector section of the vertical softkeys.
The selected detection method is indicated at the left-hand side of the display.

NOTE

If the 9132 RMS Detector Option is not installed on your 9102, the RMS detector is greyed out.

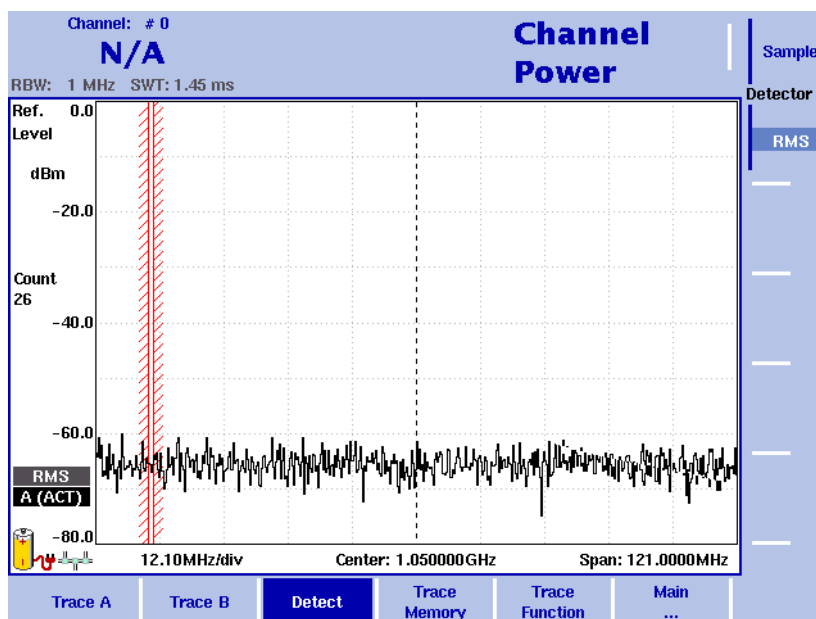

Figure 27 Detect menu with activated 9132 RMS Detector Option

Copying traces inside the 9102

You can copy an actual measurement from trace A to trace B or vice versa; this way you can keep the last measurement results on the screen and at the same time continue measuring or change the settings of the 9102 Handheld Spectrum Analyzer. The previous results in the target trace will be erased; the target trace will assume hold mode.

To copy the measurement data from one trace to another, proceed as follows:

- 1 From the main menu, select **Trace > Trace Function**.
- 2 To copy the measurement results from trace A to trace B, press **Copy A → B**.
To copy results from trace B to trace A, press **Copy B → A**.

NOTE

If you first press **Copy A → B**, then **Copy B → A** (or vice versa), both traces will display the same results and will be in hold mode.

Storing and loading traces

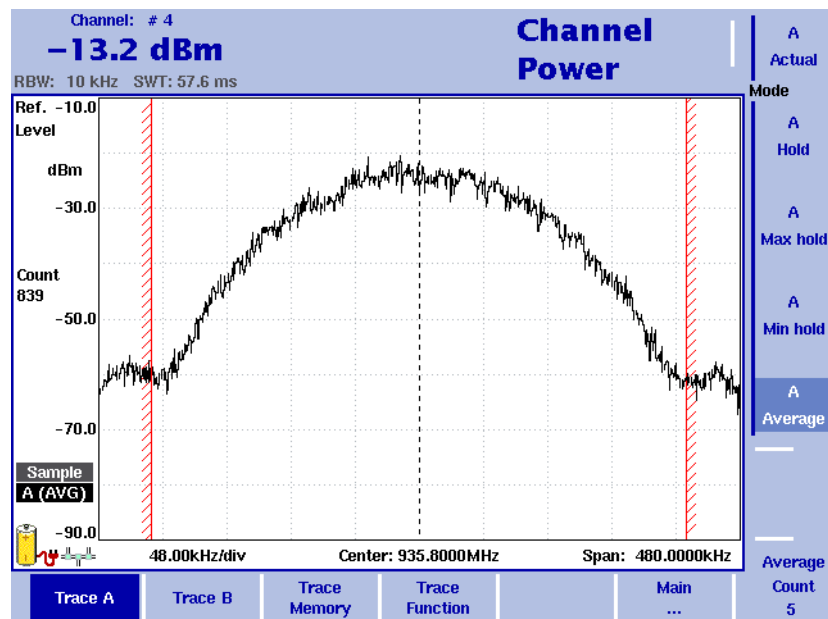

Figure 28 Trace A menu

The 9102 provides the capability to store up to 99 traces in the 9102 and load them again at random. The stored trace can then be examined or compared to a recent measurement. In addition, stored traces can also be transferred to a PC using the 9100 Data Exchange Software which is delivered with the 9102. For details on the software refer to [Chapter 15 "9100 Data Exchange Software"](#).

Storing a trace

You can store either trace A and B. Any trace can be stored under a name with up to 11 characters. The procedure to enter text in alphanumeric input fields is explained in section ["Entering numbers and text" on page 24](#). Note that along with the trace, the instrument settings such as frequency range, level range and markers are stored.

- 1 Activate the trace you want to store by pushing **Trace > Trace A** or **Trace B**.
- 2 From the main menu, select **Trace > Trace Memory**.
- 3 Push **Store Trace**.
An input field opens, allowing you to enter a name for the trace. Below the input field, a list of existing traces is indicated.
- 4 Enter a name for the trace. To use a modified trace name, you can move the cursor to a suitable trace name with the **UP/DOWN** cursor keys. The selected trace name also appears in the input field; use the **LEFT/RIGHT** cursor keys to move the cursor to the appropriate position within the trace name to enter additional characters or delete existing ones.
- 5 Confirm your choice by pressing **ENTER**.
The input field closes and the trace is stored under the selected name.

Reusing a trace name You cannot overwrite an existing trace using the same trace name. If you want to reuse a trace name, you will have to delete the old trace first.

- Reloading a trace**
- 1 From the main menu, select **Trace > Trace Memory**.
 - 2 Push **Recall Trace**.
An input field opens, allowing you to enter the trace name. Below the input field, a list of existing traces is indicated.
 - 3 Enter the name of the trace to load, or choose one with the **UP/DOWN** cursor keys.
 - 4 Confirm your choice by pressing **ENTER**.
The input field closes and the trace is displayed.

NOTE

Along with the trace, the 9102 also loads the settings that were used when the trace was saved. These will overwrite the current settings such as frequency range, reference level and markers.

Deleting a trace Stored traces can be deleted. Note that there will be no warning; once you have selected and requested a file to be deleted, this will occur immediately.

- 1 From the main menu, select **Trace > Trace Memory**.
- 2 Push **Delete Trace**.
An input field for the name of the trace to be deleted appears, together with a trace selection box.
- 3 Select the trace to be deleted using the **UP/DOWN** cursor keys. Alternatively, enter the trace name with the numeric keys.
- 4 Confirm your choice by pressing **ENTER**.
The trace is deleted from the trace list.
- 5 Select another trace for deletion, or press **ESCAPE** to leave the entry field and the trace selection box.

Deleting all traces Instead of deleting traces individually, all traces can be deleted in one step. You will be asked to confirm this step.

- 1 From the main menu, select **Trace > Trace Memory**.
- 2 Press **Delete All**.
A query appears, asking you to confirm your selection.
- 3 Press **ENTER** to have all traces deleted.
The query disappears. All traces are deleted.

Viewing the channel power mode parameters

You can get an overview of all parameters set for this mode in the Parameter Window. To view the parameters, press the **PARAM** function key. To close the Parameter Window and return to the menu you opened it from, press the **ESCAPE** function key, the **Exit** softkey or the **PARAM** function key. To close the parameter page and change to the relevant main menu press the **Main** softkey.

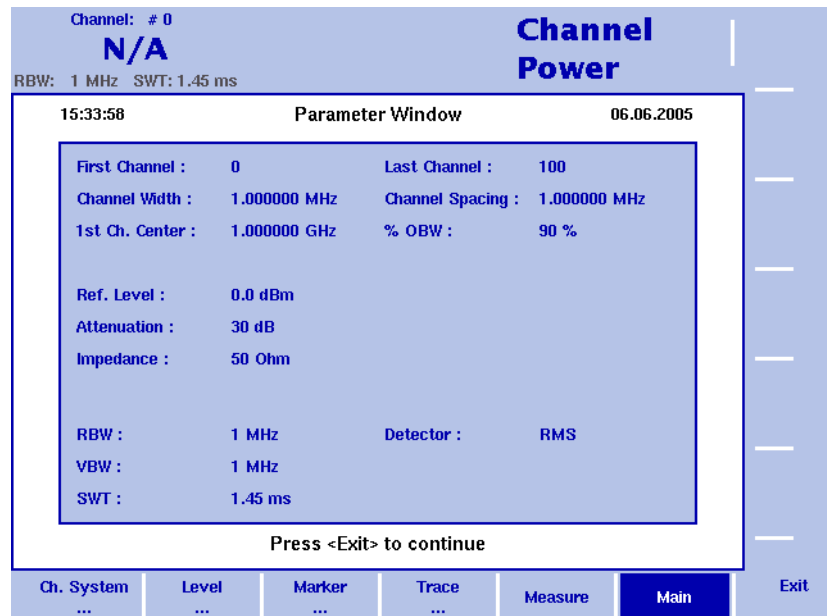

Figure 29 Channel power mode parameters

Power Sensor Operation

5

This chapter describes the instrument's functions in power sensor mode. Topics discussed in this chapter are as follows:

- ["About the power sensor mode" on page 100](#)
- ["Connecting the 9162 Insertion Power Sensor" on page 101](#)
- ["Setting up the 9102 for insertion power measurements" on page 102](#)
- ["Reading the power measurement" on page 103](#)

About the power sensor mode



WARNING

The 9162 Insertion Power Sensor may be hot during and after operation.

The 9102 offers different measurement modes, e.g. spectrum analysis and channel power measurements. The power sensor mode allows you to perform a broadband measurement of the power of a radio frequency signal. The mode uses the 9162 Insertion Power Sensor which measures the power in both directions, i.e. the transmitted and the reflected power on the way between the source and the sink. No direct RF connection to the 9102 is required.

The power sensor mode further reduces the complexity of all the setup possibilities; all you need to enter is the frequency, the expected signal type and the desired measurement unit.

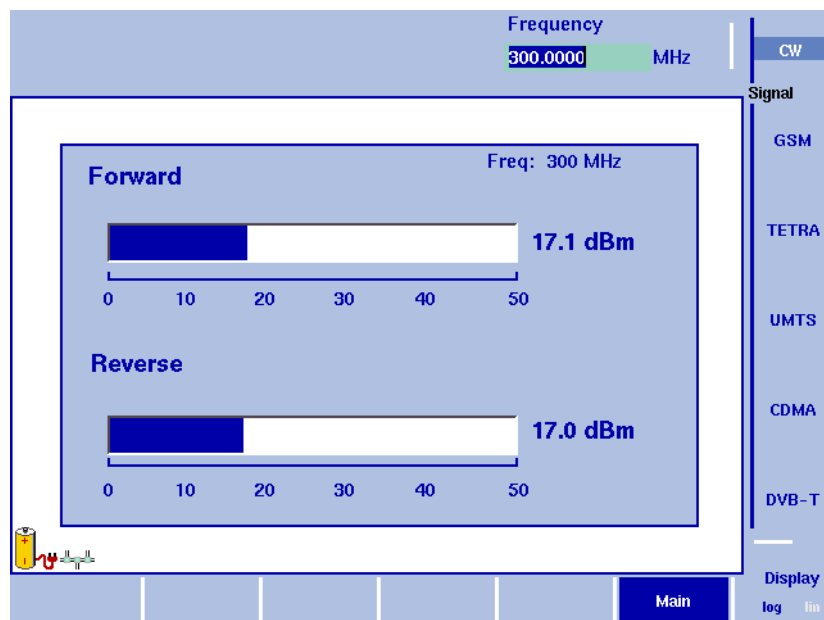

Connecting the 9162 Insertion Power Sensor

The insertion power sensor takes measurements on RF signals in the range from 70 to 2700 MHz at power levels from 1 mW to 50 W. Proper measurements are achieved if the impedance at the input and output power is 50 Ω .

To perform measurements with the power sensor and read the results on the 9102, the following connections need to be made:

- 1 Connect the cable from the 9162 Insertion Power Sensor to the Multi Port connector of the 9102.
- 2 Connect the cable coming from the signal source to the RF In port (N-type connector) of the power sensor.
- 3 Connect the cable going to the signal sink (e.g. an antenna) to the RF Out port (N-type connector) of the power sensor. If you do not have a sink, the RF Out connector should be terminated with 50 Ω .



WARNING

Do not feed more than +47 dBm into the 9162 Insertion Power Sensor, the device may be destroyed otherwise.



Setting up the 9102 for insertion power measurements

Starting the insertion power mode

To select the insertion power mode, proceed as follows:

- 1 Push the **MODE** function key.
- 2 Select the **Insertion Power** softkey.
The insertion power menu appears. If you select a new mode, all parameters are set to the values used when the mode was last active. If, however, you resume the last active mode, the measurements continue without any changes to the parameters.

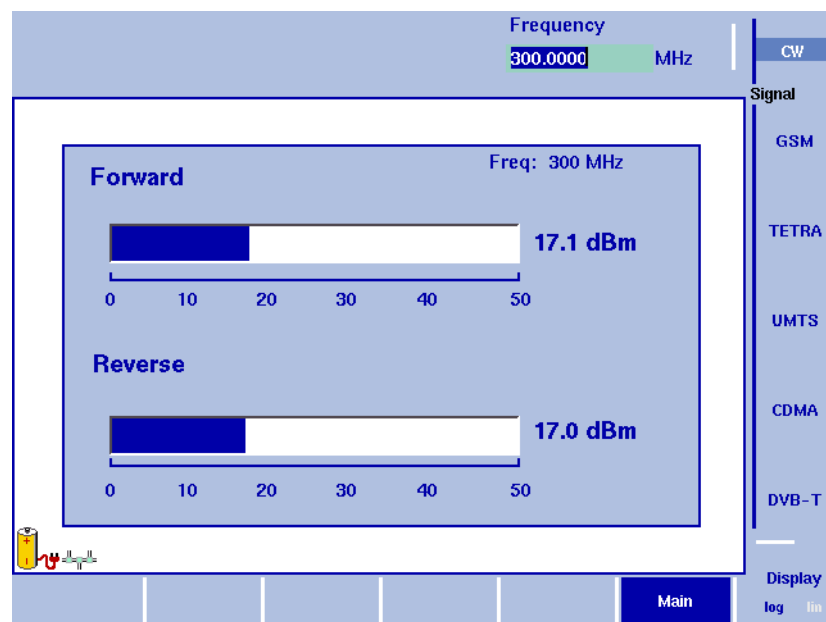

Setting up the signal type and frequency

The insertion power sensor is a broadband measuring device. However, to ensure the best measurement accuracy, it is advisable to provide information about the signal type and the frequency of the signal:

- 1 Select one of the Signal function softkeys (**CW**, **GSM**, **TETRA**, **UMTS**, **CDMA** or **DVB-T**).
The appropriate function softkey is highlighted, and the Frequency input field opens.
- 2 Enter the center frequency of the signal to be measured (in the range 70 to 2700 MHz) and conclude the entry by pushing an enter key for the unit (**GHZ** or **MHZ**).

Note

Although the frequency can be entered at a higher accuracy, it is sufficient to supply it in full megahertz.

Defining the displayed measurement unit

The 9102 can display results either in Watts (linear unit) or in dBm (logarithmic unit).

To select the desired unit, press the **Display** function softkey once or twice until the desired display mode (log or lin) is highlighted.

Reading the power measurement

The 9162 Insertion Power Sensor performs broadband measurements of the forward and reverse power. The results are shown as follows:

Forward power

The 9102 displays a bar indicating the power to the scale shown below the bar, either in Watts (linear display) or in dBm (logarithmic display). The numerical value is also shown on the right-hand side.

The forward power is the amount of power being transmitted into the RF In port and further from the RF Out port to the signal sink, without being reflected.

Reverse power

The 9102 displays a bar indicating the power to the scale shown below the bar, either in Watts (linear display) or in dBm (logarithmic display). The numerical value is also shown on the right-hand side.

The reverse power is the amount of power being transmitted (or reflected by the sink) into the RF Out port and further from the RF Out port to the signal sink, without being reflected.

Signal Generator Operation

6

This chapter describes the instrument's functions that are specific to the signal generator mode. Topics discussed in this chapter are as follows:

- ["About the signal generator mode" on page 106](#)
- ["Switching the signal generator on and off" on page 106](#)
- ["Changing the frequency" on page 106](#)
- ["Setting the level" on page 109](#)
- ["Applying special functions on the signal" on page 109](#)

About the signal generator mode

In this mode the instrument can be used to generate a signal in order to stimulate an electronic circuit with a set frequency and a set level. As this mode is only used for sending out a signal and no actual measurement takes place on the instrument there is no trace display. Depending on the application of the signal the result of the process could be for example the booting of a processor.

Selecting the measurement mode

To select signal generator mode, proceed as follows:

- 1 Push the **MODE** function key.
The Mode menu appears.
 - 2 Select **(VSWR)/Tracking ... > Signal Generator**.
The Signal Generator main menu appears (see [Figure 31](#) and [Figure 30](#)).
-

Switching the signal generator on and off

When you select the signal generator mode as described above, the signal generator is switched on by default. To switch it off press the **Output** softkey until **off** is highlighted. If you switch the signal generator off and select another mode, it will be automatically switched on again as soon as you return to signal generator mode.

Changing the frequency

The main menu shows softkeys for the definition of the frequency range on the display. The softkeys available for setting frequency parameters depend on the frequency mode you select. The modes available are: CW (Continuous Wave) and SWP (Sweep).

Selecting the frequency mode

To configure the softkeys available for setting the frequency you can choose between the two frequency modes CW and SWP. The CW mode is active by default. To change between CW and SWP, press the **Mode** softkey until the required option is highlighted. The main menu display will change accordingly.

Setting the center frequency

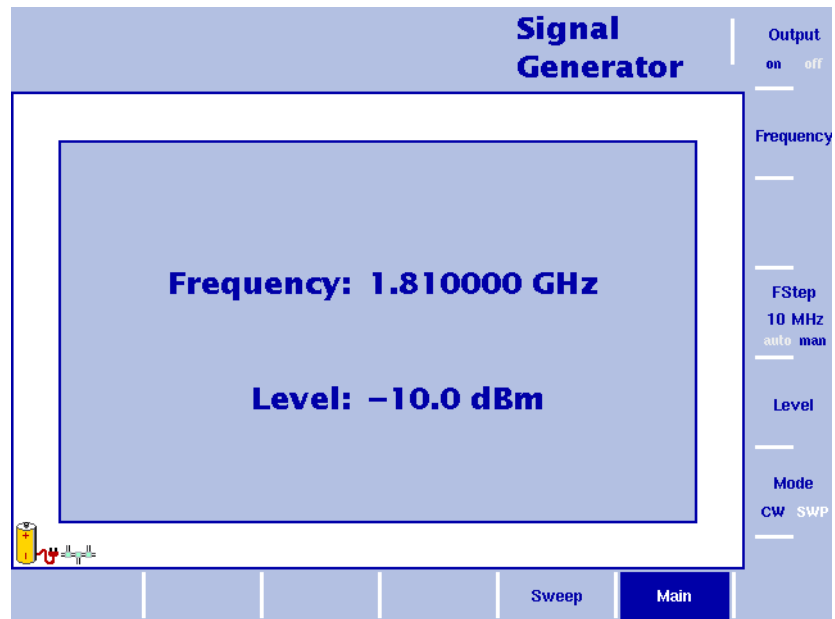

Figure 30 Signal Generator main menu in CW mode

- 1 In the main menu, select the CW mode by pressing the **Mode** softkey until CW is highlighted. The CW main menu as shown above appears.
- 2 Push the **CENT** function key (or the **Frequency** softkey in the main menu). An entry field appears, indicating the center frequency currently set and the step size for the **UP/DOWN** cursor keys.
- 3 Enter a new frequency using the numeric keys, the cursor keys and the **BACKSPACE** key.

Conclude the entry by pressing the appropriate enter key determining the unit (**GHZ/DBM** for gigahertz, **MHZ/DB/μS** for megahertz).

Setting start and stop frequency

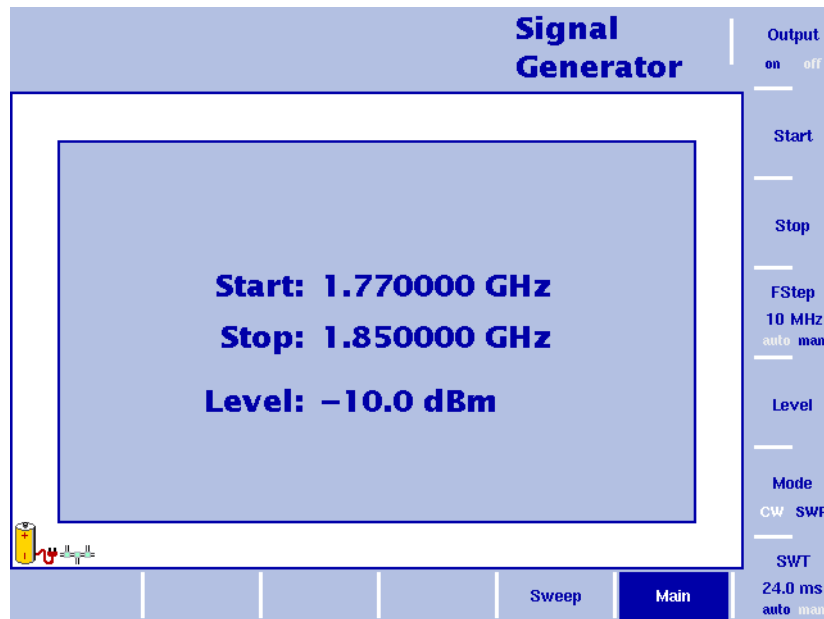

Figure 31 Signal Generator main menu in SWP mode

- 1 In the main menu select the SWP mode by pressing the **Mode** softkey until SWP is highlighted. The SWP main menu as shown above appears.
- 2 In the main menu, push the **Start** softkey.
An entry field appears, indicating the start frequency currently set and the step size for the **UP/DOWN** cursor keys.
- 3 Enter a new frequency using the numeric keys, the cursor keys and the **BACKSPACE** key.
- 4 Push the **Stop** softkey and enter the frequency.

Selecting the step size for the frequency input



The center, start and stop frequencies can either be set by entering a new value with the numeric keys, or by using the arrow keys (**UP, DOWN**) to increase or decrease the current setting. The step size for an arrow keypress can be either automatically selected by the 9102, or manually adjusted.

Manually setting the frequency step size

- 1 In the Signal Generator main menu select the frequency mode (CW or SWP) for which you want to set the frequency step size as described in ["Selecting the frequency mode" on page 106](#).
- 2 Push the **FStep** key.
The Freq Step entry field opens.
- 3 Enter a new frequency step value and close the entry field by pressing **Enter**.
The auto/manual selection switches to manual and the selected frequency step size is displayed on the softkey.

Setting the frequency step size selection to automatic

- 1 In the Transmission main menu, select **Freq.**
- 2 Push the **FStep** softkey several times until the "auto" selection is highlighted.

Setting the level

- 1 In the main menu, push the **Level** softkey.
The level input field opens.
- 2 Enter the new level either using the numeric keys, closing the input field with the appropriate enter key, or with the **UP/DOWN** arrow keys. The level can be entered in the range of -10 dBm and -30 dBm in 1 dB steps.

Applying special functions on the signal

This section shows how the number of measurements can be limited.

Performing a limited number of measurements



The 9102 can run measurements continuously or a defined number of times. Limiting the number of measurements can be useful for statistical analyses.

- 1 In the main menu, select **Sweep**.
The Sweep menu appears.
- 2 Select the sweep mode: Push **Cont.** for continuous signal generation or **Single** for a single sweep.
The selected sweep mode is highlighted.

Transmission Operation

7

This chapter describes the instrument's functions that are specific to the transmission mode. Topics discussed in this chapter are as follows:

- ["About the transmission mode" on page 112](#)
- ["Selecting the measurement mode" on page 112](#)
- ["Switching the tracking generator on and off" on page 113](#)
- ["Normalizing the trace" on page 113](#)
- ["Setting the tracking output power" on page 114](#)
- ["Changing the frequency settings" on page 115](#)
- ["Selecting RBW, VBW and SWT" on page 118](#)
- ["Setting up the level parameters" on page 118](#)
- ["Applying special functions on the signal" on page 121](#)
- ["Setting up the trace" on page 123](#)
- ["Storing and loading traces" on page 128](#)
- ["Viewing the transmission mode parameters" on page 131](#)

About the transmission mode

The transmission mode allows you to determine the frequency characteristics of passive (e.g. bandpass filters) or active devices under test (e.g. amplifiers). In this mode the 9102 Handheld Spectrum Analyzer uses a tracking generator – a signal generator which is synchronous with the receive frequency of the spectrum analyzer – to measure e.g. reflection and the transmission characteristics of devices under test. The tracking generator has an output frequency from 1 MHz to 4 GHz. Its level is adjustable from -10 to -30 dBm which allows adaptation of the output signal to the demands of devices under test. In the 9100 applications guide contained on the documentation CD delivered with your instrument you will find an application example for this mode.

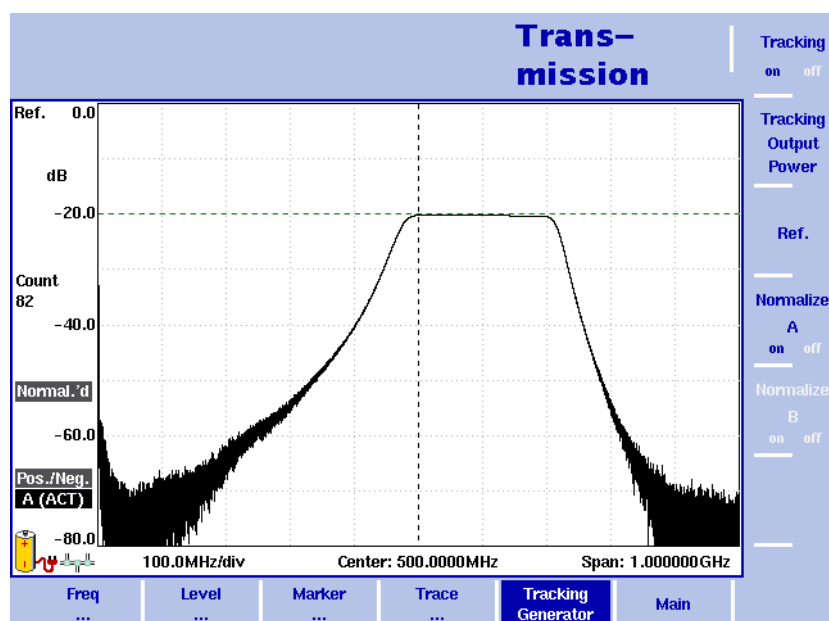

Figure 32 Example of a transmission measurement

Selecting the measurement mode

To select transmission mode, proceed as follows:

- 1 Push the **MODE** function key.
The Mode menu appears.
- 2 Select **(VSWR)/Tracking ... > Transmission**.
The Transmission main menu appears.

Switching the tracking generator on and off

When you select the transmission mode as described in ["Selecting the measurement mode"](#), the tracking generator is switched on by default. To switch it off, proceed as follows:

- 1 In the Transmission main menu, press the **Tracking Generator** softkey.
- 2 Press the **Tracking** softkey until "off" is highlighted.

If you switch the tracking generator off and select the spectrum analysis or channel power mode, it will be automatically switched on again as soon as you return to transmission mode.

Normalizing the trace

In order to eliminate slight ripples in the trace display the Normalize function should be used before taking measurements. There are two softkeys available for normalizing the display for trace A and trace B. The following figure shows trace A with normalization deactivated (off).

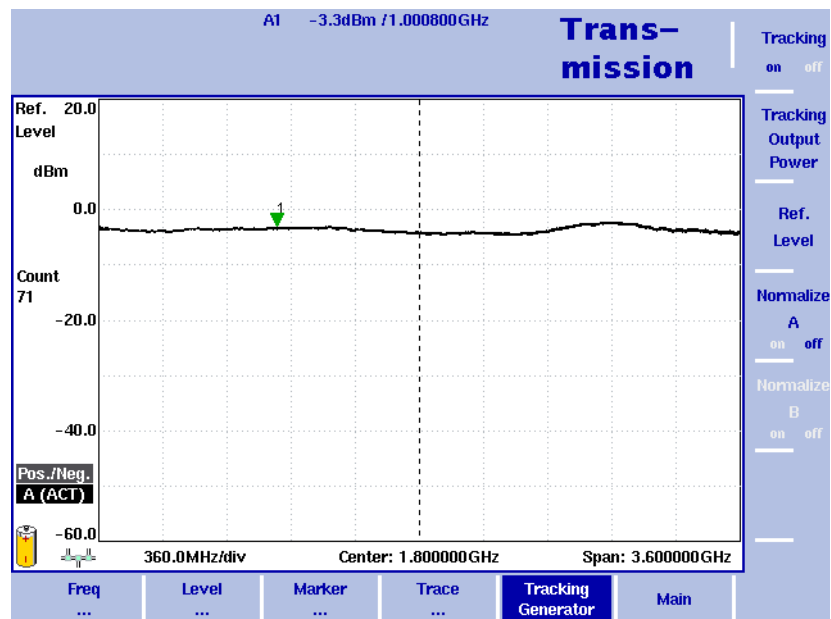

Figure 33 Normalize A off

In order to achieve a normalized trace proceed as follows:

- 1 Establish a cable connection between the **RF IN** and the **RF OUT** connector.
- 2 In the Transmission main menu, press the **Tracking Generator** softkey.
- 3 Press the **Normalize A** or **B** softkey until "on" is highlighted.

NOTE

If trace B is not active, the Normalize B softkey will be greyed out.

The message "Normal.'d" on the left-hand side of the results area indicates that the display is normalized. If you change measurement parameters, e.g. tracking output, frequency settings or attenuation, it may be necessary to repeat the normalizing procedure. If this is the case, the message "Normalize" will be displayed against a red background on the left-hand side of the results area.

The following figure shows trace A after normalization has been activated.

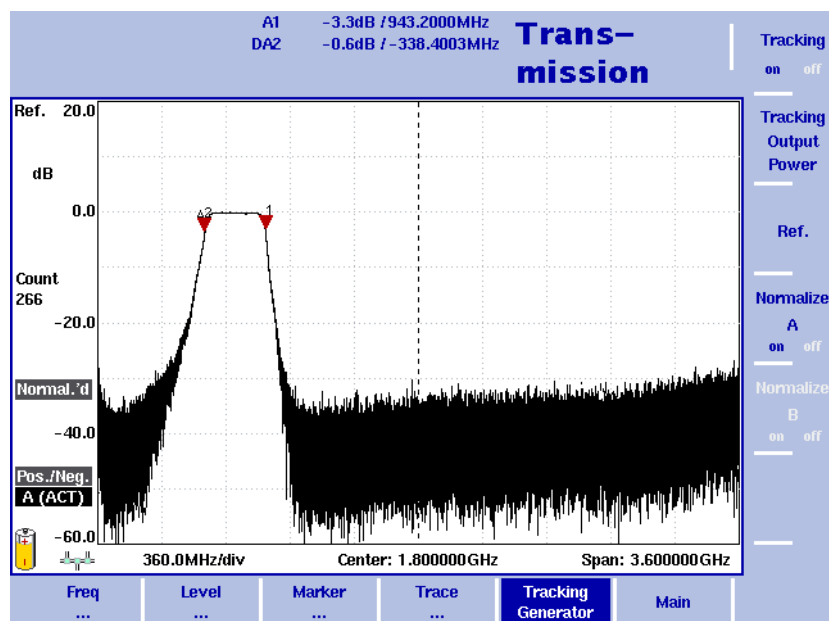

Figure 34 Normalize A on

Setting the tracking output power

The tracking generator's output power can be set in a range from -10 to -30 dBm. In order to change the output power proceed as follows:

- 1 In the Transmission main menu, press the **Tracking Generator** softkey.
- 2 Press the **Tracking Output Power** softkey. The Tracking Output Power input field appears.
- 3 Use the **UP/DOWN** cursor keys to enter a new output power value in 1 dBm steps or enter the new value using the numeric keypad.
- 4 Press **ENTER**.

Changing the frequency settings

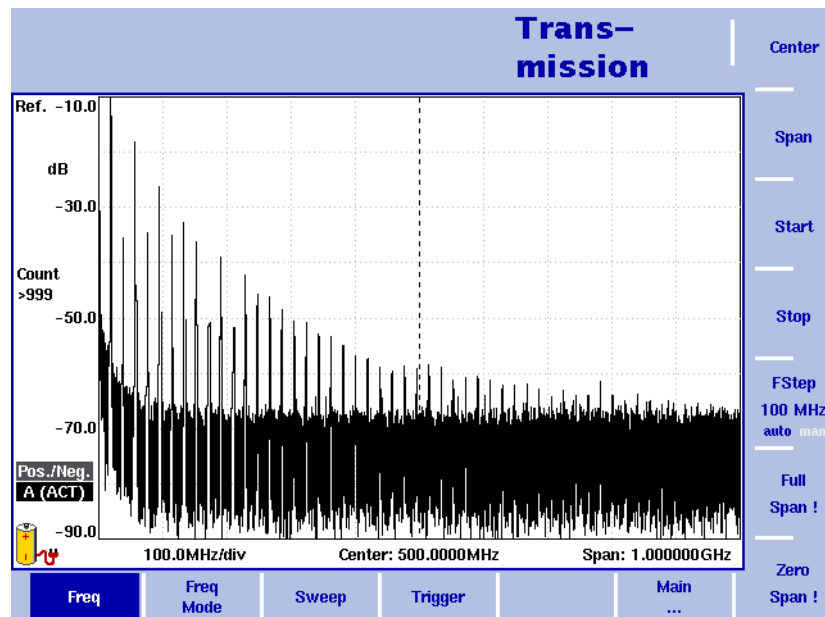

Figure 35 Frequency menu

There are different methods to set the frequency range to be measured; the range can be expressed by either the start and stop frequencies (i.e. first and last frequencies on the display), or by center frequency and span (i.e. the center and the frequency range), or by other combinations of center frequency, span, start and stop frequencies.

All four parameters are accessible in the Freq menu. On the main menu, however, only one of the combinations mentioned above is shown, depending on the parameter last entered.

NOTE

Changing a frequency parameter may affect an associated parameter.
Example: If you change the span to the maximum of 4 GHz, the start and stop frequencies are changed to 0 and 4 GHz, respectively.

Setting start and stop frequency



- 1 Push the **CENT** function key (or the **Freq** softkey in the Transmission main-menu).
The vertical softkeys include Start and Stop softkeys.
- 2 Push the **Start** softkey.
An entry field appears, indicating the start frequency currently set and the step size for the **UP/DOWN** cursor keys.
- 3 Enter a new frequency using the numeric keys, the cursor keys and the **BACKSPACE** key.

- 4 Conclude the entry by pushing an enter key for the unit (**GHZ/DBM** for gigahertz, **MHz/DB/μs** for megahertz).
 If the start frequency entered is lower than the stop frequency, the horizontal axis will display the range from the new start to the stop frequency. If the new start frequency is higher than or equal to the stop frequency, the start frequency is used as the center frequency with zero span, i.e. the signal at the selected frequency will be shown in the time domain.
- 5 Push the **Stop** softkey and enter the frequency for the right end of the display.

You can also place softkeys for the start and stop frequencies available on the main menu by changing the frequency mode, see ["Changing the main menu for different frequency parameters"](#).

Setting center frequency and span



- 1 Push the **CENT** function key (or the **Freq** softkey in the Transmission main menu).
 The vertical softkeys include Center and Span. An entry field appears, indicating the center frequency currently set and the step size for the up/down cursor keys.
- 2 Enter a new frequency using the numeric keys, the cursor keys and the **BACKSPACE** key.
- 3 Conclude the entry by pushing an enter key for the unit (**GHZ/DBM** for gigahertz, **MHz/DB/μs** for megahertz, **KHz/DBμV/MS** for kilohertz, or **ENTER** for hertz).
- 4 Push the **Span** softkey and enter the frequency for the range from the left to the right end of the display.

You can also place softkeys for the center frequency and the span available on the main menu by changing the frequency mode, see section ["Changing the main menu for different frequency parameters"](#) below.

Changing the main menu for different frequency parameters



The Transmission main menu shows two softkeys for the definition of the frequency range on the display. Different methods exist to define the range as depicted above; you can configure these softkeys to one of the two allowable combinations as follows:

- 1 From the Transmission main menu, select **Freq > Freq Mode**.
- 2 Select the combination of softkeys that you want to see in the main menu (**Start/Stop** or **Center/Span**).
- 3 Return to the main menu by pushing the **Main ...** softkey.
 The main menu appears and displays the selected combination of keys.

Note that the description of the horizontal frequency axis changes with the selected parameter set.

Viewing the complete frequency band



To change the frequency range to the full bandwidth supported by the 9102, proceed as follows:

- 1 From the Transmission main menu, push the **Freq** softkey. The Frequency menu is displayed.
- 2 Push the **Full Span** softkey. The leftmost frequency changes to 0 Hz and the rightmost frequency to 4 GHz.

Performing measurements in the time domain



Measurements on a selected center frequency can also be displayed in the time domain.

- 1 From the Transmission main menu, push the **Freq** softkey. The Frequency menu is displayed.
- 2 Push the **Center** softkey and enter the desired center frequency; close the input field by selecting the appropriate unit with one of the enter keys.
- 3 Push the **Zero Span** softkey. The horizontal axis becomes the time axis. The scale width is identical to the sweep time. See [Figure 36 on page 122](#) for an example.

Selecting the step size for the frequency input



The center, start and stop frequencies can be set either by entering a new value with the numeric keys, or by using the arrow keys (**UP**, **DOWN**) to increase or decrease the current setting. The step size for an arrow keypress can either be selected automatically by the 9102, or manually adjusted.

Manually setting the frequency step size

- 1 From the Transmission main menu, select **Freq**.
- 2 Push the **FStep** softkey. The Freq Step entry field opens.
- 3 Enter a new frequency step value and close the entry field by pressing **Enter**.

Setting the frequency step size selection to automatic

- 1 From the Transmission main menu, select **Freq**.
- 2 Push the **FStep** softkey several times until the "auto" selection is highlighted.

Selecting RBW, VBW and SWT



The resolution bandwidth (RBW) is the 3 dB bandwidth of the IF filter for selecting the signal to be measured. The resolution bandwidth describes the ability of the spectrum analyzer to discriminate between adjacent signals of similar amplitude. Only signals spaced at a frequency of more than the RBW can be discriminated from one another.

The 9102 can be set to automatically select the resolution bandwidth, depending on the frequency span.

The video bandwidth (VBW) is the lowpass filter over which several results for one frequency point are smoothed. The lower the video bandwidth, the smoother the signal curve and the less variations there are.

The 9102 can be set to select the video bandwidth automatically as a function of the resolution bandwidth. A typical value for the video bandwidth should be equal or 10 times lower than the radio bandwidth value.

The sweep time (SWT) determines how long it takes for a complete sweep over the measured frequency range (span).

The 9102 can be set to automatically select the sweep time, depending on RBW and VBW. If manually set, the sweep time should be selected long enough for the filtered signal to reach steady state. The 9102 will output an "UNCALibrated" warning if the sweep time is too low.

To set the resolution bandwidth, the video bandwidth or the sweep time, proceed as follows:

- 1 In the main menu, select the appropriate softkey (**RBW**, **VBW**, or **SWT**).
- 2 Enter the value and complete the entry with the appropriate enter key for the unit, select a new value with the help of the **UP/DOWN** cursor keys, or switch to **auto** to leave the setting to the 9102.

Changing between automatic and manual mode

Push the appropriate softkey (**RBW**, **VBW**, or **SWT**) until the desired selection (auto or manual) is highlighted.

Setting up the level parameters

The dynamic range between the measured signal and the noise floor depend on the proper setting of the level settings. These consist of the reference level and the attenuation.

The reference level basically determines the level at the top of the display. The vertical axis is divided into eight horizontal rows. You can adjust the scale (which defaults to 10 dB per line) to your preferences.

The attenuation setting can be coupled to automatically follow the reference level setting. For reference levels of -20 dBm and lower, the attenuation is set to 10 dB; the maximum attenuation is 50 dB.

Attenuation or gain due to external coupling can be compensated by frequency-dependent coupling factors, so that the displayed measurement values reflect the power at the device under test.



WARNING

The maximum input power level at the **RF IN** connector is 30 dBm (1 W). Higher input levels may result in serious damage of the instrument.

Switching the display

You can switch the display between absolute and relative as follows:

- 1 In the main menu select **Level**. The Level menu is displayed.
- 2 Toggle the display to absolute or relative by pressing the **Display** softkey until the required display option is highlighted. If you select abs, reference level and the unit dBm will be shown in the results display. If you select rel, reference and the unit dB will be shown.

Setting the reference level

- 1 In the main menu, push the **Ref.** softkey or select **Level** followed by **Ref.** Alternatively, push the **REF** function key. The Reference Level input field opens.
- 2 Enter the new reference level either using the numeric keys, closing the input field with the appropriate enter key, or with the **UP/DOWN** arrow keys. The new reference level appears at the top of the vertical axis. The reference is based on the actual set output power.

Setting the hardware attenuation

- 1 In the main menu, push the **ATTN.** softkey. The Attenuation input field opens.
- 2 Enter a new attenuation value in the range from 0 to 50 dB (in 10 dB steps) and close the input field with one of the enter keys, or use the **UP/DOWN** arrow keys to select the attenuation value in the range from 10 to 50 dB.

NOTE

The attenuation value of 0 dB can be set only with the numeric keys to avoid accidental deactivation. The 0 dB setting should be selected carefully because too high input levels may damage the instrument.

NOTE

For precision measurements, the input power level subtracted by the attenuation should not exceed -23 dBm.

Changing the vertical scale

The scale for the vertical axis (power) can be changed in the range from 1 to 20 dB per division (vertical line in the displayed grid) in 1-3-5 steps as follows:

- 1 In the main menu, select **Level**.
- 2 Push the **Scale** softkey.
The Scale input field opens.
- 3 Select a new scale by entering a new number of dB per division numerically and pressing the **ENTER** or **MHz/DB/μs** key, or by pushing the **UP/DOWN** cursor keys.

Compensating gains and losses

If the device under test is connected to the 9102 Handheld Spectrum Analyzer via an amplifier or a device attenuating the signal, such as an antenna or a long cable, the measurement results are wrong by the gain or loss factor. This factor may be a constant or even frequency-dependent.

To view the correct measurement results, the gain or loss can be compensated. The 9102 can even compensate a frequency-dependent factor; a correction curve or table can be entered on an external PC using the 9100 Data Exchange Software and loaded to the 9102. The section "[Defining and loading external coupling parameters](#)" on page 233 explains this part in more detail.

Enabling external device compensation

Once correction values are stored in the 9102, these can be selected and activated as follows:

- 1 In the main menu, select **Level > Ext. Dev. Memory**.
- 2 Press **Recall Ext. Dev. Comp.**
A pull-down menu appears with a list of names for the compensation tables available in the 9102.
- 3 Select a compensation table using the **UP/DOWN** cursor keys and confirm your choice by pressing **ENTER**.
Compensation is still off, but the 9102 changes automatically to the Level menu.
- 4 Push the **Ext. Dev. Comp.** softkey until "on" is highlighted.
The text "Ext. Dev.", together with the name of the file loaded, appears on the upper left-hand corner of the results display.

NOTE

Steps 1 thru 3 may be omitted if a file had been previously selected. In this case, select the **Level** menu and continue with step 4.

Turning external device compensation off

- 1 In the main menu, select the **Level** menu.
- 2 Press **Ext. Dev. Comp.** until "off" is highlighted.
The text "Ext. Dev." to the left of the results display disappears.

Deleting files for external device compensation

You can delete files containing compensation parameters as follows:

- 1 From the main menu, select **Level > Ext. Dev. Memory**.
- 2 a. To delete an individual compensation file from the 9102 memory, push **Delete Ext. Dev. Comp**. Select a file name and press **ENTER**.
The compensation file is deleted from the list. Note that there will be no warning; once you have selected and requested a file to be deleted, this will occur immediately.
b. To delete all the compensation files from the 9102, push **Delete All** and confirm by pressing **ENTER**.
All compensation files are deleted.

Applying special functions on the signal

This section shows how the measurement can be triggered and how the number of measurements can be limited.

Using a trigger



The 9102 can either start signal analysis at a random point in time, or start the measurement when a given signal threshold is passed. Starting measurements depending on the actual signal level is only supported in zero span mode.

Selecting untriggered signal analysis

- 1 In the the main menu push **Freq > Trigger**.
The Trigger menu appears.
- 2 Push the **Free Run** softkey.
The softkey is highlighted and the 9102 is ready for measurements at random times.

Selecting a trigger threshold in the RF signal

- 1 In the main menu push **Freq > Trigger**.
The Trigger menu appears.
- 2 Push the **Video** softkey.
The **Video** softkey is highlighted and an input field for the trigger level appears.

NOTE

The Video trigger is available in zero span mode only, otherwise the softkey description is grayed out.

- 3 Enter the trigger level (in dBm) and complete the entry by pushing either the **GHZ/DBM** or the **ENTER** key.
The trigger threshold is displayed at the power axis; the symbol also indicates the slope (direction in which the signal passes the threshold to start the measurement).

- If necessary, change the slope between positive and negative direction by pushing the **Slope** softkey.
The active slope is indicated at the power axis by the following symbol (see also Figure 36): 

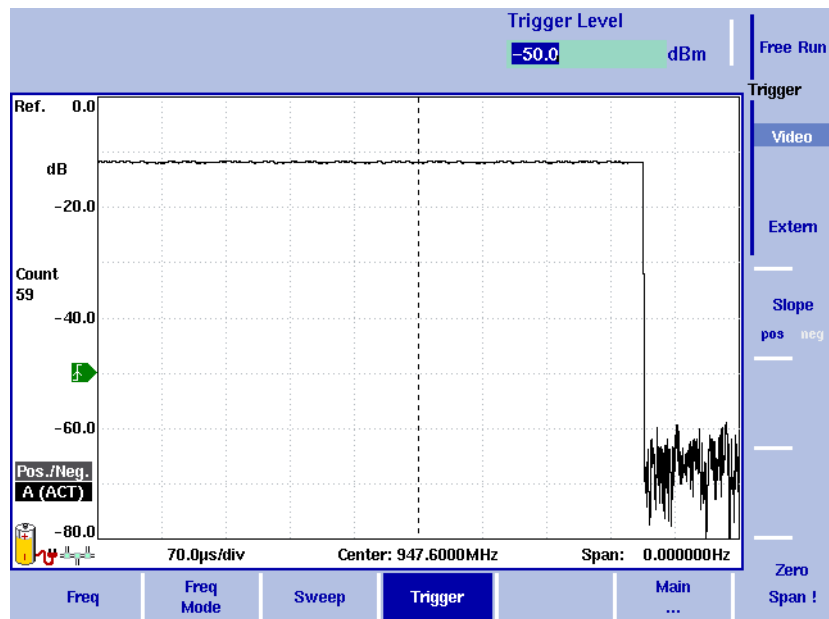

Figure 36 Triggered measurement (in the time domain)

Using an external trigger

In order to use a trigger signal generated by an external device, proceed as follows:

- Connect the external device to the **EXT. TRIG.** connector on the top of the instrument.
- In the the main menu, enter the Sweep menu by pushing **Freq > Trigger**.
The Trigger menu appears.
- Push the **Extern** softkey.
The softkey is highlighted.
After activating the external trigger the instrument waits to receive an impulse. When an impulse is detected on the external trigger entrance one sweep is performed. Afterwards the instrument waits for the next trigger event.

Performing a limited number of measurements



The 9102 can run measurements continuously or a defined number of times. Limiting the number of measurements can be useful for statistical analyses.

- 1 In the main menu, select **Freq > Sweep**.
The Sweep menu appears.
- 2 Select the trigger mode: Push **Cont.** for continuous measurements or **Single** for a limited number of measurements.
The selected trigger mode is highlighted.
- 3 To enter the number of measurements, push the **Single Count** softkey, enter a number in the range from 1 to 1000 and press **ENTER**.
If Trigger Mode is set to Single, the 9102 performs the defined number of measurements and enters hold mode.
 - To restart single-mode measurements, push the **HOLD/RUN** function key or the **Single** softkey.
 - To stop a continuous measurement, push the **HOLD/RUN** function key. Push it again to resume measurements.

Setting up the trace

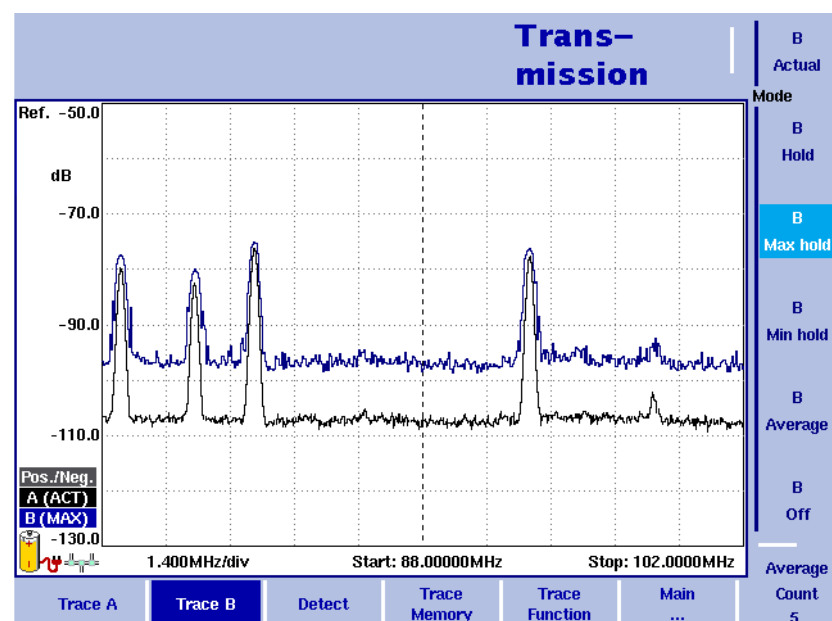

Figure 37 Example of two traces

The trace functions provide different views of the measurements, for example the actual measurement or an average over the last couple of measurements. You can even select two different views of the measurement. Another possibility is to compare the actual measurement with an older measurement which has been stored in the 9102 and loaded to one of the trace views (see section ["Storing and loading traces" on page 128](#)).

The 9102 samples many measurements for each frequency point. With the detector functions, you can define the method to select which of the samples is displayed.

Selecting the trace mode

The 9102 has five different modes to display a trace:

- In actual mode, the 9102 shows a complete new measurement in each trace. Subsequent traces are independent of each other.
- In hold mode, the last measurement is kept on the display; measurements continue but are not displayed.
- In max hold mode, the 9102 takes new measurements and, for each frequency point, compares the new measurement with the previous result. If the new measurement value is higher than the previous result, the new measurement value becomes the new result value; otherwise the old result value is kept. This way, the highest result since the start of the Max hold measurement (or a parameter change) is kept and displayed.
- Similarly, in min hold mode, the 9102 takes new measurements and compares the new measurement with the previous result. If the new measurement value is lower than the previous result, the new measurement value becomes the new result value; otherwise the old result value is kept. This way, the lowest result since the start of the Min hold measurement (or a parameter change) is kept and displayed.
- In average mode, the new measurement and previous ones are averaged for each frequency point displayed. The 9102 uses a recursive algorithm for averaging.

To select whether you want to view an actual measurement, stop and hold the last measurement, see the lowest or highest data for each frequency or an average value, proceed as follows:

- 1 In the main menu, select **Trace**.
- 2 Select the trace you want to modify (**Trace A** or **Trace B**) using the horizontal softkeys.
- 3 Select the trace mode with the vertical softkeys (**Actual**, **Hold**, **Max hold**, **Min hold**, **Average**).
The trace mode is shown at the left-hand side of the vertical axis, e.g. **A (ACT)**.

NOTE

For fastest valid results it is advisable to briefly activate the actual mode before selecting any other mode.

NOTE

When the trace is on hold, the measurement and failure counters continue counting. A second trace, if active, continues updating.

Turning the second trace on and off



You can define two different trace views, e.g. one with the actual values and one with the maximum values. While the first view (Trace A) is always active, the second can be switched off. The functions of turning Trace B on or off and selecting the trace mode are combined as follows:

- 1 In the main menu, select **Trace > Trace B**.
- 2 To turn trace B on, select the trace mode (**Actual, Hold, Max hold, Min hold, or Average**). To turn trace B off, select **Off**. If activated, the trace mode is displayed left to the vertical axis, e.g. **B (MAX)**.

Subtracting trace B from trace A

If you have used two different trace views as described above, you can show the difference between trace A and trace B by subtracting trace B from trace A as follows:

- 1 In the Trace menu select the softkey **Trace Function** followed by the softkey **Subtract A – B → A**.
- 2 Select **on** to subtract trace B from trace A. On the left-hand side of the result area the Term "Subtract" will now be displayed to indicate that a mathematical function is being performed.
- 3 The result is displayed in trace A.

NOTE

If trace A is on Hold, this function is not available and thus the **Subtract A – B → A** softkey is greyed out.

Adding trace B to trace A

If you have used two different trace views, you can also show the sum of trace A and trace B by adding the two traces as follows:

- 1 In the Trace menu select the softkey **Trace Function** followed by the softkey **Add A + B → A**.
- 2 Select **on** to add B to trace A. On the left-hand side of the result area the term "Add" will now be displayed to indicate that a mathematical function is being performed.
- 3 The result is displayed in trace A.

Trace Offset

As soon as you use one of the two mathematical functions, Subtract $A + B \rightarrow A$ or Add $A + B \rightarrow A$, the Trace Offset function is activated. You can use this function to adjust the trace display, if the mathematical calculation performed causes the resulting trace to move outside the display area. In order to bring the trace back into view, use the Trace Offset softkey to modify the offset value until the trace moves back into the display area.

Defining the number of measurements for averaging

When the trace mode is set to averaging, it may be useful to adjust the number of measurements over which the 9102 averages the results. The average count value that can be defined in the Trace menus applies to both traces alike.

The 9102 uses a recursive algorithm in which a new result is added to the older averages with a weighting factor; the description below indicates how to change this weighting factor.

- 1 Select the Trace menu (select **Trace > Trace A** or **Trace B** from the main menu).
- 2 Push the **Average Count** softkey.
The Average input field opens.
- 3 Enter the number of measurements over which to average the results, in the range from 2 to 128.
- 4 Press **ENTER**.

Selecting the detection method



For each new measurement, the 9102 selects one or two values from a number of measurements for each frequency value. The method is user-definable; the following methods are available (see also [Figure 38](#)):

- Positive/negative peak: Both the largest and smallest values are taken and displayed as a vertical bar.
- Positive peak: Only the largest value is displayed.
- Negative peak: The smallest value is shown.
- Sample: A sample measurement value is picked.
- If the 9132 RMS Detector Option is installed and activated on your 9102, the root mean square detector showing the RMS-effective level of the measured signal is also available. If the 9132 RMS Detector Option is not installed on your instrument the RMS detector will be greyed out.

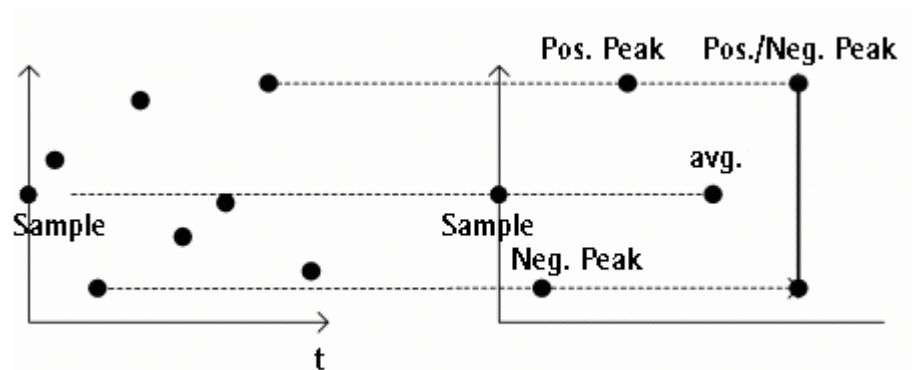

Figure 38 Trace detectors

The detection method applies to both traces. Select the detection method as follows:

- 1 From the main menu, select **Trace > Detect**.
- 2 Select the trace method from the Detector section of the vertical softkeys. The selected detection method is indicated at the left-hand side of the display.

Copying traces inside the 9102

You can copy an actual measurement from trace A to trace B or vice versa; this way you can keep the last measurement results on the screen and at the same time continue measuring or change the settings of the 9102 Handheld Spectrum Analyzer. The previous results in the target trace will be erased; the target trace will assume hold mode.

To copy the measurement data from one trace to another, proceed as follows:

- 1 From the main menu, select **Trace > Trace Function**.
- 2 To copy the measurement results from trace A to trace B, press **Copy A → B**.
To copy results from trace B to trace A, press **Copy B → A**.

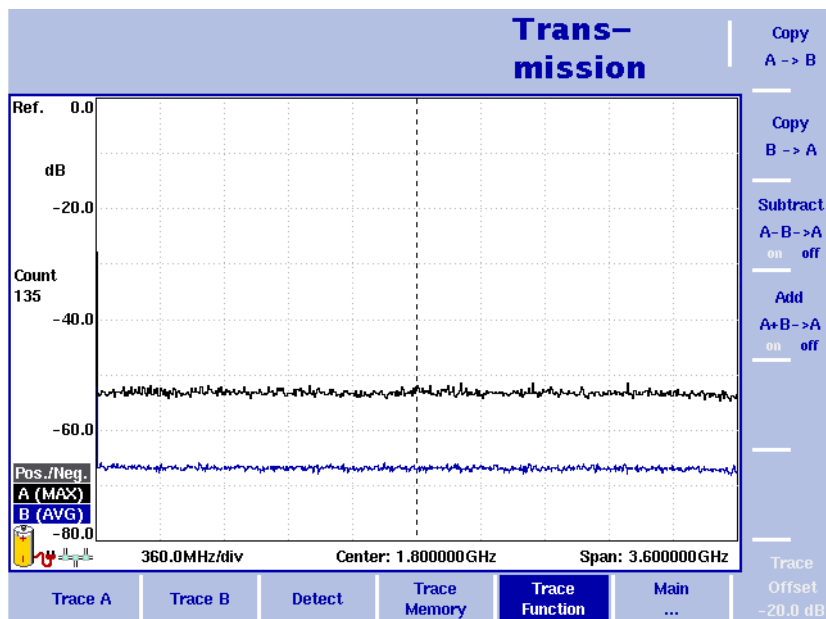

Figure 39 Trace function menu

NOTE

If you first press **Copy A → B**, then **Copy B → A** (or vice versa), both traces will display the same results and will be in hold mode.

Storing and loading traces

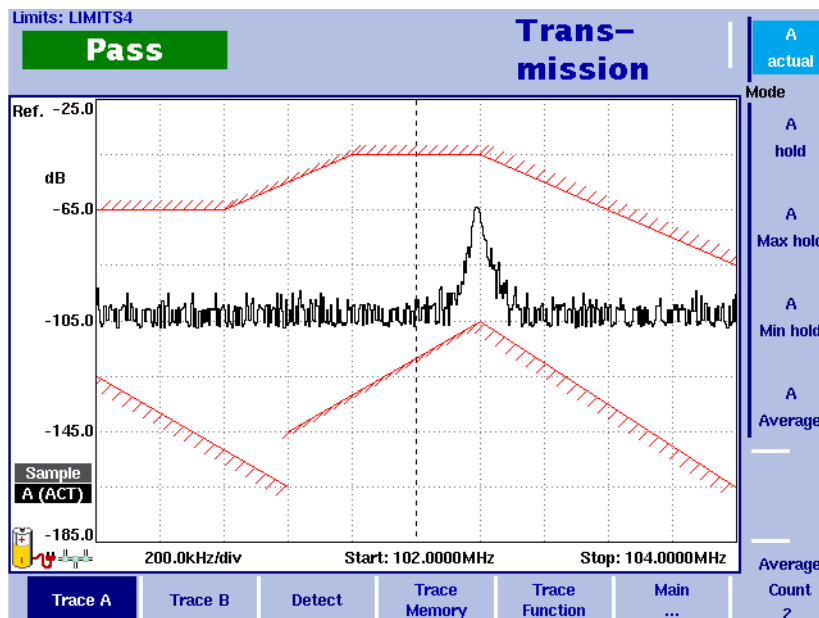

Figure 40 Trace A menu

The 9102 provides the capability to store up to 99 traces in the 9102 and load them again at random. The stored trace can then be examined or compared to a recent measurement. In addition, stored traces can also be transferred to a PC using the 9100 Data Exchange Software which is being delivered with the 9102. For details on the software refer to [Chapter 15 "9100 Data Exchange Software"](#).

Storing a trace

You can store either trace A or B. Any trace can be stored under a name with up to 11 characters. The procedure to enter text in alphanumerical input fields is explained in section ["Entering numbers and text" on page 24](#). Note that along with the trace, the instrument settings such as frequency range, level range and markers are stored.

- 1 In the main menu, select **Trace > Trace Memory**.
- 2 Press either **Store Trace**
An input field opens, allowing you to enter a name for the trace. Below the input field, a list of existing traces is indicated.
- 3 Enter a name for the trace. To use a modified trace name, you can move the cursor to a suitable trace name with the **UP/DOWN** cursor keys. The selected trace name also appears in the input field; use the **LEFT/RIGHT** cursor keys to move the cursor to the appropriate position within the trace name to enter additional characters or delete existing ones.
- 4 Confirm your choice by pressing **ENTER**.
The input field closes and the trace is stored under the selected name.

Reusing a trace name

You cannot overwrite an existing trace using the same trace name. If you want to reuse a trace name, you will have to delete the old trace first.

Reloading a trace

- 1 In the main menu, select **Trace > Trace Memory**.
- 2 Push either **Recall Trace**.
An input field opens, allowing you to enter the trace name. Below the input field, a list of existing traces is indicated.
- 3 Enter the name of the trace to load, or choose one with the **UP/DOWN** cursor keys.
- 4 Confirm your choice by pressing **ENTER**.
The input field closes and the trace is displayed.

NOTE

Along with the trace, the 9102 also loads the settings that were used when the trace was saved. These will overwrite the current settings such as frequency range, reference level and markers.

Deleting a trace

Stored traces can be deleted. Note that there will be no warning; once you have selected and requested a file to be deleted, this will occur immediately.

- 1 In the main menu, select **Trace > Trace Memory**.
- 2 Press **Delete Trace**.
An input field for the name of the trace to be deleted appears, together with a trace selection box.
- 3 Select the trace to be deleted using the **UP/DOWN** cursor keys. Alternatively, enter the trace name with the numeric keys.
- 4 Confirm your choice by pressing **ENTER**.
The trace is deleted from the trace list.
- 5 Select another trace for deletion, or press **ESCAPE** to leave the input field and the trace selection box.

Deleting all traces

Instead of deleting traces individually, all traces can be deleted in one step. You will be asked to confirm this step.

- 1 In the main menu, select **Trace > Trace Memory**.
- 2 Press **Delete All**.
A query appears, asking you to confirm your selection.
- 3 Press **ENTER** to have all traces deleted.
The query disappears. All traces are deleted.

Viewing the transmission mode parameters

You can get an overview of all parameters set for this mode in the Parameter Window. To view the parameters, press the **PARAM** function key. To close the Parameter Window and return to the menu you opened it from, press the **ESCAPE** function key, the **Exit** softkey or the **PARAM** function key. To close the parameter page and change to the relevant main menu press the **Main** softkey

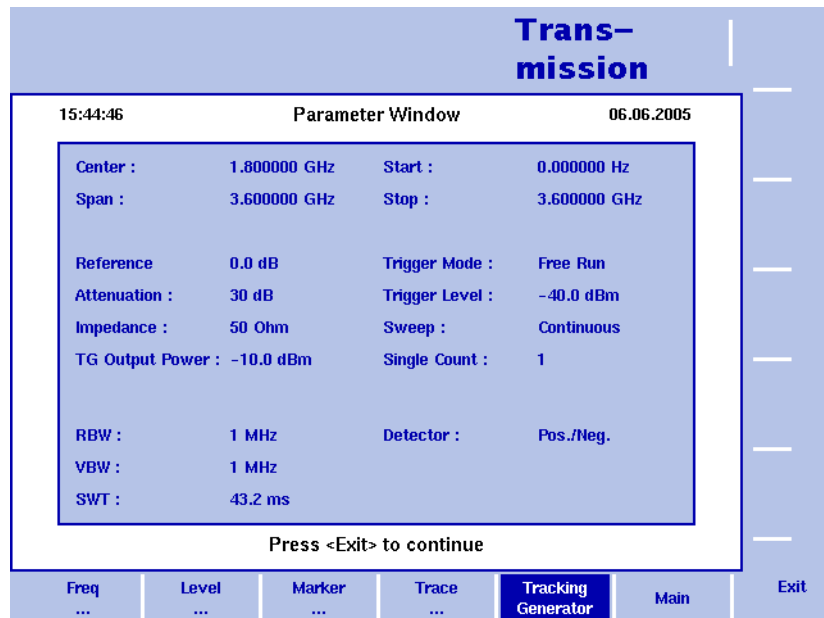

Figure 41 Transmission mode parameters

The 9130 VSWR/DTF Reflection Measurement Option

8

This chapter gives a general overview on the 9130 VSWR/DTF Reflection Measurement Option. Topics discussed in this chapter are as follows:

- ["About the 9130 VSWR/DTF Reflection Measurement Option" on page 134](#)
- ["Specifications" on page 134](#)
- ["Measurement modes" on page 135](#)
- ["Hardware requirements" on page 136](#)
- ["Connecting the 9160 VSWR/DTF Bridge" on page 136](#)
- ["Calibration" on page 137](#)

About the 9130 VSWR/DTF Reflection Measurement Option

The 9130 VSWR/DTF Reflection Measurement Option, in conjunction with the 9160 VSWR/DTF Bridge, turns the 9102 into a full-featured reflection test set. The functionality of the 9130 VSWR/DTF Reflection Measurement Option is tailored to the testing requirements involved in the acceptance and maintenance of professional antenna systems, e.g. cellular base stations. This measurement option is especially suitable for field applications. However, it also offers lab and service applications, e.g. reflection measurements at passive RF devices (such as attenuators, matching pads and filters) are possible. During reflection measurements the 9102's tracking generator works as a test signal generator while the spectrum analyzer measures the level of the reflected signal. In the 9100 applications guide contained on the documentation CD delivered in your instrument you will find detailed application examples for the 9130 VSWR/DTF Reflection Measurement Option.

Specifications

Table 14 9130 VSWR/DTF Reflection Measurement Option specifications

Measurement range	≥ 70 dB
Measurement units	dB, VSWR, mRho
Measurement sample points	501
Cable parameter edit	Auto or manual
Measurement method	Vector or scalar

Table 15 9160 VSWR/DTF Bridge specifications

Frequency range	1 MHz to 4 GHz
Directivity (10 MHz to 3 GHz)	Typ. 30 dB
Insertion Loss	$\leq 2 \times 10$ dB
Impedance	50 Ohm
DUT port return loss	≥ 18 dB

Measurement modes

The 9130 VSWR/DTF Reflection Measurement Option offers three additional measurement modes: reflection, distance to fault and cable loss. If the 9130 VSWR/DTF Reflection Measurement Option is installed and activated on your 9102, three additional submenus besides signal generator and transmission are available in the VSWR/Tracking... submenu:

- Reflection
This mode enables you to test performance and match of antenna systems over the desired frequency range in one view.
For a description of measurements using the reflection mode refer to ["Reflection Operation" on page 139](#).
- Distance to Fault
This mode puts the attention on the cable and offers a detailed analysis of feeder cables. Cable-related problems can be easily detected and located.
For a description of measurements using the distance to fault mode refer to ["Distance to Fault Operation" on page 157](#).
- Cable Loss
The cable loss mode allows you to determine the average cable loss.
For a description of measurements using the distance to fault mode refer to ["Cable Loss Operation" on page 167](#).

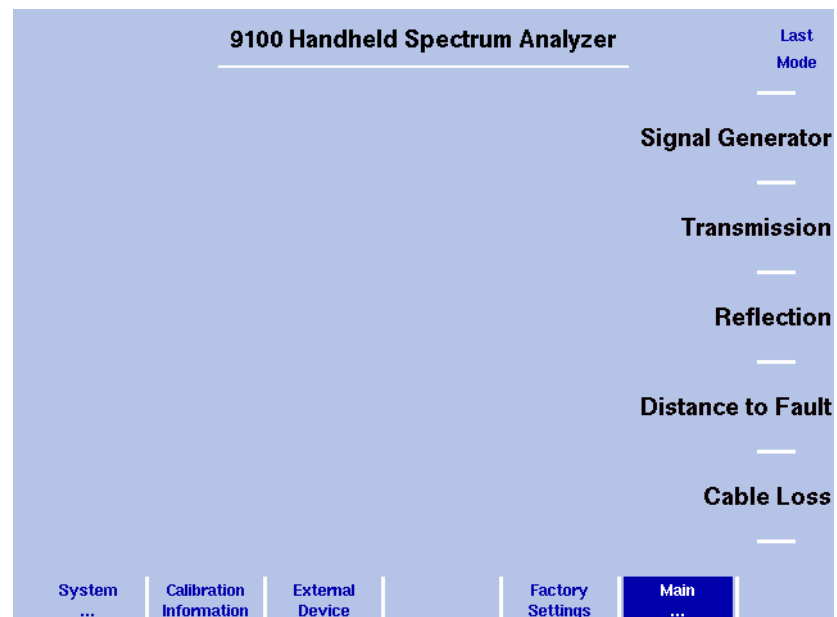

Figure 42 VSWR/Tracking menu

For details on selecting a measurement mode refer to ["Selecting the measurement mode" on page 27](#).

Hardware requirements

Following are the hardware requirements and recommendations for performing measurements using the 9130 VSWR/DTF Reflection Measurement Option:

- 9160 VSWR/DTF Bridge
- 9150 Tracking Generator
- Calibration set for N or 7/16"
- Test port extension cable N or 7/16".

NOTE

The test port extension cable is especially recommended for reflection measurements. A direct connection to antenna feeder cables is in this case often not practicable as these cables are usually very rigid. The test port extension cable can have a minimal influence on measurement results. However, test results are not influenced in a decisive way, so this effect can be disregarded.

For details on options and accessories for the 9102 please refer to ["Options and accessories"](#) on page 4

Connecting the 9160 VSWR/DTF Bridge

For reflection measurements a measurement bridge is necessary. The 9160 VSWR/DTF Bridge is used to measure the load impedance of an antenna or another device very precisely. It covers the full operational frequency range of the 9102.

In order to set up the 9102 for VSWR/DTF reflection measurements simply connect the 9160 VSWR/DTF Bridge to the RF in and RF out connectors as well as to the Multi Port connector on the top of the instrument.



For details on the 9102's connectors refer to ["Connecting the 9102 Handheld Spectrum Analyzer"](#) on page 12.

Calibration

Before starting VSWR/DTF measurement the instrument needs to be calibrated. For reference calibration a calibration standard with an open, short and load reference connector has to be connected. Willtek offers calibration sets Open/Short/Load Type 7/16" male and Type N male as well as test port extension cables with different connector standards (N and 7/16" DIN). For ordering information refer to ["Options and accessories" on page 4](#). For a description of the calibration procedure within the measurement modes reflection, distance to fault and cable loss refer to [Chapter 9](#), [Chapter 10](#) and [Chapter 11](#).



Reflection Operation

9

This chapter describes the instrument's functions that are specific to the reflection mode. Topics discussed in this chapter are as follows:

- ["About the reflection mode" on page 140](#)
- ["Selecting the measurement mode" on page 141](#)
- ["Preparative steps" on page 141](#)
- ["Changing the frequency settings" on page 142](#)
- ["Reflection calibration" on page 145](#)
- ["Changing the units settings" on page 146](#)
- ["Setting up the level parameters" on page 147](#)
- ["Performing a limited number of measurements" on page 149](#)
- ["Setting up the trace" on page 149](#)
- ["Storing and loading traces" on page 152](#)
- ["Using limits" on page 154](#)
- ["Viewing the reflection mode parameters" on page 155](#)

About the reflection mode

Modern antenna systems for professional applications are characterised by a low reflection and a good match. All components of the antenna system should be matched to 50 Ohm, the standard impedance for professional wireless equipment. If all components are matched, the system's efficiency is at its maximum level. The better the match the better the ratio between radiated and lost RF energy.

The reflection mode enables you to test performance and match of antenna systems over the desired frequency range in one view and to validate performance for acceptance and maintenance.

During reflection measurements the 9102's tracking generator generates a test signal. The 9102 measures the signal level reflected by the antenna. For measuring the load impedance of an antenna very precisely with a linear behaviour over the full operational frequency of the 9102, the 9160 VSWR DTF bridge is used. The reflection measurement modes offers scalar and vector reflection measurements and displays all common reflection measurement units such as return loss, rho, VSWR and the reflected power ratio.

Figure 43 shows an example for a return loss measurement results display.

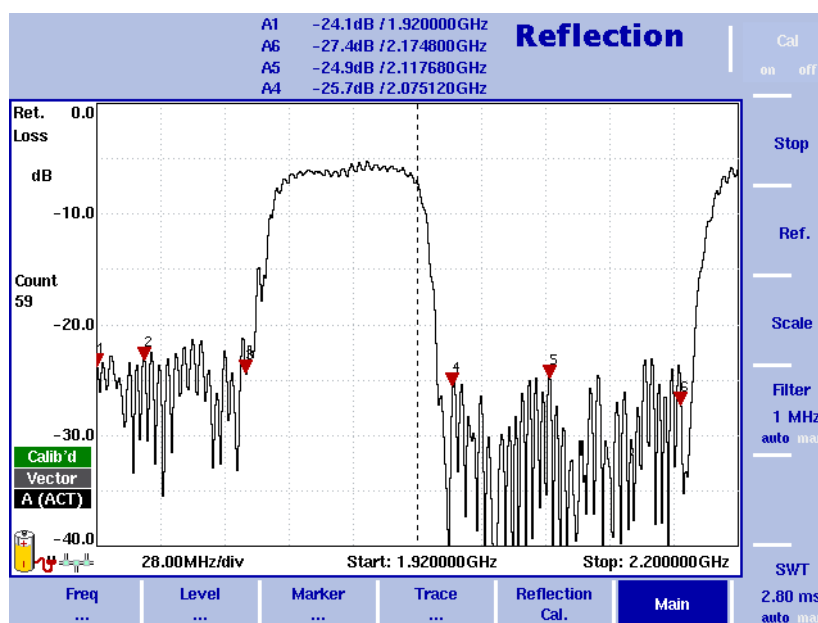

Figure 43 Example of a return loss measurement

On the measurement results screen markers are usually set on the limits of the uplink and downlink band. These are the ranges which are the interesting parts of the spectrum displayed. Two further markers are set on the maximum reflection within those bands to indicate whether the antenna system under test performs within the usual reflection limits of 17 to 20 dB return loss. For a detailed application example for the reflection measurement mode refer to the applications guide contained on the documentation CD delivered with your instrument.

Selecting the measurement mode

To select the reflection mode, proceed as follows:

- 1 Push the **MODE** function key.
The Mode menu appears.
- 2 Select **VSWR/Tracking ... > Reflection**.
The reflection main menu appears.

NOTE

This mode is available for selection, if the 9130 VSWR/DTF Reflection Measurement Option is installed and activated on your instrument.

Preparative steps

Before starting the measurement the following preparative steps are necessary:

- Connecting the 9160 VSWR/DTF Bridge
For details on this procedure refer to ["Connecting the 9160 VSWR/DTF Bridge" on page 136](#).
- Selecting the desired frequency band
- Calibration

The next section shows how to change the frequency settings on the 9102. This section is followed by a description of the calibration process.

Changing the frequency settings

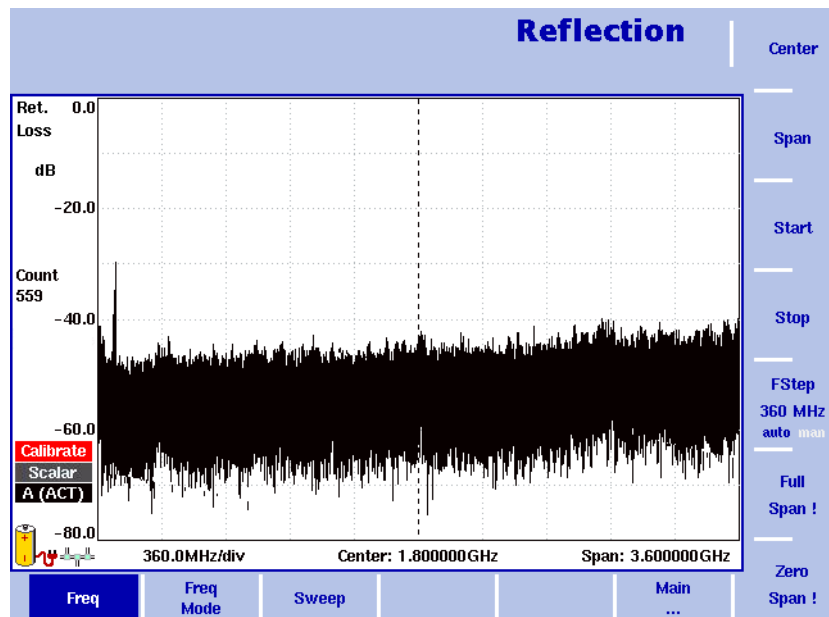

Figure 44 Frequency menu

There are different methods to set the frequency range to be measured; the range can be expressed by either the start and stop frequencies (i.e. first and last frequencies on the display), or by center frequency and span (i.e. the center and the frequency range), or by other combinations of center frequency, span, start and stop frequencies.

All four parameters are accessible in the Freq menu. On the main menu, however, only one of the combinations mentioned above is shown, depending on the parameter last entered.

NOTE

Changing a frequency parameter may affect an associated parameter.
Example: If you change the span to the maximum of 4 GHz, the start and stop frequencies are changed to 0 and 4 GHz, respectively.

Setting start and stop frequency



- 1 Push the **CENT** function key (or the **Freq** softkey in the Reflection main menu).
The vertical softkeys include Start and Stop softkeys.
- 2 Push the **Start** softkey.
An entry field appears, indicating the start frequency currently set and the step size for the **UP/DOWN** cursor keys.
- 3 Enter a new frequency using the numeric keys, the cursor keys and the **BACKSPACE** key.

- 4 Conclude the entry by pushing an enter key for the unit (**GHZ/DBM** for gigahertz, **MHZ/DB/μS** for megahertz).
If the start frequency entered is lower than the stop frequency, the horizontal axis will display the range from the new start to the stop frequency. If the new start frequency is higher than or equal to the stop frequency, the start frequency is used as the center frequency with zero span, i.e. the signal at the selected frequency will be shown in the time domain.
- 5 Push the **Stop** softkey and enter the frequency for the right end of the display.

You can also place softkeys for the start and stop frequencies available on the main menu by changing the frequency mode, see ["Changing the main menu for different frequency parameters"](#).

Setting center frequency and span



- 1 Push the **CENT** function key (or the **Freq** softkey in the Reflection main menu).
The vertical softkeys include Center and Span. An entry field appears, indicating the center frequency currently set and the step size for the up/down cursor keys.
- 2 Enter a new frequency using the numeric keys, the cursor keys and the **BACKSPACE** key.
- 3 Conclude the entry by pushing an enter key for the unit (**GHZ/DBM** for gigahertz, **MHZ/DB/μS** for megahertz, **KHZ/DBμV/MS** for kilohertz, or **ENTER** for hertz).
- 4 Push the **Span** softkey and enter the frequency for the range from the left to the right end of the display.

You can also place softkeys for the center frequency and the span available on the main menu by changing the frequency mode, see section ["Changing the main menu for different frequency parameters"](#) below.

Changing the main menu for different frequency parameters



The Reflection main menu shows two softkeys for the definition of the frequency range on the display. Different methods exist to define the range as depicted above; you can configure these softkeys to one of the two allowable combinations as follows:

- 1 From the Reflection main menu, select **Freq > Freq Mode**.
- 2 Select the combination of softkeys that you want to see in the main menu (**Start/Stop** or **Center/Span**).
- 3 Return to the main menu by pushing the **Main ...** softkey.
The main menu appears and displays the selected combination of keys.

Note that the description of the horizontal frequency axis changes with the selected parameter set.

Viewing the complete frequency band



To change the frequency range to the full bandwidth supported by the 9102, proceed as follows:

- 1 From the Reflection main menu, push the **Freq** softkey. The Frequency menu is displayed.
- 2 Push the **Full Span** softkey. The leftmost frequency changes to 0 Hz and the rightmost frequency to 4 GHz.

Performing measurements in the time domain



Measurements on a selected center frequency can also be displayed in the time domain.

- 1 From the Reflection main menu, push the **Freq** softkey. The Frequency menu is displayed.
- 2 Push the **Center** softkey and enter the desired center frequency; close the input field by selecting the appropriate unit with one of the enter keys.
- 3 Push the **Zero Span** softkey. The horizontal axis becomes the time axis. The scale width is identical to the sweep time.

Selecting the step size for the frequency input



The center, start and stop frequencies can be set either by entering a new value with the numeric keys, or by using the arrow keys (**UP**, **DOWN**) to increase or decrease the current setting. The step size for an arrow keypress can either be selected automatically by the 9102, or manually adjusted.

Manually setting the frequency step size

- 1 From the Reflection main menu, select **Freq**.
- 2 Push the **FStep** softkey. The Freq Step entry field opens.
- 3 Enter a new frequency step value and close the entry field by pressing **Enter**. The auto/manual selection switches to manual and the selected frequency step size is displayed on the softkey.

Setting the frequency step size selection to automatic

- 1 From the Reflection main menu, select **Freq**.
- 2 Push the **FStep** softkey several times until the "auto" selection is highlighted.

Reflection calibration

Before starting the measurement the instrument needs to be calibrated with a reference match resistor. For details on available calibration sets refer to ["Options and accessories" on page 4](#) and ["Calibration" on page 137](#). On the left handside of the results display a red icon reading "Calibrate" informs you that a calibration needs to be performed. You can perform a vector or scalar calibration for your measurement. In order to calibrate the instrument for your reflection measurement proceed as follows:

- 1 Connect the test port extension cable to the 9160 VSWR/DTF Bridge.
- 2 In the Reflection main menu press **Reflection Cal.** softkey. the Reflection Calibration menu is displayed.

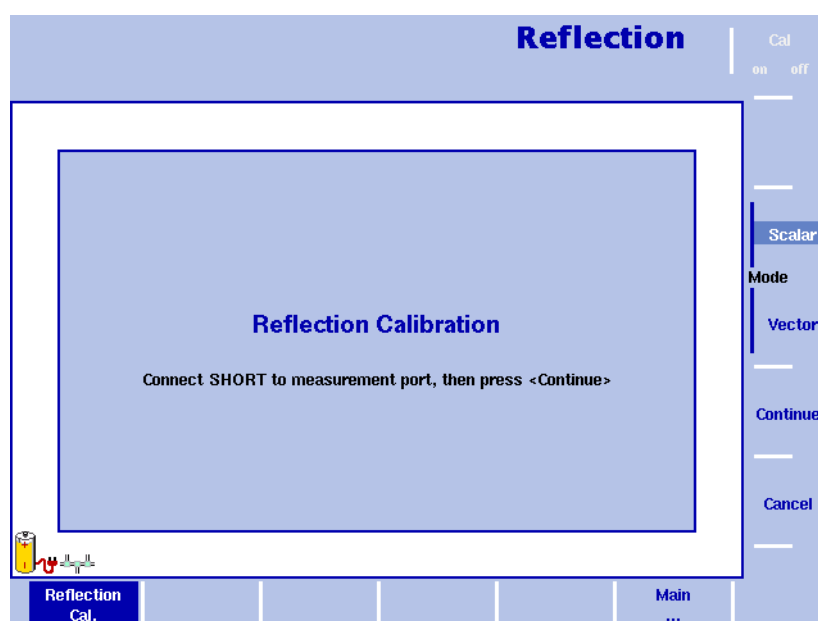

Figure 45 Reflection Calibration menu

- 3 In this menu you can select the mode to be used for your measurement by pressing the **Scalar** or **Vector** softkey. The scalar measurement measures the level of the reflected signal. The vector measurement is even more precise and also measures the phase of the reflected signal. It increases measurement accuracy as well as the return loss measurement range. The 9102 will guide you through the calibration process by onscreen messages as shown in [Figure 45](#). When prompted as shown connect the calibration set to the test port extension cable and press **Continue**. You can abort the calibration process by pressing the **Cancel !** softkey.
- 4 When calibration is completed the Reflection main menu will be displayed again. On the left handside of the results display the calibration icon will now be displayed in green and read "Calib'd" (Calibrated).

The measurement graph shows full reflection (0 dB return loss) as soon as the calibration set is removed. The instrument is now ready for starting the reflection measurement.

NOTE

When performing a number of measurements it can be necessary to repeat the calibration process due to temperature changes etc. This is regular behaviour. Furthermore if you change the frequency band, calibration has to be repeated. As soon as calibration is necessary the 9102 will inform you by displaying the red "Calibrate" icon.

Changing the units settings

The reflection mode supports all common reflection measurement units:

- Return loss
The most common reflection measurement unit. Using this unit the attenuation of the reflected signal against the test signal power is measured. Due to the fact that the return loss is linked to the signal power this measurement unit is very easy to handle. A return loss of 20 dB for example, means that 1/100 of the transmitted power is reflected back to the radio. Usually a return loss of around 17 dB is required to accept an antenna as functional.
- VSWR
This unit is based on the RF signal voltage. It represents a ratio of transmitted and received voltage. Using special alignment charts all units can be easily compared to each other. A return loss of 20 dB for example is equivalent to a VSWR of 1.22.
- Reflection factor
This unit is also based on the RF signal voltage and shows the reflection in mRho.
- Reflection power
This unit shows the reflected power ratio as a percentage.



In order to select the measurement unit for your reflection measurement proceed as follows:

- 1 In the Reflection main menu select **Level > Units**. The Unit menu is displayed on the right-hand side of the screen.
- 2 Select Return Loss, VSWR, Refl. Factor or Refl. Power by pressing the respective softkey followed by **ENTER**. The selected unit will be displayed on the left-hand side of the results display.

Setting up the level parameters

After specifying the unit for your reflection measurement you can adjust the level parameters. Depending on the unit you specified via the Units menu the display of the Level menu changes to enable you to set the level parameters for the individual units as follows:

Setting the reference level for return loss

- 1 In the main menu, push the **Ref.** softkey or select **Level** followed by **Ref.** Alternatively, push the **REF** function key. The Reference Level input field opens.
- 2 Enter the new reference level either using the numeric keys, closing the input field with the appropriate enter key, or with the **UP/DOWN** arrow keys. The new reference level appears at the top of the vertical axis. The reference is based on the actual set output power.

Changing the vertical scale for return loss

The scale for the vertical axis (power) can be changed in the range from 1 to 20 dB per division (vertical line in the displayed grid) in 1-3-5 steps as follows:

- 1 In the main menu, select **Level**.
- 2 Push the **Scale** softkey. The Scale input field opens.
- 3 Select a new scale by entering a new number of dB per division numerically and pressing the **ENTER** or **MHz/dB/μs** key, or by pushing the **UP/DOWN** cursor keys.

Setting the maximum for VSWR

- 1 In the main menu, push the **Max VSWR** softkey or select **Level** followed by **Ref.** Alternatively, push the **REF** function key. The Reference Level input field opens.
- 2 Enter the new maximum VSWR either using the numeric keys, closing the input field with the appropriate enter key, or with the **UP/DOWN** arrow keys. The new maximum level appears at the top of the vertical axis.

Changing the scale for VSWR

The scale for the vertical axis (power) can be changed in the range from 1 to 1000 per division (vertical line in the displayed grid) as follows:

- 1 In the main menu, select **Level**.
- 2 Push the **VSWR Scale** softkey. The **VSWR Scale** input field opens.
- 3 Select a new scale by entering a new number per division numerically and pressing the **ENTER** or **MHz/dB/μs** key, or by pushing the **UP/DOWN** cursor keys.

Setting the maximum for reflection factor

- 1 In the main menu, push the **Max Refl Factor** softkey or select **Level** followed by **Max Refl Factor**. Alternatively, push the **REF** function key. The Reference Level input field opens.
- 2 Enter the new maximum reflection factor either using the numeric keys, closing the input field with the appropriate enter key, or with the **UP/DOWN** arrow keys.
The new maximum reflection factor appears at the top of the vertical axis.

Changing the scale for reflection factor

The scale for the vertical axis (power) can be changed in the range from 0 to 2000 mRho per division (vertical line in the displayed grid) as follows:

- 1 In the main menu, select **Level**.
- 2 Push the **Refl. Factor Scale** softkey.
The **Refl. Factor Scale** input field opens.
- 3 Select a new scale by entering a new number per division numerically and pressing the **ENTER** or **MHz/DB/μs** key, or by pushing the **UP/DOWN** cursor keys.

Setting the maximum for reflection power

- 1 In the main menu, push the **Max Refl Power** softkey or select **Level** followed by **Max Refl Power**. Alternatively, push the **REF** function key. The Reference Level input field opens.
- 2 Enter the new maximum reflection factor either using the numeric keys, closing the input field with the appropriate enter key, or with the **UP/DOWN** arrow keys.
The new maximum reflection factor appears at the top of the vertical axis.

Changing the scale for reflection power

The scale for the vertical axis (power) can be changed in the range from 1 to 200 % per division (vertical line in the displayed grid) as follows:

- 1 In the main menu, select **Level**.
- 2 Push the **Refl. Power Scale** softkey.
The **Refl. Power Scale** input field opens.
- 3 Select a new scale by entering a new number per division numerically and pressing the **ENTER** or **MHz/DB/μs** key, or by pushing the **UP/DOWN** cursor keys.

Performing a limited number of measurements

The 9102 can run measurements continuously or a defined number of times. Limiting the number of measurements can be useful for statistical analyses.

- 1 In the main menu, select **Freq > Sweep**.
The Sweep menu appears.
- 2 Select the trigger mode: Push **Cont.** for continuous measurements or **Single** for a limited number of measurements.
The selected trigger mode is highlighted.
- 3 To enter the number of measurements, push the **Single Count** softkey, enter a number in the range from 1 to 1000 and press **ENTER**.
If Trigger Mode is set to Single, the 9102 performs the defined number of measurements and enters hold mode.
 - To restart single-mode measurements, push the **HOLD/RUN** function key or the **Single** softkey.
 - To stop a continuous measurement, push the **HOLD/RUN** function key. Push it again to resume measurements.

Setting up the trace

The trace functions provide different views of the measurements, for example the actual measurement or an average over the last couple of measurements. You can even select two different views of the measurement. Another possibility is to compare the actual measurement with an older measurement which has been stored in the 9102 and loaded to one of the trace views (see section ["Storing and loading traces" on page 152](#)).

Selecting the trace mode

The 9102 has five different modes to display a trace:

- In actual mode, the 9102 shows a complete new measurement in each trace. Subsequent traces are independent of each other.
- In hold mode, the last measurement is kept on the display; measurements continue but are not displayed.
- In max hold mode, the 9102 takes new measurements and, for each frequency point, compares the new measurement with the previous result. If the new measurement value is higher than the previous result, the new measurement value becomes the new result value; otherwise the old result value is kept. This way, the highest result since the start of the Max hold measurement (or a parameter change) is kept and displayed.
- Similarly, in min hold mode, the 9102 takes new measurements and compares the new measurement with the previous result. If the new measurement value is lower than the previous result, the new measurement value becomes the new result value; otherwise the old result value is kept. This way, the lowest result since the start of the Min hold measurement (or a parameter change) is kept and displayed.

- In average mode, the new measurement and previous ones are averaged for each frequency point displayed. The 9102 uses a recursive algorithm for averaging.

To select whether you want to view an actual measurement, stop and hold the last measurement, see the lowest or highest data for each frequency or an average value, proceed as follows:

- 1 In the main menu, select **Trace**.
- 2 Select the trace you want to modify (**Trace A** or **Trace B**) using the horizontal softkeys.
- 3 Select the trace mode with the vertical softkeys (**Actual**, **Hold**, **Max hold**, **Min hold**, **Average**).
The trace mode is shown at the left-hand side of the vertical axis, e.g. **A (ACT)**.

NOTE

For fastest valid results it is advisable to briefly activate the actual mode before selecting any other mode.

NOTE

When the trace is on hold, the measurement and failure counters continue counting. A second trace, if active, continues updating.

Turning the second trace on and off

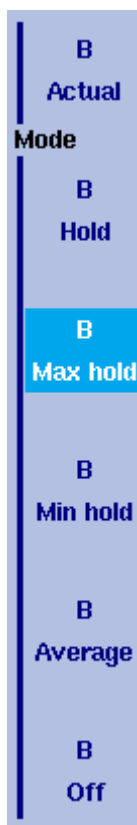

You can define two different trace views, e.g. one with the actual values and one with the maximum values. While the first view (Trace A) is always active, the second can be switched off. The functions of turning Trace B on or off and selecting the trace mode are combined as follows:

- 1 In the main menu, select **Trace > Trace B**.
- 2 To turn trace B on, select the trace mode (**Actual**, **Hold**, **Max hold**, **Min hold**, or **Average**). To turn trace B off, select **Off**.
If activated, the trace mode is displayed left to the vertical axis, e.g. **B (MAX)**.

Subtracting trace B from trace A

If you have used two different trace views as described above, you can show the difference between trace A and trace B by subtracting trace B from trace A as follows:

- 1 In the Trace menu select the softkey **Trace Function** followed by the softkey **Subtract A – B → A**.
- 2 Select **on** to subtract trace B from trace A. On the left-hand side of the result area the Term "Subtract" will now be displayed to indicate that a mathematical function is being performed.
- 3 The result is displayed in trace A.

NOTE

If trace A is on Hold, this function is not available and thus the **Subtract A – B → A** softkey is greyed out.

Adding trace B to trace A

If you have used two different trace views, you can also show the sum of trace A and trace B by adding the two traces as follows:

- 1 In the Trace menu select the softkey **Trace Function** followed by the softkey **Add A + B → A**.
- 2 Select **on** to add B to trace A. On the left-hand side of the result area the term "Add" will now be displayed to indicate that a mathematical function is being performed.
- 3 The result is displayed in trace A.

Trace Offset

As soon as you use one of the two mathematical functions, Subtract $A + B \rightarrow A$ or Add $A + B \rightarrow A$, the Trace Offset function is activated. You can use this function to adjust the trace display, if the mathematical calculation performed causes the resulting trace to move outside the display area. In order to bring the trace back into view, use the Trace Offset softkey to modify the offset value until the trace moves back into the display area.

Defining the number of measurements for averaging

When the trace mode is set to averaging, it may be useful to adjust the number of measurements over which the 9102 averages the results. The average count value that can be defined in the Trace menus applies to both traces alike.

The 9102 uses a recursive algorithm in which a new result is added to the older averages with a weighting factor; the description below indicates how to change this weighting factor.

- 1 Select the Trace menu (select **Trace > Trace A** or **Trace B** from the main menu).
- 2 Push the **Average Count** softkey.
The Average input field opens.

- 3 Enter the number of measurements over which to average the results, in the range from 2 to 128.
- 4 Press **ENTER**.

Copying traces inside the 9102

You can copy an actual measurement from trace A to trace B or vice versa; this way you can keep the last measurement results on the screen and at the same time continue measuring or change the settings of the 9102 Handheld Spectrum Analyzer. The previous results in the target trace will be erased; the target trace will assume hold mode.

To copy the measurement data from one trace to another, proceed as follows:

- 1 From the main menu, select **Trace > Trace Function**.
- 2 To copy the measurement results from trace A to trace B, press **Copy A → B**.
To copy results from trace B to trace A, press **Copy B → A**.

NOTE

If you first press **Copy A → B**, then **Copy B → A** (or vice versa), both traces will display the same results and will be in hold mode.

Storing and loading traces

The 9102 provides the capability to store up to 99 traces in the 9102 and load them again at random. The stored trace can then be examined or compared to a recent measurement. In addition, stored traces can also be transferred to a PC using the 9100 Data Exchange Software which is being delivered with the 9102. For details on the software refer to [Chapter 15 "9100 Data Exchange Software"](#).

Storing a trace

You can store trace A and trace B. Any trace can be stored under a name with up to 11 characters. The procedure to enter text in alphanumerical input fields is explained in section ["Entering numbers and text" on page 24](#). Note that along with the trace, the instrument settings such as frequency range, level range and markers are stored.

- 1 In the main menu, select **Trace > Trace Memory**.
- 2 Press either **Store Trace..**
An input field opens, allowing you to enter a name for the trace. Below the input field, a list of existing traces is indicated.
- 3 Enter a name for the trace. To use a modified trace name, you can move the cursor to a suitable trace name with the **UP/DOWN** cursor keys. The selected trace name also appears in the input field; use the **LEFT/RIGHT** cursor keys to move the cursor to the appropriate position within the trace name to enter additional characters or delete existing ones.

- 4 Confirm your choice by pressing **ENTER**.
The input field closes and the trace is stored under the selected name.

Reusing a trace name

You cannot overwrite an existing trace using the same trace name. If you want to reuse a trace name, you will have to delete the old trace first.

Reloading a trace

- 1 In the main menu, select **Trace > Trace Memory**.
- 2 Push either **Recall Trace**.
An input field opens, allowing you to enter the trace name. Below the input field, a list of existing traces is indicated.
- 3 Enter the name of the trace to load, or choose one with the **UP/DOWN** cursor keys.
- 4 Confirm your choice by pressing **ENTER**.
The input field closes and the trace is displayed.

NOTE

Along with the trace, the 9102 also loads the settings that were used when the trace was saved. These will overwrite the current settings such as frequency range, reference level and markers.

Deleting a trace

Stored traces can be deleted. Note that there will be no warning; once you have selected and requested a file to be deleted, this will occur immediately.

- 1 In the main menu, select **Trace > Trace Memory**.
- 2 Press **Delete Trace**.
An input field for the name of the trace to be deleted appears, together with a trace selection box.
- 3 Select the trace to be deleted using the **UP/DOWN** cursor keys. Alternatively, enter the trace name with the numeric keys.
- 4 Confirm your choice by pressing **ENTER**.
The trace is deleted from the trace list.
- 5 Select another trace for deletion, or press **ESCAPE** to leave the input field and the trace selection box.

Deleting all traces

Instead of deleting traces individually, all traces can be deleted in one step. You will be asked to confirm this step.

- 1 In the main menu, select **Trace > Trace Memory**.
- 2 Press **Delete All**.
A query appears, asking you to confirm your selection.
- 3 Press **ENTER** to have all traces deleted.
The query disappears. All traces are deleted.

Using limits

When activating limit lines prepared for the band to be measured, the band's ends as well as the reflection limit can be identified in on view: the 9102 provides a simple Pass/Fail verdict and displays the limit lines on screen:

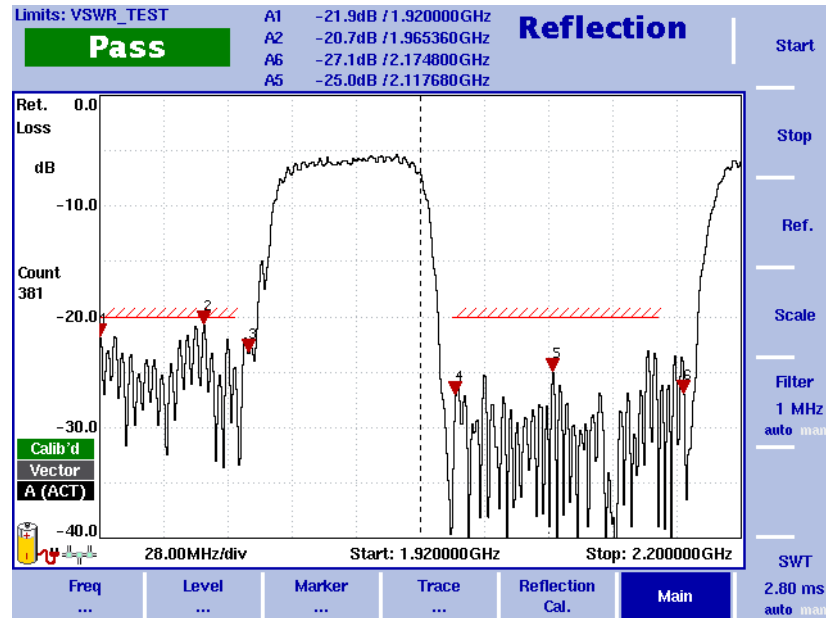

Figure 46 Example of a results display

If the reflection is higher than the limit, the test result is displayed as "Fail". For details on defining and using limit lines refer to ["Using limit lines"](#) on page 32.

Viewing the reflection mode parameters

You can get an overview of all parameters set for this mode in the Parameter Window. To view the parameters, press the **PARAM** function key. To close the Parameter Window and return to the menu you opened it from, press the **ESCAPE** function key, the **Exit** softkey or the **PARAM** function key. To close the parameter page and change to the relevant main menu press the **Main** softkey

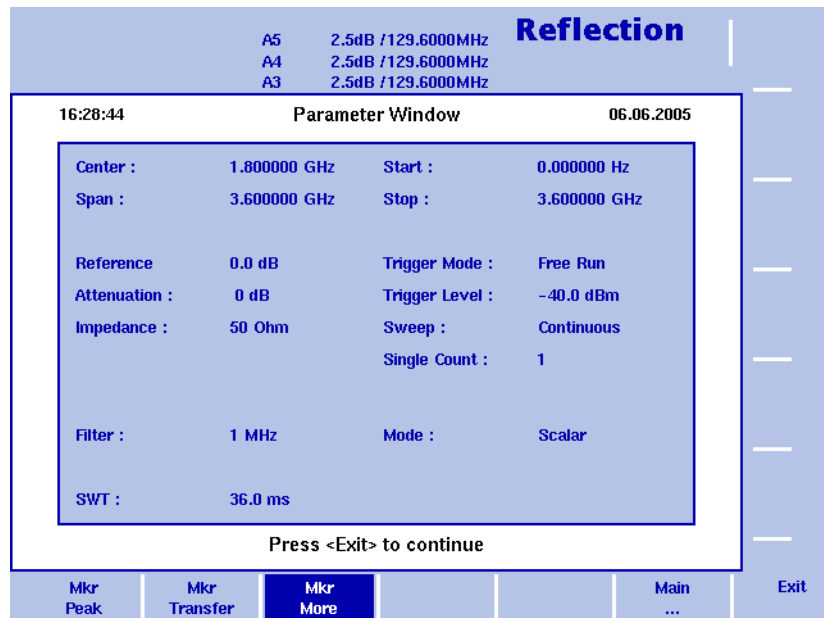

Figure 47 Reflection mode parameters

Distance to Fault Operation

10

This chapter describes the instrument's functions that are specific to the reflection mode. Topics discussed in this chapter are as follows:

- "About the distance to fault mode" on page 158
- "Selecting the measurement mode" on page 159
- "Preparative steps" on page 159
- "Selecting the measurement unit" on page 159
- "Specifying the cable length" on page 160
- "Specifying cable settings" on page 160
- "Setting center frequency and span" on page 161
- "Distance to fault calibration" on page 162
- "Specifying the level parameters" on page 163
- "Setting up the trace" on page 164
- "Using limits" on page 164
- "Viewing the distance to fault parameters" on page 165

About the distance to fault mode

The distance-to-fault measurement is essential for antenna installations. It focuses on the cable measuring the reflection arising along it in order to detect and locate weak connectors, cable kinks, water ingress and other cable-related problems. This measurement is also called structural return loss and it displays reflection arising at a certain cable position precisely in the location domain. Thereby cable problems can be easily identified. The 9102 supports a detailed analysis of the antenna feeder cable with a total length of up to 2000 m. The high 501 points measurement resolution ensures quick and efficient troubleshooting by detecting even small reflections which result in a displayed distance to fault.

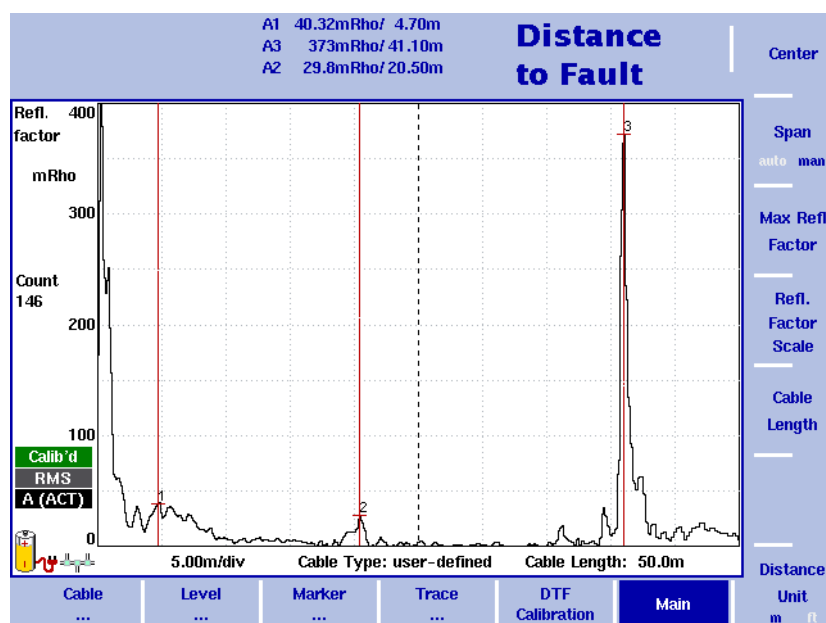

Figure 48 Example of a distance-to-fault measurement

Figure 48 shows an example of a distance-to-fault results display. As in the other measurement modes you can use markers to label all peaks. In the distance to fault mode the markers appear in line style. For a detailed application example for the distance to fault measurement mode refer to the applications guide contained on the documentation CD delivered with your instrument.

Selecting the measurement mode

To select distance to fault mode, proceed as follows:

- 1 Push the **MODE** function key.
The Mode menu appears.
- 2 Select **VSWR/Tracking ... > Distance to Fault**.
The Distance to Fault main menu appears.

NOTE

This mode is available for selection, if the 9130 VSWR/DTF Reflection Measurement Option is installed and activated on your instrument.

Preparative steps

Before starting the measurement the following preparative steps are necessary:

- Connecting the 9160 VSWR/DTF Bridge
For details on this procedure refer to ["Connecting the 9160 VSWR/DTF Bridge" on page 136](#).
- Selecting the unit for reflection
- Specifying the cable settings, e.g. cable length
- Setting center frequency and span
- Calibration

The following sections describe unit selection, cable setting specification, frequency selection and calibration.

Selecting the measurement unit

The first preparative step for your distance-to-fault measurement is selecting the unit. The distance to fault mode offers the units dB and mRho. For DTF measurements a linear scale unit like the reflection factor Rho is of advantage. Therefore the unit mRho is the default setting.



In order to select the measurement unit for your distance-to-fault measurement proceed as follows:

- 1 In the Distance to Fault main menu select **Level > Units**. The Unit menu is displayed on the right handside of the screen.
- 2 Select dB or mRho by pressing the respective softkey followed by **ENTER**. The selected unit will be displayed on the left handside of the results display: "Ref." and "dB", if you select dB. "Refl. factor" and "mRho", if you select Rho.

Specifying the cable length

One of the most important DTF measurement parameters is the cable length. In order to achieve a practical results display it is recommended to set the cable length to a value approximately 10 % higher than the actual cable length. The cable length can be specified in metres or feet.

Selecting the distance unit



To select the distance unit proceed as follows:

- 1 In the Distance to Fault main menu press the **Distance Unit** Softkey.
- 2 Toggle the softkey to the required unit, metre or feet, and press **ENTER**. The unit will be displayed in the cable length field of the results display as well as on the Cable Length input field.

Setting the length

In order to set the cable length proceed as follows:

- 1 In the Distance to Fault main menu press the **Cable Length** softkey. The Cable Length input field is displayed.
- 2 Enter the cable length in the unit specified and press **ENTER**.

Specifying cable settings

Willtek provides predefined cable parameter files for most known coaxial cables used for antenna installations within the 9100 Data Exchange Software. These parameter files can easily be uploaded to the 9102. However, the parameters for rare cable types can be set step by step on the instrument.

Using predefined parameter files

You can upload files containing predefined cable types via the 9100 Data Exchange Software. For details on the upload procedure refer to "[9100 Data Exchange Software](#)" on page 213. For a complete listing of the predefined cable types available in the 9100 Data Exchange Software refer to "[Predefined cable types](#)" on page 348. After uploading the files the cable types are stored on your 9102 and available for selection.

To select a cable type for a DTF measurement proceed as follows:

- 1 In the Distance to Fault main menu select **Cable > Cable Memory**. The Cable Memory menu is displayed
- 2 Press the **Recall Cable Type** softkey. A dropdown list containing all cable types stored on the system is displayed.
- 3 Select the required cable type using the **UP/DOWN** arrow keys and press **ENTER**. The settings of the selected cable type are now automatically used for the DTF measurement.

Specifying parameters step by step

For measurements on rare cable types the parameters can be set up via the Cable Setting menu. For the values to be entered refer to the manufacturer's information for the cable to be measured. In order to manually specify the cable parameters proceed as follows:

- 1 In the Distance to Fault main menu select **Cable > Cable Setting**. The Cable Setting menu is displayed.
- 2 To specify the dielectric of the cable to be measured, which is linked to the velocity factor, press the **Cable Dielec.** softkey. The Cable Dielectric input field is displayed. Enter the cable dielectric and press **ENTER**.
- 3 To specify the propagation velocity of the cable to be measured, which is in turn linked to the dielectric, press the **Cable Velocity Factor** softkey. The Cable Velocity Factor input field is displayed. Enter the velocity factor and press **ENTER**.
- 4 To specify the cable's cut off frequency in GHz, which is the maximum frequency up to which the cable transmits, press the **Cut Off Freq.** softkey. The Cut Off Frequency input field is displayed. Enter the frequency and press **ENTER**.
- 5 To specify the cable attenuation in dBm per 100m or dBm per 100 ft at 1 GHz of the cable to be measured press the **Cable Attn.** softkey. This softkey can be toggled between dB/100m and dB/100 ft. After pressing the softkey the Cable Attenuation input field will be displayed accordingly. Enter the attenuation and press **Enter**.

Setting center frequency and span



- 1 Push the **CENT** function key or the Center softkey in the Distance to Fault main menu.
The vertical softkeys include Center and Span. An entry field appears, indicating the center frequency currently set and the step size for the up/down cursor keys.
- 2 Enter a new frequency using the numeric keys, the cursor keys and the **BACKSPACE** key.
- 3 Conclude the entry by pushing an enter key for the unit (**GHz/dBm** for gigahertz, **MHz/dB/μs** for megahertz, **KHz/dBμV/ms** for kilohertz, or **ENTER** for hertz).
- 4 Push the **Span** softkey. If you intend to set the span manually, enter the frequency for the range from the left to the right end of the display. If you want the span to be set automatically, toggle the **Span** softkey to auto.

NOTE

If you specify the same value for the center frequency as for the cable cutoff frequency, your measurement becomes invalid as the cutoff frequency is the maximum frequency up to which the cable transmits signals. In this case the measurement would not make any sense. For details on specifying the cable cutoff frequency refer to ["Specifying cable settings" on page 160](#).

Distance to fault calibration

Before starting the measurement the instrument needs to be calibrated with a reference match resistor. For details on available calibration sets refer to "Options and accessories" on page 4 and "Calibration" on page 137. On the left-hand side of the results display a red icon reading "Calibrate" informs you that a calibration needs to be performed.

NOTE

To ensure that the calibration results in better rather than worse measurement accuracy, it is important that you know and enter the correct cable parameters for the cable between the instrument and the calibration set. See Table 16 for the parameters of cables delivered by Willtek for this purpose.

In order to calibrate the instrument for your distance-to-fault measurement proceed as follows:

- 1 Connect the test port extension cable to the 9160 VSWR/DTF Bridge.
- 2 In the Distance to Fault main menu press **DTF Cal.** softkey. The distance to fault Calibration menu is displayed.

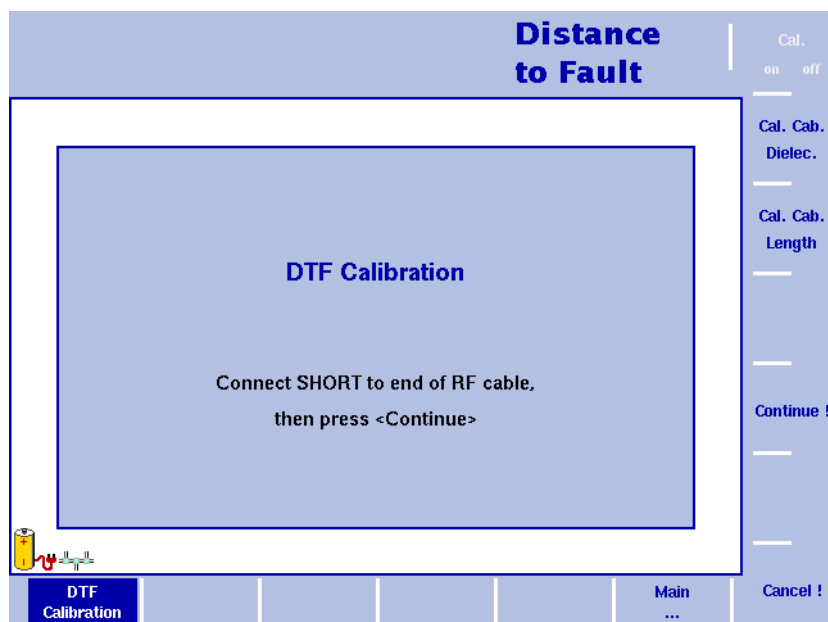

Figure 49 Distance to fault Calibration menu

- 3 Push the **Cal. Cab. Dielec.** key to enter the dielectric constant, ϵ_r . See Table 16 for the dielectric of cables delivered by Willtek for this purpose.
- 4 Push the **Cal. Cab. Length** key to enter the length of the calibration cable. See Table 16 for the length of cables delivered by Willtek for this purpose.

- 5 The 9102 will guide you through the calibration process by onscreen messages as shown in Figure 49. When prompted as shown connect the calibration set to the test port extension cable and press **Continue**. You can abort the calibration process by pressing the **Cancel !** softkey.
- 6 When calibration is completed the Distance to Fault main menu will be displayed again. On the left handside of the results display the calibration icon will now be displayed in green and read "Calib'd" (Calibrated).

NOTE

When performing a number of measurements it can be necessary to repeat the calibration process due to temperature changes etc. This is a regular behaviour. Furthermore, if you change the frequency band, calibration has to be repeated. As soon as calibration is necessary the 9102 will inform you by displaying the red "Calibrate" icon.

Table 16 Parameters for Willtek-supplied cables

Cable description	Dielectric constant ϵ_r	Length
Test port extension cable	2.3	1.0 m (3.3 ft)
SilverLine-TG™ TuffGrip™ cable	2.04	1.5 m (4.9 ft)

Specifying the level parameters

After specifying the unit for your reflection measurement you can adjust the level parameters. Depending on the unit you specified via the Units menu the display of the Level menu changes to enable you to set the level parameters for the individual units as follows:

Setting the reference level for dB

- 1 In the main menu, push the **Ref.** softkey or select **Level** followed by **Ref.** Alternatively, push the **REF** function key. The Reference Level input field opens.
- 2 Enter the new reference level either using the numeric keys, closing the input field with the appropriate enter key, or with the **UP/DOWN** arrow keys. The new reference level appears at the top of the vertical axis. The reference is based on the actual set output power.

Changing the vertical scale for dB

The scale for the vertical axis (power) can be changed in the range from 1 to 20 dB per division (vertical line in the displayed grid) in 1–3–5 steps as follows:

- 1 In the main menu, select **Level**.
- 2 Push the **Scale** softkey. The Scale input field opens.

- 3 Select a new scale by entering a new number of dB per division numerically and pressing the **ENTER** or **MHz/dB/μs** key, or by pushing the **UP/DOWN** cursor keys.

Setting the maximum for reflection factor

- 1 In the main menu, push the **Max Refl Factor** softkey or select **Level** followed by **Max Refl Factor**. Alternatively, push the **REF** function key. The Reference Level input field opens.
- 2 Enter the new maximum reflection factor either using the numeric keys, closing the input field with the appropriate enter key, or with the **UP/DOWN** arrow keys.
The new maximum reflection factor appears at the top of the vertical axis.

Changing the scale for reflection factor

The scale for the vertical axis (power) can be changed in the range from 0 to 2000 mRho per division (vertical line in the displayed grid) as follows:

- 1 In the main menu, select **Level**.
- 2 Push the **Refl. Factor Scale** softkey.
The **Refl. Factor Scale** input field opens.
- 3 Select a new scale by entering a new number per division numerically and pressing the **ENTER** or **MHz/dB/μs** key, or by pushing the **UP/DOWN** cursor keys.

Setting up the trace

The trace functions provide different views of the measurements, for example the actual measurement or an average over the last couple of measurements. You can even select two different views of the measurement. Another possibility is to compare the actual measurement with an older measurement which has been stored in the 9102 and loaded to one of the trace views. For details on setting up traces refer to ["Setting up the trace" on page 149](#) in [Chapter 9 "Reflection Operation"](#).

Using limits

As in the reflection mode you can also use limit lines for distance to fault measurements. For details on the usage of limits refer to ["Using limit lines" on page 32](#) in [Chapter 2 "General Operation"](#).

Viewing the distance to fault parameters

You can get an overview of all parameters set for this mode in the Parameter Window. To view the parameters, press the **PARAM** function key. To close the Parameter Window and return to the menu you opened it from, press the **ESCAPE** function key, the **Exit** softkey or the **PARAM** function key. To close the parameter page and change to the relevant main menu press the **Main** softkey

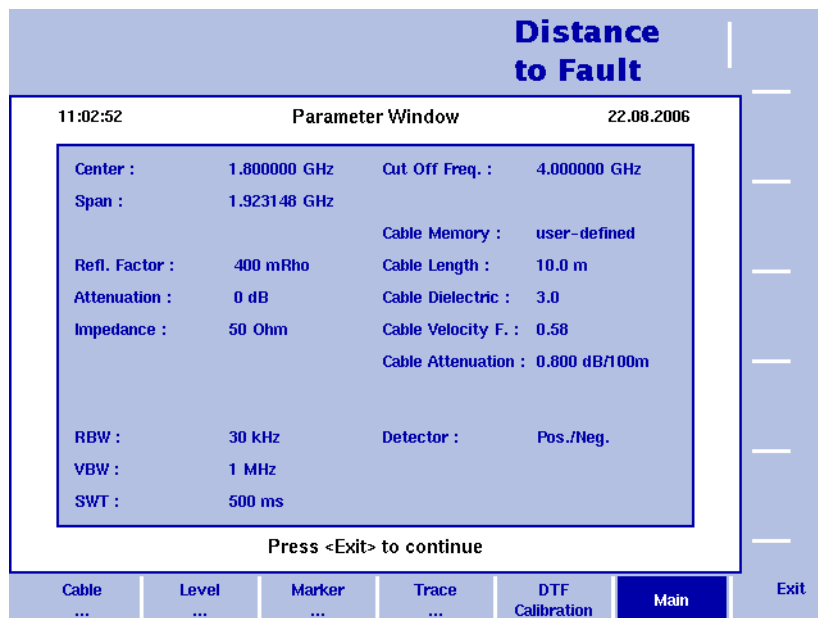

Figure 50 Distance to fault parameters

Cable Loss Operation

11

This chapter describes the instrument's functions that are specific to the reflection mode. Topics discussed in this chapter are as follows:

- ["About the cable loss mode" on page 168](#)
- ["Selecting the measurement mode" on page 168](#)
- ["Preparative steps" on page 169](#)
- ["Changing the frequency settings" on page 169](#)
- ["Cable loss calibration" on page 172](#)
- ["Setting up the level parameters" on page 173](#)
- ["Performing a limited number of measurements" on page 173](#)
- ["Using limits" on page 174](#)
- ["Viewing the cable loss parameters" on page 174](#)

About the cable loss mode

The cable loss mode is an additional measurement mode for determining the transmission quality of cables. It displays the average cable loss in dB. For measurement similar parameters and procedures as for the other VSWR/DTF measurement modes as well as cable calibration are necessary.

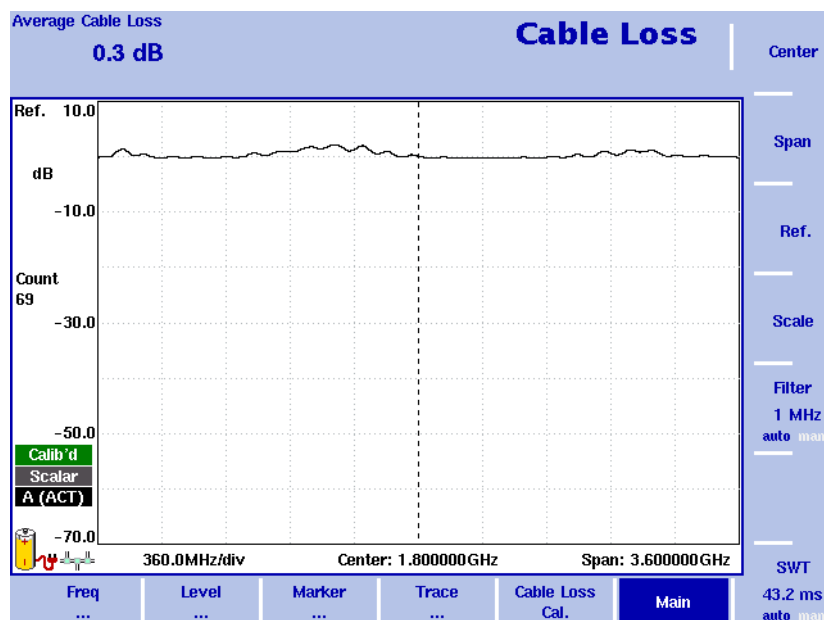

Figure 51 Cable loss measurement screen

Selecting the measurement mode

To select the cable loss mode, proceed as follows:

- 1 Push the **MODE** function key.
The Mode menu appears.
- 2 Select **VSWR/Tracking ... > Cable Loss**.
The Cable Loss main menu appears.

NOTE

This mode is available for selection, if the 9130 VSWR/DTF Reflection Measurement Option is installed and activated on your instrument.

Preparative steps

Before starting the measurement the following preparative steps are necessary:

- Connecting the 9160 VSWR/DTF Bridge
For details on this procedure refer to ["Connecting the 9160 VSWR/DTF Bridge" on page 136.](#)
- Selecting the desired frequency band
- Calibration

The next section section shows how to change the frequency settings on the 9102. It is followed by a description of the calibration process.

Changing the frequency settings

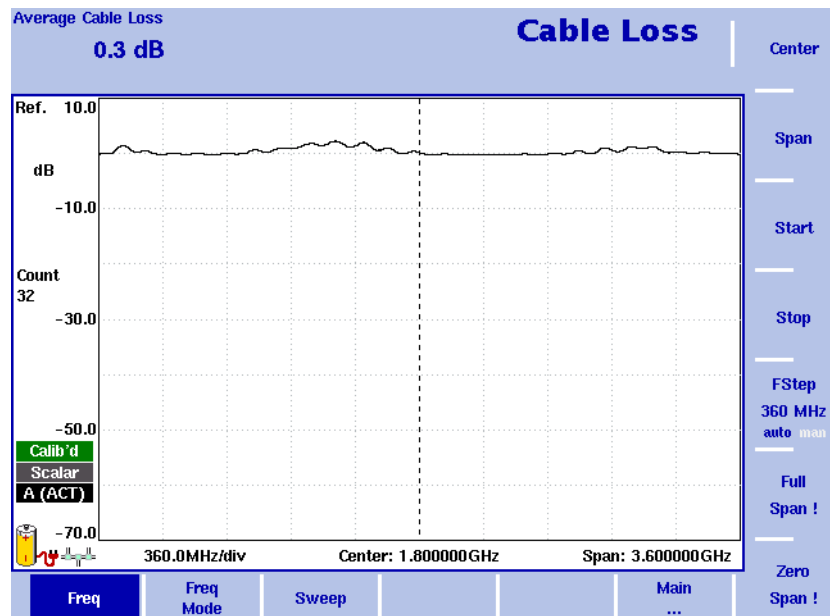

Figure 52 Frequency menu

There are different methods to set the frequency range to be measured; the range can be expressed by either the start and stop frequencies (i.e. first and last frequency on the display), or by center frequency and span (i.e. the center and the frequency range), or by other combinations of center frequency, span, start and stop frequencies.

All four parameters are accessible in the Freq menu. On the main menu, however, only one of the combinations mentioned above is shown, depending on the previously entered parameter.

NOTE

Changing a frequency parameter may affect an associated parameter.

Example: If you change the span to the maximum of 4 GHz, the start and stop frequencies are changed to 0 and 4 GHz, respectively.

Setting start and stop frequency



- 1 Push the **CENT** function key (or the **Freq** softkey in the Reflection main menu).
The vertical softkeys include Start and Stop softkeys.
- 2 Push the **Start** softkey.
An entry field appears, indicating the start frequency currently set and the step size for the **UP/DOWN** cursor keys.
- 3 Enter a new frequency using the numeric keys, the cursor keys and the **BACKSPACE** key.
- 4 Conclude the entry by pushing an enter key for the unit (**GHz/DBM** for gigahertz, **MHz/DB/μs** for megahertz).
If the start frequency entered is lower than the stop frequency, the horizontal axis will display the range from the new start to the stop frequency. If the new start frequency is higher than or equal to the stop frequency, the start frequency is used as the center frequency with zero span, i.e. the signal at the selected frequency will be shown in the time domain.
- 5 Push the **Stop** softkey and enter the frequency for the right end of the display.

You can also place softkeys for the start and stop frequencies available on the main menu by changing the frequency mode, see ["Changing the main menu for different frequency parameters"](#).

Setting center frequency and span



- 1 Push the **CENT** function key (or the **Freq** softkey in the Reflection main menu).
The vertical softkeys include Center and Span. An entry field appears, indicating the center frequency currently set and the step size for the up/down cursor keys.
- 2 Enter a new frequency using the numeric keys, the cursor keys and the **BACKSPACE** key.
- 3 Conclude the entry by pushing an enter key for the unit (**GHz/DBM** for Giga Hertz, **MHz/DB/μs** for Mega Hertz, **KHz/DBμV/ms** for Kilo Hertz, or **ENTER** for Hertz).
- 4 Push the **Span** softkey and enter the frequency for the range from the left to the right end of the display.

You can also place softkeys for the center frequency and the span available on the main menu by changing the frequency mode, see section ["Changing the main menu for different frequency parameters"](#) below.

Changing the main menu for different frequency parameters



The Reflection main menu shows two softkeys for the definition of the frequency range on the display. Different methods exist to define the range as depicted above; you can configure these softkeys to one of the two allowable combinations as follows:

- 1 From the Reflection main menu, select **Freq > Freq Mode**.
- 2 Select the combination of softkeys that you want to see in the main menu (**Start/Stop** or **Center/Span**).
- 3 Return to the main menu by pushing the **Main ...** softkey.
The main menu appears and displays the selected combination of keys.

Note that the description of the horizontal frequency axis changes with the selected parameter set.

Viewing the complete frequency band



To change the frequency range to the full bandwidth supported by the 9102, proceed as follows:

- 1 From the Reflection main menu, push the **Freq** softkey.
The Frequency menu is displayed.
- 2 Push the **Full Span** softkey.
The leftmost frequency changes to 0 Hz and the rightmost frequency to 4 GHz.

Performing measurements in the time domain



Measurements on a selected center frequency can also be displayed in the time domain.

- 1 From the Reflection main menu, push the **Freq** softkey.
The Frequency menu is displayed.
- 2 Push the **Center** softkey and enter the desired center frequency; close the input field by selecting the appropriate unit with one of the enter keys.
- 3 Push the **Zero Span** softkey.
The horizontal axis becomes the time axis. The scale width is identical to the sweep time.

Selecting the step size for the frequency input



The center, start and stop frequencies can be set either by entering a new value with the numeric keys, or by using the arrow keys (**UP**, **DOWN**) to increase or decrease the current setting. The step size for an arrow keypress can either be selected automatically by the 9102, or manually adjusted.

Manually setting the frequency step size

- 1 From the Reflection main menu, select **Freq**.
- 2 Push the **FStep** softkey.
The Freq Step entry field opens.

- 3 Enter a new frequency step value and close the entry field by pressing **Enter**. The auto/manual selection switches to manual and the selected frequency step size is displayed on the softkey.

Setting the frequency step size selection to automatic

- 1 From the Reflection main menu, select **Freq.**
- 2 Push the **FStep** softkey several times until the "auto" selection is highlighted.

Cable loss calibration

Before starting the measurement the instrument needs to be calibrated with a reference match resistor. For details on available calibration sets refer to "Options and accessories" on page 4 and "Calibration" on page 137. On the left-hand side of the results display a red icon reading "Calibrate" informs you that a calibration needs to be performed. In order to calibrate the instrument for your cable loss measurement proceed as follows:

- 1 Connect the test port extension cable to the 9160 VSWR/DTF Bridge.
- 2 In the reflection main menu press **Cable Loss Cal.** softkey. The cable loss Calibration menu is displayed.

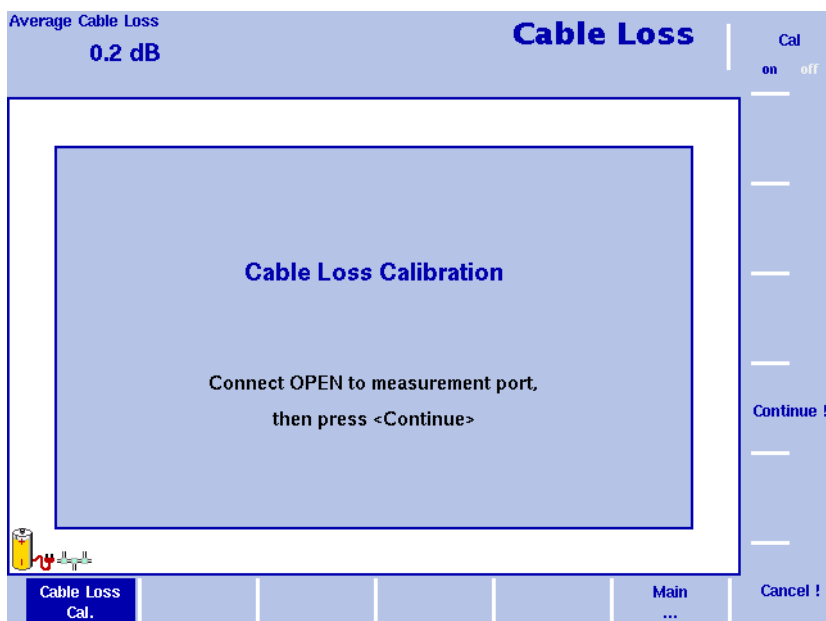

Figure 53 Cable Loss Calibration menu

- 3 The 9102 will guide you through the calibration process by onscreen messages as shown in Figure 53. When prompted as shown connect the calibration set to the test port extension cable and press **Continue**. You can abort the calibration process by pressing the **Cancel !** softkey.
- 4 When calibration is completed the Reflection main menu will be displayed again. On the left-hand side of the results display the calibration icon will now be displayed in green and read "Calib'd" (Calibrated).

The measurement graph shows full reflection (0 dB cable loss) as soon as the calibration set is removed. The instrument is now ready for starting the cable loss measurement.

NOTE

When performing a number of measurements it can be necessary to repeat the calibration process due to temperature changes etc. This is a regular behaviour. Furthermore, if you change the frequency band, calibration has to be repeated. As soon as calibration is necessary the 9102 will inform you by displaying the red "Calibrate" icon.

Setting up the level parameters

Setting the reference level

- 1 In the main menu, push the **Ref.** softkey or select **Level** followed by **Ref.** Alternatively, push the **REF** function key. The Reference Level input field opens.
- 2 Enter the new reference level either using the numeric keys, closing the input field with the appropriate enter key, or with the **UP/DOWN** arrow keys. The new reference level appears at the top of the vertical axis. The reference is based on the actual set output power.

Changing the vertical scale

The scale for the vertical axis (power) can be changed in the range from 1 to 20 dB per division (vertical line in the displayed grid) in 1-3-5 steps as follows:

- 1 In the main menu, select **Level**.
- 2 Push the **Scale** softkey. The Scale input field opens.
- 3 Select a new scale by entering a new number of dB per division numerically and pressing the **ENTER** or **MHz/dB/μs** key, or by pushing the **UP/DOWN** cursor keys.

Performing a limited number of measurements

The 9102 can run measurements continuously or a defined number of times. Limiting the number of measurements can be useful for statistical analyses. For details on limiting the number of measurements refer to ["Performing a limited number of measurements" on page 149 in Chapter 9 "Reflection Operation"](#).

Using limits

As in the reflection mode you can also use limit lines for distance to fault measurements. For details on the usage of limits refer to ["Using limit lines" on page 32 in Chapter 2 "General Operation"](#).

Viewing the cable loss parameters

You can get an overview of all parameters set for this mode in the Parameter Window. To view the parameters, press the **PARAM** function key. To close the Parameter Window and return to the menu you opened it from, press the **ESCAPE** function key, the **Exit** softkey or the **PARAM** function key. To close the parameter page and change to the relevant main menu press the **Main** softkey

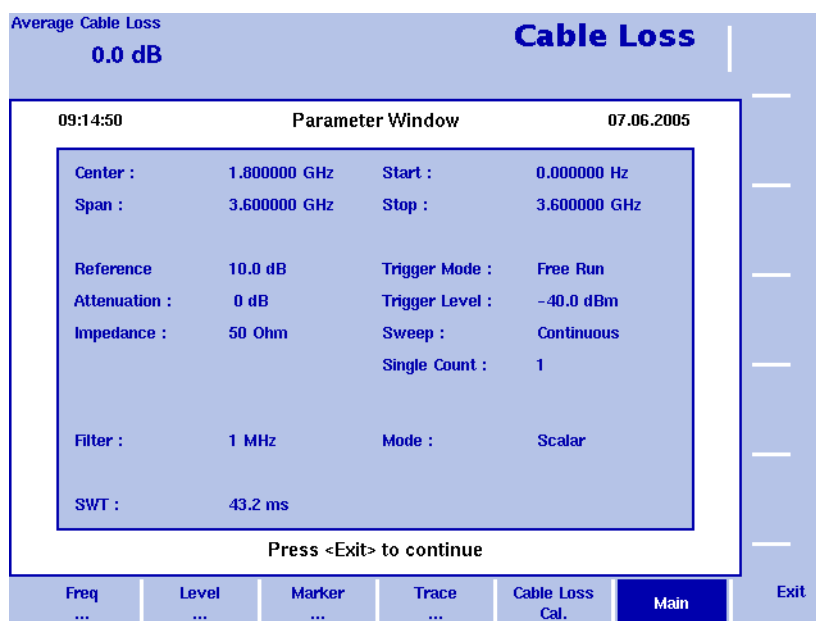

Figure 54 Cable loss parameters

EMF (EMI) Operation

12

This chapter describes the instrument's functions that are specific to the EMF (EMI) mode. Topics discussed in this chapter are as follows:

- "EMF measurements" on page 177
- "Measurement methods" on page 179
- "Measurement antennas" on page 181
- "EMF measurements with the 9102" on page 187
- "Connecting the antenna" on page 188
- "Selecting the measurement mode" on page 189
- "Selecting the unit" on page 189
- "Selecting the frequency range" on page 190
- "Selecting RBW, VBW and SWT" on page 193
- "Specifying the display calculation" on page 194
- "Specifying level settings" on page 194
- "Performing automatic measurements" on page 195
- "Performing manual measurements" on page 198
- "Using limits" on page 201
- "Using Markers" on page 201
- "Viewing the EMF (EMI) mode parameters" on page 202

About the EMF (EMI) mode

More and more sources of electromagnetic fields, mostly transmitters for mobile radio, broadcasting and other radio services, are being created and installed. Equipment for home and office communication and other technical devices also contribute to the exposure to electromagnetic fields in the working environment and at home. For health protection regulatory bodies have implemented limit recommendations which were turned into national laws. Network operators, companies installing transmitters for broadcasting and regulatory bodies are faced by the challenge of verifying that limits specified for electromagnetic fields are observed by the sources at hand.

The 9102 in conjunction with the 9131 EMF Measurement Option offers the EMF (EMI) measurement mode allowing you to perform radiation measurements easily and efficiently. All you need to effectively record electromagnetic fields is the 9102 with the 9131 EMF Measurement Option installed and the appropriate antenna for your measurement method. Willtek offers a range of antennas for different purposes. For further details on different measurement antenna types refer to "[Measurement antennas](#)" on page 181. The following picture shows a typical application example, an EMF measurement performed using the 9102 in conjunction with an isotropic antenna, the Willtek 9171 Isotropic Antenna, mounted on a tripod.



The EMF (EMI) measurement mode enables you to perform automatic EMF measurements upon the press of a button. In this mode, the 9102 measures the electromagnetic field over a user-definable frequency range and displays the field strength in V/m or the power density in W/m^2 . All necessary functions, e.g. detecting the peak value over a given time period or integrating the broadband signal power over a given frequency range, are available. You can compare the recorded measurement values with the relevant threshold values.

Results can be displayed in logarithmic or linear format, the displayed range quickly and easily being adapted to the measured signal. The measured signals can be displayed both graphically and numerically in logarithmic or linear terms as shown in the following example.

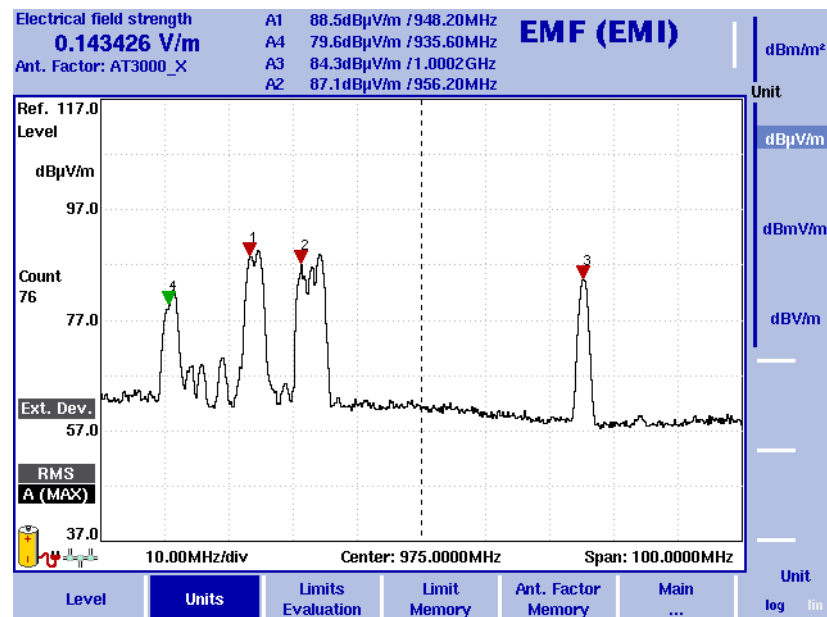

Figure 55 EMF (EMI) measurement

EMF measurements

Electromagnetic fields are usually measured over a defined frequency range to determine the amount of radiation emitted by certain sources, such as broadcast stations or mobile phone base stations. Thus, measurements should be performed on a frequency where radiation is expected, e.g. on a broadcast or cellular radio frequency. For precise measurements a frequency-selective receiver with high sensitivity, a large dynamic range and precise measurements of the field strength is required. These are the prerequisites for accurate and reproducible measurement results.

Basically, there are two different measurement approaches in EMF verification:

- Radiation emission and
- radiation immission

The equipment and the methods used vary according to measurement type. With the 9102 Handheld Spectrum Analyzer in conjunction with the 9131 EMF Measurement Option and the appropriate accessories, i.e. antennas, Willtek offers a measurement solution covering the different approaches and requirements.

In the following two sections the radiation emission and immission concepts are explained. Furthermore these sections provide you with an overview on the equipment needed in order to perform EMF measurements depending on the measurement approach.

Radiation emission

Using this measurement type operators of cellular networks and broadcast stations verify that the radiation of a particular transmitter installed is within the limits specified by law and regulatory bodies. In many countries worldwide regulatory bodies stipulate a proof of regulation adherence. The radiation emission measurement is a directional measurement determining the electromagnetic field emitted by a transmitter. Within the measurement setup a directional antenna helps to measure the emitted radiation.

Measurement setup for emission measurements

For performing emission measurements according to ICNIRP (International Commission on Non-Ionizing Radiation Protection) standard with the 9102 you just need the following two pieces of equipment:

- 9102 Handheld Spectrum Analyzer equipped with the 9131 EMF Measurement Option and the 9132 RMS Detector Option
- A directional antenna

Willtek offers two different directional antennas for performing radiation emission measurements. For a detailed description of these two antennas refer to ["Directional antennas" on page 186](#).

This measurement setup consisting of the 9102 and the directional antenna provides a handheld solution for performing radiation emission measurements easily and efficiently.

Radiation immission

For engineering offices and regulatory bodies the specific radiation exposure caused by all radiation sources in a particular place is of special interest. During an immission measurement the electromagnetic field exposure is measured at different locations within a designated area to identify minimum and/or maximum radiation. Typical applications for this kind of measurement are for example:

- Measurements for defining security zones in close proximity of transmitter sites
- Measurements for determining radiation exposure of representative and especially sensitive facilities, e.g. schools, nursery schools and hospitals situated in proximity of transmitter sites
- Long-term measurements for determining immission fluctuations

Measurement setup for immission measurements

As for emission measurements you just need two pieces of equipment for performing immission measurements with the 9102:

- 9102 Handheld Spectrum Analyzer equipped with the 9131 EMF Measurement Option and the 9132 RMS Detector Option
- 9170 Biconical Antenna (for a detailed description refer to ["9170 Biconical Antenna" on page 182](#))
or
- 9171 Isotropic Antenna (for a detailed description refer to ["9171 Isotropic Antenna" on page 184](#))

The type of antenna you use depends on your measurement requirements. The detailed descriptions of the two different antenna types in "[Measurement antennas](#)" on page 181 provide you with useful information for selecting the appropriate measurement antenna for your EMF measurement.

In this measurement setup the 9102 captures the electromagnetic waves from all directions and displays the overall field strength in the desired frequency range.

Measurement methods

The location for performing EMF measurements is usually predefined. A main goal of performing EMF measurements is determining the radiation people are exposed to in their everyday life, so the measurements are usually done at locations where people stay for a while, e.g. their work place, home, but also restaurants or sidewalks etc. At the measurement locations a search for the maximum field strength has to be performed in order to determine the radiation exposure caused for example by mobile network base stations. For longterm EMF measurements first the maximum field strength is determined and then the antenna is placed on the location of maximum exposure. Basically there are two methods for determining the maximum field strength within a designated measurement area:

- The stirring method or
- the multipoint method

Using each of the two methods the user will move with the antenna within the area to be measured as shown in the following graphic depicting a user determining the maximum field strength using a measurement setup involving an isotropic antenna.

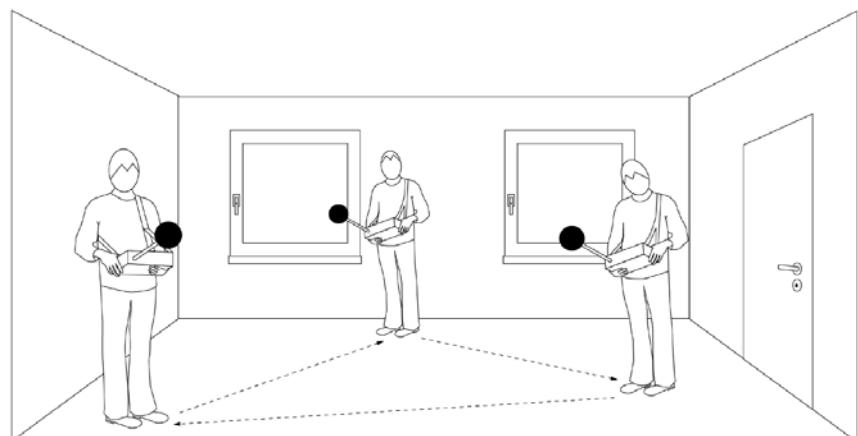

Stirring method

Using the stirring method the user sets the measurement instrument to maximum hold and moves the antenna within the designated measurement area. Depending on the antenna used the user has to be very thorough in covering the designated measurement area in order to capture the different locations, directions of incidence, and polarisations equally. Using an isotropic antenna directions of incidence and polarisations can be neglected, thus an isotropic antenna provides a more comfortable solution for using the stirring method. For further details on the characteristics of different antennas refer to "[Measurement antennas](#)" on page 181. After completing the coverage of the designated measurement area the measurement instrument provides the maximum field strength value.

Multipoint method

The multipoint approach involves a predefined multipoint matrix providing the user with designated measurement points. For this purpose the dimensions of the measurement area first have to be determined and the measurement points have to be specified. At each measurement point a measurement has to be taken. As three measurements are required at each point (one for each direction, x y, z), it is recommended to use an isotropic antenna for performing measurements using the multipoint method. For further details on the characteristics of different antennas refer to "[Measurement antennas](#)" on page 181. The user performs the measurement at each of the measurement points and documents the individual measurement results.

Another possibility is to use a simplified approach to the multipoint method. As for the stirring method the user sets the measurement instrument to maximum hold and moves within the designated measurement area covering all predefined measurement points using an isotropic antenna.

Compared to the stirring method the multipoint method, whether in its pure or in its simplified form, has the advantage of offering a guideline to the user performing the measurements and thus constitutes a more structured approach.

Measurement antennas

The antenna is one of the most important factors in EMF measurements. There are different types of antennas which can be used for measuring field strength depending on your measurement requirements. Willtek offers a range of antennas for different measurement requirements:

- The 9170 Biconical Antenna with a frequency range from 60 to 2500 MHz for immission measurements
- The 9171 Isotropic Antenna with a frequency range from 50 to 3000 MHz for immission measurements
- The 9172 and 9173 Directional Antennas, two antennas with a frequency range of 80 to 1000 MHz and 300 to 3000 MHz respectively for emission measurements

For ordering details for Willtek antennas and antenna accessories refer to ["Options and accessories" on page 4](#).

During measurements the antenna converts the free progressive wave into a line wave. For antenna calibration a correction table containing k factors is required. These factors are proportionality factors which correct the antenna's frequency response and help to convert the measured power or voltage to field strength or power density. Using the k factor table the measured level is converted into the relevant quantities, the field strength measured in V/m and the power density measured in W/m².

Willtek delivers its measurement antennas in conjunction with the appropriate correction factor tables. Using the 9100 Data Exchange Software you can transfer the k factor tables delivered to your instrument. With the 9171 Isotropic antenna this step is not necessary as the factors are stored in a memory inside the antenna interface. You can also use the 9100 Data Exchange Software to collect the correction data for antennas from other vendors and transfer them to your 9102. For further details on using the 9100 Data Exchange Software refer to [Chapter 15 "9100 Data Exchange Software"](#). After transferring the correction tables to the instrument they will be available for selection for EMF measurements.

Willtek also offers antenna accessories like a tripod as well as calibrated cables. Thus you will be able to master any situation in the field using the 9102 and its accessories. If you use a tripod and cable setup for your measurements, cable attenuation is taken into account by activating the appropriate cable factor on the instrument.

Following is a general technical description of the different measurement antenna types providing information on the relevant measurement purpose as well as technical details. For a detailed description of all individual steps to be taken during EMF measurements using the different measurement antenna types refer to ["Performing automatic measurements" on page 195](#) and ["Performing manual measurements" on page 198](#).

9170 Biconical Antenna



Biconical antennas are characterised by their dipole-like structure. The two reception lobes are highly symmetrical and provide the biconical antenna with two main reception directions with an opening angle of 120° each.

When manually turning the biconical antenna during measurements into three main planes (x, y, z) the same antenna element is used for the measurements in each of the different directions. This leads to an unmatched isotropy and thus makes biconical antennas most suitable for high-precision measurements. Mounting the antenna on a turning device you can easily turn the antenna in the directions indicated on the device and perform the measurements for each plane. Thereby a globe-like coverage for the measurement, comparable to the one using an isotropic antenna, is achieved as shown in the following graphic.

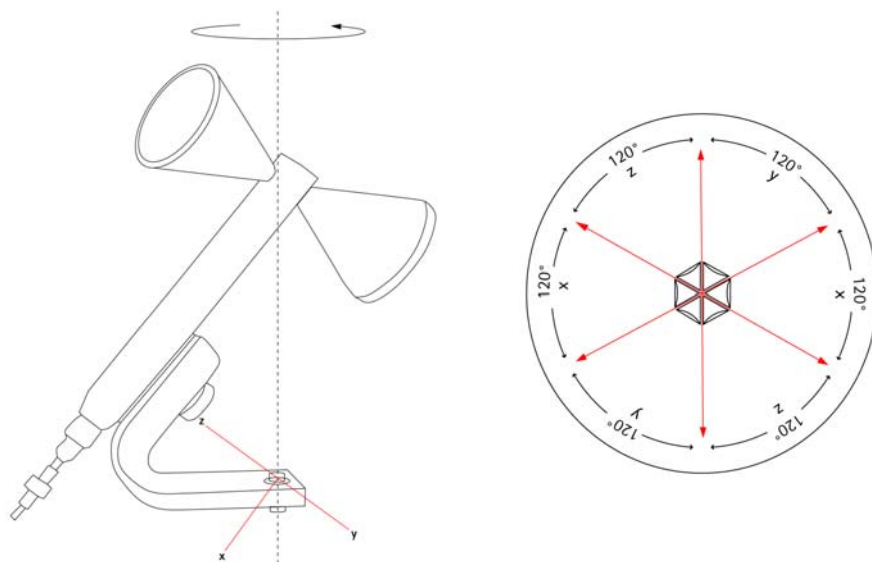

The 9102 supports consecutive measurements in three axes and automatically calculates the resulting field strength.

Willtek offers the 9170 Biconical Antenna for EMF immission measurements with the 9102 and the 9131 EMF Measurement Option.

The delivery includes:

- Antenna
- Clip with a 1/4 inch thread for an optional tripod and stops in 120° steps
- 10 m calibrated ferrite beaded coaxial cable
- Calibration certificate and k factor table

Following are the 9170 Biconical Antenna's technical specifications:

Antenna type	Biconical (linear passive device)
Frequency range	60 MHz to 2.5 GHz
Sensitivity	> 0.5 mV/m
Maximum applicable field strength	> 300 V/m
Dipole balun symmetry	
60 to 80 MHz	±0.6 dB
80 MHz to 3 GHz	±0.2 dB
Isotropy error	
up to 1.5 GHz	< 0.5 dB
1.5 to 2.2 GHz	< 0.9 dB
2.2 to 3 GHz	< 1.2 dB
Dimensions	
Width	200 mm
Length	250 mm
Weight	2.4 kg
RF connector	N type
Operational temperature range	-30°C to +55°C
Environmental protection class	IP44
RoHS-compliant	

9171 Isotropic Antenna



The most comfortable and fastest solution for performing EMF immission measurements comprises using an isotropic antenna. In an isotropic antenna three antennas or dipole elements, one for each direction (x, y and z), are arranged orthonogally and combined by interconnection as shown in the following graphic.

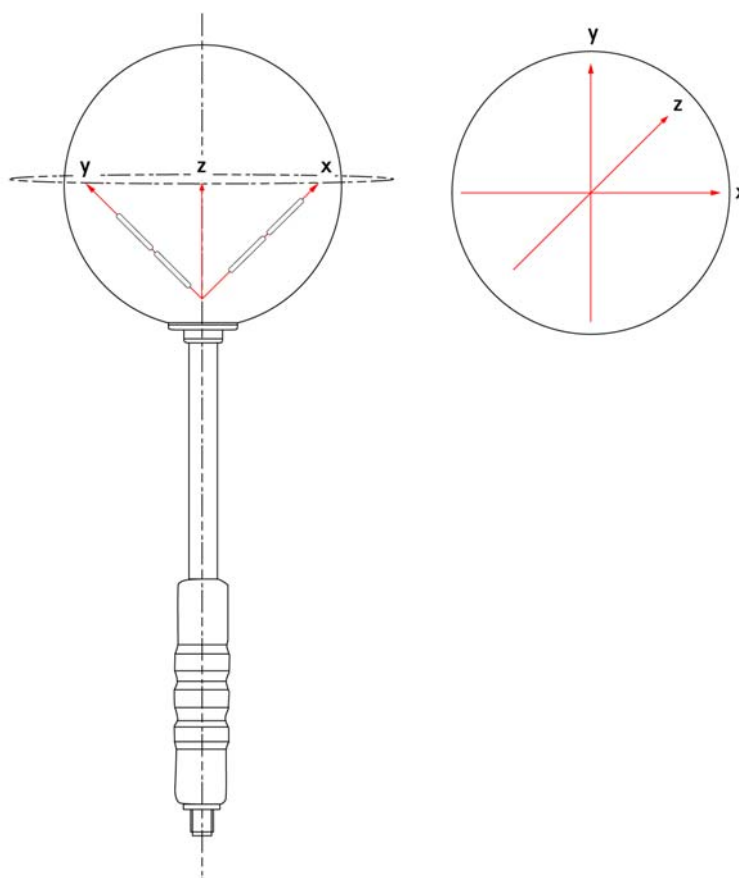

Willtek offers the 9171 Isotropic Antenna for EMF immission measurements with the 9102 equipped with the 9131 EMF Measurement Option. The 9171 Isotropic Antenna is controlled by the 9102 Handheld Spectrum Analyzer, rendering manual rotation of the antenna during measurements unnecessary. This antenna enables you to perform fast automatic measurements. Remote control is achieved by way of a circuit integrated into the antenna. The circuit is connected to the 9102's Multi Port connector via an additional shielded cable with a high-precision connector. Via this connection the 9102 also reads the calibration data, i.e. the k factor correction information, automatically from the EPROM within the circuit.

As soon as you connect the cable to the 9102's Multiport the instrument automatically detects the antenna and loads a set of individual calibration values from the antenna. On starting the measurement the instrument automatically controls the antenna's receiving direction, performs the measurements in each direction and calculates the isotropic total value from the three individual measurement values.

The delivery includes:

- Antenna
- Clip with 1/4 inch thread for an optional tripod
- 6 m combined remote control cable and a calibrated ferrite-beaded coaxial cable
- N to N adapter supporting direct antenna mounting on the instrument
- Antenna interface (control and calibration data)
- Calibration certificate and k factor table

NOTE

The 9171 Isotropic Antenna comes in a wooden crate. Please retain this crate for proper packing in case you want to dispatch the antenna to Willtek for calibration.

Following are the 9171 Isotropic Antenna's technical specifications:

Antenna type	Isotropic transducer with 3 orthogonal dipole antennas
Frequency range	30 MHz to 3 GHz
Sensitivity	< 5 mV/m
Maximum applicable field strength	< 300 V/m
Dipole balun symmetry	
50 to 80 MHz	±0.6 dB
80 MHz to 3 GHz	±0.2 dB
Isotropy error vertical polarization	
up to 1.7 GHz	±0.5 dB
1.7 to 2.1 GHz	±1.0 dB
2.1 to 3 GHz	±0.5 dB
Isotropy error horizontal polarization	
up to 1.2 GHz	±0.5 dB
1.2 to 1.7 GHz	±1.0 dB
1.7 to 2.1 GHz	±0.5 dB
2.1 to 3 GHz	±1.0 dB
Dimensions	
Radome diameter	200 mm
Length	520 mm
Weight	0.5 kg
RF connector	N type

Operational temperature range	-20°C to +60°C
Environmental protection class	IP 54
RoHS-compliant	

Directional antennas

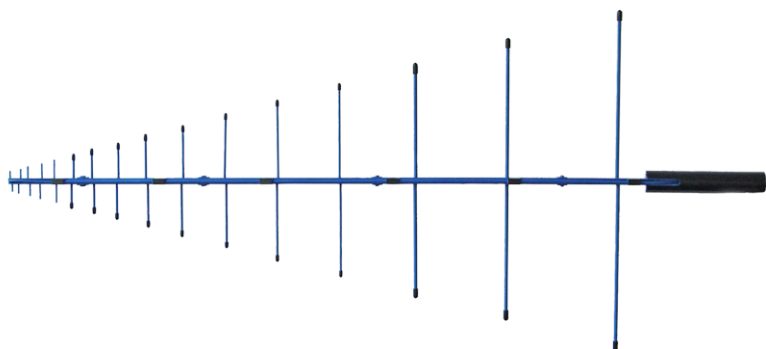

Directional antennas are log-periodic broadband antennas covering a wide spectrum of applications. They are typically used for measuring the emission from a specific antenna site.

Willtek offers two different directional antennas of 1 m length each accommodating different frequency ranges:

- 9172 Directional Antenna - 80 to 100 MHz
- 9173 Directional Antenna - 300 to 3000 MHz

Thanks to their small angle of beam and their excellent frequency response, these two directional antennas can also be used for EMF prequalification and for finding interferers. With these two antenna types and their overlapping frequency ranges, the whole range of commercial range of radio services is covered.

The delivery includes:

- Antenna
- Clip with 5/8 thread for an optional tripod

Following are the 9172 and 9173 Directional Antenna's technical specifications:

Frequency range	80 to 100 MHz and 300 MHz to 3000 MHz
Maximum transmission power (CW)	> 0.5 mV/m
Maximum applicable field strength	> 300 V/m
Nominal impedance	50 Ω
VSWR (typically)	< 2.0
RF connector	N female
Polarisation	Linear (vertical/horizontal)

Calibration	CISPR
Pole clamp	5/8" UNC thread 37 mm round flange
Size (length x width)	1 m x 0.55 m
Weight	2.4 kg

EMF measurements with the 9102

As explained the 9102 in conjunction with the 9131 EMF Measurement Option and its antenna accessory range provides you with a measurement solution suitable for performing EMF measurements according to your specific measurement requirements.

In EMF (EMI) mode the 9102 measures the electrical field strength (E) as well as the power density (S) to enable you to compare the measured EMF with the binding limits specified by the responsible regulatory bodies. You can specify which result should be displayed. For further details on specifying the value to be displayed in your EMF measurement refer to ["Specifying the display calculation" on page 194](#).

The display unit for the electrical field strength is V/m.

The electrical field strength is calculated as the square root taken from $S \times R_0$, with R_0 being the air wave resistance of 377Ω .

The 9102 displays the total electrical field strength by adding all measurement values measured for the three directions x, y, z.

E_{result} is calculated as the square root taken from $E_{\text{xresult}}^2 + E_{\text{yresult}}^2 + E_{\text{zresult}}^2$.

The display unit for the power density is W/m^2 .

It is calculated as $S = E_r^2 \div R_0$. R_0 again being the air wave resistance of 377Ω .

The following sections explain how to perform EMF measurements with the 9102 differentiating between auto and quick mode used for automatic measurements involving the 9171 Isotropic Antenna and manual mode used for manual measurements involving the 9170 Biconical Antenna. The preparative steps which have to be performed before starting the actual measurement, e.g. selecting the EMF (EMI) measurement mode, setting the required frequency range, selecting the measurement unit and specifying the measurement result to be displayed (power density or field strength) are identical for both measurements with the exception of connecting the antennas to the 9102. The steps involved in this procedure depend on the antenna used.

NOTE

Due to the physical nature of EMF measurements the following has to be taken into account.

When performing measurements on broadband signals the electrical field strength or the power density displayed may show deviations. In this case the measurement has to be performed via a channel power measurement.

Furthermore a very big or very small relation between span and RBW may lead to false measurements or invalid measurement results.

Connecting the antenna

As a first step you establish the appropriate hardware setup for the EMF measurement according to measurement type. As explained before the type of antenna you use depends on measurement type and measurement method. For further details on which antenna to use refer to ["EMF measurements" on page 177](#) and ["Measurement antennas" on page 181](#).

Connecting the 9170 Biconical Antenna

To establish a connection between the 9102 and the 9170 Biconical Antenna simply connect the antenna via an RF cable to the 9102's RF in connector.

Connecting the 9171 Isotropic Antenna

To establish a connection between the 9102 and the 9171 Isotropic Antenna connect the antenna directly to the 9102's RF in connector and connect the controller cable to the 9102's Multi Port connector. As soon as you have connected the antenna to both connectors the 9102 automatically detects the antenna and loads the correction data.

NOTE

If you connect the antenna controller to the instrument with the EMF (EMI) mode already running, it takes about 10 seconds for the 9102 to detect the antenna. In order to avoid any disturbance of the process do not press any buttons on the instrument during this time.

After the antenna is detected and the correction data are loaded the 9102 switches to the Level menu and the **Antenna Factor** softkey is highlighted. To activate the antenna factor press the **Antenna Factor** softkey until **on** is highlighted.

Connecting a directional antenna

To establish a connection between the 9102 and one of the two directional antennas, the 9172 or 9173 Directional Antenna, simply connect the antenna via an RF cable to the RF 9102's RF in connector.

Using a tripod

As a measurement antenna accessory Willtek offers a wooden tripod. For ordering details refer to ["Options and accessories" on page 4](#). Using this tripod you can for example set the 9170 Biconical Antenna up for turning. For setting up the appropriate antenna on the tripod, first fix the appropriate adapter on the tripod and then fix the antenna to the adapter. Then you can use the appropriate extension cable to connect the antenna to the 9102. In case of the 9171 Isotropic Antenna you also have to connect the controller cable to the 9102's Multi Port as described in ["Connecting the 9171 Isotropic Antenna" on page 188](#).

Selecting the measurement mode

To select the EMF (EMI) mode, proceed as follows:

- 1 Push the **MODE** function key.
The Mode menu appears.
- 2 Select **EMF (EMI)**.
The EMF (EMI) main menu appears.

NOTE

This mode is available for selection, if the 9130 EMF Measurement Option is installed and activated on your instrument.

Selecting the unit

After selecting the EMF (EMI) measurement mode the next step is to select the unit.

- 1 In the main menu, select **Level > Units**.
- 2 You can use logarithmic or linear units. In order to toggle the display between logarithmic and linear units press the **Unit** softkey in the lower right corner of the display and select log or lin.
- 3 You can now choose between the following units via the Unit softkey in the upper right corner of the display.
Logarithmic units: dB μ V/m, dBmV/m and dBV/m
Linear units: V/m, mW/m²

Selecting the frequency range

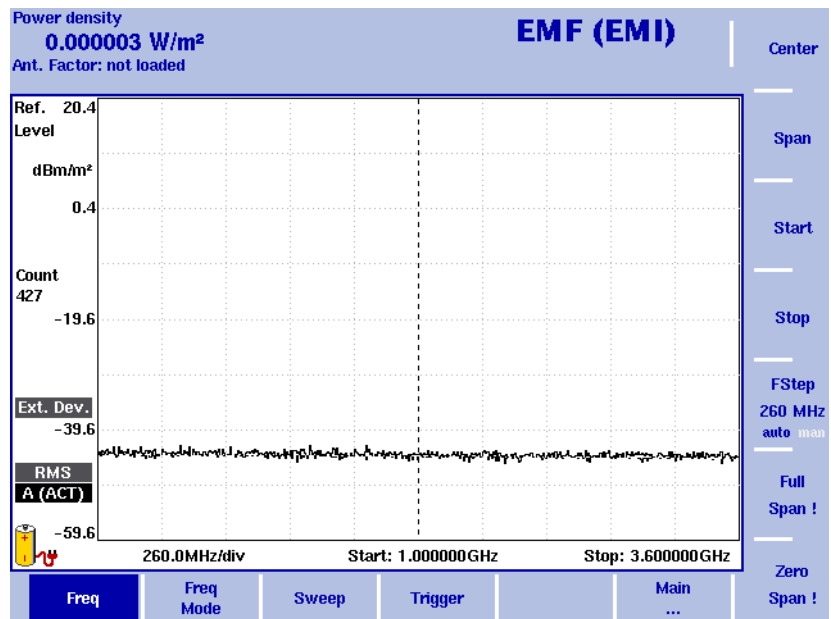

Figure 56 Frequency menu

There are different methods to set the frequency range to be measured; the range can be expressed by either the start and stop frequencies (i.e. first and last frequencies on the display), or by center frequency and span (i.e. the center and the frequency range), or by other combinations of center frequency, span, start and stop frequencies.

All four parameters are accessible in the Freq menu. On the main menu, however, only one of the combinations mentioned above is shown, depending on the parameter last entered.

NOTE

Changing a frequency parameter may affect an associated parameter.
Example: In a unit without the frequency extension option installed, if you change the span to the maximum of 4 GHz, the start and stop frequencies are changed to 0 and 4 GHz, respectively.

The following section concentrate on the different methods of setting the frequency, which is one of the preparative steps for EMF measurements. For descriptions of further Frequency menu functions (e.g. Trigger) refer to [Chapter 3 "Spectrum Analysis Operation"](#).

Setting start and stop frequency



- 1 Push the **CENT** function key (or the **Freq** softkey in the Reflection main menu).
The vertical softkeys include Start and Stop softkeys.
- 2 Push the **Start** softkey.
An entry field appears, indicating the start frequency currently set and the step size for the **UP/DOWN** cursor keys.
- 3 Enter a new frequency using the numeric keys, the cursor keys and the **BACKSPACE** key.
- 4 Conclude the entry by pushing an enter key for the unit (**GHZ/DBM** for gigahertz, **MHZ/DB/μS** for megahertz).
If the start frequency entered is lower than the stop frequency, the horizontal axis will display the range from the new start to the stop frequency. If the new start frequency is higher than or equal to the stop frequency, the start frequency is used as the center frequency with zero span, i.e. the signal at the selected frequency will be shown in the time domain.
- 5 Push the **Stop** softkey and enter the frequency for the right end of the display.

You can also place softkeys for the start and stop frequencies available on the main menu by changing the frequency mode, see ["Changing the main menu for different frequency parameters"](#).

Setting center frequency and span



- 1 Push the **CENT** function key (or the **Freq** softkey in the Reflection main menu).
The vertical softkeys include Center and Span. An entry field appears, indicating the center frequency currently set and the step size for the up/down cursor keys.
- 2 Enter a new frequency using the numeric keys, the cursor keys and the **BACKSPACE** key.
- 3 Conclude the entry by pushing an enter key for the unit (**GHZ/DBM** for gigahertz, **MHZ/DB/μS** for megahertz, **KHZ/DBμV/MS** for kilohertz, or **ENTER** for hertz).
- 4 Push the **Span** softkey and enter the frequency for the range from the left to the right end of the display.

You can also place softkeys for the center frequency and the span available on the main menu by changing the frequency mode, see section ["Changing the main menu for different frequency parameters"](#) below.

Changing the main menu for different frequency parameters



The Reflection main menu shows two softkeys for the definition of the frequency range on the display. Different methods exist to define the range as depicted above; you can configure these softkeys to one of the two allowable combinations as follows:

- 1 From the Reflection main menu, select **Freq > Freq Mode**.
- 2 Select the combination of softkeys that you want to see in the main menu (**Start/Stop** or **Center/Span**).
- 3 Return to the main menu by pushing the **Main ...** softkey.
The main menu appears and displays the selected combination of keys.

Note that the description of the horizontal frequency axis changes with the selected parameter set.

Viewing the complete frequency band



To change the frequency range to the full bandwidth supported by the 9102, proceed as follows:

- 1 From the Reflection main menu, push the **Freq** softkey.
The Frequency menu is displayed.
- 2 Push the **Full Span** softkey.
The leftmost frequency changes to 0 Hz and the rightmost frequency to 4 GHz, or 7.5 GHz if the frequency extension option is installed.

Performing measurements in the time domain



Measurements on a selected center frequency can also be displayed in the time domain.

- 1 From the Reflection main menu, push the **Freq** softkey.
The Frequency menu is displayed.
- 2 Push the **Center** softkey and enter the desired center frequency; close the input field by selecting the appropriate unit with one of the enter keys.
- 3 Push the **Zero Span** softkey.
The horizontal axis becomes the time axis. The scale width is identical to the sweep time.

Selecting the step size for the frequency input



The center, start and stop frequencies can be set either by entering a new value with the numeric keys, or by using the arrow keys (**UP**, **DOWN**) to increase or decrease the current setting. The step size for an arrow keypress can either be selected automatically by the 9102, or manually adjusted.

Manually setting the frequency step size

- 1 From the Reflection main menu, select **Freq**.
- 2 Push the **FStep** softkey.
The Freq Step entry field opens.

- 3 Enter a new frequency step value and close the entry field by pressing **Enter**. The auto/manual selection switches to manual and the selected frequency step size is displayed on the softkey.

Setting the frequency step size selection to automatic

- 1 From the Reflection main menu, select **Freq**.
- 2 Push the **FStep** softkey several times until the "auto" selection is highlighted.

Selecting RBW, VBW and SWT



The resolution bandwidth (RBW) is the 3 dB bandwidth of the IF filter for selecting the signal to be measured. The resolution bandwidth describes the ability of the spectrum analyzer to discriminate between adjacent signals of similar amplitude. Only signals spaced at a frequency of more than the RBW can be discriminated from one another.

The 9102 can be set to automatically select the resolution bandwidth, depending on the frequency span. The EMF (EMI) measurement mode offers two special RBW filters required for EMC prequalification tests: 120 kHz and 9 kHz at 6 dB.

The video bandwidth (VBW) is the lowpass bandwidth over which several results for one frequency point are smoothed. The lower the video bandwidth, the smoother the signal curve and the less variations there are.

The 9102 can be set to select the video bandwidth automatically as a function of the resolution bandwidth.

The sweep time (SWT) determines how long it takes for a complete sweep over the measured frequency range (span).

The 9102 can be set to automatically select the sweep time, depending on RBW and VBW. If manually set, the sweep time should be selected long enough for the filtered signal to reach steady state. The 9102 will output an "UNCALibrated" warning if the sweep time is too low.

To set the resolution bandwidth, the video bandwidth or the sweep time, proceed as follows:

- 1 In the main menu, select the appropriate softkey (**RBW**, **VBW**, or **SWT**).
- 2 Enter the value and complete the entry with the appropriate enter key for the unit, select a new value with the help of the **UP/DOWN** cursor keys, or switch to **auto** to leave the setting to the 9102.

Changing between automatic and manual mode

Push the appropriate softkey (**RBW**, **VBW**, or **SWT**) several times until the desired selection (auto or manual) is highlighted.

Specifying the display calculation

The 9102 measures electrical field strength (E) in V/m as well as the power density (S) in W/m². For further information about these two values and their interdependence refer to ["EMF measurements with the 9102" on page 187](#). You can switch the display between these two results values.

NOTE

This step is preparative and has to be taken before you start your actual measurement in automatic or manual mode.



To switch the display between electrical field strength and power density proceed as follows:

- 1 In the EMF (EMI) main menu select **Measure > Display Calculation**.
- 2 Toggle the **Display** softkey until the required option, E for electrical field strength and S for power density, is highlighted. In the upper left corner of the display the appropriate value will be displayed during your measurement in the relevant unit: electrical field strength in V/m and power density in W/m².

Specifying level settings

The accuracy and the dynamic range between the measured signal and the noise floor depend on the proper setting of the level settings. These consist of the reference level and the attenuation.

The reference level basically determines the level at the top of the display. The vertical axis is divided into eight horizontal lines; you can adjust the scale (which defaults to 10 dB per line) to your preferences.

Attenuation or gain due to external coupling can be compensated by frequency-dependent coupling factors, so that the displayed measurement values reflect the power at the device under test.

Setting the reference level

- 1 In the main menu, push the **Ref. Level** softkey. You can also select **Level** followed by **Ref. Level** Alternatively, push the **REF** function key. The reference level input field opens.

NOTE

Depending on the unit you use and the specified display calculation the Ref. Level softkey changes to Ref. Power or Ref. Voltage. Furthermore the input field name and the display on the left-hand side of the screen changes accordingly.

- 2 Enter the new reference power or voltage either using the numeric keys, closing the input field with the appropriate enter key, or with the **UP/DOWN** arrow keys.
The new reference level appears at the top of the vertical axis. The reference is based on the actually set output power.

Setting the hardware attenuation

- 1 In the main menu, push the **Attenuation** softkey.
The Attenuation input field opens.
- 2 Enter a new attenuation value in the range from 0 to 50 dB (in 10 dB steps) and close the input field with one of the enter keys, or use the **UP/DOWN** arrow keys to select the attenuation value in the range 10 to 50 dB.
If the attenuation value is changed, the attenuation option will change to "manual".

Performing automatic measurements

When using the 9171 Isotropic Antenna you can perform measurements in automatic mode. A prerequisite for performing automatic measurements is that the 9171 Isotropic Antenna's controller cable is connected to the 9102's multiport. Via this connection the 9102 reads the relevant correction data from the antenna and controls the measurement. However, if you use a tripod measurement setup in conjunction with an extension cable, the cable attenuation also has to be taken into account by using cable correction data.

There are two different options selectable from the Measure menu for performing automatic measurements: Auto and Quick. The two different modes are described in ["Auto measurements" on page 197](#) and ["Quick measurements" on page 198](#).

NOTE

If the 9171 Isotropic Antenna is not connected via its controller cable to the 9102's Multi Port, the two softkeys Auto and Quick will be greyed out in the EMF (EMI) Measure menu.

Activating the antenna factor settings

As soon as you have connected the antenna to the RF In connector and the antenna controller to the Multi Port connector of the 9102, the instrument automatically detects the antenna and loads the correction data.

NOTE

If you connect the antenna controller to the instrument with the EMF (EMI) mode already running, it takes about 10 seconds for the 9102 to detect the antenna. In order to avoid any disturbance of the process do not press any buttons on the instrument during this time.

After the antenna is detected and the correction data are loaded the 9102 switches to the Level menu and the **Antenna Factor** softkey is highlighted. To activate the antenna factor press the **Antenna Factor** softkey until **on** is highlighted.

Specifying cable factor settings for extension cables

If you are using an extension cable to connect the 9171 Isotropic Antenna to your 9102, for example for mounting it on a tripod, cable attenuation has to be taken into account by activating the appropriate cable correction factor. Cable factors are maintained and edited within the 9100 Data Exchange Software. You can transfer them to your 9102 for usage within EMF measurements. For further details refer to ["Managing cable factors for EMF measurements"](#) on page 240 in Chapter 15 "9100 Data Exchange Software".

In order to employ cable correction data for your measurement proceed as follows:

- 1 In the EMF (EMI) main menu select **Level > Ant. Factor Memory**. The Antenna Factor Memory is displayed.

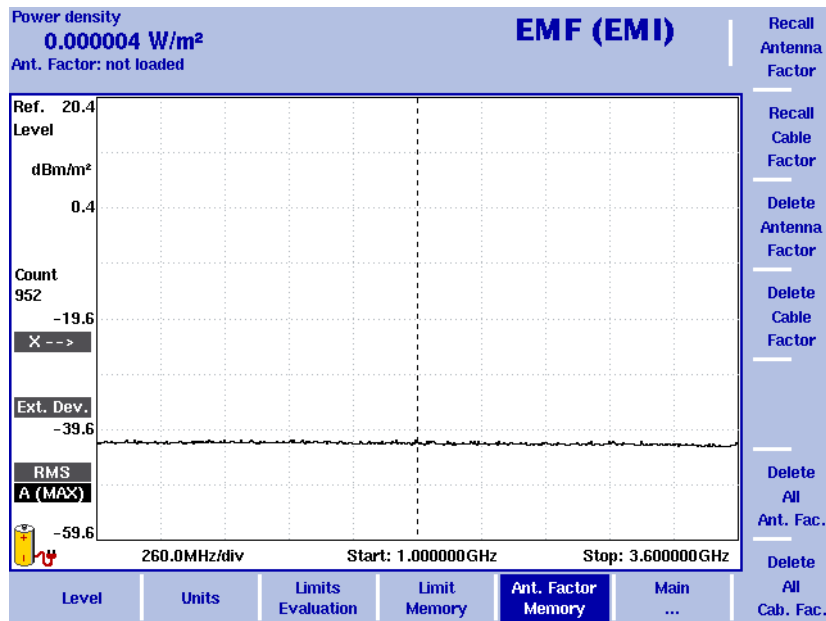

Figure 57 Antenna Factor menu

- 2 Press the **Recall Cable Factor** softkey. A dropdown list showing all cable factors stored on the system is displayed.
- 3 Select the cable factor you intend to use and press **ENTER**. Now the Level menu is displayed again with the **Cable Factor** softkey highlighted.
- 4 To activate the cable factor selected toggle the **Cable Factor** softkey until **on** is highlighted.

Auto measurements

Auto measurements provide you with the comfort of the 9102 controlling the measurement process for all three measurement panes. Once you start your Auto measurement the 9102 will run automatically through all measurements and calculate and display the overall measurement result from the individual results for x, y and z. However, you can specify the measurement time.

To start an Auto measurement proceed as follows:

- 1 In the EMF (EMI) main menu select **Measure**. The EMF (EMI) Measure menu is displayed.

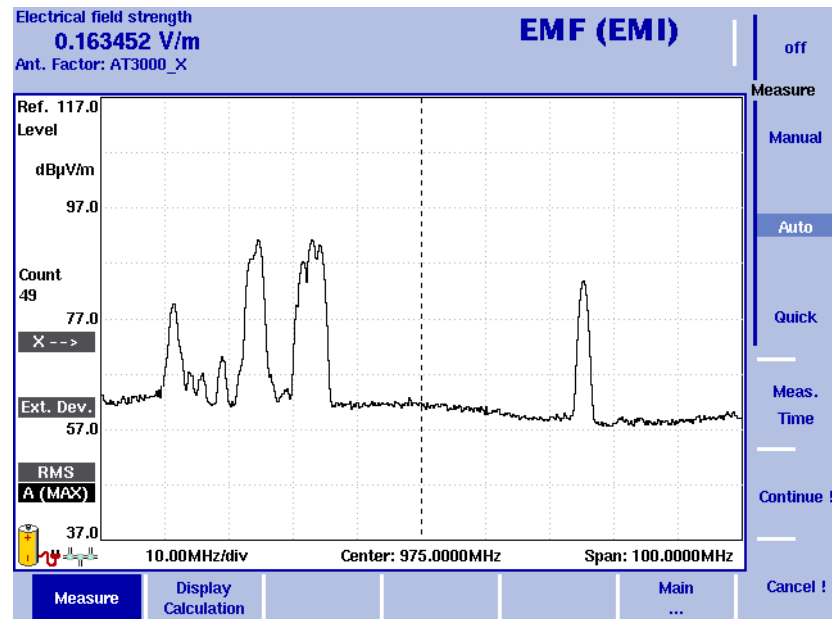

Figure 58 Measure menu

- 2 In the Measure menu select **Meas. Time**. An input field for the measurement time will be displayed.
- 3 Enter the time interval to be used for measuring on each of the measurement panes. The default is 360 seconds, the maximum value is 600 seconds. Press **ENTER** to set the measurement time.
- 4 Now select the **Auto** softkey and press **Continue !** to start the Auto measurement.
- 5 On the right-hand side of the display the red Measure indicator shows that a measurement is in progress: **Measure**. Above this indicator the direction measured is shown (x as the first one): **X -->**. You can abort the measurement by pressing the **Cancel !** softkey.
- 6 On completing the measurement for the x measurement pane the Measure indicator disappears and the 9102 automatically switches to y followed by z.

- 7 On completion of the measurement the measurement result is displayed with the graph automatically put on hold and the overall calculated electrical field strength or power density, depending on the selection you have made via **Measure > Display Calculation** (see "[Specifying the display calculation](#)" on page 194) is displayed. You can now save your results trace on the instrument.

To clear the trace and start a new measurement press the **HOLD/RUN** function key or the **Auto** softkey. You can also press the **Quick** or **Manual** softkey, if you intend to perform a measurement of one of these types.

Quick measurements

Quick measurements are a convenient way of quickly determining the maximum field strength by fast measurements with a predefined measurement duration of one single sweep per measurement pane (x, y, z). Apart from the predefined measurement duration the measurement process is identical.

To start a quick measurement proceed as follows:

- 1 In the EMF (EMI) main menu select **Measure**. Now, the EMF (EMI) Measure menu is displayed.
- 2 Select the **Quick** softkey and press **Continue !** to start the quick measurement. You can abort the measurement by pressing **Cancel !**. From now on the measurement process is identical with the process described for Auto measurements.

Performing manual measurements

The manual measurement mode provides you with a comfortable way of performing EMF measurements using the 9170 Biconical Antenna. For this type of EMF measurement the 9170 Biconical Antenna is turned manually in each of the measurement directions (x, y and z), usually mounted on a turning device. For each direction the 9102 performs the measurement of electrical field strength or power density depending on the selection you have made via **Measure > Display Calculation** (see "[Specifying the display calculation](#)" on page 194). You start the individual measurements manually after turning the antenna in the relevant direction. As for automatic measurements you can also specify the measurement time for each direction. On completing all three measurements the 9102 calculates the total result value.

As the k factor correction data are not automatically loaded and activated when using a biconical antenna you have to activate the appropriate correction table manually on your instrument. Also, as the biconical antenna will often be mounted on a tripod and connected to the 9102 via an extension cable, the cable factor has to be activated manually.

The following sections describe all steps which are specific to manual measurements. The preparative steps which have to be performed before starting the actual measurement, e.g. selecting the EMF (EMI) measurement mode, setting the required frequency range, selecting the measurement unit and specifying the measurement result to be displayed (power density or field strength) are identical for both manual and automatic measurements.

Specifying antenna factor settings

The scope of delivery of the 9170 Biconical Antenna includes the appropriate k factor correction table. The data are available within the 9100 Data Exchange Software. For details on downloading the data to the 9102 and managing antenna factors within the 9100 Data Exchange Software refer to ["Managing antenna factors for EMF measurements" on page 238](#) in [Chapter 15 "9100 Data Exchange Software"](#).

To activate the appropriate antenna factor for your EMF measurement proceed as follows:

- 1 In the EMF (EMI) main menu select **Level > Ant. Factor Memory**. The Antenna Factor Memory is displayed (see [Figure 57 on page 196](#)).
- 2 Press the **Recall Antenna Factor** softkey. A dropdown list showing all antenna factors stored on the system is displayed.
- 3 Select the appropriate antenna factor and press **ENTER**. Now the Level menu is displayed again.

To activate the antenna factor selected toggle the **Antenna Factor** softkey until **on** is highlighted.

Specifying cable factor settings for extension cables

If you are using an extension cable to connect the 9172 Biconic Antenna to your 9102, for example for mounting it on a tripod, cable attenuation has to be taken into account by activating the appropriate cable correction factor. Cable factors are maintained and edited within the 9100 Data Exchange Software. You can transfer them to your 9102 for usage within EMF measurements. For further details refer to ["Managing cable factors for EMF measurements" on page 240](#) in [Chapter 15 "9100 Data Exchange Software"](#). The procedure of specifying cable factor settings for manual measurements is identical to the one described for automatic measurements. For details refer to ["Performing manual measurements" on page 198](#).

Performing the measurement

To perform a manual measurement proceed as follows:

- 1 In the Measure menu select **Meas. Time**. An input field for the measurement time will be displayed.
- 2 Enter the time interval to be used for measuring on each of the measurement panes. The default is 360 seconds, the maximum value is 600 seconds. Press **ENTER** to set the measurement time.

- Now select the **Manual** softkey. The softkeys for the three different measurement directions (x, y and z) are available on the right-hand side with x highlighted as the first measurement direction and the x direction indicator displayed on the left-hand side as shown in the following picture.

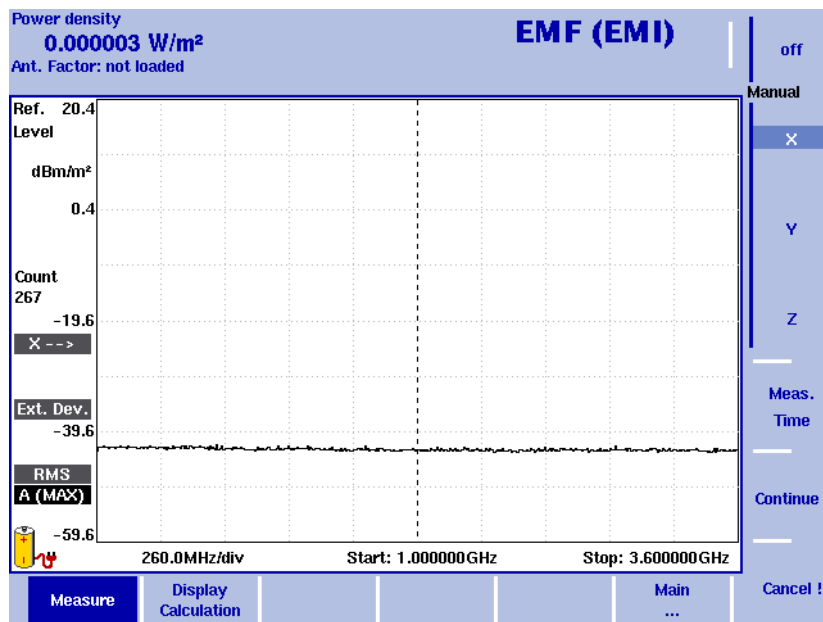

Figure 59 Softkeys for manual measurements

- Press **Continue !** to start the first measurement. On the right-hand side of the display the red Measure indicator shows that a measurement is in progress: **Measure**. You can abort the measurement by pressing the **Cancel !** softkey. After completion of the measurement the Measure indicator disappears.
- Now press the **Y** softkey followed by **Continue !** to start the measurement for the y direction. The procedure is identical to the one described for the x direction above.
- After completion of the y measurement press the **Z** softkey followed by **Continue !**. The procedure is identical to the one described for the x direction above.
- On completion of the measurement the measurement result is displayed with the graph automatically put on hold and the overall calculated electrical field strength or power density, depending on the selection you have made via **Measure > Display Calculation** (see "[Specifying the display calculation](#)" on page 194) is displayed. You can now save your results trace on the instrument.

To clear the trace and start a new measurement press the **HOLD/RUN** function key or the **Manual** softkey.

Setting up the trace

The trace functions provide different views of the measurements, for example the actual measurement or an average over the last couple of measurements. You can even select two different views of the measurement. Another possibility is to compare the actual measurement with an older measurement which has been stored in the 9102 and loaded to one of the trace views. For details on setting up traces refer to ["Setting up the trace" on page 64](#) in [Chapter 3 "Spectrum Analysis Operation"](#).

Using limits

As in the reflection mode you can also use limit lines for distance to fault measurements. For details on the usage of limits refer to ["Using limit lines" on page 32](#) in [Chapter 2 "General Operation"](#).

Using Markers

The 9102 includes powerful and easy-to-use marker functions. To further analyze your measurement result display you can employ up to six markers. For a detailed description of the usage of markers refer to ["Working with the markers" on page 29](#).

Viewing the EMF (EMI) mode parameters

You can get an overview of all parameters set for this mode in the Parameter Window. To view the parameters, press the **PARAM** function key. To close the Parameter Window and return to the menu you opened it from, press the **ESCAPE** function key, the **Exit** softkey or the **PARAM** function key. To close the parameter page and change to the relevant main menu press the **Main** softkey

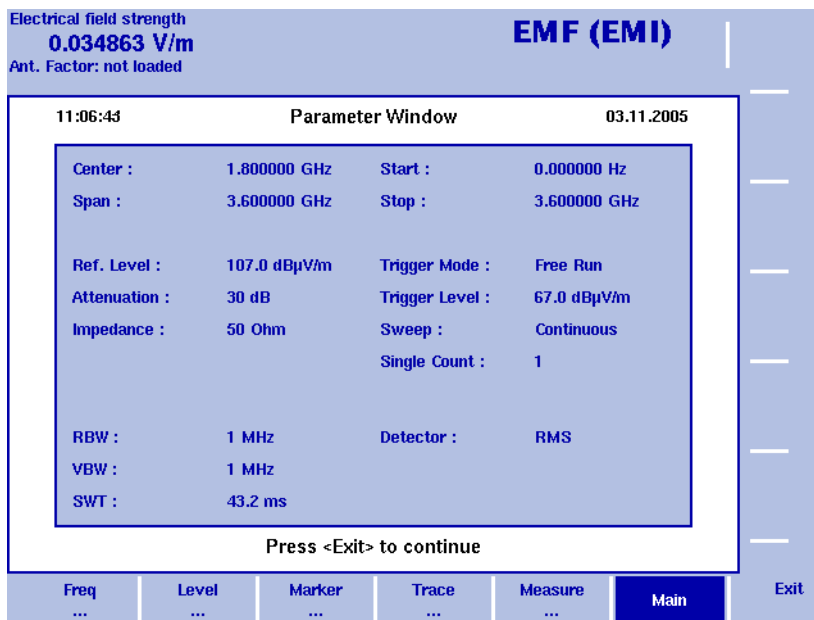

Figure 60 EMF (EMI) parameters

Troubleshooting

13

This chapter provides information on handling errors and problems related to the 9102 Handheld Spectrum Analyzer.

Recharging problems with the 9102B

If a 9102B (serial number 0604001 and higher) is completely discharged then it may happen that the 9102B does not automatically re-charge the battery while connected to an external power supply.

In such a case, to reset the "safety power-off switch", please carry out the following steps:

- 1 Switch off the 9102B.
- 2 Remove the power connector from the 9102B.
- 3 Remove the battery.
- 4 Wait a few seconds.
- 5 Insert the battery again.
- 6 Re-connect the power connector and provide external power.
The LED on the front will show that the battery is charged again.

Handling system errors

Should an error or problem occur that prevents you from controlling the instrument and thus requires the instrument software to be set up again, the 9102 offers the Setup Application Software menu. This menu provides you with access to the instrument without starting the instrument software and enables you to perform a software update.

[Chapter 14 "Updating the Instrument Software"](#) contains a detailed description of the processes involved in updating the instrument's software via the Setup Application Software menu.

Updating the Instrument Software

14

This chapter describes how to perform an update of the instrument's software via the 9102 Handheld Spectrum Analyzer's Setup Application Software menu. Topics discussed in this chapter include the following:

- ["Entering the Setup Application Software menu" on page 208](#)
- ["Setting a password" on page 208](#)
- ["Performing a serial update" on page 209](#)
- ["Performing a LAN update" on page 211](#)
- ["Determining the Host IP address" on page 212](#)

Entering the Setup Application Software menu

The 9102 Handheld Spectrum Analyzer's Setup Application Software menu can be entered instead of automatically loading the instrument software. This menu provides you with access to the instrument in case an error or problem should occur that prevents you from controlling it and requires the instrument software to be set up again. The menu offers two options for the update process: Serial update and LAN update. To enter the Setup Application Software menu, proceed as follows:

- 1 Turn on the 9102 Handheld Spectrum Analyzer.
The boot-up screen appears.
- 2 When the message "Press 0 to enter Setup" appears, press the numeric key **0**.
The Setup Application Software menu appears.

Setting a password

In order to ensure that software updates are only performed by authorized users you can set a password to protect the software update option. If a password is set, the user performing the software update via the Setup Application Software menu will be asked to enter it before data are loaded.

NOTE

This password only affects the software update options available on the Setup Application Software menu. It does not affect the usage of the instrument's application software.

In order to set a password proceed as follows:

- 1 Switch on the 9102. In order to enter the Setup Application Software menu press the numeric key **0** when the input request message is displayed on the boot-up screen. Now the Setup Application Software menu is displayed.
- 2 Press the numeric key **3** to open a password input field.
- 3 Enter a 6-digit numeric string as your password. For each digit you enter an asterisk (*) will be displayed in the input field.
- 4 Press **ENTER** to submit your input. You will now be asked to reenter your password for confirmation.
- 5 Press **ENTER** to submit your input. If your input is not identical to the password entered in the first input field, an error message will be displayed and you can enter the password again. Otherwise your new password will be saved.

You can also change a previously defined password. In order to do so proceed as described above. If a password has already been defined, you will be asked automatically to enter the old password before you can enter a new one.

NOTE

If you have forgotten your password, please contact one of Willtek's Technical Assistance Centers. For contact information please refer to section ["Technical assistance" on page xvi](#).

Performing a serial update

The software update requires a 9100 software update file, which is an executable file running on a Windows PC that also includes the software update for your 9102 Handheld Spectrum Analyzer. Such a file can be downloaded from Willtek's website, e.g. the file Willtek_9100Setup_4_50.exe.

Take the following steps to perform a serial update of the instrument software via the Setup Application Software menu:

- 1 Connect the 9102 to an external power supply.
- 2 Connect the 9102 to the PC. See section ["Connecting the 9102 Handheld Spectrum Analyzer" on page 12](#) for further details.
- 3 Switch on the 9102.
The boot-up screen is displayed.

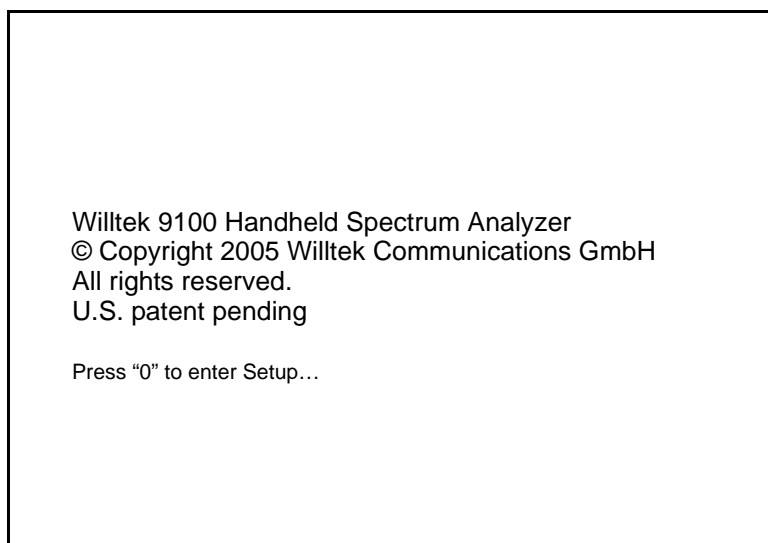

- 4 In order to enter the Setup Application Software menu press the numeric key **0** when the input request message is displayed on the boot-up screen. Now the Setup Application Software menu is displayed.

Setup Application Software:

See chapter Troubleshooting in user's guide first!

Press "1" for serial update...

Press "2" for LAN update...

Press "3" to set Password

Press "ESC" to exit

- 5 Press numeric key **1** to open the Serial Update menu.
- 6 In order to upload the application files from the PC to the instrument start the installation program on your PC. This will open the Update window as shown below.

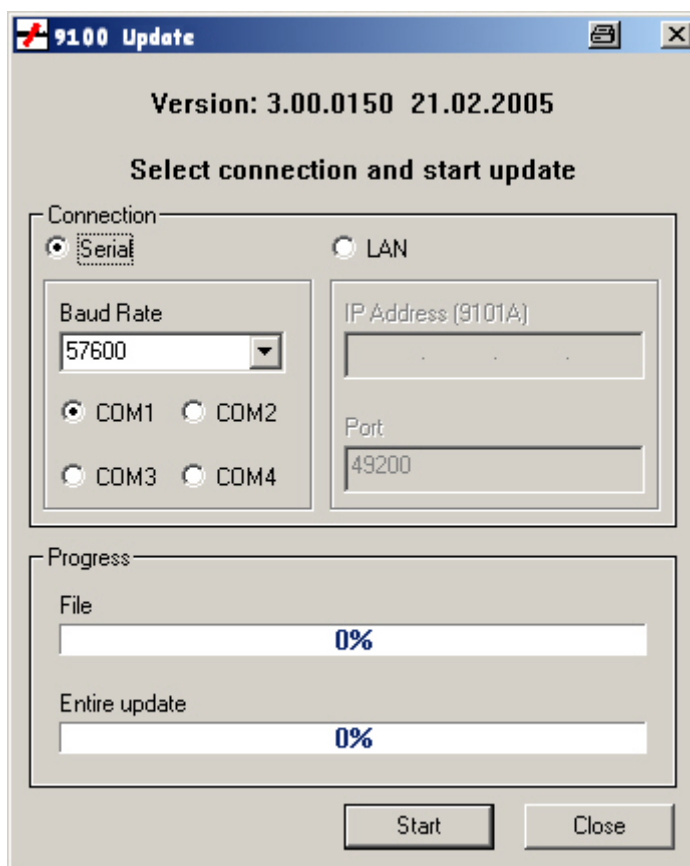

- 7 In the Connection section, select **Serial**.
- 8 To start the serial update press the numeric key **1** on the instrument.

NOTE

You do not have to click on **Start** in the Update window on your PC. The update process will be started without any further input on the PC.

Performing a LAN update

The software update requires a 9100 software update file, which is an executable file running on a Windows PC that also includes the software update for your 9102 Handheld Spectrum Analyzer. Such a file can be downloaded from Willtek's website, e.g. the file Willtek_9100Setup_4_50.exe.

Take the following steps to perform a LAN update of the instrument's software via the Setup Application Software menu:

- 1 Connect the 9102 to an external power supply.
- 2 Connect the 9102 to the PC. See section "[Connecting the 9102 Handheld Spectrum Analyzer](#)" on page 12 for further details.
- 3 Switch on the 9102. In order to enter the Setup Application Software menu press the numeric key **0** when the input request message is displayed on the boot-up screen. Now the Setup Application Software menu is displayed.
- 4 Press the numeric key **2** to open the LAN Update menu.
- 5 Here the IP addresses of the instrument (Target IP) and the PC (Host IP) are displayed. Press the numeric key **1** to change or enter the Host IP and **2** to change the Target IP. See section "[Determining the Host IP address](#)" on page 212 for information on determining the Host PC's IP address.
- 6 In order to upload the application files from the PC to the instrument start the installation program on your PC. This will open the Update window (see "[Performing a serial update](#)" on page 209).

NOTE

You do not have to click on **Start** in the Update window on your PC. The update process will be started without any further input on the PC.

- 7 In the Connection section, select **LAN**.
- 8 In order to start the update press the numeric key **6** on the instrument. A message prompts you to press any key to start the update or to hit the ESC key to abort the update.
- 9 Press the **ENTER** key to start the update. Both the instrument and the installation program on the PC display the progress of the software update.

Determining the Host IP address

In order to determine your host PC's IP address proceed as follows:

- 1 On the status bar, click **Start** and select **Run** to open an input window.
- 2 On the input line, type **cmd** to open a command prompt.
- 3 Type **IPconfig -all** to display the network settings for the PC. In this list you will find its IP address. To close the command prompt type **exit**.

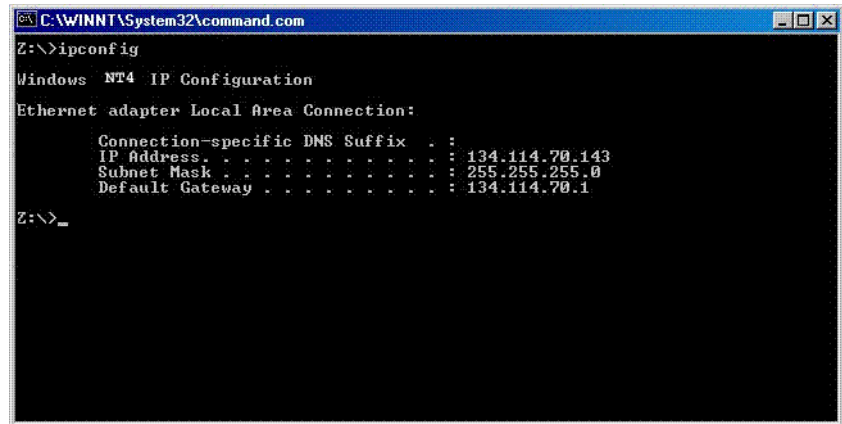

```
C:\WINNT\System32\command.com
Z:\>ipconfig

Windows NT4 IP Configuration

Ethernet adapter Local Area Connection:

    Connection-specific DNS Suffix  . : 
    IP Address . . . . . : 134.114.70.143
    Subnet Mask . . . . . : 255.255.255.0
    Default Gateway . . . . . : 134.114.70.1

Z:\>_
```

9100 Data Exchange Software

15

This chapter describes how to install and use the 9100 Data Exchange Software. The topics discussed in this chapter are as follows:

- "About the 9100 Data Exchange Software" on page 214
- "Installation requirements" on page 214
- "Understanding the license conditions" on page 214
- "Installing the software" on page 214
- "Starting the software" on page 215
- "Connecting the PC to the 9102" on page 216
- "Loading measurement results from the 9102" on page 217
- "Saving, loading and printing results on the PC" on page 221
- "Creating screen shots" on page 225
- "Working with measurement results" on page 226
- "Defining and loading limit templates" on page 229
- "Defining and loading external coupling parameters" on page 233
- "Managing communication systems for channel power measurements" on page 235
- "Managing cable types for distance-to-fault measurements" on page 236
- "Managing antenna factors for EMF measurements" on page 238
- "Managing cable factors for EMF measurements" on page 240
- "Working with settings" on page 241
- "Managing files on the PC and on the 9102" on page 242
- "Including the GPS position in the trace" on page 244

About the 9100 Data Exchange Software

The 9102 is delivered with a software product, the 9100 Data Exchange Software. This is a tool to load and display measurements from the 9102 to the PC and to install software updates on the 9102.

Installation requirements

To install the 9100 Data Exchange Software, you need

- a PC with Pentium processor or equivalent
 - Windows 98SE, Windows NT or later versions
 - a minimum of 32 megabytes of RAM
 - 50 megabytes of free space on the hard disk
 - a free serial interface or a LAN connection
-

Understanding the license conditions

Before installing the 9100 Data Exchange Software, ensure that you understand the license terms which can be found in the appendix "[Software License](#)" on [page 363](#). The software may only be installed on one computer at any one time!

Installing the software

If you received the software on a CD, just insert the CD in the CD drive of your PC.

Run **9100DataExchange.exe**.

This will start the install wizard which will copy the required files onto your PC.

Follow the instructions given by the install wizard.

By default, the install wizard will store the program files in the following directory (assuming an English Windows installation):

C:\Program files\Willtek\9100 Data Exchange.

Starting the software

Click **Start > Programs > Willtek > 9100 Data Exchange** to run the 9100 Data Exchange Software.

The following box appears:

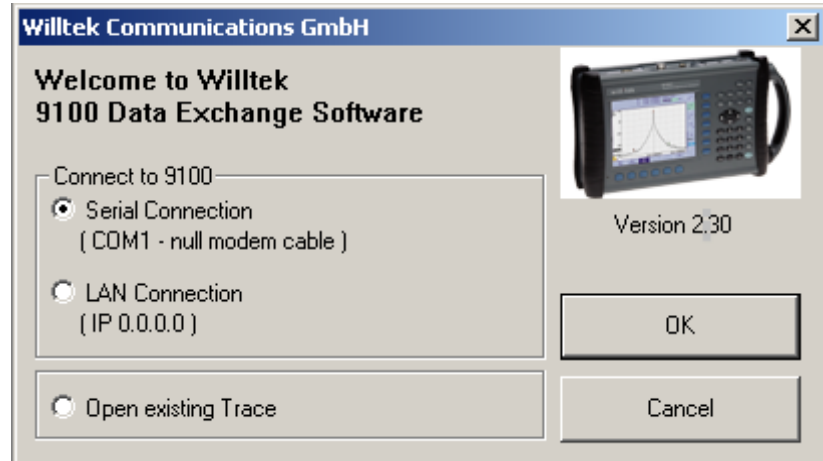

To connect to the 9102 via serial connection (RS-232 interface on a COM port of the PC), select **Serial Connection**.

To connect to the 9102 via a local area network (LAN) over TCP/IP, select **LAN Connection**.

If you do not want to connect to the 9102 but rather open a measurement trace file that has been previously stored on the PC, select **Open existing Trace** or **Cancel**.

Connecting the PC to the 9102

In order to connect the PC to the 9102, you need to configure the 9100 Data Exchange Software first.

From the menu bar, select **Connection Settings > Serial / LAN for 9100...** This will open the Connect pull-up menu as shown below:

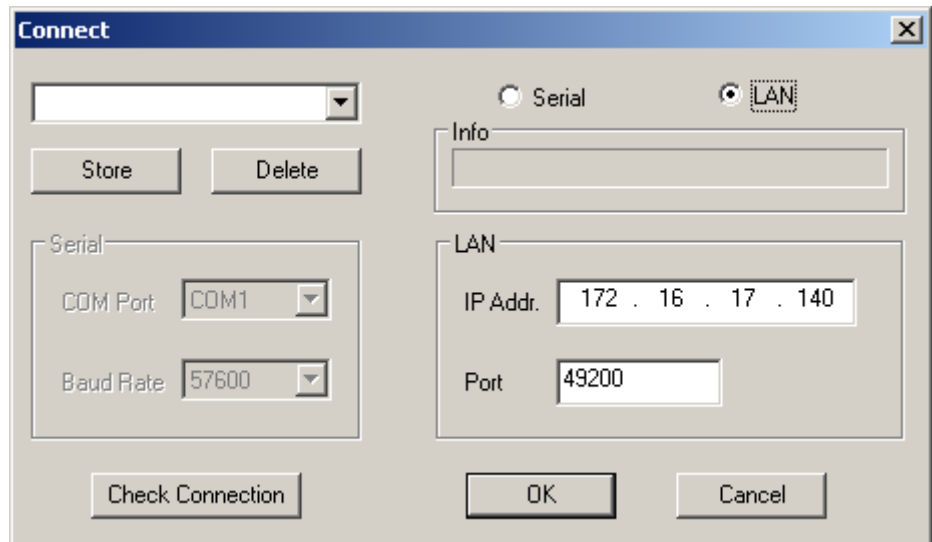

Using a predefined configuration for the connection

If you have previously stored configuration data for a successful connection with the 9102, you can proceed as follows:

- 1 Connect the 9102 with the PC using a serial interface cable or the LAN, depending on the configuration you want to use.
- 2 In the Connect dialog box of the 9100 Data Exchange Software (see above), load the configuration by selecting a name from the drop-down list box or in the upper left-hand corner of the Connect menu. Click on **OK** to load this configuration.

The PC will now attempt to exchange messages with the 9102 over the interface defined in the configuration file. The Connect dialog box will disappear and if a connection has been set up successfully, the status bar of the PC software will indicate **CONNECTED**.

Serial interface connection

- 1 Select the **Serial** radio button.
- 2 Select the baudrate (bit rate) that is set up in the 9102 as well.
- 3 Select a serial port (e.g. COM1).
- 4 Switch on the 9102 and connect it to the PC using a null modem cable as specified in ["Connecting the PC to the 9102" on page 216](#).

- 5 Click on **Check Connection** to verify that the connection is working over the selected COM port.
The PC will now attempt to exchange messages with the 9102 over the cable attached to the selected serial port. The Connect dialog box will disappear and if a connection has been set up successfully, the status bar of the PC software will indicate CONNECTED.

LAN (TCP/IP) connection

- 1 In the Connect pull-up menu, select the **LAN** radio button.
- 2 Enter the IP address of the 9102. The IP address of the 9102 can be read and modified over an RS-232 link using the SCPI command; see ["Changing the IP address of the 9102" on page 44](#) for information on changing the IP address of the 9102.
- 3 Enter the IP port number in the Port input field. Valid entries are in the range from 1024 to 65535; the default is 49200.
- 4 Switch on the 9102 and connect both 9102 and PC to the computer network with a normal patch cable, or connect them directly with each other using a cross patch cable.
- 5 Click on **Check Connection** to verify that the connection is working over the selected LAN connection.
The PC will now attempt to exchange messages with the 9102 over the network. The Connect dialog box will disappear and if a connection has been set up successfully, the status bar of the PC software will indicate CONNECTED.

Saving the configuration

You can save the configuration in a file for later use so that you do not have to reenter the configuration each time you are using 9100 Data Exchange Software.

- 1 In the entry field at the upper left-hand corner, enter a configuration name that allows you to identify the configuration that you have made. Several configurations can be stored under individual names.
- 2 Press **Store** to save the current configuration.

Loading measurement results from the 9102

The 9100 Data Exchange Software can load and display a measurement (trace) from the 9102 in two different ways. The software can load either the trace currently displayed or a trace that is saved in the 9102 memory. Using the Live Trace command available in the Instrument menu you can also display a live trace in real mode with updates continuously performed. Note that the 9100 Data Exchange Software can hold multiple windows, each with a trace.

Viewing the actual trace on the PC

- 1 Connect the PC to the 9102 as described on [page 216](#).
- 2 In the 9100 Data Exchange Software, select **Instrument > Display Trace**, or press **Ctrl+T**, or click on the icon: 

The trace is displayed in the program window (see example below). You can resize or maximize the trace within the program window.
- 3 To store the results on a local PC drive, select **File > Save** or **File > Save as** and choose a directory and file name.
The trace file is stored on your PC.

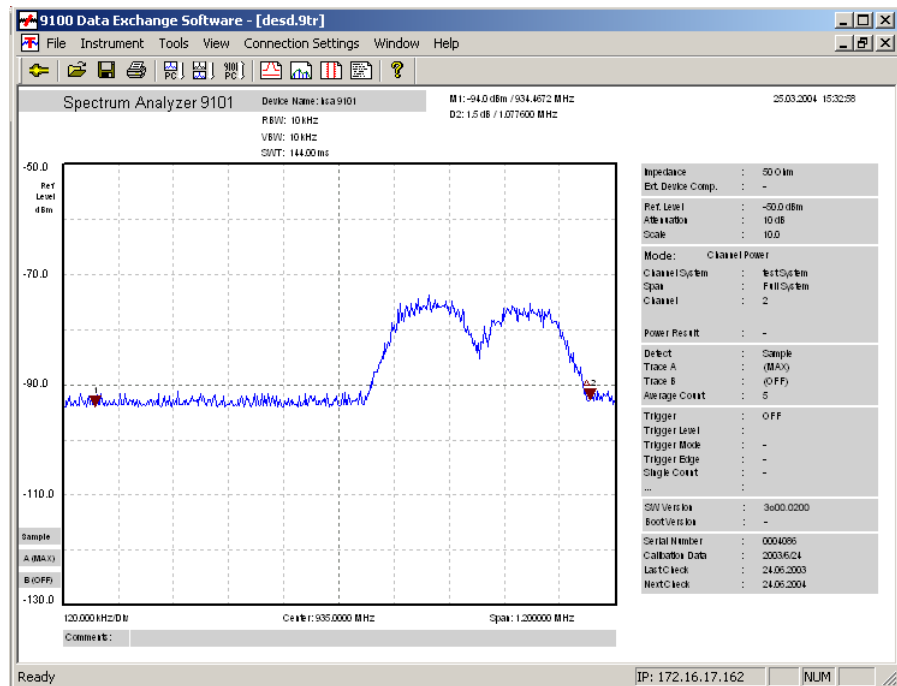

NOTE

The trace will also display any active limits. When working in channel power mode, the trace will include the communication system name.

NOTE

In signal generator mode you cannot load a trace via **Display Trace** as there are no suitable data available. If you select **Display Trace** in the signal generator mode a dialog will be displayed informing you that no data are available and asking you to select a different mode.

Toggling the view mode

You can switch the trace display from landscape to portrait and vice versa. In order to toggle the view mode proceed as follows:

- 1 Select **View > View Mode**. You can also right-click on the screen to open a right-click menu and select **View Mode**.
- 2 Select the view mode Landscape or Portrait. The display changes accordingly.

Showing and hiding parameters

You can display and hide trace parameters by selecting **View > Show All Parameters** or **View > Hide All Parameters**.

Showing and hiding markers

You can display and hide markers by selecting and deselecting **View > Markers Trace A** or **View > Markers Trace B**. On selecting to show the markers a tick is displayed next to Markers Trace A or Markers Trace B.

Continually loading live traces

You can also continually load live traces from the instrument in real-time mode which is particularly useful for monitoring ongoing measurements on your PC. To continuously download traces displayed on the 9102's screen proceed as follows:

- 1 Select **Instrument > Live Trace**, press **Ctrl+L**, or click on the icon in the menu bar: . The Live Trace Screen is displayed. On this screen you can specify several settings for the live trace process.

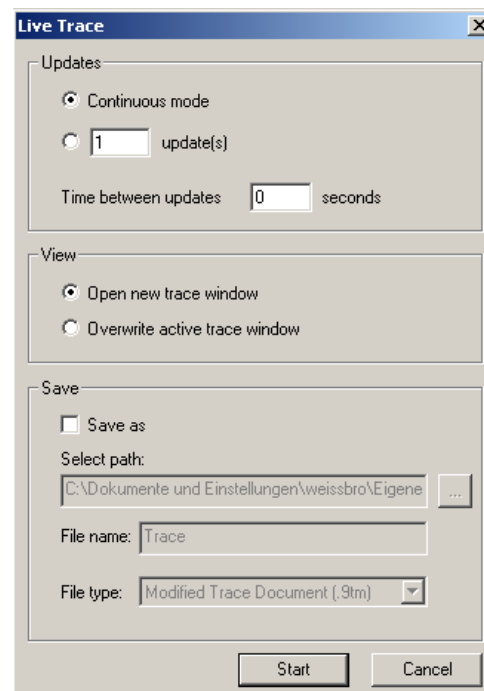

- 2 In the Updates frame select **Continuous mode**, if you want the live trace to be updated continuously until you stop the process manually. If you want to specify a fixed number of update cycles after which the process will be stopped automatically, select the second control box and enter the number of updates to be performed. In the **Time between updates** field, enter the number of seconds between each update cycle.
- 3 In the View frame select **Open new trace window**, if you want to display the live trace in a separate new window. If you want to overwrite the active trace, select **Overwrite active trace window**.
- 4 If you intend to save the live trace in a file on completion of the live trace update process, select **Save as** in the Save frame. Now the Save fields are activated enabling you to select a directory, a file name and the file type for

saving your trace on your PC. You can save the traces as *.9tm or graphic files (e.g. *.bmp, *.jpg etc.). For further details on saving traces on your PC refer to "Saving, loading and printing results on the PC" on page 221.

Transferring a saved trace to the PC

To load the data saved in the 9102 proceed as follows:

- 1 On the 9102, save the desired measurements in trace files.
- 2 Connect the PC to the 9102 as described on [page 216](#).
- 3 In the 9100 Data Exchange Software, select **Instrument > Get Trace**, or press **Ctrl+G**, or click on the icon: 

This will load and display a list of trace files that reside on the 9102 (see example below).

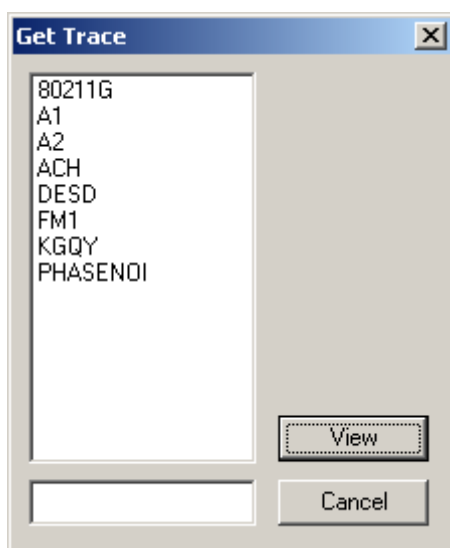

- 4 Select the desired trace file(s) and click **View**.
The trace is displayed in the program window. You can resize or maximize the trace within the program window.
- 5 To store the results on a local PC drive, select the window with the trace to be stored, select **File > Save** or **File > Save as** and choose a directory and file name. The default directory is Traces inside your 9100 Data Exchange installation directory.
The trace file is stored on your PC with the extension *.9tm differentiating it from the original trace saved on the 9102 and obtained by the Get Trace procedure. These trace files have the extension *.9tr.

NOTE

*9tr trace files can also be transferred in both directions using the Traces tab in the **Instrument > Data Transfer...** menu.

Saving, loading and printing results on the PC

Once a measurement trace has been transferred to the PC, it can be stored on the hard disk, printed or exported to a graphics or text file.

Storing results on the PC

The trace, along with the 9102 settings and markers, can be saved in a file and loaded again in a trace file. This way, information about settings and individual result values will not be lost.

- 1 Select **File > Save** or **File > Save As ...**.
A window with a file selection box appears.
- 2 Select a directory and a file name to save the trace data, and confirm by pressing **ENTER**.
The trace data are saved in a file.

Loading a trace file on the PC

Results previously stored on the PC can be retrieved and displayed in the 9100 Data Exchange Software.

- 1 Select **File > Open**.
A window with a file selection box appears.
- 2 Select the directory and the file name containing the trace data, and confirm by pressing **ENTER**.
The trace data are loaded to the 9100 Data Exchange Software.

Printing measurement results

Affecting the layout

The following steps help you to choose the best format for your print-out:

- 1 Select **File > Print Setup...** and set up the correct printer, the paper orientation and printer-dependent settings. Confirm the changes made by pressing **ENTER**.
- 2 Select **Edit > Additional Information...** to enter text for two columns of header information that is to be printed with the trace. The trace is printed with the filename; use the check box "Show File Path" to include complete information about the folder where the trace file is located.

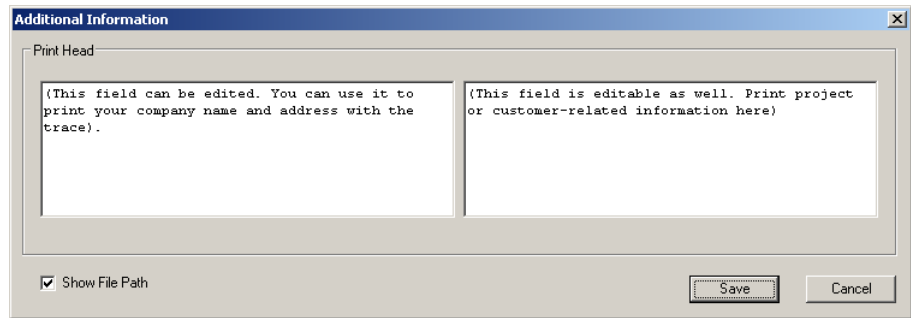

3 You can check the layout before printing by selecting **File > Print Preview**.

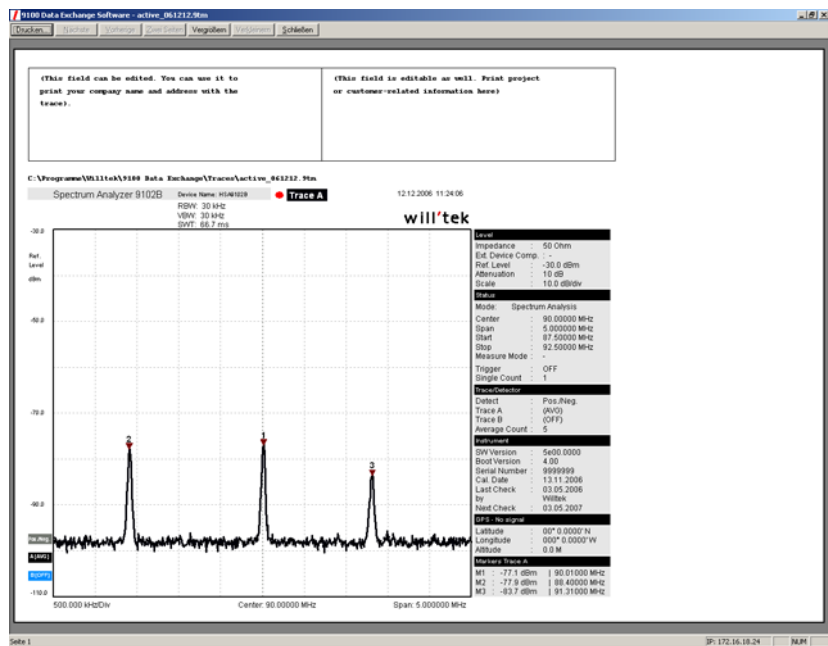

Printing a trace

Go to the **File > Print** menu to select the pages to print, and start printing by pressing **ENTER**.

Printing several traces

If you have opened several documents and you intend to print them in one go, select **File > Print Open Documents....**

Saving results to a graphics file

If you save the results in a graphics file, you can load them in other applications such as a word processor and include them in your documentation in graphical format. File formats supported are:

- Windows Bitmap (BMP)
- JPEG (JPG/JPEG)
- JPEG2000 (J2K/JP2)
- Tagged Image File Format (TIF/TIFF)
- Zsoft Paintbrush (PCX)
- Portable Network Graphics (PNG)
- Sun Raster (RAS)
- Truevision Targa (TGA)
- Portable Bitmaps (PPM/PGM)

1 Select File > Export > Image.

A file selection box appears ("Save image file").

2 Select a directory, a file name to save the measurement trace and a file format, and confirm by pressing ENTER.

The trace data are stored as a graphics file in the selected location.

Saving results to a text file

You can use the numerical results and include them in other applications for postprocessing, e.g. in Microsoft Excel.

1 Select File > Export > ASCII file.

A file selection box appears ("Save Trace as ASCII File...").

2 Select a directory and a file name to save the measurement data, and confirm by pressing ENTER.

The data are stored in a text file (*.TXT) in the selected location.

Each line in the resulting text file contains a parameter from the settings; the parameter name is separated from its value by a semicolon.

Copying the trace into a document

The 9100 Data Exchange Software offers two different methods to copy the trace into a document. The best method depends on how you intend to process the trace in that document.

Graphics copy and paste

This method is appropriate if you want to use the graphic image as is, e.g. in a document.

1 Select the trace you want to copy by selecting the appropriate number in the Window menu.

2 Select Edit > Copy Graph.

The displayed window is copied into the Windows clipboard.

3 Press Alt+Tab or the mouse to change to the application where you want to insert the graph (e.g. Microsoft Word).

- 4 Move the cursor to the position where to insert the graph.
- 5 Press **Ctrl+V** or select **Edit > Paste** to insert the graph.

Note

If you want to resize the graph in Microsoft Word, select **Format > Picture** and change to the **Size** tab to resize it.

Note

The 9100 Data Exchange Software copies the window in the size it currently has on the screen. You can resize the window to copy the graph in a different size or aspect ratio.

Data copy and paste

You will want to copy the data rather than the graphics if you want to post-process the data, e.g. in a spreadsheet.

- 1 Select the trace you want to copy by selecting the appropriate number in the **Window** menu.
- 2 Select **Edit > Copy Data**.
 All the relevant measurement data and instrument settings are copied as text into the Windows clipboard.
- 3 Press **Alt+Tab** or the mouse to change to the application where you want to insert the data (e.g. Microsoft Excel).
- 4 Move the cursor to the position where to insert the data.
- 5 Press **Ctrl+V** or select **Edit > Paste** to insert the data.
 The data is copied into the document. Measurement data and instrument settings are separated by a comma, so most spreadsheet programs will nicely place the data in individual columns.

48	Marker Trace A	Frequency[Hz]	Level[dBm]
49	M1	90010000	-79,9
50	M2	88400000	-78,6
51	M3	91310000	-87
52	M4	OFF	
53	M5	OFF	
54	M6	OFF	
55	M7	OFF	
56	M8	OFF	
57	M9	OFF	
58	M10	OFF	
59			
60			
61	[Trace A]		
62	Frequency[Hz]	Min Level[dBm]	Max Level[dBm]
63	87500000	-97,4	-97,1
64	87510000	-97,9	-97,9
65	87520000	-97,5	-97,9
66	87530000	-98,3	-98,6
67	87540000	-98	-97,6
68	87550000	-97,8	-97,8
69	87560000	-97,1	-97,5
70	87570000	-99,6	-98,5
71	87580000	-97,7	-97,9
72	87590000	-97,6	-97,8
73	87600000	-98,9	-98,3
74	87610000	-97,3	-98
75	87620000	-98,7	-98,9
76	87630000	-97,6	-97,9
77	87640000	-98,3	-98,4
78	87650000	-98,4	-98,4

Note

You can even have Microsoft Excel (or another spreadsheet program) draw the trace: Mark the table containing the measurement data (e.g. frequency and level points) and call up the **Chart Wizard**.

Creating screen shots

The 9100 Data Exchange Software also offers a Tool for directly producing screen shots of the software screen displayed on the 9102. Using the Screen Dump tool you can easily create screen shots, save them as image files, copy them to the clipboard as well as print them directly.

In order to create screen shots proceed as follows:

- 1 Select **Instrument > Screen Dump**, or press **Ctrl+N**, or click on the icon in the menu bar: . The Screen Dump window is displayed.
- 2 In order to display the screen currently shown on the 9102 in the Screen Dump window click on **Read Screen**. The screen originating from the 9102 will be displayed in the Screen Dump window as follows.

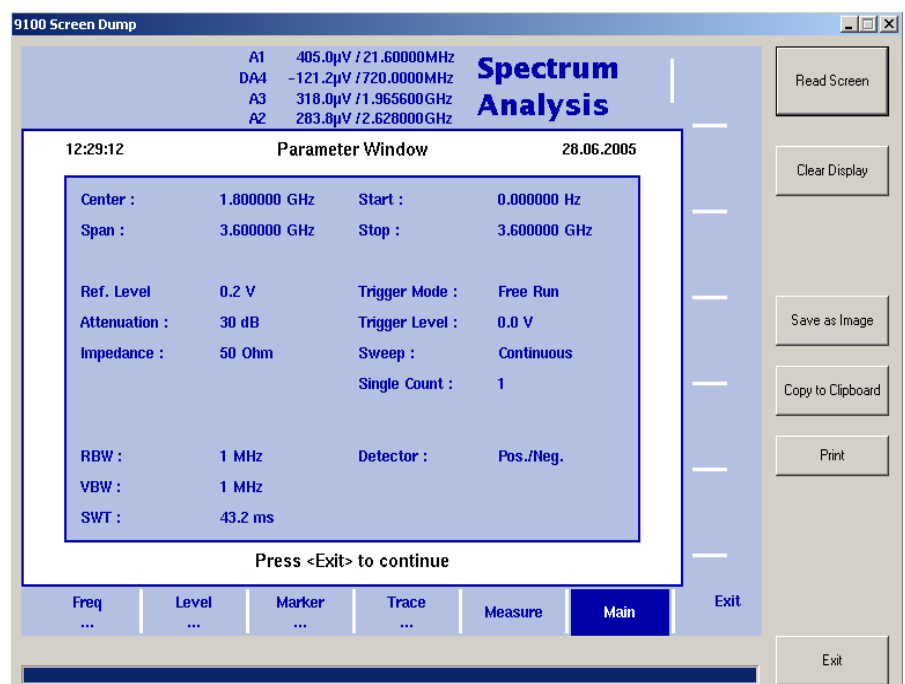

- 3 In order to save the screen shot as an image file click on **Save as Image**. A file selection box appears ("Save image file").
- 4 Select a directory, a file name to save the measurement trace and a file format, and confirm by pressing **ENTER**. The trace data are stored as a graphics file in the selected location.
- 5 In order to copy the screen shot for further usage in other applications click on **Copy to Clipboard**.
- 6 In order to print the screen shot directly from the Screen Dump tool click on **Print**.

NOTE

For best results it is recommended to use a local printer as opposed to a printer connected to a network.

- 7 If you intend to create another screen shot, click on **Clear Display** and proceed as described.
- 8 To close the Screen Dump tool click on **Exit**.

Working with measurement results

To open a measurement trace that has been previously loaded from the PC, select **File > Open**.

This will open a file selector box from which you can select a directory and a trace file.

Adding markers

The 9102 already provides up to six markers; the marker positions are stored and transferred together with the trace. You can use markers on trace A and trace B.

In addition to these static markers, you can use additional dynamic markers on the PC to read out the level values at any displayed frequency. Up to ten markers per trace are possible.

In order to enable or disable markers on the PC proceed as follows:

- 1 Select **View > Select Trace Markers**. You can also right-click on the screen to open a right-click menu and choose **Select Trace Markers**. The Select Trace Marker window is displayed.

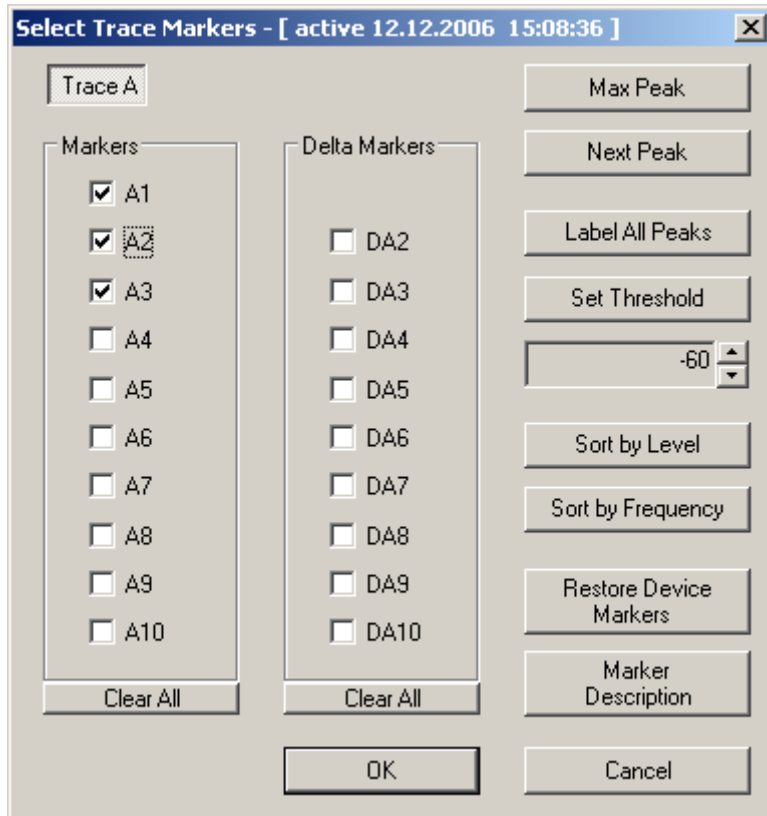

- Carry out one or several of the following steps:
 - To enable a marker select the required marker by checking the relevant control box in the Marker area (A1 to A10 or B1 to B10). To enable a delta marker check the relevant control box in the Delta Marker area (DA2 to DA10 or DB2 to DB10).
 - To put a marker on the maximum peak click on **Max Peak**.
 - To put a marker on the next peak click on **Next Peak**.
 - To put a marker on all peaks (up to the 10 supported markers) click on **Label All Peaks**.
 - To set a threshold for the Label All Peaks function click on **Set Threshold**. The button label changes to Clear Threshold. Specify your threshold in the field below by clicking on the up and down arrows. the threshold will be displayed as a read line. If you want to remove the limit, click on **Clear Threshold**. After specifying the threshold only peaks above the threshold will be labeled.
 - To enter descriptions for the markers click on Marker Description. A Marker Description window is displayed. Enter the descriptions for the markers set and click on **OK**. Deselect the text in the Show in Trace box on the right-hand side if you do not want the text to appear in the graph. The descriptions will be displayed in the graph with a line connecting the text with the appropriate marker position.

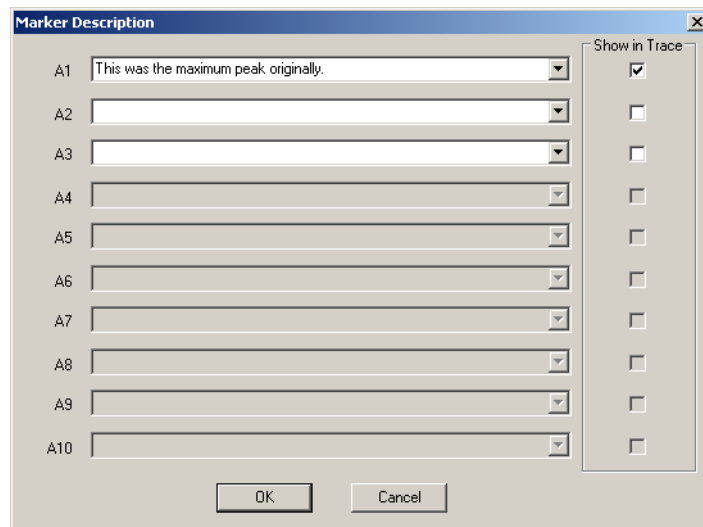

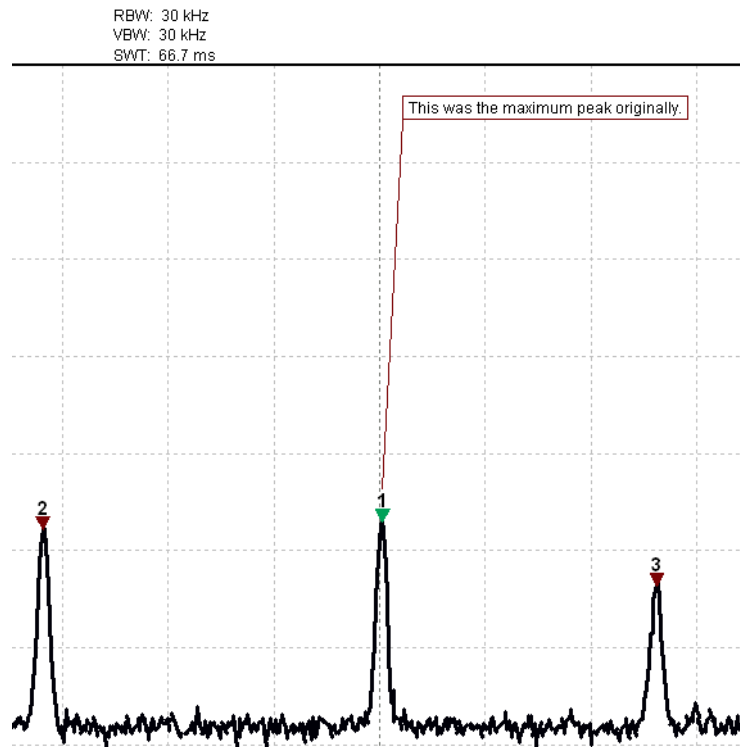

- To move the marker to another frequency, drag it with the mouse. Alternatively, use the **LEFT/RIGHT** (slow movement) or **UP/DOWN** (larger steps) cursor keys on the keyboard.

Change the reference level and scale

In order to change the reference level and scale proceed as follows:

- 1 Select **View > Level**. The Level window is displayed.
- 2 Use the up and down arrows of the Ref. field to specify the reference level.
- 3 Specify the scale in the Scale field
- 4 In the Level Unit field you can select a unit from the dropdown list.

Using a grid

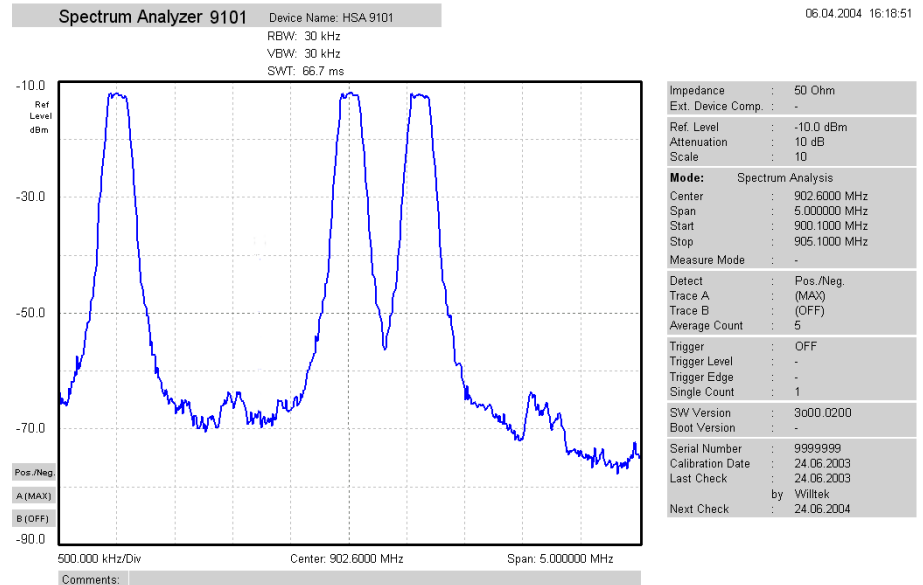

The grid of vertical and horizontal lines can be switched on and off with **View > Grid**. You can also right-click on the screen to open a right-click menu and select **Grid**. The grid is the same as on the 9102, i.e. it consists of eight horizontal and ten vertical rows.

Entering text

You can add text to the trace and store it with the measurement. This way, you can add valuable information about the conditions of the measurement. The comment text will be printed and saved with the graph but not exported to a graphics or text file.

- 1 Select **View > Comment**.
 A "Comment" window opens, allowing you to enter text.
- 2 Enter your text (three lines maximum), then click on **Save** to have the 9100 Data Exchange Software store the text along with the measurements.

Defining and loading limit templates

One of the powerful features of the 9102 is its capability to compare the measurements with predefined limits. The limits are set in the form of a template that the actual measurement passes or fails. The template can be defined on the PC using the 9100 Data Exchange Software and then loaded to the 9102; the 9102 can hold up to 99 templates.

Editing a template may be easier when an example of a typical result trace is available. The Limits Editing menu of the 9100 Data Exchange Software cannot only show the actual limit curve (template) but also an example trace that is stored on the PC.

Templates can be applied to measurements in both the spectrum and the time domain. An example of a limit template in the time domain is the power/time template for GSM phones.

The limits are expressed relative to the grid on the 9102 display, not as absolute values in terms of frequency (or time) and power. This way, you can apply the same template to different power levels and frequencies provided that the scales are as intended.

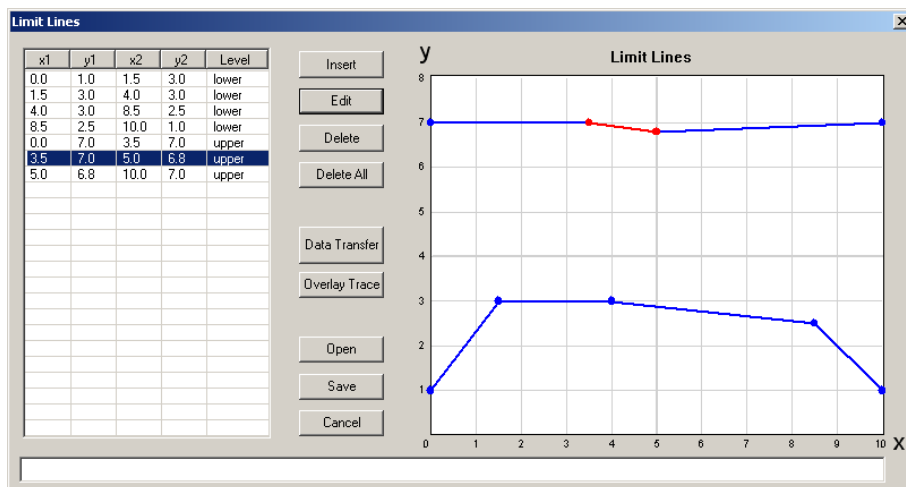

Defining limits

Limits can be defined as a template with an upper and a lower limit curve. Each curve consists of a number of straight lines between points. The Limits menu of the 9100 Data Exchange Software allows you to enter and display such lines.

The limits are expressed relative to the grid on the screen, with eight horizontal and ten vertical lines. The coordinates of each point (in x/y coordinates) correspond to these lines.

To define a new template, proceed as follows:

- 1 In the 9100 Data Exchange Software, select **Tools > Limit Editor...** or click on the icon in the menu bar:  .
 The Limit Lines window is displayed, with a limits coordinates table on the left and the limit lines on the right-hand side.
- 2 To enter a new limit line, press **Insert**.
 A window appears, allowing you to enter the x/y coordinates for two points.

- 3 Select whether you wish to define an upper or lower limit by selecting one of the **Upper Level** and **Lower Level** radio buttons.
- 4 Enter the coordinates for the first point of the limit line (x1, y1).

- 5 Enter the coordinates for the second point determining the limit line (x2, y2). You can also move the limit lines afterwards by dragging them with your mouse.
- 6 Confirm your choice and close the window by selecting **OK**.
The window disappears. The values are entered in the limits table on the left and the limit line is shown in the limit lines graph on the right.
- 7 Enter more limit lines as described above to complete the template according to your requirements.

Changing limit lines

You can change the template by modifying or deleting individual limit lines:

- 1 In the table within the Limit Lines window, click on the line that you want to modify or delete.
The line within the table is highlighted and the corresponding limit line in the graph is shown in red.
- 2 To modify the limits, click on **Edit** or double-click on the row. A dialog box appears, allowing you to change the limits.
To delete a limit line, click on **Delete**.

Alternatively, to change the starting or ending point for an existing limit line, proceed as follows:

- 1 In the graph within the Limit Lines window, click on the starting point of a limit line that you want to modify.
- 2 Point the mouse to the starting or ending point of the limit line, keep the left mouse button pressed and drag the point to its new position and release it there.

Displaying an example trace in the Limits Editing menu

- 1 In the Limit Lines window, select **Overlay Trace**.
A file selection box appears.
- 2 Select a trace file from the default or any other directory, and click on **Open**.
The file selection box disappears and the trace data is displayed in the limit lines box on the right-hand side of the Limit Lines window.

Storing a template on the PC

A template can be stored on the PC, e.g. to allow modifications later or to download it to different 9102 analyzers at any time.

- 1 In the Limit Lines window, select **Save**.
A window opens ("Save Limit Lines").
- 2 Choose a directory and enter a file name to save your limits template.
- 3 Confirm your choice by pressing **ENTER**.
The limits are saved in a file.

Loading a template from the PC

To modify or to load a template to a 9102 that has previously been stored on the PC, proceed as follows:

- 1 In the Limit Lines window, select **Open**.
A file selection window appears ("Open Limits File...").
- 2 Select the directory and the file containing a template file previously stored with the 9100 Data Exchange Software.
- 3 Confirm your choice by pressing **ENTER**.
The limits are loaded to the limits table and the graph. You can now modify the limits (see section "[Changing limit lines](#)" above), or download the limits to the 9102.

Transferring a template to the 9102

- 1 Define a template or load it from the PC's hard disk as described above.
- 2 Ensure that the PC is connected to the 9102 either via RS-232 or LAN.
- 3 Select **Data Transfer**.
If the template (characterized by its limit lines) is not yet stored you will be asked if you want to save it on the PC harddisk. If you choose not to store the template, your changes will be lost.
The Data Transfer window is displayed with the Limits tab active.

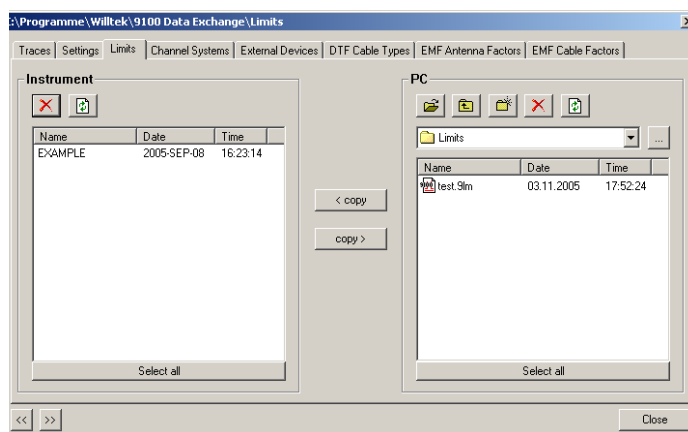

- 4 Choose a limits file (or multiple files) on the PC side (right-hand side) of the Data Transfer window, and click on **< copy**.
The 9102 will, if not done so previously, ask whether to connect to the 9102. In that case, follow the instructions in section "[Connecting the PC to the 9102](#)" on page 216.
The file name on the 9102 will only carry the first 11 characters of the file name that was used on the PC.

If a limits file on the PC has been selected for transfer and a limits file with the same name already exists on the 9102, the 9100 Data Exchange Software will display a pop-up box with the file name in question in the header bar, and offer several possibilities:

- Click on **Yes** if you want to overwrite the file in question.
- Click on **No** to cancel transmission of the file in question.
- Click on **Yes to All** to copy all files to the 9102, irrespective of duplicate file names.
- Click on **No to All** to prevent overwriting of all files with duplicate file names.
- Click on **Rename** to enter a new file name applying to that file when downloaded to the 9102.
- Click on **Cancel** to cancel transmission of all files, no matter whether file names already exist on the 9102 or not.

The 9100 Data Exchange Software will indicate when the download has been completed successfully.

- 5 On the 9102, press **ESCAPE** to return to local mode. You can then start using the limits template.

Defining and loading external coupling parameters

The 9102 Handheld Spectrum Analyzer can compensate a defined gain or attenuation introduced by external equipment between the device under test and the 9102. The coupling can be specified in the 9100 Data Exchange Software; several files for different devices can be defined, stored and downloaded to the 9102. Furthermore, on installing the 9100 Data Exchange Software two files with external coupling parameters are automatically saved to the Extdev directory of your 9100 Data Exchange directory on the PC. Once downloaded, the compensation of effects from external devices can be switched on and off at any time. The 9102 takes the coupling factor into account before presenting the measurement result.

Gain and attenuation are frequency-dependent in most cases; therefore the 9100 Data Exchange Software allows you to enter interpolation points to cover the frequency-dependent coupling factor over the whole frequency range of interest.

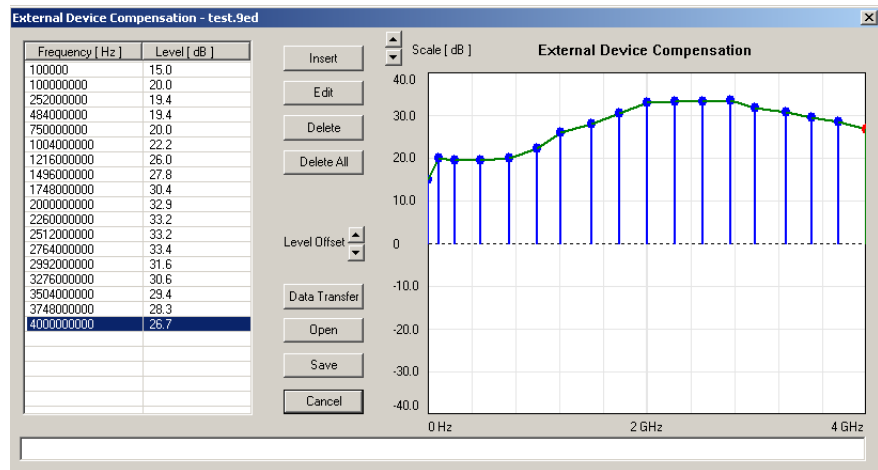

Defining the external coupling factor

- 1 Open the External Device Compensation menu by selecting **Tools > External Device Editor...** or by pressing **Alt+E** or by clicking on the icon: 
- 2 To enter an interpolation point, select **Insert**. A dialog box appears, allowing you to enter frequency and level.
- 3 Enter the frequency, select a unit (from hertz to gigahertz) and enter the coupling factor (in dB). **Positive factors indicate signal attenuation, negative factors indicate gain in the signal line.**
- 4 Close the box by pressing **OK** and repeat the last two steps with as many interpolation points as available. The frequency-dependent compensation curve appears on the right-hand side as values are entered.
- 5 If you want to change a factor, either select a line from the table on the left-hand side and click on **Edit** to change the values numerically, or point with the mouse to an interpolation point in the graph on the right and drag it to a new position.
- 6 To move the whole interpolation curve up or down in steps of 1 dB, click on the **Level Offset** arrow buttons.
- 7 When completed, save the device compensation values in a file on the PC: Click on **Save**, enter a file name and confirm by clicking on **Save**.
- 8 Press **Cancel** to close the External Device Compensation window.

Loading an external coupling loss file to the 9102

One or more files with external coupling loss data can be transferred to the 9102 and reside in the internal memory of the 9102. They will not be taken into account until they are activated (see "[Compensating gains and losses](#)").

- 1 Select **Instrument > Data Transfer (Ctrl-D)**, or in the External Device Compensation menu, select **Data Transfer**. The Data Transfer menu opens.

- 2 In the External Devices tab, select a directory and file(s) on the right-hand side and press **< copy**.
The selected files are transferred to the 9102.

Managing communication systems for channel power measurements

Measurements in channel power mode imply that a communication system with predefined channel numbers and associated frequencies has been defined. The 9102 comes with a few systems preinstalled; more systems are available for download to the 9102 in the 9100 Data Exchange Software, for example Wireless LAN, Bluetooth and TETRA. For a complete listing of the communication systems available in the 9100 Data Exchange Software refer to ["Predefined channel power communication systems" on page 345](#). Here you will also find a listing of the communication systems preinstalled on the 9102. Other systems' data can be easily entered on the PC using the 9100 Data Exchange Software. Each set of system data can be stored in a separate file; one or multiple files can be downloaded to the 9102. For downloading and copying system files between the PC and the 9102, see section ["Managing files on the PC and on the 9102"](#) below. Once data are stored in the 9102, they can be used as described in section ["Operating in channel power mode" on page 82](#).

Editing communication system parameters on the PC

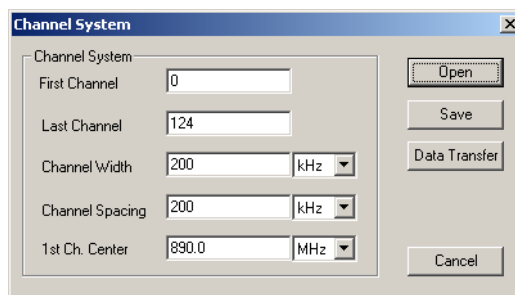

- 1 Select **Tools > Channel System Editor...** or by pressing **Alt+C** or by clicking on the icon in the menu bar: . The Channel System menu appears.
- 2 If you want to edit a communication system that is already stored on the PC, press **Open**, select the appropriate directory and file, and press **ENTER** or click on **Save**.
- 3 Enter the first and the last valid channel number of the system.
- 4 In the Channel Width line, enter the measurement bandwidth (separate input fields for value and unit).
- 5 In the Channel Spacing line, enter the frequency spacing (including the unit) between consecutive channel numbers.
- 6 Enter the carrier frequency (including the unit) corresponding to the first channel number in the **1st Ch. Center** line.
- 7 Click on **Save**.
A dialog box appears, allowing you to enter a name for the file in which the channel system parameters of the communication system shall be stored.

- 8 Enter a file name and press **ENTER** or click on **Save**. The data are stored and the dialog box disappears.
- 9 To transfer the data to the 9102, press **Data Transfer**. To close the Channel System window, press **Cancel**.

Managing cable types for distance-to-fault measurements

If the 9130 VSWR/DTF Reflection Measurement Option is installed and activated on your 9102 the VSWR/Tracking... menu offers the additional measurement modes reflection, distance to fault and cable loss. Distance-to-fault measurements focus on the cables within an antenna system, measuring the reflection arising along it in order to detect and locate weak connectors, cable kinks, water ingress and other cable-related problems.

For these measurements Willtek provides predefined cable parameter files for most known coaxial cables used for antenna installations. These parameter files come with the 9100 Data Exchange Software and can easily be uploaded to the 9102. For rare cable types you can also define the cable settings manually and transfer them to the 9102.

For further details on distance-to-fault measurements refer to [Chapter 10 "Distance to Fault Operation"](#).

NOTE

The functionality described in the following sections is specifically dedicated to the usage of the 9130 VSWR/DTF Reflection Measurement Option. If this option is not installed and activated on your 9102 this functionality is of no practical use as cable types cannot be transferred to the instrument in this case.

Uploading predefined cable types to the instrument

In order to upload the predefined parameter files delivered with your 9100 Data Exchange Software to the 9102 proceed as follows:

- 1 Select **Instrument > Data Transfer** and select the Cable Type register. You can also select **Tools > DTF Cable Type Editor...** and click on the Data Transfer button. A selection window for the cable type transfer is displayed.

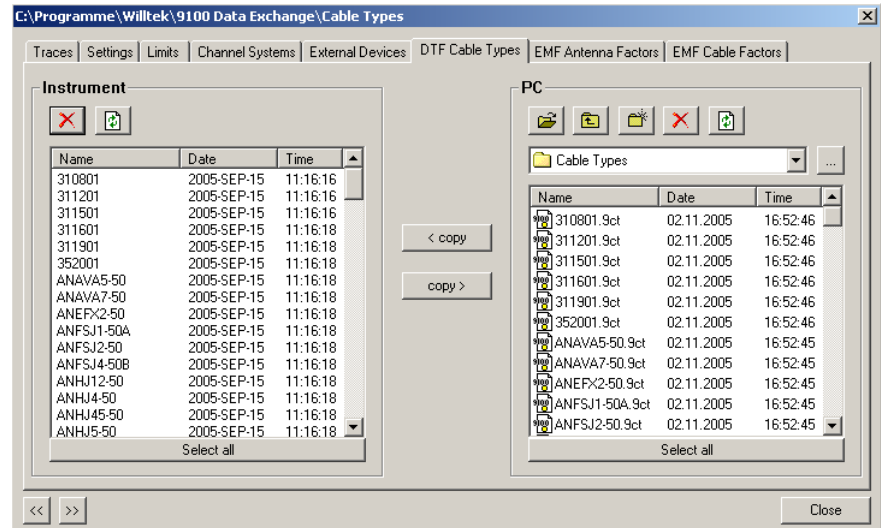

- 2 In the PC area on the righthand side the cable types stored on the PC are displayed. Select the cable types you intend to upload to the instrument and click on **< copy**. The selected cable types will be transferred to your 9102.

NOTE

It is recommended to transfer only the cable types needed for measurements to the 9102 for practical reasons. If you have too many cable types stored on your 9102 finding the one required for your distance-to-fault measurement could be time-consuming.

Defining cable types

In order to define a new cable type not available in the predefined parameter files proceed as follows:

- 1 Select **Tools > DTF Cable Type Editor ...** or **Alt+C** or click on the icon in the menu bar: . The Cable Type window is displayed.
- 2 Enter the cable characteristics: cable dielectric, cable velocity factor, cable attenuation and cable cutoff frequency. For details on the values to be entered here refer to the manufacturer's information. For general information on cable parameters refer to ["Specifying cable settings" on page 160](#).
- 3 Click on **Save** to save the cable type on your PC. A file selection window is displayed. The file will be saved with the file extension *.ct.

You can now transfer the defined cable type to your 9102 using the same procedure as described in ["Uploading predefined cable types to the instrument" on page 236](#).

Transferring cable types from the 9102

You can also transfer cable types defined on the 9102 to your PC. The procedure is virtually identical to the one described in ["Uploading predefined cable types to the instrument" on page 236](#). The cable types stored on the 9102 are displayed in the Instrument area on the lefthand side of the data transfer screen. Simply select the required cable types and click on **copy >**.

Managing antenna factors for EMF measurements

The antenna is one of the most important factors for EMF measurements. For antenna calibration a correction table containing k factors is required. These factors are proportionality factors which correct the antenna's frequency response and help to convert the measured power or voltage to field strength or power density. Using the k factor table the measured level is converted into the relevant quantities.

Willtek delivers its measurement antennas in conjunction with the appropriate correction factor tables. Using the 9100 Data Exchange Software you can transfer the k factor tables delivered to your instrument. You can also use the 9100 Data Exchange Software to collect the correction data for antennas from other vendors and transfer them to your 9102.

For a detailed description of EMF measurements and the relevant antenna types refer to [Chapter 12 "EMF \(EMI\) Operation"](#).

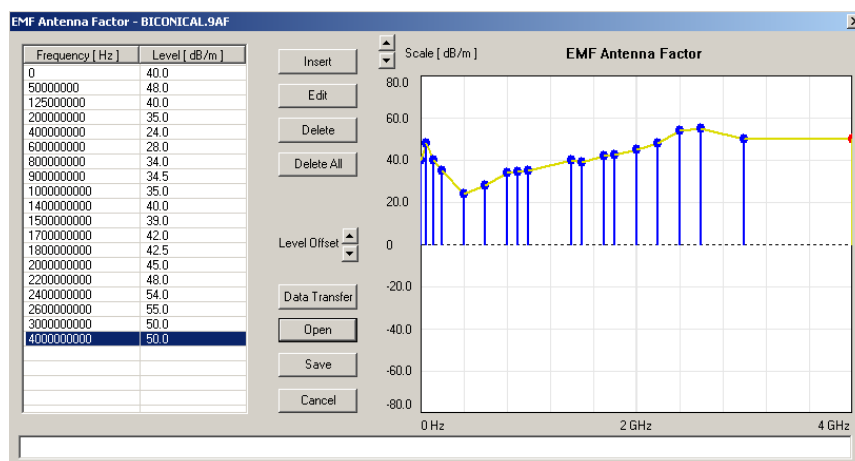

NOTE

The functionality described in the following sections is specifically dedicated to the usage of the 9131 EMF Measurement Option. If this option is not installed and activated on your 9102 this functionality is of no practical use.

Defining an antenna factor

- 1 Open the EMF Antenna Factor menu by selecting **Tools > EMF Antenna Factor Editor...** or by pressing **Alt+A** or by clicking on the icon in the menu bar: .
- 2 To enter an interpolation point, select **Insert**.
A dialog box appears, allowing you to enter frequency and level.
- 3 Enter the frequency, select a unit (from hertz to gigahertz) and enter the coupling factor (in dB). **Positive factors indicate signal attenuation, negative factors indicate gain in the signal line.**
- 4 Close the box by pressing **OK** and repeat the last two steps with as many interpolation points as available.
The frequency-dependent compensation curve appears on the right-hand side as values are entered.
- 5 If you want to change a factor, either select a line from the table on the left-hand side and click on **Edit** to change the values numerically, or point with the mouse to an interpolation point in the graph on the right and drag it to a new position.
- 6 To move the whole interpolation curve up or down in steps of 1 dB, click on the **Level Offset** arrow buttons.
- 7 When completed, save the antenna factor values in a file on the PC: Click on **Save**, enter a file name and confirm by clicking on **Save**.
- 8 Press **Cancel** to close the EMF Antenna Factor Editor window.

Loading antenna factor files to the 9102

One or more antenna factor files can be transferred to the 9102 and reside in the internal memory of the 9102. They will not be taken into account until they are activated.

- 1 Select **Instrument > Data Transfer (Ctrl-D)**, or in the EMF Antenna Factor Editor menu, select **Data Transfer**.
The Data Transfer menu opens.
- 2 In the EMF Antenna Factors tab, select a directory and file(s) on the right-hand side and press **< copy**.
The selected files are transferred to the 9102.

Managing cable factors for EMF measurements

If you are using an extension cable for your EMF measurement setup, for example in order to mount an antenna on a tripod and turning device, cable attenuation has to be taken into account by using the appropriate cable correction factors on the 9102. You maintain and edit these cable factors within the 9100 Data Exchange software. In order to employ them during EMF measurements on the 9102 you can then transfer them to your instrument.

For further details on the usage of cable factors during EMF measurements refer to [Chapter 12 "EMF \(EMI\) Operation"](#).

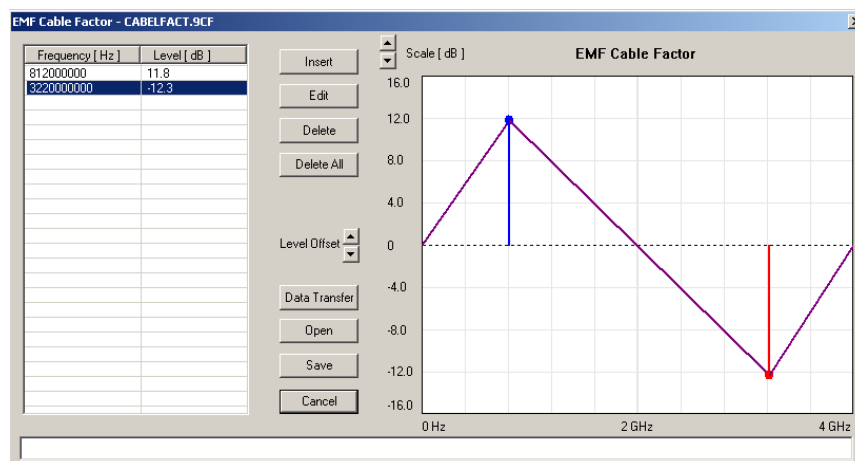

NOTE

The functionality described in the following sections is specifically dedicated to the usage of the 9131 EMF Measurement Option. If this option is not installed and activated on your 9102 this functionality is of no practical use.

Defining a cable factor

- 1 Open the EMF Cable Factor menu by selecting **Tools > EMF Cable Factor Editor...** or by pressing **Alt+F** or by clicking on the icon in the menu bar: .
- 2 To enter an interpolation point, select **Insert**.
A dialog box appears, allowing you to enter frequency and level.
- 3 Enter the frequency, select a unit (from hertz to gigahertz) and enter the coupling factor (in dB). **Positive factors indicate signal attenuation, negative factors indicate gain in the signal line.**
- 4 Close the box by pressing **OK** and repeat the last two steps with as many interpolation points as available.
The frequency-dependent compensation curve appears on the right-hand side as values are entered.
- 5 If you want to change a factor, either select a line from the table on the left-hand side and click on **Edit** to change the values numerically, or point with the mouse to an interpolation point in the graph on the right and drag it to a new position.

- 6 To move the whole interpolation curve up or down in steps of 1 dB, click on the **Level Offset** arrow buttons.
- 7 When completed, save the antenna factor values in a file on the PC: Click on **Save**, enter a file name and confirm by clicking on **Save**.
- 8 Press **Cancel** to close the EMF Cable Factor Editor window.

Loading cable factor files to the 9102

One or more cable factor files can be transferred to the 9102 and reside in the internal memory of the 9102. They will not be taken into account until they are activated.

- 1 Select **Instrument > Data Transfer (Ctrl-D)**, or in the EMF Cable Editor menu, select **Data Transfer**.
The Data Transfer menu opens.
- 2 In the **EMF Cable Factors** tab, select a directory and file(s) on the right-hand side and press **< copy**.
The selected files are transferred to the 9102.

Working with settings

The 9102 allows to store and recall settings (see section "[Working with stored settings](#)" on page 49). This can be useful when you want to perform measurements under exactly the same conditions as at an earlier time. With the 9100 Data Exchange Software, you can transfer the settings from a 9102 to the PC for backup purposes or to replicate the settings to another 9102. Another useful application is to manipulate settings on the PC; this is easily done because the settings file is editable and the format consists of SCPI commands. Changing or adding a setting is equivalent to changing or adding a line in the settings file.

Exchanging a settings file between 9102 and PC

The settings stored on the 9102 can be copied to the PC with the 9100 Data Exchange Software. Use the Settings tab within the Data Transfer utility to copy files between the PC and the 9102. See section "[Managing files on the PC and on the 9102](#)" on page 242 for more details.

Changing 9102 settings on the PC

Take the following steps to change and amend a settings file for later transfer and usage on the 9102.

- 1 In the 9100 Data Exchange Software, select **Tools > Setting Editor** or press **Alt+S**.
The 9100 Settings box appears.
- 2 Click on **Open** to open an existing settings file on the PC. The Open Settings File... dialog box appears.
- 3 Select the directory and settings file that you want to modify, and click on **Open**. An additional program window with the Microsoft Windows text editor Notepad opens, and the selected file is displayed.

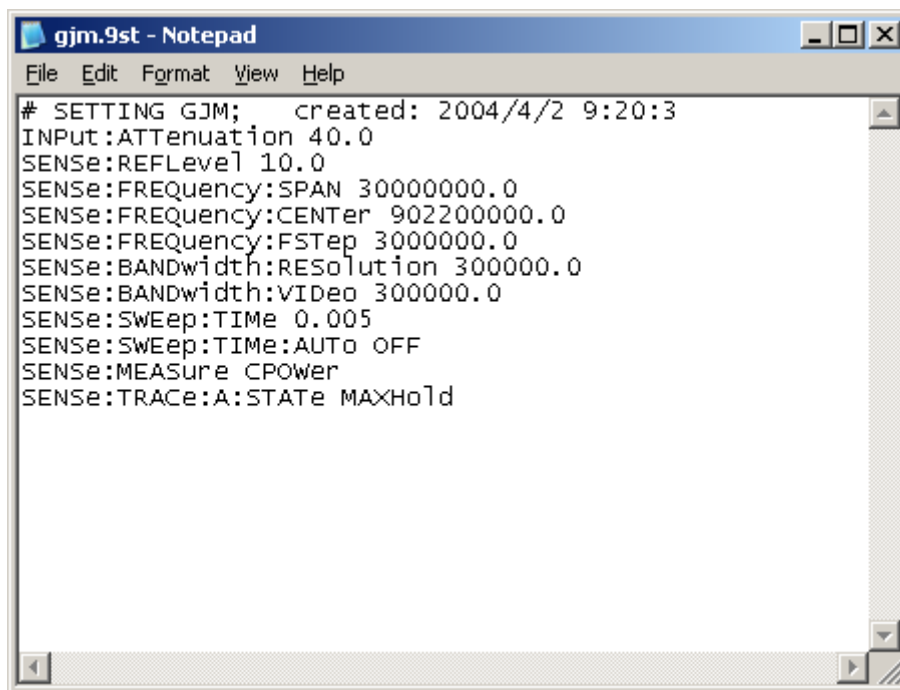

- 4 Modify or add lines with SCPI commands for the desired settings. Refer to chapter "[SCPI Command Reference](#)" on page 247 for correct syntax and value range of the parameters.
- 5 Save and close the file within Notepad, and return to 9100 Data Exchange Software to transfer the file to the 9102.

Managing files on the PC and on the 9102

There are various types of settings which can be maintained from the PC using the 9100 Data Exchange Software. This section explains how data can be transferred between the 9102 and the PC, maintained and deleted.

File types and directory structure

Each type of setting stored on the PC has a preferred file name extension and directory for different sets of parameters. The table below summarizes this file structure.

Table 17 Configuration file types

Type	File names	Directory
Traces	*.9tr	9100 Data Exchange\Traces
Modified traces saved on the PC	*.9tm	9100 Data Exchange\Traces
Settings	*.9st	9100 Data Exchange\Settings
Limits	*.9lm	9100 Data Exchange\Limits
Systems	*.9sy	9100 Data Exchange\System

Table 17 Configuration file types

Type	File names	Directory
External device	*.9ed	9100 Data Exchange\Extdev
DTF cable type	*.9ct	9100 Data Exchange\Cable Types
EMF antenna factor	*.9af	9100 Data Exchange\Antenna Factor
EMF cable factor	*.9cf	9100 Data Exchange\Cable Factor

Starting the File Manager

The files on the PC and on the 9102 can easily be selected, copied and deleted via the Data Transfer window.

- 1 In the 9100 Data Exchange Software, select **Instrument > Data Transfer** (or **Ctrl-D**).
The Data Transfer window is displayed.

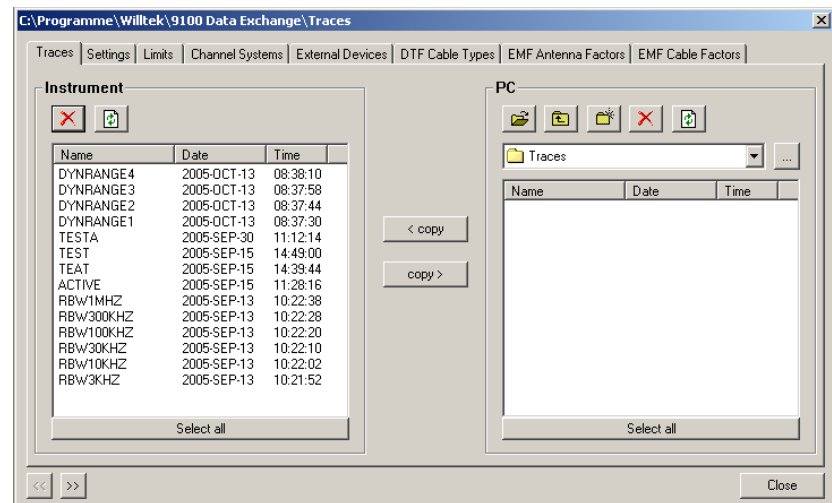

- 2 Select the appropriate tab (Traces, Settings, Limits, Systems, Ext. Device) either by clicking on it with the mouse, or by moving the tab selection with the << and >> buttons.
The window displays the appropriate files available on the 9102 on the left-hand side, and the appropriate files available on the PC on the right-hand side. Files on the PC have a file extension and can be stored on any drive and in any directory; there are no directories available on the 9102.

NOTE

File names on the 9102 only carry 11 characters. When copying a file from the PC to the 9102 that has more than 11 characters, the file name will be truncated. Only trace files with the extension *.9tr can be transferred to the 9102.

Copying configuration files from the 9102 to the PC

Files can be copied in both directions.

- 1 Select a PC directory where the file shall be stored or from which it shall be copied.
- 2 Select one or several files for copying, either on the PC or on the 9102.
- 3 Press **< copy** to transfer the files from the PC to the 9102.

or

Press **copy >** to transfer files to the PC.

If a file on one side has been selected for transfer and a file with the same name already exists on the other, the 9100 Data Exchange Software will display a pop-up box with the file name in question in the header bar, and offer several possibilities:

- Click on **Yes** if you want to overwrite the file in question.
- Click on **No** to cancel transmission of the file in question.
- Click on **Yes to All** to copy all files, irrespective of duplicate file names.
- Click on **No to All** to prevent overwriting of all files with duplicate file names.
- Click on **Rename** to enter a new file name applying to that file when transferred.

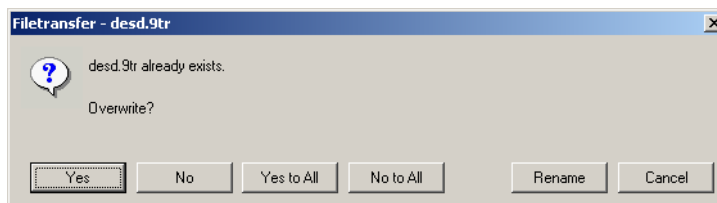

- 4 Click on **Cancel** to cancel transmission of all files, no matter whether file names already exist on the receiving side or not.

Deleting files

- 1 To delete a file either on the 9102 or on the PC, select (highlight) the file name first. Several files may be selected concurrently by holding the **Shift** or **Ctrl** key pressed while selecting individual files.
- 2 Click on the Delete button  above the files marked for deletion. A box appears asking, "Are you sure to delete the selected items?"
- 3 Click on **Yes** to confirm deletion. The selected files are removed.

Including the GPS position in the trace

The location at the time of the measurement can be recorded and viewed using the 9168 GPS Receiver Option. This requires the option to be installed; see also ["Connecting the GPS receiver" on page 36](#).

For the location to be calculated, the GPS receiver must be switched on as described in ["Enabling the GPS receiver" on page 37](#).

In the trace display of the 9100 Data Exchange Software, the display of the GPS coordinates can be enabled or disabled. Select **View > GPS** to toggle between GPS coordinates being displayed or not. Longitude, latitude and altitude are displayed on the lower right-hand side.

The resulting trace display looks about as follows:

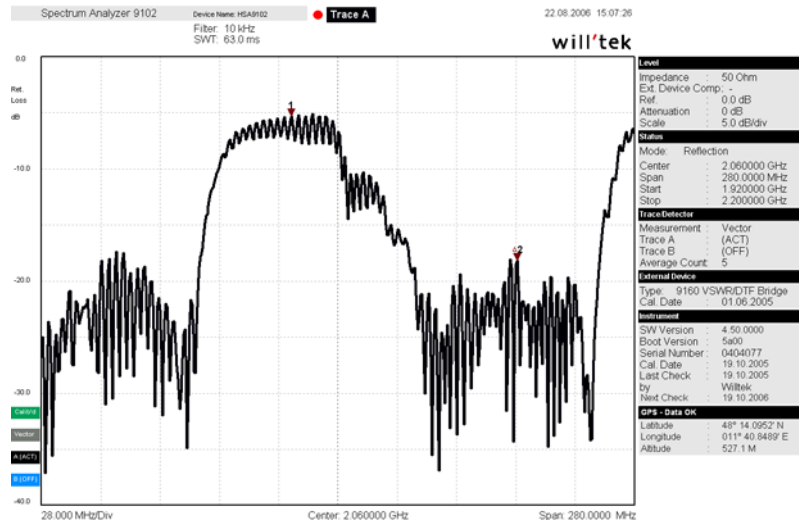

See also notes in section ["Logging the current position \(GPS-assisted\)"](#) on page 36.

SCPI Command Reference

16

This chapter provides a reference list of commands for remote control of the 9102 Handheld Spectrum Analyzer. Topics discussed in this chapter are as follows:

- "Overview" on page 248
- "General commands" on page 248
- "System commands" on page 254
- "Sense commands" on page 260
- "Input commands" on page 286
- "MMemory commands" on page 287
- "Instrument commands" on page 299
- "fDisplay commands" on page 304
- "Calculate commands" on page 308
- "Format commands" on page 317
- "Service commands" on page 318
- "SCPI errors" on page 321

Overview

The command set of the 9102 Handheld Spectrum Analyzer follows the SCPI standard and is broken down into the following subsystems:

- General commands
- System commands
- Sense commands
- Input commands
- Memory commands
- Display commands
- Calculate commands
- Format commands

Each keyword in the command can be used either in its long or its short form. Uppercase letters are used to indicate the short-form command syntax. Within one keyword, either the short form or the full version can be used, but not a mix.

The syntax can be used to form either a command or a query (with a question mark behind the command form). Many SCPI commands have either a command form or a query form, but not both.

Please refer to the ["Index of SCPI Commands" on page 337](#) for an alphabetical list of commands.

General commands

:REBoot

Syntax	:REBoot
Parameters	There are no parameters.
Command	Reboots the 9102. The current settings are not affected by this command.
Query	There is no query form of this command available.
Example	:REBoot

:HCOPY[:IMMediate]

Syntax	:HCOPY[:IMMediate]
Parameters	There are no parameters.
Command	Starts a printout over the serial port. For further informations see command :SYSTem:PRINTer:TYPE.
Query	There is no query form of this command available.
Example	:HCOPY

***CAL**

Syntax	*CAL?
Parameters	There are no parameters.
Command	The command form is not available.
Query	Returns the date of the last calibration by Willtek in the format yyyy, mm,dd.
Example	*CAL? Returns 2004, 04, 01.

***OPT**

Syntax	*OPT?
Parameters	There are no parameters.
Description	The command form is not available.
Query	
Example	*OPT?

***CLS**

Syntax	*CLS
Parameters	There are no parameters.
Command	Resets the entire status reporting system: <ul style="list-style-type: none"> - The service register will be cleared (all bits will be set to 0). - The event status register will be cleared (all bits will be set to 0). - The error message queue will be emptied. - All event-type registers will be cleared.
Query	There is no query form of this command available.

***IDN**

Syntax	*IDN?
Parameters	There are no parameters.
Command	There is only a query form of this command available.
Query	Returns a string, containing the following information: <ul style="list-style-type: none"> - manufacturer's name - name of the device - serial number - software revision number All parameters are separated by commas. Note: In times of company mergers and acquisitions, it is a good idea to check the name of the device, not the manufacturer's name which may change between software updates. This does not preclude any name changes at Willtek but rather applies to instrumentation in general.
Example	*IDN? returns: "WILLTEK, 9102, 0104012, 1.00"

***RST**

Syntax	*RST
Parameters	There are no parameters.
Command	Resets the entire test set. All parameters, limits etc. will be set to the internally pre-defined default values.
Query	There is no query form available.

***WAI**

Syntax	*WAI
Parameters	There are no parameters.
Description	Postpones the execution of a command until all commands issued previously have been completed
Query	There is no query form of this command available.

***OPC**

Syntax	*OPC?
Parameters	There are no parameters.
Command	Only the query form is available.
Query	Waits until the previous command is completed. In addition, the query returns the Operation Complete flag which is 1 in the successful case.

Commands affecting the event status register

The event status register contains eight bits. The meaning of these bits is outlined in the table below. The commands working on the event status register are described below the table.

Bit	Decimal	Meaning
7	128	Power on – this bit is always set.
6	64	User Request – a 1 on this position indicates that the 9102 is no longer controlled by remote commands but by user interaction.
5	32	Command error – this bit indicates that a SCPI command error occurred (SCPI error codes 100 to 199).
4	16	Execution error – is set after a SCPI execution error did occur (SCPI error codes 200 to 299).
3	8	Device-dependent error – this bit indicates that a device-specific SCPI error did occur (SCPI error codes 300 to 399).
2	4	Query error – is set after a SCPI query error occurred (SCPI error codes 400 to 499).

1	2	Request control – this bit is reserved for future use.
0	1	Operation complete flag – is set as soon as the execution of a command has been completed.

***ESE**

Syntax	*ESE <int1>
Parameters	int1 is an integer. The valid range is from 0 to 255 (8 bits).
Command	Sets the enable filter (mask) of the event status register. int1 is the decimal representation of the binary mask. The mask and the current contents of the event status register will be ANDed. If the result is not zero, then bit 5 of the Service register will be set.
Query	The query form reads out the enable filter (mask) currently set and returns its binary representation in a string.
Example	*ESE 128 As soon as power has been switched on, bit 7 (Power on) will be set. ANDed with the mask 128 , a binary 1 will occur and thus bit 5 of the service register will be set.

***ESR**

Syntax	*ESR?
Parameters	There are no parameters.
Command	There is only a query form of this command available.
Query	Returns the decimal representation of the current contents of the event status register in a string. Note: This register is self-destructive, i.e. its contents will be cleared after reading.
Example	After power-on, the *ESR? query will return "128". This means that bit 7 is set and all the other bits of the event status register are 0. The command will clear the event status register and a subsequent *ESR? query will return "0".

Commands affecting the service register

The service register represents the highest level within the report structure of the 9102.
The service register contains eight bits.
If any of the bits 0 to 5 or 7 is set, the summary status bit (bit 6) of the service register will be set as well.

NOTE

The service register is self-destructive. This means that its contents will be cleared after reading.

Bit	Decimal	Meaning
7	128	OPERational status summary. When this bit is set, an event within the general operation register group (e.g. the 9102 is waiting for a trigger) passed all filters.
6	64	Summary status bit. This bit will always be set as soon as any other bit of the service register has been set.
5	32	Event status summary. When this bit is set, an event within the event status register group (e.g. an error occurred) passed all filters.
4	16	Message available. This bit will be set to 1 as soon as a query has been completed and measurement results are available.
3	8	QUESTionable status summary. If this bit is set, an event within the general questionable status register group (e.g. 'value out of range') passed all filters.
2	4	Error queue status. When this bit is set, the error queue contains error messages. Up to 10 error messages can be logged in the error queue. The error queue can be read out, using the :SYSTem:ERRor? query.
1	2	Remote command completed. This bit will be set to 1 after a remote (SCPI) command has been completed. Note: When the 9102 receives a SCPI command, it will block any further input readings until the command has been completed.

***SRE**

Syntax	*SRE <int1>
Parameters	int1 is an integer. The valid range is from 0 to 255 (8 bits).
Command	Sets the enable filter (mask) for the service register. int1 is the decimal representation of this binary mask. The mask and the current contents of the service register will be ANDed.
Query	The query form reads out the mask currently set and returns its binary representation in a string.
Example	*SRE 68 As soon as an error occurs, bits 2 and 6 of the service register will be set. ANDed with the mask (68), a binary 1 will be the result.

***STB**

Syntax	*STB?
Parameters	There are no parameters.

Command	There is only a query form of this command available.
Query	Returns the decimal representation of the current contents of the service register in a string. Note: This register is self-destructive, i.e. its contents will be cleared after reading.
Example	A <code>*STB?</code> command returns <code>"68"</code> . The return value of 68 (= 64 + 4) means that an error occurred (4).

System commands

With the system commands, the internal settings of the 9102 Handheld Spectrum Analyzer can be changed.

:SYSTem:DATE

Syntax	:SYSTem:DATE <int1>,<int2>,<int3>
Parameters	<p>intx are three integers.</p> <p>The minimum value for int1 is 1998, the maximum is 2100. The default value is 1998.</p> <p>The minimum value for int2 is 1, the maximum is 12. The default value is 1.</p> <p>The minimum value for int3 is 1, the maximum is 31. The default value is 1.</p>
Command	<p>Sets the system date. This command uses the following format: <i>yyyy</i>,<i>mm</i>,<i>dd</i> where</p> <p><i>yyyy</i> stands for the four digits of the year (<i>int1</i>),</p> <p><i>mm</i> gives the current month (<i>int2</i>),</p> <p><i>dd</i> represents the day of the current month (<i>int3</i>).</p>
Query	Reads and returns the current system date in a string, using the format explained above.
Example	<pre>:SYST:DATE 2001,7,6</pre> <p>Sets the system date to the July 6, 2001.</p>

:SYSTem:TIME

Syntax	:SYSTem:TIME <int1>,<int2>,<int3>
Parameters	<p>intx are three integers.</p> <p>The minimum value for int1 is 0, the maximum is 23. The default value is 0.</p> <p>The minimum value for int2 is 0, the maximum is 59. The default value is 0.</p> <p>The minimum value for int3 is 0, the maximum is 59. The default value is 0.</p>
Command	<p>Sets the system time. This command uses the following format: <i>hh</i>,<i>mm</i>,<i>ss</i> where</p> <p><i>hh</i> stands for the two digits of the current hour, using a 24 hour time format (<i>int1</i>),</p> <p><i>mm</i> gives the current minute (<i>int2</i>) and,</p> <p><i>ss</i> represents the seconds of the system time (<i>int3</i>).</p>
Query	Reads and returns the current system time in a string, using the format explained above.
Example	<pre>:SYST:TIME?</pre> <p>String returned in this example: "14,56,05" meaning roughly four minutes to 3 pm.</p>

:SYSTem:COMMunicate:LOCal

Syntax	:SYSTem:COMMunicate:LOCal
Parameters	There are no parameters.
Command	<p>Sets up the 9102 to allow manual operation on the front panel during SCPI operation.</p> <p>Notes:</p> <ul style="list-style-type: none">- This command may be used e.g. to allow interactive alignment procedures in a production flow.- The instrument can also be set to local mode by pressing the Escape function key on the front panel.

Query	There is no query form of this command available.
Example	:SYSTem:COMM:LOC

:SYSTEM:COMMunicate:ECHO

Syntax	:SYSTem:COMMunicate:ECHo <PredefExpr>
Parameters	PredefExpr is one of the following predefined expressions: ON OFF. Default is ON.
Command	This command determines how the Willtek 9102 acts after executing a SCPI command. If echo is set to ON, there will be a response. Either "ok", if the execution was successful or "ERR" if an error occurred. The echo-on mode is preferred for entering interactive commands. If echo is set to OFF, there will be no response to a SCPI command. In this case it is possible to check with the *OPC? query, when the SCPI command is finished and the Willtek 9102 is ready to receive the next command.
Query	Reads and returns the current echo setting.
Example	:SYST:COMM:ECH ON Returns the following string: "ok" All subsequent commands returns "ok" or "ERR". :SYST:COMM:ECH? Returns the following string: "ON" :SYST:COMM:ECH OFF Returns nothing, all subsequent commands return nothing.

:SYSTEM:COMMunicate:ETHernet?

Syntax	:SYSTem:COMMunicate:ETHernet?
Parameters	There are no parameters.
Command	There is solely a query form of this command available.
Query	Returns ON, if the Willtek 9100 is connected to a local area network (LAN) via TCP/IP connector, otherwise returns OFF.
Example	:SYSTem:COMM:ETH? String returned in this example: "OFF"

:SYSTEM:COMMunicate:ETHernet:IPAddress

Syntax	:SYSTem:COMMunicate:ETHernet:IPAddress <int1>,<int2>,<int3>,<int4>
Parameters	intx are four integers. The minimum value for all integers is 0, the maximum is 255. The default value is 0.
Command	This command sets the IP address of the Willtek 9102 to the parameter values.
Query	Reads and returns the current setting of the IP address as explained above.
Example	SYST:COMM:ETH:IPAD 192,16,16,114 sets the IP address to a defined value.

:SYSTem:COMMunicate:ETHernet:TNAME

Syntax	:SYSTem:COMMunicate:ETHernet:TNAME <string>
Parameters	string is a string only containing the device name of the Willtek 9102.
Command	This command sets the device name of the Willtek 9102. It can be used to announce a symbolic device name for the 9102, if the network supports DHCP (Dynamic Host Configuration Protocol).
Query	Reads and returns the current setting of the device name as explained above.
Example	SYST:COMM:ETHernet:TNAME "TARGET9104" sets the device name to a defined value.

:SYSTem:COMMunicate:ETHernet:SUBNetmask

Syntax	:SYSTem:COMMunicate:ETHernet:SUBNetmask <int1>,<int2>,<int3>,<int4>
Parameters	intx are four integers. The minimum value for all integers is 0, the maximum is 255. The default value is 0.
Command	This command sets the subnet mask of the Willtek 9102 to the parameter values. Setting a subnet mask may speed up the traffic on the Ethernet. Note: This command is supported from software version 2.00 on.
Query	Returns the current setting of the subnet mask as explained above.
Example	SYST:COMM:ETH:SUBN 255,255,255,255 sets the subnet mask to a defined value.

:SYSTem:COMMunicate:ETHernet:PORT

Syntax	:SYSTem:COMMunicate:ETHernet:PORT <int>
Parameters	int defines the TCP/IP port address of the Willtek 9102. The address must be in the range from 1024 to 65535. Default value is 49200.
Command	This command sets the port address on which the Willtek 9102 can be controlled via LAN to a new value.
Query	Reads and returns the current setting of the port used by TCP/IP as explained above.
Example	SYST:COMM:ETHernet:PORT 49200 sets the TCP/IP port address to its default.

:SYSTem:COMMunicate:ETHernet:TERMinator

Syntax	:SYSTem:COMMunicate:ETHernet:TERMinator <PredefExpr>
Parameters	PredefExpr is one of the following predefined expressions: CRLF LF CR. Default is CRLF.
Command	Sets the terminator characters, which are appended to every SCPI respond from the Willtek 9102 LAN interface.
Query	Reads and returns the current terminator setting for the LAN interface.
Example	:SYST:COMM:ETH:TERM CR :SYST:COMM:ETH:TERM? Returns the following string: "CR"

:SYSTem:COMMunicate:SER:BAUDrate

Syntax	:SYSTem:COMMunicate:SER:BAUDrate <int1>
Parameters	int1 is an integer. The minimum value for int1 is 300, the maximum value is 57600. The default value for int1 is 57600. Valid values are 300, 1200, 2400, 4800, 9600, 19200, 38400 and 57600.
Command	Sets the data rate for the serial port. Only the data rate can be changed; all other parameters are fixed. The number of bits per character is set to 8, the number of stop bits is set to 1 and parity is set to NO.
Query	Reads and returns the serial interface data rate currently set.
Example	:SYST:COMM:SER:BAUD 9600 :SYST:COMM:SER:BAUD? String returned in this example: "9600".

:SYSTem:COMMunicate:SER:TERMinator

Syntax	:SYSTem:COMMunicate:SER:TERMinator <PredefExpr>
Parameters	PredefExpr is one of the following predefined expressions: CRLF LF CR. Default is CRLF.
Command	Sets the terminator characters, which are appended to every SCPI response from the Willtek 9102 serial interface.
Query	Reads and returns the current terminator setting for the serial interface.
Example	:SYST:COMM:SER:TERM LF :SYST:COMM:SER:TERM? Returns the following string: "LF"

:SYSTem:ERRor [:NEXT] ?

Syntax	:SYSTem:ERRor [:NEXT] ?
Parameters	There are no parameters.
Command	There is solely a query form of this command available.
Query	Returns the oldest unread error message from the internal error queue of the Willtek 9102. The queue entry returned will be a string (text). The maximum length of the text is 255 characters. Note: A list of error messages can be found in section "SCPI errors" on page 321 .
Example	*RESET :SYSTem:ERRor:NEXT? String returned in this example: -113, "Undefined header"

:SYSTem:ERRor:COUNT?

Syntax	:SYSTem:ERRor:COUNT?
Parameters	There are no parameters.
Command	There is solely a query form of this command available.

Query	Returns the number of unread error messages in the internal error queue of the Willtek 9102. The string returned will contain one integer. The maximum number of errors stored internally is 10.
Example	:SYSTem:ERRor:COUNT? String returned in this example: "0" This means that there are no unread error messages in the error queue.

:SYSTem:ERRor:CODE[:NEXT]?

Syntax	:SYSTem:ERRor:CODE[:NEXT]?
Parameters	There are no parameters.
Command	There is solely a query form of this command available.
Query	Returns the code of the oldest unread error message in the internal error queue of the Willtek 9102. The string returned will contain one integer (and no text). Note: A list of error messages can be found in section " SCPI errors " on page 321.
Example	*RESET :SYSTem:ERRor:CODE? String returned in this example: "-113" This means that an undefined header (*RESET) was received.

:SYSTem:ERRor:CODE:ALL?

Syntax	:SYSTem:ERRor:CODE:ALL?
Parameters	There are no parameters.
Command	There is solely a query form of this command available.
Query	Returns the error codes of all unread error messages in the internal error queue of the Willtek 9102. The string returned will contain a maximum of 100 integers, separated by commas. Note: A list of error messages can be found in section " SCPI errors " on page 321.
Example	:SYSTem:ERRor:CODE:ALL? String returned in this example: "-113,-112,0,0,0,0,0,0,0,0" This means that there were two unread error messages in the error queue.

:SYSTem:DNAME

Syntax	:SYSTem:DNAME <string1>
Parameters	string1 is a string (text) parameter. The maximum length of string1 is 11 characters.
Command	Sets a user-definable device name for the 9102 to use this unique name on protocols.
Query	Reads and returns the device name set on this 9102.
Example	:SYSTem:DNAME "Develop5" :SYST:DNAME? String returned in this example: "Develop5"

:SYSTem:OPTions

Syntax	:SYSTem:OPTions <string1>
Parameters	string1 is a string (text) parameter. The maximum length of string1 is 25 characters.
Command	Enables or disables a software option on the Willtek 9102 with the appropriate option key string1.
Query	There is no query form available.
Example	:SYSTem:OPTions "00172663845433" Enables the option corresponding to the key.

:SYSTem:SCReendump:COLor?

Syntax	:SYSTem:SCReendump:COLor? <int1>
Parameters	int1 is a integer in the range of 0 to 255.
Command	There is only the query form available.
Query	Returns the RGB color value (in hexadecimal) of the given color palette entry. Max. 256 palette entries are available.
Example	:SYST:SCR:COL? 5 String returned in this example: "a800a8"

:SYSTem:SCReendump:LINE?

Syntax	:SYSTem:SCReendump:LINE? <int1>
Parameters	int1 is a integer in the range of 0 to 479.
Command	There is only the query form available.
Query	Returns one pixel line (of 480) of the screen as pairs of hexadecimal values.
Example	:SYST:SCR:LIN? 345 String returned in this example: "0201420fff00f600010f0201080b1e0f1e0b"

:SYSTem:SCReendump:REMOte

Syntax	:SYSTem:SCReendump:REMOte <PredefExpr>
Parameters	PredefExpr is one of the following predefined expressions: ON OFF. Default is ON.
Command	This command removes the Remote display when it is set to OFF. This is useful for screen dumps.
Query	Reads and returns the current setting.
Example	:SYST:SCR:REM OFF :SYST:SCR:REM? Returns the following string: "OFF"

:SYSTem:PRINter:TYPE

Syntax	:SYSTem:PRINter:TYPE <PredefExpr>
Parameters	PredefExpr is one of the following predefined expressions: OFF PCL. Default is OFF.
Command	This command set the printer type for a hardcopy of the display. At the moment, only PCL capable printer like HP Laserjet are supported. The printer has to be connected to the serial port (normaly with a RS232/Centronics converter), therefore remote control of printer output is only possible via TCP/IP. The serial interface has to be set to the maximum possible baudrate of the printer/converter with command SYSTem:COM-Municate:SER:BAUDrate. The output to the printer is started with command HCOPy[:IMMediate].
Query	Reads and returns the current setting.
Example	:SYSTem:PRINter:TYPE PCL :SYSTem:PRINter:TYPE? Returns the following string: "PCL"

:SYSTem:PRINter:BAUDrate

Syntax	:SYSTem:PRINter:BAUDrate <int1>
Parameters	int1 is an integer. The minimum value for int1 is 300, the maximum value is 57600. The default value for int1 is 19200. Valid values are 300, 1200, 2400, 4800, 9600, 19200, 38400 and 57600.
Command	Sets the data rate for the serial port if a printer is connected. The print output can be started with HCOPy. Only the data rate can be changed; all other parameters are fixed. The number of bits per character is set to 8, the number of stop bits is set to 1 and parity is set to NO.
Query	Reads and returns the serial interface data rate currently set.
Example	:SYST:PRINter:BAUD 9600 :SYST:PRINter:BAUD? String returned in this example: 9600.

Sense commands

These commands affect the spectrum analyzer settings, start measurements and return results.

:SENSe:BANDwidth:RESolution

Syntax	:SENSe:BANDwidth:RESolution <real1>
Parameters	real1 is a floating point real number. The minimum value for real1 is 100, the maximum value 1000000. real1 can be set as $1 \cdot 10^n$ or $3 \cdot 10^n$. The default value for real1 is 1000000.
Command	This command sets the resolution bandwidth of the 9102, in Hertz.
Query	Reads and returns the current setting.

Example :SENSe:BANDwidth:RESolution 300000
 :SENSe:BANDwidth:RESolution?
The value returned in this example is: "300000".

:SENSe:BANDwidth:RESolution:AUTO

Syntax :SENSe:BANDwidth:RESolution:AUTO <PredefExpr>

Parameters PredefExpr is one of the following predefined expressions: ON | OFF.
Default is ON.

Command Switches the automatic selection of the bandwidth resolution on or off. If switched on, the 9102 selects the resolution bandwidth depending on the current span, video bandwidth, and sweep time.

Query Reads and returns the current setting.

Example :SENSe:BANDwidth:RESolution:AUTO ON
 :SENSe:BANDwidth:RESolution:AUTO?
Returns the following string: "ON"

:SENSe:BANDwidth:VIDeo

Syntax :SENSe:BANDwidth:VIDeo <real1>

Parameters real1 is a floating point real number.
The minimum value for real1 is 10, the maximum value 1000000.
Possible values are:
10, 100, 300, 1000, 3000, 10000, 30000, 100000, 300000, 1000000.
The default value for real1 is 1000000.

Command Sets the video bandwidth of the 9102. The unit of real1 is Hertz.

Query Reads and returns the current setting.

Example :SENSe:BANDwidth:VIDeo 300000
 :SENSe:BANDwidth:VIDeo?
The value returned in this example is: "300000".

:SENSe:BANDwidth:VIDeo:AUTO

Syntax :SENSe:BANDwidth:VIDeo:AUTO <PredefExpr>

Parameters PredefExpr is one of the following predefined expressions: ON | OFF | .
Default is ON.

Command Switches the automatic selection of the video bandwidth on or off. If switched on, the 9102 selects the video bandwidth depending on the current span, resolution bandwidth, and sweep time.

Query Reads and returns the current setting.

Example :SENSe:BANDwidth:VIDeo:AUTO OFF
 :SENSe:BANDwidth:VIDeo:AUTO?
Returns the following string: "OFF"

:SENSe:FREQuency:CENTer

Syntax	:SENSe:FREQuency:CENTer <real1>
Parameters	real1 is a floating point real number. The minimum value for real1 is 5000, the maximum value 7500000000. real1 can be set in multiples of 1000. The default value for real1 is 1800000000.
Command	Sets the center frequency of the 9102, in Hertz. When a new center frequency is selected, this affects the start and stop frequencies, leaving the span unchanged so long as the new start and stop frequencies do not exceed the limits of the 9102.
Query	Returns the current setting.
Example	:SENSe:FREQuency:CENTer 1500000000 :SENSe:FREQuency:CENTer? The value returned in this example is: "1500000000".

:SENSe:FREQuency:SPAN

Syntax	:SENSe:FREQuency:SPAN <real1>
Parameters	real1 is a floating point real number. The minimum value for real1 is 0, the maximum value 7500000000. The minimum resolution possible for real1 is 1000. The default value for real1 is 3600000000.
Command	Sets the frequency span, i.e. the measured bandwidth, in Hertz. A new frequency span setting will leave the center frequency unchanged but affect start and stop frequencies; only if the new start or stop frequency exceeds a limit of the 9102, the center frequency will be changed accordingly.
Query	Reads and returns the current setting.
Example	:SENSe:FREQuency:SPAN 1500000000 :SENSe:FREQuency:SPAN? The value returned in this example is: "1500000000".

:SENSe:FREQuency:SPAN:FULL

Syntax	:SENSe:FREQuency:SPAN:FULL
Parameters	There are no parameters.
Command	Sets the 9102 to the maximum supported frequency span. This command affects start, stop and corresponding center frequency. Note: If you set the span to 0, the 9102 will perform measurements in the time rather than the frequency domain.
Query	There is no query form of this command available.
Example	:SENS:FREQ:SPAN:FULL Sets the start frequency of the 9102 to 0 and the stop frequency to 4 GHz (or 7.5 GHz if the frequency extension option is installed).

:SENSe:FREQuency:START

Syntax	:SENSe:FREQuency:START <real1>
Parameters	real1 is a floating point real number. The minimum value for real1 is 0, the maximum value 7500000000. The minimum resolution possible for real1 is 1000. The default value for real1 is 0.
Command	Sets the start frequency of the 9102, in Hertz. This command leaves the span as is but affects the center frequency and the stop frequency.
Query	Reads and returns the current setting.
Example	:SENSe:FREQuency:START 1500000000 :SENSe:FREQuency:START? The value returned in this example is: "1500000000".

:SENSe:FREQuency:STOP

Syntax	:SENSe:FREQuency:STOP <real1>
Parameters	real1 is a floating point real number. The minimum value for real1 is 10000, the maximum value 7500000000. The minimum resolution possible for real1 is 1000. The default value for real1 is 3600000000.
Command	Sets the stop frequency of the measured bandwidth, in Hertz. This command leaves the span unchanged but affects the center frequency and the start frequency.
Query	Reads and returns the current setting.
Example	:SENSe:FREQuency:STOP 2500000000 :SENSe:FREQuency:STOP? The value returned in this example is: "2500000000".

:SENSe:FREQuency:STOP:MAX

Syntax	:SENSe:FREQuency:MAX?
Parameters	There are no parameters.
Command	There is only the query form available.
Query	Returns the maximum stop frequency supported by the instrument at hand.
Example	:SENS:FREQ:STOP:MAX?

:SENSe:FREQuency:MODE

Syntax	:SENSe:FREQuency:MODE <PredefExpr>
Parameters	PredefExpr is one of the following predefined expressions: CSPan SSTop SSPAN. Default is CSPan.
Command	Defines which frequency mode is active. Three modes are available: Center-Span, Start-Stop, Start-Span.
Query	Returns the current setting.
Example	:SENSe:FREQuency:MODE CSPan :SENSe:FREQuency:MODE? Returns the following string: "CSPan"

:SENSe:FREQuency:FSTep

Syntax	:SENSe:FREQuency:FSTep <real1>
Parameters	real1 is a floating point real number. The minimum value for real1 is 0, the maximum value 1000000000. The minimum resolution possible for real1 is 1000. The default value for real1 is 360000000.
Command	Sets the step size for the center frequency setting using the cursor keys in manual mode.
Query	Reads and returns the current setting.
Example	:SENSe:FREQuency:FSTep 2.5E6 :SENSe:FREQuency:FST? Value returned in this example: 2500000

:SENSe:FREQuency:FSTep:AUTO

Syntax	:SENSe:FREQuency:FSTep:AUTO <PredefExp>
Parameters	PredefExp is one of the following predefined expressions: ON OFF. Default is ON.
Command	Enables or disables the automatic selection of the step size for the center frequency setting using the cursor keys in manual mode.
Query	Reads and returns the current setting.
Example	:SENSe:FREQuency:FSTep:AUTO ON :SENSe:FREQuency:FSTep:AUTO? Returns the following string: "ON"

:SENSe:CPOWer:SPAN

Syntax	:SENSe:CPOWer:SPAN <PredefExp>
Parameters	PredefExp is one of the following predefined expressions: FULL SINGLE. Default is FULL.
Command	Sets the channel power display mode of the 9102. FULL selects the whole system spectrum. SINGLE displays the spectrum of the selected channel.
Query	Reads and returns the current setting.
Example	:CPOWer:SPAN SINGLE :SENSe:CPOWer:SPAN? Returns the following string: "SINGLE"

:SENSe:CPOWer:CHANnel

Syntax	:SENSe:CPOWer:CHANnel <int1>
Parameters	int1 is an integer. The minimum value for int1 is 0, the maximum is 1000000. The default value is 0.
Command	Sets the actual channel number which is displayed in SINGLE and FULL mode.
Query	Reads and returns the current setting.

Example :SENSe:CPOWer:CHANnel 50
 :SENSe:CPOWer:CHANnel?
The value returned in this example is: "50".

:SENSe:CPOWer:OBW

Syntax :SENSe:CPOWer:OBW <int1>

Parameters int1 is a integer. The minimum value for int1 is 5, the maximum is 99. The default value for int1 is 90.

Command Sets the percentage value for which the 9102 shall determine the occupied bandwidth (channel power mode).

Query Reads and returns the current setting.

Example :SENSe:CPOWer:OBW 20
 :SENSe:CPOWer:OBW?
The value returned in this example is: "20"

:SENSe:CPOWer:MEASure

Syntax :SENSe:CPOWer:MEASure <PredefExpr>

Parameters PredefExpr is one of the following predefined expressions: CPOWer | ACPR | OBW. Default is CPOWer.

Command Starts measurements of the type described by PredefExpr.

Query Reads and returns the current setting.

Example :SENSe:CPOWer:MEASure ACPR
 :SENSe:CPOWer:MEASure?
Returns the following string: "ACPR".

:SENSe:SWEep:TIME

Syntax :SENSe:SWEep:TIME <real1>

Parameters real1 is a floating point real number. The minimum value for real1 is 0.0, the maximum value 250.0. The minimum resolution possible for real1 is 0.0001. The default value for real1 is 0.0432.

Command Sets the sweep time, i.e. the measurement time to cover the full frequency span. real1 is the time in seconds.

Query Reads and returns the current setting.

Example :SENSe:SWEep:TIME 0.3
 :SENSe:SWEep:TIME?
The value returned in this example is: "0.3".

:SENSe:SWEep:TIME:AUTO

Syntax :SENSe:SWEep:TIME:AUTO <PredefExpr>

Parameters PredefExpr is one of the following predefined expressions: ON | OFF. Default is ON.

Command	Switches the automatic selection of the sweep time on or off. If turned on, the 9102 will decide on the best sweep time depending on the current settings of span, resolution bandwidth and video bandwidth.
Query	Reads and returns the current setting.
Example	:SENSe:SWEep:TIME:AUTO ON :SENSe:SWEep:TIME:AUTO? Returns the following string: "ON".

:SENSe:SWEep:STATe

Syntax	:SENSe:SWEep:STATe <PredefExpr>[,<int1>]
Parameters	PredefExpr is one of the following predefined expressions: CONTinuous SINGLe HOLD. Default is CONTinuous. int1 is an optional integer. It is only valid for SINGLe sweeps. The minimum value for int1 is 1, the maximum is 999. The default value is 1.
Command	Sets the measurement display mode of the 9102. CONTinuous selects repetitive measurements. SINGLe lets the 9102 perform and display one (or a limited number of) measurement(s). The optional second parameter indicates how often a sweep will be performed. HOLD immediately stops any ongoing measurement.
Query	Reads and returns the current setting.
Example	:SENSe:SWEep:STATe SINGLe :SENSe:SWEep:STATe? Returns the following string: "SINGLe".

:SENSe:TRIGger

Syntax	:SENSe:TRIGger <PredefExpr>
Parameters	PredefExpr is one of the following predefined expressions: OFF VIDEo. Default is OFF.
Command	Sets the trigger mode of the 9100. OFF means no trigger is active. VIDEo activates the trigger at chosen level.
Query	Reads and returns the current setting.
Example	SENSe:TRIGger VIDEo :SENSe:TRIGger? Returns the following string: "VIDEo".

:SENSe:TRIGger:LEVel

Syntax	:SENSe:TRIGger:LEVel <real1>
Parameters	real1 is a floating point real number. The minimum value for real1 is -100, the maximum value 30.0. The minimum resolution possible for real1 is 0.1. The default value is -40.
Command	Sets the trigger level which is active, if SENSe:TRIGger is set to VIDEo. real1 is the level in dBm.
Query	Reads and returns the current setting.

Example :SENSe:TRIGger:LEVel -10
 :SENSe:TRIGger:LEVel?
The value returned in this example is: "-10".

:SENSe:TRIGger:EDGE

Syntax :SENSe:TRIGger:EDGE <PredefExpr>

Parameters PredefExpr is one of the following predefined expressions:
 POSitive|NEGative. Default is POSitive.

Command Sets either the positive or the negative slope for the trigger.

Query Reads and returns the current setting.

Example SENSe:TRIGger:EDGE NEGative
 :SENSe:TRIGger?
Returns the following string: "NEGative".

:SENSe:DEMod[:MODulation]

Syntax :SENSe:DEMod[:MODulation] <PredefExpr>

Parameters PredefExpr is one of the following predefined expressions: OFF|AM|FM.
 Default is OFF.

Command Sets the demodulation mode, which can be off, AM (amplitude modulation) or FM
(frequency modulation). FM demodulation is performed in a 30 kHz bandwidth.

Query Reads and returns the current setting.

Example :SENSe:DEMod FM
 :SENSe:DEMod:MODulation?
Returns the following string: "FM"

:SENSe:DEMod:DEMod

Syntax :SENSe:DEMod:DEMod <PredefExpr>

Parameters PredefExpr is one of the following predefined expressions:
 PERManent|ATMarker.
 Default is PERManent.

Command Sets the demodulation permanent to center frequency or at marker.

Query Reads and returns the current setting.

Example :SENSe:DEMod:DEMod PERManent
 :SENSe:DEMod:DEMod?
Returns the following string: "PERManent "

:SENSe:DEMod:VOLume

Syntax :SENSe:DEMod:VOLume <int1>

Parameters int1 is an integer. The minimum value for int1 is 0, the maximum is 100. The
 default value for int1 is 50.

Command Sets the volume of the demodulated signal in percent.

Query Reads and returns the current setting.

Example	<pre>:SENSe:DEMod:VOLume 20 :SENSe:DEMod:VOLume? The value returned in this example is: "20".</pre>
----------------	---

:SENSe:DEMod:DURation

Syntax	<code>:SENSe:DEMod:DURation <real1></code>
Parameters	<code>real1</code> is a floating point real number. The minimum value for <code>real1</code> is 0, the maximum value 10. The minimum resolution is 0.001. The default value is 2.
Command	Sets the duration of the demodulated signal in seconds.
Query	Reads and returns the current setting.
Example	<pre>:SENSe:DEMod:DURation 10 :SENSe:DEMod:DURation? The value returned in this example is: "10".</pre>

:SENSe:DETEctor:FUNction

Syntax	<code>:SENSe:DETEctor:FUNction <PredefExpr></code>
Parameters	<code>PredefExpr</code> is one of the following predefined expressions: <code>POSNeg</code> <code>SAMPlE</code> <code>POSitive</code> <code>NEGative</code> . Default is <code>POSNeg</code> .
Command	Defines which measurement values shall be displayed. The 9102 takes far more measurements than can be displayed on the screen, so several results are summarized into one. <code>POSNeg</code> indicates both the maximum and minimum values for each frequency point in the form of a straight vertical line between these values. <code>SAMPlE</code> lets the 9102 randomly select one of the measurement values for each frequency point. <code>POSitive</code> lets the 9102 pick the highest value. <code>NEGative</code> lets the 9102 select the lowest value.
Query	Reads and returns the current setting.
Example	<pre>:SENSe:DETEctor:FUNction SAMPlE :SENSe:DETEctor:FUNction? Returns the following string: "SAMPlE".</pre>

:SENSe:TRACe:A[:STATe]

Syntax	<code>:SENSe:TRACe:A[:STATe] <PredefExpr></code>
Parameters	<code>PredefExpr</code> is one of the following predefined expressions: <code>ACTual</code> <code>MAXHold</code> <code>MINHold</code> <code>HOLD</code> <code>AVG</code> <code>OFF</code> . Default is <code>ACTual</code> .
Command	Sets the display mode for Trace A. <code>ACTual</code> shows measurement by measurement. <code>MAXHold</code> displays the maximum value for each frequency point over all the measurements. <code>MINHold</code> shows the minimum value for each frequency point over all the measurements. <code>HOLD</code> stops the measurement immediately. <code>AVG</code> displays, for each frequency point, an average value over all the measurements. <code>OFF</code> switches the trace off.

Query	Reads and returns the current settings.
Example	:SENSe:TRACe:A MAXHold :SENSe:TRACe:A:STATe? Returns the following string: "MAXHold".

:SENSe:TRACe:A:FETCh?

Syntax	:SENSe:TRACe:A:FETCh? <PredefExpr>
Parameters	PredefExpr is one of the following predefined expressions: ALL MINimum MAXimum FREQuency FMINimum FMAXimum.
Command	There is solely a query form of this command available.
Query	Reads and returns the data of trace A depending on the parameter: Param ALL returns: <min>,<max>,<freq>,<min>,<max>,<freq>, Param MIN returns: <min>,<min>, Param MAX returns: <max>,<max>, Param FREQ returns: <freq>,<freq>, Param FMIN returns: <min>,<freq>,<min>,<freq>, Param FMAX returns: <max>,<freq>,<max>,<freq>,
Example	:SENSe:TRACe:A:FETCh? ALL Returns the following string: "1000000.0,-50.3,-45.5,1001000.0,-53.4,-48.2,...".

:SENSe:TRACe:B[:STATe]

Syntax	:SENSe:TRACe:B[:STATe] <PredefExpr>
Parameters	PredefExpr is one of the following predefined expressions: ACTual MAXHold MINHold HOLD AVG OFF. Default is OFF.
Command	Sets the display mode for Trace B. ACTual shows measurement by measurement. MAXHold displays the maximum value for each frequency point over all the measurements. MINHold shows the minimum value for each frequency point over all the measurements. HOLD stops the measurement immediately. AVG displays, for each frequency point, an average value over all the measurements. OFF switches Trace B off.
Query	Reads and returns the current settings.
Example	:SENSe:TRACe:B MAXHold :SENSe:TRACe:B? Returns the following string: "MAXHold".

:SENSe:TRACe:B:FETCh?

Syntax	:SENSe:TRACe:B:FETCh? <PredefExpr>
Parameters	PredefExpr is one of the following predefined expressions: ALL MINimum MAXimum FREQuency FMINimum FMAXimum.
Command	There is solely a query form of this command available.
Query	Reads and returns the data of trace B depending on the parameter: Param ALL returns: <min>,<max>,<freq>,<min>,<max>,<freq>, Param MIN returns: <min>,<min>, Param MAX returns: <max>,<max>, Param FREQ returns: <freq>,<freq>, Param FMIN returns: <min>,<freq>,<min>,<freq>, Param FMAX returns: <max>,<freq>,<max>,<freq>,
Example	:SENSe:TRACe:B:FETCh? ALL Returns the following string: "1000000.0,-50.3,-45.5,1001000.0,-53.4,-48.2,..."

:SENSe:TRACe:AVGFactor

Syntax	:SENSe:TRACe:AVGFactor <int1>
Parameters	int1 is an integer. The minimum value for int1 is 1, the maximum is 125. The default value for int1 is 5.
Command	Sets the trace averaging factor.
Query	Reads and returns the current setting.
Example	:SENSe:TRACe:AVGFactor 10 :SENSe:TRACe:AVGFactor? Value returned in this example: "10".

:SENSe:TRACe:CLEAr

Syntax	:SENSe:TRACe:CLEAr
Parameters	There are no parameters.
Command	Clears the current trace.
Query	There is no query form of this command available.
Example	:SENSe:TRACe:CLEAr

:SENSe:TRACe:COPY

Syntax	:SENSe:TRACe:COPY <PredefExpr>[,<int>]
Parameters	PredefExpr is one of the following predefined expressions: ATOB BTOA.
Command	Copies trace A to B or vice versa.
Query	There is no query form of this command available.
Example	:SENSe:TRACe:COPY ATOB

:SENSe:TRACe:DATA?

Syntax	:SENSe:TRACe:DATA? <PredefExpr>[,<int>]
Parameters	PredefExpr is one of the following predefined expressions: A B which returns Trace A or Trace B.
Command	There is solely a query form of this command available.
Query	First return string: "ALL" or "MINM". "ALL" returns, if minimum and maximum values are identical, e.g. "Max hold" or "Min hold". 501 values returned, no redundant data is sent. "MINM" returns, if minimum and maximum Values are NOT identical, e.g. "ACTUAL" or "Average". 1002 Values returned, the first 501 values are the minimum values and after them follow the maximum values. Second return string: the trace data. Every level value is represented by 3 bytes. The following formula is used to calculate the level value in dBm: Level = Hexvalue / 10 - 200.
Example	:SENSe:TRACe:DATA? A The values returned in this example are: "ALL" , " 38D36F37238B38D3A63A73BC4103A63E33A13CB... "

:SENSe:TRACe:DATA:LIMit

Syntax	:SENSe:TRACe:DATA:LIMit?
Parameters	There are no parameters.
Command	There is solely a query form of this command available.
Query	Reads and returns the Pass/Fail criteria for the recently received trace with SENSe:TRACe:DATA?. There will be returned one of the predefined expressions: PASS FAIL
Example	:SENSe:TRACe:DATA:LIMit? Returns the following string: "PASS"

:SENSe:TRACe:MATH

Syntax	:SENSe:TRACe:MATH?
Parameters	There are no parameters.
Command	There is solely a query form of this command available.
Query	Reads and returns the normalized criteria for the current trace. There will be returned one of the predefined expressions: NA UNNormalIzed NORMAlIzed
Example	:SENSe:TRACe:MATH? Returns the following string: "NORM"

:SENSe:TRACe:MATH:[A|B]

Syntax	:SENSe:TRACe:MATH:[A B] <PredefExpr>
Parameters	PredefExpr is one of the following predefined expressions: OFF SUB-tract NORMAlIze. Default is OFF.
Command	Switches math. function for traces A and B off or to Subtraction or to Normalize.
Query	Reads and returns the current setting.

Example	<pre>:SENSe:TRACe:MATH:A SUB :SENSe:TRACe:MATH:A? Returns the following string: "SUB"</pre>
----------------	---

:SENSe:TRACe:MATH:OFFSet

Syntax	<code>:SENSe:TRACe:MATH:OFFSet <real1></code>
Parameters	<code>real1</code> is a floating point real number.
Command	This command sets the trace offset for the subtracted trace (A-B->A trace).
Query	Reads and returns the current setting.
Example	<pre>:SENSe:TRACe:MATH:OFFSet -20 :SENSe:TRACe:MATH:OFFSet? The value returned in this example is: "-20".</pre>

:SENSe:REFLevel

Syntax	<code>:SENSe:REFLevel <real1></code>
Parameters	<p><code>real1</code> is a floating point real number.</p> <p>The minimum and maximum value for <code>real1</code> depend on the unit set by <code>SENS:REFLevel:UNIT</code>. When the unit is set to dBm, the minimum value is -100, the maximum value is 30. When the unit is set to dBuV, the minimum value is 7, the maximum value is 137. When the unit is set to dBmV, the minimum value is -53, the maximum value is 77. When the unit is set to dBV, the minimum value is -113, the maximum value is 17. The default value for <code>real1</code> is 0 dBm.</p>
Command	This command sets the reference level of the 9102 (0 dB line), in the unit selected with the <code>:SENS:REFLevel:UNIT</code> command.
Query	Reads and returns the current setting.
Example	<pre>:SENSe:REFLevel -50 :SENSe:REFLevel? The value returned in this example is: "-50".</pre>

:SENSe:REFLevel:UNIT

Syntax	<code>:SENSe:REFLevel:UNIT <PredefExpr></code>
Parameters	<p><code>PredefExpr</code> is one of the following predefined expressions: DBM DBUV DBMV DBV V MV UV MW UW . Default is DBM.</p>
Command	Defines the unit for the reference level to logarithmic units (dBm, dBμV, dBmV or dBV) or linear units (V, mV, μV, mW, μW). It also affects the unit in which results (on the vertical axis) are displayed.
Query	Reads and returns the current setting.
Example	<pre>:SENSe:REFLevel:UNIT DBMV :SENSe:REFLevel:UNIT? Returns the following string: "DBMV"</pre>

:SENSe:STATE

Syntax	:SENSe:STATe?
Parameters	There are no parameters.
Command	There is solely a query form of this command available.
Query	Reads and returns the Uncal state.
Example	:SENSe:STATe? Returns the following string: "ON".

:SENSe:MEASure

Syntax	:SENSe:MEASure <PredefExpr>
Parameters	PredefExpr is one of the following predefined expressions: NONE CPOWer ACPR OBW. Default is NONE.
Command	Starts measurements of the type described by PredefExp.
Query	Reads and returns the current setting.
Example	:SENSe:MEASure ACPR :SENSe:MEASure? Returns the following string: "ACPR"

:SENSe:MEASure:OBW

Syntax	:SENSe:MEASure:OBW <int1>
Parameters	int1 is an integer. The minimum value for int1 is 5, the maximum is 99. The default value for int1 is 90.
Command	Sets the percentage value for which the 9102 shall determine the occupied bandwidth (spectrum analyzer mode).
Query	Reads and returns the current setting.
Example	:SENSe:MEASure:OBW 20 :SENSe:MEASure:OBW? The value returned in this example is: "20".

:SENSe:MEASure:CHANnel:WIDTh

Syntax	:SENSe:MEASure:CHANnel:WIDTh <real1>
Parameters	real1 is a floating point real number. The minimum value for real1 is 100000, the maximum value 2000000000. real1 can be set in multiples of 1000. The default value for real1 is 5000000.
Command	Sets the actual channel width in spectrum analyzer mode.
Query	Reads and returns the current setting.
Example	:SENSe:MEASure:CHANnel:WIDTh 150000000 :SENSe:MEASure:CHANnel:WIDTh? The value returned in this example is: "150000000".

:SENSe:MEASure:CHANnel:SPACing

Syntax	<code>:SENSe:MEASure:CHANnel:SPACing <real1></code>
Parameters	<code>real1</code> is a floating point real number. The minimum value for <code>real1</code> is 100000, the maximum value 2000000000. <code>real1</code> can be set in multiples of 1000. The default value for <code>real1</code> is 10000000.
Command	Sets the actual channel spacing in spectrum analyzer mode.
Query	Reads and returns the current setting.
Example	<code>:SENSe:MEASure:CHANnel:SPACing 1500000000</code> <code>:SENSe:MEASure:CHANnel:SPACing?</code> The value returned in this example is: "1500000000".

:SENSe:MEASure:ADJSettings

Syntax	<code>:SENSe:MEASure:ADJSettings</code>
Parameters	There are no parameters.
Command	Adjusts settings in display made with ...CHAN:WIDTh and ...SPACing in the corresponding measure mode CPOWer, ACPR or OBW.
Query	Reads and returns the current setting.
Example	<code>:SENSe:MEASure:ADJSettings</code>

:SENSe:DTF:CLENgtH

Syntax	<code>:SENSe:DTF:CLENgtH <real1></code>
Parameters	<code>real1</code> is a floating point real number. The minimum- and maximum value for <code>real1</code> depends on the unit set by <code>SENS:DTF:CLENgtH:UNIT</code> . When unit is set to <code>m</code> , the minimum value is 1, the maximum value is 2000. When unit is set to <code>ft</code> , the minimum value is 3, the maximum value is 6660. The default value for <code>real1</code> is 1 <code>m</code> .
Command	This command defines the cable length to be tested, in the unit selected with the <code>:SENS:DTF:CLEN:UNIT</code> command.
Query	Reads and returns the current setting.
Example	<code>:SENSe:DTF:CLENgtH 50</code> <code>:SENSe:DTF:CLENgtH?</code> The value returned in this example is: "50".

:SENSe:DTF:CLENgtH:UNIT

Syntax	<code>:SENSe:DTF:CLENgtH:UNIT <PredefExpr></code>
Parameters	<code>PredefExpr</code> is one of the following predefined expressions: <code>METer</code> <code>FEET</code> . Default is <code>METer</code> .
Command	Defines the unit for the cable length (m, ft). It also affects the unit for the cable attenuation.
Query	Reads and returns the current setting.

Example :SENSe:DTF:CLENgth:UNIT FEET
 :SENSe:DTF:CLENgth:UNIT?
Returns the following string: "FEET"

:SENSe:DTF:REFEreNce

Syntax :SENSe:DTF:REFEreNce <real1>

Parameters real1 is a floating point real number.
The minimum value for real1 is -100.0 dB. The maximum value for real1 is 0.0 dB. The default value for real1 is 0.0 dB

Command This command sets the reference level of the 9100 (0 dB line), in DTF mode.

Query Reads and returns the current setting.

Example :SENSe:DTF:REFEreNce -50
 :SENSe:DTF:REFEreNce?
The value returned in this example is: "-50".

:SENSe:DTF:REFEreNce:UNIT

Syntax :SENSe:DTF:REFEreNce:UNIT <PreDefExpr>

Parameters PreDefExpr is one of the following predefined expressions: DB | MRHO | .
Default is DB.

Command Defines the unit in which results (on the vertical axis) are displayed (dB, mRho). It not affects the unit for the DTF reference level.

Query Reads and returns the current setting.

Example :SENSe:DTF:REFEreNce:UNIT DB
 :SENSe:DTF:REFEreNce:UNIT?
Returns the following string: "DB"

:SENSe:DTF:REFEreNce:RFACTOR

Syntax :SENSe:DTF:REFEreNce:RFACTOR <real1>

Parameters real1 is a floating point real number.
The minimum value for real1 is 0 mRho. The maximum value for real1 is 2000 mRho. The default value for real1 is 1000 mRho.

Command This command sets the maximum factor value for DTF display when the unit is set to mRho.

Query Reads and returns the current setting.

Example :SENSe:DTF:REFEreNce:RFACTOR 1000
 :SENSe:DTF:REFEreNce:RFACTOR?
The value returned in this example is: "1000.0".

:SENSe:DTF:CALibratiON

Syntax :SENSe:DTF:CALibratiON

Parameters There are no parameters.

Command Starts DTF calibration. Before executing this command, a SHORT has to be connected to measurement port.

Query	Reads and returns the current calibration state. This is one of the following predefined expressions: NO YES.
Example	:SENSe:DTF:CALibration :SENSe:DTF:CALibration? Returns the following string: "YES"

:SENSe:DTF:CALibration:ENABled

Syntax	:SENSe:DTF:CALibration:ENABled <PredefExpr>
Parameters	PredefExpr is one of the following predefined expressions: ON OFF. Default is ON.
Command	Switches the DTF calibration correction on or off.
Query	Reads and returns the current setting.
Example	:SENSe:DTF:CALibration:ENABled OFF :SENSe:DTF:CALibration:ENABled? Returns the following string: "OFF"

:SENSe:TRANsmiSSion:REFerence

Syntax	:SENSe:TRANsmiSSion:REFerence <real1>
Parameters	real1 is a floating point real number. The minimum value for real1 is -60.0 dB. The maximum value for real1 is 60.0 dB. The default value for real1 is 0.0 dB.
Command	This command sets the reference of the 9102 (0 dB line), in Transmission mode. The reference refers to the current set output power level of the tracking generator.
Query	Reads and returns the current setting.
Example	:SENSe:TRANsmiSSion:REFerence -10 :SENSe:TRANsmiSSion:REFerence? The value returned in this example is: "-10".

:SENSe:TRANsmiSSion:REFerence:UNIT

Syntax	:SENSe:TRANsmiSSion:REFerence:UNIT <PredefExpr>
Parameters	PredefExpr is one of the following predefined expressions: DB DBM . Default is DB.
Command	Switches the display absolute or relative to the tracking generator output power. This command is linked to INSTRument:GENerator:DISPlay.
Query	Reads and returns the current setting.
Example	:SENSe:TRANsmiSSion:REFerence:UNIT DBM :SENSe:TRANsmiSSion:REFerence:UNIT? Returns the following string: "DBM"

:SENSe:EMF:REFErrence

Syntax	:SENSe:EMF:REFErrence <real1>
Parameters	real1 is a floating point real number. The minimum- and maximum value for real1 depend on the unit set by SENS:EMF:REFErrence:UNIT. When the unit is set to dBm/m ² , the minimum value is -100, the maximum value is 30. When the unit is set to dBuV/m, the minimum value is 7, the maximum value is 137. When the unit is set to dBmV/m, the minimum value is -53, the maximum value is 77. When the unit is set to dBV/m, the minimum value is -113, the maximum value is 17. When the unit is set to V/m, the minimum value is 0.000002236, the maximum value is 7.0710678. When the unit is set to mW/m ² , the minimum value is 0.0001, the maximum value is 1000.0. The default value for real1 is 107.0 dBuV/m.
Command	This command sets the EMF reference level of the 9100, in the unit selected with the :SENS:EMF:REFErrence:UNIT command.
Query	Reads and returns the current setting.
Example	:SENSe:EMF:REFErrence -50 :SENSe:EMF:REFErrence? The value returned in this example is: "-50".

:SENSe:EMF:REFErrence:UNIT

Syntax	:SENSe:EMF:REFErrence:UNIT <PredefExp>
Parameters	PredefExp is one of the following predefined expressions: DBUvm DBMvm DBVM VM MWM2 . Default is DBUvm.
Command	Defines the unit for the EMF reference, either logarithmic (dBuV/m, dBmV/m or dBV/m) or linear (V/m or mW/m ²). It also affects the unit in which results (on the vertical axis) are displayed.
Query	Reads and returns the current setting.
Example	:SENSe:EMF:REFErrence:UNIT DBVM :SENSe:EMF:REFErrence:UNIT? Returns the following string: "DBVM"

:SENSe:EMF:ANTenna:DIRection

Syntax	:SENSe:EMF:ANTenna:DIRection <PredefExp>
Parameters	PredefExp is one of the following predefined expressions: X Y Z . Default is X.
Command	Defines the direction of the antenna.
Query	Reads and returns the current setting.
Example	:SENSe:EMF:ANTenna:DIRection Y :SENSe:EMF:ANTenna:DIRection? Returns the following string: "Y"

:SENSe:EMF:MEASure

Syntax	:SENSe:EMF:MEASure <PredefExp>
Parameters	PredefExp is one of the following predefined expressions: OFF MANual AUTo QUICk . Default is OFF.
Command	Defines the mode of the antenna EMF measurement.
Query	Reads and returns the current setting.
Example	:SENSe:EMF:MEASure AUTo :SENSe:EMF:MEASure? Returns the following string: "AUT"

:SENSe:EMF:MEASure:LAST?

Syntax	:SENSe:EMF:MEASure:LAST?
Parameters	There are no parameters.
Command	There is only a no query form of this command available.
Query	Returns the last measurement setting, which was performed in EMF mode.
Example	:SENSe:EMF:MEASure:LAST? Returns the following string: "AUT"

:SENSe:EMF:MEASure:DISPlay

Syntax	:SENSe:EMF:MEASure:DISPlay <PredefExp>
Parameters	PredefExp is one of the following predefined expressions: EFSTrength PDENsity . Default is EFSTrength.
Command	Defines the display mode of the antenna EMF measurement. It can be either "Electric field strength" or "Power density".
Query	Reads and returns the current setting.
Example	:SENSe:EMF:MEASure:DISPlay PDEN :SENSe:EMF:MEASure:DISPlay? Returns the following string: "PDEN"

:SENSe:EMF:MEASure:TIME

Syntax	:SENSe:EMF:MEASure:TIME <real1>
Parameters	real1 is a floating point real number. The minimum value for real1 is 1000, the maximum value 1000000. real1 can be set as $1 \cdot 10^n$ or $3 \cdot 10^n$. The default value for real1 is 1000000.
Command	This command sets the measure time in EMF mode in seconds.
Query	Reads and returns the current setting.
Example	:SENSe:EMF:MEASure:TIME 100 :SENSe:EMF:MEASure:TIME? The value returned in this example is: "100".

:SENSe:RFLection:REFerence[:RETurnloss]

Syntax	:SENSe:RFLection:REFerence[:RETurnloss] <real1>
Parameters	real1 is a floating point real number. The minimum value for real1 is -60.0 dB. The maximum value for real1 is 60.0 dB. The default value for real1 is 0.0 dB.
Command	This command sets the reference of the 9102 (0 dB line), in Reflection mode, when unit is set to Return Loss. The reference refers to the current set output power level of the tracking generator.
Query	Reads and returns the current setting.
Example	:SENSe:RFLection:REFerence -10 :SENSe:RFLection:REFerence? The value returned in this example is: "-10".

:SENSe:RFLection:REFerence:UNIT

Syntax	:SENSe:RFLection:REFerence:UNIT <PredefExpr>
Parameters	PredefExpr is one of the following predefined expressions: RETurn-loss VSWR RFACTOR RPOWER. Default is RETurnloss.
Command	Switches the display to following units: return loss (dB), VSWR (-), reflection factor (mRho) or reflected power (%).
Query	Reads and returns the current setting.
Example	:SENSe:RFLection:REFerence:UNIT DBM :SENSe:RFLection:REFerence:UNIT? Returns the following string: "DBM"

:SENSe:RFLection:REFerence:VSWR

Syntax	:SENSe:RFLection:REFerence:VSWR <real1>
Parameters	real1 is a floating point real number. The minimum value for real1 is 1.0. The maximum value for real1 is 1000.0. The default value for real1 is 10.0.
Command	This command sets the maximum VSWR value for reflection display when the unit is set to VSWR.
Query	Reads and returns the current setting.
Example	:SENSe:RFLection:REFerence:VSWR 500 :SENSe:RFLection:REFerence:VSWR? The value returned in this example is: "500.0".

:SENSe:RFLection:REFerence:RFACTOR

Syntax	:SENSe:RFLection:REFerence:RFACTOR <real1>
Parameters	real1 is a floating point real number. The minimum value for real1 is 0 mRho. The maximum value for real1 is 2000 mRho. The default value for real1 is 2000 mRho.
Command	This command sets the maximum factor value for reflection display when the unit is set to reflection factor.

Query	Reads and returns the current setting.
Example	:SENSe:RFLection:REFErence:RFACTOR 1000 :SENSe:RFLection:REFErence:RFACTOR? The value returned in this example is: "1000.0".

:SENSe:RFLection:REFErence:RPOWER

Syntax	:SENSe:RFLection:REFErence:RPOWER <real1>
Parameters	real1 is a floating point real number. The minimum value for real1 is 0.0 %. The maximum value for real1 is 200.0 %. The default value for real1 is 200.0 %.
Command	This command sets the maximum power value for reflection display when the unit is set to reflected power.
Query	Reads and returns the current setting.
Example	:SENSe:RFLection:REFErence:RPOWER 120 :SENSe:RFLection:REFErence:RPOWER? The value returned in this example is: "120.0".

:SENSe:RFLection:FILTer

Syntax	:SENSe:RFLection:FILTer <real1>
Parameters	real1 is a floating point real number. The minimum value for real1 is 1000, the maximum value 1000000. real1 can be set as 1×10^n or 3×10^n . The default value for real1 is 1000000.
Command	This command sets the resolution bandwidth filter of the 9100, in Hertz.
Query	Reads and returns the current setting.
Example	:SENSe:RFLection:FILTer 300000 :SENSe:RFLection:FILTer? The value returned in this example is: "300000".

:SENSe:RFLection:FILTer:AUTO

Syntax	:SENSe:RFLection:FILTer:AUTO <PredefExpr>
Parameters	PredefExpr is one of the following predefined expressions: ON OFF. Default is ON.
Command	Switches the automatic selection of the bandwidth resolution filter on or off. If switched on, the 9102 selects the resolution bandwidth depending on the current span, video bandwidth, and sweep time.
Query	Reads and returns the current setting.
Example	:SENSe:RFLection:FILTer:AUTO ON :SENSe:RFLection:FILTer:AUTO? Returns the following string: "ON"

:SENSe:RFLection:CALibration

Syntax	:SENSe:RFLection:CALibration <PredefExpr>
Parameters	PredefExpr is one of the following predefined expressions: OPEN SHORT LOAD.
Command	Starts reflection calibration. The following sequence is necessary: 1. Scalar mode: Connect an OPEN to measurement port. Then execute :SENSe:RFLection:CALibration OPEN. Connect a SHORT to measurement port. Then execute :SENSe:RFLection:CALibration SHORT. 2. Vector mode: Connect an OPEN to measurement port. Then execute :SENSe:RFLection:CALibration OPEN. Connect a SHORT to measurement port. Then execute :SENSe:RFLection:CALibration SHORT. Connect a LOAD to measurement port. Then execute :SENSe:RFLection:CALibration LOAD. The mode has to be set before with :SENSe:RFLection:CALibration:MODE SCALAr VECTOr.
Query	Reads and returns the current calibration state. This is one of the following pre-defined expressions: NO YES.
Example	:SENSe:RFLection:CALibration? Returns the following string: "YES"

:SENSe:RFLection:CALibration:MODE

Syntax	:SENSe:RFLection:CALibration:MODE <PredefExpr>
Parameters	PredefExpr is one of the following predefined expressions: SCALAr VECTOr. Default is SCALAr.
Command	Sets reflection calibration mode to scalar or vector.
Query	Reads and returns the current calibration state. This is one of the following pre-defined expressions: NO YES.
Example	:SENSe:RFLection:CALibration:MODE VECTOr :SENSe:RFLection:CALibration:MODE? Returns the following string: "VECT"

:SENSe:RFLection:CALibration:ENABLEd

Syntax	:SENSe:RFLection:CALibration:ENABLEd <PredefExpr>
Parameters	PredefExpr is one of the following predefined expressions: ON OFF. Default is OFF.
Command	Switches reflection calibration correction on or off.
Query	Reads and returns the current calibration state. This is one of the following pre-defined expressions: NO YES.
Example	:SENSe:RFLection:CALibration:ENABLEd OFF :SENSe:RFLection:CALibration:ENABLEd? Returns the following string: "OFF"

:SENSe:CLOsS:REFEreNce

Syntax	:SENSe:CLOsS:REFEreNce <real1>
Parameters	real1 is a floating point real number. The minimum value for real1 is -60.0 dB. The maximum value for real1 is 60.0 dB. The default value for real1 is 0.0 dB.
Command	This command sets the reference of the 9102 (0 dB line), in Cable Loss mode. The reference refers to the current set output power level of the tracking generator.
Query	Reads and returns the current calibration state. This is one of the following pre-defined expressions: NO YES.
Example	:SENSe:CLOsS:REFEreNce -10 :SENSe:CLOsS:REFEreNce? The value returned in this example is: "-10".

:SENSe:CLOsS:FILTEr

Syntax	:SENSe:CLOsS:FILTEr <real1>
Parameters	real1 is a floating point real number. The minimum value for real1 is 1000, the maximum value 1000000. real1 can be set as $1 \cdot 10^n$ or $3 \cdot 10^n$. The default value for real1 is 1000000.
Command	This command sets the resolution bandwidth filter of the 9102, in Hertz.
Query	Reads and returns the current calibration state. This is one of the following pre-defined expressions: NO YES.
Example	:SENSe:CLOsS:FILTEr 300000 :SENSe:CLOsS:FILTEr? The value returned in this example is: "300000".

:SENSe:CLOsS:FILTEr:AUTO

Syntax	:SENSe:CLOsS:FILTEr:AUTO <PredefExpr>
Parameters	PredefExpr is one of the following predefined expressions: ON OFF. Default is ON.
Command	Switches the automatic selection of the bandwidth resolution filter on or off. If switched on, the 9102 selects the resolution bandwidth depending on the current span, video bandwidth, and sweep time.
Query	Reads and returns the current calibration state. This is one of the following pre-defined expressions: NO YES.
Example	:SENSe:CLOsS:FILTEr:AUTO ON :SENSe:CLOsS:FILTEr:AUTO? Returns the following string: "ON"

:SENSe:CLOsS:CALibratiON

Syntax	:SENSe:CLOsS:CALibratiON <PredefExpr>
Parameters	PredefExpr is one of the following predefined expressions: SHORT OPEN.

Command	Starts Cable Loss calibration. The following sequence is necessary: Connect a SHORT to measurement port. Then execute :SENSe:CLOSS:CALibration SHORT. Connect an OPEN to measurement port. Then execute :SENSe:CLOSS:CALibration OPEN.
Query	Reads and returns the current calibration state. This is one of the following pre-defined expressions: NO YES.
Example	:SENSe:CLOSS:CALibration? Returns the following string: "YES"

:SENSe:CLOSS:CALibration:ENABled

Syntax	:SENSe:CLOSS:CALibration:ENABled <PredefExpr>
Parameters	PredefExpr is one of the following predefined expressions: ON OFF. Default is OFF.
Command	Switches the cable loss calibration correction on or off.
Query	Reads and returns the current calibration state. This is one of the following pre-defined expressions: NO YES.
Example	:SENSe:CLOSS:CALibration:ENABled OFF :SENSe:CLOSS:CALibration:ENABled? Returns the following string: "OFF"

:SENSe:PSENSor:MODE

Syntax	:SENSe:PSENSor:MODE <PredefExpr>
Parameters	PredefExpr is one of the following predefined expressions: DBM W . Default is DBM.
Command	Defines the unit for the power sensor measurement to logarithmic unit (dBm) or linear unit (W).
Query	Reads and returns the current setting.
Example	:SENSe:CLOSS:CALibration:ENABled OFF :SENSe:CLOSS:CALibration:ENABled? Returns the following string: "OFF" :SENSe:PSENSor:MODE LIN :SENSe:PSENSor:MODE? Returns the following string: "LIN"

SENSe:PSENSor:TYPE

Syntax	:SENSe:PSENSor:TYPE <PredefExpr>
Parameters	PredefExpr is one of the following predefined expressions: CW GSM TETRA UMTS CDMA DVBT . Default is CW.
Command	Switches the power sensor system to the following settings: continuous wave, GSM, TETRA, UMTS, CDMA and DVBT.
Query	Reads and returns the current setting.

Example	<code>:SENSe:PSENsOr:TYPe UMTS</code> <code>:SENSe:PSENsOr:TYPe?</code> Returns the following string: "UMTS"
----------------	--

:SENSe:PSENsOr:FREQuency:CW

Syntax	<code>:SENSe:PSENsOr:FREQuency:CW <real1></code>
Parameters	<code>real1</code> is a floating point real number. The minimum value for <code>real1</code> is 70000000, the maximum value 2700000000. The default value for <code>real1</code> is 1000000000.
Command	Sets the continuous wave frequency for the power sensor measurement in Hertz.
Query	Reads and returns the current setting.
Example	<code>:SENSe:PSENsOr:FREQuency:CW 1500000000</code> <code>:SENSe:PSENsOr:FREQuency:CW?</code> The value returned in this example is: "1500000000".

:SENSe:PSENsOr:FREQuency:GSM

Syntax	<code>:SENSe:PSENsOr:FREQuency:GSM <real1></code>
Parameters	<code>real1</code> is a floating point real number. The minimum value for <code>real1</code> is 70000000, the maximum value 2700000000. The default value for <code>real1</code> is 900000000.
Command	Sets the GSM frequency for the power sensor measurement in Hertz.
Query	Reads and returns the current setting.
Example	<code>:SENSe:PSENsOr:FREQuency:GSM 1800000000</code> <code>:SENSe:PSENsOr:FREQuency:GSM?</code> The value returned in this example is: "1800000000".

:SENSe:PSENsOr:FREQuency:TETRa

Syntax	<code>:SENSe:PSENsOr:FREQuency:TETRa <real1></code>
Parameters	<code>real1</code> is a floating point real number. The minimum value for <code>real1</code> is 70000000, the maximum value 2700000000. The default value for <code>real1</code> is 900000000.
Command	Sets the TETRA frequency for the power sensor measurement in Hertz.
Query	Reads and returns the current setting.
Example	<code>:SENSe:PSENsOr:FREQuency:TETRa 800000000</code> <code>:SENSe:PSENsOr:FREQuency:TETRa?</code> The value returned in this example is: "800000000".

:SENSe:PSENsOr:FREQuency:UMTS

Syntax	<code>:SENSe:PSENsOr:FREQuency:UMTS <real1></code>
Parameters	<code>real1</code> is a floating point real number. The minimum value for <code>real1</code> is 70000000, the maximum value 2700000000. The default value for <code>real1</code> is 2000000000.

Command	Sets the UMTS frequency for the power sensor measurement in Hertz.
Query	Reads and returns the current setting.
Example	:SENSe:PSENsOr:FREQuency:UMTS 2400000000 :SENSe:PSENsOr:FREQuency:UMTS? The value returned in this example is: "2400000000".

:SENSe:PSENsOr:FREQuency:CDMA

Syntax	:SENSe:PSENsOr:FREQuency:CDMA <real1>
Parameters	real1 is a floating point real number. The minimum value for real1 is 70000000, the maximum value 2700000000. The default value for real1 is 1800000000.
Command	Sets the CDMA frequency for the power sensor measurement in Hertz.
Query	Reads and returns the current setting.
Example	:SENSe:PSENsOr:FREQuency:CDMA 1900000000 :SENSe:PSENsOr:FREQuency:CDMA? The value returned in this example is: "1900000000".

:SENSe:PSENsOr:FREQuency:DVBT

Syntax	:SENSe:PSENsOr:FREQuency:DVBT <real1>
Parameters	real1 is a floating point real number. The minimum value for real1 is 70000000, the maximum value 2700000000. The default value for real1 is 300000000.
Command	Sets the DVBT frequency for the power sensor measurement in Hertz.
Query	Reads and returns the current setting.
Example	:SENSe:PSENsOr:FREQuency:CDMA 6000000000 :SENSe:PSENsOr:FREQuency:CDMA? The value returned in this example is: "6000000000".

:SENSe:EDEVice:RFINput

Syntax	:SENSe:EDEVice:RFINput <int1>
Parameters	int1 is a integer. The minimum value for int1 is 1, the maximum is 6. The default value for int1 is 1.
Command	Sets the RF input channel on the external device.
Query	Reads and returns the current setting.
Example	:SENSe:EDEVice:RFINput 2 :SENSe:EDEVice:RFINput? The value returned in this example is: "2".

Input commands

With these commands, the input stage of the 9102 Handheld Spectrum Analyzer is affected.



WARNING

The maximum input power level at the **RF IN** connector is 30 dBm (1 W). Higher input levels may result in serious damage of the instrument.

:INPut:ATTenuation

Syntax	<code>:INPut:ATTenuation <real1></code>
Parameters	<code>real1</code> is a floating point real number. The minimum value for <code>real1</code> is 0, the maximum value 50. <code>real1</code> can be set in steps of 10. The default value for <code>real1</code> is 30.
Command	This command sets the RF preattenuation of the Willtek 9102. The physical dimension of <code>real1</code> is dB.
Query	Reads and returns the current setting.
Example	<code>:INP:ATT 20</code> <code>:INPut:ATTenuation?</code> The value returned is in this example: "20".

:INPut:ATTenuation:AUTO

Syntax	<code>:INPut:ATTenuation:AUTO <PredefExpr></code>
Parameters	<code>PredefExpr</code> is one of the following predefined expressions: ON OFF. Default is ON.
Command	Lets the 9102 select the preattenuation depending on the reference level.
Query	Reads and returns the current setting.
Example	<code>:INP:ATT:AUTO ON</code> <code>:INPut:ATTenuation:AUTO?</code> Returns the following string: "ON"

:INPut:IMPedance

Syntax	<code>:INPut:IMPedance <PredefExpr></code>
Parameters	<code>PredefExpr</code> is one of the following predefined expressions: IMP50 IMP75. Default is IMP50.
Command	Lets the 9102 select between 50 Ω and 75 Ω impedance.
Query	Reads and returns the current setting.
Example	<code>:INP:IMP IMP75</code> <code>:INPut:IMPedance?</code> Returns the following string: "IMP75"

:INPut:EDEvice

Syntax	<code>:INPut:EDEvice <PredefExpr></code>
---------------	--

Parameters	<code>PredefExpr</code> is one of the following predefined expressions: <code>ON</code> <code>OFF</code> . Default is <code>OFF</code> .
Command	Switches the external device compensation on or off. A corresponding file has to be loaded first with command <code>MMemory:LOAD:EDevice</code> .
Query	Reads and returns the current setting.
Example	<code>:INP:EDevice ON</code> <code>:INPut:EDevice?</code> Returns the following string: "ON"

:INPut:AFACtor

Syntax	<code>:INPut:AFACtor <PredefExpr></code>
Parameters	<code>PredefExpr</code> is one of the following predefined expressions: <code>OFF</code> <code>ON</code> . Default is <code>OFF</code> .
Command	Switches the antenna factor compensation on or off. A corresponding file has to be loaded first with command <code>MMemory:LOAD:AFACtor</code> .
Query	Reads and returns the current setting.
Example	<code>:INPut:AFACtor ON</code> <code>:INPut:AFACtor?</code> Returns the following string: "ON"

:INPut:CFACtor

Syntax	<code>:INPut:CFACtor <PredefExpr></code>
Parameters	<code>PredefExpr</code> is one of the following predefined expressions: <code>OFF</code> <code>ON</code> . Default is <code>OFF</code> .
Command	Switches the cable factor compensation on or off. A corresponding file has to be loaded first with command <code>MMemory:LOAD:CFACtor</code> .
Query	Reads and returns the current setting.
Example	<code>:INPut:CFACtor ON</code> <code>:INPut:CFACtor?</code> Returns the following string: "ON"

MMemory commands

With the MMemory commands, you can fully exploit the capabilities of the instrument to store and reload measurement results in its nonvolatile memory.

:MMEMory:STORe:STATe

Syntax	<code>:MMEMory:STORe:STATe <string1></code>
Parameters	<code>string1</code> is a string (text) parameter. The maximum length of <code>string1</code> is 11 characters.
Command	Stores the actual parameter settings of the 9102 in the SETTINGS directory on the flash disk in a file named <code><string1></code> .

Query	Reads and returns the file name last stored with this command.
Example	:MMEMory:STORe:STATe "sett3"

:MMEMory:STORe:TRACe

Syntax	:MMEMory:STORe:TRACe <string1>[,<PredefExpr>]
Parameters	string1 is a string (text) parameter. The maximum length of string1 is 11 characters. PredefExpr is an optional parameter and one of the following predefined expressions: A B. Default is A.
Command	Stores the current trace A or B and the parameter settings on the flash disk in the TRACE directory in a file named <string1>.
Query	Reads and returns the file name last stored with this command.
Example	:MMEMory:STORe:TRACe "GSM900" ,A

:MMEMory:STORe:LIMit

Syntax	:MMEMory:STORe:LIMit <string1>{ ,<PredefExpr> ,<x1> ,<y1> ,<x2> ,<y2> . . . } :MMEMory:STORe:LIMit? <string1>
Parameters	string1 is a string (text) parameter. The maximum length of string1 is 11 characters. PredefExpr is one of the following predefined expressions: MINimum MAXimum. x1 y1 x2 y2 are floating point real numbers. The minimum value for all these reals is 0, the maximum value for the x values is 10, the maximum value for the y values is 8, the resolution for all real values is 0.1 and the default is 0.
Command	Stores the limits defined as lines in the LIMIT directory on the flash disk in a file named <string1>. A line is defined by a parameter set PredefExpr ,x1 ,y1 ,x2 ,y2. Up to 30 parameter sets can follow the string parameter.
Query	Reads and returns the parameter sets of the limit file which is given as parameter.
Example	:MMEMory:STORe:LIMit "lim2" ,UPP ,2.3 ,4.5 ,6.9 ,7 ,2 ,LOW ,2.3 ,1.5 ,6.9 ,3 ,2 :MMEMory:STORe:LIMit? "lim2" String returned: UPP ,2.3 ,4.5 ,6.9 ,7 ,2 ,LOW ,2.3 ,1.5 ,6.9 ,3 ,2

:MMEMemory:STORe:CHANnel

Syntax	:MMEMemory:STORe:CHANnel <string1>, <int1>, <int2>, <real1>, <real2>, <real3>, <real4>
Parameters	<p>string1 is a string (text) parameter. The maximum length of string1 is 11 characters.</p> <p>int1 is an integer. The minimum value for int1 is 1, the maximum is 1000000. The default value is 100.</p> <p>int2 is an integer. The minimum value for int2 is 0, the maximum is 1000000. The default value is 0.</p> <p>real1 is a floating point real number. The minimum value for real1 is 0, the maximum value 7500000000. The minimum resolution is 1000. The default value is 1000000.</p> <p>real2 is a floating point real number. The minimum value for real2 is 0, the maximum value 7500000000. The minimum resolution is 1000. The default value is 1000000.</p> <p>real3 is a floating point real number. The minimum value for real3 is 0, the maximum value 7500000000. The minimum resolution is 1000. The default value is 1000000000.</p> <p>real4 is a floating point real number. The minimum value for real4 is -100, the maximum value 30. The minimum resolution is 1. The default value is 0.</p>
Command	<p>This command stores the present communication system settings within the 9102 (e.g. for the channel power mode).</p> <p>string1 is the name of system settings file in which the parameters are stored. int1 sets the number of channels. int2 sets the start channel number. real1 sets the channel bandwidth over which to measure, in Hertz. real2 sets the frequency spacing of the channels, in Hertz. real3 sets the frequency of the first channel, in Hertz. real4 sets the system reference level (0 dB line).</p>
Query	Reads and returns the parameter set from the limit file given as a parameter.
Example	:MMEMemory:STORe:CHANnel "P-GSM9DO",125,0,400000,200000,935000000,0.0

:MMEMemory:STORe:EDEvice

Syntax	:MMEMemory:STORe:EDEvice <string1>, <real1freq>, <real1lev>, <real2freq>, <real2lev>, ... <real100freq>, <real100lev>
Parameters	<p>string1 is a string (text) parameter. The maximum length of string1 is 11 characters.</p> <p>real1freq to real100freq are floating point real numbers. The minimum value is 0, the maximum value 4e9. The minimum resolution is 1.</p> <p>real1lev to real100lev are floating point real numbers. The minimum value is -100, the maximum value 30. The minimum resolution is 0.01.</p>
Command	<p>This command stores settings for external device compensation. string1 is the name of the external device compensation file in which the parameters are stored. realxfreq and realxlev are pairs of frequency and level values to set the attenuation on the respective frequency. The instrument applies linear interpolation for the level between frequency points.</p>
Query	Reads and returns the parameter sets of the external device compensation file which is given as a parameter.

Example	<pre>:MMEMory:STORE:EDEvice "EXT_DEV2",1000000, -5.1, 2000000,-3.2,5000000,-4.1,10000000,-3.8,20000000,-2.6 :MMEM:STOR:EDEV? "EXT_DEV2" String returned: 1000000, -5.1,2000000,-3.2,5000000,-4.1, 10000000,-3.8,20000000,-2.6</pre>
----------------	---

:MMEMory:STORe:CTYPe

Syntax	<code>:MMEMory:STORe:CTYPe <string1>,<real1>,<real2>,<PredefExpr>,<real3></code>
Parameters	<p><code>string1</code> is a string (text) parameter. The maximum length of <code>string1</code> is 11 characters.</p> <p><code>real1</code> is a floating point real number. The minimum value is 1.0, the maximum value 20.0. The minimum resolution is 0.1. The default value is 1.0.</p> <p><code>real2</code> is a floating point real number. The minimum value is 0.0, the maximum value 2000.0. The minimum resolution is 0.01. The default value is 0.0.</p> <p><code>PredefExpr</code> is optional and one of the following predefined expressions: M100 FT100. Default is M100.</p> <p><code>real3</code> is a floating point real number and also optional. The minimum value is 500000, the maximum value 4000000000. The minimum resolution is 0.1. The default value is 4000000000.</p>
Command	This command stores settings for cable types. <code>string1</code> is the name of the cable type file in which the parameters are stored. <code>real1</code> is the cable dielectric of the cable. <code>real2</code> is the attenuation of the cable per meter or feet. <code>PredefExpr</code> sets the attenuation to meter or feet. <code>real3</code> is the cable cutoff frequency.
Query	Reads and returns the parameter sets of the cable type file which is given as parameter.
Example	<pre>:MMEMory:STORe:CTYPe "EXT_DEV2",2.4,9.3,"MET",2000000000</pre>

:MMEMory:STORe:CTYPe:CALibration

Syntax	<code>:MMEMory:STORe:CTYPe:CALibration <real1>,<real2></code>
Parameters	<p><code>real1</code> is a floating point real number. The minimum value is 1.0, the maximum value 20.0. The minimum resolution is 0.1. The default value is 2.3.</p> <p><code>real2</code> is a floating point real number. The minimum value is 1.0, the maximum value 2000.0. The minimum resolution is 0.01. The default value is 1.0.</p>
Command	This command stores settings for cable type calibration. <code>real1</code> is the cable dielectric of the calibration cable. <code>real2</code> is the length of the calibration cable per meter.
Query	Reads and returns the parameter sets of the calibration cable type file which is given as parameter.
Example	<code>:MMEMory:STORe:CTYPe:CALibration 2.5,1.5</code>

:MMEMemory:STORE:AFACtor

Syntax	:MMEMemory:STORE:AFACtor <string1>,<real1freq>,<real1lev>,<real2freq>, <real2lev>,...,<real100freq>,<real100lev>
Parameters	string1 is a string (text) parameter. The maximum length of string1 is 11 characters. real1freq to real100freq are floating point real numbers. The minimum value is 0, the maximum value 4e9. The minimum resolution is 1. real1lev to real100lev are floating point real numbers. The minimum value is -100, the maximum value 30. The minimum resolution is 0.01.
Command	This command stores settings for cable types. string1 is the name of the cable type file in which the parameters are stored. real1 is the cable dielectric of the cable. real2 is the attenuation of the cable per meter or feet. PredefExpr sets the attenuation to meter or feet. real3 is the cable cutoff frequency.
Query	Reads and returns the parameter sets of the external device compensation file which is given as parameter.
Example	:MMEMemory:STORE:AFACtor "AFAC2",1000000,-5.1,2000000, -3.2,5000000,-4.1,10000000,-3.8,20000000,-2.6

:MMEMemory:STORE:CFACtor

Syntax	:MMEMemory:STORE:CFACtor <string1>,<real1freq>,<real1lev>,<real2freq>, <real2lev>,...,<real100freq>,<real100lev>
Parameters	string1 is a string (text) parameter. The maximum length of string1 is 11 characters. real1freq to real100freq are floating point real numbers. The minimum value is 0, the maximum value 4e9. The minimum resolution is 1. real1lev to real100lev are floating point real numbers. The minimum value is -100, the maximum value 30. The minimum resolution is 0.01.
Command	This command stores settings for cable factor compensation. string1 is the name of cable factor compensation file in which the parameters are stored. realxfreq and realxlev are pairs of frequency and level values to set the attenuation on this frequency. Between frequency values there is a linear interpolation for the level.
Query	Reads and returns the parameter sets of the cable factor compensation file which is given as parameter.
Example	:MMEMemory:STORE:CFACtor "CFAC7",1000000,-5.1,2000000, -3.2,5000000,-4.1,10000000,-3.8,20000000,-2.6

:MMEMemory[:LOAD]:FILElist[:TRACe]?

Syntax	:MMEMemory:LOAD:FILElist[:TRACe]? <PredefExpr>
Parameters	PredefExpr is an optional parameter and one of the following predefined expressions: SHORT EXTent. Default is SHORT.
Command	There is only a query form of this command available.
Query	Reads and returns the list of files stored in the TRACE directory. The file names are separated by commas.

Example :MMEMory:LOAD:FILElist:TRACe?
String returned in this example:
"TRACE1", "TRACE2", "TRACE3"

:MMEMory[:LOAD]:FILElist:STATe?

Syntax :MMEMory[:LOAD]:FILElist:STATe? <PredefExpr>
Parameters PredefExpr is an optional parameter and one of the following predefined expressions: SHORT | EXTent. Default is SHORT.
Command There is only a query form of this command available.
Query Reads and returns the list of files stored in the SETTINGS directory. The file names are separated by commas.
Example :MMEMory:LOAD:FILElist:STATe?
String returned in this example:
"SETT1", "SETT2", "SETT3"

:MMEMory[:LOAD]:FILElist:LIMit?

Syntax :MMEMory[:LOAD]:FILElist:LIMit? <PredefExpr>
Parameters PredefExpr is an optional parameter and one of the following predefined expressions: SHORT | EXTent. Default is SHORT.
Command There is only a query form of this command available.
Query Reads and returns a **comma-separated** list of file names. Each file contains spectrum limit values stored on the 9102.
Example :MMEMory:LOAD:FILElist:LIMit?
String returned in this example:
"LIM1", "LIM2"

:MMEMory[:LOAD]:FILElist:CHANnel?

Syntax :MMEMory[:LOAD]:FILElist:CHANnel? <PredefExpr>
Parameters PredefExpr is an optional parameter and one of the following predefined expressions: SHORT | EXTent. Default is SHORT.
Command There is only a query form of this command available.
Query Reads and returns a **comma-separated** list of file names. Each file contains channel values stored on the 9102.
Example :MMEMory:LOAD:FILElist:CHANnel?
String returned: "GSM900", "GSM1800"

:MMEMory[:LOAD]:FILElist:EDEVice?

Syntax :MMEMory[:LOAD]:FILElist:EDEVice? <PredefExpr>
Parameters PredefExpr is an optional parameter and one of the following predefined expressions: SHORT | EXTent. Default is SHORT.
Command There is only a query form of this command available.

Query	Reads and returns a comma-separated list of file names. Each file contains external device compensation values stored on the 9102.
Example	:MMEMory:LOAD:FILElist:EDEvice? String returned in this example: "EXT_DEV2" , "EXT_DEV5 "

:MMEMory[:LOAD]:FILElist:CTYPE?

Syntax	:MMEMory[:LOAD]:FILElist:CTYPE? <PredefExpr>
Parameters	PredefExpr is an optional parameter and one of the following predefined expressions: SHORT EXTent. Default is SHORT.
Command	There is only a query form of this command available.
Query	Reads and returns a comma-separated list of file names. Each file contains a cable type stored on the 9102.
Example	:MMEMory:LOAD:FILElist:CTYPE? String returned in this example: "CABLE2" , "CABLE5 "

:MMEMory[:LOAD]:FILElist:AFACtor?

Syntax	:MMEMory[:LOAD]:FILElist:AFACtor? <PredefExpr>
Parameters	PredefExpr is an optional parameter and one of the following predefined expressions: SHORT EXTent. Default is SHORT.
Command	There is only a query form of this command available.
Query	Reads and returns a comma-separated list of file names. Each file contains antenna factor compensation stored on the 9102.
Example	:MMEMory:LOAD:FILElist:AFACtor? String returned in this example: "AFAC2" , "AFAC5 "

:MMEMory[:LOAD]:FILElist:CFACtor?

Syntax	:MMEMory[:LOAD]:FILElist:CFACtor? <PredefExpr>
Parameters	PredefExpr is an optional parameter and one of the following predefined expressions: SHORT EXTent. Default is SHORT.
Command	There is only a query form of this command available.
Query	Reads and returns a comma-separated list of file names. Each file contains cable factor compensation stored on the 9102.
Example	:MMEMory:LOAD:FILElist:CFACtor? String returned in this example: "CFAC7" , "CFAC8 "

:MMEmory:LOAD:STATe

Syntax	:MMEmory:LOAD:STATe <string1>
Parameters	string1 is a string (text) parameter. The maximum length of string1 is 11 characters.
Command	Loads 9102 parameter settings from file string1 located in the SETTINGS directory on the flash disk.
Query	Reads and returns the file name last loaded with this command.
Example	:MMEmory:LOAD:STATe "sett3"

:MMEmory:LOAD:TRACe

Syntax	:MMEmory:LOAD:TRACe <string1>,<PredefExpr>
Parameters	string1 is a string (text) parameter. The maximum length of string1 is 11 characters. PredefExpr is an optional parameter and one of the following predefined expressions: A B. Default is A.
Command	Loads 9102 traces from file string1 located in the TRACE directory on the flash disk to trace A or B.
Query	Reads and returns the file name last loaded with this command.
Example	:MMEmory:LOAD:TRACe "TESTTRACE2"

:MMEmory:LOAD:LIMit

Syntax	:MMEmory:LOAD:LIMit <string1>
Parameters	string1 is a string (text) parameter. The maximum length of string1 is 11 characters.
Command	Loads 9102 limit settings from file string1 located in the LIMIT directory on the flash disk.
Query	Reads and returns the file name last loaded with this command.
Example	:MMEmory:LOAD:LIMit "sett3"

:MMEmory:LOAD:CHANnel

Syntax	:MMEmory:LOAD:CHANnel <string1>
Parameters	string1 is a string (text) parameter. The maximum length of string1 is 11 characters.
Command	Load saved channel data from file <string1> in the CHANNEL directory on the flash disk.
Query	Reads and returns the file name last loaded with this command.
Example	:MMEmory:LOAD:CHANnel "GSM900"

:MMEMory:LOAD:EDEvice

Syntax	:MMEMory:LOAD:EDEvice <string1>
Parameters	string1 is a string (text) parameter. The maximum length of string1 is 11 characters.
Command	Loads saved channel data from file <string1> in the external device directory on the flash disk.
Query	Reads and returns the file name last loaded with this command.
Example	:MMEMory:LOAD:EDEvice "EXT_DEV2"

:MMEMory:LOAD:CTYPE

Syntax	:MMEMory:LOAD:CTYPE <string1>
Parameters	string1 is a string (text) parameter. The maximum length of string1 is 11 characters.
Command	Loads saved cable type from file in the cable type directory on the flash disk.
Query	Reads and returns the file name last loaded with this command.
Example	:MMEMory:LOAD:CTYPE "RG58"

:MMEMory:LOAD:AFACtor

Syntax	:MMEMory:LOAD:AFACtor <string1>
Parameters	string1 is a string (text) parameter. The maximum length of string1 is 11 characters.
Command	Load saved cable factor data from file in the cable factor directory on the flash disk.
Query	Reads and returns the file name last loaded with this command.
Example	:MMEMory:LOAD:CFACtor "CFAC7"

:MMEMory:LOAD:CFACtor

Syntax	:MMEMory:LOAD:CFACtor <string1>
Parameters	string1 is a string (text) parameter. The maximum length of string1 is 11 characters.
Command	Load saved antenna factor data from file in the antenna factor directory on the flash disk.
Query	Reads and returns the file name last loaded with this command.
Example	:MMEMory:LOAD:AFACtor "AFAC2"

:MMEMory:DELeTe:STATE

Syntax	:MMEMory:DELeTe:STATE <string1>
Parameters	string1 is a string (text) parameter. The maximum length of string1 is 11 characters.

Command	Deletes file <string1> in the SETTINGS directory on the flash disk. Files in this directory usually contain parameter settings of the device.
Query	Reads and returns the name of the file last deleted with this command.
Example	:MMEMemory:DELEte:STATe "sett3"

:MMEMemory:DELEte:STATe:ALL

Syntax	:MMEMemory:DELEte:STATe:ALL
Parameters	There are no parameters.
Command	Deletes all the files in the SETTINGS directory on the flash disk. These files usually contain parameter settings of the 9102.
Query	There is no query form of this command available.
Example	:MMEMemory:DELEte:STATe:ALL

:MMEMemory:DELEte:TRACe

Syntax	:MMEMemory:DELEte:TRACe <string1>
Parameters	string1 is a string (text) parameter. The maximum length of string1 is 11 characters.
Command	Deletes file string1 (saved trace data and parameter settings) from the TRACE directory on the flash disk.
Query	Reads and returns the name of the file last deleted with this command.
Example	:MMEMemory:DELEte:TRACe "GSM900"

:MMEMemory:DELEte:TRACe:ALL

Syntax	:MMEMemory:DELEte:TRACe:ALL
Parameters	There are no parameters.
Command	Deletes all the files in the TRACE directory on the flash disk.
Query	There is no query form of this command available.
Example	:MMEMemory:DELEte:TRACe:ALL

:MMEMemory:DELEte:LIMit

Syntax	:MMEMemory:DELEte:LIMit <string1>
Parameters	string1 is a string (text) parameter. The maximum length of string1 is 11 characters.
Command	Deletes file string1 in the LIMIT directory. Files in this directory contain limit settings of the device.
Query	Reads and returns the name of the file last deleted with this command.
Example	:MMEMemory:DELEte:LIMit "lim3"

:MMEMemory:DELEte:LIMit:ALL

Syntax	:MMEMemory:DELEte:LIMit:ALL
Parameters	There are no parameters.
Command	Deletes all the files in the LIMIT directory on the flash disk. These files contain spectrum limit settings of the 9102.
Query	There is no query form of this command available.
Example	:MMEMemory:DELEte:LIMit:ALL

:MMEMemory:DELEte:CHANnel

Syntax	:MMEMemory:DELEte:CHANnel <string1>
Parameters	string1 is a string (text) parameter. The maximum length of string1 is 11 characters.
Command	Deletes file string1 from the CHANNEL directory. Files in this directory contain channel settings of the device.
Query	Reads and returns the name of the file last deleted with this command.
Example	:MMEMemory:DELEte:CHAN "P-GSM"

:MMEMemory:DELEte:CHANnel:ALL

Syntax	:MMEMemory:DELEte:CHANnel:ALL
Parameters	There are no parameters.
Command	Deletes all the files in the CHANNEL directory on the flash disk.
Query	There is no query form of this command available.
Example	:MMEMemory:DELEte:CHANnel:ALL

:MMEMemory:DELEte:EDEVice

Syntax	:MMEMemory:DELEte:EDEVice <string1>
Parameters	string1 is a string (text) parameter. The maximum length of string1 is 11 characters.
Command	Deletes file string1 in the external device directory on the flash disk. Files in this directory contain external device compensation settings on the 9102.
Query	Reads and returns the name of the file last deleted with this command.
Example	:MMEMemory:DELEte:EDEVice "EXT_DEV3"

:MMEMory:DELeTe:EDEvice:ALL

Syntax	:MMEMory:DELeTe:EDEvice:ALL
Parameters	There are no parameters.
Command	Deletes all the files in the external device directory on the flash disk.
Query	There is no query form of this command available.
Example	:MMEMory:DELeTe:EDEvice:ALL

:MMEMory:DELeTe:CTYPe

Syntax	:MMEMory:DELeTe:CTYPe <string1>
Parameters	string1 is a string (text) parameter. The maximum length of string1 is 11 characters.
Command	Deletes file string1 in the cable type directory on the flash disk. Files in this directory contain cable type settings on the 9102.
Query	Reads and returns the name of the file deleted last with this command.
Example	:MMEMory:DELeTe:CTYPe "cable3"

:MMEMory:DELeTe:CTYPe:ALL

Syntax	:MMEMory:DELeTe:CTYPe:ALL
Parameters	There are no parameters.
Command	Deletes all the files in the cable type directory on the flash disk.
Query	There is no query form of this command available.
Example	:MMEMory:DELeTe:CTYPe:ALL

:MMEMory:DELeTe:AFACtor

Syntax	:MMEMory:DELeTe:AFACtor <string1>
Parameters	string1 is a string (text) parameter. The maximum length of string1 is 11 characters.
Command	Deletes file string1 in the antenna factor directory on the flash disk. Files in this directory contain antenna factor compensation settings on the 9102.
Query	Reads and returns the name of the file deleted last with this command.
Example	:MMEMory:DELeTe:AFACtor "AFAC2"

:MMEMemory:DELEte:AFACtor:ALL

Syntax	:MMEMemory:DELEte:AFACtor:ALL
Parameters	There are no parameters.
Command	Deletes all the files in the antenna factor directory on the flash disk.
Query	There is no query form of this command available.
Example	:MMEMemory:DELEte:AFACtor:ALL

:MMEMemory:DELEte:CFACTOR

Syntax	:MMEMemory:DELEte:CFACTOR <string1>
Parameters	string1 is a string (text) parameter. The maximum length of string1 is 11 characters.
Command	Deletes file string1 in the cable factor directory on the flash disk. Files in this directory contain cable factor compensation settings on the 9102.
Query	Reads and returns the name of the file deleted last with this command.
Example	:MMEMemory:DELEte:CFACTOR "CFAC7"

:MMEMemory:DELEte:CFACTOR:ALL

Syntax	:MMEMemory:DELEte:CFACTOR:ALL
Parameters	There are no parameters.
Command	Deletes all the files in the cable factor directory on the flash disk.
Query	There is no query form of this command available.
Example	:MMEMemory:DELEte:AFACtor:ALL

Instrument commands

:INSTRument:SELEct

Syntax	:INSTRument:SELEct <PredefExpr>
Parameters	PredefExpr is one of the following expressions: SANalyzer CPOWer TRANSmISSION DTF SGENerator RFLectIon CLOSS EMF PSENSor. Default is SANalyzer.
Command	Selects the measurement mode. Available modes are spectrum analysis channel power, transmission, distance to fault, signal generator, reflection, cable loss, electro magnetic field and power sensor. Selects the measurement mode. Available modes are spectrum analysis, channel power, transmission, distance to fault, signal generator, reflection, cable loss, electro magnetic field and power sensor.
Query	Reads and returns the current setting.

Example	<pre>:INSTRument:SElect CPOWer :INSTRument:SElect? Returns the following string: "CPOWer"</pre>
----------------	---

:INSTRument:GENERator

Syntax	<code>:INSTRument:GENERator <PredefExpr></code>
Parameters	<code>PredefExpr</code> is one of the following predefined expressions: ON OFF. Default is OFF.
Command	Switches the tracking generator on and off.
Query	Reads and returns the current setting.
Example	<pre>:INSTRument:GENERator ON :INSTRument:GENERator? Returns the following string: "ON"</pre>

:INSTRument:GENERator:LEVel

Syntax	<code>:INSTRument:GENERator:LEVel <reall></code>
Parameters	<code>reall</code> is a floating point real number. The minimum- and maximum value for <code>reall</code> depend on the unit set by <code>SENS:REFL:UNIT</code> . When the unit is set to dBm, the minimum value is -100, the maximum value is 30. When the unit is set to dBuV, the minimum value is 7, the maximum value is 137. When the unit is set to dBmV, the minimum value is -53, the maximum value is 77. When the unit is set to dBV, the minimum value is -113, the maximum value is 17. The default value for <code>reall</code> is 0 dBm.
Command	This command sets output power of the 9100 tracking generator in the unit selected with the <code>:SENS:REFL:UNIT</code> command.
Query	Reads and returns the current setting.
Example	<pre>:INSTRument:GENERator:LEVel -50 :INSTRument:GENERator:LEVel? The value returned in this example is: "-50".</pre>

:INSTRument:GENERator:MODE

Syntax	<code>:INSTRument:GENERator:MODE <PredefExpr></code>
Parameters	<code>PredefExpr</code> is one of the following predefined expressions: CW SWP. Default is CW.
Command	Switches the generator between continuous wave signal (CW) at a certain frequency and sweeping signal which sweeps from start to stop frequency. This command works only in SIGNAL GENERATOR mode.
Query	Reads and returns the current setting.
Example	<pre>:INSTRument:GENERator:MODE CW :INSTRument:GENERator:MODE? Returns the following string: "CW"</pre>

:INSTRument:GENERator:DISPlay

Syntax	:INSTRument:GENERator:DISPlay <PredefExpr>
Parameters	PredefExpr is one of the following predefined expressions: ABSolute RELative. Default is ABSolute.
Command	Switches the display absolute or relative to the tracking generator output power. This command is linked to SENSE:TRANSMission:REFERENCE:UNIT.
Query	Reads and returns the current setting.
Example	:INSTRument:GENERator:DISPlay RELative :INSTRument:GENERator:DISPlay? Returns the following string: "REL"

:INSTRument:GPS:QUALity

Syntax	:INSTRument:GPS:QUALity?
Parameters	There are no parameters.
Command	There is solely a query form of this command available.
Query	Returns a string containing one enum value representing the quality of the received GPS signal: FAIL means, no data is received; WARNing means, data is received, but will be inaccurate; OK means, data is valid.
Example	INSTRument:GPS:QUALity? The value returned in this example is: "OK".

:INSTRument:GPS:LATitude

Syntax	:INSTRument:GPS:LATitude?
Parameters	There are no parameters.
Command	There is solely a query form of this command available.
Query	Returns a string containing one real value representing the latitude of the received GPS data. The value is in degree an in a range between -90 deg (South) and +90 deg (North).
Example	:INSTRument:GPS:LATitude? The value returned in this example is: -7.8323.

:INSTRument:GPS:LONGitude

Syntax	:INSTRument:GPS:LONGitude?
Parameters	There are no parameters.
Command	There is solely a query form of this command available.
Query	Returns a string containing one real value representing the longitude of the received GPS data. The value is in degree an in a range between -180 deg (East) and +180 deg (West).
Example	:INSTRument:GPS:LONGitude? The value returned in this example is: -137.2475.

:INSTRument:GPS:LONGitude

Syntax	:INSTRument:GPS:LONGitude?
Parameters	There are no parameters.
Command	There is solely a query form of this command available.
Query	Returns a string containing one real value representing the longitude of the received GPS data. The value is in degree an in a range between -180 deg (East) and +180 deg (West).
Example	:INSTRument:GPS:LONGitude? The value returned in this example is: -137.2475.

:INSTRument:GPS:SPEEd

Syntax	:INSTRument:GPS:SPEEd?
Parameters	PredefExpr is one of the following predefined expressions: ABSolute RELative. Default is ABSolute.
Command	There is solely a query form of this command available.
Query	Returns a string containing one real value representing the speed of the received GPS data. The value returned is converted to the unit selected by the INSTRument:GPS:SPEEd:UNIT command.
Example	:INSTRument:GPS:SPEEd? The value returned in this example is: 54.4.

:INSTRument:GPS:SPEEd:UNIT

Syntax	:INSTRument:GPS:SPEEd:UNIT <PredefExpr>
Parameters	PredefExpr is one of the following predefined expressions: KPH KTS MPH. Default is KPH.
Command	Selects the unit for GPS speed result in km/h, knots or mile per hour.
Query	Reads and returns the current setting.
Example	:INST:GPS:SPE:UNIT FEET :INST:GPS:SPE:UNIT? Returns the following string: "FEET"

:INSTRument:GPS:TRACk

Syntax	:INSTRument:GPS:TRACk?
Parameters	There are no parameters.
Command	There is solely a query form of this command available.
Query	Returns a string containing one real value representing the track (direction) of the received GPS data. The value is in degree an in a range between 0.0 deg (North) and +359.9 deg.
Example	:INSTRument:GPS:TRACk? The value returned in this example is: 272.7.

:INSTRUMENT:GPS:DATE

Syntax	:INSTRUMENT:GPS:DATE?
Parameters	There are no parameters.
Command	There is solely a query form of this command available.
Query	Returns a string containing three integer values representing the date (year,month,day) of the received GPS data.
Example	:INSTRUMENT:GPS:DATE? The value returned in this example is: 2006,01,31.

:INSTRUMENT:GPS:TIME

Syntax	:INSTRUMENT:GPS:TIME?
Parameters	There are no parameters.
Command	There is solely a query form of this command available.
Query	Returns a string containing three integer values representing the time (hour, minute, second) of the received GPS data.
Example	:INSTRUMENT:GPS:DATE? The value returned in this example is: 2006,01,31.

:INSTRUMENT:GPS:SATELLITES

Syntax	:INSTRUMENT:GPS:SATELLITES?
Parameters	There are no parameters.
Command	There is solely a query form of this command available.
Query	Returns a string containing one integer value representing the number of satellites of the received GPS data.
Example	:INSTRUMENT:GPS:SATELLITES? The value returned in this example is: 7.

:INSTRUMENT:GPS:HDOP

Syntax	:INSTRUMENT:GPS:HDOP?
Parameters	There are no parameters.
Command	There is solely a query form of this command available.
Query	Returns a string containing one real value representing the HDOP value of the received GPS data. This is a quality characteristic of the signal, values below 2.0 representing a good signal.
Example	:INSTRUMENT:GPS:HDOP? The value returned in this example is: 1.8.

:INSTRUMENT:GPS:ALTITUDE

Syntax	:INSTRUMENT:GPS:ALTITUDE?
Parameters	There are no parameters.

Command	There is solely a query form of this command available.
Query	Returns a string containing one real value representing the altitude of the received GPS data. The value returned is converted to unit selected by <code>INSTrument:GPS:ALTititude:UNIT</code> .
Example	<code>:INSTrument:GPS:ALTititude?</code> The value returned in this example is: 574.3.

:INSTrument:GPS:ALTititude:UNIT

Syntax	<code>:INSTrument:GPS:ALTititude:UNIT <PredefExpr></code>
Parameters	<code>PredefExpr</code> is one of the following predefined expressions: <code>METer</code> <code>FEET</code> . Default is <code>METer</code> .
Command	Selects the unit for GPS altitude result in meter or feet.
Query	Reads and returns the current setting.
Example	<code>:INST:GPS:ALT:UNIT FEET</code> <code>:INST:GPS:ALT:UNIT?</code> Returns the following string: "FEET".

:INSTrument:GPS:COORDinate:UNIT

Syntax	<code>:INSTrument:GPS:COORDinate:UNIT <PredefExpr></code>
Parameters	<code>PredefExpr</code> is one of the following predefined expressions: <code>MINutes</code> <code>DEGree</code> . Default is <code>MINutes</code> .
Command	Selects the unit for GPS latitude and longitude results. This setting only affects the manual mode; in remote mode, the results are always returned in degrees.
Query	Reads and returns the current setting.
Example	<code>:INST:GPS:COORDinate:UNIT DEG</code> <code>:INST:GPS:COORDinate:UNIT?</code> Returns the following string: "DEGR".

fDisplay commands

The display command subsystem affects the screen of the instrument.

:DISPlay:TRACe:Y[:SCALE][:LOGarithmic]

Syntax	<code>:DISPlay:TRACe:Y[:SCALE][:LOGarithmic] <int1></code>
Parameters	<code>int1</code> is an integer. The minimum value for <code><int1></code> is 1, the maximum is 20. Valid values are 1, 2, 5, 10, 20. The default value is 10.
Command	Holds the upper limit of the power scale but changes the resolution (and the lower limit) of the scale when <code>int1</code> defines how many dB per scale unit are shown on the display.
Query	Returns the current setting.

Example :DISPlay:TRACe:Y[:SCALe][:LOGarithmic] 20
 :DISPlay:TRACe:Y[:SCALe][:LOGarithmic]?
 The value returned in this example is: "20".

:DISPlay:TRACe:Y[:SCALe]:LINear:VOLT

Syntax :DISPlay:TRACe:Y[:SCALe]:LINear:VOLT <real1>

Parameters real1 is a floating point real number.
 The minimum value for real1 is 0.00001. The maximum value for real1 is 1.0. The default value for real1 is 0.001.

Command This command is only in effect when 9102 is set to voltage unit. It holds the upper limit of the scale but changes the resolution (and the lower limit) of the voltage scale. real1 defines how many volts per scale unit are shown on the display. The resolution depends on which unit is set with SENSE:REFLevel:UNIT. If it set to V the command and query is in Volts. If it set to MV the command and query is in Milli Volts. If it set to UV the command and query is in Micro Volts.

Query Returns the current setting.

Example :DISPlay:TRACe:Y[:SCALe]:LINear:VOLT 0.0005
 :DISPlay:TRACe:Y[:SCALe]:LINear:VOLT?
 The value returned in this example is: "0.0005".

:DISPlay:TRACe:Y[:SCALe]:LINear:WATT

Syntax :DISPlay:TRACe:Y[:SCALe]:LINear:WATT <real1>

Parameters real1 is a floating point real number.
 The minimum value for real1 is 0.00000000001. The maximum value for real1 is 0.1. The default value for real1 is 0.000001.

Command This command is only in effect when 9102 is set to Watt unit. It holds the upper limit of the scale but changes the resolution (and the lower limit) of the Watt scale. real1 defines how many Watts per scale unit are shown on the display. The resolution depends on which unit is set with SENSE:REFLevel:UNIT. If it set to MW the command and query is in Milli Watts. If it set to UW the command and query is in Micro Watts.

Query Returns the current setting.

Example :DISPlay:TRACe:Y[:SCALe]:LINear:WATT 0.0002
 :DISPlay:TRACe:Y[:SCALe]:LINear:WATT?
 The value returned in this example is: "0.0002".

:DISPlay:TRACe:Y[:SCALe]:RFLection:VSWR

Syntax :DISPlay:TRACe:Y[:SCALe]:RFLection:VSWR <real1>

Parameters real1 is a floating point real number.
 The minimum value for real1 is 1.0. The maximum value for real1 is 1000.0. The default value for real1 is 100.0.

Command This command is only in effect when 9102 is set to reflection mode and the unit is set to VSWR. It holds the upper limit of the VSWR scale but changes the resolution (and the lower limit) of the scale. real1 defines how many VSWR units per scale unit are shown on the display.

Query Returns the current setting.

Example :DISPlay:TRACe:Y[:SCALe]:RFLectio:n:VSWR 0.5
 :DISPlay:TRACe:Y[:SCALe]:RFLectio:n:VSWR?
 The value returned in this example is: "0.5".

:DISPlay:TRACe:Y[:SCALe]:RFLectio:n:RFACTOR

Syntax :DISPlay:TRACe:Y[:SCALe]:RFLectio:n:RFACTOR <real1>

Parameters real1 is a floating point real number.
 The minimum value for real1 is 1 mRho. The maximum value for real1 is 2000 mRho. The default value for real1 is 200 mRho.

Command This command is only in effect when 9102 is set to reflection mode and unit is set to reflection factor. It holds the upper limit of the reflection factor scale but changes the resolution (and the lower limit) of the scale. real1 defines how many mRho per scale unit are shown on the display.

Query Returns the current setting.

Example :DISPlay:TRACe:Y[:SCALe]:RFLectio:n:RFACTOR 100
 :DISPlay:TRACe:Y[:SCALe]:RFLectio:n:RFACTOR?
 The value returned in this example is: "100".

:DISPlay:TRACe:Y[:SCALe]:RFLectio:n:RPOWER

Syntax :DISPlay:TRACe:Y[:SCALe]:RFLectio:n:RPOWER <real1>

Parameters real1 is a floating point real number.
 The minimum value for real1 is 1.0 %. The maximum value for real1 is 200.0 %. The default value for real1 is 20.0 %.

Command This command is only in effect when 9102 is set to reflection mode and unit is set to reflection power. It holds the upper limit of the reflection power scale but changes the resolution (and the lower limit) of the scale. real1 defines how many % per scale unit are shown on the display.

Query Returns the current setting.

Example :DISPlay:TRACe:Y[:SCALe]:RFLectio:n:RPOWER 10
 :DISPlay:TRACe:Y[:SCALe]:RFLectio:n:RPOWER?
 The value returned in this example is: "10".

:DISPlay:TRACe:Y[:SCALe]:DTF:RFACTOR

Syntax :DISPlay:TRACe:Y[:SCALe]:DTF:RFACTOR <real1>

Parameters real1 is a floating point real number.
 The minimum value for real1 is 1 mRho. The maximum value for real1 is 1000 mRho. The default value for real1 is 100 mRho.

Command This command is only in effect when 9102 is set to Reflection Mode and unit is set to Reflection Factor. It holds the upper limit of the Reflection Factor scale but changes the resolution (and the lower limit) of the scale. real1 defines how many mRho per scale unit are shown on the display.

Query Returns the current setting.

Example :DISPlay:TRACe:Y[:SCALe]:DTF:RFACTOR 100
 :DISPlay:TRACe:Y[:SCALe]:DTF:RFACTOR?
 The value returned in this example is: "100".

:DISPlay:BACKlight[:BATTery]

Syntax	:DISPlay:BACKlight[:BATTery] <int1>
Parameters	int1 is an integer. The minimum value for <int1> is 0, the maximum is 100. The default value is 50.
Command	Sets the brightness of the screen in battery mode. A setting of 100 leads to the maximum brightness.
Query	Returns the current setting.
Example	:DISPlay:BACKlight 30 :DISPlay:BACKlight? The value returned in this example is: "30".

:DISPlay:BACKlight:EXTErn

Syntax	:DISPlay:BACKlight:EXTErn <int1>
Parameters	int1 is an integer. The minimum value for <int1> is 0, the maximum is 100. The default value is 100.
Command	Sets the brightness of the screen when external power supply is connected. A setting of 100 leads to the maximum brightness.
Query	Returns the current setting.
Example	:DISPlay:BACKlight:EXTErn 50 :DISPlay:BACKlight:EXTErn? The value returned in this example is: "50".

:DISPlay:BEEP

Syntax	:DISPlay:BEEP <PredefExpr>
Parameters	PredefExpr is one of the following predefined expressions: ON OFF. Default is ON.
Command	Sets the beep tone on and off.
Query	Reads and returns the current setting.
Example	:DISPlay:BEEP ON :DISPlay:BEEP? Returns the following string: "ON"

:DISPlay:COLor:TRACe:[A|B]

Syntax	:DISPlay:COLor:TRACe:[A B] <int1>
Parameters	int1 is an integer. The minimum value for <int1> is 1, the maximum is 8. The default value is 1 for trace A and 3 for trace B.
Command	Sets the color from the color palette for trace A or B.
Query	Reads and returns the current setting.
Example	:DISPlay:COLor:TRACe:A 5 :DISPlay:COLor:TRACe:A? The value returned in this example is: "5".

:DISPlay:COLor:TRACe:OFFSet

Syntax	:DISPlay:COLor:TRACe:OFFSet <int1>
Parameters	int1 is an integer. The minimum value for <int1> is 1, the maximum is 8. The default value is 7.
Command	Sets the color from the color palette for the trace offset for the subtracted trace (A-B->A trace).
Query	Reads and returns the current setting.
Example	:DISPlay:COLor:TRACe:OFFSet 5 :DISPlay:COLor:TRACe:OFFSet? The value returned in this example is: "5".

:DISPlay:COLor:GRATicule

Syntax	:DISPlay:COLor:GRATicule <int1>
Parameters	int1 is an integer. The minimum value for <int1> is 1, the maximum is 8. The default value is 2.
Command	Sets the color from the color palette for the graticule.
Query	Reads and returns the current setting.
Example	:DISPlay:COLor:GRATicule 5 :DISPlay:COLor:GRATicule? The value returned in this example is: "5".

:DISPlay:COLor:LIMits

Syntax	:DISPlay:COLor:LIMits <int1>
Parameters	int1 is an integer. The minimum value for <int1> is 1, the maximum is 8. The default value is 7.
Command	Sets the color from the color palette for the limit lines.
Query	Reads and returns the current setting.
Example	:DISPlay:COLor:LIM 5 :DISP:COL:LIMits? The value returned in this example is: "5".

Calculate commands

The markers of the 9102 can be set using the calculate commands.

:CALCulate:MARKer:AOff

Syntax	:CALCulate:MARKer:AOff
Parameters	There are no parameters.
Command	All markers are switched off.
Query	There is no query form of this command available.

Example :CALC:MARK:A:STAT NORM
 :CALC:MARK:B:STAT DELT
 :CALC:MARK:C:STAT DELT
 :CALC:MARK:AOFF

:CALCulate:MARKer:{A|B|C|D|E|F}[:STATE]

Syntax :CALCulate:MARKer:{A|B|C|D|E|F}[:STATE]
 <PredefExpr>

Parameters PredefExpr is one of the following predefined expressions:
 OFF|NORMal|DELTA.
 Default is OFF.

Command Selects an active marker and sets it to one of three different modes:
 OFF|NORMal|COUNTER or OFF|NORMal|DELTA.
 OFF is used to switch off the selected marker.
 NORMal switches the selected marker on.
 DELTA changes the marker B, C or D to a delta marker; the REF marker is always A.
 Marker A cannot be set to DELTA. Only Marker A can be set to COUNTER which
 switches on the frequency counter.

Query The query form of this command will return the current setting. The string delivered
 back will contain the short-form version of one of the predefined expressions
 explained above.

Example :CALC:MARK:A:STAT NORM
 :CALC:MARK:A:STAT?
 Value returned in this example: "NORM".

:CALCulate:MARKer:{A|B|C|D|E|F}:DTF[:STATE]

Syntax :CALCulate:MARKer:{A|B|C|D|E|F}:DTF[:STATE]
 <PredefExpr>

Parameters PredefExpr is one of the following predefined expressions:
 OFF|NORMal|DELTA.
 Default is OFF.

Command Selects an active marker and sets it to one of three different modes:
 OFF|NORMal|COUNTER or OFF|NORMal|DELTA.
 OFF is used to switch off the selected marker.
 NORMal switches the selected marker on.
 DELTA changes the marker B, C or D to a delta marker; the REF marker is always A.
 Marker A cannot be set to DELTA. Only Marker A can be set to COUNTER which
 switches on the frequency counter.

Query The query form of this command will return the current setting. The string delivered
 back will contain the short-form version of one of the predefined expressions
 explained above.

Example :CALC:MARK:A:DTF NORM
 :CALC:MARK:A:DTF?
 Value returned in this example: "NORM".

:CALCulate:MARKer:{A|B|C|D|E|F}:Y?

Syntax :CALCulate:MARKer:{A|B|C|D|E|F}:Y?

Parameters There are no parameters.

Command	There is solely a query form of this command available.
Query	The query form of this command returns the level value at the current marker position set by <code>CALCulate:MARKer:{A B C D E F}:X</code> . The string delivered will contain one floating point real number with the physical dimension that has been selected for the reference level (<code>:SENSe:REFLevel:UNIT</code>).
Example	<code>:CALCulate:MARKer:B:X 2200000000</code> <code>:CALCulate:MARKer:B:Y?</code> The value returned is: "-22.4".

`:CALCulate:MARKer:{A|B|C|D|E|F}:X[:FREQUENCY]`

Syntax	<code>:CALCulate:MARKer:{A B C D E F}:X[:FREQUENCY] <real1></code>
Parameters	<code>real1</code> is a floating point real number. The minimum value for <code>real1</code> is 0, the maximum value 7500000000. The minimum resolution possible for <code>real1</code> is 1. The default value for <code>real1</code> is 1800000000.
Command	This command sets the marker frequency for one of the six markers of the Willtek 9102 when in spectrum analysis mode. The physical dimension of <code>real1</code> is Hertz.
Query	The query form of this command will return the current marker frequency setting of the respective marker of the Willtek 9102 (A, B, C, D, E or F). The string delivered back will contain one real number.
Example	<code>:CALCulate:MARKer:C:X 1500000000</code> <code>:CALCulate:MARKer:C:X?</code> The value returned in this example is: "1500000000".

`:CALCulate:MARKer:{A|B|C|D|E|F}:X:TIME`

Syntax	<code>:CALCulate:MARKer:{A B C D E F}:X:TIME <real1></code>
Parameters	<code>real1</code> is a floating point real number. The minimum value for <code>real1</code> is 0.001, the maximum value 250.0. The minimum resolution possible for <code>real1</code> is 1. The default value for <code>real1</code> is 0.0432.
Command	This command sets the marker time for zero-span measurements for one of the six markers of the Willtek 9102. The physical dimension of <code>real1</code> is seconds.
Query	The query form of this command will return the current marker time setting of the respective marker of the Willtek 9102 (A, B, C, D, E or F). The string delivered back will contain one real number.
Example	<code>:CALCulate:MARKer:C:X:TIME 0.5</code> <code>:CALCulate:MARKer:C:X:TIME?</code> The value returned in this example is: "0.5".

`:CALCulate:MARKer:{A|B|C|D|E|F}:X:DISTance`

Syntax	<code>:CALCulate:MARKer:{A B C D E F}:X:DISTance <real1></code>
Parameters	<code>real1</code> is a floating point real number. The minimum value for <code>real1</code> is 0.0, the maximum value 2000.0. The minimum resolution possible for <code>real1</code> is 1. The default value for <code>real1</code> is 0.0432.
Command	This command sets the marker time for distance to fault measurements for one of the six markers of the Willtek 9100. The physical dimension of <code>real1</code> is meter or feet, respectively.

Query	The query form of this command will return the current DTF marker length setting of the respective marker of the Willtek 9102 (A, B, C, D, E or F). The string delivered back will contain one real number.
Example	:CALCulate:MARKer:C:X:DIStance 10.5 :CALCulate:MARKer:C:X:DIStance? The value returned in this example is: "10.5".

:CALCulate:{A|B|C|D|E|F}:MARKer:FSTep

Syntax	:CALCulate:MARKer:{A B C D E F}:FSTep
Parameters	There are no parameters.
Command	Sets Marker A, B, C, D, E or F to current frequency step (FSTep).
Query	There is no query form of this command available.
Example	:CALCulate:MARKer:A:FSTep

:CALCulate:MARKer:{A|B|C|D|E|F}:TSElect

Syntax	:CALCulate:MARKer:{A B C D E F}:TSElect <PredefExpr>
Parameters	PredefExpr is one of the following predefined expressions: A B. Default is A.
Command	Selects an active marker and sets it either to trace A or trace B. Note: Set to trace B is only possible when trace B is active.
Query	The query form of this command will return the current setting. The string delivered back will contain the short-form version of one of the predefined expressions explained above.
Example	:CALC:MARK:A:TSElect B :CALC:MARK:A:TSElect? Value returned in this example: "B".

:CALCulate:MARKer:MAXPeak

Syntax	:CALCulate:MARKer:MAXPeak
Parameters	There are no parameters.
Command	Sets the currently selected marker to the maximum measured level. A marker is "selected" by way of the :CALCulate:MARKer:{A B C D E F}[:STATE] command.
Query	There is no query form of this command available.
Example	:CALCulate:MARKer:MAXPeak.

:CALCulate:MARKer:NPEak

Syntax	:CALCulate:MARKer:NPEak
Parameters	There are no parameters.
Command	Sets the currently selected marker to the next highest level value.

Query There is no query form of this command available.

Example :CALCulate:MARKer:NPEak.

:CALCulate:MARKer:MCENter

Syntax :CALCulate:MARKer:MCENter

Parameters There are no parameters.

Command The center frequency is changed to the current marker frequency.

Query There is no query form of this command available.

Example :CALCulate:MARKer:MCENter.

:CALCulate:MARKer:MREFlevel

Syntax :CALCulate:MARKer:MREFlevel

Parameters There are no parameters.

Command The REFerence level is changed to the level at the marker position.

Query There is no query form of this command available.

Example :CALCulate:MARKer:MREFlevel.

:CALCulate:MARKer:FCOunt?

Syntax :CALCulate:MARKer:FCOunt?

Parameters There are no parameters.

Command There is solely a query form of this command available.

Query Returns a string with the floating point value for the current result of the frequency counter, in Hz. Marker M1 (CALC:MARK:A COUNTER) has to be set before to get a valid result.

Example :CALCulate:MARKer:FCOunt?
The value returned in this example is: "2694365000.0".

:CALCulate:MARKer:FCOunt:RESolution

Syntax :CALCulate:MARKer:FCOunt:RESolution <real1>

Parameters real1 is an integer. The minimum value for <real1> is 1, the maximum is 1000. Valid values are 1, 10, 100, 1000. The default value is 1000.

Command Sets the counter resolution of the frequency counter in Hz.

Query Reads and returns the current setting.

Example :CALC:MARK:FCO:RES 10
:CALC:MARK:FCO:RES?
The value returned in this example is: "10".

:CALCulate:LIMit[:STATe]

Syntax	:CALCulate::LIMit[:STATe] <PredefExpr>
Parameters	PredefExpr is one of the following predefined expressions: OFF UPPER LOWER UPPLow. Default is OFF.
Command	Selects the limit lines to one of four different modes: OFF UPPER LOWER UPPLow. OFF is used to switch off the limit lines. UPPER switches only the upper limit line on. LOWER switches only the lower limit line on. UPPLow switches both upper and lower limit lines on.
Query	The query form of this command will return the current setting. The string delivered back will contain the short-form version of one of the predefined expressions explained above.
Example	CALC:LIM:STAT UPPLow :CALC:LIM? Value returned in this example: "UPPL" .

:CALCulate:LIMit:FCOunt

Syntax	:CALCulate:LIMit:FCOunt <PredefExpr>
Parameters	PredefExpr is one of the following predefined expressions: ON OFF. Default is OFF.
Command	Enables (and resets) or disables the failure counter. When enabled, requires that limit checking is also active (see CALC:LIM:STAT).
Query	Reads and returns the current setting.
Example	:CALCulate:LIMit:FCOunt ON :CALCulate:LIMit:FCOunt? Returns the following string: "ON"

:CALCulate:LIMit:FCOunt:COUNT?

Syntax	:CALCulate:LIMit:FCOunt:COUNT?
Parameters	There are no parameters.
Command	There is solely a query form of this command available.
Query	Gets the current count of fails in the limit check.
Example	:CALCulate:LIMit:FCOunt:COUNT? The value returned in this example is: "5" .

:CALCulate:LIMit:FBEep

Syntax	:CALCulate:LIMit:FBEep <PredefExpr>
Parameters	PredefExpr is one of the following predefined expressions: ON OFF. Default is OFF.
Command	Enables or disables a sound that can be output each time a measurement fails the limits.

Query	Reads and returns the current setting.
Example	:CALC:LIMit:FBEep ON :CALCulate:LIMit:FBEep? Returns the following string: "ON".

:CALCulate:LIMit:FHOLD

Syntax	:CALCulate:LIMit:FHOLD <PredefExpr>
Parameters	PredefExpr is one of the following predefined expressions: ON OFF. Default is OFF.
Command	Enables or disables hold, if measurement fails the limits.
Query	Reads and returns the current setting.
Example	:CALCulate:LIMit:FHOLD ON :CALCulate:LIMit:FHOLD? Returns the following string: "ON".

:CALCulate:LIMit:SIMPLE

Syntax	:CALCulate:LIMit:SIMPLE <PredefExpr>
Parameters	PredefExpr is one of the following predefined expressions: ON OFF. Default is OFF.
Command	Enables or disables the simple limit lines.
Query	Reads and returns the current setting.
Example	:CALCulate:LIMit:SIMPLE ON :CALCulate:LIMit:SIMPLE? Returns the following string: "ON".

:CALCulate:LIMit:SIMPLE:UPPER

Syntax	:CALCulate:LIMit:SIMPLE:UPPER <real1>
Parameters	real1 is a floating point real number. The minimum value for real1 is 0.0, the maximum value 8.0. The minimum resolution possible for real1 is 0.1. The default value for real1 is 7.0.
Command	Sets the simple upper limit line. The unit is one grid. 0.0 means the lower border of the visible display and 8.0 means the upper border.
Query	Reads and returns the current setting.
Example	:CALCulate:LIMit:SIMPLE:UPPER 6 :CALCulate:LIMit:SIMPLE:UPPER? The value returned in this example is: "6.0".

:CALCulate:LIMit:SIMPLE:LOWER

Syntax	:CALCulate:LIMit:SIMPLE:LOWER <real1>
Parameters	real1 is a floating point real number. The minimum value for real1 is 0.0, the maximum value 8.0. The minimum resolution possible for real1 is 0.1. The default value for real1 is 1.0.

Command	Sets the simple lower limit line. The unit is one grid. 0 . 0 means the lower border of the visible display and 8 . 0 means the upper border.
Query	Reads and returns the current setting.
Example	:CALCulate:LIMit:SIMPlE:LOWer 2 :CALCulate:LIMit:SIMPlE:LOWer? The value returned in this example is: " 2 . 0 " .

:CALCulate:MEASure:ACPR

Syntax	:CALCulate:MEASure:ACPR?
Parameters	There are no parameters.
Command	There is solely a query form of this command available.
Query	Returns a string containing three floating point values; these represent the relative power in the lower adjacent channel (in dB), the in-channel power (in dBm) and the relative power in the upper adjacent channel (in dB).
Example	:CALCulate:MEASure:ACPR? The value returned in this example is: "-14.9, -31.5, -14.1" .

:CALCulate:MEASure:OBW

Syntax	:CALCulate:MEASure:OBW?
Parameters	There are no parameters.
Command	There is solely a query form of this command available.
Query	Returns a string with the floating point value for the occupied bandwidth, in Hz.
Example	:CALCulate:MEASure:OBW? The value returned in this example is: " 2694000 . 0 " .

:CALCulate:MEASure:CPOWER

Syntax	:CALCulate:MEASure:CPOWer?
Parameters	There are no parameters.
Command	There is solely a query form of this command available.
Query	Returns the measured in-channel power, in dBm.
Example	:CALCulate:MEASure:CPOW? Returns the following string: "-32.2" .

NOTE

The :CALCulate:MEASure:CPOWer? command only returns a valid measurement result after a complete sweep has been made. Should the channel power be determined before the sweep is complete, the value -9999 will be returned. This value will also be returned, if the channel system settings defined cause an invalid measurement result. The value -9999 always indicates an invalid measurement value.

:CALCulate:MEASure:ACLoss

Syntax	:CALCulate:MEASure:ACLoss?
Parameters	There are no parameters.
Command	There is solely a query form of this command available.
Query	Returns the average cable loss, in dB. This query returns valid results only in Cable Loss mode.
Example	:CALCulate:MEASure:ACLoss? The value returned in this example is: "-22.5".

:CALCulate:MEASure:EMF

Syntax	:CALCulate:MEASure:EMF?
Parameters	There are no parameters.
Command	There is solely a query form of this command available.
Query	Returns the EMF measurement value. The result depends on the setting of the :SENSE:EMF:MEASure:DISPlay command. If it is set to EFStrength (electric field strength) the unit for the result is Volt/meter. If it is set to PDENSITY (power density) the unit for the result is Watt/squaremeter. This query only returns valid results in EMF mode.
Example	:CALCulate:MEASure:EMF? The value returned in this example is: "0.103352".

:CALCulate:MEASure:PSENSor[:ALL]?

Syntax	:CALCulate:MEASure:PSENSor[:ALL]?
Parameters	There are no parameters.
Command	There is solely a query form of this command available.
Query	Returns the power sensor measurement values. The first result represent the forward power, the second result represent the reverse power. The results depends on the setting :SENSe:PSENSor:UNIT command. If it is set to DBM the unit for the result is dBm. If it is set to W the unit for the result is Watt. This query returns valid results only in power sensor mode.
Example	:CALCulate:MEASure:PSENSor? The value returned in this example is: "20.1,18.5".

:CALCulate:MEASure:PSENSor:FPOWER?

Syntax	:CALCulate:MEASure:PSENSor:FPOWER?
Parameters	There are no parameters.
Command	There is solely a query form of this command available.
Query	Returns the power sensor measurement value for the forward power. The result depends on the setting :SENSe:PSENSor:UNIT command. If it is set to DBM the unit for the result is dBm. If it is set to W the unit for the result is Watt. This query returns valid results only in power sensor mode.

Example	<code>:CALCulate:MEASure:PSENSor:FPOWER?</code> The value returned in this example is: "20.1".
----------------	---

:CALCulate:MEASure:PSENSor:RPOWER?

Syntax	<code>:CALCulate:MEASure:PSENSor:RPOWER?</code>
Parameters	There are no parameters.
Command	There is solely a query form of this command available.
Query	Returns the power sensor measurement value for the reverse power. The result depends on the setting <code>:SENSE:PSENSor:UNIT</code> command. If it is set to <code>DBM</code> the unit for the result is dBm. If it is set to <code>W</code> the unit for the result is Watt. This query returns valid results only in power sensor mode.
Example	<code>:CALCulate:MEASure:PSENSor:RPOWER?</code> The value returned in this example is: "20.1".

Format commands

These commands are used for formatting the SCPI output of the 9102 Handheld Spectrum Analyzer.

:FORMat:ADELimiter

Syntax	<code>:FORMat:ADELimiter <PredefExp></code>
Parameters	<code>PredefExp</code> is one of the following predefined expressions: <code>COMMa</code> <code>COLOn</code> <code>SEMIcolon</code> . Default is <code>COMMa</code> .
Command	Selects the delimiter to be used to separate parameters in SCPI commands, and also to separate the individual measurement result values in a result return string. <code>COMMa</code> stands for commas (default), <code>COLOn</code> sets the delimiter to be a colon (:), while <code>SEMIcolon</code> will use and expect a semicolon (;) to be used.
Query	Reads and returns the current setting.
Example	<code>:FORM:ADEL</code> Defines the comma to be used as delimiter for both commands and measurement results.

:FORMat:RESolution

Syntax	<code>:FORMat:RESolution <int1></code>
Parameters	<code>int1</code> is an integer. The minimum value for <code><int1></code> is 0, the maximum is 20. The default value is 6.
Command	Defines the number of digits after the decimal point to be used for floating point real figures.
Query	Reads and returns the current setting.
Example	<code>:FORM:RES 0</code> Defines that there will be no digits after the decimal point.

Service commands

These commands are used for information regarding the status of the 9102.

:SERVice:BOOTversion?

Syntax	:SERVice:BOOTversion?
Parameters	There are no parameters.
Command	There is only a query form of this command available.
Query	Reads and returns the version of the boot software of your Willtek 9102. The command will return a string.
Example	:SERVice:BOOTversion? String returned in this example: "2.00".

:SERVice:BOOTversion:DATE?

Syntax	:SERVice:BOOTversion:DATE?
Parameters	There are no parameters.
Command	There is only a query form of this command available.
Query	Reads and returns the date of the Boot Software of your Willtek 9102. The command will return a string.
Example	:SERVice:BOOTversion:DATE? String returned in this example: "2004/10/22".

:SERVice:BATTery

Syntax	:SERVice:BATTery?
Parameters	There are no parameters.
Command	There is only a query form of this command available.
Query	Reads and returns the the current loading state of the battery in %. The command will return an integer.
Example	:SERVice:BATTery? String returned in this example: "40".

:SERVice:BATTery:SERialnumber?

Syntax	:SERVice:BATTery:SERialnumber?
Parameters	There are no parameters.
Command	There is only a query form of this command available.
Query	Reads and returns the serial number of the battery of your Willtek 9102. The command will return a string.
Example	:SERVice:BATTery:SERialnumber? String returned in this example: "00300402".

:SERvice:POWerline?

Syntax	:SERvice:POWerline?
Parameters	There are no parameters.
Command	There is only a query form of this command available.
Query	Returns ON, if the Willtek 9102 is connected to the 12 V power line, otherwise returns OFF.
Example	:SERV:POW? String returned in this example: "OFF".

:SERvice:CHECK:LAST

Syntax	:SERvice:CHECK:LAST <int1>,<int2>,<int3>,<string>
Parameters	intx are three integers. The minimum value for int1 is 1998, the maximum is 2100. The default value is 1998. The minimum value for int2 is 1, the maximum is 12. The default value is 1. The minimum value for int3 is 1, the maximum is 31. The default value is 1. string is a string (text) parameter. The maximum length of string1 is 16 characters.
Command	Sets date and name of the last check of this device.
Query	Reads and returns current settings. The command will return 3 integers and a string.
Example	:SERvice:CHECK:LAST? String returned in this example: 2004,04,01,"John Williams".

:SERvice:CHECK:NEXT

Syntax	:SERvice:CHECK:NEXT?
Parameters	There are no parameters.
Command	There is only a query form of this command available.
Query	Reads and returns the date of the next check to be performed on this device. The command will return 3 integers.
Example	:SERvice:CHECK:NEXT? String returned in this example: 2005,04,01.

:SERvice:DEvice:TYPe?

Syntax	:SERvice:DEvice:TYPe?
Parameters	There are no parameters.
Command	There is only a query form of this command available.
Query	Reads and returns the type of your Willtek 9102. The command will return a string.
Example	:SERvice:DEvice:TYPe? String returned in this example: "9102".

:SERvice:DEvice:TEXT?

Syntax	:SERvice:DEvice:TEXT?
Parameters	There are no parameters.
Command	There is only a query form of this command available.
Query	Reads and returns the description text of your Willtek 9102. The command will return a string.
Example	:SERvice:DEvice:TEXT? String returned in this example: "Willtek 9102 Handheld Spectrum Analyzer".

:SERvice:DEvice:CALibration:NUMBer?

Syntax	:SERvice:DEvice:CALibration:NUMBer?
Parameters	There are no parameters.
Command	There is only a query form of this command available.
Query	Reads and returns the calibration number of your Willtek 9102. The command will return a string.
Example	:SERvice:DEvice:CALibration:NUMBer? String returned in this example: "1234".

:SERvice:EDEvice:SERialnumber?

Syntax	:SERvice:EDEvice:SERialnumber?
Parameters	There are no parameters.
Command	There is only a query form of this command available.
Query	Reads and returns the serial number of the external device connected to your Willtek 9102. The command will return a string.
Example	:SERvice:EDEvice:SERialnumber? String returned in this example: "00100202".

:SERvice:EDEvice:TYPe?

Syntax	:SERvice:EDEvice:TYPe?
Parameters	There are no parameters.
Command	There is only a query form of this command available.
Query	Reads and returns the type of the external device connected to your Willtek 9102. The command will return a string.
Example	:SERvice:EDEvice:TYPe? String returned in this example: "1234".

:SERVICE:EDEVICE:TEXT?

Syntax	:SERVICE:EDEVICE:TEXT?
Parameters	There are no parameters.
Command	There is only a query form of this command available.
Query	Reads and returns the description text of the external device connected to your Willtek 9102. The command will return a string.
Example	:SERVICE:EDEVICE:TEXT? String returned in this example: "VSWR Bridge".

:SERVICE:EDEVICE:CALIBRATION:DATE?

Syntax	:SERVICE:EDEVICE:CALIBRATION:DATE?
Parameters	There are no parameters.
Command	The command form is not available.
Query	Returns date of last calibration by Willtek of the external device connected in the form yyyy,mm,dd.
Example	:SERVICE:EDEVICE:CALIBRATION:DATE? String returned in this example: "2004/12/31".

:SERVICE:EDEVICE:CALIBRATION:NUMBER?

Syntax	:SERVICE:EDEVICE:CALIBRATION:NUMBER?
Parameters	There are no parameters.
Command	There is only a query form of this command available.
Query	Reads and returns the calibration number of the external device connected to your Willtek 9102. The command will return a string.
Example	:SERVICE:EDEVICE:CALIBRATION:NUMBER? String returned in this example: "1234".

SCPI errors

The following table from MKS, `scpi/inc/scpierrs.h` lists the error numbers which the 9102 may return in case of a problem.

Error number	Error description
Command errors	
-100	Internal error only, for debugging purposes (Command error)
-101	Invalid character in command string
-102	SCPI syntax error: Command is not available as a query, or vice versa

-103	Invalid separator between parameters
-104	Data type error (mismatch between parameters and allowable data formats)
-108	Parameter not allowed (too many parameters)
-109	Missing parameter (too few parameters)
-111	Header separator error (probably colon missing between command keywords)
-112	Program mnemonic too long (i.e. longer than 12 characters)
-113	Keyword not found in command list
-114	Header suffix out of range (invalid character in command keyword)
-121	Invalid character in number (not a digit, or exponent value missing)
-123	Exponent out of range
-128	Numerical data not allowed
-131	Invalid suffix (appended unit not found)
-134	Suffix too long (appended unit is longer than 12 characters)
-138	Suffix not allowed (parameter type is not real)
-141	Invalid character data (parameter expression is not in pre-defined list)
-144	Character data too long (string data longer than allowed)
-158	String data not allowed for this parameter type
-160	Internal error only, for debugging purposes (block data error)
-168	Internal error only, for debugging purposes (block data not allowed)
Execution errors	
-201	Internal error only, for debugging purposes (SCPI execution function not defined)
-202	Internal error only, for debugging purposes (SCPI query function not defined)
-210	Internal error only, for debugging purposes (out of memory)
-222	Data out of range
-230	Internal error only, for debugging purposes (invalid token received by EXEC)
-231	Internal error only, for debugging purposes (invalid index for parameter)
-232	Internal error only, for debugging purposes (invalid parameter)

-233	Internal error only, for debugging purposes (parameter has wrong type)
-234	Internal error only, for debugging purposes (parameter missing)
-235	Internal error only, for debugging purposes (index error)
-236	Parameter out of range
-260	File name not found in defined directory
-261	File creation failed in defined directory
-262	Internal error only, for debugging purposes (label not found, config file)
-264	Error while saving or recalling trace file
Device-dependent errors	
-300	SYSTEM_ERROR
-310	Internal error only, for debugging purposes (error no. not found)
-311	Internal error only, for debugging purposes (function not yet supported)
-319	Error queue overflow (more than 10 entries)
-320	Wrong password
-321	Internal error only, for debugging purposes (serial number error)
-322	Wrong option key
-323	Option not available
-330	Download command error
-331	Upload command error
Query errors	
-400	Checkrule conflict, parameters outside limits
-401	Internal error only, for debugging purposes (EPROM write error)
-402	Internal error only, for debugging purposes (EPROM read error)
-410	Result not valid

Programming Examples

17

This chapter provides examples how to use the SCPI commands to set up and control the 9102 Handheld Spectrum Analyzer.

- ["Overview" on page 326](#)
- ["Command examples" on page 326](#)
- ["Application examples" on page 334](#)

Overview

This chapter describes how to control the 9102 from a personal computer via a serial or LAN connection. It explains the basic commands for the 9102 Handheld Spectrum Analyzer and describes a few typical applications together with the SCPI command sequence.

This documents does not show every command possible. It is assumed that the user has some basic knowledge about remote control and also some experience in the use of a spectrum analyzer.

Command examples

Introduction

The whole command set can be divided into three categories: settings, measurements and others. Each category is described in a separate section.

The word <val> stands for a numerical value.

The word <enum> is a placeholder for a string.

Prerequisites

Over serial interface

The 9102 must be powered on. A serial cable (null modem cable with crossed lines) must connect the 9102 with the PC. The interface settings should be set to 57600 bps, 8 bits per character, no parity, 1 stop bit.

Over LAN interface

The 9102 must be powered on. A crosspatch LAN cable must connect the 9102 with the PC, or a normal LAN cable must connect the 9102 to a local area network. The 9102 must be programmed with its own IP address.

Settings

Please note that the 9102 always tries to execute the commands. However, under some circumstances, the 9102 must adjust or change other settings. If this happens, please check all previous settings and try to resolve this conflict.

Center frequency

`SENSe:FREQuency:CENTer <val>`

Sets the center frequency in Hz.

Examples:

Long format:

SENSE:FREQUENCY:CENTER 96500000
 Center frequency set to 96.5 MHz

Short format:

SENS:FREQ:CENT 96.5E06
 Center programmed to 96.5 MHz

Span SENSE:FREQUENCY:SPAN <val> Sets the span (dimension Hz)

Examples:

Long format:

SENSE:FREQUENCY:SPAN 20000000 Span programmed to 20 MHz

Short format:

SENS:FREQ:SPAN 20E06 Span programmed to 20 MHz

SENS:FREQ:SPAN:FULL Full span programmed

SENS:FREQ:SPAN 0 Zero span activated

Resolution bandwidth SENSE:BANDWIDTH:RESOLUTION <val>
 Sets the resolution bandwidth (dim. Hz)

Valid values for <val>: 10 kHz, 30 kHz, 100 kHz, 300 kHz or 1 MHz.

Examples:

Long format:

SENSE:BANDWIDTH:RESOLUTION 30000 Resolution set to 30 kHz

Short format:

SENS:BAND:RES 30E03 Resolution set to 30 kHz

SENS:BAND:RES:AUTO ON Automatic selection active

Video bandwidth SENSE:BANDWIDTH:VIDEO <val> Sets the video bandwidth (dim. Hz)

Valid values for <val>: 100, 300 Hz, 1, 3, 10, 30, 100, 300 kHz or 1 MHz.

Examples:

Long format:

SENSE:BANDWIDTH:VIDEO 300000 Video set to 300 kHz

Short format:

SENS:BAND:VID 10E03 Video set to 10 kHz

SENS:BAND:VID:AUTO ON Automatic selection active

Sweep time `SENSE:SWEEP:TIME <val>` Sets the sweep time (dimension ms)

Valid values for <val>: 1, 2, 5, 10, 20, 50, 100, 200 or 500 ms; 1, 2, 5, 10 or 20 s.

Examples:

Long format:

`SENSE:SWEEP:TIME 200` Sweep time set to 200 ms

Short format:

`SENS:SWE:TIME 10` Sweep time set to 10 ms

`SENS:SWE:TIME:AUTO ON` Automatic selection active

Reference level `SENSE:RFLEVEL <val>` Defines the reference level (in dBm)

Examples:

Long format:

`SENSE:RFLEVEL -30.0` Reference level set to -30.0 dBm

Short format

`SENS:RFL 10` Reference level set to +10 dBm

Scale `DISPLAY:TRACE:Y <val>` Defines scale per div. (in dB)

Examples:

Long format:

`DISPLAY:TRACE:Y 10` Scale set to 10 dB per division

Short format:

`DISPL:TRAC:Y 20` Scale set to 20 dB per div.

Input attenuation `INPUT:ATTENUATION <val>` Sets the input attenuation (in dB)

Valid input attenuation values: 0, 10, 20, 30, 40 or 50 dB.



WARNING

Be careful with 0 dB. This value may damage the unit if the actual power is too high.

Examples:

Long format:

`INPUT:ATTENUATION 10` 10 dB attenuation

Short format:

`INP:ATT 20` 20 dB attenuation

Measurements

Trace `SENSE:TRACE:<x>:FETCH? <enum>` Reads the trace data in a definable format

<x> is the trace (A or B)

Valid entries for <enum>: ALL, MIN, MAX, FREQ, FMIN or FMAX.

Examples:

Long format:

`SENSE:TRACE:A:FETCH? ALL` All measured data requested

Short format:

`SENS:TRAC:B:FETC? MAX` Trace B (only MAX) requested

Format examples:

ALL: <min level>, <max level>, <freq>, <min level>, ...

MAX: <max level>, <max level>,

MIN: <min level>, <min level>,

FREQ: <freq>, <freq>,

FMAX: <max level>, <freq>, <max level>, <freq>, <max level>,

FMIN: <min level>, <freq>, <min level>, <freq>, <min level>,

NOTE

One trace contains 500 samples.

Sweep `SENSE:SWEep:STATE <enum>` Controls the sweep

Valid entries for <enum>: CONTInuous, SINGle or HOLD

Examples:

Long format:

`SENSE:SWEeP:STATE SINGLE` One sweep performed

Short format:

`SENS:SWE:STAT CONT` Repetitive sweeps started

Max Peak `CALCulate:MARKer:MAXPeak` Sets the marker to the maximum peak

Examples:

Long format:

`CALCULATE:MARKER:MAXPEAK` Marker set to max. peak

Short format:

`CALC:MARK:MAXP` Marker set to max. peak

NOTE

A marker must be activated first using the following command:

`CALC:MARKer:<x>[:STATE] {NORMAL|DELTA|NOISE}`.

Next Peak `CALCulate:MARKer:NPEak` Sets the marker to the next highest peak

Examples:

Long format:

`CALCULATE:MARKER:NPEAK` Marker set to the next peak

Short format:

`CALC:MARK:NPE` Marker set to the next peak

NOTE

A marker must be activated first using the following command:

`CALC:MARKer:<x>[:STATE] {NORMAL|DELTA|NOISE}`.

Marker level `CALCulate:MARKer:<x>:Y?` Reads the level at the actual marker position
<x> selects the trace (A to D)

Examples:

Long format:

`CALCULATE:MARKER:B:Y?` Marker B level requested

Short format:

`CALC:MARK:A:Y?` Marker A level requested

Marker frequency `CALCulate:MARKer:<x>:X?` Reads the actual marker frequency
<x> selects the trace (A to D)

Examples:

Long format:

`CALCULATE:MARKER:B:X?` Marker B frequency requested

Short format:
CALC:MARK:A:X?

Marker A frequency requested

Others

Identity *IDN? Reads serial number of the instrument

Format returned: "<Manufacturer>, <Model>, <Serial number>, <Software version>"

Manufacturer: Willtek

Model: 9102

Serial number: (seven digits)

Software version: 2.00 (for example)

Reset *RST Resets the unit

Example:

*RST Unit set to idle state

Error queue SYST:ERR? Queries the error queue

Format returned: <Error number>, "<Error description>"

If no error is present, 0, "No Error" is returned.

NOTE

The error queue can hold up to 10 error messages. Read always until the NO ERROR is given back.

Echo SYST:COMM:ECHO <enum> Enables/disables echo function

Range: ON or OFF.

Example:

SYST:COMM:ECHO ON Echo feature activated

NOTE

We recommend to always activate the echo. It gives back "OK" after a command was successfully executed or in case of errors "ERR".

The additional advantage of this is to create a kind of handshake mechanism.

Local mode SYST:COMM:LOCAL

Switches unit back to local mode

Example:

SYST:COMM:LOCAL

Remote session finished

Application examples

The application examples below use three subroutines which transmit a command (Output9100), read a result (Input9100) or send a command and read the acknowledgement (OutAck9100). These subroutines are not printed here but available from Willtek on request. The program examples are written in BASIC.

Signal monitoring

Task: Permanently monitor a signal and check, if it is still present. The signal frequency is 97.3 MHz and the signal strength is around -40 dBm.

```
OutAck9100 ("SENS:FREQ:CENT 97300000") ' set the center to the frequency
OutAck9100 ("SENS:FREQ:SPAN 2E06")    ' set span to 2 MHz

OutAck9100 ("SENS:REFL -30")           ' set a sensitive ref level
OutAck9100 ("INP:ATT 10")              ' set a low attenuation
OutAck9100 ("SENS:TRAC:A ACT")         ' activate an normal trace
OutAck9100 ("SENS:DET:FUNC POS")      ' use only positive samples

OutAck9100 ("CALC:MARK:A OFF")         ' switch all markers off
OutAck9100 ("CALC:MARK:A NORM")       ' activate marker A
SIG_FLAG = True

While SIG_FLAG = True
  OutAck9100 ("SENS:SWE:STAT SING")    ' do one measurement

  OutAck9100 ("CALC:MARK:A:X 97.3E06") ' set marker to the signal

  Output9100 ("CALC:MARK:A:Y?")        ' read the signal level
  Lvl = Val(Input9100())

  If Lvl < -45 Then SIG_FLAG = False   ' signal lost
Wend

Print "Signal disappeared!!!"
```

Signal search

Task: Search for transmitters within a frequency band. If a signal is present and higher than a level of -80 dBm, the frequency is printed.

```

OutAck9100 ("SENS:FREQ:SPAN 2000000") ' set span to 2 MHz
OutAck9100 ("SENS:FREQ:CENT 936000000") ' start with channel 0

OutAck9100 ("SENS:REFL -40")           ' set a sensitive ref-level
OutAck9100 ("INP:ATT 0")               ' remove any attenuation !!
OutAck9100 ("SENS:TRAC:A MAXH")        ' activate a max hold trace
OutAck9100 ("SENS:DET:FUNC POS")       ' use only positive samples

OutAck9100 ("CALC:MARK:AOFF")          ' switch all markers off

channel = 1
For I = 9360 To 9594 Step 18             ' scan the gsm band in small portions
  Msg$ = "SENS:FREQ:CENT" & Str$(I) & "00000"
  OutAck9100 (Msg$)                     ' set frequency

  For J = 0 To 4
    OutAck9100 ("SENS:SWE:STAT SING")   ' do the measurements 5 times
  Next J

  Output9100 ("SENS:TRAC:A:FETC? MAX")
  MXdata$ = Input9100()                 ' read trace data

  For J = 0 To 499                       ' isolate the data into an array
    P = InStr(MXdata$, ",") ' search for the COMMA between two values
    Yfeld(J) = Val(Mid$(MXdata$, 1, P))
    MXdata$ = Right$(MXdata$, Len(MXdata$) - P)
                                          ' remove the actual value
  Next J

  For J = 45 To 445 Step 50
    P = -120
    For K = 0 To 8                         ' do a maximum search
      If Yfeld(J + K) > P Then
        P = Yfeld(J + K)                   ' store the new maximum
      End If
    Next K

    If P > -80 And channel < 125 Then     ' blocked channel found
      Print "Channel " & Str$(channel) & " = " & Str$(P) & " dBm."
    End If
    channel = channel + 1
  Next J
Next I

```

Index of SCPI Commands

A

*CAL	249
*CLS	249
*ESE	251
*ESR	251
*IDN	249
*OPC	250
*OPT	249
*RST	250
*SRE	252
*STB	252
*WAI	250
:CALCulate:{A B C D E F}:MARKer:FSTep	311
:CALCulate:LIMit:FBEP	313
:CALCulate:LIMit:FCOunt	313
:CALCulate:LIMit:FCOunt:COUnT?	313
:CALCulate:LIMit:FHOLd	314
:CALCulate:LIMit:SIMPlE	314
:CALCulate:LIMit:SIMPlE:LOWer	314
:CALCulate:LIMit:SIMPlE:UPPer	314
:CALCulate:LIMit[:STATe]	313
:CALCulate:MARKer:{A B C D E F}:DTF[:STATe]	309
:CALCulate:MARKer:{A B C D E F}:TSElect	311
:CALCulate:MARKer:{A B C D E F}:X:DISTance	310
:CALCulate:MARKer:{A B C D E F}:X:TIME	310
:CALCulate:MARKer:{A B C D E F}:X[:FREQuency]	310
:CALCulate:MARKer:{A B C D E F}:Y?	309
:CALCulate:MARKer:{A B C D E F}[:STATe]	309
:CALCulate:MARKer:AOff	308
:CALCulate:MARKer:FCOunt:RESolution	312
:CALCulate:MARKer:FCOunt?	312
:CALCulate:MARKer:MAXPeak	311
:CALCulate:MARKer:MCENter	312
:CALCulate:MARKer:MREFlevel	312
:CALCulate:MARKer:NPEak	311

:CALCulate:MEASure:ACLoss	316
:CALCulate:MEASure:ACPR	315
:CALCulate:MEASure:CPOWer	315
:CALCulate:MEASure:EMF	316
:CALCulate:MEASure:OBW	315
:CALCulate:MEASure:PSEnSor:FPOWer?	316
:CALCulate:MEASure:PSEnSor:RPOWer?	317
:CALCulate:MEASure:PSEnSor[:ALL]?	316
:DISPlay:BACKlight:EXTern	307
:DISPlay:BACKlight[:BATTery]	307
:DISPlay:BEEP	307
:DISPlay:COLor:GRATicule	308
:DISPlay:COLor:LIMits	308
:DISPlay:COLor:TRACe:[A B]	307
:DISPlay:COLor:TRACe:OFFSet	308
:DISPlay:TRACe:Y[:SCALe]:DTF:RFACtor	306
:DISPlay:TRACe:Y[:SCALe]:LINear:VOLT	305
:DISPlay:TRACe:Y[:SCALe]:LINear:WATT	305
:DISPlay:TRACe:Y[:SCALe]:RFLection:RFACtor	306
:DISPlay:TRACe:Y[:SCALe]:RFLection:RPOWer	306
:DISPlay:TRACe:Y[:SCALe]:RFLection:VSWR	305
:DISPlay:TRACe:Y[:SCALe][:LOGarithmic]	304
:FORMat:ADELimiter	317
:FORMat:RESolution	317
:HCOPy[:IMMEdiate]	248
:INPut:AFACtor	287
:INPut:ATTenuation	286
:INPut:ATTenuation:AUTO	286
:INPut:CFACTOR	287
:INPut:EDEvice	286
:INPut:IMPedance	286
:INSTrument:GENerator	300
:INSTrument:GENerator:DISPlay	301
:INSTrument:GENerator:LEVel	300
:INSTrument:GENerator:MODE	300
:INSTrument:GPS:ALTitude	303
:INSTrument:GPS:ALTitude:UNIT	304
:INSTrument:GPS:COORdinate:UNIT	304
:INSTrument:GPS:DATE	303
:INSTrument:GPS:HDOP	303
:INSTrument:GPS:LATitude	301
:INSTrument:GPS:LONGitude	301
:INSTrument:GPS:LONGitude	302
:INSTrument:GPS:QUALity	301
:INSTrument:GPS:SATellites	303
:INSTrument:GPS:SPEed	302
:INSTrument:GPS:SPEed:UNIT	302
:INSTrument:GPS:TIME	303
:INSTrument:GPS:TRACk	302
:INSTrument:SElect	299
:MMEMory:DElete:AFACtor	298
:MMEMory:DElete:AFACtor:ALL	299
:MMEMory:DElete:CFACTOR	299
:MMEMory:DElete:CFACTOR:ALL	299

:MMEMory:DELeTe:CHANnel	297
:MMEMory:DELeTe:CHANnel:ALL	297
:MMEMory:DELeTe:CTYPe	298
:MMEMory:DELeTe:CTYPe:ALL	298
:MMEMory:DELeTe:EDEVice	297
:MMEMory:DELeTe:EDEVice:ALL	298
:MMEMory:DELeTe:LIMit	296
:MMEMory:DELeTe:LIMit:ALL	297
:MMEMory:DELeTe:STATe	295
:MMEMory:DELeTe:STATe:ALL	296
:MMEMory:DELeTe:TRACe	296
:MMEMory:DELeTe:TRACe:ALL	296
:MMEMory:LOAD:AFACtor	295
:MMEMory:LOAD:CFACtor	295
:MMEMory:LOAD:CHANnel	294
:MMEMory:LOAD:CTYPe	295
:MMEMory:LOAD:EDEVice	295
:MMEMory:LOAD:LIMit	294
:MMEMory:LOAD:STATe	294
:MMEMory:LOAD:TRACe	294
:MMEMory:STORe:AFACtor	291
:MMEMory:STORe:CFACtor	291
:MMEMory:STORe:CHANnel	289
:MMEMory:STORe:CTYPe	290
:MMEMory:STORe:CTYPe:CALibration	290
:MMEMory:STORe:EDEVice	289
:MMEMory:STORe:LIMit	288
:MMEMory:STORe:STATe	287
:MMEMory:STORe:TRACe	288
:MMEMory[:LOAD]:FILElist:AFACtor?	293
:MMEMory[:LOAD]:FILElist:CFACtor?	293
:MMEMory[:LOAD]:FILElist:CHANnel?	292
:MMEMory[:LOAD]:FILElist:CTYPe?	293
:MMEMory[:LOAD]:FILElist:EDEVice?	292
:MMEMory[:LOAD]:FILElist:LIMit?	292
:MMEMory[:LOAD]:FILElist:STATe?	292
:MMEMory[:LOAD]:FILElist[:TRACe]?	291
:REBoot	248
:SENSe:BANDwidth:RESolution	260
:SENSe:BANDwidth:RESolution:AUTO	261
:SENSe:BANDwidth:VIDeo	261
:SENSe:BANDwidth:VIDeo:AUTO	261
:SENSe:CLOSs:CALibration	282
:SENSe:CLOSs:CALibration:ENABled	283
:SENSe:CLOSs:FILTer	282
:SENSe:CLOSs:FILTer:AUTO	282
:SENSe:CLOSs:REFerence	282
:SENSe:CPOWer:CHANnel	264
:SENSe:CPOWer:MEASure	265
:SENSe:CPOWer:OBW	265
:SENSe:CPOWer:SPAN	264
:SENSe:DEMod:DEMod	267
:SENSe:DEMod:DUration	268
:SENSe:DEMod:VOLume	267

:SENSe:DEMod[:MODulation]	267
:SENSe:DETEctor:FUNCTion	268
:SENSe:DTF:CALibration	275
:SENSe:DTF:CALibration:ENABled	276
:SENSe:DTF:CLENgth	274
:SENSe:DTF:CLENgth:UNIT	274
:SENSe:DTF:REFerence	275
:SENSe:DTF:REFerence:RFACTor	275
:SENSe:DTF:REFerence:UNIT	275
:SENSe:EDEVice:RFINput	285
:SENSe:EMF:ANTenna:DIRection	277
:SENSe:EMF:MEASure	278
:SENSe:EMF:MEASure:DISPlay	278
:SENSe:EMF:MEASure:LAST?	278
:SENSe:EMF:MEASure:TIme	278
:SENSe:EMF:REFerence	277
:SENSe:EMF:REFerence:UNIT	277
:SENSe:FREQuency:CENTer	262
:SENSe:FREQuency:FSTep	264
:SENSe:FREQuency:FSTep:AUTO	264
:SENSe:FREQuency:MODE	263
:SENSe:FREQuency:SPAN	262
:SENSe:FREQuency:SPAN:FULL	262
:SENSe:FREQuency:STARt	263
:SENSe:FREQuency:STOP	263
:SENSe:FREQuency:STOP:MAX	263
:SENSe:MEASure	273
:SENSe:MEASure:ADJSettings	274
:SENSe:MEASure:CHANnel:SPACing	274
:SENSe:MEASure:CHANnel:WIDTh	273
:SENSe:MEASure:OBW	273
:SENSe:PSENSor:FREQuency:CDMA	285
:SENSe:PSENSor:FREQuency:CW	284
:SENSe:PSENSor:FREQuency:DVBT	285
:SENSe:PSENSor:FREQuency:GSM	284
:SENSe:PSENSor:FREQuency:TETRa	284
:SENSe:PSENSor:FREQuency:UMTS	284
:SENSe:PSENSor:MODE	283
:SENSe:REFLevel	272
:SENSe:REFLevel:UNIT	272
:SENSe:RFLection:CALibration	281
:SENSe:RFLection:CALibration:ENABled	281
:SENSe:RFLection:CALibration:MODE	281
:SENSe:RFLection:FILTer	280
:SENSe:RFLection:FILTer:AUTO	280
:SENSe:RFLection:REFerence:RFACTor	279
:SENSe:RFLection:REFerence:RPOWER	280
:SENSe:RFLection:REFerence:UNIT	279
:SENSe:RFLection:REFerence:VSWR	279
:SENSe:RFLection:REFerence[:RETurnloss]	279
:SENSe:STATe	273
:SENSe:SWEep:STATe	266
:SENSe:SWEep:TIme	265
:SENSe:SWEep:TIme:AUTO	265

:SENSe:TRACe:A:FETCh?	269
:SENSe:TRACe:A[:STATe]	268
:SENSe:TRACe:AVGFactor	270
:SENSe:TRACe:B:FETCh?	270
:SENSe:TRACe:B[:STATe]	269
:SENSe:TRACe:CLear	270
:SENSe:TRACe:COpy	270
:SENSe:TRACe:DATA:LIMit	271
:SENSe:TRACe:DATA?	271
:SENSe:TRACe:MATH	271
:SENSe:TRACe:MATH:[A B]	271
:SENSe:TRACe:MATH:OFFSet	272
:SENSe:TRANsmission:REFerence	276
:SENSe:TRANsmission:REFerence:UNIT	276
:SENSe:TRIGger	266
:SENSe:TRIGger:EDGE	267
:SENSe:TRIGger:LEVel	266
:SERVice:BATTery	318
:SERVice:BATTery:SERialnumber?	318
:SERVice:BOOTversion:DATE?	318
:SERVice:BOOTversion?	318
:SERVice:CHECK:LAST	319
:SERVice:CHECK:NEXT	319
:SERVice:DEVice:CALibration:NUMBer?	320
:SERVice:DEVice:TEXT?	320
:SERVice:DEVice:TYPe?	319
:SERVice:EDEVice:CALibration:DATE?	321
:SERVice:EDEVice:SERialnumber?	320
:SERVice:EDEVice:TEXT?	321
:SERVice:EDEVice:TYPe?	320
:SERVice:POWerline?	319
:SYSTem:COMMunicate:ECHO	255
:SYSTem:COMMunicate:ETHernet:IPADdress	255
:SYSTem:COMMunicate:ETHernet:PORT	256
:SYSTem:COMMunicate:ETHernet:SUBNetmask	256
:SYSTem:COMMunicate:ETHernet:TERMinator	256
:SYSTem:COMMunicate:ETHernet:TNAME	256
:SYSTem:COMMunicate:ETHernet?	255
:SYSTem:COMMunicate:LOCal	254
:SYSTem:COMMunicate:SER:BAUDrate	257
:SYSTem:COMMunicate:SER:TERMinator	257
:SYSTem:DATE	254
:SYSTem:DNAME	258
:SYSTem:ERRor:CODE:ALL?	258
:SYSTem:ERRor:CODE[:NEXT]?	258
:SYSTem:ERRor:COUNT?	257
:SYSTem:ERRor[:NEXT]?	257
:SYSTem:OPTions	259
:SYSTem:PRINter:BAUDrate	260
:SYSTem:PRINter:TYPe	260
:SYSTem:SCReendump:COLor?	259
:SYSTem:SCReendump:LINE?	259
:SYSTem:SCReendump:REMote	259
:SYSTem:TIME	254

SENSe:PENSor:TYPe 283

Predefined settings

A large, bold, black letter 'B' is centered within a thin black rectangular border.

This appendix provides an overview on settings and parameters predefined on the 9102 as well as in the 9100 Data Exchange Software for your convenience. The topics discussed in this appendix are as follows:

- ["Predefined measurement settings" on page 344](#)
- ["Predefined channel power communication systems" on page 345](#)
- ["Predefined cable types" on page 348](#)

Predefined measurement settings

The 9102 provides the capability of storing all parameters for a particular measurement for reuse when repeating the measurement under the same conditions. In the 9100 Data Exchange Software delivered with your instrument a number of predefined settings for common measurements are available. For details on working with these settings refer to ["Working with settings" on page 241](#).

The following table provides an overview on the settings available within the 9100 Data Exchange Software. The names for the predefined settings files have prefixes assigned to them indicating the measurement modes used for performing the individual measurements:

- SP for spectrum analysis mode
- CH for channel power mode
- SG for signal generator mode
- TR for transmission mode
- RFL for reflection mode
- DTF for distance to fault mode
- CL for cable loss mode
- EMF for EMF (EMI) mode

Table 1 Predefined measurement settings

Name	Meaning	Frequency range
SP-UKW	Ultra short wave	87.5 to 108 MHz
SP-DAB I	Digital audio broadcast band I	223 to 230 MHz
SP-DAB II	Digital audio broadcast band II	1452 to 1479.5 MHz
SP-VHF I	Very high frequency TV band I	47 to 68 MHz
SP-VHF III	Very high frequency TV band III	174 to 230 MHz
SP-UHF IV	Ultra high frequency TV band IV	470 to 606 MHz
SP-UHF V	Ultra high frequency TV band V	606 to 862 MHz
SP-LNB	SAT-ZF	950 to 2050 MHz
RFL-GSM900	GSM 900 frequency range	875 to 965 MHz
RFL-GSM1800	GSM 1800 frequency range	1700 to 1890 MHz
RFL-UMTS	UMTS band I frequency range	1890 to 2200 MHz

Predefined channel power communication systems

Measurements in channel power mode imply that a communication system with predefined channel numbers and associated frequencies has been defined. The 9102 comes with a few systems preinstalled. More systems are available for download to the 9102 in the 9100 Data Exchange Software. The following two sections provide you with an overview on the communication systems preinstalled on your 9102 as well as on the systems available in the 9100 Data Exchange Software.

Preinstalled systems on the 9102

The following table lists all communication systems preinstalled as a default on your 9102. For details on working with the preinstalled systems refer to ["Working with communication systems and frequency settings"](#) on page 83.

Table 2 Default preinstalled channel power systems

System name	Meaning	Frequency range	Channel numbers (n)	Center frequencies (f_c)	Channel width
DECT		1880 to 1900 MHz	0 to 9	$f_c = 1897.344 - n \cdot 1.728$	1728 kHz
PGSM900-DL	Primary GSM Downlink	935 to 960 MHz	1 to 124	$f_c = 935 + 0.2 \cdot n$	200 kHz
RGSM900-DL	Railways GSM Downlink	921 to 960 MHz	955 to 1023	$f_c = 935 + 0.2 \cdot (n - 1024)$	200 kHz
PCN1800-DL	GSM 1800 Downlink	1805 to 1880 MHz	512 to 885	$f_c = 1805.2 + 0.2 \cdot (n - 512)$	200 kHz
PCS1900-DL	GSM 1900 Downlink	1930 to 1990 MHz	512 to 810	$f_c = 1930.2 + 0.2 \cdot (n - 512)$	200 kHz
WCDMA-DL	UTRA-FDD Downlink	2110 to 2170 MHz	10562 to 10838	$f_c = n / 5$	5 MHz
WCDMA-UL	UTRA-FDD Uplink	1920 to 1980 MHz	9612 to 9888	$f_c = n / 5$	5 MHz
WLAN	IEEE 802.11b,g	2400 to 2484 MHz	1 to 13	$f_c = 2412 + (n - 1) \cdot 5$	22 MHz

Predefined systems in the 9100 Data Exchange Software

The following table lists all further communication systems available in the 9100 Data Exchange Software for download to the 9102. For details on using these systems refer to ["Managing communication systems for channel power measurements" on page 235.](#)

Table 3 9100 Data Exchange Software channel power systems

System name	Meaning	Frequency range	Channel numbers (n)	Center frequencies (f _c)	Channel width
GSM450-UL	GSM 450 Uplink	450.4 to 457.6 MHz	259 to 293	$f_c = 450.6 + 0.2*(n - 259)$	200 kHz
GSM450-DL	GSM 450 Downlink	460.4 to 467.6 MHz	259 to 293	$f_c = 460.6 + 0.2*(n - 259)$	200 kHz
GSM480-UL	GSM 480 Uplink	478.8 to 468 MHz	306 to 340	$f_c = 479 + 0.2*(n - 306)$	200 kHz
GSM480-DL	GSM 480 Downlink	488.8 to 496 MHz	306 to 340	$f_c = 489 + 0.2*(n - 306)$	200 kHz
GSM850-UL	GSM 850 Uplink	824 to 849 MHz	128 to 251	$f_c = 824.2 + 0.2*(n - 128)$	200 kHz
GSM850-DL	GSM 850 Downlink	869 to 894 MHz	128 to 251	$f_c = 869.2 + 0.2*(n - 128)$	200 kHz
EGSM900-UL	Extended GSM Uplink	880 to 915 MHz	975 to 1023	$f_c = 890 + 0.2*(n - 1024)$	200 kHz
EGSM900-DL	Extended GSM Downlink	925 to 960 MHz	975 to 1023	$f_c = 935 + 0.2*(n - 1024)$	200 kHz
PGSM900-UL	Primary GSM Uplink	890 to 915 MHz	1 to 124	$f_c = 890 + 0.2*n$	200 kHz
RGSM900-UL	Railways GSM Uplink	876 to 915 MHz	955 to 1023	$f_c = 890 + 0.2*(n - 1024)$	200 kHz
PCN1800-UL	GSM 1800 Uplink	1710 to 1785 MHz	512 to 885	$f_c = 1710.2 + 0.2*(n - 512)$	200 kHz
PCS1900-UL	GSM 1900 Uplink	1850 to 1910 MHz	512 to 810	$f_c = 1850.2 + 0.2*(n - 512)$	200 kHz
BLUETOOTH	USA/Europe	2402 to 2480 MHz	0 to 78	$f_c = 2402 + n$	1 MHz
USCELL-UL	U.S. cellular Uplink	824 to 849 MHz	1 to 799	$f_c = 825 + 0.03*n$	1.25 MHz
USCELL-DL	U.S. cellular Downlink	869 to 894 MHz	1 to 799	$f_c = 870 + 0.03*n$	1.25 MHz
USPCS-UL	North America PCS Uplink	1850 to 1910 MHz	0 to 1199	$f_c = 1850 + 0.05*n$	1.25 MHz

Table 3 9100 Data Exchange Software channel power systems (Continued)

System name	Meaning	Frequency range	Channel numbers (n)	Center frequencies (f_c)	Channel width
USPCS-DL	North America PCS Downlink	1930 to 1990 MHz	0 to 1199	$f_c = 1930 + 0.05*n$	1.25 MHz
TACS-UL	TACS Uplink	872 to 915 MHz	0 to 1000	$f_c = 889.9875 + 0.025*n$	1.25 MHz
TACS-DL	TACS Downlink	917 to 960 MHz	0 to 1000	$f_c = 934.9875 + 0.025*n$	1.25 MHz
JTACS-UL	JTACS Uplink	887 to 925 MHz	1 to 799	$f_c = 915 + 0.0125*n$	1.25 MHz
JTAGS-DL	JTACS Downlink	832 to 870 MHz	1 to 799	$f_c = 860 + 0.0125*n$	1.25 MHz
KORPCS-UL	Korean PCS Uplink	1850 to 1780 MHz	0 to 599	$f_c = 1750 + 0.05*n$	1.25 MHz
KORPCS-DL	Korean PCS Downlink	1840 to 1870 MHz	0 to 599	$f_c = 1840 + 0.05*n$	1.25 MHz
NMT450-UL	NMT-450 Uplink	411 to 484 MHz	1 to 300	$f_c = 450 + 0.025*(n - 1)$	1.25 MHz
NMT450-DL	NMT-450 Downlink	421 to 494 MHz	1 to 300	$f_c = 460 + 0.025*(n - 1)$	1.25 MHz
IMT2000-UL	IMT-2000 Uplink	1920 to 1980 MHz	0 to 1199	$f_c = 1920 + 0.05*n$	1.25 MHz
IMT2000-DL	IMT-2000 Downlink	2110 to 2170 MHz	0 to 1199	$f_c = 2110 + 0.05*n$	1.25 MHz
CDMA700-UL	CDMA 700 MHz Uplink	776 to 794 MHz	0 to 359	$f_c = 776 + 0.05*n$	1.25 MHz
CDMA700-DL	CDMA 700 MHz Downlink	746 to 764 MHz	0 to 359	$f_c = 746 + 0.05*n$	1.25 MHz
CDMA1800-UL	CDMA 1800 MHz Uplink	1710 to 1785 MHz	0 to 1499	$f_c = 1710 + 0.05*n$	1.25 MHz
CDMA1800-DL	CDMA 1800 MHz Downlink	1805 to 1880 MHz	0 to 1499	$f_c = 1805 + 0.05*n$	1.25 MHz
CDMA900-UL	CDMA 900 MHz Uplink	880 to 915 MHz	0 to 699	$f_c = 880 + 0.05*n$	1.25 MHz
CDMA900-DL	CDMA 900 MHz Downlink	925 to 960 MHz	0 to 699	$f_c = 925 + 0.05*n$	1.25 MHz

Predefined cable types

For DTF measurements in the distance to fault measurement mode Willtek provides predefined cable types for most known coaxial cables. These cable types are available in the 9100 Data Exchange Software. You can upload the cable types you use frequently to the 9102. For further details on the usage of cable types in distance to fault measurements refer to ["Specifying cable settings" on page 160](#). For information on managing cable types within the 9100 Data Exchange Software refer to ["Managing cable types for distance-to-fault measurements" on page 236](#).

The following table provides an overview on all predefined cable types implemented in the 9100 Data Exchange Software.

Table 4 9100 Data Exchange Software cable types

Cable type	Description	Velocity (Vf %)	Attn. (dB/100m)	Dielec.
ANAVA5-50	AVA5-50 7/8"	91.00	5.530	1.21
ANAVA7-50	AVA7-50 1 5/8"	92.00	3.360	1.18
ANEFX2-50	EFX2-50	85.00	17.800	1.38
ANFSJ1-50A	FSJ1-50A	84.00	28.500	1.42
ANFSJ2-50	FSJ2-50	83.00	19.600	1.45
ANFSJ4-50B	FSJ4-50B	81.00	17.600	1.52
ANHJ12-50	HJ12-50	93.10	2.890	1.15
ANHJ45-50	HJ4.5-50	92.00	7.860	1.18
ANHJ4-50	HJ4-50	91.40	13.700	1.20
ANHJ5-50	HJ5-50	91.60	6.260	1.19
ANHJ7-50A	HJ7-50A	92.10	3.420	1.18
ANHL4RP-50	HL4RP-50	88.00	12.200	1.29
ANLDF12-50	LDF12-50	88.00	3.260	1.29
ANLDF1-50	LDF1-50	86.00	20.000	1.35
ANLDF2-50	LDF2-50	88.00	17.000	1.29
ANLDF45-50A	LDF4.5-50A	89.00	8.020	1.26
ANLDF4-50A	LDF4-50A	88.00	10.700	1.29
ANLDF5-50A	LDF5-50A	89.00	6.110	1.26
ANLDF5-50B	LDF5-50B	91.00	6.100	1.21
ANLDF6-50	LDF6-50	89.00	4.430	1.26
ANLDF7-50A	LDF7-50A	88.00	3.710	1.29
ANVXL5-50	VXL5-50	88.00	6.590	1.29
ANVXL5-5078	VXL5-50 7/8"	88.00	6.590	1.29

Table 4 9100 Data Exchange Software cable types (Continued)

Cable type	Description	Velocity (Vf %)	Attn. (dB/100m)	Dielec.
ANVXL6-50	VXL6-50	88.00	4.830	1.29
ANVXL6-50	VXL6-50 1 1/4"	88.00	4.830	1.29
ANVXL7-50	VXL7-50	88.00	3.710	1.29
BERG10	RG10	65.90	26.201	2.30
BERG10A	RG10A	65.90	26.201	2.30
BERG142	RG142	65.90	44.300	2.30
BERG17	RG17	65.90	18.000	2.30
BERG174	RG174	65.90	98.400	2.30
BERG178B	RG178B	65.90	150.900	2.30
BERG17A	RG17A	65.90	18.000	2.30
BERG188	RG188	65.90	101.700	2.30
BERG213	RG213	65.90	29.200	2.30
BERG214	RG214	65.90	29.200	2.30
BERG223	RG223	65.90	53.500	2.30
BERG55	RG55	65.90	54.100	2.30
BERG55A	RG55A	65.90	54.100	2.30
BERG55B	RG55B	65.90	54.100	2.30
BERG58	RG58	65.90	55.800	2.30
BERG58A	RG58A	66.00	55.900	2.30
BERG58B	RG58B	65.90	78.700	2.30
BERG58C	RG58C	65.90	78.700	2.30
BERG8	RG8	65.90	26.201	2.30
BERG8A	RG8A	65.90	26.201	2.30
BERG9	RG9	65.90	28.900	2.30
BERG9A	RG9A	65.90	28.900	2.30
CSCR501070	CR50 1070PE	88.00	5.510	1.29
CSCR501873	CR50 1873PE	88.00	3.440	1.29
CSCR50540	CR50 540PE	88.00	10.300	1.29
EUEC12-50	EC12-50 2-1/4	88.00	3.370	1.29
EUEC1-50	EC1-50 1/4	82.00	20.980	1.49
EUEC1-50-HF	EC1-50-HF 1/4	83.00	26.890	1.45
EUEC2-50	EC2-50 3/8	88.00	15.100	1.29

Table 4 9100 Data Exchange Software cable types (Continued)

Cable type	Description	Velocity (Vf %)	Attn. (dB/100m)	Dielec.
EUEC45-50	EC4.5-50 5/8	88.00	8.150	1.29
EUEC4-50	EC4-50 1/2	88.00	10.880	1.29
EUEC4-50-HF	EC4-50-HF 1/2	82.00	16.080	1.49
EUEC5-50	EC5-50 7/8	88.00	6.100	1.29
EUEC6-50	EC6-50 1-1/4	88.00	4.510	1.29
EUEC7-50	EC7-50 1-5/8	88.00	3.810	1.29
NKRF114-50	RF 1 1/4"-50	88.00	4.290	1.29
NKRF158-50	RF 1 5/8"-50	88.00	3.630	1.29
NKRF12-50	RF 1/2"-50	88.00	10.700	1.29
NKRF214-50	RF 2 1/4"-50	88.00	3.220	1.29
NKRF38-50	RF 3/8"-50	86.00	16.200	1.35
NKRF58-50	RF 5/8"-50	88.00	7.460	1.29
NKRF78-50	RF 7/8"-50	88.00	5.850	1.29
NKRFE114-50	RFE 1 1/4"-50	88.00	4.440	1.29
NKRFE158-50	RFE 1 5/8"-50	88.00	3.680	1.29
NKRFE78-50	RFE 7/8"-50	84.00	6.290	1.42
NKRFF12-50	RFF 1/2"-50	82.00	15.700	1.49
NKRFF14-50	RFF 1/4"-50	83.00	27.200	1.45
NKRFF38-50	RFF 3/8"-50	81.00	20.900	1.52
RFHCA118-50	HCA118-50	92.00	4.550	1.18
RFHCA12-50	HCA12-50	93.00	11.100	1.16
RFHCA158-50	HCA158-50	95.00	2.890	1.11
RFHCA214-50	HCA214-50	95.00	2.880	1.11
RFHCA300-50	HCA300-50	96.00	1.483	1.09
RFHCA318-50	HCA318-50	96.00	1.260	1.09
RFHCA38-50	HCA38-50	89.00	13.200	1.26
RFHCA418-50	HCA418-50	97.00	0.957	1.06
RFHCA58-50	HCA58-50	92.00	8.180	1.18
RFHCA78-50	HCA78-50	93.00	5.750	1.16
RFHF4-18	HF 4-1/8" Cu2Y	97.00	1.000	1.06
RFHF5	HF 5" Cu2Y	96.00	0.700	1.09
RFHF6-18	HF 6-1/8" Cu2Y	97.00	0.600	1.06

Table 4 9100 Data Exchange Software cable types (Continued)

Cable type	Description	Velocity (Vf %)	Attn. (dB/100m)	Dielec.
RFLCF12-50	LCF12-50	88.00	10.500	1.29
RFLCF14-50	LCF14-50	83.00	20.200	1.45
RFLCF158-50	LCF158-50A	89.00	3.640	1.26
RFLCF214-50	LCF214-50A	88.00	3.260	1.29
RFLCF38-50	LCF38-50	88.00	16.500	1.29
RFLCF58-50	LCF58-50	88.00	8.260	1.29
RFLCF78-50A	LCF78-50A	89.00	5.820	1.26
RFLCFS114	LCFS114-50A	89.00	4.420	1.26
RFSCF114-50	SCF114-50A	89.00	4.720	1.26
RFSCF12-50	SCF12-50	82.00	16.400	1.49
RFSCF14-50	SCF14-50	82.00	28.500	1.49
RFSCF38-50	SCF38-50	82.00	20.600	1.49
RFSCF78-50A	SCF78-50A	88.00	6.160	1.29
TMLMR100A	LMR100A	66.00	115.463	2.30
TMLMR1200	LMR1200	88.00	6.532	1.29
TMLMR1700	LMR1700	89.00	4.931	1.26
TMLMR195	LMR195	80.00	55.443	1.56
TMLMR200	LMR200	83.00	49.249	1.45
TMLMR240	LMR240	84.00	37.684	1.42
TMLMR300	LMR300	85.00	30.325	1.38
TMLMR400	LMR400	85.00	19.646	1.38
TMLMR500	LMR500	86.00	15.876	1.35
TMLMR600	LMR600	87.00	12.789	1.32
TMLMR900	LMR900	87.00	8.645	1.32
310801	310801	82.10	11.500	1.48
311201	311201	82.00	18.000	1.49
311501	311501	80.00	23,000	1.56
311601	311601	80,00	26.200	1.56
311901	311901	80.00	37.700	1.56
352001	352001	80.00	37.700	1.56

Menu Structure

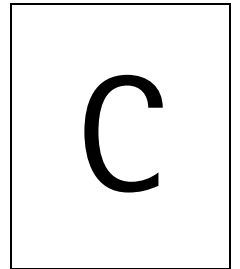

This appendix provides an overview of the menu structure of the 9102 Handheld Spectrum Analyzer.

Mode function key menus

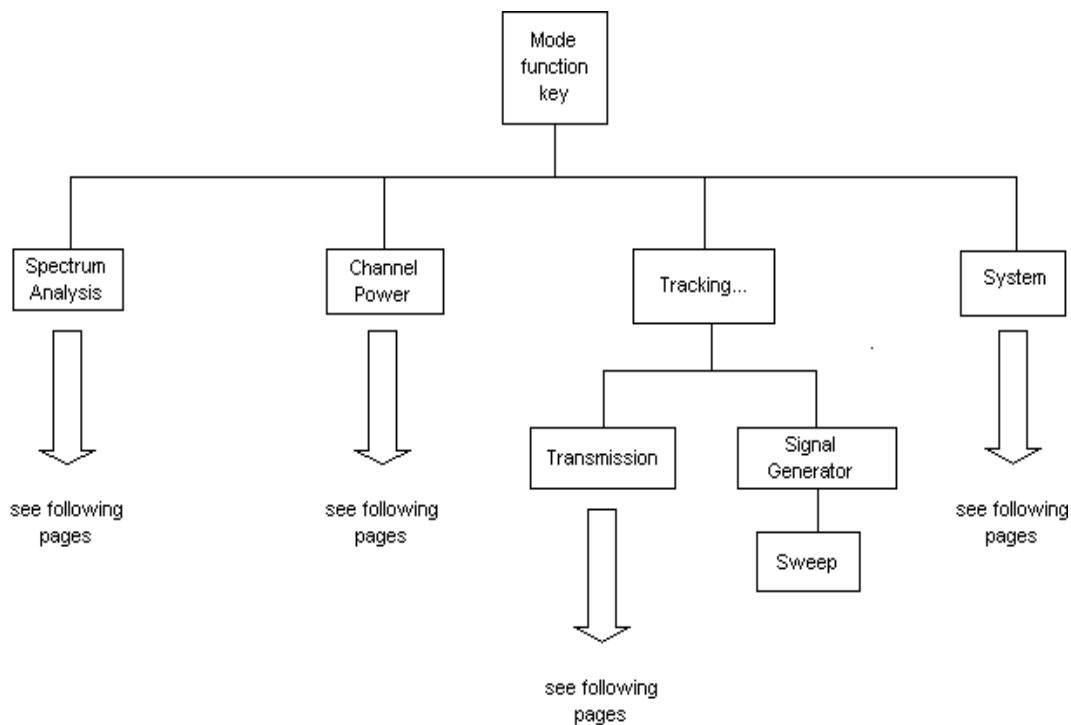

Application menus

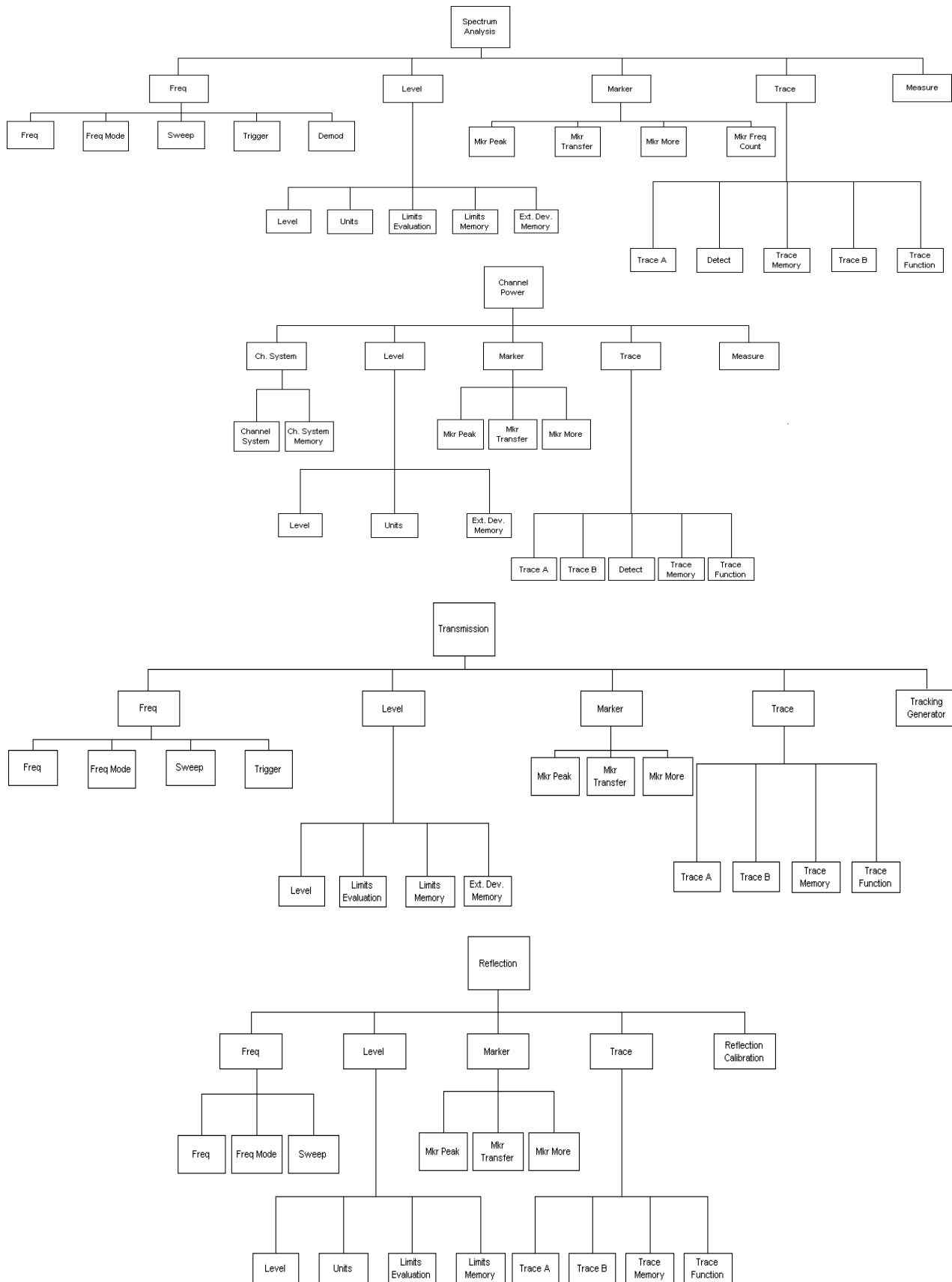

Appendix C Menu Structure
Application menus

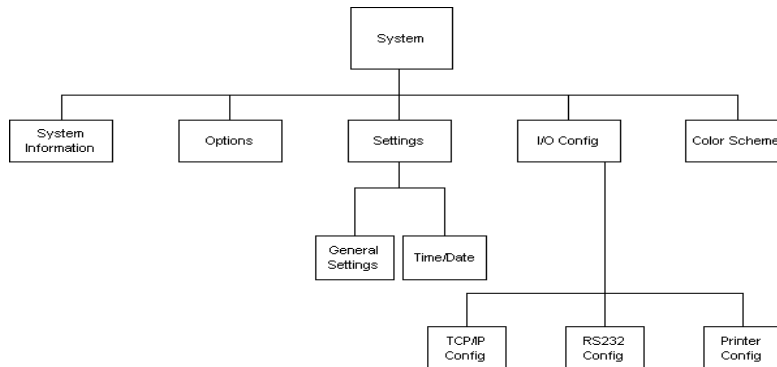
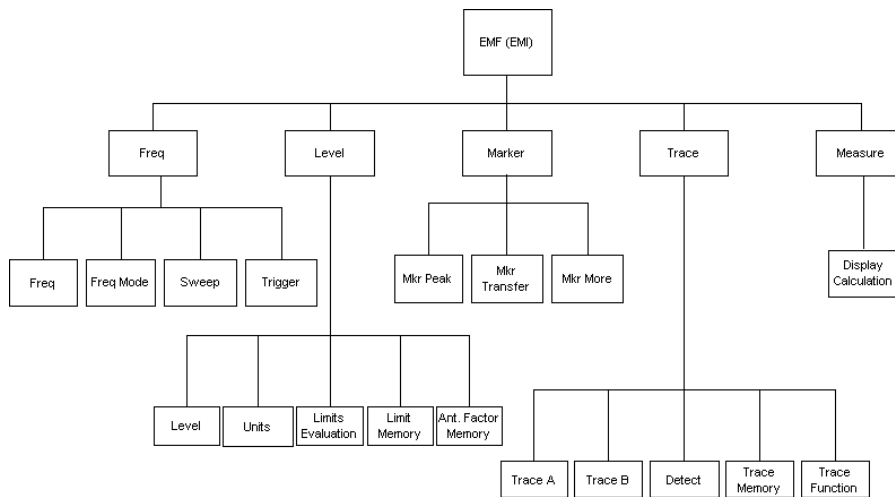
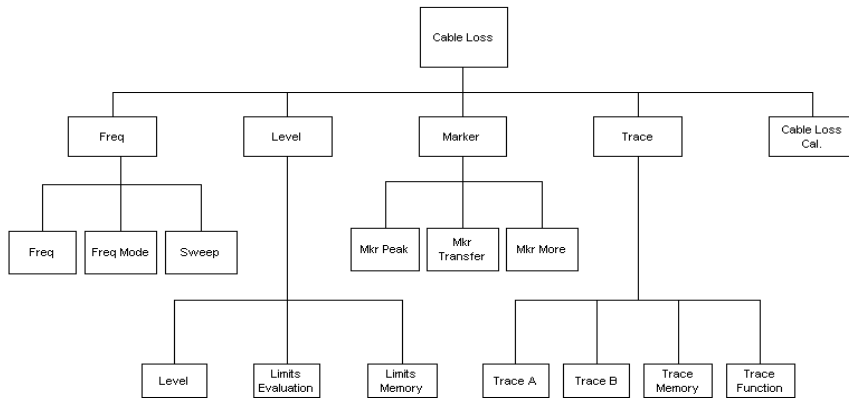
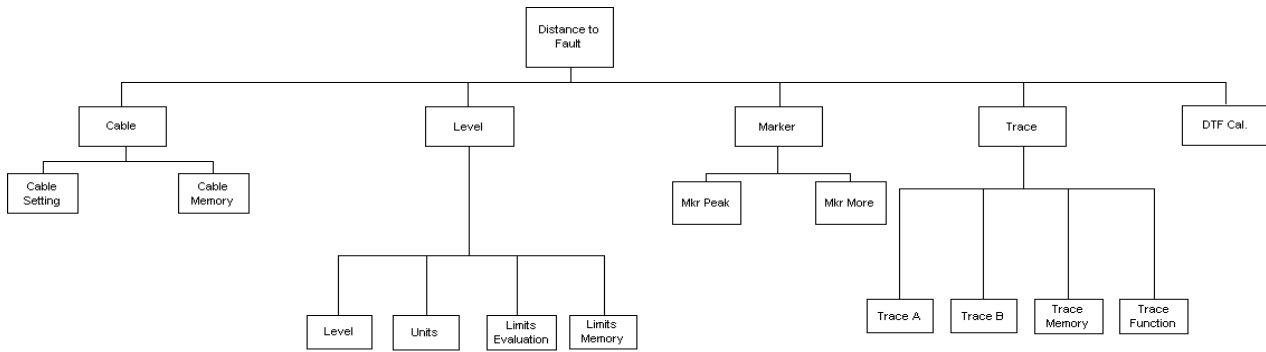

Warranty and Repair

A square box with a black border containing the letter 'D' in a bold, black, sans-serif font.

This chapter describes the customer services available through Willtek. Topics discussed in this chapter include the following:

- ["Warranty information" on page 360](#)
- ["Equipment return instructions" on page 361](#)

Warranty information

Willtek warrants that all of its products conform to Willtek's published specifications and are free from defects in materials and workmanship for a period of one year from the date of delivery to the original buyer, when used under normal operating conditions and within the service conditions for which they were designed. This warranty is not transferable and does not apply to used or demonstration products.

In case of a warranty claim, Willtek's obligation shall be limited to repairing, or at its option, replacing without charge, any assembly or component (except batteries) which in Willtek's sole opinion proves to be defective within the scope of the warranty. In the event Willtek is not able to modify, repair or replace nonconforming defective parts or components to a condition as warranted within a reasonable time after receipt thereof, the buyer shall receive credit in the amount of the original invoiced price of the product.

It is the buyer's responsibility to notify Willtek in writing of the defect or nonconformity within the warranty period and to return the affected product to Willtek's factory, designated service provider, or authorized service center within thirty (30) days after discovery of such defect or nonconformity. The buyer shall prepay shipping charges and insurance for products returned to Willtek or its designated service provider for warranty service. Willtek or its designated service provider shall pay costs for return of products to the buyer.

Willtek's obligation and the customer's sole remedy under this hardware warranty is limited to the repair or replacement, at Willtek's option, of the defective product. Willtek shall have no obligation to remedy any such defect if it can be shown: (a) that the product was altered, repaired, or reworked by any party other than Willtek without Willtek's written consent; (b) that such defects were the result of customer's improper storage, mishandling, abuse, or misuse of the product; (c) that such defects were the result of customer's use of the product in conjunction with equipment electronically or mechanically incompatible or of an inferior quality; or (d) that the defect was the result of damage by fire, explosion, power failure, or any act of nature.

The warranty described above is the buyer's sole and exclusive remedy and no other warranty, whether written or oral, expressed or implied by statute or course of dealing shall apply. Willtek specifically disclaims the implied warranties of merchantability and fitness for a particular purpose. No statement, representation, agreement, or understanding, oral or written, made by an agent, distributor, or employee of Willtek, which is not contained in the foregoing warranty will be binding upon Willtek, unless made in writing and executed by an authorized representative of Willtek. Under no circumstances shall Willtek be liable for any direct, indirect, special, incidental, or consequential damages, expenses, or losses, including loss of profits, based on contract, tort, or any other legal theory.

Equipment return instructions

Please contact your local service center for Willtek products via telephone or web site for return or reference authorization to accompany your equipment. For each piece of equipment returned for repair, attach a tag that includes the following information:

- Owner's name, address, and telephone number.
- Serial number, product type, and model.
- Warranty status. (If you are unsure of the warranty status of your instrument, include a copy of the invoice or delivery note.)
- Detailed description of the problem or service requested.
- Name and telephone number of the person to contact regarding questions about the repair.
- Return authorization (RA) number or reference number.

If possible, return the equipment using the original shipping container and material. Additional Willtek shipping containers are available from Willtek on request. If the original container is not available, the unit should be carefully packed so that it will not be damaged in transit. Willtek is not liable for any damage that may occur during shipping. The customer should clearly mark the Willtek-issued RA or reference number on the outside of the package and ship it prepaid and insured to Willtek.

Software License

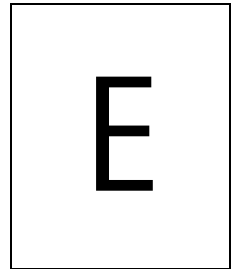

This chapter contains the license conditions for use of the 9102 Handheld Spectrum Analyzer and the 9100 Data Exchange Software.

End-user license agreement

All copyrights in and to the software product are owned by Willtek Communications or its licensors. The software is protected by copyright laws and international copyright treaties, as well as other intellectual property laws and treaties.

This end-user license agreement grants you the right to use the software contained in this product subject to the following restrictions. You may not:

- (i) use the software and/or any copy of the software in different computers concurrently, unless the software is an update that has been downloaded from the Internet at www.willtek.com;
- (ii) copy the software, except for archive purposes consistent with your standard archive procedures;
- (iii) transfer the software to a third party apart from the entire product;
- (iv) modify, decompile, disassemble, reverse engineer or otherwise attempt to derive the source code of the software;
- (v) export the software in contravention of applicable export laws and regulations of the country of purchase;
- (vi) use the software other than in connection with operation of the product.

The licensor's suppliers do not make or pass on to end users or any other third party, any express, implied or statutory warranty or representation on behalf of such suppliers, including but not limited to the implied warranties of non-infringement, title, merchantability or fitness for a particular purpose.

Willtek Communications shall not be held liable for any damages suffered or incurred by you or any other third party (including, but not limited to, general, special, consequential or incidental damages including damages for loss of business profits, business interruption, loss of business information and the like), arising out of or in connection with the delivery, use or performance of the software.

Index

Numerics

9100 Data Exchange Software [213 - 244](#)

connecting PC and the instrument [216](#)

copying configuration files [244](#)

creating screen shots [225](#)

defining antenna factor files [239](#)

defining cable factor files [240](#)

defining cable types for DTF measurements [237](#)

directory structure [242](#)

external coupling factor definition [234](#)

external device compensation [233](#)

file management [242](#)

File Manager [243](#)

file types [242](#)

license information [363](#)

limit templates [229](#)

loading a trace file on the PC [221](#)

loading antenna factor files [239](#)

loading cable factor files [241](#)

loading external coupling loss files [234](#)

loading measurement results from the instrument [217](#)

managing cable factors for EMF measurements [240](#)

managing antenna factors for EMF measurements [238](#)

managing cable types for DTF measurements [236](#)

managing communication systems [235](#)

predefined cable types [348](#)

predefined channel power communication systems [346](#)

printing results [221](#)

saving results on the PC [221](#)

transferring cable types from the 9102 [237](#)

uploading predefined cable types for DTF measurements [236](#)

working with measurement results [226](#)
 working with settings [241](#)

A

Accessories [4](#)
 ACPR *see also* Adjacent channel power ratio
 Actual trace mode [64, 90, 124, 149](#)
 Adjacent channel power ratio [72](#)
 Application examples [343](#)
 Attenuation [58, 87, 119, 195](#)
 Average trace mode [64, 90, 124, 149](#)

B

Backspace key [23](#)
 Battery status [15](#)
 Biconical antennas [182](#)

C

Cable loss mode [167 - 174](#)
 changing the vertical scale [173](#)
 full span [171](#)
 level settings [173](#)
 reference level [173](#)
 selecting step size for frequency input [171](#)
 viewing parameters [174](#)
 Cable settings [160](#)
 Cable types [160](#)
 Calibration for VSWR/DTF measurements [137](#)
 Calibration information [39](#)
 Calibration Information menu [40](#)
 Calibration sets [137](#)
 Cent function key [21](#)
 Center frequency [55, 107, 116, 143, 161, 170, 191, 194](#)
 Channel power [72](#)
 level settings [86](#)
 Channel power measurements
 managing communication systems [235](#)
 Channel power mode [77 - 97](#)
 adding trace B to trace A [93](#)
 changing the occupied bandwidth [83](#)
 changing the sweep time [86](#)
 compensating gains and losses [88](#)
 copying traces [94](#)
 deleting traces [96](#)
 external device compensation [88](#)
 reading the channel power [83](#)
 reference level [87](#)
 selecting the trace mode [90](#)
 setting up the trace [90](#)
 storing and loading traces [95](#)

- subtracting trace B from trace A [92](#)
- trace detectors [93](#)
- traces [90](#)
- turning the second trace on and off [92](#)
- viewing parameters [97](#)
- working with communication systems [83](#)
- Clr Trc function key [21](#)
- Communication systems [83 - 86](#)
 - usage in channel power mode [83](#)
- Connecting the VSWR/DTF Bridge [136](#)
- Connectors [12](#)
- Copying traces [69, 94, 127, 152](#)
- Cursor keys [21](#)

- D**
- Date and time settings
 - adjustment [42](#)
- DC in connector [12](#)
- Deleting traces [71, 96, 129, 153](#)
- Device name
 - assigning a device name to the instrument [42](#)
- Direct printing [36](#)
- Directional antennas [186](#)
- Display
 - changing the brightness [41](#)
 - horizontal axis [17](#)
 - icons [17](#)
 - input field [19](#)
 - Marker field [19](#)
 - sections [16](#)
 - selecting the user interface colors [47](#)
 - softkey descriptions [19](#)
 - trace finder [19](#)
 - vertical axis [17](#)
- Display brightness [41](#)
- Distance to fault mode [157 - 165](#)
 - calibration [162](#)
 - changing the vertical scale [163](#)
 - preparational steps [159](#)
 - reference level [163](#)
 - selecting the unit [159](#)
 - setting up the trace [164](#)
 - specifying cable settings [160](#)
 - specifying the cable length [160](#)
 - traces [164](#)
 - using predefined cable types [160](#)
 - viewing parameters [165, 165](#)

- E**
- EMF (EMI) mode [175 - 202](#)

- antenna factor settings [195, 199](#)
 - Auto measurements [197](#)
 - automatic measurements [195](#)
 - cable factor settings [196, 199](#)
 - display calculation [194](#)
 - full span [192](#)
 - manual measurements [198](#)
 - Quick measurements [198](#)
 - reference level [194](#)
 - selecting step size for frequency input [192](#)
 - setting the attenuation [195](#)
 - setting up the trace [201](#)
 - traces [201](#)
 - EMF measurement antennas [181](#)
 - EMF measurement methods [179](#)
 - multipoint method [180](#)
 - stirring method [180](#)
 - Emission measurements [178](#)
 - Enter keys
 - Enter [22](#)
 - GHz/dBM [22](#)
 - kHz/dB μ V/m [22](#)
 - MHz/dB/ μ s [22](#)
 - Entering numbers and text [24](#)
 - Errors *see also* [Troubleshooting](#)
 - Escape key [22](#)
 - External device compensation [59, 88, 120](#)
 - defining and saving parameter files [233](#)
 - external coupling factor definition [234](#)
- F**
- Factory settings
 - restoring defaults for all modes [50](#)
 - File Manager [243](#)
 - Frequency
 - center frequency [55, 107, 116, 143, 161, 170, 191, 194](#)
 - span [55, 116, 143, 161, 170, 191, 194](#)
 - Start and stop [55, 108, 115, 142, 170, 191](#)
 - Frequency menu
 - cable loss [169](#)
 - distance to fault [162](#)
 - EMF (EMI) [190, 196, 197](#)
 - reflection [142, 145](#)
 - spectrum analysis [54](#)
 - transmission [115](#)
 - Frequency range [54](#)
 - Frequency settings [54, 106](#)
 - Frequency step size [56, 108, 117, 144, 171, 192](#)
 - Front panel [15 - 26](#)
 - entering numbers and text [24](#)

- function keys [20](#)
- keypad [20](#)
- usage [15](#)
- Full span [56, 117, 144, 171, 192](#)
- Function keys
 - Cent [21](#)
 - Clr Trc [21](#)
 - Hold/Run [20](#)
 - Mkr [21](#)
 - Mode [20](#)
 - Param [20](#)
 - Preset [20](#)
 - RCL/Store [21](#)
 - Ref [21](#)
 - Span [21](#)
- Function softkeys [23](#)

G

- Gains and losses
 - compensation [59, 88, 120](#)
- General settings [38 - 48](#)
 - calibration information [39](#)
 - date and time [42](#)
 - device name [42](#)
 - display brightness [41](#)
 - instrument IP address [44](#)
 - instrument IP port [46](#)
 - options [40](#)
 - PC IP address [45](#)
 - RS-232 port baud rate [43](#)
 - serial number [38](#)
 - software version number [39](#)
 - user interface colors [47](#)
 - warning and error beeps [42](#)
- General Settings menu [43](#)
- GHz/dBM enter key [22](#)

H

- Handling errors and problems see *also* Troubleshooting
- Hardware attenuation [58, 87, 119, 195](#)
- Hold trace mode [64, 90, 124, 149](#)
- Hold/Run function key [20](#)

I

- Icons [17](#)
- Immission measurements [178](#)
- In [164](#)
- Input
 - acoustical reaction [25](#)
 - numbers and text [24](#)

Input field [16, 19](#)
Installing options [41](#)
IP address configuration [44, 45](#)
IP port [46](#)
Isotropic antennas [184](#)

K

Keypad [20](#)
Keys
 Backspace key [23](#)
 cursor keys [21](#)
 enter keys [22](#)
 Escape key [22](#)
 function keys [20](#)
 numeric keys [22](#)
 Print key [22](#)
 softkeys [23](#)
kHz/dB μ V/m enter key [22](#)

L

LAN connector [14](#)
Level [109](#)
 selecting unit for input and output [59, 88](#)
Level settings [57, 86, 118, 147, 173](#)
Limit lines
 usage [32](#)
Limit templates [34, 229](#)
 changing limit lines [231](#)
 defining limits [230](#)
 loading a template [232](#)
 storing a template [231](#)
 transfer [232](#)

M

Marker field [16, 19](#)
Markers [29 - 32](#)
 disabling a marker [30](#)
 enabling a delta marker [30](#)
 enabling and moving a marker [30](#)
 working with [29 - 32](#)
Max hold trace mode [64, 90, 124, 149](#)
Measurement mode selection [27, 81, 106, 112, 141, 159, 168, 189](#)
Measurement type [74](#)
Menu softkeys [23](#)
Menu structure [353](#)
 application menus [355](#)
 Mode function key menus [354](#)
Menus
 Cable loss Frequency Menu [169](#)
 Calibration Information [40](#)

- Distance to fault Frequency Menu [162](#)
- EMF (EMI) Frequency Menu [190, 196, 197](#)
- General Settings [43](#)
- Mode [28](#)
- Reflection Frequency Menu [142, 145](#)
- Setup Application Software Menu [208](#)
- Spectrum Analysis Frequency menu [54](#)
- System Information [39](#)
- TCP/IP Configuration [47](#)
- Trace Function menu [69, 70, 76, 128](#)
- Transmission Frequency Menu [115](#)
- Trigger menu [61, 62, 121, 122](#)
- VSWR/Tracking menu [135](#)
- MHz/dB/ μ s enter key [22](#)
- Min hold trace mode [64, 90, 124, 149](#)
- Mkr function key [21](#)
- Mode function key [20](#)
- Mode menu [28](#)
- Mode selection [27, 81, 106, 112, 141, 159, 168, 189](#)
- Modes
 - cable loss [135, 167](#)
 - channel power [77](#)
 - distance to fault [135, 157](#)
 - EMF (EMI) [175](#)
 - reflection [135, 139](#)
 - restoring factory settings for all modes [50](#)
 - signal generator [105](#)
 - spectrum analysis [53, 53](#)
 - transmission [111](#)

N

- Normalizing [113](#)
- Numeric keys [22](#)

O

- OBW *see also* Occupied bandwidth
- Occupied bandwidth [72](#)
- Options [4, 40](#)
 - installing a new option [41](#)

P

- Param function key [20](#)
- Power switch [14](#)
- Predefined settings
 - cable types [348](#)
 - channel power communication systems [345](#)
 - measurement settings [344](#)
- Preset function key [20](#)
- Print key [22](#)
- Printer configuration [47](#)

Printing screens [36](#)

R

Radiation emission [177](#)

Radiation immission [177](#)

RBW *see also* Resolution bandwidth

RCL/Store function key [21](#)

Ref function key [21](#)

Reference level [58](#), [87](#), [119](#), [147](#), [147](#), [148](#), [148](#), [163](#), [173](#), [194](#)

Reflection mode [139](#) - [155](#)

 changing the vertical scale [147](#), [147](#), [148](#), [148](#)

 copying traces [152](#)

 deleting traces [153](#)

 full span [144](#)

 level settings [147](#)

 reference level [147](#), [147](#), [148](#), [148](#)

 selecting step size for frequency input [144](#)

 selecting the trace mode [149](#)

 setting up the trace [149](#)

 storing and loading traces [152](#)

 subtracting trace B from trace A [151](#)

 traces [149](#)

 turning the second trace on and off [150](#)

 viewing parameters [155](#)

Resolution bandwidth [57](#), [193](#)

Restoring factory settings [50](#)

Results area [16](#)

RF in connector [12](#)

RF out connector [13](#)

RS-232 configuration [43](#)

S

Safety warnings [xx](#)

Scale [58](#), [88](#), [120](#), [147](#), [147](#), [148](#), [148](#), [163](#), [173](#)

SCPI commands [247](#) - [323](#)

 application examples [334](#)

 Calculate [308](#)

 Display [304](#)

 Format [317](#)

 general [248](#)

 Input [286](#)

 Instrument [299](#)

 MMemory [287](#)

 programming examples [325](#)

 Sense [260](#)

 Service [318](#)

 System [254](#)

SCPI error messages [321](#)

Selecting modes

 cable loss [168](#)

- channel power [81](#)
- distance to fault [159](#)
- EMF (EMI) [189](#)
- reflection [141](#)
- signal generator [106](#)
- transmission [112](#)
- Selecting the measurement type [74](#)
- Serial (RS-232) connector [14](#)
- Serial number [38](#)
- Settings
 - storing [49](#)
 - working with stored settings [49](#)
- Setup Application Software Menu [208](#)
- Signal generator [106](#)
- Signal generator mode [105 - 109](#)
 - frequency settings [106](#)
 - level [109](#)
 - selecting step size for frequency input [108](#)
 - selecting the frequency mode [106](#)
 - special functions [109](#)
 - switching the signal generator on and off [106](#)
- Softkey descriptions [16, 19](#)
- Softkeys
 - horizontal (menu) softkeys [23](#)
 - vertical (function) softkeys [23](#)
- Software license [363 - 364](#)
- Software update [207 - 212](#)
 - LAN [211](#)
 - serial [209](#)
 - setting a password for updates [208](#)
- Software version number [39](#)
- Span [55, 116, 143, 161, 170, 191, 194](#)
- Span function key [21](#)
- Special functions
 - demodulating AM or FM signals [63](#)
 - limiting the number of measurements [62, 109, 123, 149, 173](#)
- Special spectrum analysis measurement functions [72 - 74](#)
 - adjacent channel power ratio [72](#)
 - channel power [72](#)
 - occupied bandwidth [72](#)
 - switching special measurement functions off [74](#)
- Spectrum analysis [53](#)
- Spectrum analysis mode [53 - 76](#)
 - adding trace B to trace A [67](#)
 - changing the vertical scale [58, 88](#)
 - compensating gains and losses [59](#)
 - copying traces [69](#)
 - defining the number of measurements for averaging [68, 93, 93, 126, 151](#)
 - deleting traces [71](#)
 - external device compensation [59](#)

- frequency range [54](#)
- frequency settings [54](#)
- full span [56](#)
- level settings [57](#)
- reference level [58](#), [119](#)
- selecting step size for frequency input [56](#)
- selecting the trace mode [64](#)
- setting the attenuation [58](#), [87](#)
- setting up the trace [64](#)
- special functions [61](#)
- storing and loading traces [70](#)
- subtracting trace B from trace A [66](#)
- trace detector [68](#)
- traces [64](#)
- turning the second trace on and off [66](#)
- viewing parameters [76](#)
- Storing and loading traces [70](#), [95](#), [128](#), [152](#)
- Storing settings [49](#)
- Sweep time [57](#), [193](#)
- Switching special measurement functions off [74](#)
- Switching the instrument on [14](#)
- SWT *see also* Sweep time
- Symbols [17](#)
- System Information Menu [39](#)

T

- TCP/IP configuration [44](#), [45](#), [46](#)
- TCP/IP Configuration menu [47](#)
- The [164](#)
- Trace finder [19](#)
- Trace Function Menu [69](#), [70](#), [76](#), [128](#)
- Trace modes
 - Actual [64](#), [90](#), [124](#), [149](#)
 - Average [64](#), [90](#), [124](#), [149](#)
 - Hold [64](#), [90](#), [124](#), [149](#)
 - Max hold [64](#), [90](#), [124](#), [149](#)
 - Min hold [64](#), [90](#), [124](#), [149](#)
- Traces
 - adding trace B to trace A [67](#), [93](#)
 - copying traces [69](#), [94](#), [127](#), [152](#)
 - defining the number of measurements for averaging [68](#), [93](#), [93](#), [126](#), [151](#)
 - deleting traces [71](#), [96](#), [129](#), [153](#)
 - selecting the detection method [68](#), [93](#), [93](#), [127](#)
 - storing and loading traces [70](#), [95](#), [128](#), [152](#)
 - subtracting trace B from trace A [66](#), [92](#), [125](#), [151](#)
 - trace detectors [68](#), [93](#), [93](#), [127](#)
 - turning the second trace on and off [66](#), [92](#), [125](#), [150](#)
- Tracking generator [113](#)
 - setting the output power [114](#)
- Transmission mode [111](#) - [131](#)

- changing the vertical scale [120](#)
- compensating gains and losses [120](#)
- copying traces [127](#)
- deleting traces [129](#)
- external device compensation [120](#)
- full span [117](#)
- level settings [118](#)
- normalizing [113](#)
- selecting step size for frequency input [117](#)
- selecting the trace mode [124](#)
- setting the attenuation [119](#)
- setting the tracking output power [114](#)
- setting up the trace [123](#)
- special functions [121](#)
- storing and loading traces [128](#)
- subtracting trace B from trace A [125](#)
- switching the tracking generator on and off [113](#)
- trace detector [127](#)
- traces [123](#)
- turning the second trace on and off [125](#)
- viewing parameters [131](#)

Trigger menu [61](#), [62](#), [121](#), [122](#)

Triggering

- external trigger [62](#), [122](#)
- video trigger [61](#), [121](#)

Troubleshooting [203 - 205](#)

V

VBW *see also* Video bandwidth

Vertical scale [58](#), [88](#), [120](#), [147](#), [147](#), [148](#), [148](#), [163](#), [173](#)

Video bandwidth [57](#), [193](#)

Video Trigger [61](#), [121](#)

Viewing parameters [76](#), [97](#), [131](#), [155](#), [165](#), [174](#)

VSWR/DTF Bridge [136](#)

VSWR/DTF Reflection Measurement Option [133 - 137](#)

W

Warranty information [359](#)

Publication History

Revision	Comment
0411-300-A	First version.
0412-300-A	Ext. Trig. connector designation and description corrected.
0503-301-A	New Trace Functions added. New Measure menu position within Spectrum Analysis mode.
0507-310-A	New reflection measurement functionality and several enhancements. For details refer to "What's new" on page 3. Enhancements within the 9100 Data Exchange Software.
0512-400-A	New EMF (EMI) mode chapter added. Description of new trace finder added. 9100 Data Exchange Software description updated with new EMF functionality and live trace functionality. Channel power mode description enhanced. New appendix containing predefined measurement settings.
0608-450-A	Minor corrections. In DTF mode, the calibration cable parameters can be specified.
0612-500-A	New features of software version 5.00: 9168 GPS Receiver Option, 9162 Insertion Power Sensor, 9151 Frequency Extension 7.5 GHz, improvements of the 9100 Data Exchange Software.

Willtek and its logo are trademarks of Willtek Communications GmbH. All other trademarks and registered trademarks are the property of their respective owners.

Specifications, terms and conditions are subject to change without notice.

© Copyright 2006 Willtek Communications GmbH. All rights reserved.

No part of this manual may be reproduced or transmitted in any form or by any means (printing, photocopying or any other method) without the express written permission of Willtek Communications GmbH.

Manual ident no. M 290 204

Manual version
0612-500-A

English

Willtek Communications GmbH
85737 Ismaning
Germany
Tel: +49 (0) 89 996 41-0
Fax: +49 (0) 89 996 41-440
info@willtek.com

Willtek Communications UK
Cheadle Hulme
United Kingdom
Tel: +44 (0) 161 486 3353
Fax: +44 (0) 161 486 3354
willtek.uk@willtek.com

Willtek Communications SARL
Roissy
France
Tel: +33 (0) 1 72 02 30 30
Fax: +33 (0) 1 49 38 01 06
willtek.fr@willtek.com

Willtek Communications Inc.
Parsippany
USA
Tel: +1 973 386 9696
Fax: +1 973 386 9191
willtek.cala@willtek.com
sales.us@willtek.com

Willtek Communications
Singapore
Asia Pacific
Tel: +65 6827 9670
Fax: +65 6827 9601
willtek.ap@willtek.com

Willtek Communications Ltd.
Shanghai
China
Tel: +86 21 5835 8037/9
Fax: +86 21 5835 5238
willtek.cn@willtek.com

© Copyright 2006 Willtek Communications GmbH. All rights reserved.
Willtek Communications, Willtek and its logo are trademarks of Willtek Communications GmbH. All other trademarks and registered trademarks are the property of their respective owners.

Note: Specifications, terms and conditions are subject to change without prior notice.

will'tek