



Acterna BAT-2700 TestPad

Base Station & Air Interface Test Module

Product features

- Multiple wireless system testing: AMPS, CDMA, GSM and TDMA
- On-site measurement of output power level and stability, frequency offset and spectrum
- Built-in antenna enables over-the-air check of base stations
- Interference analysis tool helps to detect interfering signals in the RF environment
- Database of base stations with full details of site locations, configuration and settings
- Integrated single platform-based solution for RF and landline testing from air interface to complement T1/E1 up to 10 Gbps optical test modules
- Intuitive and easy-to-use graphical user interface (GUI)
- Rugged construction, lightweight design and battery-powered operation
- Dual PCMCIA slots for upgrades and expanded result storage
- Automated testing procedures to minimize complexity and training costs

Application features

- Provide field technicians with capability to maintain base stations and relieve RF experts from time-consuming tasks
- Verify cell operability with Go/NoGo check without taking the cell site out of service
- Verify RF output from the base station, and monitor the RF power and spectrum
- Confirm antenna and antenna cable quality by measuring forward and reflected power
- Perform RF environment tests and detect interfering signals on both uplink and downlink
- Provide data indicating that faults may be present for further evaluation by RF experts
- Store and record all measured data including screen captures for review by RF engineering resources

Highlights

- Use cell site support team resources efficiently for all types of trouble tickets
- Troubleshoot difficult problems or issues quickly using detailed reports and screen captures
- Test under live traffic conditions without interrupting operation and cash flow
- Protect investment by verifying landline and RF interface using the same TestPad 2000™ platform
- Reduce the need for shared, specialized and expensive test equipment with the TestPad 2000 platform and application modules

After configuring the system and carrier information of the base station, the technician can quickly and easily run RF checks

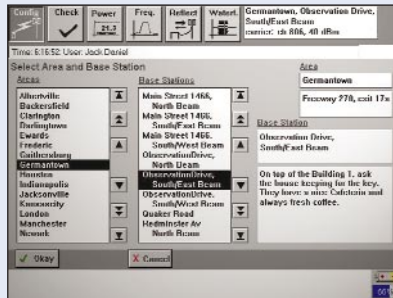
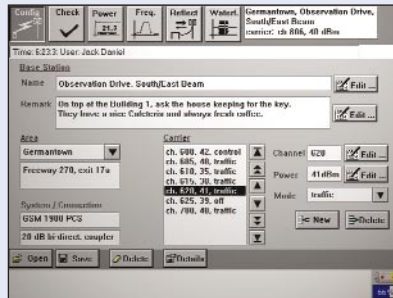

The Acterna BAT-2700 TestPad Base Station & Air Interface Test Module is a test and measurement instrument designed to boost the productivity of base station support teams.

A wireless extension module for the TestPad 2000, this rugged, lightweight handheld tester enables field technicians to run defined RF test procedures for a Go/NoGo decision – freeing RF performance engineers to focus on more critical tasks.

The Base Station & Air Interface Test Module (BAT-2700) offers a technologically advanced solution to one of network operators’ most challenging problems: How to maintain the growing number of base stations with a shrinking supply of skilled RF technicians.

With the BAT-2700, field technicians can easily check the performance of a cell site without disrupting revenue-generating traffic. This easy-to-use handheld tester allows Go/NoGo checks by non-RF technicians, as well as detailed analysis by RF experts.

The BAT-2700 module measures RF parameters from a base station via direct connect or air interface.

Like a multimeter for RF the BAT-2700 measures power output, spectrum and match (VSWR). It combines all this to a fast Go/NoGo decision without having to interrupt a base station’s operation. By plugging in the appropriate module, users can verify wired interfaces from copper and T1/E1 up to 10 Gbit optical as well as wireless interfaces. Because the test set is battery powered there is no need to search for a power outlet on the site. Field technicians hook the BAT-2700 module into the system by the attenuated RF outlet on the base station.

When a bidirectional coupler is installed between the antenna and the base station transmitter, fix or temporary, the BAT-2700 provides more detailed checks such as automatic checking of the antennas and base station without affecting the operation.

Designed for field use, the BAT-2700 module features one-button execution of measurements. All necessary preset parameters can be downloaded from a configuration database by an accessory tool. The user simply selects the base station by its location, and initiates a test with just the push of a button. A green field indicates “PASS” and a red field indicates “FAIL” (figures 1 and 2).

If all measurements remain within set limits, a large green light indicates a “PASS” situation. If one or more values fall outside tolerance limits, a red light indicates a “FAIL” situation. Arrows in the red field also point to the failing parameters. In addition, a special icon indicates if the measurement exceeds the threshold’s upper limit, or if the lower limit was not attained.

The BAT eliminates the guesswork with clear PASS or FAIL indicators

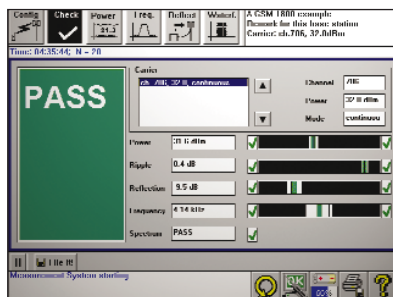

figure 1

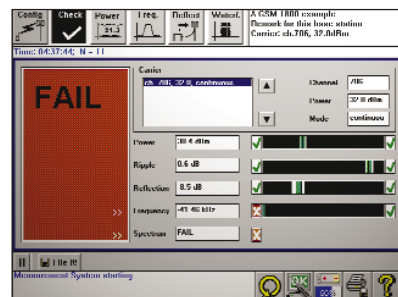

figure 2

Outside the building, the field technician can analyze the RF environment. The BAT module, equipped with its own antenna, provides reliable measurements of RF signals. The technician can detect interference in the base station frequency band (downlink), as well as in the mobile phone band (uplink) due to the high sensitivity of the BAT-2700 module.

The Acterna BAT-2700 module allows you to perform multiple applications. These applications range from simple Go/NoGo check to power alignment up to detailed RF interference analysis. This tool is applicable for both an entry level to a senior engineer.

Applications

The BAT-2700 module enables field technicians to quickly verify that base stations are operating at peak performance. With user-selectable predefined tests, even novice technicians can quickly perform such previously time-consuming tasks as pinpointing interference problems, optimizing performance and completing base station final checks.

Detect presence of faults to speed up RF experts' troubleshooting

If first-level measurements indicate interference trouble, the BAT-2700 module identifies the cause of the problem – such as the radio, antenna or RF environment. The BAT-2700 module also provides RF experts with easy access to all the information they need to diagnose the source of more complex interference problems.

Measurement data can be stored as a report or screen shot, uploaded to a PC, and attached to e-mails or inserted into a report, eliminating the need for manual data entry or a long verbal text and description.

Measure output power, ripple, frequency, spectrum and reflection

To measure the base station output parameters, the field technician hooks up the BAT-2700 to the base station transmitter output. Possible access points include a bidirectional coupler which is often located inside the rack, an attenuated RF output, or a coupler that can be inserted at the hatch between the RF output and antenna. When a coupler is the access point, the technician can also check the match of the RF cable and antenna.

The BAT-2700 measures signal power levels, power ripple, frequency and spectrum shape on the selected carriers (figures 1 and 2).

The test results are continuously updated. A graph shows the current reading, average of all readings, lowest and highest reading, and a special indicator is displayed if threshold limits were exceeded.

Verify and align the output power

Like a power meter the BAT-2700 presents the transmitted power on the screen. Easy to reach and to align in large letters. Coupling losses and pre-attenuation values are compensated so that the user reads the real power sent to the antenna. A large graphic field indicates the power in relation to the rated power (figure 3). The range of this field can be enlarged up to a factor of 10 to ease the alignment at the beginning.

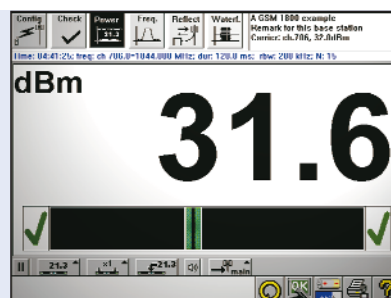

figure 3

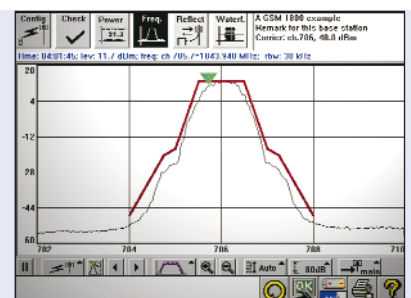

figure 4

Test the RF environment in the frequency and time domains

Testing the RF signals as they appear in the frequency domain is one of the first tests performed on any fault find task (figure 4). Normally spectrum analyzers are used for this. The BAT-2700 also shows the RF spectrum, measuring it with a fast sweeping receiver. This technique increases the dynamic range, allowing the user to detect interfering signals beside the main carrier. It also allows the user to look into the receive band, measure the noise floor and check the mobile phone transmission signals in this band. This is a passive way to check the whole receive chain, from the antenna to the receive input of the base station. The RF signals can be monitored in both the frequency and time domains. Like a zero span mode, the BAT-2700 shows also the signal strength over time. The technician can also check the burst shape or the flatness of the power roof on timed signals (figure 5). Continuous signal ripples can be detected on the RF output which are caused, for example, by a defective power supply of the base station power amplifier.

Verify the antenna match in the frequency domain

Unlike ordinary voltage standing wave ratio (VSWR) meters, the BAT-2700 can measure the antenna match in the frequency domain. The match can be measured on individual base station carriers, and these results are shown over the frequency range (figure 6). As a result, the BAT-2700 can identify errors that cannot be detected by a VSWR meter either outside or inside a base station.

The field engineer uses a bidirectional coupler to determine the ratio of the power sent to the antenna, to the power reflected by the antenna, indicating a possible mismatch.

If the mismatch value is similar across all carriers, this could indicate a frequency-independent problem, such as water in the RF cable. On the other hand, a frequency-dependent mismatch often indicates a problem in the antenna or at a connector. Therefore, checking the match in the frequency domain helps to determine the type of problem that is occurring.

Check the noise floor and high-level signal environments

Based on a unique receiver concept, the BAT-2700 measures RF levels very quickly across multiple frequencies. Its sensitivity exceeds that of mobile phones. The resolution bandwidth and power level sensitivity provide measurement capabilities unlike any spectrum analyzer.

As a result, when the BAT-2700's antenna is used, the RF spectrum appears as it does on a mobile phone. This means that you can identify the noise floor on your base station area and find broadband interference or noise emitters in your frequency band (figure 7).

Since the BAT-2700 also covers the mobile phone's transmitting frequency band, you can measure the noise floor on the receive path by using either the BAT's antenna or the base station's receive antenna. By hooking up the receive path cable to the BAT-2700, you will see noise levels and signals on your frequency screen just as your base station receiver would see them. By checking these signals and noise levels, you can find sources of interference in the mobile frequency band that are causing problems on the receive path.

Due to this receiver concept, the BAT-2700 is also robust enough to operate in high-level signal environments such as a cell site. Unlike other spectrum analyzers, however, the BAT-2700 does not generate spurious signals nor develops intermodulation products on its own. The BAT-2700 can measure low-level carrier frequencies, and find intermodulation signals inside the base station or sources of interference even close to strong base station carriers.

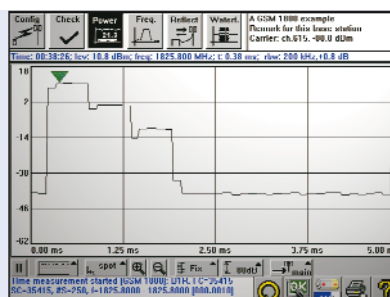

figure 5

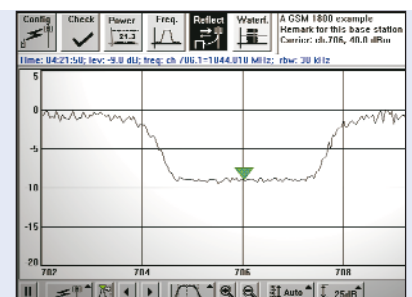
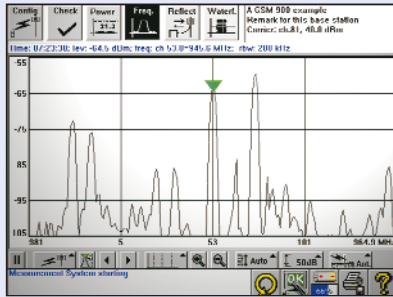

figure 6

figure 7



Find interference within and outside the base station receive and transmit band

To detect interference, the BAT-2700 provides a special screen called “Waterfall”. The signals are displayed over time and their power levels are represented in different colors. Each frequency sweep adds another line on the top and moves the display down. The time of the sweep is displayed on the vertical axis. This screen makes it possible to detect interference as well as detect its characteristics over time. In this screen, the horizontal lines represent a temporary broadband interference and the vertical lines represent a narrowband interference. Bursting signals are represented as dots like the hopping traffic channel above (figure 8). With the BAT-2700, screen results can be easily captured and forwarded to an RF performance engineer for further analysis.

figure 8

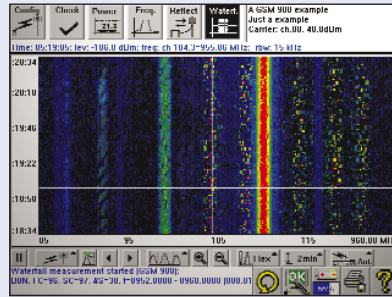

Generate detailed reports for RF performance engineers

The BAT-2700 provides RF performance engineers with full test information. Test results and BAT-2700 screens are stored at the press of a button. After returning to the office, a field technician can upload all the stored results and screen to a PC and attach them to e-mails or overall reports. The RF performance engineers can have immediate access to the data and can make fast, accurate decisions away from the faulty site to troubleshoot and improve the performance of a system.

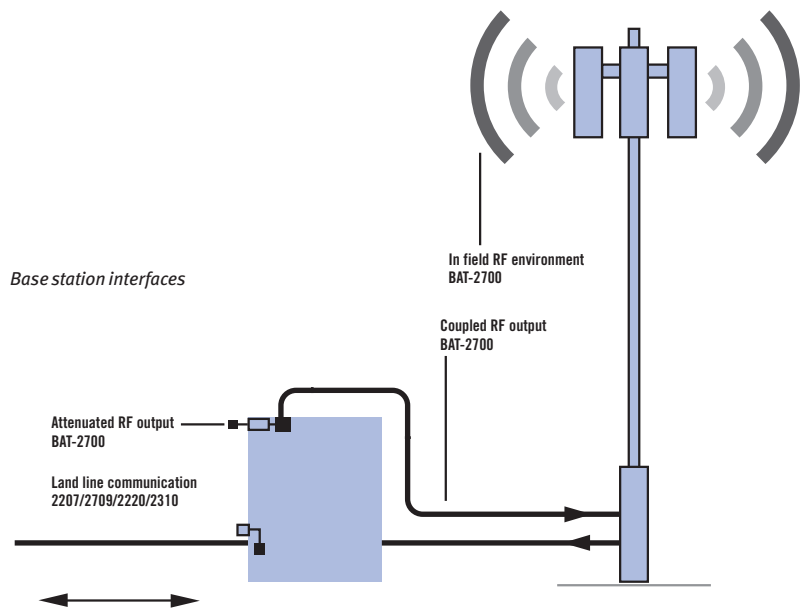

Specifications

Physical characteristics

- Overall dimensions 7.5 x 13.63 x 2.25 in
(19 x 34.6 x 5.7 cm)
- Weight with battery 5.2 lb (2.3 kg)

Environment

- Operating temperature 32°F to 113°F (0°C to 45°C)
- Storage temperature –40°F to +167°F (–40°C to +75°C)
- Humidity 10 to 90%, noncondensing

Power requirements

- AC adapter 100 to 120 V, 200 to 240 V
50 to 60 Hz, 45 W
- DC adapter (option) 12 to 19 V, 3 A
- Operation time typically 1.5 to 2 hours

Display

- 6.5 in (16.5 cm) diagonal
- Full VGA (640 x 480 pix.)

Measurement connectors

- Main N-type female
- Reflection N-type female
- Trigger BNC female
- Antenna TNC female

Frequency range

- Cellular version 800 to 1000 MHz
- PCS version 1700 to 2000 MHz
- Dual band version 800 to 1000 MHz
and 1700 to 2000 MHz

RF specifications

- Resolution BW 200 kHz, 30 kHz
- Tuning speed > 1000 channels/sec
- Sampling speed > 50,000 samples/sec
- RF dynamic range instantaneous 80 dB
- Total dynamic range > 110 dB
- Max save power 36 dBm (4 W) main and reflection input
18 dBm antenna input
- Max measurement power 30 dBm (1 W) main and reflection input
0 dBm antenna input
- Accuracy 1 dB from 41°F to 98°F (5°C to 35°C)
- RF impedance 50 Ω
- VSWR better 2:1
- DC blocking 50 V

Strong signal robustness

(falsify power read max 1 dB)

- Adjacent channel 60 dB
- 600 kHz to 800 kHz 66 dB
- 800 kHz to 1.6 MHz 71 dB
- 1.6 MHz to band end 81 dB
- Out of band 104 dB
- Image rejection > 70 dB

Ordering information

User interface module

- Acterna TestPad™ 2000 (UIM) 2000-SV3
(included color display, kickstand,
AC adapter/charger and printer cable)

Application module

- Base Station & Air Interface Test Module
- Cellular version 2700-Cell
- PCS version 2700-PCS
- Dual-band version 2700-Dual
(includes two N-to-N cables (6 ft, 1.8 m),
two N-to-SMA adapters, antenna,
Getting Started Guide)

Software options

- Cellsite Database for BAT-2700 2700-PC
(requires MS-Excel; includes CD-ROM, RS-232-C
connection cable, Getting Started Guide)

Additional application modules available

- T1/T3 Wireless Field Services Module
- Copper Analyzer Module
- E1/Data Communications Analyzer Module
- DSL Broadband Services Module
- SDH Field Services Module

Accessories

- Bidirectional coupler AC-016953
- External battery charger AC-31705
- Hanging strap AC-31891
- Cigarette lighter adapter/charger AC-31905
- Kickstand AC-44418
- Replacement battery BA-014081
- Carrying case, large soft CC-44605
- Carrying case, multimodule soft CC-45158

Worldwide Headquarters

20400 Observation Drive
Germantown, Maryland
20876-4023
USA

Acterna is present in more
than 80 countries. To find
your local sales office go to:
www.acterna.com

Regional Sales Headquarters

North America
20400 Observation Drive
Germantown, Maryland
20876-4023
USA
Toll Free: +1 866 ACTERNA
Toll Free: +1 866 228 3762
Tel: +1 301 353 1560 x2850
Fax: +1 301 353 9216

Latin America
Av. Eng. Luis Carlos Berrini
936/8° e 9° andares
04571-000 São Paulo
SP-Brazil
Tel: +55 11 5503 3800
Fax: +55 11 5505 1598

Asia Pacific
42 Clarendon Street
PO Box 141
South Melbourne
Victoria 3205
Australia
Tel: +61 3 9690 6700
Fax: +61 3 9690 6750

Western Europe
Arbachtalstrasse 6
72800 Eningen u.A.
Germany
Tel: +49 7121 86 2222
Fax: +49 7121 86 1222

**Eastern Europe,
Middle East & Africa**
Elisabethstrasse 36
2500 Baden
Austria
Tel: +43 2252 85 521 0
Fax: +43 2252 80 727

1st Neopalmovskiy Per.
15/7 (4th floor)
RF 119121 Moscow
Russia
Tel: +7 095 248 2508
Fax: +7 095 248 4189

© Copyright 2002
Acterna, LLC.
All rights reserved.

Acterna, The Keepers of
Communications, and
its logo are trademarks
of Acterna, LLC. All
other trademarks and
registered trademarks
are the property of their
respective owners. Major
Acterna operations sites
are ISO 9001 registered.

Note: Specifications,
terms and conditions
are subject to change
without notice.