

WAYNE KERR ELECTRONICS LTD, DURBAN ROAD, BOGNOR REGIS, WEST SUSSEX, PO22 9RL, UK  
TELEPHONE (UK) 01243 825811 (INT) +44 1243 825811  
FACSIMILE (UK) 01243 824698 (INT) +44 1243 824698

Part № 9H3220A

3220A  
20A BIAS UNIT

Instruction / Service Manual  
for



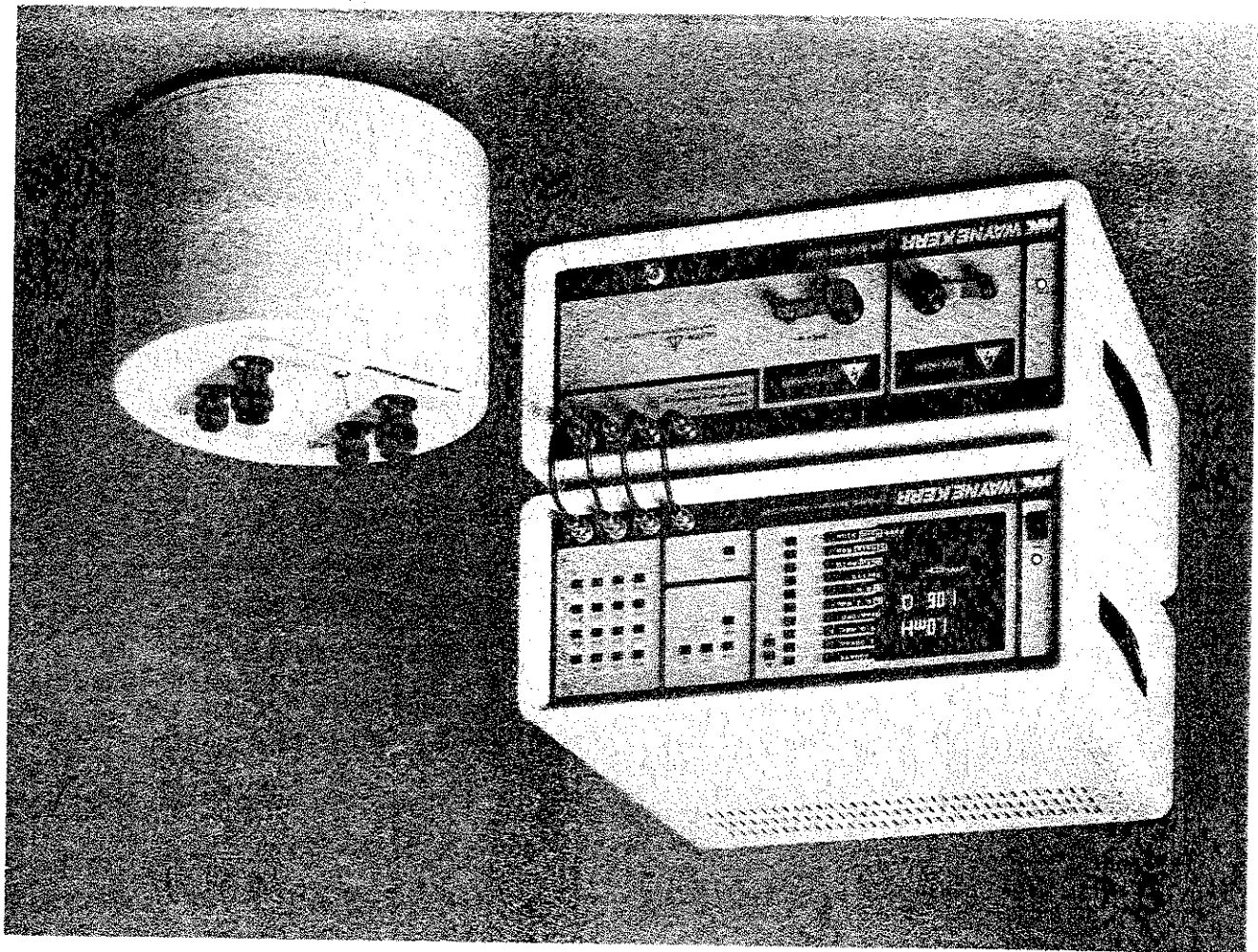


OPERATING INSTRUCTIONS

PART 1

3220A 20A BIAS UNIT







## INTRODUCTION

20A Bias Units 3220A extend the range of dc bias available during measurements of inductance on the Precision Inductance Analyzer 3245. Each 3220A can provide from 0.2amp to 20amps dc and up to five can be connected in parallel for a maximum range of 1 to 100amps dc.

Operation of the 3220A's is under the control of the 3245. All the Analyzer measurement modes are available while Bias Units are in use, although the ac signal level range available is reduced. The Analyzer displays certain informative or warning messages relating specifically to the functioning of the Bias Units.

A safety interlock resident in the 3245 is provided for use with enclosed terminal fixtures. With a micro-switch fitted to such enclosures, such that it is operated only while the door is closed, dc bias can only be activated in this protected situation. Additionally, an enable signal to operate a relay is available for use with a solenoid to lock the door while bias remains available. An led display is fitted (not on some early models) as an additional safety feature to warn operators when bias is activated.

Supplied with the 3220A is a calibration coil which can be used to obtain corrections above 10KHz for the heavy capacitive load which the Bias Unit imposes on the measure terminals of the 3245 Analyzer. Measurements can be made without using the calibration routine, but the 3245 will display "calibration error" message while bias is on, and may work at reduced accuracy, depending on the measure frequency used. Below 10KHz no corrections are required.

## WARNING

Very high voltages are generated in inductive circuits if the path is broken while a heavy current is flowing. The energy stored is proportional to the square of the current; back emf's can reach many kilovolts. NEVER touch test connections while the direct current is flowing and DO NOT TOUCH TEST CONNECTIONS while SHOCK HAZARD is displayed.





SPECIFICATION

\*MEASUREMENT FACILITIES All the 3245 facilities. Measurement of step-up transformers restricted to:

5:1 max. ratio at minimum drive level, and to 1.4:1 at maximum drive level.

FREQUENCY

Full range of 3245 frequencies.

RANGE

AC DRIVE LEVEL Normal 3245 voltages within the range 250mV - 1V rms  
Normal 3245 currents within the range 25mA - 100mA rms

DC BIAS CURRENT

0.2A to 20A in steps of 0.1A

\*\*BIAS CURRENT

±1% of setting for air inlet temperature between 15° and 30°C, steady-state operation

DC VOLTAGE

5V (dc) max at 1V (ac) signal level  
6V " " " 250mV " "

DROP

As for 3245 except Accuracy:

DC RESISTANCE

±0.5% up to 250Ω  
(±1% at 500Ω, ±2% at 1kΩ)

MEASUREMENT

MEASUREMENT MODE

All the 3245 modes are available.

(continued)

\* (1) Rdc not available with DC bias selected.

(2) Mutual inductance and external bias calibrate modes use the same area of memory for trim values. Therefore, if either facility is used after the other, re-trimming for the mode in use will be necessary. A warning message will be displayed if any trim values have been corrupted.

\*\*

Extended operation at high bias currents causes a temperature rise, producing an offset. This can be ignored at the high current levels, but may be significant if the lowest currents are



SPECIFICATION (Continued)

**MEASUREMENT ACCURACY**  
 Accuracy Chart (Fig. 1) shows L accuracies vs. frequency applicable from 15°C to 30°C, at bias levels up to 20A, with maximum ac drive level and 3245 in Slow mode.  
 D accuracies corresponding to the ±1%, ±2%, ±5% and ±10% lines for L are ±0.02, ±0.04, ±0.1 and ±0.2, respectively.  
 Fig. 2 shows accuracy multiplying factors for other temperatures.

**MEASURE** 2 or 4-terminal measurement available via heavy-current screw-terminal connections.  
**TERMINALS** Measurement terminals internally protected against normal inductor back-emf, or accidental disconnection of inductor, up to 100mH.

**TEMPERATURE** Storage: -40°C to +70°C  
 Operation: 0°C to +40°C (See Fig. 1 and Fig. 2 for relevant accuracies).  
 Full accuracy: 15°C to 30°C

**POWER SUPPLY** 115V ±10%, 50/60Hz, or 230V ±10%, 50/60Hz  
 Max. consumption each 3220A: 400W

**DIMENSIONS** Width 443mm (17½ in.)  
 Height (inc. feet) 195mm (7½ in.)  
 Depth (overall) 470mm (18½ in.)

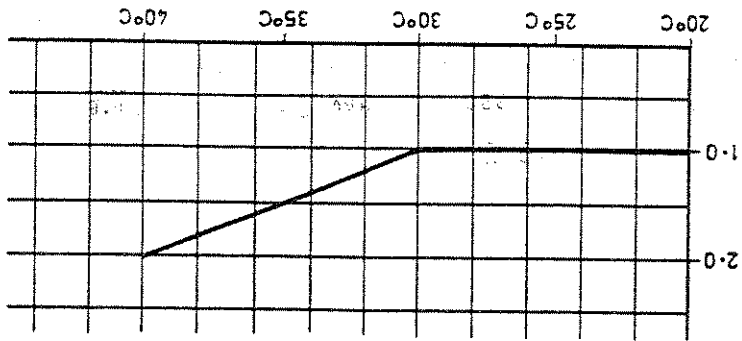
**WEIGHT** 16.2kg (36 lb)

**NOTE** 3220A's can only be supported by 3245's with BCI-A interface cards and 3245A software. These instruments have a suffix A on the rear panel label.

In step with rapidly developing technology the Company is continually improving its products and therefore reserves the right at any time to alter specifications or designs without prior notice.

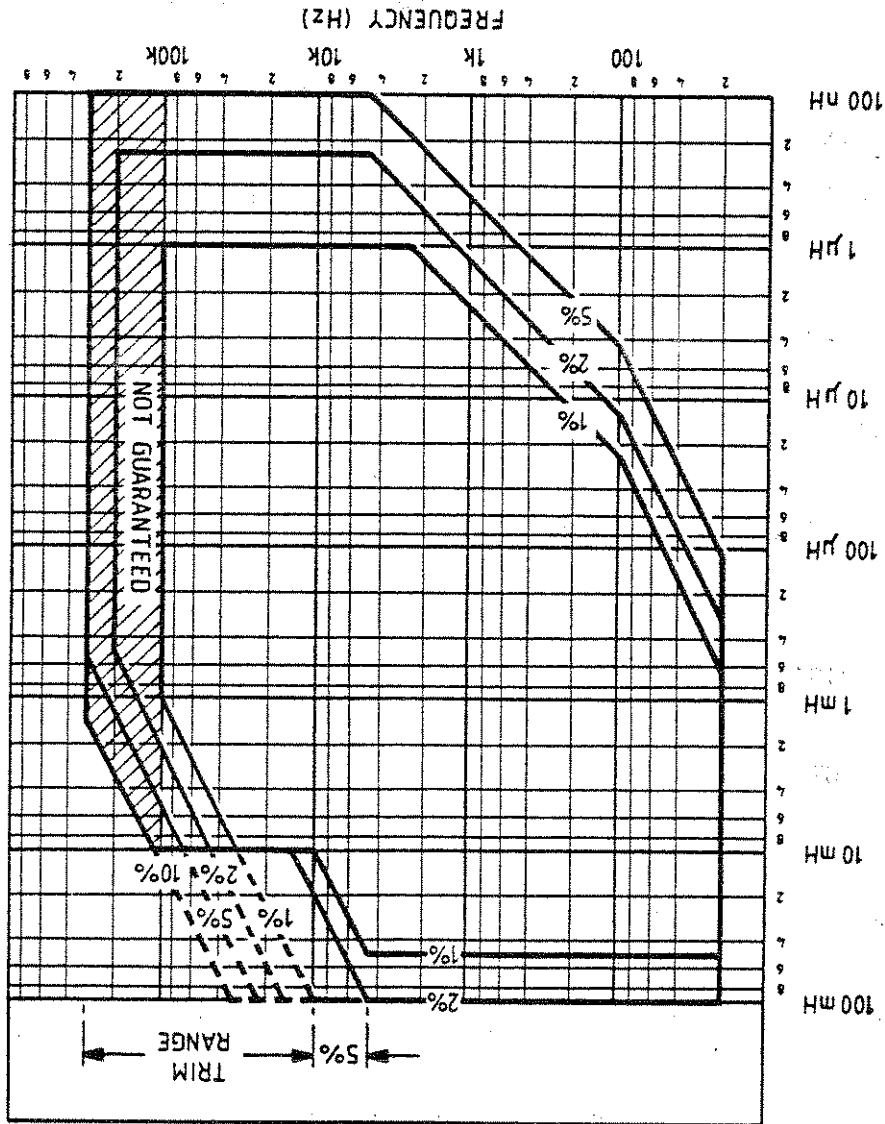


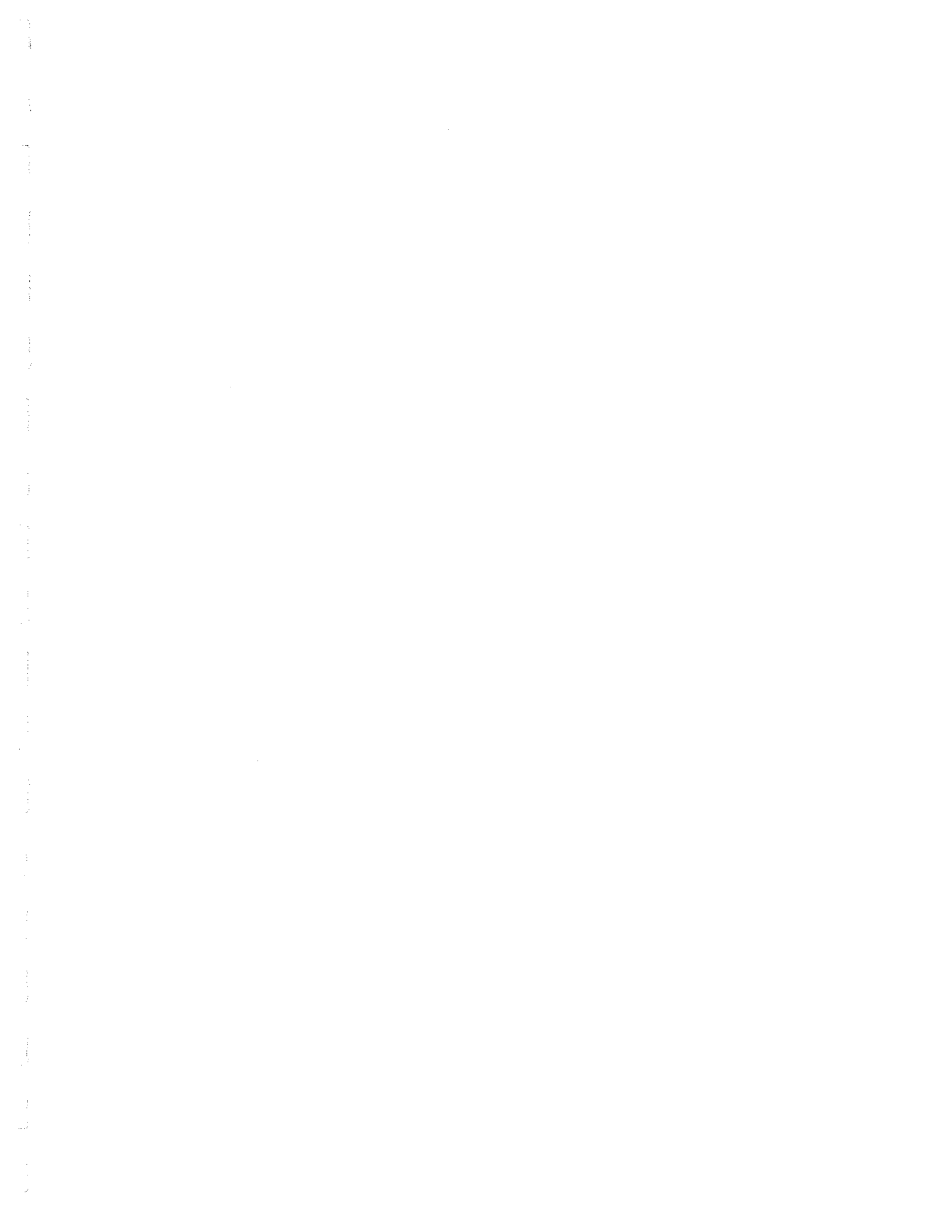
Fig. 2 Accuracy multipliers - temperature, assuming calibration at 25°C. At the higher ambient temperatures, basic accuracy can be maintained



MULTIPLYING FACTOR FOR LIMIT OF ERROR L & D VS. TEMPERATURE

Fig. 1 Accuracy for bias levels up to 20A, (15-30°C, max. drive level, Slow mode, Spot trim or Cal at Selected Freq). See 'Measurement accuracy' (page 20).





## INSTALLATION

When only one 3220A is to be used, the 3245 can be placed on top. If two or more 3220A's are to be used, rack mounting is essential. Installation is described first for a single 3220A: a later section - Stacking - details the additional procedures for multiple units.

1 Ensure that both units are completely disconnected from the ac supply. Normally, if the 3245 and 3220A were ordered together, the former will have a Bias Interface Card (BCI-A) fitted in the Option slot nearest to the heat sink. If not, refer to your supplier or see 3245 Maintenance Manual for details.

2 Connect the free plug of the 25-way D-type Custom Ribbon Assembly to the BCI-A and to the 3220A plug (top left-hand side of rear panel).

3 Insert the jack plug from the test enclosure interlock system (see Fig. 5) into the socket on the Bias Interface Card. Even if an interlocked enclosure is not used, a plug with a link fitted must be inserted (see IMPORTANT note in INTERLOCK FACILITY section).

4 Locate the two instruments so that there is an air inlet clearance of at least 30cm behind the 3220A. Each 3220A must be powered from a point capable of supplying up to 400 watts. Check that the voltage input selector plate (115V/230V) is set correctly on both units. 3220A's have two fuses on the rear panel (and additional fuses fitted internally). The upper fuse is for auxiliary supplies (the fan, etc) and is 0.25A-T for 230-volt operation or 0.5A-T for 115-volt supplies. The lower fuse, for the switched mode power supply, is 6A HRC. The power lead supplied with the instruments normally has the appropriate plug, to suit local a.c. supplies, moulded on. If for any reason the plug has to be replaced, the connections should be as follows:

Yellow/Green	to Earth (Ground)
Brown	to Live
Blue	to Neutral

If the plug is fused, a 3-amp fuse should be fitted. The instrument is not suitable for battery operation.





**SAFETY:** An adequate ground connection is essential for operator safety.

Switching-on the 3245 also switches on every 3220A linked to it, and this is confirmed by a power lamp illuminating on each 3220A.

### Stacking

When two or more (up to a maximum of five) 3220A units are to be operated in parallel, they must be rack mounted with the 3245 at the top of the stack. A rack mounting kit (part number 25539) consisting of brackets (ears) and screws is available from your supplier, but runners must also be used to support the weight of each instrument (3245 and each 3220A). To avoid excessive build-up of heated air at the air inlets, the exhaust air must be ducted away. The rear connections are as described for a single 3220A with the addition of "daisy chain" connections to each extra unit. The ribbon cable should provide short direct links between the Bias Units with a single right-angle fold to the BCI-A. This arrangement is shown in Fig. 3.

Check that every 3220A is set correctly for the local supply voltage. Each one must be powered from a socket with a 400-watt capability.

### Front-panel Connections (Applicable to single and stacked 3220A's)

**CAUTION:** Never make, break or touch front-panel connections while bias supply is on.

Use the BNC to BNC links provided to connect the four measurement sockets of the 3245 to the corresponding four sockets of the 3220A. With stacked 3220A's, also make additional ground links and fit shaped bus-bars (part number 25702) as shown in Fig. 4. An alternative to these is to use individual heavy leads (56 x 0.3mm minimum) from each 3220A to the top one. It is not sufficient to select leads of adequate current rating: they must be of very low dc resistance to ensure an absolute minimum voltage drop (see table on page 20). For best results, use screened (braided) cables for the sense and drive leads. [It may be found convenient to remove the outer braid from coaxial cable and feed this over the sense and drive leads.]



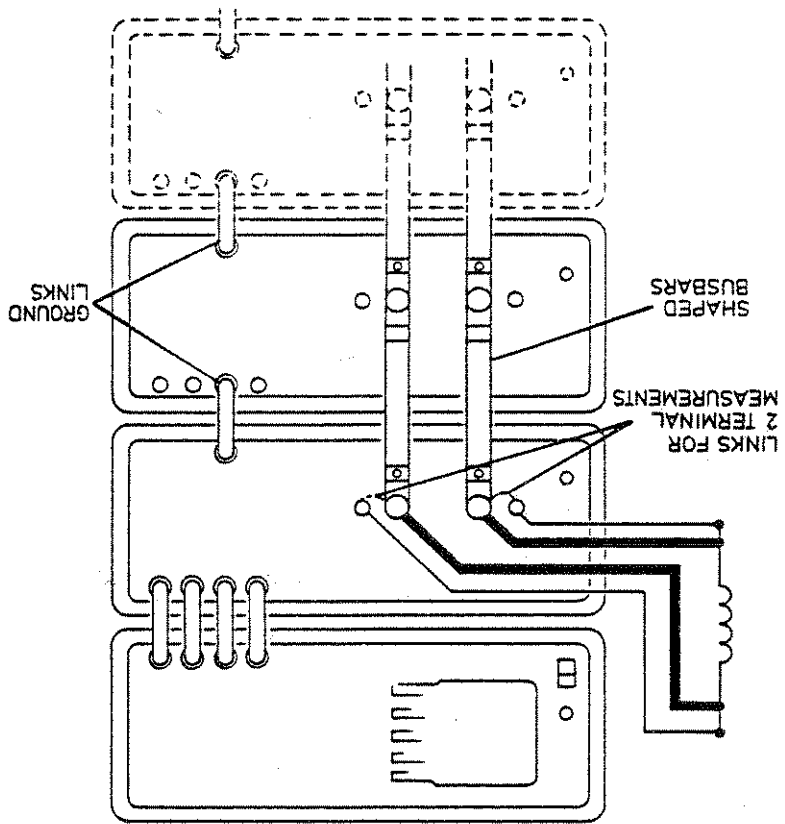
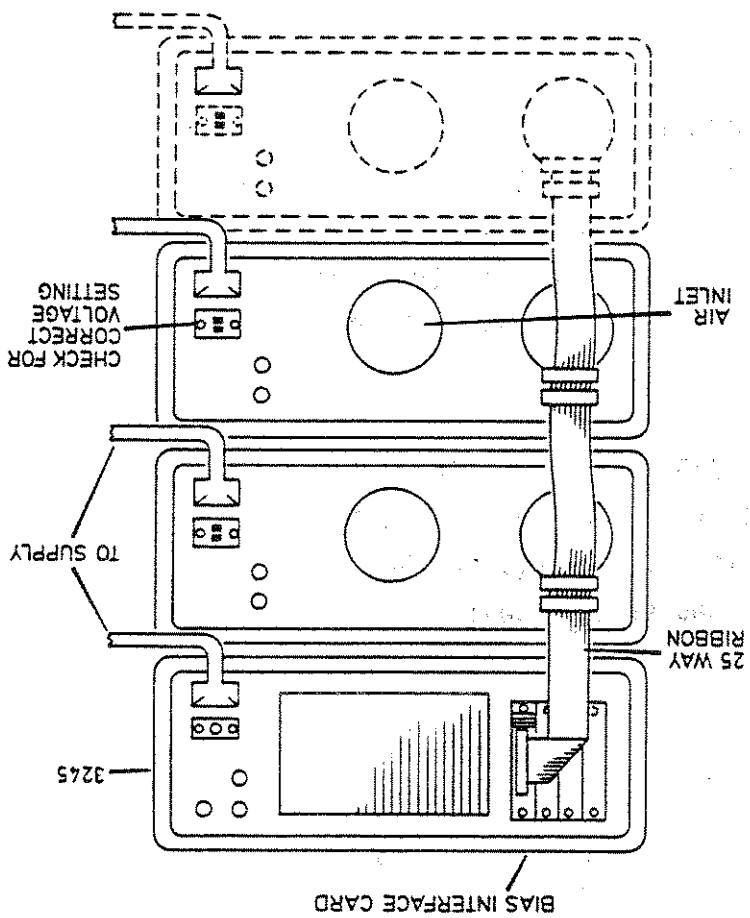




Fig. 3 Rear-panel connections





INTERLOCK FACILITY

IMPORTANT

If the Interlock facility is not required, it is necessary to insert the 3.5mm Audio Jack, with the ring and sleeve connections linked, into the socket on the Bias Interface Card. Failure to do this will result in bias being inhibited, and the message  SAFETY INTERLOCK  being displayed.

For maximum operator safety, particularly on production-line testing, it is advisable to place the terminal fixture, for the inductor under test, within a housing with an interlocked door. The Bias Interface Card, (adjacent to the heat sink of the 3245) has a jack socket for use with a standard 3-pole 3.5mm Audio Jack. The connections this provides are shown in Figure 5.

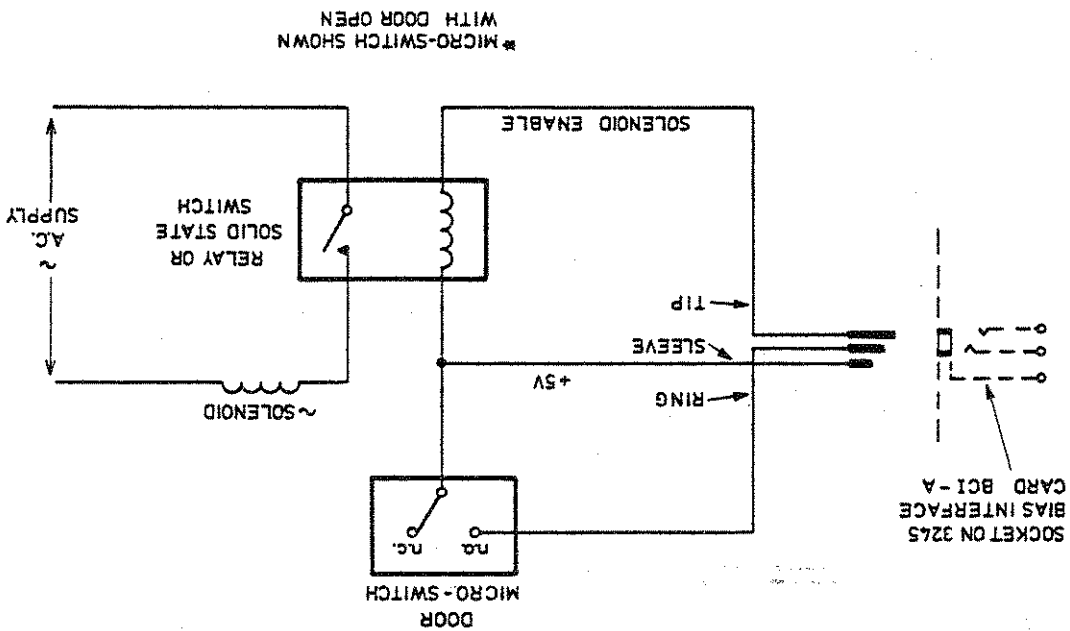


Fig. 5 Door Interlock connections



the door switch or interlock lead is broken, the dc bias is inhibited. The door lock is activated when Bias ON is selected on the 3245. If

Interface Card.

The solenoid drive relay should have a 5-volt dc coil of resistance not less than 200 ohms. Diode coil protection is provided within the Bias

door while the bias remains available. Only when the door is closed, and the micro-switch therefore made, can the dc bias be activated. At this time, the relay is energised, activating an ac supply for a solenoid which can be used to lock the





\* Necessary only on the topmost 3220A. On others in a stack, during 2-terminal tests, the presence or absence of links is immaterial but they must NOT be fitted when 4-terminal measurements are to be made.

Four-terminal measurements are made by disconnecting the sense links and connecting the measure leads as shown in Fig. 4. Leads shown in bold must be of heavy-gauge wire (56 x 0.3mm minimum). It is not sufficient to select leads of adequate current rating: they must be of very low dc resistance to minimize dc voltage drop (see Table on page 21). The sense leads (from the outermost terminals) can be of light-gauge wire.

The large, innermost, pair of terminals are the drive connections to the component under test: the outermost terminals are sense connections. Bias current is via the large terminals. If only two-terminal connections are required, sense links should be used as shown dotted on Fig. 4\*. The component under test is connected across the inner two terminals. In this arrangement, particularly with impedances below 10 $\Omega$ , some loss of accuracy can arise from variations in contact resistance at the points of connection to the Unknown. This difficulty is overcome by using four-terminal connections.

Remember that interrupting current flow in inductive circuits will generate very high voltages. Always switch Bias OFF before making any changes to measurement leads.

WARNING

Connections to Unknown

OPERATION



1 Locate the calibration coil, on a wooden or other non-metallic support, at least one metre from the 3220A and other equipment.

2 With the 3245/3220A ready for use, and Bias OFF selected, make a four-terminal connection to the calibration coil using screened\* twisted pairs for the sense and drive leads. See Figure 6. Place the sense and drive leads together (to minimize electro-magnetic coupling from the coil under test) and strap or tape down to a non-metallic fixture to avoid movement which would modify the short-circuit trim values.

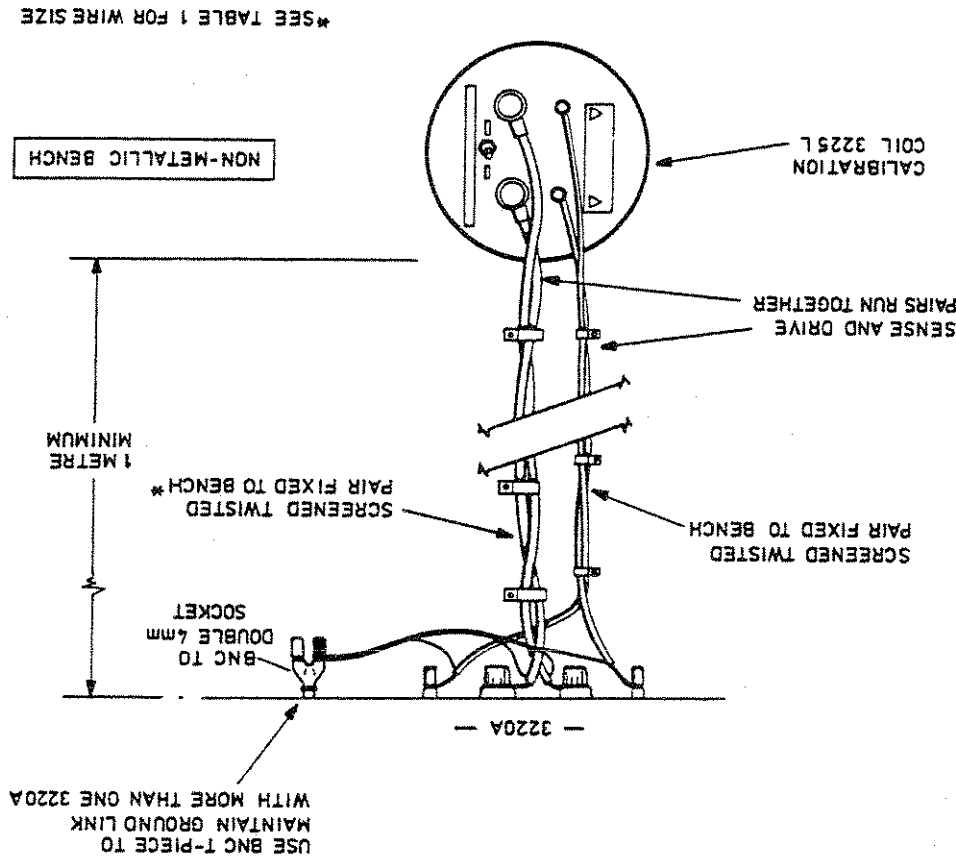


Fig. 6 Calibration Coil connections

\* Note: Screening the measure leads minimizes electrical noise pick-up and the initial open-circuit error due to the test cable which can be around 200pF. This becomes more essential with high-impedance measurements



3 Return the screens to the ground terminal of the 3220A (lower right-hand side of front panel) connecting to the black terminal in the double binding-post adaptor provided. With more than one Bias Unit fitted, use a T-piece BNC adaptor to maintain the ground link to the lower units (see Fig. 6).

4 Select the required ac drive level and frequency.

5 Connect a heavy link (see TABLE 1 on page 21) across the coil drive terminals and, if the calibration coil has been located in an interlocked enclosure, close the door.

6 Select Trim S/C and press Trigger. Wait until the display returns to normal measure mode.

7 Remove the short-circuit link at the coil, and disconnect the bias +ve drive and associated sense lead. Connect these together, disturbing the leads as little as possible.

8 Select Trim O/C and press Trigger. Wait until the display returns to normal measure mode. Re-connect the bias +ve drive and sense leads to the calibration coil.

9 From the 3245 Main Index, select EXT BIAS CALIBRATE.

The display will prompt for calibration in any of three alternative modes:

Spot trim - (single frequency and bias level)

Cal at Selected Freq - (single frequency / any bias level)

Cal over Freq Range - (all frequencies\* / any bias level)

For the highest accuracy, use the Spot trim facility or calibrate at a single frequency. The calibration operates from 10kHz for all three modes. Cal over Freq Range corrections are not applied above 100kHz.

The spot trim should be used only when a series of measurements are to be made at a constant bias level (eg checking a number of



smoothing chokes designed for the same rated load current). If the calibration conditions are inadvertently changed (eg frequency or bias) the message "calibration error" will be displayed.

10 The 3245 will now request that the calibration coil switch is set to Low Z. When this has been done, press the 3245 trigger button. This initiates calibration measurements first with bias on, followed by bias off.

11 The 3245 will now request that the coil switch is set to High Z. When this has been done, press the 3245 trigger button. Calibration measurements are again made with and without bias.

This completes the Calibration sequence.

### Making measurements

1 Select Bias OFF and replace the calibration coil by the coil to be measured, disturbing the measure leads as little as possible. This is more important with low impedance measurements and coils with a large magnetic flux path such as air-cored coils and I-cored chokes.

2 Set 3245 to Auto, Rep, before selecting Bias ON.

3 To minimize measurement noise, where practical select maximum ac drive and Slow measure mode.

In general, operation of the 3245 with one or more 3220A's in use is similar to that for a 3245 used alone, except for the modified limits to the ac drive level (see 3220A Specification).

Note: The Rdc facility is not available with DC bias.





Messages

If a 3220A is not connected to a power source, or a rear-panel fuse has failed, a message at the top of the 3245 will show\*:

20A UNIT : NO POWER

Bias messages are the same as for the 3245 internal 1A bias facility.

During ramp-up or ramp-down of dc bias, the message is:

DC CURRENT NOT SET

This is extinguished when the correct current level is established.

If there is no inductor connected to the measurement terminals, after the above display has shown for 10 seconds, the DC supply is turned off with:

SAFETY : BIAS TURNED OFF displayed.

If an inductor is connected, but the dc voltage across it is excessive, the display is:

EXCESS VOLTAGE DROP

This may be avoided by reducing the bias level and/or reducing the ac drive level.

\* Except when the 3245 is displaying 2,3,4-terminal and transformer





If an excessive voltage drop is allowed to persist for 10 seconds, the message:

SAFETY : BIAS TURNED OFF



is displayed during the controlled removal of bias.

The above message also appears at the bottom of the display if the 3220A overheats. If an attempt is made to turn the bias on, under these conditions, there is a message:

 20A OVER TEMP 



If this occurs, switch off the 3245 and allow the unit to cool before continuing measurements.

Each 3220A has eight internal fuses. Should any of these blow, the message is:

 20A UNIT FUSES 

After 10 seconds, the unit will shut down.

If the frequency and/or bias level has been changed from the setting(s) used at calibration (not applicable to Cal over Freq Range), the message\* is:

 CALIBRATION ERROR 

\* This message may also occur during a calibration routine if the



If the connection from the enclosure interlock system (Fig. 5) to the Bias Interface Card has not been made (or the interlock jack has not been correctly inserted into the BCI-A card - see IMPORTANT note in INTERLOCK FACILITY section), the message is:


 SAFETY INTERLOCK
 

Measurement techniques

Measuring inductors can be very error-prone unless care is taken of the following principles.

- 1 Avoid large loops being formed by the measure leads as this can cause magnetic coupling from the inductor under test. As stated earlier, this is more relevant with small I-cored chokes due to the higher test current and the large flux path of such components.

- 2 Keep the measure set-up physically stable to avoid changing or creating a loop area with the measure leads.

- 3 Keep the unknown component away from the 3220A metalwork or any other metallic object. Again, this is more important with inductors with a large leakage flux, ie large air gaps.

Measurement accuracy

For maximum accuracy, repeat the complete calibration procedure prior to each measurement to remove any thermal drift. If measurements are to be made at more than 5A from a cold start, allow the 3220A to thermally stabilize by running at 20A for ten minutes with a shorting link at the bias terminals before calibrating.

Accuracy Chart (Fig. 1) shows accuracies vs frequency, applicable



MAX DC BIAS	CONDUCTOR SIZE	STRANDS x DIAMETER
20A	4mm <sup>2</sup>	56 x 0.3mm
40A	16mm <sup>2</sup>	126 x 0.4mm
60A	25mm <sup>2</sup>	196 x 0.4mm
80A	35mm <sup>2</sup>	276 x 0.4mm

TABLE 1 - MINIMUM DRIVE LEAD SIZE/MAXIMUM BIAS CAPACITY

When more than one 3220A is used, the additional major term error will typically be proportional to the number of 3220A's fitted. Above 20A, the voltage drive level should be reduced proportionally with increasing current to avoid distortion of the drive signal. This is not applicable to current-driven measurements (3245 ranges 1 to 3).

Dissipation Factor (D) accuracies corresponding to the 1%, 2%, 5% and 10% lines for L are, typically, ±0.02, ±0.04, ±0.1 and ±0.2 respectively for high-Q coils. For low-Q components, Q < 10, multiply the L accuracy by (1 + 1/Q) and dissipation factor accuracy by (1 + D<sub>2</sub>), where D = 1/Q for all coils.

For measuring high impedances a more suitable calibration coil (3210HL) can be supplied, giving an extended impedance range from 10kHz when using the Spot trim mode. See dashed lines of Fig. 1 for a typical performance.

When using the Cal over Freq Range calibrate mode, the accuracy typically falls by 2 : 1.

The solid lines of the accuracy graph indicate the 1, 2, 5 and 10% boundaries when using either the Spot trim or Cal at Selected Freq calibrate modes with the standard calibration coil (3225L) provided.

3245 in Slow measure mode and Spot trim. from 15°C to 30°C for bias levels up to 20A, maximum ac drive level,

