

User's Manual

AMREL PPS Series Programmable DC Power Supplies

AMREL / AMERICAN RELIANCE INC.

11801 GOLDRING ROAD, ARCADIA, CA 91006

~~(818)~~ 303-6688 FAX: (818) 358-3838

626



Table of Contents

ONE: INTRODUCTION

1.1	DESCRIPTION	1
1.2	INSPECTION	1
1.3	INCLUDED ITEMS	1
1.4	CAUTIONS AND WARNINGS	1
1.5	LOCATION AND COOLING	2
1.6	GPIB INTERFACE CONNECTOR	2

TWO: GETTING STARTED

2.1	UNIT FAMILIARIZATION	3
2.1.1	FRONT PANEL KEYS	5
2.1.2	REAR PANEL	8
2.2	LCD STATUS ANNUNCIATORS	8
2.3	OUTPUT TERMINALS AND WIRES	10

THREE: OPERATING CHARACTERISTICS AND CONFIGURATIONS

3.1	INTRODUCTION	11
3.2	OPERATING RANGES	11
3.3	REMOTE SENSE	12
3.3.1	REMOTE SENSE CONFIGURATION	12
3.3.2	REMOTE SENSE CHARACTERISTICS	12
3.4	LOAD CONSIDERATION AND MULTIPLE LOADS CONNECTION	13
3.5	PARALLEL CONNECTION OPERATION	14
3.5.1	CV OPERATION	14
3.5.2	CC OPERATION	15
3.5.3	REMOTE SENSE CONFIGURATION (Parallel Connection Mode)	15
3.6	SERIES CONNECTION OPERATION	16
3.6.1	CV OPERATION	16
3.6.2	CC OPERATION	16
3.6.3	REMOTE SENSE CONFIGURATION (Series Connection Mode)	17
3.7	EXTERNAL ANALOG PROGRAMMING	18

FOUR: LOCAL OPERATION

4.1	INTRODUCTION	19
4.2	GENERAL INFORMATION	19
4.3	SETTING VOLTAGE	19
4.4	SETTING CURRENT	20
4.5	SETTING THE PROTECTION MODES	21
4.5.1	SETTING THE OVERVOLTAGE THRESHOLD	21
4.5.2	ENABLING / DISABLING OVERVOLTAGE PROTECTION	21
4.5.3	ENABLING / DISABLING OVERCURRENT PROTECTION	21
4.6	ENABLING/DISABLING OUTPUTS	21
4.7	TRACKING OPERATION (DUAL CHANNEL PPS).....	22
4.8	RANGE OPERATION (DUAL RANGE PPS).....	22
4.9	AUDIBLE SIGNAL	22

FIVE: REMOTE OPERATION

5.1	INTRODUCTION	23
5.2	GPIB OPERATION	24
5.2.1	GPIB INTERFACE FUNCTIONS.....	24
5.2.2	ADDRESS SETTING OF GPIB INTERFACE.....	24
5.3	PROGRAMMING SYNTAX	24
5.3.1	GPIB COMMAND LIST.....	25
5.3.2	GPIB CALIBRATION COMMANDS.....	26
5.4	STATUS REPORTING	26
5.5	PROGRAMMING THE POWER SUPPLY	27
5.5.1	OUTPUT ON/OFF	28
5.5.2	VOLTAGE PROGRAMMING.....	28
5.5.3	OVERVOLTAGE PROGRAMMING (OVSET).....	29
5.5.4	CURRENT PROGRAMMING.....	29
5.5.5	OVERCURRENT PROTECTION (OCP).....	30
5.5.6	OTHER COMMON COMMANDS.....	30

5.6	FUNDAMENTALS OF PROGRAMMING	30
-----	-----------------------------------	----

SIX: CALIBRATION

6.1	INTRODUCTION	33
6.2	CALIBRATION CONFIGURATION	33
6.3	LOCAL CALIBRATION	34
6.4	REMOTE CALIBRATION	35
6.5	CALIBRATION PROGRAM EXAMPLE	35

SEVEN: USER MAINTENANCE/SERVICE

7.1	FUSE REPLACEMENT	36
7.2	IN CASE OF DIFFICULTIES	36
7.3	WARRANTY INFORMATION	37
7.4	SHIPPING INSTRUCTIONS	38

EIGHT: APPENDICES

A.	SPECIFICATIONS	39
B.	ERROR MESSAGES	47
C.	CALIBRATION PROGRAM EXAMPLE	48

NINE: ADDENDUMS

COMMAND SUMMARIES

QUERIES SUMMARIES



ONE: INTRODUCTION

Congratulations! You have just purchased one of the most advanced professional Programmable Power Supplies available. The innovative ergonomic design and overall high quality will provide years of reliable operation. Therefore, it is very important to completely familiarize yourself with the unit before attempting use. Please read this manual carefully, paying particular attention to the Warning and Caution sections.

At this time, please fill out the warranty card with all the applicable information and return to American Reliance. The completed warranty card will ensure the benefits of a three-year warranty.

We at American Reliance, thank you for your selection of one of our products and welcome you to the family of American Reliance product owners. Remember that, at American Reliance service does not end upon your purchase, it is just beginning. If you have any questions, please do not hesitate to call our toll-free technical support line at **(800) 654-9838**.

1.1 DESCRIPTION

The Programmable Power Supply Series from American Reliance Inc. offers a complete solution to power supply system requirements. These models are indispensable instruments in assisting in the development and testing of new products, as well as being standard instruments for automatic test systems. The wide range of output selection combined with excellent load/line regulation creates a vital instrument in your lab environment.

The PPS Series come standard with a GPIB interface and a three-year warranty. Plus, all units come standard with output voltage and current programming, overvoltage and overcurrent protection, remote sense, reverse polarity protection and output enable/disable. All models of the programmable power supply series are able to be calibrated either in local or remote mode.

1.2 INSPECTION

When you unpack your new programmable power supply from its original packaging, carefully check each item for damage that may have occurred during shipment. If anything is damaged or missing, please contact American Reliance at (818) 303-6688 for immediate service.

1.3 INCLUDED ITEMS

Programmable Power Supply
Operation Manual
Power Cord

1.4 CAUTIONS AND WARNINGS

1. The input power requirements for the programmable power supplies are 115/230 VAC $\pm 10\%$ or 240VAC $\pm 10\%$, 50/60 Hz.
2. Before begin to operate the power supply, set the correct voltage 115 or 230(240) VAC setting equal to the applied voltage, otherwise damage will result to the power supply.
3. Do not use solvents or aromatic hydrocarbons to clean the module as they may damage the finish. If cleaning is necessary, use only a mild solution of soap and warm water. Be careful not to allow water to enter the unit. Please be sure to always disconnect the power cord before cleaning.
4. Use only specified fuses. Do not use a substitute fuse which is of a different size and rating. Otherwise, damage may result to the unit.
5. Do not substitute or modify any internal circuits.

6. Exercise extreme caution when cables are over four feet in length.
7. Turns off AC power (or disable unit) before disconnecting load or floating voltages.
8. Operates the power supply with properly rated wire sizes.

1.5 LOCATION AND COOLING

1. The proper operating temperature for the power supply are from 0°C to 50°C. The unit ventilates by drawing air through the sides and exhausting it through the rear.
2. Proper ventilation area for the power supplies is at least 1" of spacing on all sides.
3. The PPSs are built to configure into 1/2 rack mount configurations.

1.6 GPIB INTERFACE CONNECTOR

The GPIB connector on the rear panel connects your supply to the computer and other GPIB devices. A GPIB system can be connected in any configuration (star, linear, or both) as long as the following rules are observed:

- 1) The total number of devices including the computer should not be greater than 15.
- 2) The total length of all cables used should not be more than 2 meters times the number of devices connected together, or a maximum length of 20 meters.

Please do not stack more than three connector blocks together on any GPIB port. The resulting leverage can exert excessive force on the mounting panels. Make sure that all connectors are fully seated and that the lock screws are firmly **hand tightened**. Use a screwdriver only when removing the screw from the mounting panels.

TWO: GETTING STARTED

2.1 UNIT FAMILIARIZATION

Use the following illustrations of the power supplies in conjunction with the descriptions to familiarize yourself with the unit.

Front Panel: Figure A, B, C, D

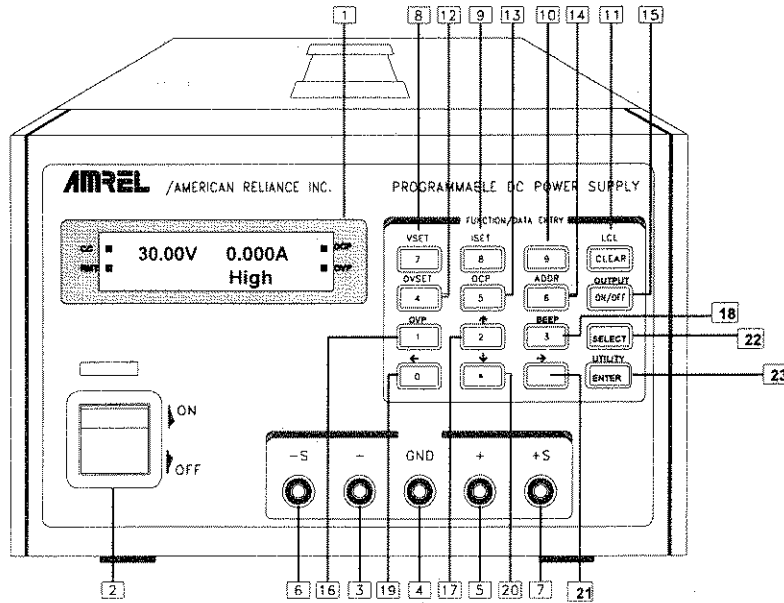

Figure A. Front Panel of The Dual Range PPS-Series

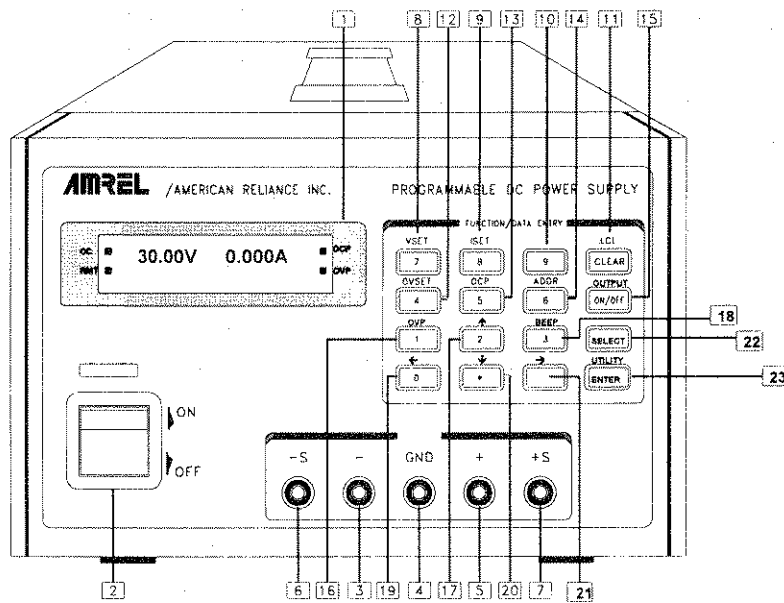

Figure B. Front Panel of The Single Channel PPS-Series

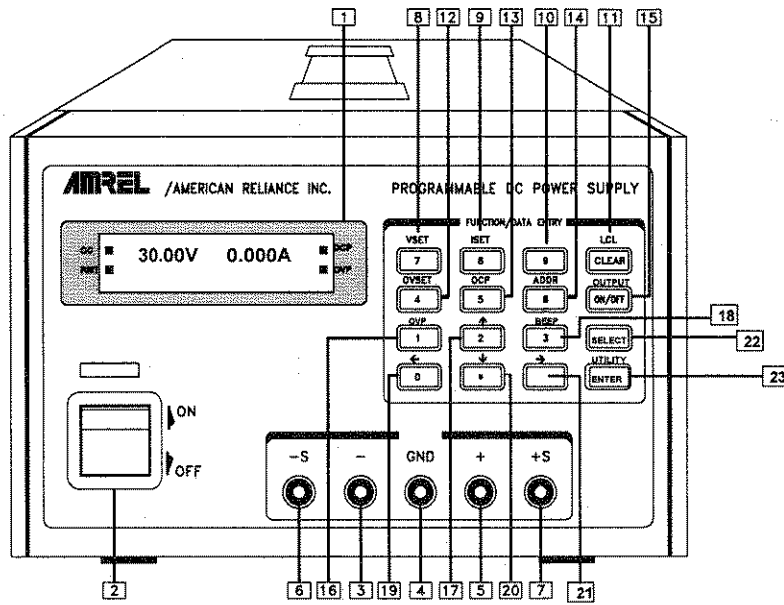

Figure C. Front Panel of PPS-Single Channel

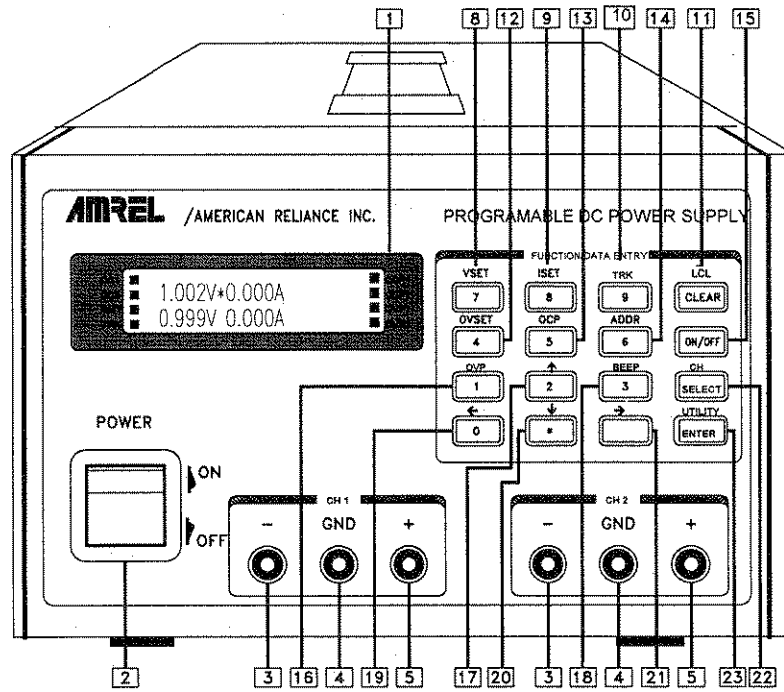

Figure D. Front Panel of PPS-Dual Channel

2.1.1 FRONT PANEL KEYS

<NOTES:>

Most soft keys have two functions. The first function of the keys is function entry (i.e. VSET, ISET, OCP etc.). The second function for the soft keys is numeric data entry (i.e. 0-9).

- | | |
|----------------------|---|
| 1. LCD Display | Displays alphanumeric information with status annunciators. A detailed listing of descriptions is presented in section LCD STATUS ANNUNCIATORS |
| 2. Power On/Off | Powers on the unit. |
| 3. Negative Terminal | Negative output terminal. |
| 4. Ground Terminal | Ground output terminal. |
| 5. Positive Terminal | Positive output terminal. |
| 6. -S Terminal | Negative remote sense (Not applicable for the Dual Channel PPS-Series) |
| 7. +S Terminal | Positive remote sense (Applicable only for the Single and Dual Range PPS-Series) |
| 8. VSET (7) | Output control key used to display or alter the present voltage setting. Numeric entry key for number seven. |
| 9. ISET (8) | Output control key used to display or alter the present current setting. Numeric entry key for number eight. |
| 10. TRK (9) | Mode control key which activates the tracking mode on or off. (Applicable only for the Dual Channel PPS-Series). Numeric entry key for number nine. |
| 11. LCL (CLEAR) | Used in conjunction with the numeric entry keys to clear partially set commands and returns unit to the metering mode. Also returns the supply to Local mode when the unit is operating in the Remote mode. |
| 12. OVSET (4) | Output control key used to display or alter the overvoltage threshold. Numeric entry key for number four. |
| 13. OCP (5) | Mode control key which activates the "OverCurrent Protection" mode on or off. Numeric entry key for number five. |
| 14. ADDR (6) | System control key used to view or alter the GPIB address. Addresses available are 0-30. Numeric entry key for number six. |
| 15. OUTPUT (ON/OFF) | Mode control key which activates the output on or off. When the output is disabled, the LCD displays "OUTPUT OFF". |
| 16. OVP (1) | Mode control key which activates the "OverVoltage Protection" mode on or off. Numeric entry key for number one. |
| 17. ▲ (2) | This key increases the value of the digit to be varied. Numeric entry key for number 2 |

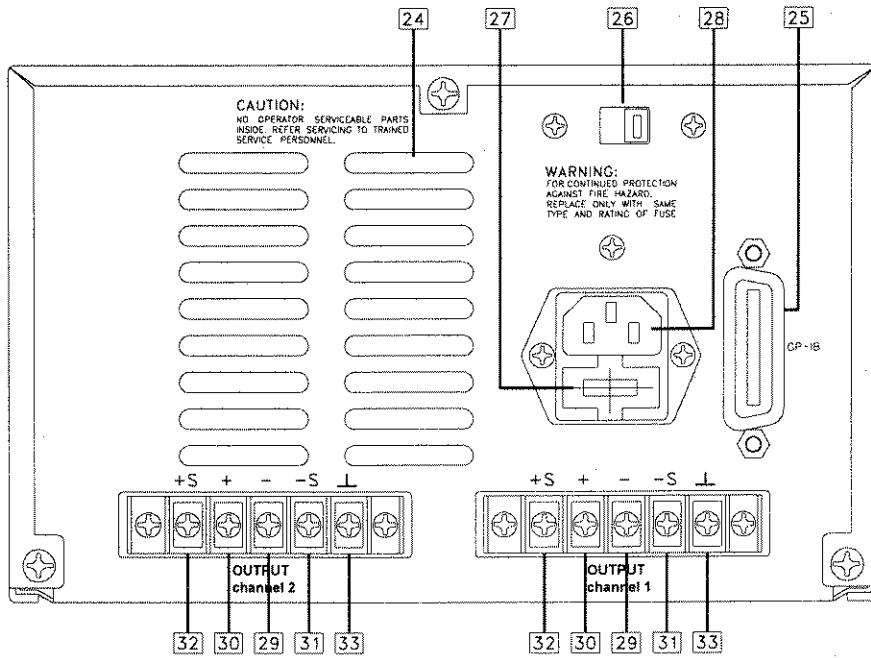

Figure E -2. Rear Panel of The Dual Channel PPS-Series

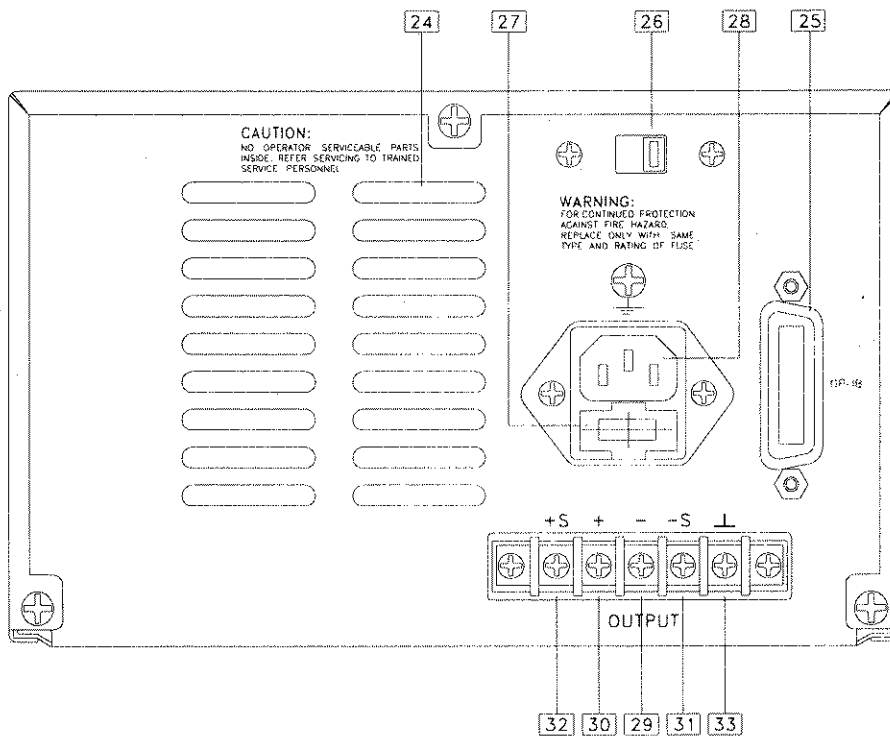

Figure E -3. Rear Panel of The Dual Range PPS-Series

2.1.2 REAR PANEL

- | | |
|---|--|
| 24. Ventilation ports | - Exhausts warm air from the unit. |
| 25. GPIB Interface | - 24 pin parallel GPIB interface connector. |
| 26. Voltage Selector | - Selects voltage of either 115VAC or 230(240)VAC, -10% ~ +10%, 50/60Hz. |
| 27. Fuseholder | - Fuseholder for AC line. |
| 28. AC receptacle | - AC plug for power cord. |
| 29. Negative Terminal (-) | - Negative rear screw terminal output for hard wiring. |
| 30. Positive Terminal (+) | - Positive rear screw terminal output for hard wiring. |
| 31. -S | - Negative rear screw terminal for remote sense output. Enables hard wiring. |
| 32. +S | - Positive rear screw terminal for remote sense output. Enables hard wiring. |
| 33. Ground Terminal | - ground rear screw terminal. |
| 34. External analog input voltage for programming output voltage. | Input voltage ranges from 0V to 10V. |
| 35. Voltage external programming reference point. | |
| 36. External analog input voltage for programming output current. | Input voltage ranges from 0V to 10V. |
| 37. Current external programming reference point. | |

<NOTES:>

1. The rear panel configuration is identical on all power supplies. The Dual Channel PPS-series have an additional terminal strip for hard wiring the second channel.
2. The Single Channel PPS-series have an external programming input terminal located at the rear of the supply. Please refer to section 3.7 for further information.

2.2 LCD STATUS ANNUNCIATORS

LIQUID CRYSTAL DISPLAY: Figure F-1, F-2, F-3

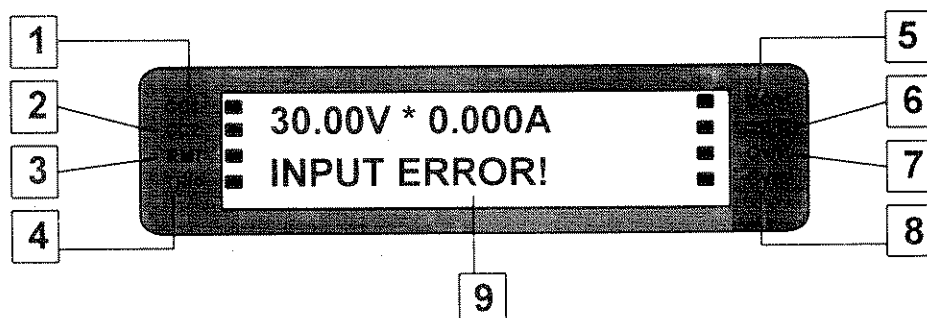

Figure F -1. LCD of The Dual Channel PPS-series

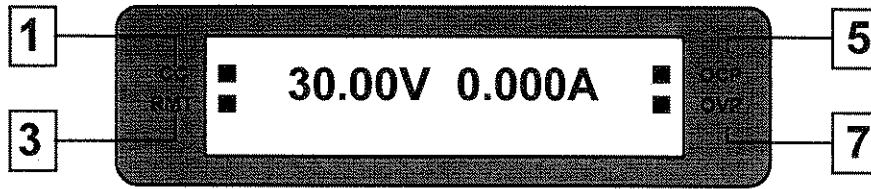

Figure F -2. LCD of PPS-1322/1302A/1603/10710

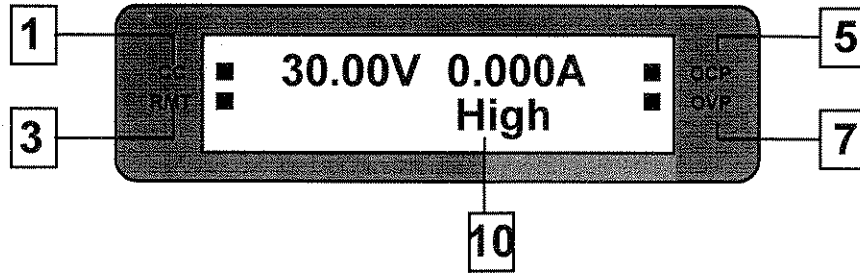

Figure F -3. LCD of PPS-1326

< NOTE: >

The LCD displays real time output Voltage/Current & mode status. There are no status indicators for CV mode. These messages are viewed in either local or remote mode.

- | | | |
|-----|--------------|---|
| 1. | CC1 | Channel 1 is operating under constant current mode. When the indicator is off the supply is operating in constant voltage mode. |
| 2. | CC2 | Channel 2 is operating under constant current mode. When the indicator is off the supply is operating in constant voltage mode. (Applicable only for the PPS-Dual Channel) |
| 3. | RMT | The supply is operating in remote mode. |
| 4. | TRK | The supply is operating in tracking mode. (Applicable only for the PPS-2322) |
| 5. | OCP1 | Overcurrent protection on channel 1 is enabled. When blinking, the overcurrent circuit has been activated and disabled the output. |
| 6. | OCP2 | Overcurrent protection on channel 2 is enabled. When blinking, the overcurrent circuit has been activated and disabled the output. (Applicable only for the PPS-Dual Channel) |
| 7. | OVP1 | Overvoltage protection on channel 1 is enabled. When blinking the overvoltage circuit has been activated and disabled the output. |
| 8. | OVP2 | Overvoltage protection on channel 2 is enabled. When blinking the overvoltage circuit has been activated and disabled the output. (Applicable only for the PPS-Dual Channel) |
| 9. | INPUT ERROR! | The numeric value entered is out of range. (Applies to all models) |
| 10. | High or Low | The supply is operating in either the high or low range. (Applicable only to the PPS-Dual Range) |

2.3 OUTPUT TERMINALS AND WIRES

All models have terminal blocks on the rear panel which include positive and negative outputs, positive and negative remote sense outputs, and earth ground.

<NOTE:>

The power supply is set at the factory for local sense operation (i.e. the +S and -S terminals are strapped to the "+" and "-" terminals by a shorting plate at the rear terminal block). When operating in remote sense mode, remove the shorting plate and refer to section 3.3 for remote sense operation.

Additionally, all models have positive, negative and earth ground terminals in the front of the unit. Remote sense capability is discussed in detail in section 3.3. A brief definition of remote sense is a measurement of voltage at the load rather than at the output terminals.

Local connections are made to the "+" and "-" terminals of the power supply. Terminated loads only. Wrap and bundle wires to reduce coupling effect.

In order to safely and sufficiently handle electric current, the proper wire size must be selected. Select a wire size with sufficient rating to carry the current without overheating. Other factors to be taken into consideration are voltage drop and conductor temperature.

The following table lists current carrying capacity of various wire sizes. For further information please refer to the NEC 1987 Handbook.

TABLE 1: Stranded Copper Wire Ampacity and Resistivity.

Ampacity Per Wire (Amps)

Wire Size (AWG)	2 Wire Bundle (Amps)	4 Wire Bundle (Amps)	Resistivity (ohm/ft)
20	7.8	6.9	0.0102
18	14.5	12.8	0.0064
16	18.2	16.1	0.0040
14	29.3	25.9	0.0025
12	37.6	33.2	0.0016

THREE: OPERATING CHARACTERISTICS AND CONFIGURATIONS

3.1 INTRODUCTION

These sections contain information on operating characteristics and how to configure the PPS Series. Sections 3.2 through 3.4 consider the power supplies operating ranges, remote sense operation and considerations when connecting loads.

The latter half of the chapter deals with connecting power supplies in parallel and series configuration for CC and CV operation.

3.2 OPERATING RANGES

All power supplies operate in either constant voltage (CV) or constant current (CC) mode over the rated output. Their respective voltage and current operating locus (figure F) are found in operating quadrants for all models. The power supply acts as a constant voltage source for comparatively large values of load resistance and as a current source for comparatively small values of load resistance. The automatic crossover or transition between these two modes of operations occurs at a critical stage or "crossover" value of load resistance; $R_c = E_s/I_s$, where E_s is the front panel voltage setting and I_s the front panel current setting.

The followings are the operating quadrants (current -vs- voltage) of the power supplies.

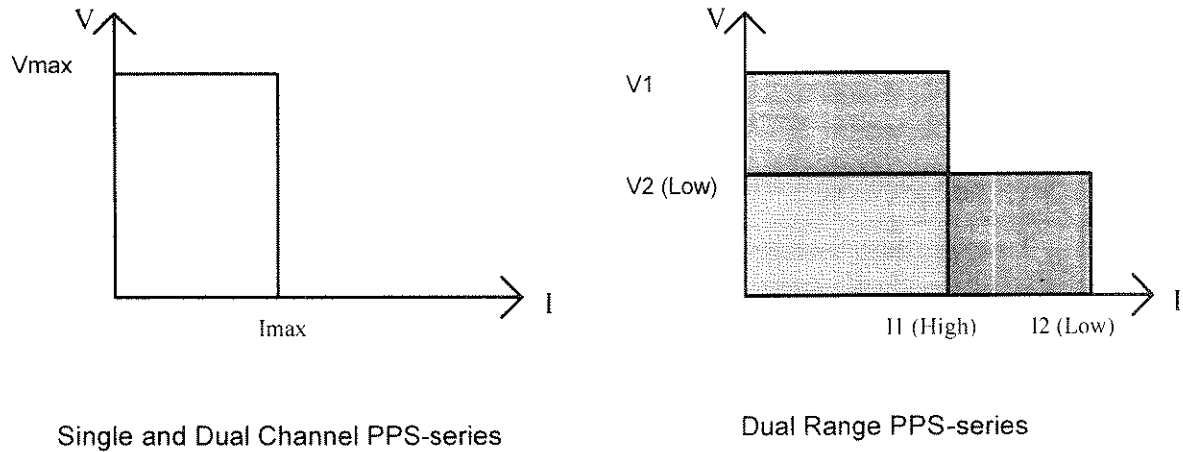

Figure G. Operating Quadrants

3.3 REMOTE SENSE

When the supply is locally strapped for local sensing (normal operation), an unavoidable voltage drop is incurred in the load leads and this adds to its voltage regulation. By connecting the supply for voltage remote sensing, as shown in figure G, voltage is sensed at the load rather than at the output terminals. This allows the supply to automatically compensate for voltage drop in the load leads and improve regulation. In remote sensing, the VOUT? query and the LCD display monitor the load voltage at the sensing points.

When the supply is connected for remote sensing, the OVP circuit senses at the main output terminal and not at the sense points. The voltage sensed by the OVP circuit could be significantly higher than the voltage being regulated at the load. Therefore, set OVP threshold voltage accordingly.

3.3.1 REMOTE SENSE CONFIGURATION

Turn off the power supply before modifying any connections on the rear panel terminal block. Configure the unit for remote sensing by first disconnecting the shorting plugs between the sense and load terminals. Connect the load and sense leads to the load as in figure G. Bear in mind that sense and load leads should be as short as possible. Additionally, the sense leads resistance should be no greater than 0.5 ohm/lead, and the voltage drop over the load leads should be no greater than 0.5V/lead.

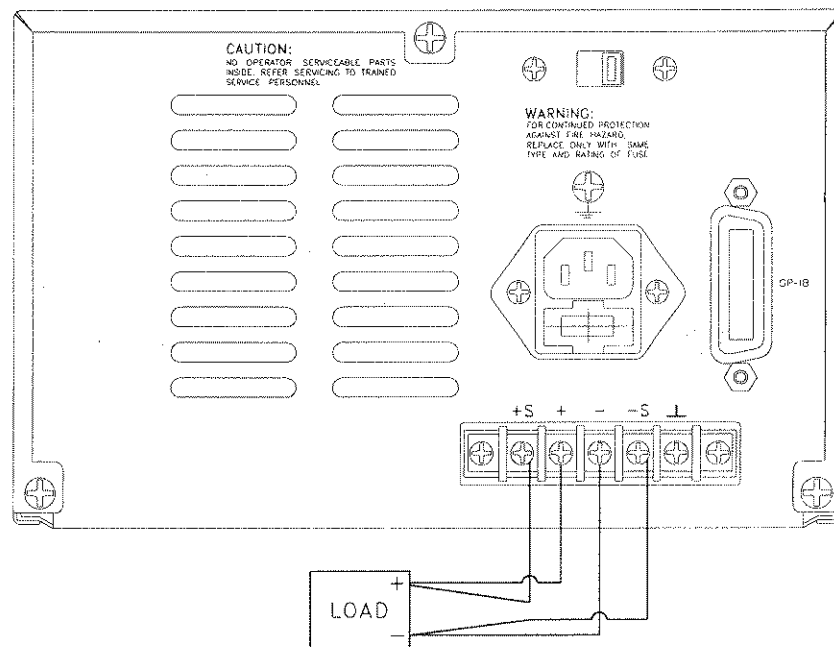

Figure G. Remote Sense Configuration

3.3.2 REMOTE SENSE CHARACTERISTICS

OUTPUT NOISE: Any noise picked up on the sense leads will appear at the supply's output and may adversely affect CV load regulation. Twist the sense leads to minimize external noise pickup and run them parallel and close to the load leads. In noisy environments, it may be necessary to shield the sense leads. Ground the shield at the power supply end only. Do not use the shield as one of the sensing conductors.

STABILITY: When the supply is connected for remote sensing, it is possible for the impedance of the load wires and the capacitance of the load to form a filter, which will become part of the supply's CV feedback loop. The extra phase shift created by this filter can degrade the supply's stability and can result in poor transient response performance. In extreme cases, it can cause oscillation.

It is difficult to state simple rules defining the conditions under which this can occur, and which corrective action to take. A certain amount of trial and error may be called for. Two guidelines which are almost always valid are:

- a. Keep the leads as short as possible.
- b. Twist the load leads together to minimize inductance.

In most circumstances, once these two guidelines are followed, problems associated with the load lead inductance are eliminated. This leaves the load lead resistance and load capacitance as the major cause of the reduced stability. In this case, you may obtain further improvement to the stability by:

- a. Keeping the load capacitance as small as possible.
- b. Increasing the diameter of the load lead to reduce resistance.

If heavier gauge load leads (#10 or greater) are used, circumstances may arise when the load lead inductance and the load capacitance can form an underdamped filter. This filter occasionally has the effect of destabilizing phase response. In this case, the above steps can worsen stability since they will reduce damping in the system.

3.4 LOAD CONSIDERATION AND MULTIPLE LOADS CONNECTION

When the supply is in local sensing mode and you are connecting multiple loads to the output, connect each load to the output terminal using separate load leads. This minimizes mutual coupling effects and takes full advantages of the supply's low output resistance. Each pair of wires should be as short as possible and twisted or bundled to reduce lead inductance and noise pickup.

If cabling considerations require the use of distribution terminals that are located remotely from the supply, connect the power supply output terminals to the remote distribution terminals by a pair of twisted or bundled wires. Connect each load to the distribution terminals separately. Remote voltage sensing is recommended in these circumstances. Sense either at the remote distribution terminals or, if one load is more sensitive than the others, directly at the critical load.

OUTPUT ISOLATION: The output of the power supply is isolated from earth ground. Either output terminal may be grounded, or an external source of voltage may be connected between either output and ground. However, both output terminals must be kept within +/-240Vdc of ground (+/-500Vdc for PPS 128-0.5, PPS 250-0.2, PPS 128-0.5D, PPS 128-1.5 and PPS 250-0.8). This includes the output voltage. An earth ground terminal is provided on the rear panel terminal block.

Each of the power supplies will operate accordingly to the various types of loads connected to the output.

CAPACITANCE LOADING: In normal conditions, the supply will be stable for almost any size load capacitance (for remote sense stability considerations). However, large load capacitance may cause ringing in the supply's transient response. It is even possible that certain combinations of capacitance and ESR (equivalent series resistance) will result in instability. If this is the case, the solution is to increase or decrease total load capacitance. In addition, the overvoltage protection SCR crowbar circuit has been designed to discharge capacitance up to a certain limit. These limits are:

1. For models of which maximum output voltage is below 18 Volts, Capacitance should not exceed 5000uF.
2. For models of which maximum output voltage is below 35 Volts, Capacitance should not exceed 5000uF.
3. For models of which maximum output voltage is below 60 Volts, Capacitance should not exceed 3000uF.
4. For models of which maximum output voltage is below 128 Volts, Capacitance should not exceed 470uF.
5. For models of which maximum output voltage is below 250 Volts, Capacitance should not exceed 220uF.

<NOTE:>

If load capacitance approaches these limits, it is recommended to not intentionally activate the OVP circuit and discharge the capacitance through the SCR crowbar as part of standard testing procedure.

3.5 PARALLEL CONNECTION OPERATION

<NOTE:>

Power supplies equipped with SCR crowbars should not be used in series or parallel with each other unless a master-slave interconnection is employed and their crowbars interlock.

Greater current capability can be achieved by connecting outputs in parallel. However, only power supplies which have equivalent voltage and current output ratings may be connected in parallel. Otherwise, damage to the unit may result.

A typical connection is shown in figure H through the back of Dual Channel PPS-series in local sensing. All leads are kept as short as possible and are bundled together. Second, connect remote sense terminals to compensate for the voltage drop in the interconnecting load leads. Lastly, the CV and CC operations have identical setups.

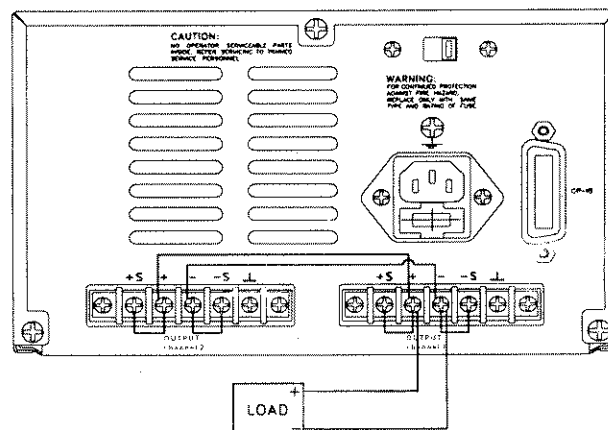

Figure H. Parallel Configuration

3.5.1 CV OPERATION

Although both outputs operate independently of each other in CV operation, one of the outputs must dominate (control) over the other. Additionally, the dominant output must operate in CV mode, while the other output may operate in CC mode.

As an example of this operation, let's assume in figure H. that output channel two operates in CC mode and output channel one operates in CV mode. Perform the following steps:

1. Set output channel two to the maximum output voltage of desired range.
2. Set output channel one to the desired operating voltage.

The voltage of output channel one controls the voltage across the load. The output currents are algebraic sums of the individual outputs.

3.5.2 CC OPERATION

The CC operation is similar in many ways to the CV operation, except that the output current must also be set. To obtain CC operation, perform the following steps:

1. Program output voltage of the two channels to the desired operating voltage.
2. Program output channel one to one-half the desired operating current.
3. Program output channel two to one-half the desired operating current.

Both outputs operate in CC mode.

3.5.3 REMOTE SENSING CONFIGURATION (Parallel Connection Mode)

The following figure I illustrates the configuration for Remote Sensing in Parallel Operation.

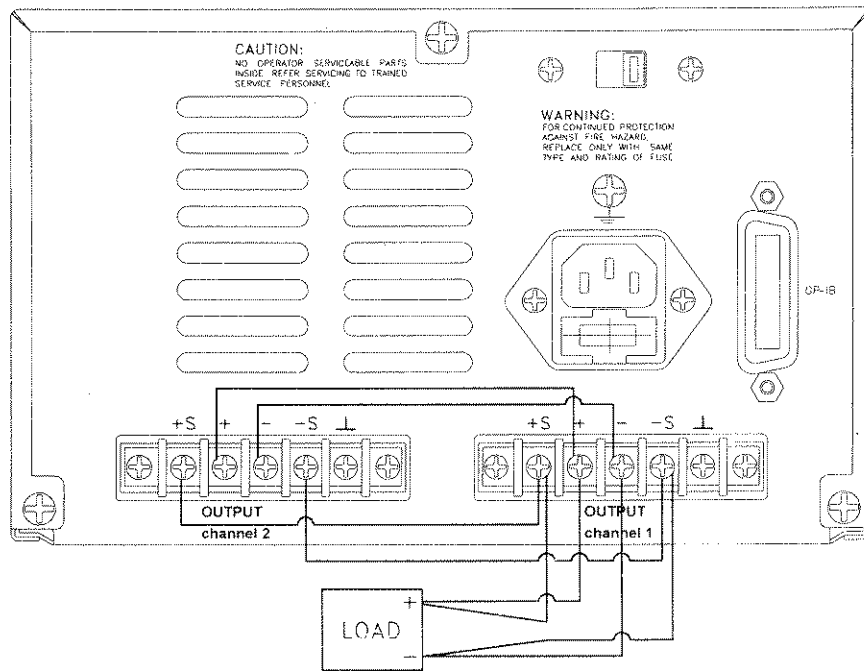

Figure I. Remote Sense, Parallel Mode

3.6 SERIES CONNECTION OPERATION

<NOTE:>

Power supplies equipped with SCR crowbars should not be used in series or parallel with each other unless a master-slave interconnection is employed and their crowbars interlock.

Greater output voltage capability can be obtained by connecting outputs in series. A note of caution, since current is the same in each element of a series circuit, both outputs need identical rated currents. If this is not followed, excessive current may be forced into one of the outputs and cause a failure.

Figure J illustrates the Series configuration on a Dual Channel PPS-series.

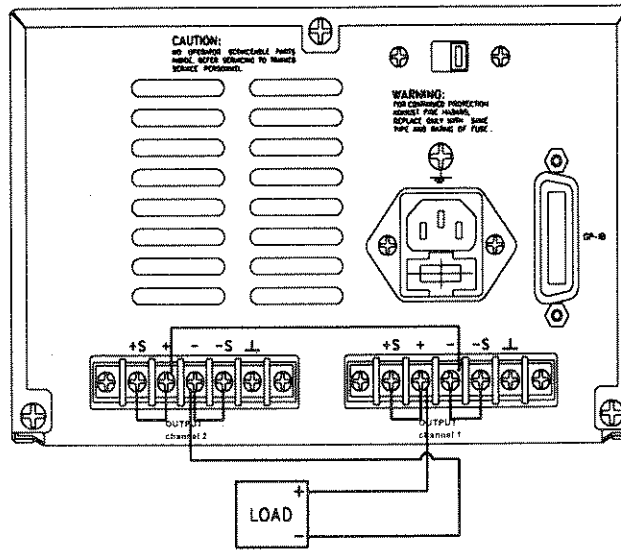

Figure J. Series Configuration

3.6.1 CV OPERATION

In CV operation, first program the current of both outputs to the desired value. Secondly, program the desired operating voltage to equal the sum of the output voltages.

3.6.2 CC OPERATION

In CC operation, one output will operate in CV mode, the other in CC mode. To obtain this operation, perform the following:

1. Program the output current of the two channels to the desired operating current.
2. Program output channel one to one-half the desired operating voltage.
3. Program output channel two to one-half the desired operating voltage.

At load levels less than one half the total voltage limit, the output that was originally in CC mode, stays in CC mode.

At load voltages greater than one-half the total voltage limit, the output that was originally in CC mode, changes to CV mode. The secondary output will regulate the current in CC mode and provide the necessary voltage.

3.6.3 REMOTE SENSE CONFIGURATION (Series Connection Mode)

The following figure K illustrates the configuration for Remote Sensing in Series Operation.

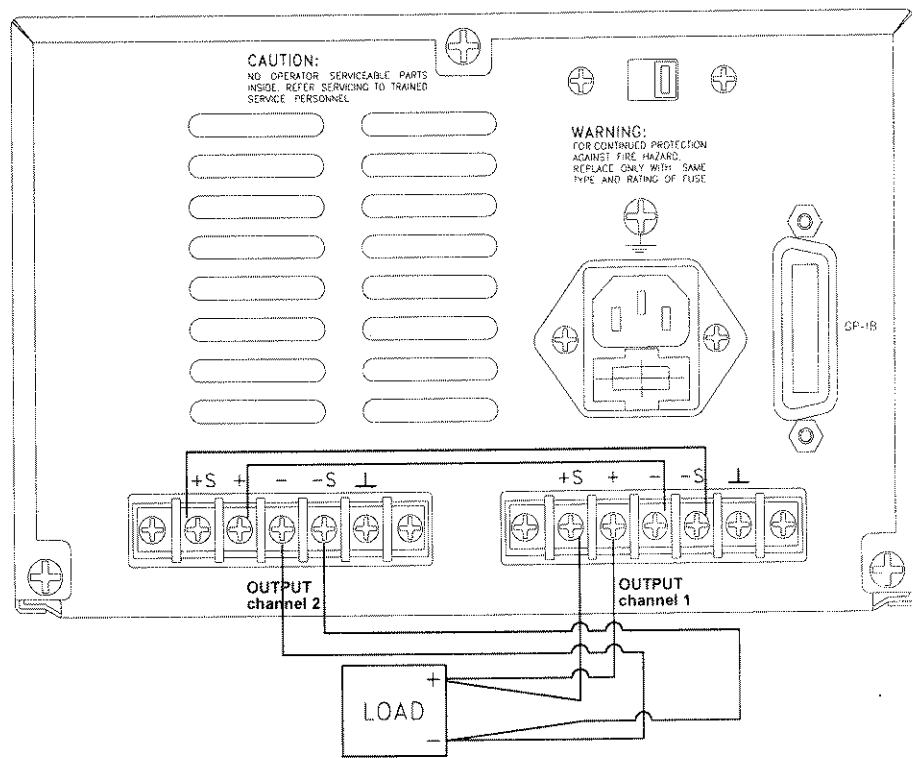

Figure K. Series Configuration with Remote Sense

3.7 External Analog Programming (Single Channel PPS-series)

The voltage and current outputs of the Single Channel PPS-series can be programmed by an external analog voltage. The outputs are linearly proportioned to an external input voltage from 0 to 10 volts. The external analog programming mode is activated by setting these parameters via the front panel or GPIB bus, VSET to 0V, ISET to a proper value for CV operation, or setting ISET to 0A and VSET to a proper value for CC operation.

To control the output voltage with the analog programming mode requires the following procedures, apply the external 0 to 10V source (Vv-pgm) between Vp (positive) and $\downarrow v$ (common) terminals. These input terminals are located at the rear of the power supply, see figure L.

The control output voltage is:

$$V_{out} = V_{v-pgm} * (\text{Rated Maximum Output Voltage} / 10)$$

To control the output current with the analog programming mode requires the following procedure, apply the external 0 to 10V source (VI-pgm) between Ip (positive) and $\downarrow i$ (common) terminals, see figure L.

The control output current is:

$$I_{out} = V_{I-pgm} * (\text{Rated Maximum output current} / 10)$$

To control both voltage and current simultaneously in the external programming method requires that the user apply two separately isolated 0 to 10V supplies.

<NOTES:>

Vp, Vn, $\downarrow v$, and $\downarrow i$ are strapped with shorting straps.

Do not remove the straps unless activating the external analog programming mode.

The V and I terminals are at a negative sense potential, with this in mind do not connect them to any other terminal on the rear panel. This precaution will prevent permanent damage to the power supply!

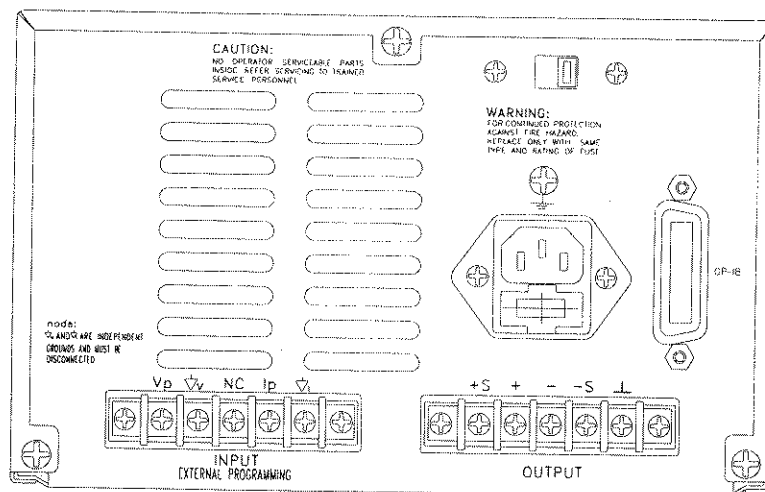

Figure L. Rear Panel of The Single Channel PPS-series

FOUR: LOCAL OPERATION

4.1 INTRODUCTION

These sections contain information on how to locally program the PPS Series. Upon powering up, the power supplies default to local mode operation. All front panel keys may be used to control the power supply.

<NOTES:>

The PPS series power supply models and their operations are essentially identical. However, two of the supplies provide more functions (i.e. The Dual Channel PPS-series has dual outputs and The Dual Range PPS-series has two output operating ranges) which may slightly alter or add to programming procedures. Therefore, please refer to the appropriate sections for these operations.

The Single Channel PPS-series are identical in operation. However their outputs differ.

All operations performed in local mode, may also be performed in remote mode. The unit indicates remote operation when the " RMT "annunciator on the display is on.

4.2 GENERAL INFORMATION

1. The power supplies are able to directly accept programming values of voltage, current and overvoltage. **"When a valid input is made, the unit will round off the value to the nearest multiple of the resolution". If a non-valid input is made, the unit will display " INPUT ERROR! " and return to previous set values.**
2. The actual operation of programming the voltage and current values is simple. Simply, press any of the functional keys and the display shows the present value. **To change this value, simply use the numeric keys to enter a value. If an error is made, press the "CLEAR" key and then reselect the parameter that was to be modified. Once the final value is set, press the "ENTER" key.** After pressing the "ENTER" key, LCD module will display the actual value, initiate the function, and return the unit to metering mode. If a user wishes to recall a setting, press the function key pertaining to the operation. For example, to recall a set voltage, press "VSET" and then press "ENTER" or "CLEAR" key to return unit to metering mode.
3. To reset any of the output parameters (i.e. VSET, ISET, OVSET) simply press the desired function keys , enter the new value and press "ENTER". The programming steps are identical to steps described in sections 4.3-4.5.
4. The PPS-1200 series has two outputs (channels) and these may be alternately viewed via the " CH/SELECT " key. In order to program the output parameters for each output channel, first toggle the " CH/SELECT " key to the desired channel and then observe the following guidelines.

4.3 SETTING VOLTAGE

To locally program the voltage (VSET), press "VSET", enter the value and press "ENTER". For example, if one wished to set a voltage of 3.99, press:

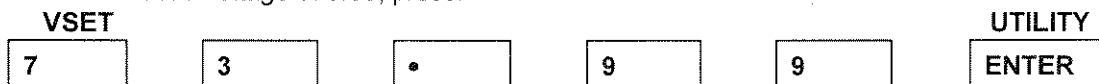

the LCD displays 3.99 and the unit returns to metering mode.

▲VSET description:

For all models, VSET can be altered by pressing " ▲ " or " ▼ " key instead of "VSET" and entry keys. When the power supply is in the CV mode, pressing " ▲ " key will increase output voltage per step. The increment step is determined by either pressing the " ◀ " or " ▶ " key until the cursor comes to the digit to be varied. The LCD module would show the following:

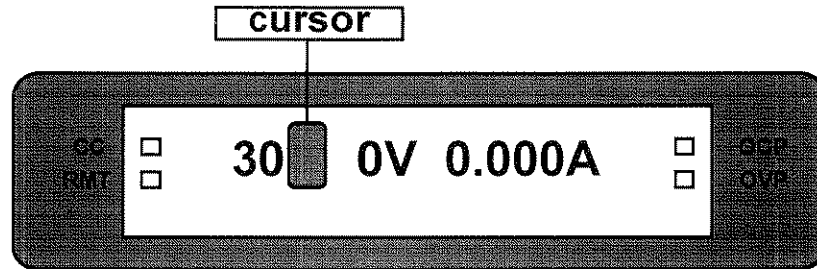

The operation of " ▼ " key is similar to " ▲ " key for decreasing the output when power supply is in CV mode.

4.4 SETTING CURRENT

To locally program the current (ISET), press "ISET" and enter the value and then press "ENTER". For example, if one wishes to set a current of 1.69 amps, press:



the LCD displays 1.69 and the unit returns to metering mode.

For all models, ISET can be altered by pressing " ▲ " or " ▼ " key instead of "ISET" and entry keys. When the power supply is in the CC mode, pressing " ▲ " key will increase output current per step. The increment step is determined by either pressing " ◀ " or " ▶ " key until the cursor comes to the digit to be varied. The LCD module would show the following:

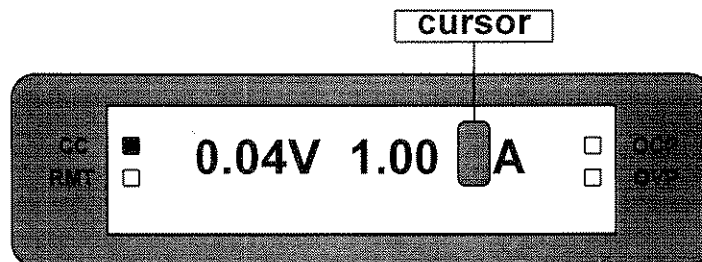

The operation of " ▼ " key is similar to " ▲ " key for decreasing the output when power supply is in CC mode.

4.5 SETTING THE PROTECTION MODES

The power supplies have overvoltage protection (OVP) and overcurrent protection (OCP) features to guard against abnormal operating conditions. When either of these two functions are activated, the unit disables the output. The LCD annunciator will indicate the condition and an audible signal will sound.

4.5.1 SETTING THE OVERVOLTAGE THRESHOLD

To locally program the threshold voltage press "OVSET", enter the value and press "ENTER". For example, to program an overvoltage value of 4.50V, press:

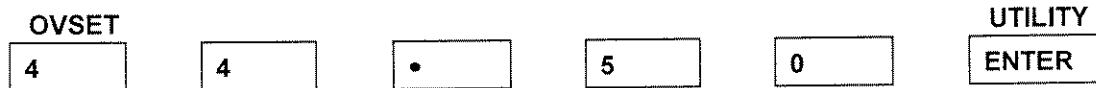

4.5.2 ENABLING / DISABLING OVERVOLTAGE PROTECTION

In all models, the user can enable or disable the OVP circuit by pressing the "OVP/4" key. When enabled the OVP annunciator is on.

When the OVP annunciator is blinking, the overvoltage protection circuit has been activated and disabled the output. An audible signal will also sound. To reset, Press the "OVP/4" key and the annunciator will stop blinking. Turn the output on and press the "OVP/4" key again.

<NOTES:>

**When remote sensing, take into consideration the voltage drop across the load leads since the threshold measurement is taken at the output terminals.
In inductive load applications, a high-surge voltage would enable the OVP circuit and disable the output.**

**Also note the programming resolution and programming accuracy specifications
When the OVP circuit is disabled, the threshold voltage becomes invalid.**

4.5.3 ENABLING / DISABLING OVERCURRENT PROTECTION

To enable the overcurrent protection circuit, press the "OCP/5" key and the OCP annunciator is turned on. To disable the overcurrent protection, press the "OCP/5" key again and the annunciator is turned off.

When the OCP annunciator is blinking, the overcurrent protection circuit has been activated and disabled the output. An audible signal will also sound. To reset, Press the "OCP/5" key and the annunciator will stop blinking. Turn the output on and press the "OCP/5" key again.

<NOTE:>

If OCP is on and the constant current mode (CC) is activated, the power supply output is disabled.

4.6 ENABLING / DISABLING OUTPUTS

All models of the PPS series have the capability of disabling their outputs to have their setting parameters modified. Once the modification has been completed, one can enable the power supply to operate at the new values.

The output is enabled or disabled by pressing the **"OUTPUT (ON/OFF)"** key. The dual channel PPS-series output is enabled or disabled by selecting the channel/s and pressing the **"OUTPUT (ON/OFF)"** key.

4.7 TRACKING OPERATION (Dual Channel PPS-series)

The Dual Channel PPS-series has the ability of tracking since it has two outputs. When the tracking mode is enabled, the annunciator **"RMT"** is on. The output of channel two is identical (in sync. with) to channel one and is controlled by channel one. For instance, a voltage increase in channel one would also cause a voltage increase in channel two.

4.8 RANGE OPERATION (Dual Range PPS-series)

The Dual Range PPS-series has two operating ranges, **"High"** or **"Low"**. These ranges are controlled by adjusting the voltage and current values to the appropriate programming settings (refer to fig. G section three & appendix A). The LCD displays **"Low"** when the low range is active or **"High"**, when the high range is active. All other operations on the Dual Range PPS-series are identical to other models. For more information on operating range characteristics, please refer to section 3.2.

4.9 AUDIBLE SIGNAL

The power supplies have an audible indicator, which allow monitoring of operating conditions. When functions are activated or parameters set, the audible signal will sound. Should the protection modes be activated an audible signal will sound, indicating a change in an operating mode has occurred. The LCD and annunciators will indicate the condition. This feature can also be disable or enabled by pressing the **"BEEP"** key.

FIVE: REMOTE OPERATION

The programmable Power Supply Series from American Reliance are compatible with **ANSI/IEEE 488.1**. This is the "Standard Digital Interface for Programmable Instrumentation". This standard provides a means for an electrical and mechanical system to interconnect electronic measurement devices.

Several key specifications of IEEE 488.1 are:

- Interconnect Devices - Up to 15 devices on one bus.
- Interconnection Path - The total transmission path for a star or linear based networks is up to 20 meters.
- Signal Lines - Sixteen active lines; 8 data lines, and 8 interface and communication management lines.
- Message Transfer Scheme - Byte-serial, bit-parallel, asynchronous data transfer using interlocking three wire handshake technique.
- Maximum Data Rate - One megabyte per second over limited distances. Typical transmission rate is 250 kilobytes per second. The actual data transmission rate is usually determined by the slowest device in communication at that time.
- Address Capability - There can be a maximum of one talker and up to 14 listeners at one time.
- Pass Control - If a system has more than one controller, only one controller may be active at a time. The active controller may pass control to one of the other passive controllers. Only the controller designated as system controller can demand control. However, a non-active controller may request control.
- Interface Circuits - Driver circuits are TTL and Schottky compatible.

5.1 INTRODUCTION

This section contains information on controlling the power supply via a computer. This material is presented in a normal manner in which a majority of programmers may benefit. Main topics of operation to be covered are:

- GPIB Operation
- Programming Syntax
- Programming the Power Supply

The GPIB sections discuss the interface functions, settings and interface. The Programming Syntax section lists all available programming commands. Last, "Programming the Power Supply" includes a variety of conditions, commands and samples useful for controlling the power supply via the computer.

5.2 GPIB OPERATION

The GPIB (General Purpose Interface Bus) operation allows for constant talk and listen between systems. The PPS series are able to act as both talkers and listeners. The computer is able to act as a talker, listener, and controller.

LISTENER: A device capable of accepting data over an interface.

TALKER: A device capable of transmitting data over an interface.

CONTROLLER: A device capable of specifying the talker and listener for an information transfer.

5.2.1 GPIB INTERFACE FUNCTIONS:

Even though the GPIB control is implemented in the power supply, instructions are only enabled when a computer is equipped with a GPIB interface controller card. A controller manages the operation of the bus systems by designating which devices to send and receive data. The controller also provides command specifications within other devices.

The PPS series support the following IEEE-488 interface functions:

- L4 - Basic Listener, Unaddressable if MTA
- T6 - Basic Talker, Serial Poll, Unaddressed if MTA
- SH1 - Full Source Handshake
- AH1 - Full Acceptor Handshake
- RL1 - Remote & Local Lockout
- DC1 - Device Clear
- E1 - Open Collector Driver Electronics (250kb/s max)
- C0 - Non-system controller
- SR0 - Omitted Service Request Function
- TE0 - Omitted extended talker function
- LE0 - Omitted extended listener function
- PP0 - Omitted parallel poll function
- DT0 - Omitted device trigger

5.2.2 ADDRESS SETTING OF GPIB INTERFACE

The main purpose of address setting is for specifying unit identification between the instruments and controller in a GPIB connection system. The PPS Series has 31 addresses (0-30) available. If a number higher than 30 is selected, the display shows **"INPUT ERROR!"** and defaults to previous values. The power supplies are preset at the address 12 by the factory. To view the present address, press the **"ADDRESS"** key. If the present value is incorrect, enter in a new value with numeric keys and press **"ENTER"** key. In remote mode, the **"ADDRESS"** command is available to modify the address.

5.3 PROGRAMMING SYNTAX

The following table lists programming commands available with the PPS Series. These standard GPIB commands readily interface with programming languages. Note that this portion of the manual only deals with GPIB commands. No programming language commands are presented here. Appendix A gives a summary of the command definitions.

5.3.1 GPIB DEVICE COMMANDS LIST

Command	Single Channel PPS	Dual Range PPS	Dual Channel PPS	Type	Input/Out put
CALCHNL	[0,1]	[0,1]	[0,3]	I	Input
OCF	[0,1]	[0,1]	[0,1]	I	Input
OUT	[0,1]	[0,1]	-	I	Input
OUT1			[0,1]	I	Input
OUT2			[0,1]	I	Input
TRACK			[0,1]	I	Input
OVP	[0,1]	[0,1]	[0,1]	I	Input
PROGRAMMING COMMANDS					
VSET	*	*		R	Input
ISET	*	*		R	Input
OVSET	*	*		R	Input
VSET1			*	R	Input
VSET2			*	R	Input
ISET1			*	R	Input
ISET2			*	R	Input
OVSET1			*	R	Input
OVSET2			*	R	Input
ADDRESS	*	*	*	I	Input
QUERY COMMANDS					
VOUT?	*	*		R	Output
IOUT?	*	*		R	Output
VSET?	*	*		R	Output
ISET?	*	*		R	Output
OVSET?	*	*		R	Output
VOUT1?			*	R	Output
VOUT2?			*	R	Output
IOUT1?			*	R	Output
IOUT2?			*	R	Output
VSET1?			*	R	Output
VSET2?			*	R	Output
ISET1?			*	R	Output
ISET2?			*	R	Output
OVSET1?			*	R	Output
OVSET2?			*	R	Output
STATUS?	*	*	*	A	Output
ERROR?	*	*	*	A	Output

5.3.2 CALIBRATION COMMANDS

Commands	Single Channel PPS	Dual Range PPS	Dual Channel PPS	Type	Input/Output
VOFF	*	*	*	R	Input
VFS	*	*	*	R	Input
IOFF	*	*	*	R	Input
IFS	*	*	*	R	Input

NOTE: 1. Types of data entry: I: Integer
 R: Real
 A: ASCII code

2. Types of input/output: INPUT: Input to the PPS
 OUTPUT: Output to the PPS

3. The "CALCHNL" commands for the Dual Channel PPS-series are: 0 - disable calibration,
 1-calibrate channel one, 2 - calibrate channel two, 3 - calibrate both channels.

4. *=> Command available to the model

5.4 STATUS REPORTING

All models of the PPS series include a status register for reporting the operating conditions of the power supply. Each output channel has an 8 bit register which signifies a true condition as "1" and a false condition as "0". These bit conditions stay true as long as the condition is true.

The status word received is in ASCII code format, and needs to be converted to binary code. Each bit is assigned a particular condition and one nibble is converted to one ASCII code. The single channel PPS send two ASCII Bytes and two Terminator Bytes to the GPIB. The terminator bytes are "line feed" & "carriage return". The dual channel PPS send four bytes of ASCII and two terminator bytes to the GPIB.

STATUS?

DEFINITION OF STATUS WORD:

Byte	value	NIBBLE 1				NIBBLE 2			
		bit 7	b 6	b 5	b 4	b 3	b 2	b 1	b 0
0	0	BEEP OFF	HIGH RNG	CV MODE	0	0	OCP OFF	OUT ON	No Error
	1	BEEP ON	LOW RNG	CC MODE	OV	OC	OCP ON	OUT OFF	Error
1	0	0	0	CV2 Mode	0	0	OCP OFF	OUT ON	CH1
	1	0	TRACK	CC2 Mode	OV2	OC2	OCP ON	OUT OFF	CH2

<NOTE:>

Byte 0 is available for all PPS models. However, byte 1 is only applicable for the dual channel models.

An explanation of these bytes/bits is as follows:

1. bit 7 (Byte 0) - Audible indicator is off (0) or on (1).
2. b6 (Byte 0) - Signifies the high range (0) or low range (1). Applicable to the Dual Range PPS-series.
3. b6 (Byte 1) - Signifies whether or not the Dual Channel PPS-series is in tracking mode.
4. b5 - Signifies which mode the power supply is operating in, constant current or constant voltage.
5. b4 - Overvoltage has toggled on (1).
6. b3 - Overcurrent has toggled on (1).
7. b2 - Overcurrent protection mode is on or off.
8. b1 - The output is on or off.
9. b0 - An error has occurred.
10. b0 (Byte 1) - CH1 or CH2 is selected (cursor).

Example: Reading the Status (dual channel)

After the "STATUS?" command is entered, the following ASCII code will be read from the PPS:

ASCII CODE	30	31	31	35	36
	convert to decimal form				
DECIMAL CODE	0	1	1	5	6
	convert to hex form				
HEX CODE	0484				
	convert to binary form				
	Byte 1			Byte 0	

	Nibble 3	Nibble 4	Nibble 1	Nibble 2
BINARY CODE	0000	0100	1000	0100

EXPLANATION OF STATUS BITS:

BYTE 0 b7 = BEEP on, b5 = CH1 in CV mode, b2 = CH1 OCP on, b1 = CH1 OUTPUT on.
 BYTE 1 b5 = CH2 in CV mode, b2 = CH2 OCP on, b1 = CH2 OUTPUT on, b0 = Cursor at CH1.

5.5 PROGRAMMING THE POWER SUPPLY

This section provides more detailed requirements of the programming commands available. Upon powering up, the PPS Series undergo self test and default to the factory settings.

INITIAL DEFAULT SETTINGS OF PPS:

COMMAND	Single Channel PPS	Dual Range PPS	Dual Channel PPS
OUT	√	√	n/a
OUT1	n/a	n/a	√
OUT2	n/a	n/a	√
OUT3	n/a	n/a	√
VSET	0	0/0	n/a
ISET	0.050	0.050/0.050	n/a
OVSET	maximum	maximum	n/a

VSET1	n/a	n/a	0
VSET2	n/a	n/a	0
ISET1	n/a	n/a	0.050
ISET2	n/a	n/a	0.050
OVSET1	n/a	n/a	maximum
OVSET2	n/a	n/a	maximum
ADDRESS	12	12	12

5.5.1 OUTPUT ON/OFF

All power supplies have their outputs off upon powering up. The command "OUT" is to enable/disable the outputs. To enable the power supply, designate the channel (Dual Channel PPS-series only) and condition (1 = on; 0 = off). For example to disable an output, Enter:

OUT0

To view if an output is on or off, query the status of the power supply.

5.5.2 VOLTAGE PROGRAMMING

To program a voltage, specify an output channel (Dual Channel PPS-series only) and the desire voltage.

<NOTE:> The default output condition of a power supply is "OFF" at startup.

All values of voltage must be in volts (i.e. no millivolts). This operation holds true for voltage settings in CV mode. Thus, actual voltage is the programmed voltage and the programmed current is the current limit. In addition, the specified voltage value will be rounded off to the nearest multiple of resolution.

For example, to program a channel for 16 volts. Enter:

VSET 16

To readback the programmed value, send the query:

VSET?

and address the power supply to talk.

To read back the voltage output of the channel, send the query:

VOUT?

Once again, the power supply should be addressed to talk and the results displayed (i.e. shown on CRT, printed, or saved).

The Dual Channel PPS-series have two outputs, please refer to the programming syntax commands for proper nomenclature of commands.

5.5.3 OVERVOLTAGE PROGRAMMING (OVSET)

In order to protect loads against excessive voltages, an overvoltage protection circuit (SCR crowbar) has been added. When a voltage exceeds the set overvoltage value, the power supply output is disabled.

To program overvoltage, specify the output channel (Dual Channel PPS-series only) and overvoltage value. For example, to program one channel of the PPS 35-2D for 18 V, Enter:

OVSET1 18

To readback the programmed value for channel one, send the query:

OVSET1?

and address the power supply to talk. When specifying the queries, only one command may be issued at a time. The power supply can access only one query at a time.

5.5.4 CURRENT PROGRAMMING

To program a current, specify an output channel (only Dual Channel PPS-series) and current. All values of current must be in amps. Additionally, the unit rounds off ISET to the nearest multiple of resolution. For example, to specify a current of 1.6 amps. Enter:

ISET 1.6

This operation holds true for current settings in CC mode. When the supply operates in CC mode, the actual current is the programmed current and the programmed voltage is the voltage limit.

To readback the programmed value, send the query:

ISET?

and address the power supply to talk.

To read back the current output of the channel, send the query:

IOUT?

Once again, the power supply should be addressed to talk and the results displayed (i.e. shown on CRT, printed, or saved).

The Dual Channel PPS-series have two outputs, please refer to the programming syntax commands for proper nomenclature of commands.

5.5.5 OVERCURRENT PROTECTION (OCP)

The overcurrent programming feature protects the load from excessive output currents. **The OCP mode cannot be used while the power supply is operating in CC mode, since OCP would disable the output.** The OCP command is enabled by a logic "1" and disabled by a logic "0". For example, to enable a channel for overcurrent protection. Enter:

OCP 1

to disable a channel from OCP, Enter:

OCP 0

5.5.6 TRACK COMMAND

This command may be controlled by a true "1" or false "0" command. The "TRACK" command is only applicable to the Dual Channel PPS-SERIES. The "TRACK" command works like a toggle between the channels. The ensuing example will assist in clarifying the command.

To set the tracking mode in the Dual Channel PPS-series, send "TRACK1"

To turn tracking mode off, send "TRACK0"

"TRACK 0" or "TRACK 1" will be recognized by the GPIB as "TRACK" (a toggle command)

Refer to section 4.7 for more information on the Dual Channel PPS-series tracking mode.

5.6 FUNDAMENTALS OF PROGRAMMING

The following section explains fundamental operations of programming the supply in remote mode. Before beginning operation, have your system completely installed and set up accepted, **do not** have a load applied at the outputs. Be aware at all times of power supply's voltage and current limits. If data greater than the range of the power supply is programmed, data is disregarded and a error occurs. Due to the extent of programming languages available, only common programming commands will be discussed.

ADDRESS SELECTION: The first step involved in remote programming is to select the power supply's address. The present power supply address may be viewed via the front panel address key or in the Default Conditions List. To alter this address, press the address key, select a new address (0-30) and press "ENTER" key. The data is stored in an EEPROM.

COMMON COMMANDS: There is a wide variety of commands available to program the power supply. However, the commands which pertain to voltage and current are of most use. These commands are: VSET, ISET, OVSET, VOUT?, IOUT?, OVSET? and OCP.

Secondary commands of prime importance pertain to the actual programming language. Some of these commands are: OUTPUT, ENTER, DELAY, SEND, PRINT, and CLEAR. The definitions and uses of these commands are as follows:

OUTPUT: Addresses the power supply to listen and sends command to power supply.

ENTER: Addresses the power supply to talk and receive data from the power supply.

DELAY: Introduces a time delay to the power supply.

<NOTE:> This command is extremely important since the power supplies occasionally require time delays in order to execute operations. Otherwise, error messages occur.

CLEAR: Clears the power supply.

<NOTE:> The PPS series does not have a CLR command. Therefore, the user must initially specify a hardware clear before beginning programming.

SEND: Sends GPIB management commands.

PRINT: Writes data to the screen or to a file.

All commands may be accepted in either upper or lower case letters in ASCII code. The PPS Series accepts integer or numeric data as input. Plus (+) and minus (-) signs are also numeric characters. Remember not to program too large a value since the power supply rounds off data to suit the power supplies resolution.

SENDING DATA: The steps involved in sending data to the power supply are setting the address (power supply & computer), function and sending the command (QBasic). For example, to turn on the output of a power supply (single output), send:

```
PRINT #1, "OUTPUT 12 ; OUT1"
```

where:

PRINT	QBasic command. Writes data to the screen or to a file
#1	File number
OUTPUT	QBasic command. Specifies that the file is opened for sequential output
12	GPIB device address
OUT	GPIB command
1	Enable output (0 disables output)

Continuing on with this example we will set the output voltage to 11V and output current to 1.7 amps, therefore send:

```
PRINT #1, "OUTPUT 12 ; VSET 11"
```

```
PRINT #1, "OUTPUT 12 ; ISET 1.7"
```

<NOTE:> The voltage and current values are given in volts and amps.

An example for sending commands to turn on both outputs for a dual channel power supply program:

```
PRINT #1, "OUTPUT 12; VSET"; CH$; " "; VSET$
```

```
CALL DELAY1(0.06)
```

```
PRINT #1, "OUTPUT 12; OUT3"; " "; OUT$
```

Where:

VSET	Command for setting output voltage
CH\$	Channel string, 1 or 2
VSET\$	Voltage setting string, any value within the supply's range
OUT3	GPIB command that enables both outputs (available only for newest firmware version 5.26B)
OUT\$	1 or 0 (on or off) string
0.06 =	60 ms

CALL DELAY1 is as followed:

```
SUB DELAY1(WAITIME!)
```

```
STARTTIME! = TIMER
```

```
DO
```

```
    TIMENOW! = TIMER
```

```
    LOOP UNTIL (TIMENOW! - STARTTIME!) ≥ WAITIME!
```

```
END SUB
```

Adding a small (60-70 ms) delay between the commands will eliminate any misinterpretation of the following command.

OBTAINING DATA: The steps involved in obtaining data from the power supply follow a similar format as in sending data. However, additional commands (Enter and Print) are necessary to view the data. For example, to query the programmed voltage of the previous example, send:

```
PRINT #1, "OUTPUT 12 ; VSET?"
```

Although a query has been sent to the power supply, there has been no command given to view the data. At this moment the power supply holds the VSET value in a sample/hold circuit till the proper command has been executed. Therefore, to retrieve data onto the screen, send:

```
PRINT #1, "ENTER 12"  
INPUT #2, VOLTAGE$  
PRINT "VOLTAGE SETTING = "; VOLTAGE$
```

The PPS Series are capable of outputting output voltage and current to the bus. Therefore, one may send queries to read in the values from the supply. In our example we set an output voltage of 11V and current of 1.7A. Let us recall these actual output values.

To query the voltage output of the power supply, send:

```
PRINT #1, "OUTPUT 12 ; VOUT?"
```

Now, proceed to obtain the voltage output value:

```
PRINT #1, "ENTER 12"  
INPUT #2, V$  
PRINT "VOUTPUT = "; V$
```

The screen now shows a value of approximately 11V.

To query the current output of the power supply, send:

```
PRINT #1, "OUTPUT 12 ; IOUT?"
```

Now, proceed to obtain the current output value:

```
PRINT #1, "ENTER 12"  
INPUT #2, I$  
PRINT "IOUTPUT = "; I$
```

Now, simply short the output terminals, and the LCD screen will now display a value of approximately 1.7 amps.

The same methods presented here hold true for programming overvoltage and overcurrent protection as well as other GPIB commands.

In order to return the supply to local mode, press the "LCL" key on the front panel.

<NOTE:>

Attempting to modify values/conditions via the front panel display during remote operation is not possible. However, values/conditions may be monitored during remote operation.

SIX: CALIBRATION

6.1 INTRODUCTION

This addendum describes calibration procedures for the AMREL Programmable DC Power Supply. The supply is calibrated either through local or remote control. The following information provides calibration procedures in local mode.

NO hardware adjustment is necessary since all calibration is accomplished by software. The software sends calibration constants to the supply via the front panel keys. Calibration should be performed at least annually.

The four parameters that must be calibrated are output voltage, output current, readback voltage and readback current. After all the power supply parameters are calibrated, the supply returns to normal operating condition. If there are any errors in the calibration, cycle the power and recalibrate. All constants are saved in a non-volatile EEPROM.

6.2 CALIBRATION CONFIGURATION

There are two configurations for calibration of power supplies. One of which would be for voltage and the second for current.

The two pieces of equipment necessary for calibration are:

1. Precision Shunt Resistor - 0.1 ohm/10 Amp, 0.001% accuracy (for smaller current) or 0.05% accuracy (for larger current), 20ppm, 10 watts
2. DMM (DC voltage and current) - 5½ digit, 0.005% accuracy

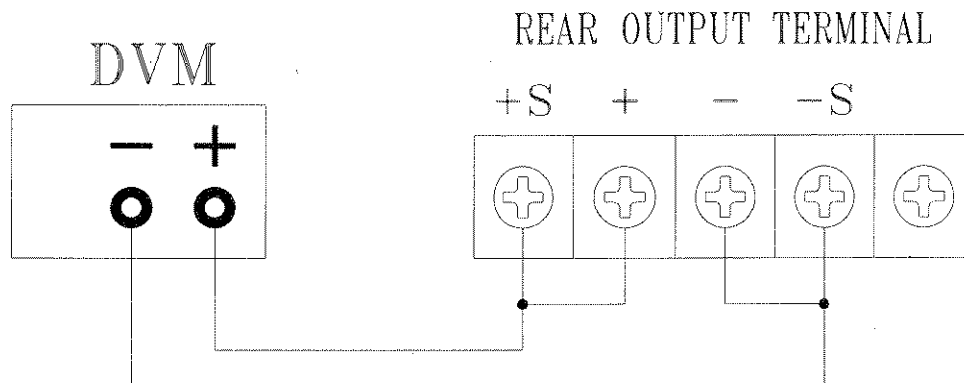

Figure M. Voltage Calibration Configuration

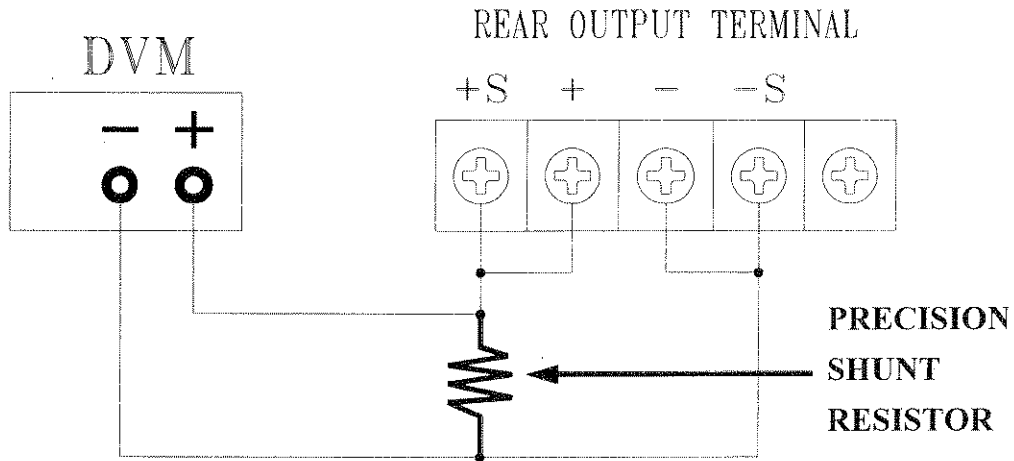

Figure N. Current Calibration Configuration

6.3 LOCAL CALIBRATION

The following steps describe the calibration procedure of the supply via front panel keypads in local mode.

CAUTION: In these procedures, voltages and currents may exceed full scale value. Take all necessary precautions.

STEPS:

1. Disconnect all loads from the supply.
2. Strap the supply for local sensing.
3. Connect the voltmeter to the +S and -S rear terminals as in figure M. for Voltage calibration.
4. Turn on the power supply and press "8" & "ON/OFF" simultaneously.
5. The supply will begin the voltage and current calibration process.

VOLTAGE CALIBRATION:

1. The supply initially sends an offset voltage to the output. This offset voltage is measured on the DMM.
2. Enter in the "V Lo =" value to the power supply by the front panel keys, and press "ENTER" once. For example, if the DMM reads 4.662 V, press:

4 . 6 6 2 ENTER

3. After calibrating the voltage offset, the supply sends full scale voltage to the output. This value is measured on the DMM.

4. Enter in the "V Hi =" value to the power supply by the front panel keys and press "ENTER" once. For example, if the full scale is 14.369 V as measured by the DMM, press:

1	4	.	3	6	9	ENTER
---	---	---	---	---	---	-------

The voltage calibration is now complete!

CURRENT CALIBRATION:

1. When the voltage calibration is complete, connect the voltmeter to the Precision Shunt Resistor as in figure N.
2. The supply initially sends an offset current to the output. This offset current is measured on the DMM.
3. Enter the "I Lo =" value to the power supply by the front panel keys, and press "ENTER" once. For example, if the DMM reads 103 mV, press:

1	.	0	3	ENTER
---	---	---	---	-------

4. After calibrating the current offset value, the supply sends full scale current to the output. This value is measured on the DMM.
5. Enter the "I Hi =" value to the power supply by the front panel keys, and press "ENTER" once. For example, if the DMM reads .3301 V press:

3	.	3	0	1	ENTER
---	---	---	---	---	-------

6. The current calibration is now complete!

<NOTE:>

For the Dual Channel PPS-series, Ch.1 and Ch.2 can only be calibrated in sequence (applies only in local mode).

6.4 REMOTE CALIBRATION

The PPS Series are able to be calibrated via computer commands. Therefore, it is not necessary to remove the power supply from the system. There are several commands available to calibrate. These are; CALCHNL, VOFF, VFS, IOFF, IFS. A definition of these commands is presented in appendix A. The equipment necessary for calibration are identical to the equipment used in local mode. Refer to figures M and N for voltage and current calibration configurations.

6.5 CALIBRATION PROGRAM EXAMPLE

Please refer to Appendix C.

SEVEN: USER MAINTENANCE/SERVICE 

7.1 FUSE REPLACEMENT

If the fuse is suspected to be defective, it should be inspected and, if necessary, replaced. To inspect or replace the fuse, please perform the following steps:

- (1) Disconnect the AC line cord from the unit to reduce electrical shock hazard.
- (2) Remove the fuse by sliding out the fuse holder. The fuseholder is beneath the AC Receptacle. Test the fuse for electrical continuity with an ohmmeter.
- (3) If the fuse is found to be defective, replace it with a replacement fuse as specified in the following table:

<u>Models</u>	<u>Fuse Rating</u>
Single Channel PPS-series (70W)	2 amp (115VAC) or 1 amp (230VAC), 250V
Dual Range PPS-series	4 amp (115VAC) or 2 amp (230VAC), 250V
Dual Channel PPS-series	4 amp (115VAC) or 2 amp (230VAC), 250V
Single Channel PPS-series (180 W)	5 amp (115VAC) or 2.5 amp (230VAC), 250V

- (4) Replace the fuse in the fuseholder and re-install.
- (5) Reconnect the AC power cord.

<NOTE:>

USE OF ANY FUSE OTHER THAN THE ONE SPECIFIED MAY CAUSE DAMAGE TO THE UNIT, POSE A SEVERE FIRE HAZARD, AND WILL VOID THE WARRANTY.

7.2 IN CASE OF DIFFICULTIES

This programmable power supply has been designed to be accurate, reliable, and easy-to-use. However, it is possible that you may experience difficulties during operation. If there appears to be any kind of problem during the use of the unit, please perform the following steps to help determine the cause:

- (1) Re-read the operating instructions. It is very easy to inadvertently make mistakes in operating procedure.
- (2) Remove and test the fuse. The power supply will not function with an open fuse.

If the preceding two steps fail to resolve the problem, please call your local distributors.

<NOTE:>

ATTEMPTED REPAIR, MODIFICATIONS, OR TAMPERING BY UNAUTHORIZED PERSONNEL WILL VOID THE WARRANTY.

7.3 WARRANTY INFORMATION

THREE-YEAR LIMITED WARRANTY

American Reliance warrants to the original user or purchaser that your unit is free from any defects in material or workmanship for a period of three years from the date of purchase. If any defect is discovered within the warranty period, American Reliance will repair or replace the unit, subject to verification of the defect or malfunction, upon delivery or prepaid shipment to American Reliance.

IMPORTANT:

- (1) Unless a problem is discovered upon initial inspection after purchase of the unit, please do not return the product to the distributor where it was purchased. American Reliance accepts the responsibility of keeping you a satisfied customer.**
- (2) If out-of-warranty or any service not covered by this warranty is needed, please contact the American Reliance Service Department at (818) 303-6688 for current charges.**

This warranty does not apply to defects or to physical damage resulting from abuse, neglect, accident, improper repair, alteration, or unreasonable use of the unit, resulting in (but not limited to) cracked or broken cases or parts, or to units damaged by excessive heat. Except upon initial purchase, this warranty does not cover finish or appearance items nor does it cover items damaged in shipment to American Reliance for repair or calibration.

To receive service under this warranty, you must include proof of purchase, including date and place of purchase (a copy of your purchase receipt) or we will not be responsible for repairs or replacement of the unit under warranty.

American Reliance assumes no responsibility for shipping and handling. However, repaired units will be shipped back to the customer with return shipping charges paid by American Reliance.

Any applicable implied warranties, including warranties of merchantability and fitness for a particular use, are hereby limited to three years from the date of purchase. Consequential or incidental damages resulting from loss of use, or from a breach of any applicable express or implied warranties are hereby excluded.

This warranty is in lieu of all other agreements and warranties, general or specific, express or implied. No representative or person is authorized to assume for us any other liability in connection with the sale or use of this American Reliance product.

Some states do not allow limitations on how long implied warranties last and do not allow exclusion of incidental or consequential damages, so the above limitations and exclusions may not apply to you. This warranty gives you specific legal rights which may vary from state to state.

NON-WARRANTY SERVICE

Any American Reliance out-of-warranty instrument that is thought to be defective, but is repairable, may be sent in for non-warranty service. Please contact our service department at (818) 303-6688 for current repair charges.

The instrument should be returned to American Reliance, please follow the directions under the heading "Shipping Instructions" in this section.

7.4 SHIPPING INSTRUCTIONS

Any product returned to American Reliance for service must be shipped, freight prepaid (we will not accept COD shipments).

**American Reliance Inc.
11801 Goldring Road,
Arcadia, CA 91006
Attn: Service Department**

The instrument must be carefully packed, preferably in its original carton, and should be accompanied by a letter or note containing the following information:

User's Name	Proof of Purchase
User's Address	Description of problem
Model number	Serial number

If service is desired, such as calibration, it must be stated in the enclosed letter. For non-warranty repairs, and for calibration, the correct service charge must accompany the unit in the form of a check or money order payable to American Reliance Inc. Please do not send cash. Contact our service department at (818) 303-6688.

American Reliance will return the serviced instrument, with freight paid by American Reliance, via UPS ground service unless otherwise requested.

NOTE: ALL INSTRUMENTS WHICH ARE RETURNED FOR REPAIR OR CALIBRATION MUST HAVE AN ASSIGNED R.G.A. NUMBER WRITTEN ON THE FRONT OF THE PACKAGE. THIS NUMBER MAY BE OBTAINED BY OUR SALES DEPARTMENT. ANY INSTRUMENT DELIVERED WITHOUT THIS NUMBER WILL BE REFUSED, AND RETURNED.

APPENDIX A: SPECIFICATIONS

The following lists the performance specifications for the American Reliance Inc., Linear Programmable DC Power Supply Series. **All specifications are at rear terminals with a resistive load, and local sensing unless otherwise stated.** All specifications apply over the full operating temperature range of 0 to 50°C, unless otherwise specified.

MODEL	PPS 8-10	PPS 18-4	PPS 30-2.5	PPS 35-2	PPS 60-10	PPS 128-0.5	PPS 250-0.2
AC INPUT	One rear panel mounted switch permits operation of 115 or 230(240) Vac line voltage.						
Input Current							
115 VAC	2.24A	1.5A	1.5A	1.5A	1.32A	1.3A	1.2A
230 VAC	1.12A	0.75A	0.75A	0.75A	0.66A	0.6A	0.6A
Fuse Rating	AC input is protected by a rear panel mounted fuse.						
115 VAC	4A	2A	2A	2A	2A	2A	2A
230 VAC	2A	1A	1A	1A	1A	1A	1A
Amplitude	115/230 Vac \pm 10% or 240 Vac \pm 10%						
Frequency	50 to 60 Hz						
Maximum VA	258VA	173VA	173VA	173VA	152VA	152VA	152VA
Maximum Power	208W	141W	141W	141W	120W	120W	120W
Peak Inrush Current	60A	20A	20A	20A	18A	18A	18A
DC OUTPUT MAXIMUM RATINGS							
Voltage	8V	18V	30V	35V	60V	128V	250V
Current	10A	4A	2.5A	2A	1A	0.5A	0.2A
DC OUTPUT PROGRAMMING RANGE							
Voltage	0-8V	0-18V	0-30V	0-35V	0-60V	0-128V	0-250V
Current	0-10A	0-4A	0-2.5A	0-2A	0-1A	0-0.5A	0-0.2A
PROGRAMMING RESOLUTION (LSB)	Voltage and current programming are monotonic over full temperature range.						
Voltage	2mV	5mV	8mV	10mV	20mV	40mV	80mV
Current	4mA	2.5mA	1mA	0.6mA	0.4mA	0.25mA	0.1mA
OVP	50mV	100mV	200mV	200mV	400mV	800mV	1.6V
PROGRAMMING ACCURACY	If the unit is recalibrated at a temperature other than 25°C, these specifications apply over a temperature band of \pm 5°C around calibration temperature.						
Voltage	0.05% +2LSB	0.05% +2LSB	0.05% +2LSB	0.05% +2LSB	0.05% +2LSB	0.05% +2LSB	0.05% +2LSB
Current	0.15% +5LSB	0.15% +5LSB	0.15% +5LSB	0.15% +5LSB	0.15% +5LSB	0.15% +5LSB	0.15% +5LSB
OVP	2.4% + 0.3V	2.4% + 0.6V	2.4% + 1.3V	2.4% + 1.3V	2.4% + 2.5V	2.4% + 5V	2.4% + 10V
EXTERNAL ANALOG PROGRAMMING GAIN							
Voltage	0.8V/V	1.8V/V	3V/V	3.5V/V	6V/V	12.8V/V	25V/V
Current	1A/V	0.4A/V	0.25A/V	0.2A/V	1A/V	0.05A/V	0.02A/V
EXTERNAL ANALOG PROGRAMMING ACCURACY							
Voltage	0.1% + 4mV	0.1% +10mV	0.1% +20mV	0.1% +20mV	0.1% +40mV	0.1% +80mV	0.1% +160mV
Current	0.1% +12mA	0.1% + 6mA	0.1% + 3mA	0.1% + 3mA	0.1% + 1mA	0.1%+0.5mA	0.1% + 0.3mA
LOAD EFFECT	Load effect is defined as the maximum change in output due to a load change up to the maximum voltage or current rating.						
Voltage	0.001% +1mV	0.001% +1mV	0.001% +1mV	0.001%+ 1mV	0.001%+ 1mV	0.001%+ 1mV	0.001%+ 1mV
Current	1mA	1mA	1mA	1mA	1mA	0.1mA	0.1mA
Remote sense operation is possible with up to 0.5V drop for positive and negative output load leads.							

Specifications are subject to change without notice.

APPENDIX A: SPECIFICATIONS (continued)

MODEL	PPS 8-10	PPS 18-4	PPS 30-2.5	PPS 35-2	PPS 60-10	PPS 128-0.5	PPS 250-0.2
SOURCE EFFECT		Maximum output change for a line voltage change within rating.					
Voltage	1mV	1mV	1mV	1mV	1mV	1mV	1mV
Current	1mA	1mA	1mA	1mA	1mA	0.1mA	0.1mA
PARD (PERIODIC AND RANDOM DEVIATION AND NOISE)		RMS/PK-PK (20Hz - 20MHz) with output ungrounded.					
Voltage	1mVrms/10mVp-p	1mVrms/10mVp-p	1mVrms/10mVp-p	1mVrms/10mVp-p	1mVrms/10mVp-p	1mVrms/10mVp-p	2mVrms/10mVp-p
Current	1mArms	1mArms	1mArms	1mArms	1mArms	0.5mArms	0.2mArms
TEMPERATURE COEFFICIENT		The temperature coefficient is defined as the change in output per degree Celsius; after a 30 minute warm-up period.					
Voltage	100ppm/°C	100ppm/°C	100ppm/°C	100ppm/°C	100ppm/°C	100ppm/°C	100ppm/°C
Current	200ppm/°C	200ppm/°C	200ppm/°C	200ppm/°C	200ppm/°C	200ppm/°C	200ppm/°C
DRIFT (STABILITY)		The drift is defined as the change in output over an eight hour interval under constant line, load, and ambient temperature after a 30 minute warm-up period.					
Voltage	0.01% + 1mV	0.01% + 1mV	0.01% + 3mV	0.01% + 3mV	0.01% + 6mV	0.01% + 10mV	0.1% + 20mV
Current	0.1% + 10mA	0.1% + 5mA	0.1% + 2mA	0.1% + 2mA	0.1% + 1mA	0.1% + 0.5mA	0.1% + 0.2mA
LOAD TRANSIENT RESPONSE		The time required for the output voltage to recover within a band of 0.1% of rated voltage around the nominal voltage, within a 50% variation in load current.					
Recovery Time	50us	50us	50us	50us	50us	50us	50us
PROGRAMMING UP/DOWN SPEED		The total programming UP/DOWN time is the sum of output voltage response time and the programming command processing time. LSB is the maximum time for the output voltage to vary within ±0.025% of a final value. UP and DOWN times are the maximum times for the output from 10% to 90% or to 10% of its total excursion value.					
Tup/Tdn	10ms/15ms	10ms/15ms	10ms/15ms	10ms/15ms	15ms/20ms	50ms/70ms	200ms/300ms
LSB	20ms/30ms	20ms/30ms	20ms/30ms	20ms/30ms	30ms/40ms	80ms/100ms	250ms/400ms
READBCK RESOLUTION							
Voltage	2mV	5mV	10mV	10mV	20mV	40mV	80mV
Current	4mA	2mA	1mA	0.8mA	0.4mA	0.2mA	0.1mA
READBCK ACCURACY		If the unit is recalibrated at a temperature other than 25°C, these specifications apply over a temperature band of ±5°C around calibration temperature.					
Voltage	0.1% + 2LSB	0.1% + 2LSB	0.1% + 2LSB	0.1% + 2LSB	0.1% + 2LSB	0.1% + 2LSB	0.1% + 2LSB
Current	0.2% + 5LSB	0.2% + 5LSB	0.2% + 5LSB	0.2% + 5LSB	0.2% + 5LSB	0.2% + 5LSB	0.2% + 5LSB
READBCK TEMPERATURE COEFFICIENT		The readback temperature coefficient is defined as the variation in reading per degree Celsius after a 30 minute warm-up.					
Voltage	100ppm+2mV	100ppm+4mV	100ppm+8mV	100ppm+10mV	100ppm+20mV	100ppm+40mV	100ppm+80mV
Current	200ppm+12mA	200ppm+4mA	200ppm+3mA	200ppm+3mA	200ppm+1mA	200ppm+0.5mA	200ppm+0.2mA
OUTPUT ISOLATION		Neither output terminal may be more than ±240Vdc from chassis ground.					
	± 240Vdc	± 240Vdc	± 240Vdc	± 240Vdc	± 240Vdc	± 500Vdc	± 500Vdc
TEMPERATURE RATINGS		Operating 0°C to 50°C Storage -40°C to 70°C					
GPIB INTERFACE CAPABILITY		SH1, AH1, T6, TE0, L4, LE0, RL1, SR0, PP0, DC1, DT0, C0, E1					
WEIGHT	18 lbs	16 lbs	16 lbs	16 lbs	16 lbs	16 lbs	16 lbs
DIMENSIONS	8.4"x5.2"x15.7" for all models						

Specifications are subject to change without notice.

APPENDIX A: SPECIFICATIONS (continued)

MODEL	PPS 5-30	PPS 35-3R	PPS 60-1.5R
AC INPUT	One rear panel mounted switch permits operation of 115 or 230(240) Vac line voltage.		
Input Current			
115 VAC	3.2A	1.92A	1.92A
230 VAC	1.6A	0.96A	0.96A
Fuse Rating			
115 VAC	5A	4A	4A
230 VAC	3A	2A	2A
Amplitude	115/230 Vac \pm 10% or 240 Vac \pm 10%		
Frequency	50 to 60 Hz		
Maximum VA	350VA	221VA	221VA
Maximum Power	150W	192W	192W
Peak Inrush Current	60A	30A	30A
DC OUTPUT MAXIMUM RATINGS			
Voltage	0 ~ 5V	0 ~ 16V; 0 ~ 35V	0 ~ 35V; 0 ~ 60V
Current	0 ~ 30A	0 ~ 6A; 0 ~ 3A	0 ~ 3A; 0 ~ 1.5A
DC OUTPUT PROGRAMMING RANGE			
Voltage	0 ~ 5V	0 ~ 16V; 0 ~ 35V	0 ~ 35V; 0 ~ 60V
Current	0 ~ 30A	0 ~ 6A; 0 ~ 3A	0 ~ 3A; 0 ~ 1.5A
PROGRAMMING RESOLUTION (LSB)	Voltage and current programming are monotonic over full temperature range.		
Voltage	2mV	10mV	20mV
Current	10mA	1mA(Low); 2mA(High)	0.5mA(Low); 1mA(High)
OVP	200mV	200mV	400mV
PROGRAMMING ACCURACY	If the unit is recalibrated at a temperature other than 25°C, these specifications apply over a temperature band of \pm 5°C around calibration temperature.		
Voltage	0.05% +2LSB	0.05% +2LSB	0.05% +2LSB
Current	0.15% +5LSB	0.15% +5LSB	0.15% +5LSB
OVP	2.4% + 0.3V	2.4% + 0.3V	2.4% + 1.3V
EXTERNAL PROGRAMMING GAIN			
Voltage	0.5V/V	N/A	N/A
Current	3A/V	N/A	N/A
EXTERNAL PROGRAMMING ACCURACY			
Voltage	0.1% + 4mV	N/A	N/A
Current	0.1% + 40mA	N/A	N/A
LOAD EFFECT	Load effect is defined as the maximum change in output due to a load change up to the maximum voltage or current rating.		
Voltage	0.001% +1mV	0.001% +1mV	0.001% +1mV
Current	1mA	1mA	1mA
Remote sense operation is possible with up to 0.5V drop for positive and negative output load leads.			

Specifications are subject to change without notice.

APPENDIX A: SPECIFICATIONS (continued)

MODEL	PPS 5-30	PPS 35-3R	PPS 60-1.5R
SOURCE EFFECT	Maximum output change for a line voltage change within rating.		
Voltage	1mV	1mV	1mV
Current	1mA	1mA	1mA
PARD (PERIODIC AND RANDOM DEVIATION AND NOISE) RMS/PK-PK (20Hz - 20MHz) with output ungrounded.			
Voltage	1mVrms/10mVp-p	1mVrms/10mVp-p	1mVrms/10mVp-p
Current	1mA _{rms}	1mA _{rms}	1mA _{rms}
TEMPERATURE COEFFICIENT	The temperature coefficient is defined as the change in output per degree Celsius; after a 30 minute warm-up period.		
Voltage	100ppm/°C	100ppm/°C	100ppm/°C
Current	200ppm/°C	200ppm/°C	200ppm/°C
DRIFT (STABILITY)	The drift is defined as the change in output over an eight hour interval under constant line, load, and ambient temperature after a 30 minute warm-up period.		
Voltage	0.01% + 1mV	0.01% + 1mV	0.01% + 3mV
Current	0.1%+20mA	0.1%+3mA \pm ; 0.1%+6mA \uparrow	0.1%+2mA \pm ; 0.1%+3mA \uparrow
LOAD TRANSIENT RESPONSE	The time required for the output voltage to recover within a band of 0.1% of rated voltage around the nominal voltage, within a 50% variation in load current.		
Recovery Time	50us	50us	50us
PROGRAMMING UP/DOWN SPEED	The total programming UP/DOWN time is the sum of output voltage response time and the programming command processing time. LSB is the maximum time for the output voltage to vary within $\pm 0.025\%$ of a final value. UP and DOWN times are the maximum times for the output from 10% to 90 % or to 10% of its total excursion value.		
T _{up} /T _{dn}	10ms/15ms	10ms/15ms	10ms/15ms
LSB	20ms/30ms	20ms/30ms	20ms/30ms
READBACK RESOLUTION(LSB)			
Voltage	2mV	10mV	20mV
Current	8mA	1mA(Low); 2mA(High)	0.5mA(Low); 1mA(High)
READBACK ACCURACY	If the unit is recalibrated at a temperature other than 25°C, these specifications apply over a temperature band of $\pm 5^\circ\text{C}$ around calibration temperature.		
Voltage	0.1% + 2LSB	0.1% + 2LSB	0.1% + 2LSB
Current	0.2% + 5LSB	0.2% + 5LSB	0.2% + 5LSB
READBACK TEMPERATURE COEFFICIENT	The readback temperature coefficient is defined as the variation in reading per degree Celsius after a 30 minute warm-up.		
Voltage	100ppm+2mV	100ppm+10mV	100ppm+20mV
Current	200ppm+20mA	200ppm+4mA	200ppm+2mA
OUTPUT ISOLATION	Neither output terminal may be more than $\pm 240\text{Vdc}$ from chassis ground.		
	$\pm 240\text{Vdc}$	$\pm 240\text{Vdc}$	$\pm 240\text{Vdc}$
TEMPERATURE RATINGS			
Operating	0°C to 50°C	0°C to 50°C	0°C to 50°C
Storage	-40°C to 70°C	-40°C to 70°C	-40°C to 70°C
GPIB INTERFACE CAPABILITY	SH1, AH1, T6, TE0, L4, LE0, RL1, SR0, PP0, DC1, DT0, C0, E1		
WEIGHT	20 lbs	18 lbs	18 lbs
DIMENSIONS	8.4"x5.2"x15.7" for all models		

Specifications are subject to change without notice.

APPENDIX A: SPECIFICATIONS (continued)

MODEL	PPS 8-6D	PPS 18-4D	PPS 35-2D	PPS 30-3D	PPS 60-1D	PPS 128.05D
AC INPUT	One rear panel mounted switch permits operation of 115 or 230(240) Vac line voltage.					
Input Current						
115 VAC	2.7A	2.7A	2.6A	3A	2.6A	2.6A
230 VAC	1.4A	1.35A	1.3A	1.5A	1.3A	1.3A
Fuse Rating	AC input is protected by a rear panel mounted fuse.					
115 VAC	4A	4A	4A	5A	4A	4A
230 VAC	2A	2A	2A	2.5A	2A	2A
Amplitude	115/230 Vac \pm 10% or 240 Vac \pm 10%					
Frequency	50 to 60 Hz					
Maximum VA	315VA	315VA	299VA	343VA	299VA	299VA
Maximum Power	240W	240W	232W	268W	232W	232W
Peak Inrush Current	30A	30A	30A	60A	30A	30A
DC OUTPUT MAXIMUM RATINGS						
Voltage	8V	18V	35V	30V	60V	128V
Current	6A	4A	2A	3A	1A	0.5A
DC OUTPUT PROGRAMMING RANGE						
Voltage	0-8V	0-18V	0-35V	0-30V	0-60V	0-128V
Current	0-6A	0-4A	0-2A	0-3A	0-1A	0-0.5A
PROGRAMMING RESOLUTION (LSB)	Voltage and current programming are monotonic over full temperature range.					
Voltage	2mV	5mV	10mV	10mV	20mV	40mV
Current	2mA	1.5mA	0.6mA	1mA	0.4mA	0.25mA
OVP	50mV	100mV	200mV	200mV	400mV	800mV
PROGRAMMING ACCURACY	If the unit is recalibrated at a temperature other than 25°C, these specifications apply over a temperature band of \pm 5°C around calibration temperature.					
Voltage	0.05% +2LSB	0.05% +2LSB	0.05% +2LSB	0.05% +2LSB	0.05% +2LSB	0.05% +2LSB
Current	0.15% +5LSB	0.15% +5LSB	0.15% +5LSB	0.15% +5LSB	0.15% +5LSB	0.15% +5LSB
OVP	2.4% + 0.3V	2.4% + 0.6V	2.4% + 1.3V	2.4% + 1.3V	2.4% + 2.5V	2.4% + 5V
LOAD EFFECT	Load effect is defined as the maximum change in output due to a load change up to the maximum voltage or current rating.					
Voltage	0.001% +1mV	0.001% +1mV	0.001% +1mV	0.001% + 1mV	0.001% + 1mV	0.001% + 1mV
Current	1mA	1mA	1mA	1mA	1mA	0.1mA
Remote sense operation is possible with up to 0.5V drop for positive and negative output load leads.						

Specifications are subject to change without notice.

APPENDIX A: SPECIFICATIONS (continued)

MODEL	PPS 8-6D	PPS 18-4D	PPS 35-2D	PPS 30-3D	PPS 60-1D	PPS 128-0.5D
SOURCE EFFECT	Maximum output change for a line voltage change within rating.					
Voltage	1mV	1mV	1mV	1mV	1mV	1mV
Current	1mA	1mA	1mA	1mA	1mA	0.1mA
PARD (PERIODIC AND RANDOM DEVIATION AND NOISE)	RMS/PK-PK (20Hz - 20MHz) with output ungrounded.					
Voltage	1mVrms/10mVp-p	1mVrms/10mVp-p	1mVrms/10mVp-p	1mVrms/10mVp-p	1mVrms/10mVp-p	1mVrms/10mVp-p
Current	1mArms	1mArms	1mArms	1mArms	1mArms	0.5mArms
TEMPERATURE COEFFICIENT	The temperature coefficient is defined as the change in output per degree Celsius; after a 30 minute warm-up period.					
Voltage	100ppm/°C	100ppm/°C	100ppm/°C	100ppm/°C	100ppm/°C	100ppm/°C
Current	200ppm/°C	200ppm/°C	200ppm/°C	200ppm/°C	200ppm/°C	200ppm/°C
DRIFT (STABILITY)	The drift is defined as the change in output over an eight hour interval under constant line, load, and ambient temperature after a 30 minute warm-up period.					
Voltage	0.01% + 1mV	0.01% + 1mV	0.01% + 3mV	0.01% + 3mV	0.01% + 6mV	0.01% + 10mV
Current	0.1% + 6mA	0.1% + 5mA	0.1% + 2mA	0.1% + 3mA	0.1% + 1mA	0.1% + 0.5mA
LOAD TRANSIENT RESPONSE	The time required for the output voltage to recover within a band of 0.1% of rated voltage around the nominal voltage, within a 50% variation in load current.					
Recovery Time	50us	50us	50us	50us	50us	50us
PROGRAMMING UP/DOWN SPEED	The total programming UP/DOWN time is the sum of output voltage response time and the programming command processing time. LSB is the maximum time for the output voltage to vary within ±0.025% of a final value. UP and DOWN times are the maximum times for the output from 10% to 90% or to 10% of its total excursion value.					
Tup/Tdn	10ms/15ms	10ms/15ms	10ms/15ms	10ms/15ms	15ms/20ms	50ms/70ms
LSB	20ms/30ms	20ms/30ms	20ms/30ms	20ms/30ms	30ms/40ms	80ms/100ms
READBACK RESOLUTION						
Voltage	2mV	5mV	10mV	10mV	20mV	40mV
Current	4mA	2mA	1mA	0.8mA	0.4mA	0.2mA
READBACK ACCURACY	If the unit is recalibrated at a temperature other than 25°C, these specifications apply over a temperature band of ±5°C around calibration temperature.					
Voltage	0.1% + 2LSB	0.1% + 2LSB	0.1% + 2LSB	0.1% + 2LSB	0.1% + 2LSB	0.1% + 2LSB
Current	0.2% + 5LSB	0.2% + 5LSB	0.2% + 5LSB	0.2% + 5LSB	0.2% + 5LSB	0.2% + 5LSB
READBACK TEMPERATURE COEFFICIENT	The readback temperature coefficient is defined as the variation in reading per degree Celsius after a 30 minute warm-up.					
Voltage	100ppm + 2mV	100ppm + 4mV	100ppm + 8mV	100ppm + 10mV	100ppm + 20mV	100ppm + 40mV
Current	200ppm + 6mA	200ppm + 4mA	200ppm + 2mA	200ppm + 3mA	200ppm + 1mA	200ppm + 0.5mA
OUTPUT ISOLATION	Neither output terminal may be more than ±240Vdc from chassis ground.					
	± 240Vdc	± 240Vdc	± 240Vdc	± 240Vdc	± 240Vdc	± 500Vdc
TEMPERATURE RATINGS	Operating Storage					
	0°C to 50°C -40°C to 70°C					
GPIB INTERFACE CAPABILITY	SH1, AH1, T6, TE0, L4, LE0, RL1, SR0, PP0, DC1, DT0, C0, E1					
WEIGHT	18 lbs	18 lbs	20 lbs	18 lbs	18 lbs	18 lbs
DIMENSIONS	8.4"x5.2"x15.7" for all models					

Specifications are subject to change without notice.

APPENDIX A: SPECIFICATIONS (continued)

MODEL	PPS 30-6	PPS 35-5	PPS 8-20	PPS 18-10	PPS 60-3	PPS 128-1.5	PPS 250-0.8
AC INPUT	One rear panel mounted switch permits operation of 115 or 230(240) Vac line voltage.						
Input Current							
115 VAC	3A	3A	3.2A	3.1A	3A	3A	3A
230 VAC	1.5A	1.5A	1.6A	1.5A	1.5A	1.5A	1.5A
Fuse Rating	AC input is protected by a rear panel mounted fuse.						
115 VAC	5A	5A	5A	5A	5A	5A	5A
230 VAC	2.5A	2.5A	2.5A	2.5A	2.5A	2.5A	2.5A
Amplitude	115/230 Vac \pm 10% or 240 Vac \pm 10%						
Frequency	50 to 60 Hz						
Maximum VA	343VA	343VA	350VA	350VA	343VA	340VA	340VA
Maximum Power	268W	268W	273W	273W	268W	270W	270W
Peak Inrush Current	60A	60A	60A	60A	60A	60A	60A
DC OUTPUT MAXIMUM RATINGS							
Voltage	30V	35V	8V	18V	60V	120V	250V
Current	6A	5A	20A	10A	3A	1.5A	0.8A
DC OUTPUT PROGRAMMING RANGE							
Voltage	0-30V	0-35V	0-8V	0-18V	0-60V	0-120V	0-250V
Current	0-6A	0-5A	0-20A	0-10A	0-3A	0-1.5A	0-0.8A
PROGRAMMING RESOLUTION (LSB)	Voltage and current programming are monotonic over full temperature range.						
Voltage	10mV	10mV	2mV	5mV	20mV	40mV	80mV
Current	2mA	2mA	7mA	3mA	1mA	0.5mA	0.1mA
OVP	200mV	200mV	50mV	100mV	400mV	800mV	1.6V
PROGRAMMING ACCURACY	If the unit is recalibrated at a temperature other than 25°C, these specifications apply over a temperature band of $\pm 5^\circ\text{C}$ around calibration temperature.						
Voltage	0.05% +2LSB	0.05% +2LSB	0.05% +2LSB	0.05% +2LSB	0.05% +2LSB	0.05% +2LSB	0.05% +2LSB
Current	0.15% +5LSB	0.15% +5LSB	0.15% +5LSB	0.15% +5LSB	0.15% +5LSB	0.15% +5LSB	0.15% +5LSB
OVP	2.4% + 1.3V	2.4% + 1.3V	2.4% + 0.3V	2.4% + 0.6V	2.4% + 2.5V	2.4% + 5V	2.4% + 10V
EXTERNAL ANALOG PROGRAMMING GAIN							
Voltage	3V/V	3.5V/V	0.8V/V	1.8V/V	6V/V	12V/V	25V/V
Current	0.6A/V	0.5A/V	2A/V	1A/V	0.3A/V	0.15A/V	0.08A/V
EXTERNAL ANALOG PROGRAMMING ACCURACY							
Voltage	0.1% + 20mV	0.1% + 20mV	0.1% + 4mV	0.1% + 10mV	0.1% + 40mV	0.1% + 80mV	0.1% + 160mV
Current	0.1% + 12mA	0.1% + 12mA	0.1% + 40mA	0.1% + 20mA	0.1% + 6mA	0.1% + 3mA	0.1% + 1.5mA
LOAD EFFECT	Load effect is defined as the maximum change in output due to a load change up to the maximum voltage or current rating.						
Voltage	0.001% + 1mV	0.001% + 1mV	0.001% + 1mV	0.001% + 1mV	0.001% + 1mV	0.001% + 1mV	0.001% + 1mV
Current	1mA	1mA	1mA	1mA	1mA	0.5mA	0.1mA
Remote sense operation is possible with up to 0.5V drop for positive and negative output load leads.							

Specifications are subject to change without notice.

APPENDIX A: SPECIFICATIONS (continued)

MODEL	PPS 30-6	PPS 35-5	PPS 8-20	PPS 18-10	PPS 60-3	PPS 128-1.5	PPS 250-0.8
SOURCE EFFECT	Maximum output change for a line voltage change within rating. (PPS-2015 with 90% of Full Load)						
Voltage	1mV	1mV	1mV	1mV	1mV	1mV	1mV
Current	1mA	1mA	1mA	1mA	1mA	0.1mA	0.1mA
PARD (PERIODIC AND RANDOM DEVIATION AND NOISE) RMS/PK-PK (20Hz - 20MHz) with output ungrounded.							
Voltage	1mVrms/10mVp-p	1mVrms/10mVp-p	1mVrms/10mVp-p	1mVrms/10mVp-p	1mVrms/10mVp-p	1mVrms/10mVp-p	2mVrms/10mVp-p
Current	1mArms	1mArms	1mArms	1mArms	1mArms	0.5mArms	0.2mArms
TEMPERATURE COEFFICIENT The temperature coefficient is defined as the change in output per degree Celsius; after a 30 minute warm-up period.							
Voltage	100ppm/°C	100ppm/°C	100ppm/°C	100ppm/°C	100ppm/°C	100ppm/°C	100ppm/°C
Current	200ppm/°C	200ppm/°C	200ppm/°C	200ppm/°C	200ppm/°C	200ppm/°C	200ppm/°C
DRIFT (STABILITY) The drift is defined as the change in output over an eight hour interval under constant line, load, and ambient temperature after a 30 minute warm-up period.							
Voltage	0.01% + 3mV	0.01% + 3mV	0.01% + 1mV	0.01% + 1mV	0.01% + 6mV	0.01% + 10mV	0.1% + 20mV
Current	0.1% + 6mA	0.1% + 6mA	0.1% + 20mA	0.1% + 10mA	0.1% + 2mA	0.1% + 1mA	0.1% + 0.5mA
LOAD TRANSIENT RESPONSE The time required for the output voltage to recover within a band of 0.1% of rated voltage around the nominal voltage, within a 50% variation in load current.							
Recovery Time	50us	50us	50us	50us	50us	50us	50us
PROGRAMMING UP/DOWN SPEED The total programming UP/DOWN time is the sum of output voltage response time and the programming command processing time. LSB is the maximum time for the output voltage to vary within ±0.025% of a final value. UP and DOWN times are the maximum times for the output from 10% to 90% or to 10% of its total excursion value.							
Tup/Tdn	10ms/15ms	10ms/15ms	10ms/15ms	10ms/15ms	15ms/20ms	50ms/70ms	200ms/300ms
LSB	20ms/30ms	20ms/30ms	20ms/30ms	20ms/30ms	30ms/40ms	80ms/100ms	250ms/400ms
READBACK RESOLUTION							
Voltage	10mV	10mV	2mV	5mV	20mV	40mV	80mV
Current	2mA	2mA	8mA	4mA	1mA	0.5mA	0.25mA
READBACK ACCURACY If the unit is recalibrated at a temperature other than 25°C, these specifications apply over a temperature band of ±5°C around calibration temperature.							
Voltage	0.1% + 2LSB	0.1% + 2LSB	0.1% + 2LSB	0.1% + 2LSB	0.1% + 2LSB	0.1% + 2LSB	0.1% + 2LSB
Current	0.2% + 5LSB	0.2% + 5LSB	0.2% + 5LSB	0.2% + 5LSB	0.2% + 5LSB	0.2% + 5LSB	0.2% + 5LSB
READBACK TEMPERATURE COEFFICIENT The readback temperature coefficient is defined as the variation in reading per degree Celsius after a 30 minute warm-up.							
Voltage	100ppm+8mV	100ppm+10mV	100ppm+2mV	100ppm+4mV	100ppm+20mV	100ppm+40mV	100ppm+80mV
Current	200ppm+6mA	200ppm+6mA	200ppm+20mA	200ppm+12mA	200ppm+3mA	200ppm+1mA	200ppm+0.5mA
OUTPUT ISOLATION Neither output terminal may be more than ±240Vdc from chassis ground.							
	± 240Vdc	± 240Vdc	± 240Vdc	± 240Vdc	± 240Vdc	± 500Vdc	± 500Vdc
TEMPERATURE RATINGS							
		Operating	0°C to 50°C				
		Storage	-40°C to 70°C				
GPIB INTERFACE CAPABILITY SH1, AH1, T6, TE0, L4, LE0, RL1, SR0, PP0, DC1, DT0, C0, E1							
WEIGHT	19 lbs	19 lbs	19 lbs	19 lbs	19 lbs	19 lbs	19 lbs
DIMENSIONS 8.4"x5.2"x15.7" for all models							

Specifications are subject to change without notice.

APPENDIX B: QUERY MESSAGES

ERROR CODE MESSAGE	DEFINTION
ERROR 0	No Errors
ERROR 1	Command String Error
ERROR 2	Numeric String Out of Range
ERROR 3	Numeric String Over Length
ERROR 4	Command Sequence Error
ERROR 5	
ERROR 6	

APPENDIX C: CALIBRATION PROGRAM EXAMPLE

The following is a software calibration program written in QBASIC for an AMREL PROGRAMMABLE DC POWER SUPPLY. The equipment necessary to calibrate the unit included a power supply (relay control), a FLUKE 8842A digital multimeter (GPIB interface), and a controller card from National Instruments (AT-GPIB). A shunt resistor used for local calibration may be utilized in remote calibration.

```

DECLARE SUB DELAY (WAITIME!)
LET PPS$ = "12": LET VCC$ = "01": LET DMM$ = "20": LET MULTIPLIER = 100
OPEN "GPIB0" FOR OUTPUT AS #1
OPEN "GPIB0" FOR INPUT AS #2
CLS
PRINT "AMREL PPS-Series Calibration Demonstration"
PRINT : PRINT "Set PPS Under Test to Address 12"
PRINT "Set Relay Control PPS to Address 01"
PRINT "Set Meter to Address 20": PRINT
DO
  INPUT "Enter Channel for Calibration (Default = 1) =>"; CH$
  IF CH$ = "" THEN LET CH$ = "1"
  LOOP UNTIL CH$ = "1" OR CH$ = "2"
PRINT
PRINT #1, "ABORT"
PRINT #1, "REMOTE"
PRINT #1, "CLEAR"
PRINT #1, "OUTPUT "; DMM$; "; *"
PRINT #1, "OUTPUT "; VCC$; "; OUT 0"
PRINT #1, "OUTPUT "; VCC$; "; VSET 24"
PRINT #1, "OUTPUT "; VCC$; "; ISET 1.2"
PRINT #1, "OUTPUT "; PPS$; "; CALCHNL"; CH$; ""
**** Voltage Calibration *****
CALL DELAY(3)
PRINT #1, "ENTER "; DMM$: INPUT #2, RD$
VOFF = VAL(RD$)
PRINT #1, "OUTPUT "; PPS$; "; VOFF "; STR$(VOFF)
CALL DELAY(2)
PRINT #1, "ENTER "; DMM$: INPUT #2, RD$
VFS = VAL(RD$)
PRINT #1, "OUTPUT "; PPS$; "; VFS "; STR$(VFS)
PRINT USING "Offset Voltage = ###.### V      Fullscale Voltage = ###.### V"; VOFF; VFS
**** Current Calibration *****
PRINT #1, "OUTPUT "; VCC$; "; OUT 1"
CALL DELAY(3)
PRINT #1, "ENTER "; DMM$: INPUT #2, RD$
IOFF = VAL(RD$) * MULTIPLIER
PRINT #1, "OUTPUT "; PPS$; "; IOFF "; STR$(IOFF)
CALL DELAY(2)
PRINT #1, "ENTER "; DMM$: INPUT #2, RD$
IFS = VAL(RD$) * MULTIPLIER
PRINT #1, "OUTPUT "; PPS$; "; IFS "; STR$(IFS)
PRINT USING "Offset Current = ###.### A      Fullscale Current = ###.### A"; IOFF; IFS
CALL DELAY(5)
PRINT #1, "CLEAR"
END

SUB DELAY (WAITIME!)
STARTIME! = TIMER
DO
  TIMENOW! = TIMER
  LOOP UNTIL (TIMENOW! - STARTIME!) >= WAITIME!
END SUB

```

ADDENDUM: COMMAND SUMMARIES

COMMANDS	DEFINITION	RANGE
ADDRESS	Sets the address of the PPS	0 to 30
BEEP	Enables or disables the beep mode	0 or 1
CALCHNL	Enables or disables the calibration mode.	1 or 0
CALCHNL1	Enables or disables the calibration mode to channel one(Dual Channel series only).	1 or 0
CALCHNL2	Enables or disables the calibration mode to channel two(Dual Channel series only).	1 or 0
IFS	Sets the fullscale current for calibration.	Varies from model to model
IOFF	Sets the current offset value in calibration.	Varies from model to model
ISET	Sets the current	Varies from model to model
ISET1_	Sets the current to channel one(Dual Channel series only).	Varies from model to model
ISET2_	Sets the current to channel two(Dual Channel series only).	Varies from model to model
OCP	Enables or disables the overcurrent protection mode.	1 or 0
OCP1_	Enables or disables the overcurrent protection mode(Dual Channel series only).	1 or 0
OCP2_	Enables or disables the overcurrent protection mode(Dual Channel series only).	1 or 0
OUT	Enables or disables the output.	1 or 0
OUT1_	Sets the output of channel one on or off(Dual Channel series only).	1 or 0
OUT2_	Sets the output of channel two on or off(Dual Channel series only).	1 or 0
OUT3	Sets the output of both channels on or off(for Dual Channel series firmware ver. 5.26B only)	1 or 0
OVSET	Sets the overvoltage protection threshold	Varies from model to model
OVSET1_	Set the overvoltage protection value for channel one(Dual Channel series only)	Varies from model to model
OVSET2_	Set the overvoltage protection value for channel two(Dual Channel series only)	Varies from model to model
TRACK	Enables or disables the tracking mode of the Dual Channel series(toggle command)	
TRACK1	Enables the tracking mode of the Dual Channel series	
TRACK_1	Enables or disables the tracking mode of the Dual Channel series(due to the space in between)	
TRACK0	Disables the tracking mode of the Dual Channel series	
TRACK_0	Enables or disables the tracking mode of the Dual Channel series(due to the space in between)	
VFS	Sets the fullscale voltage for calibration.	Varies from model to model
VOFF	Sets the offset voltage for calibration.	Varies from model to model
VSET	Sets the voltage	Varies from model to model
VSET1_	Sets the voltage to channel one(Dual Channel series only).	Varies from model to model
VSET2_	Sets the voltage to channel two(Dual Channel series only).	Varies from model to model
OVP	Enables or disables the overvoltage protection mode.	1 or 0
OVP1_	Enables or disables the overvoltage protection mode(Dual Channel series only).	1 or 0
OVP2_	Enables or disables the overvoltage protection mode(Dual Channel series only).	1 or 0

ADDENDUM: QUERIES SUMMARIES

ERROR?	Queries for command or numeric errors	ASCII code
IOUT?	Queries the current output.	Varies from model to model
IOUT1?	Queries the current output of channel one(Dual Channel series only).	Varies from model to model
IOUT2?	Queries the current output of channel two(Dual Channel series only).	Varies from model to model
ISET?	Queries the set current output.	Varies from model to model
ISET1?	Queries the set current output of channel one(Dual Channel series only).	Varies from model to model
ISET2?	Queries the set current output of channel two(Dual Channel series only).	Varies from model to model
OVSET?	Queries the overvoltage value.	Varies from model to model
OVSET1?	Queries the overvoltage value for channel one(Dual Channel series only).	Varies from model to model
OVSET2?	Queries the overvoltage value for channel two(Dual Channel series only).	Varies from model to model
STATUS?	Queries the status of the power supply.	See section 5.4
VOUT?	Queries the output voltage.	Varies from model to model
VOUT1?	Queries the output voltage of channel one(Dual Channel series only).	Varies from model to model
VOUT2?	Queries the output voltage of channel two(Dual Channel series only).	Varies from model to model
VSET?	Queries the set voltage value	Varies from model to model
VSET1?	Queries the set voltage value of channel one(Dual Channel series only).	Varies from model to model
VSET2?	Queries the set voltage value of channel two(Dual Channel series only).	Varies from model to model
MODEL?	Queries the model no. of the power supply.	Varies from model to model