

Errata

Title & Document Type: Basic Network Measurements using the 8756A and 8350B

Manual Part Number: 08756-90001

Revision Date: March 1983

HP References in this Manual

This manual may contain references to HP or Hewlett-Packard. Please note that Hewlett-Packard's former test and measurement, semiconductor products and chemical analysis businesses are now part of Agilent Technologies. We have made no changes to this manual copy. The HP XXXX referred to in this document is now the Agilent XXXX. For example, model number HP8648A is now model number Agilent 8648A.

About this Manual

We've added this manual to the Agilent website in an effort to help you support your product. This manual provides the best information we could find. It may be incomplete or contain dated information, and the scan quality may not be ideal. If we find a better copy in the future, we will add it to the Agilent website.

Support for Your Product

Agilent no longer sells or supports this product. You will find any other available product information on the Agilent Test & Measurement website:

www.tm.agilent.com

Search for the model number of this product, and the resulting product page will guide you to any available information. Our service centers may be able to perform calibration if no repair parts are needed, but no other support from Agilent is available.

Basic Network Measurements Using 8756A Scalar Network Analyzer and 8350B Sweep Oscillator

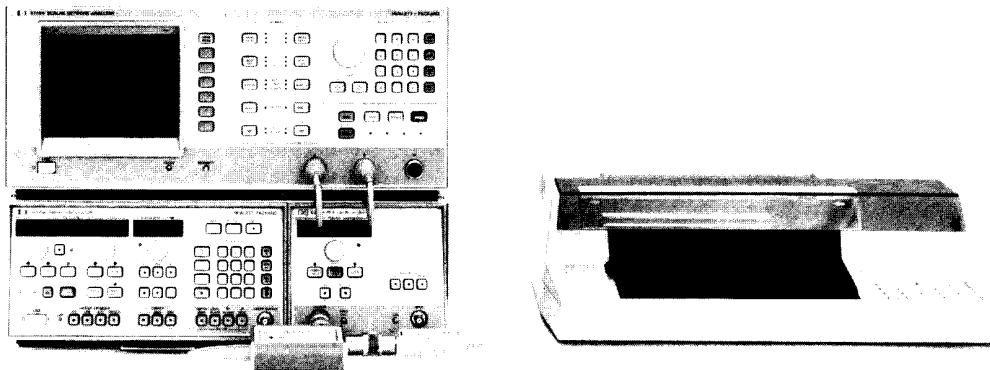

Figure 1. Scalar Network Analyzer System, 10 MHz to 18 GHz

INTRODUCTION

This operating note will help you make transmission and reflection measurements using the HP 8756A Scalar Network Analyzer, the HP 8350B Sweep Oscillator, and associated accessories. Some previous experience in network analysis techniques is assumed, so the note concentrates on generalized measurement setup, calibration, and measurement sequences using the 8756A rather than basic measurement theory. As you become familiar with operation of the instrument you can modify and extend these sequences to more specialized applications. Further information discussing specific network measurement techniques is found in HP Application Note AN 183.

The first part of this note introduces the 8756A as used in a typical setup then describes the instrument functions using basic front panel control sequences that apply to all measurements. Specific step-by-step procedures used to measure and interpret the response of the test device are found in the Transmission Measurements and

Reflection Measurements topics. Summaries at the end of this note describe the function of the 8756A controls and indicators and the input/output connections.

Although the 8756A is fully programmable via the HP-IB, this note does not describe programming operation. Refer to the 8756A Programming Notes. You will want to gain an understanding of the instrument using the front panel controls before writing automated measurement programs.

Scalar network analyzers measure power reflected or transmitted by devices such as filters, amplifiers, mixers, and attenuators. Shown in Figure 1, the configuration described here is a complete manually operated system. It consists of the source to provide stimulus to the test device, the directional bridge and detectors to sample the reflected and transmitted signals, the receiver for signal processing and display, and the plotter for hard-copy output. Together, these instruments produce fast, accurate, simultaneous swept displays of transmission loss or gain and reflection return loss versus frequency.

BASIC NETWORK ANALYZER BLOCK DIAGRAM

The 8756A is a high performance scalar receiver with three identical inputs, two independent measurement channels, and an internal microcomputer to simplify operating procedures and automate display processing. A special digital System Interface between the 8756A and its companion source, the HP 8350B Sweep Oscillator, adds measurement capability by providing communication between the source and the receiver. This interface also provides direct data transfer to the digital plotter for neat, permanent records of the measurement display.

Figure 2 shows a simplified block diagram of the source, detectors, and receiver in this setup. The source provides stimulus to the test device and signals for sweep, retrace blanking, and frequency markers. Input to each detector is a CW or swept sinusoid that is amplitude modulated by a 27.8 kHz square wave. These detectors demodulate (envelope detect) this signal to produce a 27.8 kHz square wave whose peak-to-peak voltage corresponds to the magnitude of the AM signal at the detector input. Since only the 27.8 kHz modulated signal is detected, unmodulated broadband noise generated by the test device and spurious signals like mixer local oscillator feedthrough are not included in the measurement. This receiver technique is termed AC detection.

The 8756A scalar receiver provides signal processing to convert the 27.8 kHz square wave for display. Each of the three inputs include a low pass filter, a logarithmic amplifier, and a rectifier to produce a DC voltage proportional to the detected power. The selected

inputs are sampled 401 times per sweep with sample timing accomplished by sensing the 0 to 10 volt sweep output from the source. At each positive 0.025 volt change in the sweep voltage, all selected inputs are sampled, converted to a digital value, then stored in memory of the Central Processing Unit (CPU). Using this memory, the CPU performs signal processing, such as normalization, scaling, averaging, ratioing, and detector offsets, then outputs trace data to the display memory. Display memory accepts digital trace data at the source sweep rate and asynchronously converts it for display at a flicker-free rate.

Sources

The HP 8350B Sweep Oscillator and HP 8340A Synthesized Sweeper include the correct analog interface signals as well as full compatibility with the digital 8756 System Interface. The System Interface allows the 8756A to act as the system controller by managing the sweeper using standard HP-IB protocol. Capabilities added by the System Interface include start/stop and source marker frequency annotation on the 8756A display, full use of all sweep and marker modes, and control of analyzer and sweeper Preset and Save/Recall functions using 8756A controls.

Although the network analyzer can use any CW or swept stimulus having the correct sweep and blanking waveform, without the System Interface its capabilities are reduced. Other sources which may be used with the 8756A include the HP 8620C and HP 8350A. Measurement examples using these sources are shown in Appendix A at the rear of this note.

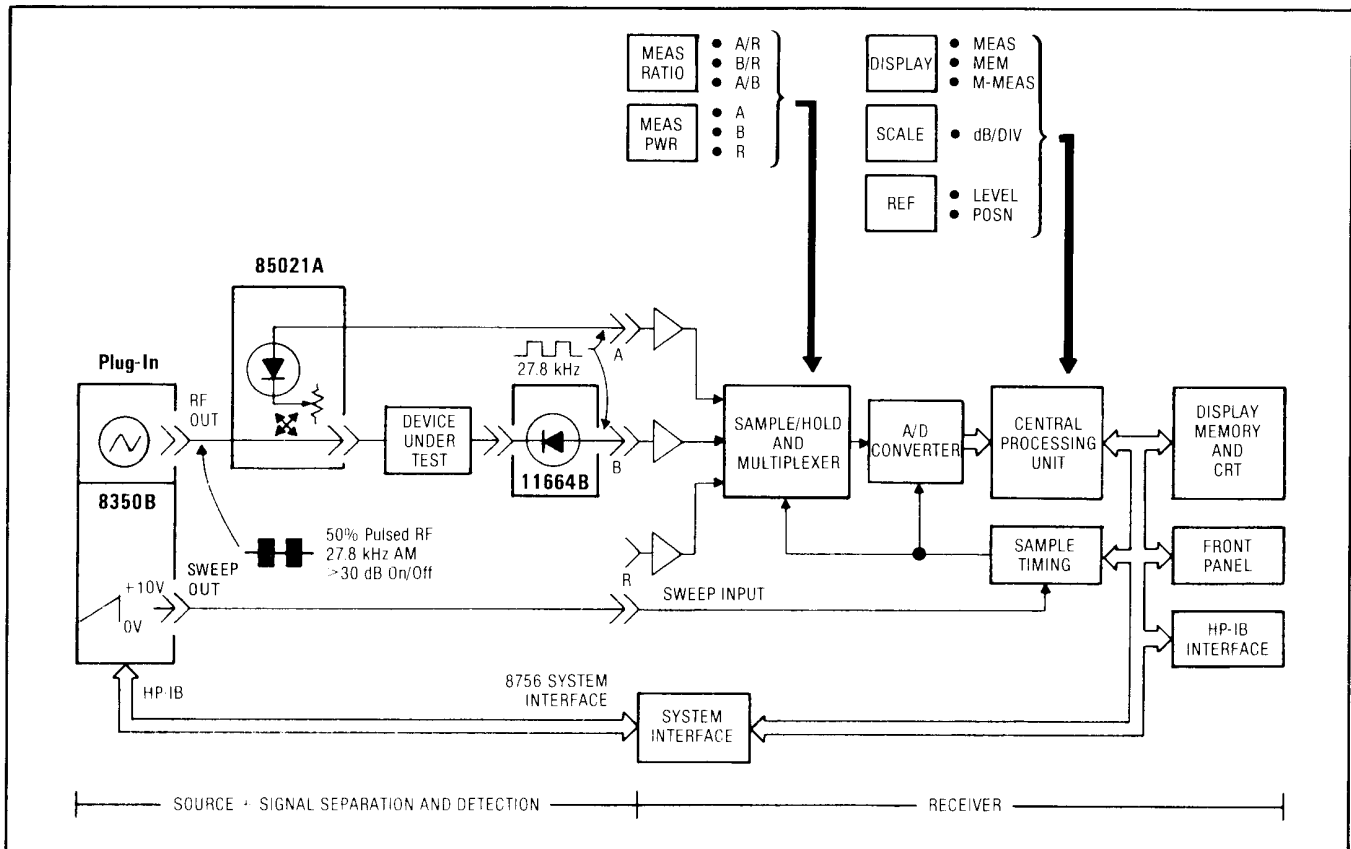

Figure 2. Source, Detectors, and Receiver Simplified Diagram

Signal Separation and Detection Devices

The setup described here to measure absolute or relative transmitted and reflected power uses two detectors. The reflected signal is measured using a directional bridge, which includes the directional device to sample the reflected signal and the diode to detect it. From Figure 3 note that the bridge exhibits about 6 dB loss from the RF input to the Test port and about 6 dB loss from the Test port to the diode. In terms of the measurement, this loss results in about -2 dBm appearing at the detector with the RF input set to +10 dBm and a short circuit at the Test port.

The transmitted signal is measured using a diode detector connected directly to the test device output. This diode, and the diode in the directional bridge, are checked over the range of +10 to -50 dBm to verify that its response matches compensation provided by the standard shaping networks in the receiver. Above +10 dBm measurement non-linearities result due to lack of compensation; the broadband noise floor is at about -52 dBm.

HP Model Number	Freq. Range (GHz)	Test Port Connector
Directional Bridges		
85020A	0.01 - 4.3	Type-N (f)
85020B	0.01 - 2.4	Type-N (f) (75Ω)
85021A	0.01 - 18	APC-7
85021B	0.01 - 26.5	APC-3.5 (f)
85021C	0.01 - 18	Type-N (f)
Detectors		
11664A	0.01 - 18	Type-N (m)
11664A	0.01 - 18	APC-7
Option 001	0.01 - 18	APC-7
11664B	0.01 - 26.5	APC-3.5 (m)
Power Splitter		
11667A	DC - 18	Type-N (f)
11667A	DC - 18	APC-7
Option 001	DC - 18	APC-7

Calibration Standards

The HP 85023-series verification kits contain a high quality adapter to connect the source RF output to the directional bridge RF input, calibration standards, and standard devices. The APC-7® and APC-3.5 kits contain a precision combination short circuit and shielded open circuit. This unit is designed so that the phase response of the short is exactly opposite to the phase response of the shielded open. This produces maximum benefit from the Short/Open Average reflection calibration routine. The standard devices, a 50-ohm termination and a 10 dB pad, provide a convenient means to verify that the system is making good measurements.

HP Model Number	Freq. Range (GHz)	Connector Type
85023A	0.01 - 18	APC-7
85023B	0.01 - 26.5	APC-3.5
85023C	0.01 - 18	Type-N
85023D	0.01 - 2.4	Type-N (75Ω)

® APC-7 is a registered trademark of Bunker Ramo Corporation.

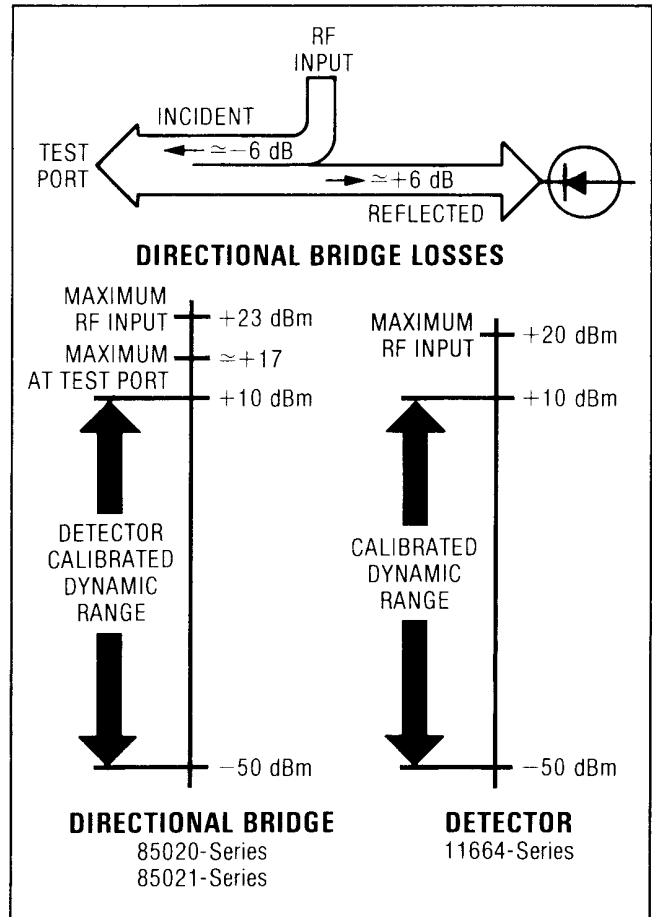

Figure 3. Dynamic Range Considerations

Accessories

High quality adapters (low insertion loss, low return loss, stable in use, and durable) are necessary to achieve accurate, repeatable measurements. Worn or unstable adapters will increase error contributions due to directivity and mismatch effects. Calibrate for measurement using the same adapters and interconnect cables that will be used during measurement. To ensure repeatable measurements the adapters and cables must be clean, in good condition, and properly tightened. Start with the best available adapters and calibration standards then replace them when they become unstable.

Adapter Type	HP P/N
APC-7 to APC-3.5 (m)	1250-1746 (Amphenol) 1250-1762 (Maury)
APC-7 to APC-3.5 (f)	1250-1747 (Amphenol) 1250-1763 (Maury)
APC-7 to Type-N (m)	11525A
APC-7 to Type-N (f)	11524A

Other accessories required for the configuration described here include three standard BNC cables (HP 11170B) between the source and receiver, and two standard HP-IB cables (HP 10833A) connecting the source and plotter to the 8756 System Interface.

MEASUREMENT SETUP

The measurement setup used in this example is shown in Figure 4. It consists of the 8756A, the 8350B with any sweeper plug-in, the directional bridge, the detector, a short circuit, various adapters and cables required to connect the equipment, and a test device with known characteristics. Standard BNC cables are used to make the sweep ramp, blanking, and stop sweep connections. Connect a standard HP-IB cable between the 8756 System Interface and the 8350B HP-IB connectors, then use a second HP-IB cable between the 8350B and plotter HP-IB connectors.

If you have any doubt concerning instrument power requirements or other connections, refer to detailed installation steps in Section II, Installation, of the 8756A Operating and Service Manual.

SYSTEM INTERFACE ADDRESS ASSIGNMENTS

The 8756 System Interface expects the source HP-IB address to be set to 19 and the plotter HP-IB address to be set to 05. These are the standard addresses. If these addresses are different, change the instrument address switches to the expected address.

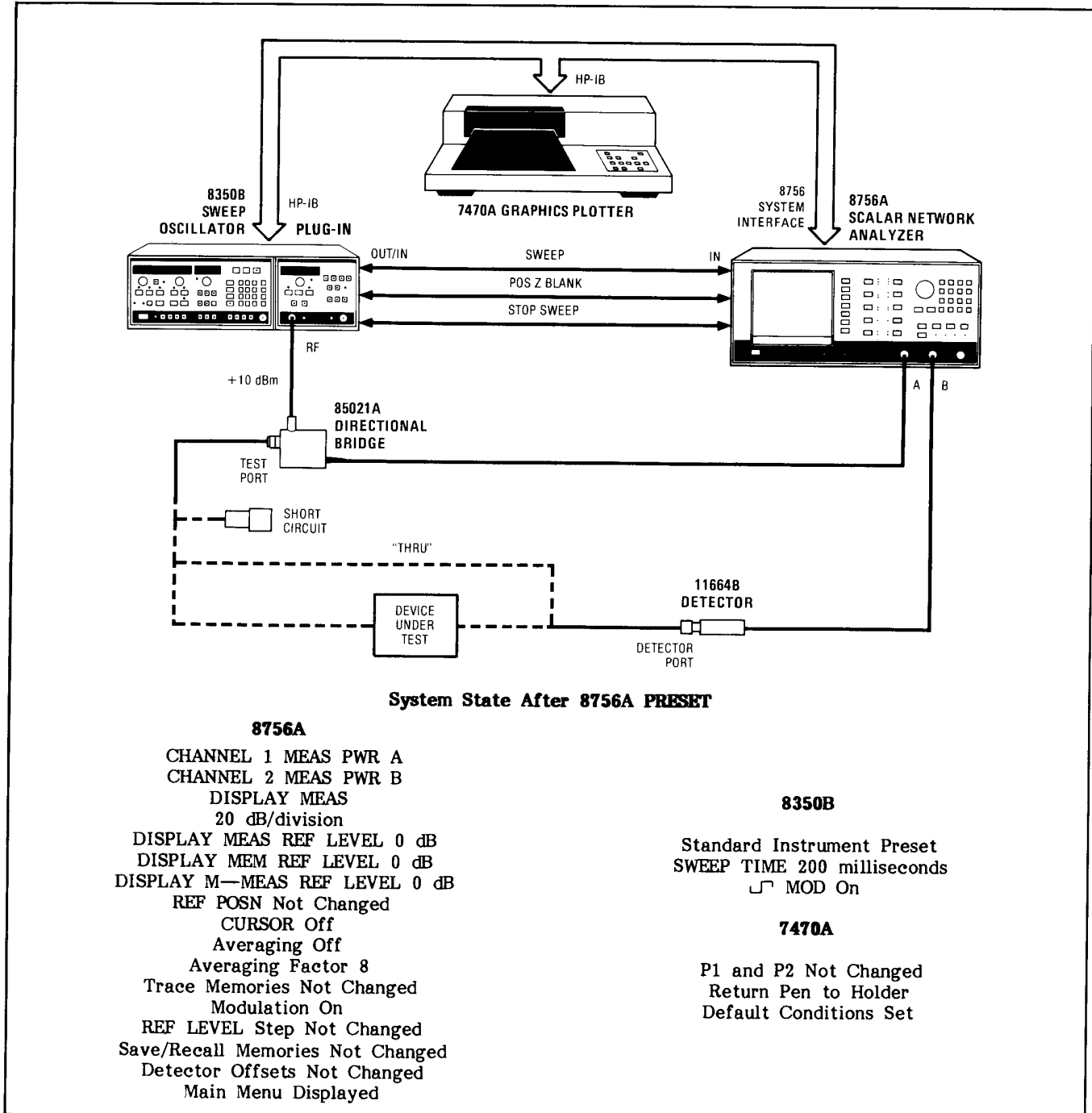

Figure 4. Example of Test Setup

Measurement Setup

- Connect Test Setup (see Figure 4).
- Connect Thru (Connect Detector port to Test port.)
- Press 8756A **PRESET**.
- Channel 2 displays power (dBm) incident at Test port.
- Use 8350B controls to set Start/Stop sweep and Power Level.

Reflection Calibration

- Connect Short Circuit at Test port.
- CHANNEL 1:
 SHIFT DISPLAY (DISPLAY→MEM)
 (store Reflection Reference trace)
 DISPLAY M—MEM
 (view normalized trace).

Transmission Calibration

- Connect Thru.
- CHANNEL 2:
 SHIFT DISPLAY (DISPLAY→MEM)
 (store Transmission Reference trace)
 DISPLAY M—MEM
 (view normalized trace).

Measurement

- Connect Device Under Test.
- Read Return Loss (dB).
 CHANNEL 1:
 SHIFT SCALE (AUTOscale)
 (Autoscale to position trace).
- Press **CURSOR** Menu Key.
- Use knob to position Cursor.
- Read magnitude and frequency from CRT Active Entry area.
- Read Insertion Loss (dB).
 CHANNEL 2:
 SHIFT SCALE (AUTOscale)
 (Autoscale to position trace).
- Use knob to position Cursor.
- Read magnitude and frequency from CRT Active Entry area.

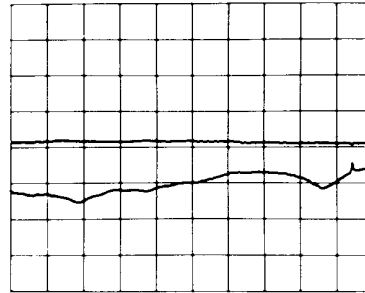

A. After **PRESET** with Thru Connected.

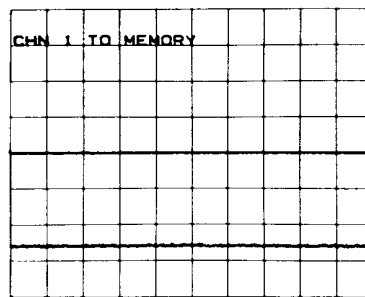

B. After Reflection Calibration.

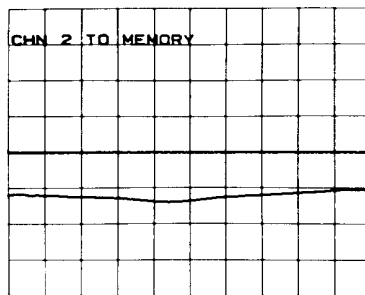

C. After Transmission Calibration.

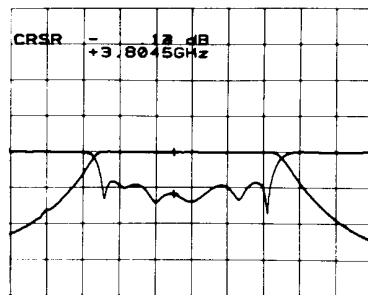

D. Measurement of Filter. (before **AUTOscale**)

Figure 5. Abbreviated Measurement Sequence

INTRODUCTORY MEASUREMENT SEQUENCE

With a basic understanding of the measurement system from the preceding paragraphs, follow this typical operating sequence to measure reflection and transmission characteristics. Figure 5 is an abbreviated version of this procedure. Use a bandpass filter or similar device with known characteristics as the device under test.

Connect Test Setup. See connection diagram. Do not connect the device under test. Connect the directional bridge RF input to the source RF output using a high quality (low loss, stable in use) adapter or cable. If necessary, install high quality adapters at the Test port and the Detector port to mate with the connectors of the Device Under Test. Set the LINE switch of each instrument ON.

System Preset. Press 8756A **PRESET**. This initializes the 8756A, the 8350B, and 7470A to the PRESET state listed in Figure 4.

Select Measurement. 8756A **PRESET** initializes the control settings correctly to measure reflected and transmitted power in dBm for the example setup: CHANNEL 1 **MEAS PWR A** and **DISPLAY MEAS** to measure reflected power; CHANNEL 2 **MEAS PWR B** and **DISPLAY MEAS** to measure transmitted power.

Set CRT Display. If necessary, use the **INTENSITY** and **FOCUS** controls to achieve a bright, sharp image on the CRT.

Labels REF 1 and REF 2 along the left side of the grid identify the position of the Channel 1 and Channel 2 reference lines. Select CHANNEL 1 or CHANNEL 2 **REF POSN**, then use the **STEP** keys to move each reference line to the desired location, usually the center graticule.

Set Frequency Sweep. Use controls on the source to set desired frequency sweep. For example,

START 2 GHz STOP 6 GHz

To test using a CW frequency, select the 8350B Swept CW mode by pressing 8350B **SHIFT**, then **CW**. This mode outputs the 0 to 10V sweep ramp, allowing the 8756A to digitize data.

Other important source settings such as square wave modulation On and sweep time of 0.20 seconds are set by 8756A **PRESET**.

Set Power Levels. Connect the Detector port to the Test port. Channel 2 now displays the test setup transmission signal path frequency response. Press **SHIFT** then CHANNEL 2 **SCALE (AUTOscale)** to position the trace for viewing. Press **CURSOR** to read power in dBm incident at the Test port.

Use controls on the Source to set the desired RF level at the Test port. For example,

POWER LEVEL 10 dBm

Source RF output level after preset depends on the particular plug-in used, usually +10 dBm.

Reflection Calibration. Connect the short circuit at the Test port. The Channel 1 trace displays the test setup reflection signal path frequency response. For CHANNEL 1, press

SHIFT DISPLAY (DISPLAY→MEM)

to store the reflection signal path reference trace. Now select **DISPLAY M—MEM** to view the normalized trace. The cursor should read near 0 dB at all frequencies.

With **DISPLAY M—MEM** selected, the displayed trace represents the current measurement trace subtracted from the stored reference trace. When the device under test is connected, its response is displayed relative to the 0 dB Return Loss of the short circuit.

Transmission Calibration. Connect the Detector port and the Test port together. If the adapters required to connect the device under test do not mate, install a Detector port adapter which will mate with the Test port adapter to make the thru connection. For CHANNEL 2, press

SHIFT DISPLAY (DISPLAY→MEM)

to store the transmission signal path reference trace. Now select **DISPLAY M—MEM** to view the normalized trace. The cursor should read near 0 dB at all frequencies.

When the device under test is connected, its response is displayed relative to the 0 dB Insertion Loss of the thru connection.

Connect Device Under Test. See connection diagram. If the Detector port adapter was switched to make the thru connection, install the correct adapter on the Detector port.

Read Measured Value. To read Return Loss, select CHANNEL 1 **AUTOscale (SHIFT then CHANNEL 1 SCALE)** to position the trace, then press the **CURSOR** menu key and use the knob to move the cursor to any point on the trace.

To read Insertion Loss, select CHANNEL 2 **AUTOscale** to position the trace, then use the knob to move the cursor to any point on the trace.

FRONT PANEL OPERATION

To begin familiarizing yourself with the front panel, note that it is divided into four areas: the CRT with seven menu keys directly to the right, the CHANNEL area, the ENTRY area, and the INSTRUMENT STATE area.

Operate the CHANNEL keys to select measurement mode and display functions. Indicators next to each key illuminate to show current selections. Pressing a key activates the function for the channel and lights the indicator next to the key. Repeatedly pressing the multifunction keys **MEAS RATIO**, **MEAS PWR**, **DISPLAY**, or **REF** advances the indicator one position to select the function. For example, if the **DISPLAY MEAS** indicator is lit, pressing **DISPLAY** once selects **DISPLAY MEM**; another press selects **DISPLAY M—MEAS**; another press selects **DISPLAY MEAS**.

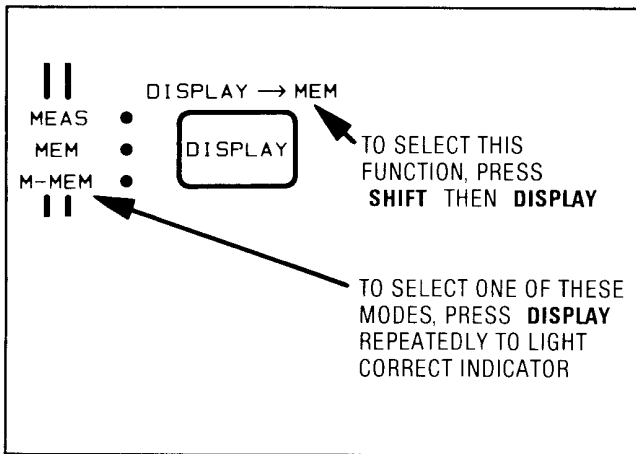

Figure 6. CHANNEL Keys Operation

Use the blue **SHIFT** key in the INSTRUMENT STATE area to select one of the additional functions labeled in blue above the CHANNEL keys. For example, press **SHIFT** then CHANNEL 1 **MEAS RATIO** (**CHAN OFF**) to turn Channel 1 Off. All CHANNEL 1 indicators will go out and CRT information relating to the Channel 1 measurement will disappear. Press any CHANNEL 1 key to turn the channel On.

The **SAVE** and **RECALL** keys in the INSTRUMENT STATE area use nine 8756A registers to save front panel control settings of both the receiver and sweeper. With the 8756 System Interface connected to the sweeper, press **SAVE** then a digit 1 through 9 on the numeric pad to save the 8756A and 8350B current front panel settings. Press **RECALL** then a digit 1 through 9 to recall the saved state. Selecting Save or Recall on either the 8756A or the source (8350B or 8340A) will save or recall the state of both instruments.

The CRT displays the grid on which the measurement data is plotted, the currently selected measurement traces, and other information describing the measurement. When a measurement channel is On, the Mode Labels at the top of the grid show the **MEAS RATIO** or **MEAS PWR** selection, the cursor value (if **CURSOR ON**),

the display units per division scale factor, and the reference line value. Frequency labels along the bottom of the grid display the sweeper start and stop frequencies (if 8350B or 8340A used) and the cursor frequency (if **CURSOR ON** selected).

The labels REF 1 and REF 2 on the left side of the grid identify the reference line position for measurement channels 1 and 2, respectively. The reference line is the position from which scale factor changes expand or contract the trace. After **PRESET** the reference line value is 0 dB or 0 dBm and the trace is positioned above or below the reference line depending upon whether the response is positive or negative. **REF** controls the reference line position and value. Select **REF LEVEL** then use the knob, **STEP** keys, or numeric entry followed by **dB** to change its value. Select **REF POSN** then use the knob or **STEP** keys to move the reference line to the desired position. The Cursor value is not changed by changes to reference line value or position.

The Active Entry area in the upper left corner of the grid displays the currently selected active function. For example, pressing CHANNEL 1 **SCALE** displays the current dB per division scale factor for Channel 1 as the active function, and causes the Channel 1 Mode Labels and measurement trace to intensify thus indicating that the active function displayed relates to Channel 1.

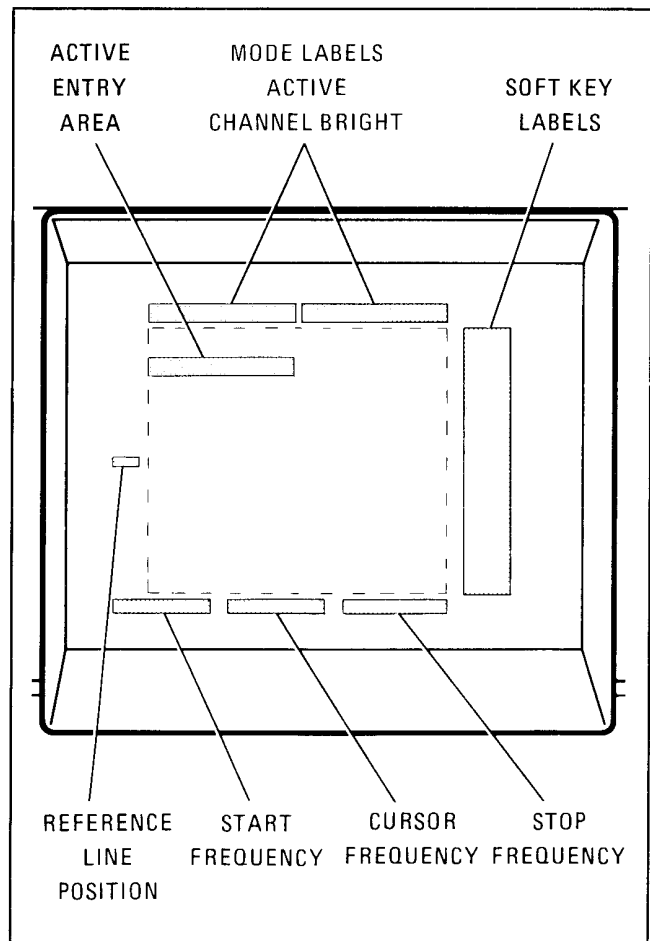

Figure 7. 8756A CRT

The ENTRY area provides the numeric and units keypad, the knob, and the **STEP** keys used with **SCALE** and **REF**, and other functions, to enter data. For example, pressing **SCALE** lights the **dB/DIV** indicator and activates the ENTRY area allowing you to change the displayed dB per division scale factor for the selected measurement channel. Use the **STEP** keys to change the displayed scale factor, or enter the desired dB/division by pressing the numeric keys then terminating the entry by pressing the **dB** units key.

The seven keys to the right of the CRT allow use of screen-labeled "soft-keys" which extend instrument capabilities by adding functions without adding front

panel complexity. The basic menu structure is shown in Figure 8. After instrument power On, after the **PRESET** key is pressed, and any time the **MAIN MENU** key is pressed, the Main Menu is displayed. Pressing any of the soft keys either executes the function named adjacent to the key on the CRT or presents another set of menu labels. For example with the Main Menu displayed, pressing the key labeled **CURSOR** turns the cursor On and presents the Cursor Menu with functions such as **CURSOR ON/OFF** and **CURSOR MAX 1** (moves the 8756A cursor to the maximum value on the Channel 1 trace). The complete menu structure is shown in Figure 22 at the rear of this note. Use of the menu is described in following paragraphs.

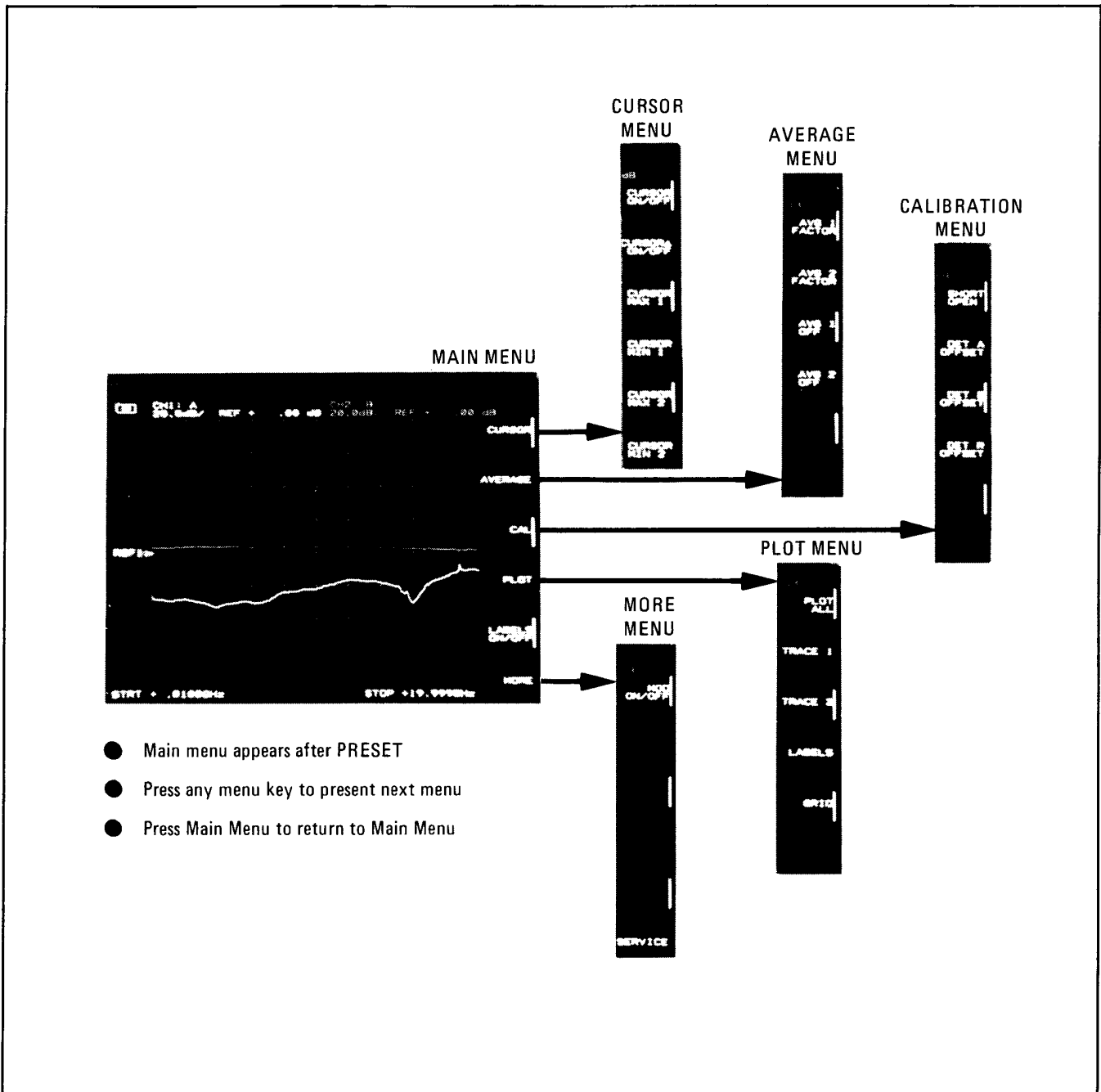

Figure 8. 8756A Main and First Level Menus

READ MEASURED VALUE (CURSOR Menu)

To read the measured value using the 8756A measurement cursor, press the **CURSOR** menu key, then use the knob to move the cursor (+ symbol) to the desired position on the trace. When the cursor is On, the current value of the active channel trace at the cursor position is displayed in the CRT Active Entry Area. The cursor dB value is also displayed in the Mode Labels area above the grid, and the frequency value is displayed centered at the bottom of the grid. The cursor value is always displayed with 0.01 dB resolution regardless of the scale per division setting or reference line value.

As shown in the following table, the value read by the 8756A cursor depends upon the measurement and display mode selections. With **DISPLAY MEAS** selected,

the cursor value either represents the power difference in dB between the two selected inputs (**MEAS RATIO**) or the absolute power in dBm at the selected input (**MEAS PWR**). With **DISPLAY M—MEM** selected, the cursor value represents the power difference in dB between the current measurement trace and the stored reference trace (stored by **DISPLAY—>MEM**).

Because the cursor always reads the true measured value, it is unnecessary to know the value or position of the reference line in order to determine the value at a point on the trace. This makes the **AUTOscale** function (**SHIFT** then **SCALE**) very valuable. Selecting **AUTOscale** centers the trace on the grid allowing you to move the cursor to any point on the trace and read the actual measured value with full resolution.

8756A Cursor Measured Value.

	DISPLAY MEAS	DISPLAY M—MEM
MEAS RATIO	Power ratio (dB) A/R, B/R, A/B	Relative Power (dB) (current - stored) measurement - trace
MEAS PWR	Power (dBm) A, B, R	

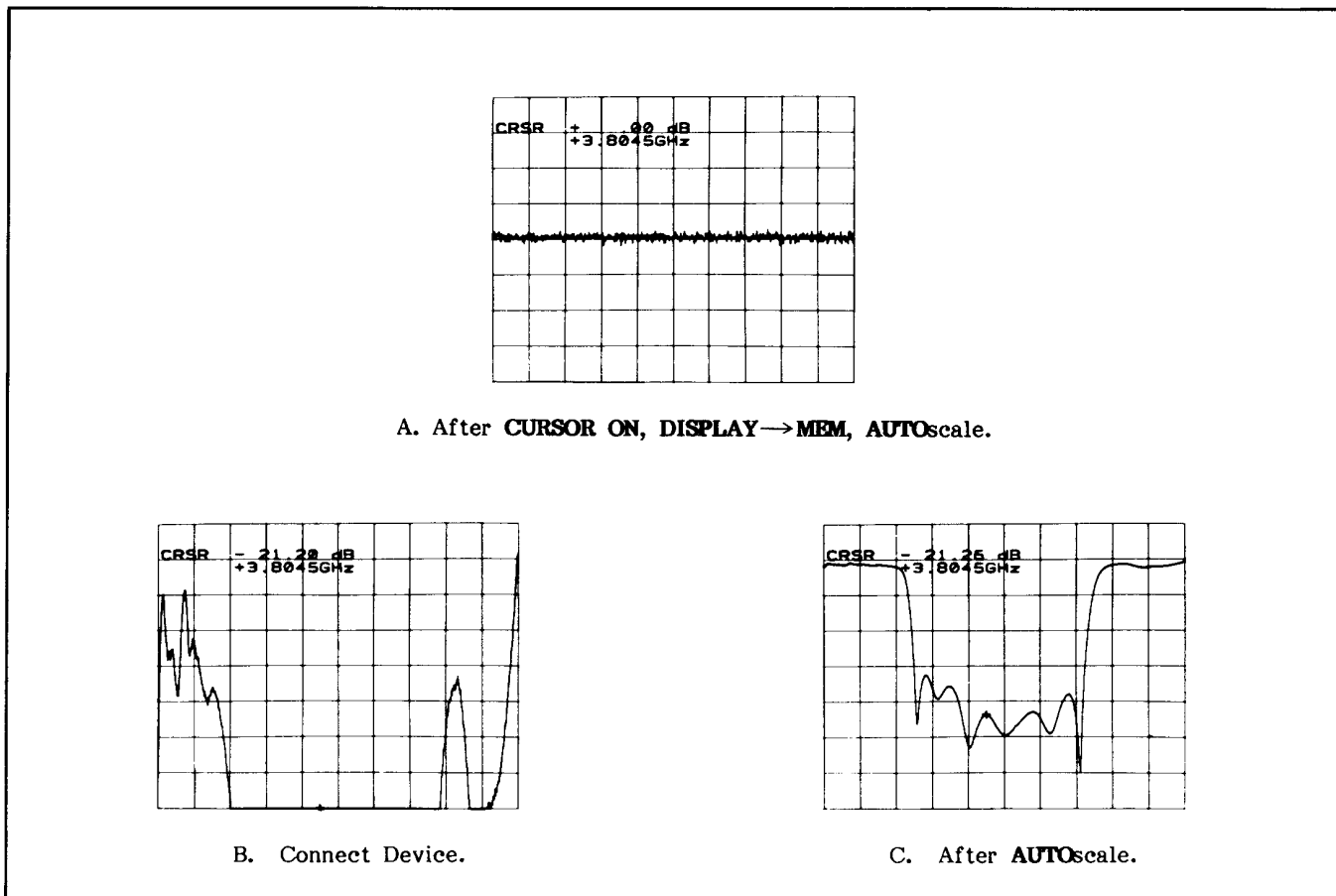
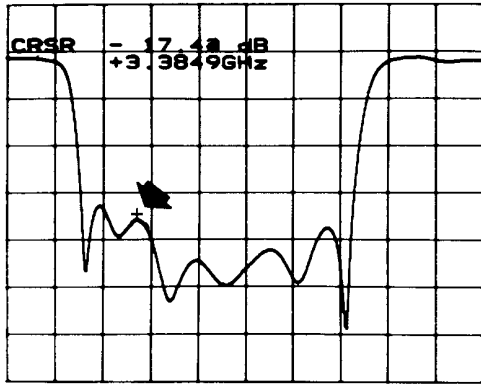

Figure 9. Using **AUTOscale** to Read Measured Value

These cursor functions can simplify many measurement procedures. For instance, as shown in Figure 10, to measure the difference between maximum and minimum values on the trace, use the sequence **CURSOR**, **CURSOR**

MAX, **CURSOR Δ ON**, then **CURSOR MIN**. The value displayed in the Active Entry area will be the dB difference between the maximum and minimum trace values.



A. CURSOR ON.

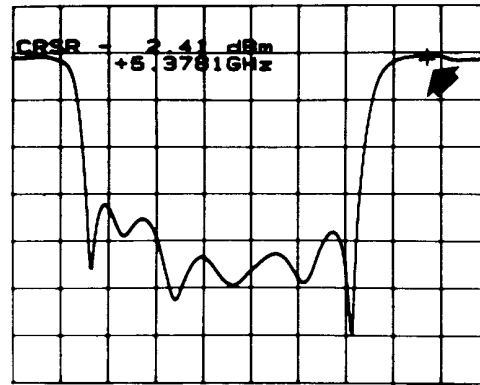

B. After CURSOR MAX.

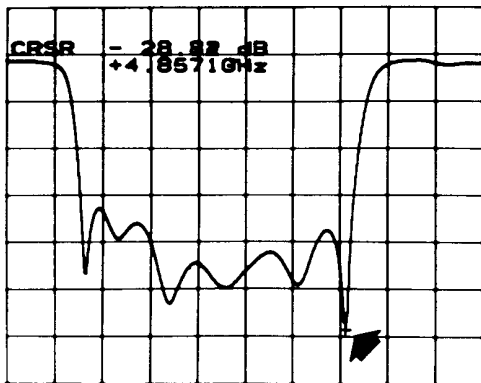

C. After CURSOR MIN.

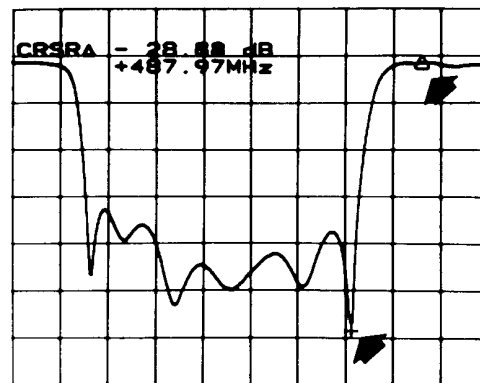

D. After CURSOR MAX, CURSOR Δ ON, CURSOR MIN.

Figure 10. 8756A Cursor Modes

Familiarize yourself with control of the cursor with any trace displayed. Press the Main Menu **CURSOR** key to present the Cursor Menu shown below.

CURSOR Menu

CURSOR ON/OFF ● Press **CURSOR ON/OFF** to switch the Cursor On and Off. With Cursor On, the + symbol appears on the trace.

CURSOR Δ ON/OFF Use the knob to move the + to any point on the trace. The magnitude and frequency value at the + are displayed on the grid. The value for the active channel is displayed in the Active Entry area.

CURSOR MAX 1 ● Press **CURSOR MAX 1**. The + moves to the Channel 1 trace maximum value.

CURSOR MIN 1 ● Press **CURSOR MIN 1**. The + moves to the Channel 1 trace minimum value.

CURSOR MAX 2 ● Press **CURSOR Δ ON/OFF**. The Δ symbol appears at the + position. The Active Entry area now displays the magnitude and frequency difference between Δ and +.

CURSOR MIN 2 Use the knob to move the + to any point on the trace; the Δ position remains unchanged.

● Press **CURSOR MAX 1** or **CURSOR MIN 1**. The + moves to the Channel 1 maximum or minimum value; the Δ position remains unchanged.

● Press **CURSOR Δ ON/OFF** to turn Off Cursor Δ.

● Press **MAIN MENU** to return to the Main Menu.

Markers generated by the 8350B are displayed as ovals on the trace. Use the source marker selection keys and knob to control these markers. The active 8350B marker, the blinking 8350B marker key, is identified by a flag on the marker. With 8756A **CURSOR ON**, the source markers are shown on the trace but their values

are not displayed. With 8756A **CURSOR OFF**, the active source marker value is displayed in the 8756A Active Entry Area, the Mode Labels area, and in the Frequency Labels area. All standard 8350B marker modes may be used.

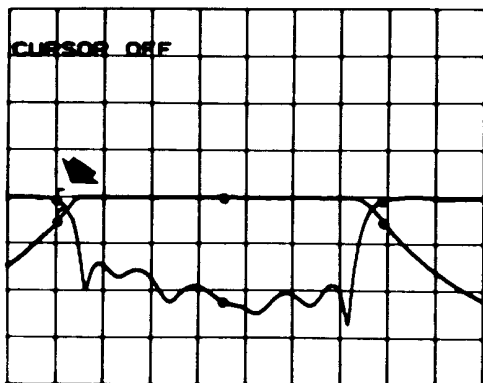

A. After 8756 **CURSOR OFF**, 8350B MKR 1, 2, 3 On, MKR 1 Active.

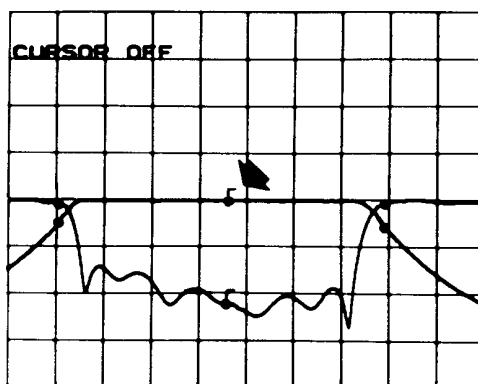

B. MKR 2 Active.

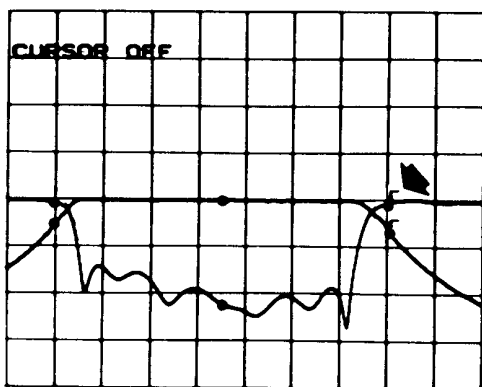

C. MKR 3 Active.

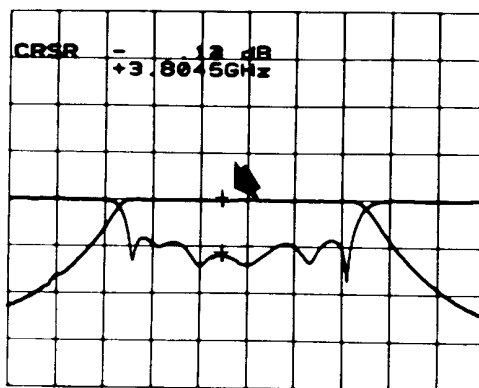

D. 8756 **CURSOR ON**.

Figure 11. Read Magnitude and Frequency Using 8350B MKR and 8756A Cursor

SELECT AVERAGING FACTOR (AVERAGE Menu)

Digital averaging used in the 8756A functions similarly to a video (post-detection) low pass filter to eliminate random noise fluctuations in the displayed trace. This technique improves accuracy and meaningful resolution in network measurements by effectively increasing the signal-to-noise ratio of calibration and measurement traces.

Averaging is accomplished by computing the exponential running average in which the new measurement data is weighted $1/n$ where n is the selected averaging factor. For example, if an averaging factor of 128 is selected, the new measurement will have a weight of $1/128$ and

the previous measurement will be weighted $127/128$. Given a trace with a small signal-to-noise ratio this technique converges to the final value exponentially: to 98% of the final value in $4n$ sweeps, to 87% in $2n$ sweeps, and 67% in $1n$ sweeps. Thus, to use averaging to full advantage, especially with large averaging factors, be sure to allow a sufficient number of sweeps to allow the trace to settle.

Assuming a very noisy trace, an averaging factor of 8, and sweep time of 150 milliseconds, you should allow at least 32 sweeps or about 5 seconds for the trace to converge fully. In usual applications there is no practical value in waiting for more than $4n$ sweeps to produce the final value.

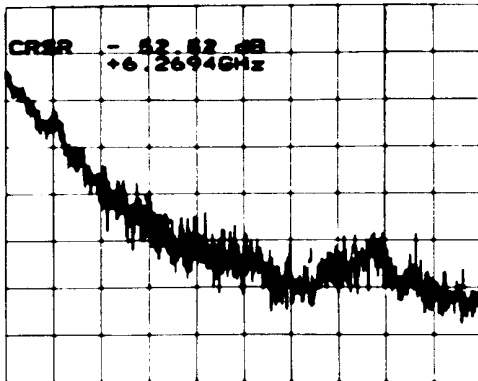

A. Averaging Off.

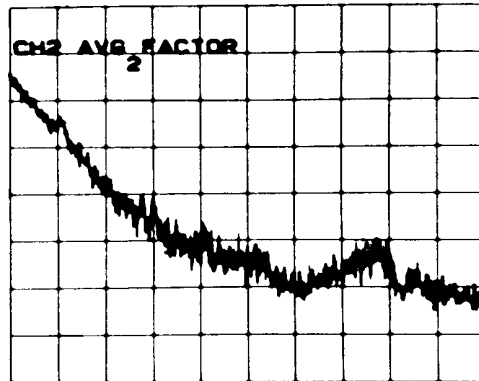

B. Averaging Factor 2.

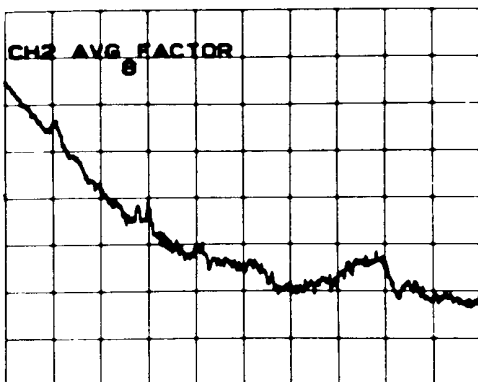

C. Averaging Factor 8.

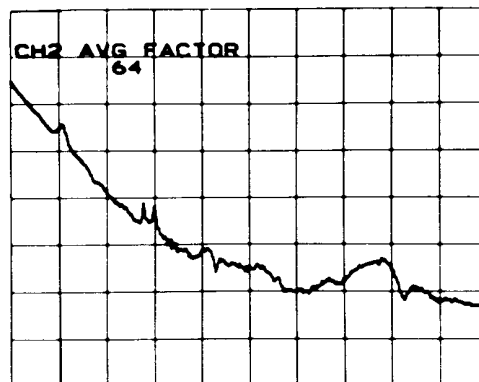

D. Averaging Factor 64.

Figure 12. Examples of Plotter Output

Familiarize yourself with control of trace averaging with any trace displayed. Averaging On/Off and averaging factors are selected independently for Channel 1 and Channel 2. Press the main menu **AVERAGE** key to present the Average Menu shown below.

Average Menu

- AVG 1 FACTOR ● Use **AUTO**scale (**SHIFT** then **SCALE**) to position trace.
- AVG 2 FACTOR ● Select Channel 1 Averaging On by pressing **AVG 1 FACTOR**. Current Channel 1 averaging factor is displayed in CRT Active Function Area.
- AVG 1 OFF ● Use the **STEP** keys or knob to change Channel 1 averaging factor. When desired averaging factor is selected, terminate averaging factor selection by pressing the **ENT** key.
- AVG 2 OFF ● Turn Channel 1 averaging Off by pressing **AVG 1 OFF**.
- When the desired averaging factors are selected, press **MAIN MENU** to terminate averaging factor selection and return to the Main Menu.

Observe the trace as the averaging factor is changed and averaging is turned On and Off. With averaging On the cursor always reads the averaged value. For large averaging factors the trace converges slowly to its final value. Start with a small factor then increase in steps to the maximum factor required for the measurement.

MEASUREMENT CALIBRATION (CAL Menu)

Scalar Network Analyzers measure the magnitude response of the device under test relative to the magnitude response of a known standard. In a typical measurement sequence, the standard is connected at the reference plane (the point at which the test device will be connected), then its response is stored. Now the test device is connected and the network analyzer displays the magnitude difference between the response of the standard and the response of the test device. This calibration process is termed Normalization. The frequency response of the device under test is normalized to the response of the measurement calibration standard. Thus, frequency response variations of the test setup are automatically removed from the measurement making it unnecessary to draw calibration lines on the CRT.

Selecting **DISPLAY→MEM** (**SHIFT** then **DISPLAY**) causes the current measurement trace to be stored as the reference trace. Selecting **DISPLAY MEM** displays the stored reference trace. Selecting **DISPLAY ←MEM** displays the result of the point by point subtraction of the current measurement trace from the stored reference trace. Each measurement channel has dedicated memory for storage of one reference trace. The reference trace is always stored at full resolution and automatically scaled to the selected scale per division, making it unnecessary to concern yourself with potential scaling errors. In the **DISPLAY M←MEM** mode, the cursor always reads the normalized value.

To achieve best accuracy, do not change the start and stop frequencies or source power level after the reference trace is stored. Also, calibrate for measurement using the same adapters and interconnect cables that will be used during measurement. Changing the frequency range, power level, or components in the test setup after the reference trace is stored will result in measurement errors because the reference trace will not represent the frequency response of the altered test setup. If the test setup changes between calibration and measurement, either reconnect the standard and store a new reference trace, or select **DISPLAY MEAS** to view the uncorrected trace.

To ensure good repeatability the Test port and Detector port connectors must be clean, in good condition, and properly tightened. Again, if the test setup is not stable during the test and from connection to connection, the actual frequency response of the test setup will not be removed from the measurement of the device under test.

The usual calibration standard for transmission measurements is a "thru" (connect the points at which the test device will be connected). Since the insertion

loss between the Test port and the Detector port should be 0 dB, a convenient reference point is obtained. Making a thru connection with **DISPLAY MEAS** selected displays the transmission signal path frequency response of the measurement system. If the test device connectors make it impossible to connect the thru then the test device without switching adapters, switch between Detector port adapters with similar insertion and return loss characteristics.

The usual calibration standard for reflection measurements is a short circuit connected at the reference plane (the point at which the test device will be connected). A short circuit reflects all incident power, so a convenient 0 dB reference level is obtained. Connecting the short circuit at the Test port with **DISPLAY MEAS** selected displays the reflection signal path frequency response of the measurement system. Always calibrate for reflection using the same adapter that will be used for the measurement.

Mismatches and leakages in the test setup cause calibration and measurement errors that vary as a function of the reflection and transmission characteristics of the device being measured. For example, connecting a short circuit at the Test port produces a trace which includes variations due to losses in the test set as well as variations due to mismatch and bridge directivity effects between the measurement system and the short circuit. Some percentage of the signal reflected by the short circuit is re-reflected by mismatches in the test setup. This causes the power incident at the Test port to vary depending upon interactions between the incident signal and the re-reflected signal. The result of this interaction is that the reference trace does not truly represent the actual reflection signal path frequency response.

Using proper standards, the short/open average reflection calibration sequence reduces measurement uncertainty for all reflection measurements. By averaging the responses of the short circuit and the shielded open circuit, mismatch effects are cancelled to produce a more accurate reflection signal path frequency response reference trace than if either standard were used alone.

To obtain maximum benefit from this technique, the short circuit and the shielded open circuit must exhibit equal return loss (0 dB), and the phase response of the shielded open must be opposite (180 degrees difference) to the short circuit over the entire frequency range of interest. If the standards do not have these characteristics, improvements in measurement calibration accuracy are minimal and, in fact, may actually introduce additional errors in the reference trace.

Press the Main Menu **CAL** key to present the Cal menu shown below.

Cal Menu

SHORT
OPEN

● Press **SHORT/OPEN** to start the Short/Open reflection calibration sequence. Although the short circuit is the best single standard for scalar reflection calibration, the response contains errors due to source match and directivity. Source match effects on the reflection calibration trace are removed by averaging the response of a second standard, the shielded open circuit. This technique produces a more accurate value for reflection signal path frequency response. Refer to paragraph Reflection Measurements in this note for more information.

DET A
OFFSET

DET B
OFFSET

DET R
OFFSET

● **DET A OFFSET**, **DET B OFFSET**, and **DET R OFFSET** keys provide a means to enter detector calibration factors. Select the network analyzer input port then enter a dB value using the knob (0.01 dB resolution), the step keys (0.05 dB/step), or the numeric keys (0.01 dB resolution), then press the **dB/dBm** units key. This offset is automatically applied to the displayed trace. For typical measurements this factor is set at 0.00.

Use the detector offset capability to produce better accuracy in power measurements when appropriate calibration facilities are available. If careful comparison with a power meter shows the power measured by the 8756A to be offset by a fixed value over the frequency range of interest, then add or subtract a value to make the measurements agree.

DISPLAY FUNCTIONS (LABELS ON/OFF)

Pressing the **LABELS ON/OFF** key does not present a next level menu. It turns On and Off all CRT labels except the soft-key labels.

HARDCOPY OUTPUT (PLOT Menu)

Use the Plot Menu to control hardcopy output to an HP 7470A or 9872C HP-IB digital plotter. To familiarize yourself with the Plot Menu, press the Main Menu **PLOT** key to present the menu shown below. Load a blank or pre-printed form, set desired P1 and P2 locations, then select one of the menu functions.

Plot Menu

- PLOT ALL** ● Press **PLOT ALL** to plot the grid, traces (if Channel On), and labels.
- TRACE 1** ● Press **TRACE 1** to plot trace 1 only.
- TRACE 2** ● Press **TRACE 2** to plot trace 2 only.
- LABELS** ● Press **LABELS** to plot mode and frequency labels only.
- GRID** ● Press **GRID** to plot the grid only.

If the message **NO PLOTTER AVAILABLE** appears, the plotter power is Off, is not connected to the 8756 System Interface, or the plotter HP-IB address is not 705. If the message **PLOTTER NOT READY** appears, the plotter is not ready for plotting (paper not loaded or other error condition). Correct the problem, then press the key again.

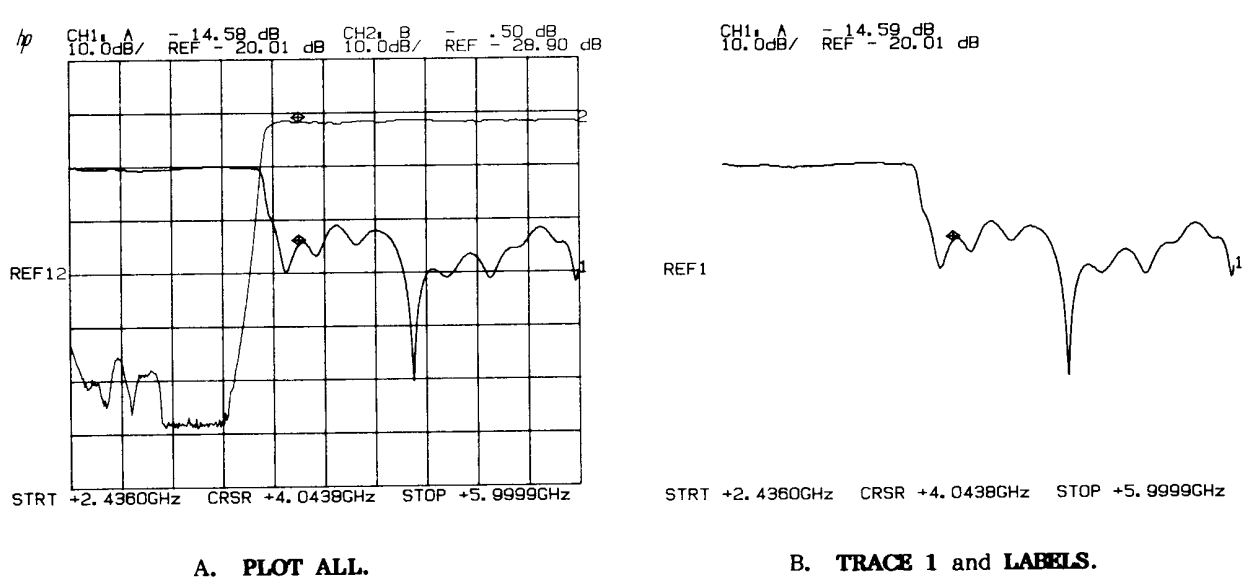

Figure 13. Examples of Plotter Output

ADDITIONAL MENU FUNCTIONS (MORE Menu)

To familiarize yourself with this menu, press the Main Menu **MORE** key to present the menu shown below.

More Menu

MOD
ON/OFF

- **MOD ON/OFF** controls the 27.8 kHz square wave modulation signal at the 8756A rear panel MODULATOR DRIVES connectors. Use this as the modulation signal when external modulators are used in the setup.

With **MOD OFF** selected, the HP 11665B Modulator is biased for minimum insertion loss.

SERVICE

- Press **SERVICE** to present the first level Service Menu, which provides automated diagnostic and troubleshooting procedures. Refer to Section VIII, Service, in the 8756A Operating and Service Manual for further information.

TRANSMISSION MEASUREMENTS

The 8756A can measure transmission using Channel 1 or Channel 2 using either a single detector (**MEAS PWR**) or two detectors (**MEAS RATIO**).

A problem often encountered in evaluating the accuracy of transmission measurements is that of measuring non-insertable devices. A non-insertable device has input and output connectors of types which will not mate. This means that it is necessary to change components in the setup between calibration and measurement. You may use a "bullet" (male-to-male) or "barrel" (female-to-female) adapter to make the thru, or you may switch one adapter to make the thru. When the device is measured, the normalized trace will be in error by the difference in frequency response characteristics between the calibration and measurement configurations.

In most situations the worst choice is to use the bullet or barrel during calibration. Better results will be obtained by switching between matched adapters. If you are only making transmission measurements it usually does not matter which adapter, the Test port or the Detector port, is switched to make the thru. If you are also measuring reflection, only the Detector port adapter should be switched.

Whatever the test setup, the ideal procedure is to calibrate using the same adapters and cables that will be used for the measurement. If it is necessary to change adapters between calibration and measurement,

best accuracy is achieved by switching between Detector port adapters having equal insertion and return loss characteristics.

Transmission Test Setup

The simplest transmission setup is to connect the detector directly to the source output for calibration, then insert the device under test between the source and detector for measurement. A potential problem when connecting the detector directly to the source output is error due to source power variations caused by source mismatch effects.

The setup shown in Figure 14 adds a power splitter and detector to obtain power for the R (reference) input. Select **MEAS RATIO B/R** to view the response. This ratio technique provides an improvement in effective source match characteristics of the setup by removing stimulus power variations common to both the reference (R) and test (B) inputs. This technique is especially appropriate for measurement of low insertion loss devices and for devices with poor input match.

For most applications (assuming a leveled source, a signal separation device with good source match, and a low reflection test device), this ratio technique is not mandatory to achieve high accuracy. If the source is not leveled, if a long cable is used to connect the source to the directional bridge, or if the power level varies between calibration and measurement (such as in gain compression tests), the ratio technique must be used.

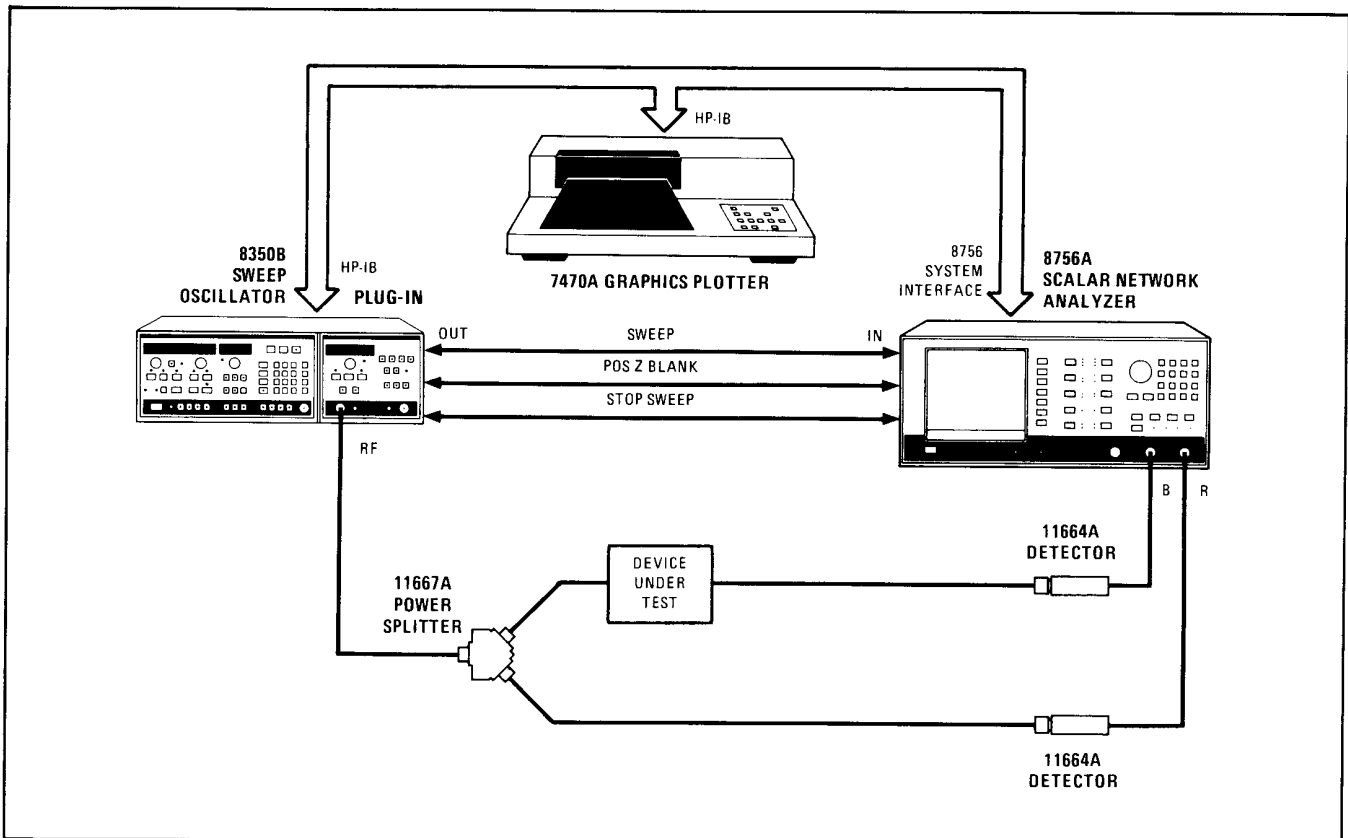

Figure 14. Transmission-Only Measurement Ratio Setup

Insertion Loss or Gain Measurements.

This sequence lists the steps for a typical insertion loss or gain measurement.

Calibration:
MEAS PWR B or **MEAS RATIO B/R**,
DISPLAY MEAS.
 Connect Thru.
 Set Start/Stop Frequencies,
 Set Power Level.
DISPLAY→**MEM**,
DISPLAY M—**MEAS**.
 Measurement:
 Connect test device.
CURSOR,
 Position Cursor,
 Read magnitude and frequency.

Calibration sets a zero dB reference with the thru connection. After connecting the test device, a negative measured value indicates insertion loss; a positive value indicates gain.

Relative Measurements.

To measure the difference between two points on the trace, select **CURSOR ON**, position the cursor to the first point, then select **CURSOR Δ**. Moving the cursor to a second point using the knob, **CURSOR MAX**, or **CURSOR MIN** displays the magnitude and frequency difference between the two points. The frequency difference is always displayed as a positive number; the magnitude difference is displayed as positive or negative depending upon whether the second value is greater than or less than the first value, respectively.

This sequence measures 3 dB frequencies of filter.

CURSOR,
CURSOR MAX 2,
CURSOR Δ ON.
 Move cursor to lower 3 dB frequency.
CURSOR Δ OFF.
 Read cursor frequency.
CURSOR Δ ON.
 Move cursor to upper 3 dB frequency
 by adjusting cursor to read 0.00 dB.
 Read frequency difference directly.
CURSOR Δ OFF
 Read cursor frequency.

In procedures that measure an exact value, such as -3.00 dB, notice that you may not be able to place the cursor exactly on the 3 dB frequency point. Magnitude values are digitized with 0.003 dB resolution in **MEAS POWER, DISPLAY MEAS** mode, and 0.006 dB resolution in **MEAS POWER, DISPLAY M—MEAS** and **MEAS RATIO, DISPLAY M—MEAS** modes. In all cases the magnitude value is rounded to 0.01 dB resolution for display. However, the trace is digitized at 401 points during the sweep. Thus, if the frequency sweep is 1 GHz, the frequency resolution is 1000/401, or about 2.5 MHz per increment. Moving the cursor one increment results in about 2.5 MHz change in the frequency reading. Thus, if the cursor must be placed exactly at 3.00 dB, or any precise value, it may be necessary to reduce the frequency sweep.

Matching

Matching the transmission characteristics of two test devices using a single measurement channel is a simple procedure using normalization. First connect the standard device and select **DISPLAY**→**MEM** and **DISPLAY M—MEM**. The trace should be a flat line. Now connect the test device. As shown in Figure 15, the trace shows the difference between the standard device and the test device. When the trace is flat, the response of the test device is the same as the response of the standard device.

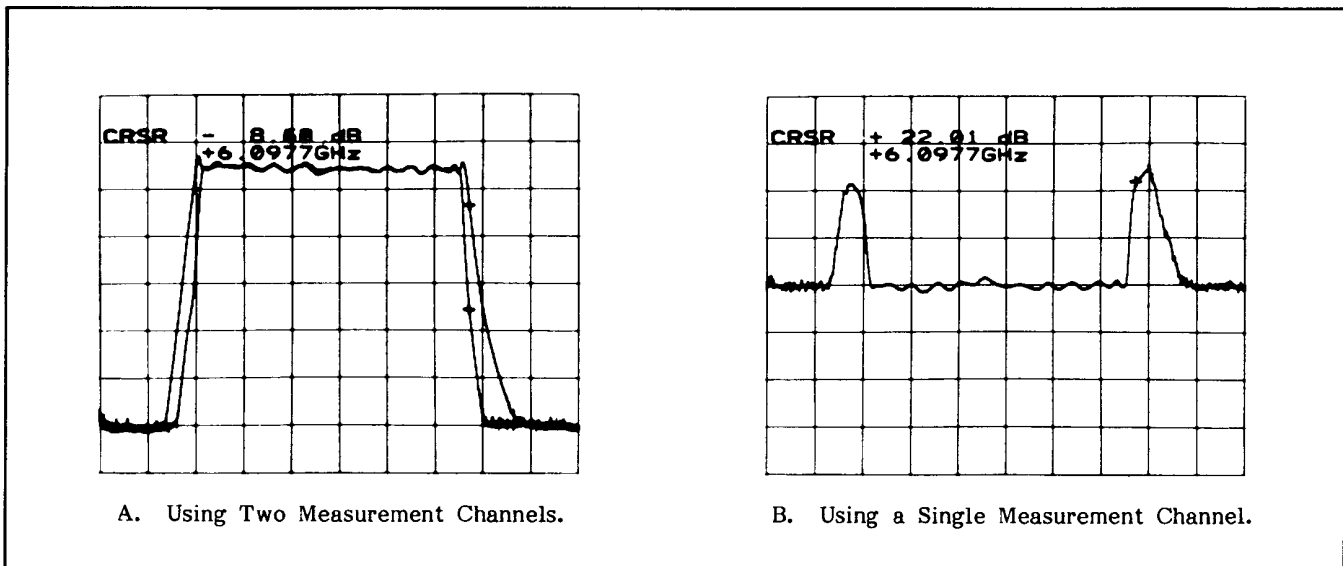

Figure 15. Matching Devices

Using Alternate Sweep.

The Alternate Sweep capability of the 8350B and 8340A sources is a simple means to simultaneously display two independent frequency sweeps. The alternate sweep mode described here uses the Save and Recall functions of the 8756A and 8350B to produce a sweep of one width for display as the Channel 1 measurement trace, and a different sweep width for display as the Channel 2 measurement trace. Use the following sequence to define conditions for alternated sweep.

Channel 2: **CHAN OFF.**
Select Channel 1 measurement.
Set frequency sweep for Channel 1.
SAVE 1.
Channel 1: **CHAN OFF.**
Select Channel 2 measurement.
Set frequency sweep for Channel 2.
SAVE 2.
RECALL 1.
Press 8350B **ALT n** then 2.
Proceed with Calibration and Measurement Sequence.

The Start, Stop, and cursor frequencies for Channels 1 and 2 are displayed in the frequency labels area beneath the grid. The Active Channel is bright. To exit the Alternate Sweep mode, press to extinguish the 8350B **ALT n** key.

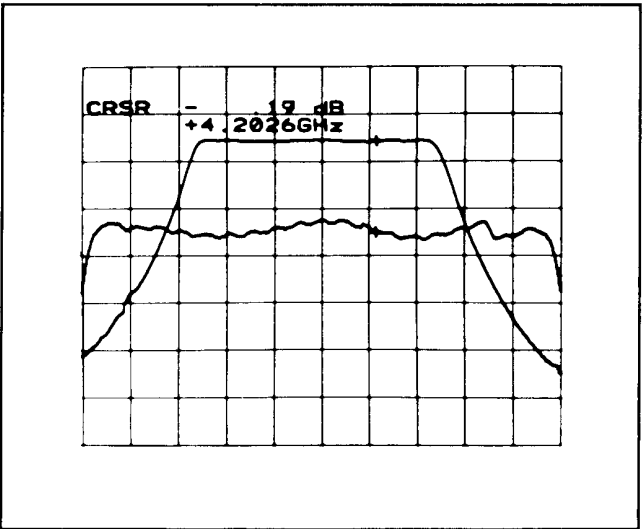

Figure 16. 8350B Alternate Sweep

Measuring Active Devices.

A typical transmission and reflection measurement on a passive device uses an arbitrary input power level. Stimulus power to the device under test is set so that maximum dynamic range is achieved. For active devices (devices with gain), it is usually necessary to measure the response to varying input levels. This means that a ratio setup must be used to obtain best results. In general, the test setup to measure devices with gain is the same as to measure insertion loss. If the device under test power output exceeds +10 dBm, it will be necessary to install an attenuator at the detector input during calibration and measurement.

RF modulation required for the detectors is usually provided by internal capabilities of the 8350B source. For test devices that cannot accept the 27.8 kHz modulation frequency, there are two potential solutions.

Amplifiers with high gain at 27.8 kHz have the potential of saturating on the modulation drive feedthrough. Use the HP 11668A High Pass Filter installed between the source and the amplifier to attenuate the 27.8 kHz modulation signal. This device reduces the modulation drive feedthrough from about 8 mV to about 1 mV and helps prevent possible amplifier saturation.

Other types of amplifiers may not tolerate even the attenuated modulation drive feedthrough. These include amplifiers using high-gain internal leveling circuits, types of high power TWT amplifiers operating in saturation, and amplifiers that are subject to self-biasing effects (such as FET amplifiers). For these devices the test signal must be modulated after the device and prior to detection. A setup for transmission-only measurements using external modulation is shown in Figure 17. An HP 11665B Modulator is installed prior to each detector.

When using external modulators, after 8756 **PRESET** the 27.8 kHz modulation signal at the 8756 rear panel **MODULATOR DRIVES** connectors is On; press the 8350B square wave **MOD** key to turn internal 8350B modulation Off.

Gain Compression.

Measurement of gain compression is useful for characterizing the power handling capability of an amplifier. The 1 dB compression point of an amplifier is an indicator of the maximum output power possible before the gain linearity and associated distortion becomes excessive. Gain compression measurements can be made in CW or swept modes; the following example uses the CW mode.

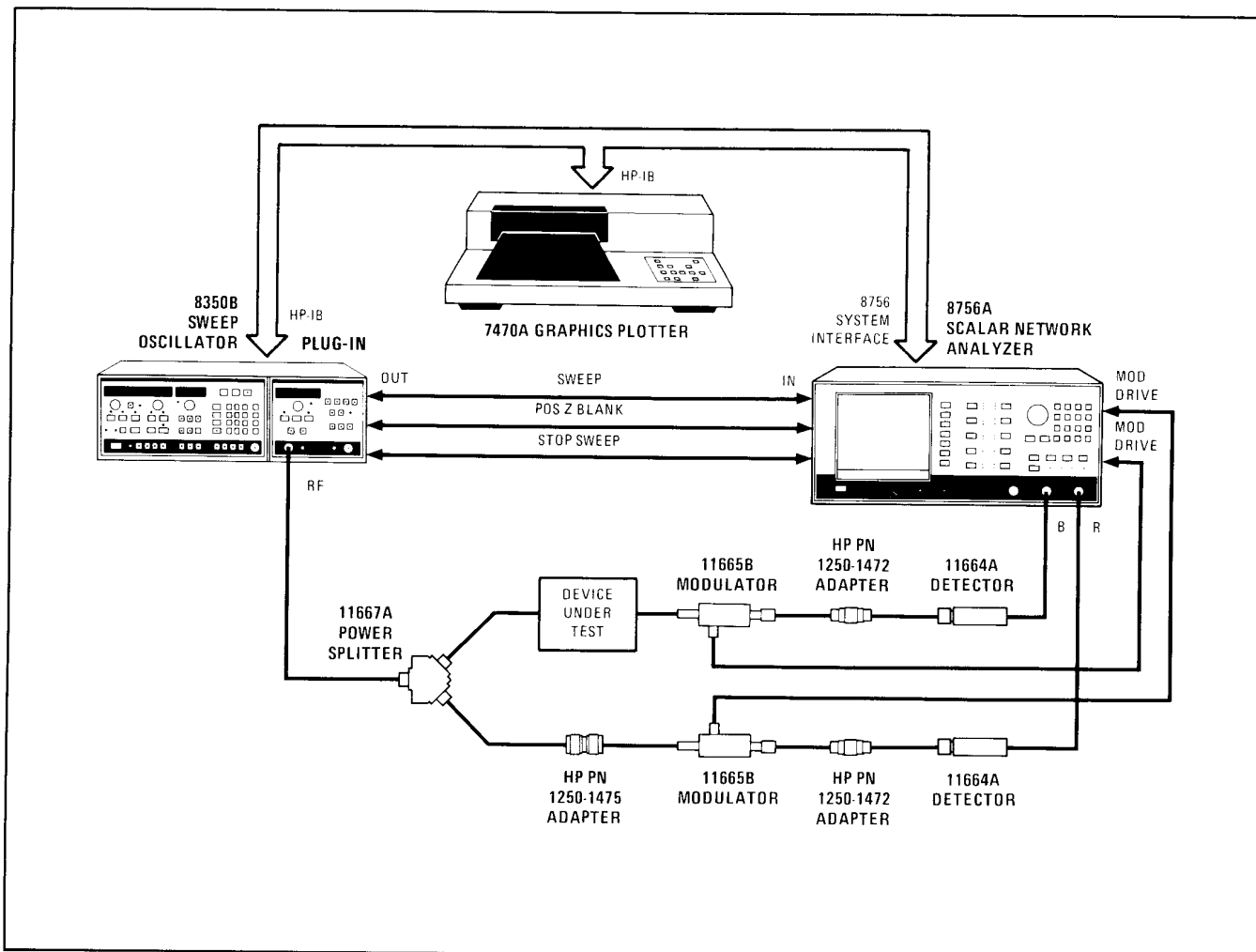

Figure 17. Transmission-Only Measurement Setup Using External Modulators

Connect Ratio Setup shown in Figure 14 or 17.

Channel 1:

MEAS RATIO B/R, DISPLAY MEAS.

Channel 2:

MEAS POWER B, DISPLAY MEAS.

Connect B Detector to measure Power to Amplifier.

8350B:

SHIFT CW, set desired frequency.

POWER LEVEL to starting power level.

POWER SWEEP to desired dB/SWP.

Observe Channel 2 response using **POWER LEVEL** and **POWER SWEEP** to set start and stop Power Sweep Levels.

Channel 1:

DISPLAY→**MEM**, **DISPLAY M**→**MEM**.

Channel 2:

MEAS POWER R, DISPLAY MEAS.

Connect Test port to Amplifier Input.

Connect Detector port to Amplifier Output.

tion, the amplifier response will increase, then begin to decrease with increasing power input. Use **CURSOR MAX** and **CURSOR Δ** to find 1 dB compression point.

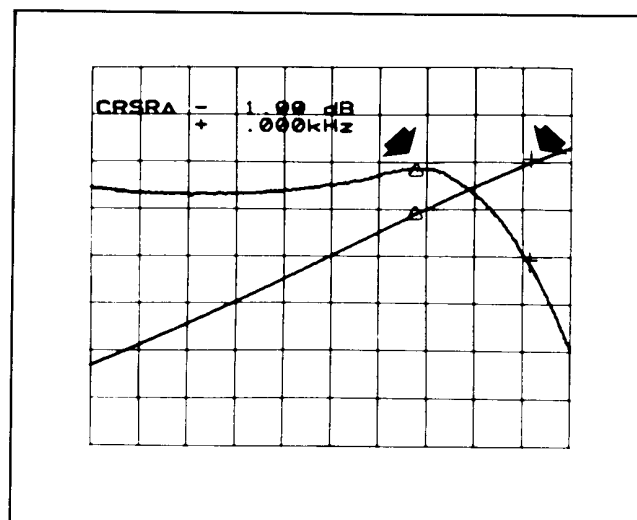

Figure 18. Measuring Gain Compression, CW Mode

Channel 1 displays amplifier response, and Channel 2 displays Power Sweep (see Figure 18). If the signal level to the amplifier is sufficient to cause compression,

REFLECTION MEASUREMENTS

The 8756A can measure reflection using Channel 1 or Channel 2 using either a single detector (**MEAS PWR**) or two detectors (**MEAS RATIO**).

Reflection Test Setup.

For typical reflection measurements connect the device under test to the directional bridge Test port. If adapters are required, use the same adapter for calibration and measurement.

Especially for reflection measurements it is very important to use a high quality Test port adapter. Since the adapter quality directly affects the system source match and directivity characteristics, the best accuracy solution is to select a directional bridge with the correct Test port connector. If you test many different devices with several different connector types, choose the HP 85021A Directional Bridge with an APC-7 connector, then use the best available adapters.

When testing reflection of low loss two-port devices, best accuracy is achieved by terminating the output port with a very good 50-ohm termination rather than the detector. Using a very good termination reduces the effect of output mismatch on the reflection measurement.

To measure reflection characteristics using the setup with external modulation shown in Figure 17, add a directional coupler, modulator, and detector to sample the reflected signal.

In order to take full advantage of the reflection measurement dynamic range afforded by the 40 dB directivity of the HP 85021A, the RF input level to the directional bridge must be at least +7 dBm.

Return Loss Measurements.

This sequence lists the steps for a typical Return Loss Measurement. The procedure shows the Short/Open Average reflection calibration technique available using the Cal menu.

Calibration (Short/Open Average):
CAL,
SHORT/OPEN.
Select Measurement (**MEAS PWR A**
or **MEAS RATIO A/R**).
CHAN 1.
Connect Short Circuit.
STORE SHORT.
Connect Shielded Open Circuit.
STORE OPEN.
DISPLAY M—MEM.
Measurement:
Connect test device.
CURSOR.
Position Cursor,
Read magnitude and frequency.

Calibration sets a zero dB reference with the short circuit or the Short/Open Average. After connecting the test device, a negative measured value indicates that the reflected power is less than the incident power.

Short/Open Average Reflection Calibration.

The Short/Open Average Reflection Calibration can improve accuracy of any reflection measurement if proper standards are used. You can test the standards by performing the Short/Open calibration then remeasuring the standards and evaluating the results. Figure 19 shows plots of two different sets of short/shielded open circuit pairs after performing the short/open average calibration. Note that in A. the traces are symmetrical about the flat reference line; in B. the center of the normalized traces is not flat. If the responses are not symmetrical (approximately equal excursions from a flat reference line), then the short and shielded open circuit standards do not exhibit opposite phase response across the frequency range.

Source match (test setup impedance looking back into the Test port) can be approximated by measuring the peak-to-peak amplitude of the short/open ripple pattern. Use the equation

$$\text{Test Port SWR} = 10^x$$

where $x = (\text{dB p-p}/20)$. For example, if the p-p difference between the short and open circuit response is 1.6 dB, then

$$\text{SWR} = 10^{(1.6/20)} = 1.2$$

To find equivalent Test port Return Loss in dB, use

$$\text{Return Loss (dB)} = -20 \log((\text{SWR}-1)/(\text{SWR}+1))$$

For example, for an observed 1.6 dB peak-to-peak difference between the short and open responses, the Test port match is about 1.2 SWR, or about 20 dB Return Loss.

CONTROLS, INDICATORS, and DISPLAYS SUMMARY

CHANNEL Keys.

Controls to select measurement and display modes. Each independent channel has identical keys. For multi-function keys, press the key repeatedly to light the desired indicator adjacent to the key. The selection, along with its current value appears in the CRT Active Entry Area.

MEAS RATIO and **MEAS PWR** select measurement mode. **MEAS RATIO** selects measurement of the logarithmic power ratios A/R, B/R, or A/B. (Numerator dBm - Denominator dBm = dB Power Ratio.) **MEAS PWR** measures the absolute power at the A, B, or R input. The value of the displayed trace depends upon the **DISPLAY** selection.

DISPLAY selects the display mode. **DISPLAY MEAS** displays the actual measured value; **DISPLAY MEM** displays the stored reference trace; **DISPLAY M—MEM** displays the normalized trace (current trace - stored trace). The stored trace is automatically scaled to the currently selected scale factor.

SCALE selects CRT dB per division scale factor of 20, 10, 5, 2, 1, 0.5, 0.2, or 0.1 dB vertical resolution per division. Use the **STEP** keys, or numeric entry followed by **dB** to change scale factor.

REF controls Reference Position Line location and value. The current position is identified by the labels REF 1 and REF 2 on the CRT, and its value is shown in the Mode Labels area above the grid. Select **REF LEVEL** then use the knob, **STEP** keys, or numeric entry followed by **dB** to change its value. Select **REF POSN** then use the knob or **STEP** keys to move the Reference Position Line to the desired major graticule location. The Cursor value is not changed by changes to reference line value or position.

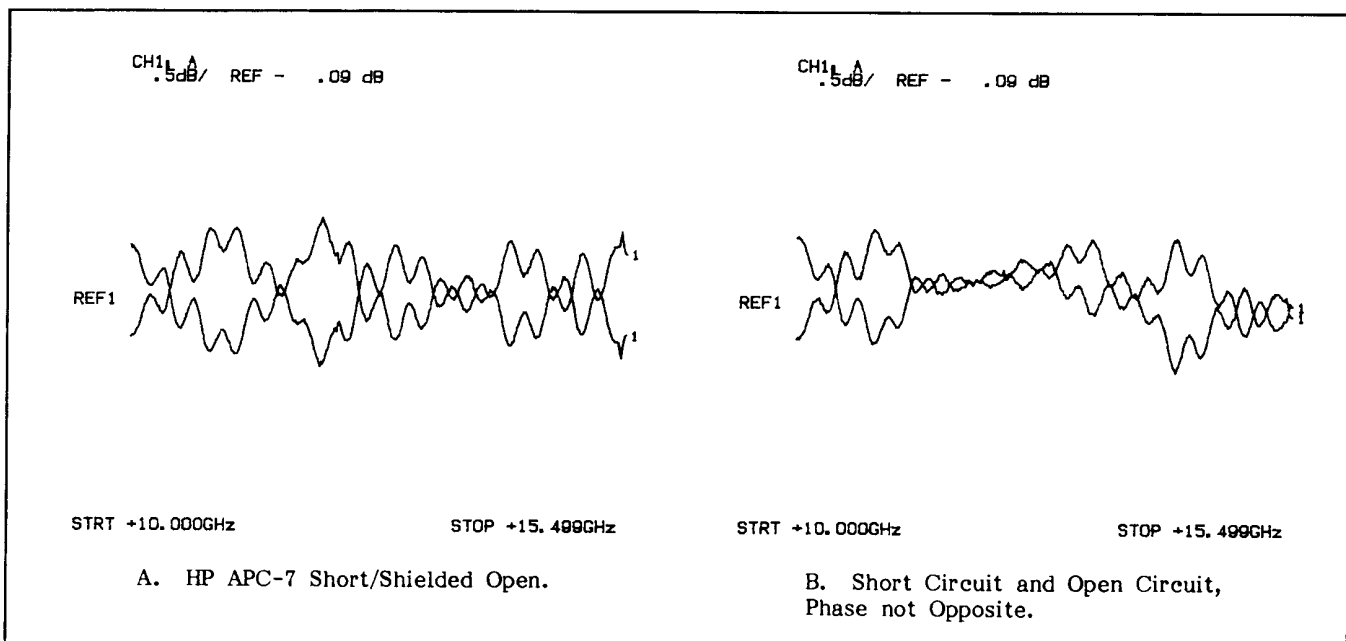

Figure 19. Plots of Short and Shielded Open Responses After Short/Open Average Calibration

SHIFT Functions.

The blue **SHIFT** key in the INSTRUMENT STATE Area provides additional functions labeled in blue above some of the front panel keys.

CHAN OFF (SHIFT MEAS RATIO) turns the selected measurement channel Off. Both channels cannot be Off. Pressing any CHANNEL key, or a soft-key which includes a channel number in its description, turns the channel back On.

DISPLAY→MEM (SHIFT DISPLAY) stores the current trace as the reference trace for Normalization. The trace is stored at the highest resolution regardless of the currently selected scale factor. Selecting **DISPLAY MEM** displays the stored trace; **DISPLAY M—MEM** displays the difference between the current trace and the stored trace.

AUTO (SHIFT SCALE) executes the **AUTO**scale function in which the scale factor and reference line value are changed to center the complete trace on the CRT at the minimum possible scale factor. The Cursor value is not changed.

MKR→REF (SHIFT REF) changes the reference line value so that the trace position is moved so that the Cursor (or active 8350B marker, if 8756 Cursor Off) is on the reference line. The Cursor value is not changed.

REF (SHIFT STEP down) allows changing the **REF LEVEL** step from the Preset value of one division per step. Type a numeric, such as 0.5, press **dB/dBm**, then select

REF LEVEL. The Ref Step is equal to the current scale per division setting unless changed. If you change the value, it remains as long as power is applied to the instrument.

ADDRESS (SHIFT LOCAL) allows changing the 8756A HP-IB address from the standard address of 16. Type a two digit numeric then **ENT.**

ENTRY Area.

Provides the numeric and units keypad, the **STEP** keys, and the knob to allow operator entry of data to control the measurement and display.

ENT OFF clears the Active Entry Area.

ENT serves as a terminator for unitless numeric entries.

dBm/dB serves as terminator for **SCALE**, **REF LEVEL**, Detector Offset, and Ref Step entries.

BK SP allows backspace to delete last digit(s) entered.

INSTRUMENT STATE Area.

This area controls and provides information on the instrument state.

SHIFT enables the shifted (blue) functions of the front panel keys.

SAVE, when followed by a numeric 1 through 9, saves the current front panel control settings of the 8756A and 8350B. An acknowledgement of these keystrokes is shown in the Active Entry Area.

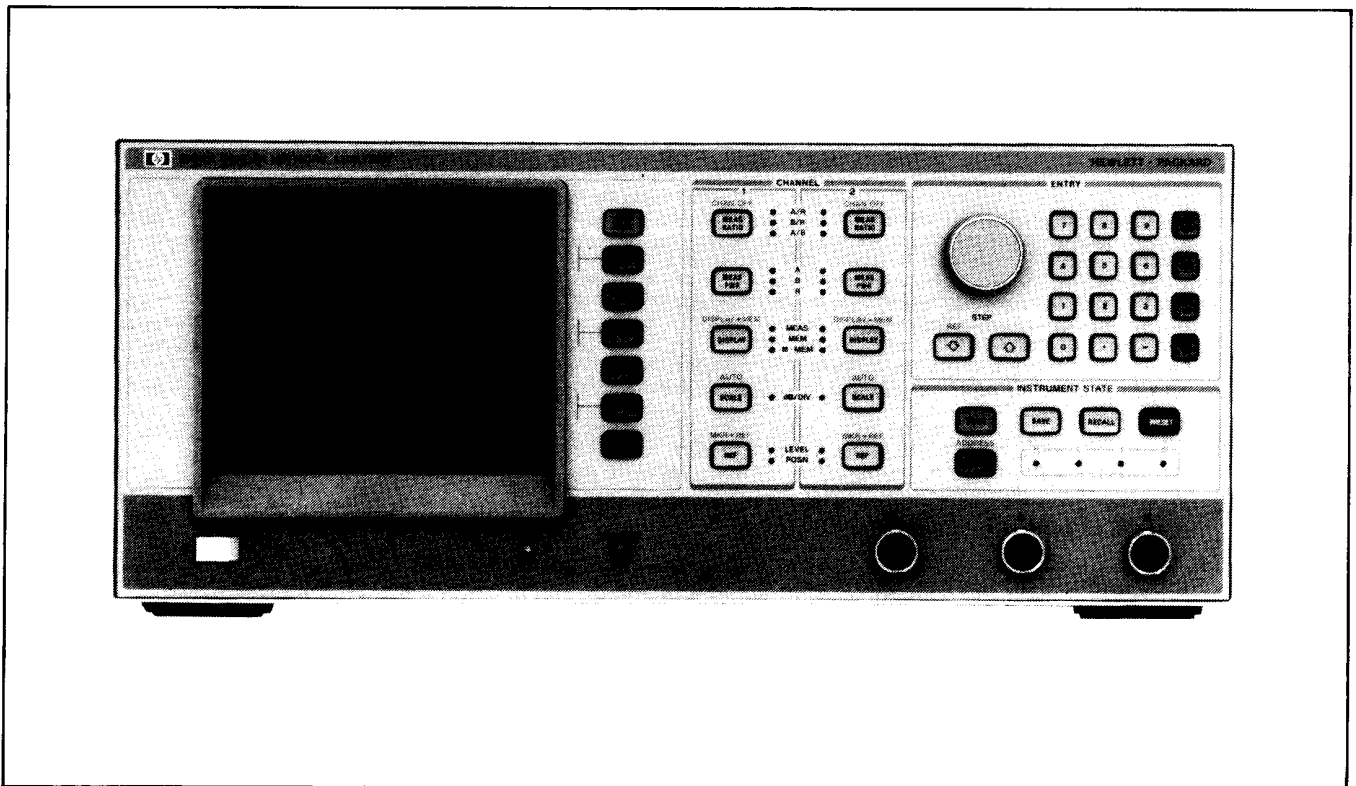

Figure 20. 8756A Front Panel

RECALL, when followed by a numeric 1 through 9, recovers the string stored by **SAVE** and sets the 8756A and 8350B to that state. An acknowledgement of these keystrokes is shown in the Active Entry Area.

PRESET sets the 8756A, and 8350B (if 8756A System Interface connected) to a known state. The following actions take place:

1. 8756A Self-Test, indicated by the lighting of all LED's on the front panel and clearing of the CRT display. Refer to Section 8 of the 8756A Operating and Service Manual if an error indication is displayed.
2. The 8756A, source, and plotter are set to the Preset State listed in Figure 4 of this note.

LOCAL returns the 8756A to local operation from the remote operation state.

R,L,T, and **S** indicators display HP-IB (not 8756A System Interface status). Refer to 8756A HP-IB Programming Note for detailed information.

INPUT/OUTPUT SUMMARY

A, B, and **R** Detector Inputs each have identical characteristics for connection of 8756A compatible detectors and/or bridges. **A** is typically used for the connection of a directional bridge for reflection measurements. **B** is typically used for the connection of a detector for transmission measurements. **R** is usually used for the reference detector input when making ratio measurements.

8756 SYSTEM INTERFACE input/output connector allows control of the 8350B Sweep Oscillator and the HP 7470A Plotter using internal 8756A firmware and standard HP-IB connectors and protocol.

HP INTERFACE BUS input/output connector allows interfacing with other HP-IB instruments or a controller.

SWEEP IN 0-10V input connector accepts 0V to 10V sweep signal from sweep oscillator.

POS Z BLANK input connector accepts positive 5V retrace and bandswitch blanking and accepts negative Intensity Marker (Z-axis Modulation) signals.

STOP SWEEP output connector provides the interface signal to stop the sweep of the 8350B or 8340A when controlled over the 8756 System Interface.

MODULATOR DRIVES output connectors, each providing 27.8 kHz square wave signals, nominally +/-6V, for driving external HP 11665B Modulators or the external Amplitude or Pulse modulation input of a sweep oscillator.

DISPLAY OUTPUTS output connectors provide 1V p-p X, Y, and Z axis drive into 600 ohm, >2 MHz bandwidth external display. Cable lengths should not exceed 1.8 meters (6 feet).

POWER LINE MODULE input connector accepts primary line voltage to power the instrument. Refer to Section II, Installation, of the 8756A Operating and Service Manual for instructions.

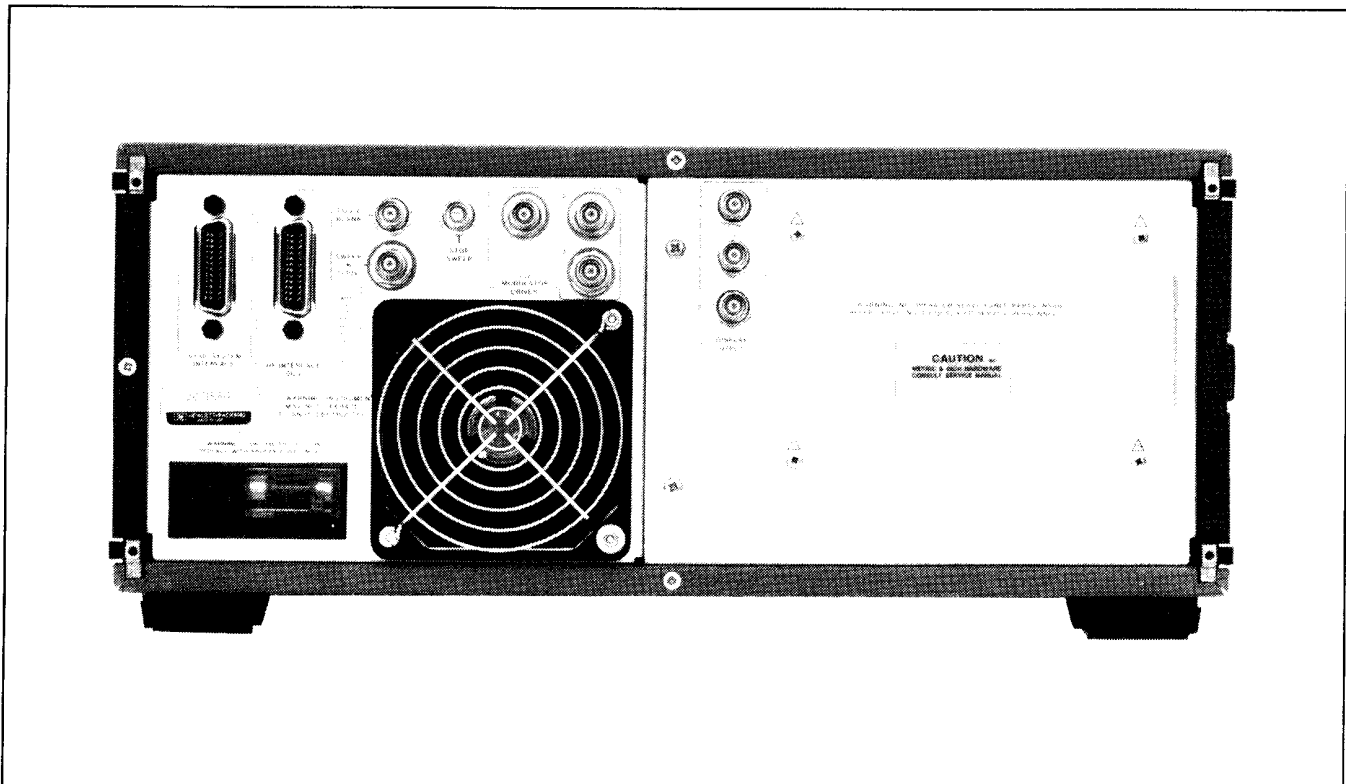

Figure 21. 8756A Rear Panel Connections

MENU STRUCTURE

Figure 22 shows the complete 8756A Menu Structure. The menus are defined by the internal firmware of the 8756A.

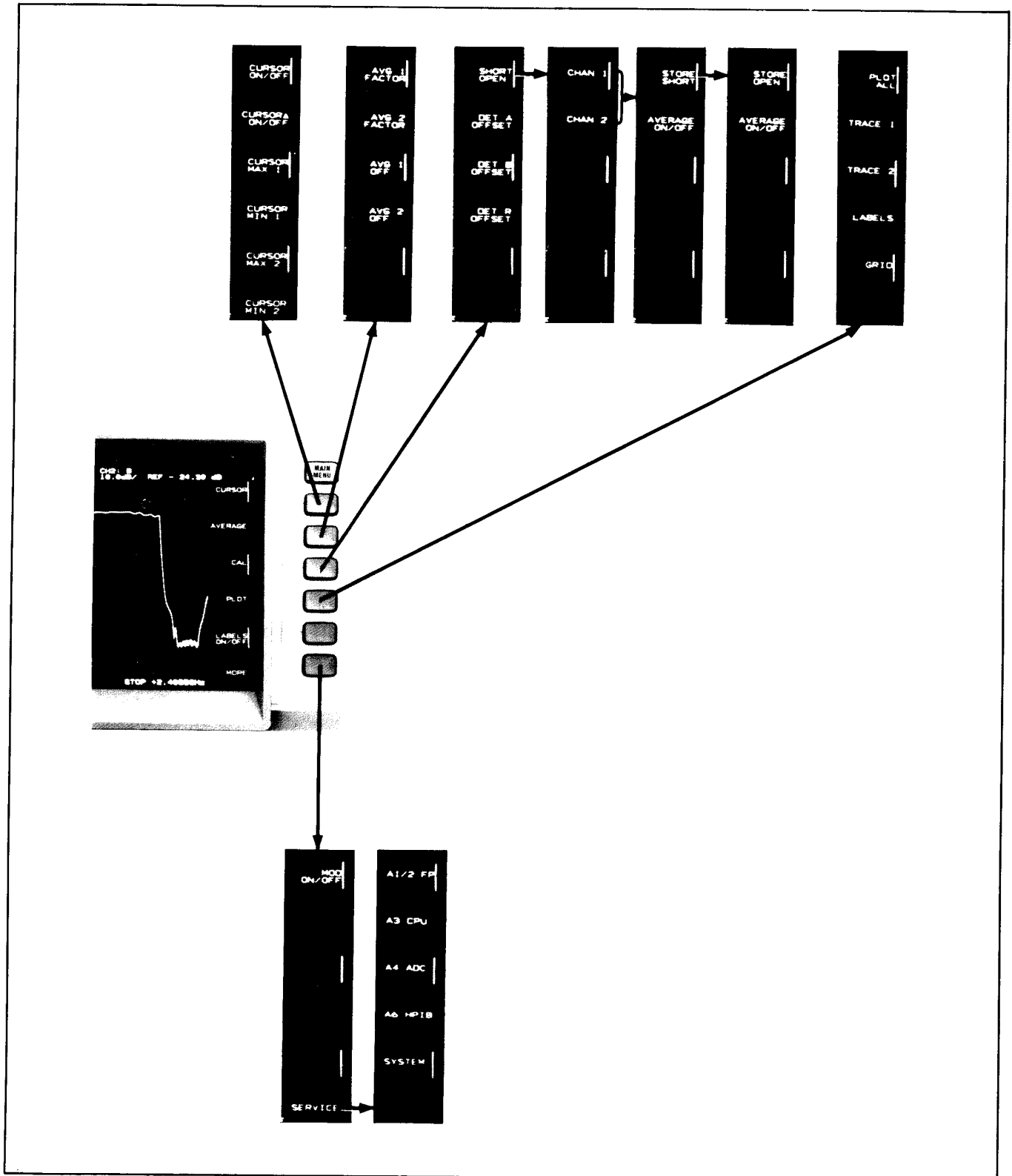

Figure 22. 8756A Menu Structure

APPENDIX A

USING SOURCES WITHOUT 8756A SYSTEM INTERFACE

To use sources not equipped to connect to the 8756 SYSTEM INTERFACE, connect the source 0 to 10 V Sweep Output to the 8756A SWEEP IN 0-10V, and the source positive z-axis blanking to the 8756A POS Z

BLANK. Figures A1 and A2 show operation using an 8620C Sweep Oscillator and an 8350A Sweep Oscillator, respectively, with the 8756A. The 8350A may be updated by internal changes to obtain the full capability offered by the 8756 System Interface.

Capabilities added using the 8756 System Interface include CRT display annotation of start/stop and marker frequencies, alternate sweep, and save/recall.

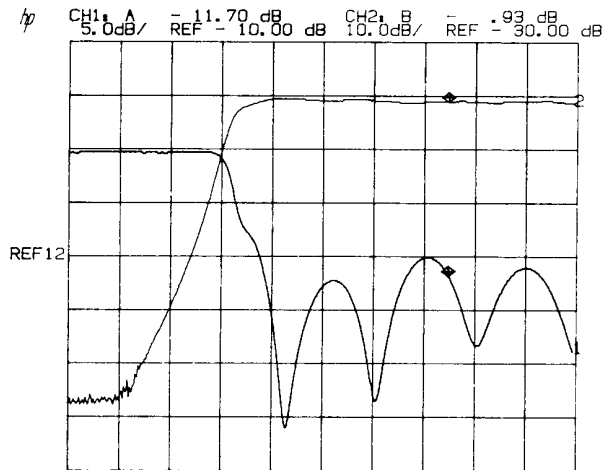

Figure A1. Using an 8620-series Sweep Oscillator.

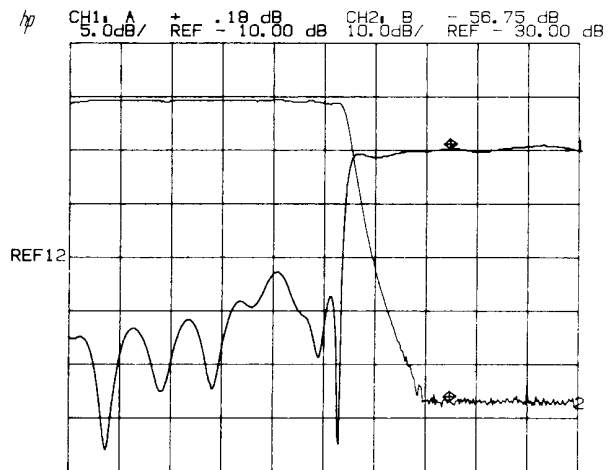

Figure A2. Using an 8350A Sweep Oscillator.



For more information, call your local HP Sales Office or nearest Regional Office: **Eastern** (201) 265-5000; **Midwestern** (312) 255-9800; **Southern** (404) 955-1500; **Western** (213) 970-7500; **Canadian** (416) 678-9430. Ask the operator for instrument sales. Or write Hewlett-Packard, 1501 Page Mill Road, Palo Alto, CA 94304. In Europe: Hewlett-Packard S.A., 7, rue du Bois-du-Lan, P.O. Box, CH 1217 Meyrin 2, Geneva, Switzerland. In Japan: Yokogawa-Hewlett-Packard Ltd., 29-21, Takaide-Higashi 3-chome, Suginami-ku, Tokyo 168.